

TEST REPORT

CERTIFICATE OF CONFORMITY

Standard: 47 CFR FCC Part 15, Subpart C (Section 15.247)

Report No.: RFBBUI-WTW-P22100654

FCC ID: TX2-RTL8851B

Product: 11ax RTL8851BE one antenna Combo module

Brand: REALTEK

Model No.: RTL8851B

Received Date: 2022/10/25

Test Date: 2022/12/13 ~ 2023/3/30

Issued Date: 2023/5/16

Applicant: Realtek Semiconductor Corp.

Address: No. 2, Innovation Road II, Hsinchu Science Park, Hsinchu 300, Taiwan

Issued By: Bureau Veritas Consumer Products Services (H.K.) Ltd., Taoyuan Branch
Hsin Chu Laboratory

Lab Address: E-2, No.1, Li Hsin 1st Road, Hsinchu Science Park, Hsinchu City 300, Taiwan

Test Location: E-2, No.1, Li Hsin 1st Road, Hsinchu Science Park, Hsinchu City 300, Taiwan

FCC Registration / 723255 / TW2022

Designation Number:

Approved by: _____

May Chen / Manager

, Date: _____

2023/5/16

This test report consists of 315 pages in total. It may be duplicated completely for legal use with the approval of the applicant. It should not be reproduced except in full, without the written approval of our laboratory. The test results in the report only apply to the tested sample. The test results in this report are traceable to the national or international standards.

Prepared by : Luna Yu / Specialist



This report is governed by, and incorporates by reference, the Conditions of Testing as posted at the date of issuance of this report at <http://www.bureauveritas.com/home/about-us/our-business/cps/about-us/terms-conditions/> and is intended for your exclusive use. Any copying or replication of this report to or for any other person or entity, or use of our name or trademark, is permitted only with our prior written permission. This report sets forth our findings solely with respect to the test samples identified herein. The results set forth in this report are not indicative or representative of the quality or characteristics of the lot from which a test sample was taken or any similar or identical product unless specifically and expressly noted. Our report includes all of the tests requested by you and the results thereof based upon the information that you provided to us. Measurement uncertainty is only provided upon request for accredited tests. Statements of conformity are based on simple acceptance criteria without taking measurement uncertainty into account, unless otherwise requested in writing. You have 60 days from date of issuance of this report to notify us of any material error or omission caused by our negligence or if you require measurement uncertainty; provided, however, that such notice shall be in writing and shall specifically address the issue you wish to raise. A failure to raise such issue within the prescribed time shall constitute your unqualified acceptance of the completeness of this report, the tests conducted and the correctness of the report contents.

Table of Contents

Release Control Record	4
1 Certificate	5
2 Summary of Test Results	6
2.1 Measurement Uncertainty	6
2.2 Supplementary Information	6
3 General Information	7
3.1 General Description	7
3.2 Antenna Description of EUT	8
3.3 Channel List	9
3.4 Test Mode Applicability and Tested Channel Detail	10
3.5 Duty Cycle of Test Signal	12
3.6 Test Program Used and Operation Descriptions	15
3.7 Connection Diagram of EUT and Peripheral Devices	15
3.8 Configuration of Peripheral Devices and Cable Connections	16
4 Test Instruments	17
4.1 RF Output Power	17
4.2 Power Spectral Density	17
4.3 6 dB Bandwidth	17
4.4 Conducted Out of Band Emissions	17
4.5 AC Power Conducted Emissions	18
4.6 Unwanted Emissions below 1 GHz	18
4.7 Unwanted Emissions above 1 GHz	19
5 Limits of Test Items	20
5.1 RF Output Power	20
5.2 Power Spectral Density	20
5.3 6 dB Bandwidth	20
5.4 Conducted Out of Band Emissions	20
5.5 AC Power Conducted Emissions	20
5.6 Unwanted Emissions below 1 GHz	20
5.7 Unwanted Emissions above 1 GHz	21
6 Test Arrangements	22
6.1 RF Output Power	22
6.1.1 Test Setup	22
6.1.2 Test Procedure	22
6.2 Power Spectral Density	22
6.2.1 Test Setup	22
6.2.2 Test Procedure	22
6.3 6 dB Bandwidth	23
6.3.1 Test Setup	23
6.3.2 Test Procedure	23
6.4 Conducted Out of Band Emissions	23
6.4.1 Test Setup	23
6.4.2 Test Procedure	23
6.5 AC Power Conducted Emissions	24
6.5.1 Test Setup	24
6.5.2 Test Procedure	24
6.6 Unwanted Emissions below 1 GHz	25
6.6.1 Test Setup	25
6.6.2 Test Procedure	26
6.7 Unwanted Emissions above 1 GHz	27
6.7.1 Test Setup	27
6.7.2 Test Procedure	27
7 Test Results of Test Item	28



7.1	RF Output Power	28
7.2	Power Spectral Density	33
7.3	6 dB Bandwidth	37
7.4	Conducted Out of Band Emissions	40
7.5	AC Power Conducted Emissions	54
7.6	Unwanted Emissions below 1 GHz	56
7.7	Unwanted Emissions above 1 GHz	62
8	Pictures of Test Arrangements	314
9	Information of the Testing Laboratories	315



Release Control Record

Issue No.	Description	Date Issued
RFBBUI-WTW-P22100654	Original release.	2023/5/16

1 Certificate

Product: 11ax RTL8851BE one antenna Combo module

Brand: REALTEK

Test Model: RTL8851B

Sample Status: Engineering sample

Applicant: Realtek Semiconductor Corp.

Test Date: 2022/12/13 ~ 2023/3/30

Standard: 47 CFR FCC Part 15, Subpart C (Section 15.247)

Measurement ANSI C63.10-2013

procedure: KDB 558074 D01 15.247 Meas Guidance v05r02

The above equipment has been tested by **Bureau Veritas Consumer Products Services (H.K.) Ltd., Taoyuan Branch**, and found compliance with the requirement of the above standards. The test record, data evaluation & Equipment Under Test (EUT) configurations represented herein are true and accurate accounts of the measurements of the sample's RF characteristics under the conditions specified in this report.

2 Summary of Test Results

47 CFR FCC Part 15, Subpart C (Section 15.247)			
Standard / Clause	Test Item	Result	Remark
15.247(b)	RF Output Power	Pass	Meet the requirement of limit.
15.247(e)	Power Spectral Density	Pass	Meet the requirement of limit.
15.247(a)(2)	6 dB Bandwidth	Pass	Meet the requirement of limit.
15.247(d)	Conducted Out of Band Emissions	Pass	Meet the requirement of limit.
15.207	AC Power Conducted Emissions	Pass	Minimum passing margin is -9.06 dB at 28.25391 MHz
15.205 / 15.209 / 15.247(d)	Unwanted Emissions below 1 GHz	Pass	Minimum passing margin is -7.6 dB at 44.10 MHz
15.205 / 15.209 / 15.247(d)	Unwanted Emissions above 1 GHz	Pass	Minimum passing margin is -0.2 dB at 2390.00 MHz
15.203	Antenna Requirement	Pass	Antenna connector is IPEX4 not a standard connector.

Note: Determining compliance based on the results of the compliance measurement, not taking into account measurement instrumentation uncertainty.

2.1 Measurement Uncertainty

Where relevant, the following measurement uncertainty levels have been estimated for tests performed on the EUT as specified in CISPR 16-4-2:

Parameter	Specification	Expanded Uncertainty (k=2) (±)
Conducted Out of Band Emissions	9 kHz ~ 40 GHz	2.5 dB
AC Power Conducted Emissions	150 kHz ~ 30 MHz	1.9 dB
Unwanted Emissions below 1 GHz	9 kHz ~ 30 MHz	3.1 dB
	30 MHz ~ 1 GHz	5.1 dB
Unwanted Emissions above 1 GHz	1 GHz ~ 18 GHz	5.1 dB
	18 GHz ~ 40 GHz	5.3 dB

The other instruments specified are routine verified to remain within the calibrated levels, no measurement uncertainty is required to be calculated.

2.2 Supplementary Information

There is not any deviation from the test standards for the test method, and no modifications required for compliance.

3 General Information

3.1 General Description

Product	11ax RTL8851BE one antenna Combo module
Brand	REALTEK
Test Model	RTL8851B
Status of EUT	Engineering sample
Power Supply Rating	3.3Vdc from host equipment
Modulation Type	CCK, DQPSK, DBPSK for DSSS 64QAM, 16QAM, QPSK, BPSK for OFDM 256QAM for OFDM in VHT mode 1024QAM for OFDMA in 11ax mode
Modulation Technology	DSSS, OFDM, OFDMA
Transfer Rate	802.11b: up to 11 Mbps 802.11g: up to 54 Mbps 802.11n: up to 150 Mbps VHT: up to 200 Mbps 802.11ax: up to 286.8 Mbps
Operating Frequency	2.412 GHz ~ 2.472 GHz
Number of Channel	802.11b, 802.11g, 802.11n (HT20), VHT20, 802.11ax (HE20): 13 802.11n (HT40), VHT40, 802.11ax (HE40): 9
Output Power	620.869 mW (27.93 dBm)

Note:

1. There are Bluetooth and WLAN (2.4 GHz & 5 GHz) technology used for the EUT.
2. Simultaneously transmission condition.

Condition	Technology	
1	WLAN (5 GHz)	Bluetooth

Note: The emission of the simultaneous operation has been evaluated and no non-compliance was found.

3. The EUT support OFDMA and Partial RU mode, therefore partial RU combination were investigated and the worst case scenario was identified.
4. The above EUT information is declared by manufacturer and for more detailed features description, please refer to the manufacturer's specifications or user's manual.

3.2 Antenna Description of EUT

1. The antenna information is listed as below.

Antenna NO.	RF Chain NO.	Brand	Model	Antenna Net Gain (dBi)	Frequency range	Antenna Type	Connector Type	Cable Length (mm)
1	Chain 1	REALTEK	RTK-ANT-0022	3.4	2.4~2.4835GHz	PIFA	IPEX4	300
				5	5.15~5.895GHz			
2	Chain 1	Aristotle	RFA-27-C38H1-MHF4300	3	2.4~2.4835GHz	Dipole	IPEX4	300
				5	5.15~5.895GHz			
3	Chain 1	LYNwave	ALX22F-120AA0-00	3.2	2.4~2.4835GHz	Monopole	IPEX4	200
				4	5.15~5.895GHz			

Note:

1. Max. gain was selected for the final test, except for Unwanted Emissions.

* Detail antenna specification please refer to antenna datasheet and/or antenna measurement report.

2. The EUT incorporates a SISO function:

2.4 GHz Band		
Modulation Mode	TX & RX Configuration	
802.11b	1TX	1RX
802.11g	1TX	1RX
802.11n (HT20)	1TX	1RX
802.11n (HT40)	1TX	1RX
VHT20	1TX	1RX
VHT40	1TX	1RX
802.11ax (HE20)	1TX	1RX
802.11ax (HE40)	1TX	1RX
802.11ax (RU26/52/106/242/484)	1TX	1RX

Note:

1. The modulation and bandwidth are similar for 802.11n mode for 20 MHz (40 MHz) and VHT mode for 20 MHz (40 MHz), therefore the manufacturer will control the power for 802.11n/VHT mode is the same as the 802.11ax or more lower than it and investigated worst case to representative mode in test report.

3.3 Channel List

13 channels are provided for 802.11b, 802.11g, 802.11n (HT20), VHT20, 802.11ax (HE20):

Channel	Frequency	Channel	Frequency
1	2412 MHz	8	2447 MHz
2	2417 MHz	9	2452 MHz
3	2422 MHz	10	2457 MHz
4	2427 MHz	11	2462 MHz
5	2432 MHz	12	2467 MHz
6	2437 MHz	13	2472 MHz
7	2442 MHz		

9 channels are provided for 802.11n (HT40), VHT40, 802.11ax (HE40):

Channel	Frequency	Channel	Frequency
3	2422 MHz	8	2447 MHz
4	2427 MHz	9	2452 MHz
5	2432 MHz	10	2457 MHz
6	2437 MHz	11	2462 MHz
7	2442 MHz		

3.4 Test Mode Applicability and Tested Channel Detail

Pre-Scan:	<p>1. PIFA / Monopole ANT can be used in the following ways: X / Y / Z axis. Pre-scan in these ways and find the worst case as a representative test condition.</p> <p>2. For Partial RU modes of 20MHz and 40MHz bandwidth needs to be pre-worst.</p> <p>3. Pre-Scan has been conducted to determine the worst-case mode from all possible combinations between available modulations, data rates and antenna ports (if EUT with antenna diversity architecture).</p>
Worst Case:	<p>1. PIFA / Monopole ANT the worst case was found when positioned on (X / Y / Z axis): Unwanted Emissions below 1 GHz Y axis worst, and Unwanted Emissions above 1 GHz Y axis worst for PIFA ANT; Unwanted Emissions below 1 GHz X axis worst, and Unwanted Emissions above 1 GHz X axis worst for Monopole ANT.</p> <p>2. The worst case occurs in 20MHz bandwidth (partial RU 26 / 52 / 106).</p> <p>3. Dipole ANT was used typical placement for the test: Y axis.</p>

Following channel(s) was (were) selected for the final test as listed below:

Test Item	EUT Configure Mode	Mode	Tested Channel	Modulation	Data Rate Parameter	RU Configuration
RF Output Power	-	802.11b	1, 6, 11, 12, 13	DBPSK	1Mb/s	-
		802.11g	1, 6, 11, 12, 13	BPSK	6Mb/s	-
		VHT20	1, 6, 11, 12, 13	BPSK	MCS0	-
		VHT40	3, 6, 9, 10, 11	BPSK	MCS0	-
		802.11ax (HE20)	1, 6, 11, 12, 13	BPSK	MCS0	-
		802.11ax (HE40)	3, 6, 9, 10, 11	BPSK	MCS0	-
		802.11ax (HE20) 26-tone RU	1, 6, 11, 12, 13	BPSK	MCS0	26/0, 26/4, 26/8, 26/8, 26/8
		802.11ax (HE20) 52-tone RU	1, 6, 11, 12, 13	BPSK	MCS0	52/37, 52/39, 52/40, 52/40, 52/40
		802.11ax (HE20) 106-tone RU	1, 6, 11, 12, 13	BPSK	MCS0	106/53, 106/54, 106/54, 106/54, 106/54

6 dB Bandwidth / Conducted Out of Band Emissions / Power Spectral Density	-	802.11b	1, 6, 11, 12, 13	DBPSK	1Mb/s	-
		802.11g	1, 6, 11, 12, 13	BPSK	6Mb/s	-
		802.11ax (HE20)	1, 6, 11, 12, 13	BPSK	MCS0	-
		802.11ax (HE40)	3, 6, 9, 10, 11	BPSK	MCS0	-
		802.11ax (HE20) 26-tone RU	1, 6, 11, 12, 13	BPSK	MCS0	26/0, 26/4, 26/8, 26/8, 26/8
		802.11ax (HE20) 52-tone RU	1, 6, 11, 12, 13	BPSK	MCS0	52/37, 52/39, 52/40, 52/40, 52/40
		802.11ax (HE20) 106-tone RU	1, 6, 11, 12, 13	BPSK	MCS0	106/53, 106/54, 106/54, 106/54, 106/54
AC Power Conducted Emissions	B	802.11g	6	BPSK	6Mb/s	-
Unwanted Emissions below 1 GHz	A, B, C	802.11g	6	BPSK	6Mb/s	-
Unwanted Emissions above 1 GHz	A, B, C	802.11b	1, 6, 11, 12, 13	DBPSK	1Mb/s	-
		802.11g	1, 6, 11, 12, 13	BPSK	6Mb/s	-
		802.11ax (HE20)	1, 6, 11, 12, 13	BPSK	MCS0	-
		802.11ax (HE40)	3, 6, 9, 10, 11	BPSK	MCS0	-
		802.11ax (HE20) 26-tone RU	1, 6, 11, 12, 13	BPSK	MCS0	26/0, 26/4, 26/8, 26/8, 26/8
		802.11ax (HE20) 52-tone RU	1, 6, 11, 12, 13	BPSK	MCS0	52/37, 52/39, 52/40, 52/40, 52/40
		802.11ax (HE20) 106-tone RU	1, 6, 11, 12, 13	BPSK	MCS0	106/53, 106/54, 106/54, 106/54, 106/54
EUT Configure Mode:	A	with Dipole Antenna				
	B	with PIFA Antenna				
	C	with Monopole Antenna				

3.5 Duty Cycle of Test Signal

802.11b: Duty cycle = 8.194 ms / 8.199 ms x 100% = 99.9%

802.11g: Duty cycle = 1.361 ms / 1.368 ms x 100% = 99.5%

802.11ax (HE20): Duty cycle = 1.168 ms / 1.175 ms x 100% = 99.4%

802.11ax (HE40): Duty cycle = 8.194 ms / 8.199 ms x 100% = 99.9%

802.11ax (HE) 26-tone RU: Duty cycle = 5.433 ms / 5.438 ms x 100% = 99.9%

802.11ax (HE) 52-tone RU: Duty cycle = 2.757 ms / 2.762 ms x 100% = 99.8%

802.11ax (HE) 106-tone RU: Duty cycle = 1.329 ms / 1.334 ms x 100% = 99.6%

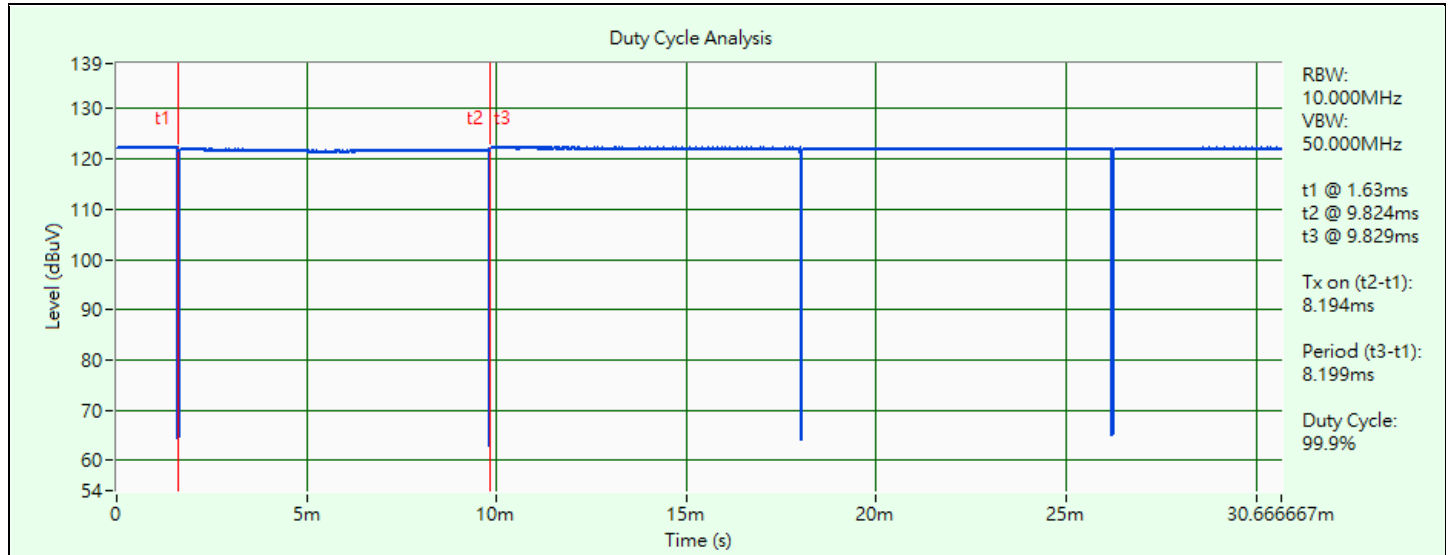

802.11b

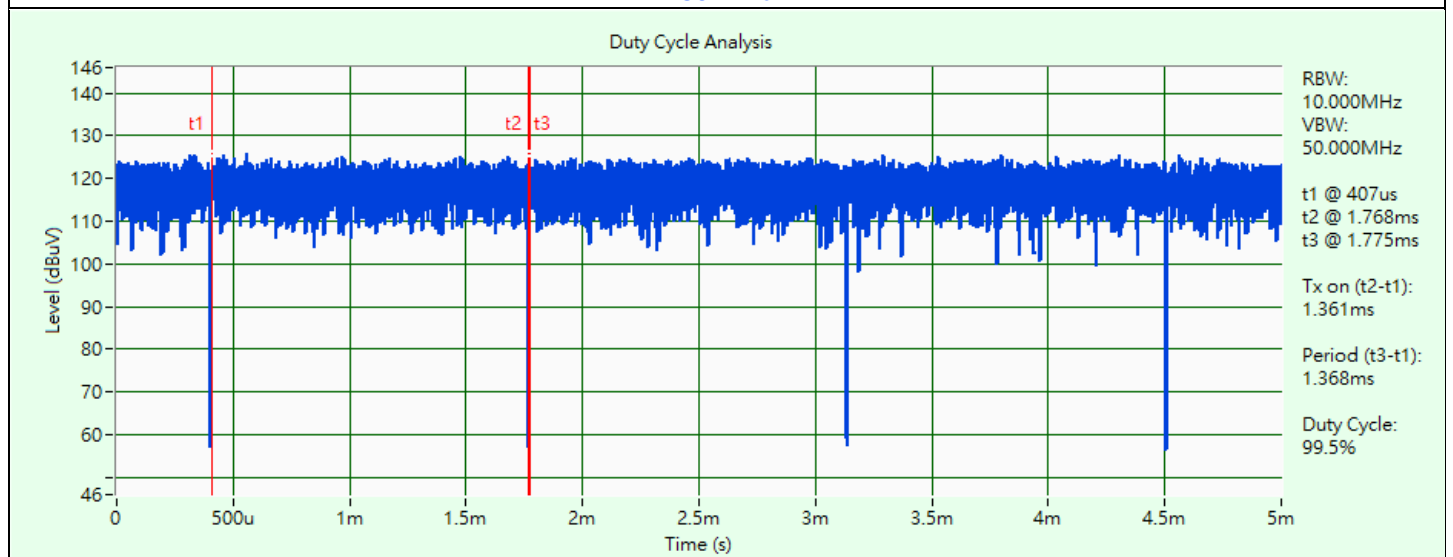

802.11g

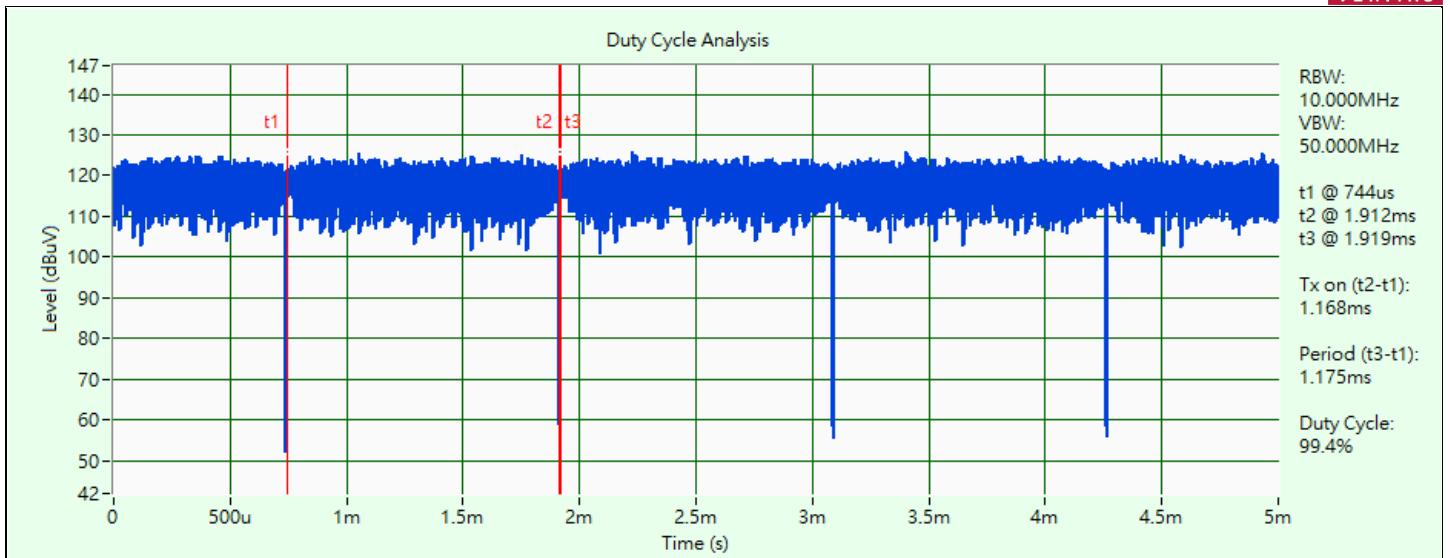

802.11ax (HE20)

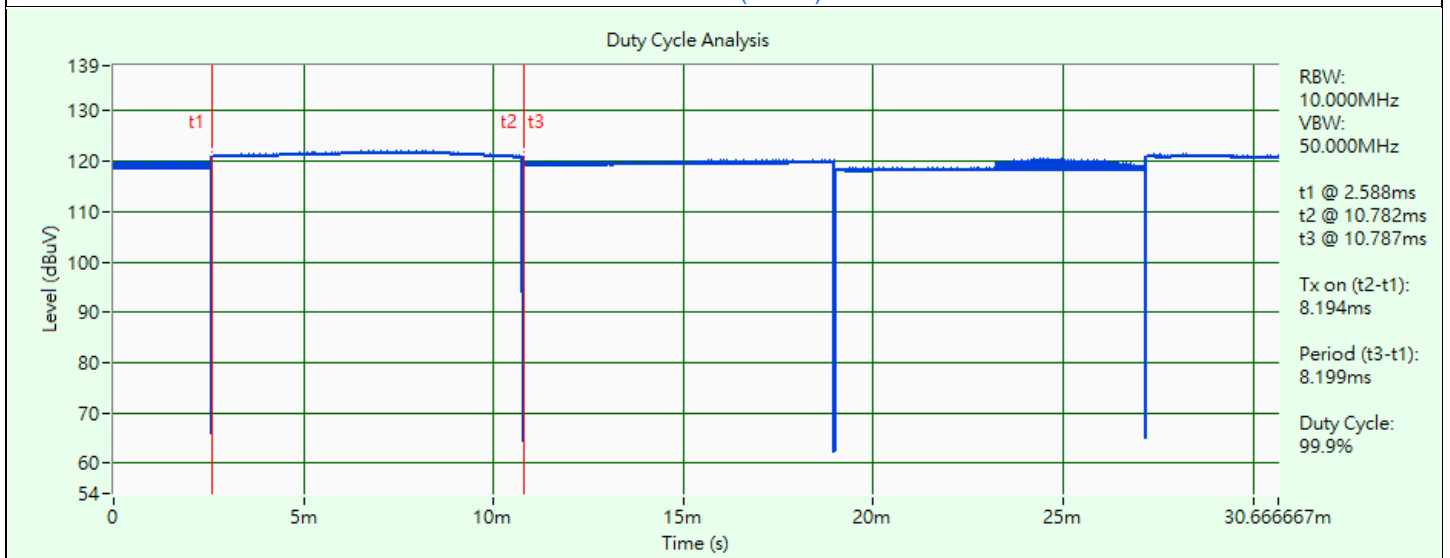

802.11ax (HE40)

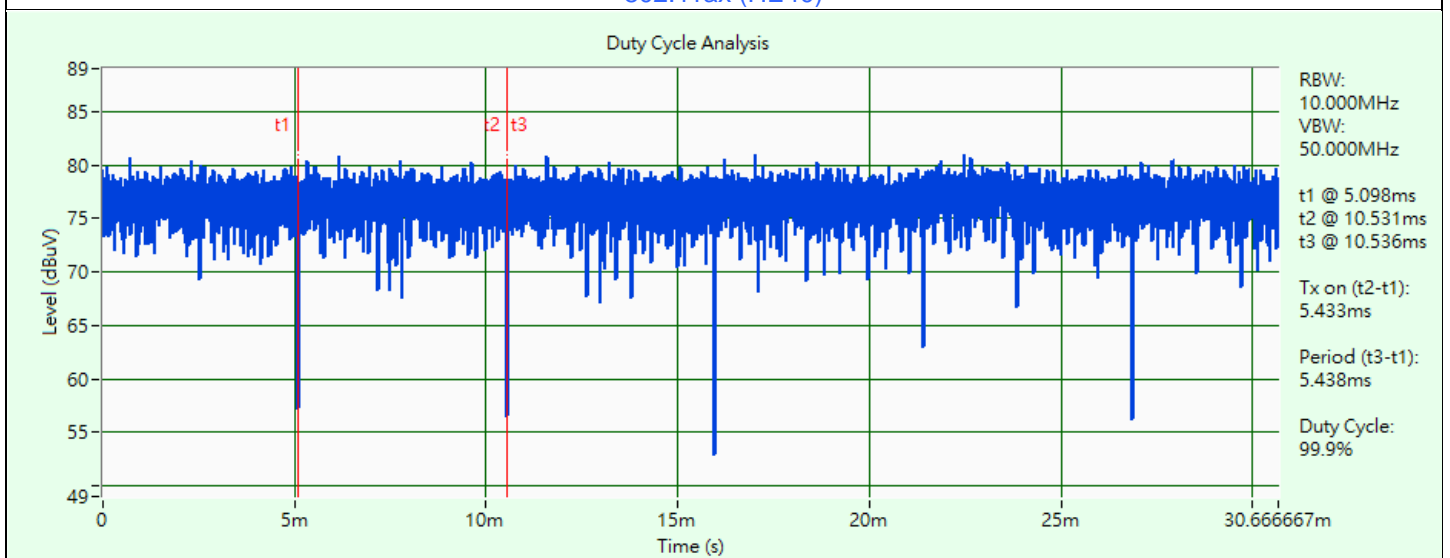

802.11ax (HE) 26-tone RU

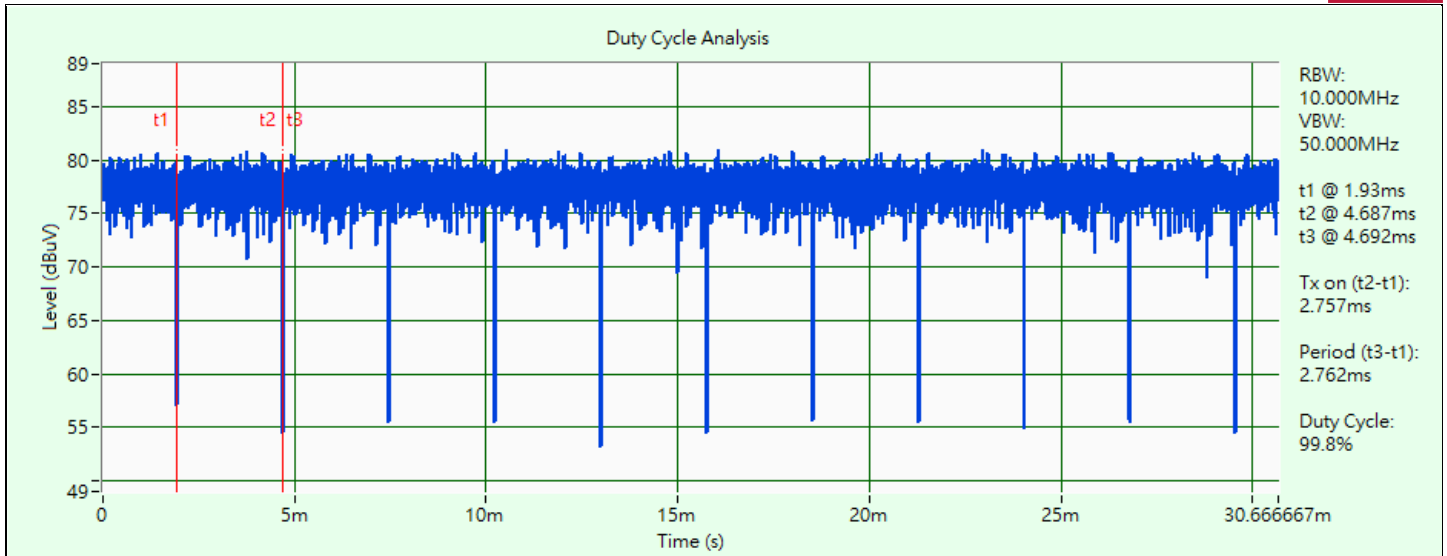

802.11ax (HE) 52-tone RU

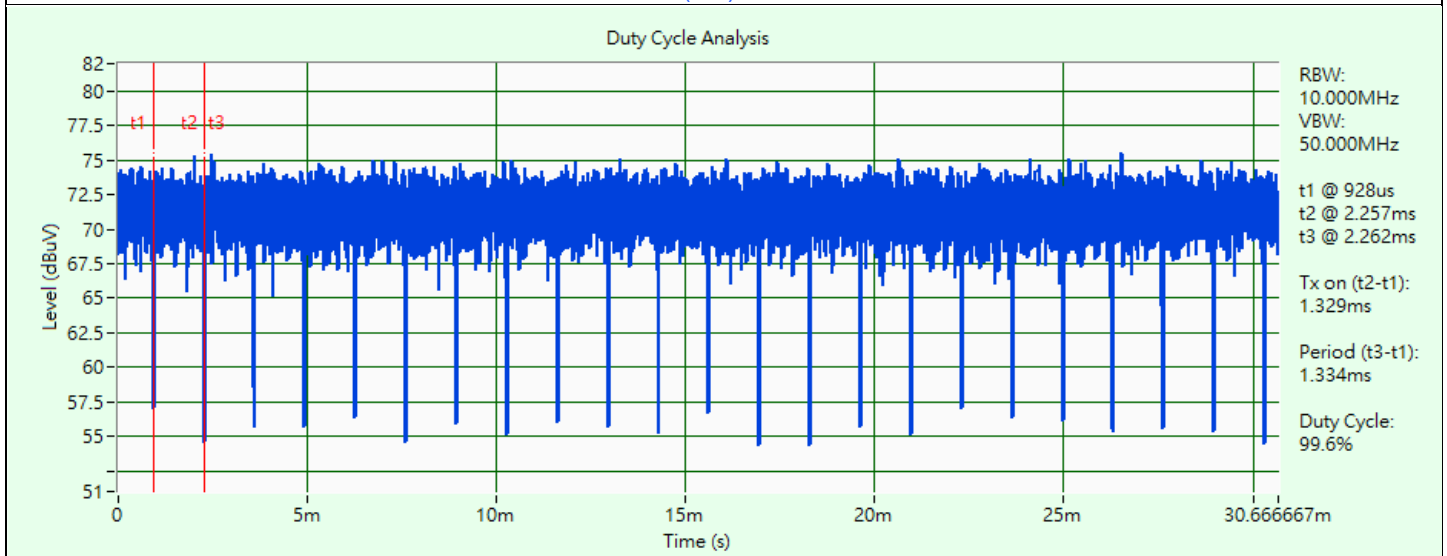

802.11ax (HE) 106-tone RU

3.6 Test Program Used and Operation Descriptions

Controlling software (RTL8851B_PCIE_MP_Package_ALPHA_v2.0.20_homologation(94894)) has been activated to set the EUT under transmission condition continuously at specific channel frequency.

3.7 Connection Diagram of EUT and Peripheral Devices

For Unwanted Emission Test

Mode A

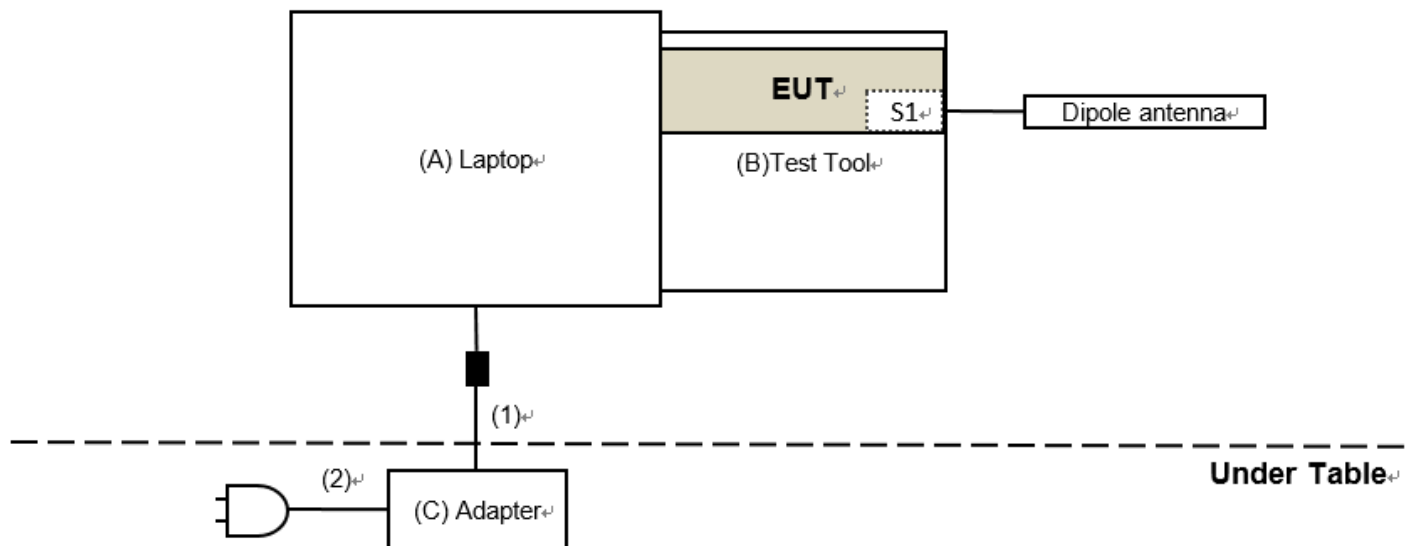

Mode B

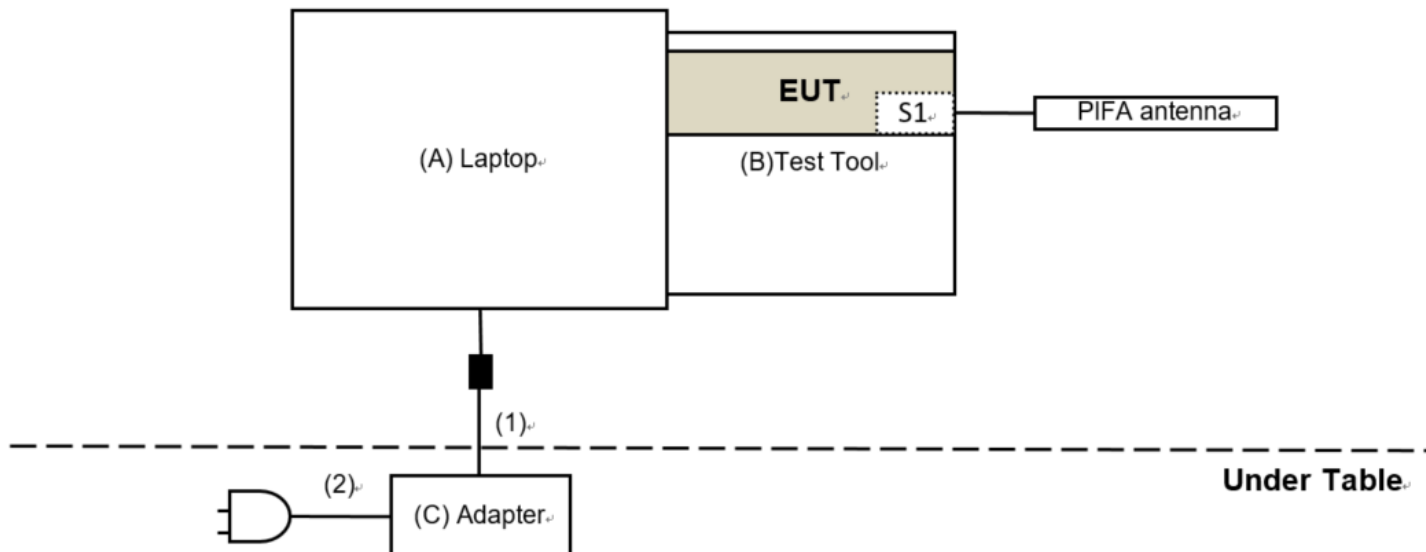

Mode C

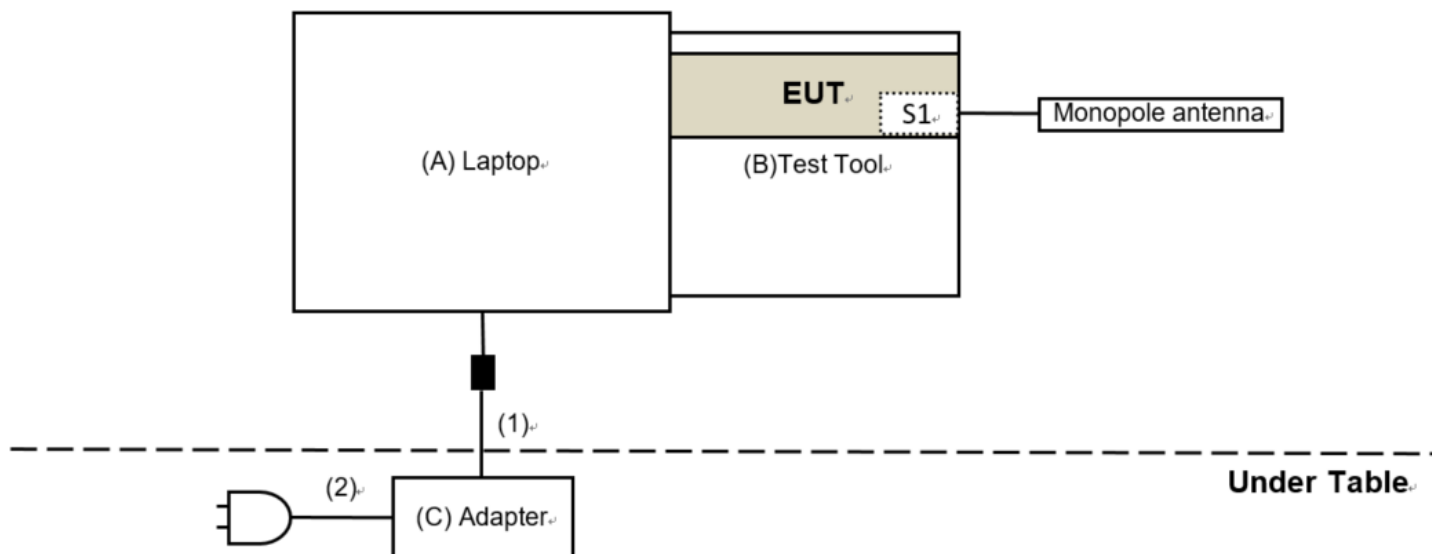

For AC Power Conducted Emission Test

Mode B

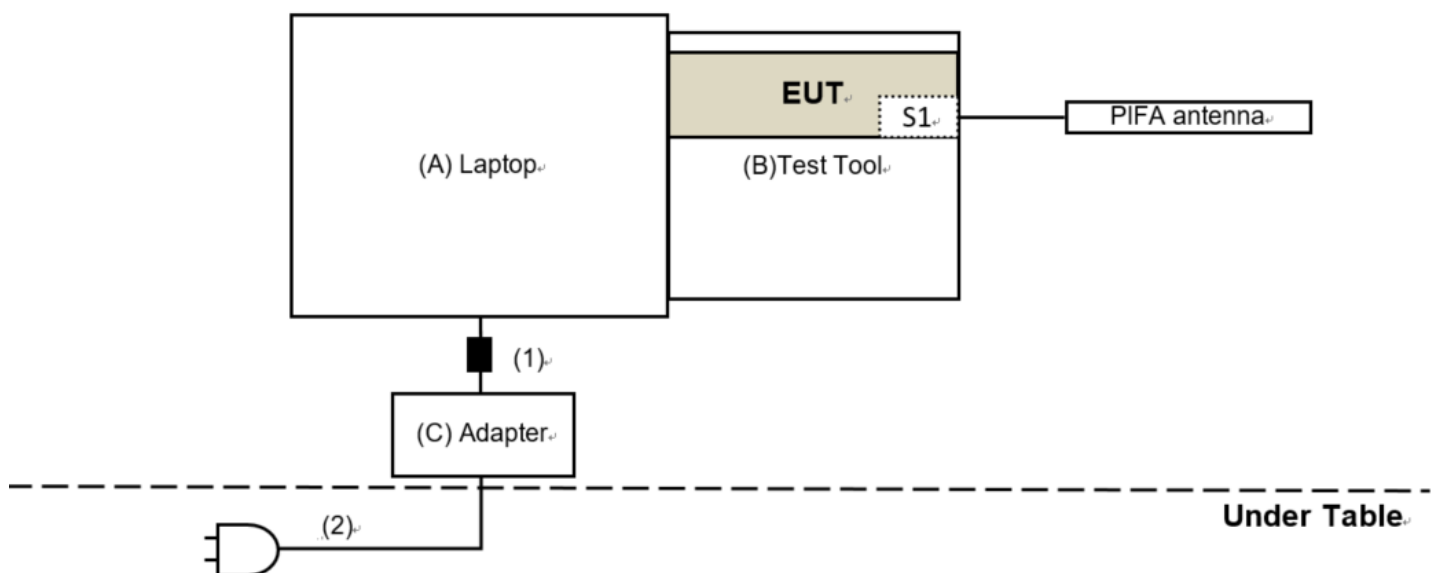

3.8 Configuration of Peripheral Devices and Cable Connections

ID	Product	Brand	Model No.	Serial No.	FCC ID	Remarks
A	Laptop	Dell	E5420	FHNS4S1	NA	Provided by Lab
B	Test Tool	Realtek	NA	NA	NA	Supplied by applicant
C	Adapter	Dell	FA65NE0-00	NA	NA	Provided by Lab

ID	Cable Descriptions	Qty.	Length (m)	Shielding (Yes/No)	Cores (Qty.)	Remarks
1	DC Cable	1	1.8	NO	1	Provided by Lab
2	AC Cable	1	1	NO	0	Provided by Lab

4 Test Instruments

The calibration interval of the all test instruments are 12 months and the calibrations are traceable to NML/ROC and NIST/USA.

4.1 RF Output Power

Description Manufacturer	Model No.	Serial No.	Calibrated Date	Calibrated Until
Power Meter Anritsu	ML2495A	1529002	2022/6/22	2023/6/21
Pulse Power Sensor Anritsu	MA2411B	1726434	2022/6/22	2023/6/21
Attenuator WOKEN	MDCS18N-10	MDCS18N-10-01	2023/3/27	2024/3/26

Notes:

1. The test was performed in Oven room 2.
2. Tested Date: 2023/3/29

4.2 Power Spectral Density

Description Manufacturer	Model No.	Serial No.	Calibrated Date	Calibrated Until
Attenuator WOKEN	MDCS18N-10	MDCS18N-10-01	2022/4/5	2023/4/4
Software	ADT_RF Test Software V6.6.5.4	N/A	N/A	N/A
Spectrum Analyzer Keysight	N9020B	MY60112409	2023/2/18	2024/2/17

Notes:

1. The test was performed in Oven room 2.
2. Tested Date: 2023/3/29

4.3 6 dB Bandwidth

Refer to section 4.2 to get information of the instruments.

4.4 Conducted Out of Band Emissions

Refer to section 4.2 to get information of the instruments.

4.5 AC Power Conducted Emissions

Description Manufacturer	Model No.	Serial No.	Calibrated Date	Calibrated Until
50 ohm terminal resistance	N/A	EMC-01	2022/9/27	2023/9/26
Fixed attenuator STI	STI02-2200-10	005	2022/8/24	2023/8/23
LISN R&S	ESH3-Z5	848773/004	2022/10/18	2023/10/17
RF Coaxial Cable JYEBO	5D-FB	COCCAB-001	2022/8/24	2023/8/23
Software BVADT	BVADT_Cond_V7.3.7.4	N/A	N/A	N/A
TEST RECEIVER R&S	ESCS 30	847124/029	2022/10/14	2023/10/13

Notes:

1. The test was performed in Conduction 1
2. Tested Date: 2023/3/21

4.6 Unwanted Emissions below 1 GHz

Description Manufacturer	Model No.	Serial No.	Calibrated Date	Calibrated Until
Bilog Antenna Schwarzbeck	VULB 9168	9168-0842	2022/10/24	2023/10/23
Boresight Antenna Tower & Turn Table Max-Full	MF-7802BS	MF780208530	N/A	N/A
Fixed attenuator Mini-Circuits	UNAT-5+	PAD-ATT5-02	2022/12/28	2023/12/27
LOOP ANTENNA Electro-Metrics	EM-6879	264	2023/2/21	2024/2/20
Pre_Amplifier Agilent	8447D	2944A10636	2023/3/12	2024/3/11
Pre_Amplifier EMCI	EMC330N	980538	2022/4/25	2023/4/24
RF Coaxial Cable COMMATE/PEWC	8D	966-5-1	2023/2/18	2024/2/17
		966-5-2	2023/2/18	2024/2/17
		966-5-3	2023/2/18	2024/2/17
RF Coaxial Cable JYEBO	5D-FB	LOOPCAB-001	2022/12/19	2023/12/18
		LOOPCAB-002	2022/12/19	2023/12/18
Software	ADT_Radiated_V8.7.08	N/A	N/A	N/A
Spectrum Analyzer Keysight	N9020B	MY60112410	2023/3/6	2024/3/5
Test Receiver R&S	ESR3	102528	2023/2/10	2024/2/9

Notes:

1. The test was performed in 966 Chamber No. 5.
2. Tested Date: 2023/3/24

4.7 Unwanted Emissions above 1 GHz

Description Manufacturer	Model No.	Serial No.	Calibrated Date	Calibrated Until
Boresight Antenna Tower & Turn Table Max-Full	MF-7802BS	MF780208530	N/A	N/A
Horn Antenna Schwarzbeck	BBHA 9120D	9120D-1819	2022/11/13	2023/11/12
	BBHA 9170	9170-739	2022/11/13	2023/11/12
Pre_Amplifier EMCI	EMC12630SE	980509	2022/4/25	2023/4/24
	EMC184045SE	980387	2022/1/10 2022/12/28	2023/1/9 2023/12/27
RF Cable-Frequency range: 1- 40GHz EMCI	EMC102-KM-KM-1200	160924	2022/1/10 2022/12/28	2023/1/9 2023/12/27
RF Coaxial Cable EMCI	EMC-KM-KM-4000	200214	2022/3/8 2023/2/20	2023/3/7 2024/2/19
	EMC104-SM-SM-1500	180503	2022/4/25	2023/4/24
	EMC104-SM-SM-2000	180501	2022/4/25	2023/4/24
	EMC104-SM-SM-6000	180506	2022/4/25	2023/4/24
Software	ADT_Radiated_V8.7.08	N/A	N/A	N/A
Spectrum Analyzer Keysight	N9020B	MY60112410	2022/3/13 2023/3/6	2023/3/12 2024/3/5
Test Receiver R&S	ESR3	102528	2022/2/25 2023/2/10	2023/2/24 2024/2/9

Notes:

1. The test was performed in 966 Chamber No. 5.
2. Tested Date: 2022/12/13 ~ 2023/3/30

5 Limits of Test Items

5.1 RF Output Power

For systems using digital modulation in the 2400–2483.5 MHz bands: 1 Watt (30 dBm)

5.2 Power Spectral Density

The Maximum of Power Spectral Density Measurement is 8 dBm in any 3 kHz.

5.3 6 dB Bandwidth

The minimum of 6 dB Bandwidth Measurement is 0.5 MHz.

5.4 Conducted Out of Band Emissions

Below 20 dB of the highest emission level of operating band (in 100 kHz Resolution Bandwidth).

5.5 AC Power Conducted Emissions

Frequency (MHz)	Conducted Limit (dBuV)	
	Quasi-peak	Average
0.15 - 0.5	66 - 56	56 - 46
0.50 - 5.0	56	46
5.0 - 30.0	60	50

Notes:

1. The lower limit shall apply at the transition frequencies.
2. The limit decreases in line with the logarithm of the frequency in the range of 0.15 to 0.50 MHz.

5.6 Unwanted Emissions below 1 GHz

Radiated emissions up to 1 GHz which fall in the restricted bands must comply with the radiated emission limits specified as below table. Other emissions shall be at least 20 dB below the highest level of the desired power:

Frequencies (MHz)	Field Strength (microvolts/meter)	Measurement Distance (meters)
0.009 ~ 0.490	2400/F(kHz)	300
0.490 ~ 1.705	24000/F(kHz)	30
1.705 ~ 30.0	30	30
30 ~ 88	100	3
88 ~ 216	150	3
216 ~ 960	200	3
Above 960	500	3

Notes:

1. The lower limit shall apply at the transition frequencies.
2. Emission level (dBuV/m) = 20 log Emission level (uV/m).

5.7 Unwanted Emissions above 1 GHz

Radiated emissions above 1 GHz which fall in the restricted bands must comply with the radiated emission limits specified as below table. Other emissions shall be at least 20 dB below the highest level of the desired power:

Frequencies (MHz)	Field Strength (microvolts/meter)	Measurement Distance (meters)
Above 960	500	3

Notes:

1. The lower limit shall apply at the transition frequencies.
2. Emission level (dBuV/m) = 20 log Emission level (uV/m).
3. For frequencies above 1000 MHz, the field strength limits are based on average detector, however, the peak field strength of any emission shall not exceed the maximum permitted average limits, specified above by more than 20 dB under any condition of modulation.

6 Test Arrangements

6.1 RF Output Power

6.1.1 Test Setup

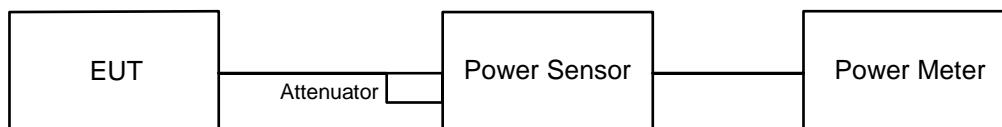

6.1.2 Test Procedure

Peak Power:

A peak power sensor was used on the output port of the EUT. A power meter was used to read the response of the peak power sensor. Record the power level.

Average Power:

Average power sensor was used to perform output power measurement, trigger and gating function of wide band power meter is enabled to measure max output power of TX on burst. Duty factor is not added to measured value.

6.2 Power Spectral Density

6.2.1 Test Setup

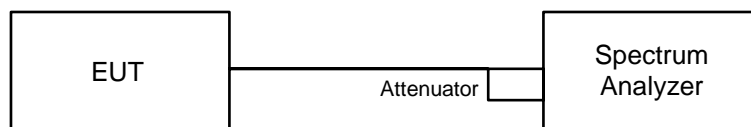

6.2.2 Test Procedure

- a. Set analyzer center frequency to DTS channel center frequency.
- b. Set the span to 1.5 times the DTS bandwidth.
- c. Set the RBW to: 3 kHz.
- d. Set the VBW $\geq 3 \times$ RBW.
- e. Detector = peak.
- f. Sweep time = auto couple.
- g. Trace mode = max hold.
- h. Allow trace to fully stabilize.
- i. Use the peak marker function to determine the maximum amplitude level within the RBW.

6.3 6 dB Bandwidth

6.3.1 Test Setup

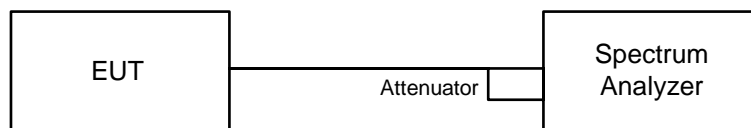

6.3.2 Test Procedure

- Set resolution bandwidth (RBW) = 100 kHz.
- Set the video bandwidth (VBW) $\geq 3 \times$ RBW, Detector = Peak.
- Trace mode = max hold.
- Sweep = auto couple.
- Measure the maximum width of the emission that is constrained by the frequencies associated with the two amplitude points (upper and lower) that are attenuated by 6 dB relative to the maximum level measured in the fundamental emission.

6.4 Conducted Out of Band Emissions

6.4.1 Test Setup

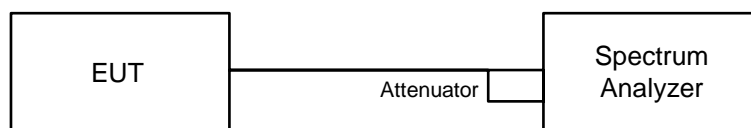

6.4.2 Test Procedure

MEASUREMENT PROCEDURE REF

- Set the RBW = 100 kHz.
- Set the VBW ≥ 300 kHz.
- Detector = peak.
- Sweep time = auto couple.
- Trace mode = max hold.
- Allow trace to fully stabilize.
- Use the peak marker function to determine the maximum power level in any 100 kHz band segment within the fundamental EBW.

MEASUREMENT PROCEDURE OOB

- Set RBW = 100 kHz.
- Set VBW ≥ 300 kHz.
- Detector = peak.
- Sweep = auto couple.
- Trace Mode = max hold.
- Allow trace to fully stabilize.
- Use the peak marker function to determine the maximum amplitude level.

6.5 AC Power Conducted Emissions

6.5.1 Test Setup

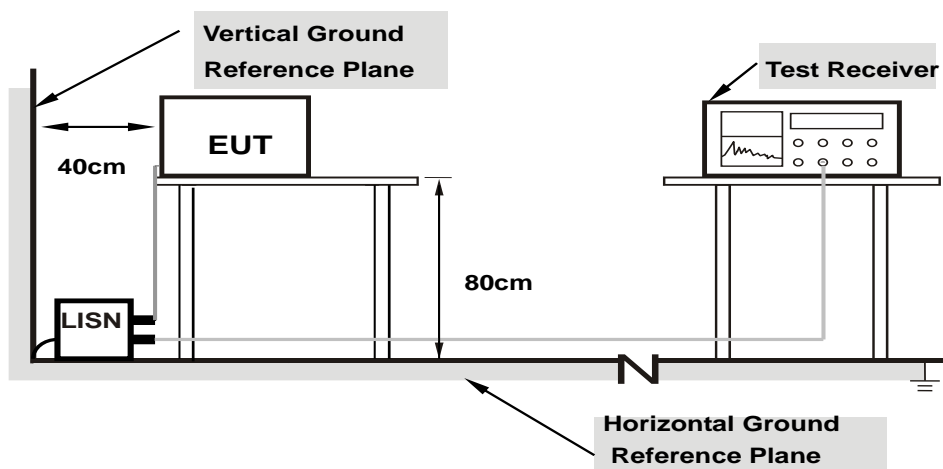

Note: 1.Support units were connected to second LISN.

For the actual test configuration, please refer to the attached file (Test Setup Photo).

6.5.2 Test Procedure

- The EUT was placed on a 0.8 meter to the top of table and placed 0.4 meters from the conducting wall of the shielded room with EUT being connected to the power mains through a line impedance stabilization network (LISN). Other support units were connected to the power mains through another LISN. The two LISNs provide 50 ohm/ 50 uH of coupling impedance for the measuring instrument.
- Both lines of the power mains connected to the EUT were checked for maximum conducted interference.
- The frequency range from 150 kHz to 30 MHz was searched. Emission levels under (Limit – 20 dB) was not recorded.

Note: The resolution bandwidth and video bandwidth of test receiver is 9 kHz for quasi-peak detection (QP) and average detection (AV) at frequency 0.15 MHz-30 MHz.

6.6 Unwanted Emissions below 1 GHz

6.6.1 Test Setup

For Radiated emission below 30 MHz

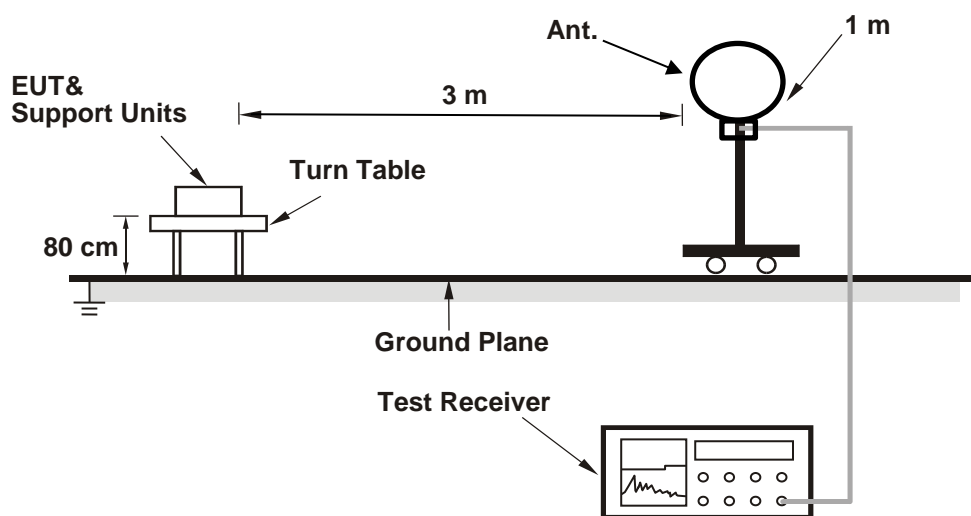

For Radiated emission above 30 MHz

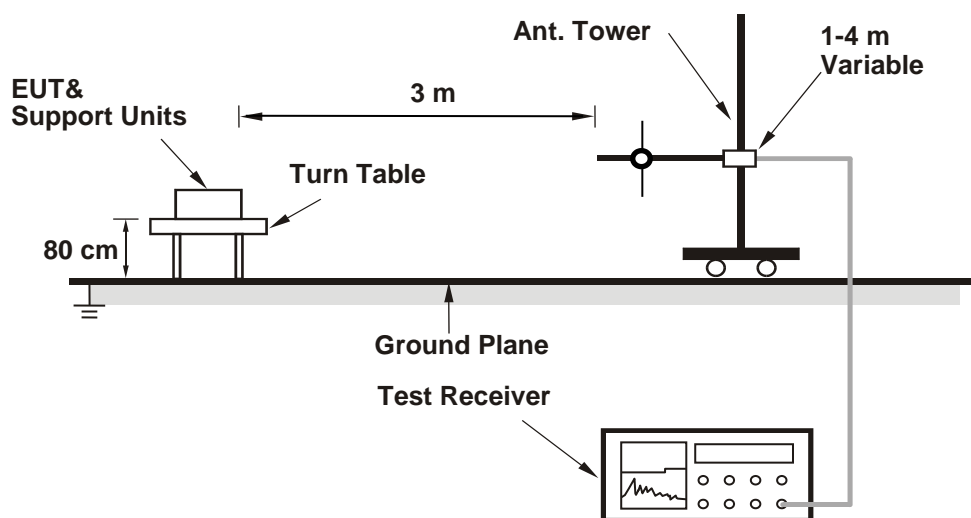

For the actual test configuration, please refer to the attached file (Test Setup Photo).

6.6.2 Test Procedure

For Radiated emission below 30 MHz

- a. The EUT was placed on the top of a rotating table 0.8 meters above the ground at 3 meter chamber room for test. The table was rotated 360 degrees to determine the position of the highest radiation.
- b. The EUT was set 3 meters away from the interference-receiving antenna, which was mounted on the top of a variable-height antenna tower.
- c. Parallel, perpendicular, and ground-parallel orientations of the antenna are set to make the measurement.
- d. For each suspected emission, the EUT was arranged to its worst case and the rotatable table was turned from 0 degrees to 360 degrees to find the maximum reading.
- e. The test-receiver system was set to Quasi-Peak Detect Function and Specified Bandwidth with Maximum Hold Mode, except for the frequency band (9 kHz to 90 kHz and 110 kHz to 490 kHz) set to average detect function and peak detect function.

Notes:

1. The resolution bandwidth and video bandwidth of test receiver/spectrum analyzer is 200 Hz at frequency below 150 kHz.
2. The resolution bandwidth and video bandwidth of test receiver/spectrum analyzer is 9 kHz or 10 kHz at frequency (150 kHz to 30 MHz).
3. All modes of operation were investigated and the worst-case emissions are reported.

For Radiated emission above 30 MHz

- a. The EUT was placed on the top of a rotating table 0.8 meters above the ground at 3 meter chamber room for test. The table was rotated 360 degrees to determine the position of the highest radiation.
- b. The EUT was set 3 meters away from the interference-receiving antenna, which was mounted on the top of a variable-height antenna tower.
- c. The height of antenna is varied from one meter to four meters above the ground to determine the maximum value of the field strength. Both horizontal and vertical polarizations of the antenna are set to make the measurement.
- d. For each suspected emission, the EUT was arranged to its worst case and then the antenna was tuned to heights from 1 meter to 4 meters and the rotatable table was turned from 0 degrees to 360 degrees to find the maximum reading.
- e. The test-receiver system was set to quasi-peak detect function and specified bandwidth with maximum hold mode when the test frequency is below 1 GHz.

Notes:

1. The resolution bandwidth and video bandwidth of test receiver/spectrum analyzer is 120 kHz for Quasi-peak detection (QP) at frequency below 1 GHz.
2. All modes of operation were investigated and the worst-case emissions are reported.

6.7 Unwanted Emissions above 1 GHz

6.7.1 Test Setup

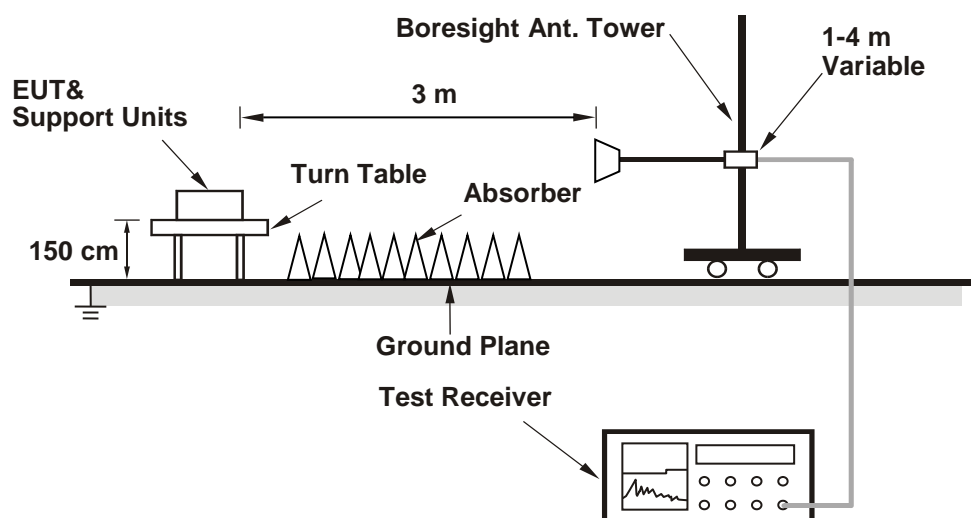

For the actual test configuration, please refer to the attached file (Test Setup Photo).

6.7.2 Test Procedure

- The EUT was placed on the top of a rotating table 1.5 meters above the ground at 3 meter chamber room for test. The table was rotated 360 degrees to determine the position of the highest radiation.
- The EUT was set 3 meters away from the interference-receiving antenna, which was mounted on the top of a variable-height antenna tower.
- The height of antenna is varied from one meter to four meters above the ground to determine the maximum value of the field strength. Both horizontal and vertical polarizations of the antenna are set to make the measurement.
- For each suspected emission, the EUT was arranged to its worst case and then the antenna was tuned to heights from 1 meter to 4 meters and the rotatable table was turned from 0 degrees to 360 degrees to find the maximum reading.
- The test-receiver system was set to peak and average detects function and specified bandwidth with maximum hold mode when the test frequency is above 1 GHz. If the peak reading value also meets average limit, measurement with the average detector is unnecessary.

Notes:

- The resolution bandwidth of test receiver/spectrum analyzer is 1 MHz and the video bandwidth is 3 MHz for Peak detection (PK) and Average detection (AV) at frequency above 1 GHz.
- For fundamental and harmonic signal measurement, the resolution bandwidth of test receiver/spectrum analyzer is 1 MHz and the video bandwidth is $\geq 1/T$ (Duty cycle $< 98\%$) or 10 Hz (Duty cycle $\geq 98\%$) for Average detection (AV) at frequency above 1 GHz.
- All modes of operation were investigated and the worst-case emissions are reported.

7 Test Results of Test Item

7.1 RF Output Power

Input Power:	3.3 Vdc	Environmental Conditions:	25°C, 60% RH	Tested By:	Katina Lu
--------------	---------	---------------------------	--------------	------------	-----------

For Peak Power

802.11b

Chan.	Chan. Freq. (MHz)	Peak Power (mW)	Peak Power (dBm)	Power Limit (dBm)	Test Result
1	2412	225.944	23.54	30	Pass
6	2437	244.343	23.88	30	Pass
11	2462	194.984	22.90	30	Pass
12	2467	83.368	19.21	30	Pass
13	2472	36.728	15.65	30	Pass

Note: The antenna gain is 3.4 dBi < 6 dBi, so the output power limit shall not be reduced.

802.11g

Chan.	Chan. Freq. (MHz)	Peak Power (mW)	Peak Power (dBm)	Power Limit (dBm)	Test Result
1	2412	296.483	24.72	30	Pass
6	2437	620.869	27.93	30	Pass
11	2462	307.61	24.88	30	Pass
12	2467	277.971	24.44	30	Pass
13	2472	278.612	24.45	30	Pass

Note: The antenna gain is 3.4 dBi < 6 dBi, so the output power limit shall not be reduced.

VHT20

Chan.	Chan. Freq. (MHz)	Peak Power (mW)	Peak Power (dBm)	Power Limit (dBm)	Test Result
1	2412	284.446	24.54	30	Pass
6	2437	574.116	27.59	30	Pass
11	2462	284.446	24.54	30	Pass
12	2467	136.144	21.34	30	Pass
13	2472	143.219	21.56	30	Pass

Note: The antenna gain is 3.4 dBi < 6 dBi, so the output power limit shall not be reduced.

VHT40

Chan.	Chan. Freq. (MHz)	Peak Power (mW)	Peak Power (dBm)	Power Limit (dBm)	Test Result
3	2422	281.19	24.49	30	Pass
6	2437	469.894	26.72	30	Pass
9	2452	287.078	24.58	30	Pass
10	2457	271.019	24.33	30	Pass
11	2462	258.226	24.12	30	Pass

Note: The antenna gain is 3.4 dBi < 6 dBi, so the output power limit shall not be reduced.

802.11ax (HE20)

Chan.	Chan. Freq. (MHz)	Peak Power (mW)	Peak Power (dBm)	Power Limit (dBm)	Test Result
1	2412	299.916	24.77	30	Pass
6	2437	608.135	27.84	30	Pass
11	2462	304.089	24.83	30	Pass
12	2467	147.911	21.70	30	Pass
13	2472	156.315	21.94	30	Pass

Note: The antenna gain is 3.4 dBi < 6 dBi, so the output power limit shall not be reduced.

802.11ax (HE40)

Chan.	Chan. Freq. (MHz)	Peak Power (mW)	Peak Power (dBm)	Power Limit (dBm)	Test Result
3	2422	303.389	24.82	30	Pass
6	2437	490.908	26.91	30	Pass
9	2452	300.608	24.78	30	Pass
10	2457	295.801	24.71	30	Pass
11	2462	283.139	24.52	30	Pass

Note: The antenna gain is 3.4 dBi < 6 dBi, so the output power limit shall not be reduced.

802.11ax (HE) 26-tone RU

Chan.	Chan. Freq. (MHz)	Peak Power (mW)	Peak Power (dBm)	Power Limit (dBm)	Test Result
1	2412	176.198	22.46	30	Pass
6	2437	299.916	24.77	30	Pass
11	2462	154.17	21.88	30	Pass
12	2467	132.434	21.22	30	Pass
13	2472	59.704	17.76	30	Pass

Note: The antenna gain is 3.4 dBi < 6 dBi, so the output power limit shall not be reduced.

802.11ax (HE) 52-tone RU

Chan.	Chan. Freq. (MHz)	Peak Power (mW)	Peak Power (dBm)	Power Limit (dBm)	Test Result
1	2412	299.226	24.76	30	Pass
6	2437	299.226	24.76	30	Pass
11	2462	306.196	24.86	30	Pass
12	2467	299.226	24.76	30	Pass
13	2472	56.754	17.54	30	Pass

Note: The antenna gain is 3.4 dBi < 6 dBi, so the output power limit shall not be reduced.

802.11ax (HE) 106-tone RU

Chan.	Chan. Freq. (MHz)	Peak Power (mW)	Peak Power (dBm)	Power Limit (dBm)	Test Result
1	2412	298.538	24.75	30	Pass
6	2437	296.483	24.72	30	Pass
11	2462	296.483	24.72	30	Pass
12	2467	296.483	24.72	30	Pass
13	2472	56.494	17.52	30	Pass

Note: The antenna gain is 3.4 dBi < 6 dBi, so the output power limit shall not be reduced.

For Average Power

802.11b

Chan.	Chan. Freq. (MHz)	Average Power (mW)	Average Power (dBm)
1	2412	175.792	22.45
6	2437	170.216	22.31
11	2462	156.315	21.94
12	2467	50.35	17.02
13	2472	29.107	14.64

802.11g

Chan.	Chan. Freq. (MHz)	Average Power (mW)	Average Power (dBm)
1	2412	135.831	21.33
6	2437	176.198	22.46
11	2462	116.95	20.68
12	2467	72.778	18.62
13	2472	59.02	17.71

VHT20

Chan.	Chan. Freq. (MHz)	Average Power (mW)	Average Power (dBm)
1	2412	124.738	20.96
6	2437	151.356	21.80
11	2462	103.039	20.13
12	2467	73.451	18.66
13	2472	76.384	18.83

VHT40

Chan.	Chan. Freq. (MHz)	Average Power (mW)	Average Power (dBm)
3	2422	81.47	19.11
6	2437	112.98	20.53
9	2452	121.339	20.84
10	2457	103.992	20.17
11	2462	75.162	18.76

802.11ax (HE20)

Chan.	Chan. Freq. (MHz)	Average Power (mW)	Average Power (dBm)
1	2412	129.718	21.13
6	2437	164.059	22.15
11	2462	111.173	20.46
12	2467	76.033	18.81
13	2472	81.47	19.11

802.11ax (HE40)

Chan.	Chan. Freq. (MHz)	Average Power (mW)	Average Power (dBm)
3	2422	88.716	19.48
6	2437	120.504	20.81
9	2452	126.765	21.03
10	2457	110.917	20.45
11	2462	80.538	19.06

802.11ax (HE) 26-tone RU

Chan.	Chan. Freq. (MHz)	Average Power (mW)	Average Power (dBm)
1	2412	51.88	17.15
6	2437	178.649	22.52
11	2462	41.783	16.21
12	2467	34.914	15.43
13	2472	11.83	10.73

802.11ax (HE) 52-tone RU

Chan.	Chan. Freq. (MHz)	Average Power (mW)	Average Power (dBm)
1	2412	88.92	19.49
6	2437	176.604	22.47
11	2462	82.224	19.15
12	2467	69.984	18.45
13	2472	11.117	10.46

802.11ax (HE) 106-tone RU

Chan.	Chan. Freq. (MHz)	Average Power (mW)	Average Power (dBm)
1	2412	113.24	20.54
6	2437	167.109	22.23
11	2462	94.624	19.76
12	2467	59.704	17.76
13	2472	10.864	10.36

7.2 Power Spectral Density

Input Power:	3.3 Vdc	Environmental Conditions:	25°C, 60% RH	Tested By:	Katina Lu
--------------	---------	---------------------------	--------------	------------	-----------

802.11b

Chan.	Chan. Freq. (MHz)	PSD (dBm/3kHz)	PSD Limit (dBm/3kHz)	Test Result
1	2412	-1.09	8	Pass
6	2437	-1.13	8	Pass
11	2462	-1.80	8	Pass
12	2467	-5.78	8	Pass
13	2472	-7.44	8	Pass

Note: The antenna gain is 3.4 dBi < 6 dBi, so the power density limit shall not be reduced.

802.11g

Chan.	Chan. Freq. (MHz)	PSD (dBm/3kHz)	PSD Limit (dBm/3kHz)	Test Result
1	2412	-4.58	8	Pass
6	2437	-2.62	8	Pass
11	2462	-5.51	8	Pass
12	2467	-7.15	8	Pass
13	2472	-7.94	8	Pass

Note: The antenna gain is 3.4 dBi < 6 dBi, so the power density limit shall not be reduced.

802.11ax (HE20)

Chan.	Chan. Freq. (MHz)	PSD (dBm/3kHz)	PSD Limit (dBm/3kHz)	Test Result
1	2412	-4.68	8	Pass
6	2437	-2.75	8	Pass
11	2462	-5.40	8	Pass
12	2467	-6.90	8	Pass
13	2472	-6.34	8	Pass

Note: The antenna gain is 3.4 dBi < 6 dBi, so the power density limit shall not be reduced.

802.11ax (HE40)

Chan.	Chan. Freq. (MHz)	PSD (dBm/3kHz)	PSD Limit (dBm/3kHz)	Test Result
3	2422	-9.42	8	Pass
6	2437	-7.80	8	Pass
9	2452	-7.96	8	Pass
10	2457	-8.56	8	Pass
11	2462	-9.51	8	Pass

Note: The antenna gain is 3.4 dBi < 6 dBi, so the power density limit shall not be reduced.

802.11ax (HE) 26-tone RU

Chan.	Chan. Freq. (MHz)	PSD (dBm/3kHz)	PSD Limit (dBm/3kHz)	Test Result
1	2412	-1.23	8	Pass
6	2437	4.67	8	Pass
11	2462	-1.85	8	Pass
12	2467	-2.90	8	Pass
13	2472	-7.76	8	Pass

Note: The antenna gain is 3.4 dBi < 6 dBi, so the power density limit shall not be reduced.

802.11ax (HE) 52-tone RU

Chan.	Chan. Freq. (MHz)	PSD (dBm/3kHz)	PSD Limit (dBm/3kHz)	Test Result
1	2412	-1.21	8	Pass
6	2437	3.04	8	Pass
11	2462	-0.76	8	Pass
12	2467	-2.06	8	Pass
13	2472	-8.98	8	Pass

Note: The antenna gain is 3.4 dBi < 6 dBi, so the power density limit shall not be reduced.

802.11ax (HE) 106-tone RU

Chan.	Chan. Freq. (MHz)	PSD (dBm/3kHz)	PSD Limit (dBm/3kHz)	Test Result
1	2412	-2.82	8	Pass
6	2437	-0.11	8	Pass
11	2462	-3.96	8	Pass
12	2467	-5.55	8	Pass
13	2472	-12.13	8	Pass

Note: The antenna gain is 3.4 dBi < 6 dBi, so the power density limit shall not be reduced.

Spectrum Plot of Maximum Value

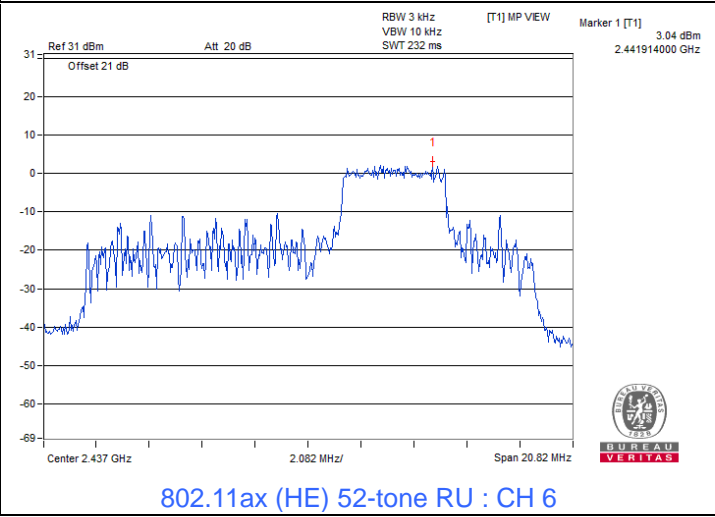
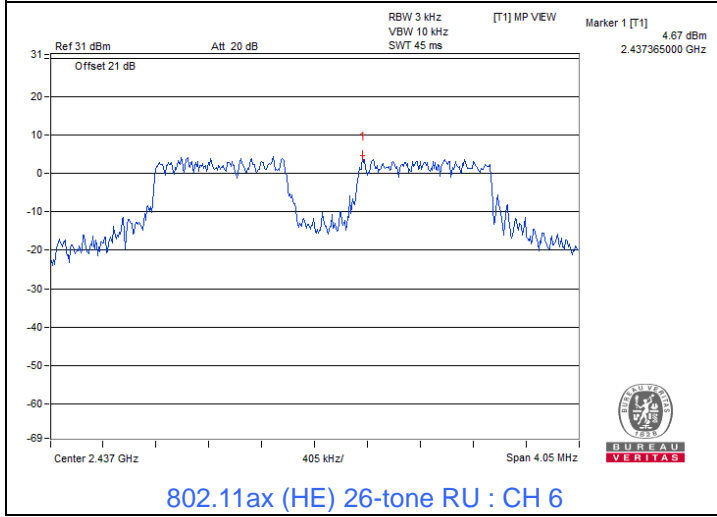
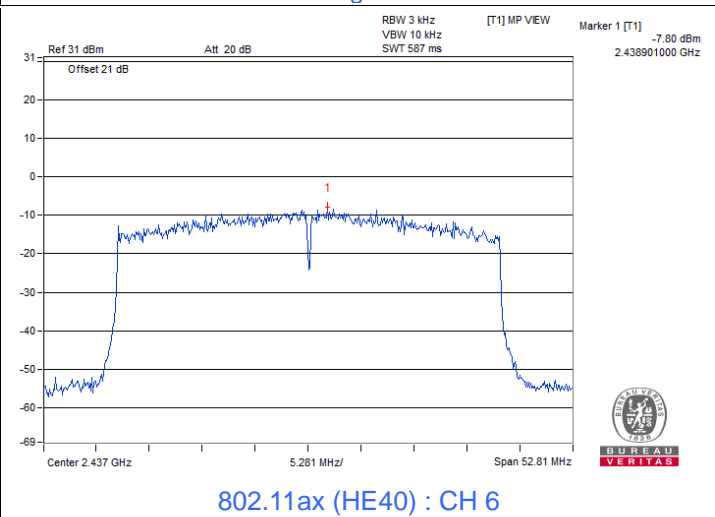
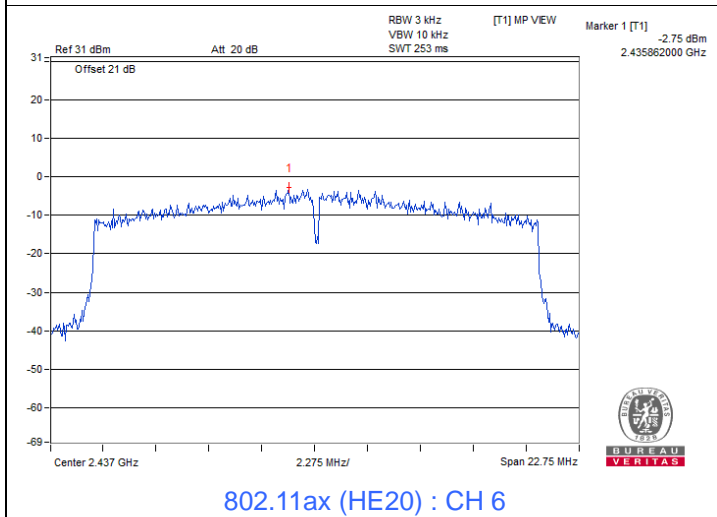
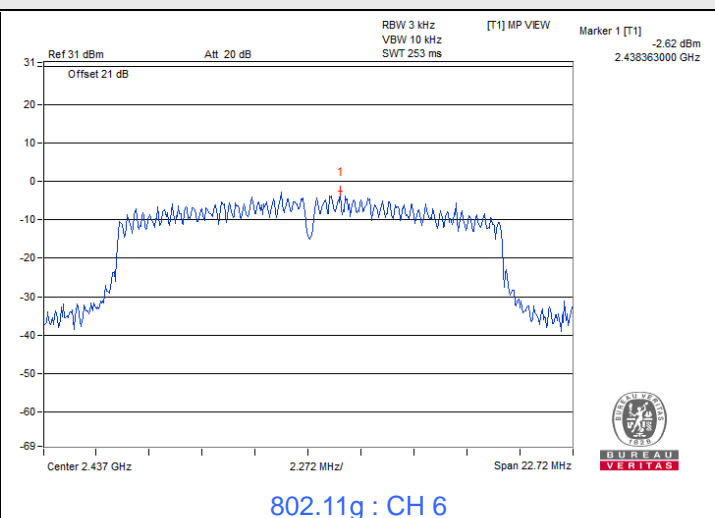
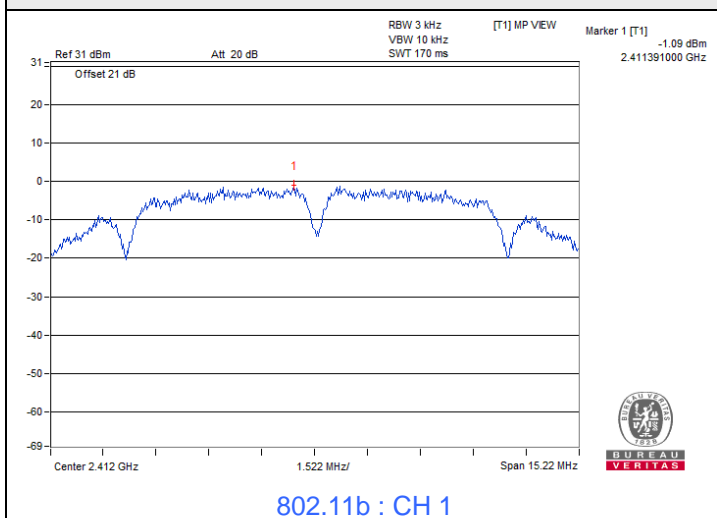



Spectrum Plot of Maximum Value

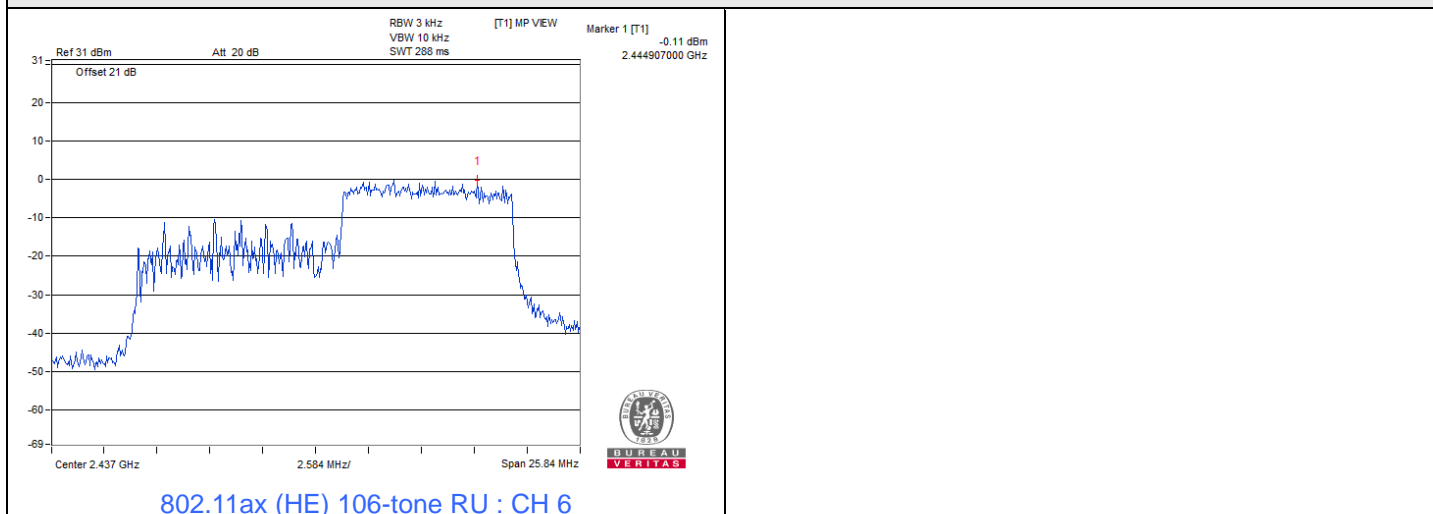

7.3 6 dB Bandwidth

Input Power:	3.3 Vdc	Environmental Conditions:	25°C, 60% RH	Tested By:	Katina Lu
--------------	---------	---------------------------	--------------	------------	-----------

802.11b

Channel	Frequency (MHz)	6dB Bandwidth (MHz)	Minimum Limit (MHz)	Test Result
1	2412	10.15	0.5	Pass
6	2437	10.15	0.5	Pass
11	2462	10.15	0.5	Pass
12	2467	10.16	0.5	Pass
13	2472	10.16	0.5	Pass

802.11g

Channel	Frequency (MHz)	6dB Bandwidth (MHz)	Minimum Limit (MHz)	Test Result
1	2412	15.14	0.5	Pass
6	2437	15.15	0.5	Pass
11	2462	15.09	0.5	Pass
12	2467	15.13	0.5	Pass
13	2472	15.15	0.5	Pass

802.11ax (HE20)

Channel	Frequency (MHz)	6dB Bandwidth (MHz)	Minimum Limit (MHz)	Test Result
1	2412	15.15	0.5	Pass
6	2437	15.17	0.5	Pass
11	2462	15.15	0.5	Pass
12	2467	15.16	0.5	Pass
13	2472	15.16	0.5	Pass

802.11ax (HE40)

Channel	Frequency (MHz)	6dB Bandwidth (MHz)	Minimum Limit (MHz)	Test Result
3	2422	35.2	0.5	Pass
6	2437	35.21	0.5	Pass
9	2452	35.2	0.5	Pass
10	2457	35.21	0.5	Pass
11	2462	35.21	0.5	Pass

802.11ax (HE) 26-tone RU

Channel	Frequency (MHz)	6dB Bandwidth (MHz)	Minimum Limit (MHz)	Test Result
1	2412	14.58	0.5	Pass
6	2437	2.7	0.5	Pass
11	2462	15.82	0.5	Pass
12	2467	15.82	0.5	Pass
13	2472	15.82	0.5	Pass

802.11ax (HE) 52-tone RU

Channel	Frequency (MHz)	6dB Bandwidth (MHz)	Minimum Limit (MHz)	Test Result
1	2412	17.05	0.5	Pass
6	2437	13.88	0.5	Pass
11	2462	17.03	0.5	Pass
12	2467	17.05	0.5	Pass
13	2472	17.03	0.5	Pass

802.11ax (HE) 106-tone RU

Channel	Frequency (MHz)	6dB Bandwidth (MHz)	Minimum Limit (MHz)	Test Result
1	2412	17.18	0.5	Pass
6	2437	17.23	0.5	Pass
11	2462	17.22	0.5	Pass
12	2467	17.22	0.5	Pass
13	2472	17.22	0.5	Pass

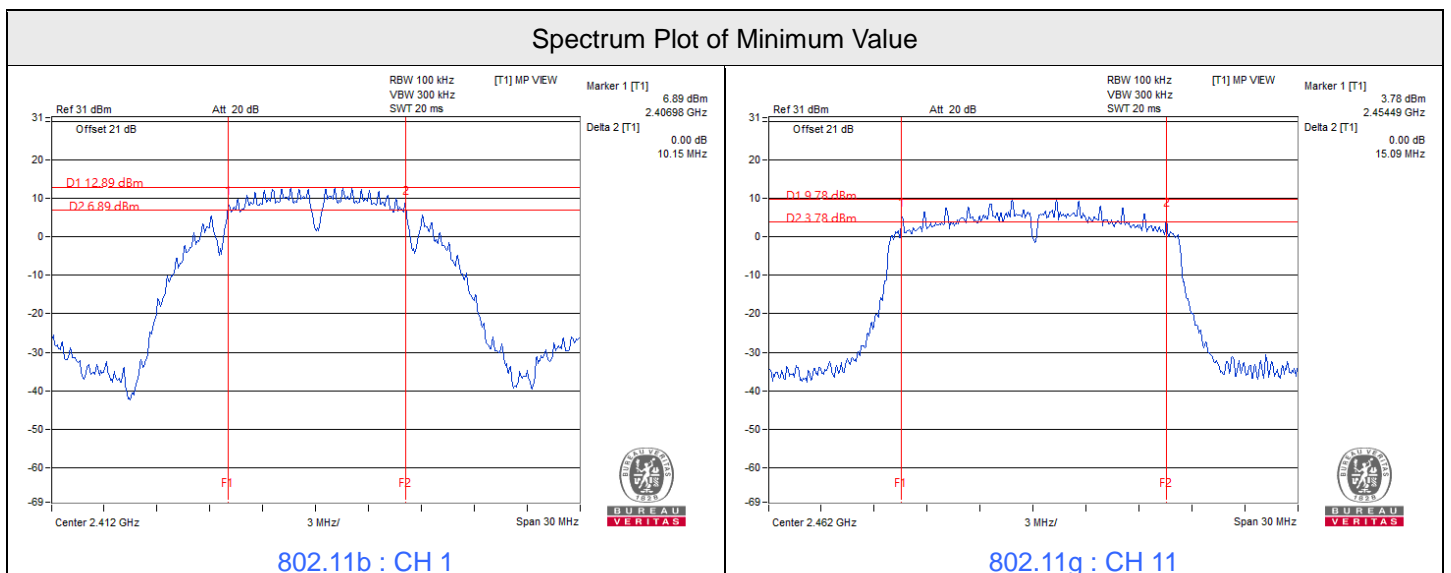

Spectrum Plot of Minimum Value

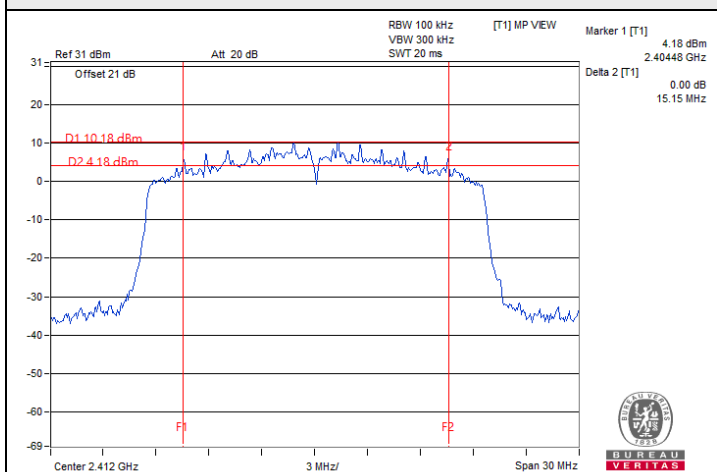

802.11ax (HE20) : CH 1

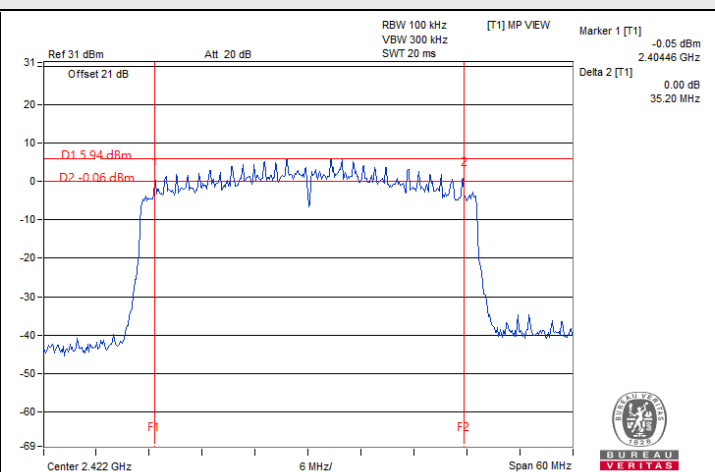

802.11ax (HE40) : CH 3

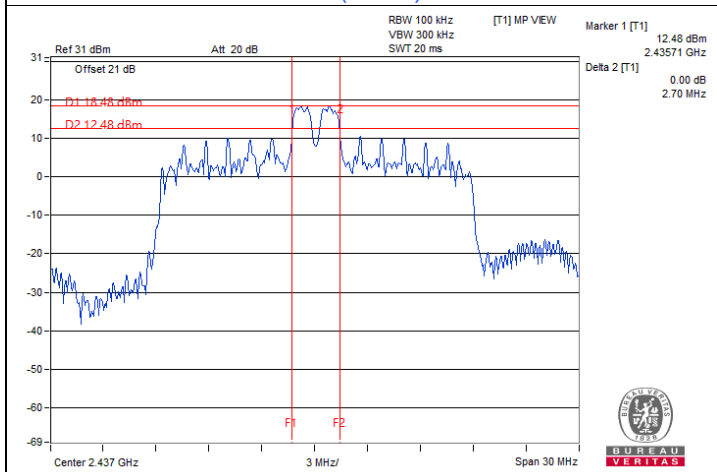

802.11ax (HE) 26-tone RU : CH 6

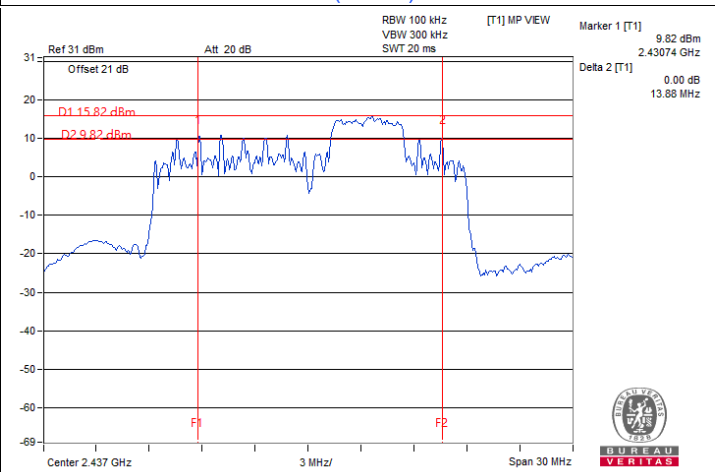

802.11ax (HE) 52-tone RU : CH 6

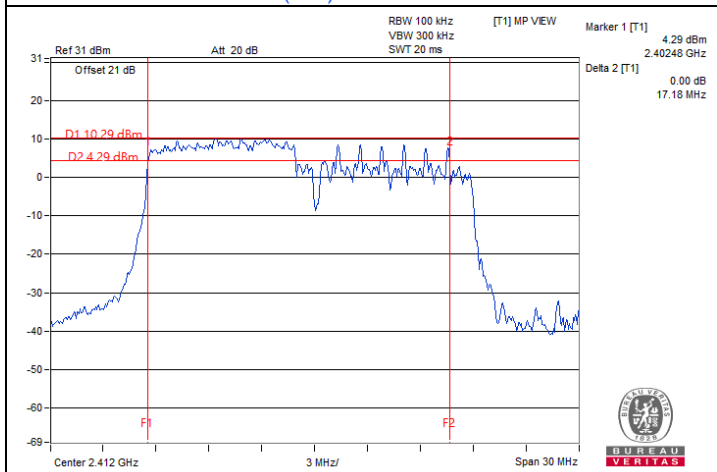

802.11ax (HE) 106-tone RU : CH 1



7.4 Conducted Out of Band Emissions

Input Power:	3.3 Vdc	Environmental Conditions:	25°C, 60% RH	Tested By:	Katina Lu
--------------	---------	---------------------------	--------------	------------	-----------

802.11b

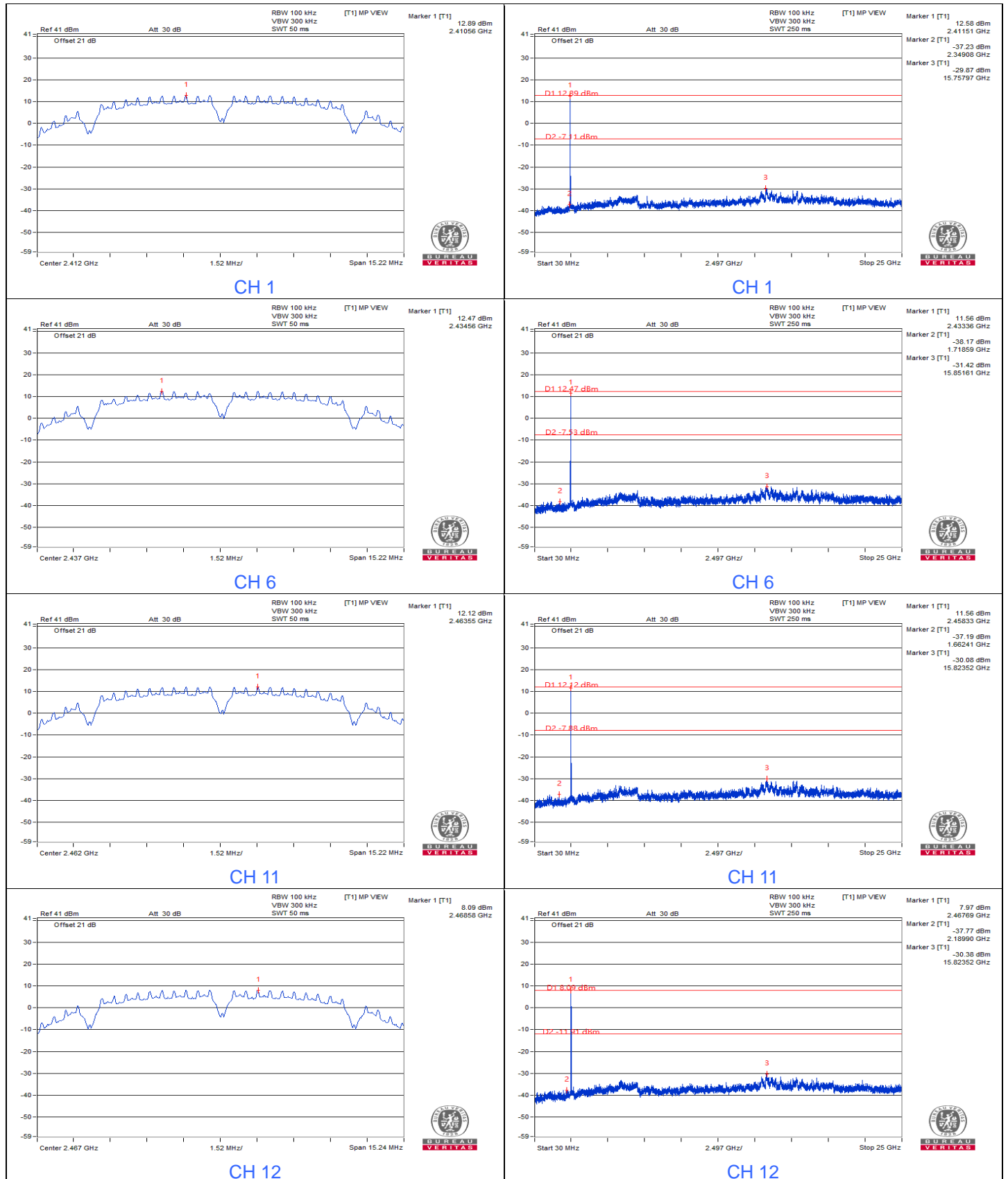

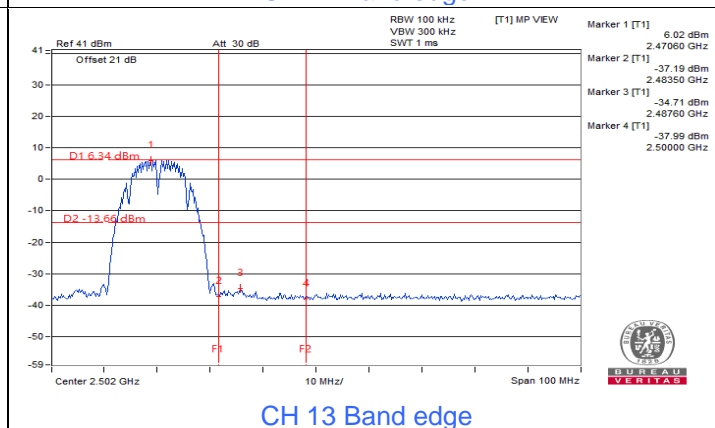
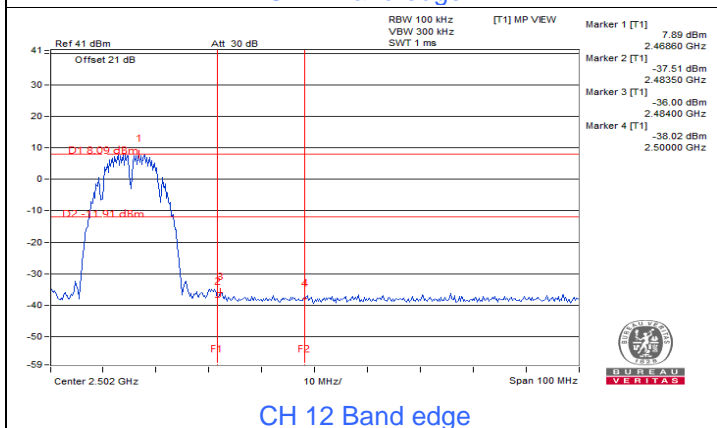
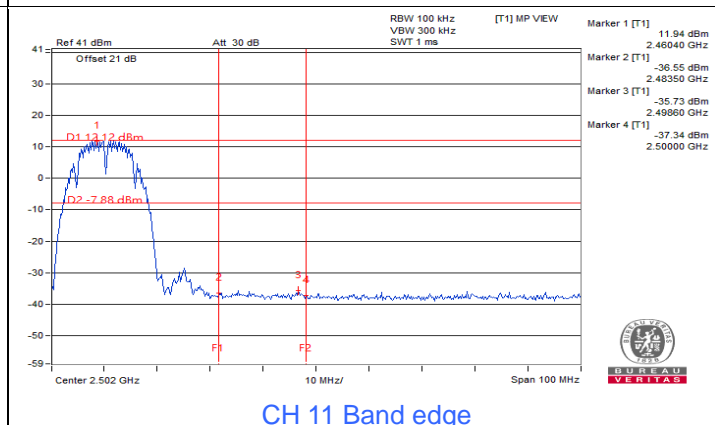
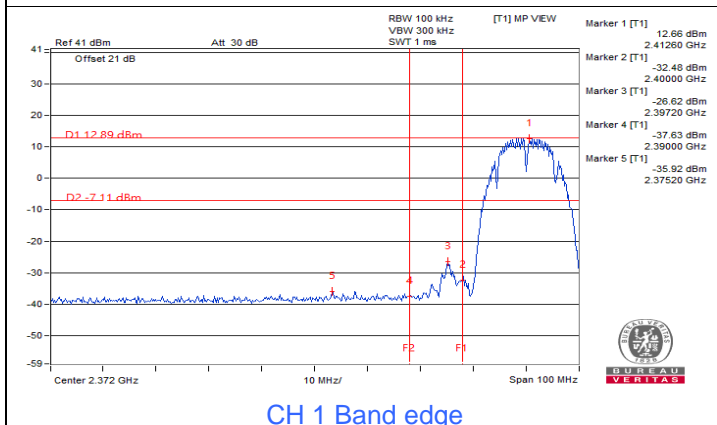
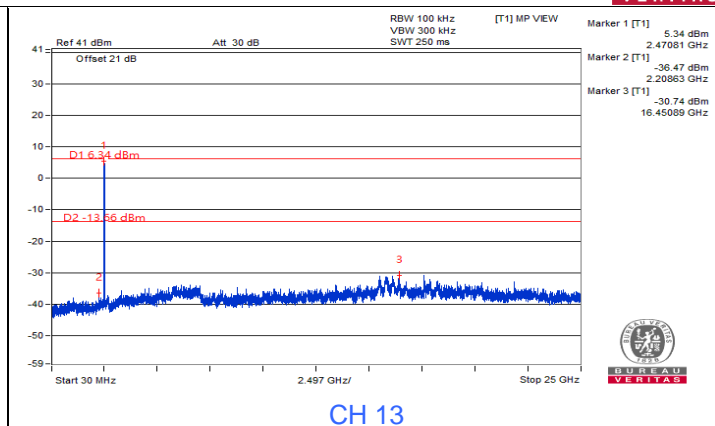
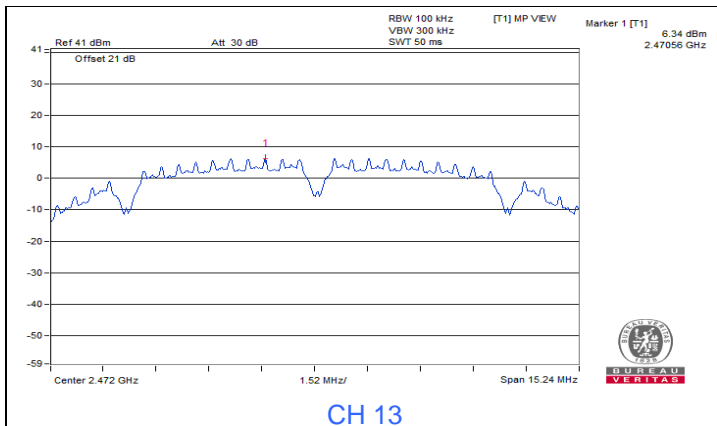



802.11g

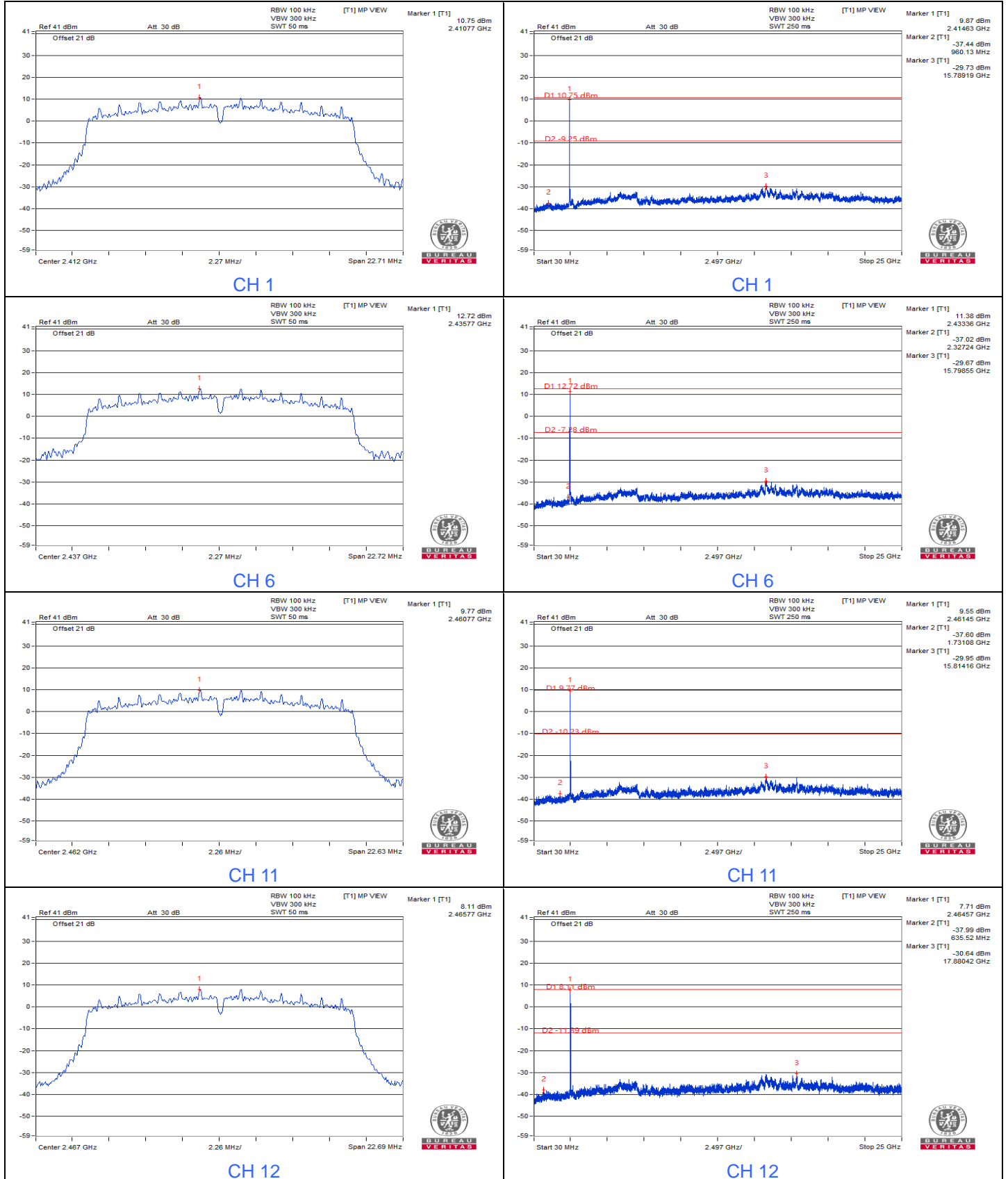

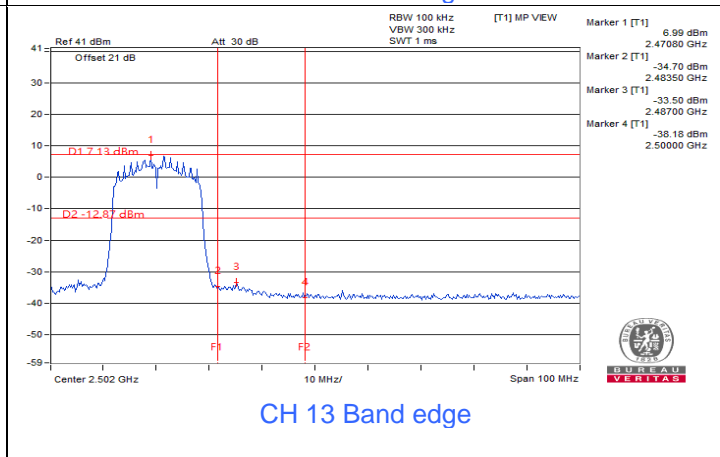
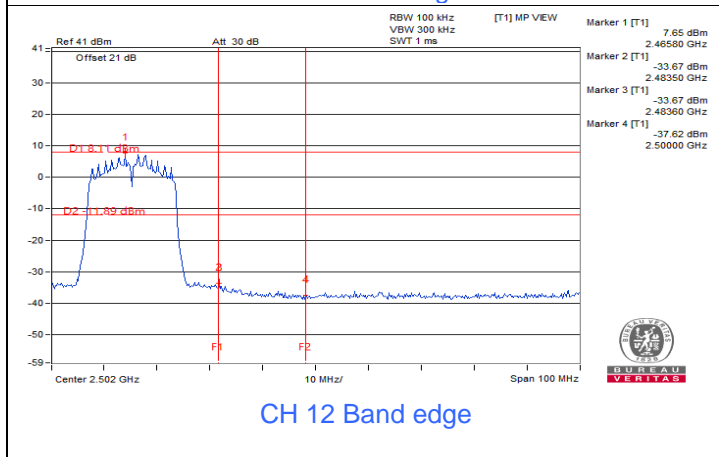
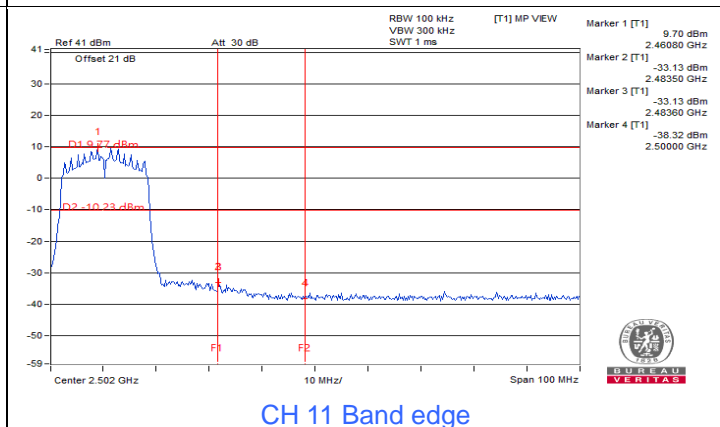
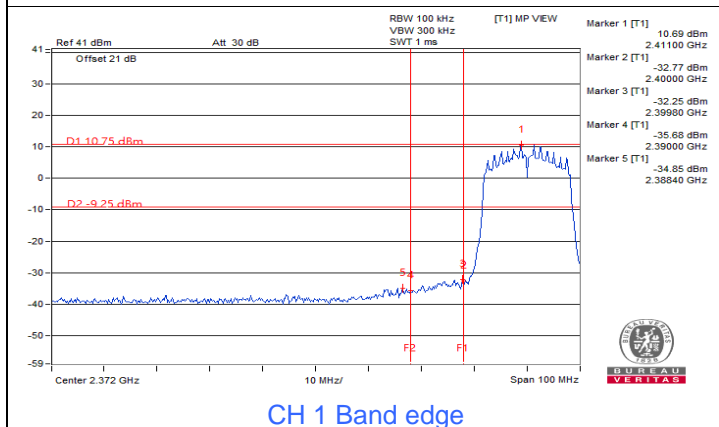
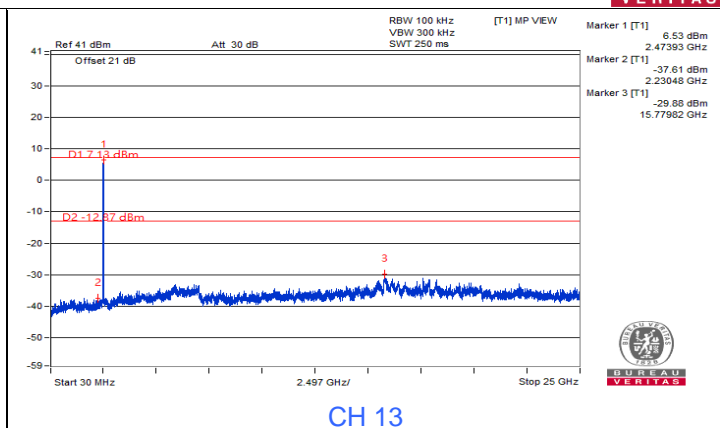
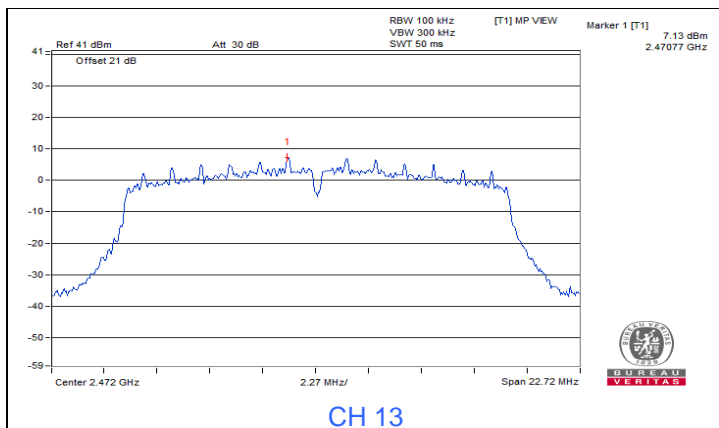



802.11ax (HE20)

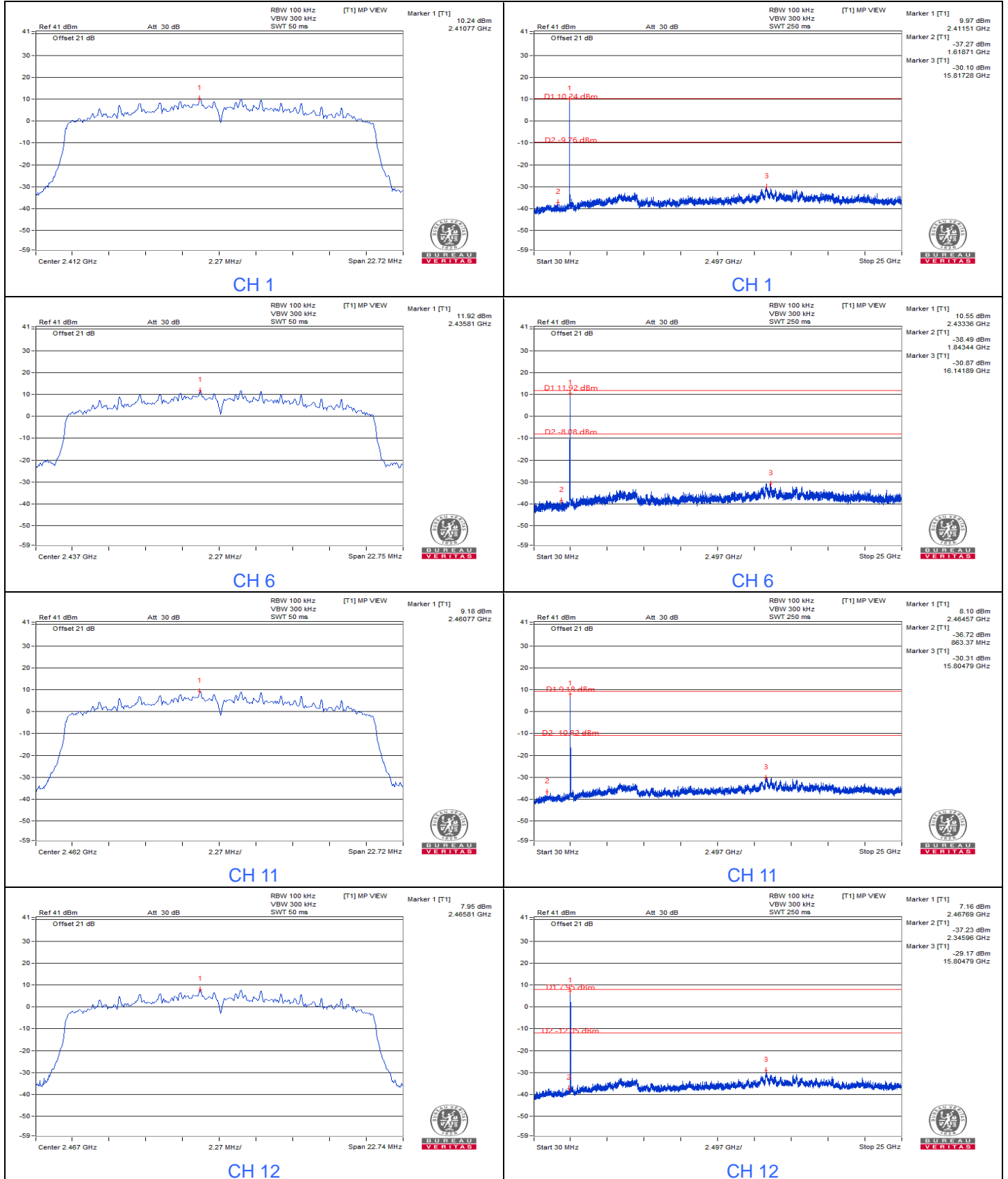

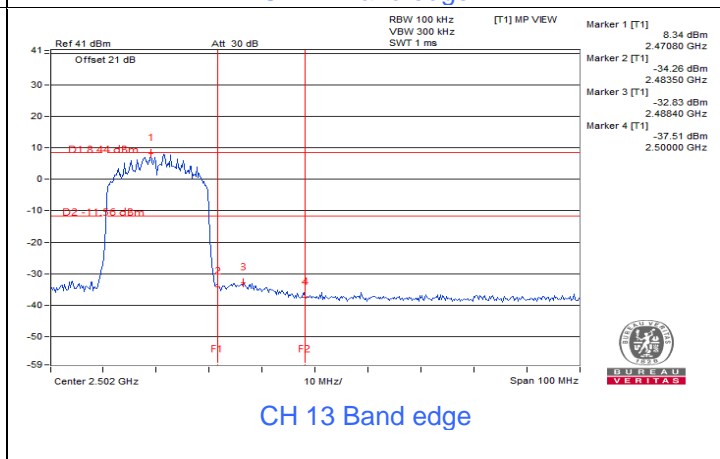
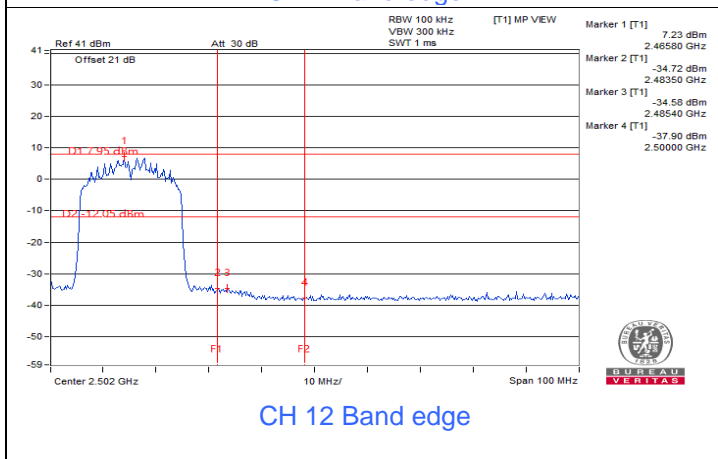
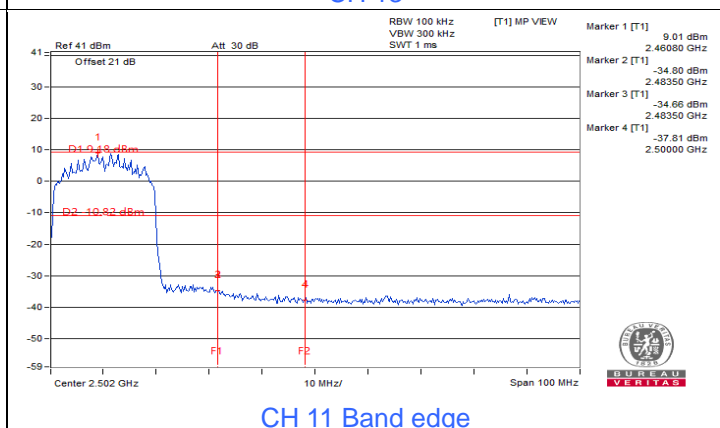
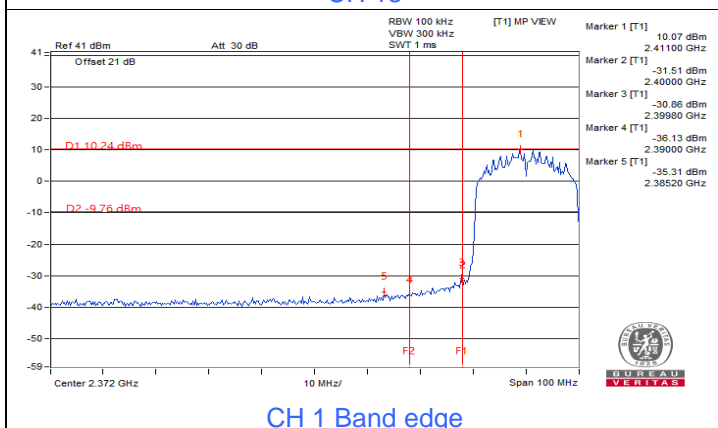
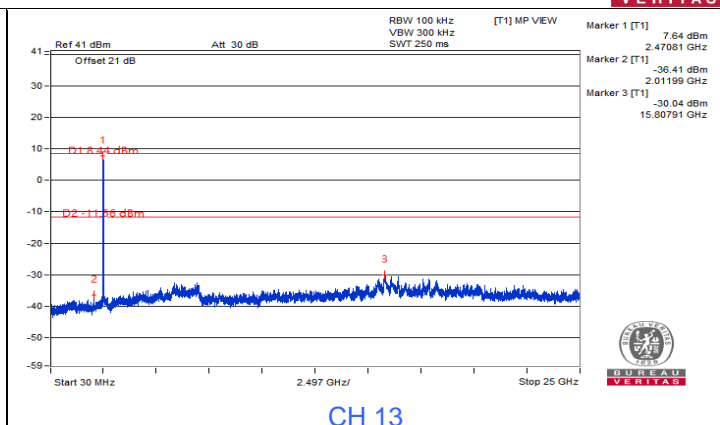
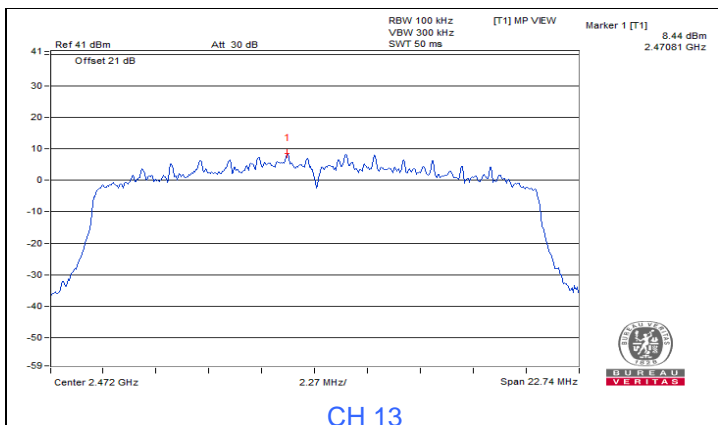



802.11ax (HE40)



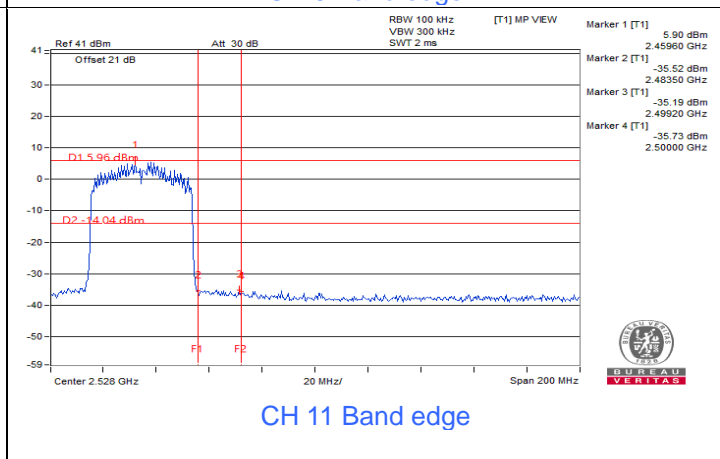
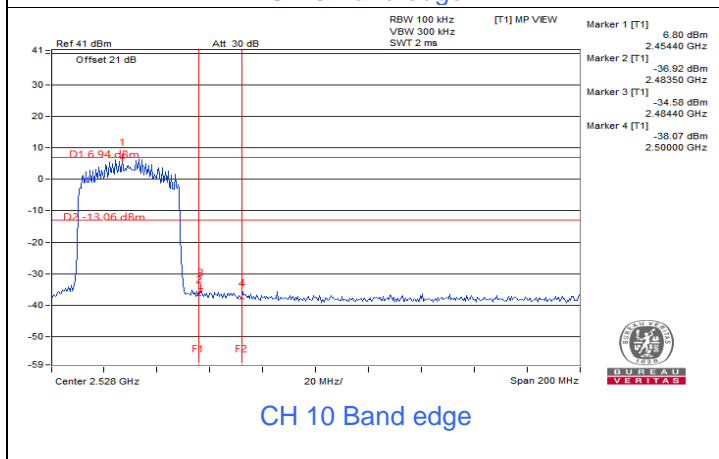
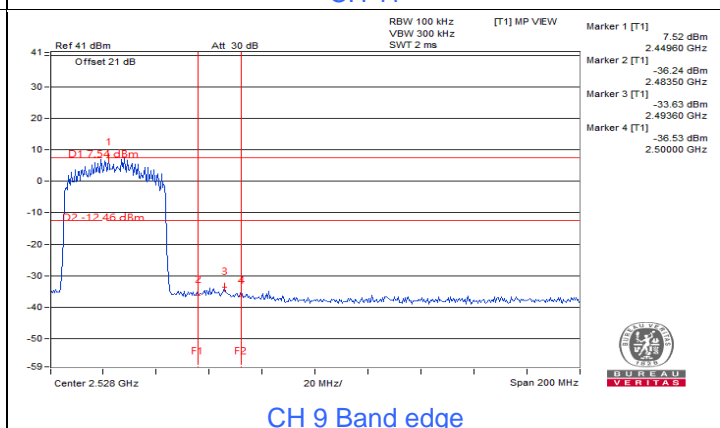
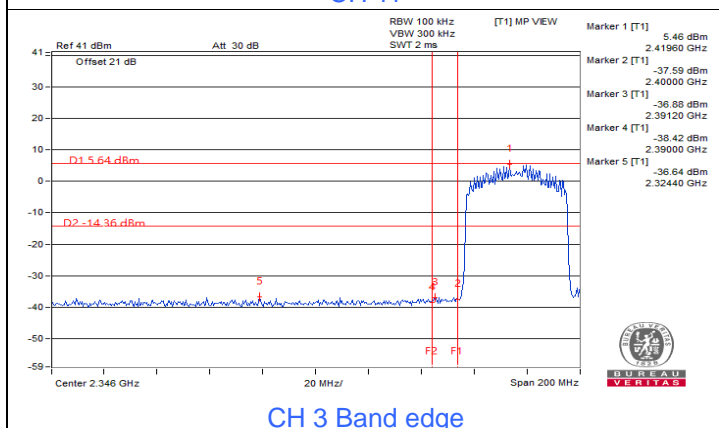
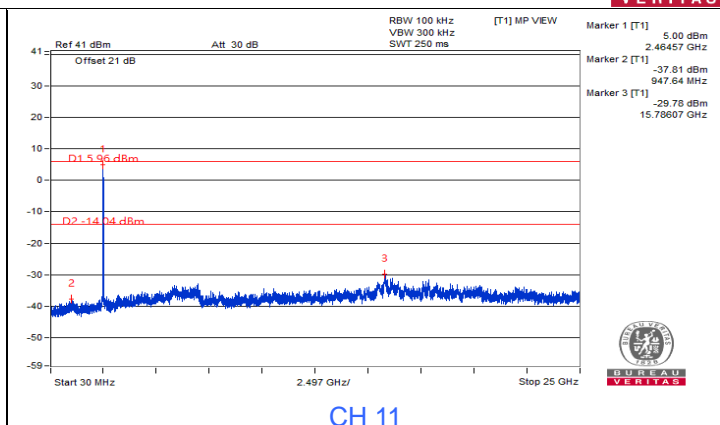
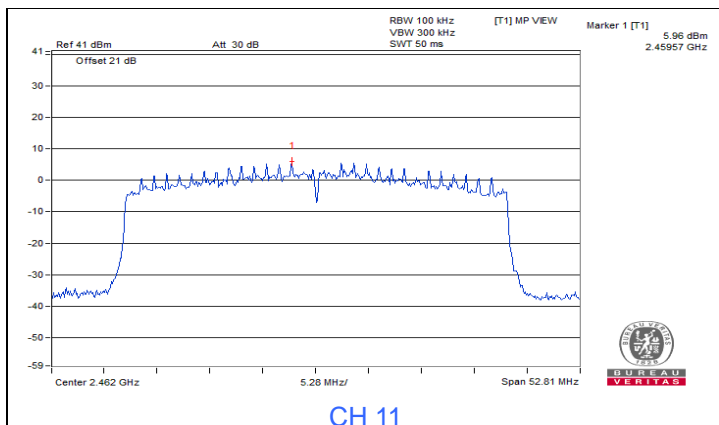



802.11ax (HE) 26-tone RU

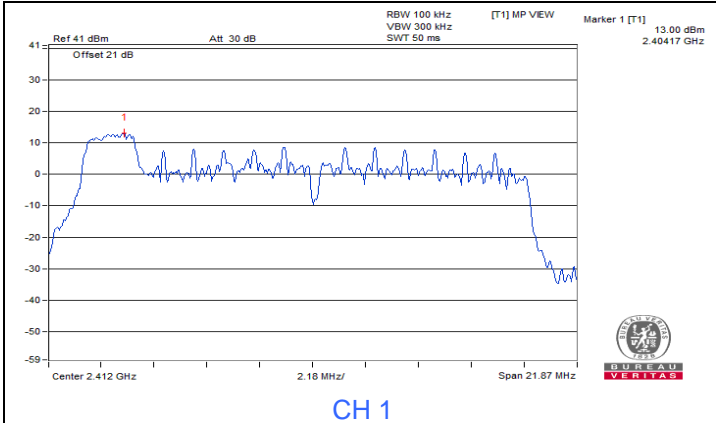

CH 1

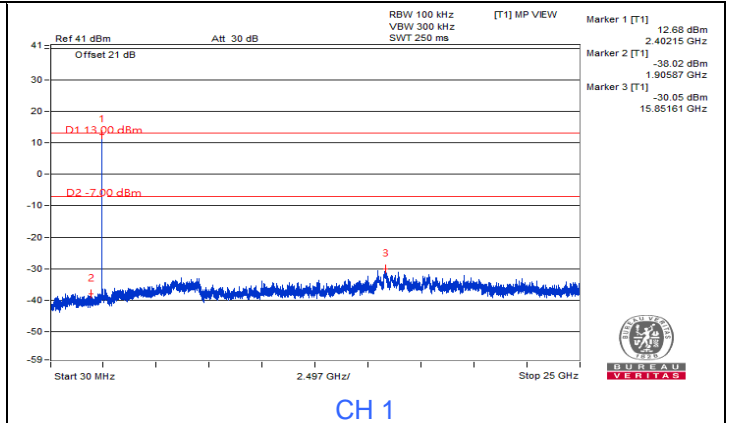

CH 1

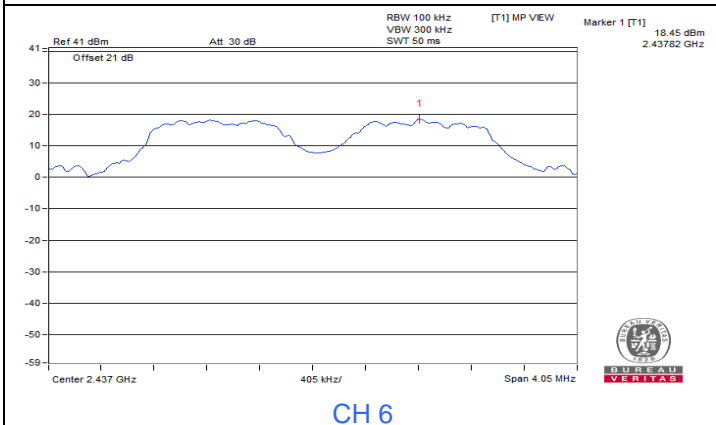

CH 6

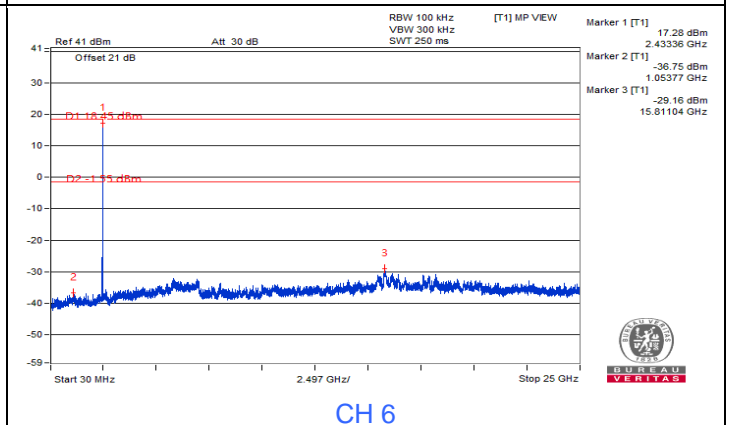

CH 6

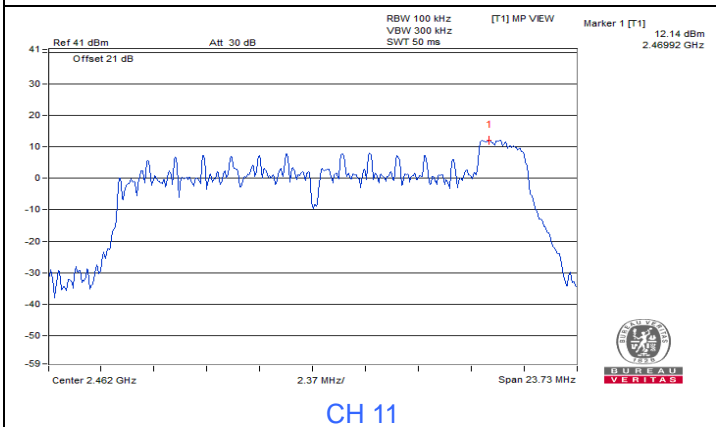

CH 11

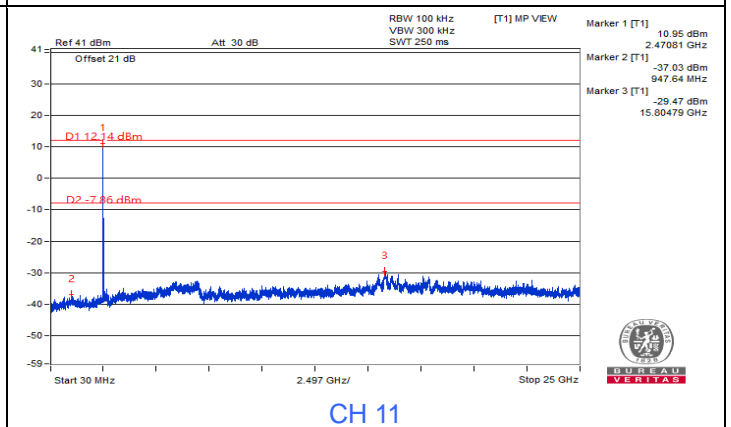

CH 11

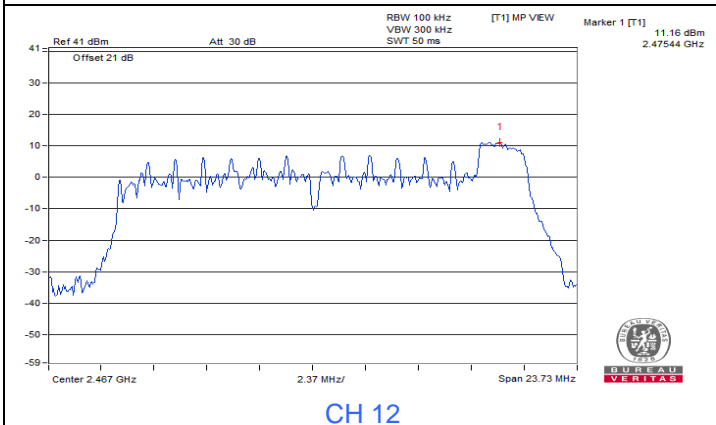

CH 12

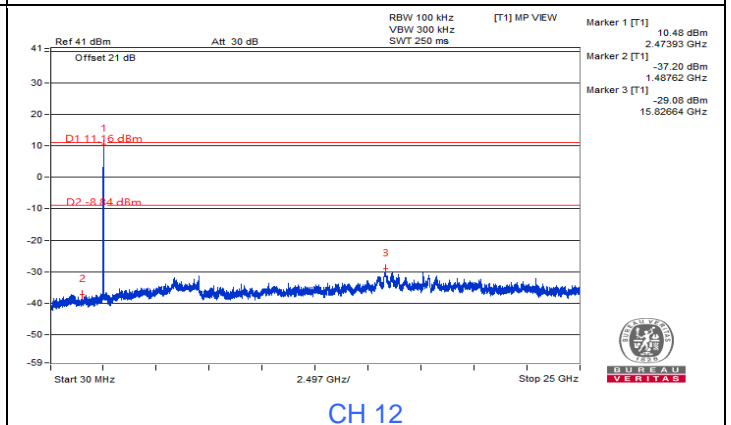

CH 12

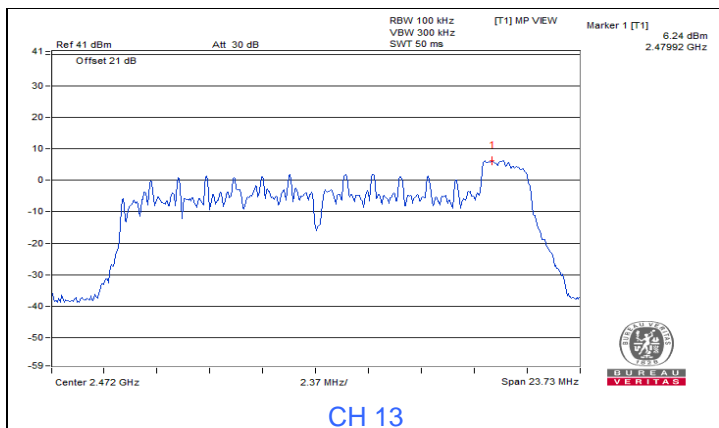

CH 13

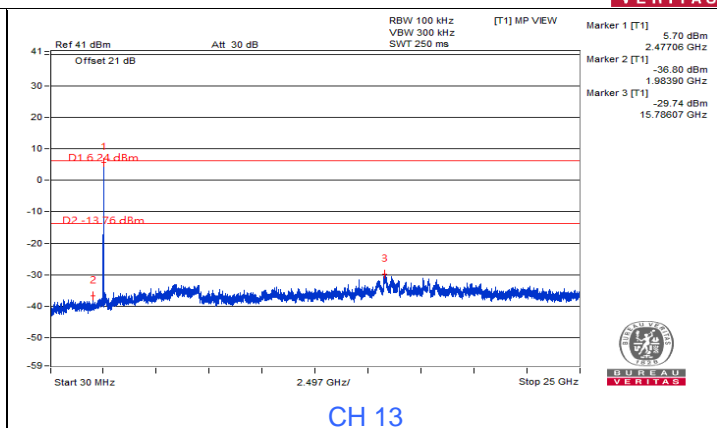

CH 13

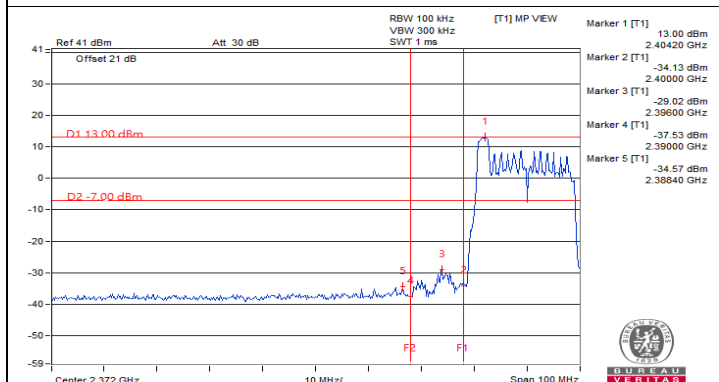

CH 1 Band edge

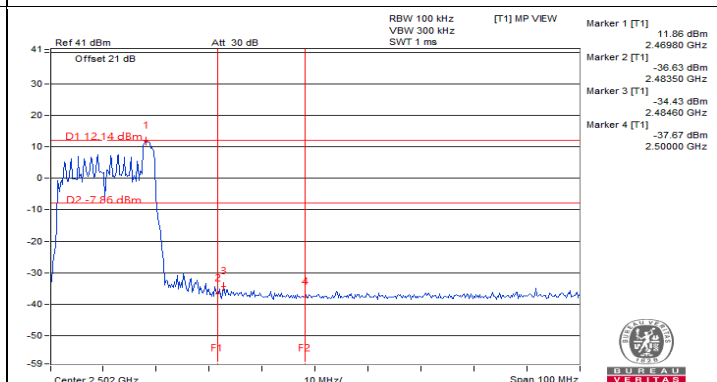

CH 11 Band edge

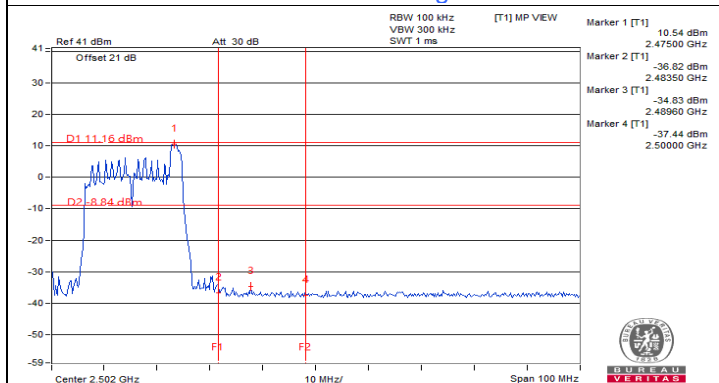

CH 12 Band edge

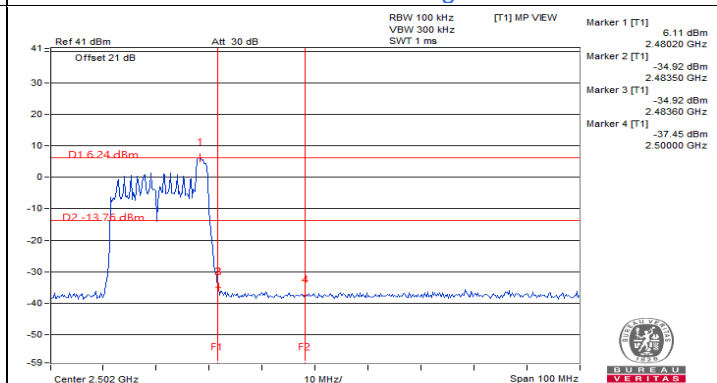

CH 13 Band edge



802.11ax (HE) 52-tone RU

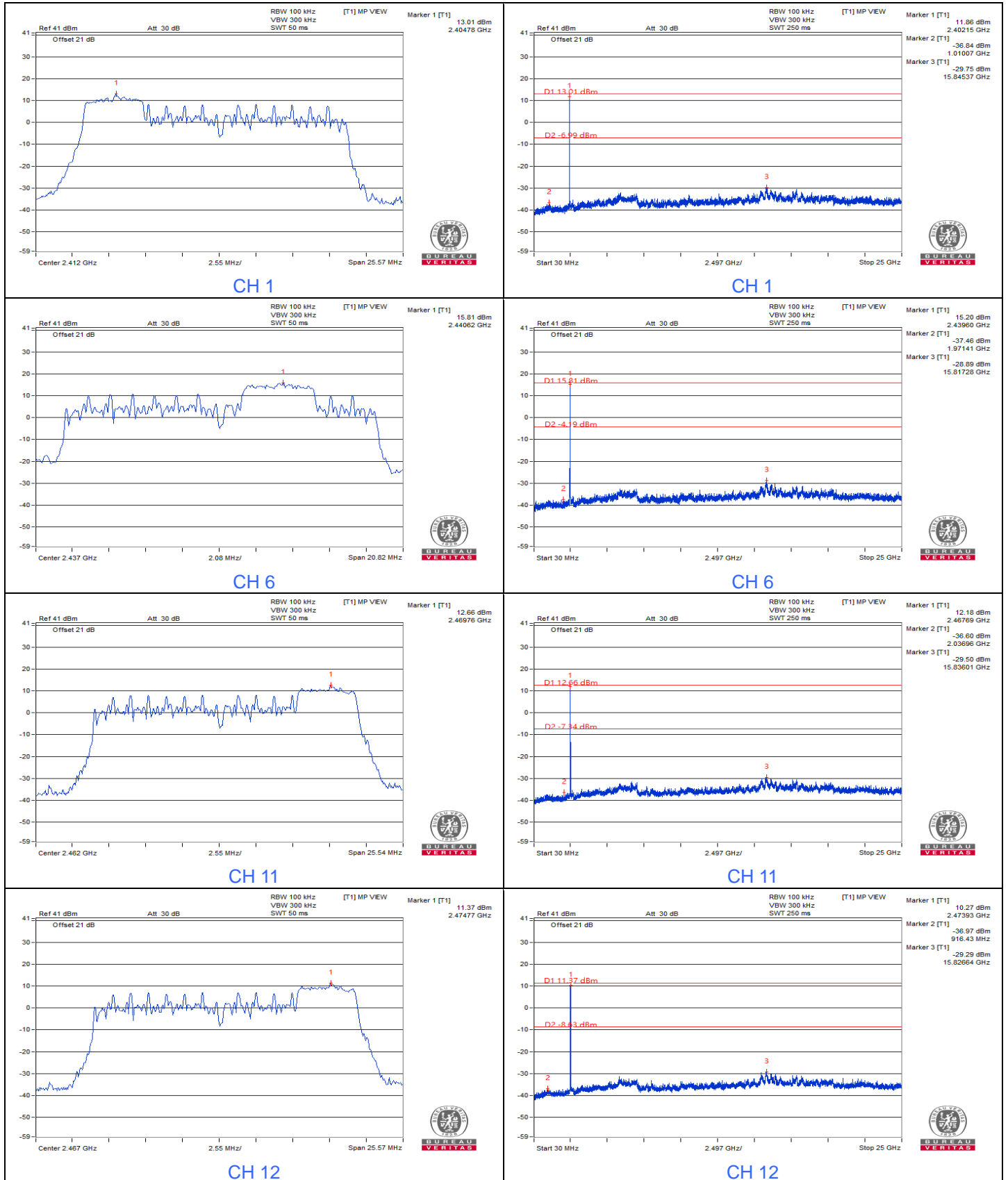

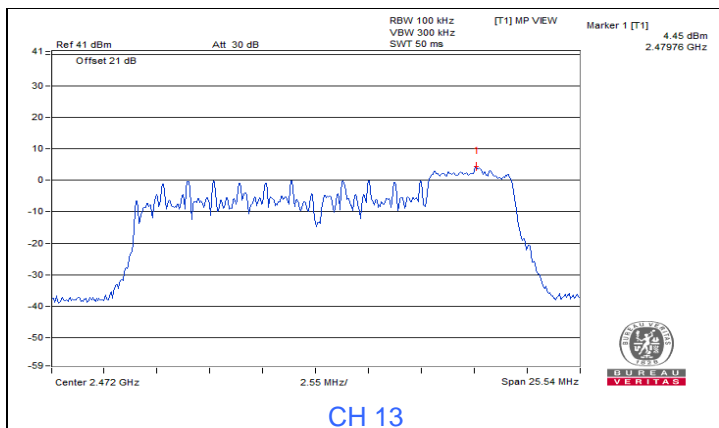

CH 13

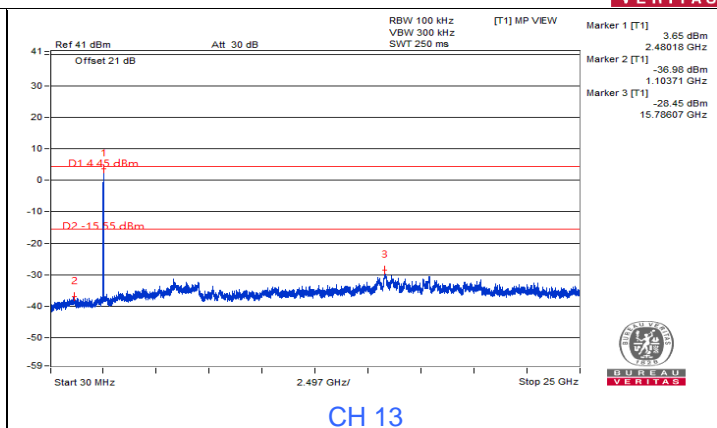

CH 13

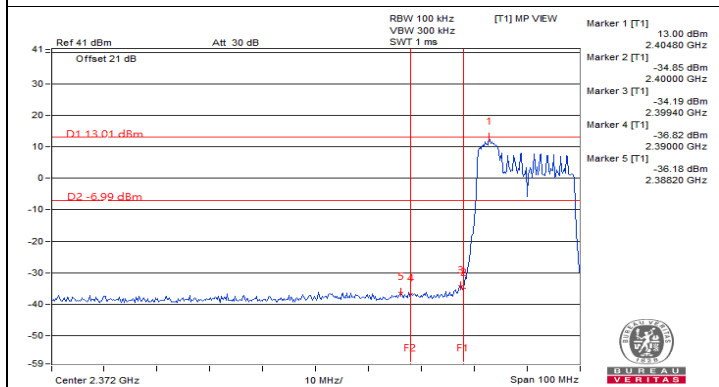

CH 1 Band edge

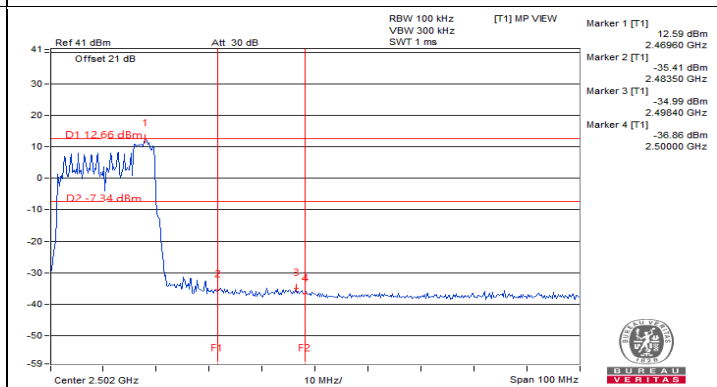

CH 11 Band edge

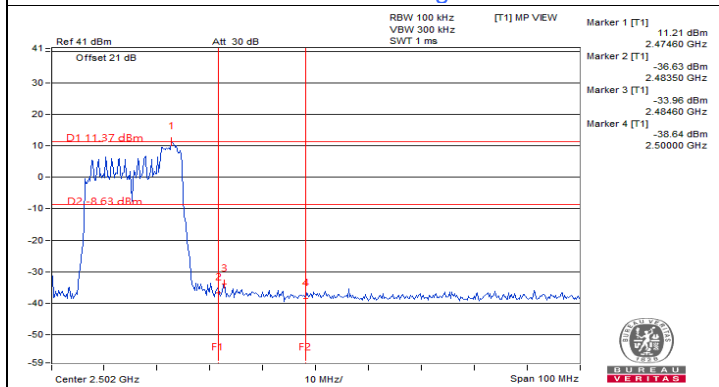

CH 12 Band edge

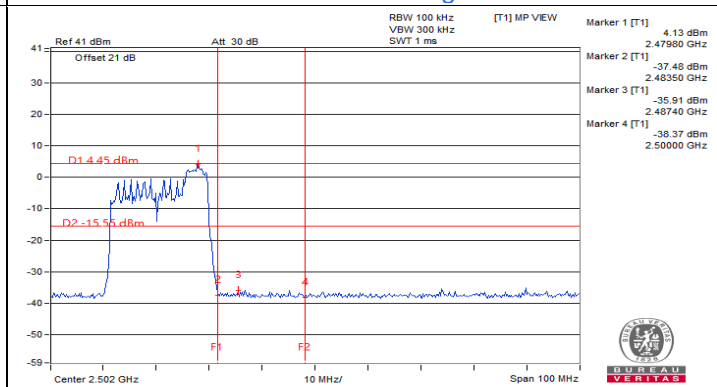

CH 13 Band edge



802.11ax (HE) 106-tone RU

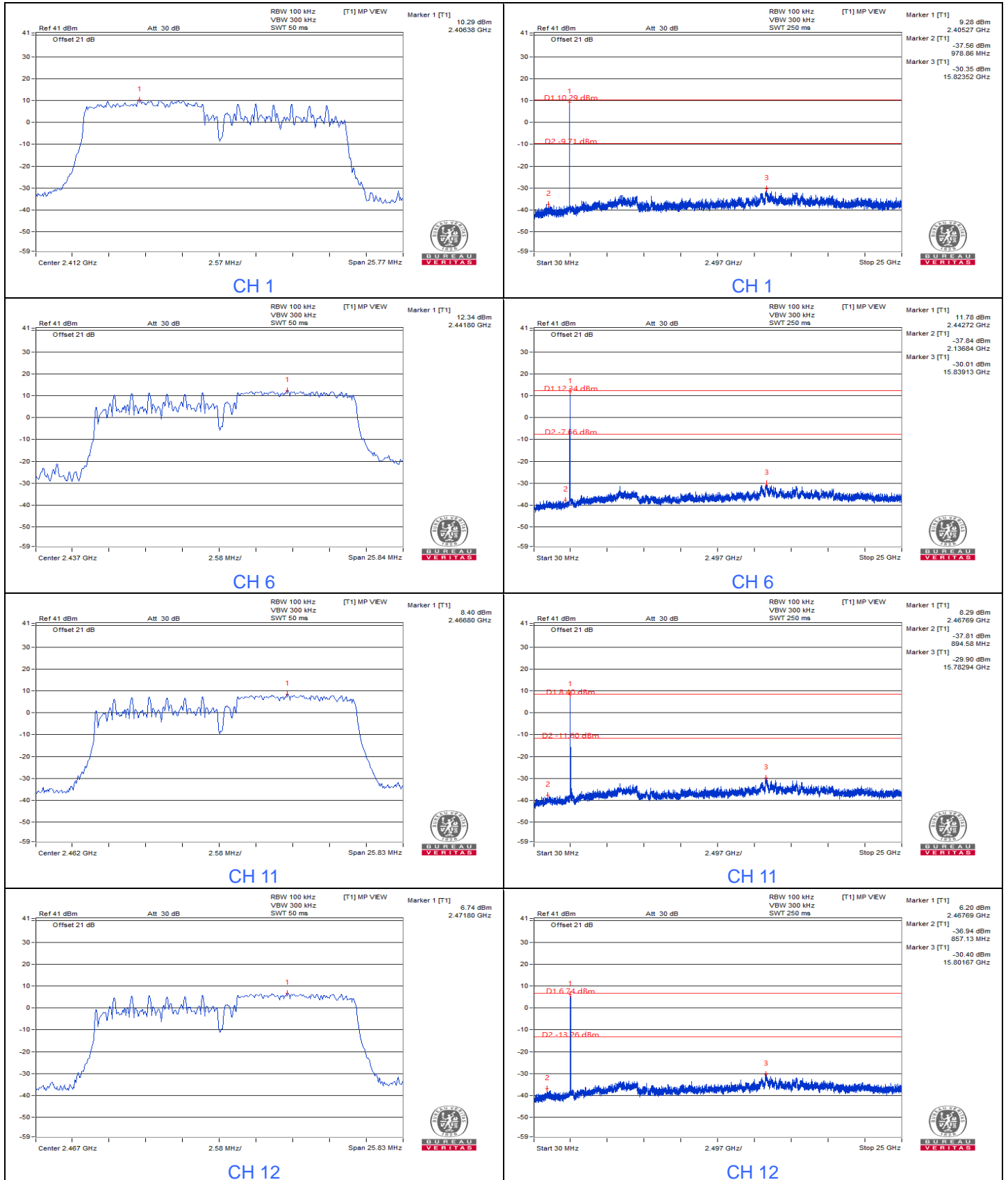

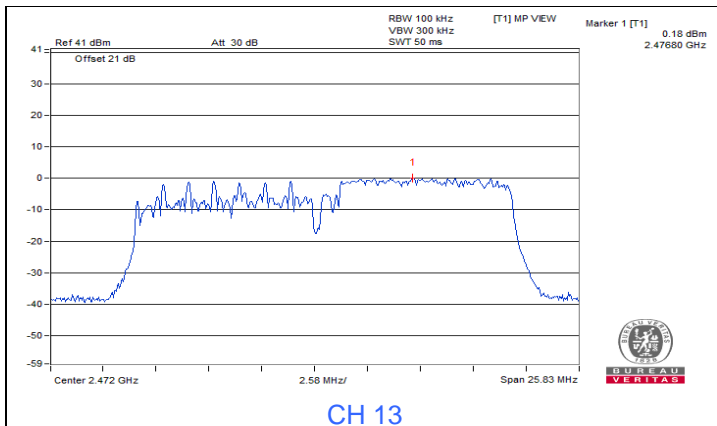

CH 13

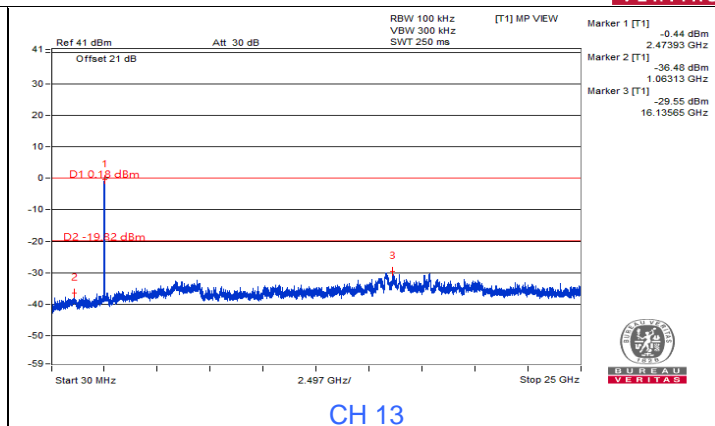

CH 13

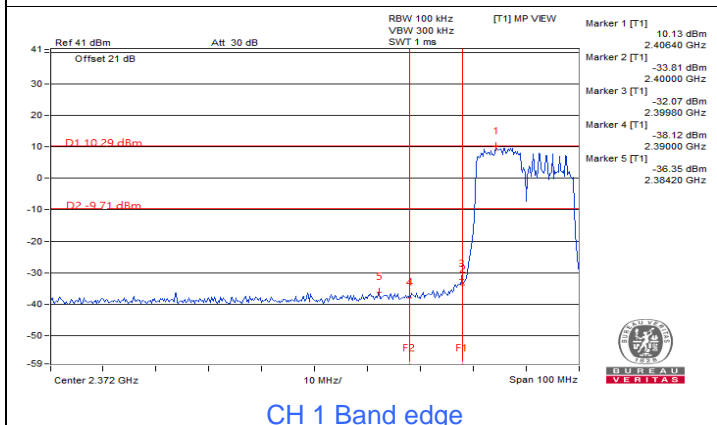

CH 1 Band edge

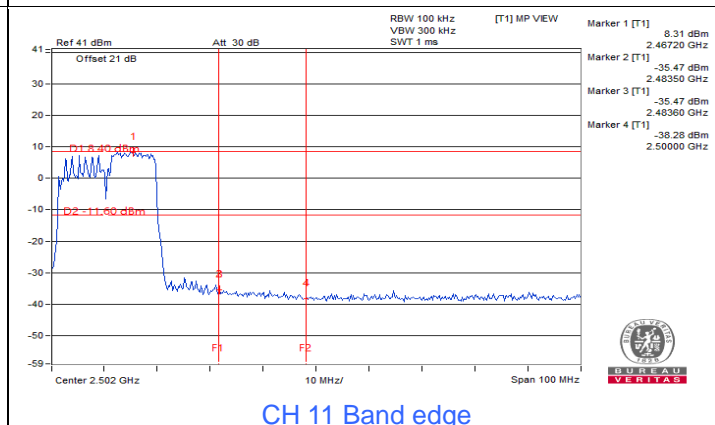

CH 11 Band edge

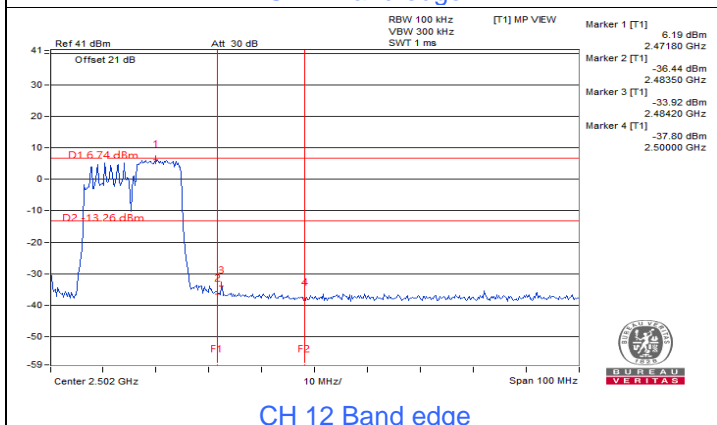

CH 12 Band edge

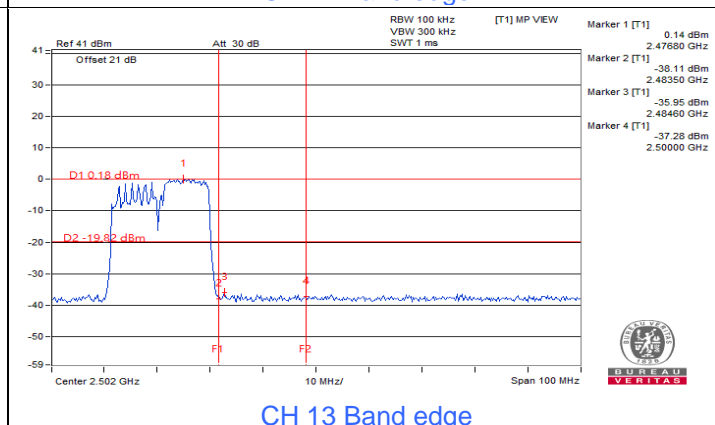

CH 13 Band edge

7.5 AC Power Conducted Emissions

Mode B

RF Mode	802.11g	Channel	CH 6 : 2437 MHz
Frequency Range	150kHz ~ 30MHz	Detector Function & Resolution Bandwidth	Quasi-Peak (QP) / Average (AV), 9 kHz
Input Power (System)	120 Vac, 60 Hz	Environmental Conditions	23°C, 71% RH
Tested By	Sampson Chen		

Phase Of Power : Line (L)

No	Frequency (MHz)	Correction Factor (dB)	Reading Value (dBuV)		Emission Level (dBuV)		Limit (dBuV)		Margin (dB)	
			Q.P.	AV.	Q.P.	AV.	Q.P.	AV.	Q.P.	AV.
1	0.17734	9.96	40.58	20.78	50.54	30.74	64.61	54.61	-14.07	-23.87
2	0.19297	9.96	42.90	24.48	52.86	34.44	63.91	53.91	-11.05	-19.47
3	0.27891	9.96	28.35	4.25	38.31	14.21	60.85	50.85	-22.54	-36.64
4	3.72266	10.14	29.63	21.79	39.77	31.93	56.00	46.00	-16.23	-14.07
5	22.52734	11.14	24.90	19.43	36.04	30.57	60.00	50.00	-23.96	-19.43
6	28.27734	11.23	31.36	26.73	42.59	37.96	60.00	50.00	-17.41	-12.04

Remarks:

1. Q.P. and AV. are abbreviations of quasi-peak and average individually.
2. The emission levels of other frequencies were very low against the limit.
3. Margin value = Emission level – Limit value
4. Correction factor = Insertion loss + Cable loss
5. Emission Level = Correction Factor + Reading Value

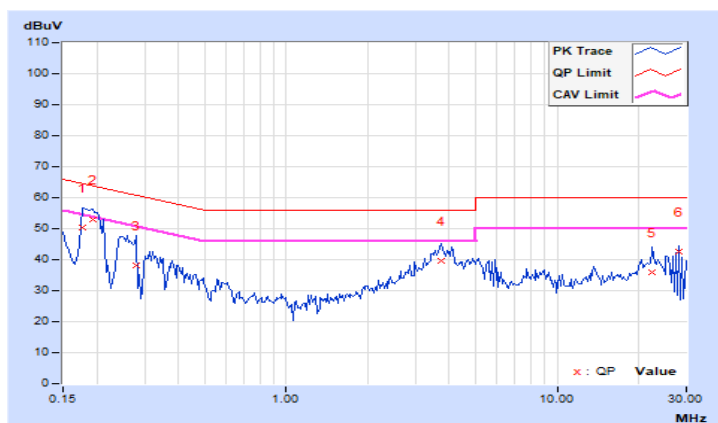

RF Mode	802.11g	Channel	CH 6 : 2437 MHz
Frequency Range	150kHz ~ 30MHz	Detector Function & Resolution Bandwidth	Quasi-Peak (QP) / Average (AV), 9 kHz
Input Power (System)	120 Vac, 60 Hz	Environmental Conditions	23°C, 71% RH
Tested By	Sampson Chen		

Phase Of Power : Neutral (N)										
No	Frequency (MHz)	Correction Factor (dB)	Reading Value (dBuV)		Emission Level (dBuV)		Limit (dBuV)		Margin (dB)	
			Q.P.	AV.	Q.P.	AV.	Q.P.	AV.	Q.P.	AV.
1	0.18516	9.94	44.97	30.91	54.91	40.85	64.25	54.25	-9.34	-13.40
2	0.24375	9.94	36.32	20.40	46.26	30.34	61.97	51.97	-15.71	-21.63
3	0.29844	9.94	25.84	5.50	35.78	15.44	60.29	50.29	-24.51	-34.85
4	3.44922	10.08	27.96	20.14	38.04	30.22	56.00	46.00	-17.96	-15.78
5	3.87500	10.10	30.74	21.86	40.84	31.96	56.00	46.00	-15.16	-14.04
6	28.25391	10.87	31.54	30.07	42.41	40.94	60.00	50.00	-17.59	-9.06

Remarks:

1. Q.P. and AV. are abbreviations of quasi-peak and average individually.
2. The emission levels of other frequencies were very low against the limit.
3. Margin value = Emission level – Limit value
4. Correction factor = Insertion loss + Cable loss
5. Emission Level = Correction Factor + Reading Value

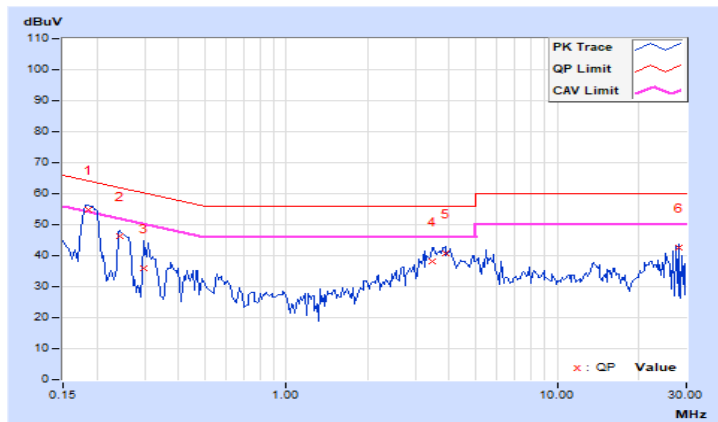

7.6 Unwanted Emissions below 1 GHz

Mode A

RF Mode	802.11g	Channel	CH 6 : 2437 MHz
Frequency Range	30 MHz ~ 1 GHz	Detector Function & Bandwidth	(QP) RB = 120kHz
Input Power (System)	120 Vac, 60 Hz	Environmental Conditions	28°C, 76% RH
Tested By	Louis Yang		

Antenna Polarity & Test Distance : Horizontal at 3 m

No	Frequency (MHz)	Emission Level (dBuV/m)	Limit (dBuV/m)	Margin (dB)	Antenna Height (m)	Table Angle (Degree)	Raw Value (dBuV)	Correction Factor (dB/m)
1	39.30	28.6 QP	40.0	-11.4	1.12 H	360	41.9	-13.3
2	77.40	19.5 QP	40.0	-20.5	1.00 H	325	36.4	-16.9
3	232.50	30.5 QP	46.0	-15.5	1.52 H	360	45.6	-15.1
4	284.60	31.6 QP	46.0	-14.4	1.50 H	74	44.2	-12.6
5	376.20	21.4 QP	46.0	-24.6	1.05 H	360	31.9	-10.5
6	444.10	25.8 QP	46.0	-20.2	1.00 H	122	34.2	-8.4

Remarks:

1. Emission Level(dBuV/m) = Raw Value(dBuV) + Correction Factor(dB/m)
2. Correction Factor(dB/m) = Antenna Factor(dB/m) + Cable Factor(dB) – Pre-Amplifier Factor(dB)
3. Margin value = Emission Level – Limit value
4. The other emission levels were very low against the limit of frequency range 30 MHz ~ 1 GHz.
5. The emission levels were very low against the limit of frequency range 9 kHz ~ 30 MHz: the amplitude of spurious emissions attenuated more than 20 dB below the permissible value to be report.

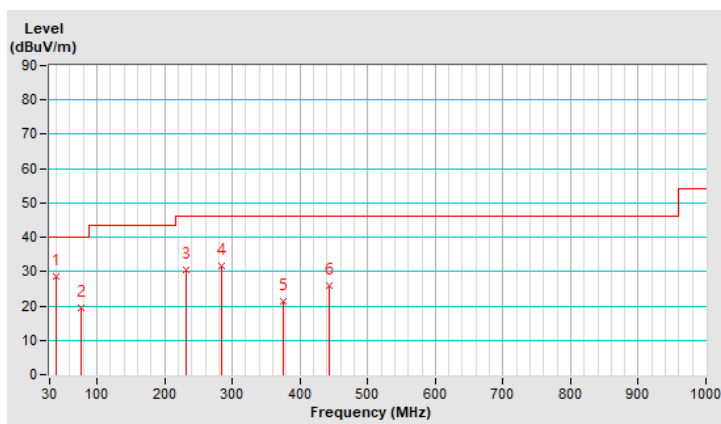

RF Mode	802.11g	Channel	CH 6 : 2437 MHz
Frequency Range	30 MHz ~ 1 GHz	Detector Function & Bandwidth	(QP) RB = 120kHz
Input Power (System)	120 Vac, 60 Hz	Environmental Conditions	28°C, 76% RH
Tested By	Louis Yang		

Antenna Polarity & Test Distance : Vertical at 3 m								
No	Frequency (MHz)	Emission Level (dBuV/m)	Limit (dBuV/m)	Margin (dB)	Antenna Height (m)	Table Angle (Degree)	Raw Value (dBuV)	Correction Factor (dB/m)
1	35.50	24.8 QP	40.0	-15.2	1.05 V	62	38.4	-13.6
2	138.10	28.1 QP	43.5	-15.4	1.00 V	325	41.4	-13.3
3	174.20	18.6 QP	43.5	-24.9	1.00 V	299	32.2	-13.6
4	228.20	34.2 QP	46.0	-11.8	1.00 V	172	49.9	-15.7
5	362.50	22.5 QP	46.0	-23.5	1.00 V	38	33.4	-10.9
6	637.20	23.6 QP	46.0	-22.4	1.12 V	355	28.2	-4.6

Remarks:

1. Emission Level(dBuV/m) = Raw Value(dBuV) + Correction Factor(dB/m)
2. Correction Factor(dB/m) = Antenna Factor(dB/m) + Cable Factor(dB) – Pre-Amplifier Factor(dB)
3. Margin value = Emission Level – Limit value
4. The other emission levels were very low against the limit of frequency range 30 MHz ~ 1 GHz.
5. The emission levels were very low against the limit of frequency range 9 kHz ~ 30 MHz: the amplitude of spurious emissions attenuated more than 20 dB below the permissible value to be report.

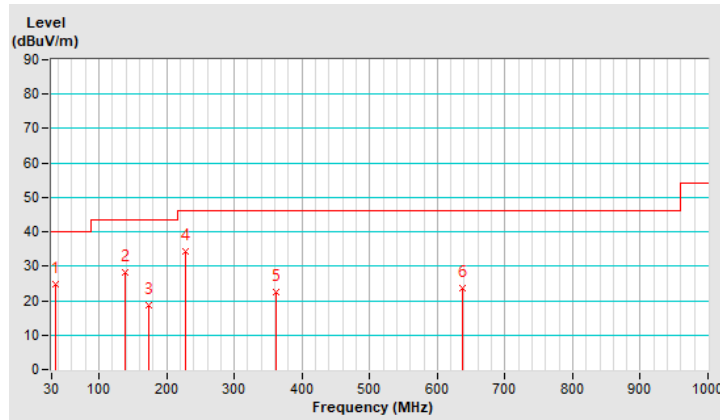

Mode B

RF Mode	802.11g	Channel	CH 6 : 2437 MHz
Frequency Range	30 MHz ~ 1 GHz	Detector Function & Bandwidth	(QP) RB = 120kHz
Input Power (System)	120 Vac, 60 Hz	Environmental Conditions	28°C, 76% RH
Tested By	Louis Yang		

Antenna Polarity & Test Distance : Horizontal at 3 m								
No	Frequency (MHz)	Emission Level (dBuV/m)	Limit (dBuV/m)	Margin (dB)	Antenna Height (m)	Table Angle (Degree)	Raw Value (dBuV)	Correction Factor (dB/m)
1	44.10	32.4 QP	40.0	-7.6	1.12 H	360	45.3	-12.9
2	74.50	20.5 QP	40.0	-19.5	1.00 H	325	36.5	-16.0
3	235.90	31.7 QP	46.0	-14.3	1.52 H	360	46.4	-14.7
4	285.70	31.9 QP	46.0	-14.1	1.50 H	74	44.4	-12.5
5	386.90	22.7 QP	46.0	-23.3	1.05 H	360	32.9	-10.2
6	454.70	26.9 QP	46.0	-19.1	1.00 H	122	35.0	-8.1

Remarks:

1. Emission Level(dBuV/m) = Raw Value(dBuV) + Correction Factor(dB/m)
2. Correction Factor(dB/m) = Antenna Factor(dB/m) + Cable Factor(dB) – Pre-Amplifier Factor(dB)
3. Margin value = Emission Level – Limit value
4. The other emission levels were very low against the limit of frequency range 30 MHz ~ 1 GHz.
5. The emission levels were very low against the limit of frequency range 9 kHz ~ 30 MHz: the amplitude of spurious emissions attenuated more than 20 dB below the permissible value to be report.

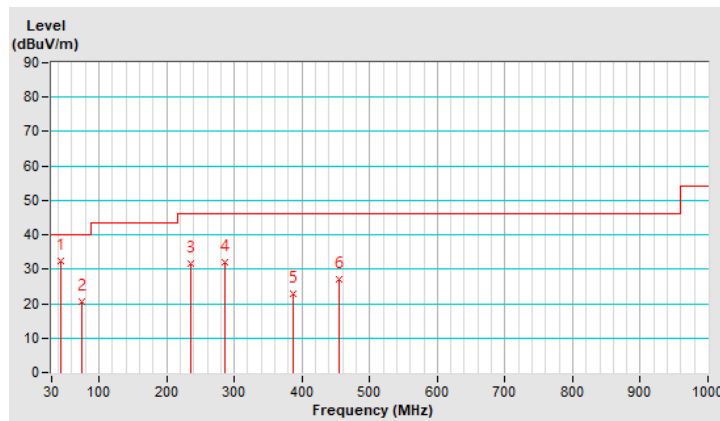

RF Mode	802.11g	Channel	CH 6 : 2437 MHz
Frequency Range	30 MHz ~ 1 GHz	Detector Function & Bandwidth	(QP) RB = 120kHz
Input Power (System)	120 Vac, 60 Hz	Environmental Conditions	28°C, 76% RH
Tested By	Louis Yang		

Antenna Polarity & Test Distance : Vertical at 3 m								
No	Frequency (MHz)	Emission Level (dBuV/m)	Limit (dBuV/m)	Margin (dB)	Antenna Height (m)	Table Angle (Degree)	Raw Value (dBuV)	Correction Factor (dB/m)
1	36.20	23.6 QP	40.0	-16.4	1.05 V	62	37.2	-13.6
2	138.40	26.4 QP	43.5	-17.1	1.00 V	325	39.7	-13.3
3	177.60	22.0 QP	43.5	-21.5	1.00 V	299	36.1	-14.1
4	233.40	29.3 QP	46.0	-16.7	1.00 V	172	44.3	-15.0
5	363.80	20.3 QP	46.0	-25.7	1.00 V	38	31.2	-10.9
6	640.50	30.9 QP	46.0	-15.1	1.12 V	355	35.4	-4.5

Remarks:

1. Emission Level(dBuV/m) = Raw Value(dBuV) + Correction Factor(dB/m)
2. Correction Factor(dB/m) = Antenna Factor(dB/m) + Cable Factor(dB) – Pre-Amplifier Factor(dB)
3. Margin value = Emission Level – Limit value
4. The other emission levels were very low against the limit of frequency range 30 MHz ~ 1 GHz.
5. The emission levels were very low against the limit of frequency range 9 kHz ~ 30 MHz: the amplitude of spurious emissions attenuated more than 20 dB below the permissible value to be report.

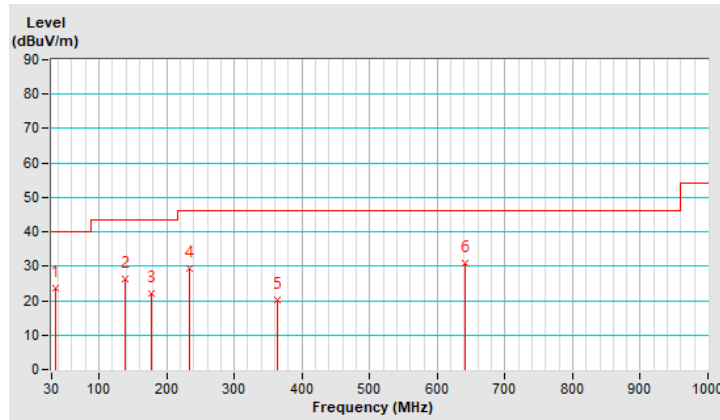

Mode C

RF Mode	802.11g	Channel	CH 6 : 2437 MHz
Frequency Range	30 MHz ~ 1 GHz	Detector Function & Bandwidth	(QP) RB = 120kHz
Input Power (System)	120 Vac, 60 Hz	Environmental Conditions	28°C, 76% RH
Tested By	Louis Yang		

Antenna Polarity & Test Distance : Horizontal at 3 m								
No	Frequency (MHz)	Emission Level (dBuV/m)	Limit (dBuV/m)	Margin (dB)	Antenna Height (m)	Table Angle (Degree)	Raw Value (dBuV)	Correction Factor (dB/m)
1	44.30	30.3 QP	40.0	-9.7	1.12 H	360	43.2	-12.9
2	76.00	18.3 QP	40.0	-21.7	1.00 H	325	34.8	-16.5
3	231.90	29.6 QP	46.0	-16.4	1.52 H	360	44.8	-15.2
4	282.90	29.3 QP	46.0	-16.7	1.50 H	74	42.0	-12.7
5	382.20	19.3 QP	46.0	-26.7	1.05 H	360	29.7	-10.4
6	449.80	22.8 QP	46.0	-23.2	1.00 H	122	31.0	-8.2

Remarks:

1. Emission Level(dBuV/m) = Raw Value(dBuV) + Correction Factor(dB/m)
2. Correction Factor(dB/m) = Antenna Factor(dB/m) + Cable Factor(dB) – Pre-Amplifier Factor(dB)
3. Margin value = Emission Level – Limit value
4. The other emission levels were very low against the limit of frequency range 30 MHz ~ 1 GHz.
5. The emission levels were very low against the limit of frequency range 9 kHz ~ 30 MHz: the amplitude of spurious emissions attenuated more than 20 dB below the permissible value to be report.

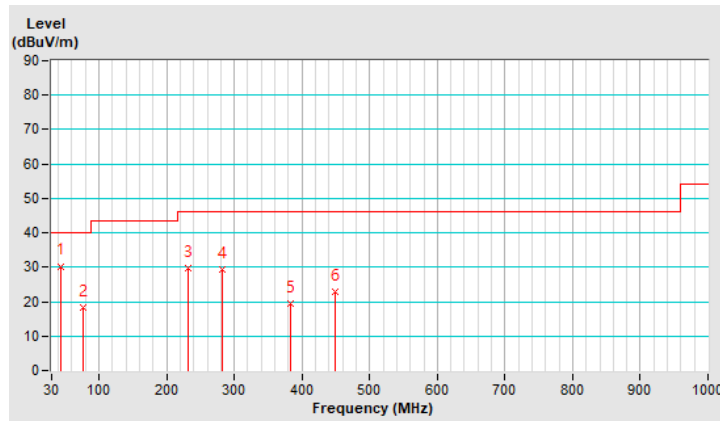

RF Mode	802.11g	Channel	CH 6 : 2437 MHz
Frequency Range	30 MHz ~ 1 GHz	Detector Function & Bandwidth	(QP) RB = 120kHz
Input Power (System)	120 Vac, 60 Hz	Environmental Conditions	28°C, 76% RH
Tested By	Louis Yang		

Antenna Polarity & Test Distance : Vertical at 3 m								
No	Frequency (MHz)	Emission Level (dBuV/m)	Limit (dBuV/m)	Margin (dB)	Antenna Height (m)	Table Angle (Degree)	Raw Value (dBuV)	Correction Factor (dB/m)
1	40.30	26.8 QP	40.0	-13.2	1.05 V	62	40.0	-13.2
2	140.30	29.5 QP	43.5	-14.0	1.00 V	325	42.6	-13.1
3	180.00	24.4 QP	43.5	-19.1	1.00 V	299	38.8	-14.4
4	234.60	35.9 QP	46.0	-10.1	1.00 V	172	50.7	-14.8
5	367.90	24.3 QP	46.0	-21.7	1.00 V	38	35.0	-10.7
6	641.10	27.9 QP	46.0	-18.1	1.12 V	355	32.4	-4.5

Remarks:

1. Emission Level(dBuV/m) = Raw Value(dBuV) + Correction Factor(dB/m)
2. Correction Factor(dB/m) = Antenna Factor(dB/m) + Cable Factor(dB) – Pre-Amplifier Factor(dB)
3. Margin value = Emission Level – Limit value
4. The other emission levels were very low against the limit of frequency range 30 MHz ~ 1 GHz.
5. The emission levels were very low against the limit of frequency range 9 kHz ~ 30 MHz: the amplitude of spurious emissions attenuated more than 20 dB below the permissible value to be report.

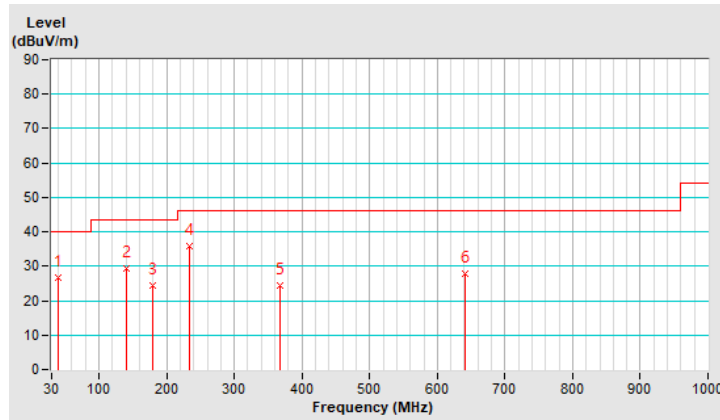

7.7 Unwanted Emissions above 1 GHz

Mode A

RF Mode	802.11b	Channel	CH 1 : 2412 MHz
Frequency Range	1 GHz ~ 25 GHz	Detector Function & Bandwidth	(PK) RB = 1 MHz, VB = 3 MHz (AV) RB = 1 MHz, VB = 10 Hz
Input Power (System)	120 Vac, 60 Hz	Environmental Conditions	29°C, 78% RH
Tested By	Louis Yang		

Antenna Polarity & Test Distance : Horizontal at 3 m								
No	Frequency (MHz)	Emission Level (dBuV/m)	Limit (dBuV/m)	Margin (dB)	Antenna Height (m)	Table Angle (Degree)	Raw Value (dBuV)	Correction Factor (dB/m)
1	2390.00	59.1 PK	74.0	-14.9	3.32 H	297	62.5	-3.4
2	2390.00	52.4 AV	54.0	-1.6	3.32 H	297	55.8	-3.4
3	*2412.00	107.1 PK			3.32 H	297	110.5	-3.4
4	*2412.00	105.0 AV			3.32 H	297	108.4	-3.4
5	4824.00	39.0 PK	74.0	-35.0	3.18 H	294	37.7	1.3
6	4824.00	33.3 AV	54.0	-20.7	3.18 H	294	32.0	1.3

Remarks:

1. Emission Level(dBuV/m) = Raw Value(dBuV) + Correction Factor(dB/m)
2. Correction Factor(dB/m) = Antenna Factor(dB/m) + Cable Factor(dB) – Pre-Amplifier Factor(dB)
3. Margin value = Emission Level – Limit value
4. The other emission levels were very low against the limit.
5. " * ": Fundamental frequency, the limit was restricted at the RF Output Power.

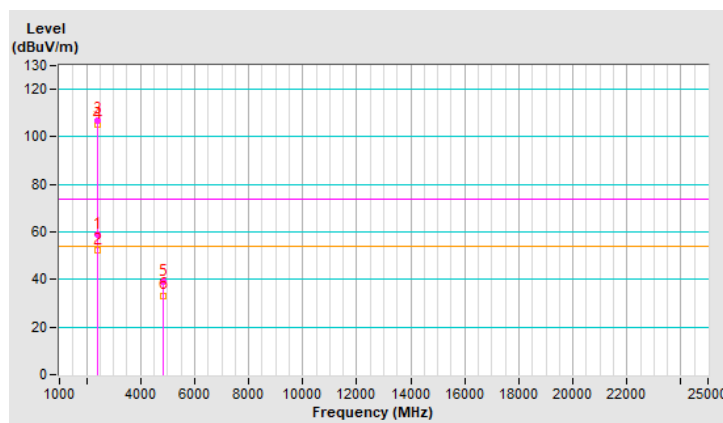

RF Mode	802.11b	Channel	CH 1 : 2412 MHz
Frequency Range	1 GHz ~ 25 GHz	Detector Function & Bandwidth	(PK) RB = 1 MHz, VB = 3 MHz (AV) RB = 1 MHz, VB = 10 Hz
Input Power (System)	120 Vac, 60 Hz	Environmental Conditions	29°C, 78% RH
Tested By	Louis Yang		

Antenna Polarity & Test Distance : Vertical at 3 m								
No	Frequency (MHz)	Emission Level (dBuV/m)	Limit (dBuV/m)	Margin (dB)	Antenna Height (m)	Table Angle (Degree)	Raw Value (dBuV)	Correction Factor (dB/m)
1	2390.00	57.4 PK	74.0	-16.6	1.09 V	335	60.8	-3.4
2	2390.00	48.7 AV	54.0	-5.3	1.09 V	335	52.1	-3.4
3	*2412.00	103.7 PK			1.09 V	335	107.1	-3.4
4	*2412.00	101.2 AV			1.09 V	335	104.6	-3.4
5	4824.00	40.2 PK	74.0	-33.8	2.96 V	250	38.9	1.3
6	4824.00	32.8 AV	54.0	-21.2	2.96 V	250	31.5	1.3

Remarks:

1. Emission Level(dBuV/m) = Raw Value(dBuV) + Correction Factor(dB/m)
2. Correction Factor(dB/m) = Antenna Factor(dB/m) + Cable Factor(dB) – Pre-Amplifier Factor(dB)
3. Margin value = Emission Level – Limit value
4. The other emission levels were very low against the limit.
5. " * " : Fundamental frequency, the limit was restricted at the RF Output Power.

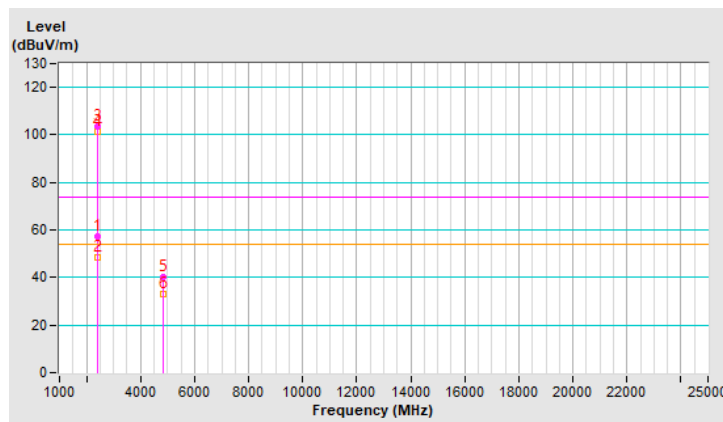

RF Mode	802.11b	Channel	CH 6 : 2437 MHz
Frequency Range	1 GHz ~ 25 GHz	Detector Function & Bandwidth	(PK) RB = 1 MHz, VB = 3 MHz (AV) RB = 1 MHz, VB = 10 Hz
Input Power (System)	120 Vac, 60 Hz	Environmental Conditions	29°C, 78% RH
Tested By	Louis Yang		

Antenna Polarity & Test Distance : Horizontal at 3 m								
No	Frequency (MHz)	Emission Level (dBuV/m)	Limit (dBuV/m)	Margin (dB)	Antenna Height (m)	Table Angle (Degree)	Raw Value (dBuV)	Correction Factor (dB/m)
1	2390.00	56.5 PK	74.0	-17.5	3.21 H	281	59.9	-3.4
2	2390.00	45.6 AV	54.0	-8.4	3.21 H	281	49.0	-3.4
3	*2437.00	107.6 PK			3.21 H	281	111.0	-3.4
4	*2437.00	105.3 AV			3.21 H	281	108.7	-3.4
5	2483.50	55.8 PK	74.0	-18.2	3.21 H	281	59.2	-3.4
6	2483.50	44.2 AV	54.0	-9.8	3.21 H	281	47.6	-3.4
7	4874.00	41.1 PK	74.0	-32.9	3.16 H	294	39.8	1.3
8	4874.00	34.6 AV	54.0	-19.4	3.16 H	294	33.3	1.3
9	7311.00	46.9 PK	74.0	-27.1	3.59 H	297	39.9	7.0
10	7311.00	38.9 AV	54.0	-15.1	3.59 H	297	31.9	7.0

Remarks:

1. Emission Level(dBuV/m) = Raw Value(dBuV) + Correction Factor(dB/m)
2. Correction Factor(dB/m) = Antenna Factor(dB/m) + Cable Factor(dB) – Pre-Amplifier Factor(dB)
3. Margin value = Emission Level – Limit value
4. The other emission levels were very low against the limit.
5. " * ": Fundamental frequency, the limit was restricted at the RF Output Power.

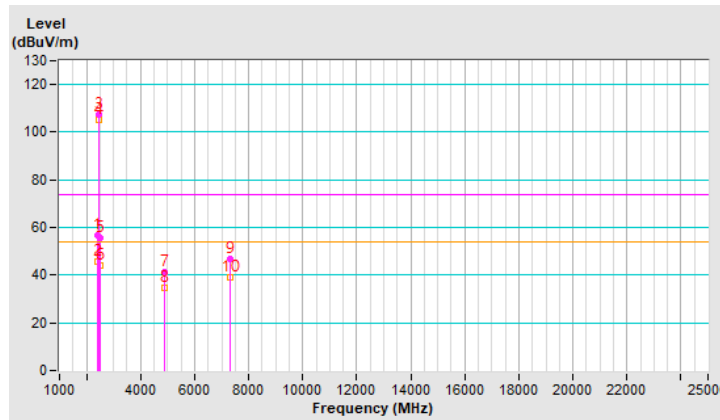

RF Mode	802.11b	Channel	CH 6 : 2437 MHz
Frequency Range	1 GHz ~ 25 GHz	Detector Function & Bandwidth	(PK) RB = 1 MHz, VB = 3 MHz (AV) RB = 1 MHz, VB = 10 Hz
Input Power (System)	120 Vac, 60 Hz	Environmental Conditions	29°C, 78% RH
Tested By	Louis Yang		

Antenna Polarity & Test Distance : Vertical at 3 m								
No	Frequency (MHz)	Emission Level (dBuV/m)	Limit (dBuV/m)	Margin (dB)	Antenna Height (m)	Table Angle (Degree)	Raw Value (dBuV)	Correction Factor (dB/m)
1	2390.00	57.7 PK	74.0	-16.3	1.07 V	352	61.1	-3.4
2	2390.00	48.4 AV	54.0	-5.6	1.07 V	352	51.8	-3.4
3	*2437.00	105.2 PK			1.07 V	352	108.6	-3.4
4	*2437.00	103.0 AV			1.07 V	352	106.4	-3.4
5	2483.50	55.7 PK	74.0	-18.3	1.07 V	352	59.1	-3.4
6	2483.50	45.3 AV	54.0	-8.7	1.07 V	352	48.7	-3.4
7	4874.00	41.0 PK	74.0	-33.0	3.13 V	253	39.7	1.3
8	4874.00	34.4 AV	54.0	-19.6	3.13 V	253	33.1	1.3
9	7311.00	46.7 PK	74.0	-27.3	3.64 V	289	39.7	7.0
10	7311.00	38.8 AV	54.0	-15.2	3.64 V	289	31.8	7.0

Remarks:

1. Emission Level(dBuV/m) = Raw Value(dBuV) + Correction Factor(dB/m)
2. Correction Factor(dB/m) = Antenna Factor(dB/m) + Cable Factor(dB) – Pre-Amplifier Factor(dB)
3. Margin value = Emission Level – Limit value
4. The other emission levels were very low against the limit.
5. " * ": Fundamental frequency, the limit was restricted at the RF Output Power.

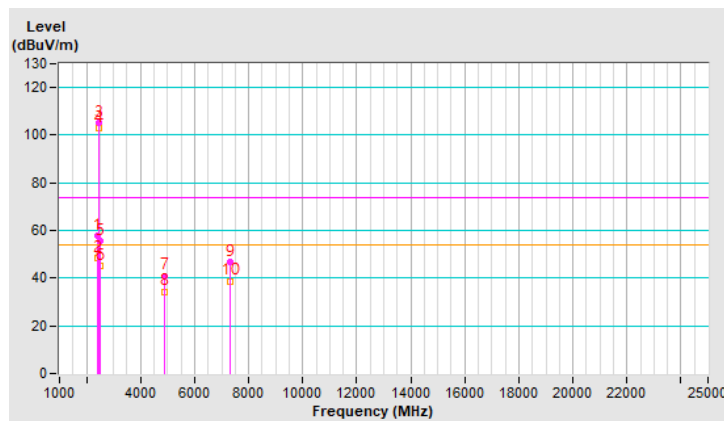

RF Mode	802.11b	Channel	CH 11 : 2462 MHz
Frequency Range	1 GHz ~ 25 GHz	Detector Function & Bandwidth	(PK) RB = 1 MHz, VB = 3 MHz (AV) RB = 1 MHz, VB = 10 Hz
Input Power (System)	120 Vac, 60 Hz	Environmental Conditions	29°C, 78% RH
Tested By	Louis Yang		

Antenna Polarity & Test Distance : Horizontal at 3 m								
No	Frequency (MHz)	Emission Level (dBuV/m)	Limit (dBuV/m)	Margin (dB)	Antenna Height (m)	Table Angle (Degree)	Raw Value (dBuV)	Correction Factor (dB/m)
1	*2462.00	106.1 PK			3.19 H	290	109.5	-3.4
2	*2462.00	105.0 AV			3.19 H	290	108.4	-3.4
3	2483.50	59.2 PK	74.0	-14.8	3.19 H	290	62.6	-3.4
4	2483.50	52.1 AV	54.0	-1.9	3.19 H	290	55.5	-3.4
5	4924.00	40.9 PK	74.0	-33.1	3.09 H	277	39.7	1.2
6	4924.00	33.6 AV	54.0	-20.4	3.09 H	277	32.4	1.2
7	7386.00	47.2 PK	74.0	-26.8	3.43 H	270	40.2	7.0
8	7386.00	38.1 AV	54.0	-15.9	3.43 H	270	31.1	7.0

Remarks:

1. Emission Level(dBuV/m) = Raw Value(dBuV) + Correction Factor(dB/m)
2. Correction Factor(dB/m) = Antenna Factor(dB/m) + Cable Factor(dB) – Pre-Amplifier Factor(dB)
3. Margin value = Emission Level – Limit value
4. The other emission levels were very low against the limit.
5. " * ": Fundamental frequency, the limit was restricted at the RF Output Power.

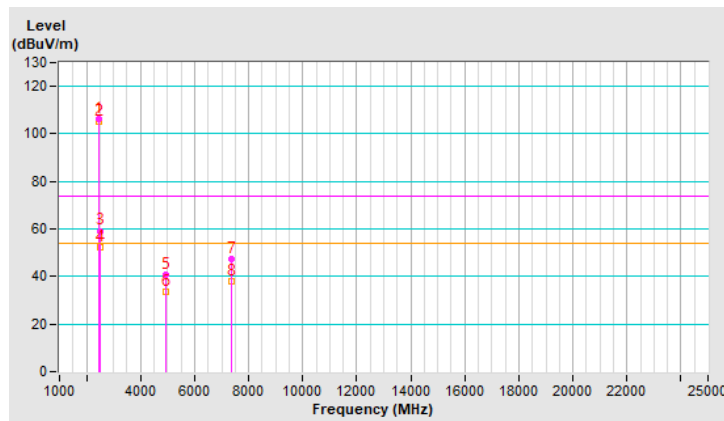

RF Mode	802.11b	Channel	CH 11 : 2462 MHz
Frequency Range	1 GHz ~ 25 GHz	Detector Function & Bandwidth	(PK) RB = 1 MHz, VB = 3 MHz (AV) RB = 1 MHz, VB = 10 Hz
Input Power (System)	120 Vac, 60 Hz	Environmental Conditions	29°C, 78% RH
Tested By	Louis Yang		

Antenna Polarity & Test Distance : Vertical at 3 m								
No	Frequency (MHz)	Emission Level (dBuV/m)	Limit (dBuV/m)	Margin (dB)	Antenna Height (m)	Table Angle (Degree)	Raw Value (dBuV)	Correction Factor (dB/m)
1	*2462.00	106.5 PK			1.01 V	335	109.9	-3.4
2	*2462.00	104.1 AV			1.01 V	335	107.5	-3.4
3	2483.50	60.7 PK	74.0	-13.3	1.01 V	335	64.1	-3.4
4	2483.50	52.6 AV	54.0	-1.4	1.01 V	335	56.0	-3.4
5	4924.00	55.7 PK	74.0	-18.3	3.31 V	293	54.5	1.2
6	4924.00	44.3 AV	54.0	-9.7	3.31 V	293	43.1	1.2
7	7386.00	40.8 PK	74.0	-33.2	3.24 V	297	33.8	7.0
8	7386.00	34.3 AV	54.0	-19.7	3.24 V	297	27.3	7.0

Remarks:

1. Emission Level(dBuV/m) = Raw Value(dBuV) + Correction Factor(dB/m)
2. Correction Factor(dB/m) = Antenna Factor(dB/m) + Cable Factor(dB) – Pre-Amplifier Factor(dB)
3. Margin value = Emission Level – Limit value
4. The other emission levels were very low against the limit.
5. " * ": Fundamental frequency, the limit was restricted at the RF Output Power.

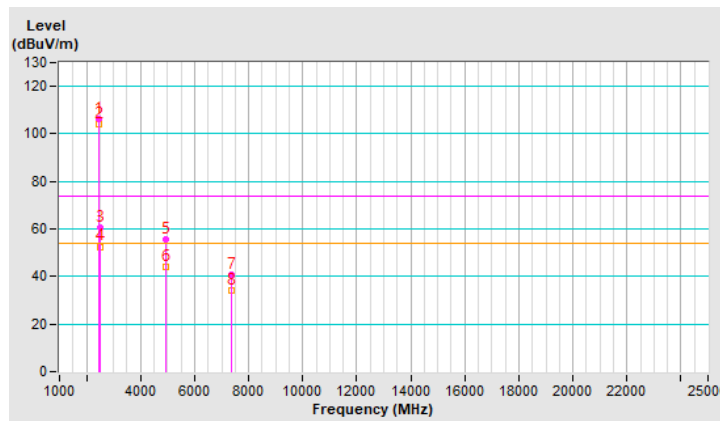

RF Mode	802.11b	Channel	CH 12 : 2467 MHz
Frequency Range	1 GHz ~ 25 GHz	Detector Function & Bandwidth	(PK) RB = 1 MHz, VB = 3 MHz (AV) RB = 1 MHz, VB = 10 Hz
Input Power (System)	120 Vac, 60 Hz	Environmental Conditions	29°C, 78% RH
Tested By	Louis Yang		

Antenna Polarity & Test Distance : Horizontal at 3 m								
No	Frequency (MHz)	Emission Level (dBuV/m)	Limit (dBuV/m)	Margin (dB)	Antenna Height (m)	Table Angle (Degree)	Raw Value (dBuV)	Correction Factor (dB/m)
1	*2467.00	107.1 PK			3.19 H	302	110.5	-3.4
2	*2467.00	104.7 AV			3.19 H	302	108.1	-3.4
3	2483.50	59.3 PK	74.0	-14.7	3.19 H	302	62.7	-3.4
4	2483.50	52.2 AV	54.0	-1.8	3.19 H	302	55.6	-3.4
5	4934.00	41.5 PK	74.0	-32.5	3.16 H	242	40.3	1.2
6	4934.00	34.4 AV	54.0	-19.6	3.16 H	242	33.2	1.2
7	7401.00	46.5 PK	74.0	-27.5	3.34 H	232	39.5	7.0
8	7401.00	38.5 AV	54.0	-15.5	3.34 H	232	31.5	7.0

Remarks:

1. Emission Level(dBuV/m) = Raw Value(dBuV) + Correction Factor(dB/m)
2. Correction Factor(dB/m) = Antenna Factor(dB/m) + Cable Factor(dB) – Pre-Amplifier Factor(dB)
3. Margin value = Emission Level – Limit value
4. The other emission levels were very low against the limit.
5. " * ": Fundamental frequency, the limit was restricted at the RF Output Power.

