



(Realtek RTL8822C)

Combo NGFF Type1216 Module User's Manual

Preliminary Version

2020/01/14



REALTEK

Realtek Semiconductor Corp.

No. 2, Innovation Road II, Hsinchu Science Park, Hsinchu 300, Taiwan

Tel.: +886-3-578-0211. Fax: +886-3-577-6047

www.realtek.com

CONTENT

ENVIRONMENTAL **3**

OPERATING 3

STORAGE..... 3

MTBF CALCULATION 3

WARNING **4**

 Federal Communication Commission Interference Statement 4

INDUSTRY CANADA STATEMENT 8

NCC 警語 **8**

ENVIRONMENTAL

Operating

Operating Temperature: 0°C to +70 °C

Relative Humidity: 5-90% (non-condensing)

Storage

Temperature: -40°C to +80°C (non-operating)

Relevant Humidity: 5-95% (non-condensing)

MTBF caculation

Over 150,000hours

Warning

Federal Communication Commission Interference Statement

This device complies with Part 15 of the FCC Rules. Operation is subject to the following two conditions: (1) This device may not cause harmful interference, and (2) this device must accept any interference received, including interference that may cause undesired operation.

This equipment has been tested and found to comply with the limits for a Class B digital device, pursuant to Part 15 of the FCC Rules. These limits are designed to provide reasonable protection against harmful interference in a residential installation. This equipment generates, uses and can radiate radio frequency energy and, if not installed and used in accordance with the instructions, may cause harmful interference to radio communications. However, there is no guarantee that interference will not occur in a particular installation. If this equipment does cause harmful interference to radio or television reception, which can be determined by turning the equipment off and on, the user is encouraged to try to correct the interference by one of the following measures:

- Reorient or relocate the receiving antenna.
- Increase the separation between the equipment and receiver.
- Connect the equipment into an outlet on a circuit different from that to which the receiver is connected.
- Consult the dealer or an experienced radio/TV technician for help.

FCC Caution: Any changes or modifications not expressly approved by the party responsible for compliance could void the user's authority to operate this equipment.

This transmitter must not be co-located or operating in conjunction with any other antenna or transmitter.

Operations in the 5.15-5.25GHz band are restricted to indoor usage only.

- The SAR test is according to KDB 616217 for test requirements.”
- The maximum output power is reduced by software to perform SAR evaluation as application.

This device meets all the other requirements specified in Part 15E, Section 15.407 of the FCC Rules.

Radiation Exposure Statement: (Portable)

The product comply with the FCC portable RF exposure limit set forth for an uncontrolled environment and are safe for intended operation as described in this manual. The further RF exposure reduction can be achieved if the product can be kept as far as possible from the user body or set the device to lower output power if such function is available.

The SAR evaluation is according to KDB 616217, and the module approach distance restriction is 5 mm for notebook, 10 mm for tablet.

Radiation Exposure Statement: (Mobile)

This equipment complies with FCC radiation exposure limits set forth for an uncontrolled environment. This equipment should be installed and operated with minimum distance 20cm between the radiator & your body.

This module is intended for OEM integrators only. Per FCC KDB 996369 D03 OEM Manual v01 guidance, the following conditions must be strictly followed when using this certified module:

KDB 996369 D03 OEM Manual v01 rule sections:

2.2 List of applicable FCC rules

This module has been tested for compliance to FCC Part 15

2.3 Summarize the specific operational use conditions

The module is tested for standalone mobile RF exposure use condition. Any other usage conditions such as co-location with other transmitter(s) or being used in a portable condition will need a separate reassessment through a class II permissive change application or new certification.

2.4 Limited module procedures

Not applicable.

2.5 Trace antenna designs

Not applicable.

2.6 RF exposure considerations

This equipment complies with FCC mobile radiation exposure limits set forth for an uncontrolled environment. This equipment should be installed and operated with a minimum distance of 20cm between the radiator & your body. If the module is installed in a portable host, a separate SAR evaluation is required to confirm compliance with relevant FCC portable RF exposure rules.

2.7 Antennas

The following antennas have been certified for use with this module; antennas of the same type with equal or lower gain may also be used with this module. The antenna must be installed such that 20 cm can be maintained between the antenna and users.

Approved antenna(s) list :**(Mobile)**

Antenna Set	Chain NO.	Brand	Model	Antenna Gain (dBi)	Frequency range (GHz)	Antenna Type	Connector Type
1	Chain 0	LYNwave	ALA110-222050-300011	3.5	2.4~2.5	PIFA	i-pex(MHF)
				5	5.15~5.85		
	Chain 1	LYNwave	ALA110-222050-300011	3.5	2.4~2.5	PIFA	i-pex(MHF)
				5	5.15~5.85		
2	Chain 0	PSA	RFDPA171320EMLB301	3.14	2.4~2.5	Dipole	i-pex(MHF)
				5	5.15~5.85		
	Chain 1	PSA	RFDPA171320EMLB301	3.14	2.4~2.5	Dipole	i-pex(MHF)
				5	5.15~5.85		

For SAR :**(Portable)**

Brand	Model	Antenna Gain (dBi)	Frequency range (GHz)	Antenna Type	Connector Type
REALTEK	RTK-ANT-0006	3.5	2.4~2.5	PIFA	i-pex(MHF)

		5	5.15~5.85		
--	--	---	-----------	--	--

2.8 Label and compliance information

The final end product must be labeled in a visible area with the following: “Contains FCC ID: TX2-RTL8822C”. The grantee's FCC ID can be used only when all FCC compliance requirements are met.

2.9 Information on test modes and additional testing requirements

This transmitter is tested in a standalone mobile RF exposure condition and any co-located or simultaneous transmission with other transmitter(s) or portable use will require a separate class II permissive change re-evaluation or new certification.

2.10 Additional testing, Part 15 Subpart B disclaimer

This transmitter module is tested as a subsystem and its certification does not cover the FCC Part 15 Subpart B (unintentional radiator) rule requirement applicable to the final host. The final host will still need to be reassessed for compliance to this portion of rule requirements if applicable.

As long as all conditions above are met, further transmitter test will not be required. However, the OEM integrator is still responsible for testing their end-product for any additional compliance requirements required with this module installed.

IMPORTANT NOTE: In the event that these conditions can not be met (for example certain laptop configurations or co-location with another transmitter), then the FCC authorization is no longer considered valid and the FCC ID can not be used on the final product. In these circumstances, the OEM integrator will be responsible for re-evaluating the end product (including the transmitter) and obtaining a separate FCC authorization.

Manual Information To the End User

The OEM integrator has to be aware not to provide information to the end user regarding how to install or remove this RF module in the user's manual of the end product which integrates this module.

The end user manual shall include all required regulatory information/warning as show in this manual.

OEM/Host manufacturer responsibilities

OEM/Host manufacturers are ultimately responsible for the compliance of the Host and Module. The final product must be reassessed against all the essential requirements of the FCC rule such as FCC Part 15 Subpart B before it can be placed on the US market. This includes reassessing the transmitter module for compliance with the Radio and EMF essential requirements of the FCC rules. This module must not be incorporated into any other device or system without retesting for compliance as multi-radio and combined equipment

Industry Canada statement:

This device complies with ISED's licence-exempt RSSs. Operation is subject to the following two conditions: (1) This device may not cause harmful interference, and (2) this device must accept any interference received, including interference that may cause undesired operation.

Le présent appareil est conforme aux CNR d'ISED applicables aux appareils radio exempts de licence. L'exploitation est autorisée aux deux conditions suivantes : (1) le dispositif ne doit pas produire de brouillage préjudiciable, et (2) ce dispositif doit accepter tout brouillage reçu, y compris un brouillage susceptible de provoquer un fonctionnement indésirable.

Radiation Exposure Statement: (Portable)

The product comply with the Canada portable RF exposure limit set forth for an uncontrolled environment and are safe for intended operation as described in this manual. The further RF exposure reduction can be achieved if the product can be kept as far as possible from the user body or set the device to lower output power if such function is available.

The SAR evaluation is according to KDB 616217, and the module approach distance restriction is 5 mm for notebook, 10 mm for tablet.

Déclaration d'exposition aux radiations:

Le produit est conforme aux limites d'exposition pour les appareils portables RF pour les Etats-Unis et le Canada établies pour un environnement non contrôlé.

Le produit est sûr pour un fonctionnement tel que décrit dans ce manuel. La réduction aux expositions RF peut être augmentée si l'appareil peut être conservé aussi loin que

possible du corps de l'utilisateur ou que le dispositif est réglé sur la puissance de sortie la plus faible si une telle fonction est disponible.

L'évaluation SAR est conforme à KDB 616217, et la restriction de distance d'approche du module est de 5 mm pour le portable, 10 mm pour la tablette.

Radiation Exposure Statement: (Mobile)

This equipment complies with ISED radiation exposure limits set forth for an uncontrolled environment. This equipment should be installed and operated with greater than 20cm between the radiator & your body.

Déclaration d'exposition aux radiations:

Cet équipement est conforme aux limites d'exposition aux rayonnements ISED établies pour un environnement non contrôlé. Cet équipement doit être installé et utilisé à plus de 20 cm entre le radiateur et votre corps.

This device is intended only for OEM integrators under the following conditions: (For module device use)

- 1) The antenna must be installed and operated with greater than 20cm between the antenna and users, and
- 2) The transmitter module may not be co-located with any other transmitter or antenna.

As long as **2** conditions above are met, further transmitter test will not be required. However, the OEM integrator is still responsible for testing their end-product for any additional compliance requirements required with this module installed.

Cet appareil est conçu uniquement pour les intégrateurs OEM dans les conditions suivantes: (Pour utilisation de dispositif module)

- 1) L'antenne doit être installée et exploitée avec plus de 20 cm entre l'antenne et les utilisateurs, et
 - 2) Le module émetteur peut ne pas être coïmplanté avec un autre émetteur ou antenne.

Tant que les **2** conditions ci-dessus sont remplies, des essais supplémentaires sur l'émetteur ne seront pas nécessaires. Toutefois, l'intégrateur OEM est toujours responsable des essais sur son produit final pour toutes exigences de conformité supplémentaires requis pour ce module installé.

IMPORTANT NOTE:

In the event that these conditions can not be met (for example certain laptop configurations or co-location with another transmitter), then the Canada authorization is no longer considered valid and the IC ID can not be used on the final product. In these circumstances, the OEM integrator will be responsible for re-evaluating the end product (including the transmitter) and obtaining a separate Canada authorization.

NOTE IMPORTANTE:

Dans le cas où ces conditions ne peuvent être satisfaites (par exemple pour certaines configurations d'ordinateur portable ou de certaines co-localisation avec un autre émetteur), l'autorisation du Canada n'est plus considéré comme valide et l'ID IC ne peut pas être utilisé sur le produit final. Dans ces circonstances, l'intégrateur OEM sera chargé de réévaluer le produit final (y compris l'émetteur) et l'obtention d'une autorisation distincte au Canada.

End Product Labeling

This transmitter module is authorized only for use in device where the antenna may be installed and operated with greater than 20cm between the antenna and users. The final end product must be labeled in a visible area with the following: "Contains IC: **6317A-RTL8822C**".

Plaque signalétique du produit final

Ce module émetteur est autorisé uniquement pour une utilisation dans un appareil où l'antenne peut être installée et utilisée à plus de 20 cm entre l'antenne et les utilisateurs. Le produit final doit être étiqueté dans un endroit visible avec l'inscription suivante: "Contient des IC: **6317A-RTL8822C**".

End Product Labeling

The product can be kept as far as possible from the user body or set the device to lower output power if such function is available. The final end product must be labeled in a visible area with the following: "Contains IC: **6317A-RTL8822C**".

Plaque signalétique du produit final

L'appareil peut être conservé aussi loin que possible du corps de l'utilisateur ou que le

dispositif est réglé sur la puissance de sortie la plus faible si une telle fonction est disponible. Le produit final doit être étiqueté dans un endroit visible avec l'inscription suivante: "Contient des IC: **6317A-RTL8822C**".

Manual Information To the End User

The OEM integrator has to be aware not to provide information to the end user regarding how to install or remove this RF module in the user's manual of the end product which integrates this module.

The end user manual shall include all required regulatory information/warning as show in this manual.

Manuel d'information à l'utilisateur final

L'intégrateur OEM doit être conscient de ne pas fournir des informations à l'utilisateur final quant à la façon d'installer ou de supprimer ce module RF dans le manuel de l'utilisateur du produit final qui intègre ce module.

Le manuel de l'utilisateur final doit inclure toutes les informations réglementaires requises et avertissements comme indiqué dans ce manuel.

Caution :

- (i) the device for operation in the band 5150-5250 MHz is only for indoor use to reduce the potential for harmful interference to co-channel mobile satellite systems;
- (ii) for devices with detachable antenna(s), the maximum antenna gain permitted for devices in the bands 5250-5350 MHz and 5470-5725 MHz shall be such that the equipment still complies with the e.i.r.p. limit;
- (iii) for devices with detachable antenna(s), the maximum antenna gain permitted for devices in the band 5725-5850 MHz shall be such that the equipment still complies with the e.i.r.p. limits as appropriate;
- (iv) where applicable, antenna type(s), antenna models(s), and worst-case tilt angle(s) necessary to remain compliant with the e.i.r.p. elevation mask requirement set forth in section 6.2.2.3 shall be clearly indicated.

Avertissement:

Le guide d'utilisation des dispositifs pour réseaux locaux doit inclure des instructions précises sur les restrictions susmentionnées, notamment :

- (i) les dispositifs fonctionnant dans la bande 5150-5250 MHz sont réservés uniquement pour une utilisation à l'intérieur afin de réduire les risques de brouillage préjudiciable aux systèmes de satellites mobiles utilisant les mêmes canaux;
- (ii) pour les dispositifs munis d'antennes amovibles, le gain maximal d'antenne permis pour les dispositifs utilisant les bandes de 5 250 à 5 350 MHz et de 5 470 à 5 725 MHz doit être conforme à la limite de la p.i.r.e.;
- (iii) pour les dispositifs munis d'antennes amovibles, le gain maximal d'antenne permis (pour les dispositifs utilisant la bande de 5 725 à 5 850 MHz) doit être conforme à la limite de la p.i.r.e. spécifiée, selon le cas;
- (iv) lorsqu'il y a lieu, les types d'antennes (s'il y en a plusieurs), les numéros de modèle de l'antenne et les pires angles d'inclinaison nécessaires pour rester conforme à l'exigence de la p.i.r.e. applicable au masque d'élévation, énoncée à la section 6.2.2.3, doivent être clairement indiqués

DETACHABLE ANTENNA USAGE

This radio transmitter (**IC: 6317A-RTL8822C / Model: RTL8822C**) has been approved by ISED to operate with the antenna type listed below with maximum permissible gain indicated. Antenna types not included in this list, having a gain greater than the maximum gain indicated for that type, are strictly prohibited for use with this device.

Le présent émetteur radio (**IC: 6317A-RTL8822C / Model: RTL8822C**) a été approuvé par ISED pour fonctionner avec les types d'antenne énumérés ci-dessous et ayant un gain admissible maximal. Les types d'antenne non inclus dans cette liste, et dont le gain est supérieur au gain maximal indiqué, sont strictement interdits pour l'exploitation de l'émetteur.

Approved antenna(s) list **(Mobile)**

Antenna Set	Chain NO.	Brand	Model	Antenna Gain	Frequency range	Antenna Type	Connector Type
-------------	-----------	-------	-------	--------------	-----------------	--------------	----------------

RTL8822C User's Manual

				(dBi)	(GHz)		
1	Chain 0	LYNwave	ALA110-222050-300011	3.5	2.4~2.5	PIFA	i-pex(MHF)
				5	5.15~5.85		
	Chain 1	LYNwave	ALA110-222050-300011	3.5	2.4~2.5	PIFA	i-pex(MHF)
				5	5.15~5.85		
2	Chain 0	PSA	RFDPA171320EMLB301	3.14	2.4~2.5	Dipole	i-pex(MHF)
				5	5.15~5.85		
	Chain 1	PSA	RFDPA171320EMLB301	3.14	2.4~2.5	Dipole	i-pex(MHF)
				5	5.15~5.85		

For SAR (Portable)

Brand	Model	Antenna Gain (dBi)	Frequency range (GHz)	Antenna Type	Connector Type
REALTEK	RTK-ANT-0006	3.5	2.4~2.5	PIFA	i-pex(MHF)
		5	5.15~5.85	PIFA	i-pex(MHF)

低功率電波輻射性電機管理辦法

第十二條 經型式認證合格之低功率射頻電機，非經許可，公司、商號或使用者均不得擅自變更頻率、加大功率或變更原設計之特性及功能。

第十四條 低功率射頻電機之使用不得影響飛航安全及干擾合法通信；經發現有干擾現象時，應立即停用，並改善至無干擾時方得繼續使用。

前項合法通信，指依電信法規定作業之無線電通信。

低功率射頻電機須忍受合法通信或工業、科學及醫療用電波
輻射性電機設備之干擾。

1. 使用此產品時應避免影響附近雷達系統之操作。
2. 高增益指向性天線只得應用於固定式點對點系統。

模組認證：

1. 本模組於取得認證後將依規定於模組本體標示審驗合格標籤。
2. 系統廠商應於平台上標示「本產品內含射頻模組：

XXXyyyLPDzzzz-x」字樣。

Japan Statement

Host system must be labeled with "Contains MIC ID:xxxxxx", MIC ID displayed on label.

Installing the Wireless PCIe NGFF1216 module

Hardware

Installing PCIe NGFF1216 module on NGFF2230 bad board to PCIe NGFF2230 connector and connect two external Wi-Fi antennas on I-PEX connectors.



Un-installing the Wireless PCIe NGFF1216 module

Hardware

Remove 2 external Wi-Fi Antennas from the Wireless PCIe NGFF1216 module on NGFF2230 bad board and remove the Wireless PCIe NGFF1216 module on NGFF2230 board from PCIe NGFF2230 connector port



Installing the Wireless PCIe NGFF1216 module

Software

Before you proceed with the installation, please notice following descriptions.

Note1: The following installation was operated under Windows 7.

Note2: If you have installed the WLAN driver & utility before, please uninstall the old version first.

A. Execute the "setup.exe", Click "Next" to process the installation

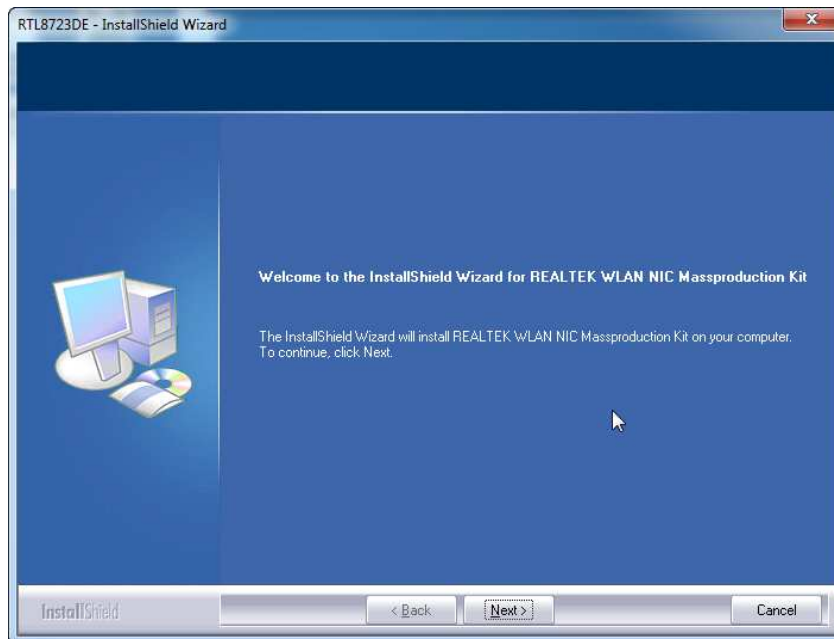

B. Click "Install" to process the installation

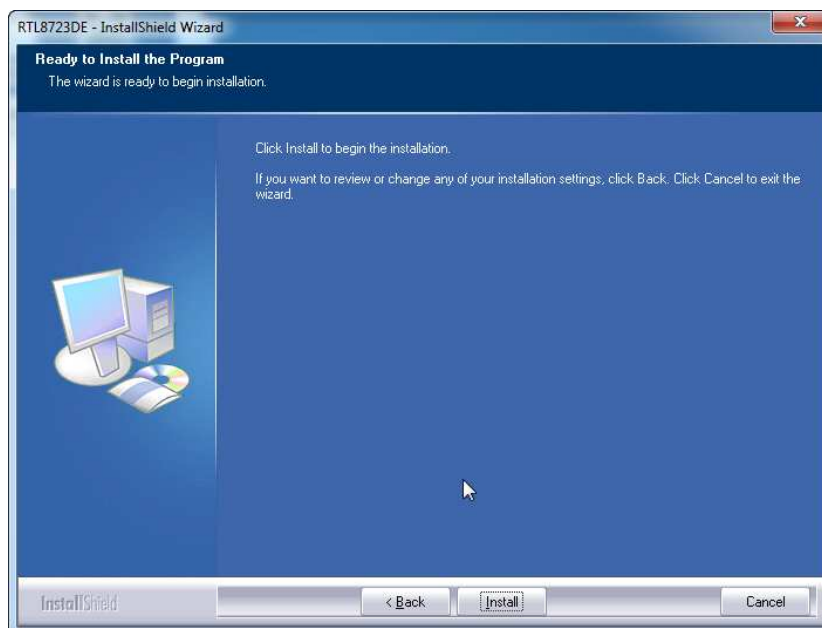

C. Click Install this driver software anyway



D. After step "C" please press Next button.

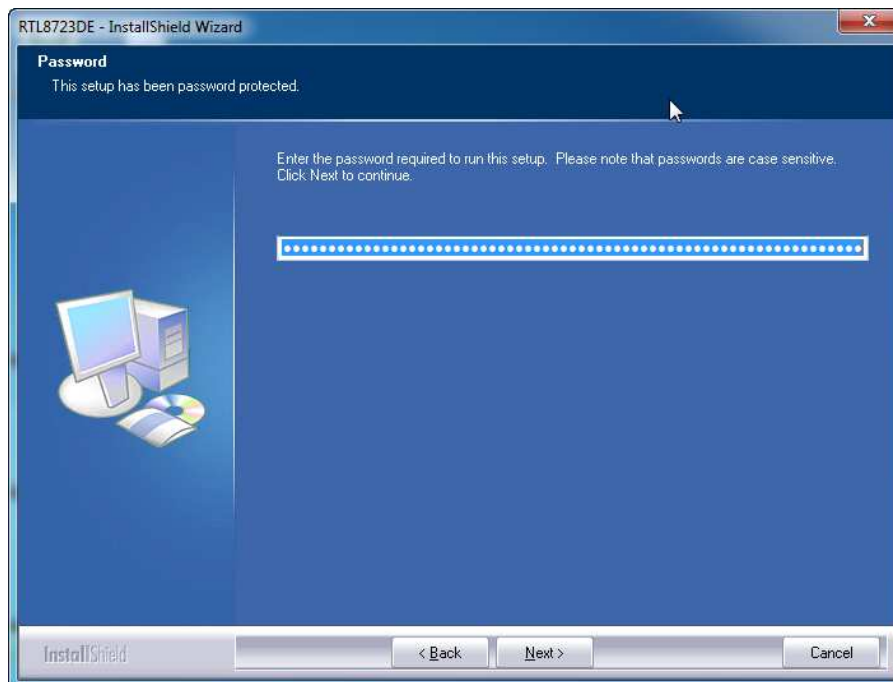

E. Please click "YES" to install BT package.

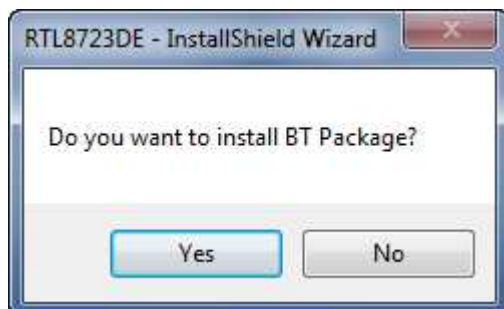

F. Please click "下一步" to continue.

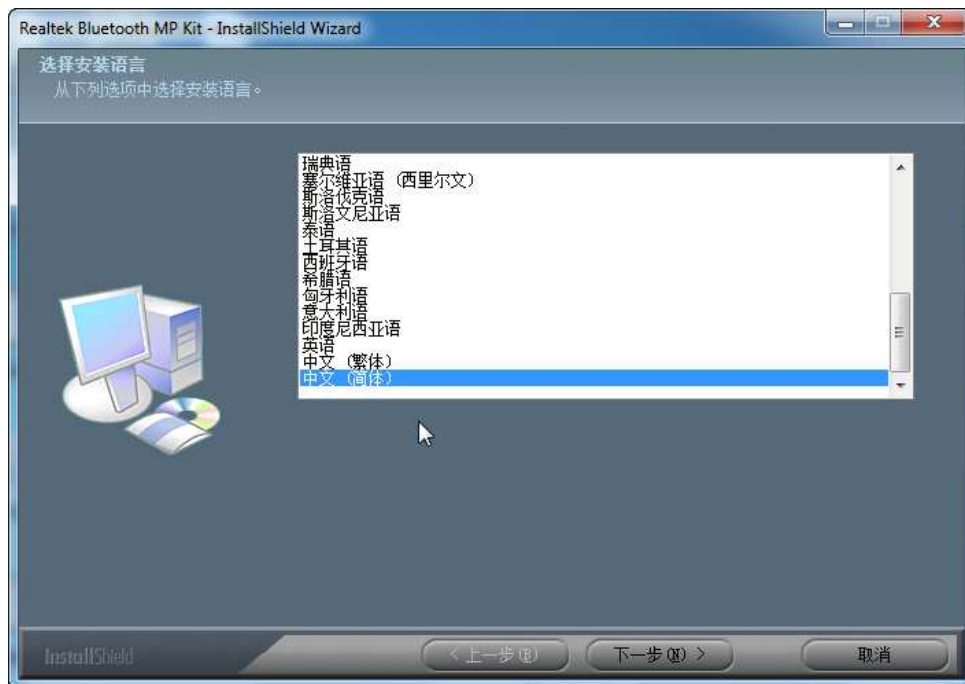

G. Please click “下一步”to continue.

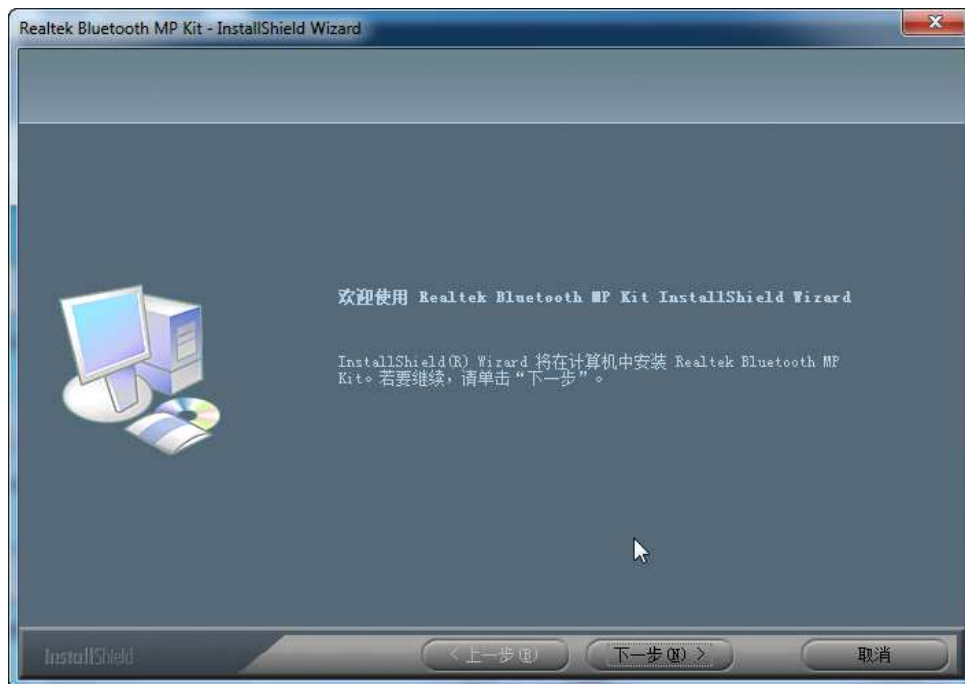

H. Please click “安装”to start installation.



I. Please click “完成”to finish the installation.

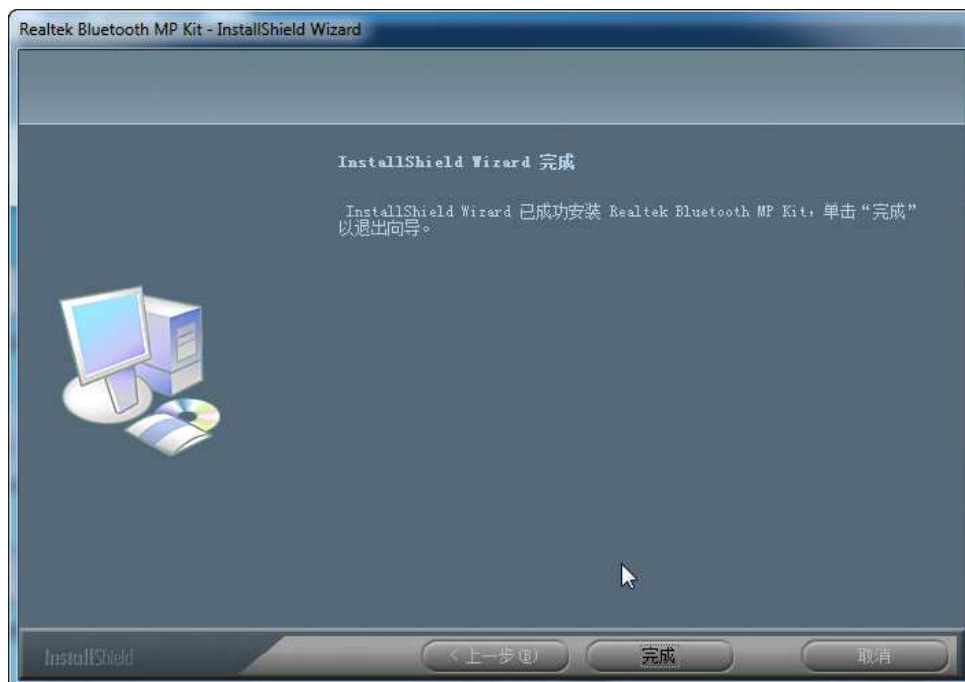

J. Press Finish button to complete the install process

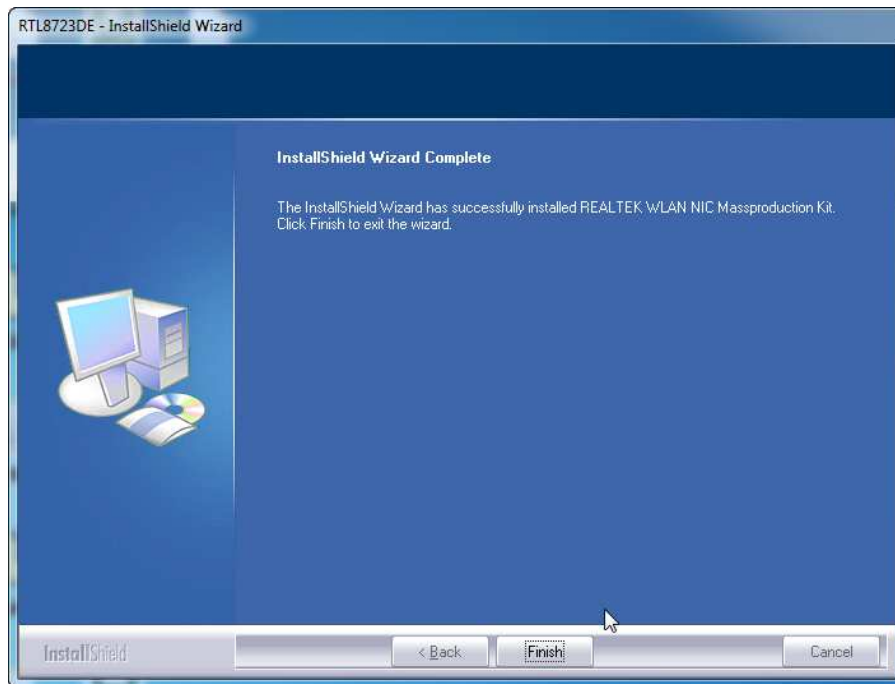

Un-installing the Wireless PCIe NGFF1216 module

Software

A. Uninstall the RTL8822C WLAN Driver from “Start”→ “All Programs”→ “REALTEK 11ac 8822CE PCIE WLAN NIC Massproduction kit”

Please click “Uninstall” to remove RTL8822C WLAN driver.

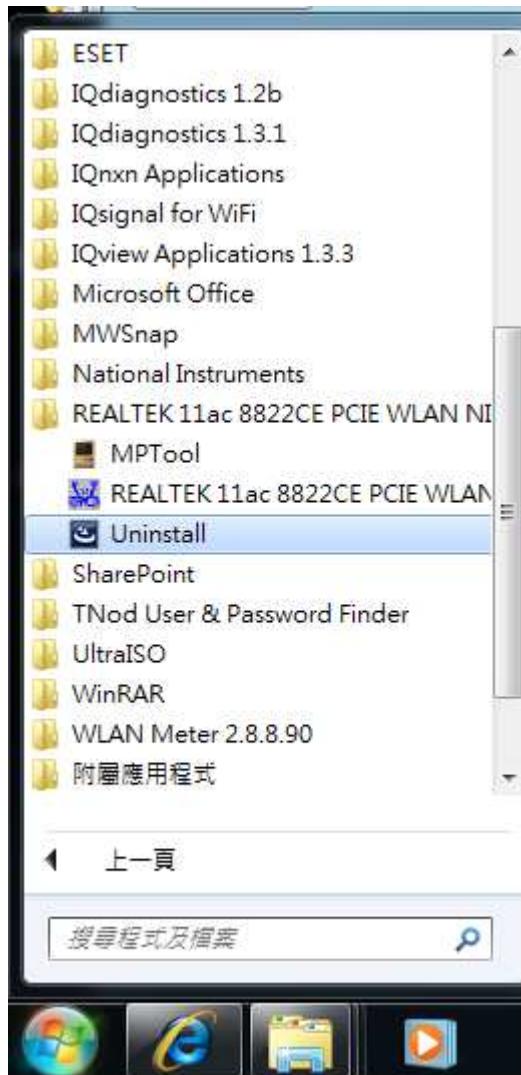

Installing the Bluetooth USB Module

Software

- A. Insert the NGFF1 card into system connector.
- B. Boot on system then the “Generic Bluetooth Adapter” device will show up in device manager.

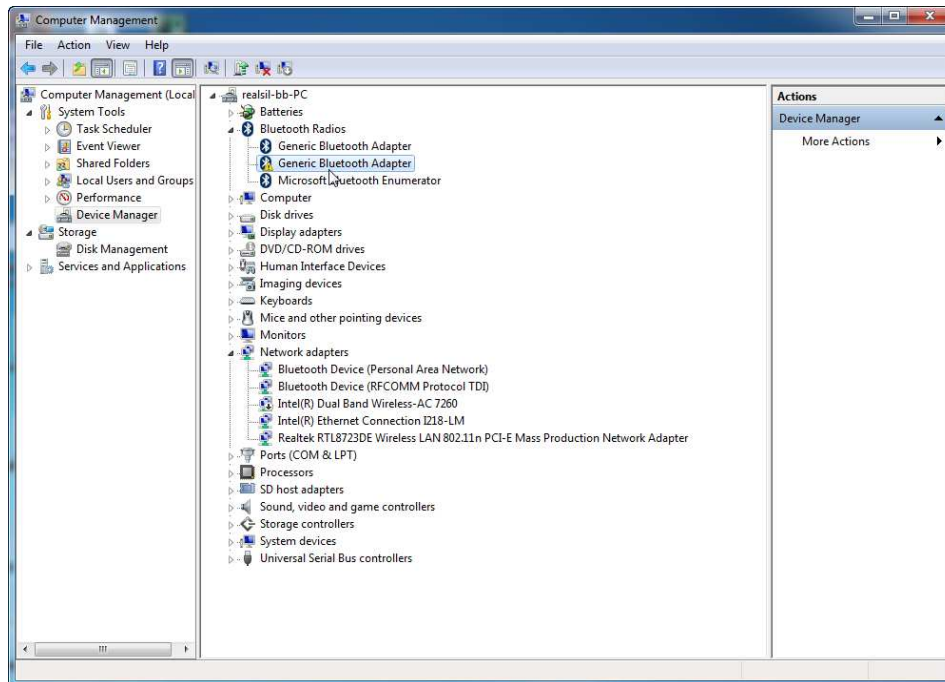

- C. Click right button on “RT Bluetooth Radio” and select “Update Driver”.

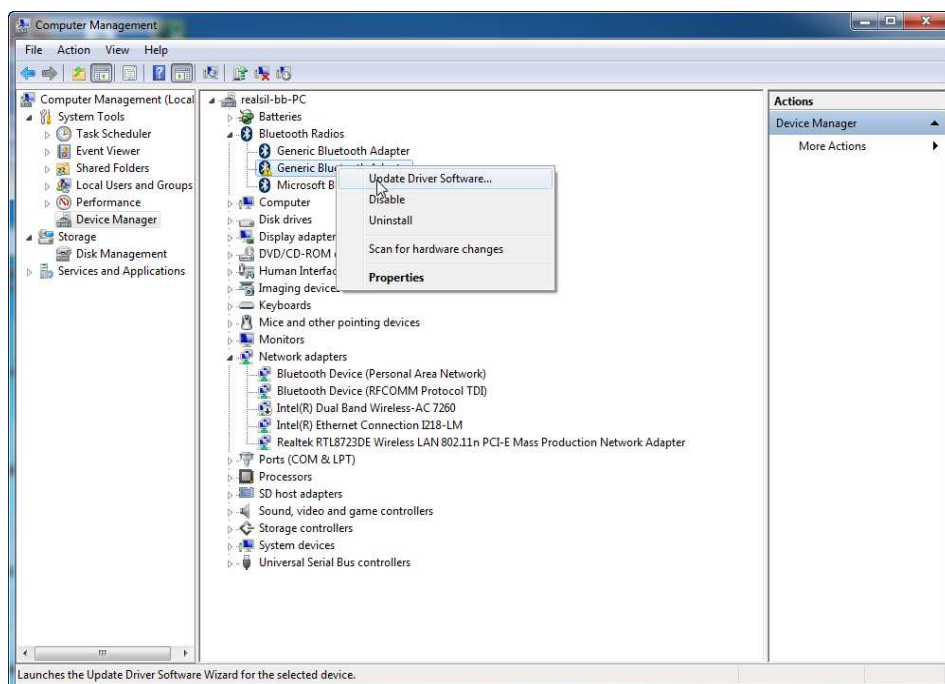

- D. After select “Update Driver Software ” then the Hardware Update Wizard will pop up, please select “Browse my computer for driver software” and press Next button.

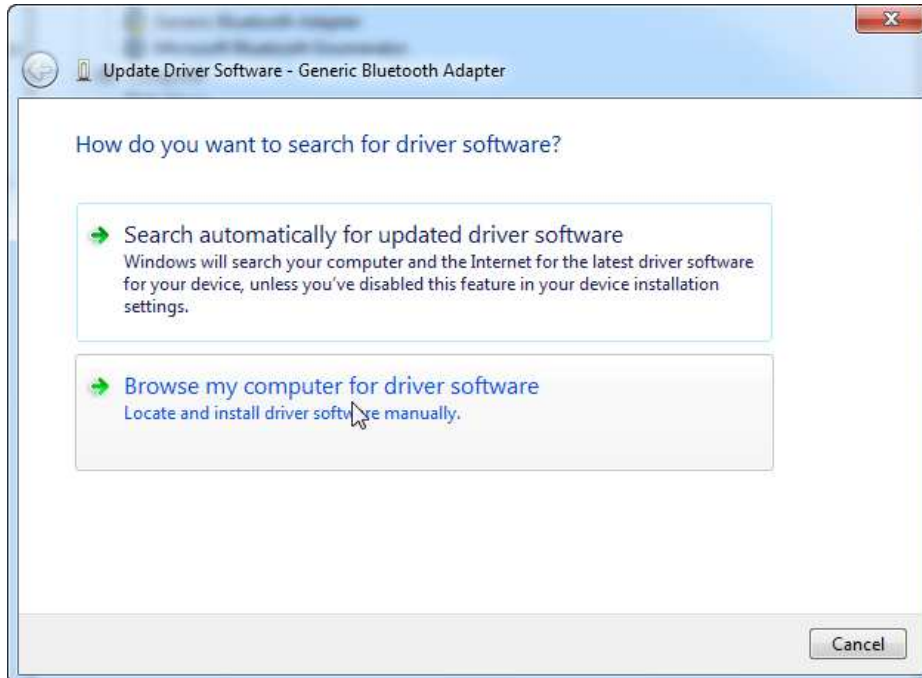

- E. After step “D” please Select “Let me pick from a list of device drivers on my computer ”.

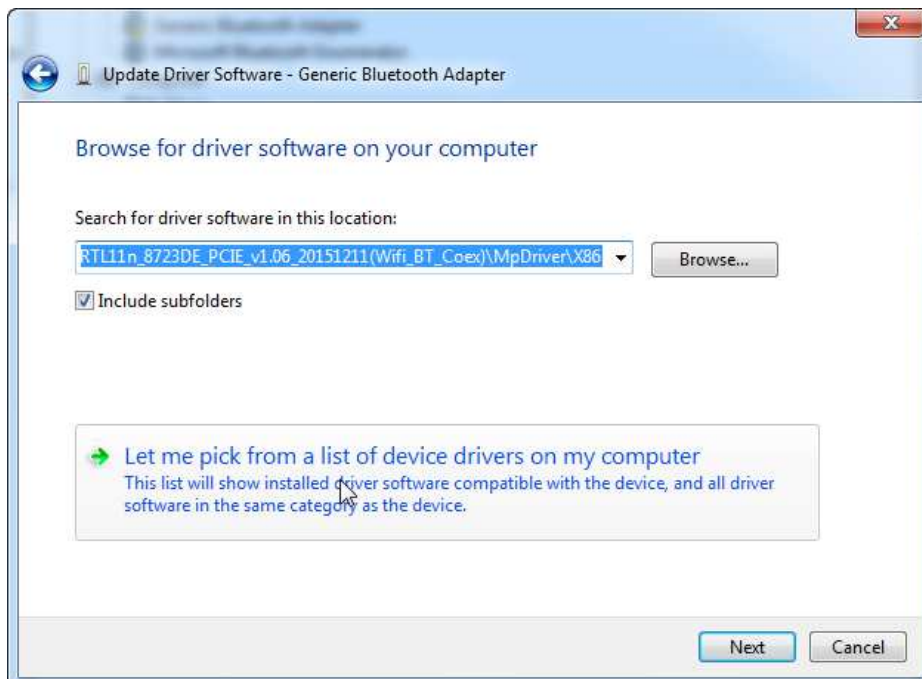

F. Finish step "E" then select "Have Disk.."

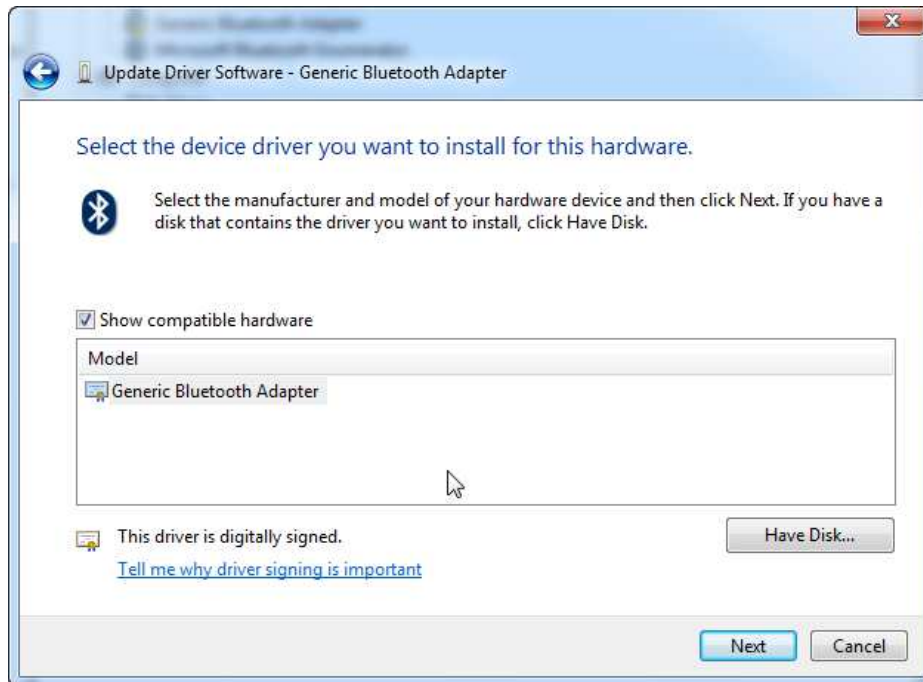

G. Now select browse to find the driver for device and press Next button.(The driver's locate is the same with WiFi driver)

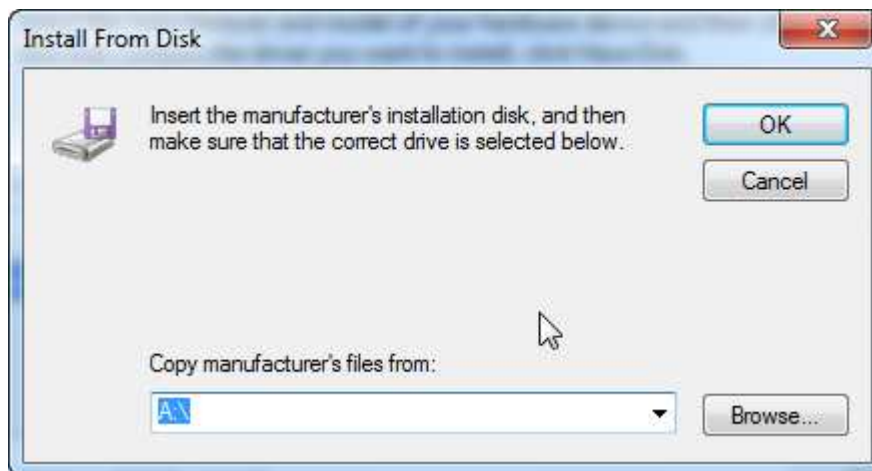

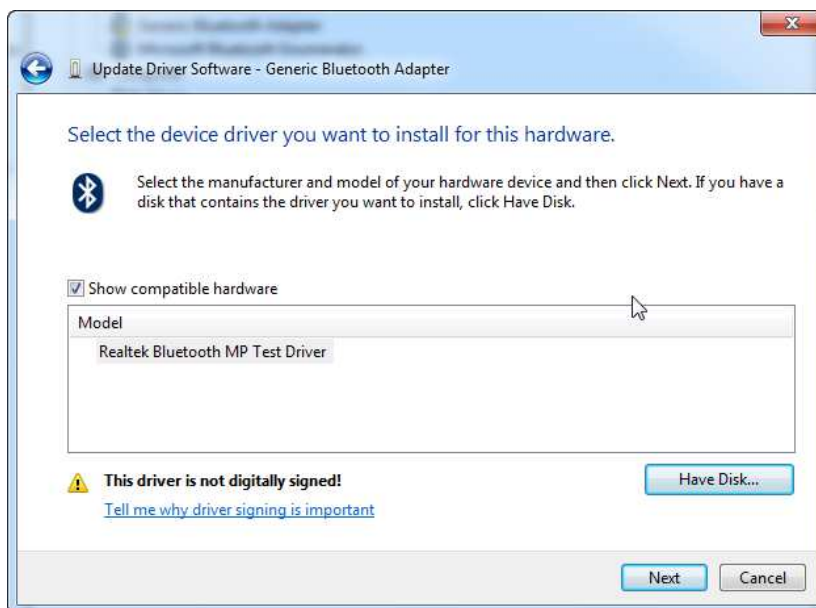
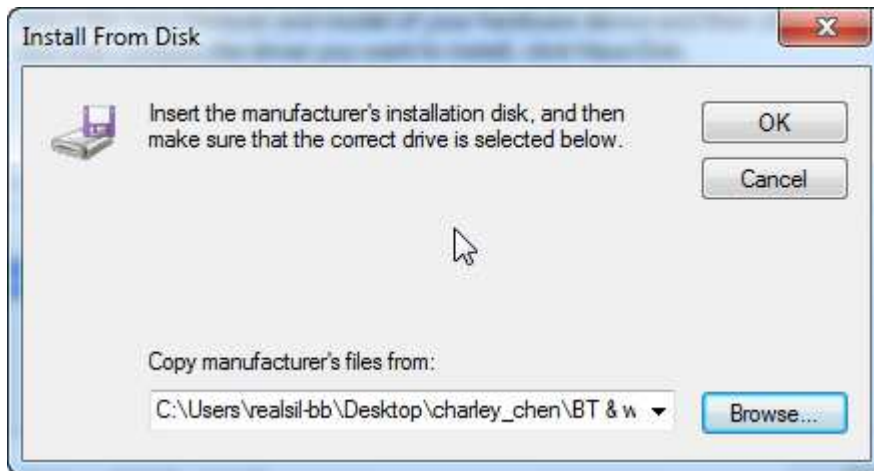

H. Then click "Install this driver software anyway" to continue.

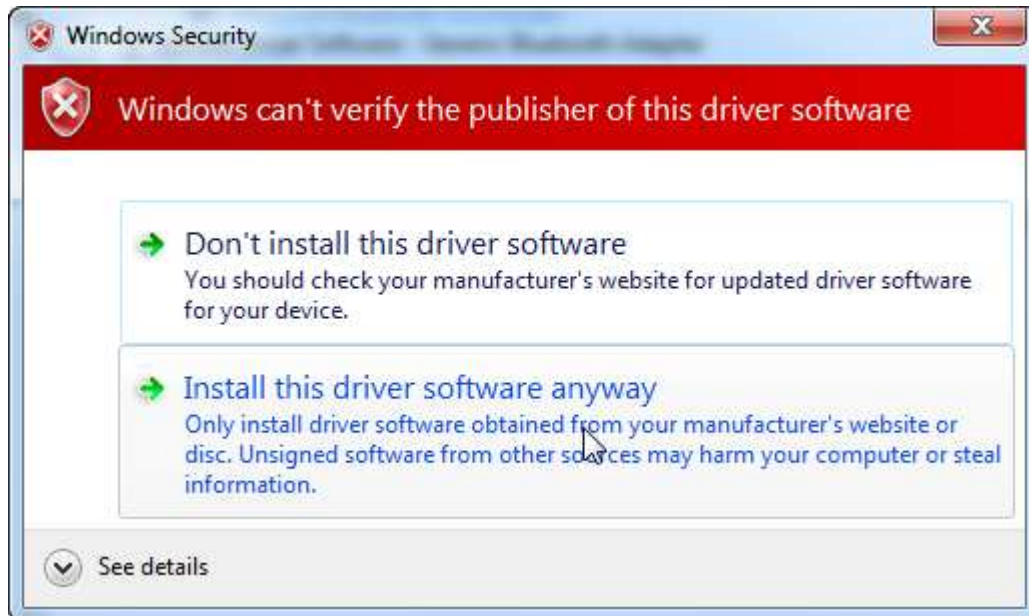

I. Press close button to complete the install process and you can see the Driver will be show up in Device Manager.

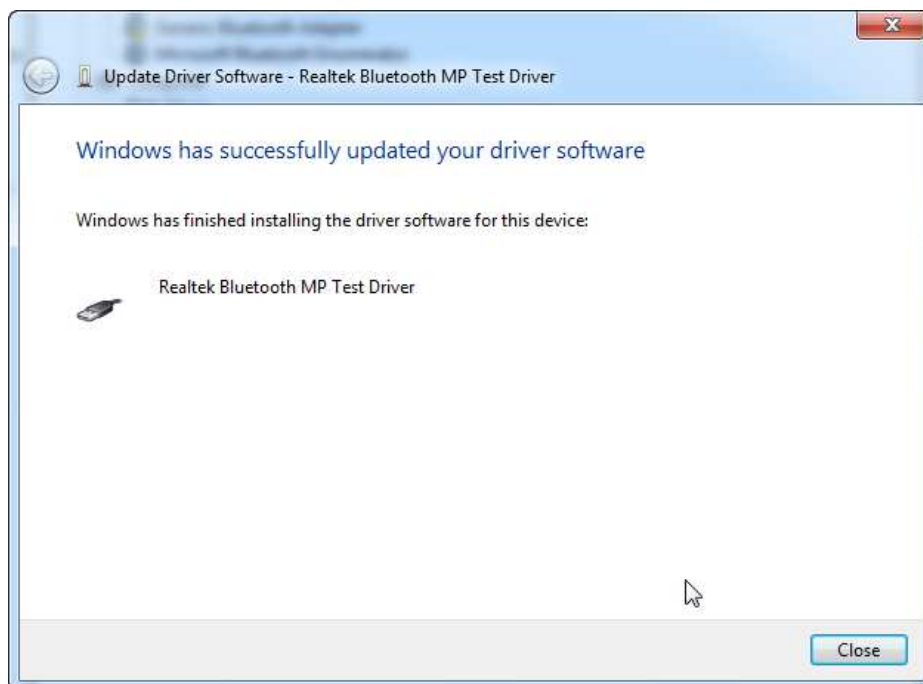



REALTEK

RTL8822CE

**SINGLE-CHIP 802.11ac/a/b/g/n 2T2R WLAN AND
INTEGRATED BLUETOOTH 5 CONTROLLER WITH
PCI EXPRESS /USB2.0 MIXED INTERFACE**

DATASHEET

(CONFIDENTIAL: Development Partners Only)

**Rev. 0.1
27, Aug., 2018
Track ID:**



Realtek Semiconductor Corp.

No. 2, Innovation Road II, Hsinchu Science Park, Hsinchu 300, Taiwan

Tel.: +886-3-578-0211. Fax: +886-3-577-6047

www.realtek.com

1. General Description

The Realtek RTL8822CE is a highly integrated single-chip that support 2-stream 802.11ac solutions with Multi-user MIMO (Multiple-Input , Multiple-Output) with Wireless LAN (WLAN) PCI Express network interface controller with integrated Bluetooth 5 USB interface controller. It combines a WLAN MAC, a 2T2R capable WLAN baseband, and RF in single chip. The RTL8822CE-CG provides a complete solution for a high-performance integrated wireless and Bluetooth device.

The RTL8822CE baseband implements Multi-user Multiple Input, Multiple Output (MU-MIMO) Orthogonal Frequency Division Multiplexing (OFDM) with two transmit and two receive paths (2T2R). Features include two spatial stream transmissions, short Guard Interval (GI) of 400ns, spatial spreading, and support for variant channel bandwidth. Moreover, RTL8822CE provides one spatial stream space-time block code (STBC), Transmit Beamforming (TxBF) and Low Density Parity Check (LDPC) to extend the range of transmission. At the receiver, extended range and good minimum sensitivity is achieved by having receiver diversity up to 2 antennas. As the recipient, the RTL8822CE also supports explicit sounding packet feedback that helps senders with beamforming capability.

For legacy compatibility, Direct Sequence Spread Spectrum (DSSS), Complementary Code Keying (CCK) and OFDM baseband processing are included to support all IEEE 802.11b, 802.11g and 802.11a data rates. Differential phase shift keying modulation schemes, DBPSK and DQPSK with data scrambling capability are available, and CCK provides support for legacy data rates, with long or short preamble. The high speed FFT/IFFT paths, combined with BPSK, QPSK, 16QAM, 64QAM and 256QAM modulation of the individual subcarriers, and rate compatible coding rate of 1/2, 2/3, 3/4, and 5/6, provide up to 866.7Mbps for IEEE 802.11ac MIMO OFDM.

The RTL8822CE builds in an enhanced signal detector, an adaptive frequency domain equalizer, and a soft-decision Viterbi decoder to alleviate severe multi-path effects and mutual interference in the reception of multiple streams. For better detection quality, receive diversity with Maximal-Ratio-Combine (MRC) applying up to two receive paths, and Maximum-Likelihood Detection (MLD) are implemented. Robust interference detection and suppression are provided to protect against Bluetooth, cordless phone, and microwave oven interference.

Receive vector diversity for multi-stream application is implemented for efficient utilization of the MIMO channel. Efficient IQ-imbalance, DC offset, phase noise, frequency offset, and timing offset compensations are provided for the radio frequency front-end.

The RTL8822CE supports fast receiver Automatic Gain Control (AGC) with synchronous and asynchronous control loops among antennas, antenna diversity functions, and adaptive transmit power control functions to obtain better performance in the analog portions of the transceiver.

The RTL8822CE MAC supports 802.11e for multimedia applications, 802.11i and WAPI (Wireless Authentication Privacy Infrastructure) for security, and 802.11n/802.11ac for enhanced MAC protocol efficiency. Using packet aggregation techniques such as A-MPDU with BA and A-MSDU, protocol efficiency is significantly improved. Power saving mechanisms such as Legacy Power Save, U-APSD, and MIMO power saving reduce the power wasted during idle time, and compensate for the extra power required to transmit MIMO OFDM. The RTL8822CE provides simple legacy, 20MHz/40MHz/80MHz co-existence mechanisms to ensure backward and network compatibility.

2. Features

General

- 76-pin QFN
- CMOS MAC, Baseband PHY and RF in a single chip for IEEE 802.11a/b/g/n/ac compatible WLAN
- Support 802.11ac 2x2, Wave-2 compliant with MU-MIMO
- Complete 802.11n MIMO solution for 2.4GHz and 5GHz band
- Maximum PHY data rate up to 173.3 Mbps using 20MHz bandwidth, 400Mbps using 40MHz bandwidth, and 866.7Mbps using 80MHz bandwidth.
- Backward compatible with 802.11a/b/g devices while operating at 802.11n data rates
- Backward compatible with 802.11a/n devices while operating at 802.11ac data rates.

Host Interface

- Complies with PCI Express Base Specification Revision 2.1
- Complies with USB2.0 FS-mode Specification for Bluetooth
- PCIe LTR/L1.Off state supported
- USB Selective Suspend supported

Standards Supported

- IEEE 802.11a/b/g/n/ac compatible WLAN
- IEEE 802.11e QoS Enhancement (WMM)
- IEEE 802.11i (WPA, WPA2). Open, shared key, and pair-wise key authentication services
- IEEE 802.11h DFS, TPC, Spectrum Measurement
- IEEE 802.11k Radio Resource Measurement
- WAPI (Wireless Authentication Privacy Infrastructure) certified.

MAC Features

- Frame aggregation for increased MAC efficiency (A-MSDU, A-MPDU)
- Low latency immediate Block Acknowledgement (BA)
- Long NAV for media reservation with CF-End for NAV release
- PHY-level spoofing to enhance legacy compatibility
- MIMO power saving mechanism
- Channel management and co-existence
- Multiple BSSID feature allows the RTL8822CE to assume multiple MAC identities when used as a wireless bridge
- Transmit Opportunity (TXOP) Short Inter-Frame Space (SIFS) bursting for higher multimedia bandwidth
- WiFi Direct supports wireless peer to peer applications.

Other Features

- Supports Wake-On-WLAN via Magic Packet and Wake-up frame
- Transmit Beamforming
- Support S3/S4 AES/TKIP group key update
- Support Network List Offload
- CCA on secondary through RTS/CTS handshake.
- Support TCP/UDP/IP checksum offload

Peripheral Interfaces

- Up to 15 General Purpose Input/Output pins
- Two configurable LED pins
- Generates 40MHz clock for peripheral chip.
- Single external power source 3.3V only

PHY Features

- IEEE 802.11ac MIMO OFDM
- IEEE 802.11n MIMO OFDM
- Two Transmit and Two Receive paths
- 5MHz / 10MHz / 20MHz / 40MHz / 80MHz bandwidth transmission
- Support 2.4Ghz and 5Ghz band channels
- Short Guard Interval (400ns)
- Sounding packet.
- DSSS with DBPSK and DQPSK, CCK modulation with long and short preamble
- OFDM with BPSK, QPSK, 16QAM, 64QAM and 256QAM modulation. Convolutional Coding Rate: 1/2, 2/3, 3/4, and 5/6

3. Application Diagrams

3.1. 11ac Dual-Band 2x2 RF Application

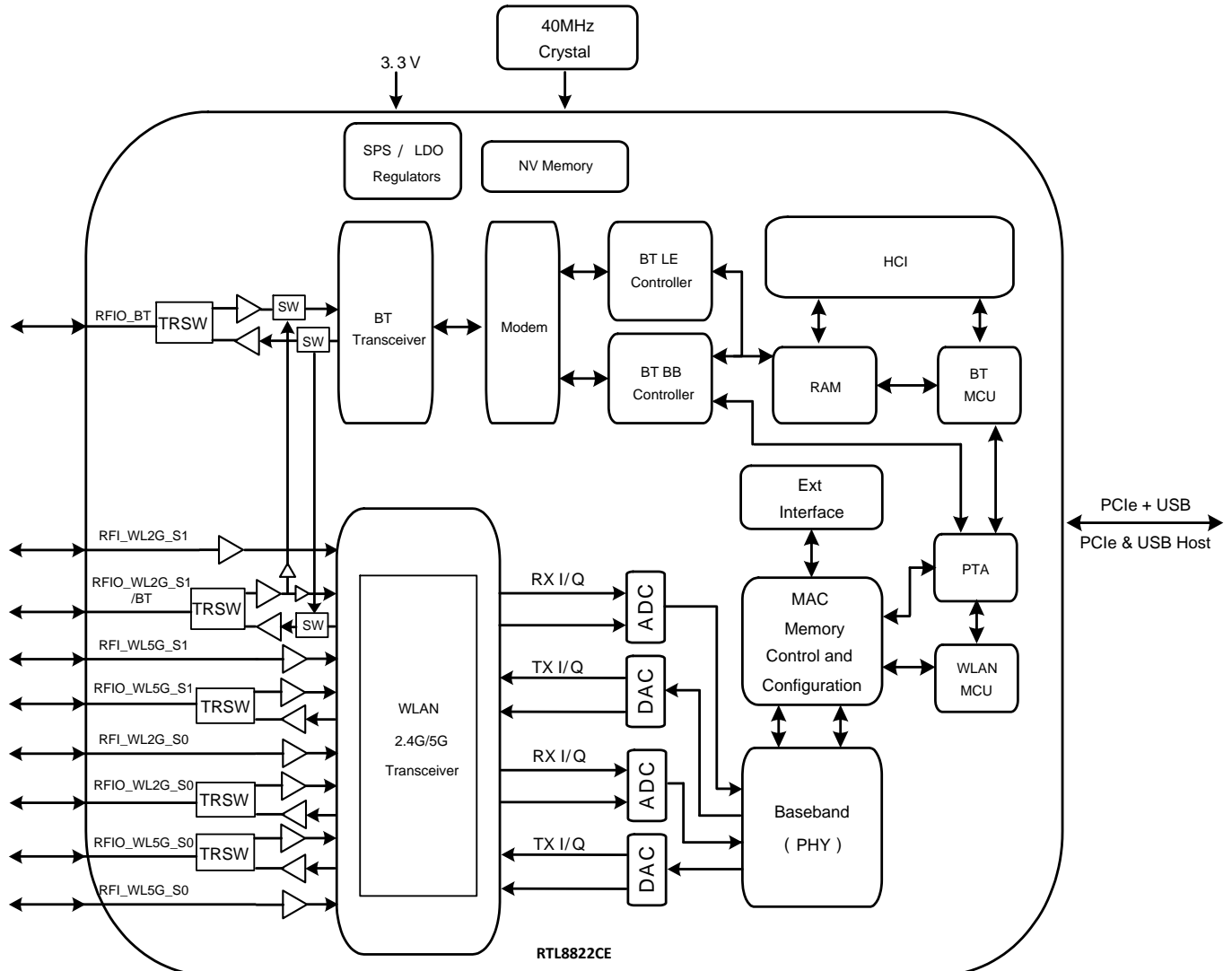

Figure 1. Dual-Band MIMO 2x2 Solution(11ac 2x2 MAC/BB/RF + PA) and Integrated Bluetooth Controller Solution --- RTL8822CE

4.1. Package Identification & Mark Information

Green package is indicated by a ‘G’ in the location marked ‘V’ in Figure 2. The version is shown in the location marked ‘V’.

5. Pin Descriptions

The following signal type codes are used in the tables:

I:	Input	O:	Output
T/S:	Tri-State bi-directional input/output pin	S/T/S:	Sustained Tri-State
O/D:	Open Drain	P:	Power pin
N/A:	No Bonding pin		

5.1. Power On Trap Pin

Table 1. Power-On Trap Pins

Symbol	Type	Pin No	Description
TEST_MODE_SEL	I	73	Shared with GPIO4 0: Normal operation mode 1: Test/debug mode

5.2. PCI Express Transceiver Interface

Table 2. PCI Express Transceiver Interface

Symbol	Type	Pin No	Description	Voltage
HSIN/HSIP	I	53,54	PCI Express Receive Differential Pair	
HSOP/HSOP	O	50,51	PCI Express Transmit Differential Pair	

Symbol	Type	Pin No	Description	Voltage
REFCLK_N/REFCLK_P	I	47,48	PCI Express Differential Reference Clock Source: 100MHz \pm 300ppm	
CLKREQ#	I/O/D	33	Reference Clock Request Signal. Also used by L1 PM substates. This signal is used by the RTL8822CE to request for the PCI Express reference clock.	3.3V
WAKE#	O/D	32	Power Management Event: Open drain, active low. Used to reactivate the PCI Express slot's main power rails and reference clocks. This WAKE# can be shared with BT wake up host function via sideband signals.	3.3V
PERST#	I	31	PCI Express Reset Signal: active low. When the PERST# is asserted at power-on state, the RTL8822CE returns to a pre-defined reset state and is ready for initialization and configuration after the de-assertion of the PERST#.	3.3V

5.3. USB Transceiver Interface

Table 3. USB Transceiver Interface

Symbol	Type	Pin No	Description
HSDP	IO	56	High-Speed USB D+ Signal
HSDM	IO	57	High-Speed USB D- Signal

5.4. RF Interface

Table 4. RF Interface

Symbol	Type	Pin No	Description
RFIO_BT	I/O	76	BT RF input/output.
RFI_WL2G_S1	I	3	WLAN 2G RF input for path S1 in external LNA/FEM configuration
RFIO_WL2G_S1/BT	I/O O	4	(1) RF input/output of BT and path S1 WLAN 2G. (TDM for Tx) (LNA sharing for Rx) (2) Or RF output of path S1 WLAN 2G in external PA/FEM configuration
TSSI_S1	I	6	TSSI input from external PA/FEM
RFI_WL5G_S1	I	7	WLAN 5G RF input for path S1 in external LNA/FEM configuration
RFIO_WL5G_S1	I/O O	9	(1) WLAN 5G RF input/output for path S1 (2) Or WLAN 5G RF output for path S1 in external PA/FEM configuration
RFI_WL2G_S0	I	11	WLAN 2G RF input for path S0 in external LNA/FEM configuration
RFIO_WL2G_S0	I/O O	12	(1) RF input/output of path S0 WLAN 2G (2) Or RF output of path S0 WLAN 2G in external PA/FEM configuration
TSSI_S0	I	14	TSSI input from external PA/FEM
RFIO_WL5G_S0	I/O O	17	(1) WLAN 5G RF input/output for path S0 (2) Or WLAN 5G RF output for path S0 in external PA/FEM configuration

Symbol	Type	Pin No	Description
RFI_WL5G_S0	I	18	WLAN 5G RF input for path S0 in external LNA/FEM configuration

5.5. LED Interface

Table 5. LED Interface

Symbol	Type	Pin No	Description
BT_LED	O	65	BT LED Pin (Active Low)
WL_LED	O	66	WL LED Pin (Active Low), shared with GPIO8

5.6. Power Management Handshake Interface

Table 6. Power Management Handshake Interface

Symbol	Type	Pin No	Description
WL_DIS#	I	27	Shared with GPIO9. This pin can be defined as the WLAN Radio-off function with host interface remaining connected. When this pin is pulled low, WLAN function will be Radio-off. When this function is not required, external pull high is not required.
BT_DIS#	I	53	Shared with GPIO11. This pin can externally shut down the RTL8822CE BT function when BT_DIS# is pulled Low. When this pin is pulled low, USB interface will be also disabled. When this function is not required, external pull high is not required.
HOST_WAKE_WL	O	29	Shared with GPIO12. The Host wakes up the WLAN controller in Remote Wakeup Mode.

5.7. Clock and Other Pins

Table 7. Clock and Other Pins

Symbol	Type	Pin No	Description
XI	I	22	40MHz OSC Input 40MHz crystal reference clock input
XO	O	23	40MHz Crystal reference clock output
SUS_CLK	I	67	External 32K or RTC clock input.
EESK	I	68	WLAN eFuse autoloading
GPIO0	IO	69	General Purpose Input/Output Pin
GPIO1	IO	70	General Purpose Input/Output Pin
GPIO2	IO	71	General Purpose Input/Output Pin
GPIO3	IO	72	General Purpose Input/Output Pin
GPIO4	IO	73	General Purpose Input/Output Pin
GPIO5	IO	26	General Purpose Input/Output Pin
GPIO6	IO	28	General Purpose Input/Output Pin
GPIO7	IO	30	General Purpose Input/Output Pin

Symbol	Type	Pin No	Description
GPIO8	IO	66	General Purpose Input/Output Pin
GPIO9	IO	27	General Purpose Input/Output Pin
GPIO11	IO	63	General Purpose Input/Output Pin
GPIO12	IO	29	General Purpose Input/Output Pin
GPIO13	IO	61	General Purpose Input/Output Pin
GPIO14	IO	62	General Purpose Input/Output Pin

5.8. HCI Power Pins

Table 8. HCI Power Pins

Symbol	Type	Pin No	Description
LDO_V13_PHY_I	P	46	LDO 1.3V PHY Input
GND_TX	P	52	Ground for host interface
RREF	P	45	Precision Resistor for Bandgap
VD10_VDDTX	P/I	49	1.05V for analog circuits in interface
VD33_USB	P	59	3.3V for USB
VD10_USB	P	55	1.05V for USB
GND_USB	P	58	Digital GND

5.9. Digital Power Pins

Table 9. Digital Power Pins

Symbol	Type	Pin No	Description
VD33_IO	P	43	VDD3.3V for Digital IO (PERST#, WAKE#, CLKREQ#, WL_LED, BT_LED)
VDD_IO	P	60	VDD for GPIO[0:14], SUS_CLK, EESK
VD10D_WLBB_T OP / VD10D_WLBB_R IGHT	P	44,31	1.05V for WLAN BB digital power
VD10D_WLBT	P	64	1.05V for WLAN and BT digital power

5.10. REGU Power Pins

Table 10. REGU Power Pins

Symbol	Type	Pin No	Description
LX_SPS_V13_O	P	40,41	Switching Regulator 1.3V Output
VD33_SPS	P	42	Switching Regulator Input Or Linear Regulator input from 3.3V to 1.5V
LDO_V13_I	P	37,38	LDO 1.3V Input
LDO_V10_O	P	35,36	LDO 1.05 Output

Symbol	Type	Pin No	Description
GND_SPS	P	39	Switching Regulator Ground

5.11. RF Power Pins

Table 11. RF Power Pins

Symbol	Type	Pin No	Description
VD13_BT	P	74	VDD 1.3V for BT RF
VD33_BT	P	75	VDD 3.3V for BT RF
VD33_LDO_WL	P	1	VDD 3.3V for internal LDO input
VD13_TRX_S1	P	2	VDD 1.3V for S1 WLAN RF
VD33_TX2G_S1	P	5	VDD 3.3V for S1 2G WLAN PA
VD33_TX5G_S1	P	8	VDD 3.3V for S1 5G WLAN PA
VD33_PAD_S1	P	10	VDD 3.3V for S1 2/5G WLAN PAD
VD33_TX2G_S0	P	13	VDD 3.3V for S0 2G WLAN PA
VD33_PAD_S0	P	15	VDD 3.3V for S0 2/5G WLAN PAD
VD33_TX5G_S0	P	16	VDD 3.3V for S0 5G WLAN PA
VD13_TRX_S0	P	19	VDD 1.3V for S0 WLAN RF
VD13_SYN	P	20	VDD 1.3V for WLAN synthesizer
VD33_SYN	P	21	VDD 3.3V for WLAN synthesizer
VD33X	P	24	VDD 3.3V for Crystal
VD13_AFE	P	25	VDD 1.3V for WLAN AFE

6. Electrical and Thermal Characteristics

6.1. Temperature Limit Ratings

Table 12. Temperature Limit Ratings

Parameter	Minimum	Maximum	Units
Storage Temperature	-55	+125	°C
Ambient Operating Temperature	0	70	°C
Junction Temperature	0	125	°C

6.2. DC Characteristics

6.2.1. Power Supply Characteristics

Table 13. DC Characteristics

Symbol	Parameter	Minimum	Typical	Maximum	Units
VD33	3.3V I/O Supply Voltage	3.0	3.3	3.6	V
VD10	1.05V Core Supply Voltage	0.945	1.05	1.155	V

6.2.2. Digital IO Pin DC Characteristics

Table 14. 3.3V IO DC Characteristics

Symbol	Parameter	Minimum	Normal	Maximum	Units
V _{IH}	Input high voltage	2.0	3.3	3.6	V
V _{IL}	Input low voltage	--	0	0.9	V
V _{OH}	Output high voltage	2.97	--	3.3	V
V _{OL}	Output low voltage	0	--	0.33	V

Table 15. 1.8V IO DC Characteristics

Symbol	Parameter	Minimum	Normal	Maximum	Units
V _{IH}	Input high voltage	1.7	1.8	3.6	V
V _{IL}	Input low voltage	--	0	0.8	V
V _{OH}	Output high voltage	1.62	--	1.8	V
V _{OL}	Output low voltage	0	--	0.18	V

7. Interface Timing Specification

7.1. PCIe Bus during Power On Sequence

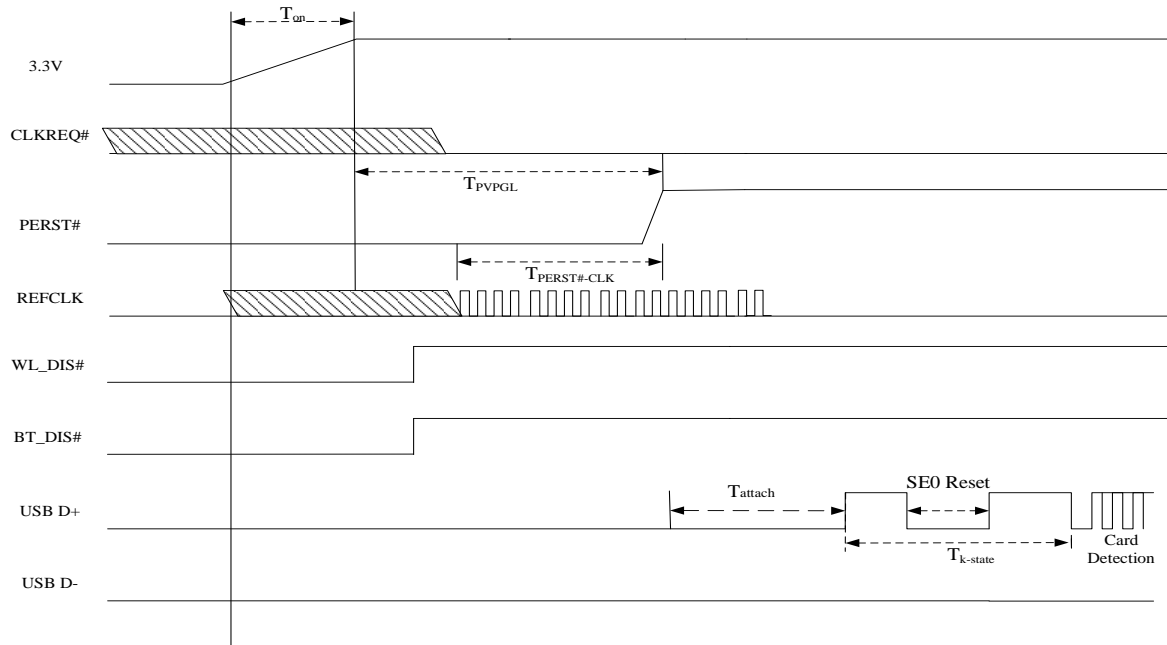

Figure 3. RTL8822CE PCIe and USB Bus Power On Sequence

T_{on} : The main power ramp up duration

T_{PVPGL} : Power valid to PERST# input inactive

$T_{PERST\#-CLK}$: Reference clock stable before PERST# inactive

T_{attach} : The interval to turn on BT after PERST# de-asserted

$T_{k-state}$: the duration from resistor attached to USB host starting card detection procedure

Symbol	Unit	Min	Typical	Max
T_{on}	ms	0.5	1.5	5
T_{PVPGL}	ms	Implementation specific; recommended 50ms		--
$T_{PERST\#-CLK}$	us	100		--
T_{attach}	ms	0.5	2	5
$T_{k-state}$	ms	50	250	--

Table 16. The typical timing range

7.2. PCIe PERST# Timing Sequence

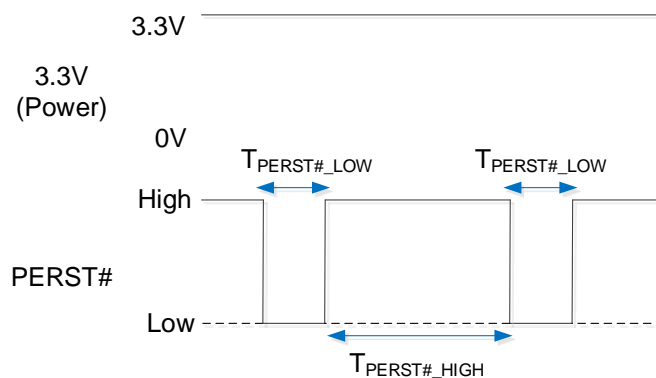

Table 17. RTL8822CE-CG PCIe PERST# Timing Parameters

	Min	Typical	Max	Unit	Description
T_{PERST_LOW}	6	10	X	ms	PERST# low duration
T_{PERST_HIGH}	400	500	X	ms	PERST# high duration

7.3. Power Off Sequence

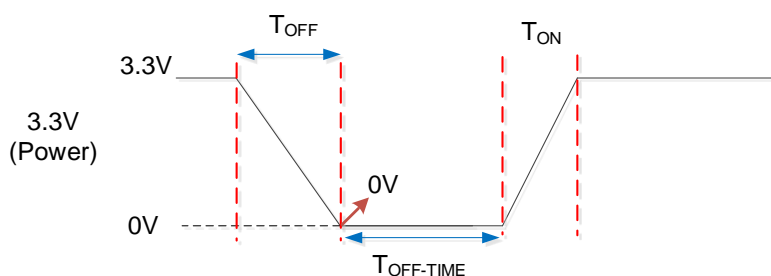

Figure 4. RTL8822CE-CG Power Off Sequence

Table 18. RTL8822CE-CG Power Off Timing Parameters

Symbol	Unit	Min	Typical	Max
T_{OFF}	ms	5	20	50
$T_{OFF-TIME}$	ms	500	--	--
T_{ON}	ms	0.5	1.5	5

7.4. Platform state transitions

3.3V Power range	3.3V Ripple	3.3V Noise	Rise time	
			Min	Max
+/-0.165V	300mVpp @ switching frequency > 400KHz		1ms	5ms

8. Mechanical Dimensions

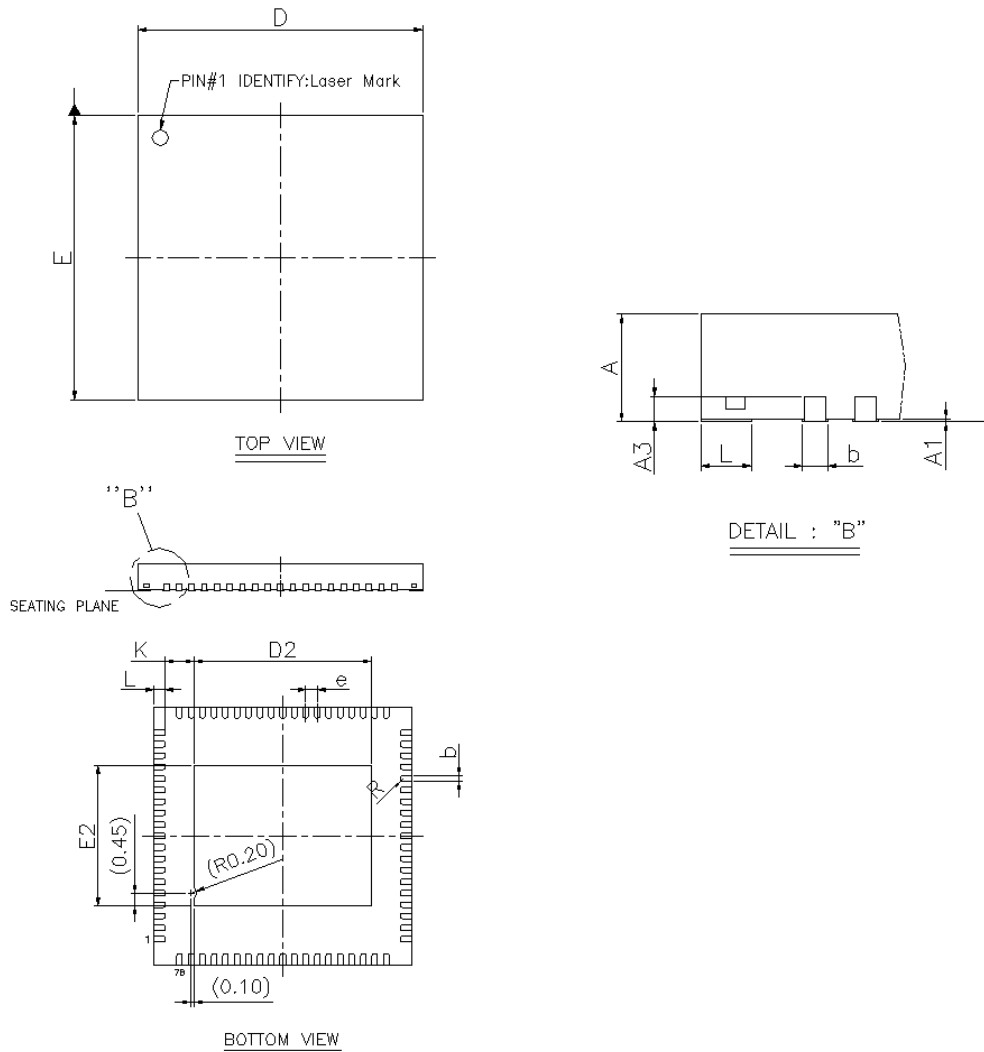

Symbol	Dimension in mm			Dimension in inch		
	Min	Nom	Max	Min	Nom	Max
A	0.80	0.85	0.90	0.031	0.033	0.035
A ₁	0.00	0.02	0.05	0.000	0.001	0.002
A ₃	0.2 REF			0.008 REF		
b	0.15	0.20	0.25	0.006	0.008	0.010
D/E	8.90	9.00	9.10	0.350	0.354	0.358
D ₂	6.10	6.20	6.30	0.240	0.244	0.248
E ₂	4.78	4.88	4.98	0.188	0.192	0.196
e	0.40 BSC			0.016 BSC		
L	0.30	0.40	0.50	0.012	0.016	0.020

Notes :

1. CONTROLLING DIMENSION : MILLIMETER(mm).
2. REFERENCE DOCUMENTL : JEDEC MO-220.