

Supplemental “Transmit Simultaneously” Test Report

Report No.: RF200114E03-4

FCC ID: TX2-RTL8822C

Test Model: RTL8822C

Received Date: Jan. 14, 2020

Test Date: Mar. 09 to 25, 2020

Issued Date: Apr. 14, 2020

Applicant: Realtek Semiconductor Corp.

Address: No. 2, Innovation Road II, Hsinchu Science Park, Hsinchu 300, Taiwan

Issued By: Bureau Veritas Consumer Products Services (H.K.) Ltd., Taoyuan Branch
Hsin Chu Laboratory

Lab Address: E-2, No.1, Li Hsin 1st Road, Hsinchu Science Park, Hsinchu City 300,
Taiwan

Test Location: E-2, No.1, Li Hsin 1st Road, Hsinchu Science Park, Hsinchu City 300,
Taiwan

**FCC Registration /
Designation Number:** 723255 / TW2022



This report is for your exclusive use. Any copying or replication of this report to or for any other person or entity, or use of our name or trademark, is permitted only with our prior written permission. This report sets forth our findings solely with respect to the test samples identified herein. The results set forth in this report are not indicative or representative of the quality or characteristics of the lot from which a test sample was taken or any similar or identical product unless specifically and expressly noted. Our report includes all of the tests requested by you and the results thereof based upon the information that you provided to us. You have 60 days from date of issuance of this report to notify us of any material error or omission caused by our negligence, provided, however, that such notice shall be in writing and shall specifically address the issue you wish to raise. A failure to raise such issue within the prescribed time shall constitute your unqualified acceptance of the completeness of this report, the tests conducted and the correctness of the report contents. Unless specific mention, the uncertainty of measurement has been explicitly taken into account to declare the compliance or non-compliance to the specification. This report should not be used by the client to claim product certification, approval, or endorsement by TAF or any government agencies.

Table of Contents

Release Control Record	3
1 Certificate of Conformity	4
2 Summary of Test Results	5
2.1 Measurement Uncertainty	5
2.2 Modification Record	5
3 General Information	6
3.1 General Description of EUT	6
3.1.1 Test Mode Applicability and Tested Channel Detail	8
3.2 Description of Support Units	10
3.2.1 Configuration of System under Test	11
4 Test Types and Results	12
4.1 Radiated Emission and Bandedge Measurement	12
4.1.1 Limits of Radiated Emission and Bandedge Measurement	12
4.1.2 Test Instruments	13
4.1.3 Test Procedures	16
4.1.4 Deviation from Test Standard	17
4.1.5 Test Setup	17
4.1.6 EUT Operating Conditions	18
4.1.7 Test Results (Mode 1)	19
4.1.8 Test Results (Mode 2)	25
4.2 Conducted Emission Measurement	31
4.2.1 Limits of Conducted Emission Measurement	31
4.2.2 Test Instruments	31
4.2.3 Test Procedures	32
4.2.4 Deviation from Test Standard	32
4.2.5 Test Setup	32
4.2.6 EUT Operating Conditions	32
4.2.7 Test Results (Mode 1)	33
4.2.8 Test Results (Mode 2)	35
4.3 Conducted Out of Band Emission Measurement	37
4.3.1 Limits of Conducted Out of Band Emission Measurement	37
4.3.2 Test Setup	37
4.3.3 Test Instruments	37
4.3.4 Test Procedures	37
4.3.5 Deviation from Test Standard	37
4.3.6 EUT Operating Conditions	37
4.3.7 Test Results (Mode 1)	38
4.3.8 Test Results (Mode 2)	38
5 Pictures of Test Arrangements	39
Appendix – Information of the Testing Laboratories	40

Release Control Record

Issue No.	Description	Date Issued
RF200114E03-4	Original release.	Apr. 14, 2020

1 Certificate of Conformity

Product: 11a/b/g/n/ac RTL8822C Combo module

Brand: Realtek

Test Model: RTL8822C

Sample Status: ENGINEERING SAMPLE

Applicant: Realtek Semiconductor Corp.

Test Date: Mar. 09 to 25, 2020

Standards: 47 CFR FCC Part 15, Subpart C (Section 15.247)

47 CFR FCC Part 15, Subpart E (Section 15.407)

ANSI C63.10: 2013

The above equipment has been tested by **Bureau Veritas Consumer Products Services (H.K.) Ltd., Taoyuan Branch**, and found compliance with the requirement of the above standards. The test record, data evaluation & Equipment Under Test (EUT) configurations represented herein are true and accurate accounts of the measurements of the sample's EMC characteristics under the conditions specified in this report.

Prepared by : Phoenix Huang , **Date:** Apr. 14, 2020
Phoenix Huang / Specialist

Approved by : Clark Lin , **Date:** Apr. 14, 2020
Clark Lin / Technical Manager

2 Summary of Test Results

47 CFR FCC Part 15, Subpart C, E (SECTION 15.247, 15.407)			
FCC Clause	Test Item	Result	Remarks
15.207 15.407(b)(6)	AC Power Conducted Emission	PASS	Meet the requirement of limit. Minimum passing margin is -8.38 dB at 0.19687 MHz.
15.205 / 15.209 / 15.247(d) 15.407(b) (1/2/3/4(i/ii)/6)	Radiated Emissions and Band Edge Measurement	PASS	Meet the requirement of limit. Minimum passing margin is -6.5 dB at 699.40 MHz.

Note:

Determining compliance based on the results of the compliance measurement, not taking into account measurement instrumentation uncertainty.

2.1 Measurement Uncertainty

Where relevant, the following measurement uncertainty levels have been estimated for tests performed on the EUT as specified in CISPR 16-4-2:

Measurement	Frequency	Expanded Uncertainty (k=2) (\pm)
Conducted Emissions at mains ports	150kHz ~ 30MHz	1.8 dB
Conducted emissions	-	3.1 dB
Radiated Emissions up to 1 GHz	9kHz ~ 30MHz	3.0 dB
	30MHz ~ 1GHz	4.9 dB
Radiated Emissions above 1 GHz	1GHz ~ 6GHz	5.1 dB
	6GHz ~ 18GHz	4.9 dB
	18GHz ~ 40GHz	5.2 dB

2.2 Modification Record

There were no modifications required for compliance.

3 General Information

3.1 General Description of EUT

Product	11a/b/g/n/ac RTL8822C Combo module
Brand	Realtek
Test Model	RTL8822C
Status of EUT	ENGINEERING SAMPLE
Power Supply Rating	3.3Vdc from host equipment
Modulation Type	CCK, DQPSK, DBPSK for DSSS 64QAM, 16QAM, QPSK, BPSK for OFDM 256QAM for OFDM in 11ac mode and VHT (20/40) mode in 2.4GHz
Modulation Technology	DSSS, OFDM
Transfer Rate	802.11b: up to 11Mbps 802.11a/g: up to 54 Mbps 802.11n: up to 300 Mbps 802.11ac: up to 866.7 Mbps
Operating Frequency	2.4GHz: 2.412 ~ 2.472 GHz 5GHz: 5.18 ~ 5.24 GHz, 5.26 ~ 5.32 GHz, 5.50 ~ 5.72 GHz, 5.745 ~ 5.825 GHz
Number of Channel	2.4GHz: 802.11b, 802.11g, 802.11n (HT20), VHT20: 13 802.11n (HT40), VHT40: 9 5GHz: 802.11a, 802.11n (HT20), 802.11ac (VHT20): 25 802.11n (HT40), 802.11ac (VHT40): 12 802.11ac (VHT80): 6
Antenna Type	Refer to Note
Antenna Connector	Refer to Note
Accessory Device	NA
Data Cable Supplied	NA

Note:

1. Simultaneously transmission condition.

Condition	Technology	
1	WLAN (2.4GHz)	Bluetooth
2	WLAN (5GHz)	Bluetooth

2. The antennas provided to the EUT, please refer to the following table:

Antenna Set	Chain NO.	Brand	Model	Antenna Gain (dBi)	Frequency range (GHz)	Antenna Type	Connector Type
1	Chain 0	LYNwave	ALA110-222050-300011	3.5	2.4~2.5	PIFA	i-pex(MHF)
				5	5.15~5.85		
	Chain 1	LYNwave	ALA110-222050-300011	3.5	2.4~2.5	PIFA	i-pex(MHF)
				5	5.15~5.85		
2	Chain 0	PSA	RFDPA171320EMLB301	3.14	2.4~2.5	Dipole	i-pex(MHF)
				5	5.15~5.85		
	Chain 1	PSA	RFDPA171320EMLB301	3.14	2.4~2.5	Dipole	i-pex(MHF)
				5	5.15~5.85		
3	-	REALTEK	RTK-ANT-0006	3.5	2.4~2.4835	PIFA	i-pex(MHF)
	-	REALTEK	RTK-ANT-0006	5	5.15~5.85	PIFA	i-pex(MHF)

Note:

1. From the above transmission chains, the worse case was found in transmission on Chain 0 for 1TX mode. Therefore only the test data of the mode was recorded in this report.
2. The Bluetooth technology will fix transmission on Chain 1.
3. From the above antennas, antenna set 1 and 2 was selected as representative antenna for the test.

3. The EUT incorporates a MIMO function:

2.4GHz Band			
MODULATION MODE	DATA RATE (MCS)	TX & RX CONFIGURATION	
802.11b	1 ~ 11Mbps	2TX/1TX Diversity	2RX
802.11g	6 ~ 54Mbps	2TX/1TX Diversity	2RX
802.11n (HT20)	MCS 0~7	2TX/1TX Diversity	2RX
	MCS 8~15	2TX	2RX
802.11n (HT40)	MCS 0~7	2TX/1TX Diversity	2RX
	MCS 8~15	2TX	2RX
VHT20	MCS0~8 Nss=1	2TX/1TX Diversity	2RX
	MCS0~8 Nss=2	2TX	2RX
VHT40	MCS0~9 Nss=1	2TX/1TX Diversity	2RX
	MCS0~9 Nss=2	2TX	2RX
5GHz Band			
MODULATION MODE	DATA RATE (MCS)	TX & RX CONFIGURATION	
802.11a	6 ~ 54Mbps	2TX/1TX Diversity	2RX
802.11n (HT20)	MCS 0~7	2TX/1TX Diversity	2RX
	MCS 8~15	2TX	2RX
802.11n (HT40)	MCS 0~7	2TX/1TX Diversity	2RX
	MCS 8~15	2TX	2RX
802.11ac (VHT20)	MCS0~8 Nss=1	2TX/1TX Diversity	2RX
	MCS0~8 Nss=2	2TX	2RX
802.11ac (VHT40)	MCS0~9 Nss=1	2TX/1TX Diversity	2RX
	MCS0~9 Nss=2	2TX	2RX
802.11ac (VHT80)	MCS0~9 Nss=1	2TX/1TX Diversity	2RX
	MCS0~9 Nss=2	2TX	2RX

Note: All of modulation mode support beamforming function except 802.11a/b/g modulation mode.

4. The above EUT information is declared by manufacturer and for more detailed features description, please refer to the manufacturer's specifications or user's manual.

3.1.1 Test Mode Applicability and Tested Channel Detail

EUT CONFIGURE MODE	APPLICABLE TO				DESCRIPTION
	RE \geq 1G	RE<1G	PLC	OB	
1	√	√	√	√	WLAN (2.4GHz) + Bluetooth
2	√	√	√	√	WLAN (5GHz) + Bluetooth

Where **RE \geq 1G**: Radiated Emission above 1GHz & Bandedge Measurement
RE<1G: Radiated Emission below 1GHz
PLC: Power Line Conducted Emission
OB: Conducted Out-Band Emission Measurement

Note: The EUT's PIFA antenna had been pre-tested on the positioned of each 3 axis. The worst case was found when positioned on Y-plane.

Radiated Emission Test (Above 1GHz):

The tested configurations represent the worst-case mode from all possible combinations by the maximum power.

Following channel(s) was (were) selected for the final test as listed below.

EUT CONFIGURE MODE	MODE	AVAILABLE CHANNEL	TESTED CHANNEL	MODULATION TECHNOLOGY	MODULATION TYPE
1	VHT20 + BT-EDR	1 to 13	6	OFDM	BPSK
		0 to 78	0	FHSS	8DPSK
2	802.11ac (VHT20) + BT-EDR	36 to 64, 100 to 144, 149 to 165	157	OFDM	BPSK
		0 to 78	0	FHSS	8DPSK

Radiated Emission Test (Below 1GHz):

The tested configurations represent the worst-case mode from all possible combinations by the maximum power.

Following channel(s) was (were) selected for the final test as listed below.

EUT CONFIGURE MODE	MODE	AVAILABLE CHANNEL	TESTED CHANNEL	MODULATION TECHNOLOGY	MODULATION TYPE
1	VHT20 + BT-EDR	1 to 13	6	OFDM	BPSK
		0 to 78	0	FHSS	8DPSK
2	802.11ac (VHT20) + BT-EDR	36 to 64, 100 to 144, 149 to 165	157	OFDM	BPSK
		0 to 78	0	FHSS	8DPSK

Power Line Conducted Emission Test:

The tested configurations represent the worst-case mode from all possible combinations by the maximum power.

Following channel(s) was (were) selected for the final test as listed below.

EUT CONFIGURE MODE	MODE	AVAILABLE CHANNEL	TESTED CHANNEL	MODULATION TECHNOLOGY	MODULATION TYPE
1	VHT20 + BT-EDR	1 to 13	6	OFDM	BPSK
		0 to 78	0	FHSS	8DPSK
2	802.11ac (VHT20) + BT-EDR	36 to 64, 100 to 144, 149 to 165	157	OFDM	BPSK
		0 to 78	0	FHSS	8DPSK

Conducted Out-Band Emission Measurement:

The tested configurations represent the worst-case mode from all possible combinations by the maximum power.

Following channel(s) was (were) selected for the final test as listed below.

EUT CONFIGURE MODE	MODE	AVAILABLE CHANNEL	TESTED CHANNEL	MODULATION TECHNOLOGY	MODULATION TYPE
1	VHT20 + BT-EDR	1 to 13	6	OFDM	BPSK
		0 to 78	0	FHSS	8DPSK
2	802.11ac (VHT20) + BT-EDR	36 to 64, 100 to 144, 149 to 165	157	OFDM	BPSK
		0 to 78	0	FHSS	8DPSK

Test Condition:

Applicable To	Environmental Conditions	Input Power (System)	Tested By
RE \geq 1G	25deg. C, 75%RH	120Vac, 60Hz	Gary Cheng
RE $<$ 1G	22deg. C, 70%RH	120Vac, 60Hz	Kevin Ko
PLC	25deg. C, 75%RH	120Vac, 60Hz	Kevin Ko
OB	25deg. C, 60%RH	120Vac, 60Hz	Anderson Chen

3.2 Description of Support Units

The EUT has been tested as an independent unit together with other necessary accessories or support units. The following support units or accessories were used to form a representative test configuration during the tests.

ID	Product	Brand	Model No.	Serial No.	FCC ID	Remarks
A.	Laptop	Lenovo	769	NA	NA	Provided by Lab
B.	Test Tool	Realtek	NA	NA	NA	Supplied by client
C.	Adapter	Lenovo	ADLX45YCC3A	NA	NA	Provided by Lab

ID	Descriptions	Qty.	Length (m)	Shielding (Yes/No)	Cores (Qty.)	Remarks
1.	DC Cable	1	1.8	No	1	Provided by Lab
2.	AC Cable	1	1.8	No	0	Provided by Lab

Note: The core(s) is(are) originally attached to the cable(s).

3.2.1 Configuration of System under Test

For AC Power Conducted Emissions test:

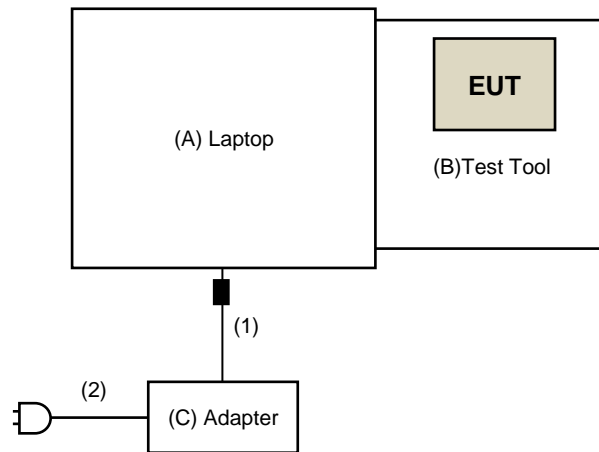

For Radiated Emissions test:

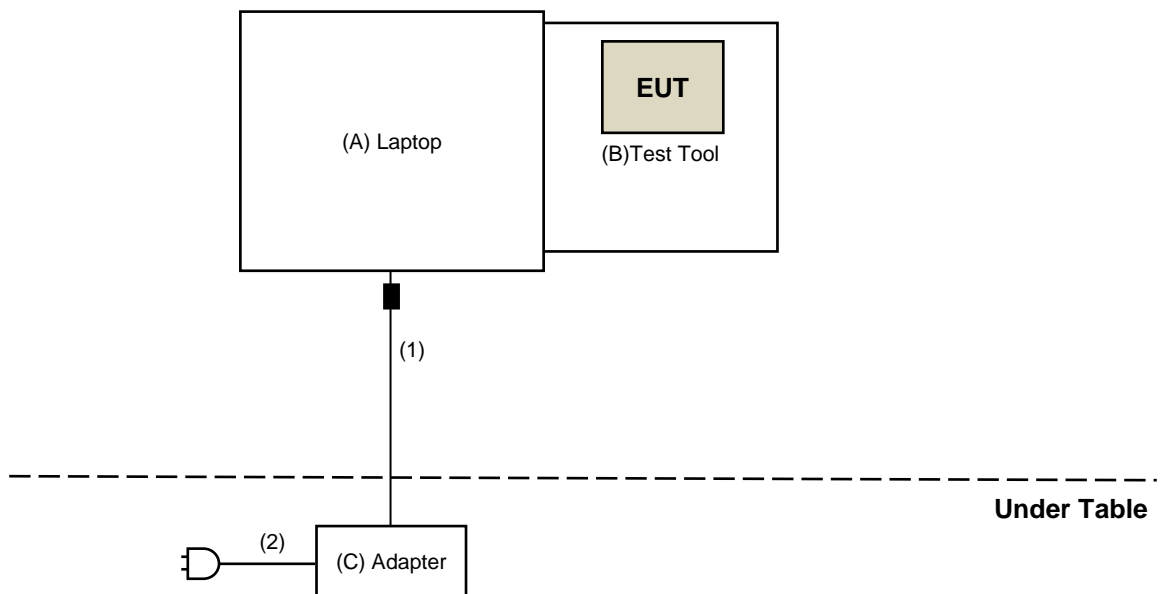

4 Test Types and Results

4.1 Radiated Emission and Bandedge Measurement

4.1.1 Limits of Radiated Emission and Bandedge Measurement

Radiated emissions which fall in the restricted bands must comply with the radiated emission limits specified as below table.

Frequencies (MHz)	Field Strength (microvolts/meter)	Measurement Distance (meters)
0.009 ~ 0.490	2400/F(kHz)	300
0.490 ~ 1.705	24000/F(kHz)	30
1.705 ~ 30.0	30	30
30 ~ 88	100	3
88 ~ 216	150	3
216 ~ 960	200	3
Above 960	500	3

Note:

- The lower limit shall apply at the transition frequencies.
- Emission level (dBuV/m) = 20 log Emission level (uV/m).
- For frequencies above 1000MHz, the field strength limits are based on average detector, however, the peak field strength of any emission shall not exceed the maximum permitted average limits, specified above by more than 20dB under any condition of modulation.

Limits of unwanted emission out of the restricted bands

Applicable To		Limit	
789033 D02 General UNII Test Procedure New Rules v02r01		Field Strength at 3m	
		PK:74 (dBµV/m)	AV:54 (dBµV/m)
Frequency Band	Applicable To	EIRP Limit	Equivalent Field Strength at 3m
5150~5250 MHz	15.407(b)(1)	PK:-27 (dBm/MHz)	PK:68.2(dBµV/m)
5250~5350 MHz	15.407(b)(2)		
5470~5725 MHz	15.407(b)(3)		
5725~5850 MHz	15.407(b)(4)(i)	PK: -27 (dBm/MHz) ^{*1} PK: 10 (dBm/MHz) ^{*2} PK: 15.6 (dBm/MHz) ^{*3} PK: 27 (dBm/MHz) ^{*4}	PK: 68.2(dBµV/m) ^{*1} PK: 105.2 (dBµV/m) ^{*2} PK: 110.8(dBµV/m) ^{*3} PK: 122.2 (dBµV/m) ^{*4}
^{*1} beyond 75 MHz or more above of the band edge. ^{*3} below the band edge increasing linearly to a level of 15.6 dBm/MHz at 5 MHz above.		^{*2} below the band edge increasing linearly to 10 dBm/MHz at 25 MHz above. ^{*4} from 5 MHz above or below the band edge increasing linearly to a level of 27 dBm/MHz at the band edge.	

Note:

The following formula is used to convert the equipment isotropic radiated power (eirp) to field strength:

$$E = \frac{1000000\sqrt{30P}}{3} \mu\text{V/m, where P is the eirp (Watts).}$$

4.1.2 Test Instruments

For Dipole Antenna Radiated Emission (below 1GHz) Test

DESCRIPTION & MANUFACTURER	MODEL NO.	SERIAL NO.	CALIBRATED DATE	CALIBRATED UNTIL
Test Receiver Agilent	N9038A	MY51210202	Dec. 13, 2019	Dec. 12, 2020
Pre-Amplifier EMCI	EMC001340	980142	May 30, 2019	May 29, 2020
Loop Antenna Electro-Metrics	EM-6879	264	Feb. 18, 2020	Feb. 17, 2021
RF Cable	NA	LOOPCAB-001	Jan. 08, 2020	Jan. 07, 2021
RF Cable	NA	LOOPCAB-002	Jan. 08, 2020	Jan. 07, 2021
Pre-Amplifier Mini-Circuits	ZFL-1000VH2B	AMP-ZFL-01	Oct. 23, 2019	Oct. 22, 2020
Trilog Broadband Antenna SCHWARZBECK	VULB 9168	9168-406	Nov. 11, 2019	Nov. 10, 2020
RF Cable	8D	966-4-1	Mar. 19, 2019	Mar. 18, 2020
RF Cable	8D	966-4-2	Mar. 19, 2019	Mar. 18, 2020
RF Cable	8D	966-4-3	Mar. 19, 2019	Mar. 18, 2020
Fixed attenuator Mini-Circuits	UNAT-5+	PAD-3m-4-01	Sep. 26, 2019	Sep. 25, 2020
Software	ADT_Radiated_V8.7.08	NA	NA	NA
Boresight Antenna Tower & Turn Table Max-Full	MF-7802BS	MF780208530	NA	NA

Note:

1. The calibration interval of the above test instruments is 12 months and the calibrations are traceable to NML/ROC and NIST/USA.
2. The test was performed in 966 Chamber No. 4.
3. Tested Date: Mar. 12, 2020

For Other Radiated Emission Test

DESCRIPTION & MANUFACTURER	MODEL NO.	SERIAL NO.	CALIBRATED DATE	CALIBRATED UNTIL
Test Receiver Agilent	N9038A	MY51210202	Dec. 13, 2019	Dec. 12, 2020
Pre-Amplifier EMCI	EMC001340	980142	May 30, 2019	May 29, 2020
Loop Antenna Electro-Metrics	EM-6879	264	Feb. 18, 2020	Feb. 17, 2021
RF Cable	NA	LOOPCAB-001	Jan. 08, 2020	Jan. 07, 2021
RF Cable	NA	LOOPCAB-002	Jan. 08, 2020	Jan. 07, 2021
Pre-Amplifier Mini-Circuits	ZFL-1000VH2B	AMP-ZFL-01	Oct. 23, 2019	Oct. 22, 2020
Trilog Broadband Antenna SCHWARZBECK	VULB 9168	9168-406	Nov. 11, 2019	Nov. 10, 2020
RF Cable	8D	966-4-1	Mar. 18, 2020	Mar. 17, 2021
RF Cable	8D	966-4-2	Mar. 18, 2020	Mar. 17, 2021
RF Cable	8D	966-4-3	Mar. 18, 2020	Mar. 17, 2021
Fixed attenuator Mini-Circuits	UNAT-5+	PAD-3m-4-01	Sep. 26, 2019	Sep. 25, 2020
Horn_Antenna SCHWARZBECK	BBHA 9120D	9120D-783	Nov. 24, 2019	Nov. 23, 2020
Pre-Amplifier EMCI	EMC12630SE	980385	Aug. 15, 2019	Aug. 14, 2020
RF Cable	EMC104-SM-SM-1200	160923	Jan. 15, 2020	Jan. 14, 2021
RF Cable	104 RF cable	131215	Jan. 09, 2020	Jan. 08, 2021
RF Cable	EMC104-SM-SM-6000	180418	May 03, 2019	May 02, 2020
Pre-Amplifier EMCI	EMC184045SE	980387	Jan. 15, 2020	Jan. 14, 2021
Horn_Antenna SCHWARZBECK	BBHA 9170	BBHA9170519	Nov. 24, 2019	Nov. 23, 2020
RF Cable	EMC102-KM-KM-1200	160924	Jan. 15, 2020	Jan. 14, 2021
RF Cable	EMC-KM-KM-4000	200214	Mar. 11, 2020	Mar. 10, 2021
Software	ADT_Radiated_V8.7.08	NA	NA	NA
Boresight Antenna Tower & Turn Table Max-Full	MF-7802BS	MF780208530	NA	NA

Note:

1. The calibration interval of the above test instruments is 12 months and the calibrations are traceable to NML/ROC and NIST/USA.
2. The test was performed in 966 Chamber No. 4.
3. Tested Date: Mar. 24 to 25, 2020

For other test items:

DESCRIPTION & MANUFACTURER	MODEL NO.	SERIAL NO.	CALIBRATED DATE	CALIBRATED UNTIL
Spectrum Analyzer R&S	FSV40	100964	June 04, 2019	June 03, 2020
Fixed Attenuator Mini-Circuits	MDCS18N-10	MDCS18N-10-01	Apr. 15, 2019	Apr. 14, 2020
Software	ADT_RF Test Software V6.6.5.4	NA	NA	NA

- NOTE:**
1. The test was performed in Oven room 2.
 2. The calibration interval of the above test instruments is 12 months and the calibrations are traceable to NML/ROC and NIST/USA.
 3. Tested Date: Mar. 13, 2020

4.1.3 Test Procedures

For Radiated emission below 30MHz

- a. The EUT was placed on the top of a rotating table 0.8 meters above the ground at a 3 meter chamber room. The table was rotated 360 degrees to determine the position of the highest radiation.
- b. The EUT was set 3 meters away from the interference-receiving antenna, which was mounted on the top of a variable-height antenna tower.
- c. Parallel, perpendicular, and ground-parallel orientations of the antenna are set to make the measurement.
- d. For each suspected emission, the EUT was arranged to its worst case and the rotatable table was turned from 0 degrees to 360 degrees to find the maximum reading.
- e. The test-receiver system was set to Quasi-Peak Detect Function and Specified Bandwidth with Maximum Hold Mode.

Note:

1. The resolution bandwidth and video bandwidth of test receiver/spectrum analyzer is 9kHz at frequency below 30MHz.

For Radiated emission above 30MHz

- a. The EUT was placed on the top of a rotating table 0.8 meters (for 30MHz ~ 1GHz) / 1.5 meters (for above 1GHz) above the ground at 3 meter chamber room for test. The table was rotated 360 degrees to determine the position of the highest radiation.
- b. The EUT was set 3 meters away from the interference-receiving antenna, which was mounted on the top of a variable-height antenna tower.
- c. The height of antenna is varied from one meter to four meters above the ground to determine the maximum value of the field strength. Both horizontal and vertical polarizations of the antenna are set to make the measurement.
- d. For each suspected emission, the EUT was arranged to its worst case and then the antenna was tuned to heights from 1 meter to 4 meters and the rotatable table was turned from 0 degrees to 360 degrees to find the maximum reading.
- e. The test-receiver system was set to quasi-peak detect function and specified bandwidth with maximum hold mode when the test frequency is below 1 GHz.
- f. The test-receiver system was set to peak and average detect function and specified bandwidth with maximum hold mode when the test frequency is above 1 GHz. If the peak reading value also meets average limit, measurement with the average detector is unnecessary.

Note:

1. The resolution bandwidth and video bandwidth of test receiver/spectrum analyzer is 120kHz for Quasi-peak detection (QP) at frequency below 1GHz.
2. The resolution bandwidth of test receiver/spectrum analyzer is 1 MHz and the video bandwidth is 3 MHz for Peak detection (PK) at frequency above 1GHz.
3. The resolution bandwidth of test receiver/spectrum analyzer is 1MHz and the video bandwidth is $\geq 1/T$ (Duty cycle $< 98\%$) or 10Hz (Duty cycle $\geq 98\%$) for Average detection (AV) at frequency above 1GHz.
4. All modes of operation were investigated and the worst-case emissions are reported.

4.1.4 Deviation from Test Standard

No deviation.

4.1.5 Test Setup

For Radiated emission below 30MHz

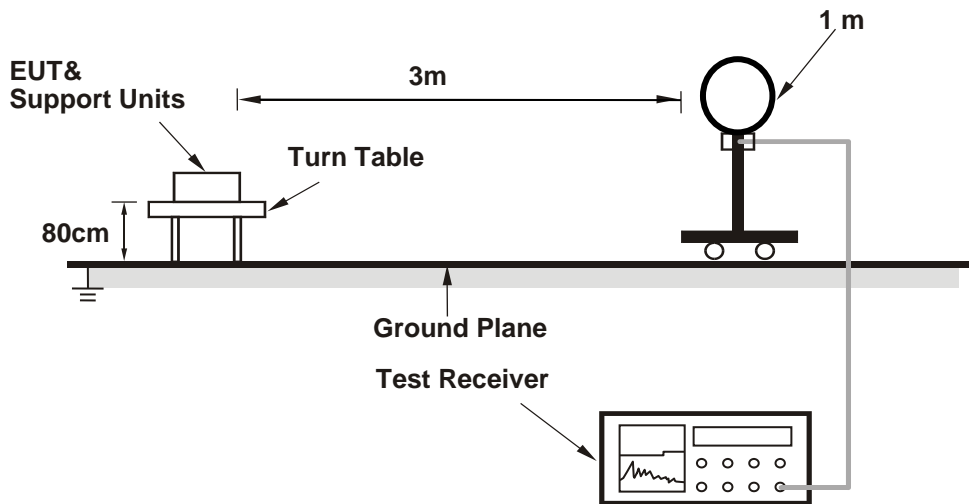

For Radiated emission 30MHz to 1GHz

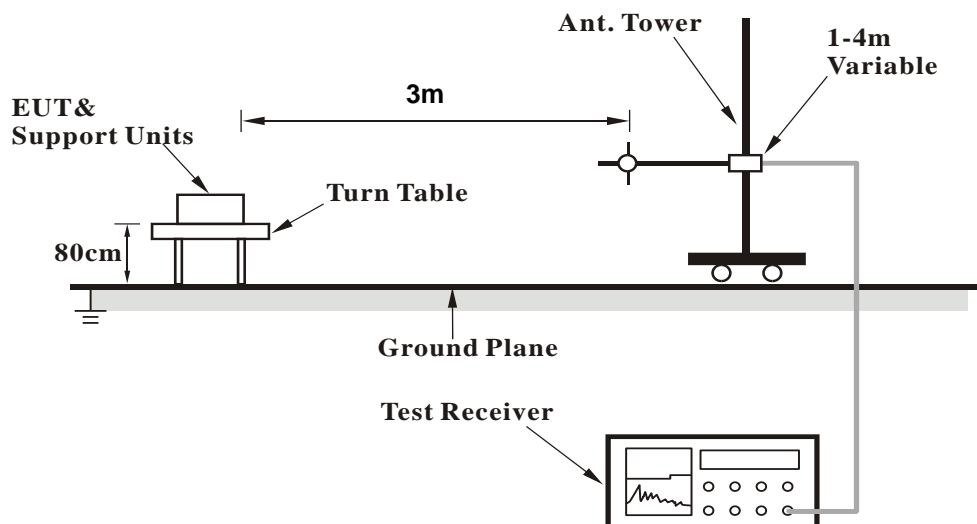

For Radiated emission above 1GHz

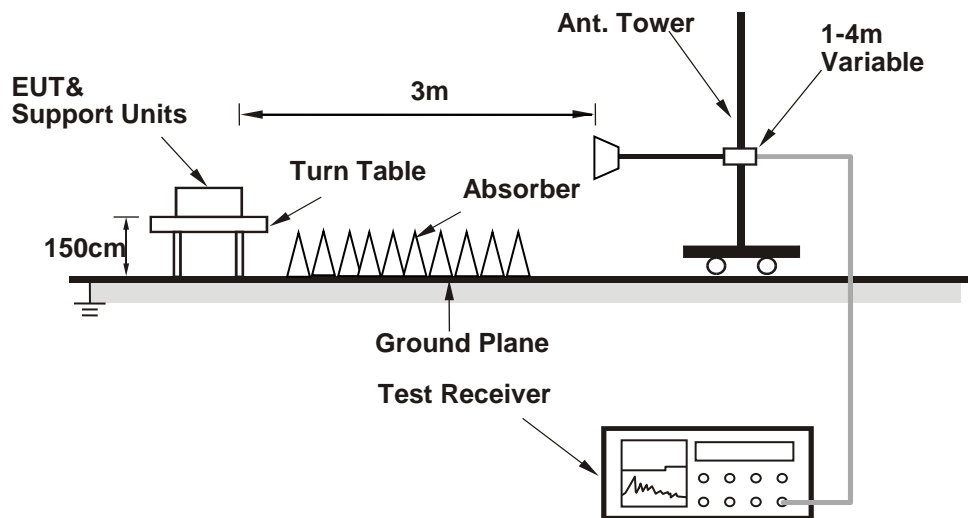

For the actual test configuration, please refer to the attached file (Test Setup Photo).

4.1.6 EUT Operating Conditions

- Connected the EUT with the Laptop which is placed on the testing table.
- Controlling software (WLAN: Win7_MP_Kit_RTL11ac_8822CE_PCIE_v9.00_20191217 / Bluetooth: BLUETOOTH RF TEST TOOL (5.2.2.59)) has been activated to set the EUT under transmission condition continuously.

4.1.7 Test Results (Mode 1)

Dipole Antenna

Above 1GHz Data:

FREQUENCY RANGE	1GHz ~ 25GHz	DETECTOR FUNCTION	Peak (PK) Average (AV)
------------------------	--------------	--------------------------	---------------------------

ANTENNA POLARITY & TEST DISTANCE: HORIZONTAL AT 3 M

NO.	FREQ. (MHz)	EMISSION LEVEL (dBuV/m)	LIMIT (dBuV/m)	MARGIN (dB)	ANTENNA HEIGHT (m)	TABLE ANGLE (Degree)	RAW VALUE (dBuV)	CORRECTION FACTOR (dB/m)
1	4804.00	37.6 PK	74.0	-36.4	2.04 H	175	34.9	2.7
2	4804.00	27.1 AV	54.0	-26.9	2.04 H	175	24.4	2.7
3	4874.00	37.8 PK	74.0	-36.2	1.65 H	129	35.3	2.5
4	4874.00	25.6 AV	54.0	-28.4	1.65 H	129	23.1	2.5
5	7311.00	44.8 PK	74.0	-29.2	1.54 H	31	35.3	9.5
6	7311.00	32.7 AV	54.0	-21.3	1.54 H	31	23.2	9.5

ANTENNA POLARITY & TEST DISTANCE: VERTICAL AT 3 M

NO.	FREQ. (MHz)	EMISSION LEVEL (dBuV/m)	LIMIT (dBuV/m)	MARGIN (dB)	ANTENNA HEIGHT (m)	TABLE ANGLE (Degree)	RAW VALUE (dBuV)	CORRECTION FACTOR (dB/m)
1	4804.00	39.3 PK	74.0	-34.7	1.77 V	127	36.6	2.7
2	4804.00	26.5 AV	54.0	-27.5	1.77 V	127	23.8	2.7
3	4874.00	38.4 PK	74.0	-35.6	1.75 V	197	35.9	2.5
4	4874.00	28.0 AV	54.0	-26.0	1.75 V	197	25.5	2.5
5	7311.00	46.1 PK	74.0	-27.9	2.48 V	299	36.6	9.5
6	7311.00	33.6 AV	54.0	-20.4	2.48 V	299	24.1	9.5

REMARKS:

1. Emission Level(dBuV/m) = Raw Value(dBuV) + Correction Factor(dB/m)
2. Correction Factor(dB/m) = Antenna Factor(dB/m) + Cable Factor(dB) – Pre-Amplifier Factor(dB)
3. Margin value = Emission Level – Limit value
4. The other emission levels were very low against the limit.

Below 1GHz Data:

FREQUENCY RANGE	9kHz ~ 1GHz	DETECTOR FUNCTION	Quasi-Peak (QP)
------------------------	-------------	--------------------------	-----------------

ANTENNA POLARITY & TEST DISTANCE: HORIZONTAL AT 3 M

NO.	FREQ. (MHz)	EMISSION LEVEL (dBuV/m)	LIMIT (dBuV/m)	MARGIN (dB)	ANTENNA HEIGHT (m)	TABLE ANGLE (Degree)	RAW VALUE (dBuV)	CORRECTION FACTOR (dB/m)
1	199.80	35.4 QP	43.5	-8.1	1.00 H	2	46.3	-10.9
2	299.73	37.2 QP	46.0	-8.8	1.00 H	346	43.9	-6.7
3	323.81	38.4 QP	46.0	-7.6	1.00 H	261	44.4	-6.0
4	497.95	36.8 QP	46.0	-9.2	1.50 H	220	38.5	-1.7
5	699.40	39.5 QP	46.0	-6.5	1.00 H	266	37.2	2.3
6	896.19	33.6 QP	46.0	-12.4	1.50 H	256	27.9	5.7

REMARKS:

1. Emission Level(dBuV/m) = Raw Value(dBuV) + Correction Factor(dB/m)
2. Correction Factor(dB/m) = Antenna Factor(dB/m) + Cable Factor(dB) – Pre-Amplifier Factor(dB)
3. Margin value = Emission Level – Limit value
4. The other emission levels were very low against the limit of frequency range 30MHz~1000MHz.
5. The emission levels were very low against the limit of frequency range 9kHz~30MHz: the amplitude of spurious emissions attenuated more than 20 dB below the permissible value to be report.

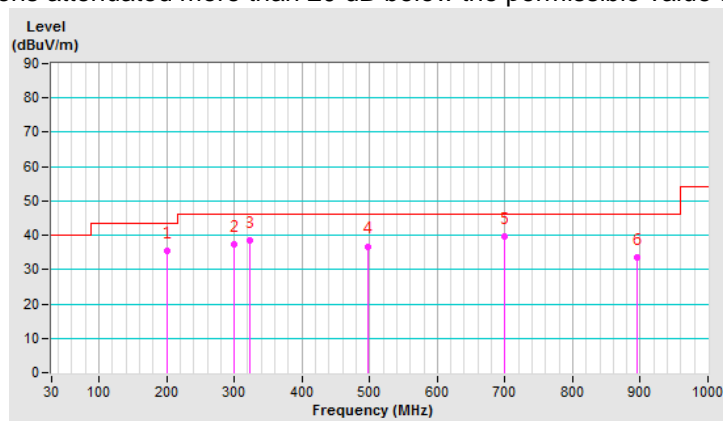

FREQUENCY RANGE	9kHz ~ 1GHz	DETECTOR FUNCTION	Quasi-Peak (QP)
------------------------	-------------	--------------------------	-----------------

ANTENNA POLARITY & TEST DISTANCE: VERTICAL AT 3 M

NO.	FREQ. (MHz)	EMISSION LEVEL (dBuV/m)	LIMIT (dBuV/m)	MARGIN (dB)	ANTENNA HEIGHT (m)	TABLE ANGLE (Degree)	RAW VALUE (dBuV)	CORRECTION FACTOR (dB/m)
1	322.75	38.7 QP	46.0	-7.3	1.50 V	0	44.8	-6.1
2	358.64	35.6 QP	46.0	-10.4	1.50 V	356	41.0	-5.4
3	431.87	37.1 QP	46.0	-8.9	1.00 V	319	40.3	-3.2
4	499.65	38.8 QP	46.0	-7.2	1.00 V	98	40.5	-1.7
5	699.52	34.2 QP	46.0	-11.8	1.00 V	281	31.9	2.3
6	896.19	37.1 QP	46.0	-8.9	1.50 V	259	31.4	5.7

REMARKS:

1. Emission Level(dBuV/m) = Raw Value(dBuV) + Correction Factor(dB/m)
2. Correction Factor(dB/m) = Antenna Factor(dB/m) + Cable Factor(dB) – Pre-Amplifier Factor(dB)
3. Margin value = Emission Level – Limit value
4. The other emission levels were very low against the limit of frequency range 30MHz~1000MHz.
5. The emission levels were very low against the limit of frequency range 9kHz~30MHz: the amplitude of spurious emissions attenuated more than 20 dB below the permissible value to be report.

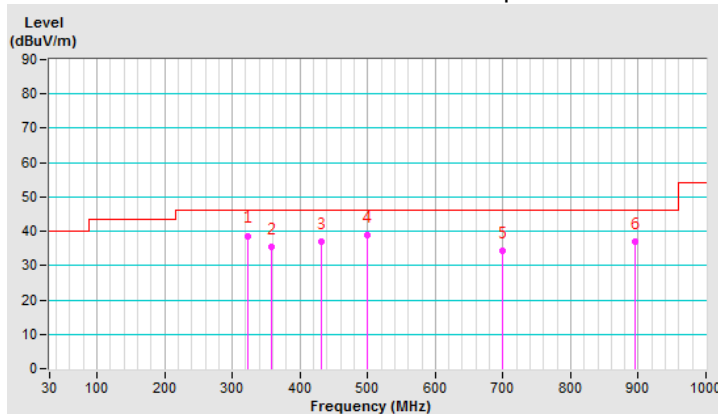

PIFA Antenna

Above 1GHz Data:

FREQUENCY RANGE	1GHz ~ 25GHz	DETECTOR FUNCTION	Peak (PK) Average (AV)
------------------------	--------------	--------------------------	---------------------------

ANTENNA POLARITY & TEST DISTANCE: HORIZONTAL AT 3 M

NO.	FREQ. (MHz)	EMISSION LEVEL (dBuV/m)	LIMIT (dBuV/m)	MARGIN (dB)	ANTENNA HEIGHT (m)	TABLE ANGLE (Degree)	RAW VALUE (dBuV)	CORRECTION FACTOR (dB/m)
1	4804.00	37.5 PK	74.0	-36.5	2.33 H	164	34.8	2.7
2	4804.00	27.1 AV	54.0	-26.9	2.33 H	164	24.4	2.7
3	4874.00	38.0 PK	74.0	-36.0	1.71 H	153	35.5	2.5
4	4874.00	25.7 AV	54.0	-28.3	1.71 H	153	23.2	2.5
5	7311.00	44.9 PK	74.0	-29.1	1.52 H	49	35.4	9.5
6	7311.00	32.7 AV	54.0	-21.3	1.52 H	49	23.2	9.5

ANTENNA POLARITY & TEST DISTANCE: VERTICAL AT 3 M

NO.	FREQ. (MHz)	EMISSION LEVEL (dBuV/m)	LIMIT (dBuV/m)	MARGIN (dB)	ANTENNA HEIGHT (m)	TABLE ANGLE (Degree)	RAW VALUE (dBuV)	CORRECTION FACTOR (dB/m)
1	4804.00	39.1 PK	74.0	-34.9	1.57 V	142	36.4	2.7
2	4804.00	26.4 AV	54.0	-27.6	1.57 V	142	23.7	2.7
3	4874.00	38.6 PK	74.0	-35.4	1.91 V	175	36.1	2.5
4	4874.00	28.0 AV	54.0	-26.0	1.91 V	175	25.5	2.5
5	7311.00	46.3 PK	74.0	-27.7	2.24 V	303	36.8	9.5
6	7311.00	33.9 AV	54.0	-20.1	2.24 V	303	24.4	9.5

REMARKS:

1. Emission Level(dBuV/m) = Raw Value(dBuV) + Correction Factor(dB/m)
2. Correction Factor(dB/m) = Antenna Factor(dB/m) + Cable Factor(dB) – Pre-Amplifier Factor(dB)
3. Margin value = Emission Level – Limit value
4. The other emission levels were very low against the limit.

Below 1GHz Data:

FREQUENCY RANGE	9kHz ~ 1GHz	DETECTOR FUNCTION	Quasi-Peak (QP)
------------------------	-------------	--------------------------	-----------------

ANTENNA POLARITY & TEST DISTANCE: HORIZONTAL AT 3 M

NO.	FREQ. (MHz)	EMISSION LEVEL (dBuV/m)	LIMIT (dBuV/m)	MARGIN (dB)	ANTENNA HEIGHT (m)	TABLE ANGLE (Degree)	RAW VALUE (dBuV)	CORRECTION FACTOR (dB/m)
1	155.17	36.3 QP	43.5	-7.2	1.15 H	114	43.8	-7.5
2	177.21	33.2 QP	43.5	-10.3	1.04 H	101	42.2	-9.0
3	267.19	33.3 QP	46.0	-12.7	1.28 H	111	41.3	-8.0
4	475.27	35.3 QP	46.0	-10.7	1.17 H	61	37.4	-2.1
5	582.15	34.4 QP	46.0	-11.6	1.17 H	227	34.1	0.3
6	884.97	38.1 QP	46.0	-7.9	1.12 H	101	32.5	5.6

REMARKS:

1. Emission Level(dBuV/m) = Raw Value(dBuV) + Correction Factor(dB/m)
2. Correction Factor(dB/m) = Antenna Factor(dB/m) + Cable Factor(dB) – Pre-Amplifier Factor(dB)
3. Margin value = Emission Level – Limit value
4. The other emission levels were very low against the limit of frequency range 30MHz~1000MHz.
5. The emission levels were very low against the limit of frequency range 9kHz~30MHz: the amplitude of spurious emissions attenuated more than 20 dB below the permissible value to be report.

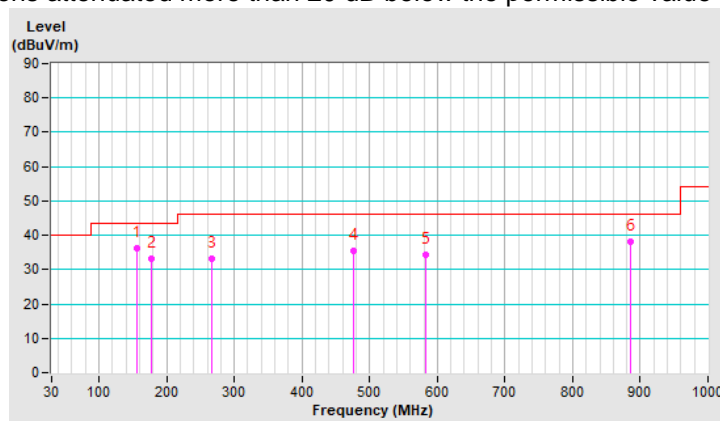

FREQUENCY RANGE	9kHz ~ 1GHz	DETECTOR FUNCTION	Quasi-Peak (QP)
------------------------	-------------	--------------------------	-----------------

ANTENNA POLARITY & TEST DISTANCE: VERTICAL AT 3 M								
NO.	FREQ. (MHz)	EMISSION LEVEL (dBuV/m)	LIMIT (dBuV/m)	MARGIN (dB)	ANTENNA HEIGHT (m)	TABLE ANGLE (Degree)	RAW VALUE (dBuV)	CORRECTION FACTOR (dB/m)
1	135.17	36.2 QP	43.5	-7.3	1.17 V	144	44.7	-8.5
2	175.21	33.1 QP	43.5	-10.4	3.04 V	121	41.8	-8.7
3	257.19	33.3 QP	46.0	-12.7	1.18 V	211	42.0	-8.7
4	474.25	35.3 QP	46.0	-10.7	1.15 V	81	37.4	-2.1
5	581.15	34.4 QP	46.0	-11.6	1.19 V	337	34.1	0.3
6	884.94	38.1 QP	46.0	-7.9	1.10 V	121	32.5	5.6

REMARKS:

1. Emission Level(dBuV/m) = Raw Value(dBuV) + Correction Factor(dB/m)
2. Correction Factor(dB/m) = Antenna Factor(dB/m) + Cable Factor(dB) – Pre-Amplifier Factor(dB)
3. Margin value = Emission Level – Limit value
4. The other emission levels were very low against the limit of frequency range 30MHz~1000MHz.
5. The emission levels were very low against the limit of frequency range 9kHz~30MHz: the amplitude of spurious emissions attenuated more than 20 dB below the permissible value to be report.

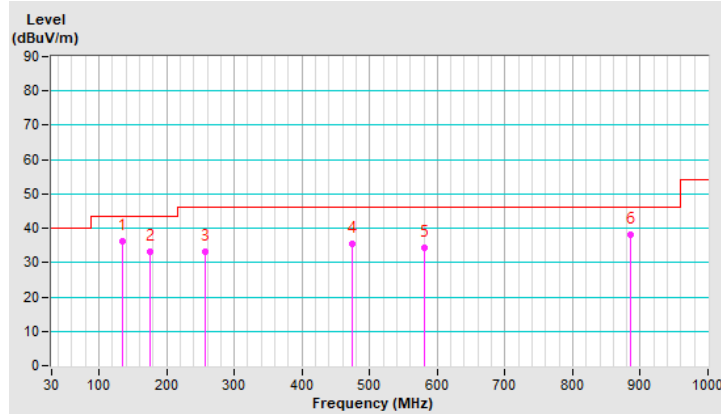

4.1.8 Test Results (Mode 2)

Dipole Antenna
Above 1GHz Data:

FREQUENCY RANGE	1GHz ~ 40GHz	DETECTOR FUNCTION	Peak (PK) Average (AV)
------------------------	--------------	--------------------------	---------------------------

ANTENNA POLARITY & TEST DISTANCE: HORIZONTAL AT 3 M

NO.	FREQ. (MHz)	EMISSION LEVEL (dBuV/m)	LIMIT (dBuV/m)	MARGIN (dB)	ANTENNA HEIGHT (m)	TABLE ANGLE (Degree)	RAW VALUE (dBuV)	CORRECTION FACTOR (dB/m)
1	4804.00	37.4 PK	74.0	-36.6	1.99 H	179	34.7	2.7
2	4804.00	26.9 AV	54.0	-27.1	1.99 H	179	24.2	2.7
3	11570.00	59.0 PK	74.0	-15.0	1.51 H	92	44.9	14.1
4	11570.00	43.4 AV	54.0	-10.6	1.51 H	92	29.3	14.1
5	17355.00	51.3 PK	68.2	-16.9	2.50 H	268	33.7	17.6

ANTENNA POLARITY & TEST DISTANCE: VERTICAL AT 3 M

NO.	FREQ. (MHz)	EMISSION LEVEL (dBuV/m)	LIMIT (dBuV/m)	MARGIN (dB)	ANTENNA HEIGHT (m)	TABLE ANGLE (Degree)	RAW VALUE (dBuV)	CORRECTION FACTOR (dB/m)
1	4804.00	38.9 PK	74.0	-35.1	1.73 V	127	36.2	2.7
2	4804.00	26.0 AV	54.0	-28.0	1.73 V	127	23.3	2.7
3	11570.00	59.0 PK	74.0	-15.0	3.48 V	81	44.9	14.1
4	11570.00	44.4 AV	54.0	-9.6	3.48 V	81	30.3	14.1
5	17355.00	52.0 PK	68.2	-16.2	1.83 V	155	34.4	17.6

REMARKS:

1. Emission Level(dBuV/m) = Raw Value(dBuV) + Correction Factor(dB/m)
2. Correction Factor(dB/m) = Antenna Factor(dB/m) + Cable Factor(dB) – Pre-Amplifier Factor(dB)
3. Margin value = Emission Level – Limit value
4. The other emission levels were very low against the limit.

Below 1GHz Data:

FREQUENCY RANGE	9kHz ~ 1GHz	DETECTOR FUNCTION	Quasi-Peak (QP)
------------------------	-------------	--------------------------	-----------------

ANTENNA POLARITY & TEST DISTANCE: HORIZONTAL AT 3 M								
NO.	FREQ. (MHz)	EMISSION LEVEL (dBuV/m)	LIMIT (dBuV/m)	MARGIN (dB)	ANTENNA HEIGHT (m)	TABLE ANGLE (Degree)	RAW VALUE (dBuV)	CORRECTION FACTOR (dB/m)
1	166.41	36.4 QP	43.5	-7.1	2.00 H	71	44.4	-8.0
2	199.82	34.8 QP	43.5	-8.7	1.50 H	360	45.7	-10.9
3	299.76	38.6 QP	46.0	-7.4	1.00 H	352	45.3	-6.7
4	499.50	33.9 QP	46.0	-12.1	1.50 H	236	35.6	-1.7
5	599.63	35.2 QP	46.0	-10.8	1.50 H	229	34.3	0.9
6	699.37	37.1 QP	46.0	-8.9	1.00 H	251	34.8	2.3

REMARKS:

1. Emission Level(dBuV/m) = Raw Value(dBuV) + Correction Factor(dB/m)
2. Correction Factor(dB/m) = Antenna Factor(dB/m) + Cable Factor(dB) – Pre-Amplifier Factor(dB)
3. Margin value = Emission Level – Limit value
4. The other emission levels were very low against the limit of frequency range 30MHz~1000MHz.
5. The emission levels were very low against the limit of frequency range 9kHz~30MHz: the amplitude of spurious emissions attenuated more than 20 dB below the permissible value to be report.

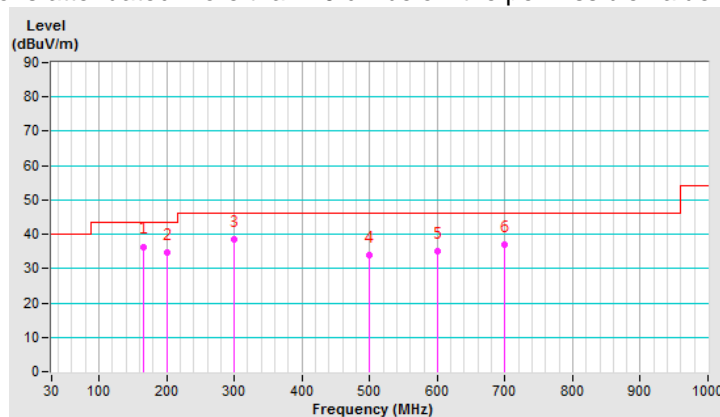

FREQUENCY RANGE	9kHz ~ 1GHz	DETECTOR FUNCTION	Quasi-Peak (QP)
------------------------	-------------	--------------------------	-----------------

ANTENNA POLARITY & TEST DISTANCE: VERTICAL AT 3 M								
NO.	FREQ. (MHz)	EMISSION LEVEL (dBuV/m)	LIMIT (dBuV/m)	MARGIN (dB)	ANTENNA HEIGHT (m)	TABLE ANGLE (Degree)	RAW VALUE (dBuV)	CORRECTION FACTOR (dB/m)
1	322.96	38.8 QP	46.0	-7.2	2.00 V	0	44.8	-6.0
2	359.24	37.2 QP	46.0	-8.8	2.00 V	0	42.6	-5.4
3	431.82	39.4 QP	46.0	-6.6	1.00 V	242	42.6	-3.2
4	499.60	34.5 QP	46.0	-11.5	1.00 V	100	36.2	-1.7
5	699.42	33.7 QP	46.0	-12.3	1.00 V	294	31.4	2.3
6	899.36	38.1 QP	46.0	-7.9	1.50 V	253	32.4	5.7

REMARKS:

1. Emission Level(dBuV/m) = Raw Value(dBuV) + Correction Factor(dB/m)
2. Correction Factor(dB/m) = Antenna Factor(dB/m) + Cable Factor(dB) – Pre-Amplifier Factor(dB)
3. Margin value = Emission Level – Limit value
4. The other emission levels were very low against the limit of frequency range 30MHz~1000MHz.
5. The emission levels were very low against the limit of frequency range 9kHz~30MHz: the amplitude of spurious emissions attenuated more than 20 dB below the permissible value to be report.

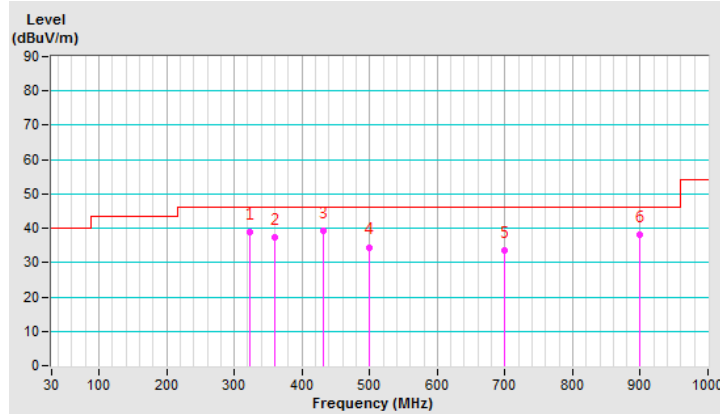

PIFA Antenna

Above 1GHz Data:

FREQUENCY RANGE	1GHz ~ 40GHz	DETECTOR FUNCTION	Peak (PK) Average (AV)
------------------------	--------------	--------------------------	---------------------------

ANTENNA POLARITY & TEST DISTANCE: HORIZONTAL AT 3 M

NO.	FREQ. (MHz)	EMISSION LEVEL (dBuV/m)	LIMIT (dBuV/m)	MARGIN (dB)	ANTENNA HEIGHT (m)	TABLE ANGLE (Degree)	RAW VALUE (dBuV)	CORRECTION FACTOR (dB/m)
1	4804.00	37.3 PK	74.0	-36.7	1.87 H	192	34.6	2.7
2	4804.00	26.8 AV	54.0	-27.2	1.87 H	192	24.1	2.7
3	11570.00	59.2 PK	74.0	-14.8	1.63 H	88	45.1	14.1
4	11570.00	43.5 AV	54.0	-10.5	1.63 H	88	29.4	14.1
5	17355.00	51.5 PK	68.2	-16.7	2.39 H	291	33.9	17.6

ANTENNA POLARITY & TEST DISTANCE: VERTICAL AT 3 M

NO.	FREQ. (MHz)	EMISSION LEVEL (dBuV/m)	LIMIT (dBuV/m)	MARGIN (dB)	ANTENNA HEIGHT (m)	TABLE ANGLE (Degree)	RAW VALUE (dBuV)	CORRECTION FACTOR (dB/m)
1	4804.00	38.7 PK	74.0	-35.3	1.65 V	136	36.0	2.7
2	4804.00	26.1 AV	54.0	-27.9	1.65 V	136	23.4	2.7
3	11570.00	58.8 PK	74.0	-15.2	3.02 V	113	44.7	14.1
4	11570.00	44.3 AV	54.0	-9.7	3.02 V	113	30.2	14.1
5	17355.00	52.3 PK	68.2	-15.9	1.68 V	164	34.7	17.6

REMARKS:

1. Emission Level(dBuV/m) = Raw Value(dBuV) + Correction Factor(dB/m)
2. Correction Factor(dB/m) = Antenna Factor(dB/m) + Cable Factor(dB) – Pre-Amplifier Factor(dB)
3. Margin value = Emission Level – Limit value
4. The other emission levels were very low against the limit.

Below 1GHz Data:

FREQUENCY RANGE	9kHz ~ 1GHz	DETECTOR FUNCTION	Quasi-Peak (QP)
------------------------	-------------	--------------------------	-----------------

ANTENNA POLARITY & TEST DISTANCE: HORIZONTAL AT 3 M

NO.	FREQ. (MHz)	EMISSION LEVEL (dBuV/m)	LIMIT (dBuV/m)	MARGIN (dB)	ANTENNA HEIGHT (m)	TABLE ANGLE (Degree)	RAW VALUE (dBuV)	CORRECTION FACTOR (dB/m)
1	155.16	36.2 QP	43.5	-7.3	1.05 H	163	43.7	-7.5
2	165.22	33.1 QP	43.5	-10.4	2.94 H	121	41.0	-7.9
3	247.18	33.3 QP	46.0	-12.7	2.17 H	121	42.2	-8.9
4	462.25	35.3 QP	46.0	-10.7	1.25 H	101	37.7	-2.4
5	570.15	34.3 QP	46.0	-11.7	1.30 H	317	34.5	-0.2
6	873.94	38.1 QP	46.0	-7.9	1.10 H	11	32.7	5.4

REMARKS:

1. Emission Level(dBuV/m) = Raw Value(dBuV) + Correction Factor(dB/m)
2. Correction Factor(dB/m) = Antenna Factor(dB/m) + Cable Factor(dB) – Pre-Amplifier Factor(dB)
3. Margin value = Emission Level – Limit value
4. The other emission levels were very low against the limit of frequency range 30MHz~1000MHz.
5. The emission levels were very low against the limit of frequency range 9kHz~30MHz: the amplitude of spurious emissions attenuated more than 20 dB below the permissible value to be report.

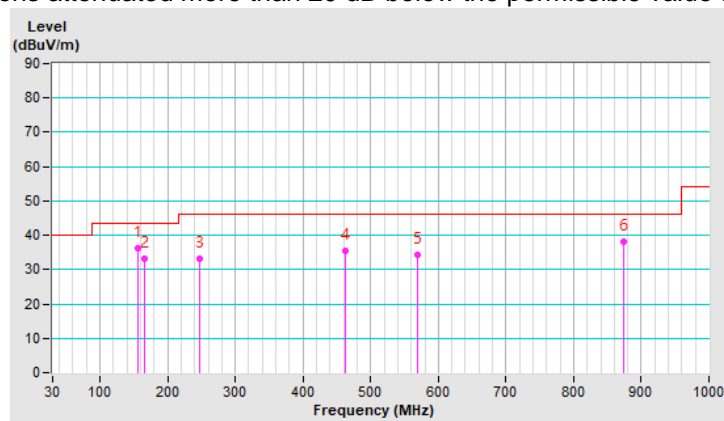

FREQUENCY RANGE	9kHz ~ 1GHz	DETECTOR FUNCTION	Quasi-Peak (QP)
------------------------	-------------	--------------------------	-----------------

ANTENNA POLARITY & TEST DISTANCE: VERTICAL AT 3 M								
NO.	FREQ. (MHz)	EMISSION LEVEL (dBuV/m)	LIMIT (dBuV/m)	MARGIN (dB)	ANTENNA HEIGHT (m)	TABLE ANGLE (Degree)	RAW VALUE (dBuV)	CORRECTION FACTOR (dB/m)
1	135.16	36.2 QP	43.5	-7.3	1.16 V	143	44.7	-8.5
2	175.22	33.1 QP	43.5	-10.4	3.14 V	111	41.8	-8.7
3	257.18	33.3 QP	46.0	-12.7	1.17 V	311	42.0	-8.7
4	464.25	35.3 QP	46.0	-10.7	1.35 V	121	37.6	-2.3
5	571.15	34.4 QP	46.0	-11.6	1.20 V	327	34.6	-0.2
6	874.94	38.1 QP	46.0	-7.9	1.20 V	111	32.7	5.4

REMARKS:

1. Emission Level(dBuV/m) = Raw Value(dBuV) + Correction Factor(dB/m)
2. Correction Factor(dB/m) = Antenna Factor(dB/m) + Cable Factor(dB) – Pre-Amplifier Factor(dB)
3. Margin value = Emission Level – Limit value
4. The other emission levels were very low against the limit of frequency range 30MHz~1000MHz.
5. The emission levels were very low against the limit of frequency range 9kHz~30MHz: the amplitude of spurious emissions attenuated more than 20 dB below the permissible value to be report.

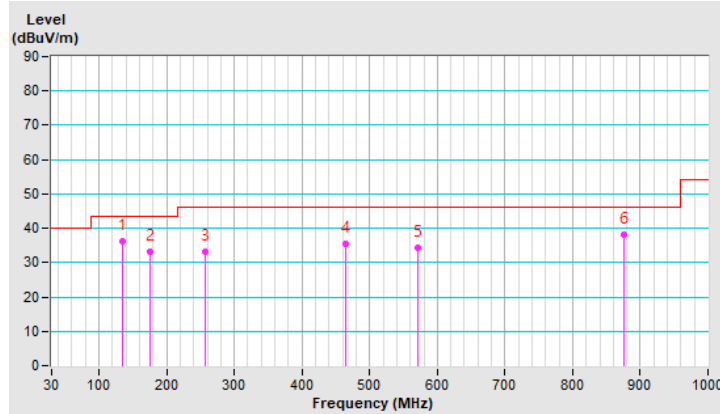

4.2 Conducted Emission Measurement

4.2.1 Limits of Conducted Emission Measurement

Frequency (MHz)	Conducted Limit (dBuV)	
	Quasi-peak	Average
0.15 - 0.5	66 - 56	56 - 46
0.50 - 5.0	56	46
5.0 - 30.0	60	50

Note: 1. The lower limit shall apply at the transition frequencies.

2. The limit decreases in line with the logarithm of the frequency in the range of 0.15 to 0.50MHz.

4.2.2 Test Instruments

DESCRIPTION & MANUFACTURER	MODEL NO.	SERIAL NO.	CALIBRATED DATE	CALIBRATED UNTIL
Test Receiver R&S	ESCS 30	847124/029	Oct. 23, 2019	Oct. 22, 2020
Line-Impedance Stabilization Network (for EUT) R&S	ESH3-Z5	848773/004	Oct. 23, 2019	Oct. 22, 2020
Line-Impedance Stabilization Network (for Peripheral) R&S	ESH3-Z5	835239/001	Mar. 17, 2019	Mar. 16, 2020
50 ohms Terminator	50	3	Oct. 23, 2019	Oct. 22, 2020
RF Cable	5D-FB	COCCAB-001	Sep. 27, 2019	Sep. 26, 2020
Fixed attenuator EMCI	STI02-2200-10	005	Aug. 30, 2019	Aug. 29, 2020
Software BVADT	BVADT_Cond_V7.3.7.4	NA	NA	NA

1. The calibration interval of the above test instruments are 12 months and the calibrations are traceable to NML/ROC and NIST/USA.
2. The test was performed in Conduction 1.
- 3 Tested Date: Mar. 09, 2020

4.2.3 Test Procedures

- The EUT was placed 0.4 meters from the conducting wall of the shielded room with EUT being connected to the power mains through a line impedance stabilization network (LISN). Other support units were connected to the power mains through another LISN. The two LISNs provide 50 ohm/ 50uH of coupling impedance for the measuring instrument.
- Both lines of the power mains connected to the EUT were checked for maximum conducted interference.
- The frequency range from 150kHz to 30MHz was searched. Emission levels under (Limit - 20dB) was not recorded.

Note: The resolution bandwidth and video bandwidth of test receiver is 9kHz for quasi-peak detection (QP) and average detection (AV) at frequency 0.15MHz-30MHz.

4.2.4 Deviation from Test Standard

No deviation.

4.2.5 Test Setup

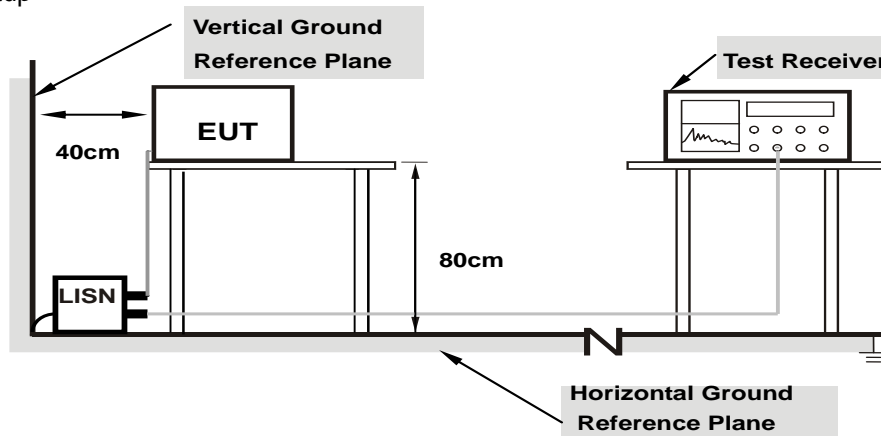

Note: 1.Support units were connected to second LISN.

For the actual test configuration, please refer to the attached file (Test Setup Photo).

4.2.6 EUT Operating Conditions

Same as 4.1.6.

4.2.7 Test Results (Mode 1)

Phase	Line (L)	Detector Function	Quasi-Peak (QP) / Average (AV)
-------	----------	-------------------	--------------------------------

Phase Of Power : Line (L)										
No	Frequency (MHz)	Correction Factor (dB)	Reading Value (dBuV)		Emission Level (dBuV)		Limit (dBuV)		Margin (dB)	
			Q.P.	AV.	Q.P.	AV.	Q.P.	AV.	Q.P.	AV.
1	0.15000	9.97	43.06	20.30	53.03	30.27	66.00	56.00	-12.97	-25.73
2	0.18906	9.97	44.17	25.39	54.14	35.36	64.08	54.08	-9.94	-18.72
3	0.20078	9.97	43.81	28.47	53.78	38.44	63.58	53.58	-9.80	-15.14
4	0.25156	9.97	37.04	18.95	47.01	28.92	61.71	51.71	-14.70	-22.79
5	0.28672	9.97	35.49	18.72	45.46	28.69	60.62	50.62	-15.16	-21.93
6	0.32969	9.98	34.65	21.90	44.63	31.88	59.46	49.46	-14.83	-17.58

Remarks:

1. Q.P. and AV. are abbreviations of quasi-peak and average individually.
2. The emission levels of other frequencies were very low against the limit.
3. Margin value = Emission level – Limit value
4. Correction factor = Insertion loss + Cable loss
5. Emission Level = Correction Factor + Reading Value

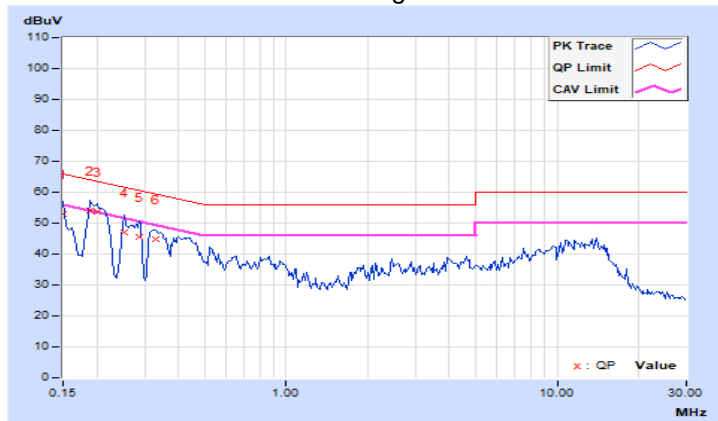

Phase	Neutral (N)	Detector Function	Quasi-Peak (QP) / Average (AV)
-------	-------------	-------------------	--------------------------------

Phase Of Power : Neutral (N)										
No	Frequency (MHz)	Correction Factor (dB)	Reading Value (dBuV)		Emission Level (dBuV)		Limit (dBuV)		Margin (dB)	
			Q.P.	AV.	Q.P.	AV.	Q.P.	AV.	Q.P.	AV.
1	0.15000	9.97	43.02	19.27	52.99	29.24	66.00	56.00	-13.01	-26.76
2	0.18906	9.97	43.95	24.42	53.92	34.39	64.08	54.08	-10.16	-19.69
3	0.27500	9.97	34.73	20.63	44.70	30.60	60.97	50.97	-16.27	-20.37
4	0.34141	9.98	33.92	21.35	43.90	31.33	59.17	49.17	-15.27	-17.84
5	0.43516	9.98	31.73	15.11	41.71	25.09	57.15	47.15	-15.44	-22.06
6	11.44922	10.45	25.56	16.42	36.01	26.87	60.00	50.00	-23.99	-23.13

Remarks:

1. Q.P. and AV. are abbreviations of quasi-peak and average individually.
2. The emission levels of other frequencies were very low against the limit.
3. Margin value = Emission level – Limit value
4. Correction factor = Insertion loss + Cable loss
5. Emission Level = Correction Factor + Reading Value

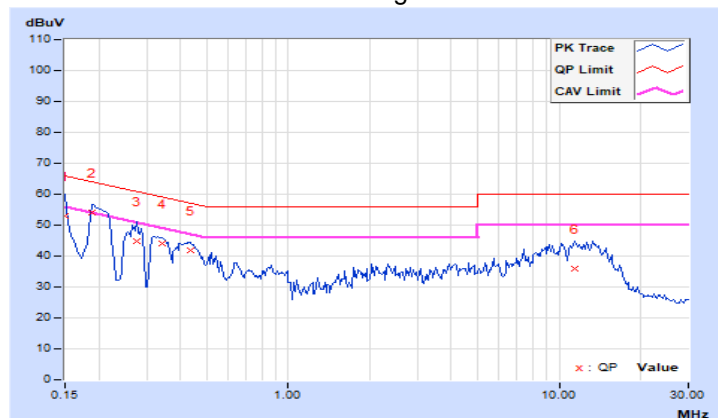

4.2.8 Test Results (Mode 2)

Phase	Line (L)	Detector Function	Quasi-Peak (QP) / Average (AV)
-------	----------	-------------------	--------------------------------

Phase Of Power : Line (L)										
No	Frequency (MHz)	Correction Factor (dB)	Reading Value (dBuV)		Emission Level (dBuV)		Limit (dBuV)		Margin (dB)	
			Q.P.	AV.	Q.P.	AV.	Q.P.	AV.	Q.P.	AV.
1	0.15000	9.97	43.12	20.18	53.09	30.15	66.00	56.00	-12.91	-25.85
2	0.19297	9.97	44.43	28.45	54.40	38.42	63.91	53.91	-9.51	-15.49
3	0.21250	9.97	42.24	25.98	52.21	35.95	63.11	53.11	-10.90	-17.16
4	0.28672	9.97	35.99	18.41	45.96	28.38	60.62	50.62	-14.66	-22.24
5	0.32969	9.98	34.71	21.96	44.69	31.94	59.46	49.46	-14.77	-17.52
6	0.43516	9.98	33.14	16.24	43.12	26.22	57.15	47.15	-14.03	-20.93

Remarks:

1. Q.P. and AV. are abbreviations of quasi-peak and average individually.
2. The emission levels of other frequencies were very low against the limit.
3. Margin value = Emission level – Limit value
4. Correction factor = Insertion loss + Cable loss
5. Emission Level = Correction Factor + Reading Value

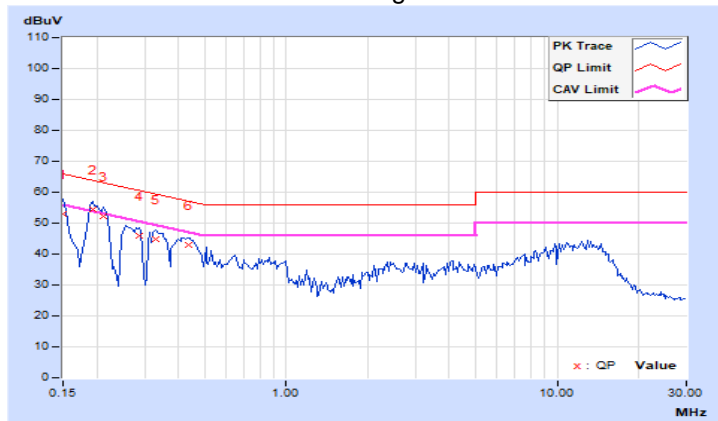

Phase	Neutral (N)	Detector Function	Quasi-Peak (QP) / Average (AV)
-------	-------------	-------------------	--------------------------------

Phase Of Power : Neutral (N)										
No	Frequency (MHz)	Correction Factor (dB)	Reading Value (dBuV)		Emission Level (dBuV)		Limit (dBuV)		Margin (dB)	
			Q.P.	AV.	Q.P.	AV.	Q.P.	AV.	Q.P.	AV.
1	0.15000	9.97	43.12	19.31	53.09	29.28	66.00	56.00	-12.91	-26.72
2	0.19687	9.97	45.39	29.05	55.36	39.02	63.74	53.74	-8.38	-14.72
3	0.25547	9.97	36.98	21.31	46.95	31.28	61.58	51.58	-14.63	-20.30
4	0.27891	9.97	34.73	19.99	44.70	29.96	60.85	50.85	-16.15	-20.89
5	0.34531	9.98	33.26	20.77	43.24	30.75	59.07	49.07	-15.83	-18.32
6	0.43516	9.98	31.83	15.17	41.81	25.15	57.15	47.15	-15.34	-22.00

Remarks:

1. Q.P. and AV. are abbreviations of quasi-peak and average individually.
2. The emission levels of other frequencies were very low against the limit.
3. Margin value = Emission level – Limit value
4. Correction factor = Insertion loss + Cable loss
5. Emission Level = Correction Factor + Reading Value

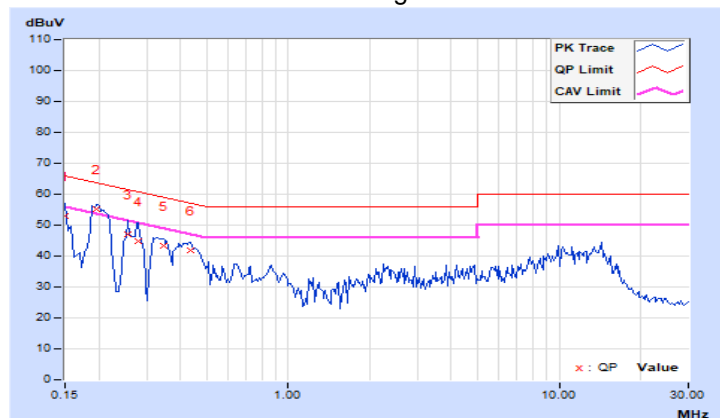

4.3 Conducted Out of Band Emission Measurement

4.3.1 Limits of Conducted Out of Band Emission Measurement

Below 30dB of the highest emission level of operating band (in 100kHz Resolution Bandwidth).

4.3.2 Test Setup

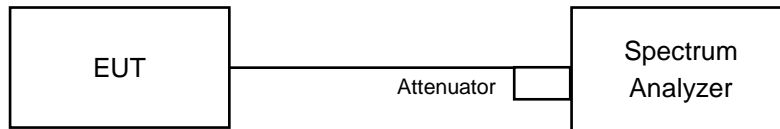

4.3.3 Test Instruments

Refer to section 4.1.2 to get information of above instrument.

4.3.4 Test Procedures

MEASUREMENT PROCEDURE REF

1. Set the RBW = 100 kHz.
2. Set the VBW \geq 300 kHz.
3. Detector = peak.
4. Sweep time = auto couple.
5. Trace mode = max hold.
6. Allow trace to fully stabilize.
7. Use the peak marker function to determine the maximum power level in any 100 kHz band segment within the fundamental EBW.

MEASUREMENT PROCEDURE OOB

1. Set RBW = 100 kHz.
2. Set VBW \geq 300 kHz.
3. Detector = peak.
4. Sweep = auto couple.
5. Trace Mode = max hold.
6. Allow trace to fully stabilize.
7. Use the peak marker function to determine the maximum amplitude level.

4.3.5 Deviation from Test Standard

No deviation.

4.3.6 EUT Operating Conditions

The software provided by client to enable the EUT under transmission condition continuously at lowest, middle and highest channel frequencies individually.

4.3.7 Test Results (Mode 1)

The spectrum plots are attached on the following pages. D1 line indicates the highest level, and D2 line indicates the 30dB offset below D1. It shows compliance with the requirement.

2.4GHz_VHT20 CH6 + BT-EDR_8DPSK CH0

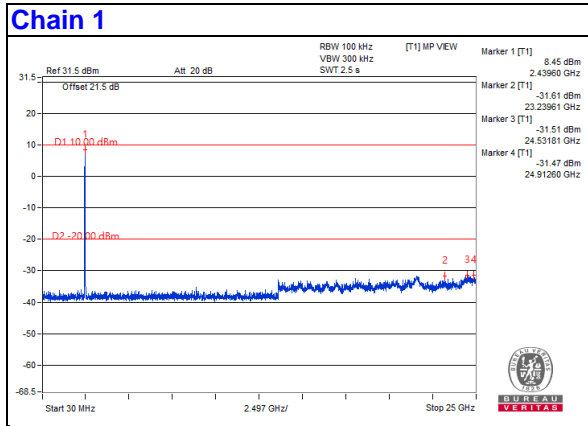

4.3.8 Test Results (Mode 2)

The spectrum plots are attached on the following pages. D1 line indicates the highest level, and D2 line indicates the 30dB offset below D1. It shows compliance with the requirement.

5GHz_802.11ac (VHT20) CH157 + BT-EDR_8DPSK CH0

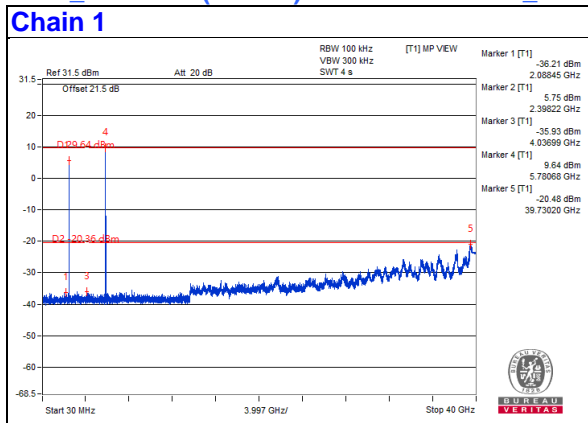

5 Pictures of Test Arrangements

Please refer to the attached file (Test Setup Photo).

Appendix – Information of the Testing Laboratories

We, Bureau Veritas Consumer Products Services (H.K.) Ltd., Taoyuan Branch, were founded in 1988 to provide our best service in EMC, Radio, Telecom and Safety consultation. Our laboratories are FCC recognized accredited test firms and accredited according to ISO/IEC 17025.

If you have any comments, please feel free to contact us at the following:

Lin Kou EMC/RF Lab

Tel: 886-2-26052180

Fax: 886-2-26051924

Hsin Chu EMC/RF/Telecom Lab

Tel: 886-3-6668565

Fax: 886-3-6668323

Hwa Ya EMC/RF/Safety Lab

Tel: 886-3-3183232

Fax: 886-3-3270892

Email: service.adt@tw.bureauveritas.com

Web Site: www.bureauveritas-adt.com

The address and road map of all our labs can be found in our web site also.

--- END ---