

Lenovo ideapad MIIX 510-12IKB MIIX 510-12IKB LTE User Guide



Read the safety notices and important tips in the included manuals before using your computer.

Lenovo™

Notes

- Before using the product, be sure to read *Lenovo Safety and General Information Guide* first.
- The latest electronic compliance and environmental information are available from the Lenovo compliance information Web sites.
 - To view compliance information go to:
<http://www.lenovo.com/compliance>
 - To download environmental information go to:
<http://www.lenovo.com/ecodeclaration>
- Some instructions in this guide may assume that you are using Windows® 10. If you are using another Windows operating system, some operations may be slightly different. If you are using other operating systems, some operations may not apply to you.
- The features described in this guide are common to most models. Some features may not be available on your computer or your computer may include features that are not described in this user guide.
- The illustrations in this manual may differ from the actual product. The screenshots of operating system are for reference only. Please refer to the actual product.

Regulatory Notice

- For details, refer to **Guides & Manuals** at <http://support.lenovo.com>.

First Edition (November 2016)

© Copyright Lenovo 2016.

LIMITED AND RESTRICTED RIGHTS NOTICE: If data or software is delivered pursuant to a General Services Administration "GSA" contract, use, reproduction, or disclosure is subject to restrictions set forth in Contract No. GS-35F-05925.

Contents

Chapter 1. Contents	i
Chapter 2. Getting to know your computer	1
Front view	1
Left-side view	3
Right-side view	4
Top View	5
Bottom view.....	6
Rear view	7
To use the stand cover.....	8
Keyboard folio top view	10
To use the Lenovo Active Pen (on select models).....	18
To use the Lenovo Active Pen2 (on select models).....	19
Chapter 3. Starting to use Windows 10	21
Configuring the operating system for the first time	21
Operating system interfaces.....	21
Putting the computer to sleep or shutting it down.....	24
Touch screen operation.....	26
Connecting to a wireless network	29
Get help from Windows	30
Chapter 4. Recovery system	31
Chapter 5. Troubleshooting	33
Frequently asked questions.....	33
Troubleshooting.....	34
Chapter 6. Trademarks	37

Chapter 1. Getting to know your computer

■ ■ Front view

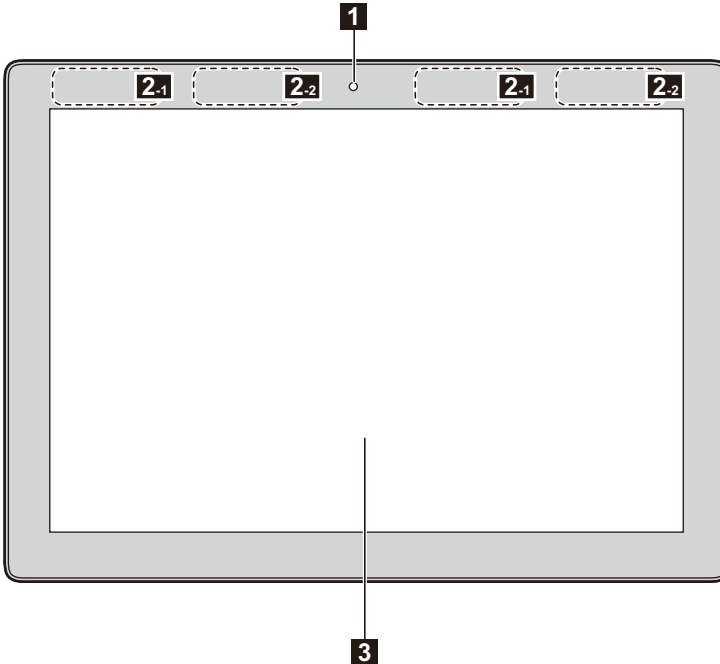

1 Front camera

Use the camera for video communication or taking photos.

2 Wireless LAN antenna

Connects to a wireless LAN adapter to send and receive wireless radio signals.

Notes:

- For Wi-Fi models, the WLAN antennas are located in **2-1**; For LTE models, the WLAN antennas are located in **2-1** and **2-2**.
- For LTE models, frequency Band of 28 is not available in Australia and Taiwan.

3 Multi-touch screen

Functions as the visual display as well as touch pad input.

Note: For details, see “Touch screen operation” on page 26.

Chapter 1. Getting to know your computer

■ Screen orientation

You can rotate the display panel to your preferred orientation. The orientation of the display automatically changes (alternating between portrait and landscape modes) depending on how you hold it.



■ ■ Left-side view

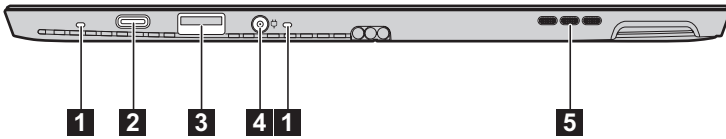

- | | | |
|----------|---------------------------------|----------------------------------------------------------------------------------------------------------------------------------------------------------------------------------------------------------|
| 1 | Digital array microphone | Captures sound which can be used for video conferencing, voice narration, or audio recording. |
| 2 | Type-C port | Type-C port supports: <ul style="list-style-type: none">• USB 3.0• Native display port 1.2 video output• VGA/HDMI output using Type-C VGA/HDMI adapter (sold separately) |
| 3 | USB 3.0 port | Connects to USB devices. |
| 4 | AC power adapter jack | Connects to the AC power adapter. |
| 5 | Speakers | Provide audio output. |

■ ■ Right-side view

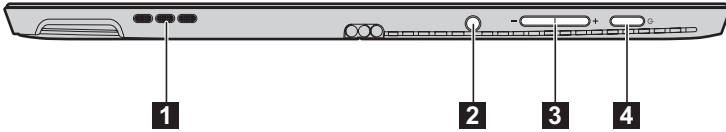

1 Speakers Provide audio output.

2 Combo audio jack Connects to headsets.

Notes:

- The combo audio jack does not support conventional microphones.
- The recording function might not be supported if third-party headphones or headsets are connected, due to different industry standards.

3 Volume up/down button Increases/decreases the volume level.

4 Power button When the computer is off, press and hold this button to turn on the computer.

Note: The computer will become hot after connection to the AC power adapter, but it will not affect the usage.

■ ■ Top View

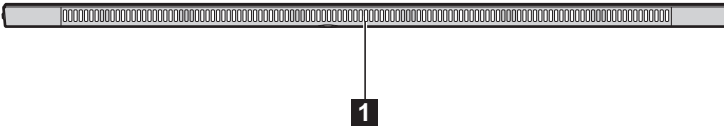

- 1** **Ventilation slots** Dissipate internal heat.

Note: Make sure that none of the ventilation slots are blocked, or else overheating of the computer may occur.

■ ■ Bottom view

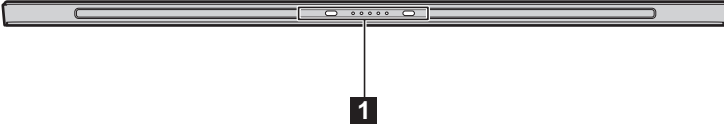

1 Pogo pin with guide pin

Note: For details, see “Combination of tablet and keyboard folio” on page 12.

■ ■ Rear view

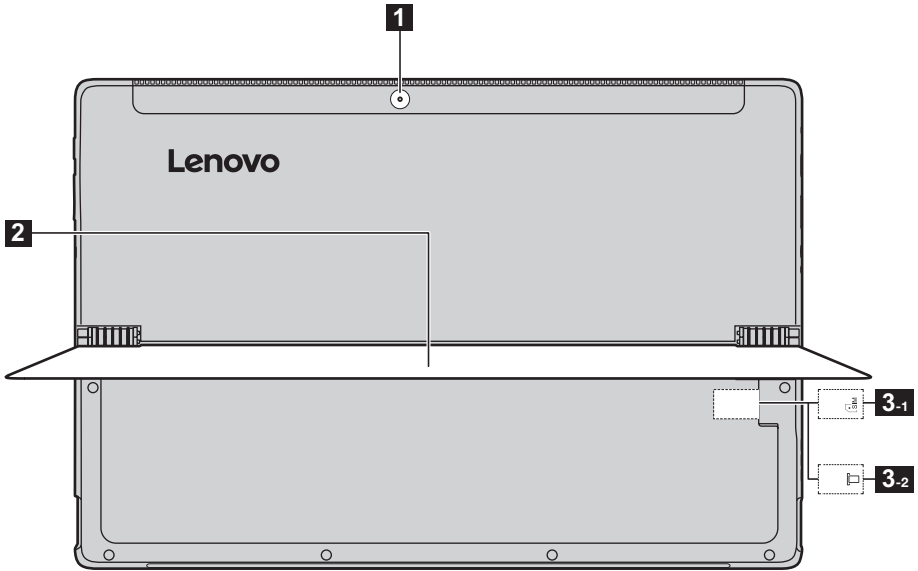

1 **Rear camera** Use the camera for video communication or taking photos.

2 **Stand cover** This stand cover can flip as required, allowing the tablet to stand at different angles.

Note: Always keep the flip angle below 150°. Be careful not to leave a pen or any other items between the stand cover and the bottom plate after closing the stand cover. Otherwise, it could be damaged.

3-1 **SIM card slot (on select models)** Accepts a SIM card (not supplied).

3-2 **Micro SD card slot** Accepts a micro SD card (not supplied).

Note: For LTE models, SIM card slot is located here as shown in figure **3-1**. For Wi-Fi models, Micro SD card slot is located here as shown in figure **3-2**.

■ ■ **To use the stand cover**

Lenovo ideapad MIIX 510-12IKB/ideapad MIIX 510-12IKB LTE is equipped with a stand cover which can be flipped as preferred; to stand the tablet at different angles.

■ **To flip the stand cover**

As shown by the arrow, flip the stand cover gently to the desired angle by inserting your finger in the finger recess between the stand cover and the bottom plate.

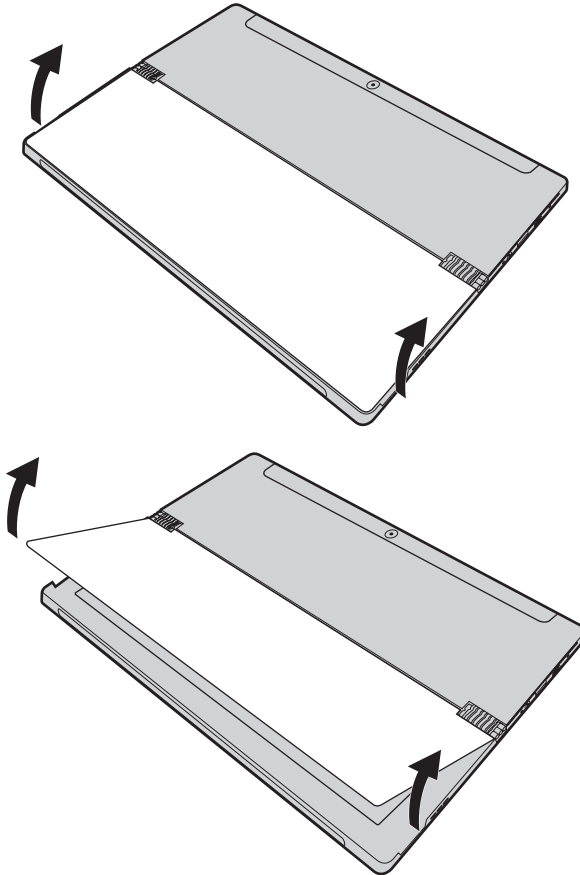

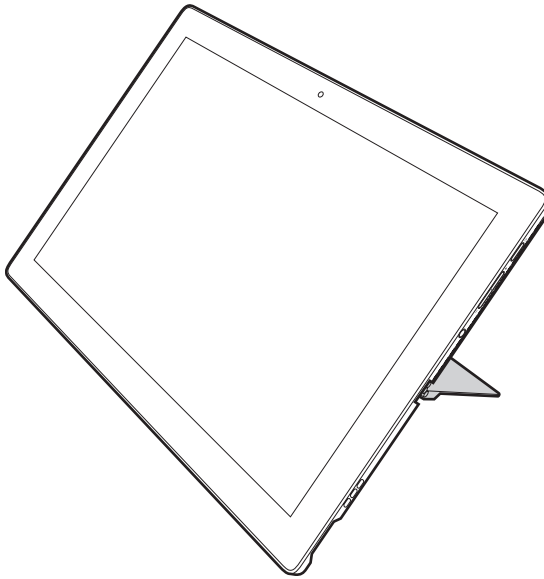

Notes:

- Do not use excessive force when flipping to avoid damage to the hinge.
- Always keep the flip angle below 150°. Be careful not to leave a pen or any other items between the stand cover and the bottom plate after closing the stand cover. Otherwise, it could be damaged.

■ ■ Keyboard folio top view

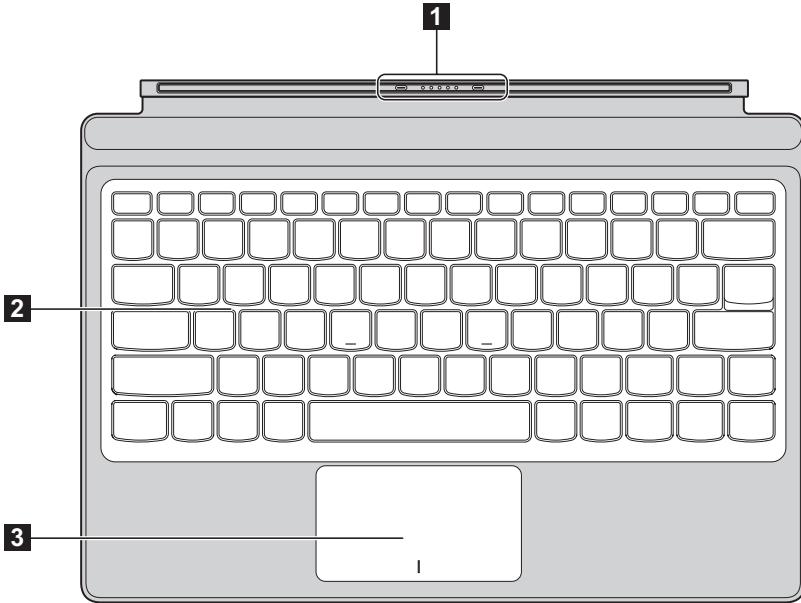

1 Pogo pin with guide pin Connect the tablet to the keyboard Folio and secure it in the installation position.

Note: For details, see “Combination of tablet and keyboard folio” on page 12.

2 Keyboard

3 Touch pad









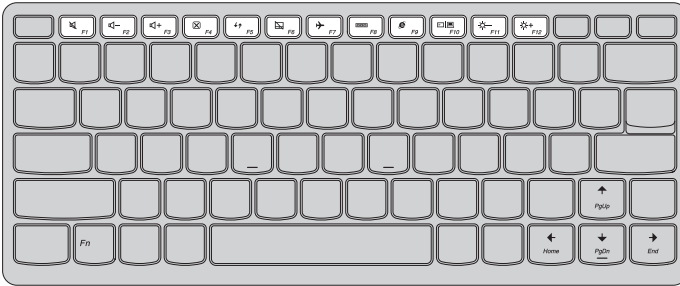



Note: When the **Keyboard folio** is rotated to 360 degrees after connection with a computer, the **Keyboard** and touch pad will be locked automatically.

■ Using the keyboard

Hotkeys

You can access certain system settings quickly by pressing the appropriate hotkeys.



 : Mutes/unmutes the sound.	 : Enables/disables Airplane mode.
 : Decreases the volume level.	 : Displays all currently active apps.
 : Increases the volume level.	 : Open the web browser.
 : Closes the currently active window.	 : Toggles the display between the computer and an external device.
 : Refreshes the desktop or the currently active window.	 : Decreases display brightness.
 : Enables/disables the touch pad.	 : Increases display brightness.

Chapter 1. Getting to know your computer

■ Combination of tablet and keyboard folio

The Lenovo ideapad MIIX 510-12IKB/ideapad MIIX 510-12IKB LTE is not only a tablet. It can be combined with a keyboard folio and used as a notebook computer.

Attaching the tablet

Align the connector of the keyboard folio with the tablet and then attach the tablet in the direction shown by the arrow.

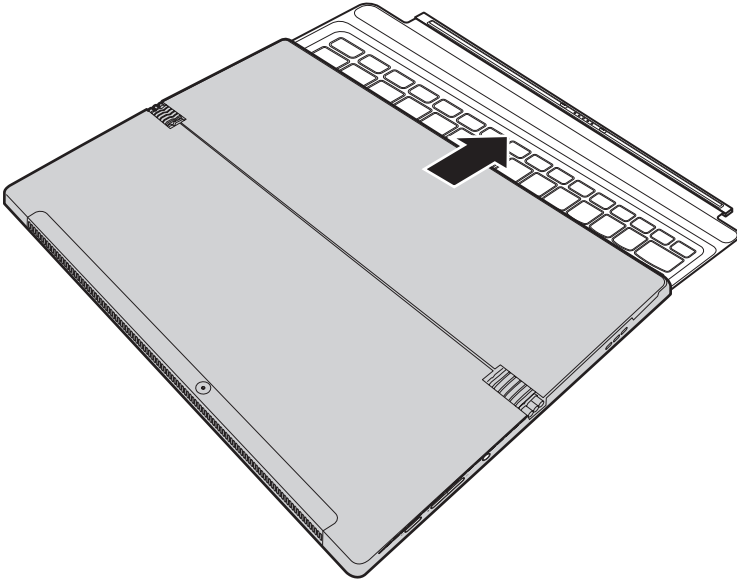

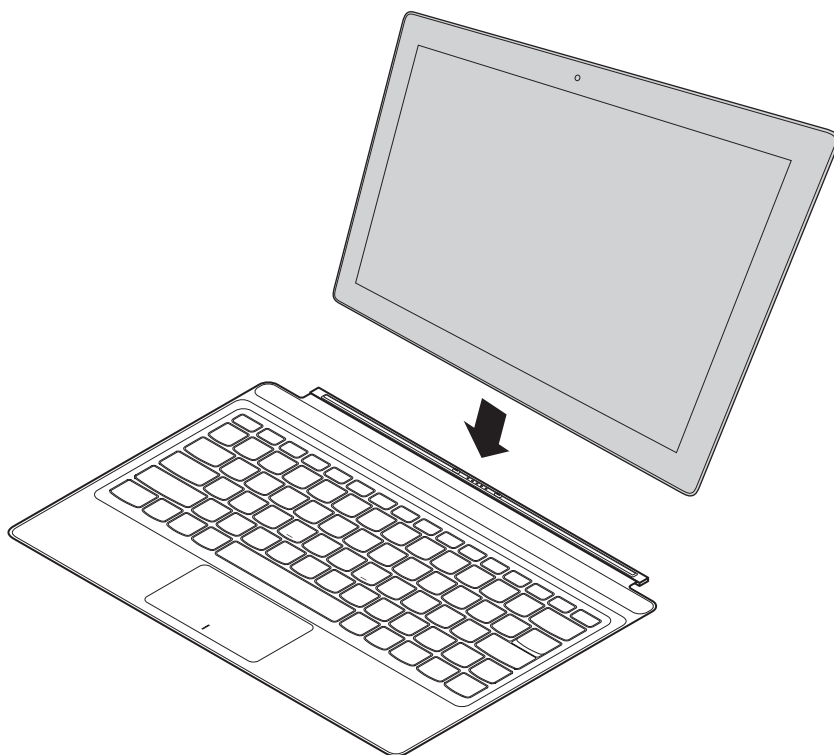

Note: Tablet-keyboard folio tongue has strong magnetic force, so as to easily connect with and secure the tablet.

Chapter 1. Getting to know your computer

Placement mode of the tablet and the keyboard folio

There are two placement modes of the tablet and the keyboard folio. You can select one as you desire.

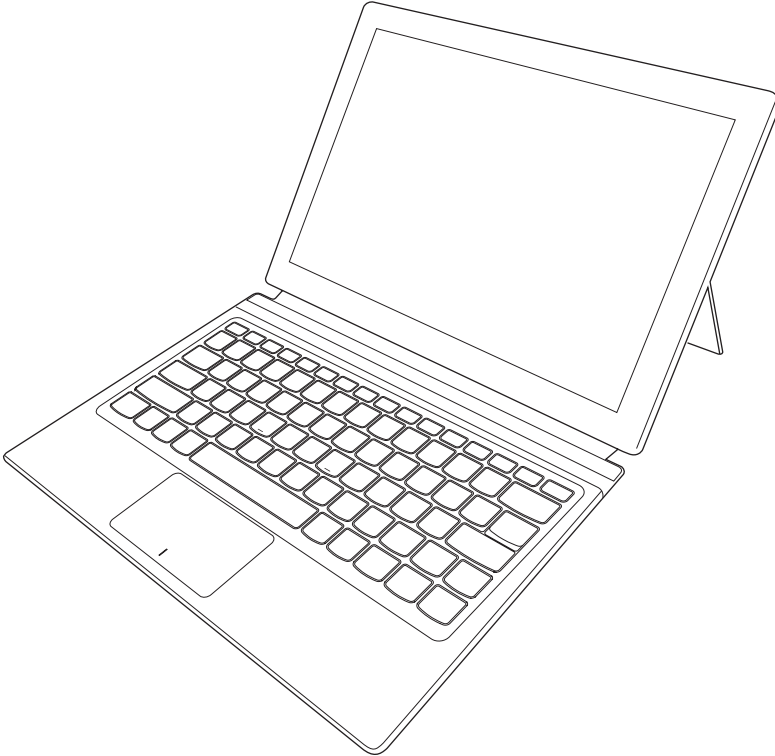

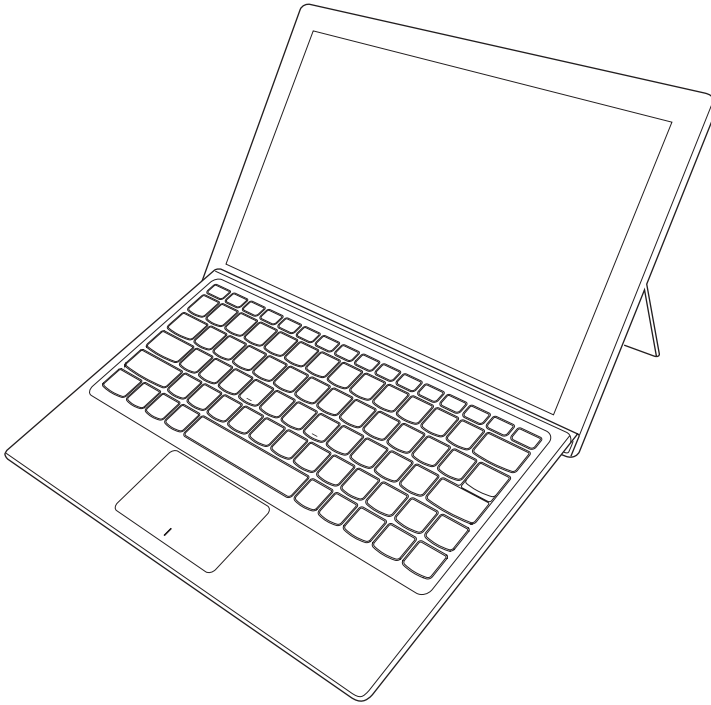

Chapter 1. Getting to know your computer

Detaching the tablet

As shown by the arrow in Fig. **1**, push both ends of the tablet-keyboard folio tongue to detach it from the tablet. while carefully detaching the tablet in the direction shown by the arrow **2**.

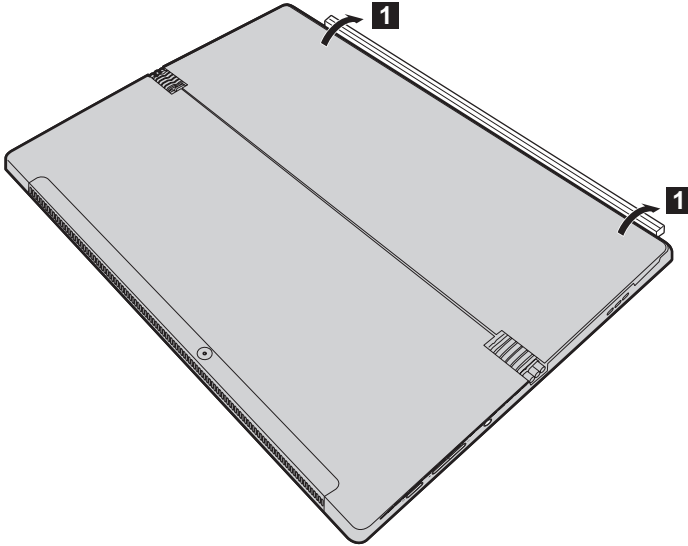

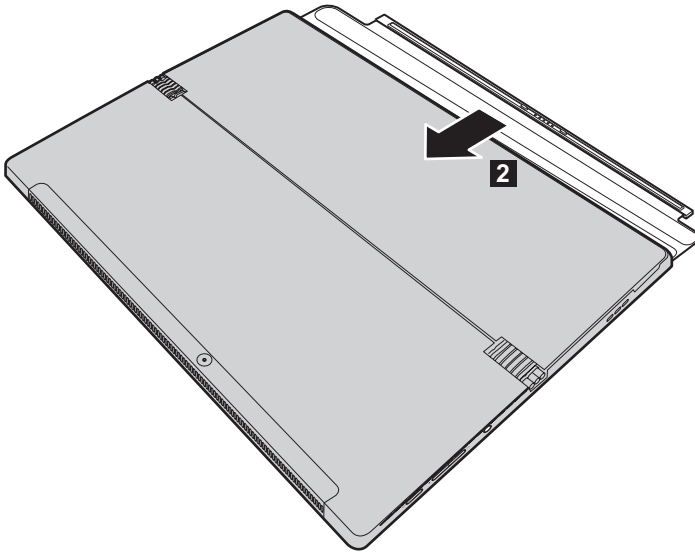

Notes:

- Be careful not to damage the connector when attaching or detaching the tablet.
- The illustrations above are for reference only, please refer to the actual product.

■ ■ To use the Lenovo Active Pen (on select models)

Select model is equipped with the Lenovo Active Pen, to use it, refer to the following illustrations.

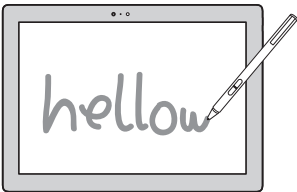
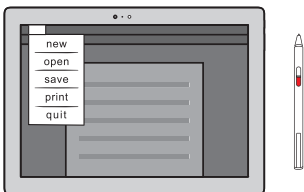
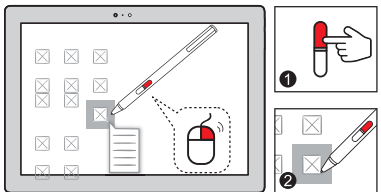
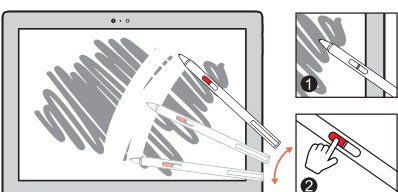
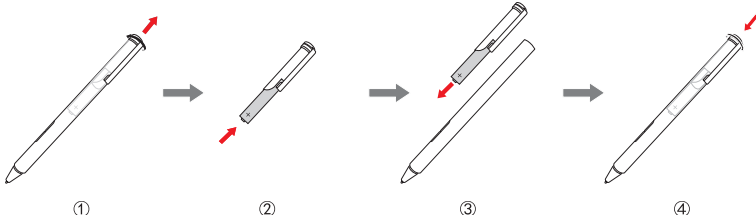
Functions	
<p>Writing</p> 	<p>Displaying the function menu Press and hold the upper button of the active pen when it approaches the display screen and the cursor appears.</p> 
<p>Right-clicking function Press the upper button, then click on the touch screen.</p> 	<p>Erasing Press the lower button when writing.</p> 
<p>To replace the battery</p>  <p>① → ② → ③ → ④</p> <p>Note: Insert the battery by matching the + and – on the battery to the + and – in the battery compartment.</p>	

■ ■ To use the Lenovo Active Pen2 (on select models) —————

Select model is equipped with the Lenovo Active Pen2, it can be used as a Lenovo Active Pen. About the function of the Lenovo Active Pen, refer to page 18. Besides, more functions can be used after successful pairing.

Pairing mode

Press and hold the Bluetooth button for more than three seconds to enter pairing mode.

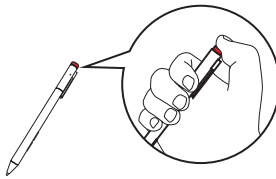

Functions

One click the Bluetooth button function

Depends on the APP preinstalled.



Double click the Bluetooth button function

Depends on the APP preinstalled.



To replace the battery

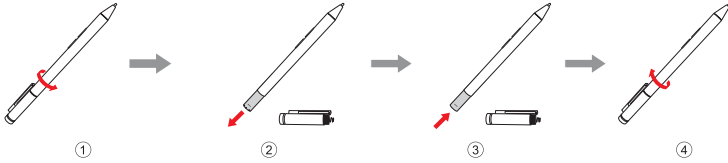

Note: Insert the battery by matching the + and - on the battery to the + and - in the battery compartment.

To replace the rear Bluetooth module battery

When the battery is low, the red LED indicator will flash.



To replace the rear Bluetooth module battery:

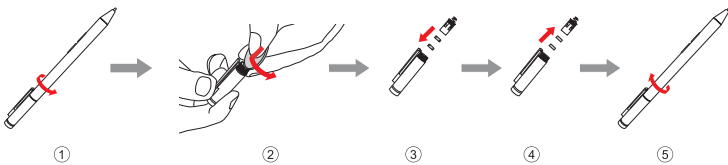

Note: Select the appropriate screwdriver or coin for removal.

Chapter 2. Starting to use Windows 10

■ ■ Configuring the operating system for the first time

You may need to configure the operating system when it is first used. The configuration process may include the procedures below:

- Accepting the end user license agreement
- Configuring the Internet connection
- Registering the operating system
- Creating a user account

■ ■ Operating system interfaces

The return of the Start menu

Windows 10 comes with a powerful and useful start menu.

To open the start menu, do one of the following:

- Select the Start button in the lower-left corner, the Start menu is displayed.
- Press the Windows key  on the keyboard.

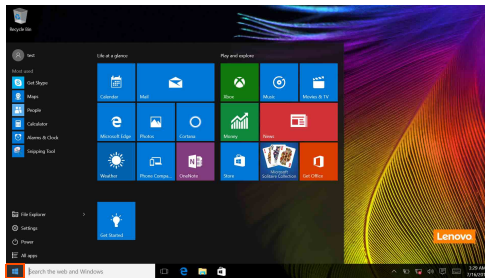

The power button is on the Start menu, select it you can choose to shut down or restart the computer, or put the computer into sleep mode.

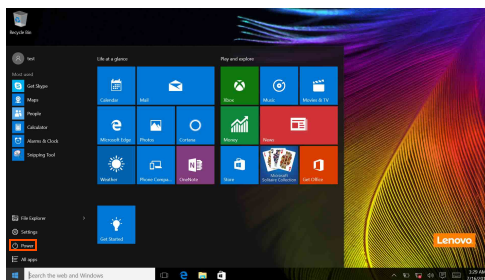

Through the Start menu, you can locate all the installed apps or view the frequently used apps.

Chapter 2. Starting to use Windows 10

The ACTION CENTER

Select the ACTION CENTER icon  on the taskbar and the ACTION CENTER is displayed.

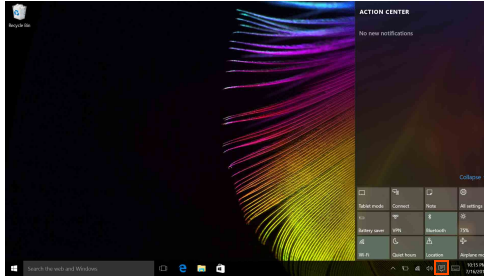

From the ACTION CENTER, you can examine important notifications from Windows and your apps. Moreover, you can change common settings quickly.

Task View in taskbar

In Windows 10, you can add a new desktop and switch between different desktops. To add a new desktop, do the following:

- Select the Task View icon  in the taskbar area.

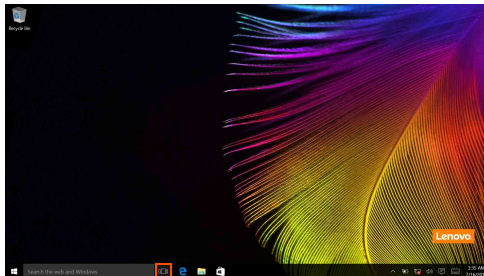

- Select **New desktop**.

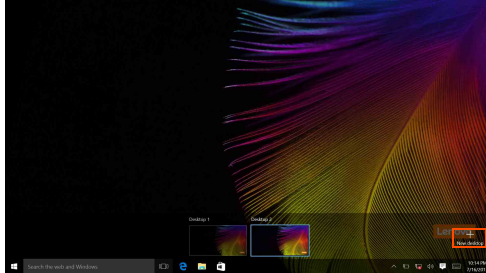

To switch between desktops, select the Task View icon  then select your desired desktop. Also, you can manage apps in the multi-tasking view:

- 1** Select the Task View button to display all apps in use on the screen.
- 2** Select to enter the apps or close the apps.

■ ■ Putting the computer to sleep or shutting it down

When you have finished working with your computer, you can put it to sleep or shut it down.

■ Putting your computer to sleep

If you will be away from your computer for only a short time, put the computer to sleep. When the computer is in sleep mode, you can quickly wake it to resume use, bypassing the startup process.

To put the computer to sleep, do one of the following:

- Press the Power button.
- Select the Start button, then select **Power**  → **Sleep**.

Note: Put your computer to sleep before you move it. Moving your computer while the hard disk drive is spinning can damage the hard disk, causing loss of data.

To wake up the computer, perform the following:

- Press the Power button.

■ **Shutting down the computer**

If you are not going to use your computer for a long time, shut it down. To shut down the computer, do one of the following:

- Select the Start button, then select **Power**  → **Shut down**.

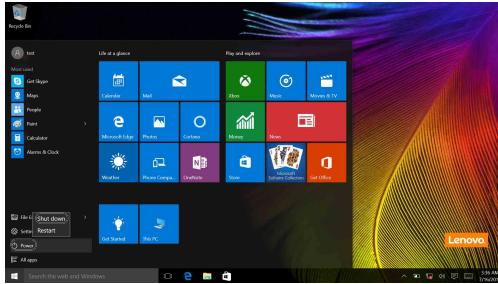

- Right-click or press the Start button in the lower-left corner and select **Shut down or sign out** → **Shut down**.

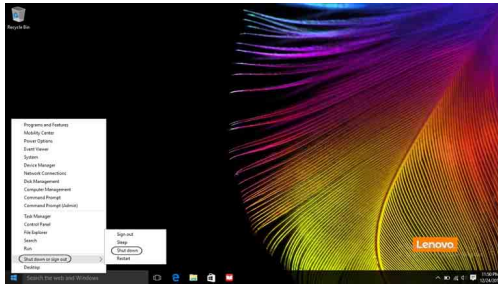



■ ■ Touch screen operation



The display panel can accept inputs like a tablet, using the multi-touch screen, or like a traditional notebook computer, using the keyboard and touch pad.

■ Multi-touch gestures

You can touch the screen with one or more fingertips to perform a variety of tasks.

Frequently used gestures	Tasks performed
<p>Tap Tap once on an item.</p>  An illustration of a hand with the index finger touching a tablet screen. The screen displays the Windows 10 Start menu with various app tiles. The finger is positioned over one of the tiles.	<p>Performs an action, such as starting an app, opening a link, or performing a command. Similar to left-clicking with a mouse.</p>
<p>Press and hold Press your finger down and leave it there for a moment.</p>  An illustration of a hand with the index finger pressing down on a tablet screen. The screen displays the Windows 10 Start menu with various app tiles. The finger is positioned over one of the tiles.	<p>Enables you to see detailed information before selecting an action. Can also open a menu with more options. Similar to right-clicking with a mouse.</p>

(continued)

Frequently used gestures	Tasks performed
<p>Zoom Move two fingers together or apart while touching the screen.</p> 	<p>Zooms in and out on visual apps, such as pictures and maps. Can also jump to the beginning or end of a list.</p>
<p>Rotate Place two or more fingers on an item and then turn your hand.</p> 	<p>Rotates an object (Note: Not all items can be rotated, depending upon the app.).</p>
<p>Slide Drag your finger across the screen.</p> 	<p>Pans or scrolls through lists and pages. Can also move an object or be used to draw or write, depending upon the app. Similar to pressing and holding to pan and to scrolling with a mouse.</p>

Chapter 2. Starting to use Windows 10

(continued)

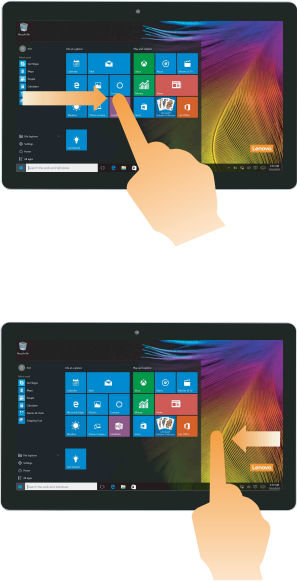
Frequently used gestures	Tasks performed
<p data-bbox="140 320 210 344">Swipe</p> <p data-bbox="140 349 568 399">Start from any edge of the screen, then swipe inwards toward the center.</p> 	<p data-bbox="609 405 930 430">Swiping in from the left edge can:</p> <ul data-bbox="609 434 967 485" style="list-style-type: none"><li data-bbox="609 434 967 485">• Bring in and open an app currently running in the background. <p data-bbox="609 745 986 794">Swipe from the right edge can open the ACTION CENTER.</p>

■ ■ Connecting to a wireless network



Enabling wireless connection

To confirm that Airplane mode is disabled, go to the desktop and check the notification area.

If you see the  icon displayed on the lower right, then Airplane mode is on. Otherwise, wireless function is enabled.

Note: Airplane mode is disabled by default.

If Airplane mode is on, do one of the following to enable the wireless function:

- Press  to disable Airplane mode (located on the keyboard).
- Select the  icon on the lower right corner of the notification area to open the network configuration page.
- Select **Settings**  → **Network & Internet** → **Airplane mode** to open the network configuration page. Then toggle the airplane mode switch to **Off**.

Connecting to a wireless network

After wireless has been enabled, the computer will scan for available wireless networks and display them in the wireless network list. To connect to a wireless network, click the network name in the list, and then click **Connect**.

Note: Some networks require a network security key or passphrase for connection. To connect to one of those networks, ask the network administrator or the Internet Service Provider (ISP) for the security key or passphrase.

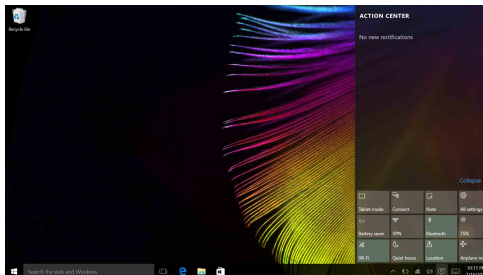

■ ■ Get help from Windows

If you have a problem with the operating system, see the Windows Get Started app. To open it, do the following:

- Select the Start button, then select **Get Started** from **All apps**.

Chapter 3. Recovery system

■ Introduction

Reset this PC is a built-in recovery tool that enables users to restore their operating system to its original state. This preserves their data and important customizations, without the need to back up their data in advance.

The following **Reset this PC** features are available to users from multiple locations within Windows:

keep my files

Fixes software problems by reinstalling the factory default configuration. This preserves the personal files, and deletes apps and settings.

Remove everything

Prepares the computer for recycling or transfer of ownership. This reinstalls the factory default configuration and returns all user data and applications to the state of their original Out-of-Box Experience (OOBE).

■ Using Reset this PC

Reset this PC can be launched using one of the following methods:

- Power button + Volume up button:
 - Shut down the computer and wait at least five seconds.
 - Press and hold the volume up button and then press the Power button, until the Novo Menu appears on the screen.
 - Novo menu → **System Recovery** → **Troubleshoot** → **Reset this PC**
- Windows PC settings:
 - Windows PC settings → **Update&security** → **Recovery** → **Reset this PC** → select **Start**.

For more instructions, see the Windows Help and Support file on your computer.

When I purchased my computer, it included a copy of Windows. How can I determine whether the copy of Windows is preinstalled by Lenovo?

On the outside of the sales package of your computer, you should find a label containing configuration information for your computer. Check the printed string next to **OS**. If it contains **Windows** or **WIN**, the copy of Windows was preinstalled by Lenovo.

What is the Recovery Partition?

If your computer is preinstalled with any version of Windows 10, the storage device of your computer contains a Recovery Partition. This partition contains the image file of the preinstalled Windows operating system. In cases of system failure, you can use the Lenovo OneKey Recovery system or the Windows Reset feature to restore the operating system to its factory status.

Note: The Recovery Partition is not assigned a drive letter and cannot be accessed through Windows File Explorer.

Chapter 3. Recovery system

I uninstalled a preinstalled software, but there is no significant increase in the free drive space.

The copy of Windows running on your computer may be Compact technology enabled. For computers with Compact technology enabled Windows, the majority of files needed for preinstalled software are installed on the Recovery Partition and won't be deleted through normal uninstallation.

What happens if I attempt to delete or modify the Recovery Partition?

ⓘ Attention:

- Do *not* delete or modify the Recovery Partition on a Compact technology enabled computer. If the Recovery Partition is deleted or modified, you may not be able to restore Windows to the factory status. For computer models on which Compact technology is enabled, deleting the Recovery Partition may cause Windows to fail to start.

How can I determine whether the Windows running on my computer is Compact technology enabled?

Compact technology is normally enabled on copies of Windows 10 Update running on SSD (or eMMC) -only computer models. To check your computer,

- 1 Right-click the Start button in the lower-left corner and select **Disk Management**.
- 2 The Disk Management program starts.

If **Wim Boot** is labeled on the Windows partition (as illustrated), Compact technology is enabled on your copy of Windows.



Chapter 4. Troubleshooting

■ ■ Frequently asked questions

This section lists frequently asked questions by category.

■ Finding information

What safety precautions should I follow when using my computer?

The Lenovo *Safety and General Information Guide* which came with your computer contains safety precautions for using your computer. Read and follow all precautions during use.

Where can I find the hardware specifications for my computer?

You can find hardware specifications for your computer on the printed flyers which came with your computer.

Where can I find warranty information?

For detailed warranty information on this machine, please visit below website to check out: support.lenovo.com/warrantystatus.

■ Drivers

Where can I find drivers for the various hardware devices of my computer?

You can download the latest device drivers from the Lenovo consumer support website.

■ Getting help

How can I contact the customer support center?

See “Chapter 3. Getting help and service” in the Lenovo *Safety and General Information Guide*.

■ ■ Troubleshooting

If you do not find your problem here, see Chapter 1. The following section only describes problems that might negate the need to refer to the more comprehensive information in Chapter 1.

Display problems

When I turn on the computer, nothing appears on the screen.

- If the screen is blank, make sure that:
 - The AC power adapter is connected to the computer and the power cord is plugged into a working electrical outlet.
 - The computer power is on. Press and hold the Power button for about three seconds for confirmation.
 - Press and hold the Power button for about ten seconds to force shut down the computer. Then press the Power button for about three seconds to restart.
- If these items are set correctly and the screen remains blank, have the computer serviced.

The screen goes blank while the computer is on.

- Your power management is enabled. Do one of the following to resume from sleep mode:
 - Press any key on the keyboard.
 - Press the Power button.

Sleep problems

The critical low-battery error message appears, and the computer immediately turns off.

- The battery power is getting low. Connect the AC power adapter to the computer.

The computer enters sleep mode immediately after Power-on.

- Make sure that:
 - The battery is charged.
 - The operating temperature is within the acceptable range. See “Chapter 2. Use and care Information” in the *Lenovo Safety and General Information Guide*.

Note: If the battery is charged and the temperature is within range, do the following:

- 1 Press the Power button to turn on the computer.
- 2 Press and hold the Power button for about ten seconds to force shut down.
- 3 Press the Power button for more than two seconds to restart. Then reset the computer with the **Reset this PC** recovery system.

If the problem persists, have the computer serviced.

The computer does not return from sleep mode and the computer does not work.

- If the computer does not return from sleep mode, it might be because the battery is depleted.
- If your computer is in sleep mode, connect the AC power adapter to the computer. Then press the Power button.
- If your computer is powered-off, connect the AC power adapter to the computer. Then press the Power button to resume operation.

Note: If the system still does not return from sleep mode, your system has stopped responding, and you cannot turn off the computer; force shut down the computer (Unsaved data may be lost). To force shut down the computer, press and hold the Power button for about ten seconds or more.

Display panel problems

The screen is blank.

- Do the following:
 - If you are using the AC power adapter or the battery, press **F12** (located on the keyboard) to make the screen brighter.
 - Press the Power button to confirm if the computer is in sleep mode.
 - If the problem persists, follow the solution in the next problem "The screen is unreadable or distorted."

The screen is unreadable or distorted.

- Make sure that the screen resolution and color quality are correctly set.

Incorrect characters appear on the screen.

- Is the operating system or programs installed correctly? If they are installed and configured correctly. If the battery is charged and the temperature is within range, do the following:
 - 1** Press the Power button to turn on the computer.
 - 2** Press and hold the Power button for about ten seconds to force shut down.
 - 3** Press the Power button for more than two seconds to restart. Then reset the computer with the **Reset this PC** recovery system.

If the problem persists, have the computer serviced.

Sound problems

No sound can be heard from the speakers even when the volume is turned up.

- Make sure that:
 - The Mute function is off.
 - The combo audio jack is not being used.
 - Speakers are selected as the playback device.

Chapter 4. Troubleshooting

Battery problems

Your computer shuts down before the battery status icon shows it is empty.

-or-

Your computer operates after the battery status icon shows it is empty.

- Recharge the battery.

A startup problem

The Microsoft® Windows operating system does not start.

- For details, see “Recovery system” on page 31.

Recovery System problems

Failure to restore system partition to factory default.

- The system partition (e.g. the partition size or the drive capacity of C) has been modified.

Other problems

Your computer does not respond.

- To turn off your computer, press and hold the Power button for about ten seconds or more.

Trademarks

The following terms are trademarks or registered trademarks of Lenovo in the United States, other countries, or both.

Lenovo
ideapad

Microsoft and Windows are trademarks of Microsoft Corporation in the United States, other countries, or both.

