



SPORTON International Inc.

No. 52, Hwa Ya 1st Rd., Hwa Ya Technology Park, Kwei-Shan Hsiang, Tao Yuan Hsien, Taiwan, R.O.C.
Ph: 886-3-327-3456 / FAX: 886-3-327-0973 / www.sporton.com.tw

FCC RADIO TEST REPORT

Applicant's company	Realtek Semiconductor Corp.
Applicant Address	No. 2, Innovation Road II, Hsinchu Science Park, Hsinchu 300, Taiwan
FCC ID	TX2-RTL8723DE
Manufacturer's company	Realtek Semiconductor Corp.
Manufacturer Address	No. 2, Innovation Road II, Hsinchu Science Park, Hsinchu 300, Taiwan

Product Name	802.11 b/g/n RTL8723DE Combo module
Brand Name	REALTEK
Model Name	RTL8723DE
Test Rule	47 CFR FCC Part 15 Subpart C § 15.247
Test Freq. Range	2402 ~ 2480MHz
Received Date	Nov. 01, 2016
Final Test Date	Nov. 25, 2016
Submission Type	Class II Change

Statement

Test result included is only for the Bluetooth LE of the product.

The test result in this report refers exclusively to the presented test model / sample.

Without written approval of SPORTON International Inc., the test report shall not be reproduced except in full.

The measurements and test results shown in this test report were made in accordance with the procedures and found in compliance with the limit given in **ANSI C63.10-2013, 47 CFR FCC Part 15 Subpart C** and **KDB558074 D01 v03r05**.

The test equipment used to perform the test is calibrated and traceable to NML/ROC.





Table of Contents

1. VERIFICATION OF COMPLIANCE	1
2. SUMMARY OF THE TEST RESULT	2
3. GENERAL INFORMATION	3
3.1. Product Details.....	3
3.2. Accessories.....	3
3.3. Table for Filed Antenna.....	3
3.4. Table for Carrier Frequencies	4
3.5. Table for Test Modes	4
3.6. Table for Testing Locations.....	5
3.7. Table for Class II Change	5
3.8. Table for Supporting Units	6
3.9. EUT Operation during Test	6
3.10. Duty Cycle.....	6
3.11. Test Configurations	7
4. TEST RESULT	10
4.1. AC Power Line Conducted Emissions Measurement.....	10
4.2. Radiated Emissions Measurement	14
4.3. Emissions Measurement	27
4.4. Antenna Requirements	41
5. LIST OF MEASURING EQUIPMENTS	42
6. MEASUREMENT UNCERTAINTY	43
APPENDIX A. TEST PHOTOS	A1 ~ A9
APPENDIX B. RADIATED EMISSION CO-LOCATION REPORT	B1 ~ B3



History of This Test Report

REPORT NO.	VERSION	DESCRIPTION	ISSUED DATE
FR5D1601-03AC	Rev. 01	Initial issue of report	Dec. 13, 2016

1. VERIFICATION OF COMPLIANCE

Product Name : 802.11 b/g/n RTL8723DE Combo module
Brand Name : REALTEK
Model No. : RTL8723DE
Applicant : Realtek Semiconductor Corp.
Test Rule Part(s) : 47 CFR FCC Part 15 Subpart C § 15.247

Sporton International as requested by the applicant to evaluate the EMC performance of the product sample received on Nov. 01, 2016 would like to declare that the tested sample has been evaluated and found to be in compliance with the tested rule parts. The data recorded as well as the test configuration specified is true and accurate for showing the sample's EMC nature.

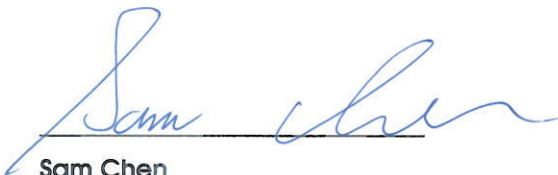

Sam Chen

SPORTON INTERNATIONAL INC.

2. SUMMARY OF THE TEST RESULT

Applied Standard: 47 CFR FCC Part 15 Subpart C			
Part	Rule Section	Description of Test	Result
4.1	15.207	AC Power Line Conducted Emissions	Complies
4.2	15.247(d)	Radiated Emissions	Complies
4.3	15.247(d)	Band Edge Emissions	Complies
4.4	15.203	Antenna Requirements	Complies

3. GENERAL INFORMATION

3.1. Product Details

Items	Description
Power Type	From host system
Modulation	DSSS
Data Rate (Mbps)	GFSK: 1
Frequency Range	2402 ~ 2480MHz
Channel Number	40 (37 hopping + 3 advertising channel)
Carrier Frequencies	Please refer to section 3.4
Antenna	Please refer to section 3.3

3.2. Accessories

N/A

3.3. Table for Filed Antenna

Ant.	Brand	P/N	Antenna Type	Connector	Gain (dBi)
1	LYNwave	ALA110-222050-300011	PIFA Antenna	I-PEX MHF4	3.5
2	PSA	RFDPA171320EMLB301	Dipole Antenna	I-PEX MHF4	3.14

Note1: The EUT has two antennas.

Note2: Chain 1 can connect to Ant. 1 or Ant. 2.

For WLAN 802.11b/g/n (1TX, 1RX) mode:

Chain 1 can be used as transmitting/receiving antenna.

For Bluetooth mode:

Chain 1 can be used as transmitting/receiving antenna.

3.4. Table for Carrier Frequencies

Frequency Band	Channel No.	Frequency	Channel No.	Frequency
2400~2483.5MHz	0	2402 MHz	20	2442 MHz
	1	2404 MHz	:	:
	2	2406 MHz	37	2476 MHz
	:	:	38	2478 MHz
	18	2438 MHz	39	2480 MHz
	19	2440 MHz	-	-

3.5. Table for Test Modes

Preliminary tests were performed in different data rate to find the worst radiated emission. The data rate shown in the table below is the worst-case rate with respect to the specific test item. The following table is a list of the test modes shown in this test report.

Test Items	Mode	Data Rate	Channel	Chain
AC Power Line Conducted Emissions	Normal Link	-	-	-
Radiated Emissions 9kHz~1GHz	Normal Link	-	-	-
Radiated Emissions 1GHz~10 th Harmonic	GFSK	1 Mbps	0/20/39	1
Band Edge Emissions	GFSK	1 Mbps	0/20/39	1

The following test modes were performed for all tests:

For Conducted Emission test:

Mode 1. EUT + Ant. 1

Mode 2. EUT + Ant. 2

Mode 1 is the worst case, so it was selected to record in this test report

For Radiated Emission below 1GHz test:

Mode 1. EUT in Z axis + Ant. 1

Mode 2. EUT in Z axis + Ant. 2

Mode 1 is the worst case, so it was selected to record in this test report

For Radiated Emission above 1GHz test:

The EUT was performed at X axis, Y axis and Z axis position for Radiated emission above 1GHz test, and the worst case was found at Z axis. So the measurement will follow this same test configuration.

Mode 1. EUT in Z axis + Ant. 1

Mode 2. EUT in Z axis + Ant. 2

For Radiated Emission Co-location Test:

Mode 1. EUT in X axis + Ant. 1

Mode 2. EUT in Y axis + Ant. 1

Mode 3. EUT in Z axis + Ant. 1

Mode 3 has been evaluated to be the worst case among Mode 1~3, thus measurement for Mode 4 will follow this same test mode.

Mode 4. EUT in Z axis + Ant. 2

Mode 3 is the worst case, so it was selected to record in this test report

The EUT could be applied with 2.4GHz WLAN function and Bluetooth function; therefore Radiated Emission Co-location (please refer to Appendix B) tests are added for simultaneously transmit between 2.4GHz WLAN function and Bluetooth function.

3.6. Table for Testing Locations

Test Site Location				
Address:	No.8, Lane 724, Bo-ai St., Jhubei City, Hsinchu County 302, Taiwan, R.O.C.			
TEL:	886-3-656-9065			
FAX:	886-3-656-9085			
Test Site No.	Site Category	Location	FCC Designation No.	IC File No.
03CH01-CB	SAC	Hsin Chu	TW0006	IC 4086D
CO01-CB	Conduction	Hsin Chu	TW0006	IC 4086D

Open Area Test Site (OATS); Semi Anechoic Chamber (SAC).

3.7. Table for Class II Change

This product is an extension of original one reported under Sporton project number: FR5D1601AC

Below is the table for the change of the product with respect to the original one.

Modifications	Performance Checking
Adding an one-connector type module (fixed to CON1) for A+E key type	1. AC Power Line Conducted Emissions 2. Radiated Emissions 3. Band Edge Emissions

Note: The above test items will be based on original output power to re-test.

3.8. Table for Supporting Units

For Test Site No: CO01-CB

Support Unit	Brand	Model	FCC ID
AP Router	Planex	GW-AP54SGX	KA220030603014-1
NB	DELL	E6430	DoC
NB	DELL	E6430	DoC
Test fixture*2	Realtek	Ameba adapter	N/A
Device	REALTEK	RTL8723DE	TX2-RTL8723DE
Earphone	SHYARO CHI	MIC-04	DoC
Mouse	Logitech	M-U0026	DoC

For Test Site No: 03CH01-CB below 1GHz

Support Unit	Brand	Model	FCC ID
NB	DELL	E4300	DoC
NB	DELL	E4300	DoC
WLAN AP	Netgear	R7500	PY314300288
Test fixture*2	Realtek	Ameba adapter	NA
Device	REALTEK	RTL8723DE	TX2-RTL8723DE
Mouse	Logitech	M-U0026	DoC
Earphone	SHYARO CHI	MIC-04	DoC

For Test Site No: 03CH01-CB above 1GHz

Support Unit	Brand	Model	FCC ID
NB	DELL	E4300	DoC
Test fixture	Realtek	Ameba adapter	N/A

3.9. EUT Operation during Test

The EUT was programmed to be in continuously transmitting mode.

3.10. Duty Cycle

Mode	On Time (ms)	On+Off Time (ms)	Duty Cycle (%)	Duty Factor (dB)	1/T Minimum VBW (kHz)
GFSK	0.385	0.625	61.60	2.10	2.60

3.11. Test Configurations

3.11.1.AC Power Line Conduction Emissions Test Configuration

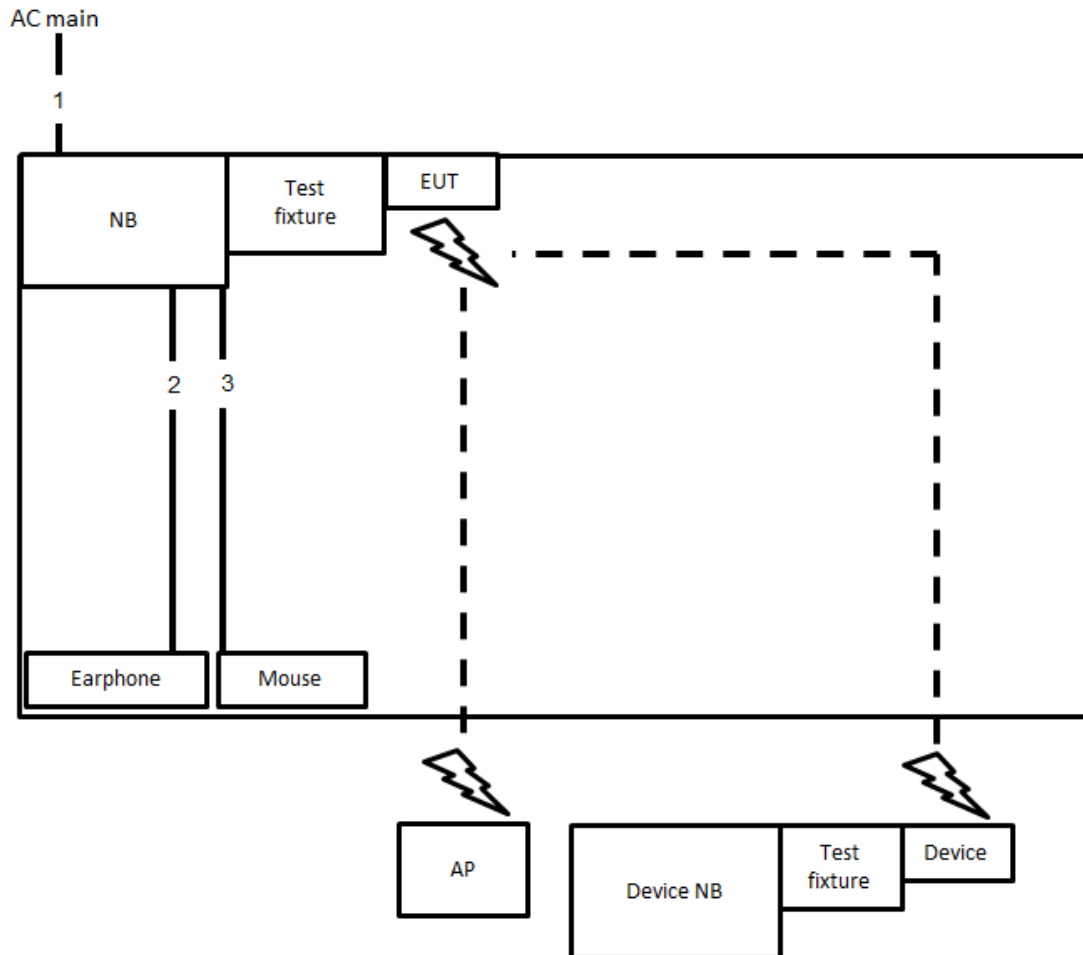

Item	Connection	Shielded	Length
1	Power cable	No	2.6m
2	Audio cable	No	1.1m
3	USB cable	Yes	1.8m

3.11.2. Radiation Emissions Test Configuration

Test Configuration: 30MHz~1GHz

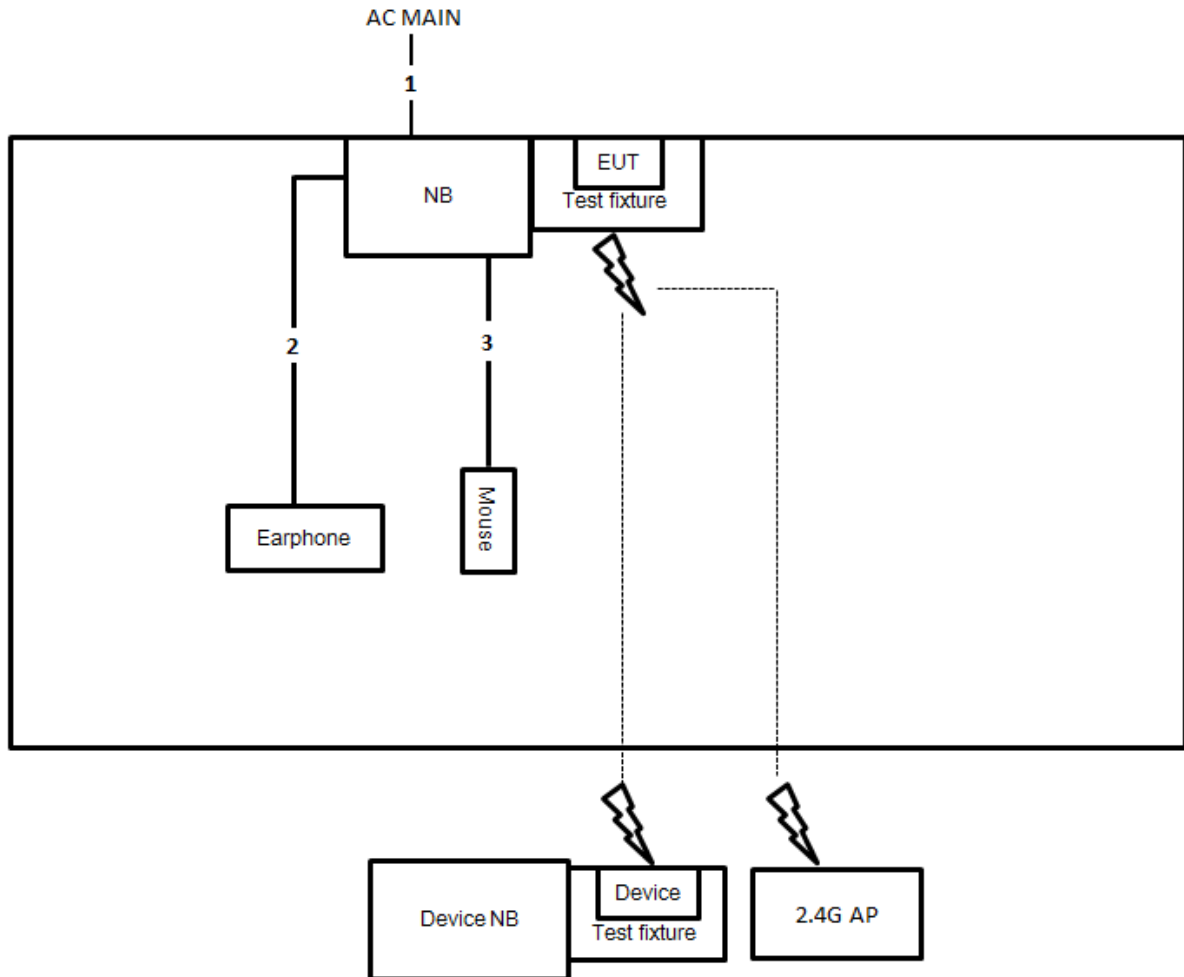

Item	Connection	Shielded	Length
1	Power cable	No	2.6m
2	Audio cable	No	1.8m
3	USB cable	Yes	1.8m

Test Configuration: above 1GHz

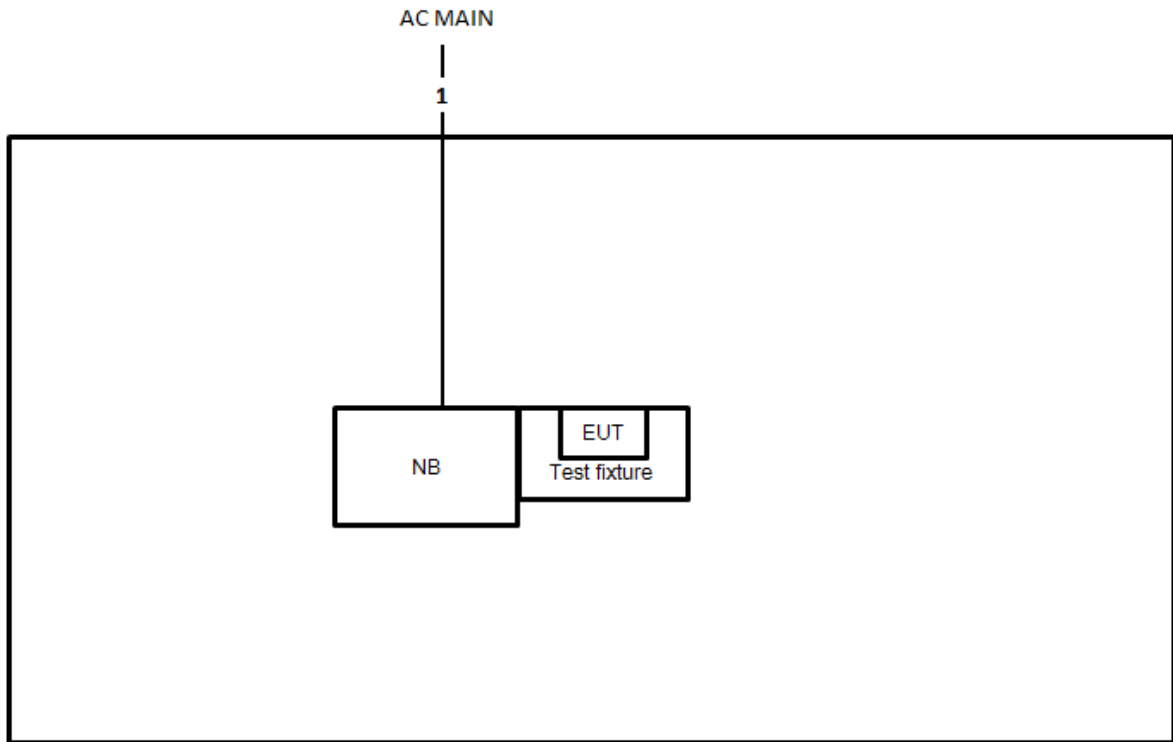

Item	Connection	Shielded	Length
1	Power cable	No	2.6m

4. TEST RESULT

4.1. AC Power Line Conducted Emissions Measurement

4.1.1. Limit

For a Low-power Radio-frequency Device which is designed to be connected to the AC power line, the radio frequency voltage that is conducted back onto the AC power line on any frequency or frequencies within the band 150 kHz to 30 MHz shall not exceed below limits table.

Frequency (MHz)	QP Limit (dBuV)	AV Limit (dBuV)
0.15~0.5	66~56	56~46
0.5~5	56	46
5~30	60	50

4.1.2. Measuring Instruments and Setting

Please refer to section 5 of equipments list in this report. The following table is the setting of the receiver.

Receiver Parameters	Setting
Attenuation	10 dB
Start Frequency	0.15 MHz
Stop Frequency	30 MHz
IF Bandwidth	9 kHz

4.1.3. Test Procedures

1. Configure the EUT according to ANSI C63.10. The EUT or host of EUT has to be placed 0.4 meter far from the conducting wall of the shielding room and at least 80 centimeters from any other grounded conducting surface.
2. Connect EUT or host of EUT to the power mains through a line impedance stabilization network (LISN).
3. All the support units are connected to the other LISNs. The LISN should provide 50uH/50ohms coupling impedance.
4. The frequency range from 150 kHz to 30 MHz was searched.
5. Set the test-receiver system to Peak Detect Function and Specified Bandwidth with Maximum Hold Mode.
6. The measurement has to be done between each power line and ground at the power terminal.

4.1.4. Test Setup Layout

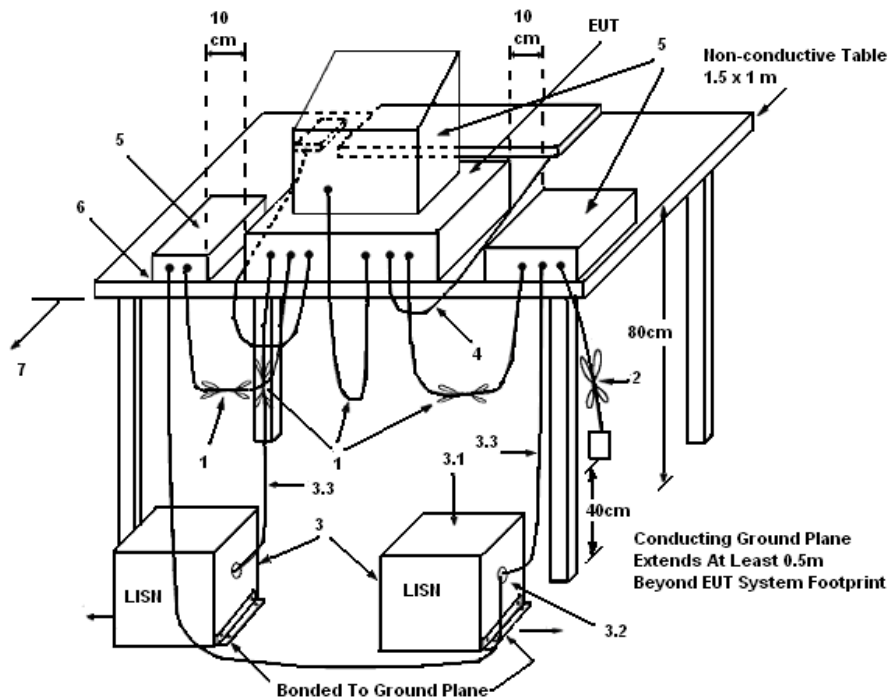

LEGEND:

- (1) Interconnecting cables that hang closer than 40 cm to the ground plane shall be folded back and forth in the center forming a bundle 30 to 40 cm long.
- (2) I/O cables that are not connected to a peripheral shall be bundled in the center. The end of the cable may be terminated, if required, using the correct terminating impedance. The overall length shall not exceed 1 m.
- (3) EUT connected to one LISN. Unused LISN measuring port connectors shall be terminated in 50 Ω . LISN can be placed on top of, or immediately beneath, reference ground plane.
 - (3.1) All other equipment powered from additional LISN(s).
 - (3.2) Multiple outlet strip can be used for multiple power cords of non-EUT equipment.
 - (3.3) LISN at least 80 cm from nearest part of EUT chassis.
- (4) Cables of hand-operated devices, such as keyboards, mice, etc., shall be placed as for normal use.
- (5) Non-EUT components of EUT system being tested.
- (6) Rear of EUT, including peripherals, shall all be aligned and flush with rear of tabletop.
- (7) Rear of tabletop shall be 40 cm removed from a vertical conducting plane that is bonded to the ground plane.

4.1.5. Test Deviation

There is no deviation with the original standard.

4.1.6. EUT Operation during Test

The EUT was placed on the test table and programmed in normal function.

4.1.7. Results of AC Power Line Conducted Emissions Measurement

Temperature	22°C	Humidity	52%
Test Engineer	Ryo Fan & Kane Liu	Phase	Line
Configuration	Normal Link		

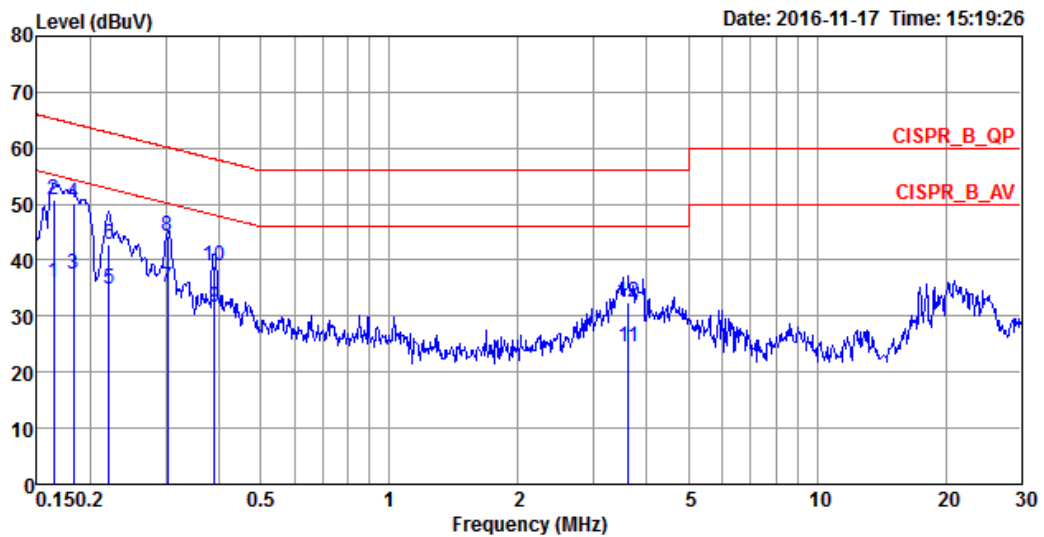

	Freq	Level	Over Limit	Limit Line	Read Level	LISN Factor	Cable Loss	Pol/Phase	Remark
	MHz	dBuV	dB	dBuV	dBuV	dB	dB		
1	0.1641	35.94	-19.31	55.25	25.75	10.02	0.17	LINE	Average
2	0.1641	50.90	-14.35	65.25	40.71	10.02	0.17	LINE	QP
3	0.1825	37.53	-16.84	54.37	27.43	9.92	0.18	LINE	Average
4	0.1825	50.29	-14.08	64.37	40.19	9.92	0.18	LINE	QP
5	0.2208	34.85	-17.94	52.79	24.77	9.92	0.16	LINE	Average
6	0.2208	42.68	-20.11	62.79	32.60	9.92	0.16	LINE	QP
7	0.3035	35.08	-15.07	50.15	25.08	9.92	0.08	LINE	Average
8	0.3035	44.34	-15.81	60.15	34.34	9.92	0.08	LINE	QP
9	0.3893	31.54	-16.54	48.08	21.60	9.92	0.02	LINE	Average
10	0.3893	39.01	-19.07	58.08	29.07	9.92	0.02	LINE	QP
11	3.6225	24.51	-21.49	46.00	14.44	9.98	0.09	LINE	Average
12	3.6225	32.52	-23.48	56.00	22.45	9.98	0.09	LINE	QP

Temperature	22°C	Humidity	52%
Test Engineer	Ryo Fan & Kane Liu	Phase	Neutral
Configuration	Normal Link		

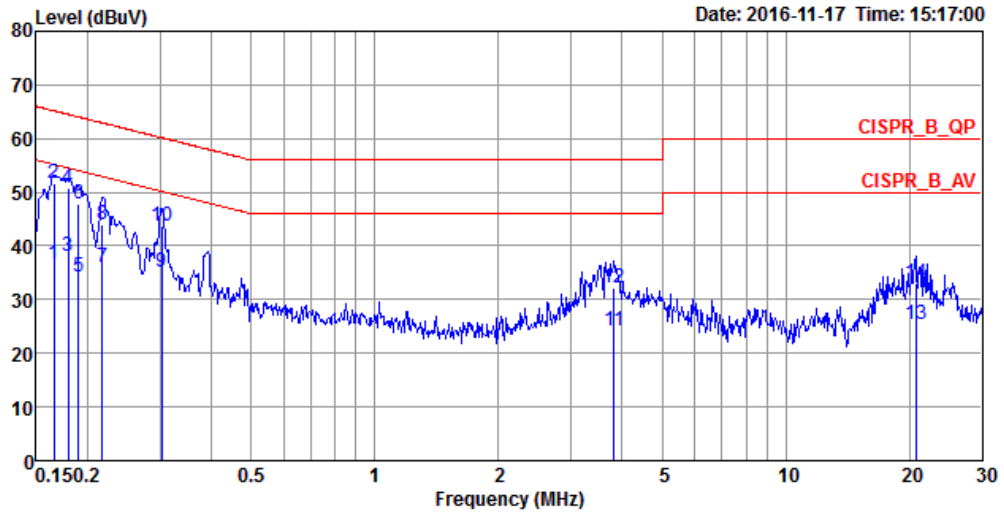

	Freq	Level	Over Limit	Limit Line	Read Level	LISN Factor	Cable Loss	Pol/Phase	Remark
	MHz	dBuV	dB	dBuV	dBuV	dB	dB		
1	0.1659	36.60	-18.56	55.16	26.41	10.02	0.17	NEUTRAL	Average
2	0.1659	51.58	-13.58	65.16	41.39	10.02	0.17	NEUTRAL	QP
3	0.1796	38.00	-16.50	54.50	27.90	9.92	0.18	NEUTRAL	Average
4	0.1796	50.91	-13.59	64.50	40.81	9.92	0.18	NEUTRAL	QP
5	0.1904	34.36	-19.66	54.02	24.25	9.92	0.19	NEUTRAL	Average
6	0.1904	47.77	-16.25	64.02	37.66	9.92	0.19	NEUTRAL	QP
7	0.2174	36.11	-16.81	52.92	26.02	9.92	0.17	NEUTRAL	Average
8	0.2174	44.08	-18.84	62.92	33.99	9.92	0.17	NEUTRAL	QP
9	0.3035	35.04	-15.11	50.15	25.04	9.92	0.08	NEUTRAL	Average
10	0.3035	43.83	-16.32	60.15	33.83	9.92	0.08	NEUTRAL	QP
11	3.8196	24.08	-21.92	46.00	14.00	9.99	0.09	NEUTRAL	Average
12	3.8196	32.19	-23.81	56.00	22.11	9.99	0.09	NEUTRAL	QP
13	20.7038	25.36	-24.64	50.00	14.79	10.33	0.24	NEUTRAL	Average
14	20.7038	33.09	-26.91	60.00	22.52	10.33	0.24	NEUTRAL	QP

Note: Level = Read Level + LISN Factor + Cable Loss.

4.2. Radiated Emissions Measurement

4.2.1. Limit

30dBc in any 100 kHz bandwidth outside the operating frequency band. In case the emission fall within the restricted band specified on 15.205(a), then the 15.209(a) limit in the table below has to be followed.

Frequencies (MHz)	Field Strength (micorvolts/meter)	Measurement Distance (meters)
0.009~0.490	2400/F(kHz)	300
0.490~1.705	24000/F(kHz)	30
1.705~30.0	30	30
30~88	100	3
88~216	150	3
216~960	200	3
Above 960	500	3

4.2.2. Measuring Instruments and Setting

Please refer to section 5 of equipments list in this report. The following table is the setting of spectrum analyzer and receiver.

Spectrum Parameter	Setting
Attenuation	Auto
Start Frequency	1000 MHz
Stop Frequency	10th carrier harmonic
RBW / VBW (Emission in restricted band)	1MHz / 3MHz for Peak, 1MHz / 1/T for Average
RBW / VBW (Emission in non-restricted band)	100kHz / 300kHz for peak

Receiver Parameter	Setting
Attenuation	Auto
Start ~ Stop Frequency	9kHz~150kHz / RBW 200Hz for QP
Start ~ Stop Frequency	150kHz~30MHz / RBW 9kHz for QP
Start ~ Stop Frequency	30MHz~1000MHz / RBW 120kHz for QP

4.2.3. Test Procedures

1. Configure the EUT according to ANSI C63.10. The EUT was placed on the top of the turntable 1.5 meter above ground. The phase center of the receiving antenna mounted on the top of a height-variable antenna tower was placed 1m & 3m far away from the turntable.
2. Power on the EUT and all the supporting units. The turntable was rotated by 360 degrees to determine the position of the highest radiation.
3. The height of the broadband receiving antenna was varied between one meter and four meters above ground to find the maximum emissions field strength of both horizontal and vertical polarization.
4. For each suspected emissions, the antenna tower was scan (from 1 M to 4 M) and then the turntable was rotated (from 0 degree to 360 degrees) to find the maximum reading.
5. Set the test-receiver system to Peak or CISPR quasi-peak Detect Function with specified bandwidth under Maximum Hold Mode.
6. For emissions above 1GHz, use 1MHz VBW and 3MHz RBW for peak reading. Then 1MHz RBW and 1/T VBW for average reading in spectrum analyzer.
7. If the emissions level of the EUT in peak mode was 3 dB lower than the average limit specified, then testing will be stopped and peak values of EUT will be reported, otherwise, the emissions which do not have 3 dB margin will be repeated one by one using the quasi-peak method for below 1GHz.
8. For testing above 1GHz, the emissions level of the EUT in peak mode was lower than average limit (that means the emissions level in peak mode also complies with the limit in average mode), then testing will be stopped and peak values of EUT will be reported, otherwise, the emissions will be measured in average mode again and reported.
9. In case the emission is lower than 30MHz, loop antenna has to be used for measurement and the recorded data should be QP measured by receiver. High – Low scan is not required in this case.

4.2.4. Test Setup Layout

For Radiated Emissions: 9kHz ~30MHz

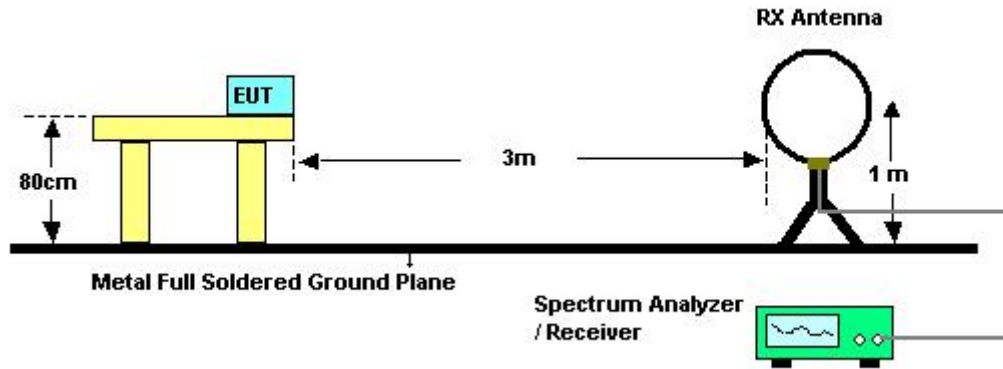

For Radiated Emissions: 30MHz~1GHz

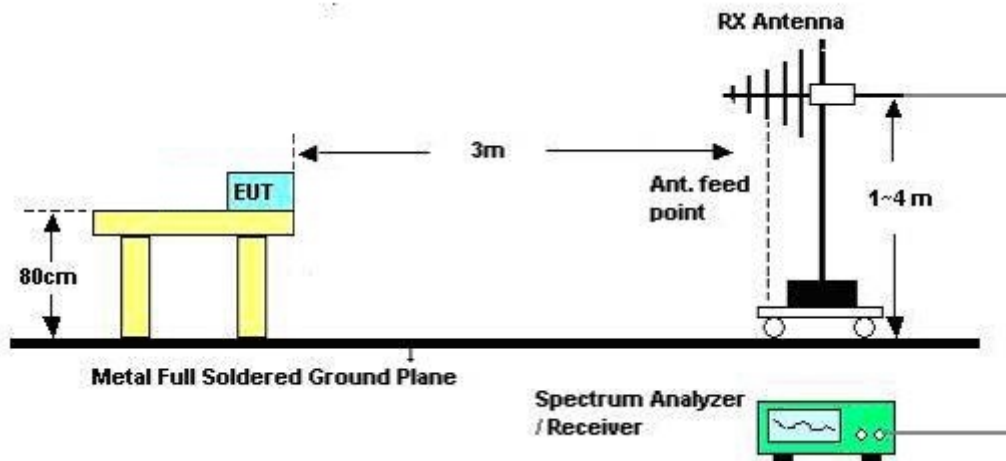

For Radiated Emissions: Above 1GHz

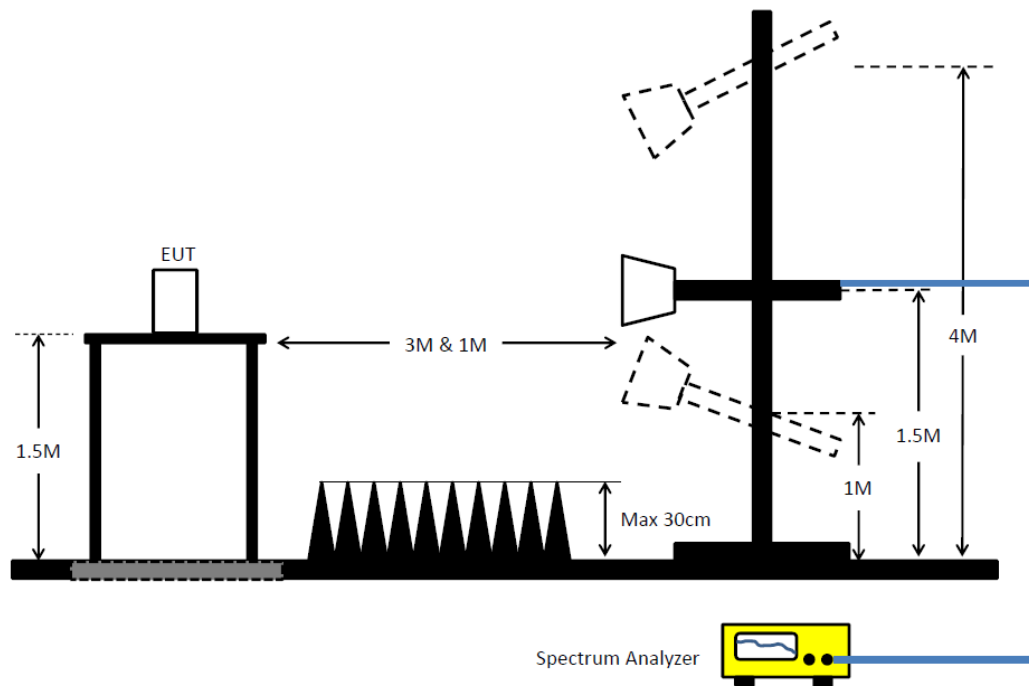

4.2.5. Test Deviation

There is no deviation with the original standard.

4.2.6. EUT Operation during Test

The EUT was programmed to be in continuously transmitting mode.

4.2.7. Results of Radiated Emissions (9kHz~30MHz)

Temperature	22°C	Humidity	54%
Test Engineer	Welson Chen & Paul Chen	Configurations	Normal Link
Test Date	Nov. 25, 2016	Test Mode	Mode 1

Freq. (MHz)	Level (dBuV)	Over Limit (dB)	Limit Line (dBuV)	Remark
-	-	-	-	See Note

Note:

The amplitude of spurious emissions that are attenuated by more than 20 dB below the permissible value has no need to be reported.

Distance extrapolation factor = $40 \log(\text{specific distance} / \text{test distance})$ (dB);

Limit line = specific limits (dBuV) + distance extrapolation factor.

4.2.8. Results of Radiated Emissions (30MHz~1GHz)

Temperature	22°C	Humidity	54%
Test Engineer	Welson Chen & Paul Chen	Configurations	Normal Link
Test Mode	Mode 1		

Horizontal

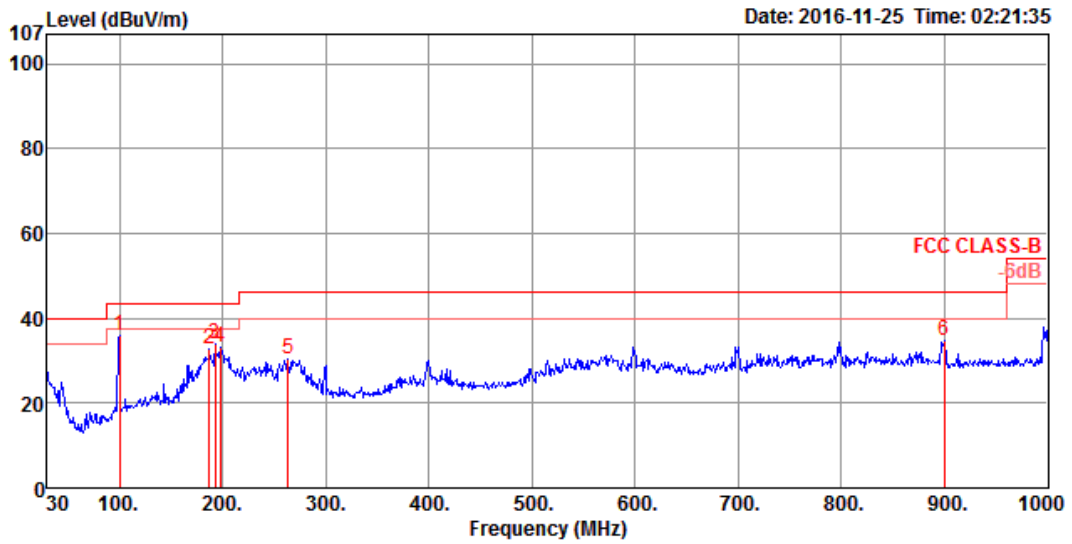

	Freq	Level	Limit	Over	Read	Cable	Antenna	Preamp	A/Pos	T/Pos	Remark	Pol/Phase
	MHz	dBuV/m	dBuV/m	dB	dBuV	dB	dB/m	dB	cm	deg		
1	99.84	36.01	43.50	-7.49	50.00	0.87	17.00	31.86	200	168	Peak	HORIZONTAL
2	187.14	32.80	43.50	-10.70	48.24	1.09	15.43	31.96	200	5	Peak	HORIZONTAL
3	192.96	33.90	43.50	-9.60	49.09	1.11	15.67	31.97	200	0	Peak	HORIZONTAL
4	197.81	33.19	43.50	-10.31	48.01	1.12	16.04	31.98	200	188	Peak	HORIZONTAL
5	263.77	30.51	46.00	-15.49	41.77	1.28	19.45	31.99	125	196	Peak	HORIZONTAL
6	900.09	34.55	46.00	-11.45	37.30	2.40	27.30	32.45	100	263	Peak	HORIZONTAL

Vertical

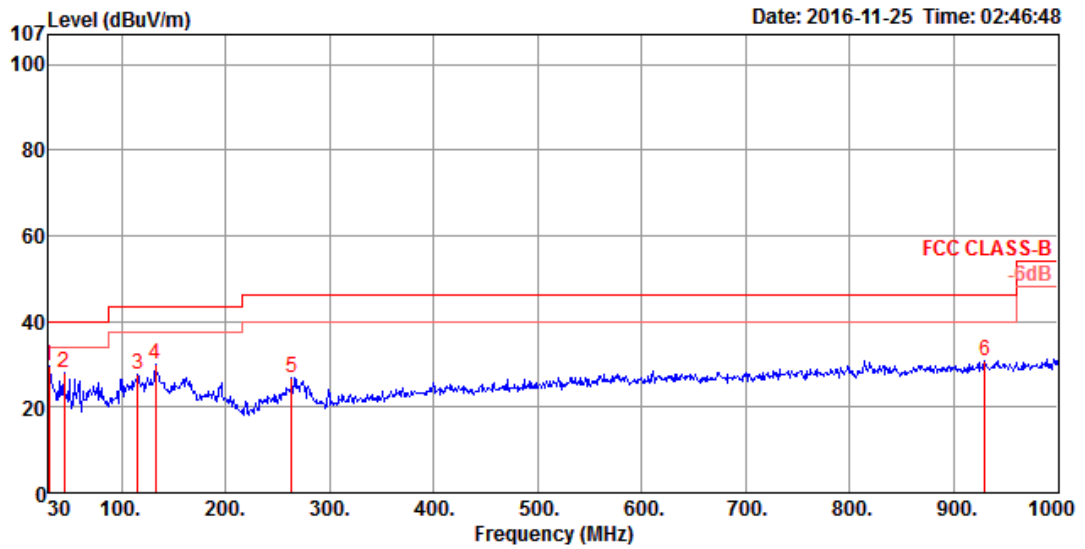

	Freq	Level	Limit	Over	Read	CableAntenna	Preamp	A/Pos	T/Pos	Remark	Pol/Phase
	MHz	dBuV/m	dBuV/m	dB	dBuV	dB	dB/m	dB	cm	deg	
1	30.00	29.53	40.00	-10.47	34.87	0.53	25.60	31.47	150	2 Peak	VERTICAL
2	44.55	27.89	40.00	-12.11	41.84	0.60	17.15	31.70	125	306 Peak	VERTICAL
3	115.36	27.45	43.50	-16.05	40.10	0.87	18.36	31.88	100	6 Peak	VERTICAL
4	132.82	30.01	43.50	-13.49	42.78	0.91	18.20	31.88	100	2 Peak	VERTICAL
5	263.77	26.93	46.00	-19.07	38.19	1.28	19.45	31.99	200	315 Peak	VERTICAL
6	930.16	30.79	46.00	-15.21	33.32	2.42	27.51	32.46	125	99 Peak	VERTICAL

Note:

The amplitude of spurious emissions which are attenuated by more than 20 dB below the permissible value has no need to be reported.

Emission level (dBuV/m) = 20 log Emission level (uV/m).

Corrected Reading: Antenna Factor + Cable Loss + Read Level - Preamp Factor = Level.

4.2.9. Results for Radiated Emissions (1GHz~10th Harmonic)

Temperature	22°C	Humidity	54%
Test Engineer	Welson Chen & Paul Chen	Configurations	Channel 0
Test Date	Nov. 25, 2016	Test Mode	Mode 1

Horizontal

	Freq	Level	Limit Line	Over Limit	Read Level	CableAntenna Loss	Antenna Factor	Preamp Factor	A/Pos	T/Pos	Remark	Pol/Phase
	MHz	dBuV/m	dBuV/m	dB	dBuV	dB	dB/m	dB	cm	deg		
1	4803.63	49.89	74.00	-24.11	43.60	6.26	33.08	33.05	258	307	Peak	HORIZONTAL
2	4803.88	38.50	54.00	-15.50	32.21	6.26	33.08	33.05	258	307	Average	HORIZONTAL

Vertical

	Freq	Level	Limit Line	Over Limit	Read Level	CableAntenna Loss	Antenna Factor	Preamp Factor	A/Pos	T/Pos	Remark	Pol/Phase
	MHz	dBuV/m	dBuV/m	dB	dBuV	dB	dB/m	dB	cm	deg		
1	4803.78	50.16	74.00	-23.84	43.87	6.26	33.08	33.05	123	326	Peak	VERTICAL
2	4803.95	39.12	54.00	-14.88	32.83	6.26	33.08	33.05	123	326	Average	VERTICAL

Temperature	22°C	Humidity	54%
Test Engineer	Welson Chen & Paul Chen	Configurations	Channel 20
Test Date	Nov. 25, 2016	Test Mode	Mode 1

Horizontal

	Freq	Level	Limit Line	Over Limit	Read Level	CableAntenna Loss	Antenna Factor	Preamp Factor	A/Pos	T/Pos	Remark	Pol/Phase
	MHz	dBuV/m	dBuV/m	dB	dBuV	dB	dB/m	dB	cm	deg		
1	4883.55	49.24	74.00	-24.76	42.72	6.28	33.26	33.02	102	67	Peak	HORIZONTAL
2	4883.70	37.01	54.00	-16.99	30.49	6.28	33.26	33.02	102	67	Average	HORIZONTAL

Vertical

	Freq	Level	Limit Line	Over Limit	Read Level	CableAntenna Loss	Antenna Factor	Preamp Factor	A/Pos	T/Pos	Remark	Pol/Phase
	MHz	dBuV/m	dBuV/m	dB	dBuV	dB	dB/m	dB	cm	deg		
1	4883.38	49.94	74.00	-24.06	43.42	6.28	33.26	33.02	132	330	Peak	VERTICAL
2	4883.83	38.74	54.00	-15.26	32.22	6.28	33.26	33.02	132	330	Average	VERTICAL



Temperature	22°C	Humidity	54%
Test Engineer	Welson Chen & Paul Chen	Configurations	Channel 39
Test Date	Nov. 25, 2016	Test Mode	Mode 1

Horizontal

	Freq	Level	Limit Line	Over Limit	Read Level	CableAntenna Loss	Antenna Factor	Preamp Factor	A/Pos	T/Pos	Remark	Pol/Phase
	MHz	dBuV/m	dBuV/m	dB	dBuV	dB	dB/m	dB	cm	deg		
1	4959.51	50.21	74.00	-23.79	43.48	6.30	33.41	32.98	102	342	Peak	HORIZONTAL
2	4959.86	38.19	54.00	-15.81	31.46	6.30	33.41	32.98	102	342	Average	HORIZONTAL

Vertical

	Freq	Level	Limit Line	Over Limit	Read Level	CableAntenna Loss	Antenna Factor	Preamp Factor	A/Pos	T/Pos	Remark	Pol/Phase
	MHz	dBuV/m	dBuV/m	dB	dBuV	dB	dB/m	dB	cm	deg		
1	4959.47	49.77	74.00	-24.23	43.04	6.30	33.41	32.98	100	315	Peak	VERTICAL
2	4959.96	38.60	54.00	-15.40	31.87	6.30	33.41	32.98	100	315	Average	VERTICAL

Note:

The amplitude of spurious emissions that are attenuated by more than 20dB below the permissible value has no need to be reported.

Emission level (dBuV/m) = 20 log Emission level (uV/m).

Corrected Reading: Antenna Factor + Cable Loss + Read Level - Preamp Factor = Level.



Temperature	22°C	Humidity	54%
Test Engineer	Welson Chen & Paul Chen	Configurations	Channel 0
Test Date	Nov. 25, 2016	Test Mode	Mode 2

Horizontal

	Freq	Level	Limit Line	Over Limit	Read Level	CableAntenna Loss	Antenna Factor	Preamp Factor	A/Pos	T/Pos	Remark	Pol/Phase
	MHz	dBuV/m	dBuV/m	dB	dBuV	dB	dB/m	dB	cm	deg		
1	4803.76	51.36	74.00	-22.64	45.07	6.26	33.08	33.05	274	20	Peak	HORIZONTAL
2	4804.08	41.07	54.00	-12.93	34.78	6.26	33.08	33.05	274	20	Average	HORIZONTAL

Vertical

	Freq	Level	Limit Line	Over Limit	Read Level	CableAntenna Loss	Antenna Factor	Preamp Factor	A/Pos	T/Pos	Remark	Pol/Phase
	MHz	dBuV/m	dBuV/m	dB	dBuV	dB	dB/m	dB	cm	deg		
1	4804.06	41.33	54.00	-12.67	35.04	6.26	33.08	33.05	281	65	Average	VERTICAL
2	4804.46	51.11	74.00	-22.89	44.82	6.26	33.08	33.05	281	65	Peak	VERTICAL



Temperature	22°C	Humidity	54%
Test Engineer	Welson Chen & Paul Chen	Configurations	Channel 20
Test Date	Nov. 25, 2016	Test Mode	Mode 2

Horizontal

	Freq	Level	Limit Line	Over Limit	Read Level	CableAntenna Loss	Antenna Factor	Preamp Factor	A/Pos	T/Pos	Remark	Pol/Phase
	MHz	dBuV/m	dBuV/m	dB	dBuV	dB	dB/m	dB	cm	deg		
1	4883.88	39.73	54.00	-14.27	33.21	6.28	33.26	33.02	110	12	Average	HORIZONTAL
2	4884.64	50.00	74.00	-24.00	43.48	6.28	33.26	33.02	110	12	Peak	HORIZONTAL

Vertical

	Freq	Level	Limit Line	Over Limit	Read Level	CableAntenna Loss	Antenna Factor	Preamp Factor	A/Pos	T/Pos	Remark	Pol/Phase
	MHz	dBuV/m	dBuV/m	dB	dBuV	dB	dB/m	dB	cm	deg		
1	4883.56	50.62	74.00	-23.38	44.10	6.28	33.26	33.02	100	317	Peak	VERTICAL
2	4883.68	39.68	54.00	-14.32	33.16	6.28	33.26	33.02	100	317	Average	VERTICAL

Temperature	22°C	Humidity	54%
Test Engineer	Welson Chen & Paul Chen	Configurations	Channel 39
Test Date	Nov. 25, 2016	Test Mode	Mode 2

Horizontal

	Freq	Level	Limit Line	Over Limit	Read Level	CableAntenna Loss	Preamp Factor	A/Pos	T/Pos	Remark	Pol/Phase
	MHz	dBuV/m	dBuV/m	dB	dBuV	dB	dB/m	dB	cm	deg	
1	4959.88	39.26	54.00	-14.74	32.53	6.30	33.41	32.98	100	11 Average	HORIZONTAL
2	4960.66	49.80	74.00	-24.20	43.07	6.30	33.41	32.98	100	11 Peak	HORIZONTAL

Vertical

	Freq	Level	Limit Line	Over Limit	Read Level	CableAntenna Loss	Preamp Factor	A/Pos	T/Pos	Remark	Pol/Phase
	MHz	dBuV/m	dBuV/m	dB	dBuV	dB	dB/m	dB	cm	deg	
1	4960.07	39.05	54.00	-14.95	32.32	6.30	33.41	32.98	106	291 Average	VERTICAL
2	4960.47	49.88	74.00	-24.12	43.15	6.30	33.41	32.98	106	291 Peak	VERTICAL

Note:

The amplitude of spurious emissions that are attenuated by more than 20dB below the permissible value has no need to be reported.

Emission level (dBuV/m) = 20 log Emission level (uV/m).

Corrected Reading: Antenna Factor + Cable Loss + Read Level - Preamp Factor = Level.

4.3. Emissions Measurement

4.3.1. Limit

30dBc in any 100 kHz bandwidth outside the operating frequency band. In case the emission fall within the restricted band specified on 15.205(a), then the 15.209(a) limit in the table below has to be followed.

Frequencies (MHz)	Field Strength (micorvolts/meter)	Measurement Distance (meters)
0.009~0.490	2400/F(kHz)	300
0.490~1.705	24000/F(kHz)	30
1.705~30.0	30	30
30~88	100	3
88~216	150	3
216~960	200	3
Above 960	500	3

4.3.2. Measuring Instruments and Setting

Please refer to section 5 of equipments list in this report. The following table is the setting of the spectrum analyzer.

Spectrum Parameter	Setting
Attenuation	Auto
Span Frequency	100 MHz
RBW / VBW (Emission in restricted band)	1MHz / 3MHz for Peak, 1MHz / 1/T for Average
RBW / VBW (30dBc in any 100 kHz bandwidth emission)	100 kHz / 300 kHz for Peak

4.3.3. Test Procedures

For Radiated band edges Measurement:

1. The test procedure is the same as section 4.2.3.

For Radiated Out of Band Emission Measurement:

1. Test was performed in accordance with KDB558074 D01 v03r05 for Performing Compliance Measurements on Digital Transmission Systems (DTS) Operating Under §15.247 section 11.0 Unwanted Emissions into Non-Restricted Frequency Bands Measurement Procedure.

4.3.4. Test Setup Layout

For Radiated band edges Measurement:

This test setup layout is the same as that shown in section 4.2.4.

For Radiated Out of Band Emission Measurement:

This test setup layout is the same as that shown in section 4.2.4.

4.3.5. Test Deviation

There is no deviation with the original standard.

4.3.6. EUT Operation during Test

The EUT was programmed to be in continuously transmitting mode.

4.3.7. Test Result of Band Edge and Fundamental Emissions

Temperature	22°C	Humidity	54%
Test Engineer	Welson Chen & Paul Chen	Configurations	Channel 0, 20, 39
Test Mode	Mode 1		

Channel 0

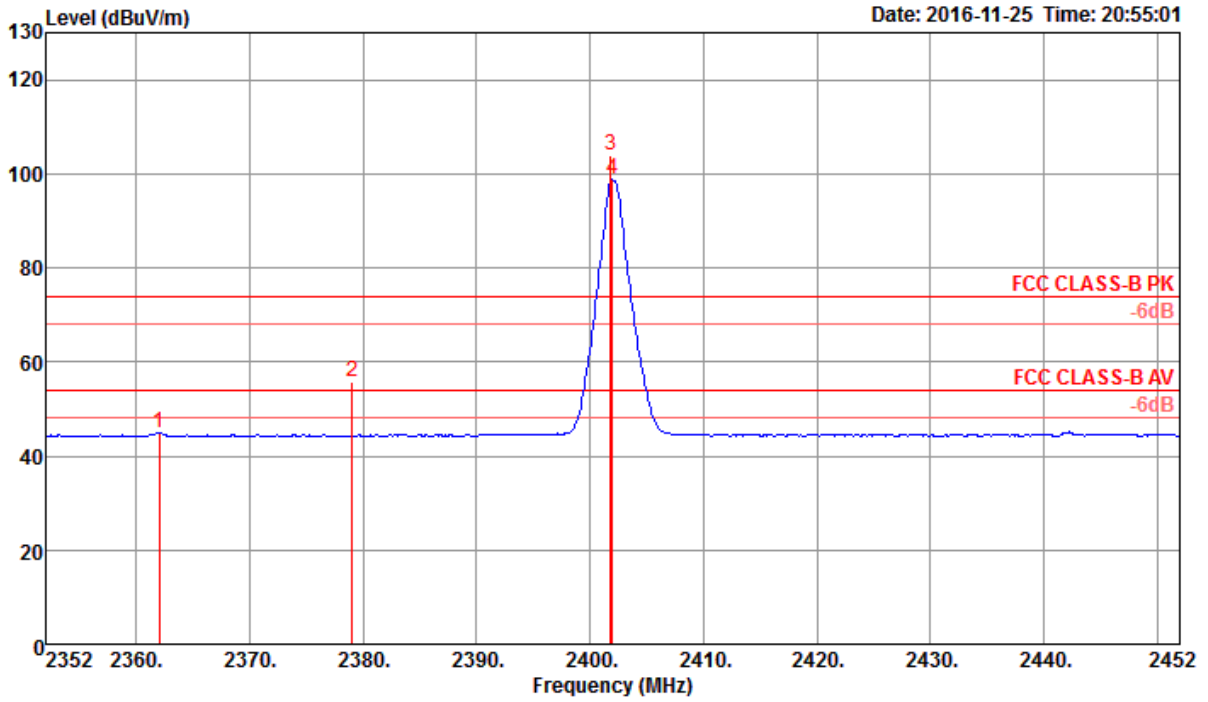

	Freq	Level	Limit Line	Over Limit	Read Level	CableAntenna Loss	Preamp Factor	A/Pos	T/Pos	Remark	Pol/Phase
	MHz	dBuV/m	dBuV/m	dB	dBuV	dB	dB/m	dB	cm	deg	
1	2362.00	44.99	54.00	-9.01	13.14	3.58	28.27	0.00	175	203 Average	HORIZONTAL
2	2379.00	55.71	74.00	-18.29	23.82	3.59	28.30	0.00	175	203 Peak	HORIZONTAL
3 @	2401.80	103.76			71.81	3.61	28.34	0.00	175	203 Peak	HORIZONTAL
4 @	2402.00	98.80			66.85	3.61	28.34	0.00	175	203 Average	HORIZONTAL

Item 3, 4 are the fundamental frequency at 2402 MHz.

Channel 20

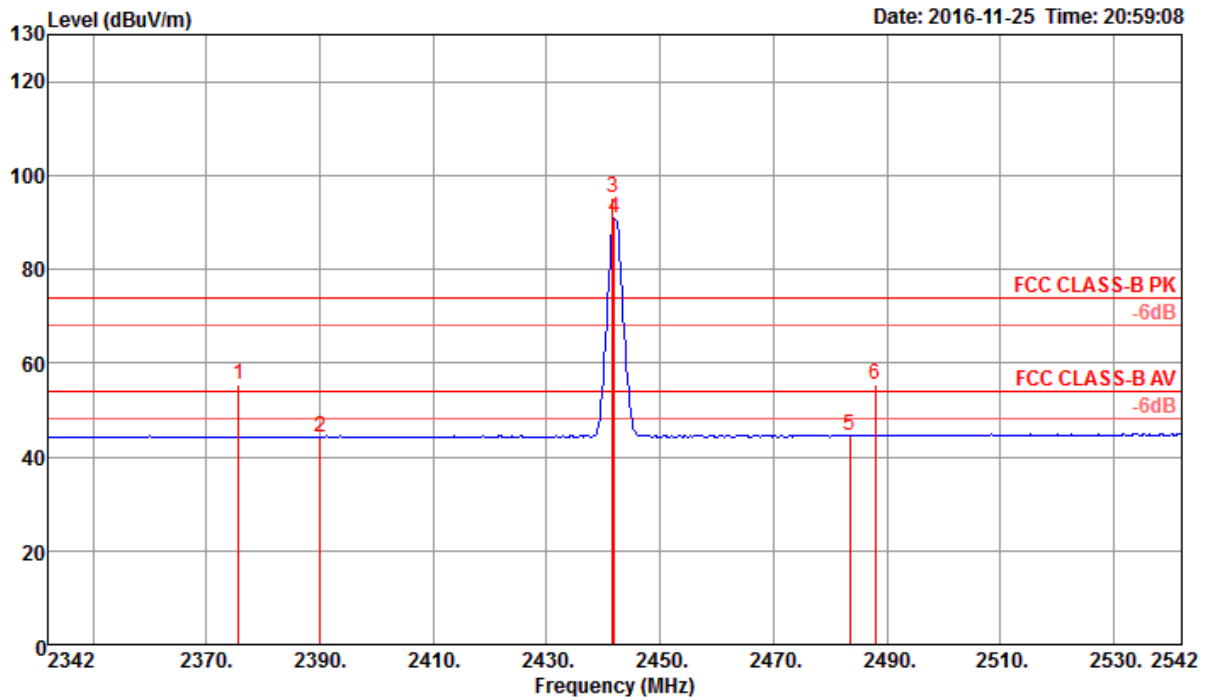

	Freq	Level	Limit Line	Over Limit	Read Level	CableAntenna Loss	Preamp Factor	A/Pos	T/Pos	Remark	Pol/Phase
	MHz	dBuV/m	dBuV/m	dB	dBuV	dB	dB/m	dB	cm	deg	
1	2375.60	55.26	74.00	-18.74	23.38	3.59	28.29	0.00	200	209 Peak	VERTICAL
2	2390.00	44.17	54.00	-9.83	12.26	3.60	28.31	0.00	200	209 Average	VERTICAL
3 @	2441.60	95.38			63.33	3.64	28.41	0.00	200	209 Peak	VERTICAL
4 @	2442.00	90.79			58.74	3.64	28.41	0.00	200	209 Average	VERTICAL
5	2483.50	44.41	54.00	-9.59	12.25	3.68	28.48	0.00	200	209 Average	VERTICAL
6	2487.90	55.55	74.00	-18.45	23.39	3.68	28.48	0.00	200	209 Peak	VERTICAL

Item 3, 4 are the fundamental frequency at 2442 MHz.

Channel 39

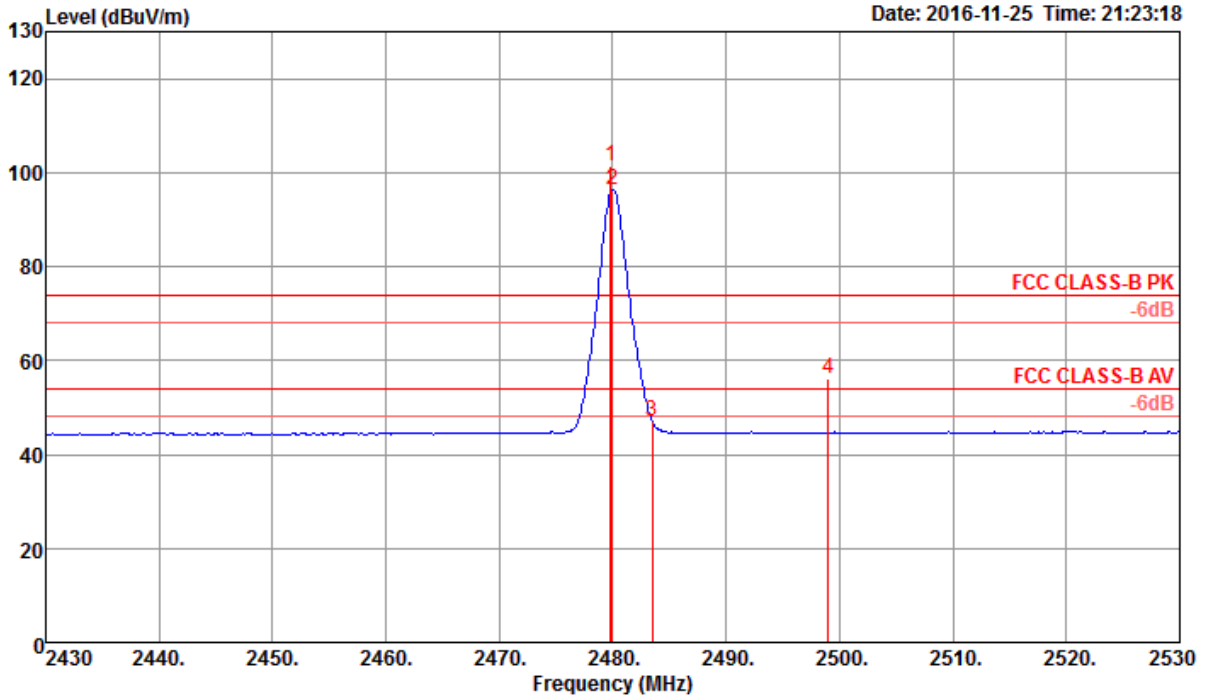

	Freq	Level	Limit Line	Over Limit	Read Level	Cable Loss	Antenna Factor	Preamp Factor	A/Pos	T/Pos	Remark	Pol/Phase
	MHz	dBuV/m	dBuV/m	dB	dBuV	dB	dB/m	dB	cm	deg		
1 @	2479.80	101.27			69.14	3.67	28.46	0.00	193	195	Peak	HORIZONTAL
2 @	2480.00	96.39			64.26	3.67	28.46	0.00	193	195	Average	HORIZONTAL
3	2483.50	47.03	54.00	-6.97	14.87	3.68	28.48	0.00	193	195	Average	HORIZONTAL
4	2499.00	56.29	74.00	-17.71	24.10	3.69	28.50	0.00	193	195	Peak	HORIZONTAL

Item 1, 2 are the fundamental frequency at 2480 MHz.

Note:

Emission level (dBuV/m) = 20 log Emission level (uV/m).

Corrected Reading: Antenna Factor + Cable Loss + Read Level - Preamp Factor = Level.

Temperature	22°C	Humidity	54%
Test Engineer	Welson Chen & Paul Chen	Configurations	Channel 0, 20, 39
Test Mode	Mode 2		

Channel 0

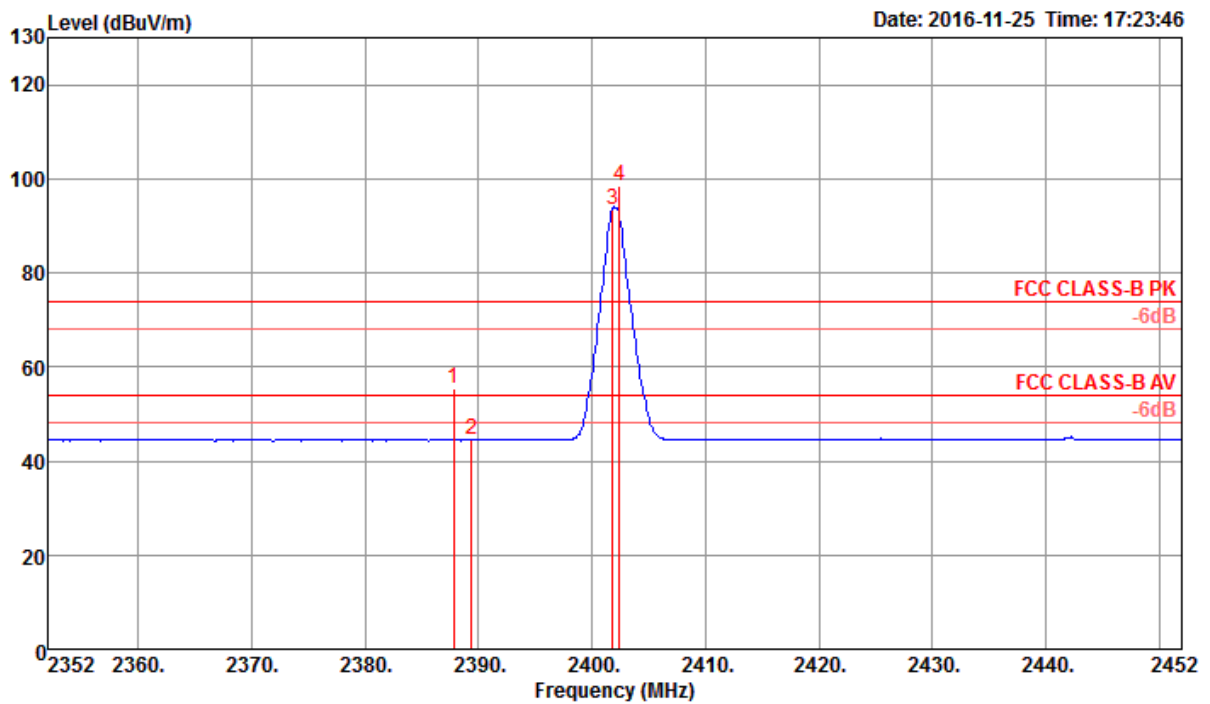

	Freq	Level	Limit Line	Over Limit	Read Level	CableAntenna Loss	Preamp Factor	A/Pos	T/Pos	Remark	Pol/Phase
	MHz	dBuV/m	dBuV/m	dB	dBuV	dB	dB/m	dB	cm	deg	
1	2387.80	55.23	74.00	-18.77	23.32	3.60	28.31	0.00	101	300 Peak	VERTICAL
2	2389.40	44.46	54.00	-9.54	12.55	3.60	28.31	0.00	101	300 Average	VERTICAL
3 @	2401.80	93.31			61.36	3.61	28.34	0.00	101	300 Average	VERTICAL
4 @	2402.40	98.39			66.44	3.61	28.34	0.00	101	300 Peak	VERTICAL

Item 3, 4 are the fundamental frequency at 2402 MHz.

Channel 20

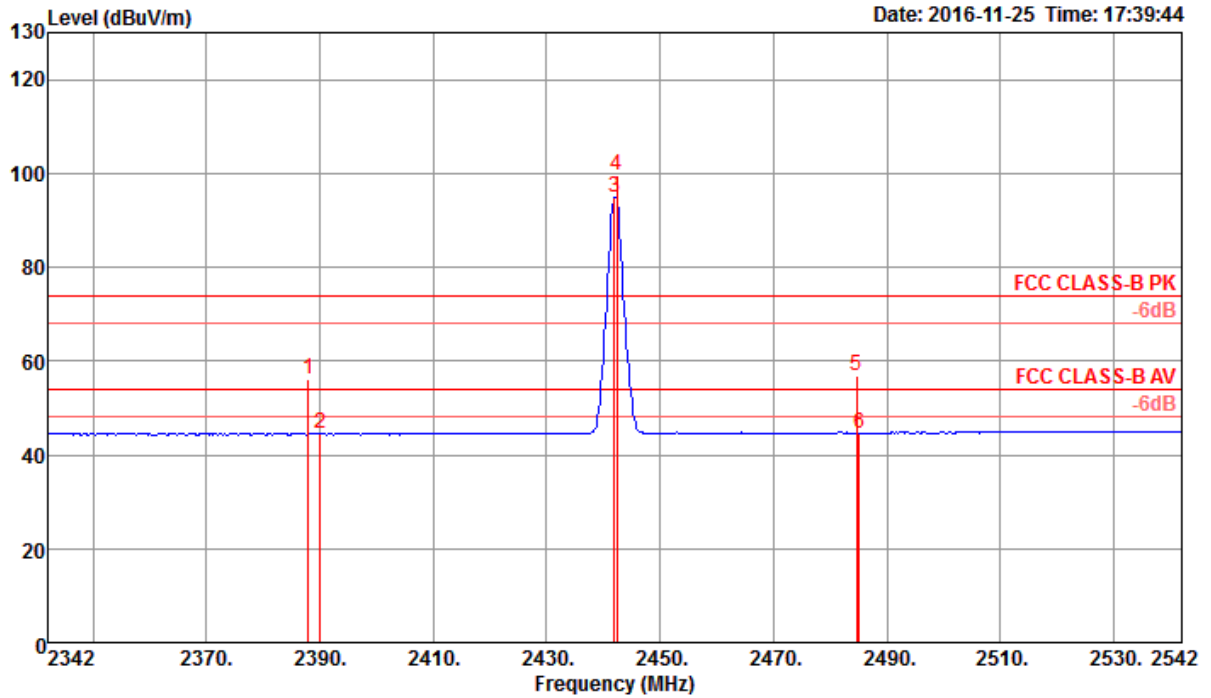

	Freq	Level	Limit Line	Over Limit	Read Level	CableAntenna Loss	Preamp Factor	A/Pos	T/Pos	Remark	Pol/Phase
	MHz	dBuV/m	dBuV/m	dB	dBuV	dB	dB/m	dB	cm	deg	
1	2388.00	56.24	74.00	-17.76	24.33	3.60	28.31	0.00	103	175 Peak	VERTICAL
2	2390.00	44.40	54.00	-9.60	12.49	3.60	28.31	0.00	103	175 Average	VERTICAL
3 @	2442.00	95.05			63.00	3.64	28.41	0.00	103	175 Average	VERTICAL
4 @	2442.40	99.74			67.69	3.64	28.41	0.00	103	175 Peak	VERTICAL
5	2484.70	56.78	74.00	-17.22	24.62	3.68	28.48	0.00	103	175 Peak	VERTICAL
6	2485.10	44.61	54.00	-9.39	12.45	3.68	28.48	0.00	103	175 Average	VERTICAL

Item 3, 4 are the fundamental frequency at 2442 MHz.

Channel 39

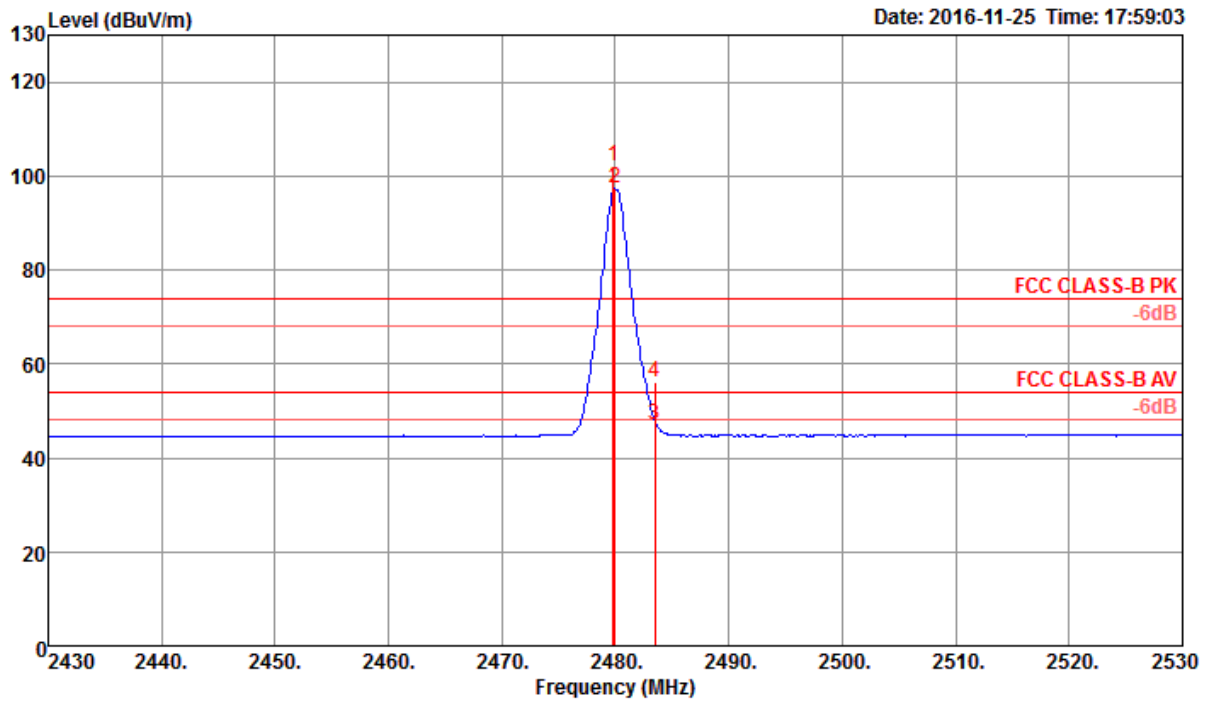

	Freq	Level	Limit Line	Over Limit	Read Level	Cable Loss	Antenna Factor	Preamp Factor	A/Pos	T/Pos	Remark	Pol/Phase
	MHz	dBuV/m	dBuV/m	dB	dBuV	dB	dB/m	dB	cm	deg		
1 @	2479.80	102.18			70.05	3.67	28.46	0.00	120	325	Peak	VERTICAL
2 @	2480.00	97.25			65.12	3.67	28.46	0.00	120	325	Average	VERTICAL
3	2483.50	47.07	54.00	-6.93	14.91	3.68	28.48	0.00	120	325	Average	VERTICAL
4	2483.50	56.13	74.00	-17.87	23.97	3.68	28.48	0.00	120	325	Peak	VERTICAL

Item 1, 2 are the fundamental frequency at 2480 MHz.

Note:

Emission level (dBuV/m) = 20 log Emission level (uV/m).

Corrected Reading: Antenna Factor + Cable Loss + Read Level - Preamp Factor = Level.

For Emission not in Restricted Band

Test Mode: Mode 1

Plot on Configuration / Reference Level

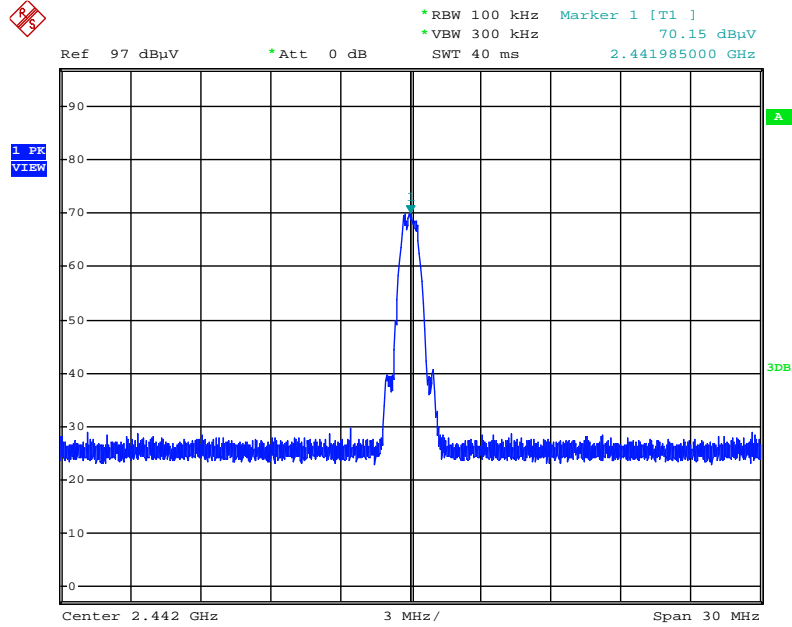

Date: 25.NOV.2016 20:26:30

Plot on Configuration For Bluetooth 4.0 / Channel 0 / 30MHz~2400MHz (down 30dBc)

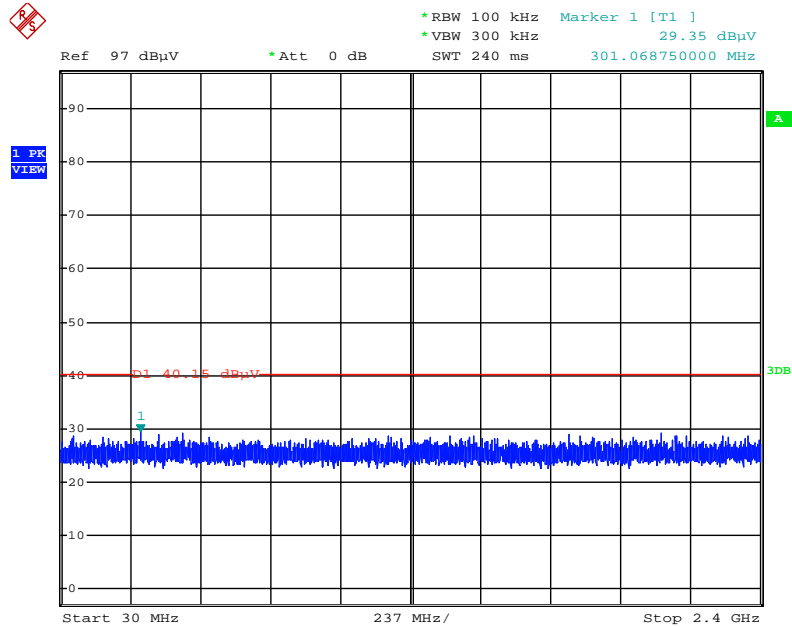

Date: 25.NOV.2016 21:03:44

Plot on Configuration For Bluetooth 4.0 / Channel 0 / 2483.5MHz~26500MHz (down 30dBc)

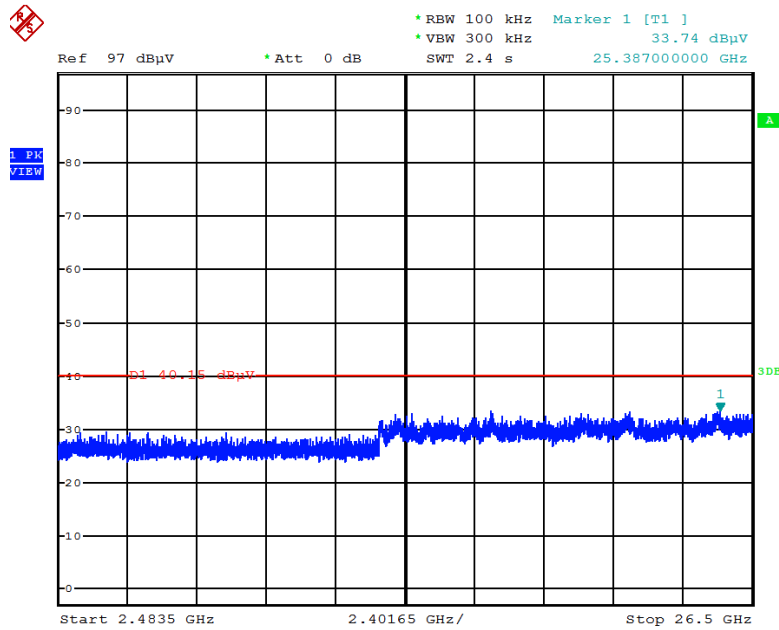

Date: 25.NOV.2016 21:04:30

Plot on Configuration For Bluetooth 4.0 / Channel 39 / 30MHz~2400MHz (down 30dBc)

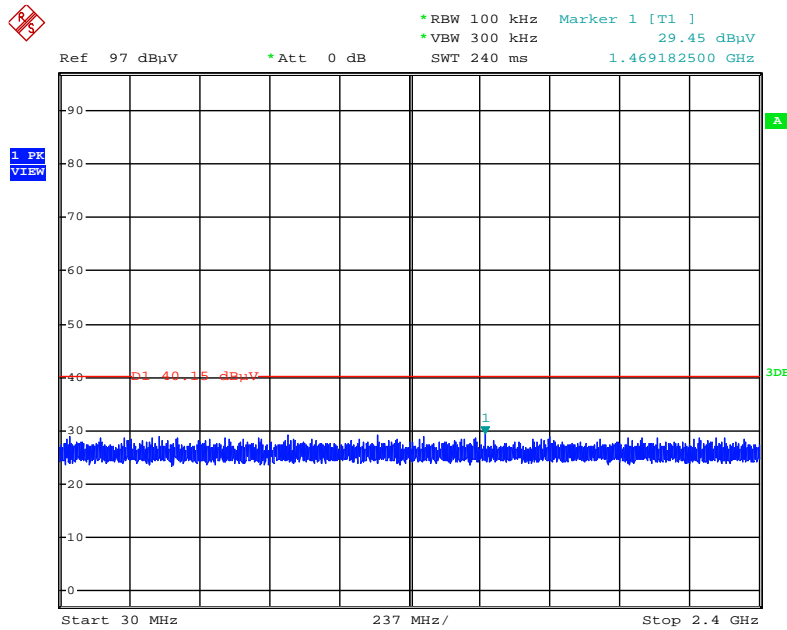

Date: 25.NOV.2016 21:06:06

Plot on Configuration For Bluetooth 4.0 / Channel 39 / 2483.5MHz~26500MHz (down 30dBc)

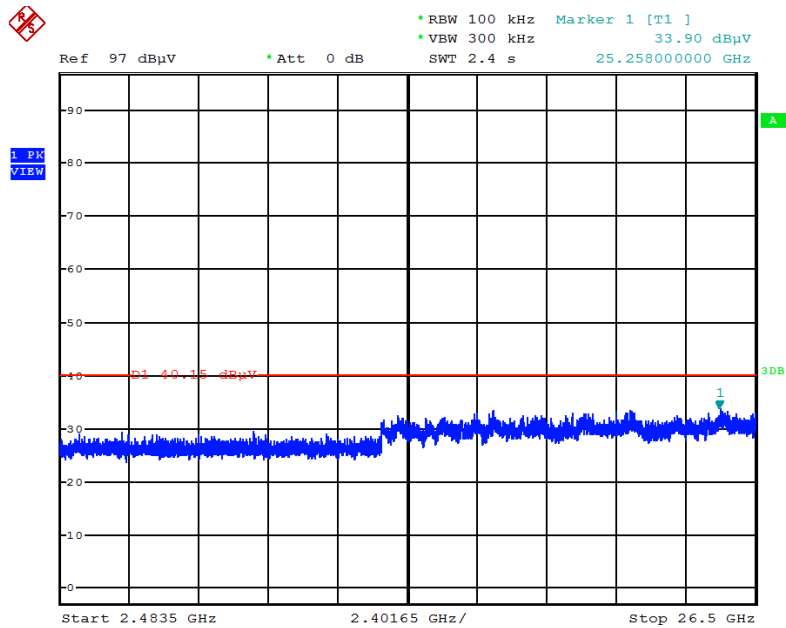

Date: 25.NOV.2016 21:05:23

Test Mode: Mode 2

Plot on Configuration / Reference Level

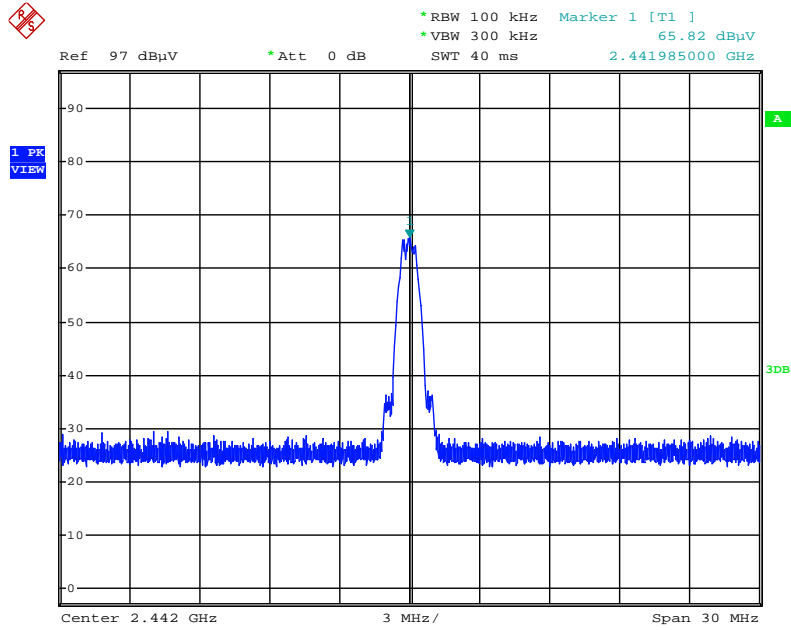

Date: 25.NOV.2016 18:50:56

Plot on Configuration For Bluetooth 4.0 / Channel 0 / 30MHz~2400MHz (down 30dBc)

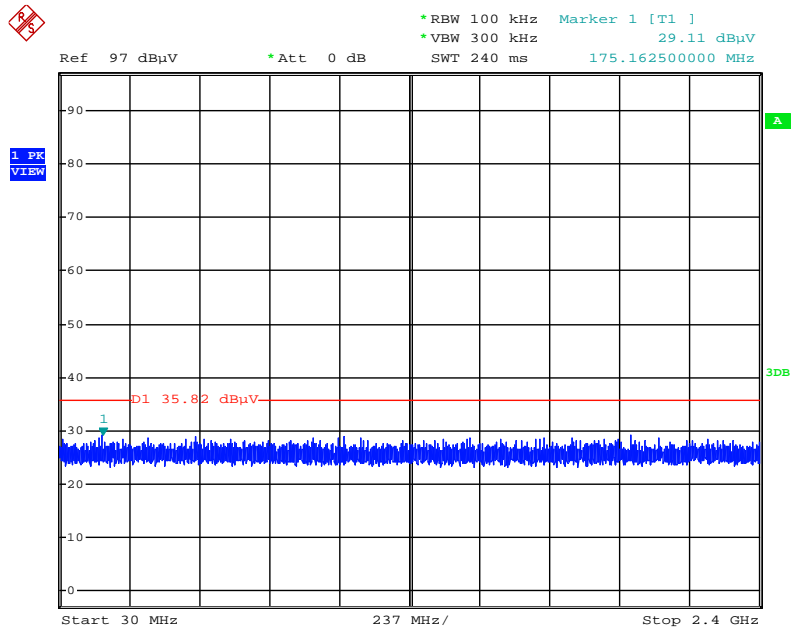

Date: 25.NOV.2016 18:53:57

Plot on Configuration For Bluetooth 4.0 / Channel 0 / 2483.5MHz~26500MHz (down 30dBc)

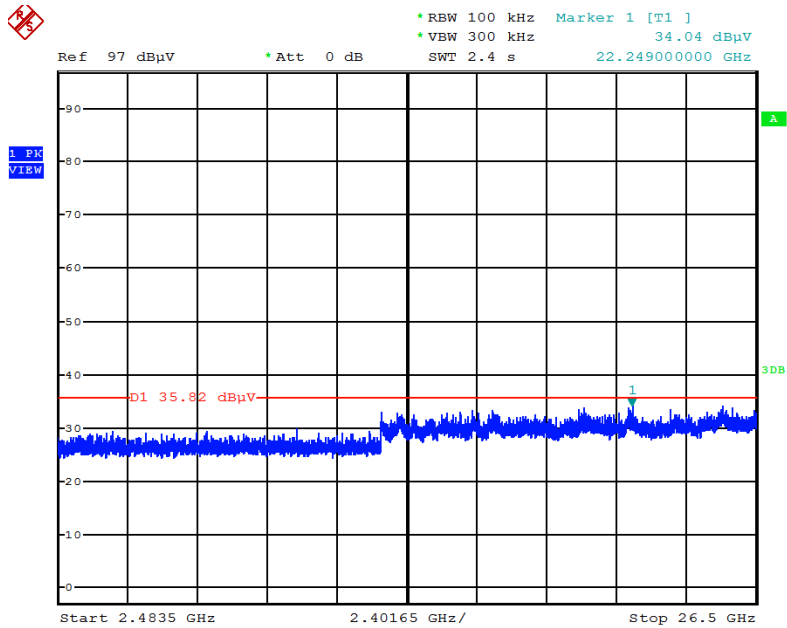

Date: 25.NOV.2016 18:56:21

Plot on Configuration For Bluetooth 4.0 / Channel 39 / 30MHz~2400MHz (down 30dBc)

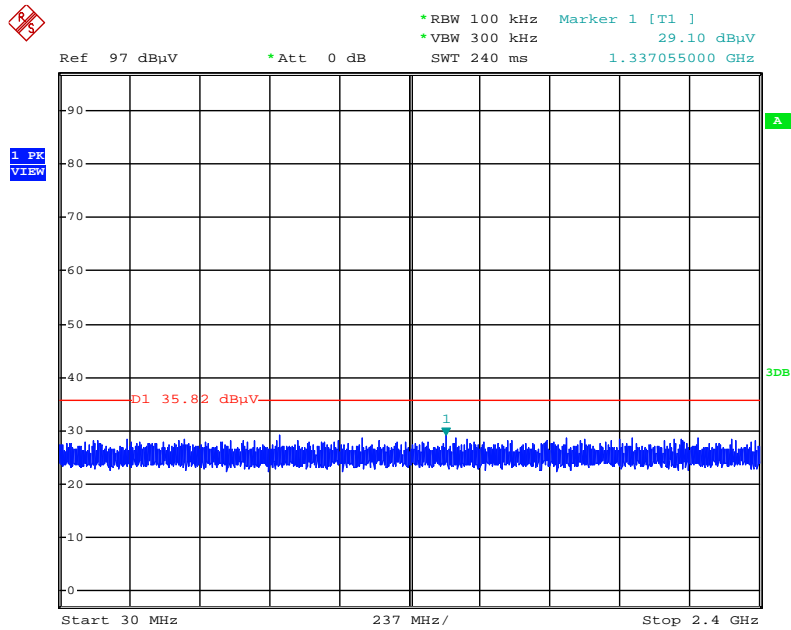

Date: 25.NOV.2016 18:56:48

Plot on Configuration For Bluetooth 4.0 / Channel 39 / 2483.5MHz~26500MHz (down 30dBc)

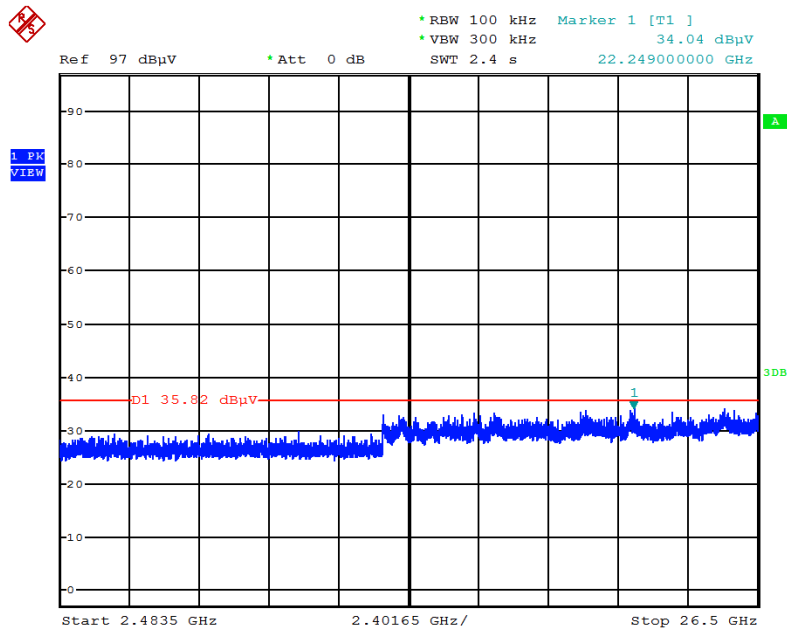

Date: 25.NOV.2016 18:56:21

4.4. Antenna Requirements

4.4.1. Limit

Except for special regulations, the Low-power Radio-frequency Devices must not be equipped with any jacket for installing an antenna with extension cable. An intentional radiator shall be designed to ensure that no antenna other than that furnished by the responsible party shall be used with the device. The use of a permanently attached antenna or of an antenna that uses a unique coupling to the intentional radiator shall be considered sufficient to comply with the provisions of this Section. The manufacturer may design the unit so that the user can replace a broken antenna, but the use of a standard antenna jack or electrical connector is prohibited. Further, this requirement does not apply to intentional radiators that must be professionally installed.

4.4.2. Antenna Connector Construction

Please refer to section 3.3 in this test report; antenna connector complied with the requirements.

5. LIST OF MEASURING EQUIPMENTS

Instrument	Manufacturer	Model No.	Serial No.	Characteristics	Calibration Date	Remark
EMI Receiver	Agilent	N9038A	My52260123	9kHz ~ 8.45GHz	Jan. 27, 2016	Conduction (CO01-CB)
LISN	F.C.C.	FCC-LISN-50-16-2	04083	150kHz ~ 100MHz	Dec. 08, 2015	Conduction (CO01-CB)
LISN	Schwarzbeck	NSLK 8127	8127647	9kHz ~ 30MHz	Dec. 23, 2015	Conduction (CO01-CB)
COND Cable	Woken	Cable	01	150kHz ~ 30MHz	May 24, 2016	Conduction (CO01-CB)
Software	Audix	E3	6.120210n	-	N.C.R.	Conduction (CO01-CB)
BILOG ANTENNA with 6dB Attenuator	TESEQ & EMCI	CBL6112D & N-6-06	37880 & AT-N0609	20MHz ~ 2GHz	Aug. 30, 2016	Radiation (03CH01-CB)
Loop Antenna	Teseq	HLA 6120	24155	9kHz - 30 MHz	Mar. 16, 2016*	Radiation (03CH01-CB)
Horn Antenna	EMCO	3115	00075790	750MHz ~ 18GHz	Nov. 10, 2016	Radiation (03CH01-CB)
Horn Antenna	Schwarzbeck	BBHA 9170	BBHA9170252	15GHz ~ 40GHz	Jul. 25, 2016	Radiation (03CH01-CB)
Pre-Amplifier	Agilent	8447D	2944A10991	0.1MHz ~ 1.3GHz	Mar. 15, 2016	Radiation (03CH01-CB)
Pre-Amplifier	Agilent	8449B	3008A02310	1GHz ~ 26.5GHz	Jan. 18, 2016	Radiation (03CH01-CB)
Pre-Amplifier	MITEQ	TTA1840-35-HG	1864479	18GHz ~ 40GHz	Jun. 28, 2016	Radiation (03CH01-CB)
Spectrum Analyzer	R&S	FSP40	100056	9kHz ~ 40GHz	Nov. 21, 2016	Radiation (03CH01-CB)
EMI Test	R&S	ESCS	100355	9kHz ~ 2.75GHz	May 16, 2016	Radiation (03CH01-CB)
RF Cable-low	Woken	Low Cable-1	N/A	30 MHz ~ 1 GHz	Oct. 24, 2016	Radiation (03CH01-CB)
RF Cable-high	Woken	High Cable-16	N/A	1 GHz ~ 18 GHz	Oct. 24, 2016	Radiation (03CH01-CB)
RF Cable-high	Woken	High Cable-17	N/A	1 GHz ~ 18 GHz	Oct. 24, 2016	Radiation (03CH01-CB)
RF Cable-high	Woken	High Cable-40G-1	N/A	18GHz ~ 40 GHz	Oct. 24, 2016	Radiation (03CH01-CB)
RF Cable-high	Woken	High Cable-40G-2	N/A	18GHz ~ 40 GHz	Oct. 24, 2016	Radiation (03CH01-CB)
Test Software	Audix	E3	6.2009-10-7	N/A	N/A	Radiation (03CH01-CB)

Note: Calibration Interval of instruments listed above is one year.

N.C.R. means Non-Calibration required.

*Calibration Interval of instruments listed above is two year.

6. MEASUREMENT UNCERTAINTY

Test Items	Uncertainty	Remark
Conducted Emission (150kHz ~ 30MHz)	3.2 dB	Confidence levels of 95%
Radiated Emission (30MHz ~ 1,000MHz)	3.6 dB	Confidence levels of 95%
Radiated Emission (1GHz ~ 18GHz)	3.7 dB	Confidence levels of 95%
Radiated Emission (18GHz ~ 40GHz)	3.5 dB	Confidence levels of 95%