



SAR Test Report

Product Name : 802.11b/g/n RTL8723AS combo module
Model No. : RTL8723AS
FCC ID : TX2-RTL8723AS

Applicant : Realtek Semiconductor Corp
Address : No. 2, Innovation Road II, Hsinchu Science Park,
Hsinchu 300, Taiwan

Date of Receipt : 27/02/2013
Date of Test : 06/03/2013
Issued Date : 27/03/2013
Report No. : 132S037R-HP-US-P03V01
Report Version : V2.0

The test results relate only to the samples tested.

The test report shall not be reproduced except in full without the written approval of Quietek Corporation.

Test Report Certification

Issued Date: 27/03/2013

Report No.: 132S037R-HP-US-P03V01



Product Name : 802.11b/g/n RTL8723AS combo module

Applicant : Realtek Semiconductor Corp

Address : No. 2, Innovation Road II, Hsinchu Science Park, Hsinchu 300,
Taiwan

Manufacturer : Realtek Semiconductor Corp

Address : No. 2, Innovation Road II, Hsinchu Science Park, Hsinchu 300,
Taiwan

Model No. : RTL8723AS

Trade Name : Realtek

EUT Voltage : AC 100-240V / 50-60Hz

Applicable Standard : FCC OET65 Supplement C June 2001
IEEE Std. 1528-2003; 47CFR § 2.1093

Test Result : Max. SAR Measurement (1g)
802.11b: 0.893W/kg

Performed Location : Suzhou EMC Laboratory
No.99 Hongye Rd., Suzhou Industrial Park Loufeng Hi-Tech
Development Zone., Suzhou, China
TEL: +86-512-6251-5088 / FAX: +86-512-6251-5098
FCC Registration Number: 800392

Documented By : Alice Ni
(Alice Ni)

Tested By : Sunny Sun
(Sunny Sun)

Approved By : Robin Wu
(Robin Wu)

Laboratory Information

We, **Quietek Corporation**, are an independent EMC and safety consultancy that was established the whole facility in our laboratories. The test facility has been accredited/accepted(audited or listed) by the following related bodies in compliance with ISO 17025, EN 45001 and specified testing scope:

Taiwan R.O.C.	:	BSMI, NCC, TAF
Germany	:	TUV Rheinland
Norway	:	Nemko, DNV
USA	:	FCC, NVLAP
Japan	:	VCCI
China	:	CNAS

The related certificate for our laboratories about the test site and management system can be downloaded from Quietek Corporation's Web Site :<http://www.quietek.com/tw/ctg/cts/accreditations.htm>

The address and introduction of Quietek Corporation's laboratories can be founded in our Web site :
<http://www.quietek.com/>

If you have any comments, Please don't hesitate to contact us. Our contact information is as below:

HsinChu Testing Laboratory :

No.75-2, 3rd Lin, Wangye Keng, Yonghxing Tsuen, Qionglin Shiang, Hsinchu County 307, Taiwan, R.O.C.
TEL:+886-3-592-8858 / FAX:+886-3-592-8859 E-Mail : service@quietek.com

LinKou Testing Laboratory :

No.5-22, Ruishukeng, Linkou Dist., New Taipei City 24451, Taiwan, R.O.C.
TEL : 886-2-8601-3788 / FAX : 886-2-8601-3789 E-Mail : service@quietek.com

Suzhou Testing Laboratory :

No.99 Hongye Rd., Suzhou Industrial Park Loufeng Hi-Tech Development Zone., SuZhou, China
TEL : +86-512-6251-5088 / FAX : 86-512-6251-5098 E-Mail : service@quietek.com

TABLE OF CONTENTS

Description	Page
1. General Information	6
1.1. EUT Description	6
1.2. Test Environment.....	8
1.3. EUT Antenna Locations.....	8
1.4. Simultaneous Transmission Configurations.....	9
1.5. SAR Test Exclusions Applied.....	9
1.6. Power Reduction for SAR.....	9
1.7. Guidance Documents.....	9
2. SAR Measurement System	10
2.1. DASY5 System Description.....	10
2.1.1. Applications	11
2.1.2. Area Scans	11
2.1.3. Zoom Scan (Cube Scan Averaging)	11
2.1.4. Uncertainty of Inter-/Extrapolation and Averaging	11
2.2. DASY5 E-Field Probe.....	12
2.2.1. Isotropic E-Field Probe Specification	12
2.3. Boundary Detection Unit and Probe Mounting Device	13
2.4. DATA Acquisition Electronics (DAE) and Measurement Server.....	13
2.5. Robot.....	14
2.6. Light Beam Unit.....	14
2.7. Device Holder.....	15
2.8. SAM Twin Phantom.....	15
3. Tissue Simulating Liquid	16
3.1. The composition of the tissue simulating liquid	16
3.2. Tissue Calibration Result.....	16
3.3. Tissue Dielectric Parameters for Head and Body Phantoms.....	17
4. SAR Measurement Procedure	18
4.1. SAR System Validation.....	18
4.1.1. Validation Dipoles	18
4.1.2. Validation Result.....	18
4.2. SAR Measurement Procedure.....	19
4.2.1. SAR Testing for Tablet per KDB Publication 616217 D04v01	19

5. SAR Exposure Limits	20
6. Test Equipment List.....	21
7. Measurement Uncertainty.....	23
8. Conducted Power Measurement	24
9. Test Results.....	25
9.1. SAR Test Results Summary	25
9.2. SAR Test Notes	26
9.3. Simultaneous Transmission Procedures	26
Appendix A. SAR System Validation Data	28
Appendix B. SAR measurement Data	29
Appendix D. Probe Calibration Data	44
Appendix E. Dipole Calibration Data.....	55
Appendix F. DAE Calibration Data.....	63

1. General Information

1.1. EUT Description

Product Name	802.11b/g/n RTL8723AS combo module
Model No.	RTL8723AS
FCC ID	TX2-RTL8723AS
Frequency Range	802.11b/g/n(20MHz): 2412 - 2462 MHz 802.11n(40MHz): 2422-2452MHz
Channel Number	802.11b/g/n(20MHz): 11 802.11n(40MHz):7
Type of Modulation	802.11b: DSSS 802.11b/n: OFDM
Data Rate	802.11b: 1/2/5.5/11 Mbps 802.11g: 6/9/12/18/24/36/48/54 Mbps 802.11n: up to 135 Mbps
Device Category	Mobile
RF Exposure Environment	Uncontrolled
Antenna Type	PIFA
Peak Antenna Gain	Reference for list
Max. Output Power (Average)	802.11b: 15.06dBm 802.11g: 14.42dBm 802.11n(20MHz): 14.29dBm 802.11n(40MHz): 11.91dBm

Antenna List

Antenna	Manufacturer	M/N	Antenna Gain(dBi)
Main Antenna(Black)	Luxshare	L01RF025-NB-R	1.42 for 2.4GHz
Aux Antenna(White)	Luxshare	L01RF026-NB-R	0.16 for 2.4GHz
Main Antenna(Black)	Amphenol	LX4073-15-000-C	-1.5 for 2.4GHz
Aux Antenna(White)	Amphenol	LX4074-15-000-C	0.2 for 2.4GHz

Note: "L01RF025-NB-R" antenna was chosen to test.

Tested System Details

Product	Manufacturer	Model No.
Notebook computer	lenovo	1) Lenovo IdeaPad Yoga 11Sxxxxxx (x=0-9, a-z, A-Z, - or Blank) 2) 20246xxxxxx (x=0-9, a-z, A-Z, - or Blank) 3) 80ABxxxxxx (x=0-9, a-z, A-Z, - or Blank)

Channel List

802.11b/g/n(20MHz) Working Frequency of Each Channel:							
Channel	Frequency	Channel	Frequency	Channel	Frequency	Channel	Frequency
01	2412 MHz	02	2417 MHz	03	2422 MHz	04	2427 MHz
05	2432 MHz	06	2437 MHz	07	2442 MHz	08	2447 MHz
09	2452 MHz	10	2457 MHz	11	2462 MHz	N/A	N/A

802.11 n(40MHz) Working Frequency of Each Channel:							
Channel	Frequency	Channel	Frequency	Channel	Frequency	Channel	Frequency
03	2422 MHz	04	2427 MHz	05	2432 MHz	06	2437 MHz
07	2442 MHz	08	2447 MHz	09	2452 MHz	N/A	N/A

1.2. Test Environment

Ambient conditions in the laboratory:

Items	Required	Actual
Temperature (°C)	18-25	21.5± 2
Humidity (%RH)	30-70	52

1.3. EUT Antenna Locations

Bottom of Tablet

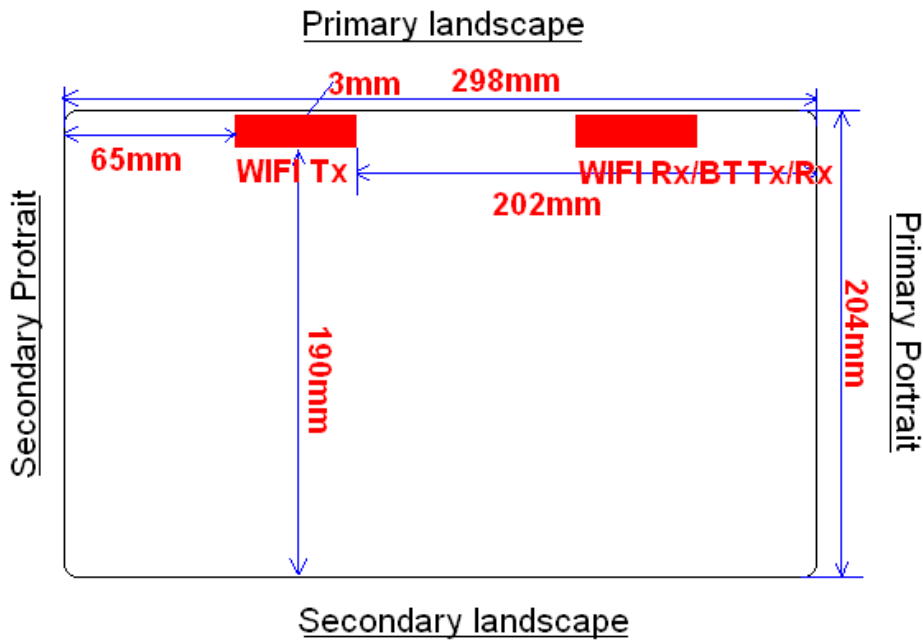

<p>Antenna-to-user separation distances:</p>	<p>WiFi Antenna</p> <p>Tablet-Bottom face: 3mm from WiFi Antenna-to-user</p> <p>Tablet-Edges with the following configurations</p> <ul style="list-style-type: none"> ● Primary landscape: 4mm from WiFi Antenna-to-user ● Secondary landscape: 190mm from WiFi Antenna-to-user ● Primary portrait: 202mm from WiFi Antenna-to-user ● Secondary portrait: 65mm from WiFi Antenna-to-user
--	---

1.4. Simultaneous Transmission Configurations

According to FCC KDB Publication 447498 D01v05, transmitters are considered to be transmitting simultaneously when there is overlapping transmission, with the exception of transmissions during network hand-offs with maximum hand-off duration less than 30 seconds. This device contains multiple transmitters that may operate simultaneously, and therefore requires a simultaneously transmission analysis according to FCC KDB Publication 447498 D01v05 procedures.

Table 1-1
Simultaneous Transmission Scenarios

No.	Simultaneous Transmit Configurations	Body	Note
		FCC KDB 616217	
1	2.4GHz WIFI + 2.4GHz Bluetooth	Yes	

1.5. SAR Test Exclusions Applied

(A) WIFI/Bluetooth

The device supports 20MHz and 40MHz Bandwidths for IEEE 802.11n. 802.11g/n was not evaluated for SAR since the average output power was not more than 0.25dB higher than the average output power of 802.11b.

Per FCC KDB 447498 D01v05, the SAR exclusion threshold for distances<50mm is defined by the following equation:

$$\frac{\text{Max Power of Channel (mW)}}{\text{Test Separation Dist (mm)}} * \sqrt{\text{Frequency(GHz)}} \leq 3.0$$

Based on the maximum conducted power of Bluetooth and the antenna to use separation distance, Bluetooth SAR was not required; [(4.571mW/3)* √2.441]=2.45<3.0.

1.6. Power Reduction for SAR

There is no power reduction used for any band/mode implemented in this device for SAR purposes.

1.7. Guidance Documents

- 1) FCC KDB Publication 248227 D01v01r02 (SAR Considerations for 802.11 Devices)
- 2) FCC KDB Publication 447498 D01v05(General SAR Guidance)
- 3) FCC KDB Publication 865664 D01v01(SAR measurement 100 MHz to 6 GHz)
- 4) FCC KDB Publication 616217 D04v01 (SAR for Laptop and Tablets)

2. SAR Measurement System

2.1. DASY5 System Description

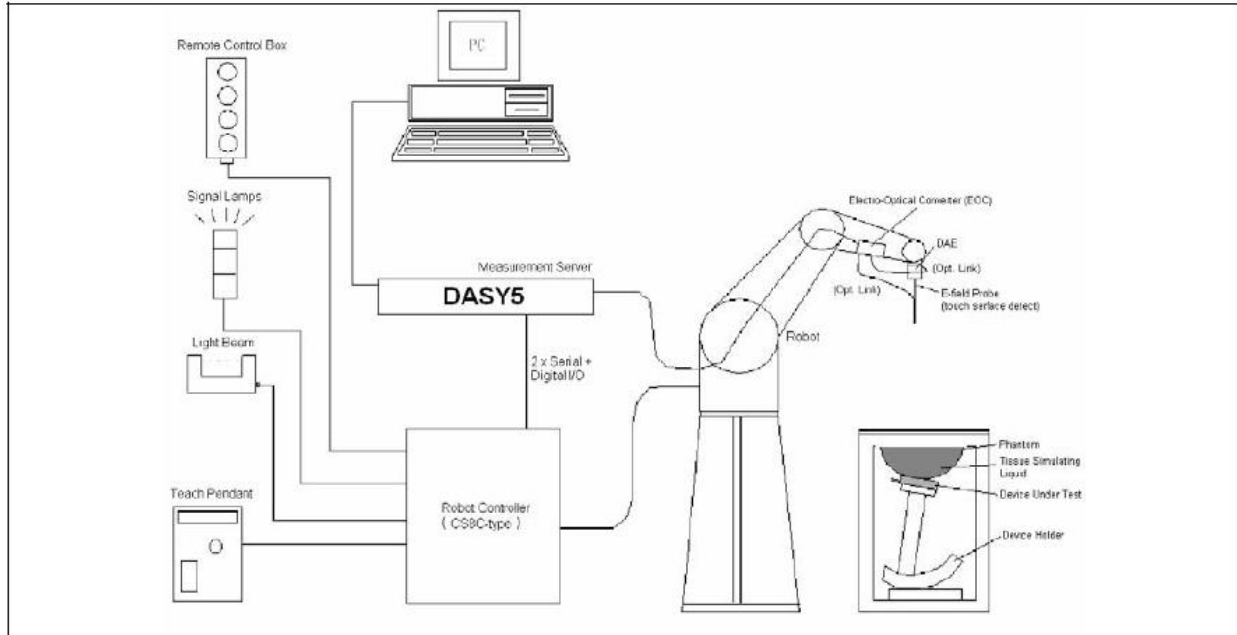

The DASY5 system for performing compliance tests consists of the following items:

- A standard high precision 6-axis robot with controller, teach pendant and software. An arm extension for accommodating the data acquisition electronics (DAE).
- A data acquisition electronics (DAE) which performs the signal amplification, signal multiplexing, AD-conversion, offset measurements, mechanical surface detection, collision detection, etc. The unit is battery powered with standard or rechargeable batteries. The signal is optically transmitted to the EOC.
- The Electro-optical converter (EOC) performs the conversion from optical to electrical signals for the digital communication to the DAE. To use optical surface detection, a special version of the EOC is required. The EOC signal is transmitted to the measurement server.
- The Light Beam used is for probe alignment. This improves the (absolute) accuracy of the probe positioning.
- A computer running WinXP and the DASY5 software.
- Remote control and teach pendant as well as additional circuitry for robot safety such as warning lamps, etc.
- The phantom, the device holder and other accessories according to the targeted measurement.

2.1.1. Applications

Predefined procedures and evaluations for automated compliance testing with all worldwide standards, e.g., IEEE 1528, OET 65, IEC 62209-1, IEC 62209-2, EN 50360, EN 50383 and others.

2.1.2. Area Scans

Area scans are defined prior to the measurement process being executed with a user defined variable spacing between each measurement point (integral) allowing low uncertainty measurements to be conducted. Scans defined for FCC applications utilize a 10mm² step integral, with 1mm interpolation used to locate the peak SAR area used for zoom scan assessments.

When an Area Scan has measured all reachable points, it computes the field maxima found in the scanned area, within a range of the global maximum. The range (in dB) is specified in the standards for compliance testing. For example, a 2 dB range is required in IEEE 1528-2003 and IEC 62209 standards, whereby 3 dB is a requirement when compliance is assessed in accordance with the ARIB standard (Japan).

2.1.3. Zoom Scan (Cube Scan Averaging)

Zoom Scans are used to assess the peak spatial SAR values within a cubic averaging volume containing 1 g and 10 g of simulated tissue. A density of 1000 kg/m³ is used to represent the head and body tissue density and not the phantom liquid density, in order to be consistent with the definition of the liquid dielectric properties, i.e. the side length of the 1 g cube is 10mm, with the side length of the 10 g cube 21,5mm.

The zoom scan integer steps can be user defined so as to reduce uncertainty, but normal practice for typical test applications utilize a physical step of 7x7x7 (5mmx5mmx5mm) providing a volume of 30mm in the X & Y axis, and 30mm in the Z axis.

2.1.4. Uncertainty of Inter-/Extrapolation and Averaging

In order to evaluate the uncertainty of the interpolation, extrapolation and averaged SAR calculation algorithms of the Postprocessor, DASY5 allows the generation of measurement grids which are artificially predefined by analytically based test functions. Therefore, the grids of area scans and zoom scans can be filled with uncertainty test data, according to the SAR benchmark functions of IEEE 1528. The three analytical functions shown in equations as below are used to describe the possible range of the expected SAR distributions for the tested handsets. The field gradients are covered by the spatially flat distribution f1, the spatially steep distribution f3 and f2 accounts for H-field cancellation on the phantom/tissue surface.

$$f_1(x, y, z) = Ae^{-\frac{z}{2a}} \cos^2 \left(\frac{\pi \sqrt{x'^2 + y'^2}}{2 \cdot 5a} \right)$$

$$f_2(x, y, z) = Ae^{-\frac{z}{a}} \frac{a^2}{a^2 + x'^2} \left(3 - e^{-\frac{2z}{a}} \right) \cos^2 \left(\frac{\pi y'}{2 \cdot 3a} \right)$$

$$f_3(x, y, z) = A \frac{a^2}{\frac{a^2}{4} + x'^2 + y'^2} \left(e^{-\frac{2z}{a}} + \frac{a^2}{2(a + 2z)^2} \right)$$

2.2. DASYS E-Field Probe

The SAR measurement is conducted with the dosimetric probe manufactured by SPEAG. The probe is specially designed and calibrated for use in liquid with high permittivity. The dosimetric probe has special calibration in liquid at different frequency. SPEAG conducts the probe calibration in compliance with international and national standards (e.g. IEEE 1528, EN 62209-1, IEC 62209, etc.) under ISO 17025. The calibration data are in Appendix D.

2.2.1. Isotropic E-Field Probe Specification

Model	EX3DV4	
Construction	Symmetrical design with triangular core Built-in shielding against static charges PEEK enclosure material (resistant to organic solvents, e.g., DGBE)	
Frequency	10 MHz to 6 GHz Linearity: ± 0.2 dB (30 MHz to 6 GHz)	
Directivity	± 0.3 dB in HSL (rotation around probe axis) ± 0.5 dB in tissue material (rotation normal to probe axis)	
Dynamic Range	10 µW/g to 100 mW/g Linearity: ± 0.2 dB (noise: typically < 1 µW/g)	
Dimensions	Overall length: 330 mm (Tip: 20 mm) Tip diameter: 2.5 mm (Body: 12 mm) Typical distance from probe tip to dipole centers: 1 mm	
Application	High precision dosimetric measurements in any exposure scenario (e.g., very strong gradient fields). Only probe which enables compliance testing for frequencies up to 6 GHz with precision of better 30%.	

2.3. Boundary Detection Unit and Probe Mounting Device

The DASY probes use a precise connector and an additional holder for the probe, consisting of a plastic tube and a flexible silicon ring to center the probe. The connector at the DAE is flexibly mounted and held in the default position with magnets and springs. Two switching systems in the connector mount detect frontal and lateral probe collisions and trigger the necessary software response.

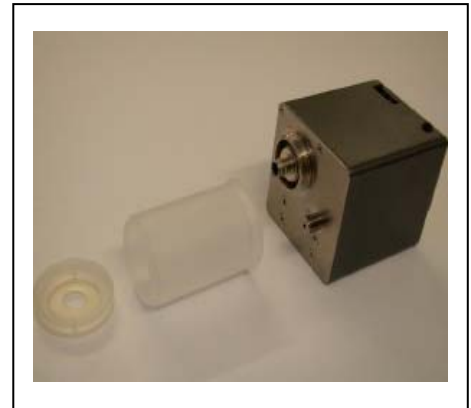

2.4. DATA Acquisition Electronics (DAE) and Measurement Server

The data acquisition electronics (DAE) consists of a highly sensitive electrometer-grade preamplifier with auto-zeroing, a channel and gain-switching multiplexer, a fast 16 bit AD-converter and a command decoder and control logic unit.

Transmission to the measurement server is accomplished through an optical downlink for data and status information as well as an optical uplink for commands and the clock.

The input impedance of the DAE4 is 200M Ohm; the inputs are symmetrical and floating. Common mode rejection is above 80dB.

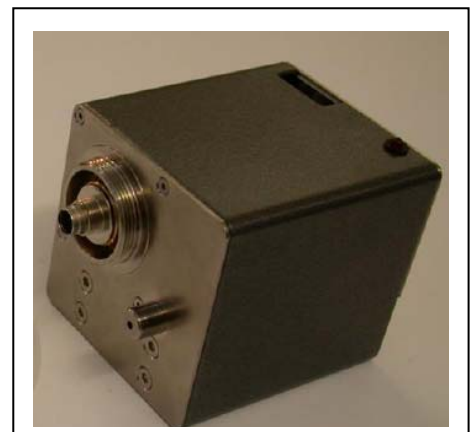

The DASY5 measurement server is based on a PC/104 CPU board with a 400MHz intel ULV Celeron, 128MB chipdisk and 128MB RAM. The necessary circuits for communication with the DAE electronics box, as well as the 16 bit AD converter system for optical detection and digital I/O interface are contained on the DASY5 I/O board, which is directly connected to the PC/104 bus of the CPU board.



2.5. Robot

The DASY5 system uses the high precision robots TX90 XL type out of the newer series from Stäubli SA (France). For the 6-axis controller DASY5 system, the CS8C robot controller version from Stäubli is used.

The XL robot series have many features that are important for our application:

- High precision (repeatability 0.02 mm)
- High reliability (industrial design)
- Jerk-free straight movements
- Low ELF interference (the closed metallic construction shields against motor control fields)
- 6-axis controller



2.6. Light Beam Unit

The light beam switch allows automatic "tooling" of the probe. During the process, the actual position of the probe tip with respect to the robot arm is measured, as well as the probe length and the horizontal probe offset. The software then corrects all movements, such that the robot coordinates are valid for the probe tip.

The repeatability of this process is better than 0.1 mm. If a position has been taught with an aligned probe, the same position will be reached with another aligned probe within 0.1 mm, even if the other probe has different dimensions. During probe rotations, the probe tip will keep its actual position.



2.7. Device Holder

The DASY5 device holder is designed to cope with different positions given in the standard. It has two scales for the device rotation (with respect to the body axis) and the device inclination (with respect to the line between the ear reference points). The rotation center for both scales is the ear reference point (EPR).

Thus the device needs no repositioning when changing the angles.

The DASY5 device holder has been made out of low-loss POM material having the following dielectric parameters: relative permittivity $\epsilon_r = 3$ and loss tangent $\delta = 0.02$. The amount of dielectric material has been reduced in the closest vicinity of the device, since measurements have suggested that the influence of the clamp on the test results could thus be lowered.



2.8. SAM Twin Phantom

The SAM twin phantom is a fiberglass shell phantom with 2mm shell thickness (except the ear region where shell thickness increases to 6mm). It has three measurement areas:

- Left head
- Right head
- Flat phantom



The bottom plate contains three pair of bolts for locking the device holder. The device holder positions are adjusted to the standard measurement positions in the three sections. A white cover is provided to tap the phantom during off-periods to prevent water evaporation and changes in the liquid parameters. On the phantom top, three reference markers are provided to identify the phantom position with respect to the robot.

3. Tissue Simulating Liquid

3.1. The composition of the tissue simulating liquid

INGREDIENT (% Weight)	2450MHz Body
Water	73.2
Salt	0.04
Sugar	0.00
HEC	0.00
Preventol	0.00
DGBE	26.7
Triton X-100	0.00

3.2. Tissue Calibration Result

The dielectric parameters of the liquids were verified prior to the SAR evaluation using DASY5 Dielectric Probe Kit and Agilent Vector Network Analyzer E5071C

Body Tissue Simulant Measurement				
Frequency [MHz]	Description	Dielectric Parameters		Tissue Temp. [°C]
		ϵ_r	σ [s/m]	
2450MHz	Reference result ± 5% window	52.7 50.07 to 55.34	1.95 1.85 to 2.05	N/A
	06-03-2013	52.09	1.99	21.0

3.3. Tissue Dielectric Parameters for Head and Body Phantoms

The head tissue dielectric parameters recommended by the IEEE SCC-34/SC-2 in P1528 have been incorporated in the following table. These head parameters are derived from planar layer models simulating the highest expected SAR for the dielectric properties and tissue thickness variations in a human head. Other head and body tissue parameters that have not been specified in P1528 are derived from the tissue dielectric parameters computed from the 4-Cole-Cole equations described in Reference [12] and extrapolated according to the head parameters specified in P1528.

Target Frequency (MHz)	Head		Body	
	ϵ_r	σ (S/m)	ϵ_r	σ (S/m)
150	52.3	0.76	61.9	0.80
300	45.3	0.87	58.2	0.92
450	43.5	0.87	56.7	0.94
835	41.5	0.90	55.2	0.97
900	41.5	0.97	55.0	1.05
915	41.5	0.98	55.0	1.06
1450	40.5	1.20	54.0	1.30
1610	40.3	1.29	53.8	1.40
1800 – 2000	40.0	1.40	53.3	1.52
2450	39.2	1.80	52.7	1.95
3000	38.5	2.40	52.0	2.73
5800	35.3	5.27	48.2	6.00

(ϵ_r = relative permittivity, σ = conductivity and $\rho = 1000 \text{ kg/m}^3$)

4. SAR Measurement Procedure

4.1. SAR System Verification

4.1.1. Verification Dipoles

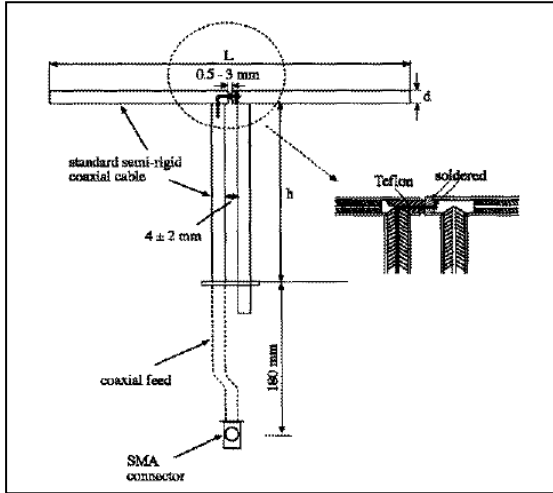

The dipoles used is based on the IEEE-1528 standard, and is complied with mechanical and electrical specifications in line with the requirements of both IEEE and FCC Supplement C. the table below provides details for the mechanical and electrical specifications for the dipoles.

Frequency	L (mm)	h (mm)	d (mm)
2450MHz	53.5	30.4	3.6

4.1.2. Verification Result

System Performance Check at 2450MHz for Body				
Verification Dipole: D2450V2, SN: 839				
Frequency [MHz]	Description	SAR [w/kg] 1g	SAR [w/kg] 10g	Tissue Temp. [°C]
2450 MHz	Reference result ± 10% window	48.7 43.83 to 53.57	22.8 20.52 to 25.08	N/A
	06-03-2013	49.20	22.28	21.0
Note: All SAR values are normalized to 1W forward power.				

4.2. SAR Measurement Procedure

The DASY5 calculates SAR using the following equation,

$$SAR = \frac{\sigma |E|^2}{\rho}$$

σ : represents the simulated tissue conductivity

ρ : represents the tissue density

The EUT is set to transmit at the required power in line with product specification, at each frequency relating to the LOW, MID, and HIGH channel settings.

Pre-scans are made on the device to establish the location for the transmitting antenna, using a large area scan in either air or tissue simulation fluid.

The EUT is placed against the Universal Phantom where the maximum area scan dimensions are larger than the physical size of the resonating antenna. When the scan size is not large enough to cover the peak SAR distribution, it is modified by either extending the area scan size in both the X and Y directions, or the device is shifted within the predefined area.

The area scan is then run to establish the peak SAR location (interpolated resolution set at 1mm²) which is then used to orient the center of the zoom scan. The zoom scan is then executed and the 1g and 10g averages are derived from the zoom scan volume (interpolated resolution set at 1mm³).

4.2.1. SAR Testing for Tablet per KDB Publication 616217 D04v01

Per FCC KDB 616217, the back surface and edges of the tablet should be tested for SAR compliance with the tablet touching the phantom. The SAR Exclusion Threshold in KDB 447498 D01v05 can be applied to determine SAR test exclusion for adjacent edge configurations. The closest distance from the antenna to an adjacent tablet edge is used to determine if SAR testing is required for the adjacent edges, with the adjacent edge positioned against the phantom and the edge containing the antenna positioned perpendicular to the phantom.

Bottom and primary landscape were required to be evaluated for the WLAN Antenna. Front side was not required to be evaluated.

5. SAR Exposure Limits

SAR assessments have been made in line with the requirements of IEEE-1528, FCC Supplement C, and comply with ANSI/IEEE C95.1-1992 “Uncontrolled Environments” limits. These limits apply to a location which is deemed as “Uncontrolled Environment” which can be described as a situation where the general public may be exposed to an RF source with no prior knowledge or control over their exposure.

Limits for General Population/Uncontrolled Exposure (W/kg)

Type Exposure	Uncontrolled Environment Limit
Spatial Peak SAR (1g cube tissue for brain or body)	1.60 W/kg
Spatial Average SAR (whole body)	0.08 W/kg
Spatial Peak SAR (10g for hands, feet, ankles and wrist)	4.00 W/kg

6. Test Equipment List

Instrument	Manufacturer	Model No.	Serial No.	Cali. Due Date
Stäubli Robot TX60L	Stäubli	TX60L	F10/5C90A1/A/01	only once
Controller	Stäubli	SP1	S-0034	only once
Dipole Validation Kits	Speag	D2450V2	839	2014.02.22
SAM Twin Phantom	Speag	SAM	TP-1561/1562	N/A
Device Holder	Speag	SD 000 H01 HA	N/A	N/A
Data Acquisition Electronic	Speag	DAE4	1220	2014.01.23
E-Field Probe	Speag	EX3DV4	3710	2013.03.12
SAR Software	Speag	DASY5	V5.2 Build 162	N/A
Power Amplifier	Mini-Circuit	ZHL-42	D051404-28	N/A
Directional Coupler	Agilent	778D	20160	N/A
Vector Network	Agilent	E5071C	MY48367267	2013.04.10
Signal Generator	Agilent	E4438C	MY49070163	2013.04.18
Power Meter	Anritsu	ML2495A	0905006	2013.11.10
Wide Bandwidth Sensor	Anritsu	MA2411B	0846014	2013.11.10

Note: Per KDB 450824 D02 requirements for dipole calibration, Quietek Lab has adopted two years calibration intervals. On annual basis, every measurement dipole has been evaluated and is in compliance with the following criteria:

1. There is no physical damage on the dipole;
2. System validation with specific dipole is within 10% of calibrated value;
3. Return-loss is within 20% of calibrated measurement (Show below);
4. Impedance is within 5Ω of calibrated measurement (Show below).

Impedance Plot for D2450V2

2450 Body

Calibrated impedance: 52.1 Ω; Measured impedance: 53.4 Ω (within 5Ω)

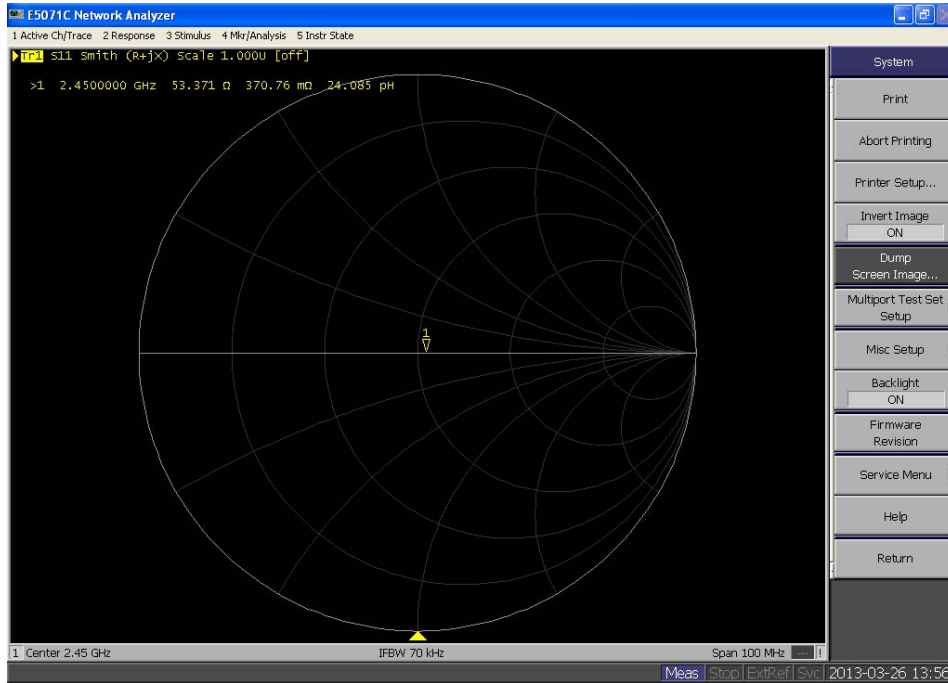

Calibrated return loss: -32.9 dB; Measured impedance: -28.4 dB (within 20%)

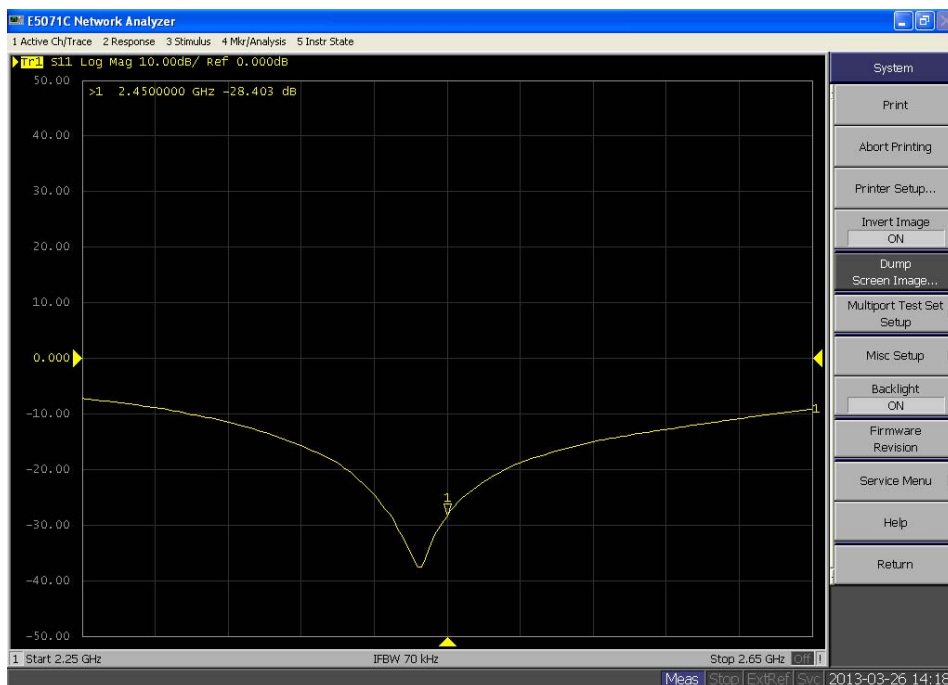

7. Measurement Uncertainty

DASY5 Uncertainty								
Measurement uncertainty for 300 MHz to 3 GHz averaged over 1 gram / 10 gram.								
Error Description	Uncert. value	Prob. Dist.	Div.	(ci) 1g	(ci) 10g	Std. Unc. (1g)	Std. Unc. (10g)	(vi) V _{eff}
Measurement System								
Probe Calibration	±6.0%	N	1	1	1	±6.0%	±6.0%	∞
Axial Isotropy	±4.7%	R	$\sqrt{3}$	0.7	0.7	±1.9%	±1.9%	∞
Hemispherical Isotropy	±9.6%	R	$\sqrt{3}$	0.7	0.7	±3.9%	±3.9%	∞
Boundary Effects	±1.0%	R	$\sqrt{3}$	1	1	±0.6%	±0.6%	∞
Linearity	±4.7%	R	$\sqrt{3}$	1	1	±2.7%	±2.7%	∞
System Detection Limits	±1.0%	R	$\sqrt{3}$	1	1	±0.6%	±0.6%	∞
Readout Electronics	±0.3%	N	1	1	1	±0.3%	±0.3%	∞
Response Time	±0.8%	R	$\sqrt{3}$	1	1	±0.5%	±0.5%	∞
Integration Time	±2.6%	R	$\sqrt{3}$	1	1	±1.5%	±1.5%	∞
RF Ambient Noise	±3.0%	R	$\sqrt{3}$	1	1	±1.7%	±1.7%	∞
RF Ambient Reflections	±3.0%	R	$\sqrt{3}$	1	1	±1.7%	±1.7%	∞
Probe Positioner	±0.4%	R	$\sqrt{3}$	1	1	±0.2%	±0.2%	∞
Probe Positioning	±2.9%	R	$\sqrt{3}$	1	1	±1.7%	±1.7%	∞
Max. SAR Eval.	±1.0%	R	$\sqrt{3}$	1	1	±0.6%	±0.6%	∞
Test Sample Related								
Device Positioning	±2.9%	N	1	1	1	±2.9%	±2.9%	145
Device Holder	±3.6%	N	1	1	1	±3.6%	±3.6%	5
Power Drift	±5.0%	R	$\sqrt{3}$	1	1	±2.9%	±2.9%	∞
Phantom and Setup								
Phantom Uncertainty	±4.0%	R	$\sqrt{3}$	1	1	±2.3%	±2.3%	∞
Liquid Conductivity (target)	±5.0%	R	$\sqrt{3}$	0.64	0.43	±1.8%	±1.2%	∞
Liquid Conductivity (meas.)	±2.5%	N	1	0.64	0.43	±1.6%	±1.1%	∞
Liquid Permittivity (target)	±5.0%	R	$\sqrt{3}$	0.6	0.49	±1.7%	±1.4%	∞
Liquid Permittivity (meas.)	±2.5%	N	1	0.6	0.49	±1.5%	±1.2%	∞
Combined Std. Uncertainty						±10.9%	±10.7%	387
Expanded STD Uncertainty						±21.9%	±21.4%	

8. Conducted Power Measurement

Wi-Fi output power

Test Mode	Channel No.	Frequency (MHz)	Average Power (dBm)	Max. Power (dBm)	Scaling Factor
802.11b	01	2412	14.60	14.60	1.0
	06	2437	14.81	14.81	1.0
	11	2462	15.06	15.06	1.0
802.11g	01	2412	12.50	12.50	1.0
	06	2437	14.42	14.42	1.0
	11	2462	12.43	12.43	1.0
802.11n (20MHz)	01	2412	11.08	11.08	1.0
	06	2437	14.29	14.29	1.0
	11	2462	11.40	11.40	1.0
802.11n (40MHz)	03	2422	11.65	11.65	1.0
	06	2437	11.62	11.62	1.0
	09	2452	11.91	11.91	1.0

9. Test Results

9.1. SAR Test Results Summary

SAR MEASUREMENT									
Ambient Temperature (°C) : 21.5 ±2				Relative Humidity (%): 52					
Liquid Temperature (°C) : 21.0 ±2				Depth of Liquid (cm):>15					
Product: 802.11b/g/n RTL8723AS combo module									
Test Mode: Tablet Mode-802.11b									
Test Position Body at 0mm	Antenna Position	Frequency		Avg. Power (dBm)	Power Drift (<±0.2)	SAR 1g (W/kg)	Scaling Factor	Scaled SAR 1g (W/kg)	Limit (W/kg)
		Channel	MHz						
Bottom of Tablet	Fixed	1	2412	14.60	0.17	0.686	1.0	0.686	1.6
Bottom of Tablet	Fixed	6	2437	14.81	0.08	0.725	1.0	0.725	1.6
Bottom of Tablet	Fixed	11	2462	15.06	0.02	0.862	1.0	0.862	1.6
Primary Landscape	Fixed	11	2462	15.06	-0.08	0.515	1.0	0.515	1.6
Test Mode: Tablet Mode-802.11g									
Bottom of Tablet	Fixed	1	2412	12.50	0.15	0.564	1.0	0.564	1.6
Bottom of Tablet	Fixed	6	2437	14.42	-0.19	0.893	1.0	0.893	1.6
Bottom of Tablet*	Fixed	6	2437	14.42	-0.04	0.846	1.0	0.846	1.6
Bottom of Tablet	Fixed	11	2462	12.43	0.09	0.510	1.0	0.510	1.6
Test Mode: Tablet Mode-802.11n(20MHz)									
Bottom of Tablet	Fixed	1	2412	11.08	-0.07	0.369	1.0	0.369	1.6
Bottom of Tablet	Fixed	6	2437	14.29	0.01	0.811	1.0	0.811	1.6
Bottom of Tablet	Fixed	11	2462	11.40	-0.05	0.447	1.0	0.447	1.6
Test Mode: Tablet Mode-802.11n(40MHz)									
Bottom of Tablet	Fixed	9	2452	11.91	0.07	0.441	1.0	0.441	1.6
Test Mode: Laptop Mode-802.11b									
Bottom of PC	Fixed	11	2462	15.06	0.13	0.589	1.0	0.589	1.6
Note 1: when the 1-g SAR is ≤ 0.8 W/kg, testing for low and high channel is optional, refer to KDB 447498. 2: * - repeated at the highest SAR measurement according to the FCC KDB 865664. Max. SAR Measurement: 0.893w/kg, the repeated SAR Measurement: 0.846w/kg, and the D-value <20% so tested once repeated SAR.									

9.2. SAR Test Notes

General Notes:

1. Batteries are fully charged at the beginning of the SAR measurements.
2. Liquid tissue depth was at least 15.0 cm for all frequencies.
3. The manufacturer has confirmed that the device(s) tested have the same physical, mechanical and thermal characteristics and are within operational tolerances expected for production units
4. SAR results were scaled to the maximum allowed power to demonstrate compliance per FCC KDB Publication 447498 D01v05.
5. Per FCC KDB 616217 D04 Section 4.3, SAR tests are required for the back surface and edges of the tablet with the tablet touching the phantom. The SAR Exclusion Threshold in FCC KDB 447498 D01v05 was applied to determine SAR test exclusion for adjacent edge configurations. SAR tests were required for bottom and primary landscape for the BT/WLAN Antenna.

WLAN/BT Notes:

1. Justification for reduced test configurations for WIFI channels per KDB Publication 248227 D01v01r02 and April 2010 FCC/TCB Meeting Notes for 2.4 GHz WIFI: Highest average RF output power channel for the lowest data rate was selected for SAR evaluation in 802.11b. Other IEEE 802.11 modes (including 802.11g/n) were not investigated since the average output powers over all channels and data rates were not more than 0.25 dB higher than the tested channel in the lowest data rate of IEEE 802.11b mode.
2. WIFI transmission was verified using a spectrum analyzer.
3. When the maximum extrapolated peak SAR of the zoom scan for the maximum output channel is <1.6 W/kg and the reported 1g averaged SAR is <0.8 W/kg, SAR testing on other default channels is not required.

9.3. Simultaneous Transmission Procedures

This device contains transmitters that may operate simultaneously; therefore simultaneous transmission analysis is required. Per FCC KDB 447498 D01v05, simultaneous transmission SAR test exclusion may be applied when the sum of the 1-g SAR for all the simultaneous transmitting antennas in a specific a physical test configuration is ≤1.6 W/kg. When standalone SAR is not required to be measured per FCC KDB 447498 D01v05, the following equation must be used to estimate the standalone 1g SAR for simultaneous transmission assessment involving that transmitter when the test separation distance is less than 50mm; otherwise 0.4 W/kg should be used for 1g SAR.

$$\text{Estimated SAR} = \frac{\sqrt{f(\text{GHz})}}{7.5} * \frac{(\text{Max Power of channel, mW})}{\text{Min. Separation Distance, mm}}$$

Estimated SAR for Bluetooth

Mode	Frequency	Maximum Allowed Power	Separation Distance (Body)	Estimated SAR (Body)
	[MHz]	[dBm]	[mm]	[W/kg]
Bluetooth	2441	6.6	3	0.317

9.3.1. Simultaneous Transmission Analysis

Simultaneous Transmission Scenario for Tablet Mode (Body at 0mm)

Simult Tx	Configuration	WIFI SAR (W/kg)	Bluetooth SAR (W/kg)	Σ SAR (W/kg)
Body	Bottom	0.893	0.317	1.21
	Primary landscape	0.515	0.317	0.832
	Secondary landscape	0.4	0.4	0.8
	Primary portrait	0.4	0.4	0.8
	Secondary portrait	0.4	0.4	0.8

Note: For configurations excluded per 447498 D01v05, an estimated SAR of 0.4 W/kg was used to determine simultaneous transmission SAR exclusion since the test separation distance was >50 mm.

Simultaneous Transmission Scenario for PC Mode (Body at 0mm)

Simult Tx	Configuration	WIFI SAR (W/kg)	Bluetooth SAR (W/kg)	Σ SAR (W/kg)
Body	Bottom	0.589	0.317	0.906

9.3.2. Simultaneous Transmission Conclusion

The above numerical summed SAR results for all the worst-case simultaneous transmission conditions were below the SAR limit. Therefore, the above analysis is sufficient to determine that simultaneous transmission cases will not exceed the SAR limit and therefore no measured volumetric simultaneous SAR summation is required per FCC KDB Publication 447498 D01v05.

Appendix A. SAR System Validation Data

Date/Time: 06-03-2013

Test Laboratory: QuieTek Lab

System Check Body 2450MHz

DUT: Dipole 2450 MHz D2450V2; Type: D2450V2

Communication System: CW; Communication System Band: D2450(2450MHz); Duty Cycle: 1:1; Frequency: 2450 MHz; Medium parameters used: $f = 2450 \text{ MHz}$; $\sigma = 1.99 \text{ mho/m}$; $\epsilon_r = 52.09$; $\rho = 1000 \text{ kg/m}^3$; Phantom section: Flat Section ; Input Power=250mW

Ambient temperature (°C): 21.5, Liquid temperature (°C): 21.0

DASY5 Configuration:

- Probe: EX3DV4 - SN3710; ConvF(6.98, 6.98, 6.98); Calibrated: 12/03/2012;
- Sensor-Surface: 4mm (Mechanical Surface Detection)
- Electronics: DAE4 Sn1220; Calibrated: 24/01/2013
- Phantom: SAM2; Type: SAM; Serial: TP1562
- Measurement SW: DASY52, Version 52.8 (1); SEMCAD X Version 14.6.5 (6469)

Configuration/System Check Body 2450MHz/Area Scan (7x11x1): Measurement grid: dx=10mm, dy=10mm, Maximum value of SAR (measured) = 13.2 mW/g

Configuration/System Check Body 2450MHz/Zoom Scan (7x7x7)/Cube 0: Measurement grid: dx=5mm, dy=5mm, dz=5mm, Reference Value = 81.516 V/m; Power Drift = 0.04 dB

Peak SAR (extrapolated) = 25.881 mW/g

SAR(1 g) = 12.3 mW/g; SAR(10 g) = 5.57 mW/g Maximum value of SAR (measured) = 14.1 mW/g

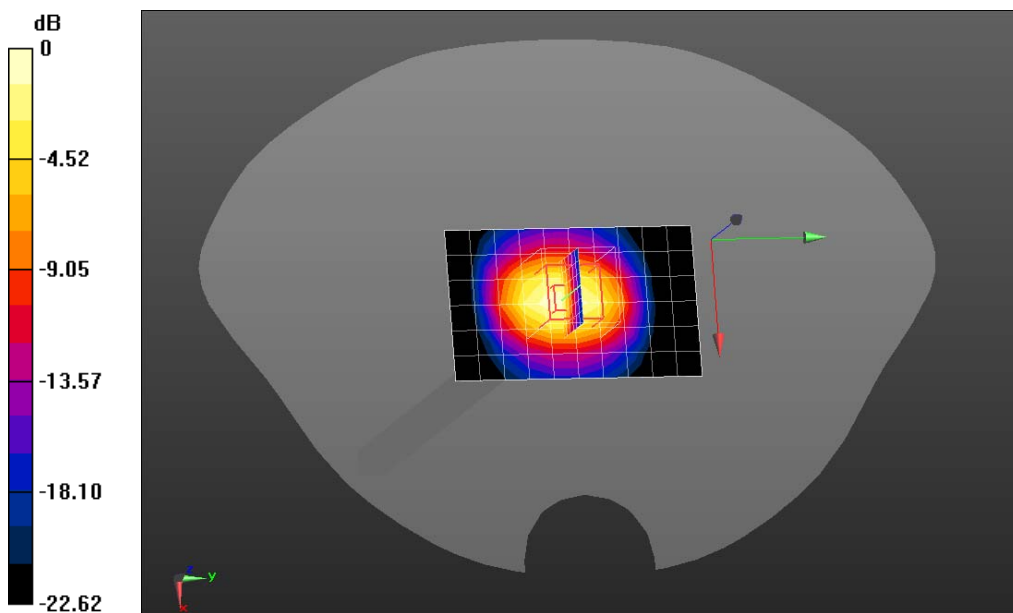

0 dB = 14.1 mW/g = 22.98 dB mW/g

Appendix B. SAR measurement Data

Date/Time: 06-03-2013

Test Laboratory: QuieTek Lab

802.11b 2412MHz-Bottom-Tablet Mode

DUT: 802.11b/g/n RTL8723AS combo module; Type: RTL8723AS

Communication System: Wi-Fi; Communication System Band: 802.11b; Duty Cycle: 1:1; Frequency: 2412 MHz; Medium parameters used: $f = 2412$ MHz; $\sigma = 1.94$ mho/m; $\epsilon_r = 53.49$; $\rho = 1000$ kg/m³; Phantom section: Flat Section

Ambient temperature (°C): 21.5, Liquid temperature (°C): 21.0

DASY5 Configuration:

- Probe: EX3DV4 - SN3710; ConvF(6.98, 6.98, 6.98); Calibrated: 12/03/2012;
- Sensor-Surface: 4mm (Mechanical Surface Detection)
- Electronics: DAE4 Sn1220; Calibrated: 24/01/2013
- Phantom: SAM2; Type: SAM; Serial: TP1562
- Measurement SW: DASY52, Version 52.8 (1); SEMCAD X Version 14.6.5 (6469)

Configuration/802.11b 2412MHz-Bottom/Area Scan (11x14x1): Measurement grid: dx=12mm, dy=12mm

Maximum value of SAR (measured) = 0.823 mW/g

Configuration/802.11b 2412MHz-Bottom/Zoom Scan (5x5x7)/Cube 0: Measurement grid: dx=8mm,

dy=8mm, dz=5mm, Reference Value = 11.195 V/m; Power Drift = 0.17 dB

Peak SAR (extrapolated) = 1.711 mW/g

SAR(1 g) = 0.686 mW/g; SAR(10 g) = 0.282 mW/g Maximum value of SAR (measured) = 0.796 mW/g

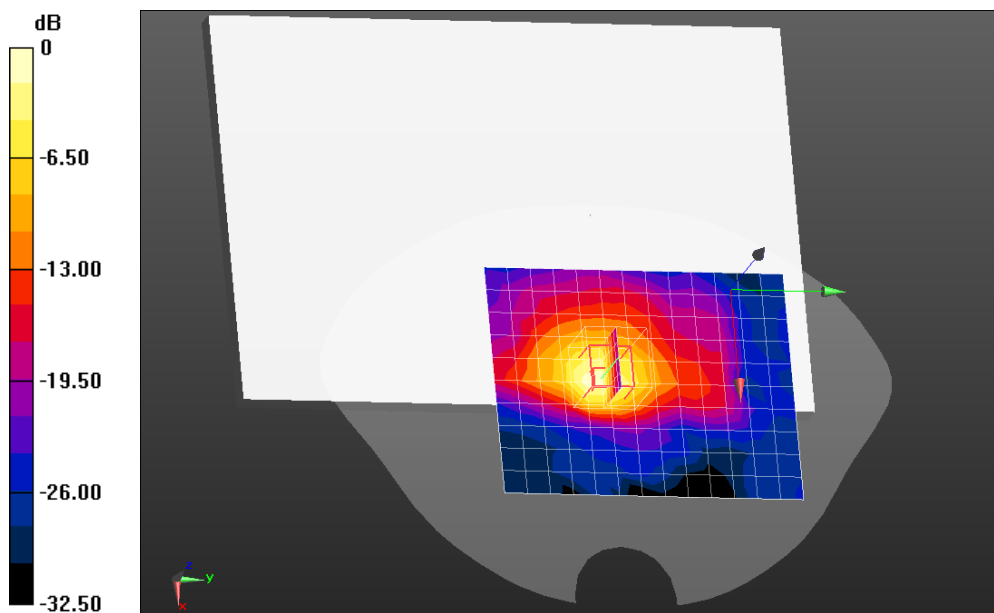

0 dB = 0.796 mW/g = -1.98 dB mW/g

Date/Time: 06-03-2013

Test Laboratory: QuieTek Lab

802.11b 2437MHz-Bottom-Tablet Mode

DUT: 802.11b/g/n RTL8723AS combo module; Type: RTL8723AS

Communication System: Wi-Fi; Communication System Band: 802.11b; Duty Cycle: 1:1; Frequency: 2437 MHz; Medium parameters used: $f = 2437$ MHz; $\sigma = 1.98$ mho/m; $\epsilon_r = 53.3$; $\rho = 1000$ kg/m³; Phantom section: Flat Section

Ambient temperature (°C): 21.5, Liquid temperature (°C): 21.0

DASY5 Configuration:

- Probe: EX3DV4 - SN3710; ConvF(6.98, 6.98, 6.98); Calibrated: 12/03/2012;
- Sensor-Surface: 4mm (Mechanical Surface Detection)
- Electronics: DAE4 Sn1220; Calibrated: 24/01/2013
- Phantom: SAM2; Type: SAM; Serial: TP1562
- Measurement SW: DASY52, Version 52.8 (1); SEMCAD X Version 14.6.5 (6469)

Configuration/802.11b 2437MHz-Bottom/Area Scan (11x14x1): Measurement grid: dx=12mm, dy=12mm

Maximum value of SAR (measured) = 0.850 mW/g

Configuration/802.11b 2437MHz-Bottom/Zoom Scan (5x5x7)/Cube 0: Measurement grid: dx=8mm, dy=8mm, dz=5mm, Reference Value = 15.882 V/m; Power Drift = 0.08 dB

Peak SAR (extrapolated) = 1.776 mW/g

SAR(1 g) = 0.725 mW/g; SAR(10 g) = 0.302 mW/g Maximum value of SAR (measured) = 0.851 mW/g

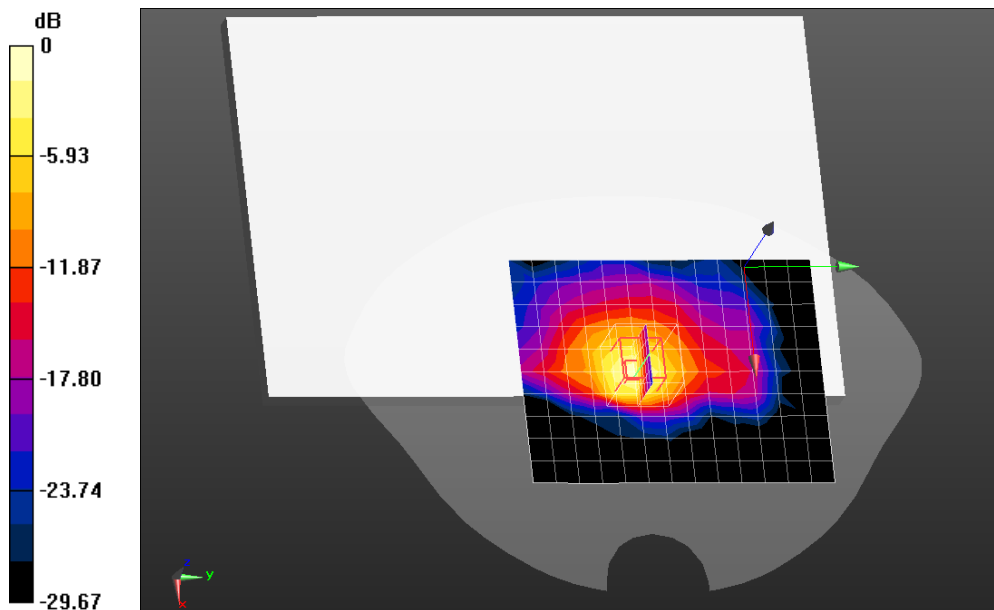

0 dB = 0.851 mW/g = -1.40 dB mW/g

Date/Time: 06-03-2013

Test Laboratory: QuieTek Lab

802.11b 2462MHz-Bottom-Tablet Mode

DUT: 802.11b/g/n RTL8723AS combo module; Type: RTL8723AS

Communication System: Wi-Fi; Communication System Band: 802.11b; Duty Cycle: 1:1; Frequency: 2462 MHz; Medium parameters used: $f = 2462$ MHz; $\sigma = 2$ mho/m; $\epsilon_r = 52.04$; $\rho = 1000$ kg/m³ ; Phantom section: Flat Section

Ambient temperature (°C): 21.5, Liquid temperature (°C): 21.0

DASY5 Configuration:

- Probe: EX3DV4 - SN3710; ConvF(6.98, 6.98, 6.98); Calibrated: 12/03/2012;
- Sensor-Surface: 4mm (Mechanical Surface Detection)
- Electronics: DAE4 Sn1220; Calibrated: 24/01/2013
- Phantom: SAM2; Type: SAM; Serial: TP1562
- Measurement SW: DASY52, Version 52.8 (1); SEMCAD X Version 14.6.5 (6469)

Configuration/802.11b 2462MHz-Bottom/Area Scan (11x14x1): Measurement grid: dx=12mm, dy=12mm

Maximum value of SAR (measured) = 0.875 mW/g

Configuration/802.11b 2462MHz-Bottom/Zoom Scan (5x5x7)/Cube 0: Measurement grid: dx=8mm, dy=8mm, dz=5mm, Reference Value = 17.661 V/m; Power Drift = 0.02 dB

Peak SAR (extrapolated) = 2.166 mW/g

SAR(1 g) = 0.862 mW/g; SAR(10 g) = 0.348 mW/g Maximum value of SAR (measured) = 1.02 mW/g

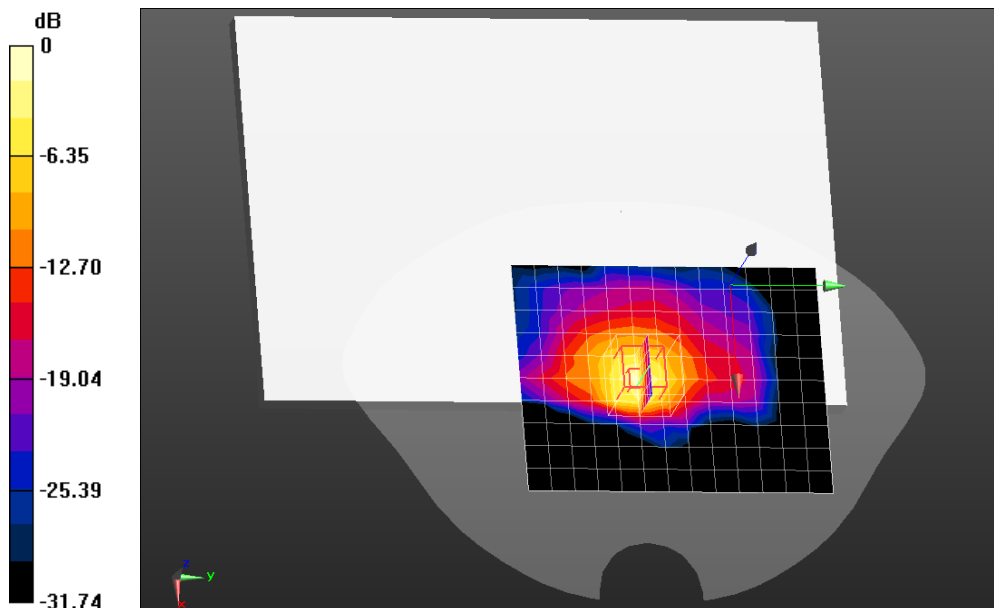

0 dB = 1.02 mW/g = 0.17 dB mW/g

Date/Time: 06-03-2013

Test Laboratory: QuieTek Lab

802.11b 2462MHz- Laptop Primary landscape

DUT: 802.11b/g/n RTL8723AS combo module; Type: RTL8723AS

Communication System: Wi-Fi; Communication System Band: 802.11b; Duty Cycle: 1:1; Frequency: 2462 MHz; Medium parameters used: $f = 2462$ MHz; $\sigma = 2$ mho/m; $\epsilon_r = 52.04$; $\rho = 1000$ kg/m³ ; Phantom section: Flat Section

Ambient temperature (°C): 21.5, Liquid temperature (°C): 21.0

DASY5 Configuration:

- Probe: EX3DV4 - SN3710; ConvF(6.98, 6.98, 6.98); Calibrated: 12/03/2012;
- Sensor-Surface: 4mm (Mechanical Surface Detection)
- Electronics: DAE4 Sn1220; Calibrated: 24/01/2013
- Phantom: SAM2; Type: SAM; Serial: TP1562
- Measurement SW: DASY52, Version 52.8 (1); SEMCAD X Version 14.6.5 (6469)

Configuration/802.11b 2462MHz-Primarylandscape/Area Scan (8x14x1): Measurement grid: dx=12mm, dy=12mm

Maximum value of SAR (measured) = 0.519 mW/g

Configuration/802.11b 2462MHz-Primarylandscape/Zoom Scan (5x5x7)/Cube 0: Measurement grid: dx=8mm, dy=8mm, dz=5mm, Reference Value = 17.001 V/m; Power Drift = -0.08 dB

Peak SAR (extrapolated) = 1.232 mW/g

SAR(1 g) = 0.515 mW/g; SAR(10 g) = 0.218 mW/g Maximum value of SAR (measured) = 0.588 mW/g

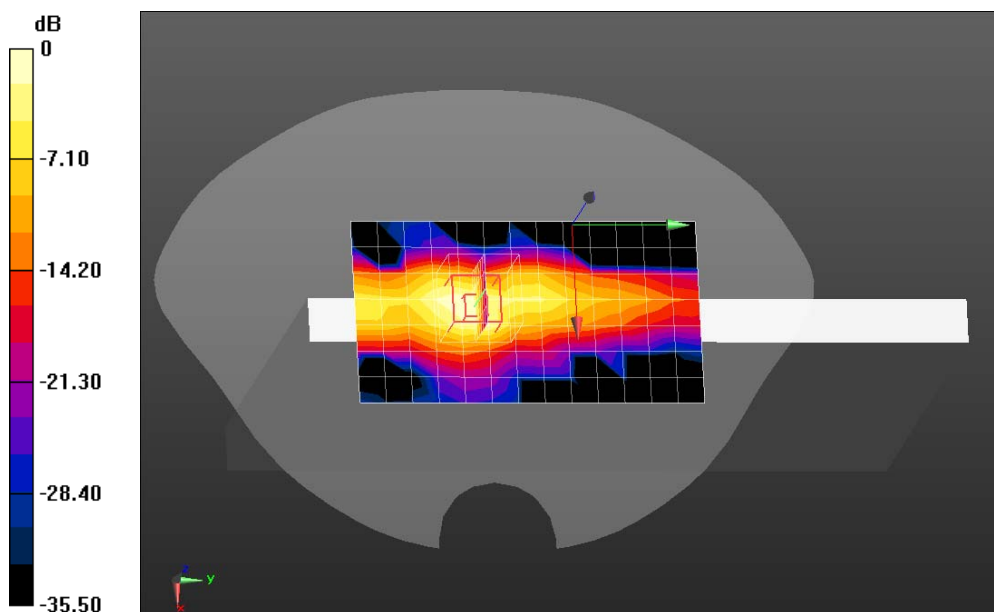

0 dB = 0.588 mW/g = -4.61 dB mW/g

Date/Time: 06-03-2013

Test Laboratory: QuieTek Lab

802.11g 2412MHz-Bottom-Tablet Mode

DUT: 802.11b/g/n RTL8723AS combo module; Type: RTL8723AS

Communication System: Wi-Fi; Communication System Band: 802.11g; Duty Cycle: 1:1; Frequency: 2412 MHz; Medium parameters used: $f = 2412$ MHz; $\sigma = 1.94$ mho/m; $\epsilon_r = 53.49$; $\rho = 1000$ kg/m³; Phantom section: Flat Section

Ambient temperature (°C): 21.5, Liquid temperature (°C): 21.0

DASY5 Configuration:

- Probe: EX3DV4 - SN3710; ConvF(6.98, 6.98, 6.98); Calibrated: 12/03/2012;
- Sensor-Surface: 4mm (Mechanical Surface Detection)
- Electronics: DAE4 Sn1220; Calibrated: 24/01/2013
- Phantom: SAM2; Type: SAM; Serial: TP1562
- Measurement SW: DASY52, Version 52.8 (1); SEMCAD X Version 14.6.5 (6469)

Configuration/802.11g 2412MHz-Bottom/Area Scan (11x14x1): Measurement grid: dx=12mm, dy=12mm

Maximum value of SAR (measured) = 0.534 mW/g

Configuration/802.11g 2412MHz-Bottom/Zoom Scan (5x5x7)/Cube 0: Measurement grid: dx=8mm, dy=8mm, dz=5mm, Reference Value = 17.255 V/m; Power Drift = 0.15 dB

Peak SAR (extrapolated) = 1.422 mW/g

SAR(1 g) = 0.564 mW/g; SAR(10 g) = 0.224 mW/g Maximum value of SAR (measured) = 0.680 mW/g

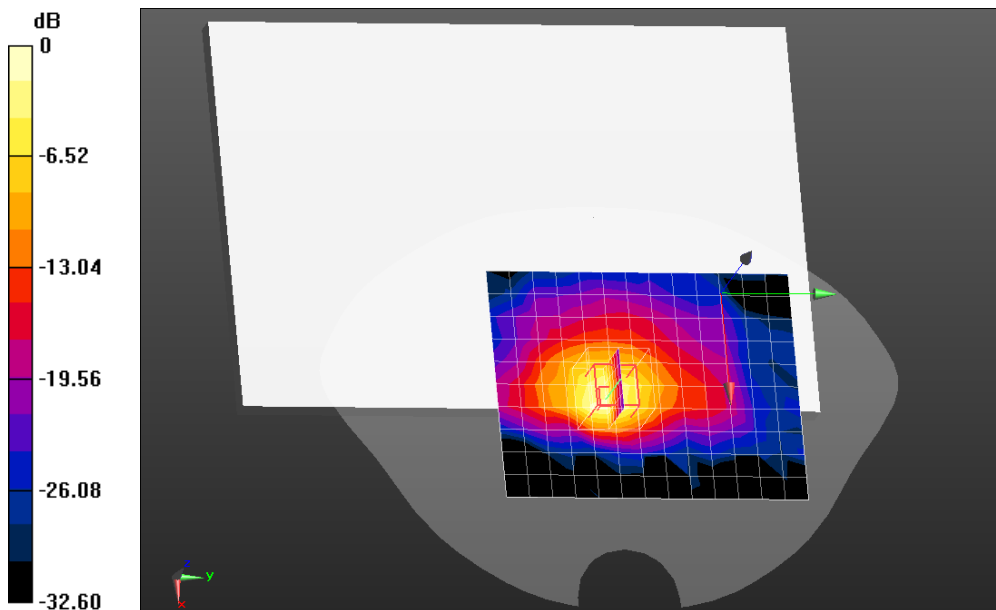

0 dB = 0.680 mW/g = -3.35 dB mW/g

Date/Time: 06-03-2013

Test Laboratory: QuieTek Lab

802.11g 2437MHz-Bottom-Tablet Mode

DUT: 802.11b/g/n RTL8723AS combo module; Type: RTL8723AS

Communication System: Wi-Fi; Communication System Band: 802.11g; Duty Cycle: 1:1; Frequency: 2437 MHz; Medium parameters used: $f = 2437$ MHz; $\sigma = 1.98$ mho/m; $\epsilon_r = 53.3$; $\rho = 1000$ kg/m³; Phantom section: Flat Section

Ambient temperature (°C): 21.5, Liquid temperature (°C): 21.0

DASY5 Configuration:

- Probe: EX3DV4 - SN3710; ConvF(6.98, 6.98, 6.98); Calibrated: 12/03/2012;
- Sensor-Surface: 4mm (Mechanical Surface Detection)
- Electronics: DAE4 Sn1220; Calibrated: 24/01/2013
- Phantom: SAM2; Type: SAM; Serial: TP1562
- Measurement SW: DASY52, Version 52.8 (1); SEMCAD X Version 14.6.5 (6469)

Configuration/802.11g 2437MHz-Bottom/Area Scan (11x14x1): Measurement grid: dx=12mm, dy=12mm

Maximum value of SAR (measured) = 0.809 mW/g

Configuration/802.11g 2437MHz-Bottom/Zoom Scan (5x5x7)/Cube 0: Measurement grid: dx=8mm, dy=8mm, dz=5mm, Reference Value = 18.056 V/m; Power Drift = -0.19 dB

Peak SAR (extrapolated) = 2.271 mW/g

SAR(1 g) = 0.893 mW/g; SAR(10 g) = 0.361 mW/g Maximum value of SAR (measured) = 1.03 mW/g

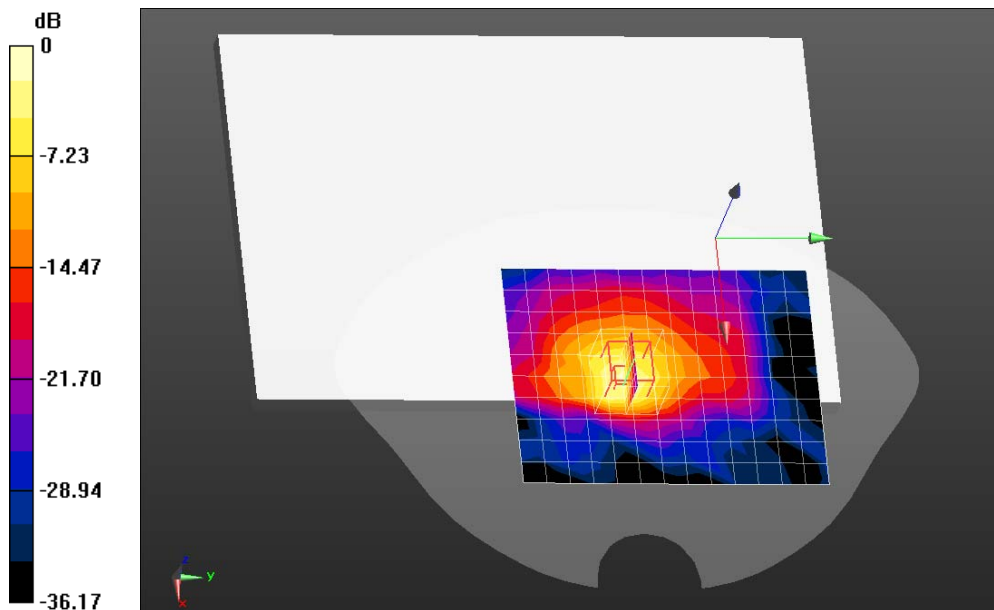

0 dB = 1.03 mW/g = 0.26 dB mW/g

Z-Axis Plot

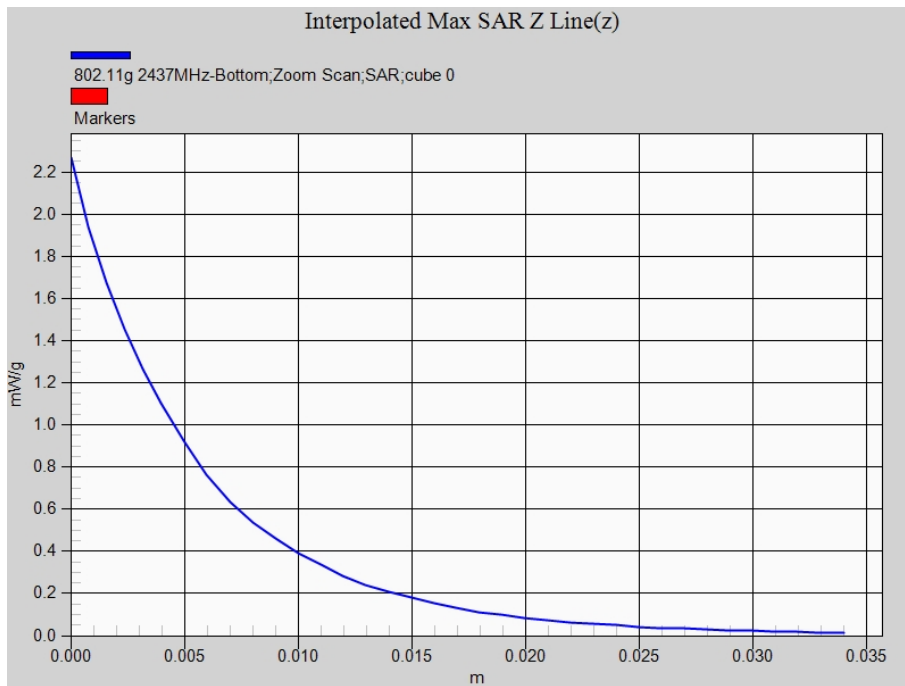

Date/Time: 06-03-2013

Test Laboratory: QuieTek Lab

802.11g 2437MHz-Bottom-Tablet Mode-1

DUT: 802.11b/g/n RTL8723AS combo module; Type: RTL8723AS

Communication System: Wi-Fi; Communication System Band: 802.11g; Duty Cycle: 1:1; Frequency: 2437 MHz; Medium parameters used: $f = 2437$ MHz; $\sigma = 1.98$ mho/m; $\epsilon_r = 53.3$; $\rho = 1000$ kg/m³; Phantom section: Flat Section

Ambient temperature (°C): 21.5, Liquid temperature (°C): 21.0

DASY5 Configuration:

- Probe: EX3DV4 - SN3710; ConvF(6.98, 6.98, 6.98); Calibrated: 12/03/2012;
- Sensor-Surface: 4mm (Mechanical Surface Detection)
- Electronics: DAE4 Sn1220; Calibrated: 24/01/2013
- Phantom: SAM2; Type: SAM; Serial: TP1562
- Measurement SW: DASY52, Version 52.8 (1); SEMCAD X Version 14.6.5 (6469)

Configuration/802.11g 2437MHz-Bottom/Area Scan (11x14x1): Measurement grid: dx=12mm, dy=12mm

Maximum value of SAR (measured) = 0.972 mW/g

Configuration/802.11g 2437MHz-Bottom/Zoom Scan (5x5x7)/Cube 0: Measurement grid: dx=8mm, dy=8mm, dz=5mm, Reference Value = 15.285 V/m; Power Drift = -0.04 dB

Peak SAR (extrapolated) = 2.221 mW/g

SAR(1 g) = 0.846 mW/g; SAR(10 g) = 0.340 mW/g Maximum value of SAR (measured) = 0.939 mW/g

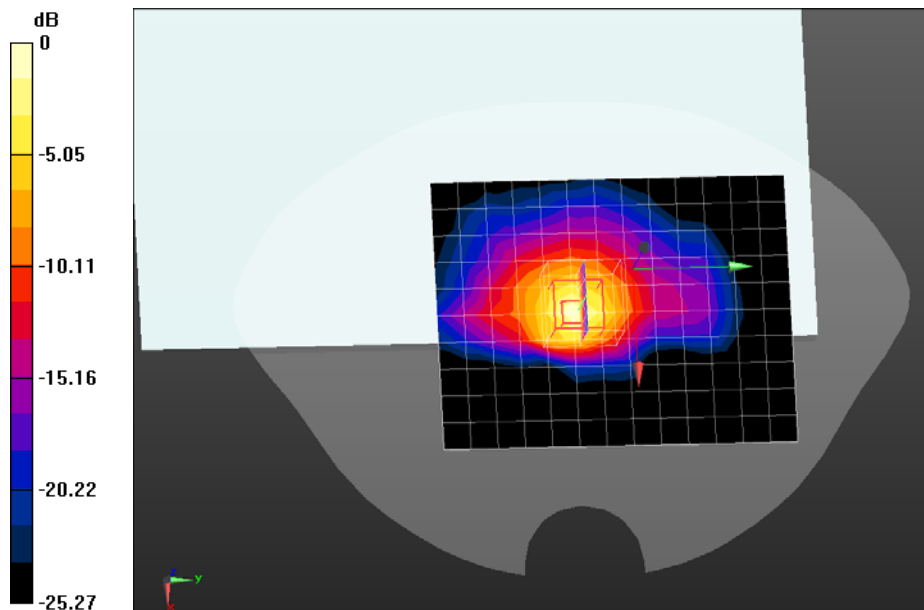

0 dB = 0.939 mW/g = -0.55 dB mW/g

Date/Time: 06-03-2013

Test Laboratory: QuieTek Lab

802.11g 2462MHz-Bottom-Tablet Mode

DUT: 802.11b/g/n RTL8723AS combo module; Type: RTL8723AS

Communication System: Wi-Fi; Communication System Band: 802.11g; Duty Cycle: 1:1; Frequency: 2462 MHz; Medium parameters used: $f = 2462$ MHz; $\sigma = 2$ mho/m; $\epsilon_r = 52.04$; $\rho = 1000$ kg/m³ ; Phantom section: Flat Section

Ambient temperature (°C): 21.5, Liquid temperature (°C): 21.0

DASY5 Configuration:

- Probe: EX3DV4 - SN3710; ConvF(6.98, 6.98, 6.98); Calibrated: 12/03/2012;
- Sensor-Surface: 4mm (Mechanical Surface Detection)
- Electronics: DAE4 Sn1220; Calibrated: 24/01/2013
- Phantom: SAM2; Type: SAM; Serial: TP1562
- Measurement SW: DASY52, Version 52.8 (1); SEMCAD X Version 14.6.5 (6469)

Configuration/802.11g 2462MHz-Bottom/Area Scan (11x14x1): Measurement grid: dx=12mm, dy=12mm

Maximum value of SAR (measured) = 0.466 mW/g

Configuration/802.11g 2462MHz-Bottom/Zoom Scan (5x5x7)/Cube 0: Measurement grid: dx=8mm, dy=8mm, dz=5mm, Reference Value = 17.221 V/m; Power Drift = 0.09 dB

Peak SAR (extrapolated) = 1.295 mW/g

SAR(1 g) = 0.510 mW/g; SAR(10 g) = 0.203 mW/g Maximum value of SAR (measured) = 0.612 mW/g

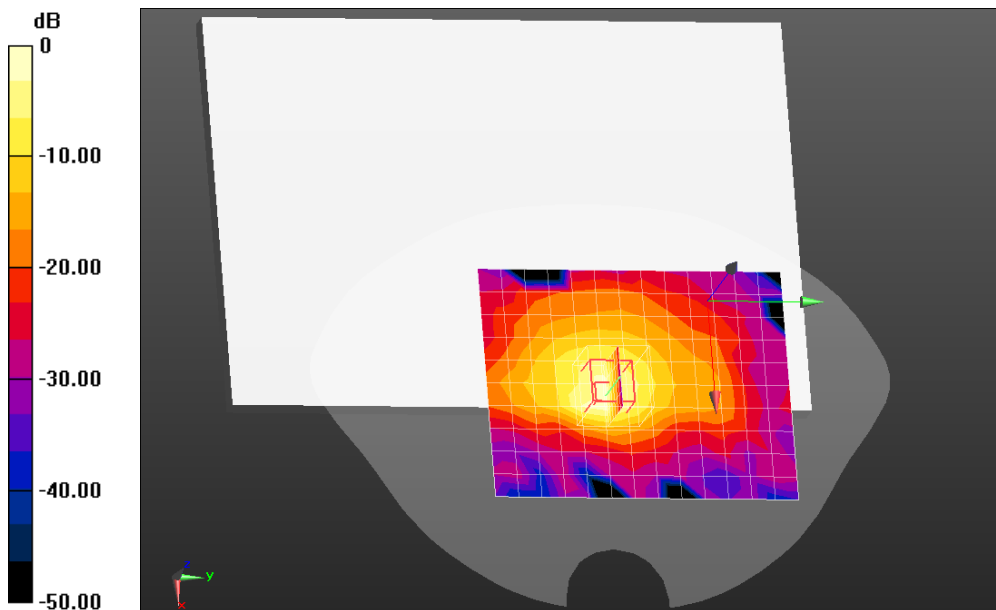

$0 \text{ dB} = 0.612 \text{ mW/g} = -4.26 \text{ dB mW/g}$

Date/Time: 06-03-2013

Test Laboratory: QuieTek Lab

802.11n(20MHz) 2412MHz-Bottom-Tablet Mode

DUT: 802.11b/g/n RTL8723AS combo module; Type: RTL8723AS

Communication System: Wi-Fi; Communication System Band: 802.11n(20MHz); Duty Cycle: 1:1; Frequency: 2412 MHz; Medium parameters used: $f = 2412 \text{ MHz}$; $\sigma = 1.94 \text{ mho/m}$; $\epsilon_r = 53.49$; $\rho = 1000 \text{ kg/m}^3$; Phantom section: Flat Section

Ambient temperature (°C): 21.5, Liquid temperature (°C): 21.0

DASY5 Configuration:

- Probe: EX3DV4 - SN3710; ConvF(6.98, 6.98, 6.98); Calibrated: 12/03/2012;
- Sensor-Surface: 4mm (Mechanical Surface Detection)
- Electronics: DAE4 Sn1220; Calibrated: 24/01/2013
- Phantom: SAM2; Type: SAM; Serial: TP1562
- Measurement SW: DASY52, Version 52.8 (1); SEMCAD X Version 14.6.5 (6469)

Configuration/802.11n(20MHz) 2412MHz-Bottom/Area Scan (11x14x1): Measurement grid: $dx=12\text{mm}$, $dy=12\text{mm}$, Maximum value of SAR (measured) = 0.359 mW/g

Configuration/802.11n(20MHz) 2412MHz-Bottom/Zoom Scan (5x5x7)/Cube 0: Measurement grid: $dx=8\text{mm}$, $dy=8\text{mm}$, $dz=5\text{mm}$, Reference Value = 11.789 V/m; Power Drift = -0.07 dB
Peak SAR (extrapolated) = 0.931 mW/g

SAR(1 g) = 0.369 mW/g; SAR(10 g) = 0.151 mW/g Maximum value of SAR (measured) = 0.438 mW/g

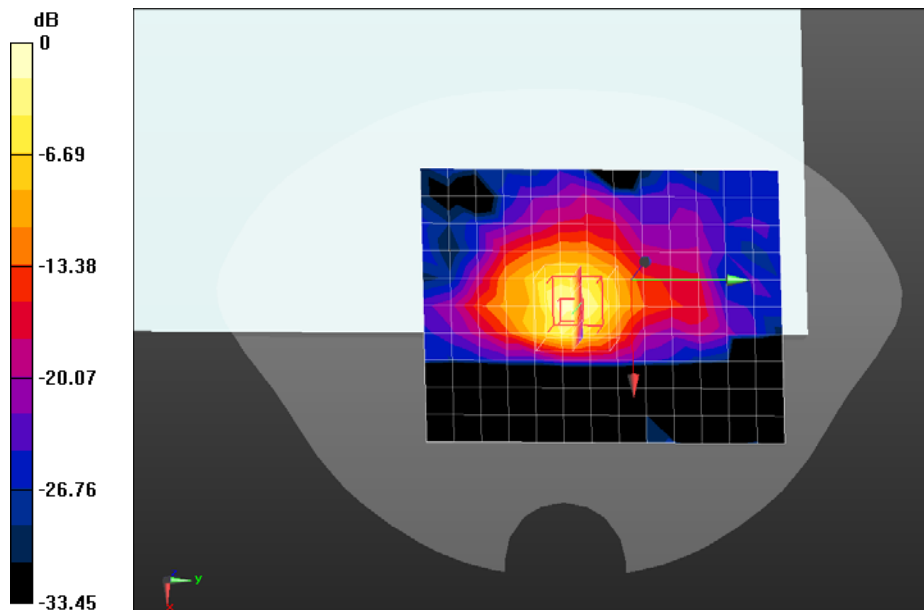

0 dB = 0.438 mW/g = -7.17 dB mW/g

Date/Time: 06-03-2013

Test Laboratory: QuieTek Lab

802.11n(20MHz) 2437MHz-Bottom-Tablet Mode

DUT: 802.11b/g/n RTL8723AS combo module; Type: RTL8723AS

Communication System: Wi-Fi; Communication System Band: 802.11n(20MHz); Duty Cycle: 1:1; Frequency: 2437 MHz; Medium parameters used: $f = 2437$ MHz; $\sigma = 1.98$ mho/m; $\epsilon_r = 53.3$; $\rho = 1000$ kg/m³; Phantom section: Flat Section

Ambient temperature (°C): 21.5, Liquid temperature (°C): 21.0

DASY5 Configuration:

- Probe: EX3DV4 - SN3710; ConvF(6.98, 6.98, 6.98); Calibrated: 12/03/2012;
- Sensor-Surface: 4mm (Mechanical Surface Detection)
- Electronics: DAE4 Sn1220; Calibrated: 24/01/2013
- Phantom: SAM2; Type: SAM; Serial: TP1562
- Measurement SW: DASY52, Version 52.8 (1); SEMCAD X Version 14.6.5 (6469)

Configuration/802.11n(20MHz) 2437MHz-Bottom/Area Scan (11x14x1): Measurement grid: dx=12mm, dy=12mm

Maximum value of SAR (measured) = 0.982 mW/g

Configuration/802.11n(20MHz) 2437MHz-Bottom/Zoom Scan (5x5x7)/Cube 0: Measurement grid: dx=8mm, dy=8mm, dz=5mm, Reference Value = 23.269 V/m; Power Drift = 0.01 dB

Peak SAR (extrapolated) = 2.044 mW/g

SAR(1 g) = 0.811 mW/g; SAR(10 g) = 0.329 mW/g Maximum value of SAR (measured) = 0.975 mW/g

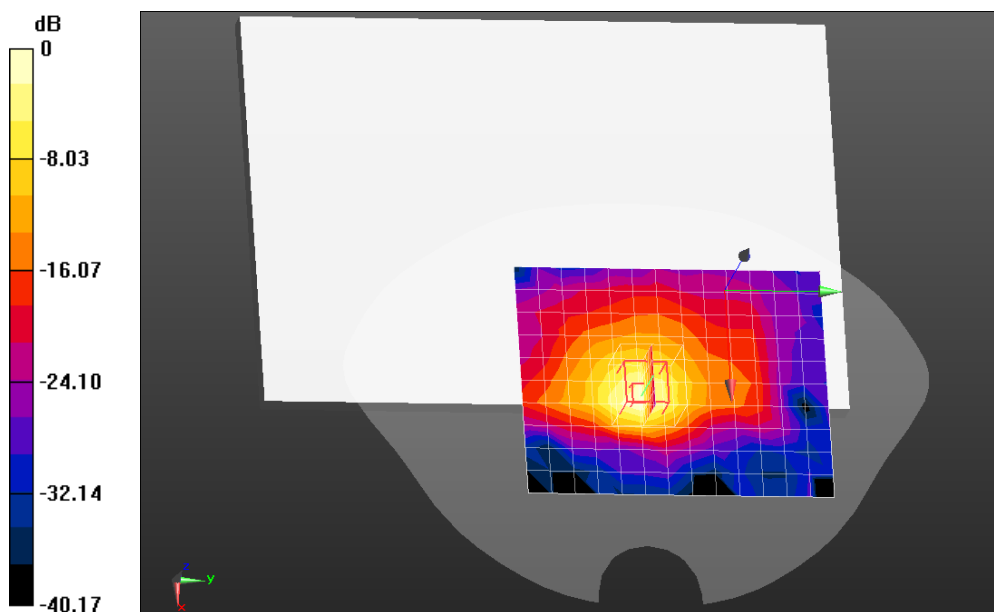

0 dB = 0.975 mW/g = -0.22 dB mW/g

Date/Time: 06-03-2013

Test Laboratory: QuieTek Lab

802.11n(20MHz) 2462MHz-Bottom-Tablet Mode

DUT: 802.11b/g/n RTL8723AS combo module; Type: RTL8723AS

Communication System: Wi-Fi; Communication System Band: 802.11n(20MHz); Duty Cycle: 1:1; Frequency: 2462 MHz; Medium parameters used: $f = 2462$ MHz; $\sigma = 2$ mho/m; $\epsilon_r = 52.04$; $\rho = 1000$ kg/m³; Phantom section: Flat Section

Ambient temperature (°C): 21.5, Liquid temperature (°C): 21.0

DASY5 Configuration:

- Probe: EX3DV4 - SN3710; ConvF(6.98, 6.98, 6.98); Calibrated: 12/03/2012;
- Sensor-Surface: 4mm (Mechanical Surface Detection)
- Electronics: DAE4 Sn1220; Calibrated: 24/01/2013
- Phantom: SAM2; Type: SAM; Serial: TP1562
- Measurement SW: DASY52, Version 52.8 (1); SEMCAD X Version 14.6.5 (6469)

Configuration/802.11n(20MHz) 2462MHz-Bottom/Area Scan (11x14x1): Measurement grid: dx=12mm, dy=12mm, Maximum value of SAR (measured) = 0.389 mW/g

Configuration/802.11n(20MHz) 2462MHz-Bottom/Zoom Scan (5x5x7)/Cube 0: Measurement grid: dx=8mm, dy=8mm, dz=5mm, Reference Value = 15.068 V/m; Power Drift = -0.05 dB
Peak SAR (extrapolated) = 1.143 mW/g

SAR(1 g) = 0.447 mW/g; SAR(10 g) = 0.177 mW/g Maximum value of SAR (measured) = 0.536 mW/g

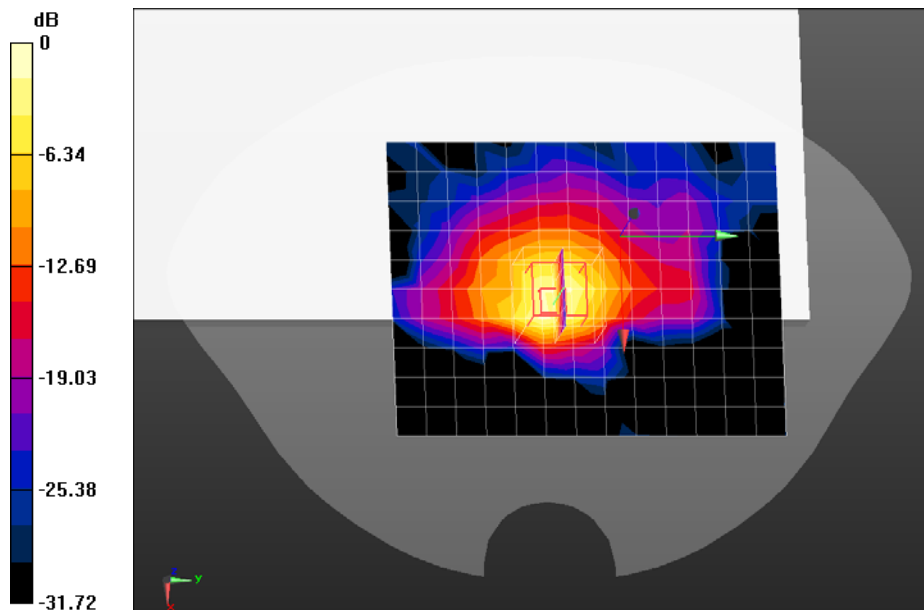

0 dB = 0.536 mW/g = -5.42 dB mW/g

Date/Time: 06-03-2013

Test Laboratory: QuieTek Lab

802.11n(40MHz) 2452MHz-Bottom-Tablet Mode

DUT: 802.11b/g/n RTL8723AS combo module; Type: RTL8723AS

Communication System: Wi-Fi; Communication System Band: 802.11n(40MHz); Duty Cycle: 1:1; Frequency: 2452 MHz; Medium parameters used: $f = 2452 \text{ MHz}$; $\sigma = 2 \text{ mho/m}$; $\epsilon_r = 53.25$; $\rho = 1000 \text{ kg/m}^3$; Phantom section: Flat Section

Ambient temperature (°C): 21.5, Liquid temperature (°C): 21.0

DASY5 Configuration:

- Probe: EX3DV4 - SN3710; ConvF(6.98, 6.98, 6.98); Calibrated: 12/03/2012;
- Sensor-Surface: 4mm (Mechanical Surface Detection)
- Electronics: DAE4 Sn1220; Calibrated: 24/01/2013
- Phantom: SAM2; Type: SAM; Serial: TP1562
- Measurement SW: DASY52, Version 52.8 (1); SEMCAD X Version 14.6.5 (6469)

Configuration/802.11n(40MHz) 2452MHz-Bottom/Area Scan (11x14x1): Measurement grid: dx=12mm, dy=12mm

Maximum value of SAR (measured) = 0.435 mW/g

Configuration/802.11n(40MHz) 2452MHz-Bottom/Zoom Scan (5x5x7)/Cube 0: Measurement grid: dx=8mm, dy=8mm, dz=5mm, Reference Value = 12.979 V/m; Power Drift = 0.07 dB

Peak SAR (extrapolated) = 1.090 mW/g

SAR(1 g) = 0.441 mW/g; SAR(10 g) = 0.180 mW/g Maximum value of SAR (measured) = 0.521 mW/g

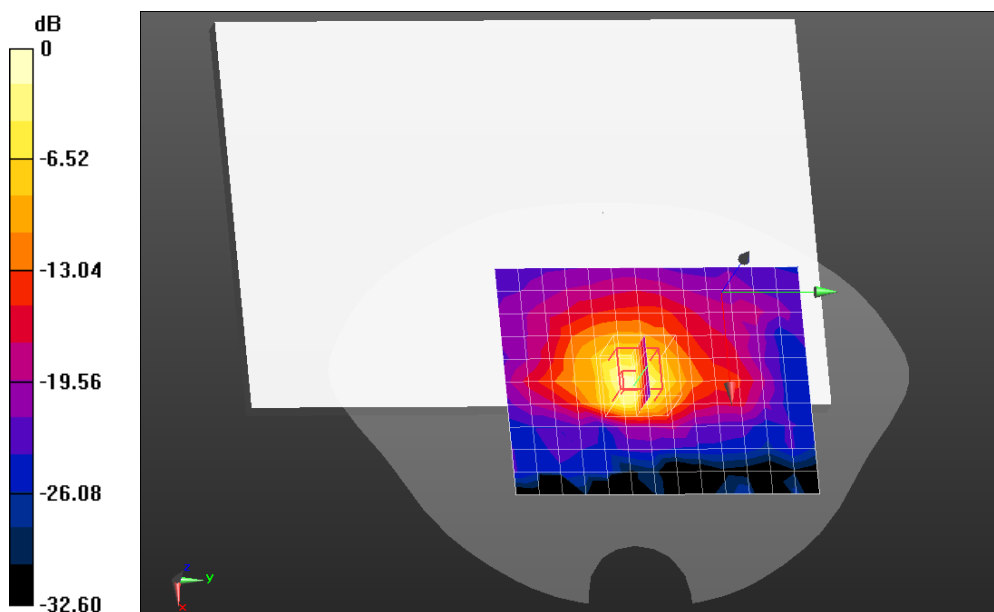

0 dB = 0.521 mW/g = -5.66 dB mW/g

Date/Time: 06-03-2013

Test Laboratory: QuieTek Lab

802.11b 2462MHz-Bottom-Laptop Mode

DUT: 802.11b/g/n RTL8723AS combo module; Type: RTL8723AS

Communication System: Wi-Fi; Communication System Band: 802.11b; Duty Cycle: 1:1; Frequency: 2462 MHz; Medium parameters used: $f = 2462$ MHz; $\sigma = 2$ mho/m; $\epsilon_r = 52.04$; $\rho = 1000$ kg/m³; Phantom section: Flat Section

Ambient temperature (°C): 21.5, Liquid temperature (°C): 21.0

DASY5 Configuration:

- Probe: EX3DV4 - SN3710; ConvF(6.98, 6.98, 6.98); Calibrated: 12/03/2012;
- Sensor-Surface: 4mm (Mechanical Surface Detection)
- Electronics: DAE4 Sn1220; Calibrated: 24/01/2013
- Phantom: SAM2; Type: SAM; Serial: TP1562
- Measurement SW: DASY52, Version 52.8 (1); SEMCAD X Version 14.6.5 (6469)

Configuration/802.11b 2462MHz-Bottom/Area Scan (11x14x1): Measurement grid: dx=12mm, dy=12mm

Maximum value of SAR (measured) = 0.617 mW/g

Configuration/802.11b 2462MHz-Bottom/Zoom Scan (5x5x7)/Cube 0: Measurement grid: dx=8mm, dy=8mm, dz=5mm, Reference Value = 7.230 V/m; Power Drift = 0.13 dB

Peak SAR (extrapolated) = 1.340 mW/g

SAR(1 g) = 0.589 mW/g; SAR(10 g) = 0.254 mW/g Maximum value of SAR (measured) = 0.686 mW/g

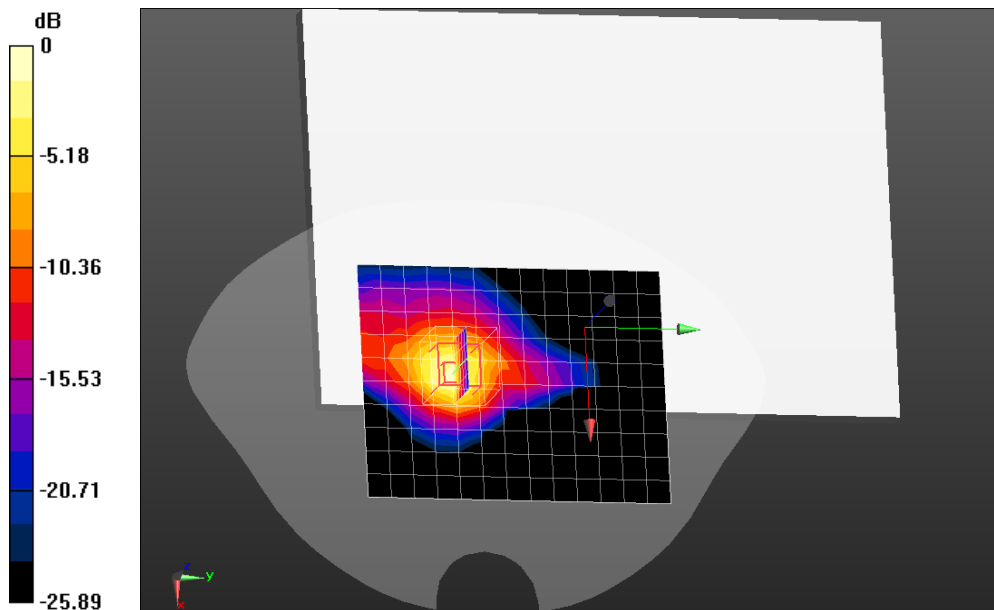

0 dB = 0.686 mW/g = -3.27 dB mW/g

Depth of the liquid in the phantom – Zoom in

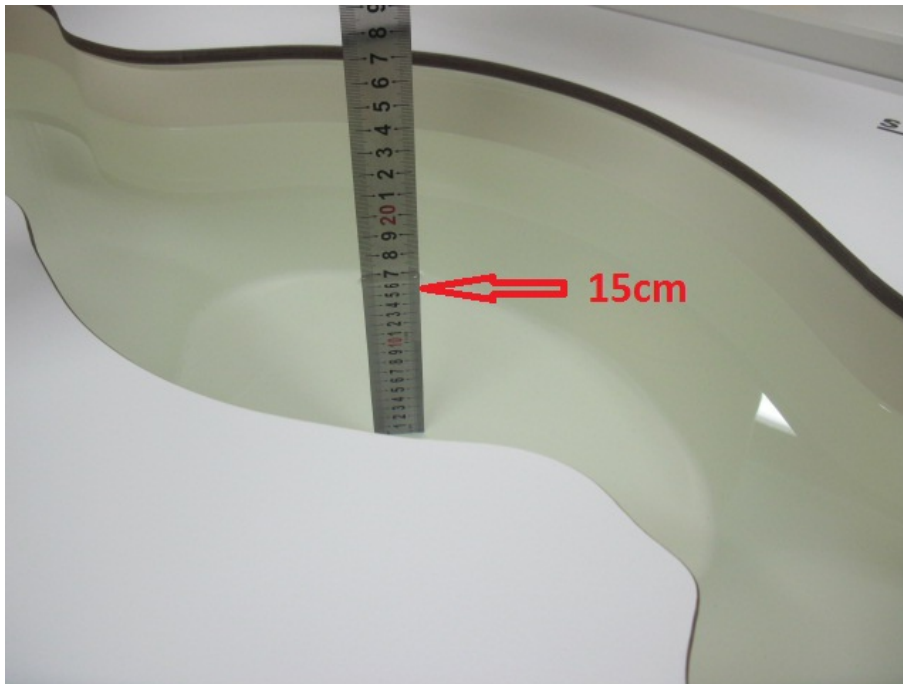

Note: The position used in the measurements were according to IEEE 1528 - 2003

Appendix D. Probe Calibration Data

**Calibration Laboratory of
Schmid & Partner
Engineering AG**
Zeughausstrasse 43, 8004 Zurich, Switzerland



S S C S Schweizerischer Kalibrierdienst
Service suisse d'étalonnage
Servizio svizzero di taratura
Swiss Calibration Service

Accredited by the Swiss Accreditation Service (SAS)
The Swiss Accreditation Service is one of the signatories to the EA
Multilateral Agreement for the recognition of calibration certificates

Accreditation No.: **SCS 108**

Client **Quietek-CN (Auden)**

Certificate No: **EX3-3710_Mar12**

CALIBRATION CERTIFICATE

Object: **EX3DV4 - SN:3710**

Calibration procedure(s): **QA CAL-01.v8, QA CAL-12.v7, QA CAL-14.v3, QA CAL-23.v4, QA CAL-25.v4
Calibration procedure for dosimetric E-field probes**

Calibration date: **March 12, 2012**

This calibration certificate documents the traceability to national standards, which realize the physical units of measurements (SI). The measurements and the uncertainties with confidence probability are given on the following pages and are part of the certificate.

All calibrations have been conducted in the closed laboratory facility: environment temperature (22 ± 3)°C and humidity < 70%.

Calibration Equipment used (M&TE critical for calibration)

Primary Standards	ID	Cal Date (Certificate No.)	Scheduled Calibration
Power meter E4419B	GB41293874	31-Mar-11 (No. 217-01372)	Apr-12
Power sensor E4412A	MY41498087	31-Mar-11 (No. 217-01372)	Apr-12
Reference 3 dB Attenuator	SN: S5054 (3c)	29-Mar-11 (No. 217-01369)	Apr-12
Reference 20 dB Attenuator	SN: S5086 (20b)	29-Mar-11 (No. 217-01367)	Apr-12
Reference 30 dB Attenuator	SN: S5129 (30b)	29-Mar-11 (No. 217-01370)	Apr-12
Reference Probe ES3DV2	SN: 3013	29-Dec-11 (No. ES3-3013_Dec11)	Dec-12
DAE4	SN: 654	3-May-11 (No. DAE4-654_May11)	May-12
Secondary Standards	ID	Check Date (in house)	Scheduled Check
RF generator HP 8648C	US3642U01700	4-Aug-99 (in house check Apr-11)	In house check: Apr-13
Network Analyzer HP 8753E	US37390585	18-Oct-01 (in house check Oct-11)	In house check: Oct-12

	Name	Function	Signature
Calibrated by:	Jeton Kastrati	Laboratory Technician	
Approved by:	Katja Pokovic	Technical Manager	

Issued: March 13, 2012

This calibration certificate shall not be reproduced except in full without written approval of the laboratory.

**Calibration Laboratory of
Schmid & Partner
Engineering AG**
Zeughausstrasse 43, 8004 Zurich, Switzerland



S Schweizerischer Kalibrierdienst
S Service suisse d'étalonnage
C Servizio svizzero di taratura
S Swiss Calibration Service

Accredited by the Swiss Accreditation Service (SAS)
The Swiss Accreditation Service is one of the signatories to the EA
Multilateral Agreement for the recognition of calibration certificates

Accreditation No.: **SCS 108**

Glossary:

TSL	tissue simulating liquid
NORM _{x,y,z}	sensitivity in free space
ConvF	sensitivity in TSL / NORM _{x,y,z}
DCP	diode compression point
CF	crest factor (1/duty_cycle) of the RF signal
A, B, C	modulation dependent linearization parameters
Polarization φ	φ rotation around probe axis
Polarization ϑ	ϑ rotation around an axis that is in the plane normal to probe axis (at measurement center), i.e., $\vartheta = 0$ is normal to probe axis

Calibration is Performed According to the Following Standards:

- IEEE Std 1528-2003, "IEEE Recommended Practice for Determining the Peak Spatial-Averaged Specific Absorption Rate (SAR) in the Human Head from Wireless Communications Devices: Measurement Techniques", December 2003
- IEC 62209-1, "Procedure to measure the Specific Absorption Rate (SAR) for hand-held devices used in close proximity to the ear (frequency range of 300 MHz to 3 GHz)", February 2005

Methods Applied and Interpretation of Parameters:

- NORM_{x,y,z}**: Assessed for E-field polarization $\vartheta = 0$ ($f \leq 900$ MHz in TEM-cell; $f > 1800$ MHz: R22 waveguide). NORM_{x,y,z} are only intermediate values, i.e., the uncertainties of NORM_{x,y,z} does not affect the E²-field uncertainty inside TSL (see below ConvF).
- NORM(f)_{x,y,z}** = NORM_{x,y,z} * frequency_response (see Frequency Response Chart). This linearization is implemented in DASY4 software versions later than 4.2. The uncertainty of the frequency response is included in the stated uncertainty of ConvF.
- DCP_{x,y,z}**: DCP are numerical linearization parameters assessed based on the data of power sweep with CW signal (no uncertainty required). DCP does not depend on frequency nor media.
- PAR**: PAR is the Peak to Average Ratio that is not calibrated but determined based on the signal characteristics
- A_{x,y,z}; B_{x,y,z}; C_{x,y,z}; VR_{x,y,z}; A, B, C** are numerical linearization parameters assessed based on the data of power sweep for specific modulation signal. The parameters do not depend on frequency nor media. VR is the maximum calibration range expressed in RMS voltage across the diode.
- ConvF and Boundary Effect Parameters**: Assessed in flat phantom using E-field (or Temperature Transfer Standard for $f \leq 800$ MHz) and inside waveguide using analytical field distributions based on power measurements for $f > 800$ MHz. The same setups are used for assessment of the parameters applied for boundary compensation (alpha, depth) of which typical uncertainty values are given. These parameters are used in DASY4 software to improve probe accuracy close to the boundary. The sensitivity in TSL corresponds to NORM_{x,y,z} * ConvF whereby the uncertainty corresponds to that given for ConvF. A frequency dependent ConvF is used in DASY version 4.4 and higher which allows extending the validity from ± 50 MHz to ± 100 MHz.
- Spherical isotropy (3D deviation from isotropy)**: in a field of low gradients realized using a flat phantom exposed by a patch antenna.
- Sensor Offset**: The sensor offset corresponds to the offset of virtual measurement center from the probe tip (on probe axis). No tolerance required.

EX3DV4 – SN:3710

March 12, 2012

Probe EX3DV4

SN:3710

Manufactured:	July 21, 2009
Repaired:	February 21, 2012
Calibrated:	March 12, 2012

Calibrated for DASY/EASY Systems
(Note: non-compatible with DASY2 system!)

EX3DV4- SN:3710

March 12, 2012

DASY/EASY - Parameters of Probe: EX3DV4 - SN:3710

Basic Calibration Parameters

	Sensor X	Sensor Y	Sensor Z	Unc (k=2)
Norm ($\mu\text{V}/(\text{V}/\text{m})^2$) ^A	0.51	0.56	0.44	$\pm 10.1 \%$
DCP (mV) ^B	101.3	98.9	100.9	

Modulation Calibration Parameters

UID	Communication System Name	PAR		A dB	B dB	C dB	VR mV	Unc ^E (k=2)
10000	CW	0.00	X	0.00	0.00	1.00	114.4	$\pm 2.2 \%$
			Y	0.00	0.00	1.00	94.4	
			Z	0.00	0.00	1.00	114.2	

The reported uncertainty of measurement is stated as the standard uncertainty of measurement multiplied by the coverage factor k=2, which for a normal distribution corresponds to a coverage probability of approximately 95%.

^A The uncertainties of NormX,Y,Z do not affect the E²-field uncertainty inside TSL (see Pages 5 and 6).

^B Numerical linearization parameter: uncertainty not required.

^E Uncertainty is determined using the max. deviation from linear response applying rectangular distribution and is expressed for the square of the field value.

EX3DV4- SN:3710

March 12, 2012

DASY/EASY - Parameters of Probe: EX3DV4 - SN:3710

Calibration Parameter Determined in Head Tissue Simulating Media

f (MHz) ^C	Relative Permittivity ^F	Conductivity (S/m) ^F	ConvF X	ConvF Y	ConvF Z	Alpha	Depth (mm)	Unct. (k=2)
450	43.5	0.87	9.61	9.61	9.61	0.12	1.00	± 13.4 %
750	41.9	0.89	9.51	9.51	9.51	0.24	1.16	± 12.0 %
835	41.5	0.90	9.18	9.18	9.18	0.22	1.15	± 12.0 %
900	41.5	0.97	8.97	8.97	8.97	0.19	1.35	± 12.0 %
1810	40.0	1.40	8.32	8.32	8.32	0.79	0.60	± 12.0 %
1900	40.0	1.40	8.16	8.16	8.16	0.72	0.66	± 12.0 %
2450	39.2	1.80	7.25	7.25	7.25	0.36	0.91	± 12.0 %
2600	39.0	1.96	6.96	6.96	6.96	0.39	0.95	± 12.0 %
3500	37.9	2.91	6.80	6.80	6.80	0.33	1.09	± 13.1 %
5200	36.0	4.66	5.21	5.21	5.21	0.35	1.80	± 13.1 %
5500	35.6	4.96	4.95	4.95	4.95	0.35	1.80	± 13.1 %
5800	35.3	5.27	4.56	4.56	4.56	0.45	1.80	± 13.1 %

^C Frequency validity of ± 100 MHz only applies for DASY v4.4 and higher (see Page 2), else it is restricted to ± 50 MHz. The uncertainty is the RSS of the ConvF uncertainty at calibration frequency and the uncertainty for the indicated frequency band.

^F At frequencies below 3 GHz, the validity of tissue parameters (ϵ and σ) can be relaxed to ± 10% if liquid compensation formula is applied to measured SAR values. At frequencies above 3 GHz, the validity of tissue parameters (ϵ and σ) is restricted to ± 5%. The uncertainty is the RSS of the ConvF uncertainty for indicated target tissue parameters.

EX3DV4– SN:3710

March 12, 2012

DASY/EASY - Parameters of Probe: EX3DV4 - SN:3710

Calibration Parameter Determined in Body Tissue Simulating Media

f (MHz) ^C	Relative Permittivity ^F	Conductivity (S/m) ^F	ConvF X	ConvF Y	ConvF Z	Alpha	Depth (mm)	Unct. (k=2)
450	56.7	0.94	10.69	10.69	10.69	0.06	1.00	± 13.4 %
750	55.5	0.96	9.33	9.33	9.33	0.43	0.86	± 12.0 %
835	55.2	0.97	9.13	9.13	9.13	0.63	0.70	± 12.0 %
900	55.0	1.05	9.04	9.04	9.04	0.39	0.88	± 12.0 %
1810	53.3	1.52	7.73	7.73	7.73	0.33	1.10	± 12.0 %
1900	53.3	1.52	7.43	7.43	7.43	0.42	0.90	± 12.0 %
2450	52.7	1.95	6.98	6.98	6.98	0.79	0.59	± 12.0 %
2600	52.5	2.16	6.68	6.68	6.68	0.79	0.52	± 12.0 %
3500	51.3	3.31	6.23	6.23	6.23	0.36	1.13	± 13.1 %
5200	49.0	5.30	4.20	4.20	4.20	0.50	1.90	± 13.1 %
5500	48.6	5.65	3.82	3.82	3.82	0.50	1.90	± 13.1 %
5800	48.2	6.00	3.89	3.89	3.89	0.60	1.90	± 13.1 %

^C Frequency validity of ± 100 MHz only applies for DASY v4.4 and higher (see Page 2), else it is restricted to ± 50 MHz. The uncertainty is the RSS of the ConvF uncertainty at calibration frequency and the uncertainty for the indicated frequency band.

^F At frequencies below 3 GHz, the validity of tissue parameters (ϵ and σ) can be relaxed to ± 10% if liquid compensation formula is applied to measured SAR values. At frequencies above 3 GHz, the validity of tissue parameters (ϵ and σ) is restricted to ± 5%. The uncertainty is the RSS of the ConvF uncertainty for indicated target tissue parameters.

EX3DV4- SN:3710

March 12, 2012

Frequency Response of E-Field (TEM-Cell:ifi110 EXX, Waveguide: R22)

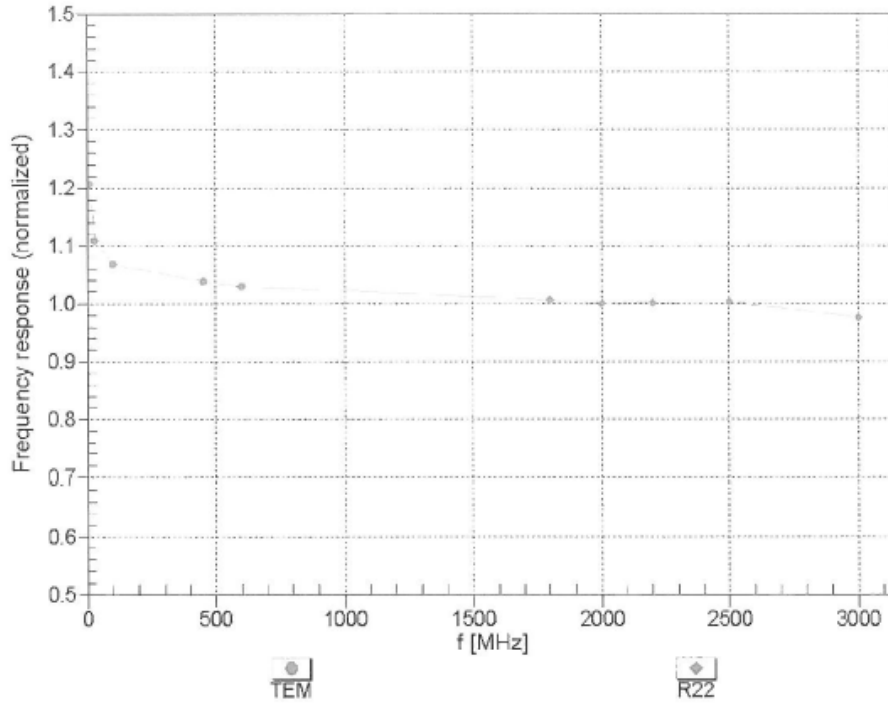

Uncertainty of Frequency Response of E-field: $\pm 6.3\%$ ($k=2$)

EX3DV4- SN:3710

March 12, 2012

Receiving Pattern (ϕ), $\theta = 0^\circ$

f=600 MHz,TEM

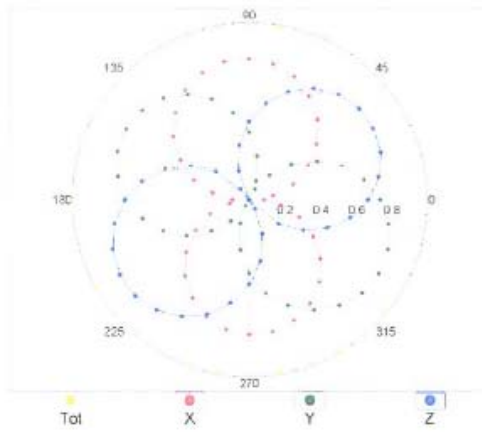

f=1800 MHz,R22

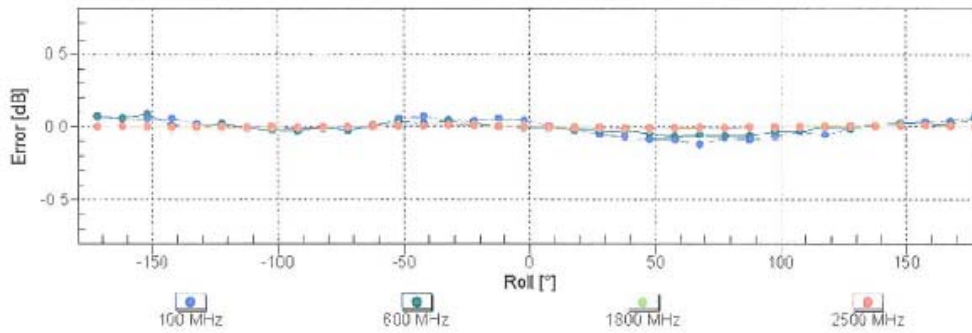
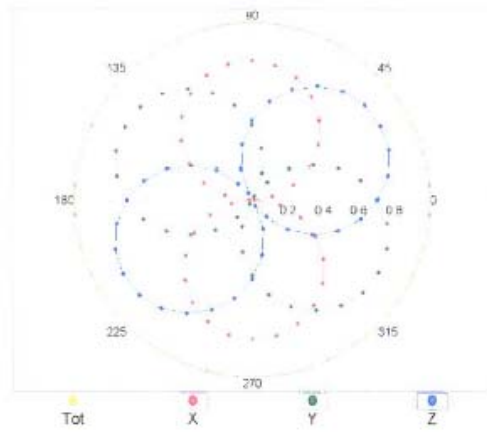

Uncertainty of Axial Isotropy Assessment: $\pm 0.5\%$ (k=2)

EX3DV4- SN:3710

March 12, 2012

Dynamic Range f(SAR_{head}) (TEM cell , f = 900 MHz)

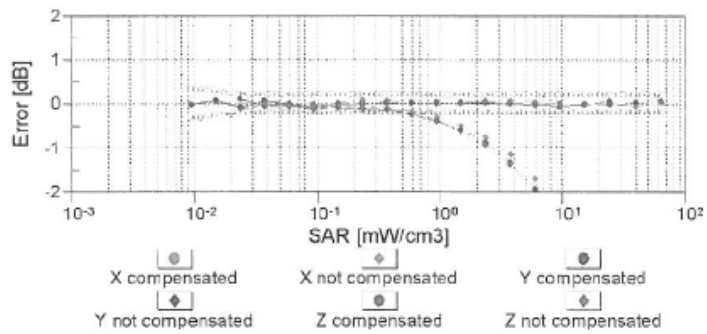
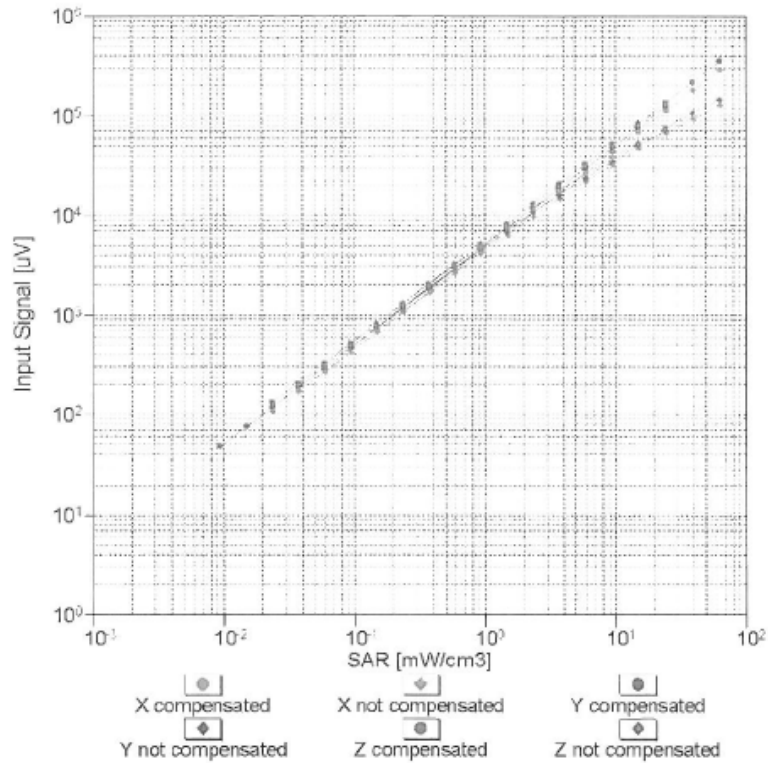

Uncertainty of Linearity Assessment: ± 0.6% (k=2)

EX3DV4-SN:3710

March 12, 2012

Conversion Factor Assessment

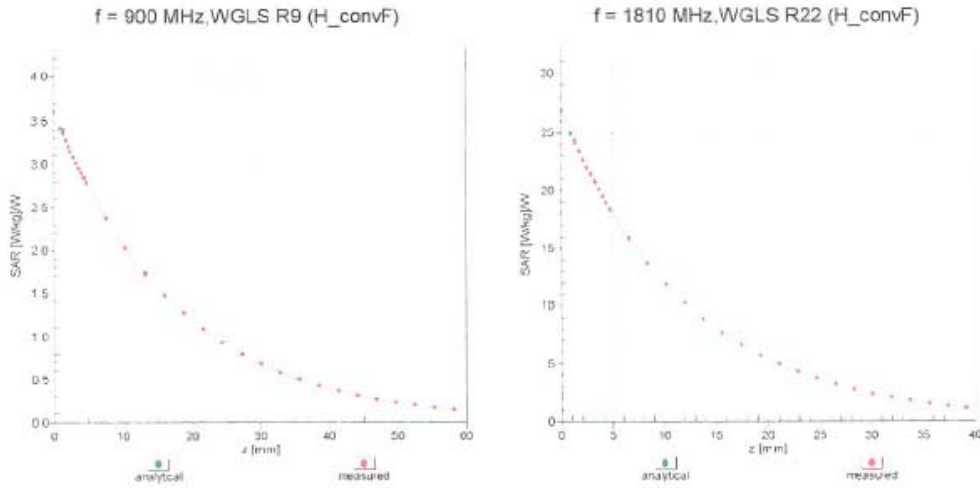

Deviation from Isotropy in Liquid Error (ϕ, θ), f = 900 MHz

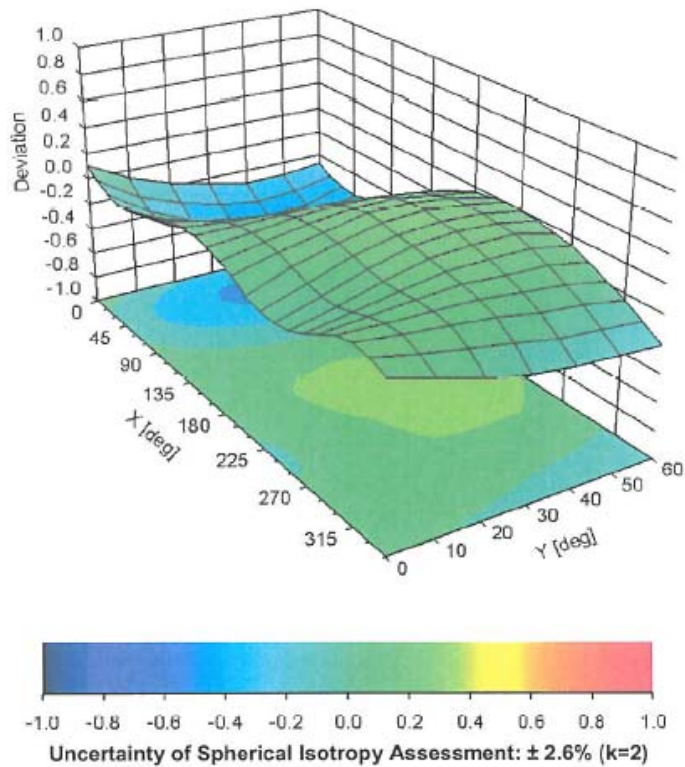

EX3DV4- SN:3710

March 12, 2012

DASY/EASY - Parameters of Probe: EX3DV4 - SN:3710

Other Probe Parameters

Sensor Arrangement	Triangular
Connector Angle (°)	Not applicable
Mechanical Surface Detection Mode	enabled
Optical Surface Detection Mode	disabled
Probe Overall Length	337 mm
Probe Body Diameter	10 mm
Tip Length	9 mm
Tip Diameter	2.5 mm
Probe Tip to Sensor X Calibration Point	1 mm
Probe Tip to Sensor Y Calibration Point	1 mm
Probe Tip to Sensor Z Calibration Point	1 mm
Recommended Measurement Distance from Surface	2 mm

Appendix E. Dipole Calibration Data

**Calibration Laboratory of
Schmid & Partner
Engineering AG**
Zeughausstrasse 43, 8004 Zurich, Switzerland



S Schweizerischer Kalibrierdienst
C Service suisse d'étalonnage
S Servizio svizzero di taratura
S Swiss Calibration Service

Accredited by the Swiss Accreditation Service (SAS)
The Swiss Accreditation Service is one of the signatories to the EA
Multilateral Agreement for the recognition of calibration certificates

Accreditation No.: **SCS 108**

Client **Quietek-CN (Auden)**

Certificate No: **D2450V2-839_Feb12**

CALIBRATION CERTIFICATE																																															
Object	D2450V2 - SN: 839																																														
Calibration procedure(s)	QA CAL-05.v8 Calibration procedure for dipole validation kits above 700 MHz																																														
Calibration date:	February 23, 2012																																														
<p>This calibration certificate documents the traceability to national standards, which realize the physical units of measurements (SI). The measurements and the uncertainties with confidence probability are given on the following pages and are part of the certificate.</p> <p>All calibrations have been conducted in the closed laboratory facility: environment temperature (22 ± 3)°C and humidity < 70%.</p> <p>Calibration Equipment used (M&TE critical for calibration)</p> <table border="1"> <thead> <tr> <th>Primary Standards</th> <th>ID #</th> <th>Cal Date (Certificate No.)</th> <th>Scheduled Calibration</th> </tr> </thead> <tbody> <tr> <td>Power meter EPM-442A</td> <td>GB37480704</td> <td>05-Oct-11 (No. 217-01451)</td> <td>Oct-12</td> </tr> <tr> <td>Power sensor HP 8481A</td> <td>US37292783</td> <td>05-Oct-11 (No. 217-01451)</td> <td>Oct-12</td> </tr> <tr> <td>Reference 20 dB Attenuator</td> <td>SN: 5086 (20g)</td> <td>29-Mar-11 (No. 217-01368)</td> <td>Apr-12</td> </tr> <tr> <td>Type N mismatch combination</td> <td>SN: 5047.2 / 06327</td> <td>29-Mar-11 (No. 217-01371)</td> <td>Apr-12</td> </tr> <tr> <td>Reference Probe ES3DV3</td> <td>SN: 3205</td> <td>30-Dec-11 (No. ES3-3205_Dec11)</td> <td>Dec-12</td> </tr> <tr> <td>DAE4</td> <td>SN: 601</td> <td>04-Jul-11 (No. DAE4-601_Jul11)</td> <td>Jul-12</td> </tr> </tbody> </table> <table border="1"> <thead> <tr> <th>Secondary Standards</th> <th>ID #</th> <th>Check Date (in house)</th> <th>Scheduled Check</th> </tr> </thead> <tbody> <tr> <td>Power sensor HP 8481A</td> <td>MY41092317</td> <td>18-Oct-02 (in house check Oct-11)</td> <td>In house check: Oct-13</td> </tr> <tr> <td>RF generator R&S SMT-06</td> <td>100005</td> <td>04-Aug-99 (in house check Oct-11)</td> <td>In house check: Oct-13</td> </tr> <tr> <td>Network Analyzer HP 8753E</td> <td>US37390585 S4206</td> <td>18-Oct-01 (in house check Oct-11)</td> <td>In house check: Oct-12</td> </tr> </tbody> </table>				Primary Standards	ID #	Cal Date (Certificate No.)	Scheduled Calibration	Power meter EPM-442A	GB37480704	05-Oct-11 (No. 217-01451)	Oct-12	Power sensor HP 8481A	US37292783	05-Oct-11 (No. 217-01451)	Oct-12	Reference 20 dB Attenuator	SN: 5086 (20g)	29-Mar-11 (No. 217-01368)	Apr-12	Type N mismatch combination	SN: 5047.2 / 06327	29-Mar-11 (No. 217-01371)	Apr-12	Reference Probe ES3DV3	SN: 3205	30-Dec-11 (No. ES3-3205_Dec11)	Dec-12	DAE4	SN: 601	04-Jul-11 (No. DAE4-601_Jul11)	Jul-12	Secondary Standards	ID #	Check Date (in house)	Scheduled Check	Power sensor HP 8481A	MY41092317	18-Oct-02 (in house check Oct-11)	In house check: Oct-13	RF generator R&S SMT-06	100005	04-Aug-99 (in house check Oct-11)	In house check: Oct-13	Network Analyzer HP 8753E	US37390585 S4206	18-Oct-01 (in house check Oct-11)	In house check: Oct-12
Primary Standards	ID #	Cal Date (Certificate No.)	Scheduled Calibration																																												
Power meter EPM-442A	GB37480704	05-Oct-11 (No. 217-01451)	Oct-12																																												
Power sensor HP 8481A	US37292783	05-Oct-11 (No. 217-01451)	Oct-12																																												
Reference 20 dB Attenuator	SN: 5086 (20g)	29-Mar-11 (No. 217-01368)	Apr-12																																												
Type N mismatch combination	SN: 5047.2 / 06327	29-Mar-11 (No. 217-01371)	Apr-12																																												
Reference Probe ES3DV3	SN: 3205	30-Dec-11 (No. ES3-3205_Dec11)	Dec-12																																												
DAE4	SN: 601	04-Jul-11 (No. DAE4-601_Jul11)	Jul-12																																												
Secondary Standards	ID #	Check Date (in house)	Scheduled Check																																												
Power sensor HP 8481A	MY41092317	18-Oct-02 (in house check Oct-11)	In house check: Oct-13																																												
RF generator R&S SMT-06	100005	04-Aug-99 (in house check Oct-11)	In house check: Oct-13																																												
Network Analyzer HP 8753E	US37390585 S4206	18-Oct-01 (in house check Oct-11)	In house check: Oct-12																																												
Calibrated by:	Name Israe El-Naouq	Function Laboratory Technician	Signature 																																												
Approved by:	Katja Pokovic	Technical Manager																																													
			Issued: February 23, 2012																																												
This calibration certificate shall not be reproduced except in full without written approval of the laboratory.																																															

**Calibration Laboratory of
Schmid & Partner
Engineering AG**
Zeughausstrasse 43, 8004 Zurich, Switzerland



S Schweizerischer Kalibrierdienst
C Service suisse d'étalonnage
S Servizio svizzero di taratura
S Swiss Calibration Service

Accredited by the Swiss Accreditation Service (SAS)
The Swiss Accreditation Service is one of the signatories to the EA
Multilateral Agreement for the recognition of calibration certificates

Accreditation No.: **SCS 108**

Glossary:

TSL	tissue simulating liquid
ConvF	sensitivity in TSL / NORM x,y,z
N/A	not applicable or not measured

Calibration is Performed According to the Following Standards:

- a) IEEE Std 1528-2003, "IEEE Recommended Practice for Determining the Peak Spatial-Averaged Specific Absorption Rate (SAR) in the Human Head from Wireless Communications Devices: Measurement Techniques", December 2003
- b) IEC 62209-1, "Procedure to measure the Specific Absorption Rate (SAR) for hand-held devices used in close proximity to the ear (frequency range of 300 MHz to 3 GHz)", February 2005
- c) Federal Communications Commission Office of Engineering & Technology (FCC OET), "Evaluating Compliance with FCC Guidelines for Human Exposure to Radiofrequency Electromagnetic Fields; Additional Information for Evaluating Compliance of Mobile and Portable Devices with FCC Limits for Human Exposure to Radiofrequency Emissions", Supplement C (Edition 01-01) to Bulletin 65

Additional Documentation:

- d) DASY4/5 System Handbook

Methods Applied and Interpretation of Parameters:

- *Measurement Conditions:* Further details are available from the Validation Report at the end of the certificate. All figures stated in the certificate are valid at the frequency indicated.
- *Antenna Parameters with TSL:* The dipole is mounted with the spacer to position its feed point exactly below the center marking of the flat phantom section, with the arms oriented parallel to the body axis.
- *Feed Point Impedance and Return Loss:* These parameters are measured with the dipole positioned under the liquid filled phantom. The impedance stated is transformed from the measurement at the SMA connector to the feed point. The Return Loss ensures low reflected power. No uncertainty required.
- *Electrical Delay:* One-way delay between the SMA connector and the antenna feed point. No uncertainty required.
- *SAR measured:* SAR measured at the stated antenna input power.
- *SAR normalized:* SAR as measured, normalized to an input power of 1 W at the antenna connector.
- *SAR for nominal TSL parameters:* The measured TSL parameters are used to calculate the nominal SAR result.

Measurement Conditions

DASY system configuration, as far as not given on page 1.

DASY Version	DASY5	V52.8.0
Extrapolation	Advanced Extrapolation	
Phantom	Modular Flat Phantom	
Distance Dipole Center - TSL	10 mm	with Spacer
Zoom Scan Resolution	dx, dy, dz = 5 mm	
Frequency	2450 MHz ± 1 MHz	

Head TSL parameters

The following parameters and calculations were applied.

	Temperature	Permittivity	Conductivity
Nominal Head TSL parameters	22.0 °C	39.2	1.80 mho/m
Measured Head TSL parameters	(22.0 ± 0.2) °C	38.9 ± 6 %	1.86 mho/m ± 6 %
Head TSL temperature change during test	< 0.5 °C	----	----

SAR result with Head TSL

SAR averaged over 1 cm ³ (1 g) of Head TSL	Condition	
SAR measured	250 mW input power	13.2 mW / g
SAR for nominal Head TSL parameters	normalized to 1W	51.9 mW / g ± 17.0 % (k=2)

SAR averaged over 10 cm ³ (10 g) of Head TSL	condition	
SAR measured	250 mW input power	6.09 mW / g
SAR for nominal Head TSL parameters	normalized to 1W	24.1 mW / g ± 16.5 % (k=2)

Body TSL parameters

The following parameters and calculations were applied.

	Temperature	Permittivity	Conductivity
Nominal Body TSL parameters	22.0 °C	52.7	1.95 mho/m
Measured Body TSL parameters	(22.0 ± 0.2) °C	52.3 ± 6 %	2.02 mho/m ± 6 %
Body TSL temperature change during test	< 0.5 °C	----	----

SAR result with Body TSL

SAR averaged over 1 cm ³ (1 g) of Body TSL	Condition	
SAR measured	250 mW input power	12.4 mW / g
SAR for nominal Body TSL parameters	normalized to 1W	48.7 mW / g ± 17.0 % (k=2)

SAR averaged over 10 cm ³ (10 g) of Body TSL	condition	
SAR measured	250 mW input power	5.76 mW / g
SAR for nominal Body TSL parameters	normalized to 1W	22.8 mW / g ± 16.5 % (k=2)

Appendix

Antenna Parameters with Head TSL

Impedance, transformed to feed point	55.7 Ω - 1.0 j Ω
Return Loss	- 25.2 dB

Antenna Parameters with Body TSL

Impedance, transformed to feed point	52.1 Ω + 1.0 j Ω
Return Loss	- 32.9 dB

General Antenna Parameters and Design

Electrical Delay (one direction)	1.160 ns
----------------------------------	----------

After long term use with 100W radiated power, only a slight warming of the dipole near the feedpoint can be measured.

The dipole is made of standard semirigid coaxial cable. The center conductor of the feeding line is directly connected to the second arm of the dipole. The antenna is therefore short-circuited for DC-signals. On some of the dipoles, small end caps are added to the dipole arms in order to improve matching when loaded according to the position as explained in the "Measurement Conditions" paragraph. The SAR data are not affected by this change. The overall dipole length is still according to the Standard.

No excessive force must be applied to the dipole arms, because they might bend or the soldered connections near the feedpoint may be damaged.

Additional EUT Data

Manufactured by	SPEAG
Manufactured on	July 20, 2009

DASY5 Validation Report for Head TSL

Date: 23.02.2012

Test Laboratory: SPEAG, Zurich, Switzerland

DUT: Dipole 2450 MHz; Type: D2450V2; Serial: D2450V2 - SN: 839

Communication System: CW; Frequency: 2450 MHz
 Medium parameters used: $f = 2450 \text{ MHz}$; $\sigma = 1.86 \text{ mho/m}$; $\epsilon_r = 38.9$; $\rho = 1000 \text{ kg/m}^3$
 Phantom section: Flat Section
 Measurement Standard: DASY5 (IEEE/IEC/ANSI C63.19-2007)

DASY52 Configuration:

- Probe: ES3DV3 - SN3205; ConvF(4.45, 4.45, 4.45); Calibrated: 30.12.2011
- Sensor-Surface: 3mm (Mechanical Surface Detection)
- Electronics: DAE4 Sn601; Calibrated: 04.07.2011
- Phantom: Flat Phantom 5.0 (front); Type: QD000P50AA; Serial: 1001
- DASY52 52.8.0(692); SEMCAD X 14.6.4(4989)

Dipole Calibration for Head Tissue/Pin=250 mW, d=10mm/Zoom Scan (7x7x7)/Cube 0:

Measurement grid: $dx=5\text{mm}$, $dy=5\text{mm}$, $dz=5\text{mm}$
 Reference Value = 98.155 V/m; Power Drift = 0.08 dB
 Peak SAR (extrapolated) = 27.8700
SAR(1 g) = 13.2 mW/g; SAR(10 g) = 6.09 mW/g
 Maximum value of SAR (measured) = 16.839 mW/g

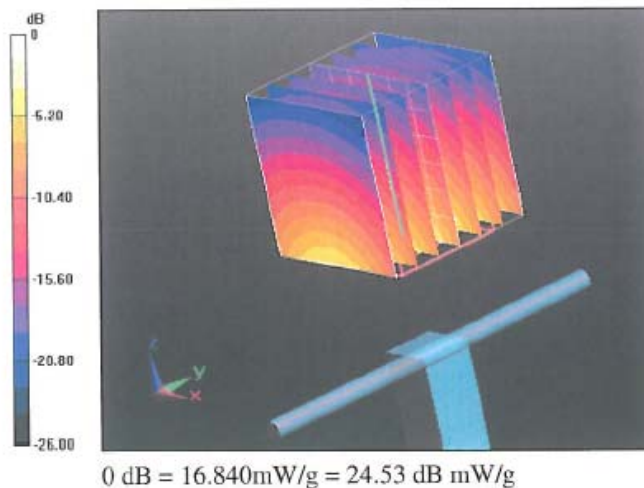

Impedance Measurement Plot for Head TSL

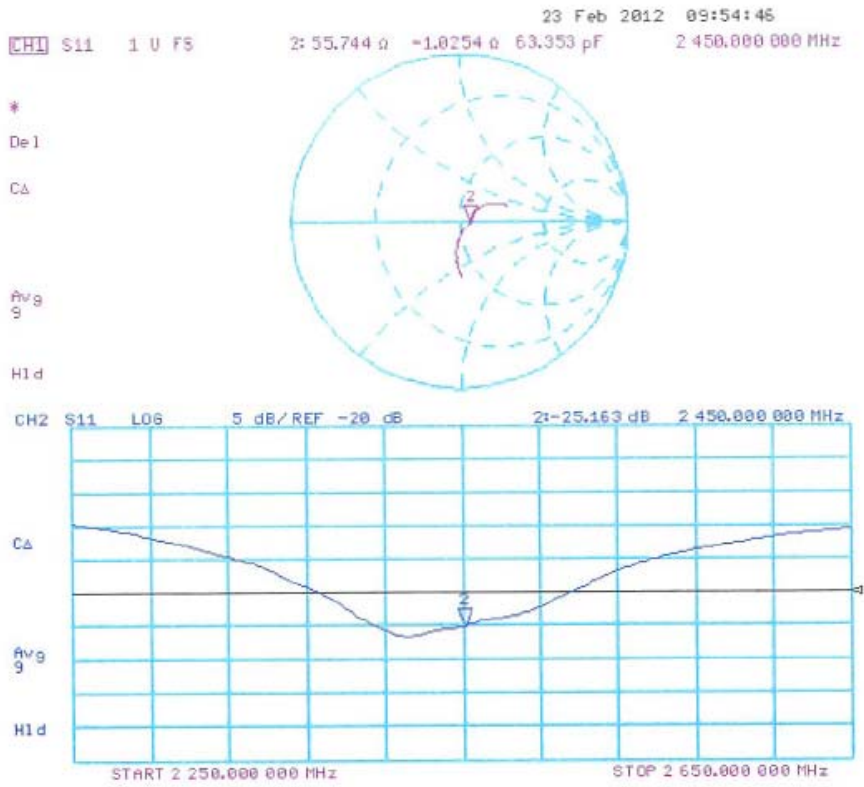

DASY5 Validation Report for Body TSL

Date: 23.02.2012

Test Laboratory: SPEAG, Zurich, Switzerland

DUT: Dipole 2450 MHz; Type: D2450V2; Serial: D2450V2 - SN: 839

Communication System: CW; Frequency: 2450 MHz

Medium parameters used: $f = 2450$ MHz; $\sigma = 2.02$ mho/m; $\epsilon_r = 52.3$; $\rho = 1000$ kg/m³

Phantom section: Flat Section

Measurement Standard: DASY5 (IEEE/IEC/ANSI C63.19-2007)

DASY52 Configuration:

- Probe: ES3DV3 - SN3205; ConvF(4.26, 4.26, 4.26); Calibrated: 30.12.2011
- Sensor-Surface: 3mm (Mechanical Surface Detection)
- Electronics: DAE4 Sn601; Calibrated: 04.07.2011
- Phantom: Flat Phantom 5.0 (back); Type: QD000P50AA; Serial: 1002
- DASY52 52.8.0(692); SEMCAD X 14.6.4(4989)

Dipole Calibration for Body Tissue/Pin=250 mW, d=10mm/Zoom Scan (7x7x7)/Cube 0:

Measurement grid: dx=5mm, dy=5mm, dz=5mm

Reference Value = 93.056 V/m; Power Drift = 0.0053 dB

Peak SAR (extrapolated) = 25.2250

SAR(1 g) = 12.4 mW/g; SAR(10 g) = 5.76 mW/g

Maximum value of SAR (measured) – 16.258 mW/g

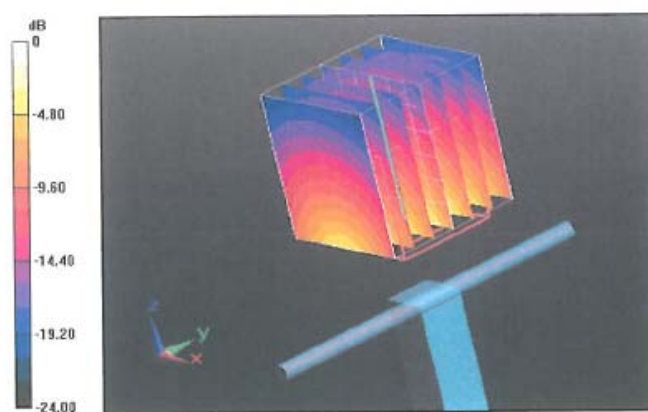

0 dB = 16.260mW/g = 24.22 dB mW/g

Impedance Measurement Plot for Body TSL

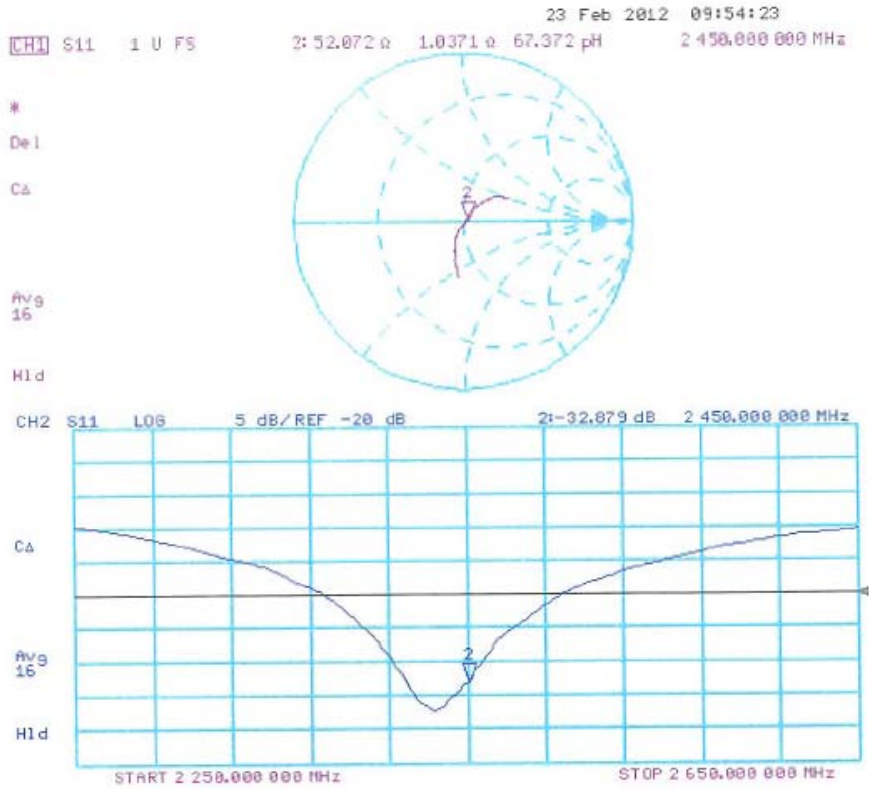

Appendix F. DAE Calibration Data

**Calibration Laboratory of
Schmid & Partner
Engineering AG**
Zeughausstrasse 43, 8004 Zurich, Switzerland



S Schweizerischer Kalibrierdienst
C Service suisse d'étalonnage
S Servizio svizzero di taratura
S Swiss Calibration Service

Accredited by the Swiss Accreditation Service (SAS)
The Swiss Accreditation Service is one of the signatories to the EA
Multilateral Agreement for the recognition of calibration certificates

Accreditation No.: **SCS 108**

Client **Quie Tek (Auden)**

Certificate No: **DAE4-1220_Jan13**

CALIBRATION CERTIFICATE

Object **DAE4 - SD 000 D04 BJ - SN: 1220**

Calibration procedure(s) **QA CAL-06.v25
Calibration procedure for the data acquisition electronics (DAE)**

Calibration date: **January 24, 2013**

This calibration certificate documents the traceability to national standards, which realize the physical units of measurements (SI).
The measurements and the uncertainties with confidence probability are given on the following pages and are part of the certificate.

All calibrations have been conducted in the closed laboratory facility: environment temperature (22 ± 3)°C and humidity < 70%.

Calibration Equipment used (M&TE critical for calibration)

Primary Standards	ID #	Cal Date (Certificate No.)	Scheduled Calibration
Keithley Multimeter Type 2001	SN: 0810278	02-Oct-12 (No:12728)	Oct-13
Secondary Standards	ID #	Check Date (in house)	Scheduled Check
Auto DAE Calibration Unit	SE UWS 053 AA 1001	07-Jan-13 (in house check)	In house check: Jan-14
Calibrator Box V2.1	SE UMS 006 AA 1002	07-Jan-13 (in house check)	In house check: Jan-14

Calibrated by: **Name** R. Mayoraz **Function** Technician **Signature** *R. Mayoraz*

Approved by: **Name** Fin Bomholt **Function** Deputy Technical Manager **Signature** *F. Bomholt*

Issued: January 24, 2013

This calibration certificate shall not be reproduced except in full without written approval of the laboratory.

**Calibration Laboratory of
Schmid & Partner
Engineering AG**
Zeughausstrasse 43, 8004 Zurich, Switzerland



S Schweizerischer Kalibrierdienst
C Service suisse d'étalonnage
S Servizio svizzero di taratura
S Swiss Calibration Service

Accredited by the Swiss Accreditation Service (SAS)
The Swiss Accreditation Service is one of the signatories to the EA
Multilateral Agreement for the recognition of calibration certificates

Accreditation No.: **SCS 108**

Glossary

DAE data acquisition electronics
Connector angle information used in DASY system to align probe sensor X to the robot coordinate system.

Methods Applied and Interpretation of Parameters

- *DC Voltage Measurement:* Calibration Factor assessed for use in DASY system by comparison with a calibrated instrument traceable to national standards. The figure given corresponds to the full scale range of the voltmeter in the respective range.
- *Connector angle:* The angle of the connector is assessed measuring the angle mechanically by a tool inserted. Uncertainty is not required.
- The following parameters as documented in the Appendix contain technical information as a result from the performance test and require no uncertainty.
 - *DC Voltage Measurement Linearity:* Verification of the Linearity at +10% and -10% of the nominal calibration voltage. Influence of offset voltage is included in this measurement.
 - *Common mode sensitivity:* Influence of a positive or negative common mode voltage on the differential measurement.
 - *Channel separation:* Influence of a voltage on the neighbor channels not subject to an input voltage.
 - *AD Converter Values with inputs shorted:* Values on the internal AD converter corresponding to zero input voltage
 - *Input Offset Measurement:* Output voltage and statistical results over a large number of zero voltage measurements.
 - *Input Offset Current:* Typical value for information; Maximum channel input offset current, not considering the input resistance.
 - *Input resistance:* Typical value for information: DAE input resistance at the connector, during internal auto-zeroing and during measurement.
 - *Low Battery Alarm Voltage:* Typical value for information. Below this voltage, a battery alarm signal is generated.
 - *Power consumption:* Typical value for information. Supply currents in various operating modes.

DC Voltage Measurement

A/D - Converter Resolution nominal

High Range: 1LSB = 6.1 μ V, full range = -100...+300 mV

Low Range: 1LSB = 61nV, full range = -1.....+3mV

DASY measurement parameters: Auto Zero Time: 3 sec; Measuring time: 3 sec

Calibration Factors	X	Y	Z
High Range	405.203 \pm 0.02% (k=2)	404.925 \pm 0.02% (k=2)	404.155 \pm 0.02% (k=2)
Low Range	3.97823 \pm 1.55% (k=2)	3.99494 \pm 1.55% (k=2)	3.98678 \pm 1.55% (k=2)

Connector Angle

Connector Angle to be used in DASY system	176.5 $^{\circ}$ \pm 1 $^{\circ}$
---	-------------------------------------

Appendix

1. DC Voltage Linearity

High Range	Reading (μV)	Difference (μV)	Error (%)
Channel X + Input	199994.51	-0.20	-0.00
Channel X + Input	20002.32	2.74	0.01
Channel X - Input	-19999.37	2.24	-0.01
Channel Y + Input	199995.12	0.58	0.00
Channel Y + Input	19999.79	0.15	0.00
Channel Y - Input	-20001.15	0.37	-0.00
Channel Z + Input	199993.80	-0.47	-0.00
Channel Z + Input	19998.06	-1.59	-0.01
Channel Z - Input	-20003.12	-1.65	0.01

Low Range	Reading (μV)	Difference (μV)	Error (%)
Channel X + Input	2000.11	0.30	0.02
Channel X + Input	199.89	-0.29	-0.15
Channel X - Input	-199.74	-0.14	0.07
Channel Y + Input	2000.30	0.54	0.03
Channel Y + Input	200.19	0.06	0.03
Channel Y - Input	-199.81	-0.14	0.07
Channel Z + Input	1999.40	-0.47	-0.02
Channel Z + Input	199.41	-0.98	-0.49
Channel Z - Input	-200.25	-0.72	0.36

2. Common mode sensitivity

DASY measurement parameters: Auto Zero Time: 3 sec; Measuring time: 3 sec

	Common mode Input Voltage (mV)	High Range Average Reading (μV)	Low Range Average Reading (μV)
Channel X	200	9.11	7.73
	- 200	-8.18	-9.59
Channel Y	200	-9.61	-9.37
	- 200	8.21	8.45
Channel Z	200	12.18	11.90
	- 200	-15.16	-14.84

3. Channel separation

DASY measurement parameters: Auto Zero Time: 3 sec; Measuring time: 3 sec

	Input Voltage (mV)	Channel X (μV)	Channel Y (μV)	Channel Z (μV)
Channel X	200	-	2.08	-4.00
Channel Y	200	7.59	-	2.69
Channel Z	200	9.59	6.24	-

4. AD-Converter Values with inputs shorted

DASY measurement parameters: Auto Zero Time: 3 sec; Measuring time: 3 sec

	High Range (LSB)	Low Range (LSB)
Channel X	15892	15975
Channel Y	16014	16213
Channel Z	15705	16067

5. Input Offset Measurement

DASY measurement parameters: Auto Zero Time: 3 sec; Measuring time: 3 sec

Input 10MΩ

	Average (μV)	min. Offset (μV)	max. Offset (μV)	Std. Deviation (μV)
Channel X	1.05	-0.80	2.18	0.45
Channel Y	-0.16	-1.22	0.92	0.45
Channel Z	-0.69	-2.22	0.60	0.48

6. Input Offset Current

Nominal Input circuitry offset current on all channels: <25fA

7. Input Resistance (Typical values for information)

	Zeroing (kOhm)	Measuring (MOhm)
Channel X	200	200
Channel Y	200	200
Channel Z	200	200

8. Low Battery Alarm Voltage (Typical values for information)

Typical values	Alarm Level (VDC)
Supply (+ Vcc)	+7.9
Supply (- Vcc)	-7.6

9. Power Consumption (Typical values for information)

Typical values	Switched off (mA)	Stand by (mA)	Transmitting (mA)
Supply (+ Vcc)	+0.01	+6	+14
Supply (- Vcc)	-0.01	-8	-9