



## SAR Test Report

Product Name : 802.11b/g/n RTL8723AS combo module  
Model No. : RTL8723AS  
FCC ID : TX2-RTL8723AS

Applicant : Realtek Semiconductor Corp  
Address : No.2, Innovation Road II, Hsinchu Science Park,  
Hsinchu 300, Taiwan

Date of Receipt : 24/04/2012  
Date of Test : 14/07/2012  
Issued Date : 19/07/2012  
Report No. : 124S053R-HP-US-P03V01  
Report Version : V2.2

The test results relate only to the samples tested.

The test report shall not be reproduced except in full without the written approval of Quietek Corporation.

# Test Report Certification

Issued Date: 19/07/2012

Report No.: 124S053R-HP-US-P03V01



Product Name : 802.11b/g/n RTL8723AS combo module

Applicant : Realtek Semiconductor Corp

Address : No.2, Innovation Road II, Hsinchu Science Park, Hsinchu 300,  
Taiwan

Manufacturer : Realtek Semiconductor Corp

Address : No.2, Innovation Road II, Hsinchu Science Park, Hsinchu 300,  
Taiwan

Model No. : RTL8723AS

Trade Name : lenovo

EUT Voltage : 3.3V

Applicable Standard : FCC OET65 Supplement C June 2001  
IEEE Std. 1528-2003; 47CFR § 2.1093

Test Result : Max. Body SAR Measurement (1g)  
802.11b: 1.05W/kg

Performed Location : Suzhou EMC Laboratory  
No.99 Hongye Rd., Suzhou Industrial Park Loufeng Hi-Tech  
Development Zone., Suzhou, China  
TEL: +86-512-6251-5088 / FAX: +86-512-6251-5098  
FCC Registration Number: 800392

Documented By : Alice Ni  
(Engineering ADM: Alice Ni)

Tested By : Robin Wu  
(Engineering Supervisor: Robin Wu)

Approved By : Marlin Chen  
(Manager: Marlin Chen)

## Laboratory Information

We, **Quietek Corporation**, are an independent EMC and safety consultancy that was established the whole facility in our laboratories. The test facility has been accredited/accepted(audited or listed) by the following related bodies in compliance with ISO 17025, EN 45001 and specified testing scope:

<b>Taiwan R.O.C.</b>	<b>:</b>	<b>BSMI, NCC, TAF</b>
<b>Germany</b>	<b>:</b>	<b>TUV Rheinland</b>
<b>Norway</b>	<b>:</b>	<b>Nemko, DNV</b>
<b>USA</b>	<b>:</b>	<b>FCC, NVLAP</b>
<b>Japan</b>	<b>:</b>	<b>VCCI</b>
<b>China</b>	<b>:</b>	<b>CNAS</b>

The related certificate for our laboratories about the test site and management system can be downloaded from Quietek Corporation's Web Site :<http://www.quietek.com/tw/ctg/cts/accreditations.htm>

The address and introduction of Quietek Corporation's laboratories can be founded in our Web site :  
<http://www.quietek.com/>

If you have any comments, Please don't hesitate to contact us. Our contact information is as below:

### **HsinChu Testing Laboratory :**

No.75-2, 3rd Lin, Wangye Keng, Yonghxing Tsuen, Qionglin Shiang, Hsinchu County 307, Taiwan, R.O.C.  
TEL:+886-3-592-8858 / FAX:+886-3-592-8859 E-Mail : [service@quietek.com](mailto:service@quietek.com)

### **LinKou Testing Laboratory :**

No.5-22, Ruishukeng, Linkou Dist., New Taipei City 24451, Taiwan, R.O.C.  
TEL : 886-2-8601-3788 / FAX : 886-2-8601-3789 E-Mail : [service@quietek.com](mailto:service@quietek.com)

### **Suzhou Testing Laboratory :**

No.99 Hongye Rd., Suzhou Industrial Park Loufeng Hi-Tech Development Zone., SuZhou, China  
TEL : +86-512-6251-5088 / FAX : 86-512-6251-5098 E-Mail : [service@quietek.com](mailto:service@quietek.com)

## TABLE OF CONTENTS

Description	Page
<b>1. General Information .....</b>	<b>6</b>
1.1. EUT Description .....	6
1.2. Test Environment.....	7
<b>2. SAR Measurement System .....</b>	<b>8</b>
2.1. DASY5 System Description.....	8
2.1.1. Applications .....	9
2.1.2. Area Scans .....	9
2.1.3. Zoom Scan (Cube Scan Averaging) .....	9
2.1.4. Uncertainty of Inter-/Extrapolation and Averaging .....	9
2.2. DASY5 E-Field Probe.....	10
2.2.1. Isotropic E-Field Probe Specification .....	10
2.3. Boundary Detection Unit and Probe Mounting Device .....	11
2.4. DATA Acquisition Electronics (DAE) and Measurement Server .....	11
2.5. Robot.....	12
2.6. Light Beam Unit.....	12
2.7. Device Holder.....	13
2.8. SAM Twin Phantom.....	13
<b>3. Tissue Simulating Liquid .....</b>	<b>14</b>
3.1. The composition of the tissue simulating liquid .....	14
3.2. Tissue Calibration Result.....	14
3.3. Tissue Dielectric Parameters for Head and Body Phantoms .....	15
<b>4. SAR Measurement Procedure .....</b>	<b>16</b>
4.1. SAR System Validation.....	16
4.1.1. Validation Dipoles .....	16
4.1.2. Validation Result.....	16
4.2. SAR Measurement Procedure.....	17
<b>5. SAR Exposure Limits .....</b>	<b>18</b>
<b>6. Test Equipment List.....</b>	<b>19</b>
<b>7. Measurement Uncertainty.....</b>	<b>20</b>
<b>8. Conducted Power Measurement .....</b>	<b>21</b>
<b>9. Test Results.....</b>	<b>22</b>

9.1. SAR Test Results Summary .....22

9.2. Operation Mode.....22

9.3. Document Reference .....22

9.4. Test Results.....23

**Appendix A. SAR System Validation Data .....24**

**Appendix B. SAR measurement Data .....25**

**Appendix C. Test Setup Photographs & EUT Photographs.....35**

**Appendix D. Probe Calibration Data .....36**

**Appendix E. Dipole Calibration Data.....47**

**Appendix F. DAE Calibration Data.....55**

## 1. General Information

### 1.1. EUT Description

Product Name	802.11b/g/n RTL8723AS combo module
Model No.	RTL8723AS
FCC ID	TX2-RTL8723AS
<b>WIFI</b>	
Frequency Range	802.11b/g/n(20MHz): 2412 - 2462 MHz 802.11n(40MHz): 2422 - 2452 MHz
Channel Number	802.11b/g/n(20MHz): 11 802.11n(40MHz): 7
Type of Modulation	802.11b: DSSS 802.11b/n: OFDM
Data Rate	802.11b: 1/2/5.5/11 Mbps 802.11g: 6/9/12/18/24/36/48/54 Mbps 802.11n: up to 150 Mbps
Device Category	Mobile
RF Exposure Environment	Uncontrolled
Antenna Type	PIFA
Antenna Delivery	1*Tx + 1*Rx
Peak Antenna Gain	0.19dBi
Max. Output Power (Average)	802.11b: 14.30dBm 802.11g: 12.97dBm 802.11n(20MHz): 12.82dBm 802.11n(40MHz): 10.57dBm
<b>Bluetooth</b>	
Bluetooth Frequency	2402~2480MHz
Bluetooth Version	V4.0
Type of modulation	FHSS
Data Rate	1Mbps(GFSK), 2Mbps(Pi/4 DQPSK), 3Mbps (8DPSK)
Antenna Gain	0.19dBi

#### Tested System Details

Product	Manufacturer	Model No.
Notebook Computer	lenovo	20175XXXX; 2191XXXX (X=0-9,A-Z or Blank)

**1.2. Test Environment**

Ambient conditions in the laboratory:

<b>Items</b>	<b>Required</b>	<b>Actual</b>
Temperature (°C)	18-25	21.5± 2
Humidity (%RH)	30-70	52

## 2. SAR Measurement System

### 2.1. DASY5 System Description

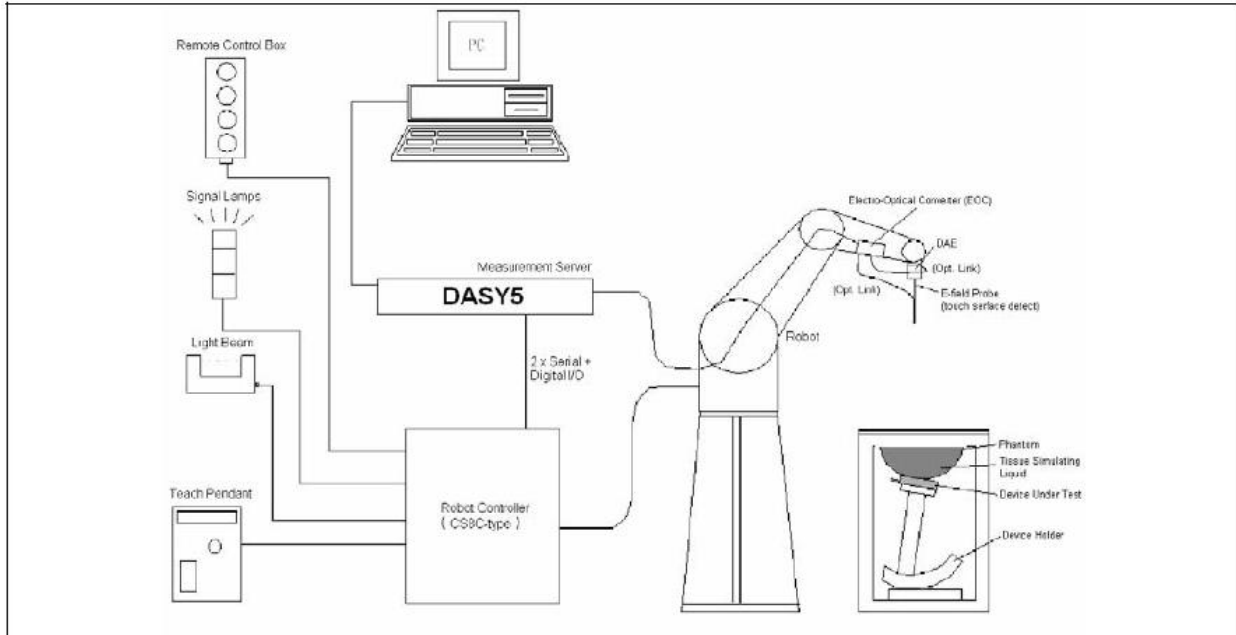

The DASY5 system for performing compliance tests consists of the following items:

- A standard high precision 6-axis robot with controller, teach pendant and software. An arm extension for accommodating the data acquisition electronics (DAE).
- A data acquisition electronics (DAE) which performs the signal amplification, signal multiplexing, AD-conversion, offset measurements, mechanical surface detection, collision detection, etc. The unit is battery powered with standard or rechargeable batteries. The signal is optically transmitted to the EOC.
- The Electro-optical converter (EOC) performs the conversion from optical to electrical signals for the digital communication to the DAE. To use optical surface detection, a special version of the EOC is required. The EOC signal is transmitted to the measurement server.
- The Light Beam used is for probe alignment. This improves the (absolute) accuracy of the probe positioning.
- A computer running WinXP and the DASY5 software.
- Remote control and teach pendant as well as additional circuitry for robot safety such as warning lamps, etc.
- The phantom, the device holder and other accessories according to the targeted measurement.



### **2.1.1. Applications**

Predefined procedures and evaluations for automated compliance testing with all worldwide standards, e.g., IEEE 1528, OET 65, IEC 62209-1, IEC 62209-2, EN 50360, EN 50383 and others.

### **2.1.2. Area Scans**

Area scans are defined prior to the measurement process being executed with a user defined variable spacing between each measurement point (integral) allowing low uncertainty measurements to be conducted. Scans defined for FCC applications utilize a 10mm<sup>2</sup> step integral, with 1mm interpolation used to locate the peak SAR area used for zoom scan assessments.

When an Area Scan has measured all reachable points, it computes the field maxima found in the scanned area, within a range of the global maximum. The range (in dB) is specified in the standards for compliance testing. For example, a 2 dB range is required in IEEE 1528-2003 and IEC 62209 standards, whereby 3 dB is a requirement when compliance is assessed in accordance with the ARIB standard (Japan).

### **2.1.3. Zoom Scan (Cube Scan Averaging)**

Zoom Scans are used to assess the peak spatial SAR values within a cubic averaging volume containing 1 g and 10 g of simulated tissue. A density of 1000 kg/m<sup>3</sup> is used to represent the head and body tissue density and not the phantom liquid density, in order to be consistent with the definition of the liquid dielectric properties, i.e. the side length of the 1 g cube is 10mm, with the side length of the 10 g cube 21,5mm.

The zoom scan integer steps can be user defined so as to reduce uncertainty, but normal practice for typical test applications utilize a physical step of 7x7x7 (5mmx5mmx5mm) providing a volume of 30mm in the X & Y axis, and 30mm in the Z axis.

### **2.1.4. Uncertainty of Inter-/Extrapolation and Averaging**

In order to evaluate the uncertainty of the interpolation, extrapolation and averaged SAR calculation algorithms of the Postprocessor, DASY5 allows the generation of measurement grids which are artificially predefined by analytically based test functions. Therefore, the grids of area scans and zoom scans can be filled with uncertainty test data, according to the SAR benchmark functions of IEEE 1528. The three analytical functions shown in equations as below are used to describe the possible range of the expected SAR distributions for the tested handsets. The field gradients are covered by the spatially flat distribution f1, the spatially steep distribution f3 and f2 accounts for H-field cancellation on the phantom/tissue surface.

$$f_1(x, y, z) = Ae^{-\frac{z}{2a}} \cos^2 \left( \frac{\pi \sqrt{x'^2 + y'^2}}{2 \cdot 5a} \right)$$

$$f_2(x, y, z) = Ae^{-\frac{z}{a}} \frac{a^2}{a^2 + x'^2} \left( 3 - e^{-\frac{2z}{a}} \right) \cos^2 \left( \frac{\pi y'}{2 \cdot 3a} \right)$$

$$f_3(x, y, z) = A \frac{a^2}{\frac{a^2}{4} + x'^2 + y'^2} \left( e^{-\frac{2z}{a}} + \frac{a^2}{2(a + 2z)^2} \right)$$

**2.2. DASY5 E-Field Probe**

The SAR measurement is conducted with the dosimetric probe manufactured by SPEAG. The probe is specially designed and calibrated for use in liquid with high permittivity. The dosimetric probe has special calibration in liquid at different frequency. SPEAG conducts the probe calibration in compliance with international and national standards (e.g. IEEE 1528, EN 62209-1, IEC 62209, etc.) under ISO 17025. The calibration data are in Appendix D.

**2.2.1. Isotropic E-Field Probe Specification**

<b>Model</b>	EX3DV4	
<b>Construction</b>	Symmetrical design with triangular core Built-in shielding against static charges PEEK enclosure material (resistant to organic solvents, e.g., DGBE)	
<b>Frequency</b>	10 MHz to 6 GHz Linearity: ± 0.2 dB (30 MHz to 6 GHz)	
<b>Directivity</b>	± 0.3 dB in HSL (rotation around probe axis) ± 0.5 dB in tissue material (rotation normal to probe axis)	
<b>Dynamic Range</b>	10 µW/g to 100 mW/g Linearity: ± 0.2 dB (noise: typically < 1 µW/g)	
<b>Dimensions</b>	Overall length: 330 mm (Tip: 20 mm) Tip diameter: 2.5 mm (Body: 12 mm) Typical distance from probe tip to dipole centers: 1 mm	
<b>Application</b>	High precision dosimetric measurements in any exposure scenario (e.g., very strong gradient fields). Only probe which enables compliance testing for frequencies up to 6 GHz with precision of better 30%.	

**2.3. Boundary Detection Unit and Probe Mounting Device**

The DASY probes use a precise connector and an additional holder for the probe, consisting of a plastic tube and a flexible silicon ring to center the probe. The connector at the DAE is flexibly mounted and held in the default position with magnets and springs. Two switching systems in the connector mount detect frontal and lateral probe collisions and trigger the necessary software response.

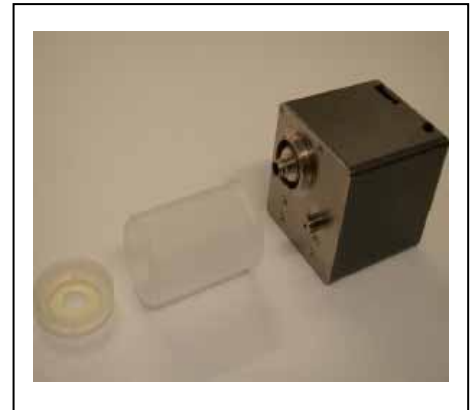

**2.4. DATA Acquisition Electronics (DAE) and Measurement Server**

The data acquisition electronics (DAE) consists of a highly sensitive electrometer-grade preamplifier with auto-zeroing, a channel and gain-switching multiplexer, a fast 16 bit AD-converter and a command decoder and control logic unit.

Transmission to the measurement server is accomplished through an optical downlink for data and status information as well as an optical uplink for commands and the clock.

The input impedance of the DAE4 is 200M Ohm; the inputs are symmetrical and floating. Common mode rejection is above 80dB.

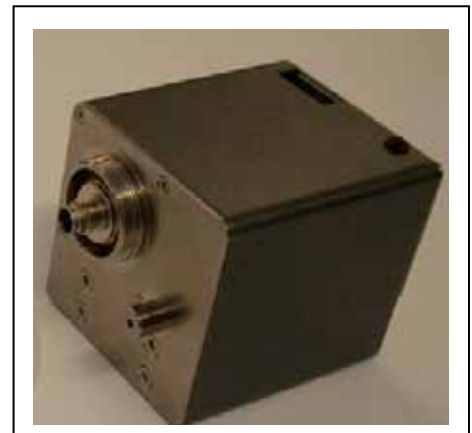

The DASY5 measurement server is based on a PC/104 CPU board with a 400MHz intel ULV Celeron, 128MB chipdisk and 128MB RAM. The necessary circuits for communication with the DAE electronics box, as well as the 16 bit AD converter system for optical detection and digital I/O interface are contained on the DASY5 I/O board, which is directly connected to the PC/104 bus of the CPU board.



**2.5. Robot**

The DASY5 system uses the high precision robots TX90 XL type out of the newer series from Stäubli SA (France). For the 6-axis controller DASY5 system, the CS8C robot controller version from Stäubli is used.

The XL robot series have many features that are important for our application:

- High precision (repeatability 0.02 mm)
- High reliability (industrial design)
- Jerk-free straight movements
- Low ELF interference (the closed metallic construction shields against motor control fields)
- 6-axis controller



**2.6. Light Beam Unit**

The light beam switch allows automatic "tooling" of the probe. During the process, the actual position of the probe tip with respect to the robot arm is measured, as well as the probe length and the horizontal probe offset. The software then corrects all movements, such that the robot coordinates are valid for the probe tip.

The repeatability of this process is better than 0.1 mm. If a position has been taught with an aligned probe, the same position will be reached with another aligned probe within 0.1 mm, even if the other probe has different dimensions. During probe rotations, the probe tip will keep its actual position.



## 2.7. Device Holder

The DASY5 device holder is designed to cope with different positions given in the standard. It has two scales for the device rotation (with respect to the body axis) and the device inclination (with respect to the line between the ear reference points). The rotation center for both scales is the ear reference point (EPR).

Thus the device needs no repositioning when changing the angles.

The DASY5 device holder has been made out of low-loss POM material having the following dielectric parameters: relative permittivity  $\epsilon_r = 3$  and loss tangent  $\delta = 0.02$ . The amount of dielectric material has been reduced in the closest vicinity of the device, since measurements have suggested that the influence of the clamp on the test results could thus be lowered.



## 2.8. SAM Twin Phantom

The SAM twin phantom is a fiberglass shell phantom with 2mm shell thickness (except the ear region where shell thickness increases to 6mm). It has three measurement areas:

- Left head
- Right head
- Flat phantom



The bottom plate contains three pair of bolts for locking the device holder. The device holder positions are adjusted to the standard measurement positions in the three sections. A white cover is provided to tap the phantom during off-periods to prevent water evaporation and changes in the liquid parameters. On the phantom top, three reference markers are provided to identify the phantom position with respect to the robot.

### 3. Tissue Simulating Liquid

#### 3.1. The composition of the tissue simulating liquid

INGREDIENT (% Weight)	2450MHz Head	2450MHz Body
Water	46.7	73.2
Salt	0.00	0.04
Sugar	0.00	0.00
HEC	0.00	0.00
Preventol	0.00	0.00
DGBE	53.3	26.7
Triton X-100	0.00	0.00

#### 3.2. Tissue Calibration Result

The dielectric parameters of the liquids were verified prior to the SAR evaluation using DASY5 Dielectric Probe Kit and Agilent Vector Network Analyzer E5071C

<b>Body Tissue Simulant Measurement</b>				
Frequency [MHz]	Description	Dielectric Parameters		Tissue Temp. [°C]
		$\epsilon_r$	$\sigma$ [s/m]	
2450MHz	Reference result ± 5% window	52.7 50.07 to 55.34	1.95 1.85 to 2.05	N/A
	14-07-2012	51.37	2.00	21.0

**3.3. Tissue Dielectric Parameters for Head and Body Phantoms**

The head tissue dielectric parameters recommended by the IEEE SCC-34/SC-2 in P1528 have been incorporated in the following table. These head parameters are derived from planar layer models simulating the highest expected SAR for the dielectric properties and tissue thickness variations in a human head. Other head and body tissue parameters that have not been specified in P1528 are derived from the tissue dielectric parameters computed from the 4-Cole-Cole equations described in Reference [12] and extrapolated according to the head parameters specified in P1528.

Target Frequency (MHz)	Head		Body	
	$\epsilon_r$	$\sigma$ (S/m)	$\epsilon_r$	$\sigma$ (S/m)
150	52.3	0.76	61.9	0.80
300	45.3	0.87	58.2	0.92
450	43.5	0.87	56.7	0.94
835	41.5	0.90	55.2	0.97
900	41.5	0.97	55.0	1.05
915	41.5	0.98	55.0	1.06
1450	40.5	1.20	54.0	1.30
1610	40.3	1.29	53.8	1.40
1800 – 2000	40.0	1.40	53.3	1.52
2450	39.2	1.80	<b>52.7</b>	<b>1.95</b>
3000	38.5	2.40	52.0	2.73
5800	35.3	5.27	48.2	6.00

( $\epsilon_r$  = relative permittivity,  $\sigma$  = conductivity and  $\rho = 1000 \text{ kg/m}^3$ )

## 4. SAR Measurement Procedure

### 4.1. SAR System Validation

#### 4.1.1. Validation Dipoles

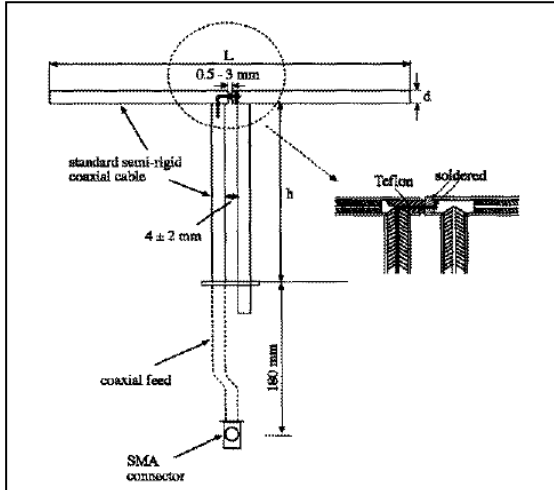

The dipoles used is based on the IEEE-1528 standard, and is complied with mechanical and electrical specifications in line with the requirements of both IEEE and FCC Supplement C. the table below provides details for the mechanical and electrical specifications for the dipoles.

Frequency	L (mm)	h (mm)	d (mm)
2450MHz	53.5	30.4	3.6

#### 4.1.2. Validation Result

System Performance Check at 2450MHz				
Validation Dipole: D2450V2, SN: 839				
Frequency [MHz]	Description	SAR [w/kg] 1g	SAR [w/kg] 10g	Tissue Temp. [°C]
2450 MHz	Reference result ± 10% window	48.7 43.83 to 53.57	22.8 20.52 to 25.08	N/A
	14-07-2012	49.20	22.40	21.0

Note: All SAR values are normalized to 1W forward power.



#### 4.2. SAR Measurement Procedure

The DASY5 calculates SAR using the following equation,

$$SAR = \frac{\sigma |E|^2}{\rho}$$

$\sigma$ : represents the simulated tissue conductivity

$\rho$ : represents the tissue density

The EUT is set to transmit at the required power in line with product specification, at each frequency relating to the LOW, MID, and HIGH channel settings.

Pre-scans are made on the device to establish the location for the transmitting antenna, using a large area scan in either air or tissue simulation fluid.

The EUT is placed against the Universal Phantom where the maximum area scan dimensions are larger than the physical size of the resonating antenna. When the scan size is not large enough to cover the peak SAR distribution, it is modified by either extending the area scan size in both the X and Y directions, or the device is shifted within the predefined area.

The area scan is then run to establish the peak SAR location (interpolated resolution set at  $1\text{mm}^2$ ) which is then used to orient the center of the zoom scan. The zoom scan is then executed and the 1g and 10g averages are derived from the zoom scan volume (interpolated resolution set at  $1\text{mm}^3$ ).

## 5. SAR Exposure Limits

SAR assessments have been made in line with the requirements of IEEE-1528, FCC Supplement C, and comply with ANSI/IEEE C95.1-1992 “Uncontrolled Environments” limits. These limits apply to a location which is deemed as “Uncontrolled Environment” which can be described as a situation where the general public may be exposed to an RF source with no prior knowledge or control over their exposure.

### Limits for General Population/Uncontrolled Exposure (W/kg)

Type Exposure	Uncontrolled Environment Limit
Spatial Peak SAR (1g cube tissue for brain or body)	1.60 W/kg
Spatial Average SAR (whole body)	0.08 W/kg
Spatial Peak SAR (10g for hands, feet, ankles and wrist)	4.00 W/kg

## 6. Test Equipment List

Instrument	Manufacturer	Model No.	Serial No.	Cali. Due Date
Stäubli Robot TX60L	Stäubli	TX60L	F10/5C90A1/A/01	only once
Controller	Stäubli	SP1	S-0034	only once
Dipole Validation Kits	Speag	D2450V2	839	2013.02.23
SAM Twin Phantom	Speag	SAM	TP-1561/1562	N/A
Device Holder	Speag	SD 000 H01 HA	N/A	N/A
Data Acquisition Electronic	Speag	DAE4	1220	2013.01.23
E-Field Probe	Speag	EX3DV4	3710	2013.03.12
SAR Software	Speag	DASY5	V5.2 Build 162	N/A
Power Amplifier	Mini-Circuit	ZHL-42	D051404-28	N/A
Directional Coupler	Agilent	778D	20160	N/A
Vector Network	Agilent	E5071C	MY48367267	2013.04.10
Signal Generator	Agilent	E4438C	MY49070163	2013.04.18
Power Meter	Anritsu	ML2495A	0905006	2013.01.12
Wide Bandwidth Sensor	Anritsu	MA2411B	0846014	2013.01.12

7. Measurement Uncertainty

DASY5 Uncertainty								
Measurement uncertainty for 300 MHz to 3 GHz averaged over 1 gram / 10 gram.								
Error Description	Uncert. value	Prob. Dist.	Div.	(ci) 1g	(ci) 10g	Std. Unc. (1g)	Std. Unc. (10g)	(vi) V <sub>eff</sub>
<b>Measurement System</b>								
Probe Calibration	±6.0%	N	1	1	1	±6.0%	±6.0%	∞
Axial Isotropy	±4.7%	R	√3	0.7	0.7	±1.9%	±1.9%	∞
Hemispherical Isotropy	±9.6%	R	√3	0.7	0.7	±3.9%	±3.9%	∞
Boundary Effects	±1.0%	R	√3	1	1	±0.6%	±0.6%	∞
Linearity	±4.7%	R	√3	1	1	±2.7%	±2.7%	∞
System Detection Limits	±1.0%	R	√3	1	1	±0.6%	±0.6%	∞
Readout Electronics	±0.3%	N	1	1	1	±0.3%	±0.3%	∞
Response Time	±0.8%	R	√3	1	1	±0.5%	±0.5%	∞
Integration Time	±2.6%	R	√3	1	1	±1.5%	±1.5%	∞
RF Ambient Noise	±3.0%	R	√3	1	1	±1.7%	±1.7%	∞
RF Ambient Reflections	±3.0%	R	√3	1	1	±1.7%	±1.7%	∞
Probe Positioner	±0.4%	R	√3	1	1	±0.2%	±0.2%	∞
Probe Positioning	±2.9%	R	√3	1	1	±1.7%	±1.7%	∞
Max. SAR Eval.	±1.0%	R	√3	1	1	±0.6%	±0.6%	∞
<b>Test Sample Related</b>								
Device Positioning	±2.9%	N	1	1	1	±2.9%	±2.9%	145
Device Holder	±3.6%	N	1	1	1	±3.6%	±3.6%	5
Power Drift	±5.0%	R	√3	1	1	±2.9%	±2.9%	∞
<b>Phantom and Setup</b>								
Phantom Uncertainty	±4.0%	R	√3	1	1	±2.3%	±2.3%	∞
Liquid Conductivity (target)	±5.0%	R	√3	0.64	0.43	±1.8%	±1.2%	∞
Liquid Conductivity (meas.)	±2.5%	N	1	0.64	0.43	±1.6%	±1.1%	∞
Liquid Permittivity (target)	±5.0%	R	√3	0.6	0.49	±1.7%	±1.4%	∞
Liquid Permittivity (meas.)	±2.5%	N	1	0.6	0.49	±1.5%	±1.2%	∞
<b>Combined Std. Uncertainty</b>						±10.9%	±10.7%	387
<b>Expanded STD Uncertainty</b>						±21.9%	±21.4%	

## 8. Conducted Power Measurement

Test Mode	Data Rate	Channel No.	Frequency (MHz)	TX Power level (in software)	Average Power (dBm)
802.11b	1Mbps	01	2412	36	14.26
		06	2437	36	14.26
		11	2462	36	14.30
802.11g	6Mbps	01	2412	39	11.65
		06	2437	42	12.97
		11	2462	38	11.54
802.11n(20MHz)	6.5Mbps	01	2412	37	10.35
		06	2437	42	12.82
		11	2462	35	9.50
802.11n(40MHz)	13.5Mbps	03	2422	37	10.57
		06	2437	36	10.16
		09	2452	36	10.30

Note: Average Power test was verified over all data rates of each mode, and the data rates listed above showed the worst case for average power.

## **9. Test Results**

### **9.1. SAR Test Results Summary**

#### **9.1.1. Test position and configuration**

Body SAR was performed with the device configured in the positions according to FCC OET65. SAR test was performed with the device 0mm (touch) from the phantom for the worst case due to antenna position. Test Position: Bottom of Laptop, Bottom of Tablet, Primary Landscape of Tablet, Secondary Portrait of Tablet. Please refer to the test photograph for details.

#### **9.1.2. Operation Mode**

During the test, "Realtek 11n 8723ASDIO WLAN MP Diagnostic Program 0.0006.0202.2012" under WIN XP was executed the test program to control the EUT continuously transmit RF signal. Evaluation mode: 802.11b, 802.11g, 802.11n (20MHz BW) and 802.11n (40MHz BW).

#### **9.1.3. Co-located SAR**

Bluetooth output power is less than Pref, and the distance between WiFi and BT is 145mm. Therefore, standalone SAR and simultaneous SAR for Bluetooth is not required.

#### **9.1.4. Document Reference**

FCC KDB 248227 D01 and KDB 447498 D01 and KDB 616217 D03

**9.2. Test Results**

SAR MEASUREMENT							
Ambient Temperature (°C) : 21.5 ±2				Relative Humidity (%): 55			
Liquid Temperature (°C) : 21.0 ±2				Depth of Liquid (cm):>15			
Product: 802.11b/g/n RTL8723AS combo module							
Test Mode: Laptop Mode-802.11b							
Test Position Body	Antenna Position	Frequency		Separation Distance (mm)	Power Drift (<±0.2)	SAR 1g (W/kg)	Limit (W/kg)
		Channel	MHz				
Bottom of PC	Fixed	1	2412	0	-0.05	1.05	1.6
Bottom of PC	Fixed	6	2437	0	0.10	0.955	1.6
Bottom of PC	Fixed	11	2462	0	-0.13	0.829	1.6
Test Mode: Laptop Mode-802.11g							
Bottom of PC	Fixed	6	2437	0	0.15	0.671	1.6
Test Mode: Laptop Mode-802.11n(20MHz)							
Bottom of PC	Fixed	6	2437	0	-0.16	0.665	1.6
Test Mode: Laptop Mode-802.11n(40MHz)							
Bottom of PC	Fixed	6	2437	0	-0.09	0.443	1.6
Test Mode: Tablet Mode-802.11b							
Bottom of Tablet	Fixed	6	2437	0	0.07	0.590	1.6
Primary Landscape	Fixed	6	2437	0	0.11	0.679	1.6
Secondary Portrait	Fixed	6	2437	0	-0.09	0.070	1.6

## Appendix A. SAR System Validation Data

Date/Time: 14-07-2012

Test Laboratory: QuieTek Lab

System Check Body 2450MHz

**DUT: Dipole 2450 MHz D2450V2; Type: D2450V2**

Communication System: CW; Communication System Band: D2450 (2450.0 MHz); Duty Cycle: 1:1;

Frequency: 2450 MHz; Medium parameters used:  $f = 2450$  MHz;  $\sigma = 2$  mho/m;  $\epsilon r = 51.37$ ;  $\rho = 1000$  kg/m<sup>3</sup> ; Phantom section: Flat Section ; Input Power=250mW

Ambient temperature (°C): 21.5, Liquid temperature (°C): 21.0

DASY5 Configuration:

- Probe: EX3DV4 - SN3710; ConvF(6.98, 6.98, 6.98); Calibrated: 12/03/2012;
- Sensor-Surface: 4mm (Mechanical Surface Detection)
- Electronics: DAE4 Sn1220; Calibrated: 23/01/2012
- Phantom: SAM2; Type: SAM; Serial: TP1562
- Measurement SW: DASY52, Version 52.8 (1); SEMCAD X Version 14.6.5 (6469)

**Configuration/System Check Body 2450MHz/Area Scan (7x11x1):** Measurement grid: dx=10mm, dy=10mm, Maximum value of SAR (measured) = 13.3 mW/g

**Configuration/System Check Body 2450MHz/Zoom Scan (7x7x7)/Cube 0:** Measurement grid: dx=5mm, dy=5mm, dz=5mm, Reference Value = 81.523 V/m; Power Drift = 0.04 dB

Peak SAR (extrapolated) = 26.016 mW/g

**SAR(1 g) = 12.3 mW/g; SAR(10 g) = 5.6 mW/g** Maximum value of SAR (measured) = 14.2 mW/g

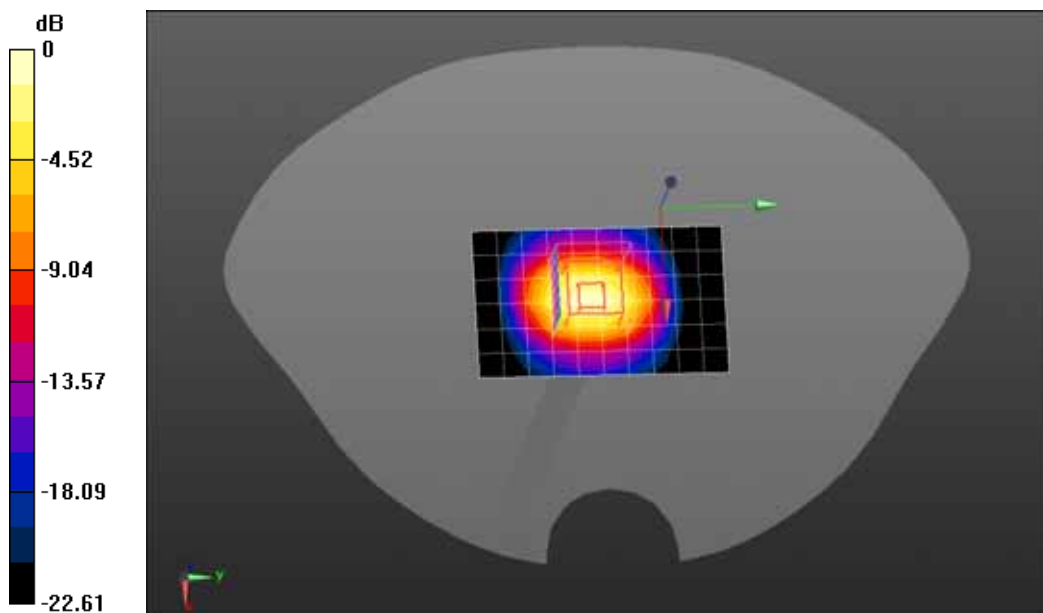

0 dB = 14.2 mW/g = 23.05 dB mW/g



## Appendix B. SAR measurement Data

Date/Time: 14-07-2012

Test Laboratory: QuieTek Lab

802.11b 2412MHz-Bottom-Laptop Mode

**DUT: 802.11b/g/n RTL8723AS combo module; Type: RTL8723AS**

Communication System: Wi-Fi; Communication System Band: 802.11b; Duty Cycle: 1:1.0; Frequency: 2412 MHz; Medium parameters used:  $f = 2412$  MHz;  $\sigma = 1.95$  mho/m;  $\epsilon_r = 51.54$ ;  $\rho = 1000$  kg/m<sup>3</sup>; Phantom section: Flat Section

Ambient temperature (°C): 21.5, Liquid temperature (°C): 21.0

DASY5 Configuration:

- Probe: EX3DV4 - SN3710; ConvF(6.98, 6.98, 6.98); Calibrated: 12/03/2012;
- Sensor-Surface: 4mm (Mechanical Surface Detection)
- Electronics: DAE4 Sn1220; Calibrated: 23/01/2012
- Phantom: SAM2; Type: SAM; Serial: TP1562
- Measurement SW: DASY52, Version 52.8 (1); SEMCAD X Version 14.6.5 (6469)

**Configuration/802.11b 2412MHz-Bottom/Area Scan (7x9x1):** Measurement grid: dx=20mm, dy=20mm

Maximum value of SAR (measured) = 0.881 mW/g

**Configuration/802.11b 2412MHz-Bottom/Zoom Scan (5x5x7)/Cube 0:** Measurement grid: dx=8mm,

dy=8mm, dz=5mm, Reference Value = 21.137 V/m; Power Drift = -0.05 dB

Peak SAR (extrapolated) = 2.760 mW/g

**SAR(1 g) = 1.05 mW/g; SAR(10 g) = 0.413 mW/g** Maximum value of SAR (measured) = 1.13 mW/g

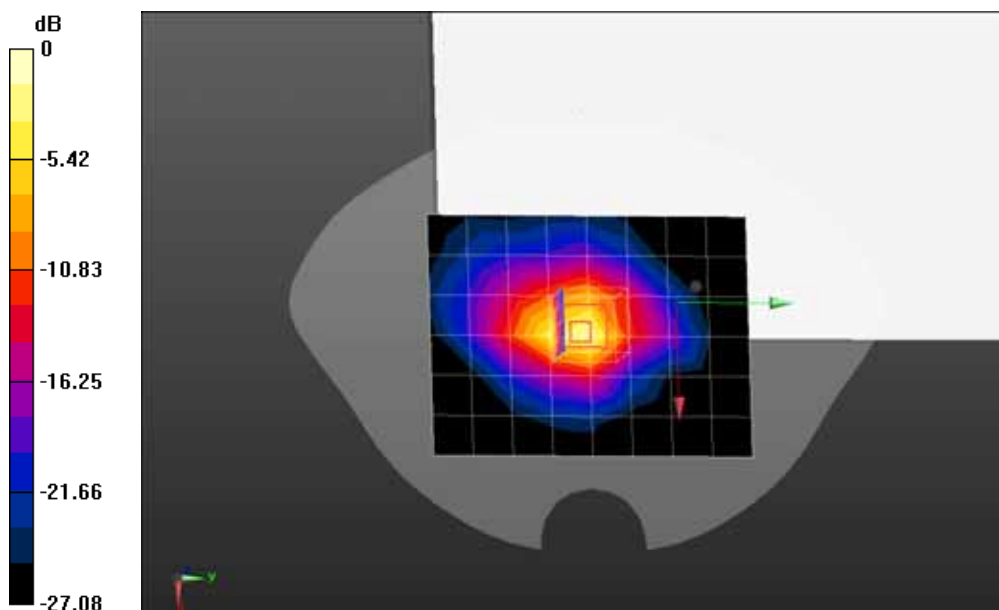

0 dB = 1.13 mW/g = 1.06 dB mW/g

Z-Axis Plot

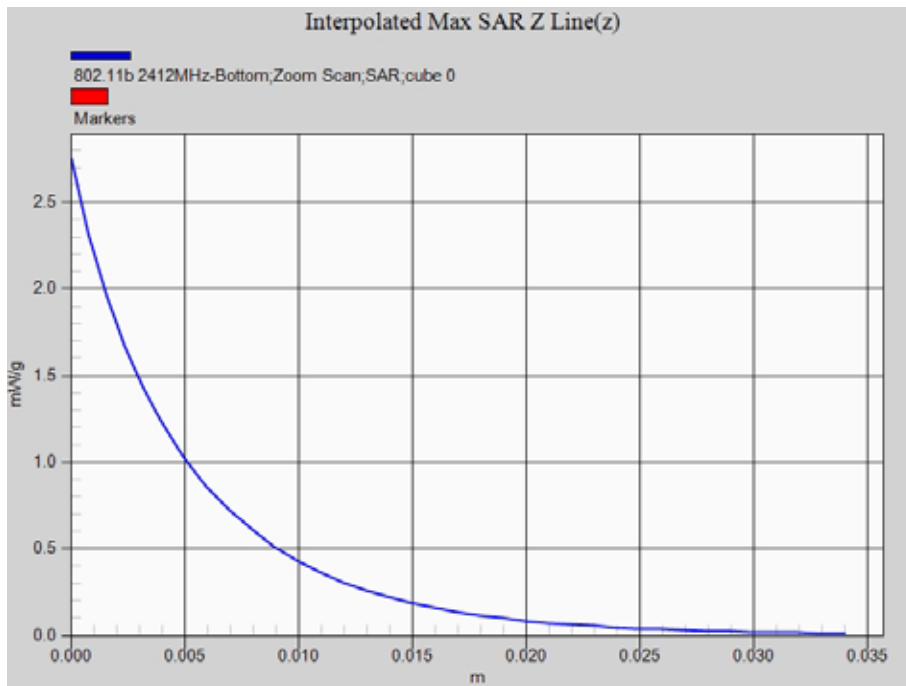

Date/Time: 14-07-2012

Test Laboratory: QuieTek Lab

802.11b 2437MHz-Bottom-Laptop Mode

**DUT: 802.11b/g/n RTL8723AS combo module; Type: RTL8723AS**

Communication System: Wi-Fi; Communication System Band: 802.11b; Duty Cycle: 1:1.0; Frequency: 2437 MHz; Medium parameters used:  $f = 2437$  MHz;  $\sigma = 1.98$  mho/m;  $\epsilon r = 51.42$ ;  $\rho = 1000$  kg/m<sup>3</sup>; Phantom section: Flat Section

Ambient temperature (°C): 21.5, Liquid temperature (°C): 21.0

DASY5 Configuration:

- Probe: EX3DV4 - SN3710; ConvF(6.98, 6.98, 6.98); Calibrated: 12/03/2012;
- Sensor-Surface: 4mm (Mechanical Surface Detection)
- Electronics: DAE4 Sn1220; Calibrated: 23/01/2012
- Phantom: SAM2; Type: SAM; Serial: TP1562
- Measurement SW: DASY52, Version 52.8 (1); SEMCAD X Version 14.6.5 (6469)

**Configuration/802.11b 2437MHz-Bottom/Area Scan (7x9x1):** Measurement grid: dx=20mm, dy=20mm

Maximum value of SAR (measured) = 0.735 mW/g

**Configuration/802.11b 2437MHz-Bottom/Zoom Scan (5x5x7)/Cube 0:** Measurement grid: dx=8mm, dy=8mm, dz=5mm, Reference Value = 19.148 V/m; Power Drift = 0.10 dB

Peak SAR (extrapolated) = 2.526 mW/g

**SAR(1 g) = 0.955 mW/g; SAR(10 g) = 0.372 mW/g** Maximum value of SAR (measured) = 1.02 mW/g

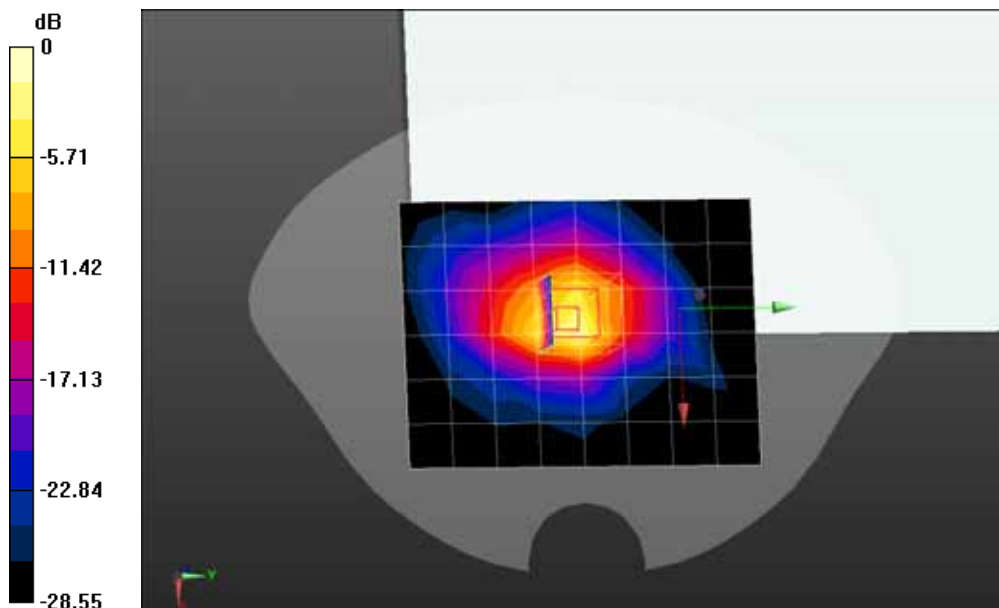

0 dB = 1.02 mW/g = 0.17 dB mW/g

Date/Time: 14-07-2012

Test Laboratory: QuieTek Lab

802.11b 2462MHz-Bottom-Laptop Mode

**DUT: 802.11b/g/n RTL8723AS combo module; Type: RTL8723AS**

Communication System: Wi-Fi; Communication System Band: 802.11b; Duty Cycle: 1:1.0; Frequency: 2462 MHz; Medium parameters used:  $f = 2462$  MHz;  $\sigma = 2.02$  mho/m;  $\epsilon_r = 51.33$ ;  $\rho = 1000$  kg/m<sup>3</sup>; Phantom section: Flat Section

Ambient temperature (°C): 21.5, Liquid temperature (°C): 21.0

DASY5 Configuration:

- Probe: EX3DV4 - SN3710; ConvF(6.98, 6.98, 6.98); Calibrated: 12/03/2012;
- Sensor-Surface: 4mm (Mechanical Surface Detection)
- Electronics: DAE4 Sn1220; Calibrated: 23/01/2012
- Phantom: SAM2; Type: SAM; Serial: TP1562
- Measurement SW: DASY52, Version 52.8 (1); SEMCAD X Version 14.6.5 (6469)

**Configuration/802.11b 2462MHz-Bottom/Area Scan (7x9x1):** Measurement grid: dx=20mm, dy=20mm

Maximum value of SAR (measured) = 0.510 mW/g

**Configuration/802.11b 2462MHz-Bottom/Zoom Scan (5x5x7)/Cube 0:** Measurement grid: dx=8mm, dy=8mm, dz=5mm, Reference Value = 16.788 V/m; Power Drift = -0.13 dB

Peak SAR (extrapolated) = 2.195 mW/g

**SAR(1 g) = 0.829 mW/g; SAR(10 g) = 0.325 mW/g** Maximum value of SAR (measured) = 0.940 mW/g

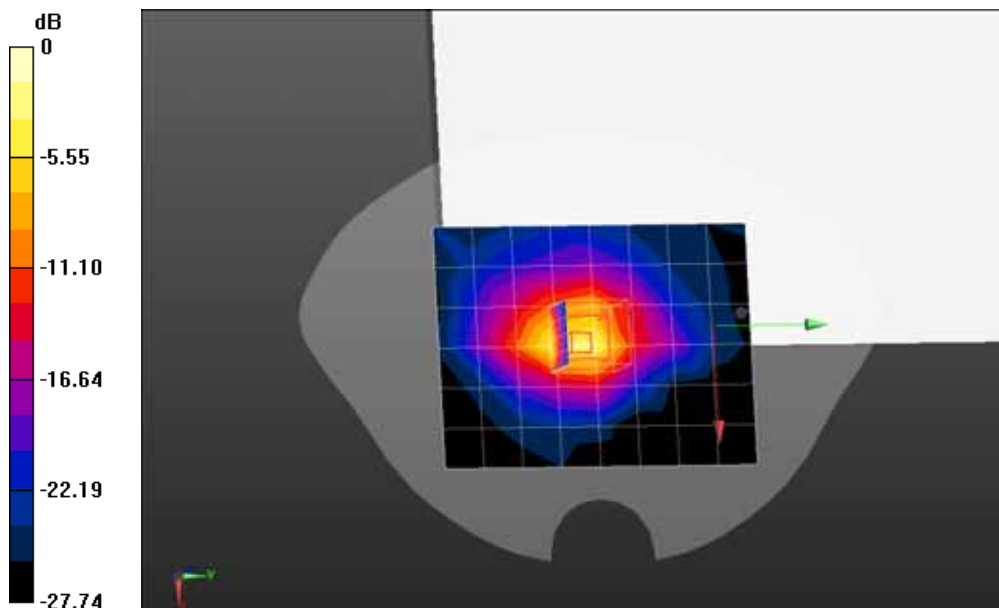

0 dB = 0.940 mW/g = -0.54 dB mW/g

Date/Time: 14-07-2012

Test Laboratory: QuieTek Lab

802.11g 2437MHz-Bottom- Laptop Mode

**DUT: 802.11b/g/n RTL8723AS combo module; Type: RTL8723AS**

Communication System: Wi-Fi; Communication System Band: 802.11g; Duty Cycle: 1:1.0; Frequency: 2437 MHz; Medium parameters used:  $f = 2437$  MHz;  $\sigma = 1.98$  mho/m;  $\epsilon_r = 51.42$ ;  $\rho = 1000$  kg/m<sup>3</sup>; Phantom section: Flat Section

Ambient temperature (°C): 21.5, Liquid temperature (°C): 21.0

DASY5 Configuration:

- Probe: EX3DV4 - SN3710; ConvF(6.98, 6.98, 6.98); Calibrated: 12/03/2012;
- Sensor-Surface: 4mm (Mechanical Surface Detection)
- Electronics: DAE4 Sn1220; Calibrated: 23/01/2012
- Phantom: SAM2; Type: SAM; Serial: TP1562
- Measurement SW: DASY52, Version 52.8 (1); SEMCAD X Version 14.6.5 (6469)

**Configuration/802.11g 2437MHz-Bottom/Area Scan (7x9x1):** Measurement grid: dx=20mm, dy=20mm

Maximum value of SAR (measured) = 0.442 mW/g

**Configuration/802.11g 2437MHz-Bottom/Zoom Scan (5x5x7)/Cube 0:** Measurement grid: dx=8mm, dy=8mm, dz=5mm, Reference Value = 14.622 V/m; Power Drift = 0.15 dB

Peak SAR (extrapolated) = 1.785 mW/g

**SAR(1 g) = 0.671 mW/g; SAR(10 g) = 0.262 mW/g** Maximum value of SAR (measured) = 0.691 mW/g

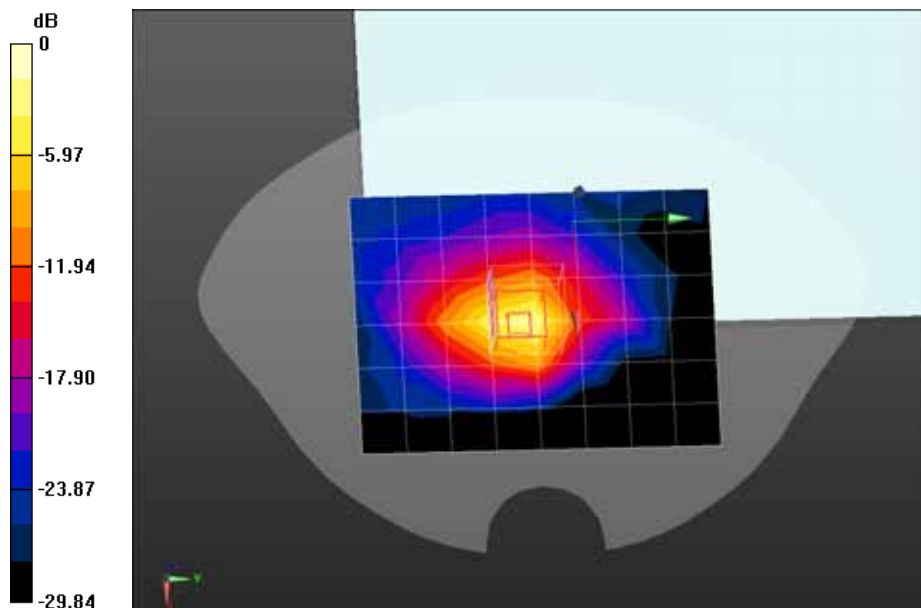

0 dB = 0.691 mW/g = -3.21 dB mW/g

Date/Time: 14-07-2012

Test Laboratory: QuieTek Lab

802.11n(20) 2437MHz-Bottom-Laptop Mode

**DUT: 802.11b/g/n RTL8723AS combo module; Type: RTL8723AS**

Communication System: Wi-Fi; Communication System Band: 802.11n(20MHz); Duty Cycle: 1:1.0;

Frequency: 2437 MHz; Medium parameters used:  $f = 2437 \text{ MHz}$ ;  $\sigma = 1.98 \text{ mho/m}$ ;  $\epsilon_r = 51.42$ ;  $\rho = 1000 \text{ kg/m}^3$ ; Phantom section: Flat Section

Ambient temperature (°C): 21.5, Liquid temperature (°C): 21.0

DASY5 Configuration:

- Probe: EX3DV4 - SN3710; ConvF(6.98, 6.98, 6.98); Calibrated: 12/03/2012;
- Sensor-Surface: 4mm (Mechanical Surface Detection)
- Electronics: DAE4 Sn1220; Calibrated: 23/01/2012
- Phantom: SAM2; Type: SAM; Serial: TP1562
- Measurement SW: DASY52, Version 52.8 (1); SEMCAD X Version 14.6.5 (6469)

**Configuration/802.11n(20) 2437MHz-Bottom/Area Scan (7x9x1):** Measurement grid: dx=20mm, dy=20mm, Maximum value of SAR (measured) = 0.443 mW/g

**Configuration/802.11n(20) 2437MHz-Bottom/Zoom Scan (5x5x7)/Cube 0:** Measurement grid: dx=8mm, dy=8mm, dz=5mm, Reference Value = 15.157 V/m; Power Drift = -0.16 dB

Peak SAR (extrapolated) = 1.764 mW/g

**SAR(1 g) = 0.665 mW/g; SAR(10 g) = 0.259 mW/g** Maximum value of SAR (measured) = 0.687 mW/g

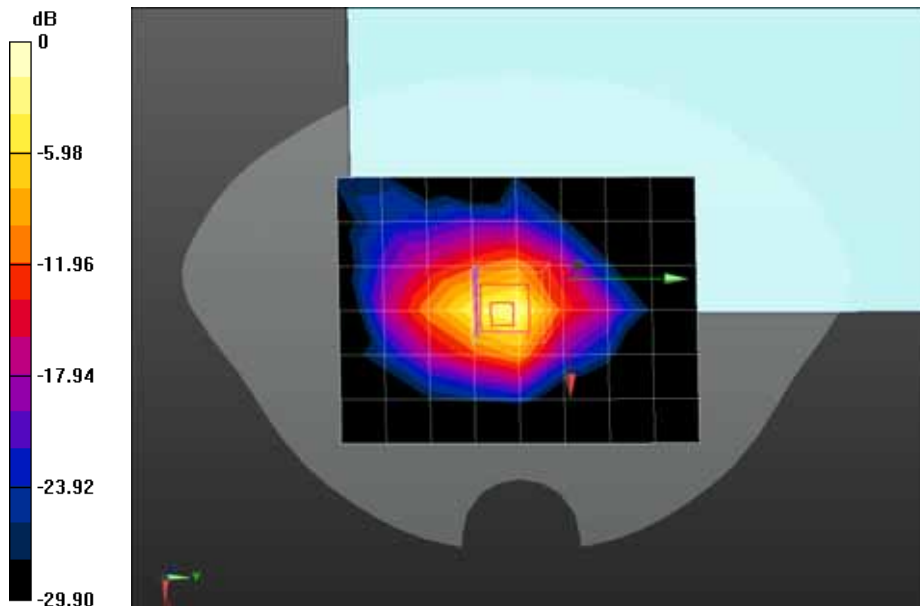

0 dB = 0.687 mW/g = -3.26 dB mW/g

Date/Time: 14-07-2012

Test Laboratory: QuieTek Lab

802.11n(40) 2437MHz-Bottom-Laptop Mode

**DUT: 802.11b/g/n RTL8723AS combo module; Type: RTL8723AS**

Communication System: Wi-Fi; Communication System Band: 802.11n(40MHz); Duty Cycle: 1:1.0;

Frequency: 2437 MHz; Medium parameters used:  $f = 2437 \text{ MHz}$ ;  $\sigma = 1.98 \text{ mho/m}$ ;  $\epsilon_r = 51.42$ ;  $\rho = 1000 \text{ kg/m}^3$ ; Phantom section: Flat Section

Ambient temperature (°C): 21.5, Liquid temperature (°C): 21.0

DASY5 Configuration:

- Probe: EX3DV4 - SN3710; ConvF(6.98, 6.98, 6.98); Calibrated: 12/03/2012;
- Sensor-Surface: 4mm (Mechanical Surface Detection)
- Electronics: DAE4 Sn1220; Calibrated: 23/01/2012
- Phantom: SAM2; Type: SAM; Serial: TP1562
- Measurement SW: DASY52, Version 52.8 (1); SEMCAD X Version 14.6.5 (6469)

**Configuration/802.11n(40) 2437MHz-Bottom/Area Scan (7x9x1):** Measurement grid: dx=20mm, dy=20mm, Maximum value of SAR (measured) = 0.303 mW/g

**Configuration/802.11n(40) 2437MHz-Bottom/Zoom Scan (5x5x7)/Cube 0:** Measurement grid: dx=8mm, dy=8mm, dz=5mm, Reference Value = 12.420 V/m; Power Drift = -0.09 dB

Peak SAR (extrapolated) = 1.158 mW/g

**SAR(1 g) = 0.443 mW/g; SAR(10 g) = 0.173 mW/g** Maximum value of SAR (measured) = 0.464 mW/g

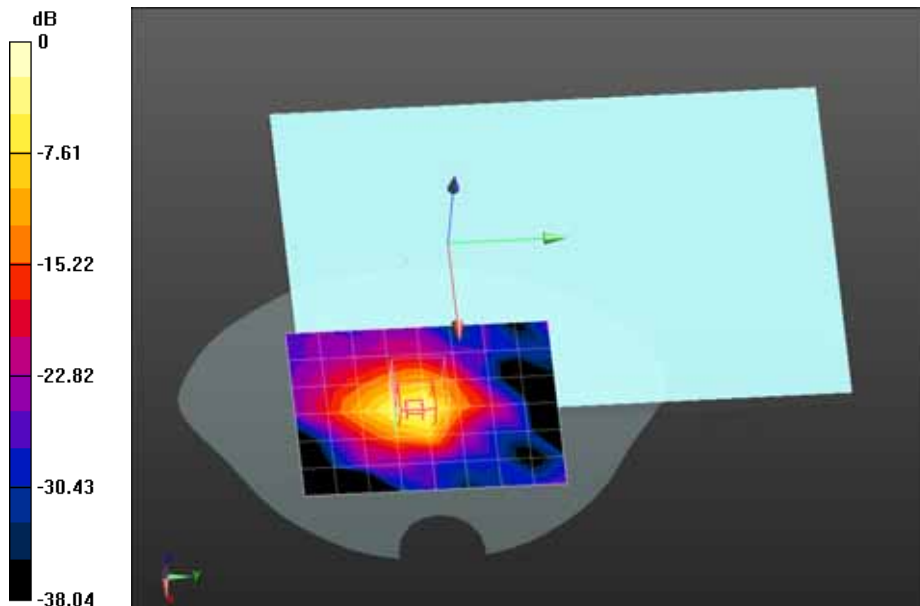

0 dB = 0.464 mW/g = -6.67 dB mW/g

Date/Time: 14-07-2012

Test Laboratory: QuieTek Lab

802.11b 2437MHz-Bottom-Tablet Mode

**DUT: 802.11b/g/n RTL8723AS combo module; Type: RTL8723AS**

Communication System: Wi-Fi; Communication System Band: 802.11b; Duty Cycle: 1:1.0; Frequency: 2437 MHz; Medium parameters used:  $f = 2437$  MHz;  $\sigma = 1.98$  mho/m;  $\epsilon r = 51.42$ ;  $\rho = 1000$  kg/m<sup>3</sup>; Phantom section: Flat Section

Ambient temperature (°C): 21.5, Liquid temperature (°C): 21.0

DASY5 Configuration:

- Probe: EX3DV4 - SN3710; ConvF(6.98, 6.98, 6.98); Calibrated: 12/03/2012;
- Sensor-Surface: 4mm (Mechanical Surface Detection)
- Electronics: DAE4 Sn1220; Calibrated: 23/01/2012
- Phantom: SAM2; Type: SAM; Serial: TP1562
- Measurement SW: DASY52, Version 52.8 (1); SEMCAD X Version 14.6.5 (6469)

**Configuration/802.11b 2437MHz-Bottom/Area Scan (7x9x1):** Measurement grid: dx=20mm, dy=20mm

Maximum value of SAR (measured) = 0.592 mW/g

**Configuration/802.11b 2437MHz-Bottom/Zoom Scan (5x5x7)/Cube 0:** Measurement grid: dx=8mm, dy=8mm, dz=5mm, Reference Value = 17.224 V/m; Power Drift = 0.07 dB

Peak SAR (extrapolated) = 1.482 mW/g

**SAR(1 g) = 0.590 mW/g; SAR(10 g) = 0.240 mW/g** Maximum value of SAR (measured) = 0.708 mW/g

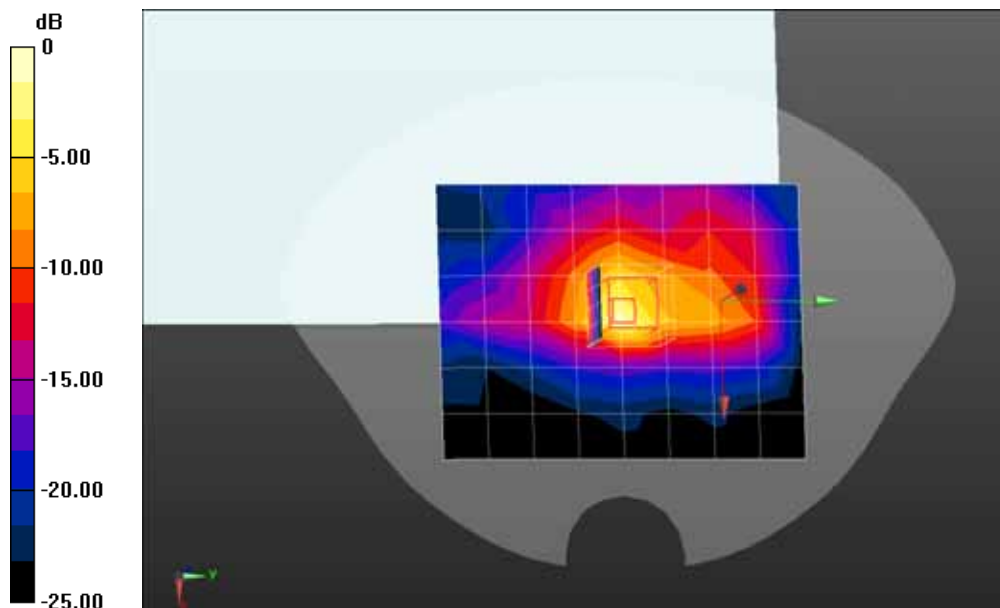

0 dB = 0.708 mW/g = -3.00 dB mW/g



Date/Time: 14-07-2012

Test Laboratory: QuieTek Lab

802.11b 2437MHz-Primary Landscape-Tablet Mode

**DUT: 802.11b/g/n RTL8723AS combo module; Type: RTL8723AS**

Communication System: Wi-Fi; Communication System Band: 802.11b; Duty Cycle: 1:1.0; Frequency: 2437 MHz; Medium parameters used:  $f = 2437$  MHz;  $\sigma = 1.98$  mho/m;  $\epsilon_r = 51.42$ ;  $\rho = 1000$  kg/m<sup>3</sup>; Phantom section: Flat Section

Ambient temperature (°C): 21.5, Liquid temperature (°C): 21.0

DASY5 Configuration:

- Probe: EX3DV4 - SN3710; ConvF(6.98, 6.98, 6.98); Calibrated: 12/03/2012;
- Sensor-Surface: 4mm (Mechanical Surface Detection)
- Electronics: DAE4 Sn1220; Calibrated: 23/01/2012
- Phantom: SAM2; Type: SAM; Serial: TP1562
- Measurement SW: DASY52, Version 52.8 (1); SEMCAD X Version 14.6.5 (6469)

**Configuration/802.11b 2437MHz-Parimary Landscape/Area Scan (7x9x1):** Measurement grid:

dx=20mm, dy=20mm

Maximum value of SAR (measured) = 0.494 mW/g

**Configuration/802.11b 2437MHz-Parimary Landscape/Zoom Scan (5x5x7)/Cube 0:** Measurement grid:

dx=8mm, dy=8mm, dz=5mm, Reference Value = 15.874 V/m; Power Drift = 0.11 dB

Peak SAR (extrapolated) = 1.755 mW/g

**SAR(1 g) = 0.679 mW/g; SAR(10 g) = 0.269 mW/g** Maximum value of SAR (measured) = 0.779 mW/g

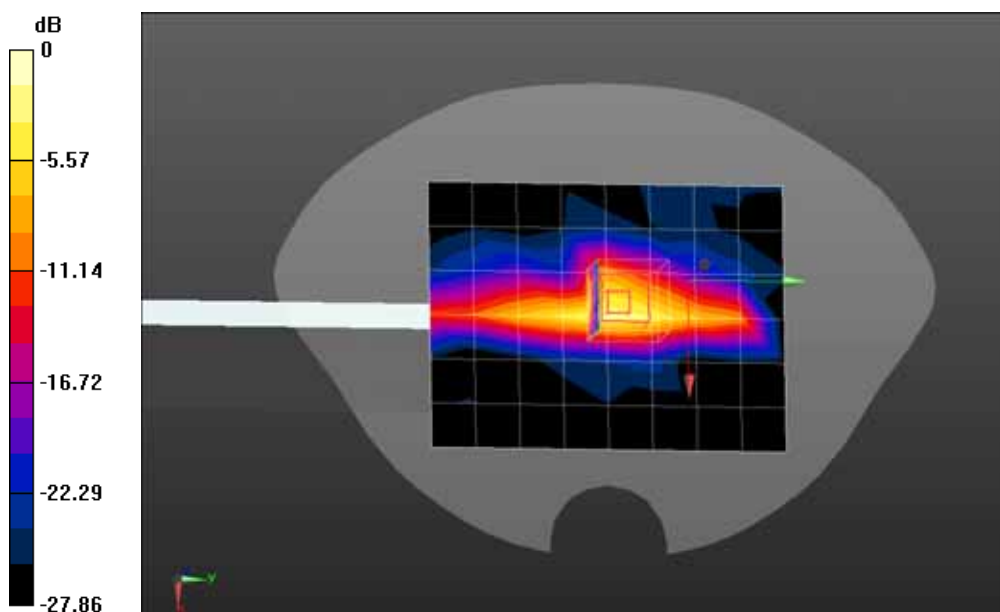

0 dB = 0.779 mW/g = -2.17 dB mW/g

Date/Time: 14-07-2012

Test Laboratory: QuieTek Lab

802.11b 2437MHz-Secondary Portrait-Tablet Mode

**DUT: 802.11b/g/n RTL8723AS combo module; Type: RTL8723AS**

Communication System: Wi-Fi; Communication System Band: 802.11b; Duty Cycle: 1:1.0; Frequency: 2437 MHz; Medium parameters used:  $f = 2437$  MHz;  $\sigma = 1.98$  mho/m;  $\epsilon_r = 51.42$ ;  $\rho = 1000$  kg/m<sup>3</sup>; Phantom section: Flat Section

Ambient temperature (°C): 21.5, Liquid temperature (°C): 21.0

DASY5 Configuration:

- Probe: EX3DV4 - SN3710; ConvF(6.98, 6.98, 6.98); Calibrated: 12/03/2012;
- Sensor-Surface: 4mm (Mechanical Surface Detection)
- Electronics: DAE4 Sn1220; Calibrated: 23/01/2012
- Phantom: SAM2; Type: SAM; Serial: TP1562
- Measurement SW: DASY52, Version 52.8 (1); SEMCAD X Version 14.6.5 (6469)

**Configuration/802.11b 2437MHz-Secondary Portrait/Area Scan (7x9x1):** Measurement grid: dx=20mm, dy=20mm, Maximum value of SAR (measured) = 0.0736 mW/g

**Configuration/802.11b 2437MHz-Secondary Portrait/Zoom Scan (5x6x7)/Cube 0:** Measurement grid: dx=8mm, dy=8mm, dz=5mm, Reference Value = 6.193 V/m; Power Drift = -0.09 dB

Peak SAR (extrapolated) = 0.168 mW/g

**SAR(1 g) = 0.070 mW/g; SAR(10 g) = 0.033 mW/g** Maximum value of SAR (measured) = 0.0740 mW/g

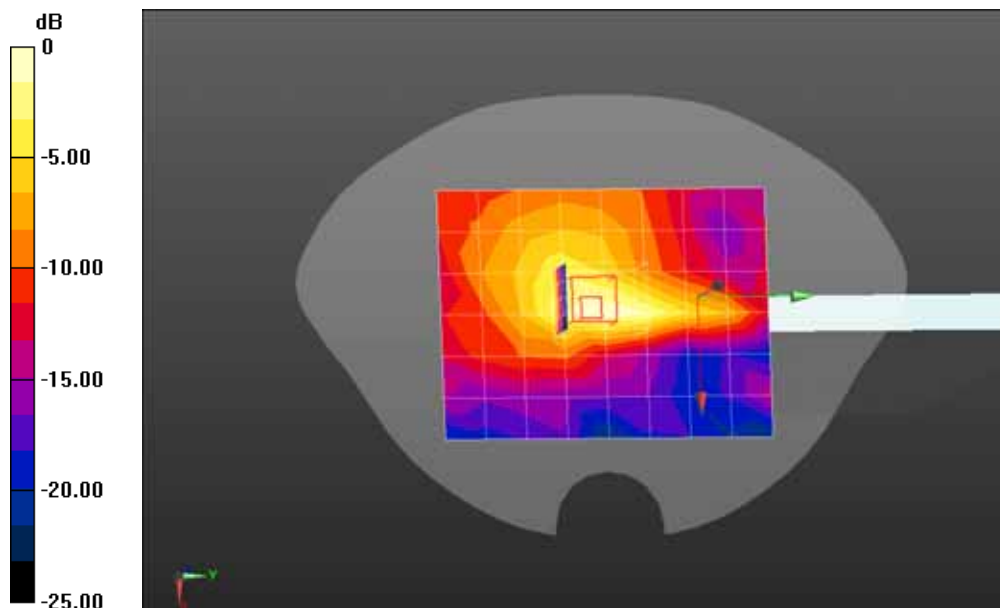

0 dB = 0.0740 mW/g = -22.62 dB mW/g

Appendix C. Test Setup Photographs & EUT Photographs

Antenna to User Separation Distances

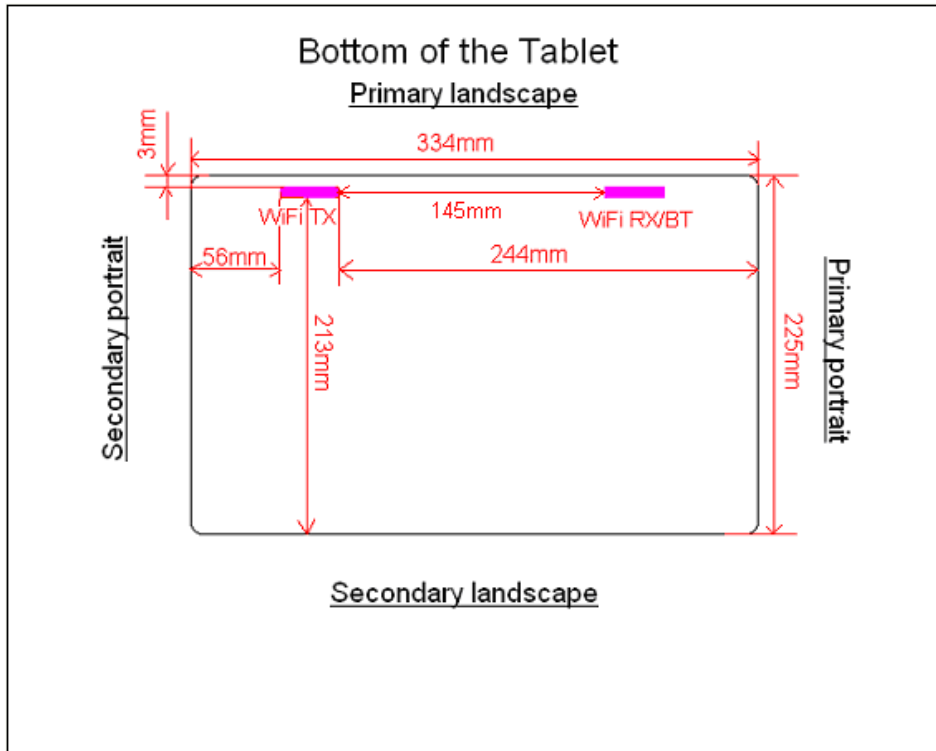

<p>Antenna-to-user separation distances:</p>	<p><b>WiFi Antenna</b></p> <p>Tablet-Bottom face: 3mm from WiFi Antenna-to-user</p> <p>Tablet-Edges with the following configurations</p> <ul style="list-style-type: none"> <li>● Primary landscape: 3mm from WiFi Antenna-to-user</li> <li>● Secondary landscape: 213mm from WiFi Antenna-to-user</li> <li>● Primary portrait: 244mm from WiFi Antenna-to-user</li> <li>● Secondary portrait: 56mm from WiFi Antenna-to-user</li> </ul>
--	---

**Appendix D. Probe Calibration Data**

**Calibration Laboratory of  
Schmid & Partner  
Engineering AG**  
Zeughausstrasse 43, 8004 Zurich, Switzerland



**S** Schweizerischer Kalibrierdienst  
**C** Service suisse d'étalonnage  
**S** Servizio svizzero di taratura  
**S** Swiss Calibration Service

Accredited by the Swiss Accreditation Service (SAS)  
The Swiss Accreditation Service is one of the signatories to the EA  
Multilateral Agreement for the recognition of calibration certificates

Accreditation No.: **SCS 108**

Client **Quietek-CN (Auden)**

Certificate No: **EX3-3710\_Mar12**

**CALIBRATION CERTIFICATE**

Object: **EX3DV4 - SN:3710**

Calibration procedure(s): **QA CAL-01.v8, QA CAL-12.v7, QA CAL-14.v3, QA CAL-23.v4, QA CAL-25.v4  
Calibration procedure for dosimetric E-field probes**

Calibration date: **March 12, 2012**

This calibration certificate documents the traceability to national standards, which realize the physical units of measurements (SI). The measurements and the uncertainties with confidence probability are given on the following pages and are part of the certificate.

All calibrations have been conducted in the closed laboratory facility: environment temperature (22 ± 3)°C and humidity < 70%.

Calibration Equipment used (M&TE critical for calibration)

Primary Standards	ID	Cal Date (Certificate No.)	Scheduled Calibration
Power meter E4419B	GB41293874	31-Mar-11 (No. 217-01372)	Apr-12
Power sensor E4412A	MY41498087	31-Mar-11 (No. 217-01372)	Apr-12
Reference 3 dB Attenuator	SN: S5054 (3c)	29-Mar-11 (No. 217-01369)	Apr-12
Reference 20 dB Attenuator	SN: S5086 (20b)	29-Mar-11 (No. 217-01367)	Apr-12
Reference 30 dB Attenuator	SN: S5129 (30b)	29-Mar-11 (No. 217-01370)	Apr-12
Reference Probe ES3DV2	SN: 3013	29-Dec-11 (No. ES3-3013_Dec11)	Dec-12
DAE4	SN: 654	3-May-11 (No. DAE4-654_May11)	May-12
Secondary Standards	ID	Check Date (in house)	Scheduled Check
RF generator HP 8648C	US3642U01700	4-Aug-99 (in house check Apr-11)	In house check: Apr-13
Network Analyzer HP 8753E	US37390585	18-Oct-01 (in house check Oct-11)	In house check: Oct-12

	Name	Function	Signature
Calibrated by:	Jeton Kastrati	Laboratory Technician	
Approved by:	Katja Pokovic	Technical Manager	

Issued: March 13, 2012

This calibration certificate shall not be reproduced except in full without written approval of the laboratory.

**Calibration Laboratory of  
Schmid & Partner  
Engineering AG**  
Zeughausstrasse 43, 8004 Zurich, Switzerland



**S** Schweizerischer Kalibrierdienst  
**S** Service suisse d'étalonnage  
**S** Servizio svizzero di taratura  
**S** Swiss Calibration Service

Accredited by the Swiss Accreditation Service (SAS)

Accreditation No.: **SCS 108**

The Swiss Accreditation Service is one of the signatories to the EA  
Multilateral Agreement for the recognition of calibration certificates

### Glossary:

TSL	tissue simulating liquid
NORM <sub>x,y,z</sub>	sensitivity in free space
ConvF	sensitivity in TSL / NORM <sub>x,y,z</sub>
DCP	diode compression point
CF	crest factor (1/duty_cycle) of the RF signal
A, B, C	modulation dependent linearization parameters
Polarization $\varphi$	$\varphi$ rotation around probe axis
Polarization $\vartheta$	$\vartheta$ rotation around an axis that is in the plane normal to probe axis (at measurement center), i.e., $\vartheta = 0$ is normal to probe axis

### Calibration is Performed According to the Following Standards:

- IEEE Std 1528-2003, "IEEE Recommended Practice for Determining the Peak Spatial-Averaged Specific Absorption Rate (SAR) in the Human Head from Wireless Communications Devices: Measurement Techniques", December 2003
- IEC 62209-1, "Procedure to measure the Specific Absorption Rate (SAR) for hand-held devices used in close proximity to the ear (frequency range of 300 MHz to 3 GHz)", February 2005

### Methods Applied and Interpretation of Parameters:

- NORM<sub>x,y,z</sub>**: Assessed for E-field polarization  $\vartheta = 0$  ( $f \leq 900$  MHz in TEM-cell;  $f > 1800$  MHz: R22 waveguide). NORM<sub>x,y,z</sub> are only intermediate values, i.e., the uncertainties of NORM<sub>x,y,z</sub> does not affect the E<sup>2</sup>-field uncertainty inside TSL (see below ConvF).
- NORM(f)<sub>x,y,z</sub> = NORM<sub>x,y,z</sub> \* frequency\_response** (see Frequency Response Chart). This linearization is implemented in DASY4 software versions later than 4.2. The uncertainty of the frequency response is included in the stated uncertainty of ConvF.
- DCP<sub>x,y,z</sub>**: DCP are numerical linearization parameters assessed based on the data of power sweep with CW signal (no uncertainty required). DCP does not depend on frequency nor media.
- PAR**: PAR is the Peak to Average Ratio that is not calibrated but determined based on the signal characteristics
- A<sub>x,y,z</sub>; B<sub>x,y,z</sub>; C<sub>x,y,z</sub>; VR<sub>x,y,z</sub>; A, B, C** are numerical linearization parameters assessed based on the data of power sweep for specific modulation signal. The parameters do not depend on frequency nor media. VR is the maximum calibration range expressed in RMS voltage across the diode.
- ConvF and Boundary Effect Parameters**: Assessed in flat phantom using E-field (or Temperature Transfer Standard for  $f \leq 800$  MHz) and inside waveguide using analytical field distributions based on power measurements for  $f > 800$  MHz. The same setups are used for assessment of the parameters applied for boundary compensation (alpha, depth) of which typical uncertainty values are given. These parameters are used in DASY4 software to improve probe accuracy close to the boundary. The sensitivity in TSL corresponds to NORM<sub>x,y,z</sub> \* ConvF whereby the uncertainty corresponds to that given for ConvF. A frequency dependent ConvF is used in DASY version 4.4 and higher which allows extending the validity from  $\pm 50$  MHz to  $\pm 100$  MHz.
- Spherical isotropy (3D deviation from isotropy)**: in a field of low gradients realized using a flat phantom exposed by a patch antenna.
- Sensor Offset**: The sensor offset corresponds to the offset of virtual measurement center from the probe tip (on probe axis). No tolerance required.

EX3DV4 – SN:3710

March 12, 2012

# Probe EX3DV4

## SN:3710

Manufactured:	July 21, 2009
Repaired:	February 21, 2012
Calibrated:	March 12, 2012

Calibrated for DASY/EASY Systems  
(Note: non-compatible with DASY2 system!)

EX3DV4- SN:3710

March 12, 2012

## DASY/EASY - Parameters of Probe: EX3DV4 - SN:3710

### Basic Calibration Parameters

	Sensor X	Sensor Y	Sensor Z	Unc (k=2)
Norm ( $\mu\text{V}/(\text{V}/\text{m})^2$ ) <sup>A</sup>	0.51	0.56	0.44	$\pm 10.1 \%$
DCP (mV) <sup>B</sup>	101.3	98.9	100.9	

### Modulation Calibration Parameters

UID	Communication System Name	PAR		A dB	B dB	C dB	VR mV	Unc <sup>E</sup> (k=2)
10000	CW	0.00	X	0.00	0.00	1.00	114.4	$\pm 2.2 \%$
			Y	0.00	0.00	1.00	94.4	
			Z	0.00	0.00	1.00	114.2	

The reported uncertainty of measurement is stated as the standard uncertainty of measurement multiplied by the coverage factor k=2, which for a normal distribution corresponds to a coverage probability of approximately 95%.

<sup>A</sup> The uncertainties of NormX,Y,Z do not affect the E<sup>2</sup>-field uncertainty inside TSL (see Pages 5 and 6).

<sup>B</sup> Numerical linearization parameter: uncertainty not required.

<sup>E</sup> Uncertainty is determined using the max. deviation from linear response applying rectangular distribution and is expressed for the square of the field value.

## DASY/EASY - Parameters of Probe: EX3DV4 - SN:3710

### Calibration Parameter Determined in Head Tissue Simulating Media

f (MHz) <sup>C</sup>	Relative Permittivity <sup>F</sup>	Conductivity (S/m) <sup>F</sup>	ConvF X	ConvF Y	ConvF Z	Alpha	Depth (mm)	Unct. (k=2)
450	43.5	0.87	9.61	9.61	9.61	0.12	1.00	± 13.4 %
750	41.9	0.89	9.51	9.51	9.51	0.24	1.16	± 12.0 %
835	41.5	0.90	9.18	9.18	9.18	0.22	1.15	± 12.0 %
900	41.5	0.97	8.97	8.97	8.97	0.19	1.35	± 12.0 %
1810	40.0	1.40	8.32	8.32	8.32	0.79	0.60	± 12.0 %
1900	40.0	1.40	8.16	8.16	8.16	0.72	0.66	± 12.0 %
2450	39.2	1.80	7.25	7.25	7.25	0.36	0.91	± 12.0 %
2600	39.0	1.96	6.96	6.96	6.96	0.39	0.95	± 12.0 %
3500	37.9	2.91	6.80	6.80	6.80	0.33	1.09	± 13.1 %
5200	36.0	4.66	5.21	5.21	5.21	0.35	1.80	± 13.1 %
5500	35.6	4.96	4.95	4.95	4.95	0.35	1.80	± 13.1 %
5800	35.3	5.27	4.56	4.56	4.56	0.45	1.80	± 13.1 %

<sup>C</sup> Frequency validity of ± 100 MHz only applies for DASY v4.4 and higher (see Page 2), else it is restricted to ± 50 MHz. The uncertainty is the RSS of the ConvF uncertainty at calibration frequency and the uncertainty for the indicated frequency band.

<sup>F</sup> At frequencies below 3 GHz, the validity of tissue parameters ( $\epsilon$  and  $\sigma$ ) can be relaxed to ± 10% if liquid compensation formula is applied to measured SAR values. At frequencies above 3 GHz, the validity of tissue parameters ( $\epsilon$  and  $\sigma$ ) is restricted to ± 5%. The uncertainty is the RSS of the ConvF uncertainty for indicated target tissue parameters.



EX3DV4–SN:3710

March 12, 2012

## DASY/EASY - Parameters of Probe: EX3DV4 - SN:3710

### Calibration Parameter Determined in Body Tissue Simulating Media

f (MHz) <sup>C</sup>	Relative Permittivity <sup>F</sup>	Conductivity (S/m) <sup>F</sup>	ConvF X	ConvF Y	ConvF Z	Alpha	Depth (mm)	Unct. (k=2)
450	56.7	0.94	10.69	10.69	10.69	0.06	1.00	± 13.4 %
750	55.5	0.96	9.33	9.33	9.33	0.43	0.86	± 12.0 %
835	55.2	0.97	9.13	9.13	9.13	0.63	0.70	± 12.0 %
900	55.0	1.05	9.04	9.04	9.04	0.39	0.88	± 12.0 %
1810	53.3	1.52	7.73	7.73	7.73	0.33	1.10	± 12.0 %
1900	53.3	1.52	7.43	7.43	7.43	0.42	0.90	± 12.0 %
2450	52.7	1.95	6.98	6.98	6.98	0.79	0.59	± 12.0 %
2600	52.5	2.16	6.68	6.68	6.68	0.79	0.52	± 12.0 %
3500	51.3	3.31	6.23	6.23	6.23	0.36	1.13	± 13.1 %
5200	49.0	5.30	4.20	4.20	4.20	0.50	1.90	± 13.1 %
5500	48.6	5.65	3.82	3.82	3.82	0.50	1.90	± 13.1 %
5800	48.2	6.00	3.89	3.89	3.89	0.60	1.90	± 13.1 %

<sup>C</sup> Frequency validity of ± 100 MHz only applies for DASY v4.4 and higher (see Page 2), else it is restricted to ± 50 MHz. The uncertainty is the RSS of the ConvF uncertainty at calibration frequency and the uncertainty for the indicated frequency band.

<sup>F</sup> At frequencies below 3 GHz, the validity of tissue parameters ( $\epsilon$  and  $\sigma$ ) can be relaxed to ± 10% if liquid compensation formula is applied to measured SAR values. At frequencies above 3 GHz, the validity of tissue parameters ( $\epsilon$  and  $\sigma$ ) is restricted to ± 5%. The uncertainty is the RSS of the ConvF uncertainty for indicated target tissue parameters.

EX3DV4- SN:3710

March 12, 2012

### Frequency Response of E-Field (TEM-Cell: ifi110 EXX, Waveguide: R22)

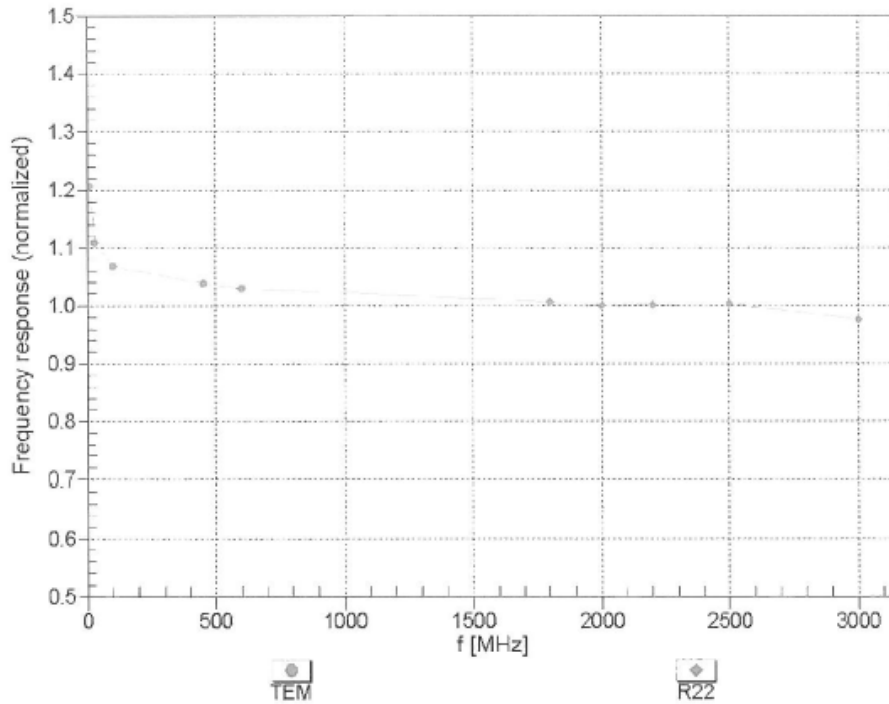

Uncertainty of Frequency Response of E-field:  $\pm 6.3\%$  ( $k=2$ )

EX3DV4- SN:3710

March 12, 2012

Receiving Pattern ( $\phi$ ),  $\theta = 0^\circ$

f=600 MHz,TEM

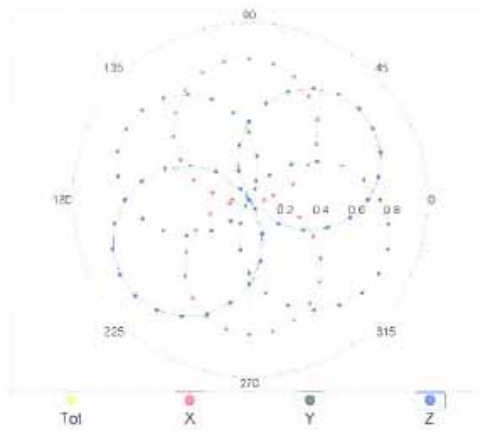

f=1800 MHz,R22

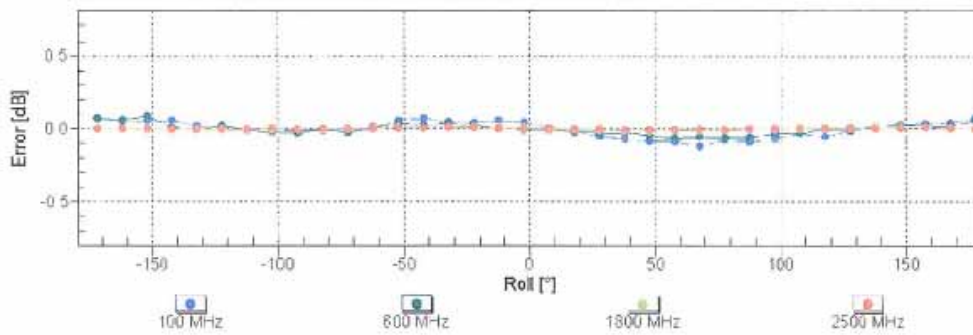
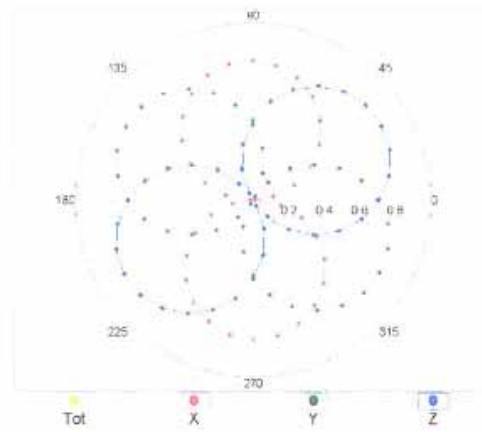

Uncertainty of Axial Isotropy Assessment:  $\pm 0.5\%$  (k=2)

EX3DV4-- SN:3710

March 12, 2012

### Dynamic Range f(SAR<sub>head</sub>) (TEM cell , f = 900 MHz)

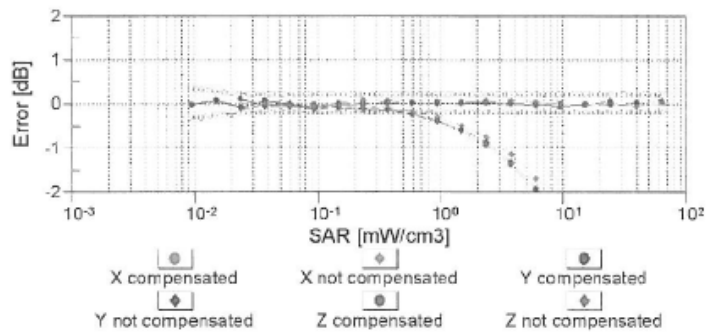
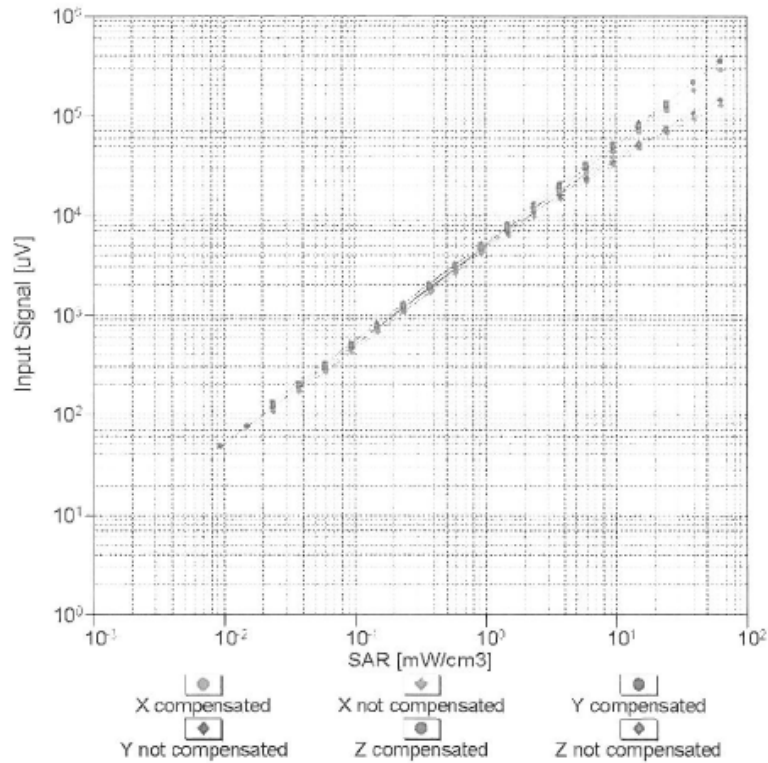

Uncertainty of Linearity Assessment: ± 0.6% (k=2)

EX3DV4-SN:3710

March 12, 2012

### Conversion Factor Assessment

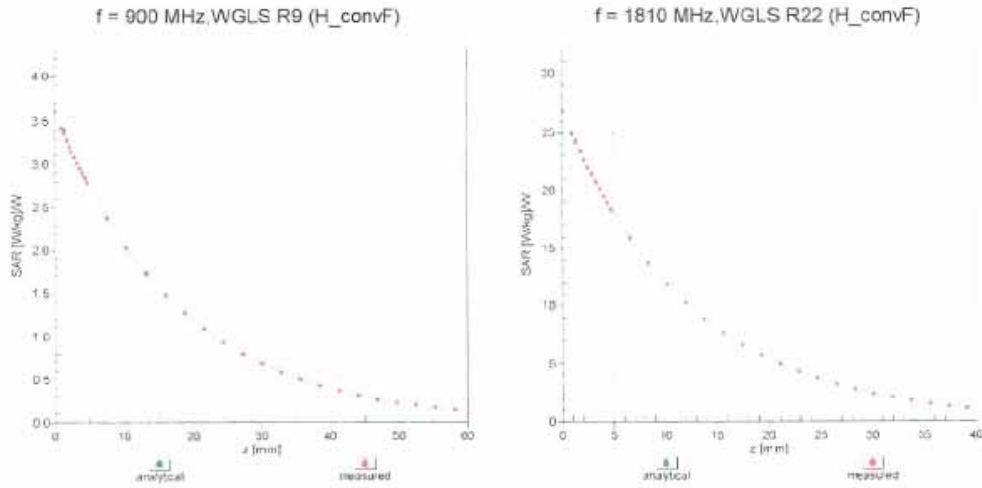

### Deviation from Isotropy in Liquid Error ( $\phi, \theta$ ), f = 900 MHz

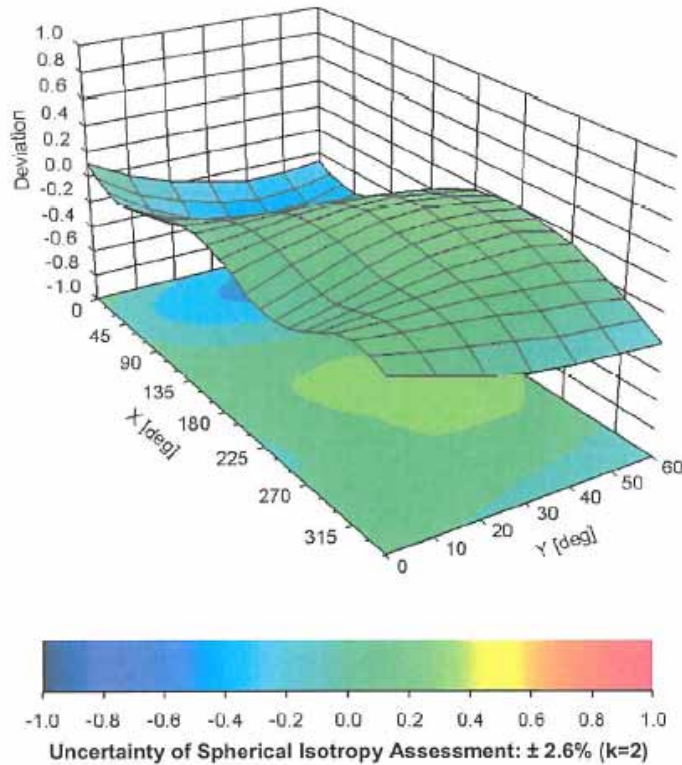

EX3DV4- SN:3710

March 12, 2012

**DASY/EASY - Parameters of Probe: EX3DV4 - SN:3710****Other Probe Parameters**

Sensor Arrangement	Triangular
Connector Angle (°)	Not applicable
Mechanical Surface Detection Mode	enabled
Optical Surface Detection Mode	disabled
Probe Overall Length	337 mm
Probe Body Diameter	10 mm
Tip Length	9 mm
Tip Diameter	2.5 mm
Probe Tip to Sensor X Calibration Point	1 mm
Probe Tip to Sensor Y Calibration Point	1 mm
Probe Tip to Sensor Z Calibration Point	1 mm
Recommended Measurement Distance from Surface	2 mm

**Appendix E. Dipole Calibration Data**

**Calibration Laboratory of  
Schmid & Partner  
Engineering AG**  
Zeughausstrasse 43, 8004 Zurich, Switzerland



**S** Schweizerischer Kalibrierdienst  
**C** Service suisse d'étalonnage  
**S** Servizio svizzero di taratura  
**S** Swiss Calibration Service

Accredited by the Swiss Accreditation Service (SAS)  
The Swiss Accreditation Service is one of the signatories to the EA  
Multilateral Agreement for the recognition of calibration certificates

Accreditation No.: **SCS 108**

Client **Quietek-CN (Auden)**

Certificate No: **D2450V2-839\_Feb12**

CALIBRATION CERTIFICATE																																															
Object	D2450V2 - SN: 839																																														
Calibration procedure(s)	QA CAL-05.v8 Calibration procedure for dipole validation kits above 700 MHz																																														
Calibration date:	February 23, 2012																																														
<p>This calibration certificate documents the traceability to national standards, which realize the physical units of measurements (SI). The measurements and the uncertainties with confidence probability are given on the following pages and are part of the certificate.</p> <p>All calibrations have been conducted in the closed laboratory facility: environment temperature (22 ± 3)°C and humidity &lt; 70%.</p> <p>Calibration Equipment used (M&amp;TE critical for calibration)</p> <table border="1"> <thead> <tr> <th>Primary Standards</th> <th>ID #</th> <th>Cal Date (Certificate No.)</th> <th>Scheduled Calibration</th> </tr> </thead> <tbody> <tr> <td>Power meter EPM-442A</td> <td>GB37480704</td> <td>05-Oct-11 (No. 217-01451)</td> <td>Oct-12</td> </tr> <tr> <td>Power sensor HP 8481A</td> <td>US37292783</td> <td>05-Oct-11 (No. 217-01451)</td> <td>Oct-12</td> </tr> <tr> <td>Reference 20 dB Attenuator</td> <td>SN: 5086 (20g)</td> <td>29-Mar-11 (No. 217-01368)</td> <td>Apr-12</td> </tr> <tr> <td>Type N mismatch combination</td> <td>SN: 5047.2 / 06327</td> <td>29-Mar-11 (No. 217-01371)</td> <td>Apr-12</td> </tr> <tr> <td>Reference Probe ES3DV3</td> <td>SN: 3205</td> <td>30-Dec-11 (No. ES3-3205_Dec11)</td> <td>Dec-12</td> </tr> <tr> <td>DAE4</td> <td>SN: 601</td> <td>04-Jul-11 (No. DAE4-601_Jul11)</td> <td>Jul-12</td> </tr> </tbody> </table> <table border="1"> <thead> <tr> <th>Secondary Standards</th> <th>ID #</th> <th>Check Date (in house)</th> <th>Scheduled Check</th> </tr> </thead> <tbody> <tr> <td>Power sensor HP 8481A</td> <td>MY41092317</td> <td>18-Oct-02 (in house check Oct-11)</td> <td>In house check: Oct-13</td> </tr> <tr> <td>RF generator R&amp;S SMT-06</td> <td>100005</td> <td>04-Aug-99 (in house check Oct-11)</td> <td>In house check: Oct-13</td> </tr> <tr> <td>Network Analyzer HP 8753E</td> <td>US37390585 S4206</td> <td>18-Oct-01 (in house check Oct-11)</td> <td>In house check: Oct-12</td> </tr> </tbody> </table>				Primary Standards	ID #	Cal Date (Certificate No.)	Scheduled Calibration	Power meter EPM-442A	GB37480704	05-Oct-11 (No. 217-01451)	Oct-12	Power sensor HP 8481A	US37292783	05-Oct-11 (No. 217-01451)	Oct-12	Reference 20 dB Attenuator	SN: 5086 (20g)	29-Mar-11 (No. 217-01368)	Apr-12	Type N mismatch combination	SN: 5047.2 / 06327	29-Mar-11 (No. 217-01371)	Apr-12	Reference Probe ES3DV3	SN: 3205	30-Dec-11 (No. ES3-3205_Dec11)	Dec-12	DAE4	SN: 601	04-Jul-11 (No. DAE4-601_Jul11)	Jul-12	Secondary Standards	ID #	Check Date (in house)	Scheduled Check	Power sensor HP 8481A	MY41092317	18-Oct-02 (in house check Oct-11)	In house check: Oct-13	RF generator R&S SMT-06	100005	04-Aug-99 (in house check Oct-11)	In house check: Oct-13	Network Analyzer HP 8753E	US37390585 S4206	18-Oct-01 (in house check Oct-11)	In house check: Oct-12
Primary Standards	ID #	Cal Date (Certificate No.)	Scheduled Calibration																																												
Power meter EPM-442A	GB37480704	05-Oct-11 (No. 217-01451)	Oct-12																																												
Power sensor HP 8481A	US37292783	05-Oct-11 (No. 217-01451)	Oct-12																																												
Reference 20 dB Attenuator	SN: 5086 (20g)	29-Mar-11 (No. 217-01368)	Apr-12																																												
Type N mismatch combination	SN: 5047.2 / 06327	29-Mar-11 (No. 217-01371)	Apr-12																																												
Reference Probe ES3DV3	SN: 3205	30-Dec-11 (No. ES3-3205_Dec11)	Dec-12																																												
DAE4	SN: 601	04-Jul-11 (No. DAE4-601_Jul11)	Jul-12																																												
Secondary Standards	ID #	Check Date (in house)	Scheduled Check																																												
Power sensor HP 8481A	MY41092317	18-Oct-02 (in house check Oct-11)	In house check: Oct-13																																												
RF generator R&S SMT-06	100005	04-Aug-99 (in house check Oct-11)	In house check: Oct-13																																												
Network Analyzer HP 8753E	US37390585 S4206	18-Oct-01 (in house check Oct-11)	In house check: Oct-12																																												
Calibrated by:	Name Israe El-Naouq	Function Laboratory Technician	Signature 																																												
Approved by:	Katja Pokovic	Technical Manager																																													
			Issued: February 23, 2012																																												
This calibration certificate shall not be reproduced except in full without written approval of the laboratory.																																															

**Calibration Laboratory of  
Schmid & Partner  
Engineering AG**  
Zeughausstrasse 43, 8004 Zurich, Switzerland



**S** Schweizerischer Kalibrierdienst  
**C** Service suisse d'étalonnage  
**S** Servizio svizzero di taratura  
**S** Swiss Calibration Service

Accredited by the Swiss Accreditation Service (SAS)  
The Swiss Accreditation Service is one of the signatories to the EA  
Multilateral Agreement for the recognition of calibration certificates

Accreditation No.: **SCS 108**

**Glossary:**

TSL	tissue simulating liquid
ConvF	sensitivity in TSL / NORM x,y,z
N/A	not applicable or not measured

**Calibration is Performed According to the Following Standards:**

- a) IEEE Std 1528-2003, "IEEE Recommended Practice for Determining the Peak Spatial-Averaged Specific Absorption Rate (SAR) in the Human Head from Wireless Communications Devices: Measurement Techniques", December 2003
- b) IEC 62209-1, "Procedure to measure the Specific Absorption Rate (SAR) for hand-held devices used in close proximity to the ear (frequency range of 300 MHz to 3 GHz)", February 2005
- c) Federal Communications Commission Office of Engineering & Technology (FCC OET), "Evaluating Compliance with FCC Guidelines for Human Exposure to Radiofrequency Electromagnetic Fields; Additional Information for Evaluating Compliance of Mobile and Portable Devices with FCC Limits for Human Exposure to Radiofrequency Emissions", Supplement C (Edition 01-01) to Bulletin 65

**Additional Documentation:**

- d) DASY4/5 System Handbook

**Methods Applied and Interpretation of Parameters:**

- *Measurement Conditions:* Further details are available from the Validation Report at the end of the certificate. All figures stated in the certificate are valid at the frequency indicated.
- *Antenna Parameters with TSL:* The dipole is mounted with the spacer to position its feed point exactly below the center marking of the flat phantom section, with the arms oriented parallel to the body axis.
- *Feed Point Impedance and Return Loss:* These parameters are measured with the dipole positioned under the liquid filled phantom. The impedance stated is transformed from the measurement at the SMA connector to the feed point. The Return Loss ensures low reflected power. No uncertainty required.
- *Electrical Delay:* One-way delay between the SMA connector and the antenna feed point. No uncertainty required.
- *SAR measured:* SAR measured at the stated antenna input power.
- *SAR normalized:* SAR as measured, normalized to an input power of 1 W at the antenna connector.
- *SAR for nominal TSL parameters:* The measured TSL parameters are used to calculate the nominal SAR result.



**Measurement Conditions**

DASY system configuration, as far as not given on page 1.

DASY Version	DASY5	V52.8.0
Extrapolation	Advanced Extrapolation	
Phantom	Modular Flat Phantom	
Distance Dipole Center - TSL	10 mm	with Spacer
Zoom Scan Resolution	dx, dy, dz = 5 mm	
Frequency	2450 MHz ± 1 MHz	

**Head TSL parameters**

The following parameters and calculations were applied.

	Temperature	Permittivity	Conductivity
Nominal Head TSL parameters	22.0 °C	39.2	1.80 mho/m
Measured Head TSL parameters	(22.0 ± 0.2) °C	38.9 ± 6 %	1.86 mho/m ± 6 %
Head TSL temperature change during test	< 0.5 °C	----	----

**SAR result with Head TSL**

SAR averaged over 1 cm <sup>3</sup> (1 g) of Head TSL	Condition	
SAR measured	250 mW input power	13.2 mW / g
SAR for nominal Head TSL parameters	normalized to 1W	<b>51.9 mW / g ± 17.0 % (k=2)</b>

SAR averaged over 10 cm <sup>3</sup> (10 g) of Head TSL	condition	
SAR measured	250 mW input power	6.09 mW / g
SAR for nominal Head TSL parameters	normalized to 1W	<b>24.1 mW / g ± 16.5 % (k=2)</b>

**Body TSL parameters**

The following parameters and calculations were applied.

	Temperature	Permittivity	Conductivity
Nominal Body TSL parameters	22.0 °C	52.7	1.95 mho/m
Measured Body TSL parameters	(22.0 ± 0.2) °C	52.3 ± 6 %	2.02 mho/m ± 6 %
Body TSL temperature change during test	< 0.5 °C	----	----

**SAR result with Body TSL**

SAR averaged over 1 cm <sup>3</sup> (1 g) of Body TSL	Condition	
SAR measured	250 mW input power	12.4 mW / g
SAR for nominal Body TSL parameters	normalized to 1W	<b>48.7 mW / g ± 17.0 % (k=2)</b>

SAR averaged over 10 cm <sup>3</sup> (10 g) of Body TSL	condition	
SAR measured	250 mW input power	5.76 mW / g
SAR for nominal Body TSL parameters	normalized to 1W	<b>22.8 mW / g ± 16.5 % (k=2)</b>

**Appendix**

**Antenna Parameters with Head TSL**

Impedance, transformed to feed point	55.7 $\Omega$ - 1.0 j $\Omega$
Return Loss	- 25.2 dB

**Antenna Parameters with Body TSL**

Impedance, transformed to feed point	52.1 $\Omega$ + 1.0 j $\Omega$
Return Loss	- 32.9 dB

**General Antenna Parameters and Design**

Electrical Delay (one direction)	1.160 ns
----------------------------------	----------

After long term use with 100W radiated power, only a slight warming of the dipole near the feedpoint can be measured.

The dipole is made of standard semirigid coaxial cable. The center conductor of the feeding line is directly connected to the second arm of the dipole. The antenna is therefore short-circuited for DC-signals. On some of the dipoles, small end caps are added to the dipole arms in order to improve matching when loaded according to the position as explained in the "Measurement Conditions" paragraph. The SAR data are not affected by this change. The overall dipole length is still according to the Standard.

No excessive force must be applied to the dipole arms, because they might bend or the soldered connections near the feedpoint may be damaged.

**Additional EUT Data**

Manufactured by	SPEAG
Manufactured on	July 20, 2009

**DASY5 Validation Report for Head TSL**

Date: 23.02.2012

Test Laboratory: SPEAG, Zurich, Switzerland

**DUT: Dipole 2450 MHz; Type: D2450V2; Serial: D2450V2 - SN: 839**

Communication System: CW; Frequency: 2450 MHz  
 Medium parameters used:  $f = 2450$  MHz;  $\sigma = 1.86$  mho/m;  $\epsilon_r = 38.9$ ;  $\rho = 1000$  kg/m<sup>3</sup>  
 Phantom section: Flat Section  
 Measurement Standard: DASY5 (IEEE/IEC/ANSI C63.19-2007)

**DASY52 Configuration:**

- Probe: ES3DV3 - SN3205; ConvF(4.45, 4.45, 4.45); Calibrated: 30.12.2011
- Sensor-Surface: 3mm (Mechanical Surface Detection)
- Electronics: DAE4 Sn601; Calibrated: 04.07.2011
- Phantom: Flat Phantom 5.0 (front); Type: QD000P50AA; Serial: 1001
- DASY52 52.8.0(692); SEMCAD X 14.6.4(4989)

**Dipole Calibration for Head Tissue/Pin=250 mW, d=10mm/Zoom Scan (7x7x7)/Cube 0:**

Measurement grid:  $dx=5$ mm,  $dy=5$ mm,  $dz=5$ mm  
 Reference Value = 98.155 V/m; Power Drift = 0.08 dB  
 Peak SAR (extrapolated) = 27.8700  
**SAR(1 g) = 13.2 mW/g; SAR(10 g) = 6.09 mW/g**  
 Maximum value of SAR (measured) = 16.839 mW/g

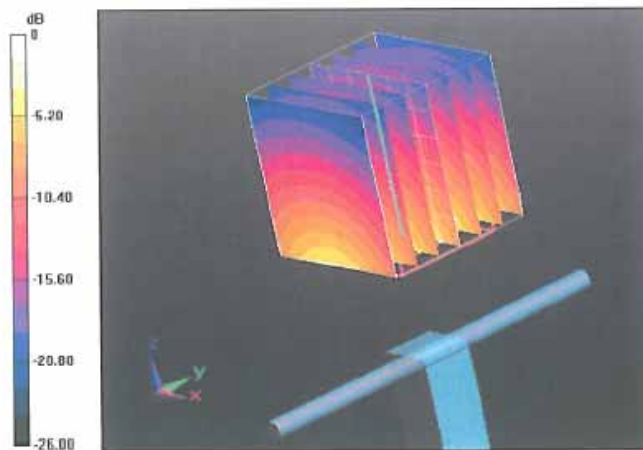

0 dB = 16.840mW/g = 24.53 dB mW/g

Impedance Measurement Plot for Head TSL

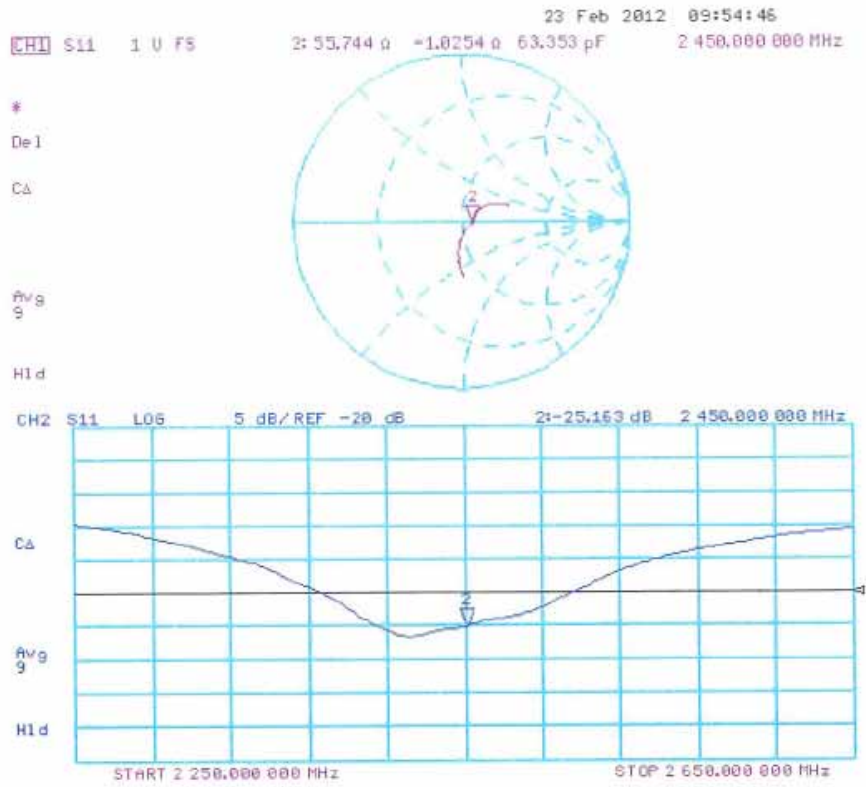

## DASY5 Validation Report for Body TSL

Date: 23.02.2012

Test Laboratory: SPEAG, Zurich, Switzerland

**DUT: Dipole 2450 MHz; Type: D2450V2; Serial: D2450V2 - SN: 839**

Communication System: CW; Frequency: 2450 MHz

Medium parameters used:  $f = 2450$  MHz;  $\sigma = 2.02$  mho/m;  $\epsilon_r = 52.3$ ;  $\rho = 1000$  kg/m<sup>3</sup>

Phantom section: Flat Section

Measurement Standard: DASY5 (IEEE/IEC/ANSI C63.19-2007)

DASY52 Configuration:

- Probe: ES3DV3 - SN3205; ConvF(4.26, 4.26, 4.26); Calibrated: 30.12.2011
- Sensor-Surface: 3mm (Mechanical Surface Detection)
- Electronics: DAE4 Sn601; Calibrated: 04.07.2011
- Phantom: Flat Phantom 5.0 (back); Type: QD000P50AA; Serial: 1002
- DASY52 52.8.0(692); SEMCAD X 14.6.4(4989)

### Dipole Calibration for Body Tissue/Pin=250 mW, d=10mm/Zoom Scan (7x7x7)/Cube 0:

Measurement grid: dx=5mm, dy=5mm, dz=5mm

Reference Value = 93.056 V/m; Power Drift = 0.0053 dB

Peak SAR (extrapolated) = 25.2250

**SAR(1 g) = 12.4 mW/g; SAR(10 g) = 5.76 mW/g**

Maximum value of SAR (measured) – 16.258 mW/g

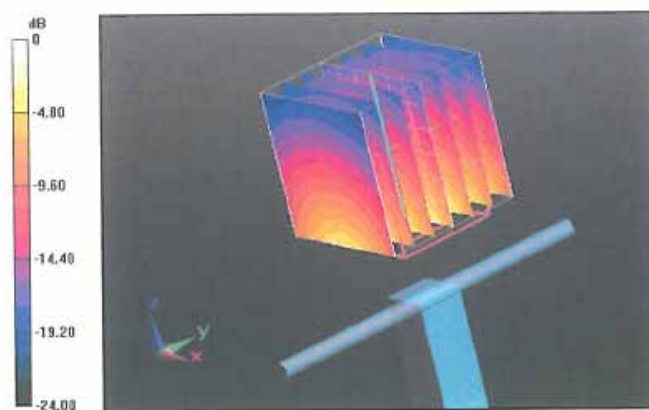

0 dB = 16.260mW/g = 24.22 dB mW/g

Impedance Measurement Plot for Body TSL

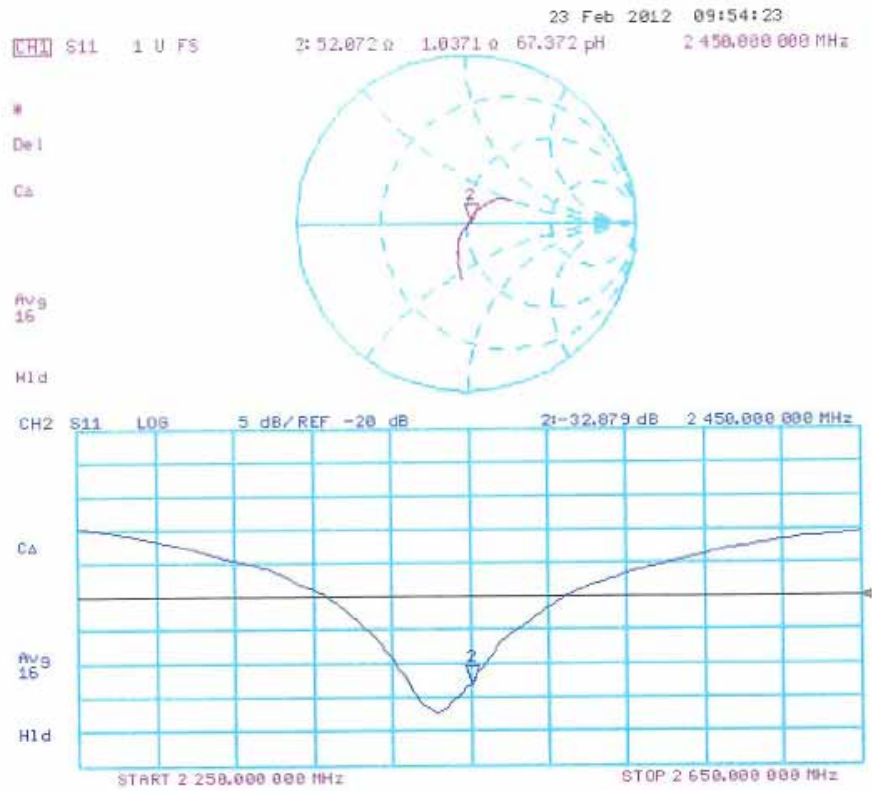

**Appendix F. DAE Calibration Data**

Calibration Laboratory of  
 Schmid & Partner  
 Engineering AG  
 Zeughausstrasse 43, 8004 Zurich, Switzerland



S Schweizerischer Kalibrierdienst  
 C Service suisse d'étalonnage  
 S Servizio svizzero di taratura  
 S Swiss Calibration Service

Accredited by the Swiss Accreditation Service (SAS)  
 The Swiss Accreditation Service is one of the signatories to the EA  
 Multilateral Agreement for the recognition of calibration certificates

Accreditation No.: **SCS 108**

Client **Quietek-CN (Auden)**

Certificate No: **DAE4-1220\_Jan12**

CALIBRATION CERTIFICATE																			
Object	DAE4 - SD 000 D04 BJ - SN: 1220																		
Calibration procedure(s)	QA CAL-06.v24 Calibration procedure for the data acquisition electronics (DAE)																		
Calibration date:	January 23, 2012																		
<p>This calibration certificate documents the traceability to national standards, which realize the physical units of measurements (SI). The measurements and the uncertainties with confidence probability are given on the following pages and are part of the certificate.</p> <p>All calibrations have been conducted in the closed laboratory facility: environment temperature (22 ± 3)°C and humidity &lt; 70%.</p> <p>Calibration Equipment used (M&amp;TE critical for calibration)</p> <table border="1"> <thead> <tr> <th>Primary Standards</th> <th>ID #</th> <th>Cal Date (Certificate No.)</th> <th>Scheduled Calibration</th> </tr> </thead> <tbody> <tr> <td>Keithley Multimeter Type 2001</td> <td>SN: 0810278</td> <td>28-Sep-11 (No:11450)</td> <td>Sep-12</td> </tr> <tr> <th>Secondary Standards</th> <th>ID #</th> <th>Check Date (in house)</th> <th>Scheduled Check</th> </tr> <tr> <td>Calibrator Box V2.1</td> <td>SE UWS 053 AA 1001</td> <td>05-Jan-12 (in house check)</td> <td>In house check: Jan-13</td> </tr> </tbody> </table>				Primary Standards	ID #	Cal Date (Certificate No.)	Scheduled Calibration	Keithley Multimeter Type 2001	SN: 0810278	28-Sep-11 (No:11450)	Sep-12	Secondary Standards	ID #	Check Date (in house)	Scheduled Check	Calibrator Box V2.1	SE UWS 053 AA 1001	05-Jan-12 (in house check)	In house check: Jan-13
Primary Standards	ID #	Cal Date (Certificate No.)	Scheduled Calibration																
Keithley Multimeter Type 2001	SN: 0810278	28-Sep-11 (No:11450)	Sep-12																
Secondary Standards	ID #	Check Date (in house)	Scheduled Check																
Calibrator Box V2.1	SE UWS 053 AA 1001	05-Jan-12 (in house check)	In house check: Jan-13																
Calibrated by:	Name Dominique Steffen	Function Technician	Signature 																
Approved by:	Fin Bomholt	R&D Director																	
Issued: January 23, 2012																			
This calibration certificate shall not be reproduced except in full without written approval of the laboratory.																			

**Calibration Laboratory of**  
 Schmid & Partner  
 Engineering AG  
 Zeughausstrasse 43, 8004 Zurich, Switzerland



**S** Schweizerischer Kalibrierdienst  
**S** Service suisse d'étalonnage  
**C** Servizio svizzero di taratura  
**S** Swiss Calibration Service

Accredited by the Swiss Accreditation Service (SAS)  
 The Swiss Accreditation Service is one of the signatories to the EA  
 Multilateral Agreement for the recognition of calibration certificates

Accreditation No.: **SCS 108**

## Glossary

DAE data acquisition electronics  
 Connector angle information used in DASY system to align probe sensor X to the robot coordinate system.

## Methods Applied and Interpretation of Parameters

- *DC Voltage Measurement:* Calibration Factor assessed for use in DASY system by comparison with a calibrated instrument traceable to national standards. The figure given corresponds to the full scale range of the voltmeter in the respective range.
- *Connector angle:* The angle of the connector is assessed measuring the angle mechanically by a tool inserted. Uncertainty is not required.
- The following parameters as documented in the Appendix contain technical information as a result from the performance test and require no uncertainty.
  - *DC Voltage Measurement Linearity:* Verification of the Linearity at +10% and -10% of the nominal calibration voltage. Influence of offset voltage is included in this measurement.
  - *Common mode sensitivity:* Influence of a positive or negative common mode voltage on the differential measurement.
  - *Channel separation:* Influence of a voltage on the neighbor channels not subject to an input voltage.
  - *AD Converter Values with inputs shorted:* Values on the internal AD converter corresponding to zero input voltage
  - *Input Offset Measurement:* Output voltage and statistical results over a large number of zero voltage measurements.
  - *Input Offset Current:* Typical value for information; Maximum channel input offset current, not considering the input resistance.
  - *Input resistance:* Typical value for information: DAE input resistance at the connector, during internal auto-zeroing and during measurement.
  - *Low Battery Alarm Voltage:* Typical value for information. Below this voltage, a battery alarm signal is generated.
  - *Power consumption:* Typical value for information. Supply currents in various operating modes.



**DC Voltage Measurement**

A/D - Converter Resolution nominal

High Range: 1LSB = 6.1 $\mu$ V, full range = -100...+300 mV

Low Range: 1LSB = 61nV, full range = -1.....+3mV

DASY measurement parameters: Auto Zero Time: 3 sec; Measuring time: 3 sec

Calibration Factors	X	Y	Z
High Range	405.267 $\pm$ 0.1% (k=2)	404.990 $\pm$ 0.1% (k=2)	404.221 $\pm$ 0.1% (k=2)
Low Range	3.97762 $\pm$ 0.7% (k=2)	3.99629 $\pm$ 0.7% (k=2)	3.98707 $\pm$ 0.7% (k=2)

**Connector Angle**

Connector Angle to be used in DASY system	176.5 $^{\circ}$ $\pm$ 1 $^{\circ}$
---	-------------------------------------

## Appendix

### 1. DC Voltage Linearity

High Range	Reading ( $\mu\text{V}$ )	Difference ( $\mu\text{V}$ )	Error (%)
Channel X + Input	199991.77	-2.52	-0.00
Channel X + Input	20001.19	1.01	0.01
Channel X - Input	-19996.52	3.93	-0.02
Channel Y + Input	199992.70	-2.15	-0.00
Channel Y + Input	19999.00	-1.14	-0.01
Channel Y - Input	-19999.75	0.71	-0.00
Channel Z + Input	199991.55	-3.11	-0.00
Channel Z + Input	19999.33	-0.76	-0.00
Channel Z - Input	-20001.23	-0.67	0.00

Low Range	Reading ( $\mu\text{V}$ )	Difference ( $\mu\text{V}$ )	Error (%)
Channel X + Input	1999.14	-1.60	-0.08
Channel X + Input	201.79	0.59	0.29
Channel X - Input	-198.19	0.48	-0.24
Channel Y + Input	1999.56	-0.99	-0.05
Channel Y + Input	200.20	-0.96	-0.48
Channel Y - Input	-199.38	-0.54	0.27
Channel Z + Input	2000.07	-0.52	-0.03
Channel Z + Input	200.32	-0.83	-0.41
Channel Z - Input	-199.60	-0.78	0.39

### 2. Common mode sensitivity

DASY measurement parameters: Auto Zero Time: 3 sec; Measuring time: 3 sec

	Common mode Input Voltage (mV)	High Range Average Reading ( $\mu\text{V}$ )	Low Range Average Reading ( $\mu\text{V}$ )
Channel X	200	10.22	8.65
	-200	-6.99	-8.91
Channel Y	200	-10.43	-11.02
	-200	7.95	9.22
Channel Z	200	14.25	13.66
	-200	-15.77	-14.99

### 3. Channel separation

DASY measurement parameters: Auto Zero Time: 3 sec; Measuring time: 3 sec

	Input Voltage (mV)	Channel X ( $\mu\text{V}$ )	Channel Y ( $\mu\text{V}$ )	Channel Z ( $\mu\text{V}$ )
Channel X	200	-	-1.62	-2.79
Channel Y	200	8.07	-	-2.95
Channel Z	200	7.90	6.93	-

**4. AD-Converter Values with inputs shorted**

DASY measurement parameters: Auto Zero Time: 3 sec; Measuring time: 3 sec

	High Range (LSB)	Low Range (LSB)
Channel X	15896	16218
Channel Y	16012	15924
Channel Z	15702	15710

**5. Input Offset Measurement**

DASY measurement parameters: Auto Zero Time: 3 sec; Measuring time: 3 sec

Input 10MΩ

	Average (μV)	min. Offset (μV)	max. Offset (μV)	Std. Deviation (μV)
Channel X	0.67	-0.77	1.84	0.43
Channel Y	-1.44	-2.35	-0.02	0.39
Channel Z	-0.81	-1.60	0.01	0.37

**6. Input Offset Current**

Nominal Input circuitry offset current on all channels: <25fA

**7. Input Resistance** (Typical values for information)

	Zeroing (kOhm)	Measuring (MOhm)
Channel X	200	200
Channel Y	200	200
Channel Z	200	200

**8. Low Battery Alarm Voltage** (Typical values for information)

Typical values	Alarm Level (VDC)
Supply (+ Vcc)	+7.9
Supply (- Vcc)	-7.6

**9. Power Consumption** (Typical values for information)

Typical values	Switched off (mA)	Stand by (mA)	Transmitting (mA)
Supply (+ Vcc)	+0.01	+6	+14
Supply (- Vcc)	-0.01	-8	-9