



SPORTON International Inc.

No.8, Lane 724, Bo-ai St., Jhubei City, HsinChu County 302, Taiwan, R.O.C.
Ph: 886-3-656-9065 / FAX: 886-3-656-9085 / www.sporton.com.tw

FCC RADIO TEST REPORT

Applicant's company	Realtek Semiconductor Corp.
Applicant Address	No. 2, Innovation Road II, Hsinchu Science Park, Hsinchu 300, Taiwan
FCC ID	TX2-RTL8723AS
Manufacturer's company	Realtek Semiconductor Corp.
Manufacturer Address	No. 2, Innovation Road II, Hsinchu Science Park, Hsinchu 300, Taiwan

Product Name	802.11b/g/n RTL8723AS combo module
Brand Name	Realtek
Model Name	RTL8723AS
Test Rule	47 CFR FCC Part 15 Subpart C § 15.247
Test Freq. Range	2400 ~ 2483.5MHz
Received Date	Jan. 19, 2012
Final Test Date	Apr. 03, 2012
Submission Type	Original Equipment



Statement

Test result included is only for the Bluetooth part of the product.

The test result in this report refers exclusively to the presented test model / sample.

Without written approval of SPORTON International Inc., the test report shall not be reproduced except in full.

The measurements and test results shown in this test report were made in accordance with the procedures and found in compliance with the limit given in **ANSI C63.10-2009** and **47 CFR FCC Part 15 Subpart C**.

The test equipment used to perform the test is calibrated and traceable to NML/ROC.



Table of Contents

1. CERTIFICATE OF COMPLIANCE	1
2. SUMMARY OF THE TEST RESULT	2
3. GENERAL INFORMATION	3
3.1. Product Details.....	3
3.2. Accessories.....	3
3.3. Table for Filed Antenna.....	4
3.4. Table for Carrier Frequencies	5
3.5. Table for Test Modes	6
3.6. Table for Testing Locations.....	8
3.7. Table for Supporting Units	8
3.8. Table for Parameters of Test Software Setting	9
3.9. Test Configurations	10
4. TEST RESULT	16
4.1. AC Power Line Conducted Emissions Measurement.....	16
4.2. Maximum Peak Output Power Measurement	22
4.3. Average Output Power Measurement	29
4.4. Hopping Channel Separation Measurement	34
4.5. Number of Hopping Frequency Measurement.....	61
4.6. Dwell Time Measurement.....	90
4.7. Radiated Emissions Measurement	127
4.8. Band Edge Emissions Measurement	159
4.9. Antenna Requirements	176
5. LIST OF MEASURING EQUIPMENTS	177
6. TEST LOCATION.....	179
7. TAF CERTIFICATE OF ACCREDITATION	180
APPENDIX A. TEST PHOTOS	A1 ~ A11
APPENDIX B. MAXIMUM PERMISSIBLE EXPOSURE	B1 ~ B4
APPENDIX C. CO-LOCATION REPORT.....	C1 ~ C5
APPENDIXD. ANTENNA LIST	

1. CERTIFICATE OF COMPLIANCE

Product Name : 802.11b/g/n RTL8723AS combo module
Brand Name : Realtek
Model Name : RTL8723AS
Applicant : Realtek Semiconductor Corp.
Test Rule Part(s) : 47 CFR FCC Part 15 Subpart C § 15.247

Sporton International as requested by the applicant to evaluate the EMC performance of the product sample received on Jan. 19, 2012 would like to declare that the tested sample has been evaluated and found to be in compliance with the tested rule parts. The data recorded as well as the test configuration specified is true and accurate for showing the sample's EMC nature.

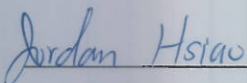

Jordan Hsiao

SPORTON INTERNATIONAL INC.

2. SUMMARY OF THE TEST RESULT

Applied Standard: 47 CFR FCC Part 15 Subpart C				
Part	Rule Section	Description of Test	Result	Under Limit
4.1	15.207	AC Power Line Conducted Emissions	Complies	10.17 dB
4.2	15.247(b)(1)	Maximum Peak Conducted Output Power	Complies	18.01 dB
4.3	-	Average Output Power	-	-
4.4	15.247(a)(1)	Hopping Channel Separation	Complies	-
4.5	15.247(b)(1)	Number of Hopping Frequency	Complies	-
4.6	15.247(a)(1)	Dwell Time	Complies	-
4.7	15.247(d)	Radiated Emissions	Complies	3.04 dB
4.8	15.247(d)	Band Edge Emissions	Complies	5.31 dB
4.9	15.203	Antenna Requirements	Complies	-

Test Items	Uncertainty	Remark
AC Power Line Conducted Emissions	±2.3dB	Confidence levels of 95%
Maximum Peak Conducted Output Power	±0.8dB	Confidence levels of 95%
Hopping Channel Separation	±8.5×10 ⁻⁸	Confidence levels of 95%
Radiated Emissions (9kHz~30MHz)	±0.8dB	Confidence levels of 95%
Radiated Emissions (30MHz~1000MHz)	±1.9dB	Confidence levels of 95%
Radiated / Band Edge Emissions (1GHz~18GHz)	±1.9dB	Confidence levels of 95%
Radiated Emissions (18GHz~40GHz)	±1.9dB	Confidence levels of 95%
Temperature	±0.7°C	Confidence levels of 95%
Humidity	±3.2%	Confidence levels of 95%
DC / AC Power Source	±1.4%	Confidence levels of 95%

3. GENERAL INFORMATION

3.1. Product Details

Items	Description
Power Type	From USB or SDIO+UART
Modulation	FHSS (GFSK / $\pi/4$ -DQPSK / 8DPSK)
Data Rate (Mbps)	GFSK: 1 ; $\pi/4$ -QPSK: 2 ; 8DPSK: 3
Frequency Range	2400 ~ 2483.5MHz
Channel Number	For Bluetooth 2.1 + EDR: 79 For Bluetooth 4.0: 40 (37 hopping + 3 advertising channel)
Channel Band Width (99%)	For Bluetooth 2.1 + EDR : 1.240 MHz For Bluetooth 4.0 : 1.06 MHz
Peak Conducted Output Power	For Bluetooth 2.1 + EDR : 11.99 dBm For Bluetooth 4.0 : 4.12 dBm
Carrier Frequencies	Please refer to section 3.4
Antenna	Please refer to section 3.3
Note: This equipment does not support adaptive frequency hopping (AFH) function, so that there is no situation channel number less than 15 channels.	

3.2. Accessories

N/A

3.3. Table for Filed Antenna

Ant.	Brand	Model Name	Antenna Type	Connector	Gain (dBi)	Remark
1	LYNwave	ALA110-222050-300010	PIFA Antenna	IPEX	3.5	TX/RX
2	JOYMAX	TWF-614XMPXX-500	Dipole Antenna	IPEX	3.0	TX/RX

Note: There are two types of EUT, one is diversity type and the other is single type. Both of the EUTs work with two types antenna.

For diversity type: (Both of those two antenna connectors can be used.)

The EUT supports the antenna with TX/RX diversity function for WLAN and Bluetooth.

802.11b/g (1TX, 1RX)

Both of Ant. 1 and Ant. 2 can be used as transmitting/receiving antennas, but only one antenna can be used as transmitting/receiving antenna at the same time.

802.11n (MCS0~7) (1TX, 1RX)

Both of Ant. 1 and Ant. 2 can be used as transmitting/receiving antennas, but only one antenna can be used as transmitting/receiving antenna at the same time.

Bluetooth:

Base on WIFI's test mode to select the other antenna to perform the test. (Ex. Assume Main port was selected to conduct transmitting function in WIFI, so AUX port was selected in Bluetooth Mode. Vice versa.)

For single type: [Only antenna connector (Main port or Aux port) can be used.]

802.11b/g (1TX, 1RX)

In case of this, only one antenna will be attached to main (or aux) port. (i.e. one antenna and two connectors will be marketed.) WiFi and BT share main(or aux) in time slot, like time division. They fix main (or aux) port to transmit and receive, depending on which port was used to attach the antenna.

802.11n (MCS0~7) (1TX, 1RX)

In case of this, only one antenna will be attached to main (or aux) port. (i.e. one antenna and two connectors will be marketed.) WiFi and BT share main(or aux) in time slot, like time division. They fix main (or aux) port to transmit and receive, depending on which port was used to attach the antenna.

Bluetooth:

In case of this, only one antenna will be attached to main (or aux) port. (i.e. one antenna and two connectors will be marketed.) WiFi and BT share main(or aux) in time slot, like time division. They fix main (or aux) port to transmit and receive, depending on which port was used to attach the antenna..

The signal path length from IC to aux port is larger by around half a wave-length, than the signal path length from IC to main port. This extra half a wave-length signal path introduce some extra loss. That's why peak power of aux port is lower than main port.



3.4. Table for Carrier Frequencies

For Bluetooth 2.1 + EDR :

Frequency Band	Channel No.	Frequency	Channel No.	Frequency
2400~2483.5MHz	0	2402 MHz	40	2442 MHz
	1	2403 MHz	:	:
	:	:	77	2479 MHz
	38	2440 MHz	78	2480 MHz
	39	2441 MHz	-	-

For Bluetooth 4.0 :

Frequency Band	Channel No.	Frequency	Channel No.	Frequency
2400~2483.5MHz	0	2402 MHz	20	2442 MHz
	1	2404 MHz	:	:
	2	2406 MHz	37	2476 MHz
	:	:	38	2478 MHz
	18	2438 MHz	39	2480 MHz
	19	2440 MHz	-	-

3.5. Table for Test Modes

Preliminary tests were performed in different data rate to find the worst radiated emission. The data rate shown in the table below is the worst-case rate with respect to the specific test item. Investigation has been done on all the possible configurations for searching the worst cases. The following table is a list of the test modes shown in this test report.

For Bluetooth 2.1 + EDR :

Test Items	Mode	Data Rate	Channel	Connector
AC Power Conducted Emissions	Normal Link	3 Mbps	Hopping 0~78	-
Max. Conducted Output Power	GFSK / 8DPSK	1Mbps /3 Mbps	0/39/78	1/2
Hopping Channel Separation	GFSK / 8DPSK	1Mbps /3 Mbps	0~1/39~40/77~78	1/2
Number of Hopping Frequency	8DPSK	3 Mbps	0~78	1/2
Dwell Time	3DH1/3DH3/3DH5	3 Mbps	0/39/78	1/2
Radiated Emissions Below 1GHz	8DPSK	3 Mbps	39	1/2
Radiated Emissions Above 1GHz	8DPSK	3 Mbps	0/39/78	1/2
Band Edge Emissions	8DPSK	3 Mbps	0/78	1/2

For Bluetooth 4.0 :

Test Items	Mode	Data Rate	Channel	Connector
AC Power Conducted Emissions	Normal Link	1 Mbps	Hopping 0~39	-
Max. Peak Conducted Output Power	GFSK	1 Mbps	0/20/39	1/2
Average Output Power	GFSK	1 Mbps	0/20/39	1/2
Hopping Channel Separation	GFSK	1 Mbps	0~1/19~20/38~39	1/2
Number of Hopping Frequency	GFSK	1 Mbps	0~39	1/2
Dwell Time	DH1	1 Mbps	0/20/39	1/2
Radiated Emissions Below 1GHz	GFSK	1 Mbps	20	1/2
Radiated Emissions Above 1GHz	GFSK	1 Mbps	0/20/39	1/2
Band Edge Emissions	GFSK	1 Mbps	0/39	1/2

The following test modes were performed for all tests:

EUT 1: Power from USB

EUT 2: Power from SDIO+UART

For Conducted Emission test:

Mode 1: EUT1 +WLAN+BT with Main port of PIFA antenna

Mode 2: EUT1 +WLAN+BT with Aux port of PIFA antenna

Mode 3: EUT2+WLAN+BT with Main port of PIFA antenna

Mode 4: EUT2+WLAN+BT with Aux port of PIFA antenna

Mode 1 and Mode 2 have been evaluated to be the worst case, thus measurement will follow the same EUT.

Mode 5: EUT1 +WLAN+BT with Main port of Dipole antenna

Mode 6: EUT1 +WLAN+BT with Aux port of Dipole antenna

Mode 1, Mode 2, Mode 5 and Mode 6 was selected and recorded in this report.

For Radiated Emission test:

<For radiated 30MHz~1GHz>

Mode 1: EUT1 +WLAN+BT with Main port of PIFA antenna

Mode 2: EUT1 +WLAN+BT with Aux port of PIFA antenna

Mode 3: EUT2 +WLAN+BT with Main port of PIFA antenna

Mode 4: EUT2 +WLAN+BT with Aux port of PIFA antenna

Mode 1 and Mode 2 have been evaluated to be the worst case, thus measurement will follow the same EUT.

Mode 5: EUT1 +WLAN+BT with Main port of Dipole antenna

Mode 6: EUT1 +WLAN+BT with Aux port of Dipole antenna

Mode 1, Mode 2, Mode 5 and Mode 6 were selected and recorded in this report.

<For radiated above 1GHz>

Mode 1: EUT1 +WLAN+BT with Main port of PIFA antenna in Bluetooth 2.1

Mode 2: EUT1 +WLAN+BT with Aux port of PIFA antenna in Bluetooth 2.1

Mode 3: EUT2 +WLAN+BT with Main port of PIFA antenna in Bluetooth 2.1

Mode 4: EUT2 +WLAN+BT with Aux port of PIFA antenna in Bluetooth 2.1

Mode 5: EUT1 +WLAN+BT with Main port of PIFA antenna in Bluetooth 4.0

Mode 6: EUT1 +WLAN+BT with Aux port of PIFA antenna in Bluetooth 4.0

Mode 7: EUT2 +WLAN+BT with Main port of PIFA antenna in Bluetooth 4.0

Mode 8: EUT2 +WLAN+BT with Aux port of PIFA antenna in Bluetooth 4.0

Mode 9: EUT1 +WLAN+BT with Main port of Dipole antenna in Bluetooth 2.1

Mode10: EUT1 +WLAN+BT with Aux port of Dipole antenna in Bluetooth 2.1

Mode 11: EUT2 +WLAN+BT with Main port of Dipole antenna in Bluetooth 2.1

Mode 12: EUT2 +WLAN+BT with Aux port of Dipole antenna in Bluetooth 2.1

Mode 13: EUT1 +WLAN+BT with Main port of Dipole antenna in Bluetooth 4.0

Mode 14: EUT1 +WLAN+BT with Aux port of Dipole antenna in Bluetooth 4.0

Mode 15: EUT2 +WLAN+BT with Main port of Dipole antenna in Bluetooth 4.0

Mode16: EUT2 +WLAN+BT with Aux port of Dipole antenna in Bluetooth 4.0

Due to Mode 3, Mode 4, Mode 7, Mode 8, Mode 11, Mode 12, Mode 15 and Mode 16 generated the worst test result, so they were recorded in the report.

3.6. Table for Testing Locations

Test Site No.	Site Category	Location	FCC Reg. No.	IC File No.	VCCI Reg. No
03CH01-CB	SAC	Hsin Chu	262045	IC 4086D	-
CO01-CB	Conduction	Hsin Chu	262045	IC 4086D	-
TH01-CB	OVEN Room	Hsin Chu	-	-	-

Open Area Test Site (OATS); Semi Anechoic Chamber (SAC); Fully Anechoic Chamber (FAC).

Please refer section 6 for Test Site Address.

3.7. Table for Supporting Units

Support Unit	Brand	Model	FCC ID
Notebook	DELL	1340	E2K4965AGNM
Notebook	DELL	PP25L	E2K4965AGNM
Mouse	Logitech	M-U0026	DoC
EARPHONES	E-books	E-EPC040	DOC
Wireless AP	Planex	GW-AP54SGX	-

3.8. Table for Parameters of Test Software Setting

During testing, Channel & Power Controlling Software provided by the customer was used to control the operating channel as well as the output power level. The RF output power selection is for the setting of RF output power expected by the customer and this must be calibrated and record the index in internal memory by manufacturer before shipping.

Power Parameters of Bluetooth 2.1

Test Software Version	Realtek Bluetooth MP v1.94 --- RTL8723a		
Frequency	2402 MHz	2441 MHz	2480 MHz
Power Parameters	13/9	13/9	13/9

Power Parameters of Bluetooth 4.0

Test Software Version	Realtek Bluetooth MP v1.94 --- RTL8723a		
Frequency	2402 MHz	2442 MHz	2480 MHz
Power Parameters	auto/9	auto/9	auto/9

During the test, "Realtek Bluetooth MP v1.94 --- RTL8723a" under WIN XP was executed the test program to control the EUT continuously transmit RF signal.

3.9. Test Configurations

3.9.1. Radiation Emissions Test Configuration

Test Configuration: 30MHz~1GHz

< Mode 1 / Mode 2 >

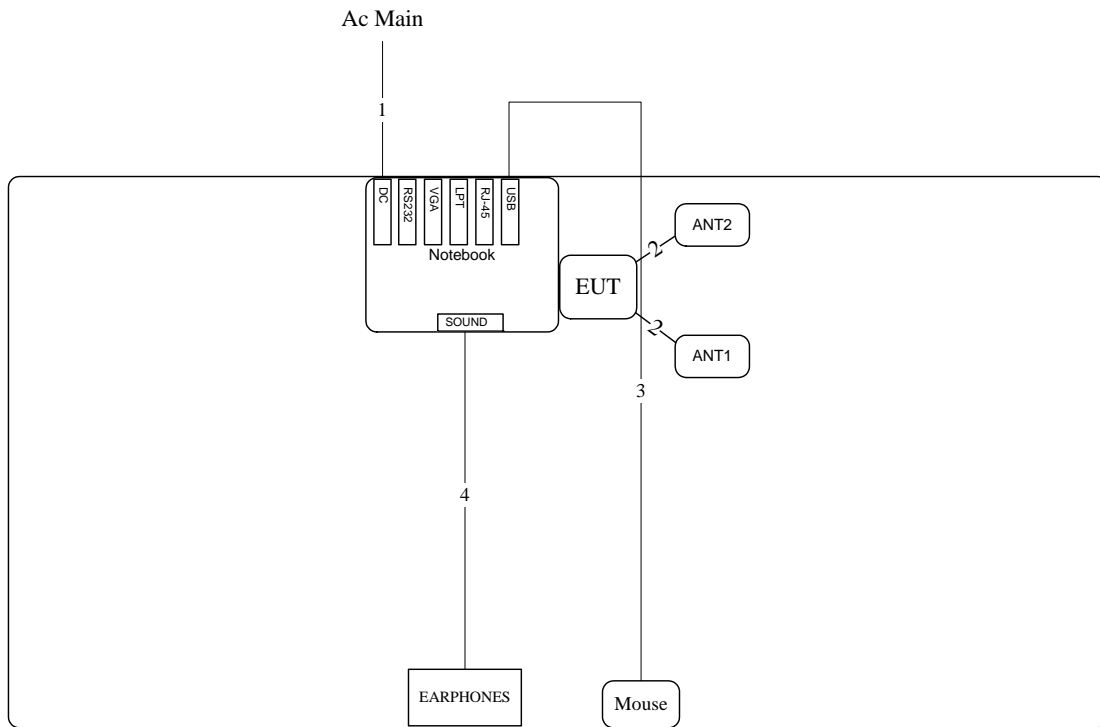

AP

BT NB

Item	Connection	Shield	Length
1	Power cable	No	1.8m
2	Ant cable	Yes	0.2m
3	Usb cable	Yes	1.8m
4	Earphones	No	1.1m

< Mode 5 / Mode 6 >

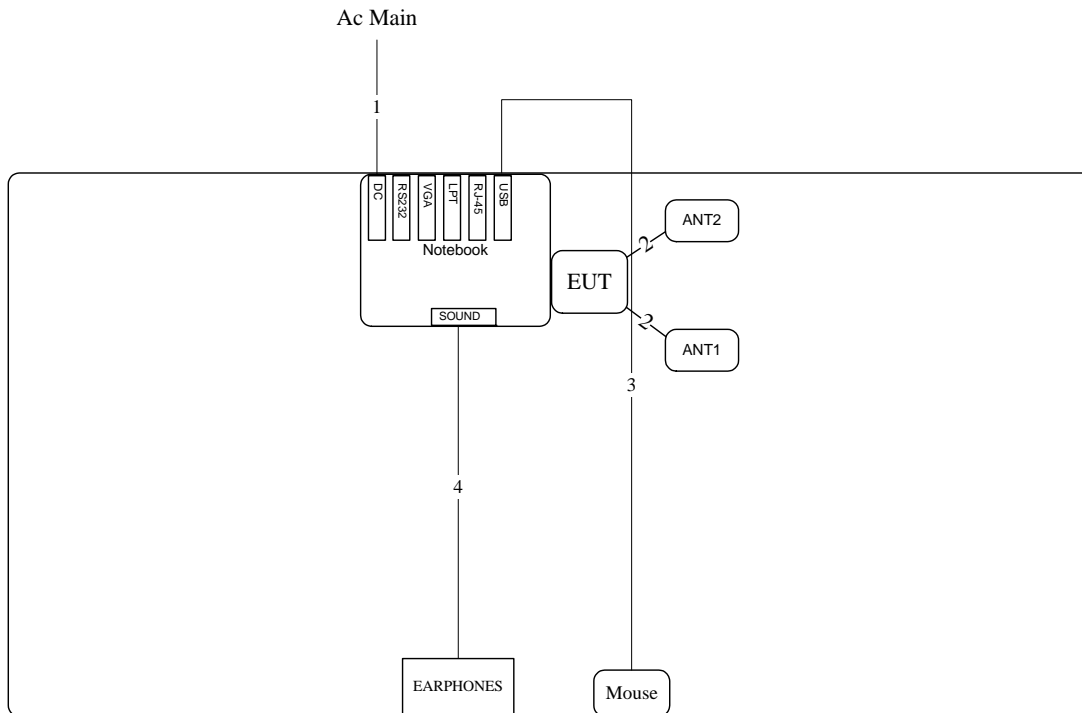

AP

BT NB

Item	Connection	Shield	Length
1	Power cable	No	1.8m
2	Ant cable	Yes	0.20m
3	Usb cable	Yes	1.8m
4	Earphones	No	1.1m

Test Configuration: above 1GHz

< Mode 3 / Mode 4 / Mode 7 / Mode 8 >

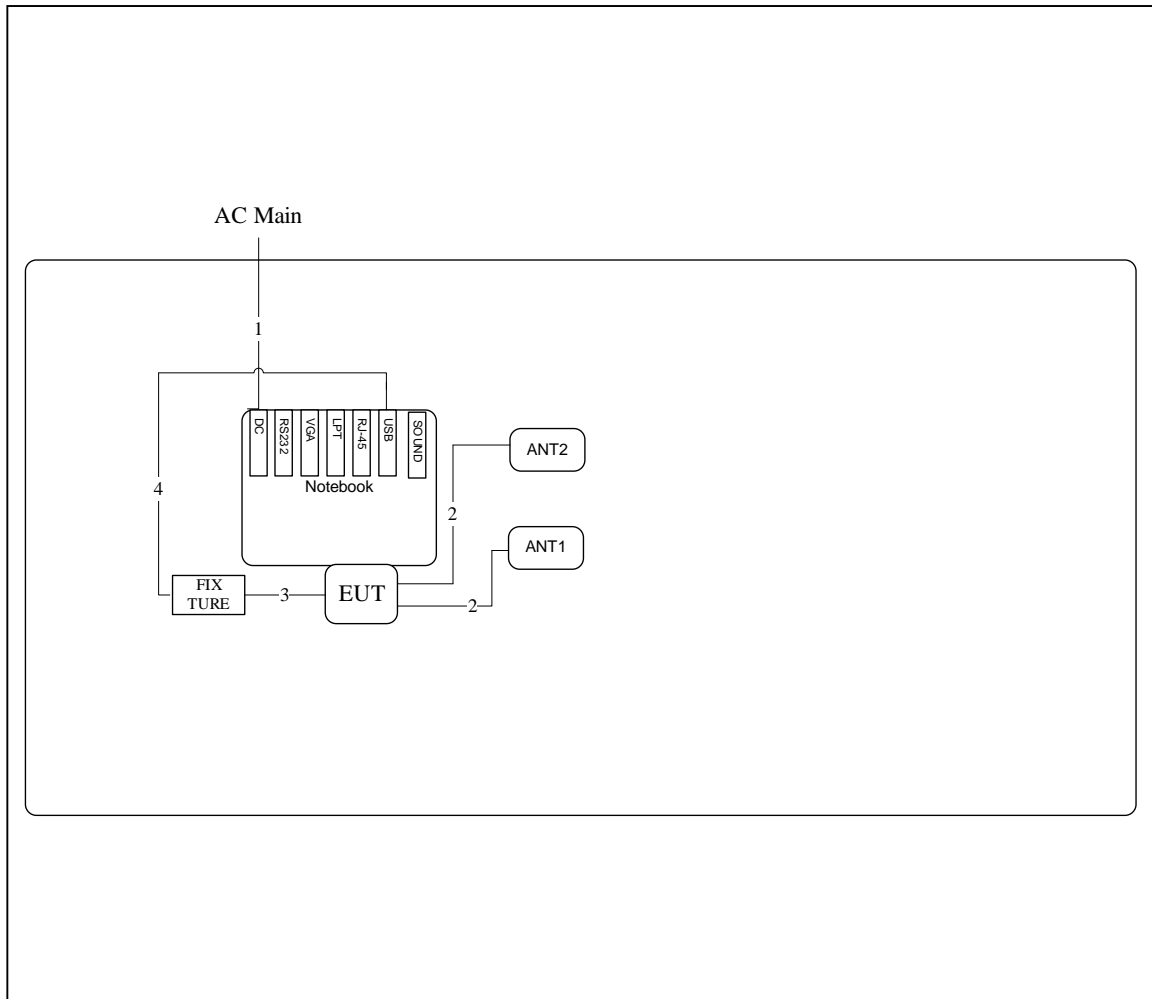

Item	Connection	Shield	Length
1	Power cable	No	1.8m
2	Ant cable	Yes	0.20m
3	Console cable	Yes	0.35m
4	RS232 to USB cable	No	0.45m

< Mode 11 / Mode 12 / Mode 15 / Mode 16 >

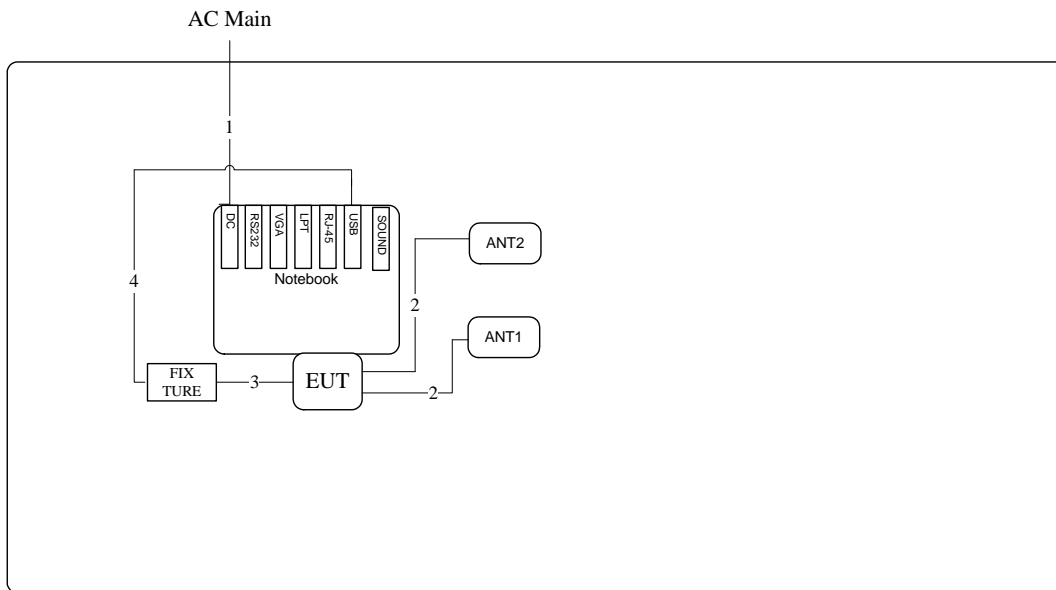

Item	Connection	Shield	Length
1	Power cable	No	1.8m
2	Ant cable	Yes	0.20m
3	Console cable	Yes	0.35m
4	RS232 to USB cable	No	0.45m

3.9.2. AC Power Line Conduction Emissions Test Configuration

< Mode 1 / Mode 2 >

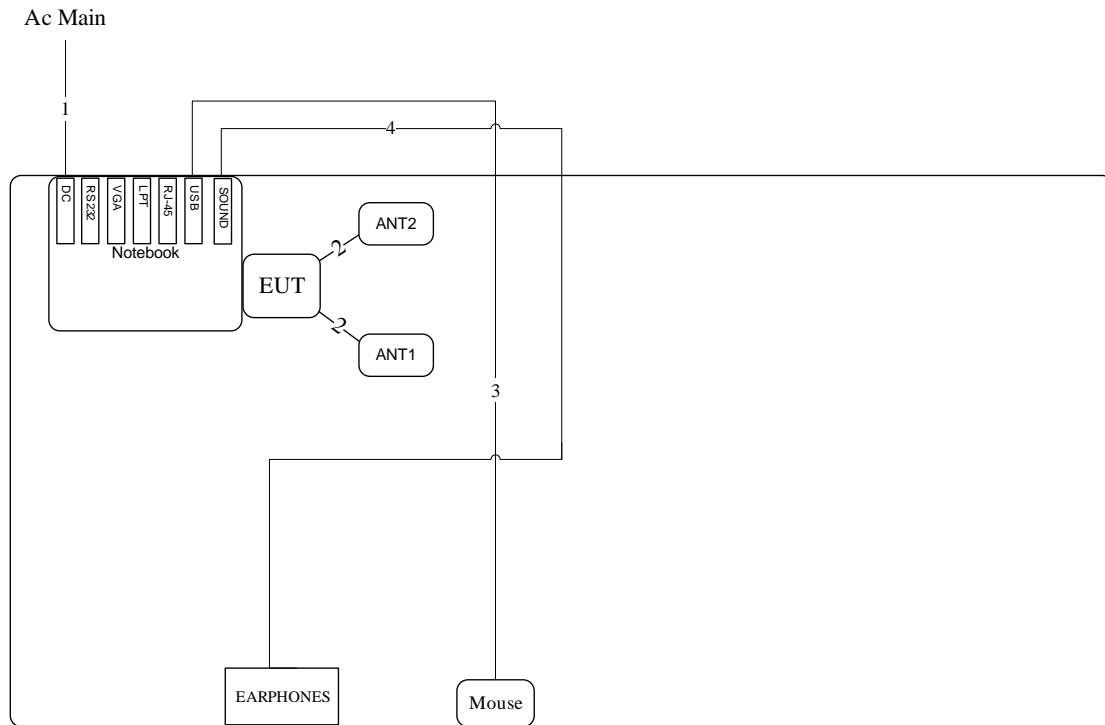

AP

BT NB

Item	Connection	Shield	Length
1	Power cable	No	1.8m
2	Ant cable	Yes	0.20m
3	Usb cable	Yes	1.8m
4	Earphones	No	1.1m

< Mode 5 / Mode 6 >

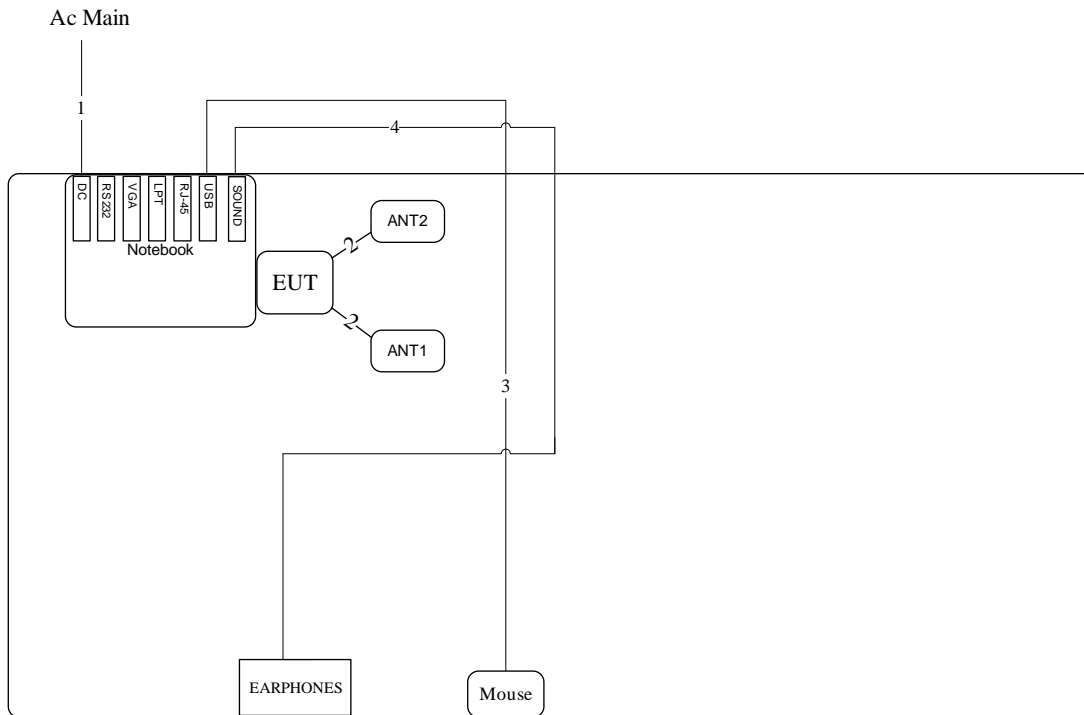

AP

BT NB

Item	Connection	Shield	Length
1	Power cable	No	1.8m
2	Ant cable	Yes	0.20m
3	Usb cable	Yes	1.8m
4	Earphones	No	1.1m

4. TEST RESULT

4.1. AC Power Line Conducted Emissions Measurement

4.1.1. Limit

For a Low-power Radio-frequency Device which is designed to be connected to the AC power line, the radio frequency voltage that is conducted back onto the AC power line on any frequency or frequencies within the band 150 kHz to 30 MHz shall not exceed below limits table.

Frequency (MHz)	QP Limit (dBuV)	AV Limit (dBuV)
0.15~0.5	66~56	56~46
0.5~5	56	46
5~30	60	50

4.1.2. Measuring Instruments and Setting

Please refer to section 5 of equipments list in this report. The following table is the setting of the receiver.

Receiver Parameters	Setting
Attenuation	10 dB
Start Frequency	0.15 MHz
Stop Frequency	30 MHz
IF Bandwidth	9 KHz

4.1.3. Test Procedures

1. Configure the EUT according to ANSI C63.10. The EUT or host of EUT has to be placed 0.4 meter far from the conducting wall of the shielding room and at least 80 centimeters from any other grounded conducting surface.
2. Connect EUT or host of EUT to the power mains through a line impedance stabilization network (LISN).
3. All the support units are connected to the other LISNs. The LISN should provide 50uH/50ohms coupling impedance.
4. The frequency range from 150 KHz to 30 MHz was searched.
5. Set the test-receiver system to Peak Detect Function and Specified Bandwidth with Maximum Hold Mode.
6. The measurement has to be done between each power line and ground at the power terminal.

4.1.4. Test Setup Layout

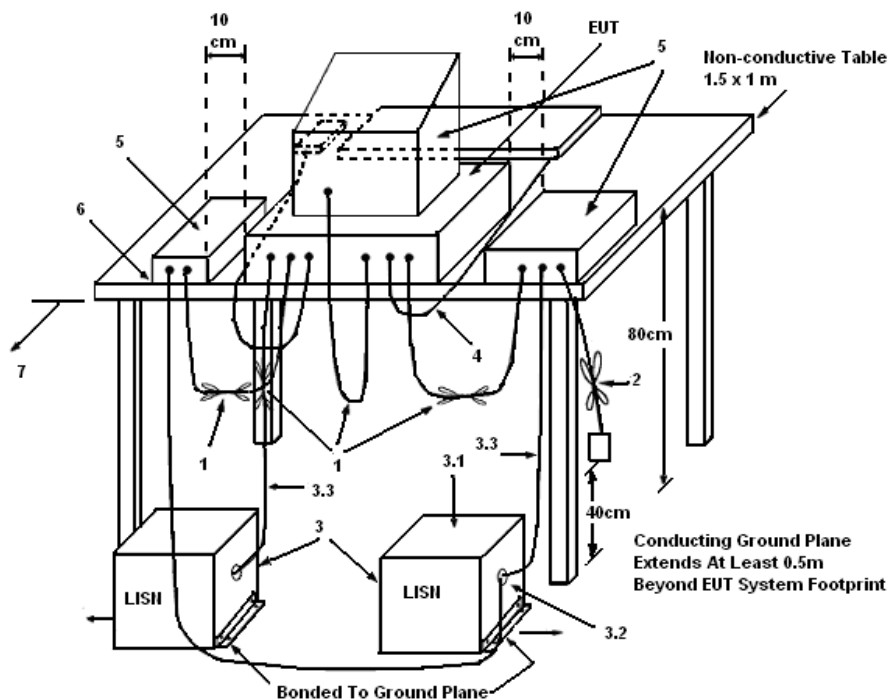

LEGEND:

- (1) Interconnecting cables that hang closer than 40 cm to the ground plane shall be folded back and forth in the center forming a bundle 30 to 40 cm long.
- (2) I/O cables that are not connected to a peripheral shall be bundled in the center. The end of the cable may be terminated, if required, using the correct terminating impedance. The overall length shall not exceed 1 m.
- (3) EUT connected to one LISN. Unused LISN measuring port connectors shall be terminated in 50 Ω . LISN can be placed on top of, or immediately beneath, reference ground plane.
 - (3.1) All other equipment powered from additional LISN(s).
 - (3.2) Multiple outlet strip can be used for multiple power cords of non-EUT equipment.
 - (3.3) LISN at least 80 cm from nearest part of EUT chassis.
- (4) Cables of hand-operated devices, such as keyboards, mice, etc., shall be placed as for normal use.
- (5) Non-EUT components of EUT system being tested.
- (6) Rear of EUT, including peripherals, shall all be aligned and flush with rear of tabletop.
- (7) Rear of tabletop shall be 40 cm removed from a vertical conducting plane that is bonded to the ground plane.

4.1.5. Test Deviation

There is no deviation with the original standard.

4.1.6. EUT Operation during Test

The EUT was placed on the test table and programmed in normal function.

4.1.7. Results of AC Power Line Conducted Emissions Measurement

Temperature	21°C	Humidity	63%
Test Engineer	Ethan Hung	Phase	Line
Configuration	Normal Link	Test Mode	Mode 1 / Mode 2

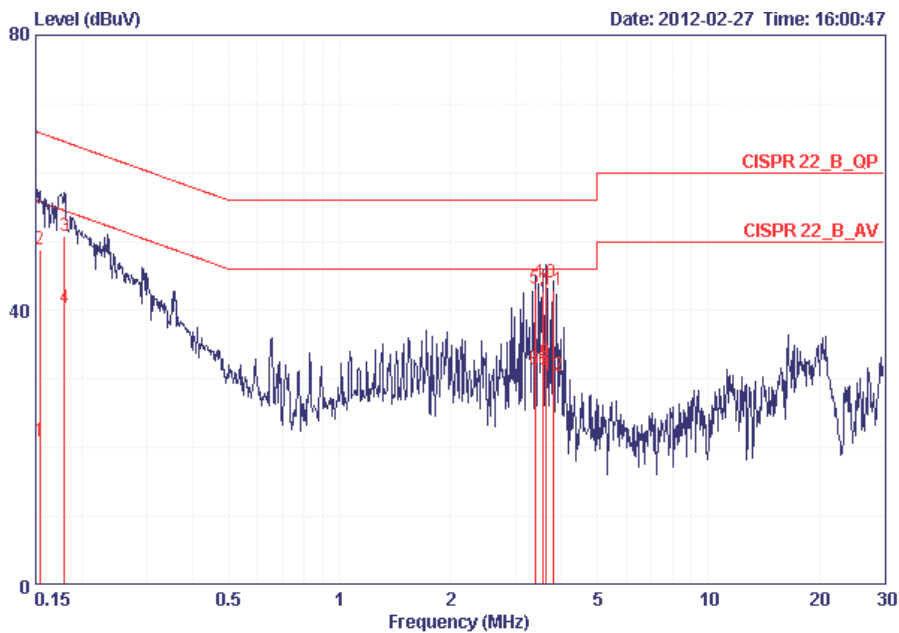

	Freq	Level	Over	Limit	Read	LISN	Cable	Remark
	MHz	dBuV	Limit	Line	Level	Factor	Loss	
			dB	dBuV	dBuV	dB	dB	
1	0.15403	20.94	-34.84	55.78	20.67	0.07	0.20	AVERAGE
2	0.15403	48.76	-17.02	65.78	48.49	0.07	0.20	QP
3	0.17961	50.89	-13.61	64.50	50.63	0.06	0.20	QP
4	0.17961	40.24	-14.26	54.50	39.98	0.06	0.20	AVERAGE
5	3.390	43.14	-12.86	56.00	42.77	0.09	0.28	QP
6	3.390	31.37	-14.63	46.00	31.00	0.09	0.28	AVERAGE
7	3.565	42.63	-13.37	56.00	42.24	0.09	0.30	QP
8	3.565	31.46	-14.54	46.00	31.07	0.09	0.30	AVERAGE
9	3.625	32.49	-13.51	46.00	32.10	0.09	0.30	AVERAGE
10	3.625	43.95	-12.05	56.00	43.56	0.09	0.30	QP
11	3.807	42.99	-13.01	56.00	42.59	0.10	0.30	QP
12	3.807	30.58	-15.42	46.00	30.18	0.10	0.30	AVERAGE

Temperature	25°C	Humidity	65%
Test Engineer	Ethan Hung	Phase	Neutral
Configuration	Normal Link	Test Mode	Mode 1 / Mode 2

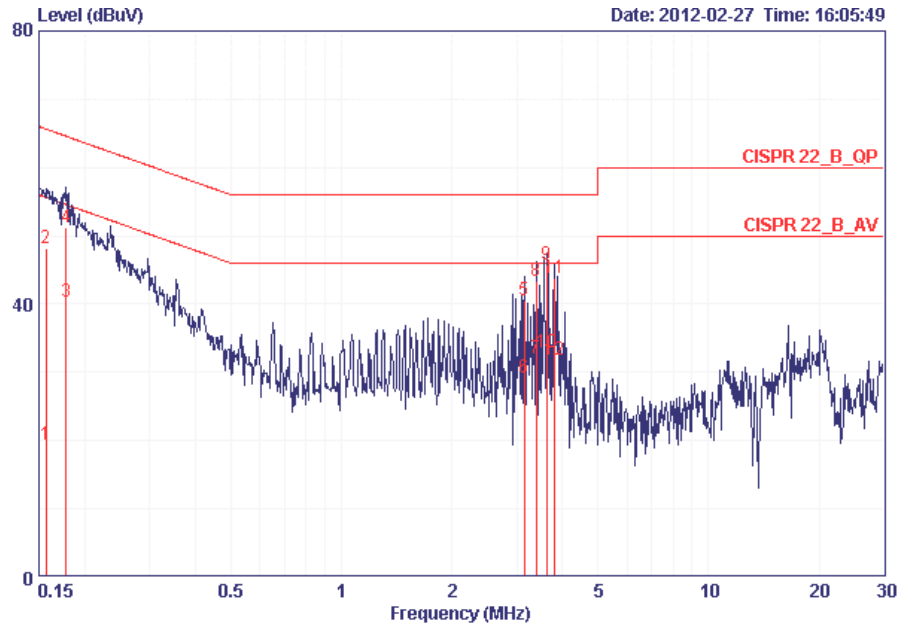

	Freq	Level	Over Limit	Limit Line	Read Level	LISN Factor	Cable Loss	Remark
	MHz	dBuV	dB	dBuV	dBuV	dB	dB	
1	0.15650	19.38	-36.27	55.65	19.08	0.10	0.20	AVERAGE
2	0.15650	48.22	-17.43	65.65	47.92	0.10	0.20	QP
3	0.17772	40.31	-14.28	54.59	40.02	0.09	0.20	AVERAGE
4	0.17772	51.33	-13.26	64.59	51.04	0.09	0.20	QP
5	3.150	40.59	-15.41	56.00	40.23	0.12	0.23	QP
6	3.150	29.25	-16.75	46.00	28.89	0.12	0.23	AVERAGE
7	3.390	32.14	-13.86	46.00	31.73	0.13	0.28	AVERAGE
8	3.390	43.28	-12.72	56.00	42.87	0.13	0.28	QP
9	3.626	45.83	-10.17	56.00	45.40	0.13	0.30	QP
10	3.626	32.96	-13.04	46.00	32.53	0.13	0.30	AVERAGE
11	3.805	43.78	-12.22	56.00	43.34	0.14	0.30	QP
12	3.805	31.80	-14.20	46.00	31.36	0.14	0.30	AVERAGE

Note:

Level = Read Level + LISN Factor + Cable Loss.

Temperature	21°C	Humidity	63%
Test Engineer	Ethan Hung	Phase	Line
Configuration	Normal Link	Test Mode	Mode 5 / Mode 6

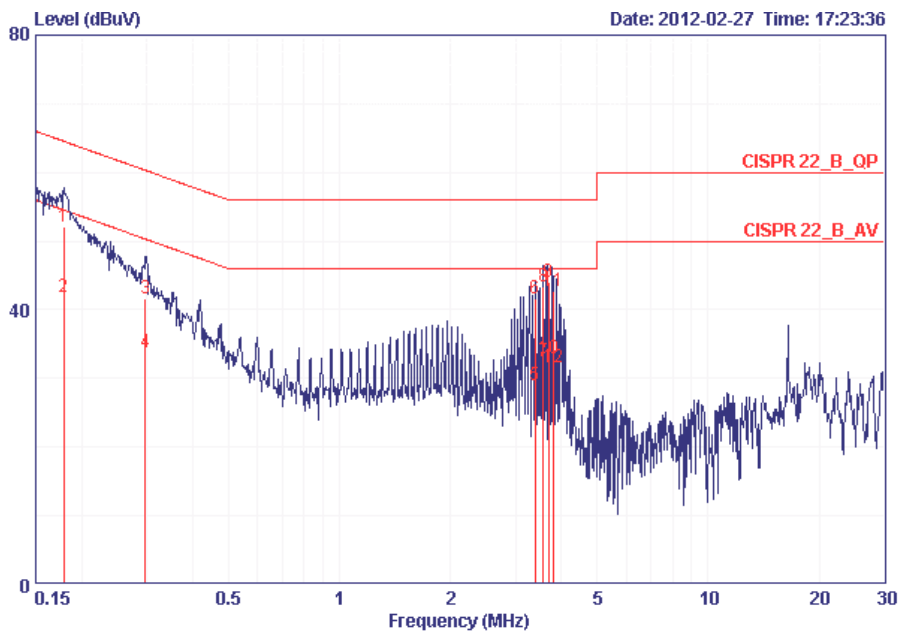

	Freq	Level	Over Limit	Limit Line	Read Level	LISN Factor	Cable Loss	Remark
	MHz	dBuV	dB	dBuV	dBuV	dB	dB	
1 @	0.17866	52.01	-12.54	64.55	51.75	0.06	0.20	QP
2 @	0.17866	41.89	-12.66	54.55	41.63	0.06	0.20	AVERAGE
3	0.29712	41.58	-18.74	60.32	41.34	0.04	0.20	QP
4	0.29712	33.74	-16.58	50.32	33.50	0.04	0.20	AVERAGE
5	3.391	28.95	-17.05	46.00	28.58	0.09	0.28	AVERAGE
6 @	3.391	41.61	-14.39	56.00	41.24	0.09	0.28	QP
7 @	3.565	32.47	-13.53	46.00	32.08	0.09	0.30	AVERAGE
8 @	3.565	43.37	-12.63	56.00	42.98	0.09	0.30	QP
9 @	3.688	44.10	-11.90	56.00	43.71	0.09	0.30	QP
10 @	3.688	32.84	-13.16	46.00	32.45	0.09	0.30	AVERAGE
11 @	3.806	42.71	-13.29	56.00	42.31	0.10	0.30	QP
12 @	3.806	31.51	-14.49	46.00	31.11	0.10	0.30	AVERAGE

Temperature	25°C	Humidity	65%
Test Engineer	Ethan Hung	Phase	Neutral
Configuration	Normal Link	Test Mode	Mode 5 / Mode 6

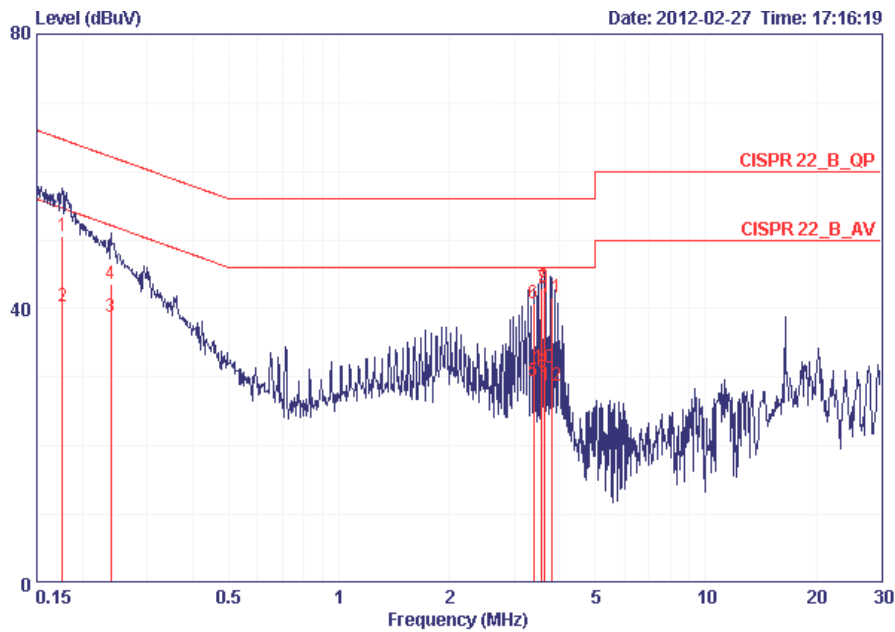

	Freq	Level	Over Limit	Limit Line	Read Level	LISN Factor	Cable Loss	Remark
	MHz	dBuV	dB	dBuV	dBuV	dB	dB	
1 @	0.17584	50.64	-14.04	64.68	50.35	0.09	0.20	QP
2 @	0.17584	40.41	-14.27	54.68	40.12	0.09	0.20	AVERAGE
3 @	0.23910	38.72	-13.41	52.13	38.44	0.08	0.20	AVERAGE
4	0.23910	43.59	-18.54	62.13	43.31	0.08	0.20	QP
5	3.390	29.48	-16.52	46.00	29.07	0.13	0.28	AVERAGE
6 @	3.390	40.78	-15.22	56.00	40.37	0.13	0.28	QP
7 @	3.568	42.89	-13.11	56.00	42.46	0.13	0.30	QP
8 @	3.568	30.78	-15.22	46.00	30.35	0.13	0.30	AVERAGE
9 @	3.627	43.14	-12.86	56.00	42.71	0.13	0.30	QP
10 @	3.627	31.45	-14.55	46.00	31.02	0.13	0.30	AVERAGE
11 @	3.804	41.70	-14.30	56.00	41.26	0.14	0.30	QP
12	3.804	28.74	-17.26	46.00	28.30	0.14	0.30	AVERAGE

Note:

Level = Read Level + LISN Factor + Cable Loss.

4.2. Maximum Peak Output Power Measurement

4.2.1. Limit

For frequency hopping systems operating in the 2400-2483.5 MHz band employing at least 75 non-overlapping hopping channels, the limit for peak output power is 1Watt (30dBm). For all other frequency hopping systems in the 2400-2483.5 MHz band: 0.125 watts (21dBm). The limited has to be reduced by the amount in dB that the gain of the antenna exceed 6dBi. In case of point-to-point operation, the limit has to be reduced by 1 dB for every 3dB that the directional gain of the antenna exceeds 6dBi.

4.2.2. Measuring Instruments and Setting

Please refer to section 5 of equipments list in this report. The following table is the setting of the power meter.

Power Meter Parameter	Setting
Filter No.	Auto
Measurement time	0.135 s ~ 26 s
Used Peak Sensor	MA2411B

Note: Because the peak power of Aux antenna is generated 1/2 attenuation, the peak power of Aux antenna is lower than Main Antenna.

4.2.3. Test Procedures

1. The transmitter output (antenna port) was connected to the power meter.
2. Turn on the EUT and power meter and then record the peak power value.
3. Repeat above procedures on all channels needed to be tested.

4.2.4. Test Setup Layout

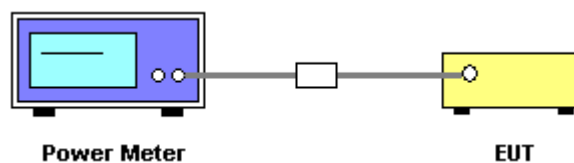

4.2.5. Test Deviation

There is no deviation with the original standard.

4.2.6. EUT Operation during Test

The EUT was programmed to be in continuously transmitting mode.

4.2.7. Test Result of Maximum Peak Output Power

For Bluetooth 2.1 + EDR : < PIFA Antenna >

Temperature	22°C	Humidity	65%
Test Engineer	Allen Liu	Configurations	GFSK/8DPSK / Main Port
Test Date	Feb. 09, 2012		

1DH5

Channel	Frequency	Conducted Power (dBm)	Max. Limit (dBm)	Result
0	2402 MHz	11.87	30.00	Complies
39	2441 MHz	11.55	30.00	Complies
78	2480 MHz	11.04	30.00	Complies

3DH5

Channel	Frequency	Conducted Power (dBm)	Max. Limit (dBm)	Result
0	2402 MHz	11.99	30.00	Complies
39	2441 MHz	11.70	30.00	Complies
78	2480 MHz	11.26	30.00	Complies

Temperature	22°C	Humidity	65%
Test Engineer	Allen Liu	Configurations	GFSK/8DPSK / Aux Port
Test Date	Feb. 09, 2012		

1DH5

Channel	Frequency	Conducted Power (dBm)	Max. Limit (dBm)	Result
0	2402 MHz	11.75	30.00	Complies
39	2441 MHz	9.28	30.00	Complies
78	2480 MHz	8.75	30.00	Complies

3DH5

Channel	Frequency	Conducted Power (dBm)	Max. Limit (dBm)	Result
0	2402 MHz	11.90	30.00	Complies
39	2441 MHz	9.53	30.00	Complies
78	2480 MHz	8.81	30.00	Complies

For Bluetooth 2.1 + EDR: < DIPOLE Antenna >

Temperature	22°C	Humidity	65%
Test Engineer	Allen Liu	Configurations	GFSK/8DPSK / Main Port
Test Date	Feb. 09, 2012		

1DH5

Channel	Frequency	Conducted Power (dBm)	Max. Limit (dBm)	Result
0	2402 MHz	11.87	30.00	Complies
39	2441 MHz	11.55	30.00	Complies
78	2480 MHz	11.04	30.00	Complies

3DH5

Channel	Frequency	Conducted Power (dBm)	Max. Limit (dBm)	Result
0	2402 MHz	11.99	30.00	Complies
39	2441 MHz	11.70	30.00	Complies
78	2480 MHz	11.26	30.00	Complies

Temperature	22°C	Humidity	65%
Test Engineer	Allen Liu	Configurations	GFSK/8DPSK / Aux Port
Test Date	Feb. 09, 2012		

1DH5

Channel	Frequency	Conducted Power (dBm)	Max. Limit (dBm)	Result
0	2402 MHz	11.75	30.00	Complies
39	2441 MHz	9.28	30.00	Complies
78	2480 MHz	8.75	30.00	Complies

3DH5

Channel	Frequency	Conducted Power (dBm)	Max. Limit (dBm)	Result
0	2402 MHz	11.90	30.00	Complies
39	2441 MHz	9.53	30.00	Complies
78	2480 MHz	8.81	30.00	Complies

For Bluetooth 4.0: < PIFA Antenna >

Temperature	22°C	Humidity	65%
Test Engineer	Allen Liu	Configurations	GFSK / Main Port
Test Date	Feb. 09, 2012		

Channel	Frequency	Conducted Power (dBm)	Max. Limit (dBm)	Result
0	2402 MHz	4.12	30.00	Complies
20	2442 MHz	3.65	30.00	Complies
39	2480 MHz	2.88	30.00	Complies

Temperature	22°C	Humidity	65%
Test Engineer	Allen Liu	Configurations	GFSK / Aux Port
Test Date	Feb. 09, 2012		

Channel	Frequency	Conducted Power (dBm)	Max. Limit (dBm)	Result
0	2402 MHz	3.58	30.00	Complies
20	2442 MHz	3.00	30.00	Complies
39	2480 MHz	2.02	30.00	Complies

For Bluetooth 4.0: < DIPOLE Antenna >

Temperature	22°C	Humidity	65%
Test Engineer	Allen Liu	Configurations	GFSK / Main Port
Test Date	Feb. 09, 2012		

Channel	Frequency	Conducted Power (dBm)	Max. Limit (dBm)	Result
0	2402 MHz	4.12	30.00	Complies
20	2442 MHz	3.65	30.00	Complies
39	2480 MHz	2.88	30.00	Complies

Temperature	22°C	Humidity	65%
Test Engineer	Allen Liu	Configurations	GFSK / Aux Port
Test Date	Feb. 09, 2012		

Channel	Frequency	Conducted Power (dBm)	Max. Limit (dBm)	Result
0	2402 MHz	3.58	30.00	Complies
20	2442 MHz	3.00	30.00	Complies
39	2480 MHz	2.02	30.00	Complies

4.3. Average Output Power Measurement

4.3.1. Measuring Instruments and Setting

Please refer to section 5 of equipments list in this report. The following table is the setting of the power meter.

Power Meter Parameter	Setting
Bandwidth	50MHz bandwidth is greater than the EUT emission bandwidth
Detector	Average

4.3.2. Test Procedures

Spectrum Parameter	Setting
RF Output Power Method	<input checked="" type="checkbox"/> ANSI C63.10 clause 6.10.2.1 (a) power meter method
RF Output Power Method	<input type="checkbox"/> ANSI C63.10 clause 6.10.2.1 (b) channel integration method
RF Output Power Method	<input type="checkbox"/> ANSI C63.10 clause 6.10.3.1 Method 1 - spectral trace averaging
RF Output Power Method	<input type="checkbox"/> ANSI C63.10 clause 6.10.3.2 Method 2 - zero-span mode with trace averaging

4.3.3. Test Setup Layout

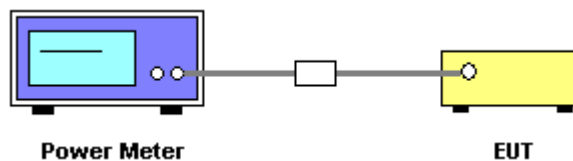

4.3.4. Test Deviation

There is no deviation with the original standard.

4.3.5. EUT Operation during Test

The EUT was programmed to be in continuously transmitting mode.

4.3.6. Test Result of Average Output Power

For Bluetooth 2.1 + EDR : < PIFA Antenna >

Temperature	22°C	Humidity	65%
Test Engineer	Allen Liu	Configurations	8DPSK / Main Port
Test Date	Feb. 09, 2012		

1DH5

Channel	Frequency	Average Conducted Power (dBm)
0	2402 MHz	9.86
39	2441 MHz	11.42
78	2480 MHz	11.05

3DH5

Channel	Frequency	Average Conducted Power (dBm)
0	2402 MHz	10.00
39	2441 MHz	11.67
78	2480 MHz	11.20

Temperature	22°C	Humidity	65%
Test Engineer	Allen Liu	Configurations	8DPSK / Aux Port
Test Date	Feb. 09, 2012		

1DH5

Channel	Frequency	Average Conducted Power (dBm)
0	2402 MHz	9.68
39	2441 MHz	9.29
78	2480 MHz	8.64

3DH5

Channel	Frequency	Average Conducted Power (dBm)
0	2402 MHz	9.72
39	2441 MHz	9.41
78	2480 MHz	8.79

For Bluetooth 2.1 + EDR: < DIPOLE Antenna >

Temperature	22°C	Humidity	65%
Test Engineer	Allen Liu	Configurations	8DPSK / Main Port
Test Date	Feb. 09, 2012		

1DH5

Channel	Frequency	Average Conducted Power (dBm)
0	2402 MHz	9.86
39	2441 MHz	11.42
78	2480 MHz	11.05

3DH5

Channel	Frequency	Average Conducted Power (dBm)
0	2402 MHz	10.00
39	2441 MHz	11.67
78	2480 MHz	11.20

Temperature	22°C	Humidity	65%
Test Engineer	Allen Liu	Configurations	8DPSK / Aux Port
Test Date	Feb. 09, 2012		

1DH5

Channel	Frequency	Average Conducted Power (dBm)
0	2402 MHz	9.68
39	2441 MHz	9.29
78	2480 MHz	8.64

3DH5

Channel	Frequency	Average Conducted Power (dBm)
0	2402 MHz	9.72
39	2441 MHz	9.41
78	2480 MHz	8.79

For Bluetooth 4.0: < PIFA Antenna >

Temperature	22°C	Humidity	65%
Test Engineer	Allen Liu	Configurations	GFSK / Main Port
Test Date	Feb. 09, 2012		

Channel	Frequency	Average Conducted Power (dBm)
0	2402 MHz	3.42
20	2442 MHz	2.96
39	2480 MHz	2.18

Temperature	22°C	Humidity	65%
Test Engineer	Allen Liu	Configurations	GFSK / Aux Port
Test Date	Feb. 09, 2012		

Channel	Frequency	Average Conducted Power (dBm)
0	2402 MHz	2.80
20	2442 MHz	2.31
39	2480 MHz	1.25

For Bluetooth 4.0 : < DIPOLE Antenna >

Temperature	22°C	Humidity	65%
Test Engineer	Allen Liu	Configurations	GFSK / Main Port
Test Date	Feb. 09, 2012		

Channel	Frequency	Average Conducted Power (dBm)
0	2402 MHz	3.42
20	2442 MHz	2.96
39	2480 MHz	2.18

Temperature	22°C	Humidity	65%
Test Engineer	Allen Liu	Configurations	GFSK / Aux Port
Test Date	Feb. 09, 2012		

Channel	Frequency	Average Conducted Power (dBm)
0	2402 MHz	2.80
20	2442 MHz	2.31
39	2480 MHz	1.25

4.4. Hopping Channel Separation Measurement

4.4.1. Limit

Frequency hopping systems shall have hopping channel carrier frequencies separated by a minimum of 25 kHz or the 20 dB bandwidth of the hopping channel, whichever is greater. Alternatively, frequency hopping systems operating in the 2400-2483.5 MHz band may have hopping channel carrier frequencies that are separated by 25 kHz or two-thirds of the 20 dB bandwidth of the hopping channel, whichever is greater.

4.4.2. Measuring Instruments and Setting

Please refer to section 5 of equipments list in this report. The following table is the setting of spectrum analyzer.

Spectrum Parameter	Setting
Attenuation	Auto
Span Frequency	> Measurement Bandwidth or Channel Separation
RB	30 kHz (20dB Bandwidth) / 100 kHz (Channel Separation)
VB	100 kHz (20dB Bandwidth) / 300 kHz (Channel Separation)
Detector	Peak
Trace	Max Hold
Sweep Time	Auto

4.4.3. Test Procedures

1. The transmitter output (antenna port) was connected to the spectrum analyzer in peak hold mode.
2. The resolution bandwidth of 30 kHz and the video bandwidth of 100 kHz were utilized for 20 dB bandwidth measurement.
3. The resolution bandwidth of 100 kHz and the video bandwidth of 300 kHz were utilized for channel separation measurement.

4.4.4. Test Setup Layout

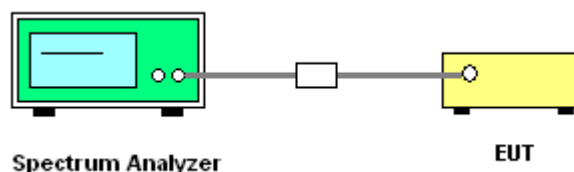

4.4.5. Test Deviation

There is no deviation with the original standard.

4.4.6. EUT Operation during Test

The EUT was programmed to be in continuously transmitting mode.

4.4.7. Test Result of Hopping Channel Separation

For Bluetooth 2.1 + EDR : < PIFA Antenna >

Temperature	22°C	Humidity	65%
Test Engineer	Allen Liu	Configurations	GFSK/8DPSK / Main Port
Test Date	Feb. 09, 2012		

1DH5

Frequency	Ch. Separation (MHz)	20dB Bandwidth (MHz)	2/3 of 20dB Bandwidth (MHz)	99% Occupied Bandwidth (MHz)	Result
2402 MHz	1.00	1.0440	0.696	0.9120	Complies
2441 MHz	1.00	1.0480	0.699	0.9080	Complies
2480 MHz	1.00	1.0440	0.696	0.9080	Complies

3DH5

Frequency	Ch. Separation (MHz)	20dB Bandwidth (MHz)	2/3 of 20dB Bandwidth (MHz)	99% Occupied Bandwidth (MHz)	Result
2402 MHz	1.00	1.3720	0.915	1.2400	Complies
2441 MHz	1.00	1.3040	0.869	1.2120	Complies
2480 MHz	1.00	1.3080	0.872	1.2160	Complies

Ch. Separation Limits: >20dB bandwidth or >2/3 of 20dB bandwidth

FTemperature	22°C	Humidity	65%
Test Engineer	Allen Liu	Configurations	GFSK/8DPSK / Aux Port
Test Date	Feb. 09, 2012		

1DH5

Frequency	Ch. Separation (MHz)	20dB Bandwidth (MHz)	2/3 of 20dB Bandwidth (MHz)	99% Occupied Bandwidth (MHz)	Result
2402 MHz	1.00	1.0360	0.691	0.9080	Complies
2441 MHz	1.00	1.0400	0.693	0.9040	Complies
2480 MHz	1.00	1.0480	0.699	0.9160	Complies

3DH5

Frequency	Ch. Separation (MHz)	20dB Bandwidth (MHz)	2/3 of 20dB Bandwidth (MHz)	99% Occupied Bandwidth (MHz)	Result
2402 MHz	1.00	1.3080	0.872	1.2160	Complies
2441 MHz	1.00	1.0340	0.689	1.2200	Complies
2480 MHz	1.00	1.3040	0.869	1.2200	Complies

Ch. Separation Limits: >20dB bandwidth or >2/3 of 20dB bandwidth

For Bluetooth 2.1 + EDR: < DIPOLE Antenna >

Temperature	22°C	Humidity	65%
Test Engineer	Allen Liu	Configurations	GFSK/8DPSK / Main Port
Test Date	Feb. 09, 2012		

1DH5

Frequency	Ch. Separation (MHz)	20dB Bandwidth (MHz)	2/3 of 20dB Bandwidth (MHz)	99% Occupied Bandwidth (MHz)	Result
2402 MHz	1.00	1.0440	0.696	0.9120	Complies
2441 MHz	1.00	1.0480	0.699	0.9080	Complies
2480 MHz	1.00	1.0440	0.696	0.9080	Complies

3DH5

Frequency	Ch. Separation (MHz)	20dB Bandwidth (MHz)	2/3 of 20dB Bandwidth (MHz)	99% Occupied Bandwidth (MHz)	Result
2402 MHz	1.00	1.3720	0.915	1.2400	Complies
2441 MHz	1.00	1.3040	0.869	1.2120	Complies
2480 MHz	1.00	1.3080	0.872	1.2160	Complies

Ch. Separation Limits: >20dB bandwidth or >2/3 of 20dB bandwidth

FTemperature	22°C	Humidity	65%
Test Engineer	Allen Liu	Configurations	GFSK/8DPSK / Aux Port
Test Date	Feb. 09, 2012		

1DH5

Frequency	Ch. Separation (MHz)	20dB Bandwidth (MHz)	2/3 of 20dB Bandwidth (MHz)	99% Occupied Bandwidth (MHz)	Result
2402 MHz	1.00	1.0360	0.691	0.9080	Complies
2441 MHz	1.00	1.0400	0.693	0.9040	Complies
2480 MHz	1.00	1.0480	0.699	0.9160	Complies

3DH5

Frequency	Ch. Separation (MHz)	20dB Bandwidth (MHz)	2/3 of 20dB Bandwidth (MHz)	99% Occupied Bandwidth (MHz)	Result
2402 MHz	1.00	1.3080	0.872	1.2160	Complies
2441 MHz	1.00	1.0340	0.689	1.2200	Complies
2480 MHz	1.00	1.3040	0.869	1.2200	Complies

Ch. Separation Limits: >20dB bandwidth or >2/3 of 20dB bandwidth

For Bluetooth 4.0 : < PIFA Antenna >

Temperature	22°C	Humidity	65%
Test Engineer	Allen Liu	Configurations	GFSK / Main Port
Test Date	Feb. 09, 2012		

Frequency	Ch. Separation (MHz)	20dB Bandwidth (MHz)	2/3 of 20dB Bandwidth (MHz)	99% Occupied Bandwidth (MHz)	Result
2402 MHz	1.00	1.1920	0.795	1.0600	Complies
2442 MHz	1.00	1.2040	0.803	1.0560	Complies
2480 MHz	1.00	1.1960	0.797	1.0600	Complies

Ch. Separation Limits: >20dB bandwidth or >2/3 of 20dB bandwidth

Temperature	22°C	Humidity	65%
Test Engineer	Allen Liu	Configurations	GFSK / Aux Port
Test Date	Feb. 09, 2012		

Frequency	Ch. Separation (MHz)	20dB Bandwidth (MHz)	2/3 of 20dB Bandwidth (MHz)	99% Occupied Bandwidth (MHz)	Result
2402 MHz	1.00	1.2240	0.816	1.0600	Complies
2442 MHz	1.00	1.2040	0.803	1.0520	Complies
2480 MHz	1.00	1.1960	0.797	1.0640	Complies

Ch. Separation Limits: >20dB bandwidth or >2/3 of 20dB bandwidth

For Bluetooth 4.0 : < DIPOLE Antenna >

Temperature	22°C	Humidity	65%
Test Engineer	Allen Liu	Configurations	GFSK / Main Port
Test Date	Feb. 09, 2012		

Frequency	Ch. Separation (MHz)	20dB Bandwidth (MHz)	2/3 of 20dB Bandwidth (MHz)	99% Occupied Bandwidth (MHz)	Result
2402 MHz	1.00	1.1920	0.795	1.0600	Complies
2442 MHz	1.00	1.2040	0.803	1.0560	Complies
2480 MHz	1.00	1.1960	0.797	1.0600	Complies

Ch. Separation Limits: >20dB bandwidth or >2/3 of 20dB bandwidth

Temperature	22°C	Humidity	65%
Test Engineer	Allen Liu	Configurations	GFSK / Aux Port
Test Date	Feb. 09, 2012		

Frequency	Ch. Separation (MHz)	20dB Bandwidth (MHz)	2/3 of 20dB Bandwidth (MHz)	99% Occupied Bandwidth (MHz)	Result
2402 MHz	1.00	1.2240	0.816	1.0600	Complies
2442 MHz	1.00	1.2040	0.803	1.0520	Complies
2480 MHz	1.00	1.1960	0.797	1.0640	Complies

Ch. Separation Limits: >20dB bandwidth or >2/3 of 20dB bandwidth

For Bluetooth 2.1 + EDR : < PIFA Antenna >

20 dB Bandwidth Plot on Channel 0 / 2402 MHz / Main Port / 1DH5

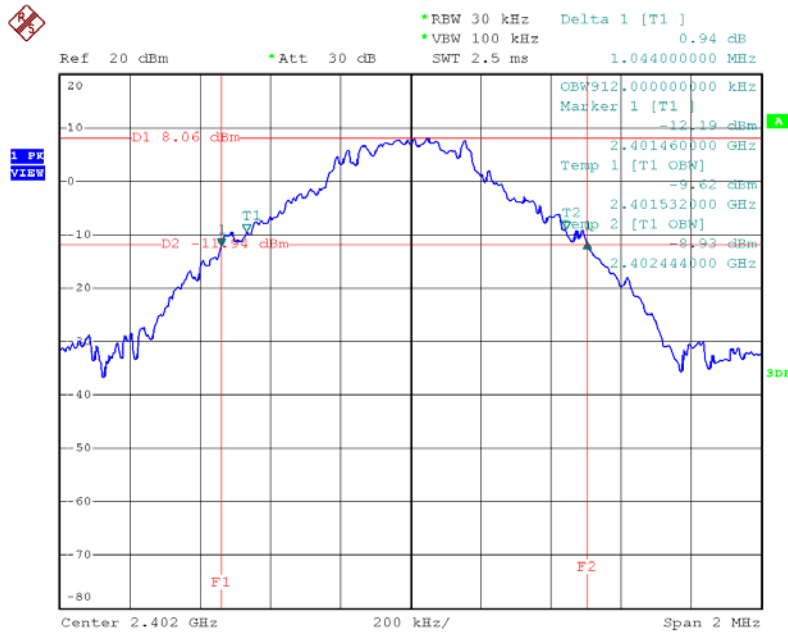

Date: 3.APR.2012 16:59:56

20 dB Bandwidth Plot on Channel 39 / 2441 MHz / Main Port / 1DH5

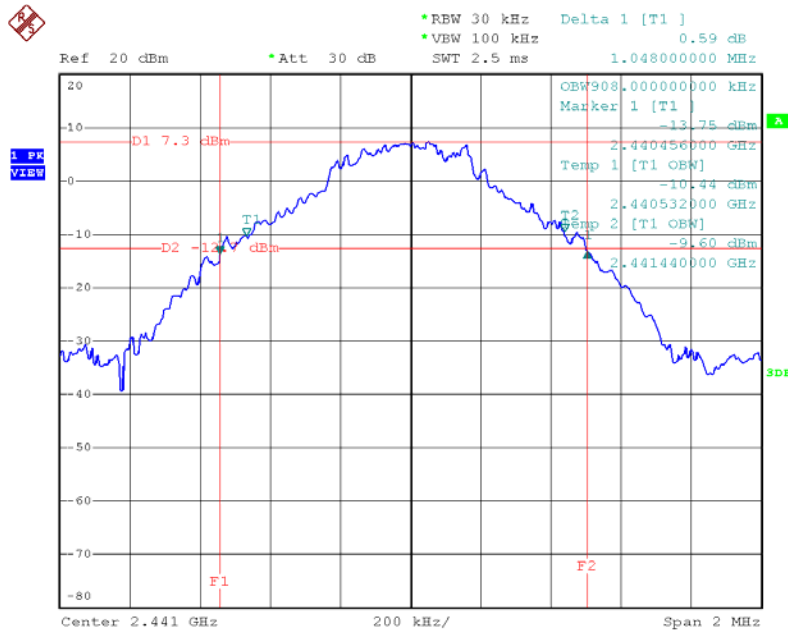

Date: 3.APR.2012 16:58:58

20 dB Bandwidth Plot on Channel 78 / 2480 MHz / Main Port / 1DH5

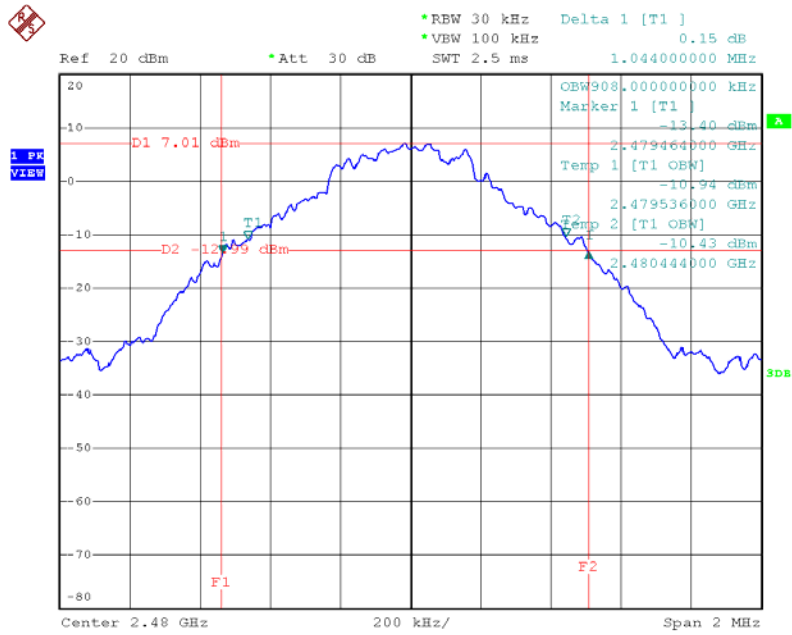

Date: 3.APR.2012 16:57:49

20 dB Bandwidth Plot on Channel 0 / 2402 MHz / Main Port / 3DH5

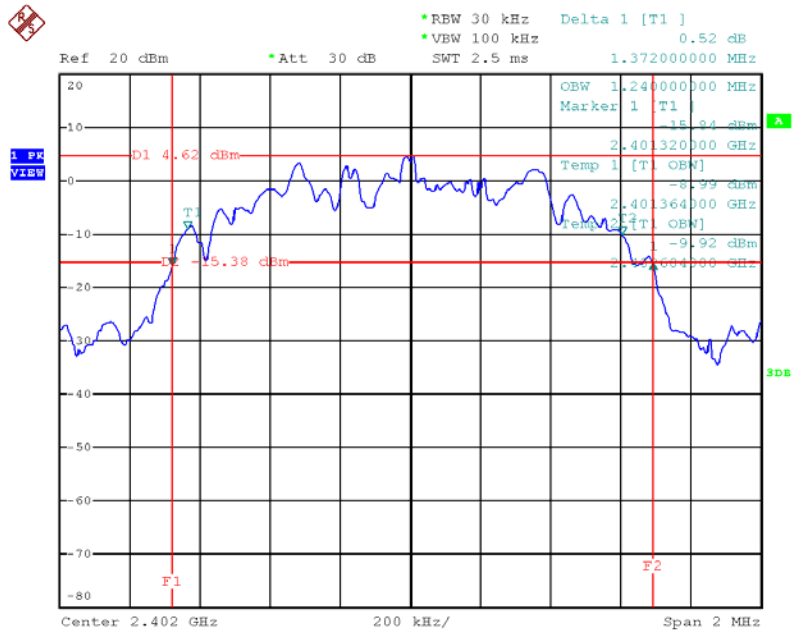

Date: 9.FEB.2012 13:15:40

20 dB Bandwidth Plot on Channel 39 / 2441 MHz / Main Port / 3DH5

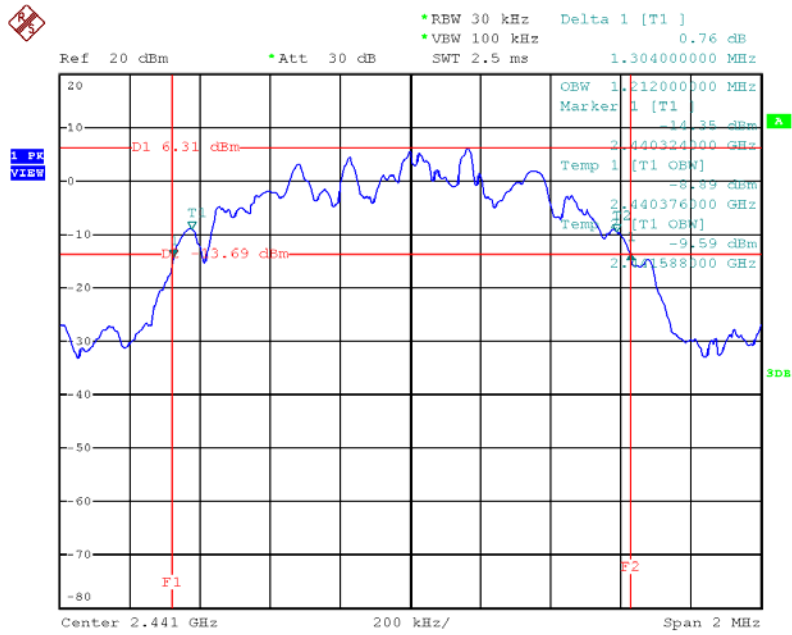

Date: 9.FEB.2012 13:16:34

20 dB Bandwidth Plot on Channel 78 / 2480 MHz / Main Port / 3DH5

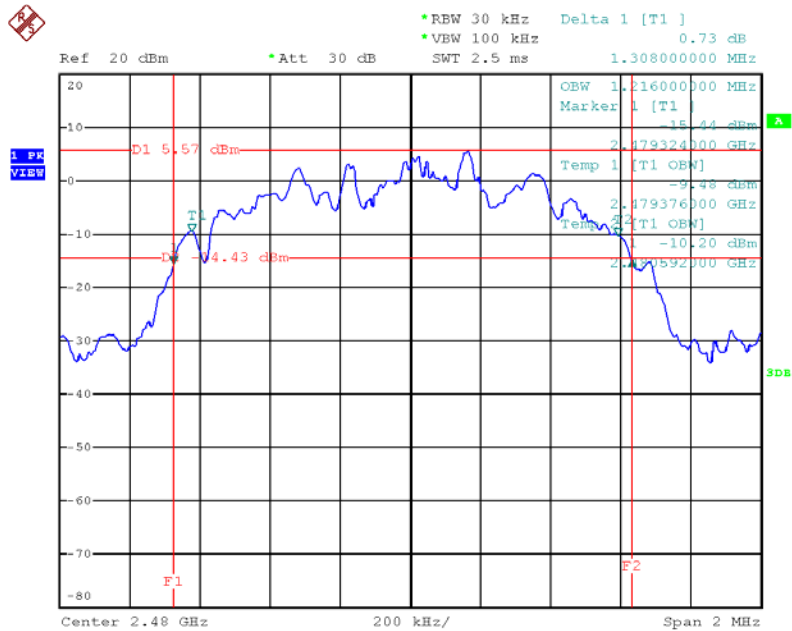

Date: 9.FEB.2012 13:17:34

20 dB Bandwidth Plot on Channel 0 / 2402 MHz / Aux Port / 1DH5

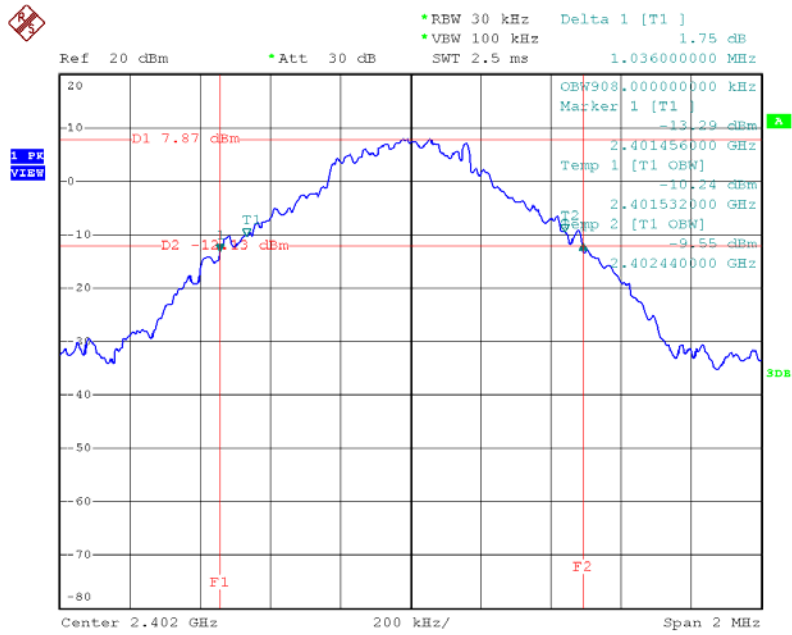

Date: 3.APR.2012 16:51:56

20 dB Bandwidth Plot on Channel 39 / 2441 MHz / Aux Port / 1DH5

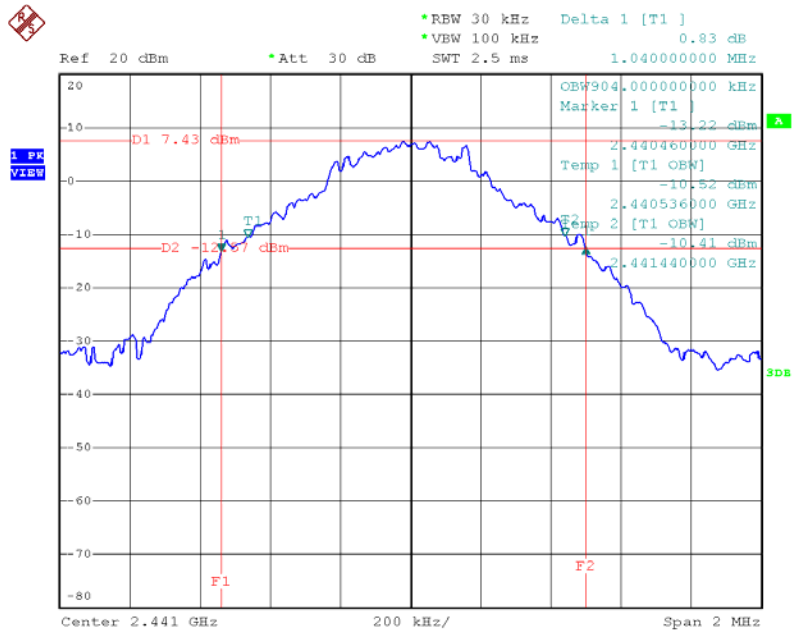

Date: 3.APR.2012 16:54:10

20 dB Bandwidth Plot on Channel 78 / 2480 MHz / Aux Port / 1DH5

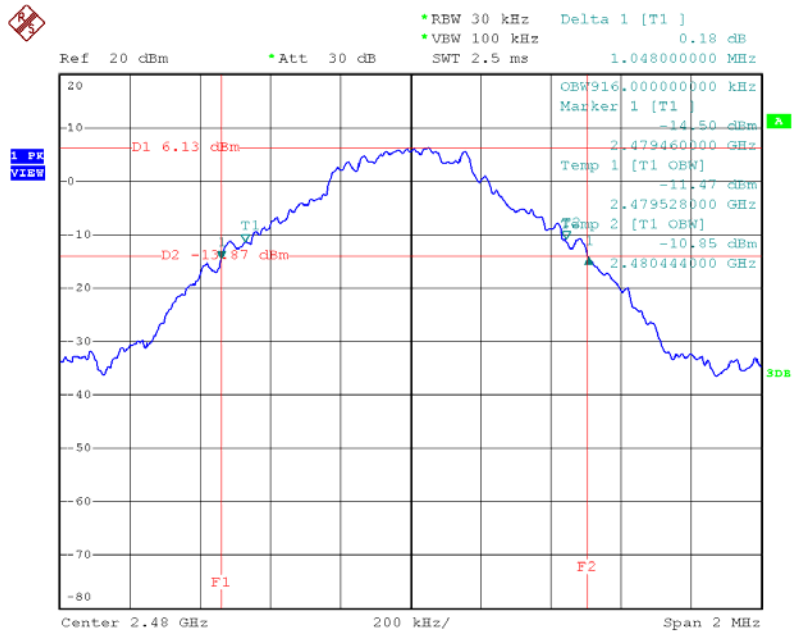

Date: 3.APR.2012 16:55:19

20 dB Bandwidth Plot on Channel 0 / 2402 MHz / Aux Port / 3DH5

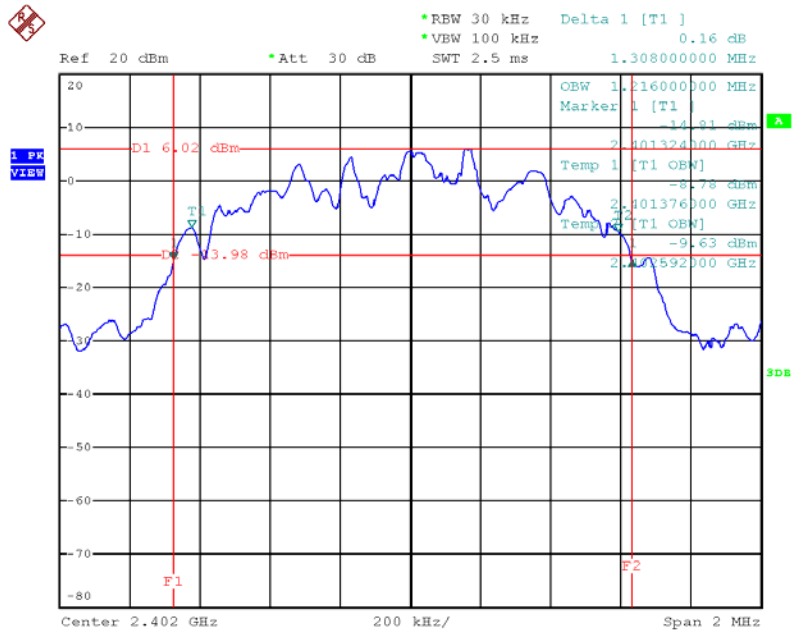

Date: 9.FEB.2012 10:40:10

20 dB Bandwidth Plot on Channel 39 / 2441 MHz / Aux Port / 3DH5

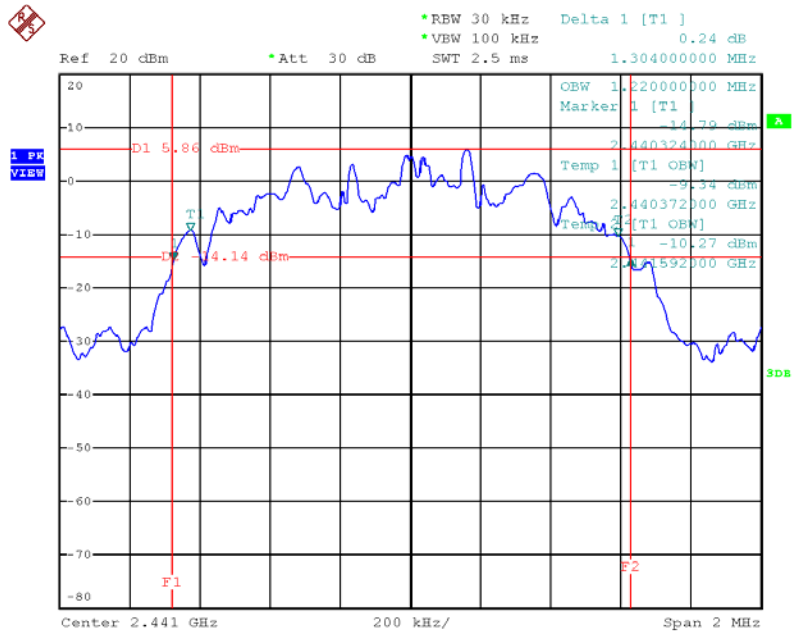

Date: 9.FEB.2012 10:41:58

20 dB Bandwidth Plot on Channel 78 / 2480 MHz / Aux Port / 3DH5

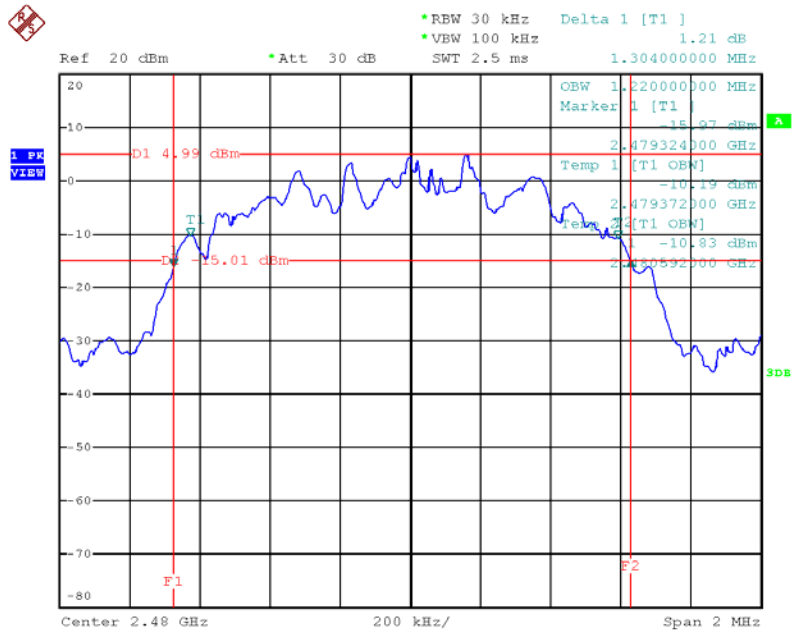

Date: 9.FEB.2012 10:43:22

For Bluetooth 2.1 + EDR : < DIPOLE Antenna >

20 dB Bandwidth Plot on Channel 0 / 2402 MHz / Main Port / 1DH5

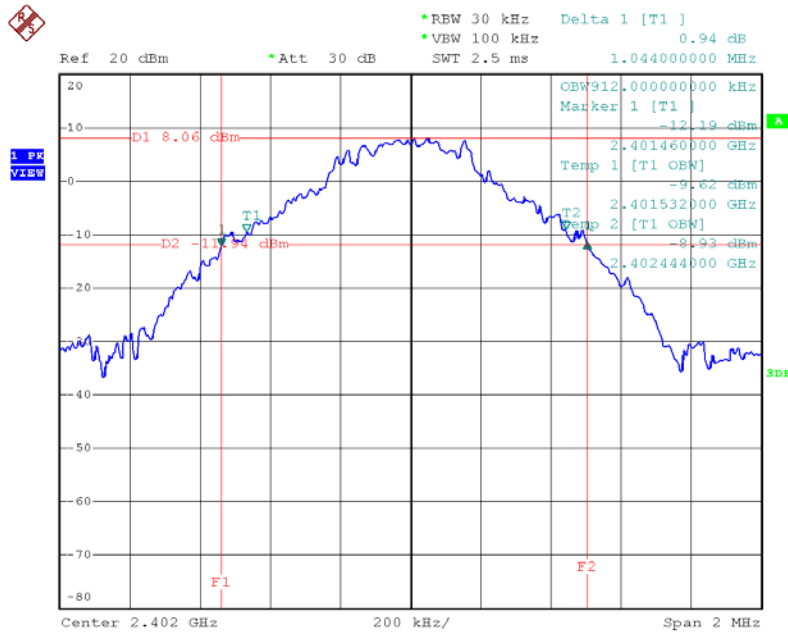

Date: 3.APR.2012 16:59:56

20 dB Bandwidth Plot on Channel 39 / 2441 MHz / Main Port / 1DH5

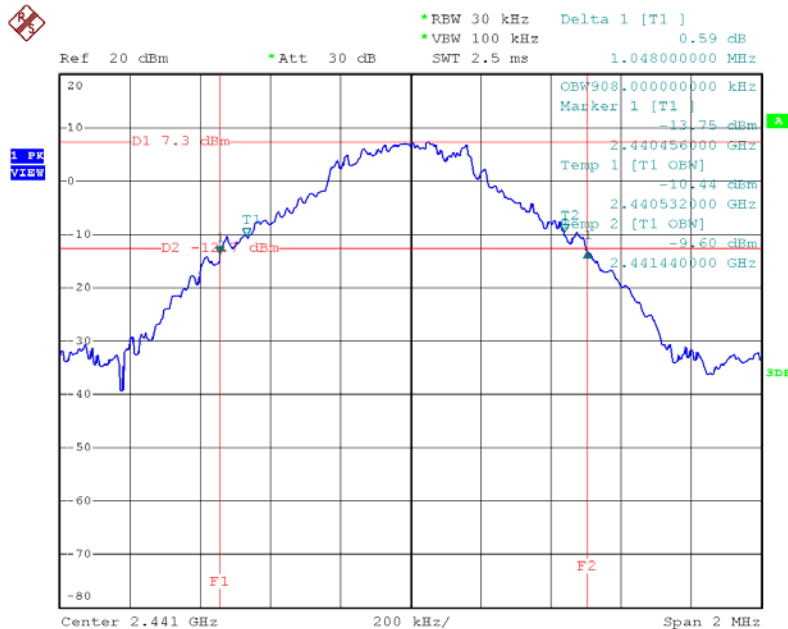

Date: 3.APR.2012 16:58:58

20 dB Bandwidth Plot on Channel 78 / 2480 MHz / Main Port / 1DH5

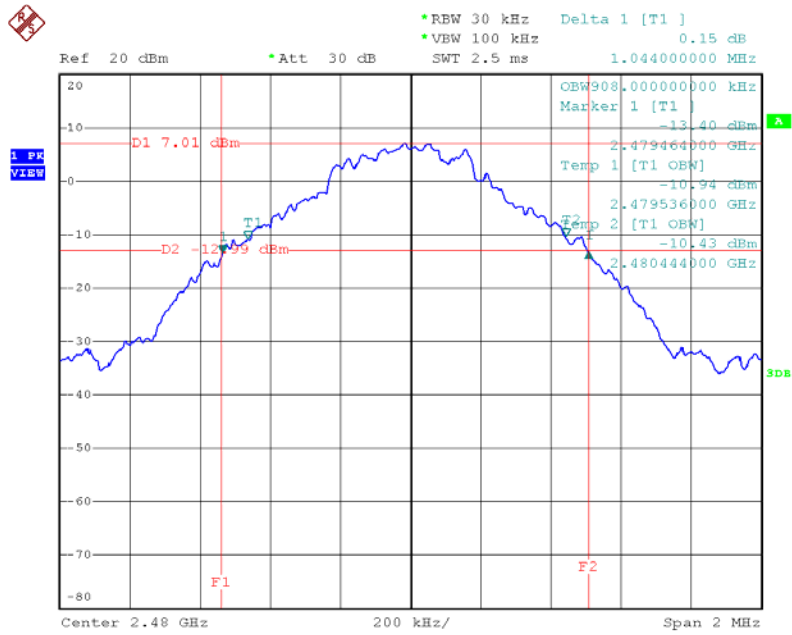

Date: 3.APR.2012 16:57:49

20 dB Bandwidth Plot on Channel 0 / 2402 MHz / Main Port / 3DH5

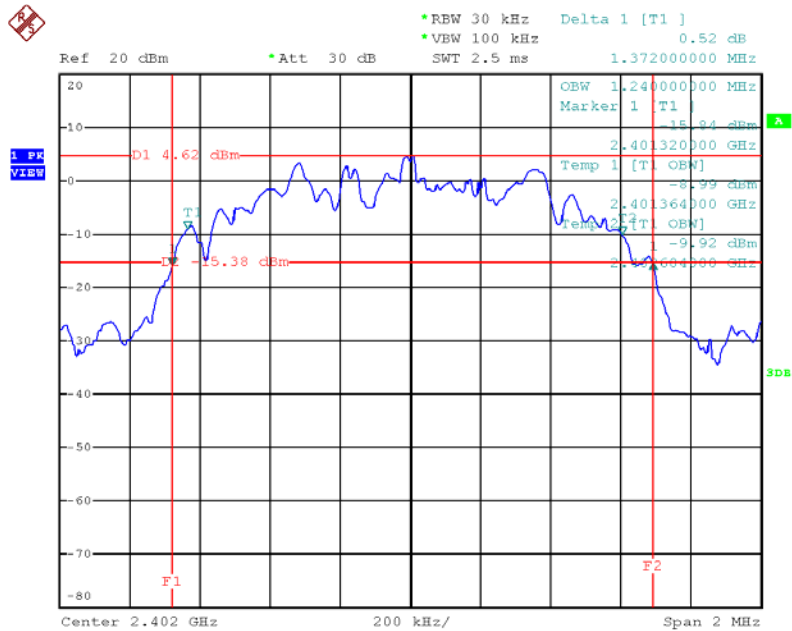

Date: 9.FEB.2012 13:15:40

20 dB Bandwidth Plot on Channel 39 / 2441 MHz / Main Port / 3DH5

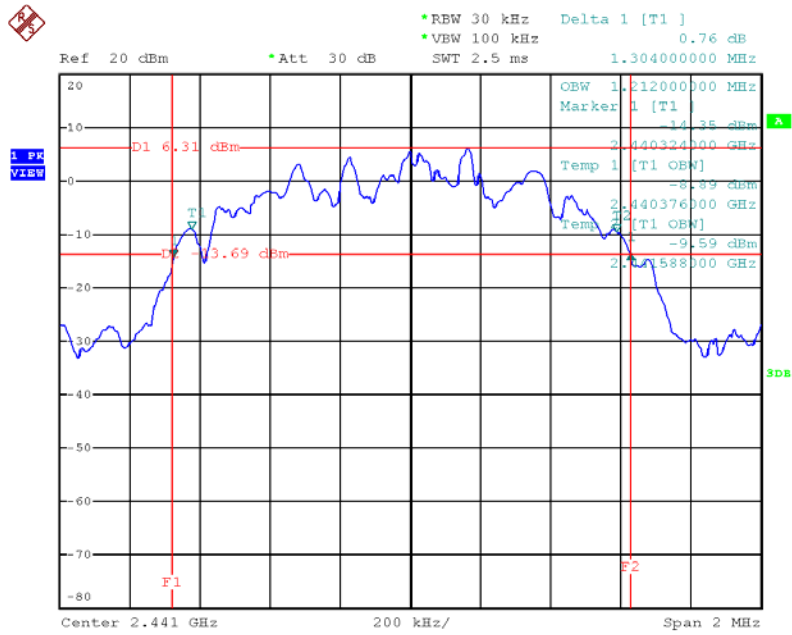

Date: 9.FEB.2012 13:16:34

20 dB Bandwidth Plot on Channel 78 / 2480 MHz / Main Port / 3DH5

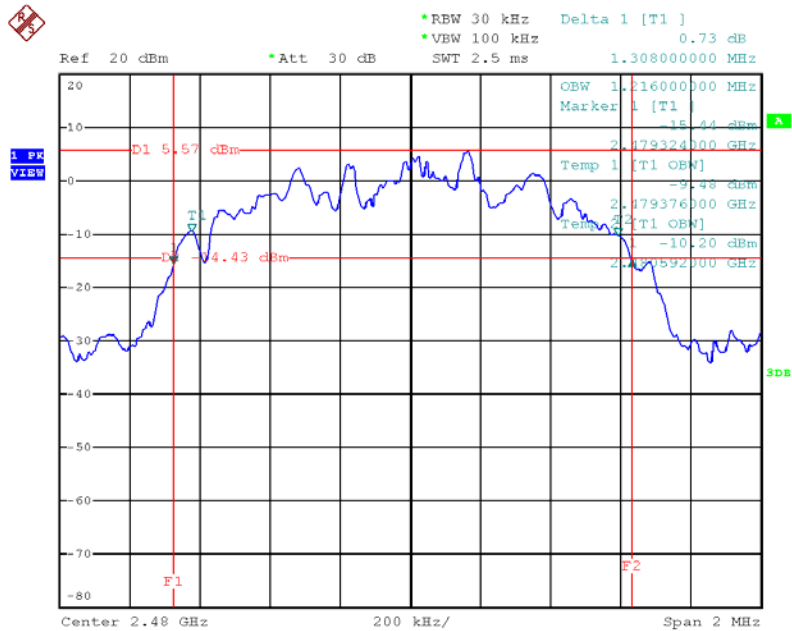

Date: 9.FEB.2012 13:17:34

20 dB Bandwidth Plot on Channel 78 / 2480 MHz / Aux Port / 1DH5

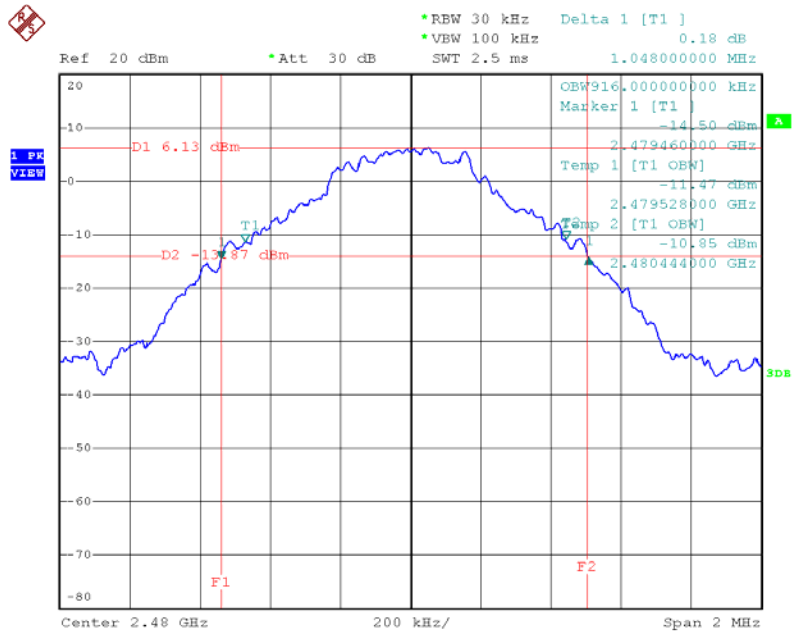

Date: 3.APR.2012 16:55:19

20 dB Bandwidth Plot on Channel 0 / 2402 MHz / Aux Port / 3DH5

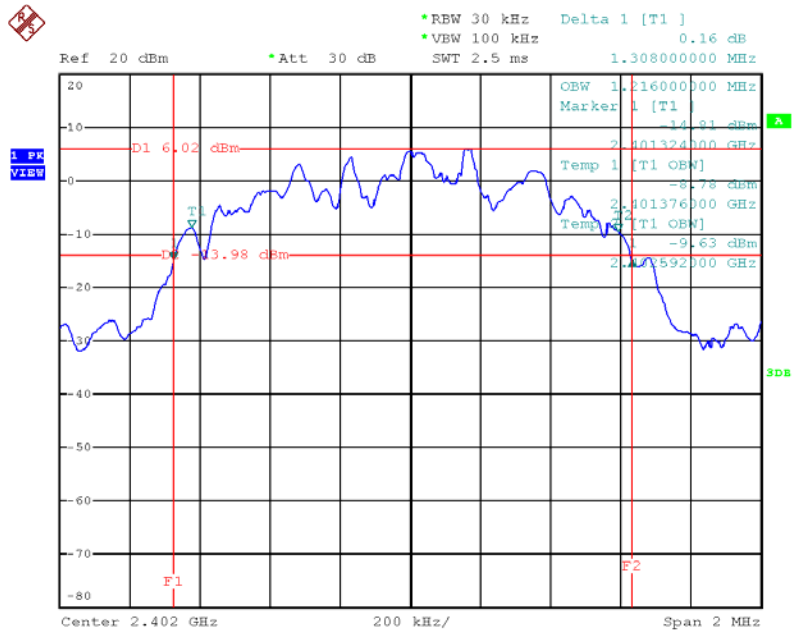

Date: 9.FEB.2012 10:40:10

20 dB Bandwidth Plot on Channel 39 / 2441 MHz / Aux Port / 3DH5

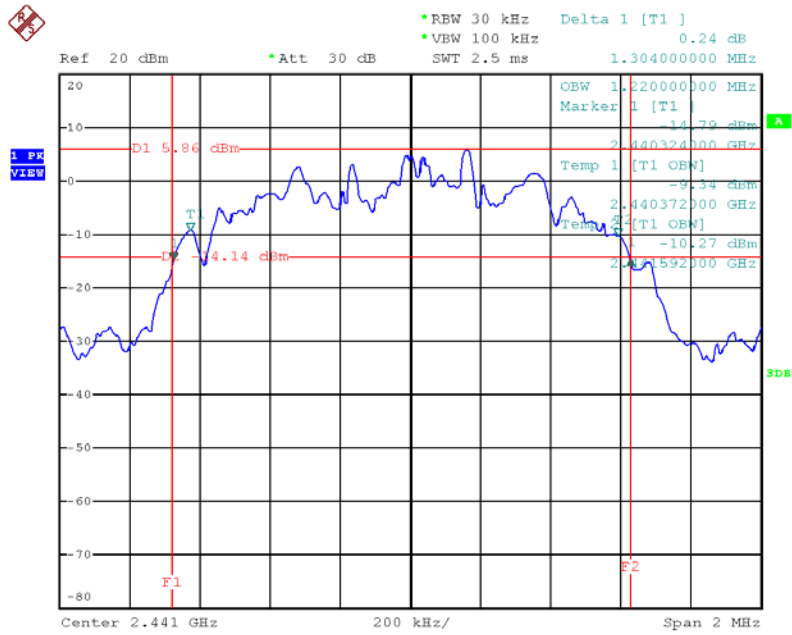

Date: 9.FEB.2012 10:41:58

20 dB Bandwidth Plot on Channel 78 / 2480 MHz / Aux Port / 3DH5

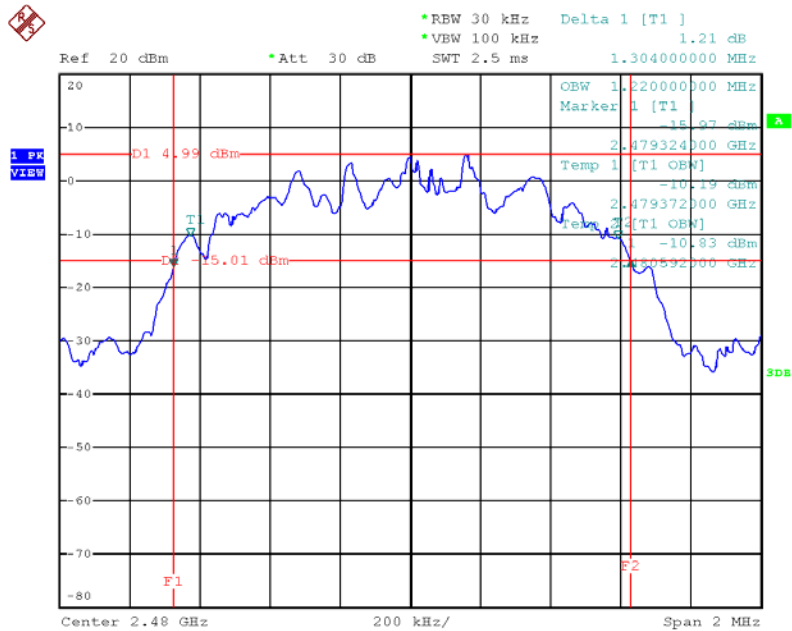

Date: 9.FEB.2012 10:43:22

For Bluetooth 4.0 : < PIFA Antenna >

20 dB Bandwidth Plot on Channel 0 / 2402 MHz / Main Port

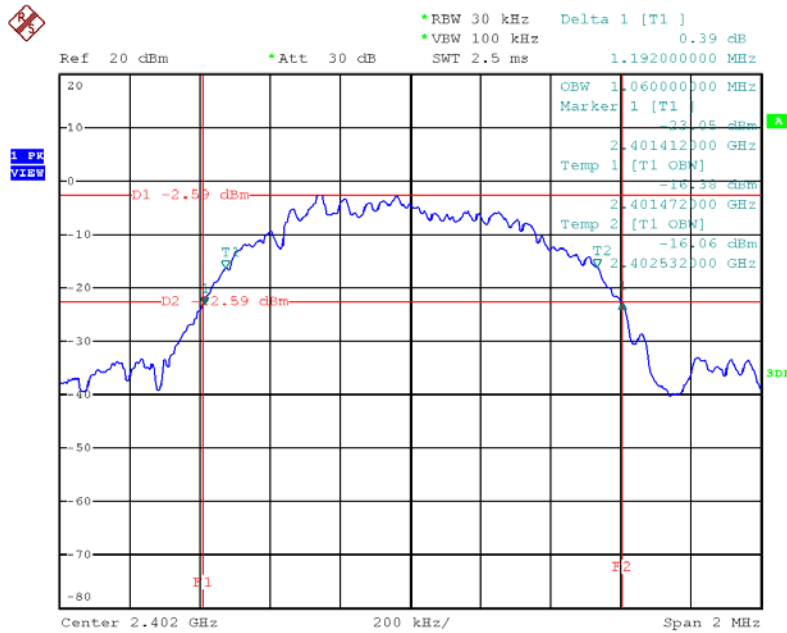

Date: 9.FEB.2012 13:47:55

20 dB Bandwidth Plot on Channel 20 / 2442 MHz / Main Port

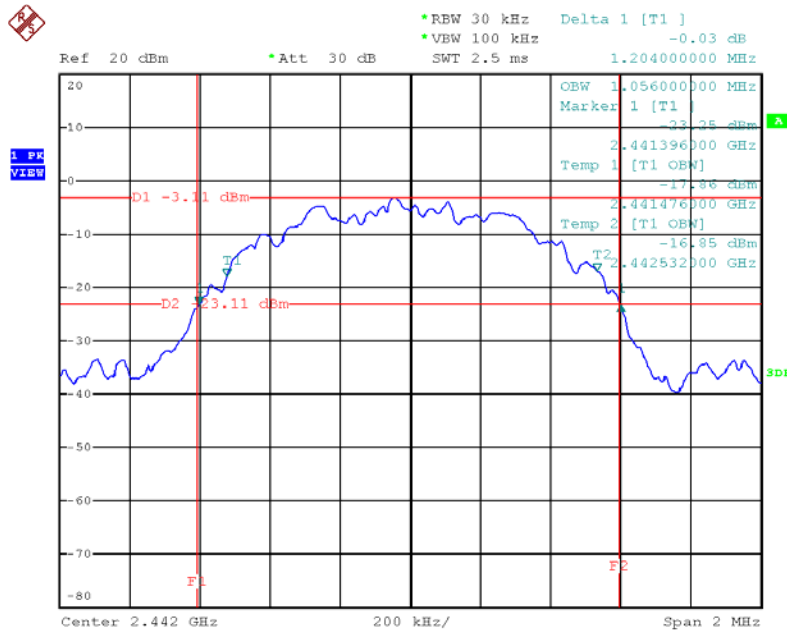

Date: 9.FEB.2012 13:49:46

20 dB Bandwidth Plot on Channel 39 / 2480 MHz / Main Port

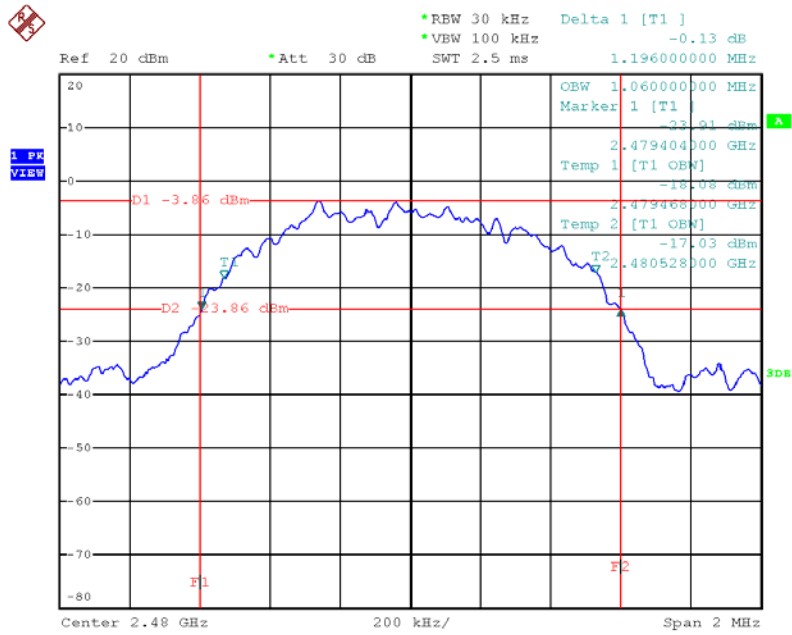

Date: 9.FEB.2012 13:50:55

20 dB Bandwidth Plot on Channel 0 / 2402 MHz / Aux Port

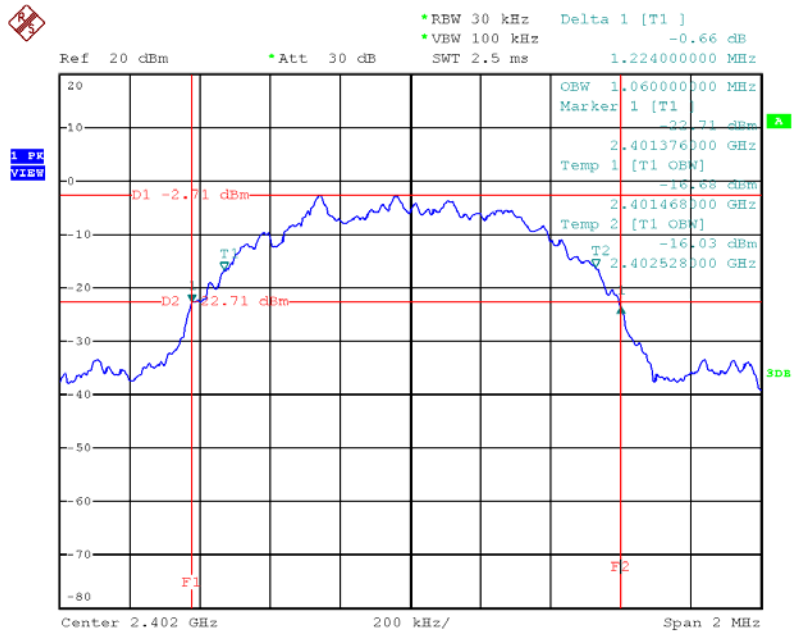

Date: 9.FEB.2012 14:16:38

20 dB Bandwidth Plot on Channel 20 / 2442 MHz / Aux Port

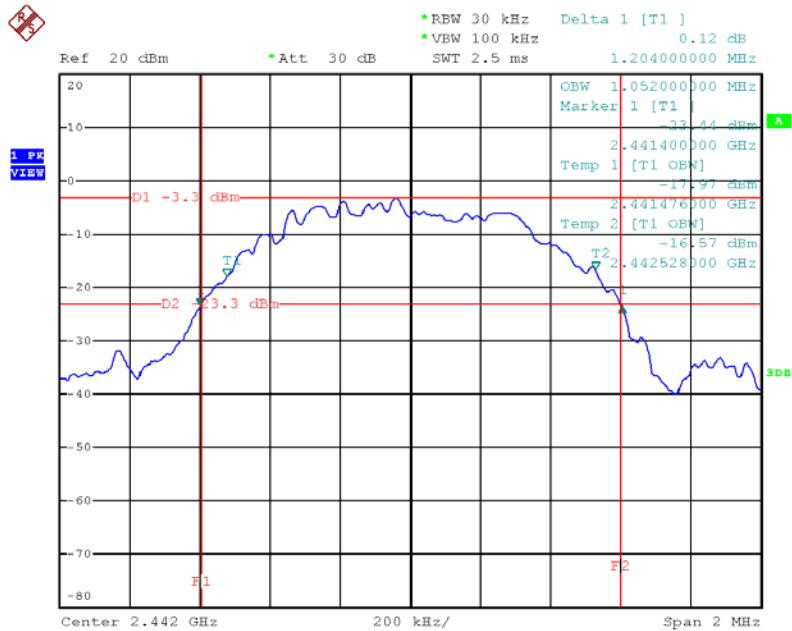

Date: 9.FEB.2012 14:15:27

20 dB Bandwidth Plot on Channel 39 / 2480 MHz / Aux Port

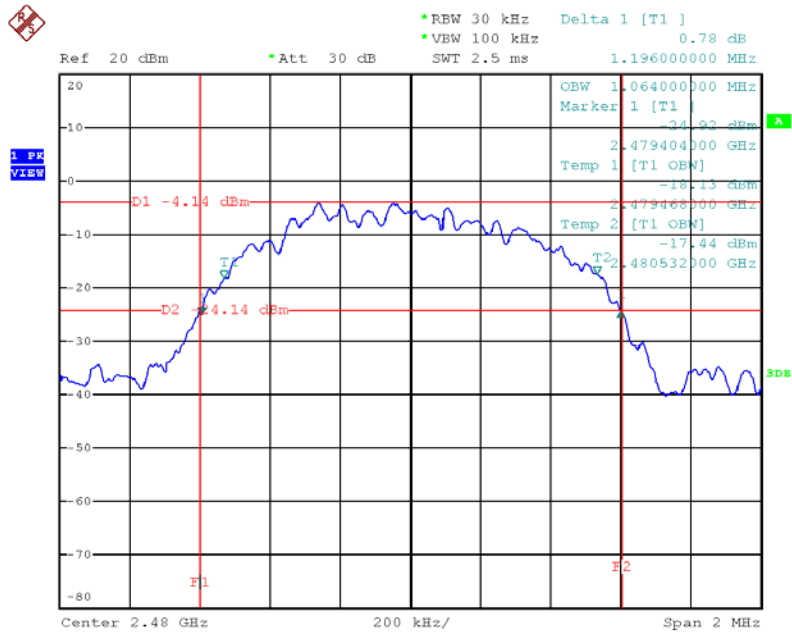

Date: 9.FEB.2012 14:14:10

For Bluetooth 4.0 : < DIPOLE Antenna >

20 dB Bandwidth Plot on Channel 0 / 2402 MHz / Main Port

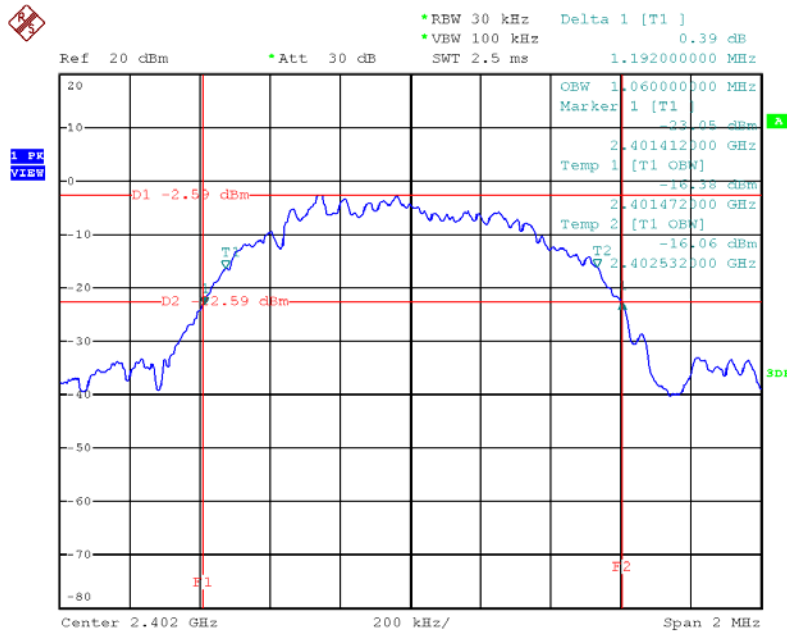

Date: 9.FEB.2012 13:47:55

20 dB Bandwidth Plot on Channel 20 / 2442 MHz / Main Port

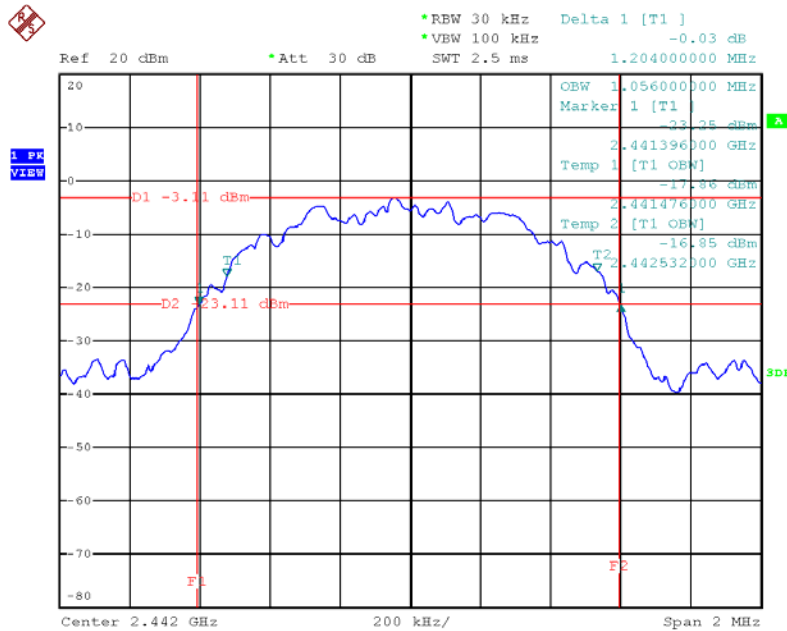

Date: 9.FEB.2012 13:49:46

20 dB Bandwidth Plot on Channel 39 / 2480 MHz / Main Port

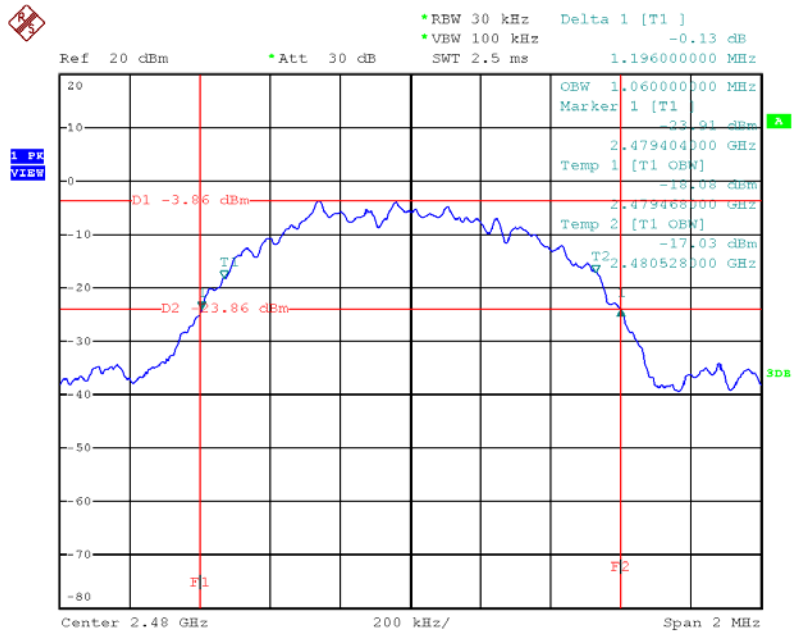

Date: 9.FEB.2012 13:50:55

20 dB Bandwidth Plot on Channel 0 / 2402 MHz / Aux Port

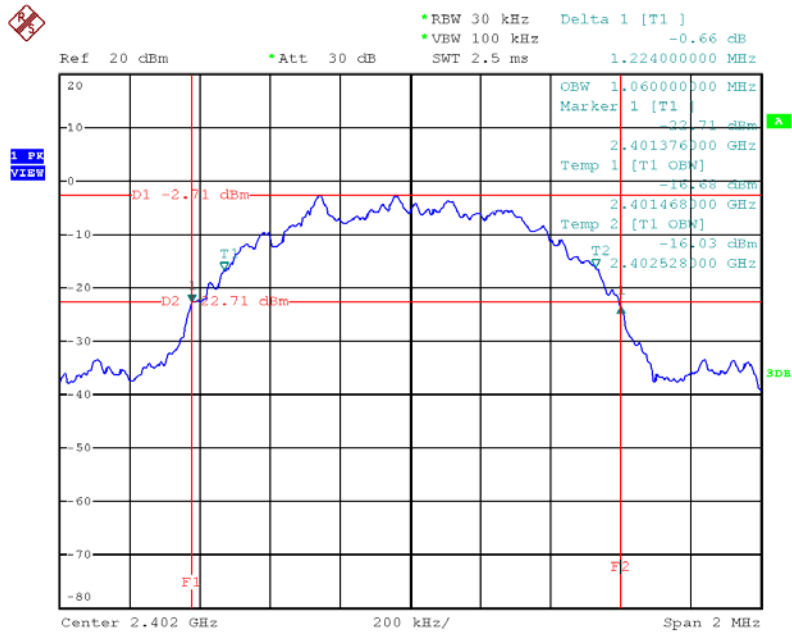

Date: 9.FEB.2012 14:16:38

20 dB Bandwidth Plot on Channel 20 / 2442 MHz / Aux Port

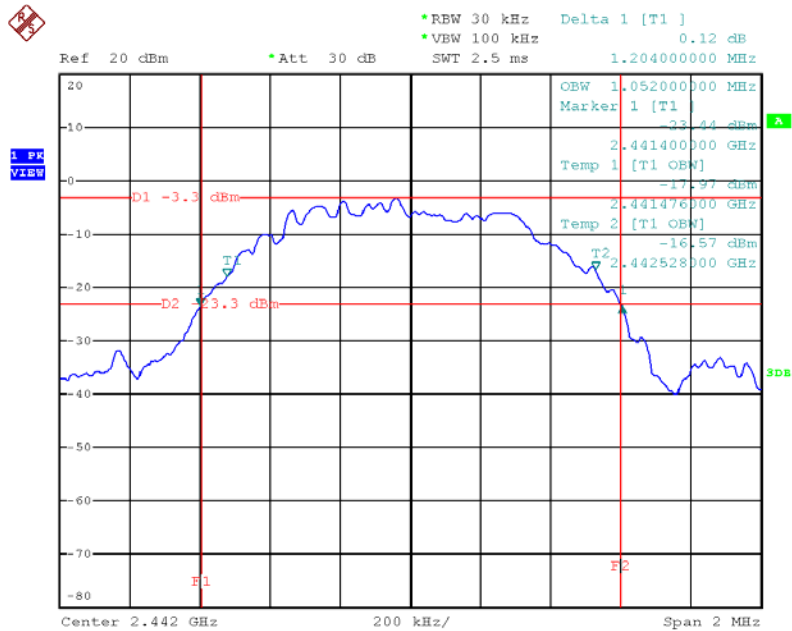

Date: 9.FEB.2012 14:15:27

20 dB Bandwidth Plot on Channel 39 / 2480 MHz / Aux Port

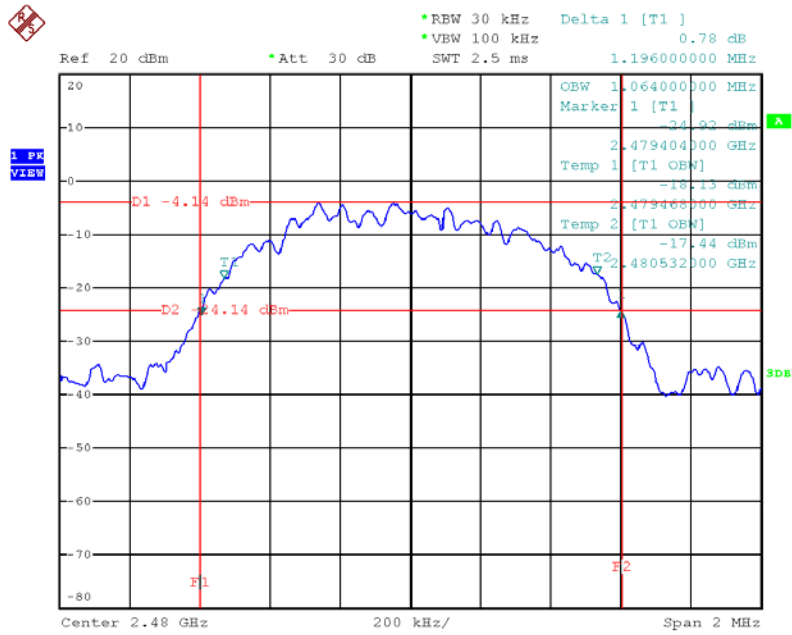

Date: 9.FEB.2012 14:14:10

4.5. Number of Hopping Frequency Measurement

4.5.1. Limit

At least 15 hopping frequencies, and should be equally spaced.

4.5.2. Measuring Instruments and Setting

Please refer to section 5 of equipments list in this report. The following table is the setting of spectrum analyzer.

Spectrum Parameters	Setting
Attenuation	Auto
Span Frequency	> Operating Frequency Range
RB	1MHz
VB	1MHz
Detector	Peak
Trace	Max Hold
Sweep Time	Auto

4.5.3. Test Procedures

1. The transmitter output (antenna port) was connected to the spectrum analyzer in peak hold mode.
2. The resolution bandwidth of 1MHz and the video bandwidth of 1KHz were utilized.
3. Observe frequency hopping in 2400MHz~2483.5MHz, there are at least 75 non-overlapping channels.

4.5.4. Test Setup Layout

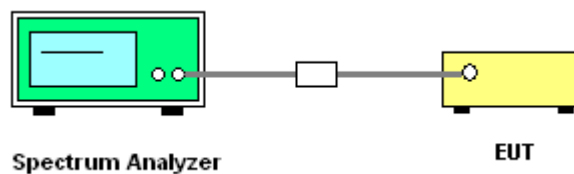

4.5.5. Test Deviation

There is no deviation with the original standard.

4.5.6. EUT Operation during Test

The EUT was programmed to be in continuously transmitting mode.

4.5.7. Test Result of Number of Hopping Frequency

For Bluetooth 2.1 + EDR : < PIFA Antenna >

Temperature	22°C	Humidity	65%
Test Engineer	Allen Liu	Configurations	8DPSK / Main Port
Test Date	Feb. 09, 2012		

Modulation Type	Channel No.	Frequency (MHz)	Hopping Ch. (Channels)	Min. Limit (Channels)	Test Result
8DPSK	0 ~ 78	2402 ~ 2480	79	15	Complies

Number of Hopping Channel Plot on Channel 0~78 / 2402 MHz ~ 2480 MHz

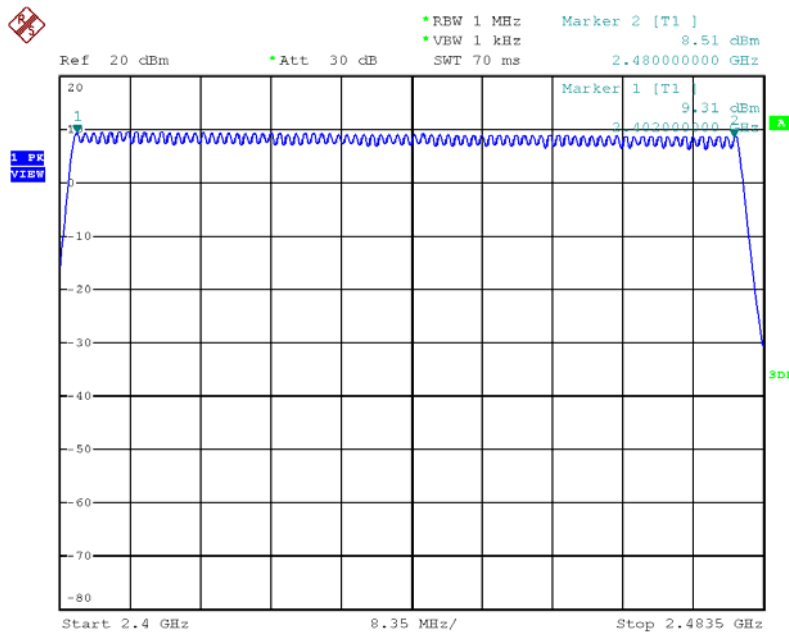

Date: 9.FEB.2012 12:14:40

Channel Separation Plot on Channel 0~1 / 2402 MHz ~ 2403MHz / 1DH5

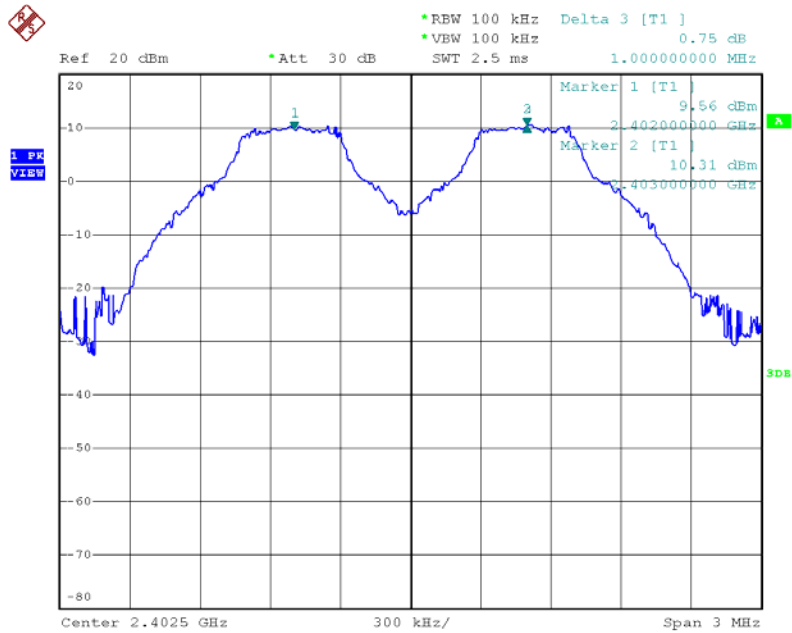

Date: 3.APR.2012 17:05:01

Channel Separation Plot on Channel 39~40 / 2441 MHz ~ 2442MHz / 1DH5

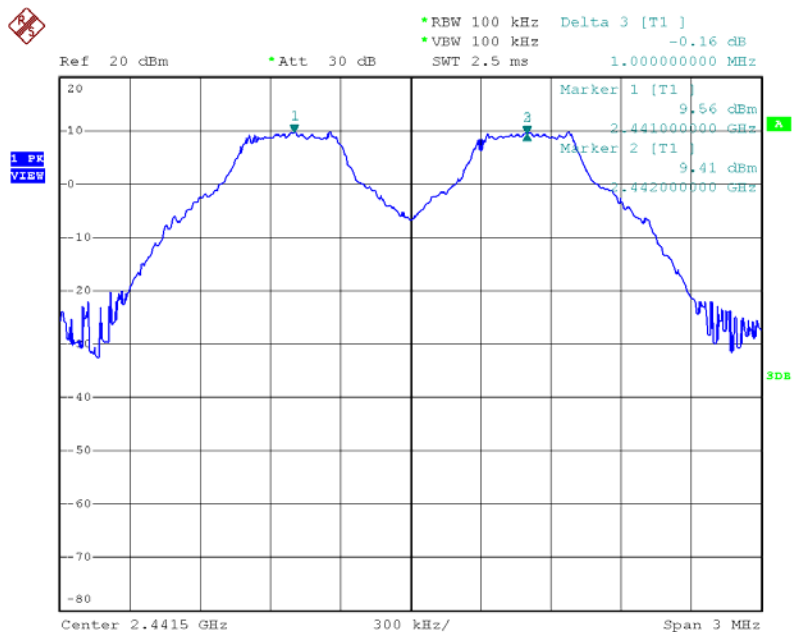

Date: 3.APR.2012 17:06:33

Channel Separation Plot on Channel 77~78 / 2479 MHz ~ 2480 MHz / 1DH5

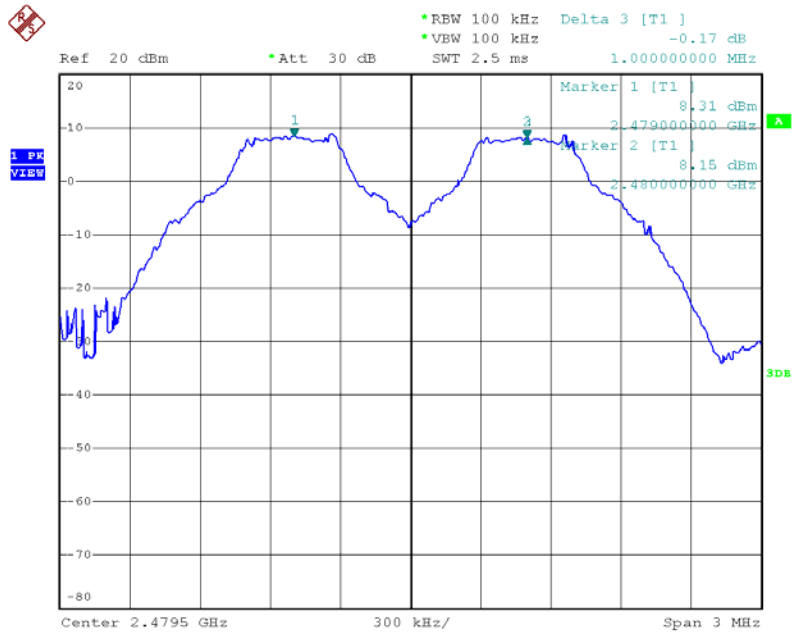

Date: 3.APR.2012 17:07:54

Channel Separation Plot on Channel 0~1 / 2402 MHz ~ 2403MHz / 3DH5

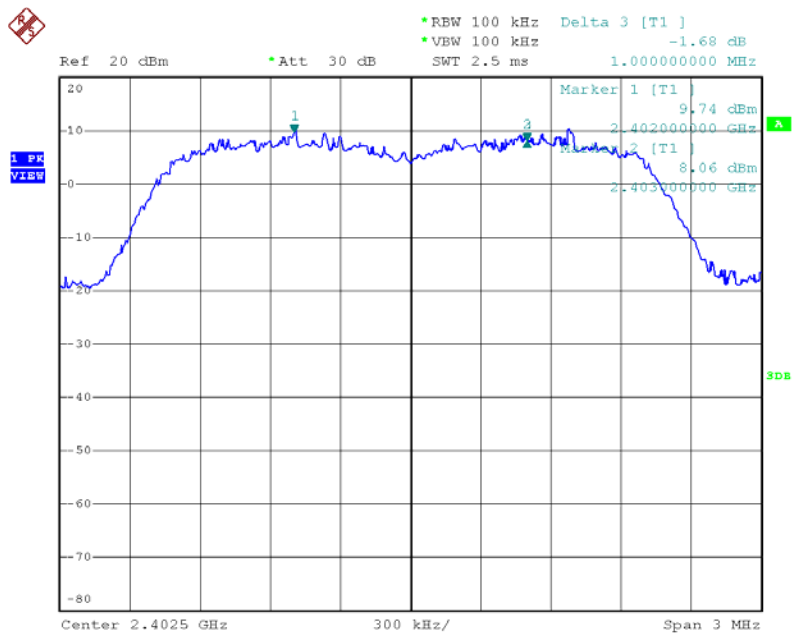

Date: 3.APR.2012 17:10:22

Channel Separation Plot on Channel 39~40 / 2441 MHz ~ 2442MHz / 3DH5

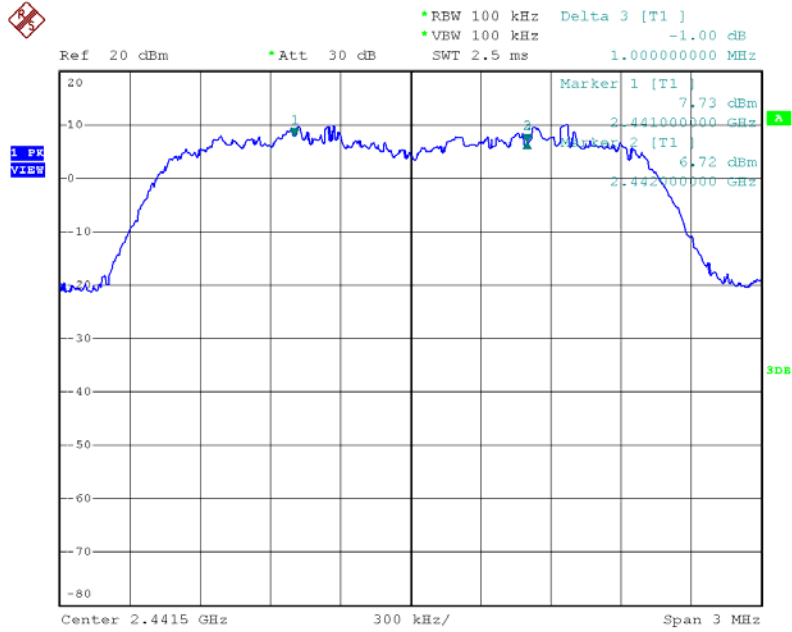

Date: 3.APR.2012 17:09:30

Channel Separation Plot on Channel 77~78 / 2479 MHz ~ 2480 MHz / 3DH5

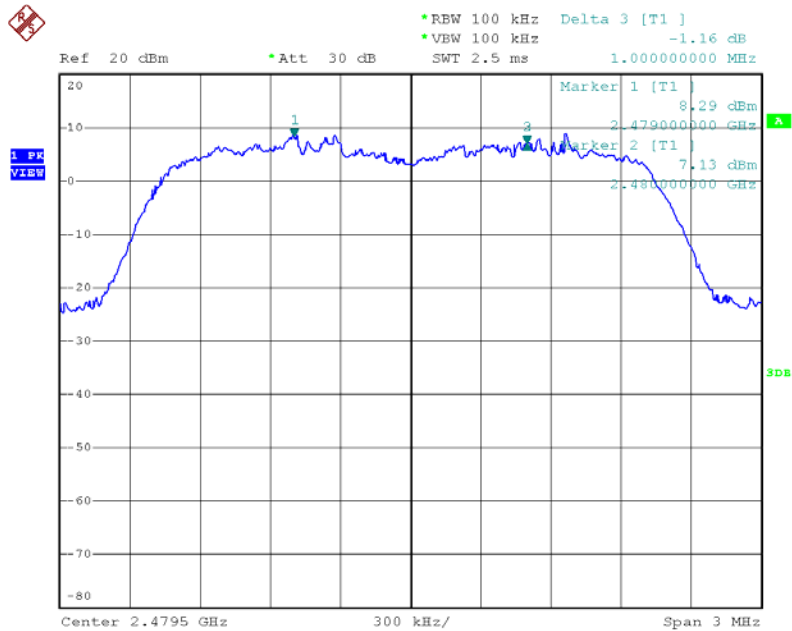

Date: 3.APR.2012 17:08:47

For Bluetooth 2.1 + EDR : < PIFA Antenna >

Temperature	22°C	Humidity	65%
Test Engineer	Allen Liu	Configurations	8DPSK / Aux Port
Test Date	Feb. 09, 2012		

Modulation Type	Channel No.	Frequency (MHz)	Hopping Ch. (Channels)	Min. Limit (Channels)	Test Result
8DPSK	0 ~ 78	2402 ~ 2480	79	15	Complies

Number of Hopping Channel Plot on Channel 0~78 / 2402 MHz ~ 2480 MHz

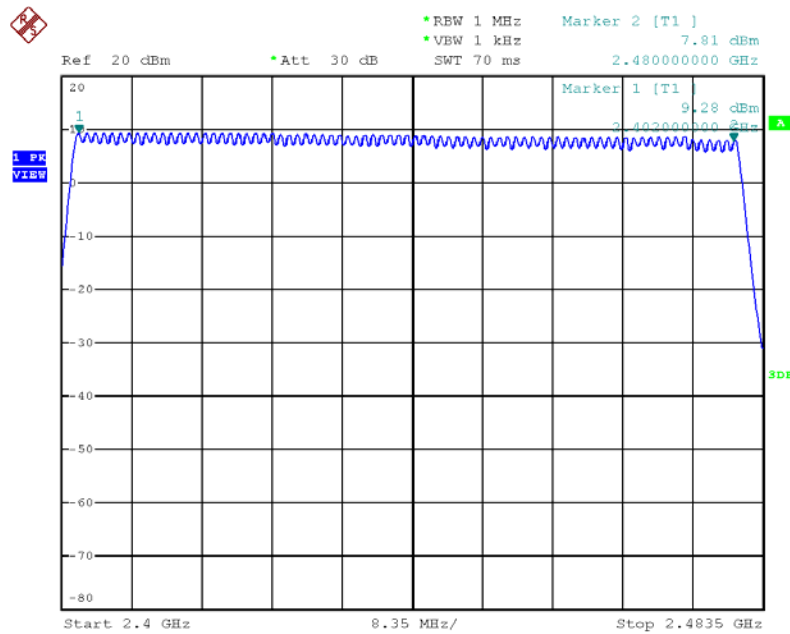

Date: 9.FEB.2012 11:39:06

Channel Separation Plot on Channel 0~1 / 2402 MHz ~ 2403MHz / 1DH5

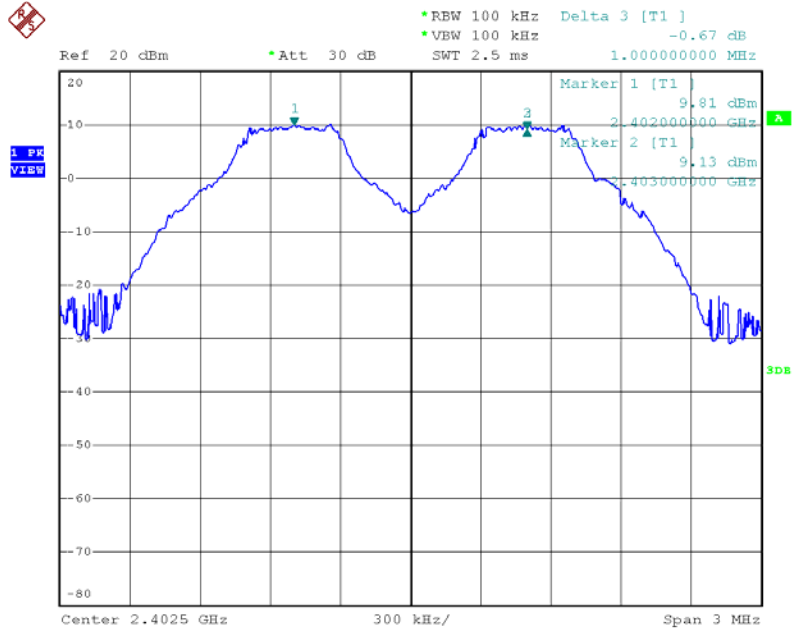

Date: 3.APR.2012 17:17:05

Channel Separation Plot on Channel 39~40 / 2441 MHz ~ 2442MHz / 1DH5

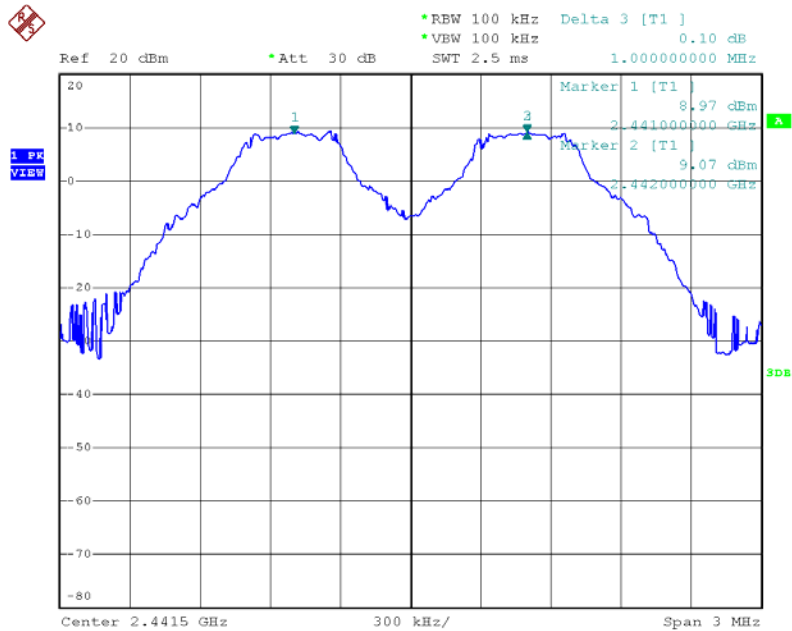

Date: 3.APR.2012 17:16:17

Channel Separation Plot on Channel 77~78 / 2479 MHz ~ 2480 MHz / 1DH5

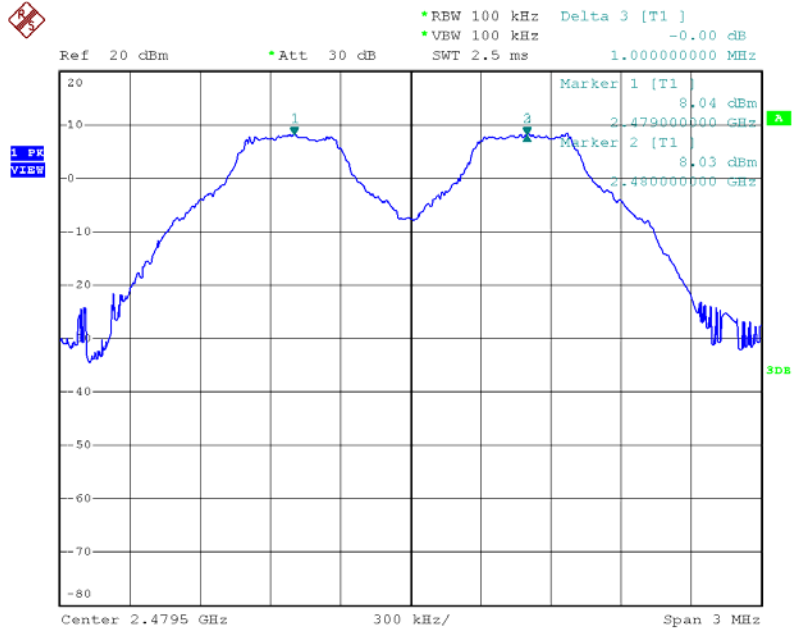

Date: 3.APR.2012 17:14:35

Channel Separation Plot on Channel 0~1 / 2402 MHz ~ 2403MHz / 3DH5

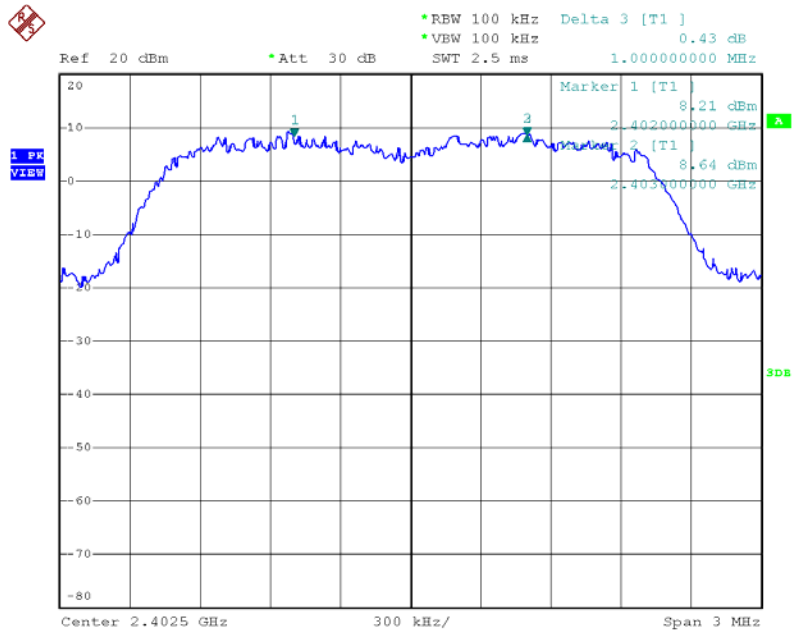

Date: 3.APR.2012 17:11:48

Channel Separation Plot on Channel 39~40 / 2441 MHz ~ 2442MHz / 3DH5

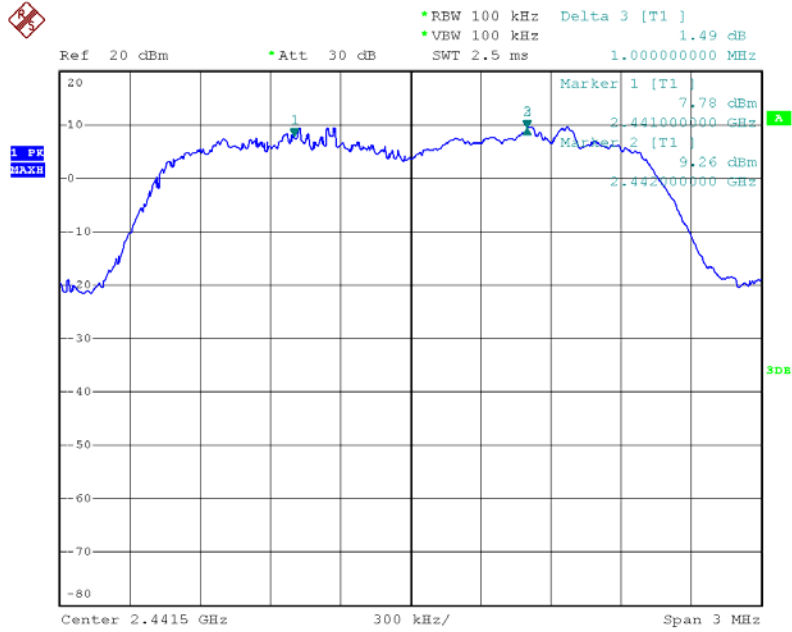

Date: 3.APR.2012 17:12:35

Channel Separation Plot on Channel 77~78 / 2479 MHz ~ 2480 MHz / 3DH5

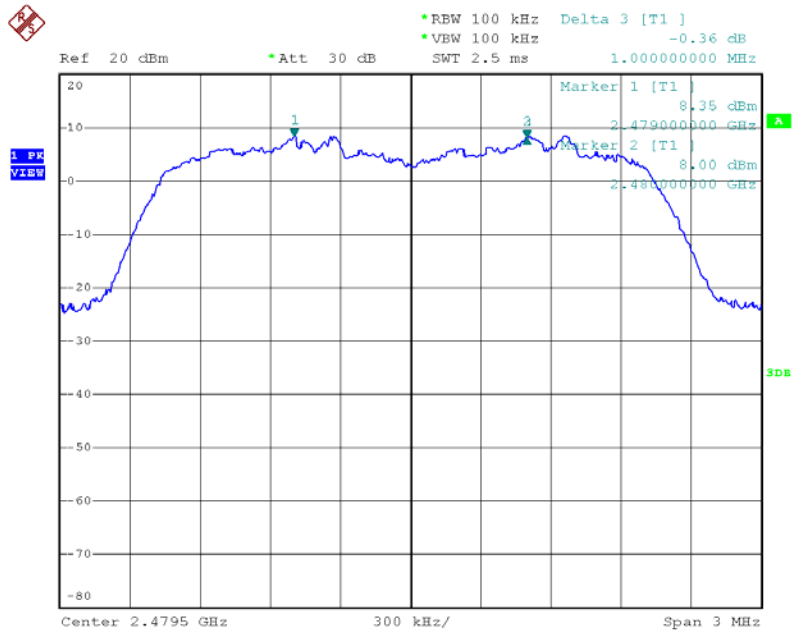

Date: 3.APR.2012 17:13:36

For Bluetooth 2.1 + EDR : < DIPOLE Antenna >

Temperature	22°C	Humidity	65%
Test Engineer	Allen Liu	Configurations	8DPSK / Main Port
Test Date	Feb. 09, 2012		

Modulation Type	Channel No.	Frequency (MHz)	Hopping Ch. (Channels)	Min. Limit (Channels)	Test Result
8DPSK	0 ~ 78	2402 ~ 2480	79	15	Complies

Number of Hopping Channel Plot on Channel 0~78 / 2402 MHz ~ 2480 MHz

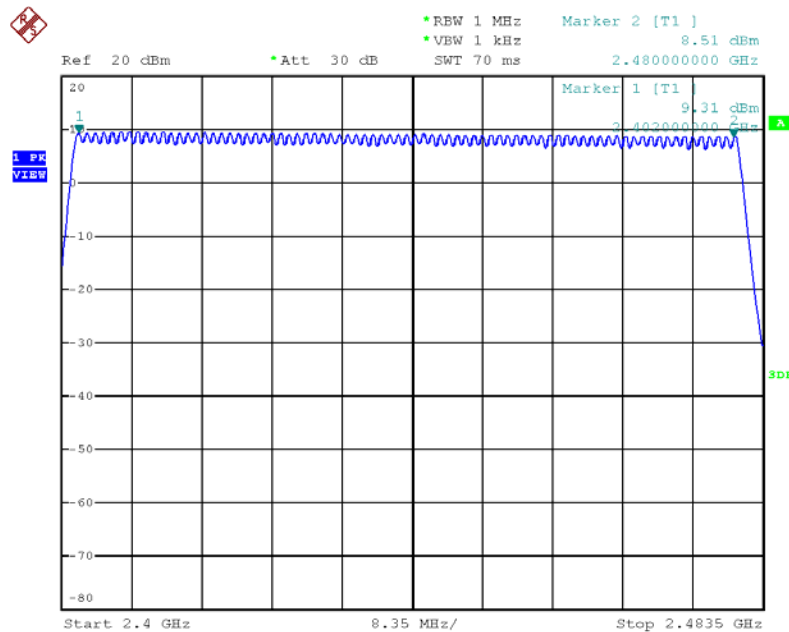

Date: 9.FEB.2012 12:14:40

Channel Separation Plot on Channel 0~1 / 2402 MHz ~ 2403MHz / 1DH5

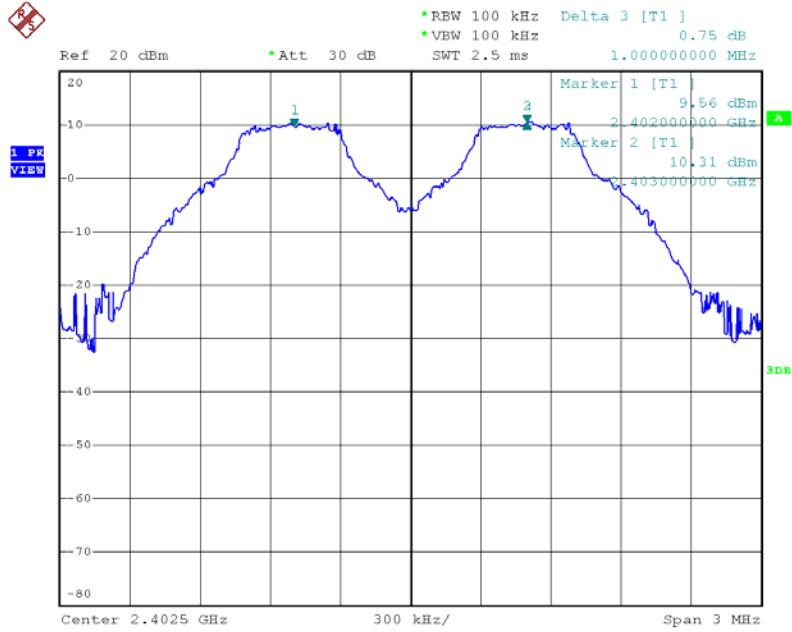

Date: 3.APR.2012 17:05:01

Channel Separation Plot on Channel 39~40 / 2441 MHz ~ 2442MHz / 1DH5

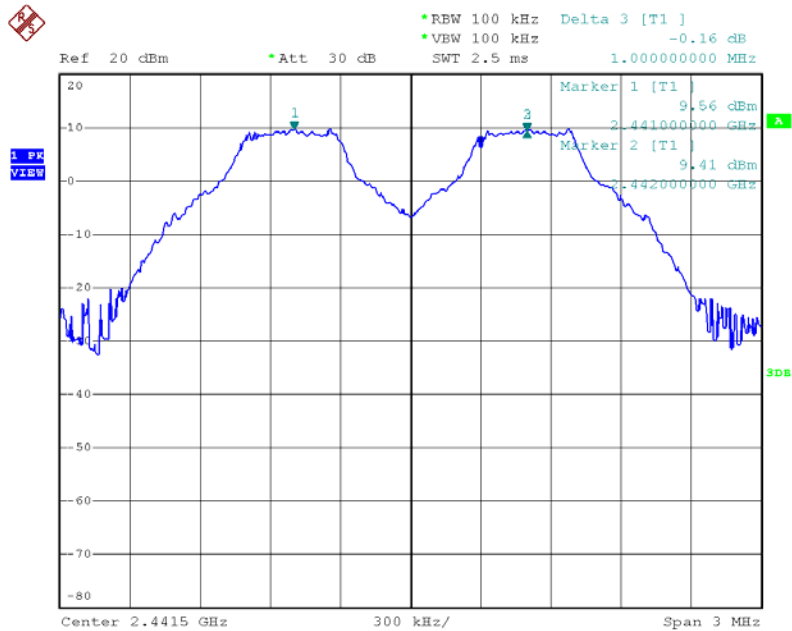

Date: 3.APR.2012 17:06:33

Channel Separation Plot on Channel 77~78 / 2479 MHz ~ 2480 MHz / 1DH5

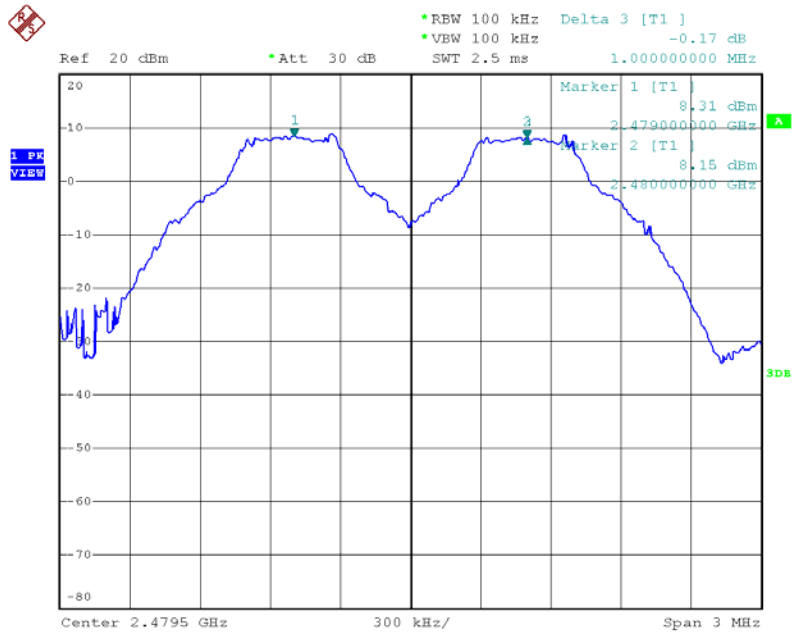

Date: 3.APR.2012 17:07:54

Channel Separation Plot on Channel 0~1 / 2402 MHz ~ 2403MHz / 3DH5

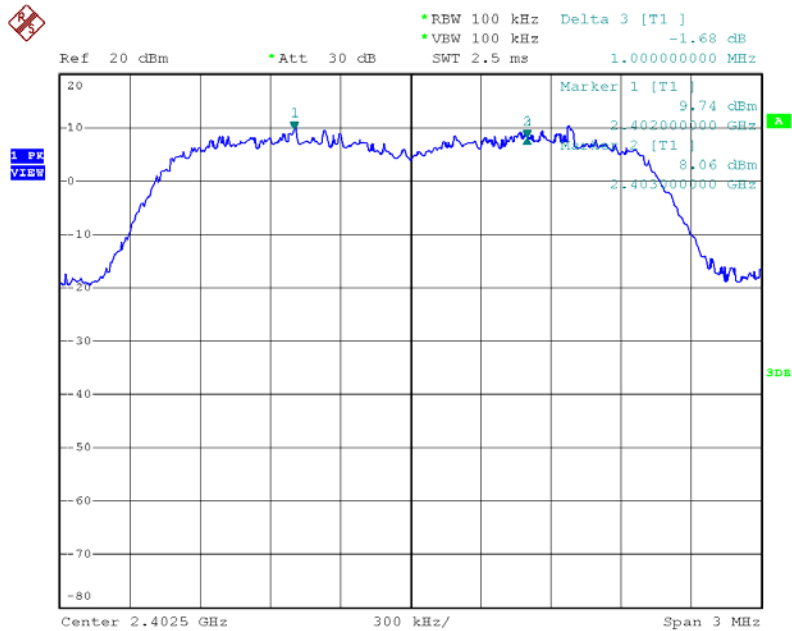

Date: 3.APR.2012 17:10:22

Channel Separation Plot on Channel 39~40 / 2441 MHz ~ 2442MHz / 3DH5

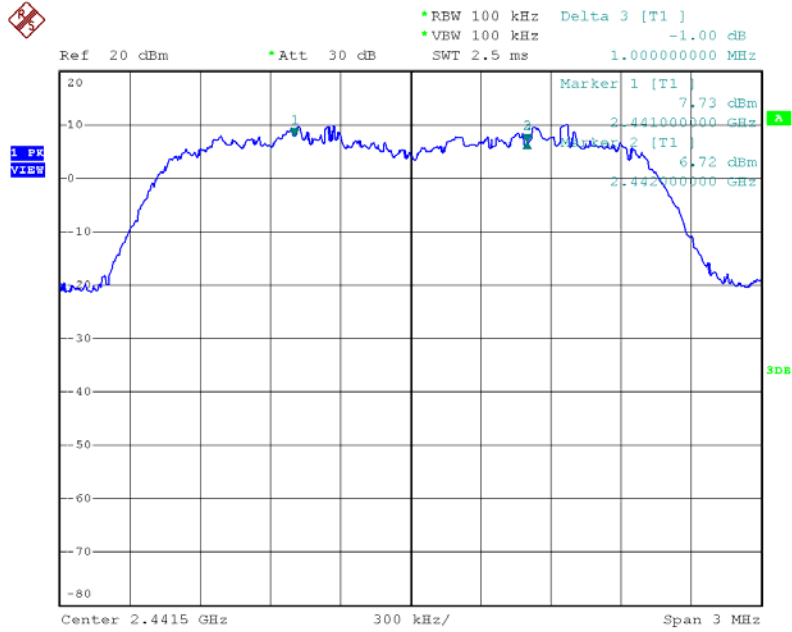

Date: 3.APR.2012 17:09:30

Channel Separation Plot on Channel 77~78 / 2479 MHz ~ 2480 MHz / 3DH5

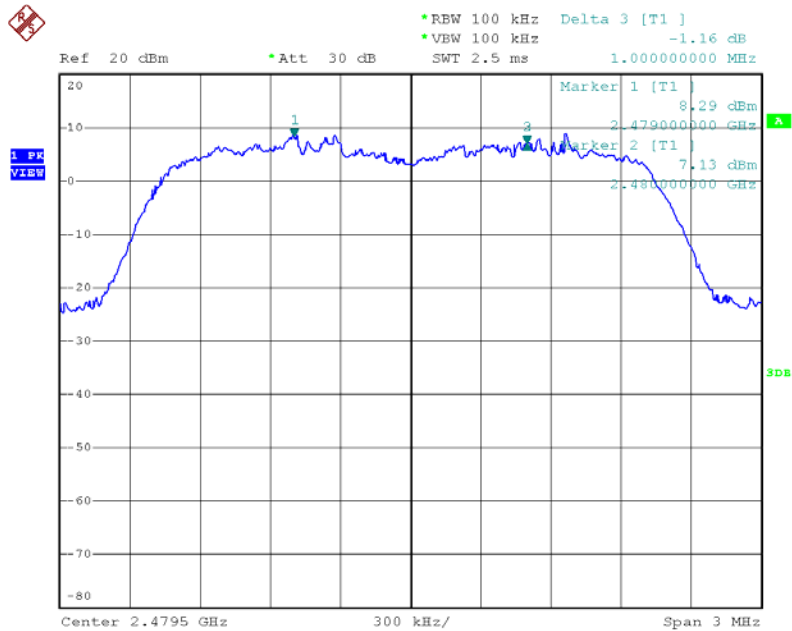

Date: 3.APR.2012 17:08:47

For Bluetooth 2.1 + EDR : < DIPOLE Antenna >

Temperature	22°C	Humidity	65%
Test Engineer	Allen Liu	Configurations	8DPSK / Aux Port
Test Date	Feb. 09, 2012		

Modulation Type	Channel No.	Frequency (MHz)	Hopping Ch. (Channels)	Min. Limit (Channels)	Test Result
8DPSK	0 ~ 78	2402 ~ 2480	79	15	Complies

Number of Hopping Channel Plot on Channel 0~78 / 2402 MHz ~ 2480 MHz

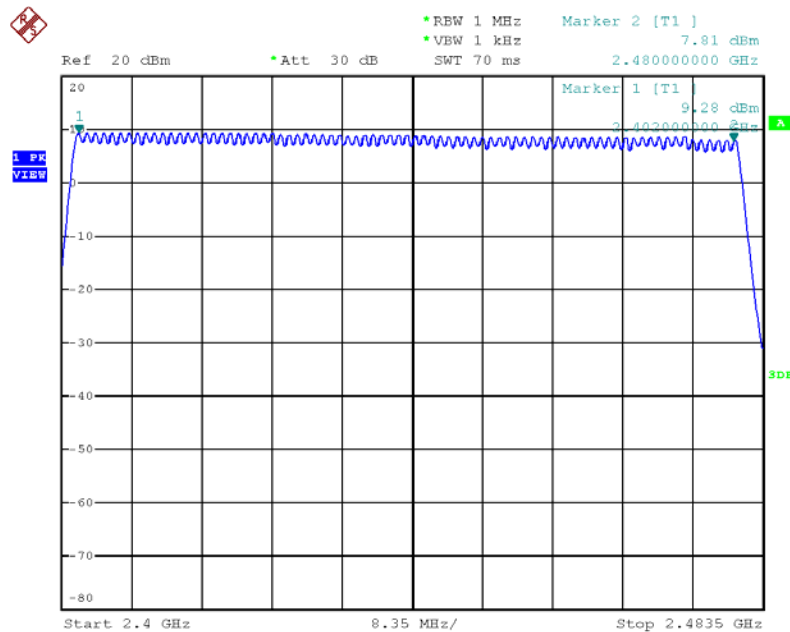

Date: 9.FEB.2012 11:39:06

Channel Separation Plot on Channel 0~1 / 2402 MHz ~ 2403MHz / 1DH5

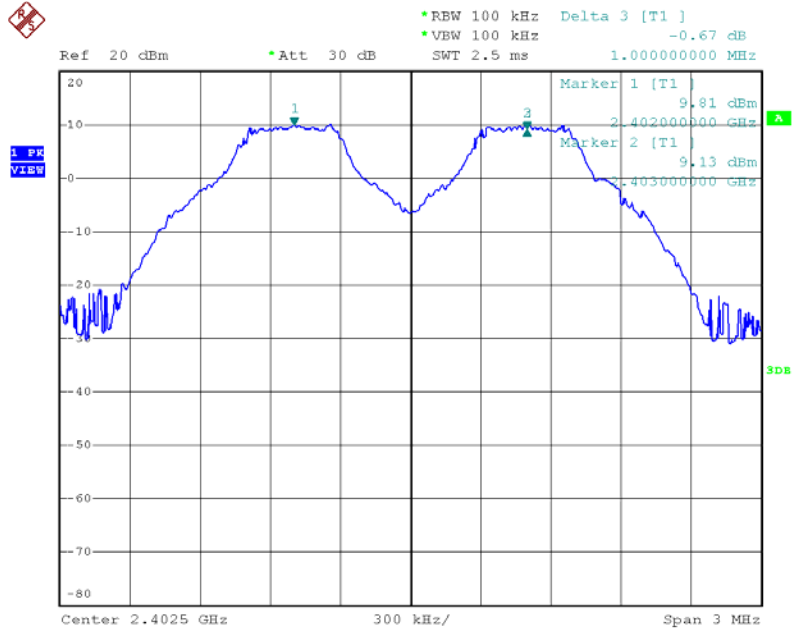

Date: 3.APR.2012 17:17:05

Channel Separation Plot on Channel 39~40 / 2441 MHz ~ 2442MHz / 1DH5

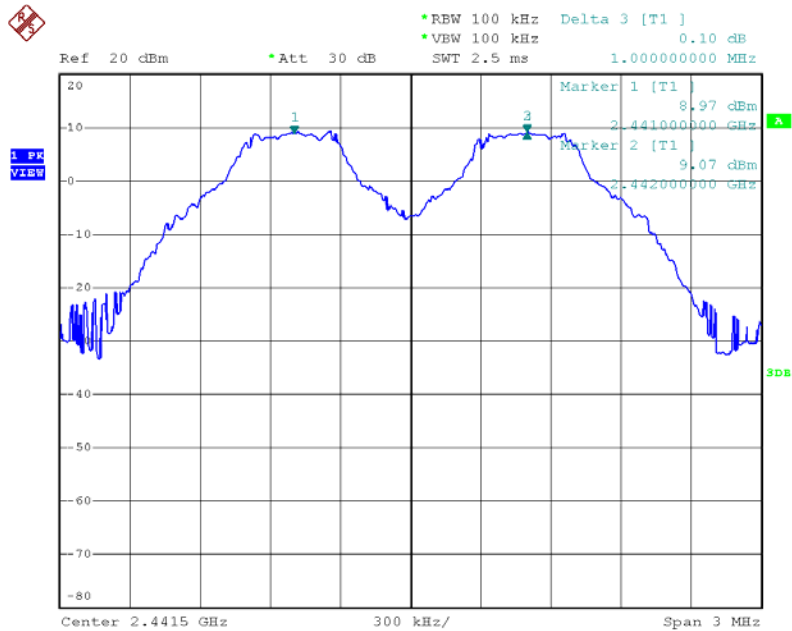

Date: 3.APR.2012 17:16:17

Channel Separation Plot on Channel 77~78 / 2479 MHz ~ 2480 MHz / 1DH5

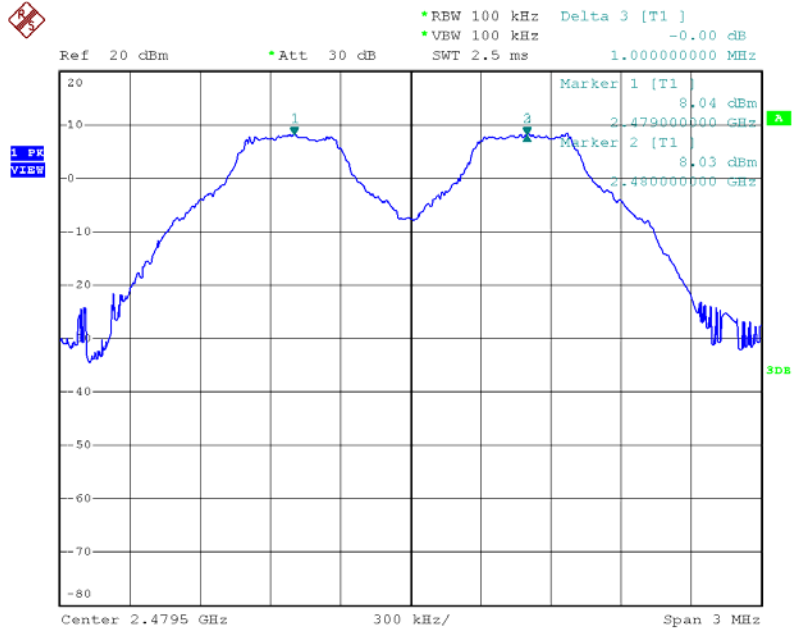

Date: 3.APR.2012 17:14:35

Channel Separation Plot on Channel 0~1 / 2402 MHz ~ 2403MHz / 3DH5

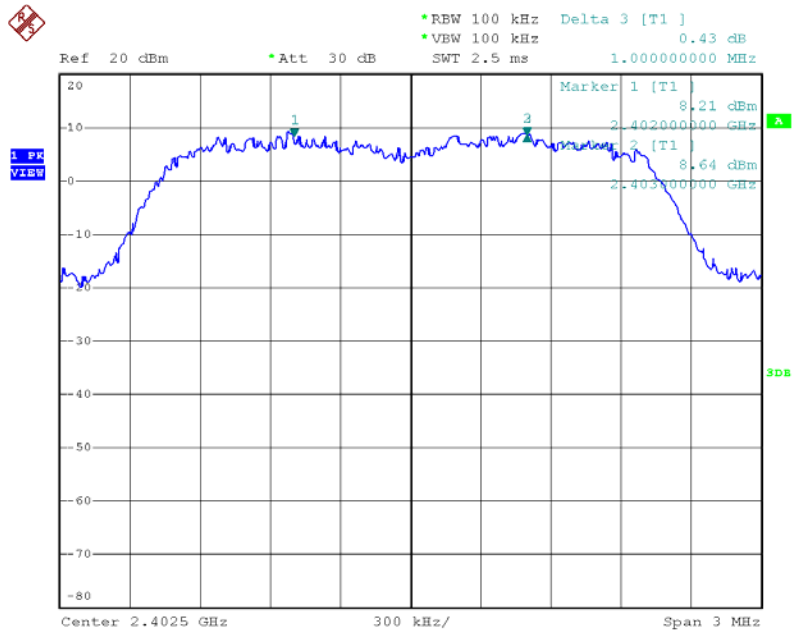

Date: 3.APR.2012 17:11:48

Channel Separation Plot on Channel 39~40 / 2441 MHz ~ 2442MHz / 3DH5

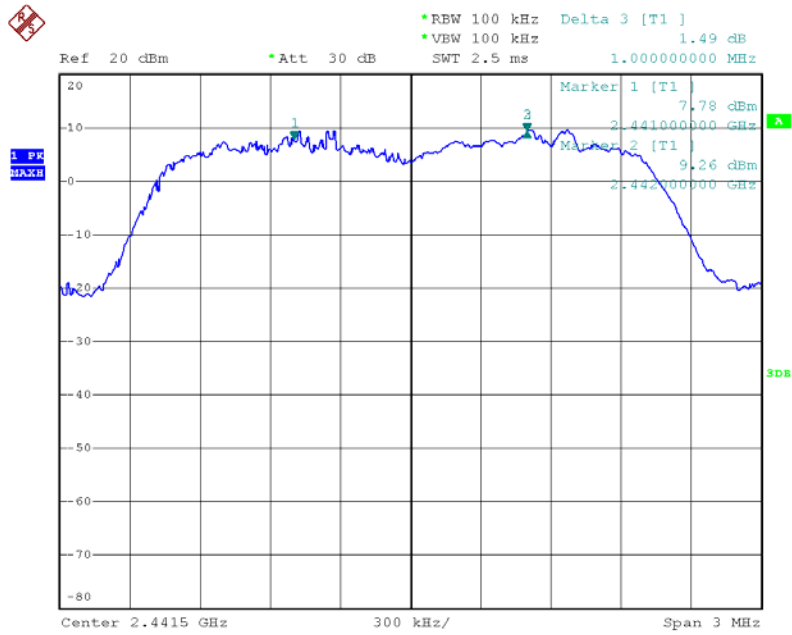

Date: 3.APR.2012 17:12:35

Channel Separation Plot on Channel 77~78 / 2479 MHz ~ 2480 MHz / 3DH5

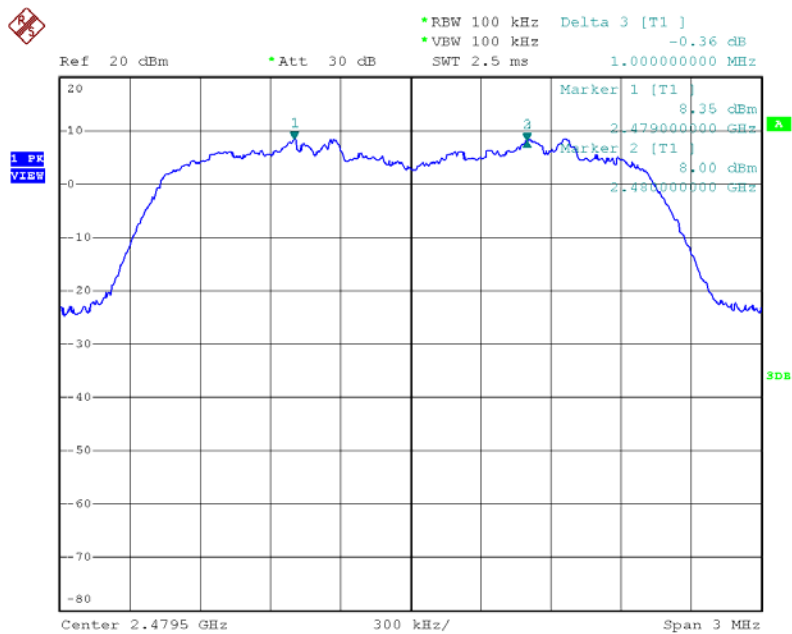

Date: 3.APR.2012 17:13:36

For Bluetooth 4.0 : < PIFA Antenna >

Temperature	22°C	Humidity	65%
Test Engineer	Allen Liu	Configurations	GFSK / Main Port
Test Date	Feb. 09, 2012		

Modulation Type	Channel No.	Frequency (MHz)	Hopping Ch. (Channels)	Min. Limit (Channels)	Test Result
GFSK	0 ~ 39	2402 ~ 2480	40	15	Complies

Number of Hopping Channel Plot on Channel 0~39 / 2402 MHz ~ 2480 MHz

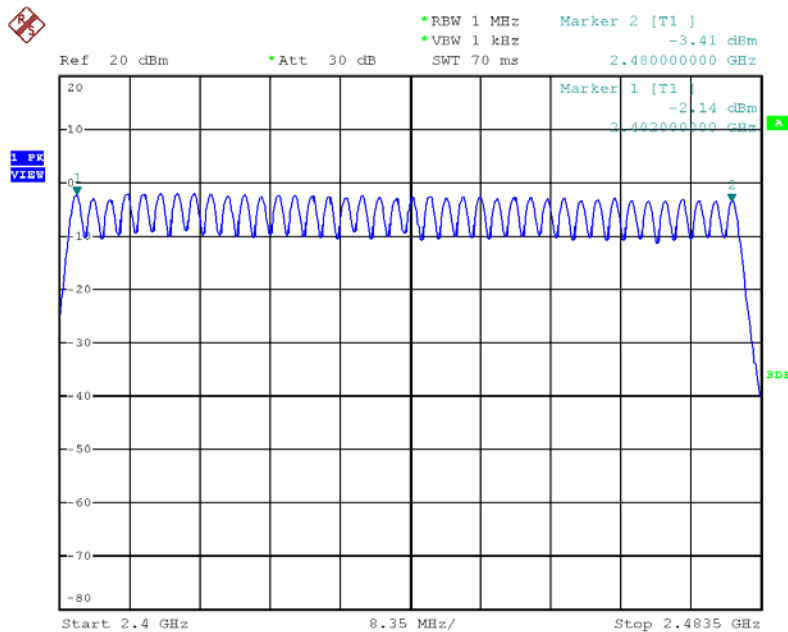

Date: 9.FEB.2012 13:36:57

Channel Separation Plot on Channel 0~1 / 2402 MHz ~ 2404 MHz

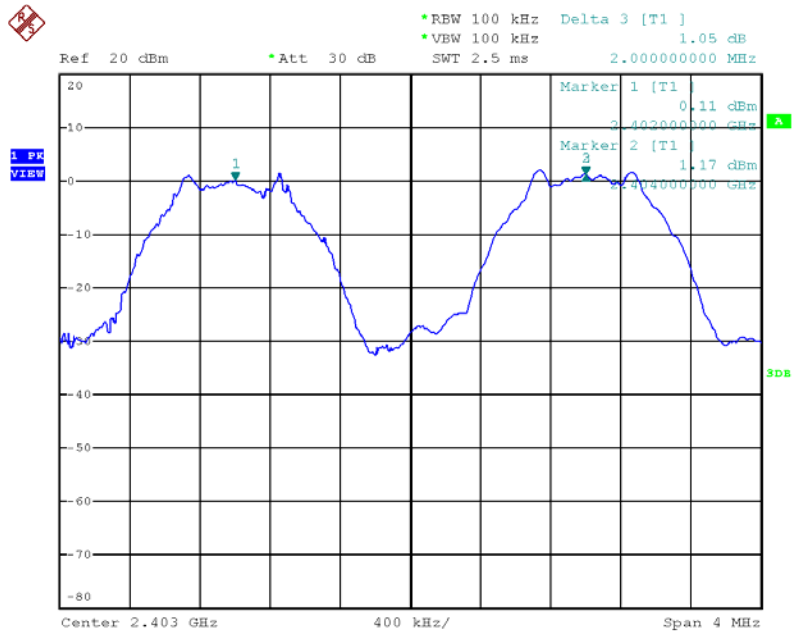

Date: 9.FEB.2012 13:39:00

Channel Separation Plot on Channel 20~20 / 2440 MHz ~ 2442 MHz

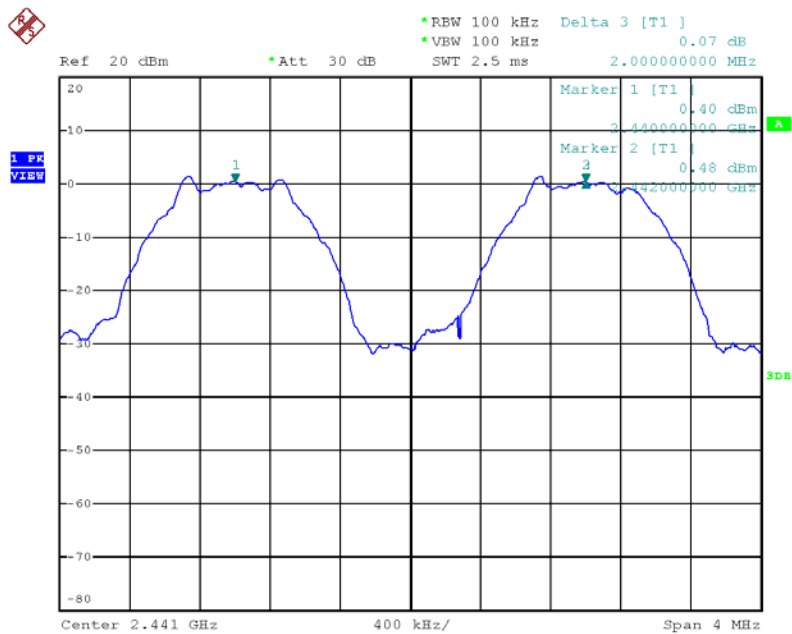

Date: 9.FEB.2012 13:40:11

Channel Separation Plot on Channel 38~39 / 2478 MHz ~ 2480 MHz

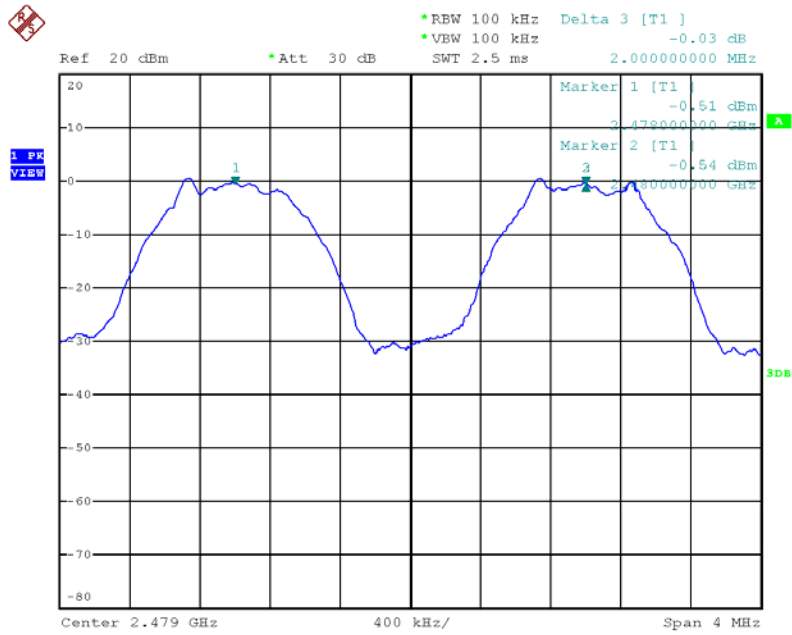

Date: 9.FEB.2012 13:41:33

For Bluetooth 4.0 : < PIFA Antenna >

Temperature	22°C	Humidity	65%
Test Engineer	Allen Liu	Configurations	GFSK / Aux Port
Test Date	Feb. 09, 2012		

Modulation Type	Channel No.	Frequency (MHz)	Hopping Ch. (Channels)	Min. Limit (Channels)	Test Result
GFSK	0 ~ 39	2402 ~ 2480	40	15	Complies

Number of Hopping Channel Plot on Channel 0~39 / 2402 MHz ~ 2480 MHz

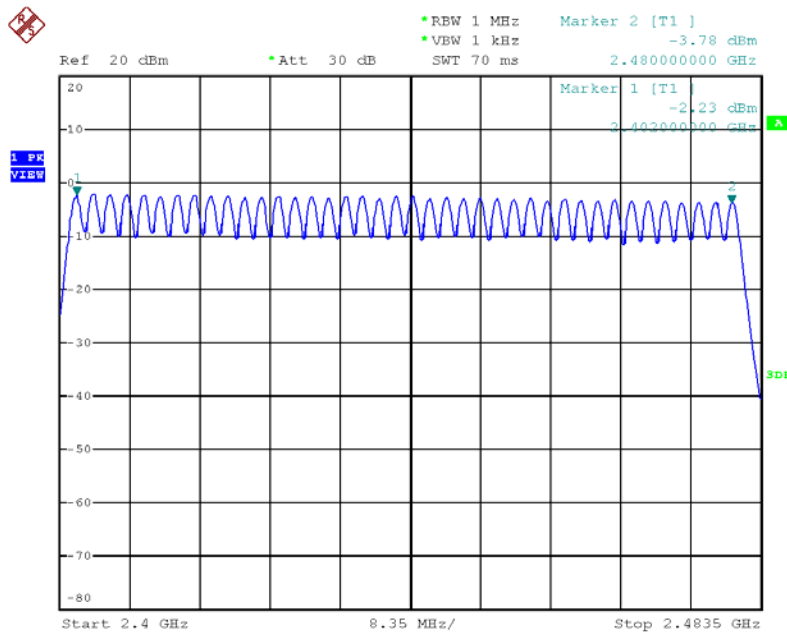

Date: 9.FEB.2012 14:05:42

Channel Separation Plot on Channel 0~1 / 2402 MHz ~ 2404 MHz

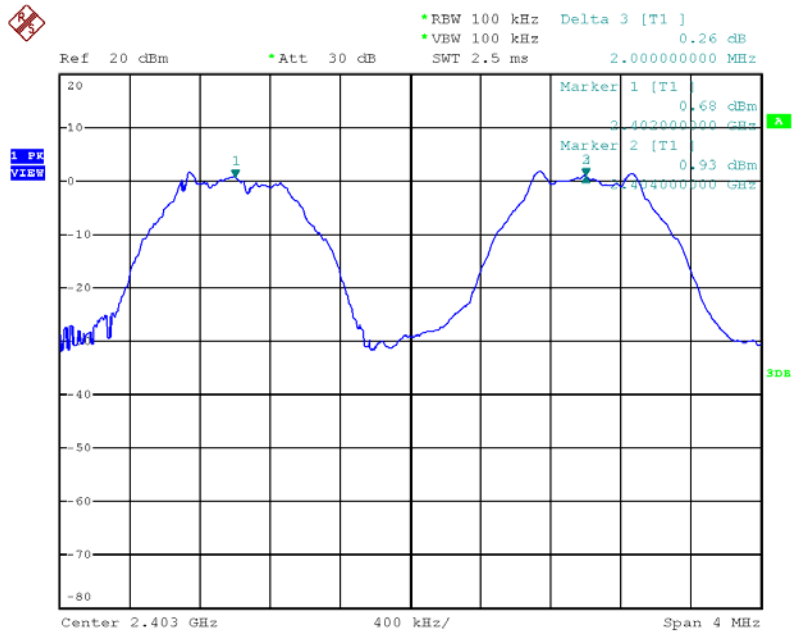

Date: 9.FEB.2012 14:08:58

Channel Separation Plot on Channel 20~20 / 2440 MHz ~ 2442 MHz

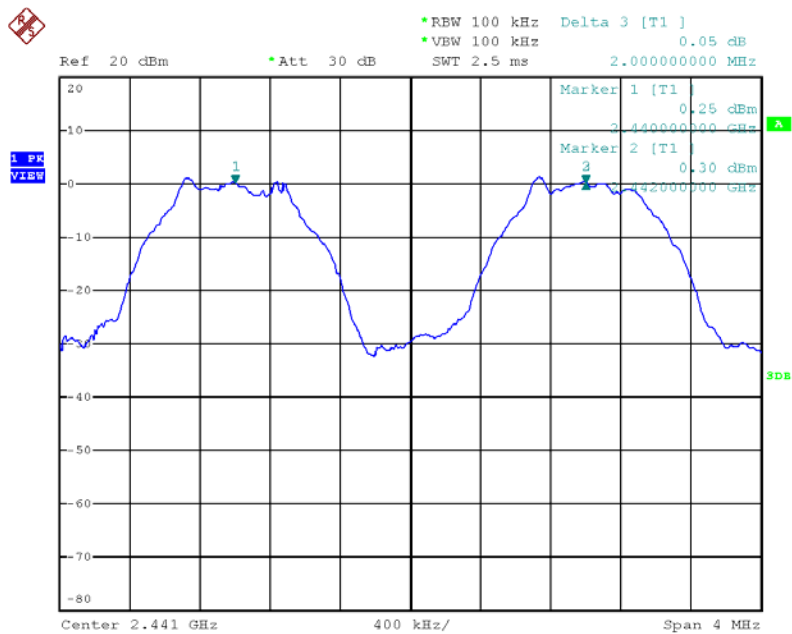

Date: 9.FEB.2012 14:10:08

Channel Separation Plot on Channel 38~39 / 2478 MHz ~ 2480 MHz

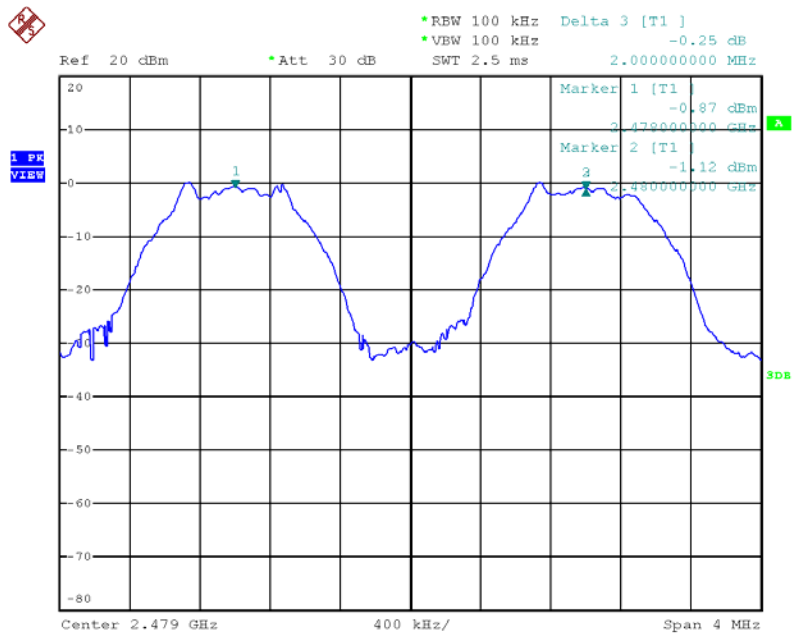

Date: 9.FEB.2012 14:11:02

For Bluetooth 4.0 : < DIPOLE Antenna >

Temperature	22°C	Humidity	65%
Test Engineer	Allen Liu	Configurations	GFSK / Main Port
Test Date	Feb. 09, 2012		

Modulation Type	Channel No.	Frequency (MHz)	Hopping Ch. (Channels)	Min. Limit (Channels)	Test Result
GFSK	0 ~ 39	2402 ~ 2480	40	15	Complies

Number of Hopping Channel Plot on Channel 0~39 / 2402 MHz ~ 2480 MHz

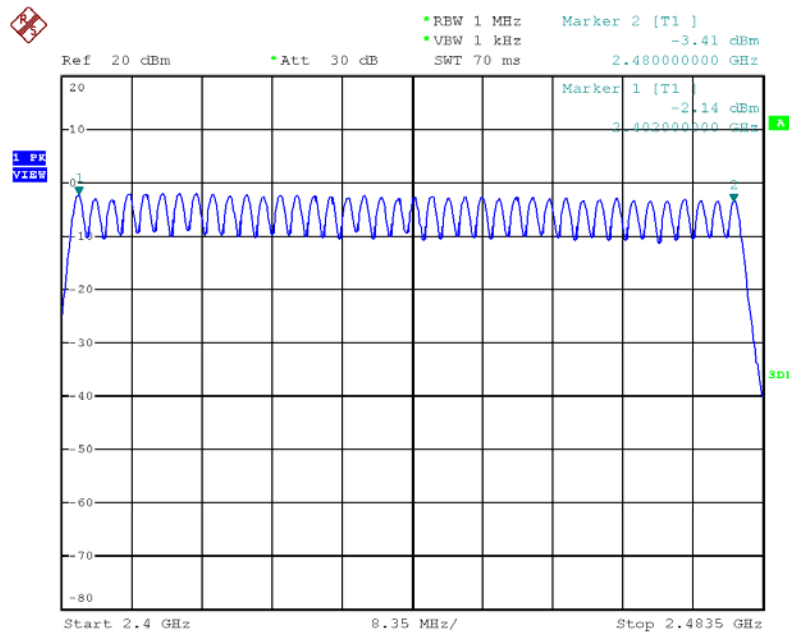

Date: 9.FEB.2012 13:36:57

Channel Separation Plot on Channel 0~1 / 2402 MHz ~ 2404 MHz

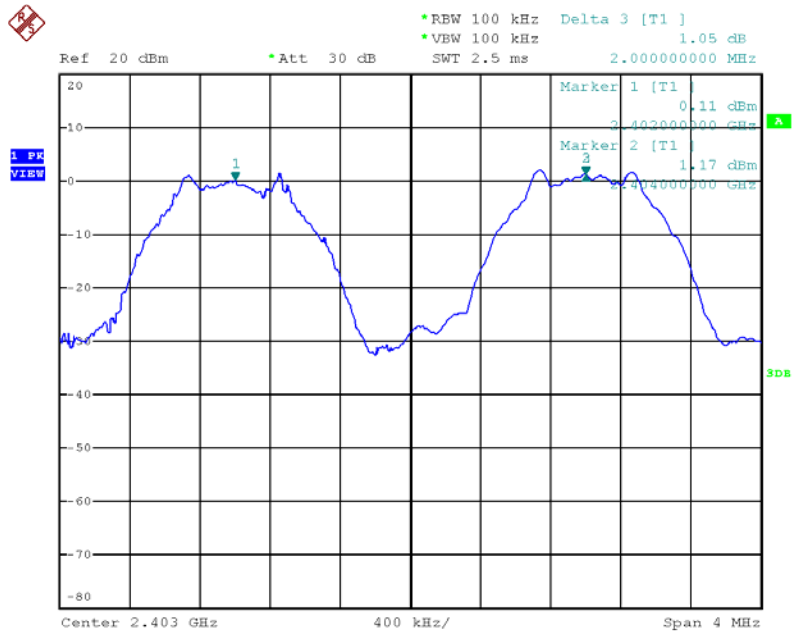

Date: 9.FEB.2012 13:39:00

Channel Separation Plot on Channel 20~20 / 2440 MHz ~ 2442 MHz

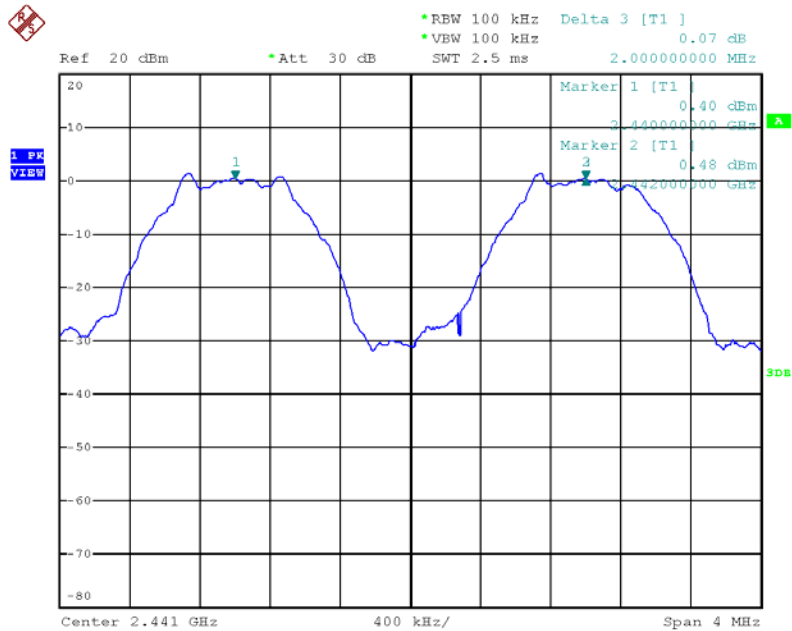

Date: 9.FEB.2012 13:40:11

Channel Separation Plot on Channel 38~39 / 2478 MHz ~ 2480 MHz

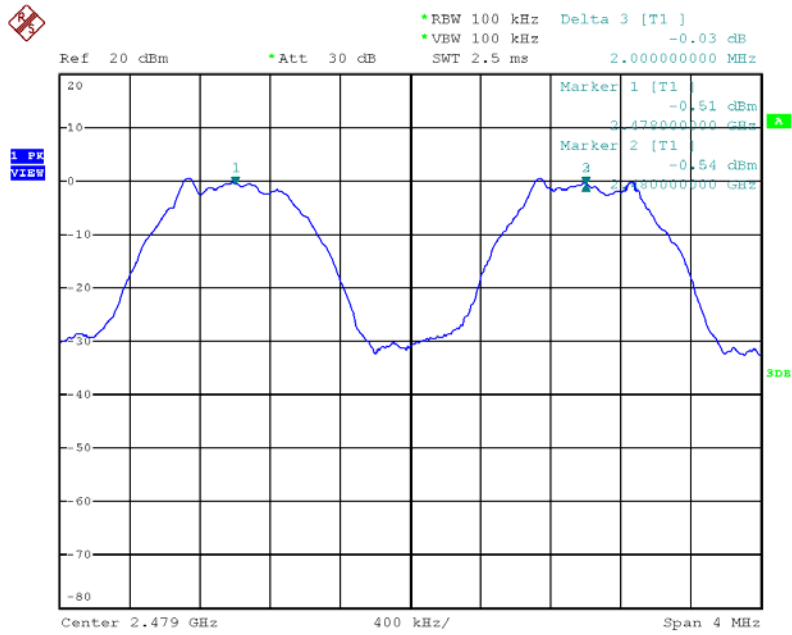

Date: 9.FEB.2012 13:41:33

For Bluetooth 4.0 : < DIPOLE Antenna >

Temperature	22°C	Humidity	65%
Test Engineer	Allen Liu	Configurations	GFSK / Aux Port
Test Date	Feb. 09, 2012		

Modulation Type	Channel No.	Frequency (MHz)	Hopping Ch. (Channels)	Min. Limit (Channels)	Test Result
GFSK	0 ~ 39	2402 ~ 2480	40	15	Complies

Number of Hopping Channel Plot on Channel 0~39 / 2402 MHz ~ 2480 MHz

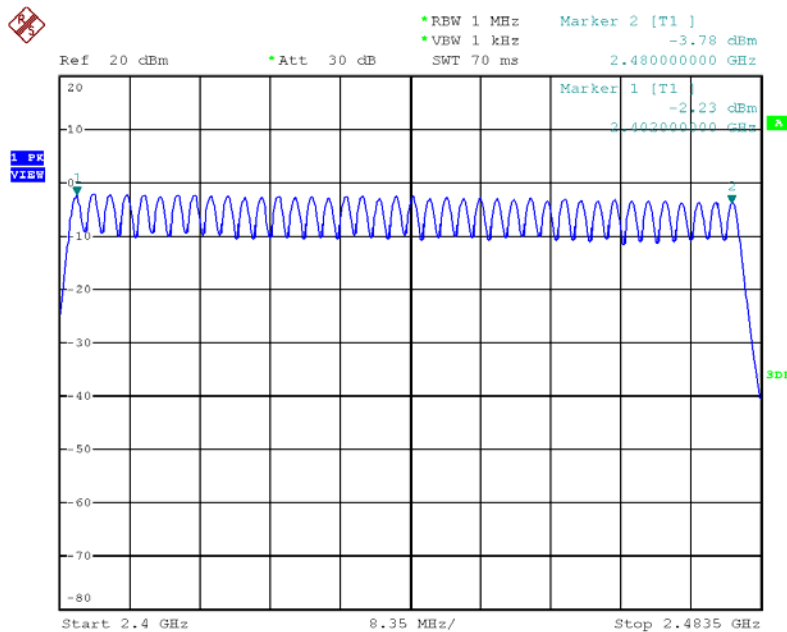

Date: 9.FEB.2012 14:05:42

Channel Separation Plot on Channel 0~1 / 2402 MHz ~ 2404 MHz

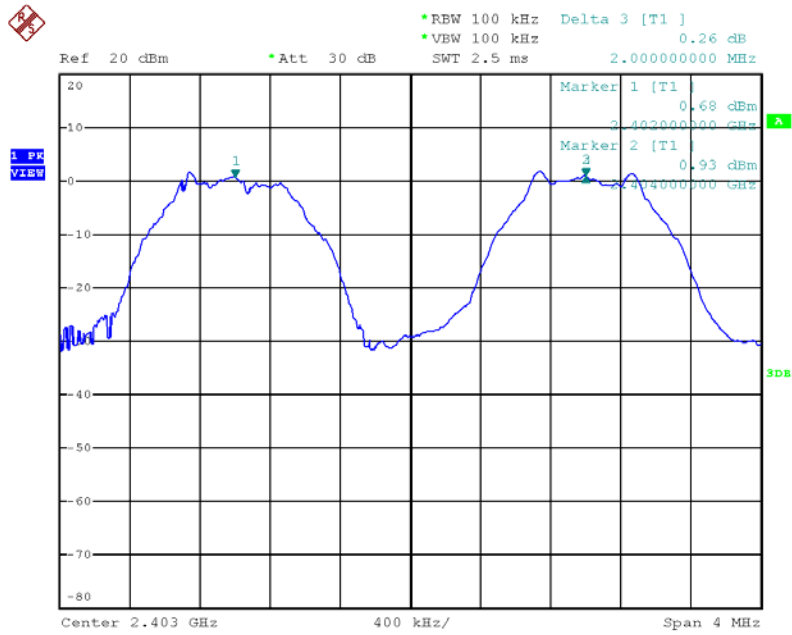

Date: 9.FEB.2012 14:08:58

Channel Separation Plot on Channel 20~20 / 2440 MHz ~ 2442 MHz

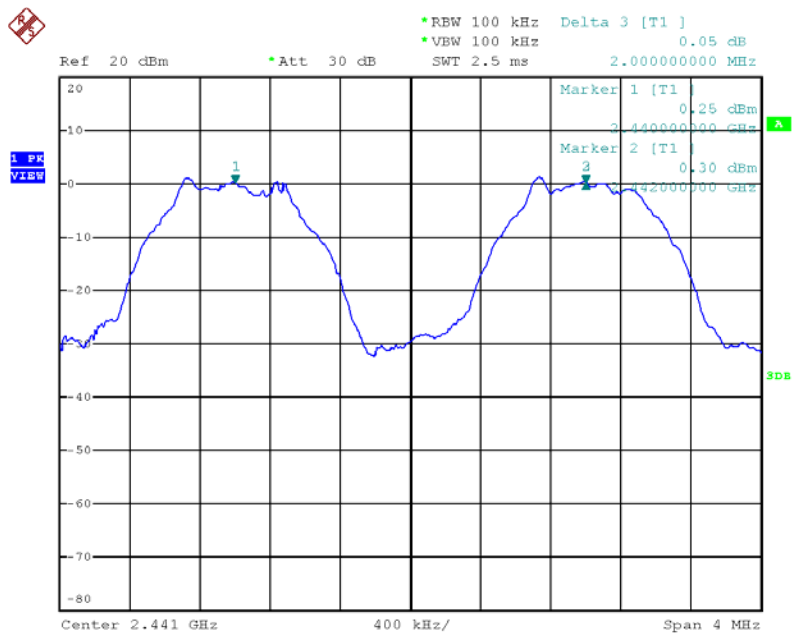

Date: 9.FEB.2012 14:10:08

Channel Separation Plot on Channel 38~39 / 2478 MHz ~ 2480 MHz

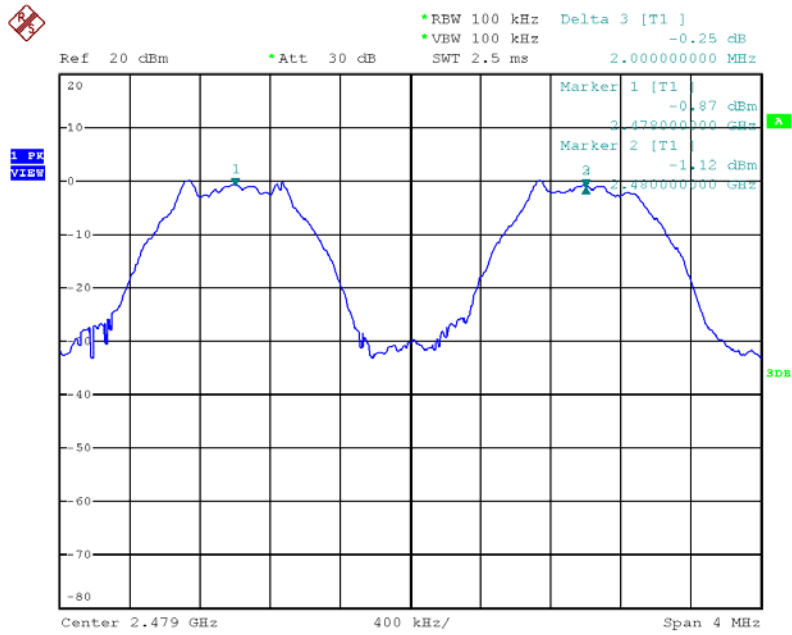

Date: 9.FEB.2012 14:11:02

4.6. Dwell Time Measurement

4.6.1. Limit

Frequency hopping systems in the 2400-2483.5 MHz band shall use at least 15 channels. The average time of occupancy on any channel shall not be greater than 0.4 seconds within a period of 0.4 seconds multiplied by the number of hopping channels employed.

4.6.2. Measuring Instruments and Setting

Please refer to section 5 of equipments list in this report. The following table is the setting of spectrum analyzer.

Spectrum Parameter	Setting
Attenuation	Auto
Span Frequency	0 MHz
RB	1000 kHz
VB	1000 kHz
Detector	Peak
Trace	Single Trigger

4.6.3. Test Procedures

1. The transmitter output (antenna port) was connected to the spectrum analyzer
2. Set RBW of spectrum analyzer to 1000kHz and VBW to 1000kHz.
3. Use a video trigger with the trigger level set to enable triggering only on full pulses.
4. Sweep Time is more than once pulse time.
5. Set the center frequency on any frequency would be measure and set the frequency span to zero span.
6. Measure the maximum time duration of one single pulse.
7. Set the EUT for 3DH5, 3DH3 and 3DH1 packet transmitting.
8. Measure the maximum time duration of one single pulse.

4.6.4. Test Setup Layout

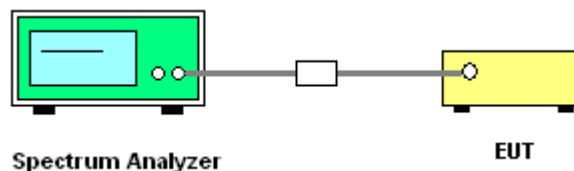

4.6.5. Test Deviation

There is no deviation with the original standard.

4.6.6. EUT Operation during Test

The EUT was programmed to be in continuously transmitting mode.

4.6.7. Test Result of Dwell Time

For Bluetooth 2.1 + EDR : < PIFA Antenna >

Temperature	22°C	Humidity	65%
Test Engineer	Allen Liu	Configurations	3DH1, 3DH3, 3DH5 / Main Port

Data Packet	Frequency	Pulse Duration (ms)	Dwell Time (s)	Limits (s)	Test Result
DH5	2402 MHz	2.8900	0.3083	0.4000	Complies
DH3	2402 MHz	1.6300	0.2608	0.4000	Complies
DH1	2402 MHz	0.3780	0.1210	0.4000	Complies
DH5	2441 MHz	2.8900	0.3083	0.4000	Complies
DH3	2441 MHz	1.6300	0.2608	0.4000	Complies
DH1	2441 MHz	0.3780	0.1210	0.4000	Complies
DH5	2480 MHz	2.8900	0.3083	0.4000	Complies
DH3	2480 MHz	1.6300	0.2608	0.4000	Complies
DH1	2480 MHz	0.3740	0.1197	0.4000	Complies

Note: Pulse Duration * Number of Pulses*(Dwell time / measure time)

Remark:

Dwell Time = 79(channels) x 0.4(s) x average hopping channel x package transfer time (us)

79 channels come from the Hopping Channel number.

Average Hopping Channel = hops / sweep time

Dwell Time Plot on Channel 0 / 3DH5 / 2402 MHz

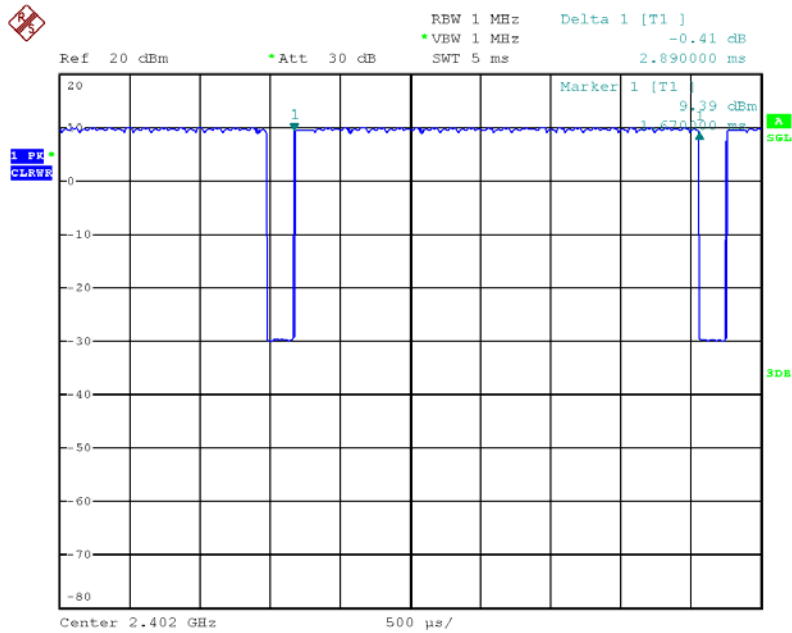

Date: 9.FEB.2012 13:09:19

Dwell Time Plot on Channel 0 / 3DH3 / 2402 MHz

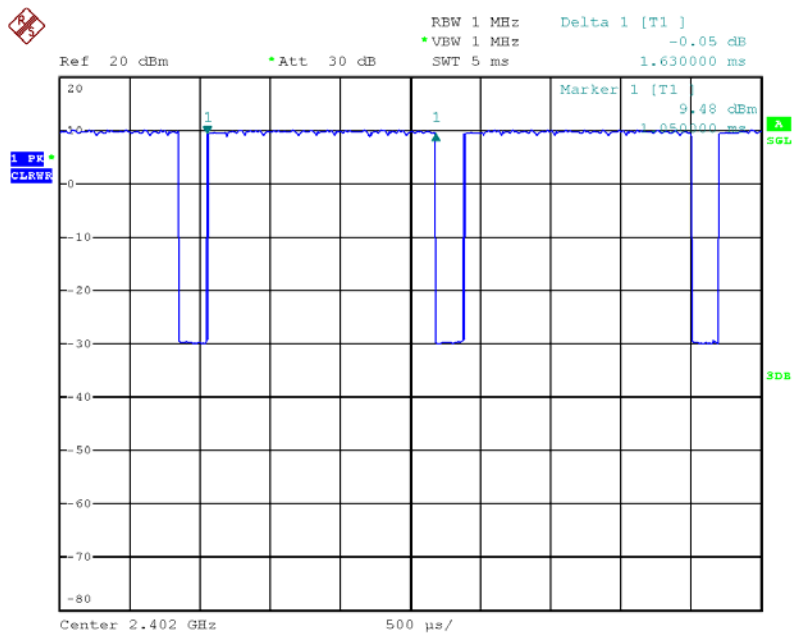

Date: 9.FEB.2012 13:11:38

Dwell Time Plot on Channel 0 / 3DH1 / 2402 MHz

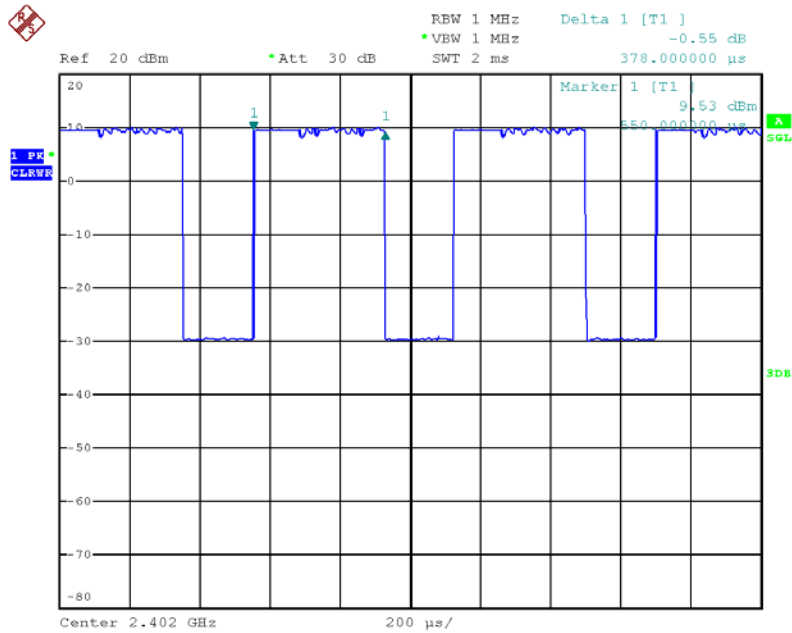

Date: 9.FEB.2012 13:12:06

Dwell Time Plot on Channel 39 / 3DH5 / 2441 MHz

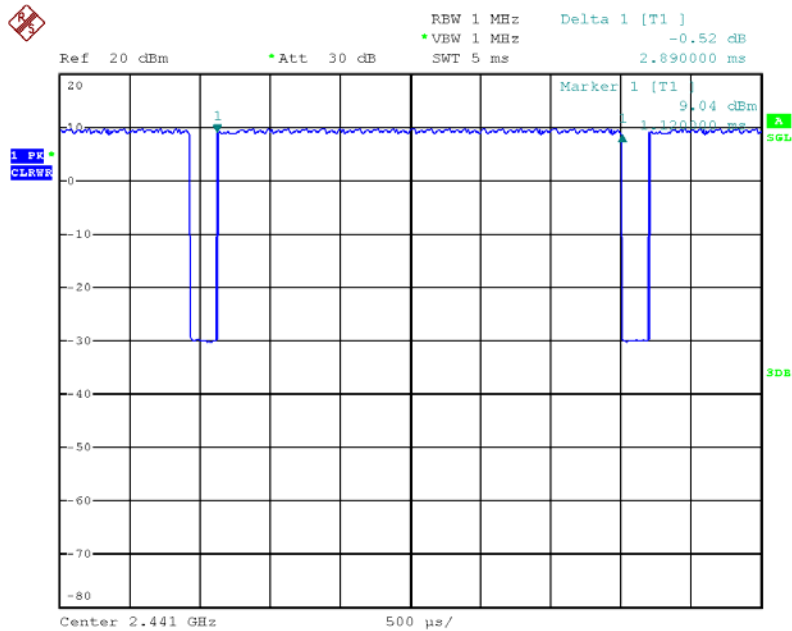

Date: 9.FEB.2012 13:09:55

Dwell Time Plot on Channel 39 / 3DH3 / 2441 MHz

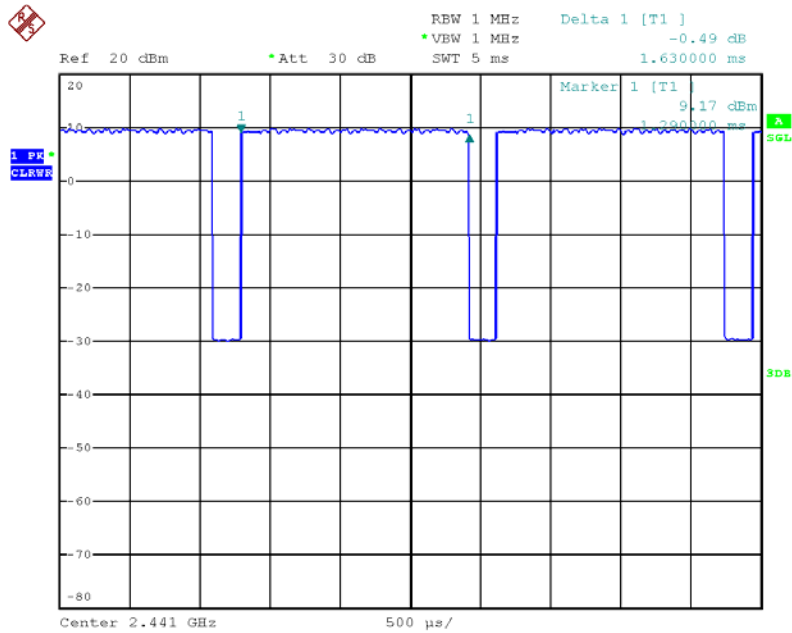

Date: 9.FEB.2012 13:11:15

Dwell Time Plot on Channel 39 / 3DH1 / 2441 MHz

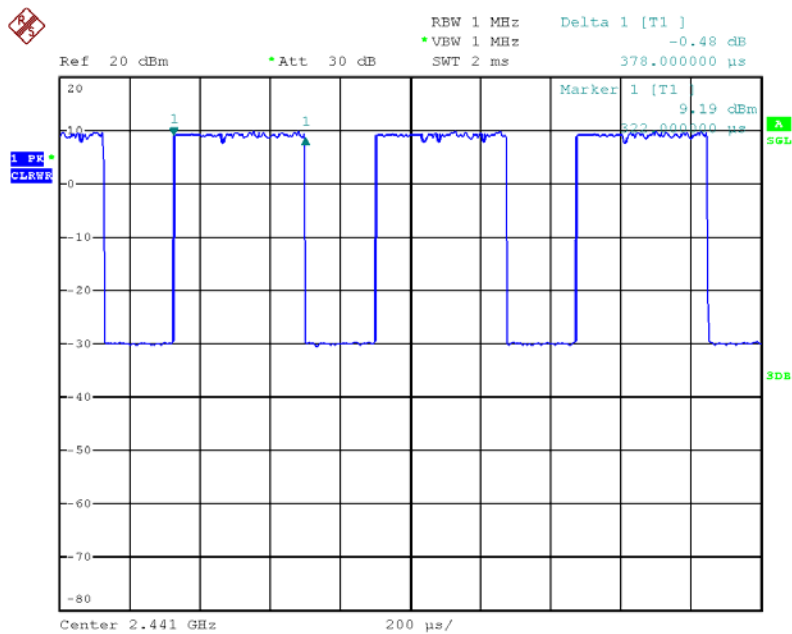

Date: 9.FEB.2012 13:12:27

Dwell Time Plot on Channel 78 / 3DH5 / 2480 MHz

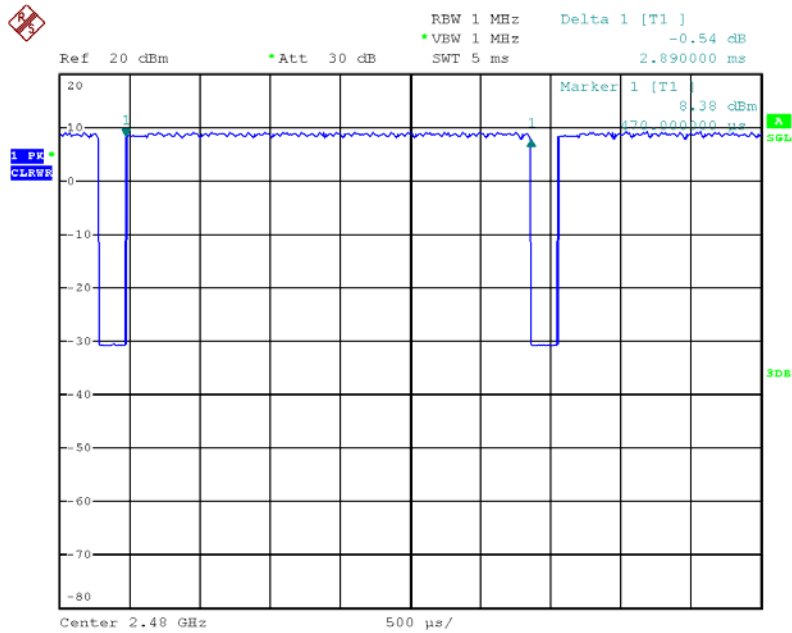

Date: 9.FEB.2012 13:10:21

Dwell Time Plot on Channel 78 / 3DH3 / 2480 MHz

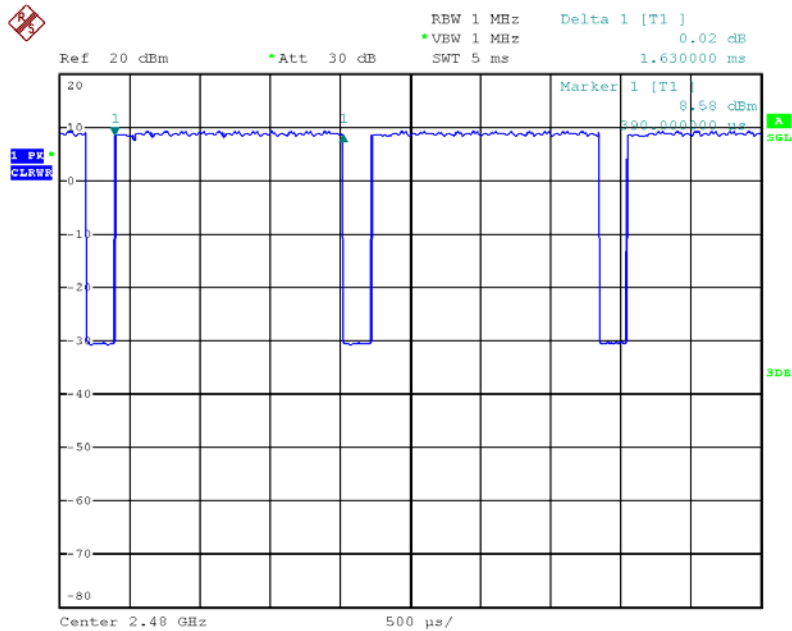

Date: 9.FEB.2012 13:10:48

Dwell Time Plot on Channel 78 / 3DH1 / 2480 MHz

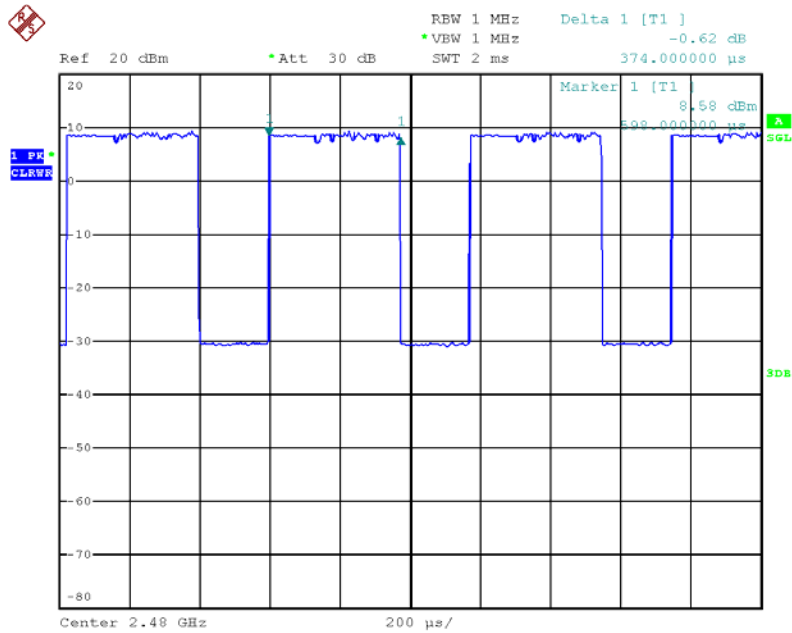

Date: 9.FEB.2012 13:12:56

For Bluetooth 2.1 + EDR : < PIFA Antenna >

Temperature	22°C	Humidity	65%
Test Engineer	Allen Liu	Configurations	3DH1, 3DH3, 3DH5 / Aux Port

Data Packet	Frequency	Pulse Duration (ms)	Dwell Time (s)	Limits (s)	Test Result
DH5	2402 MHz	2.8800	0.3072	0.4000	Complies
DH3	2402 MHz	1.6300	0.2608	0.4000	Complies
DH1	2402 MHz	0.3740	0.1197	0.4000	Complies
DH5	2441 MHz	2.8800	0.3072	0.4000	Complies
DH3	2441 MHz	1.6300	0.2608	0.4000	Complies
DH1	2441 MHz	0.3740	0.1197	0.4000	Complies
DH5	2480 MHz	2.8900	0.3083	0.4000	Complies
DH3	2480 MHz	1.6300	0.2608	0.4000	Complies
DH1	2480 MHz	0.3740	0.1197	0.4000	Complies

Note: Pulse Duration * Number of Pulses*(Dwell time / measure time)

Remark:

Dwell Time = 79(channels) x 0.4(s) x average hopping channel x package transfer time (us)

79 channels come from the Hopping Channel number.

Average Hopping Channel = hops / sweep time

Dwell Time Plot on Channel 0 / 3DH5 / 2402 MHz

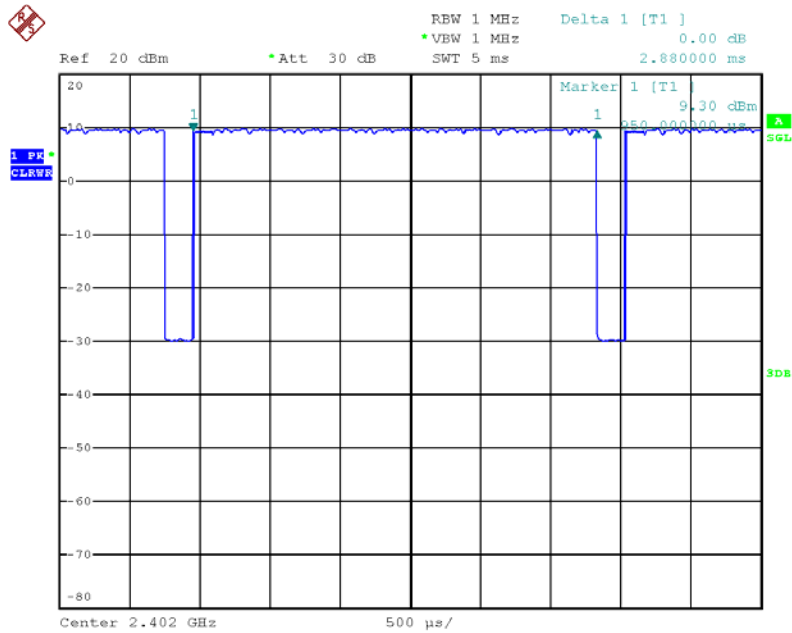

Date: 9.FEB.2012 10:48:53

Dwell Time Plot on Channel 0 / 3DH3 / 2402 MHz

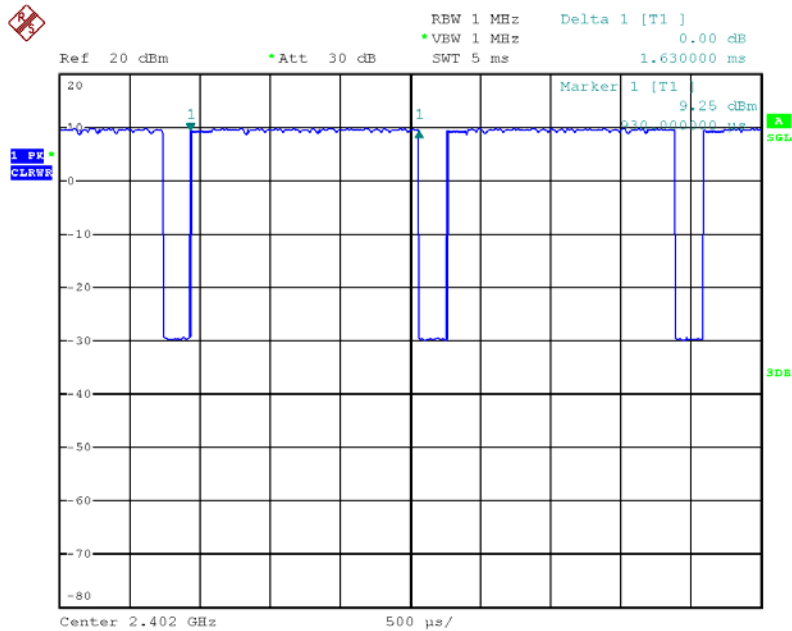

Date: 9.FEB.2012 10:59:14

Dwell Time Plot on Channel 0 / 3DH1 / 2402 MHz

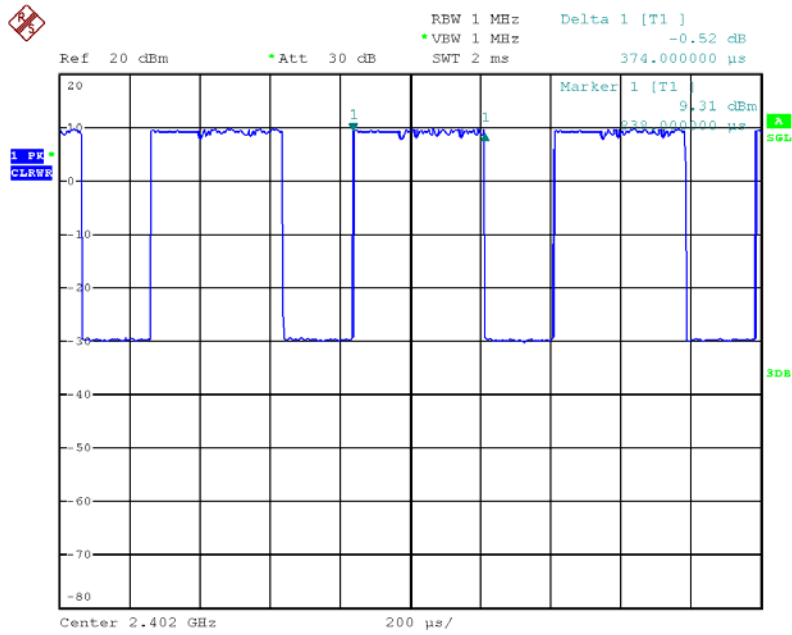

Date: 9.FEB.2012 11:01:58

Dwell Time Plot on Channel 39 / 3DH5 / 2441 MHz

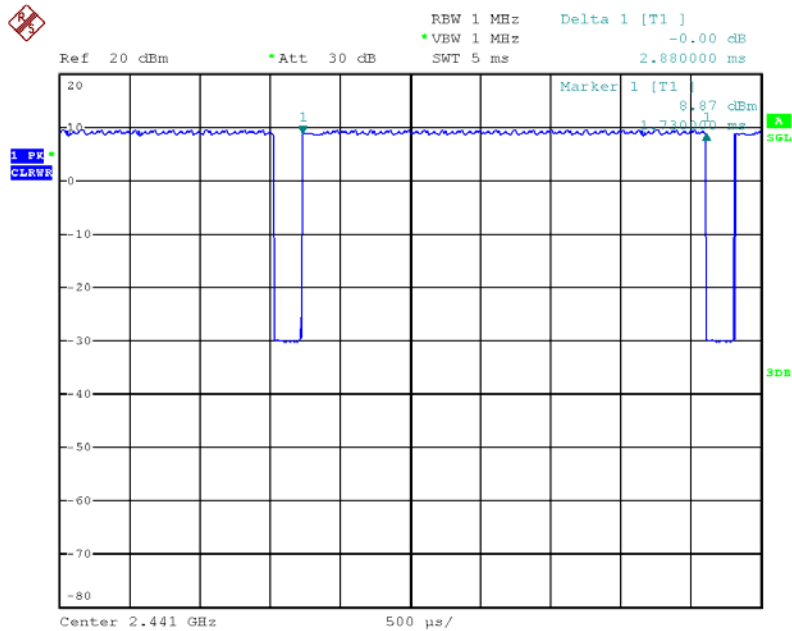

Date: 9.FEB.2012 10:48:00

Dwell Time Plot on Channel 39 / 3DH3 / 2441 MHz

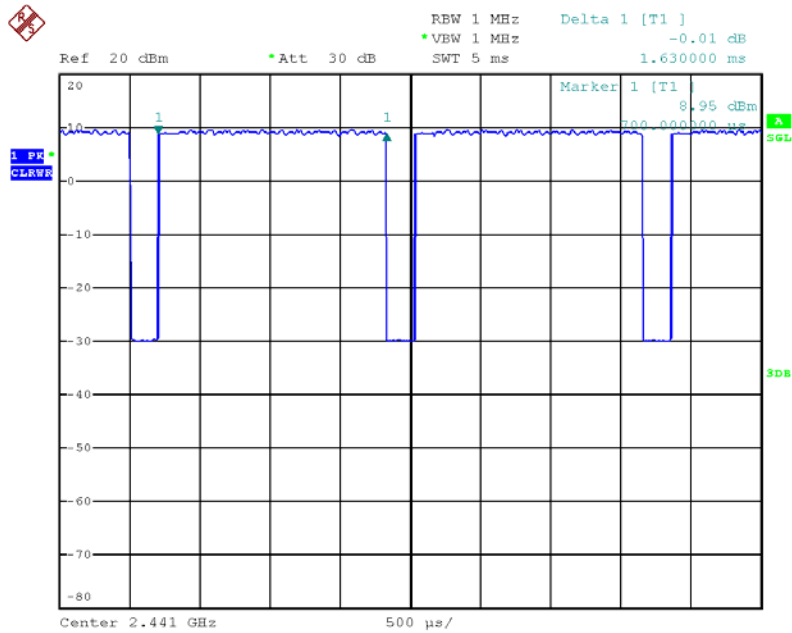

Date: 9.FEB.2012 10:59:47

Dwell Time Plot on Channel 39 / 3DH1 / 2441 MHz

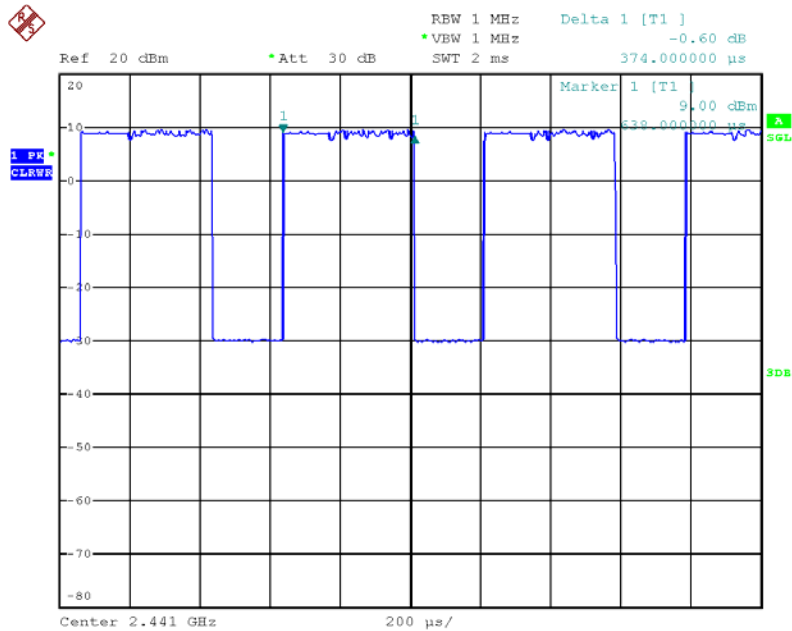

Date: 9.FEB.2012 11:01:36

Dwell Time Plot on Channel 78 / 3DH5 / 2480 MHz

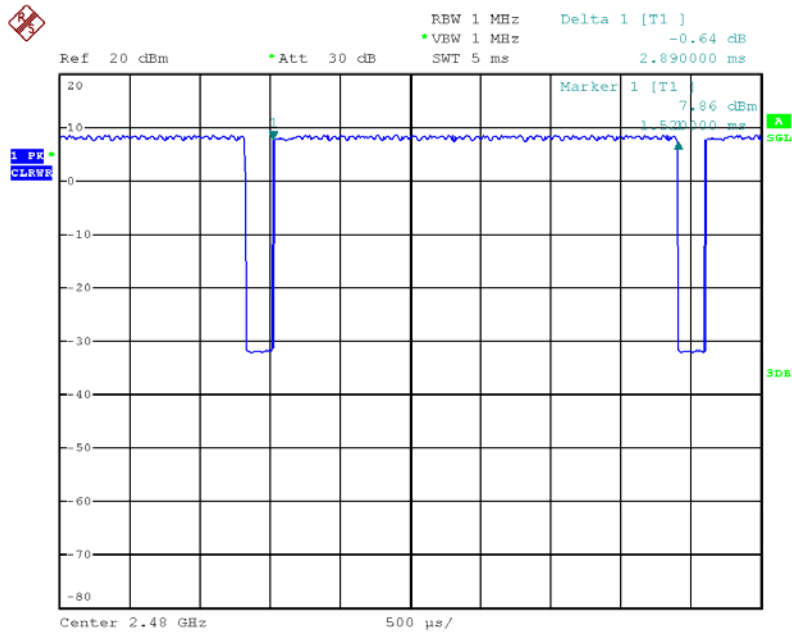

Date: 9.FEB.2012 10:44:45

Dwell Time Plot on Channel 78 / 3DH3 / 2480 MHz

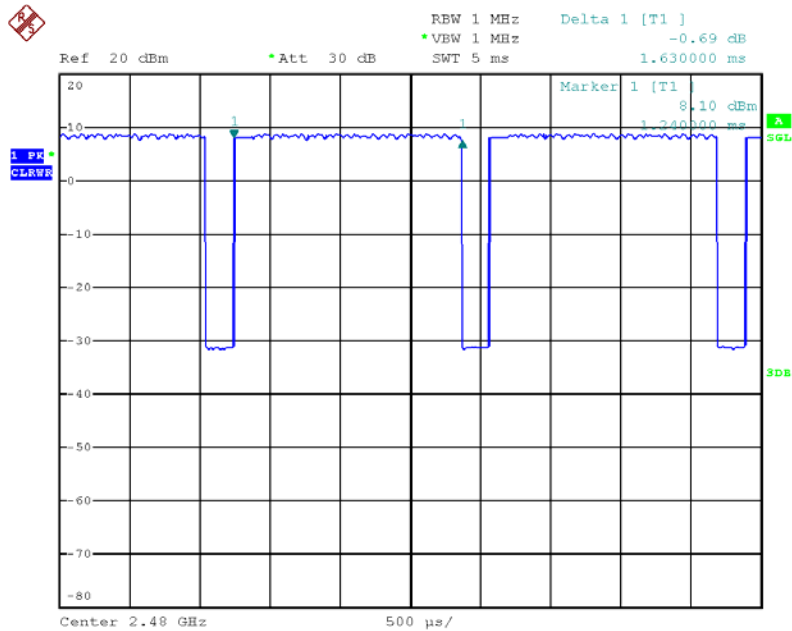

Date: 9.FEB.2012 11:00:19

For Bluetooth 2.1 + EDR : < DIPOLE Antenna >

Temperature	22°C	Humidity	65%
Test Engineer	Allen Liu	Configurations	3DH1, 3DH3, 3DH5 / Main Port

Data Packet	Frequency	Pulse Duration (ms)	Dwell Time (s)	Limits (s)	Test Result
DH5	2402 MHz	2.8900	0.3083	0.4000	Complies
DH3	2402 MHz	1.6300	0.2608	0.4000	Complies
DH1	2402 MHz	0.3780	0.1210	0.4000	Complies
DH5	2441 MHz	2.8900	0.3083	0.4000	Complies
DH3	2441 MHz	1.6300	0.2608	0.4000	Complies
DH1	2441 MHz	0.3780	0.1210	0.4000	Complies
DH5	2480 MHz	2.8900	0.3083	0.4000	Complies
DH3	2480 MHz	1.6300	0.2608	0.4000	Complies
DH1	2480 MHz	0.3740	0.1197	0.4000	Complies

Note: Pulse Duration * Number of Pulses*(Dwell time / measure time)

Remark:

Dwell Time = 79(channels) x 0.4(s) x average hopping channel x package transfer time (us)

79 channels come from the Hopping Channel number.

Average Hopping Channel = hops / sweep time

Dwell Time Plot on Channel 0 / 3DH5 / 2402 MHz

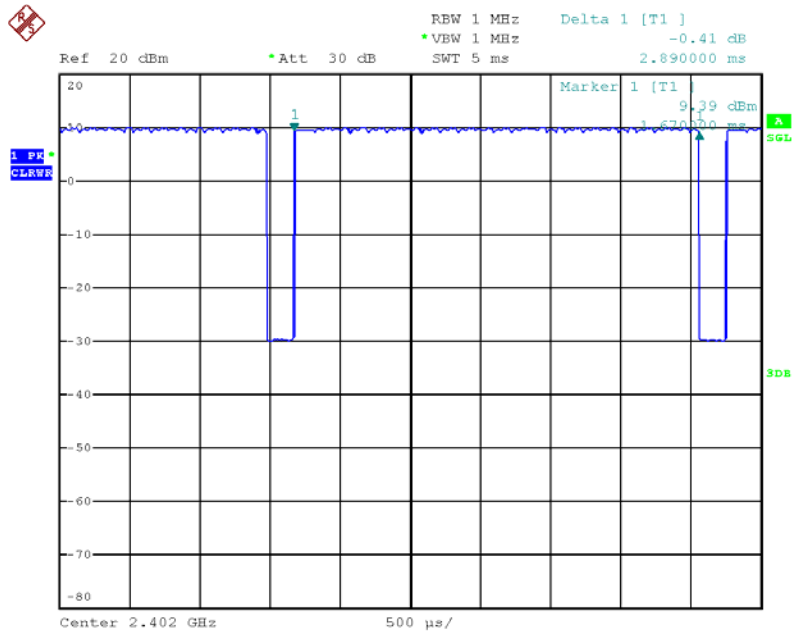

Date: 9.FEB.2012 13:09:19

Dwell Time Plot on Channel 0 / 3DH3 / 2402 MHz

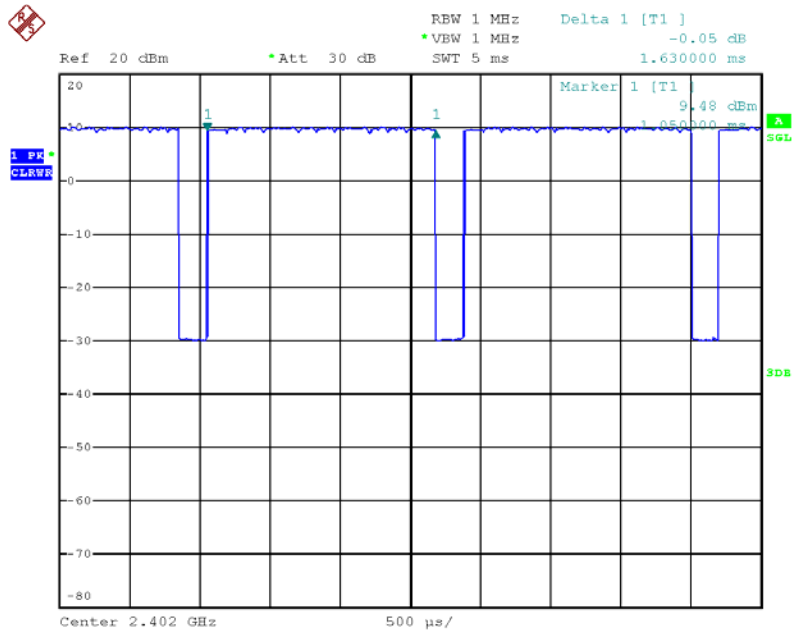

Date: 9.FEB.2012 13:11:38

Dwell Time Plot on Channel 0 / 3DH1 / 2402 MHz

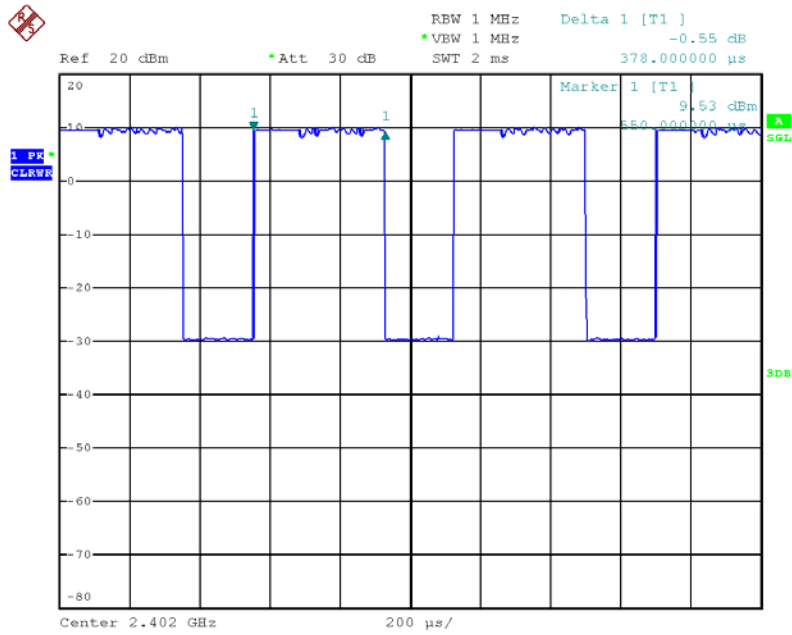

Date: 9.FEB.2012 13:12:06

Dwell Time Plot on Channel 39 / 3DH5 / 2441 MHz

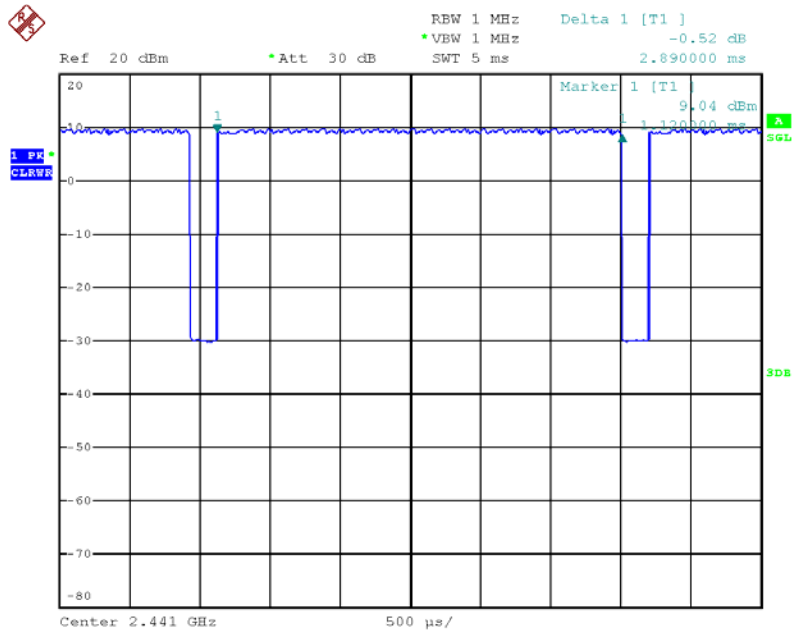

Date: 9.FEB.2012 13:09:55

Dwell Time Plot on Channel 39 / 3DH3 / 2441 MHz

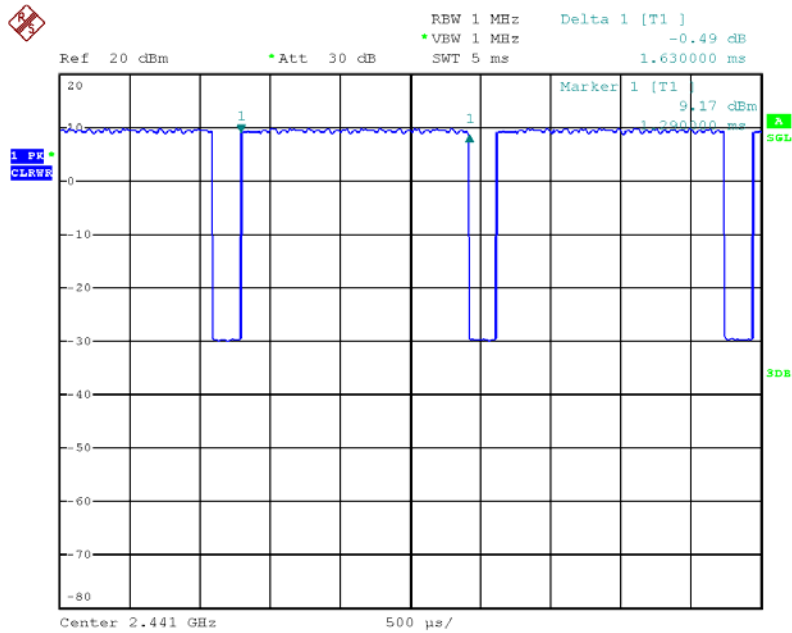

Date: 9.FEB.2012 13:11:15

Dwell Time Plot on Channel 39 / 3DH1 / 2441 MHz

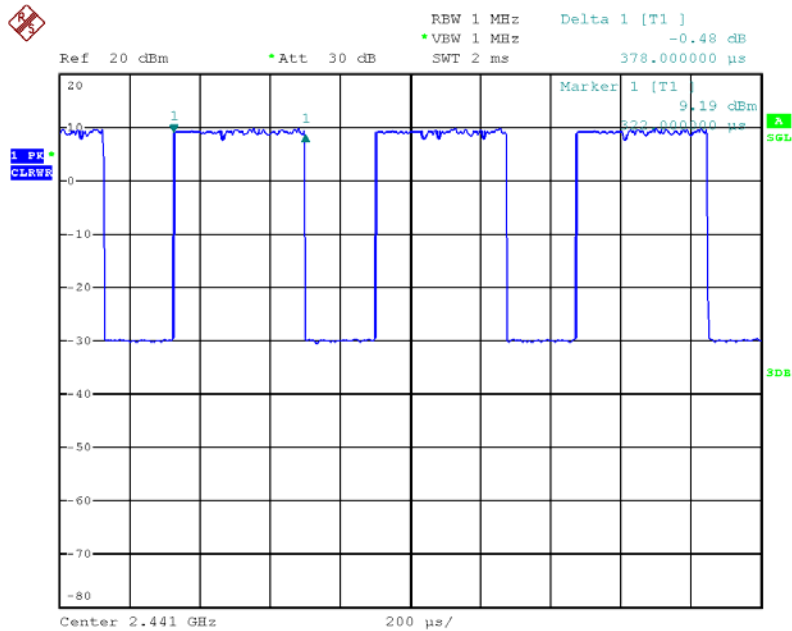

Date: 9.FEB.2012 13:12:27

Dwell Time Plot on Channel 78 / 3DH5 / 2480 MHz

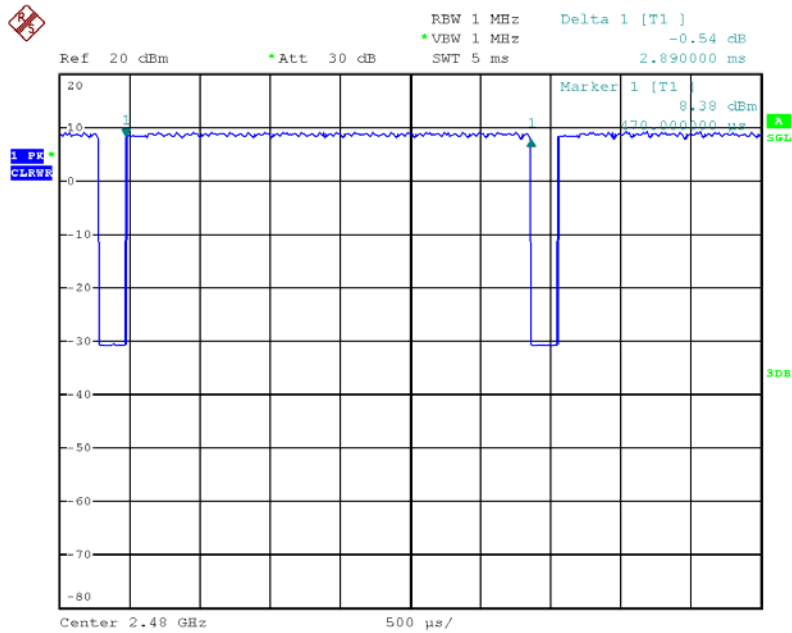

Date: 9.FEB.2012 13:10:21

Dwell Time Plot on Channel 78 / 3DH3 / 2480 MHz

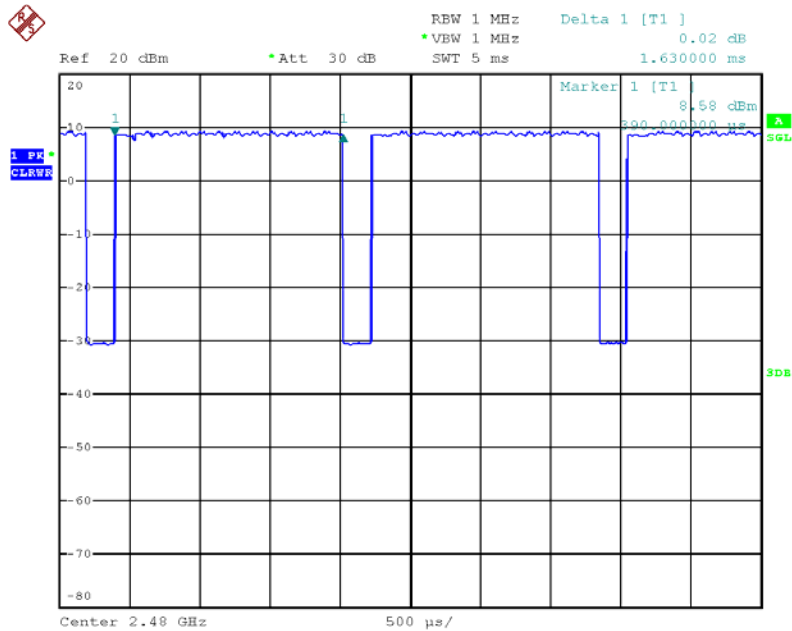

Date: 9.FEB.2012 13:10:48

Dwell Time Plot on Channel 78 / 3DH1 / 2480 MHz

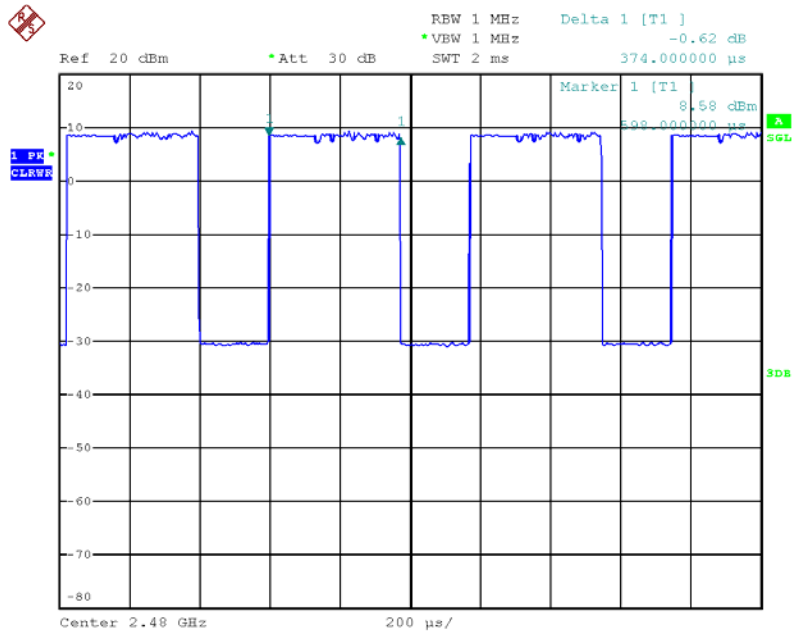

Date: 9.FEB.2012 13:12:56

For Bluetooth 2.1 + EDR : < DIPOLE Antenna >

Temperature	22°C	Humidity	65%
Test Engineer	Allen Liu	Configurations	3DH1, 3DH3, 3DH5 / Aux Port

Data Packet	Frequency	Pulse Duration (ms)	Dwell Time (s)	Limits (s)	Test Result
DH5	2402 MHz	2.8800	0.3072	0.4000	Complies
DH3	2402 MHz	1.6300	0.2608	0.4000	Complies
DH1	2402 MHz	0.3740	0.1197	0.4000	Complies
DH5	2441 MHz	2.8800	0.3072	0.4000	Complies
DH3	2441 MHz	1.6300	0.2608	0.4000	Complies
DH1	2441 MHz	0.3740	0.1197	0.4000	Complies
DH5	2480 MHz	2.8900	0.3083	0.4000	Complies
DH3	2480 MHz	1.6300	0.2608	0.4000	Complies
DH1	2480 MHz	0.3740	0.1197	0.4000	Complies

Note: Pulse Duration * Number of Pulses*(Dwell time / measure time)

Remark:

Dwell Time = 79(channels) x 0.4(s) x average hopping channel x package transfer time (us)

79 channels come from the Hopping Channel number.

Average Hopping Channel = hops / sweep time

Dwell Time Plot on Channel 0 / 3DH5 / 2402 MHz

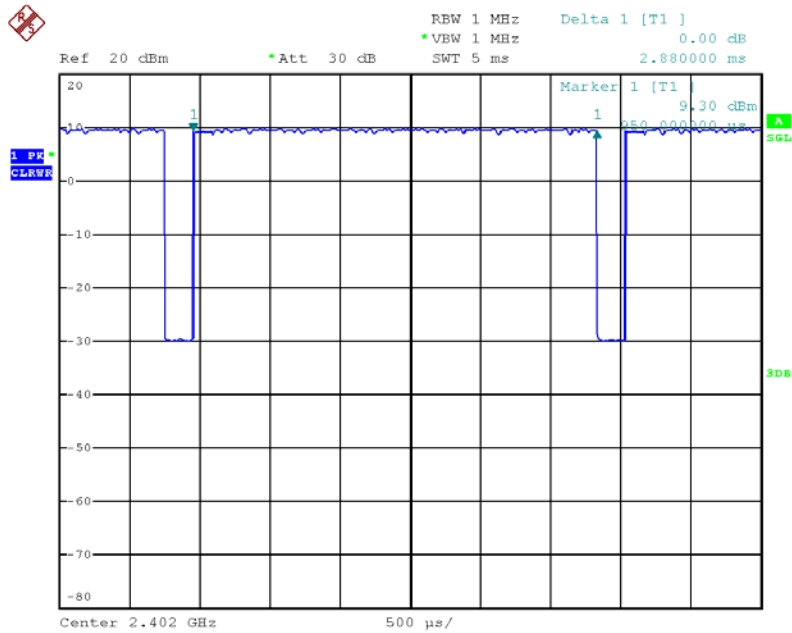

Date: 9.FEB.2012 10:48:53

Dwell Time Plot on Channel 0 / 3DH3 / 2402 MHz

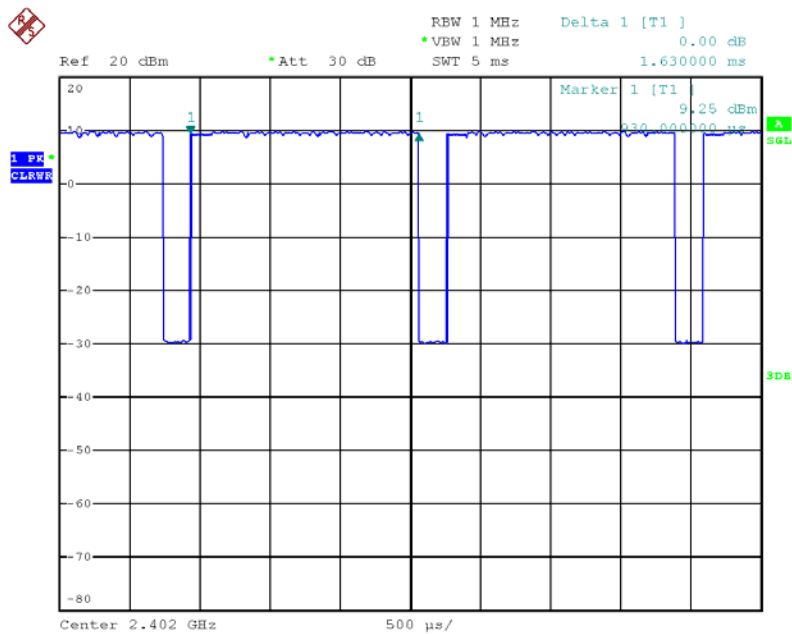

Date: 9.FEB.2012 10:59:14

Dwell Time Plot on Channel 0 / 3DH1 / 2402 MHz

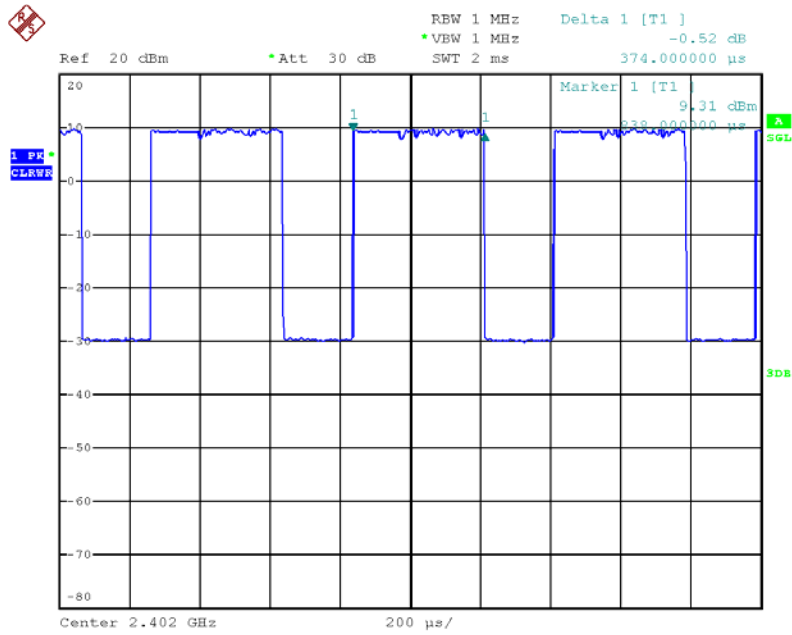

Date: 9.FEB.2012 11:01:58

Dwell Time Plot on Channel 39 / 3DH5 / 2441 MHz

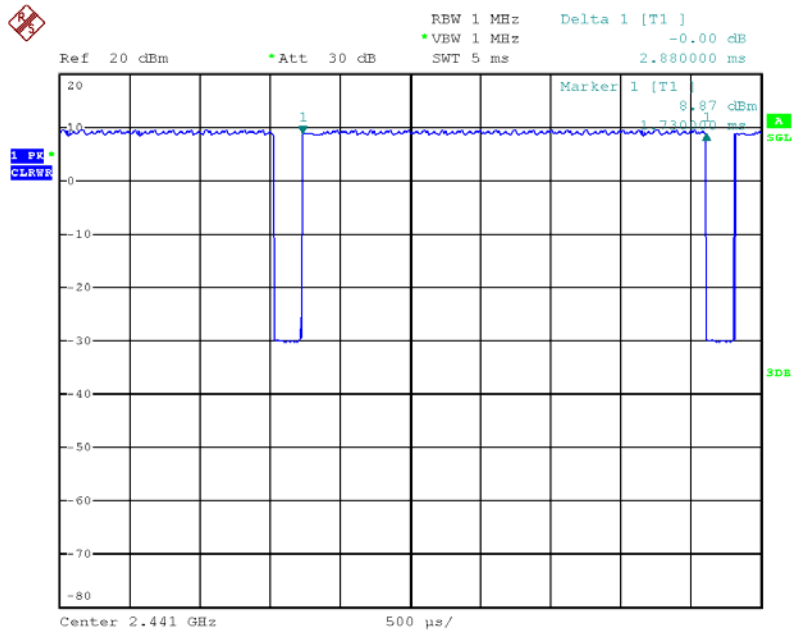

Date: 9.FEB.2012 10:48:00

Dwell Time Plot on Channel 39 / 3DH3 / 2441 MHz

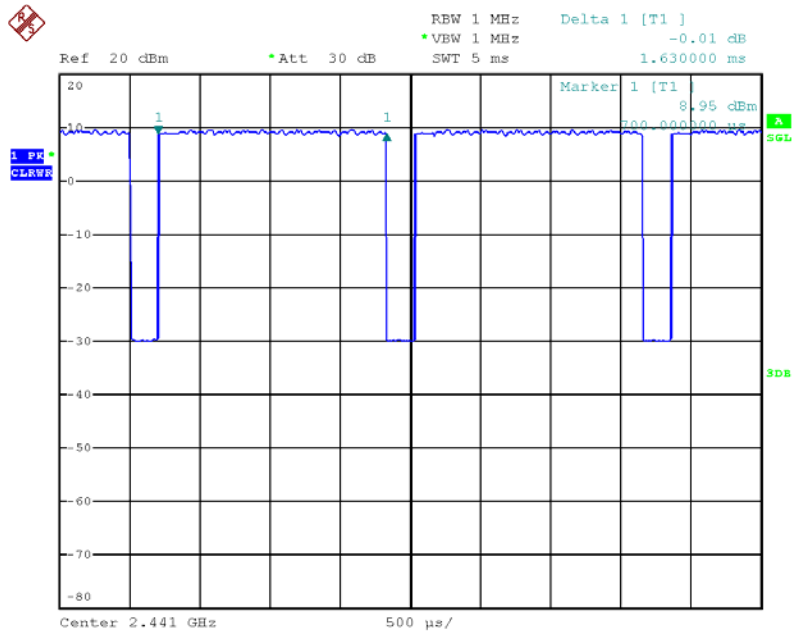

Date: 9.FEB.2012 10:59:47

Dwell Time Plot on Channel 39 / 3DH1 / 2441 MHz

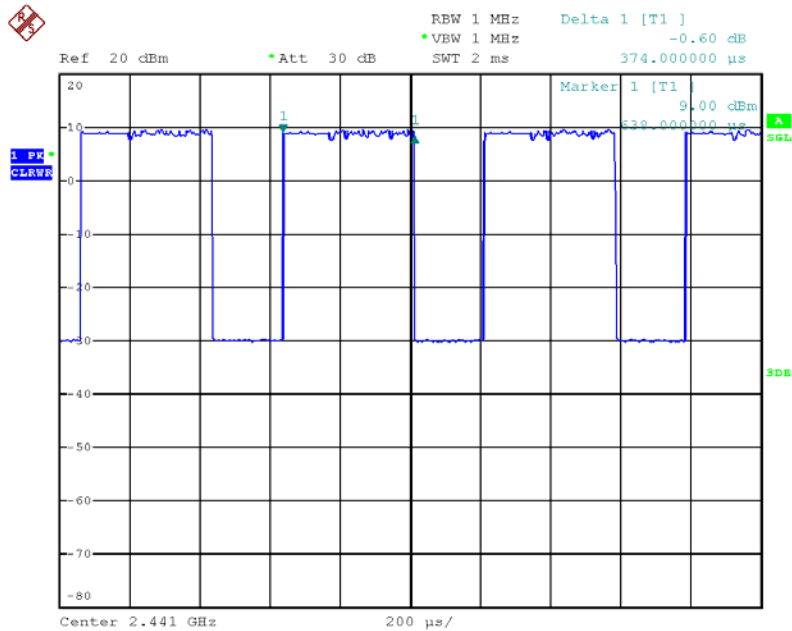

Date: 9.FEB.2012 11:01:36

Dwell Time Plot on Channel 78 / 3DH5 / 2480 MHz

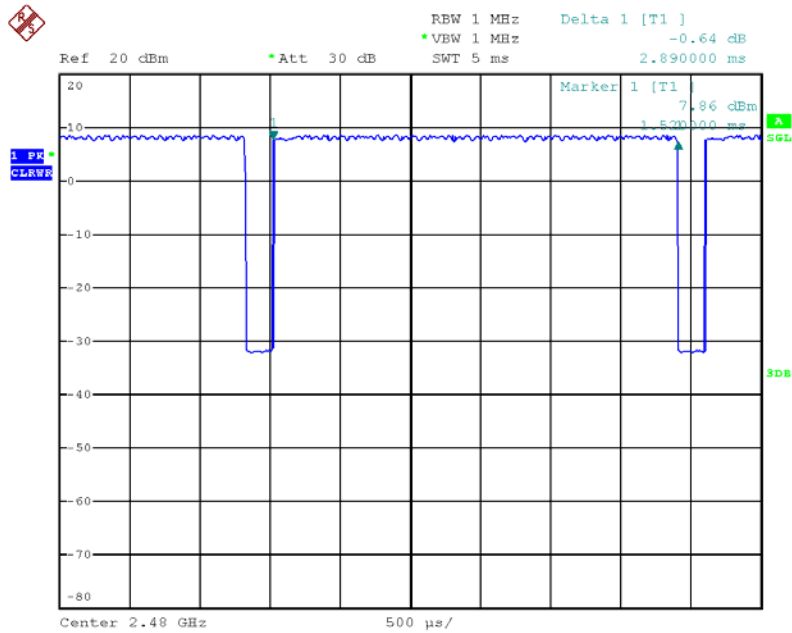

Date: 9.FEB.2012 10:44:45

Dwell Time Plot on Channel 78 / 3DH3 / 2480 MHz

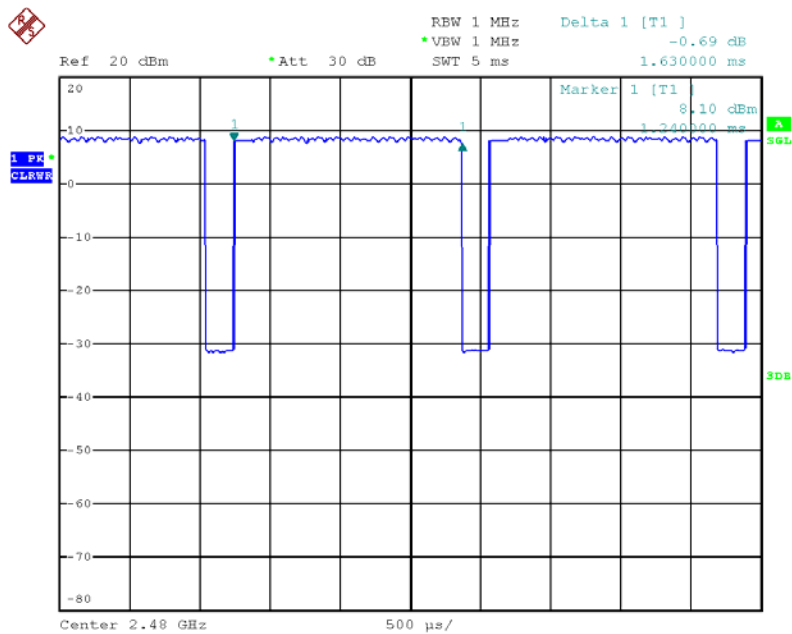

Date: 9.FEB.2012 11:00:19

Dwell Time Plot on Channel 78 / 3DH1 / 2480 MHz

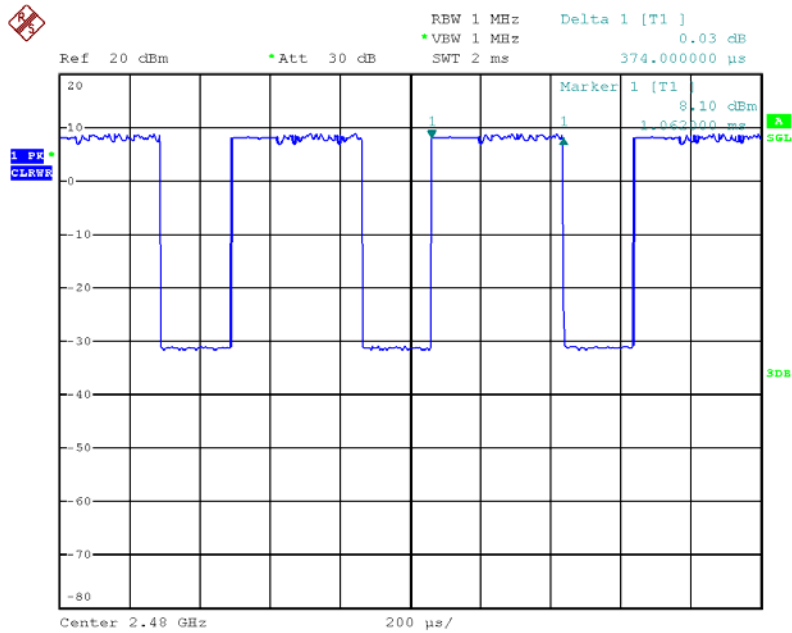

Date: 9.FEB.2012 11:01:05

For Bluetooth 4.0 : < PIFA Antenna >

Temperature	22°C	Humidity	65%
Test Engineer	Allen Liu	Configurations	DH1 / Main Port

Data Packet	Frequency	Pulse Duration (ms)	Dwell Time (s)	Limits (s)	Test Result
DH1	2402 MHz	0.3980	0.2236	0.4000	Complies
DH1	2442 MHz	0.3980	0.2236	0.4000	Complies
DH1	2480 MHz	0.3980	0.2236	0.4000	Complies

Note: Pulse Duration * Number of Pulses*(Dwell time / measure time)

Remark:

Dwell Time=40(channels) x 0.4(s) x average hopping channel x package transfer time (us)

40 channels come from the Hopping Channel number.

Average Hopping Channel = hops / sweep time

Dwell Time Plot on Channel 0 / DH1 / 2402 MHz

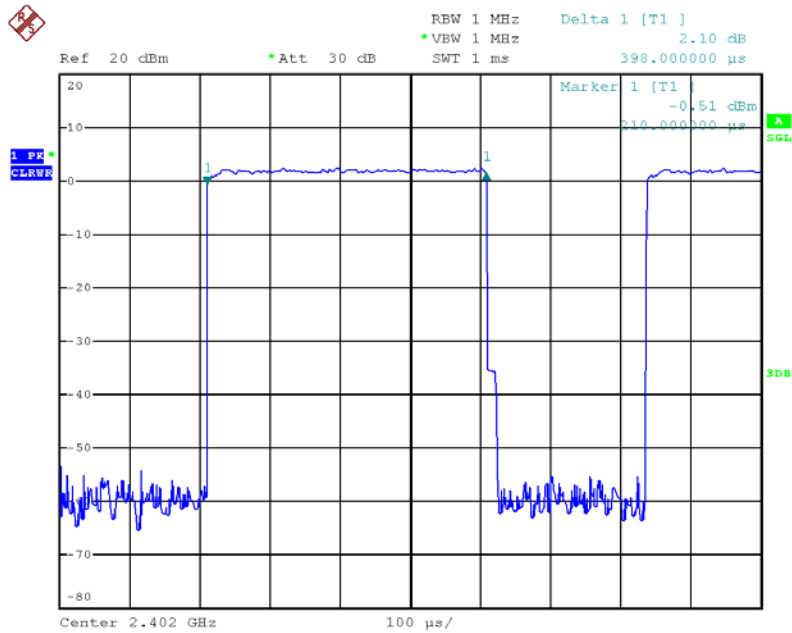

Date: 9.FEB.2012 13:45:40

Dwell Time Plot on Channel 20 / DH1 / 2442 MHz

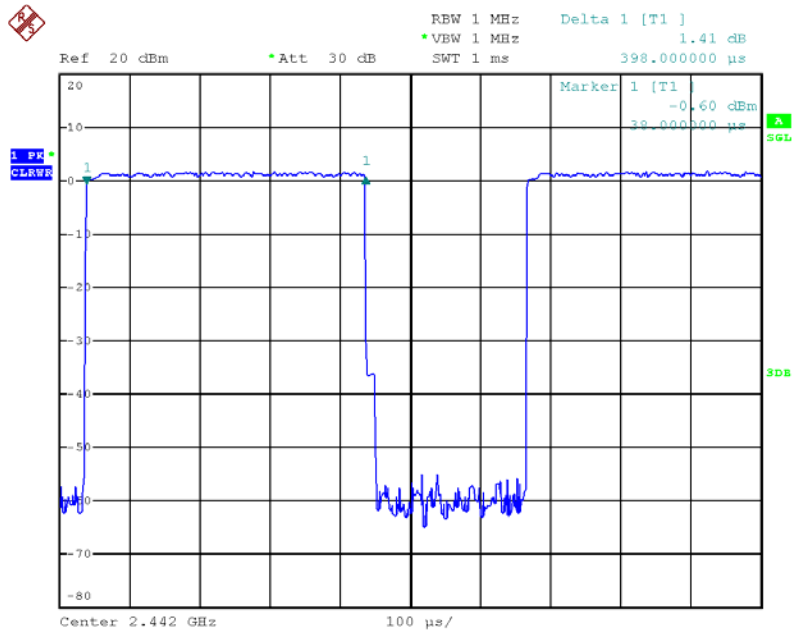

Date: 9.FEB.2012 13:44:44

Dwell Time Plot on Channel 39 / DH1 / 2480 MHz

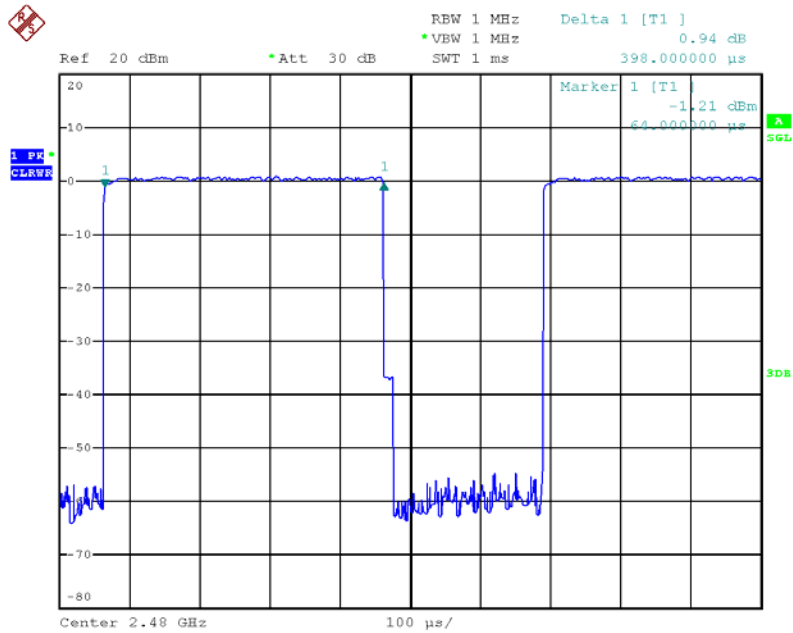

Date: 9.FEB.2012 13:42:54

For Bluetooth 4.0 : < PIFA Antenna >

Temperature	22°C	Humidity	65%
Test Engineer	Allen Liu	Configurations	DH1 / Aux Port

Data Packet	Frequency	Pulse Duration (ms)	Dwell Time (s)	Limits (s)	Test Result
DH1	2402 MHz	0.3980	0.2515	0.4000	Complies
DH1	2442 MHz	0.3980	0.2515	0.4000	Complies
DH1	2480 MHz	0.3960	0.2503	0.4000	Complies

Note: Pulse Duration * Number of Pulses*(Dwell time / measure time)

Remark:

Dwell Time=40(channels) x 0.4(s) x average hopping channel x package transfer time (us)

40 channels come from the Hopping Channel number.

Average Hopping Channel = hops / sweep time

Dwell Time Plot on Channel 0 / DH1 / 2402 MHz

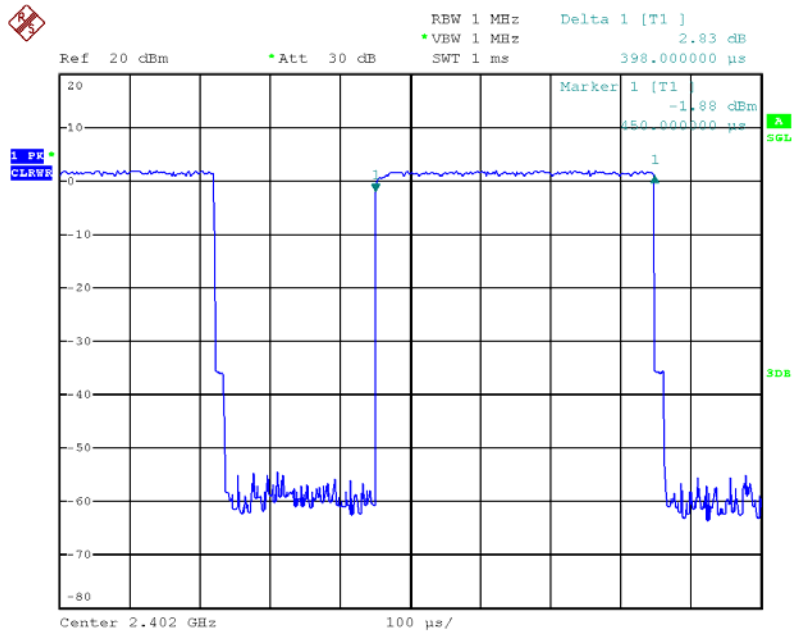

Date: 9.FEB.2012 14:17:37

Dwell Time Plot on Channel 20 / DH1 / 2442 MHz

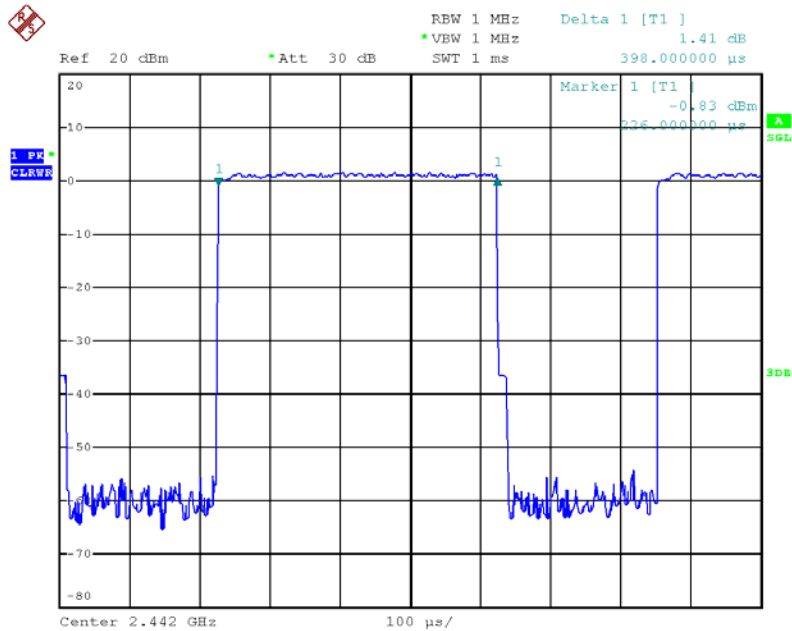

Date: 9.FEB.2012 14:18:31

Dwell Time Plot on Channel 39 / DH1 / 2480 MHz

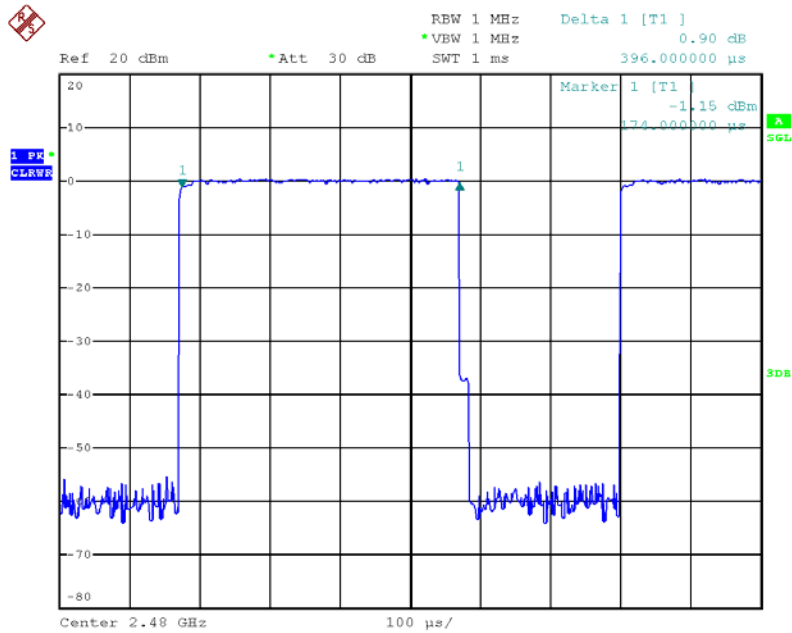

Date: 9.FEB.2012 14:19:05

For Bluetooth 4.0 : < DIPOLE Antenna >

Temperature	22°C	Humidity	65%
Test Engineer	Allen Liu	Configurations	DH1 / Main Port

Data Packet	Frequency	Pulse Duration (ms)	Dwell Time (s)	Limits (s)	Test Result
DH1	2402 MHz	0.3980	0.2515	0.4000	Complies
DH1	2442 MHz	0.3980	0.2515	0.4000	Complies
DH1	2480 MHz	0.3980	0.2515	0.4000	Complies

Note: Pulse Duration * Number of Pulses*(Dwell time / measure time)

Remark:

Dwell Time=40(channels) x 0.4(s) x average hopping channel x package transfer time (us)

40 channels come from the Hopping Channel number.

Average Hopping Channel = hops / sweep time

Dwell Time Plot on Channel 0 / DH1 / 2402 MHz

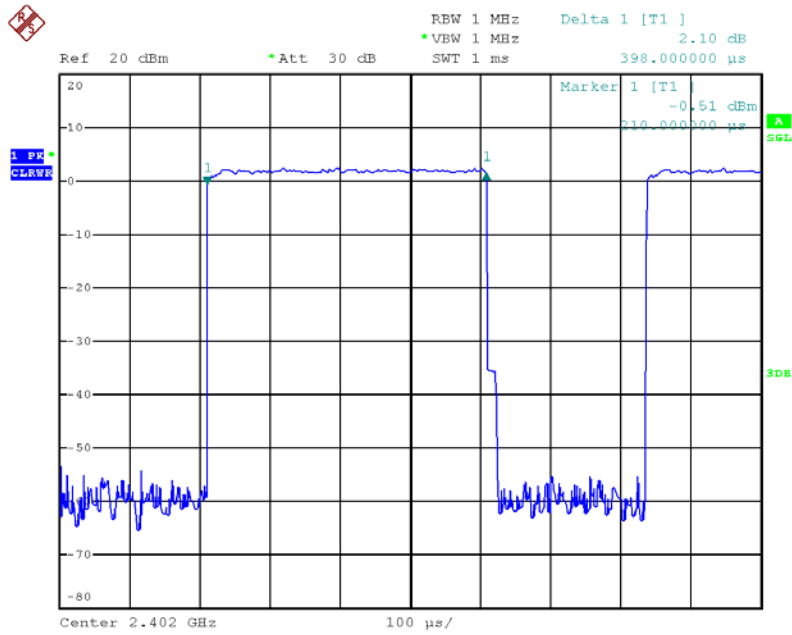

Date: 9.FEB.2012 13:45:40

Dwell Time Plot on Channel 20 / DH1 / 2442 MHz

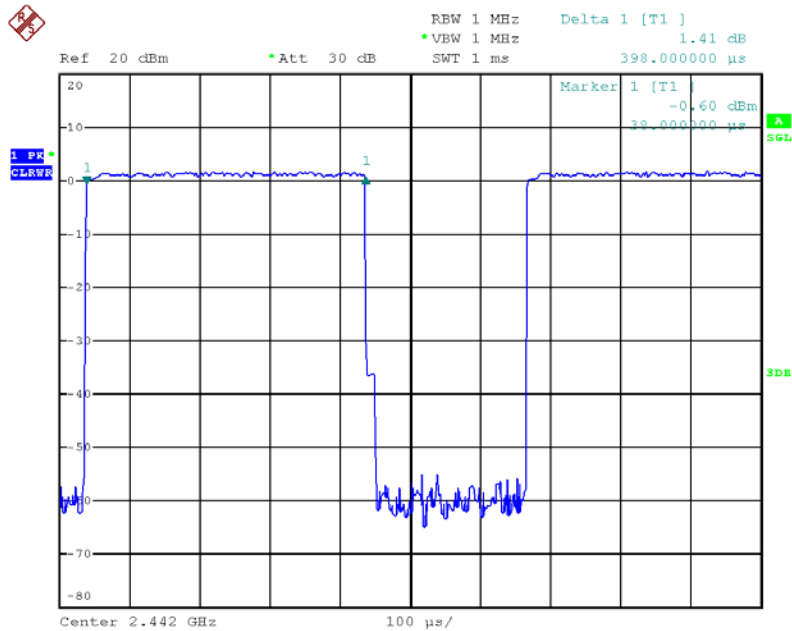

Date: 9.FEB.2012 13:44:44

Dwell Time Plot on Channel 39 / DH1 / 2480 MHz

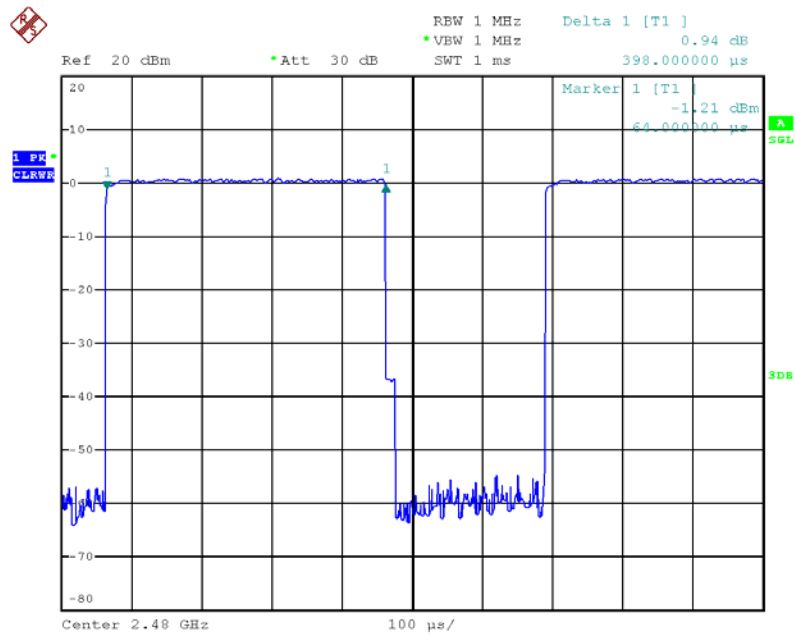

Date: 9.FEB.2012 13:42:54

For Bluetooth 4.0 : < DIPOLE Antenna >

Temperature	22°C	Humidity	65%
Test Engineer	Allen Liu	Configurations	DH1 / Aux Port

Data Packet	Frequency	Pulse Duration (ms)	Dwell Time (s)	Limits (s)	Test Result
DH1	2402 MHz	0.3980	0.2515	0.4000	Complies
DH1	2442 MHz	0.3980	0.2515	0.4000	Complies
DH1	2480 MHz	0.3960	0.2503	0.4000	Complies

Note: Pulse Duration * Number of Pulses*(Dwell time / measure time)

Remark:

Dwell Time=40(channels) x 0.4(s) x average hopping channel x package transfer time (us)

40 channels come from the Hopping Channel number.

Average Hopping Channel = hops / sweep time

Dwell Time Plot on Channel 0 / DH1 / 2402 MHz

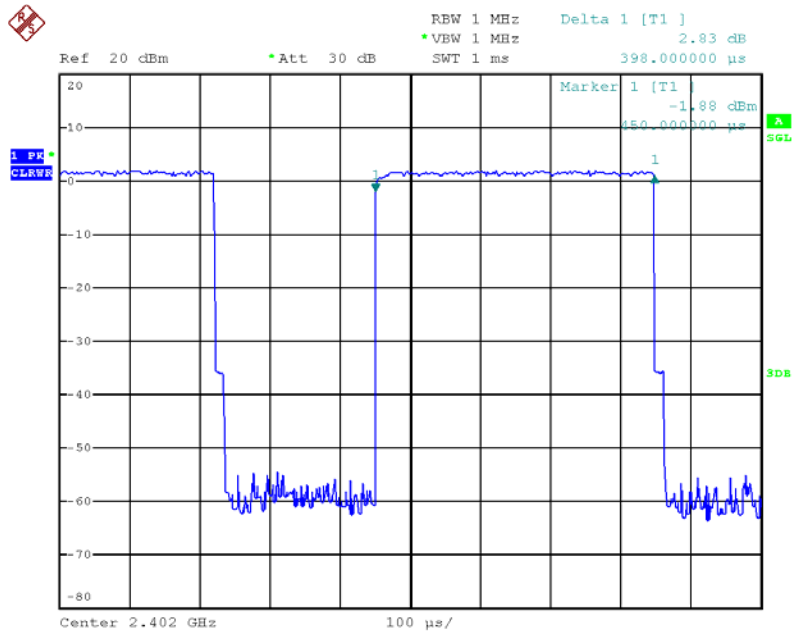

Date: 9.FEB.2012 14:17:37

Dwell Time Plot on Channel 20 / DH1 / 2442 MHz

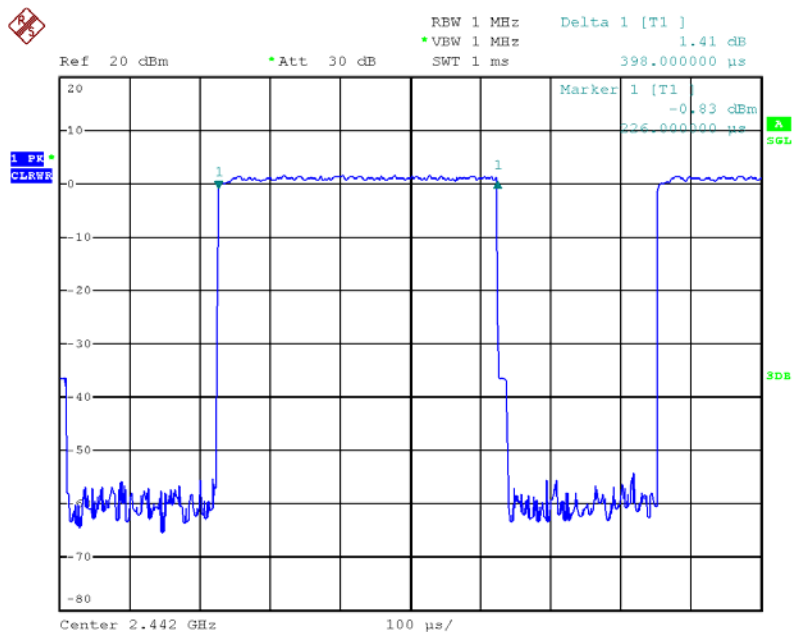

Date: 9.FEB.2012 14:18:31

Dwell Time Plot on Channel 39 / DH1 / 2480 MHz

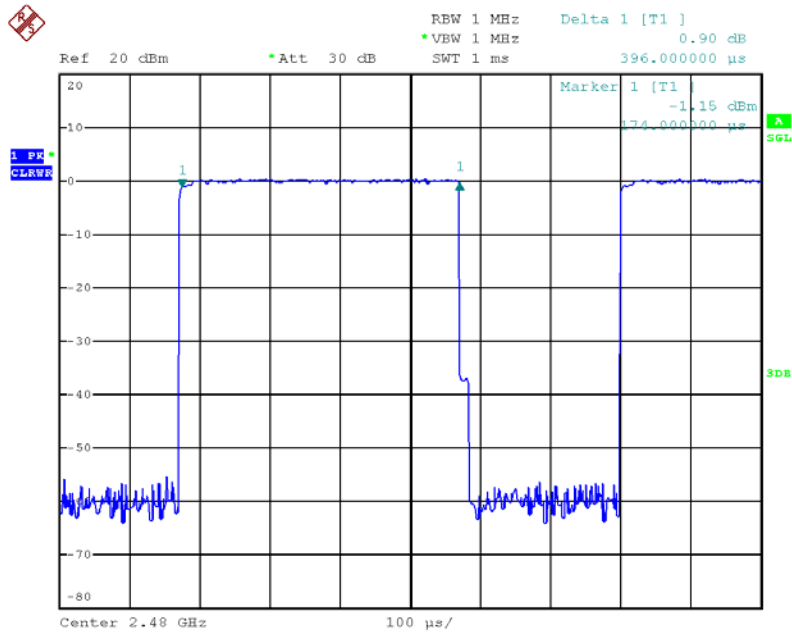

Date: 9.FEB.2012 14:19:05

4.7. Radiated Emissions Measurement

4.7.1. Limit

20dBc in any 100 kHz bandwidth outside the operating frequency band. In case the emission fall within the restricted band specified on 15.205(a), then the 15.209(a) limit in the table below has to be followed.

Frequencies (MHz)	Field Strength (micorvolts/meter)	Measurement Distance (meters)
0.009~0.490	2400/F(KHz)	300
0.490~1.705	24000/F(KHz)	30
1.705~30.0	30	30
30~88	100	3
88~216	150	3
216~960	200	3
Above 960	500	3

4.7.2. Measuring Instruments and Setting

Please refer to section 5 of equipments list in this report. The following table is the setting of spectrum analyzer and receiver.

Spectrum Parameter	Setting
Attenuation	Auto
Start Frequency	1000 MHz
Stop Frequency	10th carrier harmonic
RB / VB (Emission in restricted band)	1MHz / 3MHz for Peak, 1 MHz / 10Hz for Average
RB / VB (Emission in non-restricted band)	3MHz / 1MHz for peak

Receiver Parameter	Setting
Attenuation	Auto
Start ~ Stop Frequency	9kHz~150kHz / RB 200Hz for QP
Start ~ Stop Frequency	150kHz~30MHz / RB 9kHz for QP
Start ~ Stop Frequency	30MHz~1000MHz / RB 120kHz for QP

4.7.3. Test Procedures

1. Configure the EUT according to ANSI C63.10. The EUT was placed on the top of the turntable 0.8 meter above ground. The phase center of the receiving antenna mounted on the top of a height-variable antenna tower was placed 3 meters far away from the turntable.
2. Power on the EUT and all the supporting units. The turntable was rotated by 360 degrees to determine the position of the highest radiation.
3. The height of the broadband receiving antenna was varied between one meter and four meters above ground to find the maximum emissions field strength of both horizontal and vertical polarization.
4. For each suspected emissions, the antenna tower was scan (from 1 M to 4 M) and then the turntable was rotated (from 0 degree to 360 degrees) to find the maximum reading.
5. Set the test-receiver system to Peak or CISPR quasi-peak Detect Function with specified bandwidth under Maximum Hold Mode.
6. For emissions above 1GHz, use 1MHz VBW and RBW for peak reading. Then 1MHz RBW and 10Hz VBW for average reading in spectrum analyzer.
7. When the radiated emissions limits are expressed in terms of the average value of the emissions, and pulsed operation is employed, the measurement field strength shall be determined by averaging over one complete pulse train, including blanking intervals, as long as the pulse train does not exceed 0.1 seconds. As an alternative (provided the transmitter operates for longer than 0.1 seconds) or in cases where the pulse train exceeds 0.1 seconds, the measured field strength shall be determined from the average absolute voltage during a 0.1 second interval during which the field strength is at its maximum value.
8. If the emissions level of the EUT in peak mode was 3 dB lower than the average limit specified, then testing will be stopped and peak values of EUT will be reported, otherwise, the emissions which do not have 3 dB margin will be repeated one by one using the quasi-peak method for below 1GHz.
9. For testing above 1GHz, the emissions level of the EUT in peak mode was lower than average limit (that means the emissions level in peak mode also complies with the limit in average mode), then testing will be stopped and peak values of EUT will be reported, otherwise, the emissions will be measured in average mode again and reported.
10. In case the emission is lower than 30MHz, loop antenna has to be used for measurement and the recorded data should be QP measured by receiver. High – Low scan is not required in this case.

4.7.4. Test Setup Layout

For radiated emissions below 1GHz

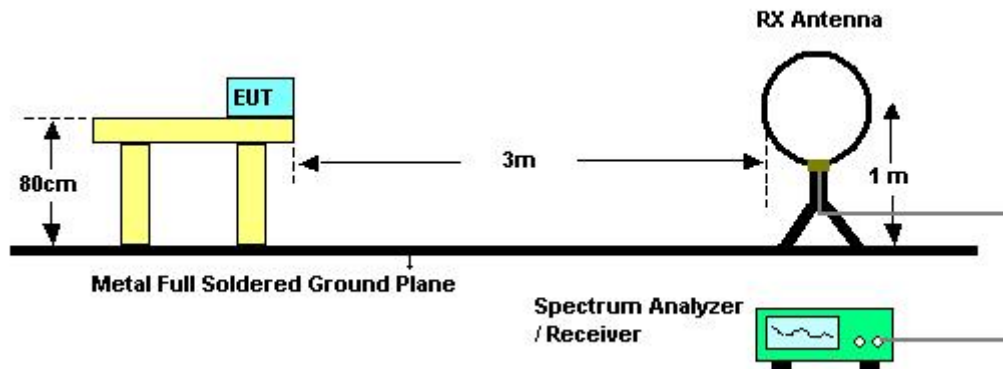

For radiated emissions above 1GHz

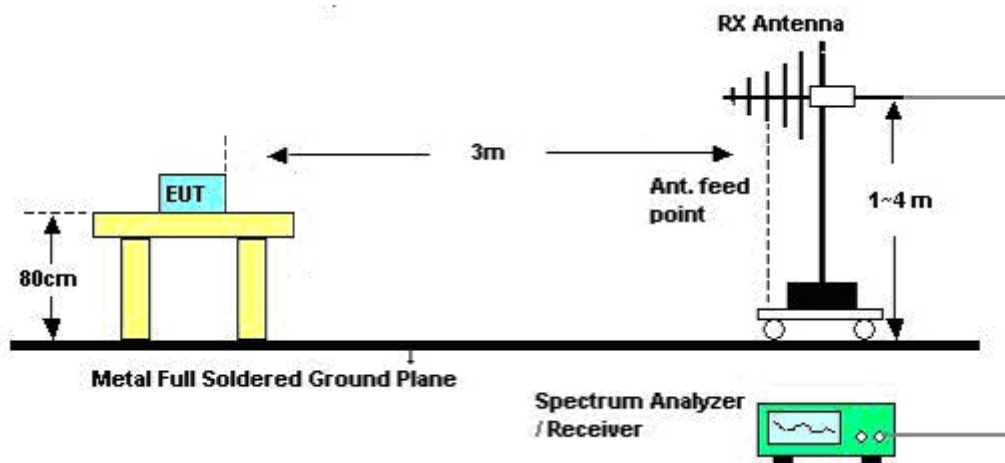

4.7.5. Test Deviation

There is no deviation with the original standard.

4.7.6. EUT Operation during Test

The EUT was programmed to be in continuously transmitting mode.

4.7.7. Results of Radiated Emissions (9kHz~30MHz)

Temperature	26°C	Humidity	60%
Test Engineer	Magic Lai	Configurations	Normal Link
Test Date	Mar. 07, 2012		

Freq. (MHz)	Level (dBuV)	Over Limit (dB)	Limit Line (dBuV)	Remark
-	-	-	-	See Note

Note:

The amplitude of spurious emissions which are attenuated by more than 20dB below the permissible value has no need to be reported.

Distance extrapolation factor = $40 \log(\text{specific distance} / \text{test distance})$ (dB);

Limit line = specific limits (dBuV) + distance extrapolation factor.

4.7.8. Results of Radiated Emissions (30MHz~1GHz)

Temperature	26°C	Humidity	60%
Test Engineer	Magic Lai	Configurations	Normal Link / Mode 1 / Mode 2

Horizontal

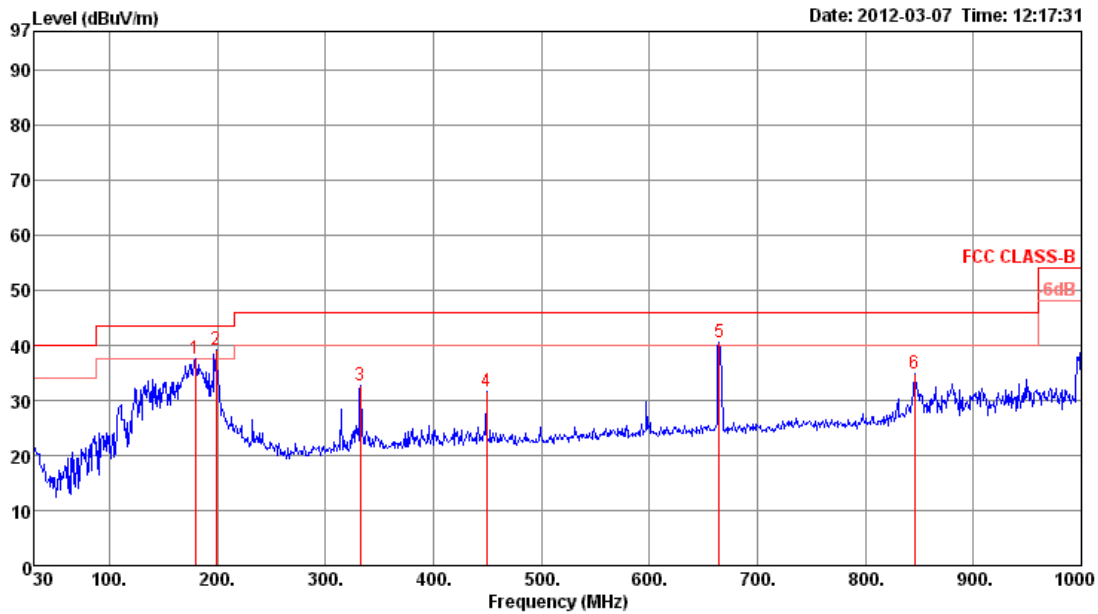

	Freq	Level	Limit	Over	Read	Cable	Antenna	Preamp	Remark	A/Pos	T/Pos	Pol/Phase
	MHz	dBuV/m	dBuV/m	dB	dBuV	dB	dB/m	dB		cm	deg	
1	179.38	37.46	43.50	-6.04	49.92	1.60	13.14	27.20	Peak	400	0	HORIZONTAL
2	198.78	39.30	43.50	-4.20	55.47	1.69	9.25	27.11	Peak	400	0	HORIZONTAL
3	332.64	32.78	46.00	-13.22	43.48	2.17	14.25	27.12	Peak	400	0	HORIZONTAL
4	449.04	31.65	46.00	-14.35	40.08	2.59	16.83	27.85	Peak	400	0	HORIZONTAL
5	664.38	40.40	46.00	-5.60	46.02	3.44	18.98	28.04	Peak	400	0	HORIZONTAL
6	845.77	34.87	46.00	-11.13	38.87	3.39	20.12	27.51	Peak	400	0	HORIZONTAL

Vertical

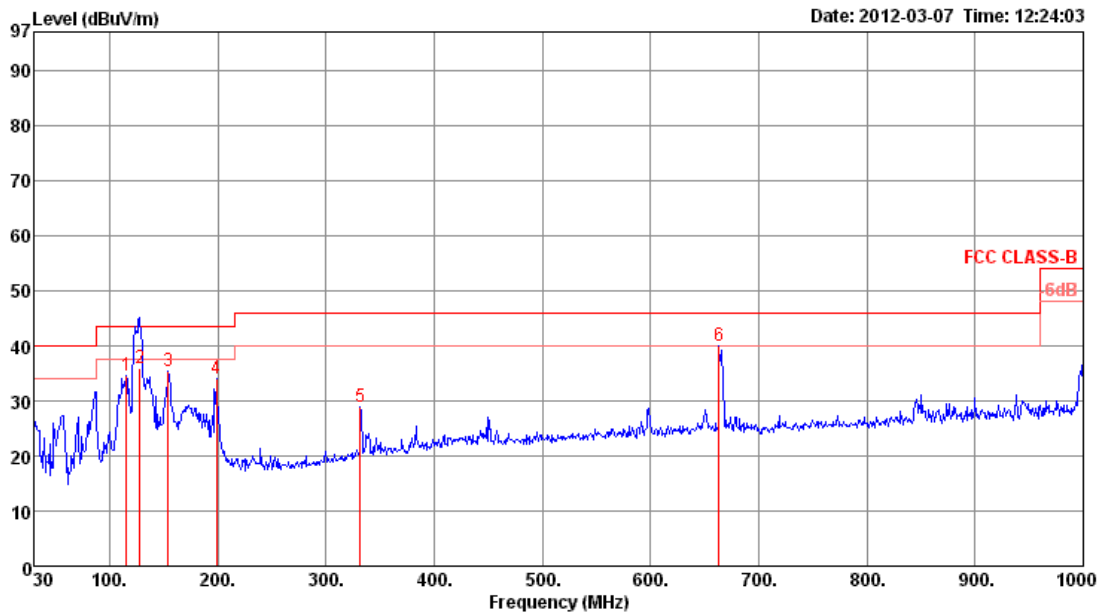

	Freq	Level	Limit	Over	Read	CableAntenna	Preamp		A/Pos	T/Pos	
	MHz	dBuV/m	dBuV/m	dB	dBuV	dB	dB/m	dB	cm	deg	Pol/Phase
1	115.36	34.52	43.50	-8.98	48.68	1.20	12.16	27.52	400	0	VERTICAL
2	127.78	35.85	43.50	-7.65	49.80	1.27	12.24	27.46	100	3	VERTICAL
3	154.16	35.39	43.50	-8.11	49.33	1.47	11.92	27.33	400	0	VERTICAL
4	198.78	34.01	43.50	-9.49	50.18	1.69	9.25	27.11	400	0	VERTICAL
5	331.67	28.90	46.00	-17.10	39.63	2.16	14.23	27.12	400	0	VERTICAL
6	663.41	39.88	46.00	-6.12	45.50	3.45	18.97	28.04	400	0	VERTICAL

Temperature	26°C	Humidity	60%
Test Engineer	Magic Lai	Configurations	Normal Link / Mode 5 / Mode 6

Horizontal

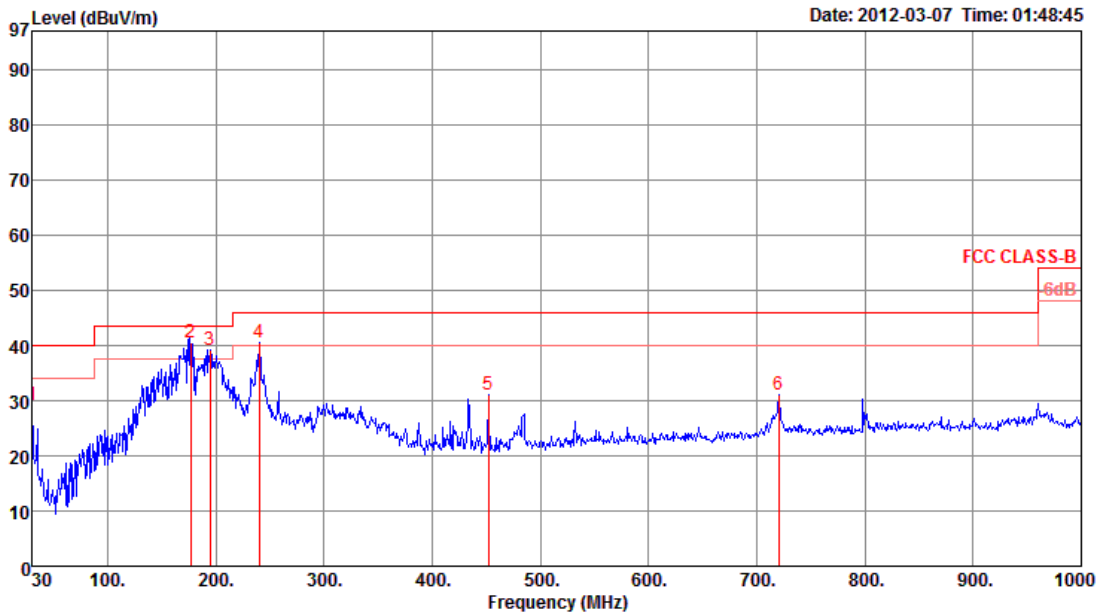

	Freq	Level	Limit	Over	Read	Cable	Preamp	Antenna	T/Pos	A/Pos	Remark	Pol/Phase
	MHz	dBuV/m	dBuV/m	dB	dBuV	dB	dB	dB/m	deg	cm		
1	30.00	29.07	40.00	-10.93	38.79	0.83	27.80	17.25	0	400	Peak	HORIZONTAL
2	176.77	40.46	43.50	-3.04	56.51	1.99	27.22	9.18	153	147	QP	HORIZONTAL
3	194.90	39.24	43.50	-4.26	54.70	2.07	27.13	9.60	0	400	Peak	HORIZONTAL
4	240.49	40.48	46.00	-5.52	53.51	2.31	27.02	11.68	0	400	Peak	HORIZONTAL
5	451.95	31.14	46.00	-14.86	38.75	3.25	27.86	17.00	0	400	Peak	HORIZONTAL
6	720.64	31.05	46.00	-14.95	34.46	4.18	27.91	20.32	0	400	Peak	HORIZONTAL

Vertical

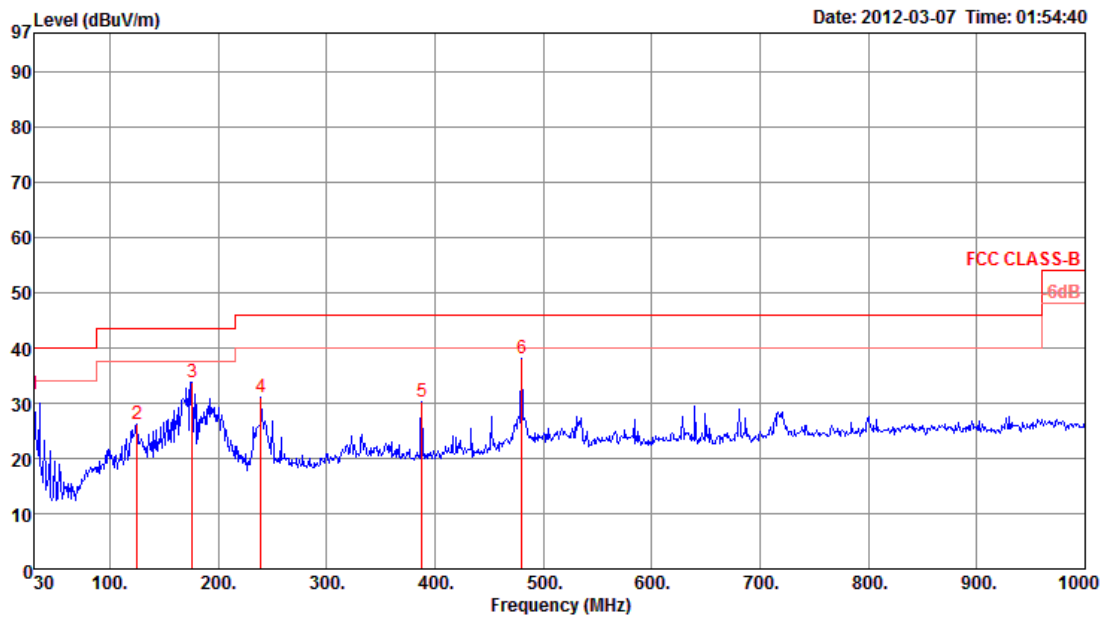

	Freq	Level	Limit	Over	Read	Cable	Preamp	Antenna	T/Pos	A/Pos	Remark	Pol/Phase
	MHz	dBuV/m	dBuV/m	dB	dBuV	dB	dB	dB/m	deg	cm		
1	30.00	31.52	40.00	-8.48	41.24	0.83	27.80	17.25	0	100	Peak	VERTICAL
2	125.06	26.33	43.50	-17.17	39.63	1.65	27.48	12.53	0	100	Peak	VERTICAL
3	176.47	33.90	43.50	-9.60	49.80	1.99	27.22	9.33	0	100	Peak	VERTICAL
4	239.52	31.17	46.00	-14.83	44.42	2.31	27.02	11.46	0	100	Peak	VERTICAL
5	387.93	30.33	46.00	-15.67	38.95	2.94	27.52	15.96	0	100	Peak	VERTICAL
6 p	480.08	38.13	46.00	-7.87	44.87	3.33	28.00	17.93	0	100	Peak	VERTICAL

Note:

The amplitude of spurious emissions which are attenuated by more than 20 dB below the permissible value has no need to be reported.

Emission level (dBuV/m) = 20 log Emission level (uV/m).

Corrected Reading: Antenna Factor + Cable Loss + Read Level - Preamp Factor = Level.

4.7.9. Results for Radiated Emissions (1GHz~10th Harmonic)

For Bluetooth 2.1 + EDR :

Temperature	26°C	Humidity	60%
Test Engineer	Rion Li	Configurations	Channel 0 / Main Port
Test Date	Feb. 14, 2012	Test Mode	Mode 3

Horizontal

	Freq	Level	Limit Line	Over Limit	Read Level	CableAntenna Loss	Antenna Factor	Preamp Factor	A/Pos	T/Pos	Remark	Pol/Phase	Aux Factor
	MHz	dBuV/m	dBuV/m	dB	dBuV	dB	dB/m	dB	cm	deg			dB
1	4803.85	35.85	54.00	-18.15	31.48	6.21	33.36	35.20	100	204	Average	HORIZONTAL	0.00
2	4804.07	46.54	74.00	-27.46	42.17	6.21	33.36	35.20	100	204	Peak	HORIZONTAL	0.00

Vertical

	Freq	Level	Limit Line	Over Limit	Read Level	CableAntenna Loss	Antenna Factor	Preamp Factor	A/Pos	T/Pos	Remark	Pol/Phase	Aux Factor
	MHz	dBuV/m	dBuV/m	dB	dBuV	dB	dB/m	dB	cm	deg			dB
1	4803.47	50.28	74.00	-23.72	45.91	6.21	33.36	35.20	100	70	Peak	VERTICAL	0.00
2	4803.90	40.59	54.00	-13.41	36.22	6.21	33.36	35.20	100	70	Average	VERTICAL	0.00

Temperature	26°C	Humidity	60%
Test Engineer	Rion Li	Configurations	Channel 39 / Main Port
Test Date	Feb. 14, 2012	Chain	Mode 3

Horizontal

	Freq	Level	Limit Line	Over Limit	Read Level	Cable Loss	Antenna Factor	Preamp Factor	A/Pos	T/Pos	Remark	Pol/Phase	Aux Factor
	MHz	dBuV/m	dBuV/m	dB	dBuV	dB	dB/m	dB	cm	deg			dB
1	4882.16	46.07	74.00	-27.93	41.50	6.29	33.48	35.20	100	251	Peak	HORIZONTAL	0.00
2	4882.23	35.01	54.00	-18.99	30.44	6.29	33.48	35.20	100	251	Average	HORIZONTAL	0.00

Vertical

	Freq	Level	Limit Line	Over Limit	Read Level	Cable Loss	Antenna Factor	Preamp Factor	A/Pos	T/Pos	Remark	Pol/Phase	Aux Factor
	MHz	dBuV/m	dBuV/m	dB	dBuV	dB	dB/m	dB	cm	deg			dB
1	4881.93	35.88	54.00	-18.12	31.31	6.29	33.48	35.20	100	24	Average	VERTICAL	0.00
2	4881.94	46.87	74.00	-27.13	42.30	6.29	33.48	35.20	100	24	Peak	VERTICAL	0.00

Temperature	26°C	Humidity	60%
Test Engineer	Rion Li	Configurations	Channel 78 / Main Port
Test Date	Feb. 07, 2012	Chain	Mode 3

Horizontal

	Freq	Level	Limit	Over	Read	CableAntenna	Preamp	A/Pos	T/Pos	Remark	Pol/Phase	Aux	
	MHz	dBuV/m	dBuV/m	dB	dBuV	Loss	Factor	Factor	cm	deg		dB	
1	4959.79	47.92	74.00	-26.08	43.11	6.37	33.64	35.20	100	246	Peak	HORIZONTAL	0.00
2	4959.87	36.80	54.00	-17.20	31.99	6.37	33.64	35.20	100	246	Average	HORIZONTAL	0.00

Vertical

	Freq	Level	Limit	Over	Read	CableAntenna	Preamp	A/Pos	T/Pos	Remark	Pol/Phase	Aux	
	MHz	dBuV/m	dBuV/m	dB	dBuV	Loss	Factor	Factor	cm	deg		dB	
1	4959.78	49.63	74.00	-24.37	44.82	6.37	33.64	35.20	100	76	Peak	VERTICAL	0.00
2	4960.04	39.42	54.00	-14.58	34.61	6.37	33.64	35.20	100	76	Average	VERTICAL	0.00

Temperature	26°C	Humidity	60%
Test Engineer	Rion Li	Configurations	Channel 0 / Aux Port
Test Date	Feb. 14, 2012	Test Mode	Mode 4

Horizontal

	Freq	Level	Limit	Over	Read	CableAntenna	Preamp	A/Pos	T/Pos	Remark	Pol/Phase	Aux	
	MHz	dBuV/m	dBuV/m	dB	dBuV	Loss	Factor	Factor	cm	deg		dB	
1	4804.07	38.48	54.00	-15.52	34.11	6.21	33.36	35.20	100	284	Average	HORIZONTAL	0.00
2	4804.27	47.96	74.00	-26.04	43.59	6.21	33.36	35.20	100	284	Peak	HORIZONTAL	0.00

Vertical

	Freq	Level	Limit	Over	Read	CableAntenna	Preamp	A/Pos	T/Pos	Remark	Pol/Phase	Aux	
	MHz	dBuV/m	dBuV/m	dB	dBuV	Loss	Factor	Factor	cm	deg		dB	
1	4803.41	50.55	74.00	-23.45	46.18	6.21	33.36	35.20	100	282	Peak	VERTICAL	0.00
2	4803.93	40.81	54.00	-13.19	36.44	6.21	33.36	35.20	100	282	Average	VERTICAL	0.00

Temperature	26°C	Humidity	60%
Test Engineer	Rion Li	Configurations	Channel 39 / Aux Port
Test Date	Feb. 14, 2012	Chain	Mode 4

Horizontal

	Freq	Level	Limit	Over	Read	CableAntenna	Preamp	A/Pos	T/Pos	Remark	Pol/Phase	Aux	
	MHz	dBuV/m	dBuV/m	dB	dBuV	Loss	Factor	dB	cm	deg		dB	
1	4881.21	47.44	74.00	-26.56	42.87	6.29	33.48	35.20	101	305	Peak	HORIZONTAL	0.00
2	4881.83	35.88	54.00	-18.12	31.31	6.29	33.48	35.20	101	305	Average	HORIZONTAL	0.00

Vertical

	Freq	Level	Limit	Over	Read	CableAntenna	Preamp	A/Pos	T/Pos	Remark	Pol/Phase	Aux	
	MHz	dBuV/m	dBuV/m	dB	dBuV	Loss	Factor	dB	cm	deg		dB	
1	4881.33	47.54	74.00	-26.46	42.97	6.29	33.48	35.20	101	190	Peak	VERTICAL	0.00
2	4881.97	36.59	54.00	-17.41	32.02	6.29	33.48	35.20	101	190	Average	VERTICAL	0.00

Temperature	26°C	Humidity	60%
Test Engineer	Rion Li	Configurations	Channel 78 / Aux Port
Test Date	Feb. 14, 2012	Chain	Mode 4

Horizontal

	Freq	Level	Limit	Over	Read	CableAntenna	Preamp	A/Pos	T/Pos	Remark	Pol/Phase	Aux	
	MHz	dBuV/m	dBuV/m	dB	dBuV	Loss	Factor	Factor	cm	deg		dB	
1	4959.86	48.00	74.00	-26.00	43.19	6.37	33.64	35.20	100	304	Peak	HORIZONTAL	0.00
2	4959.98	37.78	54.00	-16.22	32.97	6.37	33.64	35.20	100	304	Average	HORIZONTAL	0.00

Vertical

	Freq	Level	Limit	Over	Read	CableAntenna	Preamp	A/Pos	T/Pos	Remark	Pol/Phase	Aux	
	MHz	dBuV/m	dBuV/m	dB	dBuV	Loss	Factor	Factor	cm	deg		dB	
1	4959.86	51.10	74.00	-22.90	46.29	6.37	33.64	35.20	101	74	Peak	VERTICAL	0.00
2	4960.07	41.41	54.00	-12.59	36.60	6.37	33.64	35.20	101	74	Average	VERTICAL	0.00

For Bluetooth 2.1 + EDR :

Temperature	26°C	Humidity	60%
Test Engineer	Rion Li	Configurations	Channel 0 / Main Port
Test Date	Feb. 13, 2012	Test Mode	Mode 11

Horizontal

	Freq	Level	Limit Line	Over Limit	Read Level	CableAntenna Loss	Antenna Factor	Preamp Factor	A/Pos	T/Pos	Remark	Pol/Phase	Aux Factor
	MHz	dBuV/m	dBuV/m	dB	dBuV	dB	dB/m	dB	cm	deg			dB
1	4803.97	36.78	54.00	-17.22	32.41	6.21	33.36	35.20	100	166	Average	HORIZONTAL	0.00
2	4804.66	47.23	74.00	-26.77	42.86	6.21	33.36	35.20	100	166	Peak	HORIZONTAL	0.00

Vertical

	Freq	Level	Limit Line	Over Limit	Read Level	CableAntenna Loss	Antenna Factor	Preamp Factor	A/Pos	T/Pos	Remark	Pol/Phase	Aux Factor
	MHz	dBuV/m	dBuV/m	dB	dBuV	dB	dB/m	dB	cm	deg			dB
1	4803.55	50.15	74.00	-23.85	45.78	6.21	33.36	35.20	117	278	Peak	VERTICAL	0.00
2	4803.93	41.06	54.00	-12.94	36.69	6.21	33.36	35.20	117	278	Average	VERTICAL	0.00

Temperature	26°C	Humidity	60%
Test Engineer	Rion Li	Configurations	Channel 39 / Main Port
Test Date	Feb. 13, 2012	Chain	Mode 11

Horizontal

	Freq	Level	Limit Line	Over Limit	Read Level	Cable Loss	Antenna Factor	Preamp Factor	A/Pos	T/Pos	Remark	Pol/Phase	Aux Factor
	MHz	dBuV/m	dBuV/m	dB	dBuV	dB	dB/m	dB	cm	deg			dB
1	4881.57	33.47	54.00	-20.53	28.90	6.29	33.48	35.20	100	166	Average	HORIZONTAL	0.00
2	4882.34	46.39	74.00	-27.61	41.82	6.29	33.48	35.20	100	166	Peak	HORIZONTAL	0.00

Vertical

	Freq	Level	Limit Line	Over Limit	Read Level	Cable Loss	Antenna Factor	Preamp Factor	A/Pos	T/Pos	Remark	Pol/Phase	Aux Factor
	MHz	dBuV/m	dBuV/m	dB	dBuV	dB	dB/m	dB	cm	deg			dB
1	4881.97	40.06	54.00	-13.94	35.49	6.29	33.48	35.20	100	276	Average	VERTICAL	0.00
2	4882.46	49.55	74.00	-24.45	44.98	6.29	33.48	35.20	100	276	Peak	VERTICAL	0.00

Temperature	26°C	Humidity	60%
Test Engineer	Rion Li	Configurations	Channel 78 / Main Port
Test Date	Feb. 13, 2012	Chain	Mode 11

Horizontal

	Freq	Level	Limit	Over	Read	CableAntenna	Preamp	A/Pos	T/Pos	Remark	Pol/Phase	Aux	
	MHz	dBuV/m	dBuV/m	dB	dBuV	Loss	Factor	Factor	cm	deg		dB	
1	4960.16	37.09	54.00	-16.91	32.28	6.37	33.64	35.20	113	15	Average	HORIZONTAL	0.00
2	4960.47	48.39	74.00	-25.61	43.58	6.37	33.64	35.20	113	15	Peak	HORIZONTAL	0.00

Vertical

	Freq	Level	Limit	Over	Read	CableAntenna	Preamp	A/Pos	T/Pos	Remark	Pol/Phase	Aux	
	MHz	dBuV/m	dBuV/m	dB	dBuV	Loss	Factor	Factor	cm	deg		dB	
1	4959.44	52.49	74.00	-21.51	47.68	6.37	33.64	35.20	113	334	Peak	VERTICAL	0.00
2	4960.00	43.87	54.00	-10.13	39.06	6.37	33.64	35.20	113	334	Average	VERTICAL	0.00

Temperature	26°C	Humidity	60%
Test Engineer	Rion Li	Configurations	Channel 0 / Aux Port
Test Date	Feb. 13, 2012	Test Mode	Mode 12

Horizontal

	Freq	Level	Limit Line	Over Limit	Read Level	CableAntenna Loss	Antenna Factor	Preamp Factor	A/Pos	T/Pos	Remark	Pol/Phase	Aux Factor
	MHz	dBuV/m	dBuV/m	dB	dBuV	dB	dB/m	dB	cm	deg			dB
1	4803.64	47.11	74.00	-26.89	42.74	6.21	33.36	35.20	100	35	Peak	HORIZONTAL	0.00
2	4803.99	35.90	54.00	-18.10	31.53	6.21	33.36	35.20	100	35	Average	HORIZONTAL	0.00

Vertical

	Freq	Level	Limit Line	Over Limit	Read Level	CableAntenna Loss	Antenna Factor	Preamp Factor	A/Pos	T/Pos	Remark	Pol/Phase	Aux Factor
	MHz	dBuV/m	dBuV/m	dB	dBuV	dB	dB/m	dB	cm	deg			dB
1	4803.53	50.67	74.00	-23.33	46.30	6.21	33.36	35.20	116	278	Peak	VERTICAL	0.00
2	4804.04	41.08	54.00	-12.92	36.71	6.21	33.36	35.20	116	278	Average	VERTICAL	0.00

Temperature	26°C	Humidity	60%
Test Engineer	Rion Li	Configurations	Channel 39 / Aux Port
Test Date	Feb. 13, 2012	Chain	Mode 12

Horizontal

	Freq	Level	Limit	Over	Read	CableAntenna	Preamp	A/Pos	T/Pos	Remark	Pol/Phase	Aux	
	MHz	dBuV/m	dBuV/m	dB	dBuV	Loss	Factor	Factor	cm	deg		dB	
1	4881.91	33.36	54.00	-20.64	28.79	6.29	33.48	35.20	101	144	Average	HORIZONTAL	0.00
2	4882.75	46.16	74.00	-27.84	41.59	6.29	33.48	35.20	101	144	Peak	HORIZONTAL	0.00

Vertical

	Freq	Level	Limit	Over	Read	CableAntenna	Preamp	A/Pos	T/Pos	Remark	Pol/Phase	Aux	
	MHz	dBuV/m	dBuV/m	dB	dBuV	Loss	Factor	Factor	cm	deg		dB	
1	4881.97	38.85	54.00	-15.15	34.28	6.29	33.48	35.20	101	338	Average	VERTICAL	0.00
2	4882.28	49.11	74.00	-24.89	44.54	6.29	33.48	35.20	101	338	Peak	VERTICAL	0.00



Temperature	26°C	Humidity	60%
Test Engineer	Rion Li	Configurations	Channel 78 / Aux Port
Test Date	Feb. 13, 2012	Chain	Mode 12

Horizontal

	Freq	Level	Limit	Over	Read	CableAntenna	Preamp	A/Pos	T/Pos	Remark	Pol/Phase	Aux	
	MHz	dBuV/m	dBuV/m	dB	dBuV	Loss	Factor	Factor	cm	deg		dB	
1	4959.86	34.94	54.00	-19.06	30.13	6.37	33.64	35.20	109	112	Average	HORIZONTAL	0.00
2	4961.88	47.24	74.00	-26.76	42.43	6.37	33.64	35.20	100	112	Peak	HORIZONTAL	0.00

Vertical

	Freq	Level	Limit	Over	Read	CableAntenna	Preamp	A/Pos	T/Pos	Remark	Pol/Phase	Aux	
	MHz	dBuV/m	dBuV/m	dB	dBuV	Loss	Factor	Factor	cm	deg		dB	
1	4959.92	42.18	54.00	-11.82	37.37	6.37	33.64	35.20	110	284	Average	VERTICAL	0.00
2	4960.32	50.98	74.00	-23.02	46.17	6.37	33.64	35.20	110	284	Peak	VERTICAL	0.00

For Bluetooth 4.0 :

Temperature	23°C	Humidity	65%
Test Engineer	Rion Li	Configurations	Channel 0 / Main Port
Test Date	Feb. 14, 2012	Test Mode	Mode 7

Horizontal

	Freq	Level	Limit	Over	Read	CableAntenna	Preamp	A/Pos	T/Pos	Remark	Pol/Phase	Aux
	MHz	dBuV/m	dBuV/m	dB	dBuV	Loss	Factor	Factor	cm	deg		dB
1	4803.68	33.11	54.00	-20.89	28.74	6.21	33.36	35.20	100	26 Average	HORIZONTAL	0.00
2	4803.70	46.34	74.00	-27.66	41.97	6.21	33.36	35.20	100	26 Peak	HORIZONTAL	0.00

Vertical

	Freq	Level	Limit	Over	Read	CableAntenna	Preamp	A/Pos	T/Pos	Remark	Pol/Phase	Aux
	MHz	dBuV/m	dBuV/m	dB	dBuV	Loss	Factor	Factor	cm	deg		dB
1	4803.51	47.35	74.00	-26.65	42.98	6.21	33.36	35.20	100	76 Peak	VERTICAL	0.00
2	4803.87	35.22	54.00	-18.78	30.85	6.21	33.36	35.20	100	76 Average	VERTICAL	0.00

Temperature	23°C	Humidity	65%
Test Engineer	Rion Li	Configurations	Channel 20 / Main Port
Test Date	Feb. 14, 2012	Chain	Mode 7

Horizontal

	Freq	Level	Limit	Over	Read	CableAntenna	Preamp	A/Pos	T/Pos	Remark	Pol/Phase	Aux	
	MHz	dBuV/m	dBuV/m	dB	dBuV	Loss	Factor	Factor	cm	deg		dB	
1	4882.33	46.49	74.00	-27.51	41.92	6.29	33.48	35.20	100	190	Peak	HORIZONTAL	0.00
2	4883.64	32.94	54.00	-21.06	28.37	6.29	33.48	35.20	100	190	Average	HORIZONTAL	0.00

Vertical

	Freq	Level	Limit	Over	Read	CableAntenna	Preamp	A/Pos	T/Pos	Remark	Pol/Phase	Aux	
	MHz	dBuV/m	dBuV/m	dB	dBuV	Loss	Factor	Factor	cm	deg		dB	
1	4884.47	32.99	54.00	-21.01	28.42	6.29	33.48	35.20	100	30	Average	VERTICAL	0.00
2	4886.02	46.55	74.00	-27.45	41.98	6.29	33.48	35.20	100	30	Peak	VERTICAL	0.00

Temperature	23°C	Humidity	65%
Test Engineer	Rion Li	Configurations	Channel 39 / Main Port
Test Date	Feb. 14, 2012	Chain	Mode 7

Horizontal

	Freq	Level	Limit	Over	Read	CableAntenna	Preamp	A/Pos	T/Pos	Remark	Pol/Phase	Aux	
	MHz	dBuV/m	dBuV/m	dB	dBuV	Loss	Factor	Factor	cm	deg		dB	
1	4959.50	47.36	74.00	-26.64	42.55	6.37	33.64	35.20	100	275	Peak	HORIZONTAL	0.00
2	4961.02	33.55	54.00	-20.45	28.74	6.37	33.64	35.20	100	275	Average	HORIZONTAL	0.00

Vertical

	Freq	Level	Limit	Over	Read	CableAntenna	Preamp	A/Pos	T/Pos	Remark	Pol/Phase	Aux	
	MHz	dBuV/m	dBuV/m	dB	dBuV	Loss	Factor	Factor	cm	deg		dB	
1	4958.06	47.04	74.00	-26.96	42.23	6.37	33.64	35.20	100	12	Peak	VERTICAL	0.00
2	4960.47	33.83	54.00	-20.17	29.02	6.37	33.64	35.20	100	12	Average	VERTICAL	0.00



Temperature	23°C	Humidity	65%
Test Engineer	Rion Li	Configurations	Channel 0 / Aux Port
Test Date	Feb. 14, 2012	Test Mode	Mode 8

Horizontal

	Freq	Level	Limit Line	Over Limit	Read Level	CableAntenna Loss	Antenna Factor	Preamp Factor	A/Pos	T/Pos	Remark	Pol/Phase	Aux Factor
	MHz	dBuV/m	dBuV/m	dB	dBuV	dB	dB/m	dB	cm	deg			dB
1	4802.29	46.16	74.00	-27.84	41.82	6.21	33.33	35.20	100	25	Peak	HORIZONTAL	0.00
2	4803.63	33.91	54.00	-20.09	29.54	6.21	33.36	35.20	45	25	Average	HORIZONTAL	0.00

Vertical

	Freq	Level	Limit Line	Over Limit	Read Level	CableAntenna Loss	Antenna Factor	Preamp Factor	A/Pos	T/Pos	Remark	Pol/Phase	Aux Factor
	MHz	dBuV/m	dBuV/m	dB	dBuV	dB	dB/m	dB	cm	deg			dB
1	4803.79	36.93	54.00	-17.07	32.56	6.21	33.36	35.20	100	282	Average	VERTICAL	0.00
2	4804.07	47.48	74.00	-26.52	43.11	6.21	33.36	35.20	100	282	Peak	VERTICAL	0.00



Temperature	23°C	Humidity	65%
Test Engineer	Rion Li	Configurations	Channel 20 / Aux Port
Test Date	Feb. 14, 2012	Chain	Mode 8

Horizontal

	Freq	Level	Limit	Over	Read	CableAntenna	Preamp	A/Pos	T/Pos	Remark	Pol/Phase	Aux	
	MHz	dBuV/m	dBuV/m	dB	dBuV	Loss	Factor	Factor	cm	deg		dB	
1	4883.21	46.30	74.00	-27.70	41.73	6.29	33.48	35.20	118	222	Peak	HORIZONTAL	0.00
2	4883.69	32.93	54.00	-21.07	28.36	6.29	33.48	35.20	118	222	Average	HORIZONTAL	0.00

Vertical

	Freq	Level	Limit	Over	Read	CableAntenna	Preamp	A/Pos	T/Pos	Remark	Pol/Phase	Aux	
	MHz	dBuV/m	dBuV/m	dB	dBuV	Loss	Factor	Factor	cm	deg		dB	
1	4884.19	33.17	54.00	-20.83	28.60	6.29	33.48	35.20	100	30	Average	VERTICAL	0.00
2	4885.51	47.03	74.00	-26.97	42.46	6.29	33.48	35.20	100	30	Peak	VERTICAL	0.00



Temperature	23°C	Humidity	65%
Test Engineer	Rion Li	Configurations	Channel 39 / Aux Port
Test Date	Feb. 07, 2012	Chain	Mode 8

Horizontal

	Freq	Level	Limit Line	Over Limit	Read Level	CableAntenna Loss	Antenna Factor	Preamp Factor	A/Pos	T/Pos	Remark	Pol/Phase	Aux Factor
	MHz	dBuV/m	dBuV/m	dB	dBuV	dB	dB/m	dB	cm	deg			dB
1	4960.54	46.88	74.00	-27.12	42.07	6.37	33.64	35.20	100	42	Peak	HORIZONTAL	0.00
2	4960.84	33.65	54.00	-20.35	28.84	6.37	33.64	35.20	100	42	Average	HORIZONTAL	0.00

Vertical

	Freq	Level	Limit Line	Over Limit	Read Level	CableAntenna Loss	Antenna Factor	Preamp Factor	A/Pos	T/Pos	Remark	Pol/Phase	Aux Factor
	MHz	dBuV/m	dBuV/m	dB	dBuV	dB	dB/m	dB	cm	deg			dB
1	4959.84	34.11	54.00	-19.89	29.30	6.37	33.64	35.20	100	348	Average	VERTICAL	0.00
2	4960.40	46.64	74.00	-27.36	41.83	6.37	33.64	35.20	100	348	Peak	VERTICAL	0.00

For Bluetooth 4.0 :

Temperature	23°C	Humidity	65%
Test Engineer	Rion Li	Configurations	Channel 0 / Main Port
Test Date	Feb. 13, 2012	Test Mode	Mode 15

Horizontal

	Freq	Level	Limit Line	Over Limit	Read Level	CableAntenna Loss	Antenna Factor	Preamp Factor	A/Pos	T/Pos	Remark	Pol/Phase	Aux Factor
	MHz	dBuV/m	dBuV/m	dB	dBuV	dB	dB/m	dB	cm	deg			dB
1	4805.63	45.69	74.00	-28.31	41.32	6.21	33.36	35.20	100	292	Peak	HORIZONTAL	0.00
2	4806.41	31.82	54.00	-22.18	27.45	6.21	33.36	35.20	100	292	Average	HORIZONTAL	0.00

Vertical

	Freq	Level	Limit Line	Over Limit	Read Level	CableAntenna Loss	Antenna Factor	Preamp Factor	A/Pos	T/Pos	Remark	Pol/Phase	Aux Factor
	MHz	dBuV/m	dBuV/m	dB	dBuV	dB	dB/m	dB	cm	deg			dB
1	4803.56	33.17	54.00	-20.83	28.80	6.21	33.36	35.20	100	70	Average	VERTICAL	0.00
2	4804.13	47.21	74.00	-26.79	42.84	6.21	33.36	35.20	100	70	Peak	VERTICAL	0.00



Temperature	23°C	Humidity	65%
Test Engineer	Rion Li	Configurations	Channel 20 / Main Port
Test Date	Feb. 13, 2012	Chain	Mode 15

Horizontal

	Freq	Level	Limit	Over	Read	CableAntenna	Preamp	A/Pos	T/Pos	Remark	Pol/Phase	Aux	
	MHz	dBuV/m	dBuV/m	dB	dBuV	Loss	Factor	Factor	cm	deg		dB	
1	4883.54	46.12	74.00	-27.88	41.55	6.29	33.48	35.20	113	196	Peak	HORIZONTAL	0.00
2	4884.97	32.60	54.00	-21.40	28.03	6.29	33.48	35.20	113	196	Average	HORIZONTAL	0.00

Vertical

	Freq	Level	Limit	Over	Read	CableAntenna	Preamp	A/Pos	T/Pos	Remark	Pol/Phase	Aux	
	MHz	dBuV/m	dBuV/m	dB	dBuV	Loss	Factor	Factor	cm	deg		dB	
1	4883.40	33.34	54.00	-20.66	28.77	6.29	33.48	35.20	115	336	Average	VERTICAL	0.00
2	4884.34	47.12	74.00	-26.88	42.55	6.29	33.48	35.20	115	336	Peak	VERTICAL	0.00

Temperature	23°C	Humidity	65%
Test Engineer	Rion Li	Configurations	Channel 39 / Main Port
Test Date	Feb. 13, 2012	Chain	Mode 15

Horizontal

	Freq	Level	Limit	Over	Read	CableAntenna	Preamp	A/Pos	T/Pos	Remark	Pol/Phase	Aux	
	MHz	dBuV/m	dBuV/m	dB	dBuV	Loss	Factor	Factor	cm	deg		dB	
1	4960.46	46.71	74.00	-27.29	41.90	6.37	33.64	35.20	100	171	Peak	HORIZONTAL	0.00
2	4962.42	33.28	54.00	-20.72	28.47	6.37	33.64	35.20	100	171	Average	HORIZONTAL	0.00

Vertical

	Freq	Level	Limit	Over	Read	CableAntenna	Preamp	A/Pos	T/Pos	Remark	Pol/Phase	Aux	
	MHz	dBuV/m	dBuV/m	dB	dBuV	Loss	Factor	Factor	cm	deg		dB	
1	4959.71	34.68	54.00	-19.32	29.87	6.37	33.64	35.20	113	345	Average	VERTICAL	0.00
2	4959.83	46.76	74.00	-27.24	41.95	6.37	33.64	35.20	113	345	Peak	VERTICAL	0.00

Temperature	23°C	Humidity	65%
Test Engineer	Rion Li	Configurations	Channel 0 / Aux Port
Test Date	Feb. 13, 2012	Test Mode	Mode 16

Horizontal

	Freq	Level	Limit Line	Over Limit	Read Level	CableAntenna Loss	Antenna Factor	Preamp Factor	A/Pos	T/Pos	Remark	Pol/Phase	Aux Factor
	MHz	dBuV/m	dBuV/m	dB	dBuV	dB	dB/m	dB	cm	deg			dB
1	4803.40	32.91	54.00	-21.09	28.54	6.21	33.36	35.20	101	0	Average	HORIZONTAL	0.00
2	4805.63	46.08	74.00	-27.92	41.71	6.21	33.36	35.20	101	0	Peak	HORIZONTAL	0.00

Vertical

	Freq	Level	Limit Line	Over Limit	Read Level	CableAntenna Loss	Antenna Factor	Preamp Factor	A/Pos	T/Pos	Remark	Pol/Phase	Aux Factor
	MHz	dBuV/m	dBuV/m	dB	dBuV	dB	dB/m	dB	cm	deg			dB
1	4803.61	47.69	74.00	-26.31	43.32	6.21	33.36	35.20	101	217	Peak	VERTICAL	0.00
2	4803.78	35.83	54.00	-18.17	31.46	6.21	33.36	35.20	101	217	Average	VERTICAL	0.00

Temperature	23°C	Humidity	65%
Test Engineer	Rion Li	Configurations	Channel 20 / Aux Port
Test Date	Feb. 13, 2012	Chain	Mode 16

Horizontal

	Freq	Level	Limit	Over	Read	CableAntenna	Preamp	A/Pos	T/Pos	Remark	Pol/Phase	Aux	
	MHz	dBuV/m	dBuV/m	dB	dBuV	Loss	Factor	Factor	cm	deg		dB	
1	4884.19	45.95	74.00	-28.05	41.38	6.29	33.48	35.20	100	350	Peak	HORIZONTAL	0.00
2	4885.36	32.85	54.00	-21.15	28.28	6.29	33.48	35.20	100	350	Average	HORIZONTAL	0.00

Vertical

	Freq	Level	Limit	Over	Read	CableAntenna	Preamp	A/Pos	T/Pos	Remark	Pol/Phase	Aux	
	MHz	dBuV/m	dBuV/m	dB	dBuV	Loss	Factor	Factor	cm	deg		dB	
1	4883.18	46.27	74.00	-27.73	41.70	6.29	33.48	35.20	100	16	Peak	VERTICAL	0.00
2	4884.39	34.60	54.00	-19.40	30.03	6.29	33.48	35.20	124	16	Average	VERTICAL	0.00

Temperature	23°C	Humidity	65%
Test Engineer	Rion Li	Configurations	Channel 39 / Aux Port
Test Date	Feb. 13, 2012	Chain	Mode 16

Horizontal

	Freq	Level	Limit	Over	Read	Cable	Antenna	Preamp	A/Pos	T/Pos	Remark	Pol/Phase	Aux
	MHz	dBuV/m	dBuV/m	dB	dBuV	Loss	Factor	Factor	cm	deg			dB
1	4958.01	46.28	74.00	-27.72	41.47	6.37	33.64	35.20	100	298	Peak	HORIZONTAL	0.00
2	4961.98	33.42	54.00	-20.58	28.61	6.37	33.64	35.20	100	298	Average	HORIZONTAL	0.00

Vertical

	Freq	Level	Limit	Over	Read	Cable	Antenna	Preamp	A/Pos	T/Pos	Remark	Pol/Phase	Aux
	MHz	dBuV/m	dBuV/m	dB	dBuV	Loss	Factor	Factor	cm	deg			dB
1	4959.68	35.14	54.00	-18.86	30.33	6.37	33.64	35.20	125	20	Average	VERTICAL	0.00
2	4960.39	47.67	74.00	-26.33	42.86	6.37	33.64	35.20	125	20	Peak	VERTICAL	0.00

Note:

The amplitude of spurious emissions which are attenuated by more than 20dB below the permissible value has no need to be reported.

Emission level (dBuV/m) = 20 log Emission level (uV/m).

Corrected Reading: Antenna Factor + Cable Loss + Read Level - Preamp Factor = Level.

4.8. Band Edge Emissions Measurement

4.8.1. Limit

20dBc in any 100 kHz bandwidth outside the operating frequency band. In case the emission fall within the restricted band specified on 15.205(a), then the 15.209(a) limit in the table below has to be followed.

Frequencies (MHz)	Field Strength (micovolts/meter)	Measurement Distance (meters)
0.009~0.490	2400/F(KHz)	300
0.490~1.705	24000/F(KHz)	30
1.705~30.0	30	30
30~88	100	3
88~216	150	3
216~960	200	3
Above 960	500	3

4.8.2. Measuring Instruments and Setting

Please refer to section 5 of equipments list in this report. The following table is the setting of the spectrum analyzer.

Spectrum Parameter	Setting
Attenuation	Auto
Span Frequency	100 MHz
RB / VB (Emission in restricted band)	1MHz / 3MHz for Peak, 1 MHz / 10Hz for Average
RB / VB (Emission in non-restricted band)	100 KHz /100 KHz for Peak

4.8.3. Test Procedures

1. The test procedure is the same as section 4.5.3, only the frequency range investigated is limited to 100MHz around bandedges.
2. In case the emission is fail due to the used RB/VB is too wide, marker-delta method of FCC Public Notice DA00-705 will be followed.

4.8.4. Test Setup Layout

This test setup layout is the same as that shown in section 4.6.4.

4.8.5. Test Deviation

There is no deviation with the original standard.

4.8.6. EUT Operation during Test

The EUT was programmed to be in continuously transmitting mode.

4.8.7. Test Result of Band Edge and Fundamental Emissions

For Bluetooth 2.1 + EDR :

Temperature	23°C	Humidity	65%
Test Engineer	Rion Li	Configurations	Channel 0, 39, 78
Test Date	Feb. 13, 2012	Chain	Mode 3

Channel 0

	Freq	Level	Limit Line	Over Limit	Read Level	Cable Loss	Antenna Factor	Preamp Factor	A/Pos	T/Pos	Remark	Pol/Phase	Aux Factor
	MHz	dBuV/m	dBuV/m	dB	dBuV	dB	dB/m	dB	cm	deg			dB
1	2386.40	54.67	74.00	-19.33	22.51	4.11	28.05	0.00	100	183	Peak	VERTICAL	0.00
2	2390.00	41.39	54.00	-12.61	9.20	4.14	28.05	0.00	100	183	Average	VERTICAL	0.00
3	2402.00	96.93	54.00			4.14	28.09	0.00	100	183	Average	VERTICAL	0.00
4	2402.20	102.87	74.00			4.14	28.09	0.00	100	183	Peak	VERTICAL	0.00

Item 3, 4 are the fundamental frequency at 2402 MHz.

Channel 39

	Freq	Level	Limit Line	Over Limit	Read Level	Cable Loss	Antenna Factor	Preamp Factor	A/Pos	T/Pos	Remark	Pol/Phase	Aux Factor
	MHz	dBuV/m	dBuV/m	dB	dBuV	dB	dB/m	dB	cm	deg			dB
1	2390.00	41.46	54.00	-12.54	9.27	4.14	28.05	0.00	100	204	Average	VERTICAL	0.00
2	2390.00	52.77	74.00	-21.23	20.58	4.14	28.05	0.00	100	204	Peak	VERTICAL	0.00
3	2441.00	93.65	54.00			4.18	28.18	0.00	100	204	Average	VERTICAL	0.00
4	2441.20	99.51	74.00			4.18	28.18	0.00	100	204	Peak	VERTICAL	0.00
5	2483.50	41.79	54.00	-12.21	9.32	4.21	28.26	0.00	100	204	Average	VERTICAL	0.00
6	2484.32	54.48	74.00	-19.52	22.01	4.21	28.26	0.00	100	204	Peak	VERTICAL	0.00

Item 3, 4 are the fundamental frequency at 2441 MHz.

Channel 78

	Freq	Level	Limit Line	Over Limit	Read Level	Cable Loss	Antenna Factor	Preamp Factor	A/Pos	T/Pos	Remark	Pol/Phase	Aux Factor
	MHz	dBuV/m	dBuV/m	dB	dBuV	dB	dB/m	dB	cm	deg			dB
1	2480.00	89.74	54.00			4.21	28.26	0.00	100	239	Average	VERTICAL	0.00
2	2480.00	95.50	74.00			4.21	28.26	0.00	100	239	Peak	VERTICAL	0.00
3	2483.50	43.08	54.00	-10.92	10.61	4.21	28.26	0.00	100	239	Average	VERTICAL	0.00
4	2483.50	54.33	74.00	-19.67	21.86	4.21	28.26	0.00	100	239	Peak	VERTICAL	0.00

Item 1, 2 are the fundamental frequency at 2480 MHz.

Note:

Emission level (dBuV/m) = 20 log Emission level (uV/m).

Corrected Reading: Antenna Factor + Cable Loss + Read Level - Preamp Factor = Level.

For Emission not in Restricted Band
Low Band Edge Plot on Channel 0 / 2402 MHz

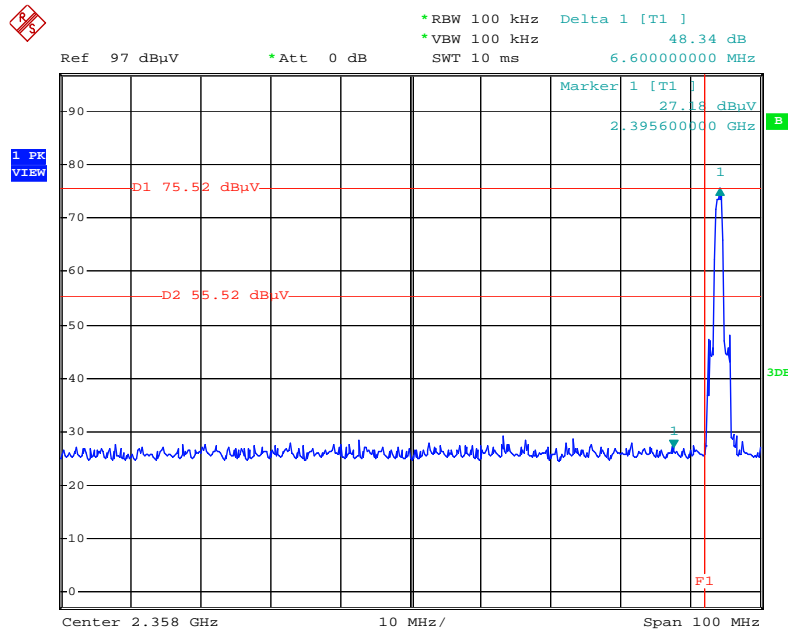

Date: 13.FEB.2012 22:16:54

High Band Edge Plot on Channel 78 / 2480 MHz

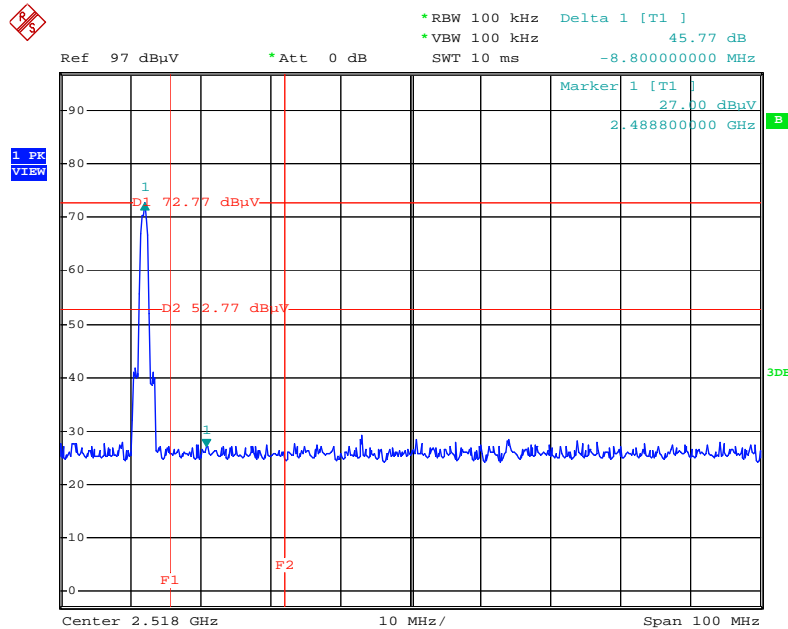

Date: 13.FEB.2012 22:46:33

Temperature	23°C	Humidity	65%
Test Engineer	Rion Li	Configurations	Channel 0, 39, 78
Test Date	Feb. 13, 2012	Chain	Mode 4

Channel 0

	Freq	Level	Limit	Over	Read	Cable	Antenna	Preamp	A/Pos	T/Pos	Remark	Pol/Phase	Aux
	MHz	dBuV/m	dBuV/m	dB	dBuV	dB	dB/m	dB	cm	deg			dB
1	2381.40	54.71	74.00	-19.29	22.59	4.11	28.01	0.00	122	226	Peak	HORIZONTAL	0.00
2	2390.00	41.46	54.00	-12.54	9.27	4.14	28.05	0.00	122	226	Average	HORIZONTAL	0.00
3	2401.80	105.95	74.00			4.14	28.09	0.00	122	226	Peak	HORIZONTAL	0.00
4	2402.00	100.03	54.00			4.14	28.09	0.00	122	226	Average	HORIZONTAL	0.00

Item 3, 4 are the fundamental frequency at 2402 MHz.

Channel 39

	Freq	Level	Limit	Over	Read	Cable	Antenna	Preamp	A/Pos	T/Pos	Remark	Pol/Phase	Aux
	MHz	dBuV/m	dBuV/m	dB	dBuV	dB	dB/m	dB	cm	deg			dB
1	2390.00	41.51	54.00	-12.49	9.32	4.14	28.05	0.00	104	165	Average	VERTICAL	0.00
2	2390.00	54.27	74.00	-19.73	22.08	4.14	28.05	0.00	104	165	Peak	VERTICAL	0.00
3	2441.00	98.03	54.00			4.18	28.18	0.00	104	165	Average	VERTICAL	0.00
4	2441.20	103.88	74.00			4.18	28.18	0.00	104	165	Peak	VERTICAL	0.00
5	2483.50	41.82	54.00	-12.18	9.35	4.21	28.26	0.00	104	165	Average	VERTICAL	0.00
6	2487.99	54.79	74.00	-19.21	22.26	4.23	28.30	0.00	104	165	Peak	VERTICAL	0.00

Item 3, 4 are the fundamental frequency at 2441 MHz.

Channel 78

	Freq	Level	Limit	Over	Read	Cable	Antenna	Preamp	A/Pos	T/Pos	Remark	Pol/Phase	Aux
	MHz	dBuV/m	dBuV/m	dB	dBuV	dB	dB/m	dB	cm	deg			dB
1	2480.00	96.42	54.00			4.21	28.26	0.00	101	160	Average	VERTICAL	0.00
2	2480.20	102.27	74.00			4.21	28.26	0.00	101	160	Peak	VERTICAL	0.00
3	2483.50	45.88	54.00	-8.12	13.41	4.21	28.26	0.00	101	160	Average	VERTICAL	0.00
4	2483.50	55.11	74.00	-18.89	22.64	4.21	28.26	0.00	101	160	Peak	VERTICAL	0.00

Item 1, 2 are the fundamental frequency at 2480 MHz.

Note:

Emission level (dBuV/m) = 20 log Emission level (uV/m).

Corrected Reading: Antenna Factor + Cable Loss + Read Level - Preamp Factor = Level.

For Emission not in Restricted Band
Low Band Edge Plot on Channel 0 / 2402 MHz

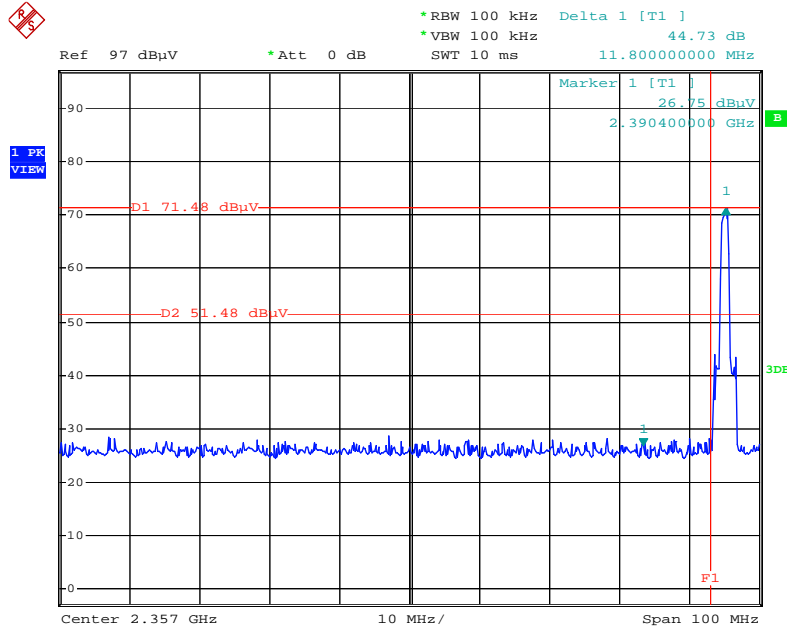

Date: 13.FEB.2012 21:34:22

High Band Edge Plot on Channel 78 / 2480 MHz

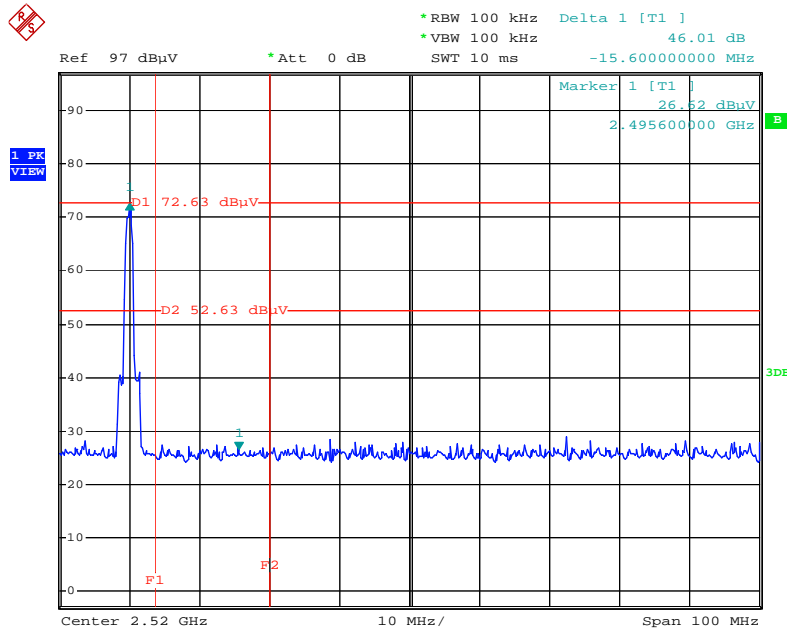

Date: 13.FEB.2012 22:00:40

Temperature	23°C	Humidity	65%
Test Engineer	Rion Li	Configurations	Channel 0, 39, 78
Test Date	Feb. 13, 2012	Chain	Mode 11

Channel 0

	Freq	Level	Limit Line	Over Limit	Read Level	CableAntenna Loss	Antenna Factor	Preamp Factor	A/Pos	T/Pos	Remark	Pol/Phase	Aux Factor
	MHz	dBuV/m	dBuV/m	dB	dBuV	dB	dB/m	dB	cm	deg			dB
1	2389.00	54.95	74.00	-19.05	22.76	4.14	28.05	0.00	101	141	Peak	VERTICAL	0.00
2	2390.00	41.77	54.00	-12.23	9.58	4.14	28.05	0.00	101	141	Average	VERTICAL	0.00
3	2401.80	108.00	74.00			4.14	28.09	0.00	101	141	Peak	VERTICAL	0.00
4	2402.00	101.95	54.00			4.14	28.09	0.00	101	141	Average	VERTICAL	0.00

Item 3, 4 are the fundamental frequency at 2402 MHz.

Channel 39

	Freq	Level	Limit Line	Over Limit	Read Level	CableAntenna Loss	Antenna Factor	Preamp Factor	A/Pos	T/Pos	Remark	Pol/Phase	Aux Factor
	MHz	dBuV/m	dBuV/m	dB	dBuV	dB	dB/m	dB	cm	deg			dB
1	2390.00	41.61	54.00	-12.39	9.42	4.14	28.05	0.00	100	141	Average	VERTICAL	0.00
2	2390.00	53.72	74.00	-20.28	21.53	4.14	28.05	0.00	100	141	Peak	VERTICAL	0.00
3	2440.80	107.19	74.00			4.18	28.18	0.00	100	141	Peak	VERTICAL	0.00
4	2441.00	101.10	54.00			4.18	28.18	0.00	100	141	Average	VERTICAL	0.00
5	2484.32	41.96	54.00	-12.04	9.49	4.21	28.26	0.00	100	141	Average	VERTICAL	0.00
6	2484.32	55.51	74.00	-18.49	23.04	4.21	28.26	0.00	100	141	Peak	VERTICAL	0.00

Item 3, 4 are the fundamental frequency at 2441 MHz.

Channel 78

	Freq	Level	Limit Line	Over Limit	Read Level	CableAntenna Loss	Antenna Factor	Preamp Factor	A/Pos	T/Pos	Remark	Pol/Phase	Aux Factor
	MHz	dBuV/m	dBuV/m	dB	dBuV	dB	dB/m	dB	cm	deg			dB
1	2480.00	99.88	54.00			4.21	28.26	0.00	100	140	Average	VERTICAL	0.00
2	2480.00	105.80	74.00			4.21	28.26	0.00	100	140	Peak	VERTICAL	0.00
3	2483.50	48.39	54.00	-5.61	15.92	4.21	28.26	0.00	100	140	Average	VERTICAL	0.00
4	2483.50	56.59	74.00	-17.41	24.12	4.21	28.26	0.00	100	140	Peak	VERTICAL	0.00

Item 1, 2 are the fundamental frequency at 2480 MHz.

Note:

Emission level (dBuV/m) = 20 log Emission level (uV/m).

Corrected Reading: Antenna Factor + Cable Loss + Read Level - Preamp Factor = Level.

For Emission not in Restricted Band
Low Band Edge Plot on Channel 0 / 2402 MHz

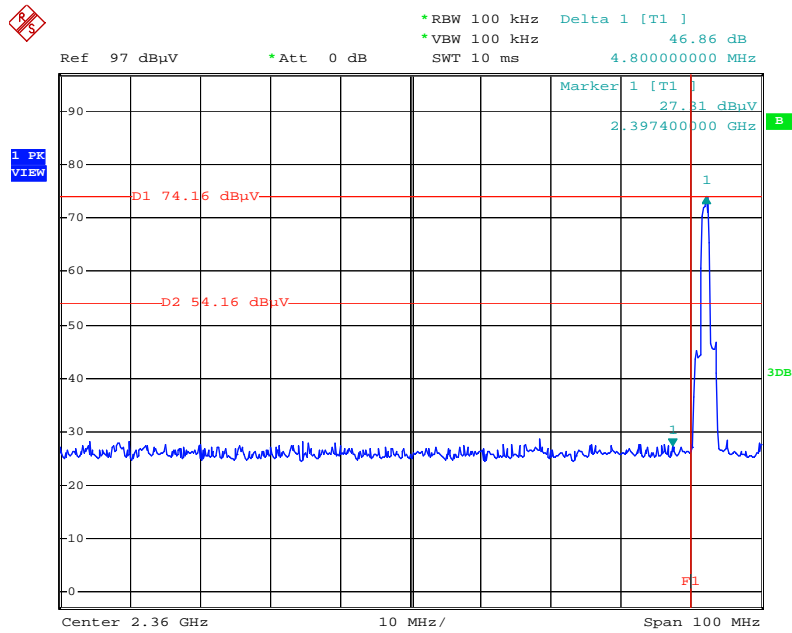

Date: 13.FEB.2012 20:49:51

High Band Edge Plot on Channel 78 / 2480 MHz

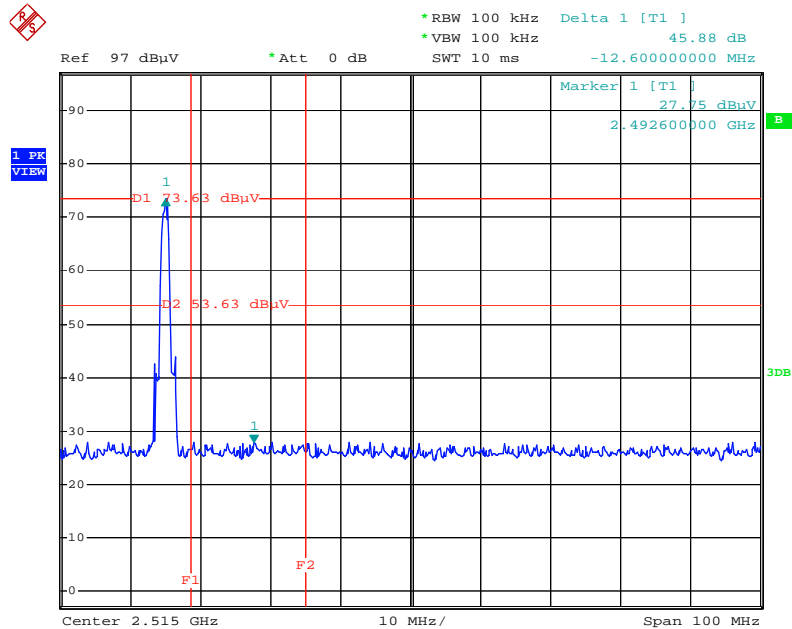

Date: 13.FEB.2012 21:08:15

Temperature	23°C	Humidity	65%
Test Engineer	Rion Li	Configurations	Channel 0, 39, 78
Test Date	Feb. 13, 2012	Chain	Mode 12

Channel 0

	Freq	Level	Limit Line	Over Limit	Read Level	CableAntenna Loss	Antenna Factor	Preamp Factor	A/Pos	T/Pos	Remark	Pol/Phase	Aux Factor
	MHz	dBuV/m	dBuV/m	dB	dBuV	dB	dB/m	dB	cm	deg			dB
1	2388.40	54.02	74.00	-19.98	21.83	4.14	28.05	0.00	101	256	Peak	VERTICAL	0.00
2	2390.00	41.48	54.00	-12.52	9.29	4.14	28.05	0.00	101	256	Average	VERTICAL	0.00
3	2402.00	100.99	54.00			4.14	28.09	0.00	101	256	Average	VERTICAL	0.00
4	2402.00	106.95	74.00			4.14	28.09	0.00	101	256	Peak	VERTICAL	0.00

Item 3, 4 are the fundamental frequency at 2402 MHz.

Channel 39

	Freq	Level	Limit Line	Over Limit	Read Level	CableAntenna Loss	Antenna Factor	Preamp Factor	A/Pos	T/Pos	Remark	Pol/Phase	Aux Factor
	MHz	dBuV/m	dBuV/m	dB	dBuV	dB	dB/m	dB	cm	deg			dB
1	2390.00	41.86	54.00	-12.14	9.67	4.14	28.05	0.00	100	139	Average	VERTICAL	0.00
2	2390.00	53.74	74.00	-20.26	21.55	4.14	28.05	0.00	100	139	Peak	VERTICAL	0.00
3	2440.80	105.71	74.00			4.18	28.18	0.00	100	139	Peak	VERTICAL	0.00
4	2441.00	99.88	54.00			4.18	28.18	0.00	100	139	Average	VERTICAL	0.00
5	2483.50	41.92	54.00	-12.08	9.45	4.21	28.26	0.00	100	139	Average	VERTICAL	0.00
6	2491.05	54.85	74.00	-19.15	22.32	4.23	28.30	0.00	100	139	Peak	VERTICAL	0.00

Item 3, 4 are the fundamental frequency at 2441 MHz.

Channel 78

	Freq	Level	Limit Line	Over Limit	Read Level	CableAntenna Loss	Antenna Factor	Preamp Factor	A/Pos	T/Pos	Remark	Pol/Phase	Aux Factor
	MHz	dBuV/m	dBuV/m	dB	dBuV	dB	dB/m	dB	cm	deg			dB
1	2480.00	100.23	54.00			4.21	28.26	0.00	100	326	Average	VERTICAL	0.00
2	2480.20	106.21	74.00			4.21	28.26	0.00	100	326	Peak	VERTICAL	0.00
3	2483.50	48.69	54.00	-5.31	16.22	4.21	28.26	0.00	100	326	Average	VERTICAL	0.00
4	2483.50	57.94	74.00	-16.06	25.47	4.21	28.26	0.00	100	326	Peak	VERTICAL	0.00

Item 1, 2 are the fundamental frequency at 2480 MHz.

Note:

Emission level (dBuV/m) = 20 log Emission level (uV/m).

Corrected Reading: Antenna Factor + Cable Loss + Read Level - Preamp Factor = Level.

For Emission not in Restricted Band
Low Band Edge Plot on Channel 0 / 2402 MHz

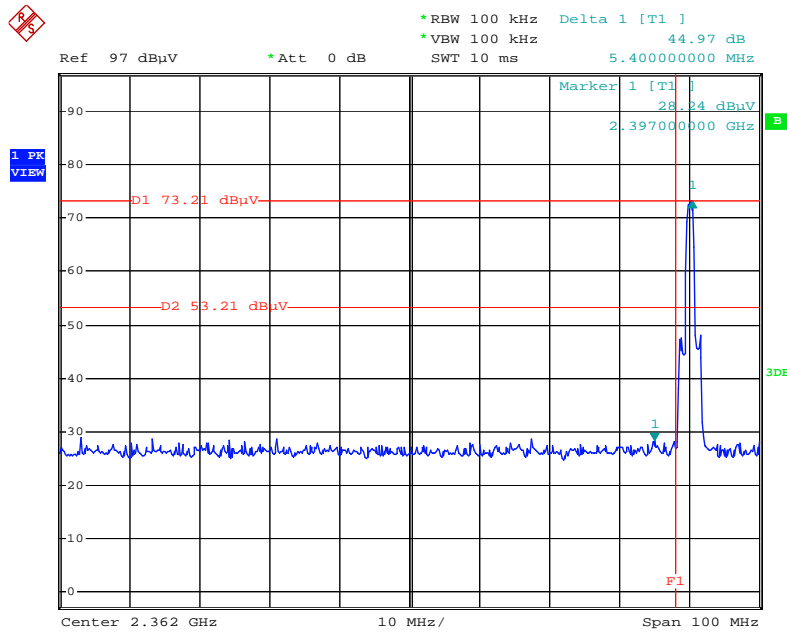

Date: 13.FEB.2012 19:40:12

High Band Edge Plot on Channel 78 / 2480 MHz

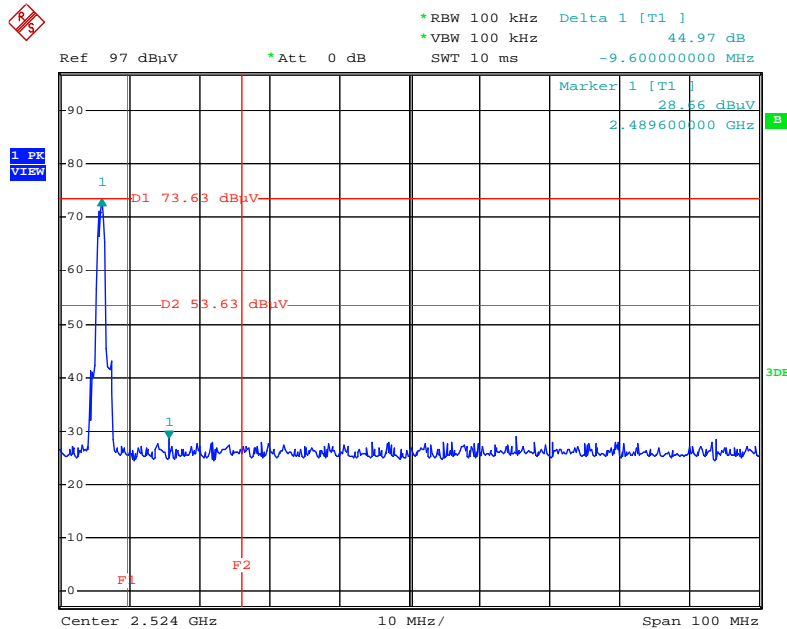

Date: 13.FEB.2012 20:35:21

For Bluetooth 4.0 :

Temperature	23°C	Humidity	65%
Test Engineer	Rion Li	Configurations	Channel 0, 20, 39
Test Date	Feb. 14, 2012	Chain	Mode 7

Channel 0

	Freq	Level	Limit Line	Over Limit	Read Level	CableAntenna Loss	Antenna Factor	Preamp Factor	A/Pos	T/Pos	Remark	Pol/Phase	Aux Factor
	MHz	dBuV/m	dBuV/m	dB	dBuV	dB	dB/m	dB	cm	deg			dB
1	2390.00	41.37	54.00	-12.63	9.18	4.14	28.05	0.00	144	281	Average	HORIZONTAL	0.00
2	2390.00	58.54	74.00	-15.46	26.35	4.14	28.05	0.00	144	281	Peak	HORIZONTAL	0.00
3	2402.00	79.05	54.00			4.14	28.09	0.00	144	281	Average	HORIZONTAL	0.00
4	2402.40	101.68	74.00			4.14	28.09	0.00	144	281	Peak	HORIZONTAL	0.00

Item 3, 4 are the fundamental frequency at 2402 MHz

Channel 20

	Freq	Level	Limit Line	Over Limit	Read Level	CableAntenna Loss	Antenna Factor	Preamp Factor	A/Pos	T/Pos	Remark	Pol/Phase	Aux Factor
	MHz	dBuV/m	dBuV/m	dB	dBuV	dB	dB/m	dB	cm	deg			dB
1	2389.79	53.69	74.00	-20.31	21.50	4.14	28.05	0.00	138	280	Peak	HORIZONTAL	0.00
2	2390.00	41.42	54.00	-12.58	9.23	4.14	28.05	0.00	138	280	Average	HORIZONTAL	0.00
3	2442.00	78.32	54.00			4.18	28.18	0.00	138	280	Average	HORIZONTAL	0.00
4	2442.21	100.07	74.00			4.18	28.18	0.00	138	280	Peak	HORIZONTAL	0.00
5	2483.50	41.79	54.00	-12.21	9.32	4.21	28.26	0.00	138	280	Average	HORIZONTAL	0.00
6	2483.50	54.71	74.00	-19.29	22.24	4.21	28.26	0.00	138	280	Peak	HORIZONTAL	0.00

Item 3, 4 are the fundamental frequency at 2442 MHz.

Channel 39

	Freq	Level	Limit Line	Over Limit	Read Level	CableAntenna Loss	Antenna Factor	Preamp Factor	A/Pos	T/Pos	Remark	Pol/Phase	Aux Factor
	MHz	dBuV/m	dBuV/m	dB	dBuV	dB	dB/m	dB	cm	deg			dB
1	2480.00	77.31	54.00			4.21	28.26	0.00	142	279	Average	HORIZONTAL	0.00
2	2480.20	98.98	74.00			4.21	28.26	0.00	142	279	Peak	HORIZONTAL	0.00
3	2483.50	43.31	54.00	-10.69	10.84	4.21	28.26	0.00	142	279	Average	HORIZONTAL	0.00
4	2483.50	68.19	74.00	-5.81	35.72	4.21	28.26	0.00	142	279	Peak	HORIZONTAL	0.00

Item 1, 2 are the fundamental frequency at 2480 MHz.

Note:

Emission level (dBuV/m) = 20 log Emission level (uV/m).

Corrected Reading: Antenna Factor + Cable Loss + Read Level - Preamp Factor = Level.

For Emission not in Restricted Band
Low Band Edge Plot on Channel 0 / 2402 MHz

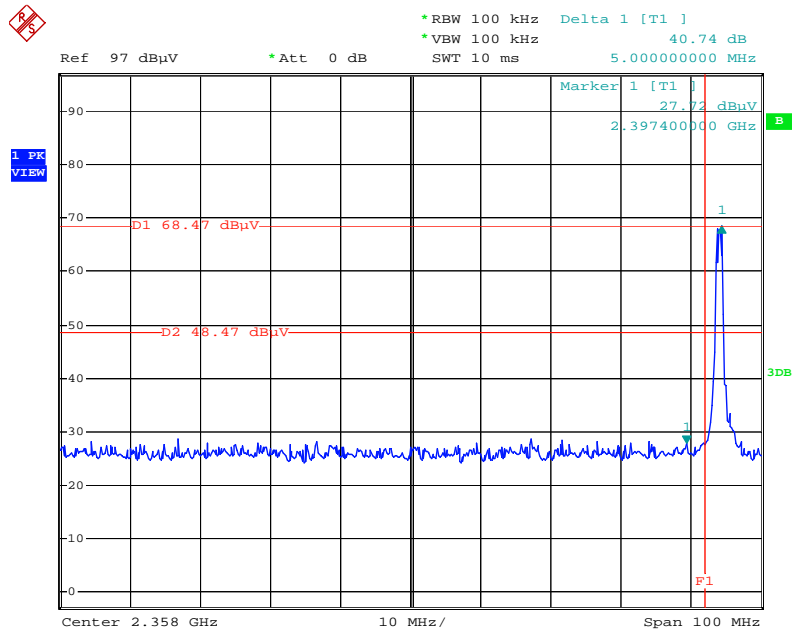

Date: 13.FEB.2012 23:44:50

High Band Edge Plot on Channel 39 / 2480 MHz

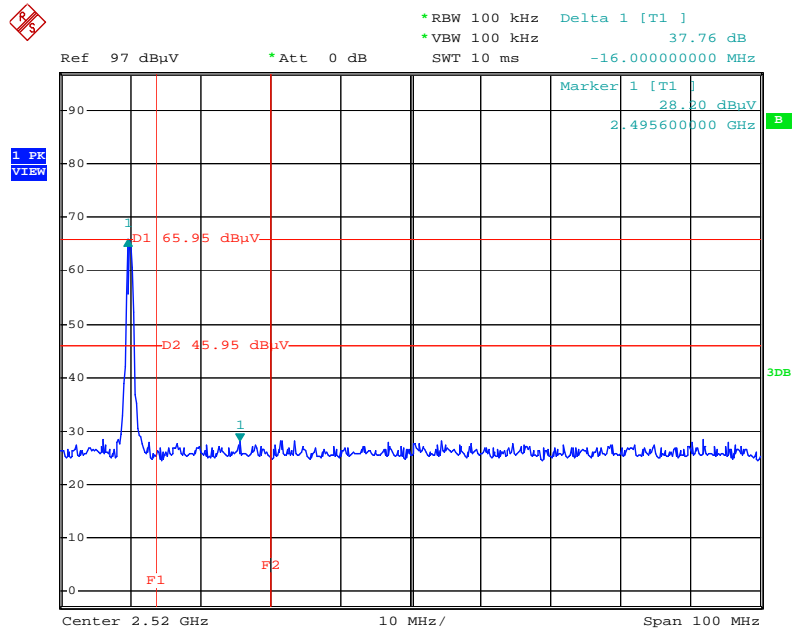

Date: 14.FEB.2012 00:09:38

Temperature	23°C	Humidity	65%
Test Engineer	Rion Li	Configurations	Channel 0, 20, 39
Test Date	Feb. 14, 2012	Chain	Mode 8

Channel 0

	Freq	Level	Limit Line	Over Limit	Read Level	Cable Loss	Antenna Factor	Preamp Factor	A/Pos	T/Pos	Remark	Pol/Phase	Aux Factor
	MHz	dBuV/m	dBuV/m	dB	dBuV	dB	dB/m	dB	cm	deg			dB
1	2388.60	58.51	74.00	-15.49	26.32	4.14	28.05	0.00	141	226	Peak	HORIZONTAL	0.00
2	2390.00	41.43	54.00	-12.57	9.24	4.14	28.05	0.00	141	226	Average	HORIZONTAL	0.00
3	2402.00	77.27	54.00			4.14	28.09	0.00	141	226	Average	HORIZONTAL	0.00
4	2402.40	98.56	74.00			4.14	28.09	0.00	141	226	Peak	HORIZONTAL	0.00

Item 3, 4 are the fundamental frequency at 2402 MHz

Channel 20

	Freq	Level	Limit Line	Over Limit	Read Level	Cable Loss	Antenna Factor	Preamp Factor	A/Pos	T/Pos	Remark	Pol/Phase	Aux Factor
	MHz	dBuV/m	dBuV/m	dB	dBuV	dB	dB/m	dB	cm	deg			dB
1	2390.00	41.35	54.00	-12.65	9.16	4.14	28.05	0.00	116	225	Average	HORIZONTAL	0.00
2	2390.00	53.65	74.00	-20.35	21.46	4.14	28.05	0.00	116	225	Peak	HORIZONTAL	0.00
3	2441.79	97.63	74.00			4.18	28.18	0.00	116	225	Peak	HORIZONTAL	0.00
4	2442.00	76.71	54.00			4.18	28.18	0.00	116	225	Average	HORIZONTAL	0.00
5	2483.50	41.77	54.00	-12.23	9.30	4.21	28.26	0.00	116	225	Average	HORIZONTAL	0.00
6	2483.50	53.28	74.00	-20.72	20.81	4.21	28.26	0.00	116	225	Peak	HORIZONTAL	0.00

Item 3, 4 are the fundamental frequency at 2442 MHz.

Channel 39

	Freq	Level	Limit Line	Over Limit	Read Level	Cable Loss	Antenna Factor	Preamp Factor	A/Pos	T/Pos	Remark	Pol/Phase	Aux Factor
	MHz	dBuV/m	dBuV/m	dB	dBuV	dB	dB/m	dB	cm	deg			dB
1	2480.00	76.58	54.00			4.21	28.26	0.00	145	267	Average	HORIZONTAL	0.00
2	2480.20	97.36	74.00			4.21	28.26	0.00	145	267	Peak	HORIZONTAL	0.00
3	2483.50	42.99	54.00	-11.01	10.52	4.21	28.26	0.00	145	267	Average	HORIZONTAL	0.00
4	2483.50	66.96	74.00	-7.04	34.49	4.21	28.26	0.00	145	267	Peak	HORIZONTAL	0.00

Item 1, 2 are the fundamental frequency at 2480 MHz.

Note:

Emission level (dBuV/m) = 20 log Emission level (uV/m).

Corrected Reading: Antenna Factor + Cable Loss + Read Level - Preamp Factor = Level.

For Emission not in Restricted Band
Low Band Edge Plot on Channel 0 / 2402 MHz

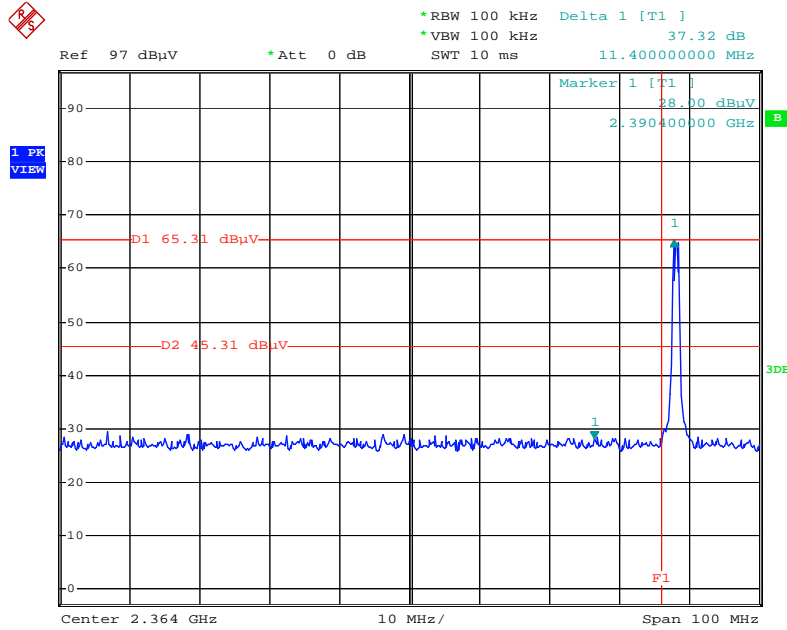

Date: 13.FEB.2012 23:03:37

High Band Edge Plot on Channel 39 / 2480 MHz

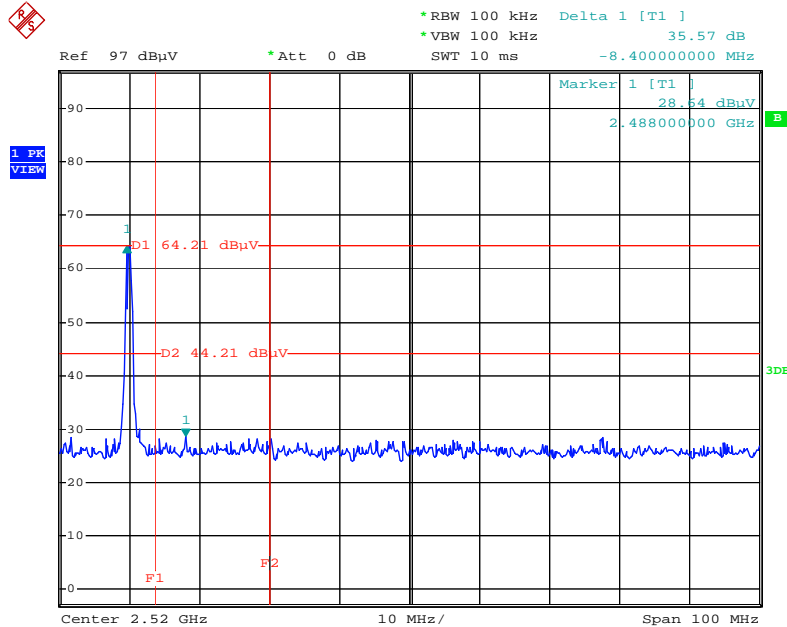

Date: 13.FEB.2012 23:27:06

Temperature	23°C	Humidity	65%
Test Engineer	Rion Li	Configurations	Channel 0, 20, 39
Test Date	Feb. 14, 2012	Chain	Mode 15

Channel 0

	Freq	Level	Limit Line	Over Limit	Read Level	Cable Loss	Antenna Factor	Preamp Factor	A/Pos	T/Pos	Remark	Pol/Phase	Aux Factor
	MHz	dBuV/m	dBuV/m	dB	dBuV	dB	dB/m	dB	cm	deg			dB
1	2386.00	58.67	74.00	-15.33	26.51	4.11	28.05	0.00	101	268	Peak	VERTICAL	0.00
2	2390.00	41.40	54.00	-12.60	9.21	4.14	28.05	0.00	101	268	Average	VERTICAL	0.00
3	2402.00	77.49	54.00			4.14	28.09	0.00	101	268	Average	VERTICAL	0.00
4	2402.40	99.41	74.00			4.14	28.09	0.00	101	268	Peak	VERTICAL	0.00

Item 3, 4 are the fundamental frequency at 2402 MHz

Channel 20

	Freq	Level	Limit Line	Over Limit	Read Level	Cable Loss	Antenna Factor	Preamp Factor	A/Pos	T/Pos	Remark	Pol/Phase	Aux Factor
	MHz	dBuV/m	dBuV/m	dB	dBuV	dB	dB/m	dB	cm	deg			dB
1	2390.00	41.57	54.00	-12.43	9.38	4.14	28.05	0.00	100	140	Average	VERTICAL	0.00
2	2390.00	53.94	74.00	-20.06	21.75	4.14	28.05	0.00	100	140	Peak	VERTICAL	0.00
3	2441.79	100.01	74.00			4.18	28.18	0.00	100	140	Peak	VERTICAL	0.00
4	2442.00	78.36	54.00			4.18	28.18	0.00	100	140	Average	VERTICAL	0.00
5	2483.50	41.71	54.00	-12.29	9.24	4.21	28.26	0.00	100	140	Average	VERTICAL	0.00
6	2491.13	55.47	74.00	-18.53	22.94	4.23	28.30	0.00	100	140	Peak	VERTICAL	0.00

Item 3, 4 are the fundamental frequency at 2441 MHz.

Channel 39

	Freq	Level	Limit Line	Over Limit	Read Level	Cable Loss	Antenna Factor	Preamp Factor	A/Pos	T/Pos	Remark	Pol/Phase	Aux Factor
	MHz	dBuV/m	dBuV/m	dB	dBuV	dB	dB/m	dB	cm	deg			dB
1	2480.00	76.93	54.00			4.21	28.26	0.00	101	142	Average	VERTICAL	0.00
2	2480.40	98.14	74.00			4.21	28.26	0.00	101	142	Peak	VERTICAL	0.00
3	2483.50	43.07	54.00	-10.93	10.60	4.21	28.26	0.00	101	142	Average	VERTICAL	0.00
4	2483.50	64.66	74.00	-9.34	32.19	4.21	28.26	0.00	101	142	Peak	VERTICAL	0.00

Item 1, 2 are the fundamental frequency at 2480 MHz.

Note:

Emission level (dBuV/m) = 20 log Emission level (uV/m).

Corrected Reading: Antenna Factor + Cable Loss + Read Level - Preamp Factor = Level.

For Emission not in Restricted Band
Low Band Edge Plot on Channel 0 / 2402 MHz

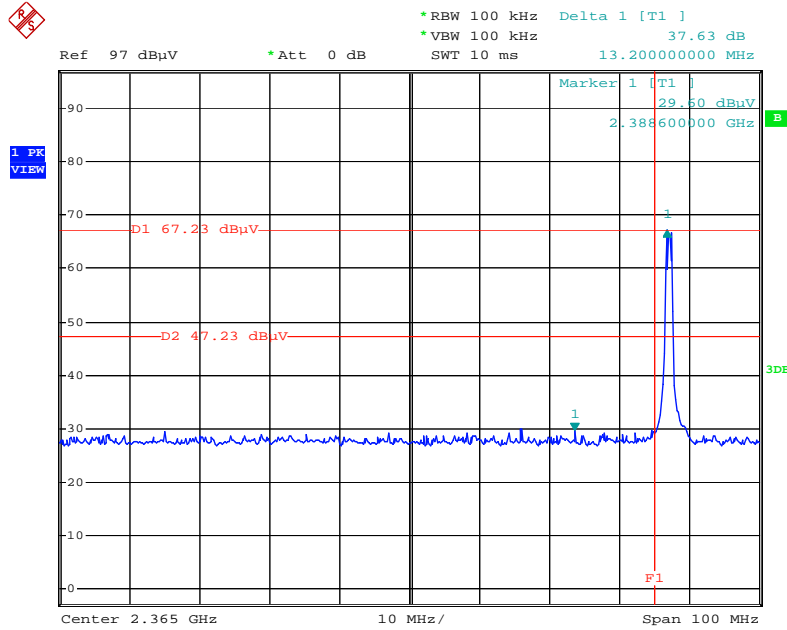

Date: 13.FEB.2012 18:29:59

High Band Edge Plot on Channel 39 / 2480 MHz

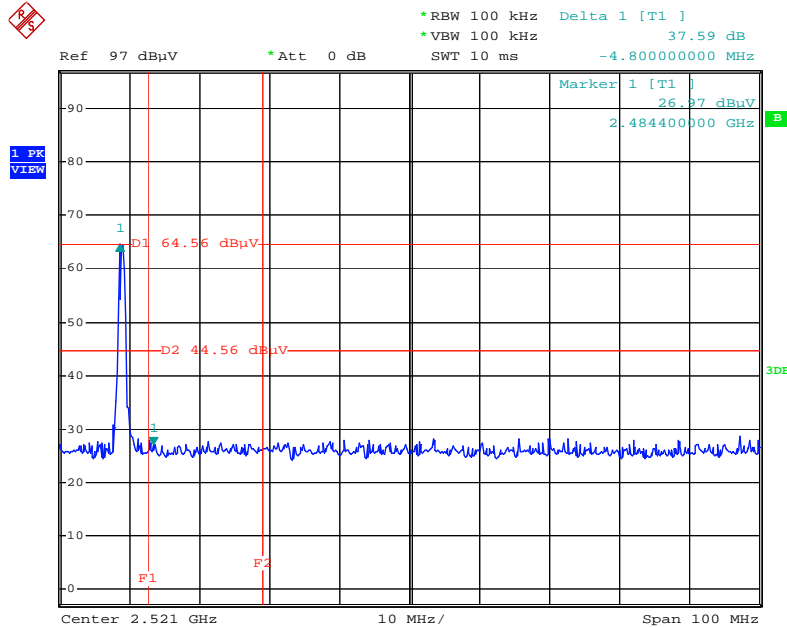

Date: 13.FEB.2012 18:57:44

Temperature	23°C	Humidity	65%
Test Engineer	Rion Li	Configurations	Channel 0, 20, 39
Test Date	Feb. 14, 2012	Chain	Mode 16

Channel 0

	Freq	Level	Limit Line	Over Limit	Read Level	Cable Loss	Antenna Factor	Preamp Factor	A/Pos	T/Pos	Remark	PoI/Phase	Aux Factor
	MHz	dBuV/m	dBuV/m	dB	dBuV	dB	dB/m	dB	cm	deg			dB
1	2389.00	56.19	74.00	-17.81	24.00	4.14	28.05	0.00	149	16	Peak	VERTICAL	0.00
2	2390.00	41.33	54.00	-12.67	9.14	4.14	28.05	0.00	149	16	Average	VERTICAL	0.00
3	2401.80	97.91	74.00			4.14	28.09	0.00	149	16	Peak	VERTICAL	0.00
4	2402.00	76.53	54.00			4.14	28.09	0.00	149	16	Average	VERTICAL	0.00

Item 3, 4 are the fundamental frequency at 2402 MHz

Channel 20

	Freq	Level	Limit Line	Over Limit	Read Level	Cable Loss	Antenna Factor	Preamp Factor	A/Pos	T/Pos	Remark	PoI/Phase	Aux Factor
	MHz	dBuV/m	dBuV/m	dB	dBuV	dB	dB/m	dB	cm	deg			dB
1	2390.00	41.40	54.00	-12.60	9.21	4.14	28.05	0.00	101	316	Average	VERTICAL	0.00
2	2390.00	53.34	74.00	-20.66	21.15	4.14	28.05	0.00	101	316	Peak	VERTICAL	0.00
3	2442.00	76.66	54.00			4.18	28.18	0.00	101	316	Average	VERTICAL	0.00
4	2442.21	97.67	74.00			4.18	28.18	0.00	101	316	Peak	VERTICAL	0.00
5	2483.50	41.74	54.00	-12.26	9.27	4.21	28.26	0.00	101	316	Average	VERTICAL	0.00
6	2483.50	54.30	74.00	-19.70	21.83	4.21	28.26	0.00	101	316	Peak	VERTICAL	0.00

Item 3, 4 are the fundamental frequency at 2442 MHz.

Channel 39

	Freq	Level	Limit Line	Over Limit	Read Level	Cable Loss	Antenna Factor	Preamp Factor	A/Pos	T/Pos	Remark	PoI/Phase	Aux Factor
	MHz	dBuV/m	dBuV/m	dB	dBuV	dB	dB/m	dB	cm	deg			dB
1	2480.00	76.60	54.00			4.21	28.26	0.00	141	315	Average	VERTICAL	0.00
2	2480.40	97.96	74.00			4.21	28.26	0.00	141	315	Peak	VERTICAL	0.00
3	2483.50	43.00	54.00	-11.00	10.53	4.21	28.26	0.00	141	315	Average	VERTICAL	0.00
4	2483.50	67.56	74.00	-6.44	35.09	4.21	28.26	0.00	141	315	Peak	VERTICAL	0.00

Item 1, 2 are the fundamental frequency at 2480 MHz.

Note:

Emission level (dBuV/m) = 20 log Emission level (uV/m).

Corrected Reading: Antenna Factor + Cable Loss + Read Level - Preamp Factor = Level.

For Emission not in Restricted Band
Low Band Edge Plot on Channel 0 / 2402 MHz

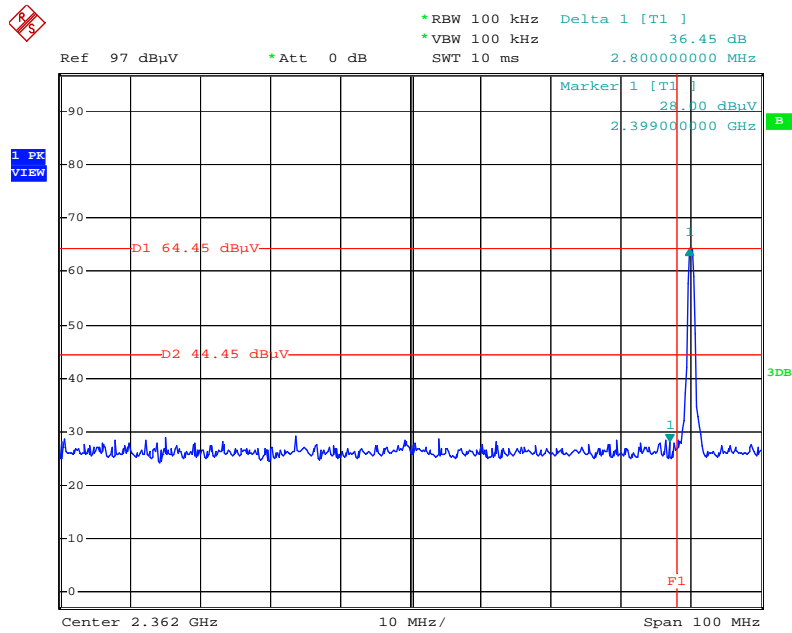

Date: 13.FEB.2012 19:29:20

High Band Edge Plot on Channel 39 / 2480 MHz

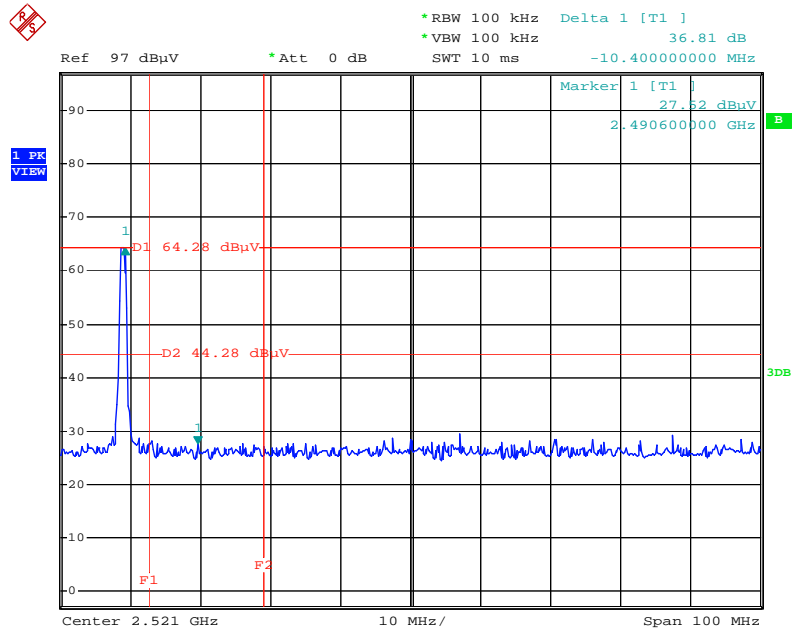

Date: 13.FEB.2012 19:07:00

4.9. Antenna Requirements

4.9.1. Limit

Except for special regulations, the Low-power Radio-frequency Devices must not be equipped with any jacket for installing an antenna with extension cable. An intentional radiator shall be designed to ensure that no antenna other than that furnished by the responsible party shall be used with the device. The use of a permanently attached antenna or of an antenna that uses a unique coupling to the intentional radiator shall be considered sufficient to comply with the provisions of this Section. The manufacturer may design the unit so that the user can replace a broken antenna, but the use of a standard antenna jack or electrical connector is prohibited. Further, this requirement does not apply to intentional radiators that must be professionally installed.

4.9.2. Antenna Connector Construction

Please refer to section 3.3 in this test report, antenna connector complied with the requirements.

5. LIST OF MEASURING EQUIPMENTS

Instrument	Manufacturer	Model No.	Serial No.	Characteristics	Calibration Date	Remark
EMI Test Receiver	R&S	ESCS 30	100377	9kHz ~ 2.75GHz	Sep. 14, 2011	Conduction (CO01-CB)
LISN	F.C.C.	FCC-LISN-50-16-2	04083	150kHz ~ 100MHz	Nov. 14, 2011	Conduction (CO01-CB)
V- LISN	Schwarzbeck	NSLK 8127	8127-478	9K ~ 30MHz	Nov. 30, 2011	Conduction (CO01-CB)
PULSE LIMITER	R&S	ESH3-Z2	100430	9K~30MHz	Jan. 04, 2012	Conduction (CO01-CB)
COND Cable	-	Cable	-	0.15MHz~30MHz	Dec. 04, 2011	Conduction (CO01-CB)
Signal analyzer	R&S	FSV40	100979	9KHz~40GHz	Sep. 26, 2011	Conducted (TH01-CB)
Thermo-Hygro Meter	N/A	HC 520	#1	15~70 degree	Nov. 02, 2011	Conducted (TH01-CB)
RF Power Divider	HP	11636A	00306	2GHz ~ 18GHz	N/A	Conducted (TH01-CB)
RF Power Splitter	Anaren	44100	1839	2GHz ~ 18GHz	N/A	Conducted (TH01-CB)
RF Power Splitter	Anaren	42100	17930	2GHz ~ 18GHz	N/A	Conducted (TH01-CB)
RF Cable-high	Woken	High Cable-7	-	1 GHz – 26.5 GHz	Nov. 17, 2011	Conducted (TH01-CB)
RF Cable-high	Woken	High Cable-8	-	1 GHz – 26.5 GHz	Nov. 17, 2011	Conducted (TH01-CB)
RF Cable-high	Woken	High Cable-9	-	1 GHz – 26.5 GHz	Nov. 17, 2011	Conducted (TH01-CB)
RF Cable-high	Woken	High Cable-10	-	1 GHz – 26.5 GHz	Nov. 17, 2011	Conducted (TH01-CB)
RF Cable-high	Woken	High Cable-11	-	1 GHz – 26.5 GHz	Nov. 17, 2011	Conducted (TH01-CB)
RF Cable-high	Woken	High Cable-12	-	1 GHz – 26.5 GHz	Nov. 17, 2011	Conducted (TH01-CB)
RF Cable-high	Woken	High Cable-13	-	1 GHz – 26.5 GHz	Nov. 17, 2011	Conducted (TH01-CB)
Power Sensor	Anritsu	MA2411B	0917223	300MHz~40GHz	Nov. 01, 2011	Conducted (TH01-CB)
Power Meter	Anritsu	ML2495A	1035008	300MHz~40GHz	Nov. 01, 2011	Conducted (TH01-CB)
BILOG ANTENNA	Schaffner	CBL6112D	22021	20MHz ~ 2GHz	Jan. 11, 2012	Radiation (03CH01-CB)
Horn Antenna	EMCO	3115	00075790	750MHz~18GHz	Nov. 25, 2011	Radiation (03CH01-CB)
Pre-Amplifier	Agilent	8447D	2944A10991	0.1MHz ~ 1.3GHz	Nov. 17, 2011	Radiation (03CH01-CB)
Pre-Amplifier	Agilent	8449B	3008A02310	1GHz ~ 26.5GHz	Nov. 29, 2011	Radiation (03CH01-CB)
Spectrum analyzer	R&S	FSP40	100056	9KHz~40GHz	Nov. 03, 2011	Radiation (03CH01-CB)
EMI Test Receiver	R&S	ESCS 30	100355	9KHz ~ 2.75GHz	Mar. 22, 2011	Radiation (03CH01-CB)
Loop Antenna	Teseq	HLA 6120	24155	9 kHz - 30 MHz	Sep. 09, 2010*	Radiation (03CH01-CB)



Turn Table	INN CO	CO 2000	N/A	0 ~ 360 degree	N/A	Radiation (03CH01-CB)
Antenna Mast	INN CO	CO2000	N/A	1 m - 4 m	N/A	Radiation (03CH01-CB)
RF Cable-low	Woken	Low Cable-1	N/A	30 MHz - 1 GHz	Nov. 17, 2011	Radiation (03CH01-CB)
RF Cable-high	Woken	High Cable-1	N/A	1 GHz – 26.5 GHz	Nov. 17, 2011	Radiation (03CH01-CB)
RF Cable-high	Woken	High Cable-2	N/A	1 GHz – 26.5 GHz	Nov. 17, 2011	Radiation (03CH01-CB)
RF Cable-high	Woken	High Cable-3	N/A	1 GHz - 40 GHz	Nov. 17, 2011	Radiation (03CH01-CB)
RF Cable-high	Woken	High Cable-4	N/A	1 GHz - 40 GHz	Nov. 17, 2011	Radiation (03CH01-CB)

Note: Calibration Interval of instruments listed above is one year.

Note: "*" Calibration Interval of instruments listed above is two years.

6. TEST LOCATION

SHIJR	ADD : 6Fl., No. 106, Sec. 1, Shintai 5th Rd., Shijr City, Taipei, Taiwan 221, R.O.C. TEL : 886-2-2696-2468 FAX : 886-2-2696-2255
HWA YA	ADD : No. 52, Hwa Ya 1st Rd., Kwei-Shan Hsiang, Tao Yuan Hsien, Taiwan, R.O.C. TEL : 886-3-327-3456 FAX : 886-3-318-0055
LINKOU	ADD : No. 30-2, Dingfu Tsuen, Linkou Shiang, Taipei, Taiwan 244, R.O.C TEL : 886-2-2601-1640 FAX : 886-2-2601-1695
DUNGHU	ADD : No. 3, Lane 238, Kangle St., Neihu Chiu, Taipei, Taiwan 114, R.O.C. TEL : 886-2-2631-4739 FAX : 886-2-2631-9740
JUNGHE	ADD : 7Fl., No. 758, Jungjeng Rd., Junghe City, Taipei, Taiwan 235, R.O.C. TEL : 886-2-8227-2020 FAX : 886-2-8227-2626
NEIHU	ADD : 4Fl., No. 339, Hsin Hu 2 nd Rd., Taipei 114, Taiwan, R.O.C. TEL : 886-2-2794-8886 FAX : 886-2-2794-9777
JHUBEI	ADD : No.8, Lane 724, Bo-ai St., Jhubei City, HsinChu County 302, Taiwan, R.O.C. TEL : 886-3-656-9065 FAX : 886-3-656-9085

7. TAF CERTIFICATE OF ACCREDITATION



Certificate No. : L1190-110702

財團法人全國認證基金會
Taiwan Accreditation Foundation

Certificate of Accreditation

This is to certify that

Sporton International Inc.

EMC & Wireless Communications Laboratory

No.52, Hwa Ya 1st Road, Hwa Ya Technology Park, Kwei-Shan Hsiang, Tao Yuan Hsien,
Taiwan, R.O.C.

is accredited in respect of laboratory

Accreditation Criteria : ISO/IEC 17025:2005
Accreditation Number : 1190
Originally Accredited : December 15, 2003
Effective Period : January 10, 2010 to January 09, 2013
Accredited Scope : Testing Field, see described in the Appendix
Specific Accreditation Program : Accreditation Program for Designated Testing Laboratory for Commodities Inspection
Accreditation Program for Telecommunication Equipment Testing Laboratory
Accreditation Program for BSMI Mutual Recognition Arrangement with Foreign Authorities



Jay-San Chen
President, Taiwan Accreditation Foundation
Date : July 02, 2011

P1, total 22 pages

The Appendix forms an integral part of this Certificate, which shall be invalid when use without the Appendix