



# SPORTON International Inc.

No.8, Lane 724, Bo-ai St., Jhubei City, HsinChu County 302, Taiwan, R.O.C.  
Ph: 886-3-656-9065 / FAX: 886-3-656-9085 / www.sporton.com.tw

## FCC RADIO TEST REPORT

Applicant's company	Realtek Semiconductor Corp.
Applicant Address	No. 2, Innovation Road II, Hsinchu Science Park, Hsinchu 300, Taiwan
FCC ID	TX2-RTL8723AS
Manufacturer's company	Realtek Semiconductor Corp.
Manufacturer Address	No. 2, Innovation Road II, Hsinchu Science Park, Hsinchu 300, Taiwan

Product Name	802.11b/g/n RTL8723AS combo module
Brand Name	Realtek
Model Name	RTL8723AS
Test Rule	47 CFR FCC Part 15 Subpart C § 15.247
Test Freq. Range	2400 ~ 2483.5MHz
Received Date	Jan. 19, 2012
Final Test Date	Mar. 07, 2012
Submission Type	Original Equipment



### Statement

Test result included in this report is for the IEEE 802.11n and IEEE 802.11b/g part of the product.

The test result in this report refers exclusively to the presented test model / sample.

Without written approval of SPORTON International Inc., the test report shall not be reproduced except in full.

The measurements and test results shown in this test report were made in accordance with the procedures and found in compliance with the limit given in ANSI C63.10-2009 and 47 CFR FCC Part 15 Subpart C.

The test equipment used to perform the test is calibrated and traceable to NML/ROC.



## Table of Contents

<b>1. CERTIFICATE OF COMPLIANCE .....</b>	<b>1</b>
<b>2. SUMMARY OF THE TEST RESULT .....</b>	<b>2</b>
<b>3. GENERAL INFORMATION .....</b>	<b>3</b>
3.1. Product Details.....	3
3.2. Accessories.....	5
3.3. Table for Filed Antenna.....	5
3.4. Table for Carrier Frequencies .....	6
3.5. Table for Test Modes .....	7
3.6. Table for Testing Locations.....	8
3.7. Table for Supporting Units .....	9
3.8. Table for Parameters of Test Software Setting .....	9
3.9. Test Configurations .....	10
<b>4. TEST RESULT .....</b>	<b>16</b>
4.1. AC Power Line Conducted Emissions Measurement.....	16
4.2. Peak Output Power Measurement .....	22
4.3. Average Output Power Measurement .....	27
4.4. Power Spectral Density Measurement .....	32
4.5. 6dB Spectrum Bandwidth Measurement .....	41
4.6. Radiated Emissions Measurement .....	50
4.7. Band Edge Emissions Measurement .....	106
4.8. Antenna Requirements .....	139
<b>5. LIST OF MEASURING EQUIPMENTS .....</b>	<b>140</b>
<b>6. TEST LOCATION.....</b>	<b>142</b>
<b>7. TAF CERTIFICATE OF ACCREDITATION .....</b>	<b>143</b>
<b>APPENDIX A. TEST PHOTOS .....</b>	<b>A1 ~ A11</b>
<b>APPENDIX B. MAXIMUM PERMISSIBLE EXPOSURE .....</b>	<b>B1 ~ B4</b>
<b>APPENDIX C. CO-LOCATION REPORT.....</b>	<b>C1 ~ C5</b>
<b>APPENDIXD. ANTENNA LIST</b>	



## History of This Test Report

REPORT NO.	VERSION	DESCRIPTION	ISSUED DATE
FR211947AA	Rev. 01	Initial issue of report	Mar. 27, 2012

## 1. CERTIFICATE OF COMPLIANCE

Product Name : 802.11b/g/n RTL8723AS combo module  
Brand Name : Realtek  
Model Name : RTL8723AS  
Applicant : Realtek Semiconductor Corp.  
Test Rule Part(s) : 47 CFR FCC Part 15 Subpart C § 15.247

Sporton International as requested by the applicant to evaluate the EMC performance of the product sample received on Jan. 19, 2012 would like to declare that the tested sample has been evaluated and found to be in compliance with the tested rule parts. The data recorded as well as the test configuration specified is true and accurate for showing the sample's EMC nature.



Jordan Hsiao

SPORTON INTERNATIONAL INC.

## 2. SUMMARY OF THE TEST RESULT

Applied Standard: 47 CFR FCC Part 15 Subpart C				
Part	Rule Section	Description of Test	Result	Under Limit
4.1	15.207	AC Power Line Conducted Emissions	Complies	10.17 dB
4.2	15.247(b)(3)	Peak Output Power	Complies	6.07 dB
4.3	-	Average Output Power	-	-
4.4	15.247(e)	Power Spectral Density	Complies	15.34 dB
4.5	15.247(a)(2)	6dB Spectrum Bandwidth	Complies	-
4.6	15.247(d)	Radiated Emissions	Complies	3.04 dB
4.7	15.247(d)	Band Edge Emissions	Complies	4.03 dB
4.8	15.203	Antenna Requirements	Complies	-

Test Items	Uncertainty	Remark
AC Power Line Conducted Emissions	±2.3dB	Confidence levels of 95%
Maximum Peak Output Power	±0.8dB	Confidence levels of 95%
Power Spectral Density	±0.5dB	Confidence levels of 95%
6dB Spectrum Bandwidth	±8.5×10 <sup>-8</sup>	Confidence levels of 95%
Radiated Emissions (9kHz~30MHz)	±0.8dB	Confidence levels of 95%
Radiated Emissions (30MHz~1000MHz)	±1.9dB	Confidence levels of 95%
Radiated / Band Edge Emissions (1GHz~18GHz)	±1.9dB	Confidence levels of 95%
Radiated Emissions (18GHz~40GHz)	±1.9dB	Confidence levels of 95%
Temperature	±0.7°C	Confidence levels of 95%
Humidity	±3.2%	Confidence levels of 95%
DC / AC Power Source	±1.4%	Confidence levels of 95%

### 3. GENERAL INFORMATION

#### 3.1. Product Details

##### IEEE 802.11n

Items	Description
Product Type	WLAN (1TX, 1RX)
Radio Type	Intentional Transceiver
Power Type	From USB or SDIO+UART
Modulation	see the below table for IEEE 802.11n
Data Modulation	OFDM (BPSK / QPSK / 16QAM / 64QAM)
Data Rate (Mbps)	see the below table for IEEE 802.11n
Frequency Range	2400 ~ 2483.5MHz
Channel Number	11 for 20MHz bandwidth ; 7 for 40MHz bandwidth
Channel Band Width (99%)	Main Port : MCS0 (20MHz): 17.72 MHz ; MCS0 (40MHz): 36.16 MHz Aux Port : MCS0 (20MHz): 17.72 MHz ; MCS0 (40MHz): 36.16 MHz
Peak Output Power	Main Port : MCS0 (20MHz): 23.78 dBm ; MCS0 (40MHz): 21.52 dBm Aux Port : MCS0 (20MHz): 23.27 dBm ; MCS0 (40MHz): 21.02 dBm
Carrier Frequencies	Please refer to section 3.4
Antenna	Please refer to section 3.3

##### IEEE 802.11b/g

Items	Description
Product Type	WLAN (1TX, 1RX)
Radio Type	Intentional Transceiver
Power Type	From USB or SDIO+UART
Modulation	DSSS for IEEE 802.11b ; OFDM for IEEE 802.11g
Data Modulation	DSSS (BPSK / QPSK / CCK) ; OFDM (BPSK / QPSK / 16QAM / 64QAM)
Data Rate (Mbps)	DSSS (1/ 2/ 5.5/11) ; OFDM (6/9/12/18/24/36/48/54)
Frequency Range	2400 ~ 2483.5MHz
Channel Number	11
Channel Band Width (99%)	Main Port : 11b: 15.08 MHz ; 11g: 16.52 MHz Aux Port : 11b: 15.12 MHz ; 11g: 16.48 MHz
Peak Output Power	Main Port : 11b: 18.71 dBm ; 11g: 23.93 dBm Aux Port : 11b: 17.32 dBm ; 11g: 23.26 dBm
Carrier Frequencies	Please refer to section 3.4
Antenna	Please refer to section 3.3

**Antenna & Band width**

Antenna	Single (TX)	
Band width Mode	20 MHz	40 MHz
802.11b	V	X
802.11g	V	X
802.11n	V	V

**IEEE 802.11n spec**

MCS Index	Nss	Modulation	R	NBPS	NCBPS		NDBPS		Datarate(Mbps)			
					20MHz	40MHz	20MHz	40MHz	800nsGI		400nsGI	
									20MHz	40MHz	20MHz	40MHz
0	1	BPSK	1/2	1	52	108	26	54	6.5	13.5	7.200	15
1	1	QPSK	1/2	2	104	216	52	108	13.0	27.0	14.400	30
2	1	QPSK	3/4	2	104	216	78	162	19.5	40.5	21.700	45
3	1	16-QAM	1/2	4	208	432	104	216	26.0	54.0	28.900	60
4	1	16-QAM	3/4	4	208	432	156	324	39.0	81.0	43.300	90
5	1	64-QAM	2/3	6	312	648	208	432	52.0	108.0	57.800	120
6	1	64-QAM	3/4	6	312	648	234	486	58.5	121.5	65.000	135
7	1	64-QAM	5/6	6	312	648	260	540	65.0	135.0	72.200	150
8	2	BPSK	1/2	1	104	216	52	108	13.0	27.0	14.444	30
9	2	QPSK	1/2	2	208	432	104	216	26.0	54.0	28.889	60
10	2	QPSK	3/4	2	208	432	156	324	39.0	81.0	43.333	90
11	2	16-QAM	1/2	4	416	864	208	432	52.0	108.0	57.778	120
12	2	16-QAM	3/4	4	416	864	312	648	78.0	162.0	86.667	180
13	2	64-QAM	2/3	6	624	1296	416	864	104.0	216.0	115.556	240
14	2	64-QAM	3/4	6	624	1296	468	972	117.0	243.0	130.000	270
15	2	64-QAM	5/6	6	624	1296	520	1080	130.0	270.0	144.444	300

Symbol	Explanation
NSS	Number of spatial streams
R	Code rate
NBPS	Number of coded bits per single carrier
NCBPS	Number of coded bits per symbol
NDBPS	Number of data bits per symbol
GI	guard interval

### 3.2. Accessories

N/A

### 3.3. Table for Filed Antenna

Ant.	Brand	Model Name	Antenna Type	Connector type	Gain (dBi)	Remark
1	LYNwave	ALA110-222050-300010	PIFA Antenna	IPEX	3.5	TX/RX
2	JOYMAX	TWF-614XMPXX-500	Dipole Antenna	IPEX	3.0	TX/RX

Note: There are two types of EUT, one is diversity type and the other is single type. Both of the EUTs work with two types antenna.

**For diversity type: (Both of those two antenna connectors can be used.)**

The EUT supports the antenna with TX/RX diversity function for WLAN and Bluetooth.

**802.11b/g (1TX, 1RX)**

Both of Ant. 1 and Ant. 2 can be used as transmitting/receiving antennas, but only one antenna can be used as transmitting/receiving antenna at the same time.

**802.11n (MCS0~7) (1TX, 1RX)**

Both of Ant. 1 and Ant. 2 can be used as transmitting/receiving antennas, but only one antenna can be used as transmitting/receiving antenna at the same time.

**Bluetooth:**

Base on WIFI's test mode to select the other antenna to perform the test. (Ex. Assume Main port was selected to conduct transmitting function in WIFI, so AUX port was selected in Bluetooth Mode. Vice versa.)

**For single type: [Only antenna connector (Main port or Aux port) can be used.]**

**802.11b/g (1TX, 1RX)**

In case of this, only one antenna will be attached to main (or aux) port. (i.e. one antenna and two connectors will be marketed.) WiFi and BT share main(or aux) in time slot, like time division. They fix main (or aux) port to transmit and receive, depending on which port was used to attach the antenna.

**802.11n (MCS0~7) (1TX, 1RX)**

In case of this, only one antenna will be attached to main (or aux) port. (i.e. one antenna and two connectors will be marketed.) WiFi and BT share main(or aux) in time slot, like time division. They fix main (or aux) port to transmit and receive, depending on which port was used to attach the antenna.

**Bluetooth:**

In case of this, only one antenna will be attached to main (or aux) port. (i.e. one antenna and two connectors will be marketed.) WiFi and BT share main(or aux) in time slot, like time division. They fix main (or aux) port to transmit and receive, depending on which port was used to attach the antenna.

The signal path length from IC to aux port is larger by around half a wave-length, than the signal path length from IC to main port. This extra half a wave-length signal path introduce some extra loss. That's why peak power of aux port is lower than main port.





### 3.4. Table for Carrier Frequencies

For IEEE 802.11b/g, use Channel 1~Channel 11.

There are two bandwidth systems for IEEE 802.11n.

For both 20MHz bandwidth systems, use Channel 1~Channel 11.

For both 40MHz bandwidth systems, use Channel 3~Channel 9.

Frequency Band	Channel No.	Frequency	Channel No.	Frequency
2400~2483.5MHz	1	2412 MHz	7	2442 MHz
	2	2417 MHz	8	2447 MHz
	3	2422 MHz	9	2452 MHz
	4	2427 MHz	10	2457 MHz
	5	2432 MHz	11	2462 MHz
	6	2437 MHz	-	-

### 3.5. Table for Test Modes

Preliminary tests were performed in different data rate to find the worst radiated emission. The data rate shown in the table below is the worst-case rate with respect to the specific test item. Investigation has been done on all the possible configurations for searching the worst cases. The following table is a list of the test modes shown in this test report.

Test Items	Mode	Data Rate	Channel	Connecter
AC Power Line Conducted Emissions	Normal Link	-	-	-
Peak Output Power	MCS0/20MHz	13 Mbps	1/6/11	1/2
Average Output Power	MCS0/40MHz	27 Mbps	3/6/9	1/2
Power Spectral Density	11b/BPSK	1 Mbps	1/6/11	1/2
	11g/BPSK	6 Mbps	1/6/11	1/2
6dB Spectrum Bandwidth	MCS0/20MHz	13 Mbps	1/6/11	1/2
	MCS0/40MHz	27 Mbps	3/6/9	1/2
	11b/BPSK	1 Mbps	1/6/11	1/2
	11g/BPSK	6 Mbps	1/6/11	1/2
Radiated Emissions 9kHz~1GHz	Normal Link	-	-	-
Radiated Emissions 1GHz~10 <sup>th</sup> Harmonic	MCS0/20MHz	13 Mbps	1/6/11	1/2
	MCS0/40MHz	27 Mbps	3/6/9	1/2
	11b/BPSK	1 Mbps	1/6/11	1/2
	11g/BPSK	6 Mbps	1/6/11	1/2
Band Edge Emissions	MCS0/20MHz	13 Mbps	1/11	1/2
	MCS0/40MHz	27 Mbps	3/9	1/2
	11b/BPSK	1 Mbps	1/11	1/2
	11g/BPSK	6 Mbps	1/11	1/2

The following test modes were performed for all tests:

EUT 1: Power from USB

EUT 2: Power from SDIO+UART

**For Conducted Emission test:**

Mode 1: EUT1 +WLAN+BT with Main port of PIFA antenna

Mode 2: EUT1 +WLAN+BT with Aux port of PIFA antenna

Mode 3: EUT2+WLAN+BT with Main port of PIFA antenna

Mode 4: EUT2+WLAN+BT with Aux port of PIFA antenna

Mode 1 and Mode 2 have been evaluated to be the worst case, thus measurement will follow the same EUT.

Mode 5: EUT1 +WLAN+BT with Main port of Dipole antenna

Mode 6: EUT1 +WLAN+BT with Aux port of Dipole antenna

Mode 1, Mode 2, Mode 5 and Mode 6 was selected and recorded in this report.

### For Radiated Emission test:

<For radiated 30MHz~1GHz>

Mode 1: EUT1 +WLAN+BT with Main port of PIFA antenna

Mode 2: EUT1 +WLAN+BT with Aux port of PIFA antenna

Mode 3: EUT2 +WLAN+BT with Main port of PIFA antenna

Mode 4: EUT2 +WLAN+BT with Aux port of PIFA antenna

Mode 1 and Mode 2 have been evaluated to be the worst case, thus measurement will follow the same EUT.

Mode 5: EUT1 +WLAN+BT with Main port of Dipole antenna

Mode 6: EUT1 +WLAN+BT with Aux port of Dipole antenna

Mode 1, Mode 2, Mode 5 and Mode 6 were selected and recorded in this report.

<For radiated above 1GHz>

Mode 1: EUT1 +WLAN+BT with Main port of PIFA antenna

Mode 2: EUT1 +WLAN+BT with Aux port of PIFA antenna

Mode 3: EUT2 +WLAN+BT with Main port of PIFA antenna

Mode 4: EUT2 +WLAN+BT with Aux port of PIFA antenna

Mode 5: EUT1 +WLAN+BT with Main port of Dipole antenna

Mode 6: EUT1 +WLAN+BT with Aux port of Dipole antenna

Mode 7: EUT2 +WLAN+BT with Main port of Dipole antenna

Mode 8: EUT2 +WLAN+BT with Aux port of Dipole antenna

Due to Mode 3, Mode 4, Mode 7 and Mode 8 generated the worst test result, so they were recorded in the report.

### 3.6. Table for Testing Locations

Test Site No.	Site Category	Location	FCC Reg. No.	IC File No.	VCCI Reg. No
03CH01-CB	SAC	Hsin Chu	262045	IC 4086D	-
CO01-CB	Conduction	Hsin Chu	262045	IC 4086D	-
TH01-CB	OVEN Room	Hsin Chu	-	-	-

Open Area Test Site (OATS); Semi Anechoic Chamber (SAC); Fully Anechoic Chamber (FAC).

Please refer section 6 for Test Site Address.

### 3.7. Table for Supporting Units

Support Unit	Brand	Model	FCC ID
Notebook	DELL	1340	E2K4965AGNM
Notebook	DELL	PP25L	E2K4965AGNM
Mouse	Logitech	M-U0026	DoC
EARPHONES	E-books	E-EPC040	DOC
Wireless AP	Planex	GW-AP54SGX	-

### 3.8. Table for Parameters of Test Software Setting

During testing, Channel & Power Controlling Software provided by the customer was used to control the operating channel as well as the output power level. The RF output power selection is for the setting of RF output power expected by the customer and this must be calibrated and record the index in internal memory by manufacturer before shipping.

#### Power Parameters of IEEE 802.11n

Test Software Version	Realtek 11n 8723ASDIO WLAN MP Diagnostic Program 0.0006.0202.2012		
Frequency	2412 MHz	2437 MHz	2462 MHz
MCS0 20MHz	40	46	40
Frequency	2422 MHz	2437 MHz	2452 MHz
MCS0 40MHz	39	39	39

#### Power Parameters of IEEE 802.11b/g

Test Software Version	Realtek 11n 8723ASDIO WLAN MP Diagnostic Program 0.0006.0202.2012		
Frequency	2412 MHz	2437 MHz	2462 MHz
IEEE 802.11b	42	42	42
IEEE 802.11g	42	46	42

During the test, "Realtek 11n 8723ASDIO WLAN MP Diagnostic Program 0.0006.0202.2012" under WIN XP was executed the test program to control the EUT continuously transmit RF signal.

### 3.9. Test Configurations

#### 3.9.1. Radiation Emissions Test Configuration

Test Configuration: 30MHz~1GHz

< Mode 1 / Mode 2 >

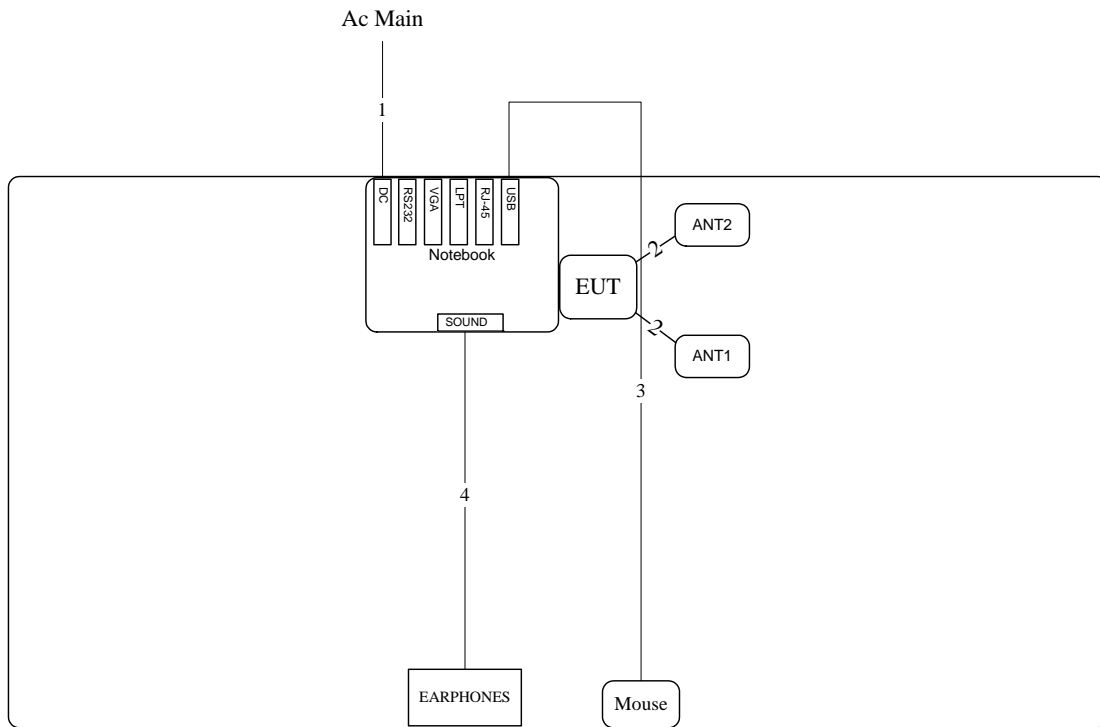

AP

BT NB

Item	Connection	Shield	Length
1	Power cable	No	1.8m
2	Ant cable	Yes	0.2m
3	Usb cable	Yes	1.8m
4	Earphones	No	1.1m

< Mode 5 / Mode 6 >

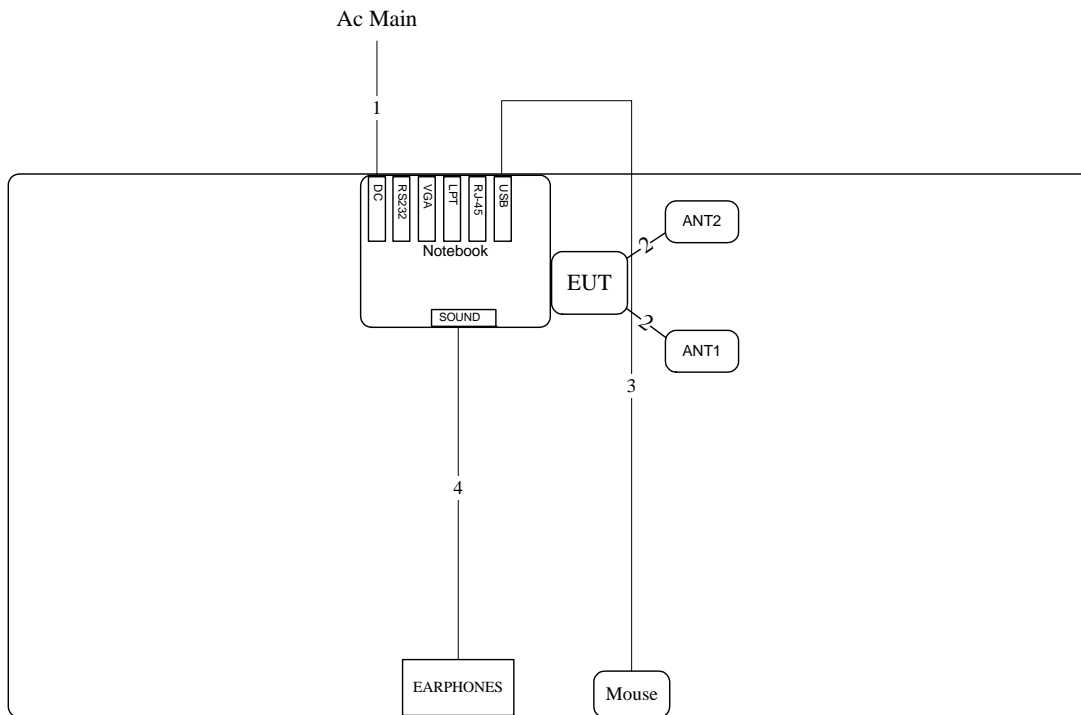

AP

BT NB

Item	Connection	Shield	Length
1	Power cable	No	1.8m
2	Ant cable	Yes	0.20m
3	Usb cable	Yes	1.8m
4	Earphones	No	1.1m

Test Configuration: above 1GHz

< Mode 3 / Mode 4 >

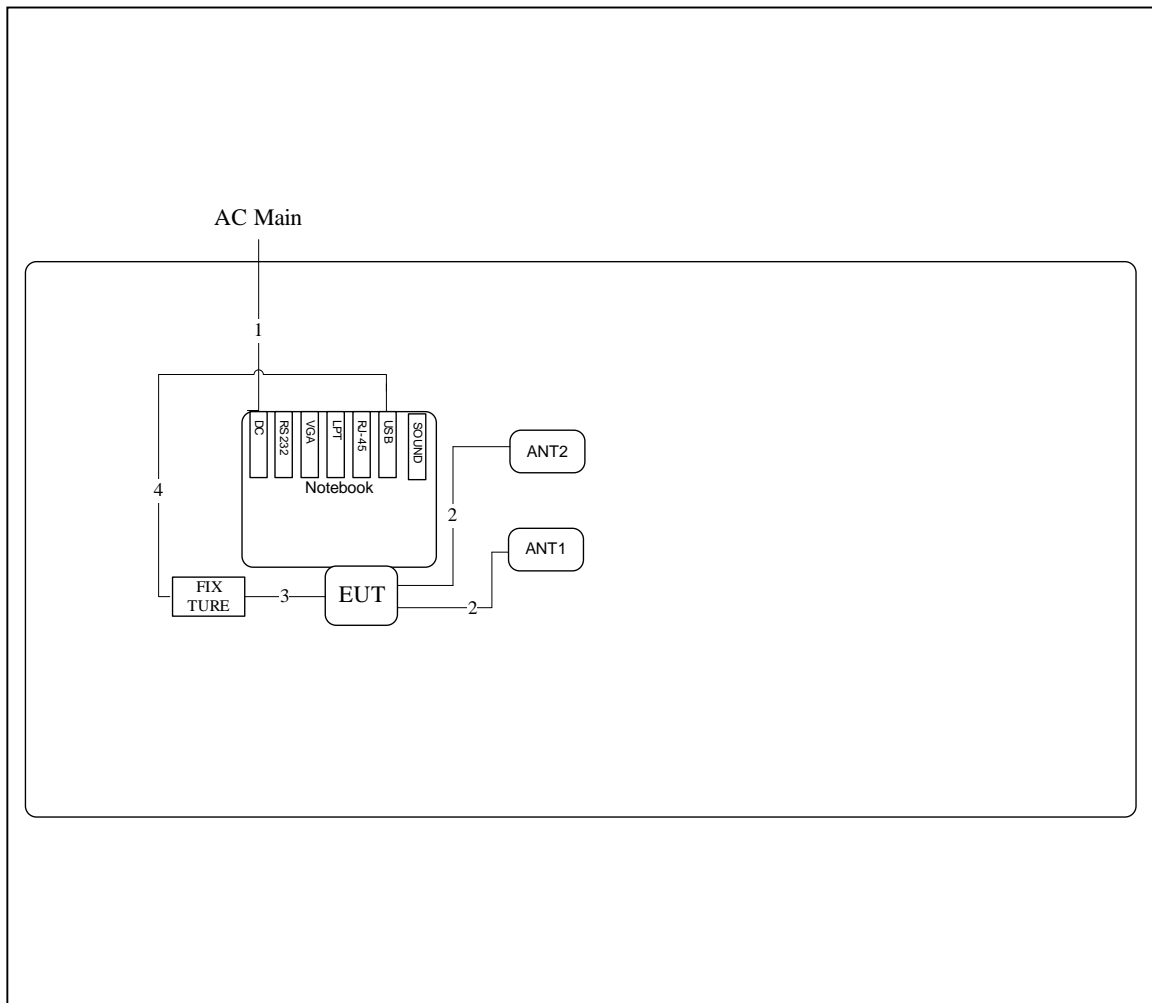

Item	Connection	Shield	Length
1	Power cable	No	1.8m
2	Ant cable	Yes	0.20m
3	Console cable	Yes	0.35m
4	RS232 TO USB CABLE	No	0.45m

< Mode 7 / Mode 8 >

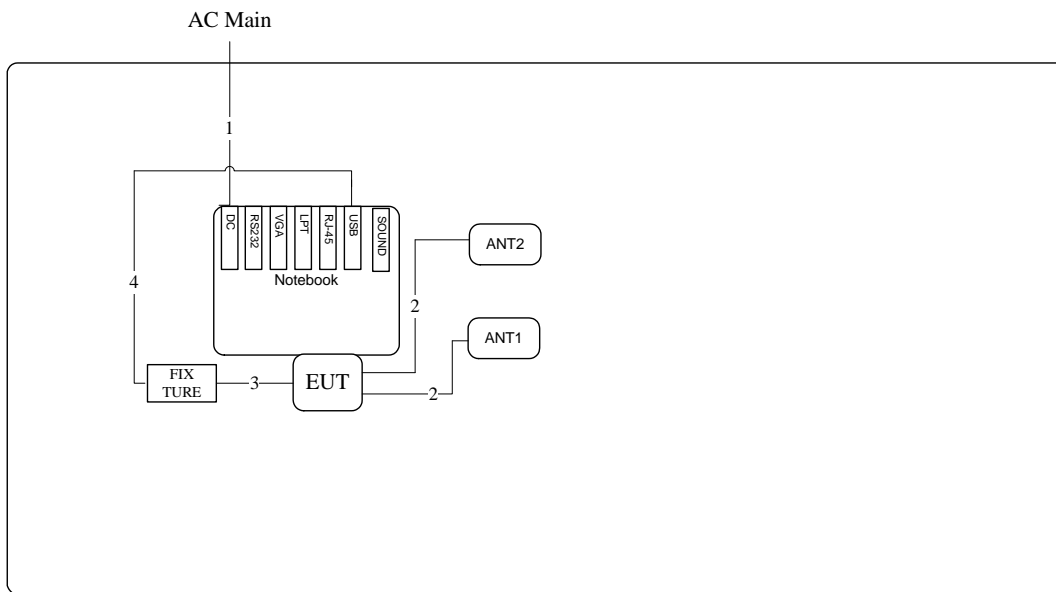

Item	Connection	Shield	Length
1	Power cable	No	1.8m
2	Ant cable	Yes	0.20m
3	Console cable	Yes	0.35m
4	RS232 TO USB CABLE	No	0.45m



### 3.9.2. AC Power Line Conduction Emissions Test Configuration

< Mode 1 / Mode 2 >

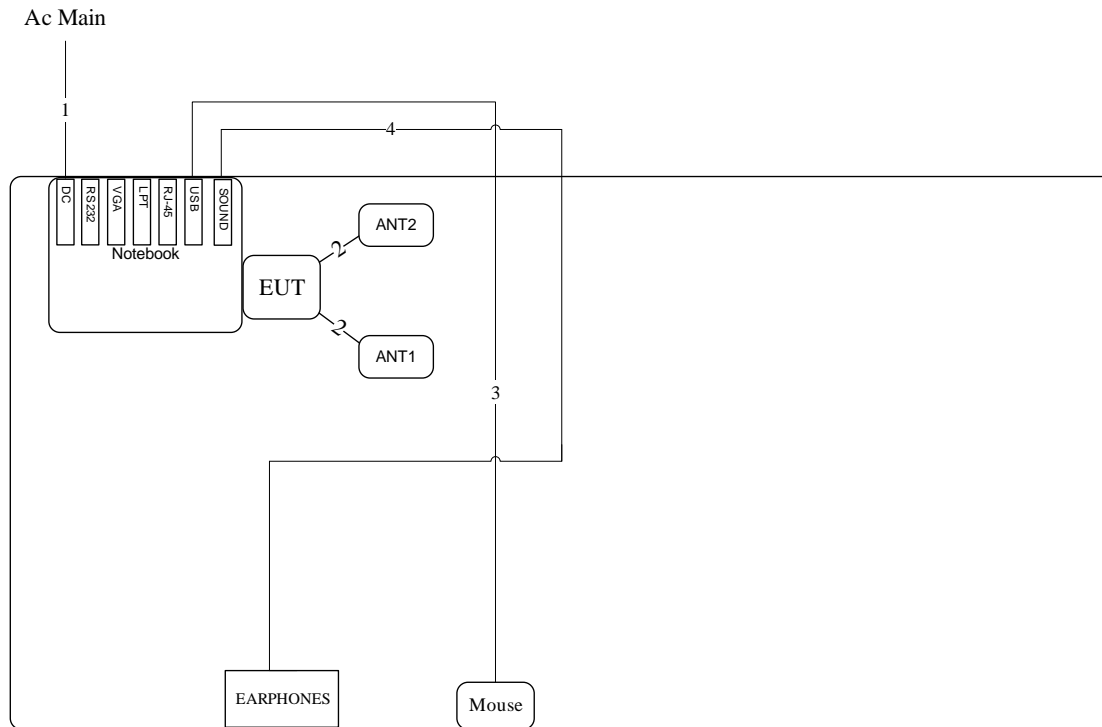

AP

BT NB

Item	Connection	Shield	Length
1	Power cable	No	1.8m
2	Ant cable	Yes	0.20m
3	Usb cable	Yes	1.8m
4	Earphones	No	1.1m

< Mode 5 / Mode 6 >

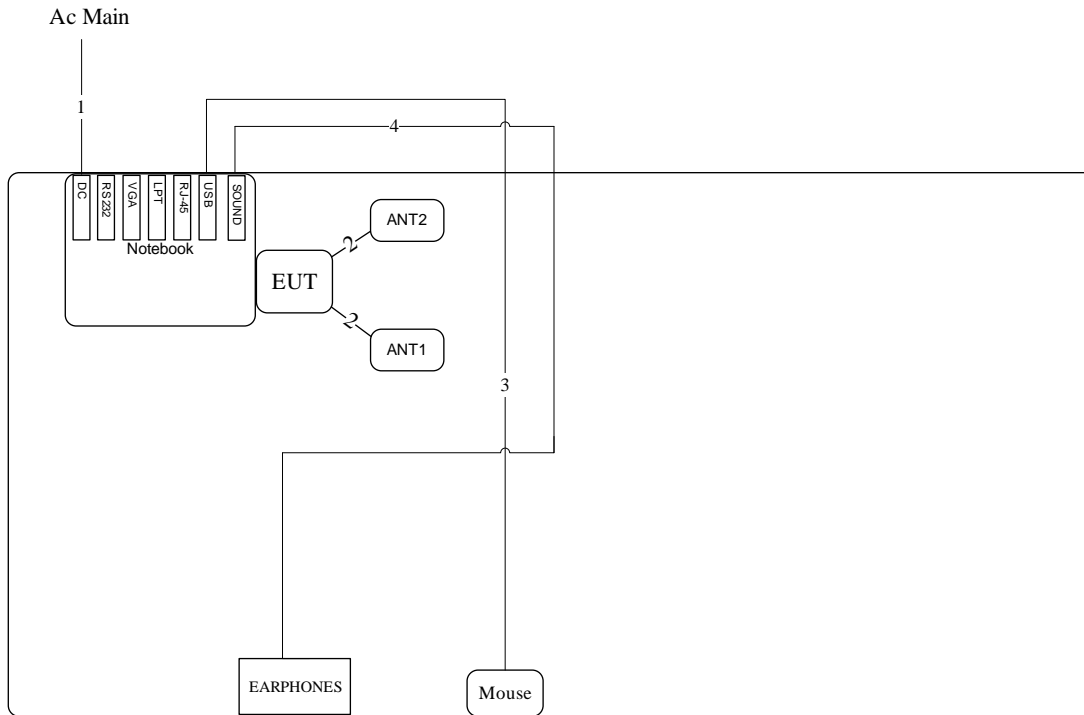

AP

BT NB

Item	Connection	Shield	Length
1	Power cable	No	1.8m
2	Ant cable	Yes	0.20m
3	Usb cable	Yes	1.8m
4	Earphones	No	1.1m

## 4. TEST RESULT

### 4.1. AC Power Line Conducted Emissions Measurement

#### 4.1.1. Limit

For this product which is designed to be connected to the AC power line, the radio frequency voltage that is conducted back onto the AC power line on any frequency or frequencies within the band 150 kHz to 30 MHz shall not exceed below limits table.

Frequency (MHz)	QP Limit (dBuV)	AV Limit (dBuV)
0.15~0.5	66~56	56~46
0.5~5	56	46
5~30	60	50

#### 4.1.2. Measuring Instruments and Setting

Please refer to section 5 of equipments list in this report. The following table is the setting of the receiver.

Receiver Parameters	Setting
Attenuation	10 dB
Start Frequency	0.15 MHz
Stop Frequency	30 MHz
IF Bandwidth	9 KHz

#### 4.1.3. Test Procedures

1. Configure the EUT according to ANSI C63.10. The EUT or host of EUT has to be placed 0.4 meter far from the conducting wall of the shielding room and at least 80 centimeters from any other grounded conducting surface.
2. Connect EUT or host of EUT to the power mains through a line impedance stabilization network (LISN).
3. All the support units are connected to the other LISNs. The LISN should provide 50uH/50ohms coupling impedance.
4. The frequency range from 150 KHz to 30 MHz was searched.
5. Set the test-receiver system to Peak Detect Function and Specified Bandwidth with Maximum Hold Mode.
6. The measurement has to be done between each power line and ground at the power terminal.

#### 4.1.4. Test Setup Layout

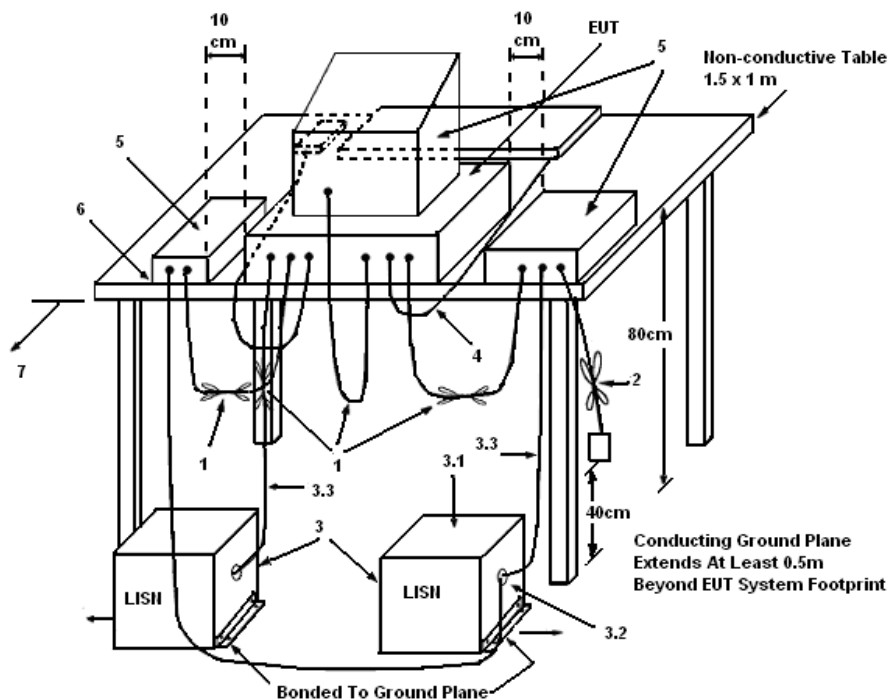

#### LEGEND:

- (1) Interconnecting cables that hang closer than 40 cm to the ground plane shall be folded back and forth in the center forming a bundle 30 to 40 cm long.
- (2) I/O cables that are not connected to a peripheral shall be bundled in the center. The end of the cable may be terminated, if required, using the correct terminating impedance. The overall length shall not exceed 1 m.
- (3) EUT connected to one LISN. Unused LISN measuring port connectors shall be terminated in 50  $\Omega$ . LISN can be placed on top of, or immediately beneath, reference ground plane.
- (3.1) All other equipment powered from additional LISN(s).
- (3.2) Multiple outlet strip can be used for multiple power cords of non-EUT equipment.
- (3.3) LISN at least 80 cm from nearest part of EUT chassis.
- (4) Cables of hand-operated devices, such as keyboards, mice, etc., shall be placed as for normal use.
- (5) Non-EUT components of EUT system being tested.
- (6) Rear of EUT, including peripherals, shall all be aligned and flush with rear of tabletop.
- (7) Rear of tabletop shall be 40 cm removed from a vertical conducting plane that is bonded to the ground plane.

#### 4.1.5. Test Deviation

There is no deviation with the original standard.

#### 4.1.6. EUT Operation during Test

The EUT was placed on the test table and programmed in normal function.

4.1.7. Results of AC Power Line Conducted Emissions Measurement

Temperature	21°C	Humidity	63%
Test Engineer	Ethan Hung	Phase	Line
Configuration	Normal Link	Test Mode	Mode 1 / Mode 2

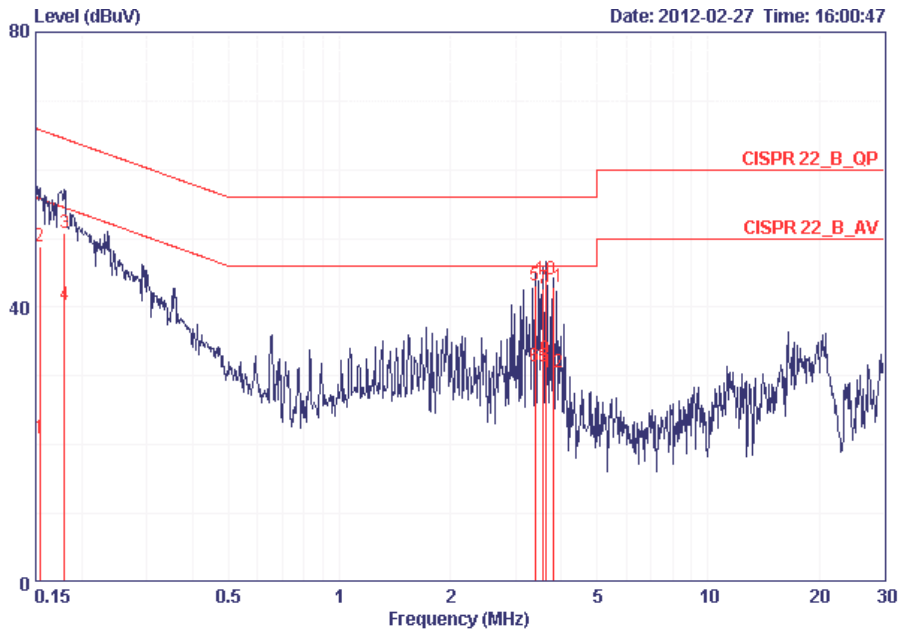

	Freq	Level	Over Limit	Limit Line	Read Level	LISN Factor	Cable Loss	Remark
	MHz	dBuV	dB	dBuV	dBuV	dB	dB	
1	0.15403	20.94	-34.84	55.78	20.67	0.07	0.20	AVERAGE
2	0.15403	48.76	-17.02	65.78	48.49	0.07	0.20	QP
3	0.17961	50.89	-13.61	64.50	50.63	0.06	0.20	QP
4	0.17961	40.24	-14.26	54.50	39.98	0.06	0.20	AVERAGE
5	3.390	43.14	-12.86	56.00	42.77	0.09	0.28	QP
6	3.390	31.37	-14.63	46.00	31.00	0.09	0.28	AVERAGE
7	3.565	42.63	-13.37	56.00	42.24	0.09	0.30	QP
8	3.565	31.46	-14.54	46.00	31.07	0.09	0.30	AVERAGE
9	3.625	32.49	-13.51	46.00	32.10	0.09	0.30	AVERAGE
10	3.625	43.95	-12.05	56.00	43.56	0.09	0.30	QP
11	3.807	42.99	-13.01	56.00	42.59	0.10	0.30	QP
12	3.807	30.58	-15.42	46.00	30.18	0.10	0.30	AVERAGE

Temperature	25°C	Humidity	65%
Test Engineer	Ethan Hung	Phase	Neutral
Configuration	Normal Link	Test Mode	Mode 1 / Mode 2

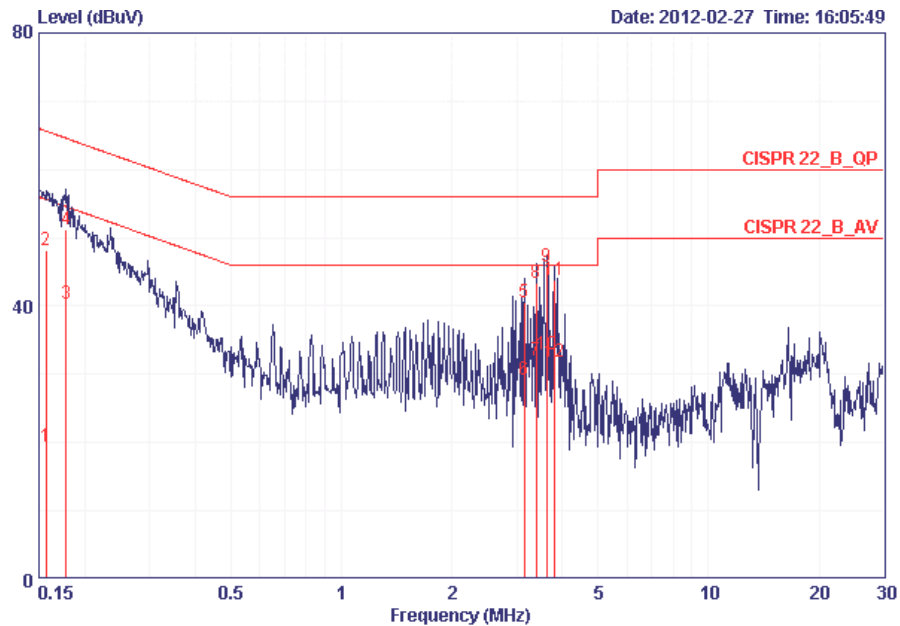

	Freq	Level	Over Limit	Limit Line	Read Level	LISN Factor	Cable Loss	Remark
	MHz	dBuV	dB	dBuV	dBuV	dB	dB	
1	0.15650	19.38	-36.27	55.65	19.08	0.10	0.20	AVERAGE
2	0.15650	48.22	-17.43	65.65	47.92	0.10	0.20	QP
3	0.17772	40.31	-14.28	54.59	40.02	0.09	0.20	AVERAGE
4	0.17772	51.33	-13.26	64.59	51.04	0.09	0.20	QP
5	3.150	40.59	-15.41	56.00	40.23	0.12	0.23	QP
6	3.150	29.25	-16.75	46.00	28.89	0.12	0.23	AVERAGE
7	3.390	32.14	-13.86	46.00	31.73	0.13	0.28	AVERAGE
8	3.390	43.28	-12.72	56.00	42.87	0.13	0.28	QP
9	3.626	45.83	-10.17	56.00	45.40	0.13	0.30	QP
10	3.626	32.96	-13.04	46.00	32.53	0.13	0.30	AVERAGE
11	3.805	43.78	-12.22	56.00	43.34	0.14	0.30	QP
12	3.805	31.80	-14.20	46.00	31.36	0.14	0.30	AVERAGE

Note:

Level = Read Level + LISN Factor + Cable Loss.

Temperature	21°C	Humidity	63%
Test Engineer	Ethan Hung	Phase	Line
Configuration	Normal Link	Test Mode	Mode 5 / Mode 6

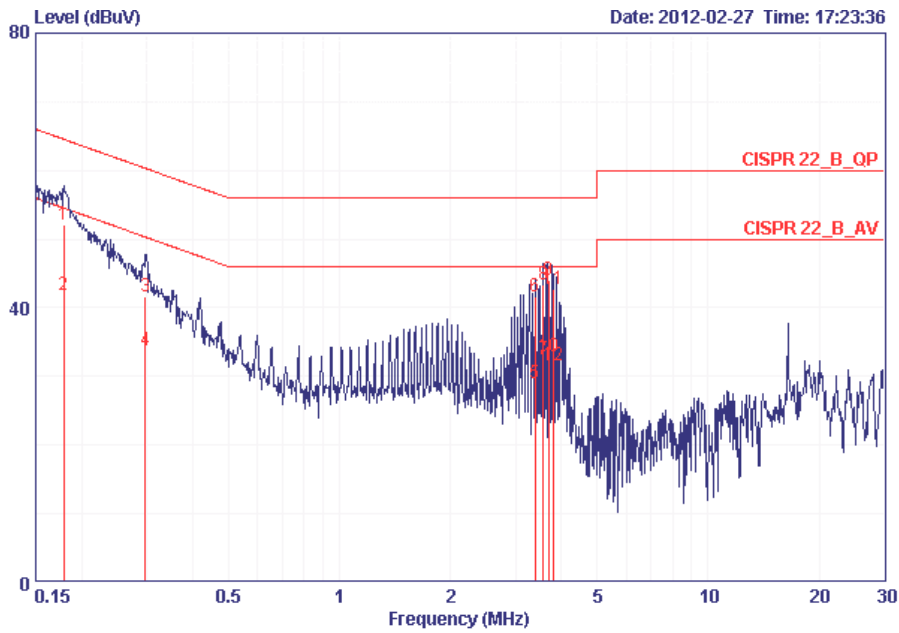

	Freq	Level	Over Limit	Limit Line	Read Level	LISN Factor	Cable Loss	Remark
	MHz	dBuV	dB	dBuV	dBuV	dB	dB	
1 @	0.17866	52.01	-12.54	64.55	51.75	0.06	0.20	QP
2 @	0.17866	41.89	-12.66	54.55	41.63	0.06	0.20	AVERAGE
3	0.29712	41.58	-18.74	60.32	41.34	0.04	0.20	QP
4	0.29712	33.74	-16.58	50.32	33.50	0.04	0.20	AVERAGE
5	3.391	28.95	-17.05	46.00	28.58	0.09	0.28	AVERAGE
6 @	3.391	41.61	-14.39	56.00	41.24	0.09	0.28	QP
7 @	3.565	32.47	-13.53	46.00	32.08	0.09	0.30	AVERAGE
8 @	3.565	43.37	-12.63	56.00	42.98	0.09	0.30	QP
9 @	3.688	44.10	-11.90	56.00	43.71	0.09	0.30	QP
10 @	3.688	32.84	-13.16	46.00	32.45	0.09	0.30	AVERAGE
11 @	3.806	42.71	-13.29	56.00	42.31	0.10	0.30	QP
12 @	3.806	31.51	-14.49	46.00	31.11	0.10	0.30	AVERAGE

Temperature	25°C	Humidity	65%
Test Engineer	Ethan Hung	Phase	Neutral
Configuration	Normal Link	Test Mode	Mode 5 / Mode 6

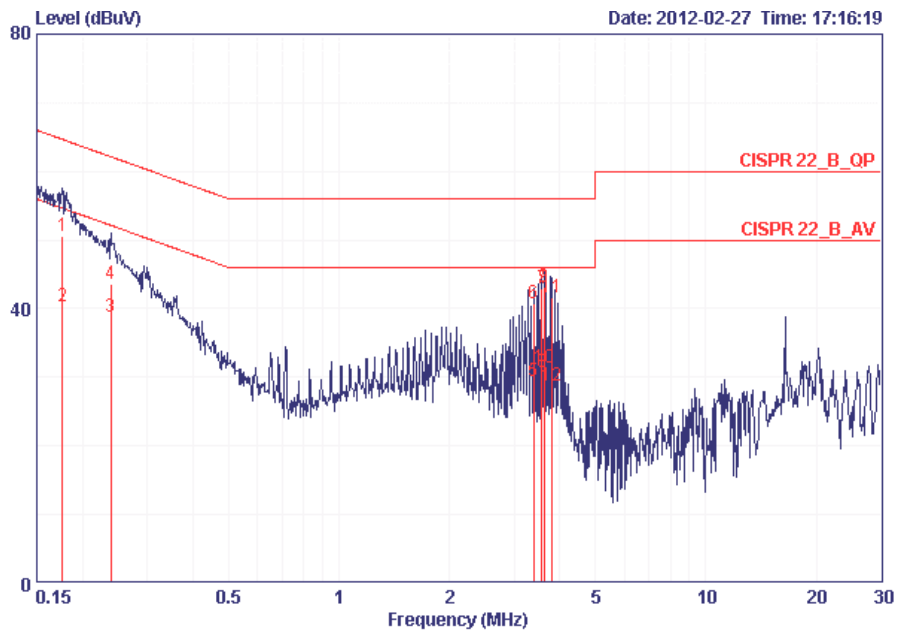

	Freq	Level	Over	Limit	Read	LISN	Cable	
	MHz	dBuV	Limit	Line	Level	Factor	Loss	Remark
			dB	dBuV	dBuV	dB	dB	
1 @	0.17584	50.64	-14.04	64.68	50.35	0.09	0.20	QP
2 @	0.17584	40.41	-14.27	54.68	40.12	0.09	0.20	AVERAGE
3 @	0.23910	38.72	-13.41	52.13	38.44	0.08	0.20	AVERAGE
4	0.23910	43.59	-18.54	62.13	43.31	0.08	0.20	QP
5	3.390	29.48	-16.52	46.00	29.07	0.13	0.28	AVERAGE
6 @	3.390	40.78	-15.22	56.00	40.37	0.13	0.28	QP
7 @	3.568	42.89	-13.11	56.00	42.46	0.13	0.30	QP
8 @	3.568	30.78	-15.22	46.00	30.35	0.13	0.30	AVERAGE
9 @	3.627	43.14	-12.86	56.00	42.71	0.13	0.30	QP
10 @	3.627	31.45	-14.55	46.00	31.02	0.13	0.30	AVERAGE
11 @	3.804	41.70	-14.30	56.00	41.26	0.14	0.30	QP
12	3.804	28.74	-17.26	46.00	28.30	0.14	0.30	AVERAGE

Note:

Level = Read Level + LISN Factor + Cable Loss.



## 4.2. Peak Output Power Measurement

### 4.2.1. Limit

For systems using digital modulation in the 2400-2483.5MHz, the limit for peak output power is 30dBm. The limited has to be reduced by the amount in dB that the gain of the antenna exceed 6dBi. In case of point-to-point operation, the limit has to be reduced by 1dB for every 3dB that the directional gain of the antenna exceeds 6dBi.

### 4.2.2. Measuring Instruments and Setting

Please refer to section 5 of equipments list in this report. The following table is the setting of the peak power meter.

Power Meter Parameter	Setting
Bandwidth	50MHz bandwidth is greater than the EUT emission bandwidth
Detector	Peak

Note: Because the peak power of Aux antenna is generated 1/2 attenuation, the peak power of Aux antenna is lower than Main Antenna.

### 4.2.3. Test Procedures

Spectrum Parameter	Setting
RF Output Power Method	<input checked="" type="checkbox"/> ANSI C63.10 clause 6.10.2.1 (a) power meter method
RF Output Power Method	<input type="checkbox"/> ANSI C63.10 clause 6.10.2.1 (b) channel integration method
RF Output Power Method	<input type="checkbox"/> ANSI C63.10 clause 6.10.3.1 Method 1 - spectral trace averaging
RF Output Power Method	<input type="checkbox"/> ANSI C63.10 clause 6.10.3.2 Method 2 - zero-span mode with trace averaging

### 4.2.4. Test Setup Layout

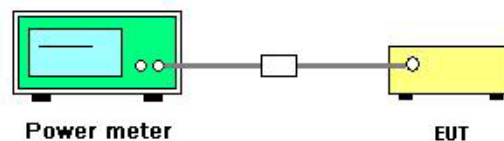

### 4.2.5. Test Deviation

There is no deviation with the original standard.

### 4.2.6. EUT Operation during Test

The EUT was programmed to be in continuously transmitting mode.

#### 4.2.7. Test Result of Peak Output Power

Temperature	22°C	Humidity	65%
Test Engineer	Allen Liu	Configurations	IEEE 802.11n / Dipole & PIFA / Main Port
Test Date	Feb. 09, 2012		

##### Configuration IEEE 802.11n MCS0 20MHz

Channel	Frequency	Conducted Power (dBm)	Max. Limit (dBm)	Result
1	2412 MHz	21.93	30.00	Complies
6	2437 MHz	23.78	30.00	Complies
11	2462 MHz	22.32	30.00	Complies

##### Configuration IEEE 802.11n MCS0 40MHz

Channel	Frequency	Conducted Power (dBm)	Max. Limit (dBm)	Result
3	2422 MHz	21.52	30.00	Complies
6	2437 MHz	21.47	30.00	Complies
9	2452 MHz	21.45	30.00	Complies

<b>Temperature</b>	22°C	<b>Humidity</b>	65%
<b>Test Engineer</b>	Allen Liu	<b>Configurations</b>	IEEE 802.11b/g / Dipole & PIFA / Main Port
<b>Test Date</b>	Feb. 09, 2012		

**Configuration IEEE 802.11b**

Channel	Frequency	Conducted Power (dBm)	Max. Limit (dBm)	Result
1	2412 MHz	18.47	30.00	<b>Complies</b>
6	2437 MHz	18.67	30.00	<b>Complies</b>
11	2462 MHz	18.71	30.00	<b>Complies</b>

**Configuration IEEE 802.11g**

Channel	Frequency	Conducted Power (dBm)	Max. Limit (dBm)	Result
1	2412 MHz	22.94	30.00	<b>Complies</b>
6	2437 MHz	23.93	30.00	<b>Complies</b>
11	2462 MHz	23.14	30.00	<b>Complies</b>

<b>Temperature</b>	22°C	<b>Humidity</b>	65%
<b>Test Engineer</b>	Allen Liu	<b>Configurations</b>	IEEE 802.11n/ Dipole & PIFA / Aux Port
<b>Test Date</b>	Feb. 09, 2012		

**Configuration IEEE 802.11n MCS0 20MHz**

Channel	Frequency	Conducted Power (dBm)	Max. Limit (dBm)	Result
1	2412 MHz	21.32	30.00	Complies
6	2437 MHz	23.27	30.00	Complies
11	2462 MHz	21.61	30.00	Complies

**Configuration IEEE 802.11n MCS0 40MHz**

Channel	Frequency	Conducted Power (dBm)	Max. Limit (dBm)	Result
3	2422 MHz	20.93	30.00	Complies
6	2437 MHz	21.02	30.00	Complies
9	2452 MHz	20.89	30.00	Complies

<b>Temperature</b>	22°C	<b>Humidity</b>	65%
<b>Test Engineer</b>	Allen Liu	<b>Configurations</b>	IEEE 802.11b/g / Dipole & PIFA / Aux Port
<b>Test Date</b>	Feb. 09, 2012		

**Configuration IEEE 802.11b**

Channel	Frequency	Conducted Power (dBm)	Max. Limit (dBm)	Result
1	2412 MHz	17.14	30.00	<b>Complies</b>
6	2437 MHz	17.32	30.00	<b>Complies</b>
11	2462 MHz	17.02	30.00	<b>Complies</b>

**Configuration IEEE 802.11g**

Channel	Frequency	Conducted Power (dBm)	Max. Limit (dBm)	Result
1	2412 MHz	22.31	30.00	<b>Complies</b>
6	2437 MHz	23.26	30.00	<b>Complies</b>
11	2462 MHz	22.52	30.00	<b>Complies</b>

### 4.3. Average Output Power Measurement

#### 4.3.1. Measuring Instruments and Setting

Please refer to section 5 of equipments list in this report. The following table is the setting of the power meter.

Power Meter Parameter	Setting
Bandwidth	50MHz bandwidth is greater than the EUT emission bandwidth
Detector	Average

#### 4.3.2. Test Procedures

Spectrum Parameter	Setting
RF Output Power Method	<input checked="" type="checkbox"/> ANSI C63.10 clause 6.10.2.1 (a) power meter method
RF Output Power Method	<input type="checkbox"/> ANSI C63.10 clause 6.10.2.1 (b) channel integration method
RF Output Power Method	<input type="checkbox"/> ANSI C63.10 clause 6.10.3.1 Method 1 - spectral trace averaging
RF Output Power Method	<input type="checkbox"/> ANSI C63.10 clause 6.10.3.2 Method 2 - zero-span mode with trace averaging

#### 4.3.3. Test Setup Layout

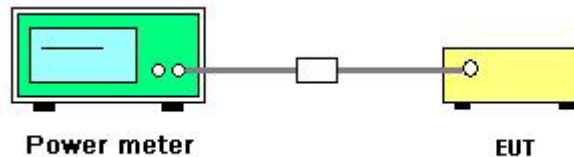

#### 4.3.4. Test Deviation

There is no deviation with the original standard.

#### 4.3.5. EUT Operation during Test

The EUT was programmed to be in continuously transmitting mode.

#### 4.3.6. Test Result of Average Output Power

<b>Temperature</b>	22°C	<b>Humidity</b>	65%
<b>Test Engineer</b>	Allen Liu	<b>Configurations</b>	IEEE 802.11n / Dipole & PIFA / Main Port
<b>Test Date</b>	Feb. 09, 2012		

##### Configuration IEEE 802.11n MCS8 20MHz

Channel	Frequency	Average Conducted Power (dBm)
1	2412 MHz	13.37
6	2437 MHz	16.36
11	2462 MHz	13.46

##### Configuration IEEE 802.11n MCS8 40MHz

Channel	Frequency	Average Conducted Power (dBm)
3	2422 MHz	13.19
6	2437 MHz	13.31
9	2452 MHz	13.25

<b>Temperature</b>	22°C	<b>Humidity</b>	65%
<b>Test Engineer</b>	Allen Liu	<b>Configurations</b>	IEEE 802.11b/g / Dipole & PIFA / Main Port
<b>Test Date</b>	Feb. 09, 2012		

**Configuration IEEE 802.11b**

Channel	Frequency	Average Conducted Power (dBm)
1	2412 MHz	16.36
6	2437 MHz	16.48
11	2462 MHz	16.47

**Configuration IEEE 802.11g**

Channel	Frequency	Average Conducted Power (dBm)
1	2412 MHz	14.25
6	2437 MHz	16.38
11	2462 MHz	14.45



<b>Temperature</b>	22°C	<b>Humidity</b>	65%
<b>Test Engineer</b>	Allen Liu	<b>Configurations</b>	IEEE 802.11n / Dipole & PIFA / Aux Port
<b>Test Date</b>	Feb. 09, 2012		

**Configuration IEEE 802.11n MCS8 20MHz**

Channel	Frequency	Average Conducted Power (dBm)
1	2412 MHz	12.57
6	2437 MHz	15.92
11	2462 MHz	12.85

**Configuration IEEE 802.11n MCS8 40MHz**

Channel	Frequency	Average Conducted Power (dBm)
3	2422 MHz	12.54
6	2437 MHz	12.56
9	2452 MHz	12.41

<b>Temperature</b>	22°C	<b>Humidity</b>	65%
<b>Test Engineer</b>	Allen Liu	<b>Configurations</b>	IEEE 802.11b/g / Dipole & PIFA / Aux Port
<b>Test Date</b>	Feb. 09, 2012		

**Configuration IEEE 802.11b**

Channel	Frequency	Average Conducted Power (dBm)
1	2412 MHz	15.06
6	2437 MHz	15.13
11	2462 MHz	14.94

**Configuration IEEE 802.11g**

Channel	Frequency	Average Conducted Power (dBm)
1	2412 MHz	13.35
6	2437 MHz	15.42
11	2462 MHz	13.67

## 4.4. Power Spectral Density Measurement

### 4.4.1. Limit

For digitally modulated systems, the power spectral density conducted from the intentional radiator to the antenna shall not be greater than 8 dBm in any 3 kHz band during any time interval of continuous transmission.

### 4.4.2. Measuring Instruments and Setting

Please refer to section 5 of equipments list in this report. The following table is the setting of Spectrum Analyzer.

Spectrum Parameter	Setting
Attenuation	Auto
Span Frequency	30 kHz
RB	3 kHz
VB	30 kHz
Detector	Peak
Trace	Max Hold
Sweep Time	10s

### 4.4.3. Test Procedures

1. The transmitter output (antenna port) was connected to the spectrum analyzer.
2. Set RBW of spectrum analyzer to 3kHz and VBW to 30kHz. Set Detector to Peak, Trace to Max Hold.
3. Mark the frequency with maximum peak power as the center of the display of the spectrum.
4. Set the span to 30kHz and the sweep time to 10s and record the maximum peak value.

### 4.4.4. Test Setup Layout

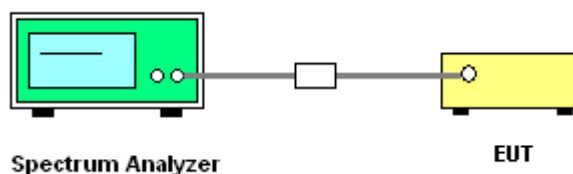

### 4.4.5. Test Deviation

There is no deviation with the original standard.

### 4.4.6. EUT Operation during Test

The EUT was programmed to be in continuously transmitting mode.

#### 4.4.7. Test Result of Power Spectral Density

<b>Temperature</b>	22°C	<b>Humidity</b>	65%
<b>Test Engineer</b>	Allen Liu	<b>Configurations</b>	IEEE 802.11n / Dipole & PIFA / Main Port

##### Configuration IEEE 802.11n MCS0 20MHz

Channel	Frequency	Power Density (dBm/3kHz)	Power Density (mW/3kHz)	Max. Limit (dBm/3kHz)	Result
1	2412 MHz	-14.60	0.03	8.00	Complies
6	2437 MHz	-11.68	0.07	8.00	Complies
11	2462 MHz	-14.48	0.04	8.00	Complies

##### Configuration IEEE 802.11n MCS0 40MHz

Channel	Frequency	Power Density (dBm/3kHz)	Power Density (mW/3kHz)	Max. Limit (dBm/3kHz)	Result
3	2422 MHz	-15.60	0.03	8.00	Complies
6	2437 MHz	-17.45	0.02	8.00	Complies
9	2452 MHz	-15.36	0.03	8.00	Complies

<b>Temperature</b>	22°C	<b>Humidity</b>	65%
<b>Test Engineer</b>	Allen Liu	<b>Configurations</b>	IEEE 802.11b/g / Dipole & PIFA / Main Port

**Configuration IEEE 802.11b**

Channel	Frequency	Power Density (dBm/3kHz)	Power Density (mW/3kHz)	Max. Limit (dBm/3kHz)	Result
1	2412 MHz	-13.43	0.05	8.00	Complies
6	2437 MHz	-13.38	0.05	8.00	Complies
11	2462 MHz	-13.35	0.05	8.00	Complies

**Configuration IEEE 802.11g**

Channel	Frequency	Power Density (dBm/3kHz)	Power Density (mW/3kHz)	Max. Limit (dBm/3kHz)	Result
1	2412 MHz	-14.19	0.04	8.00	Complies
6	2437 MHz	-12.37	0.06	8.00	Complies
11	2462 MHz	-14.25	0.04	8.00	Complies

**Power Density Plot on Configuration IEEE 802.11n MCS0 20MHz / 2437 MHz**

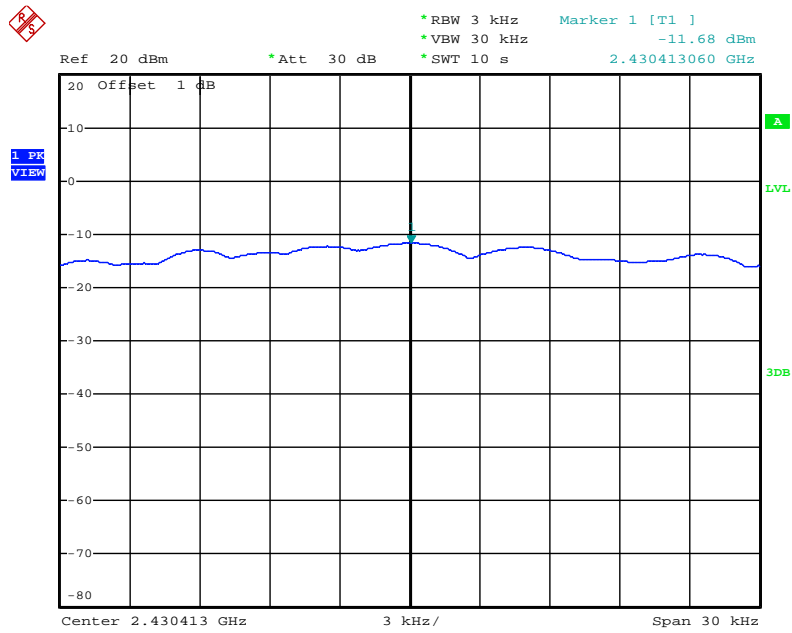

Date: 9.FEB.2012 05:03:45

**Power Density Plot on Configuration IEEE 802.11n MCS0 40MHz / 2452 MHz**

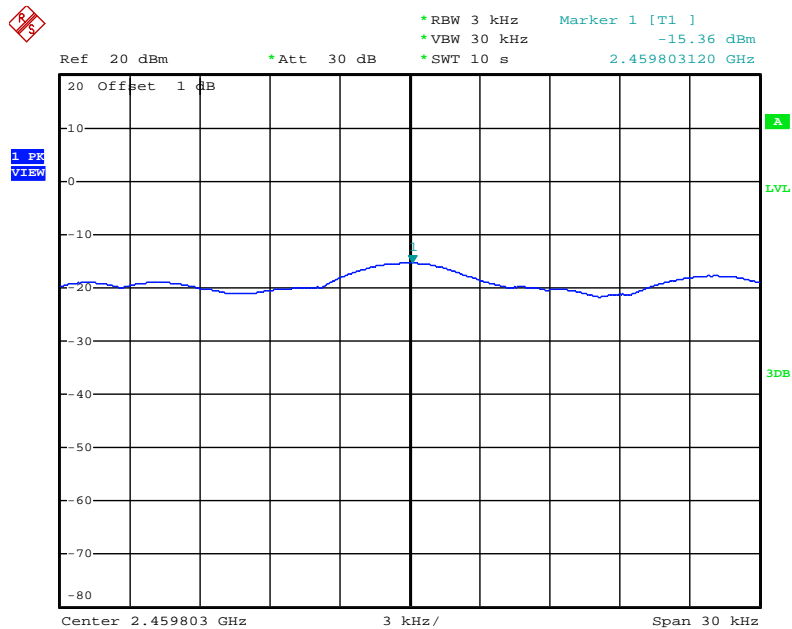

Date: 9.FEB.2012 05:07:44

**Power Density Plot on Configuration IEEE 802.11b / 2462 MHz**

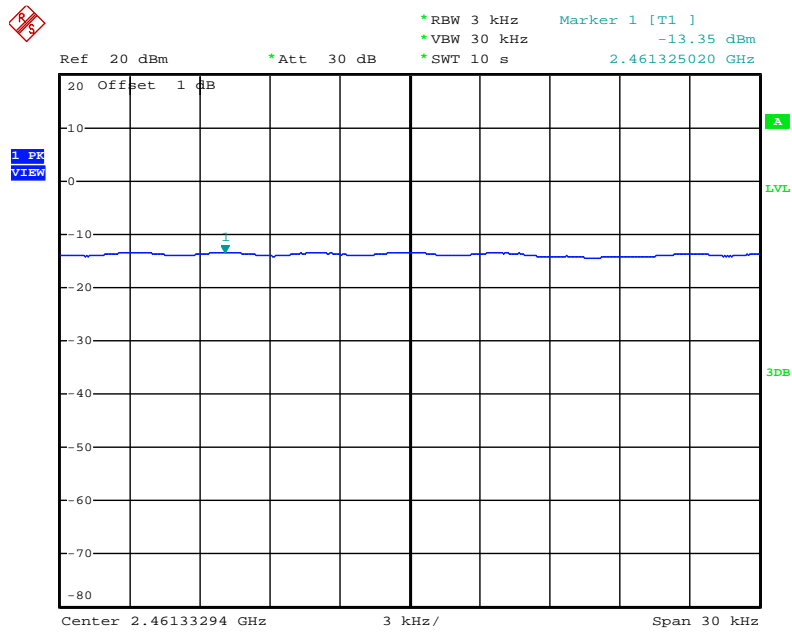

Date: 9.FEB.2012 04:49:53

**Power Density Plot on Configuration IEEE 802.11g / 2437 MHz**

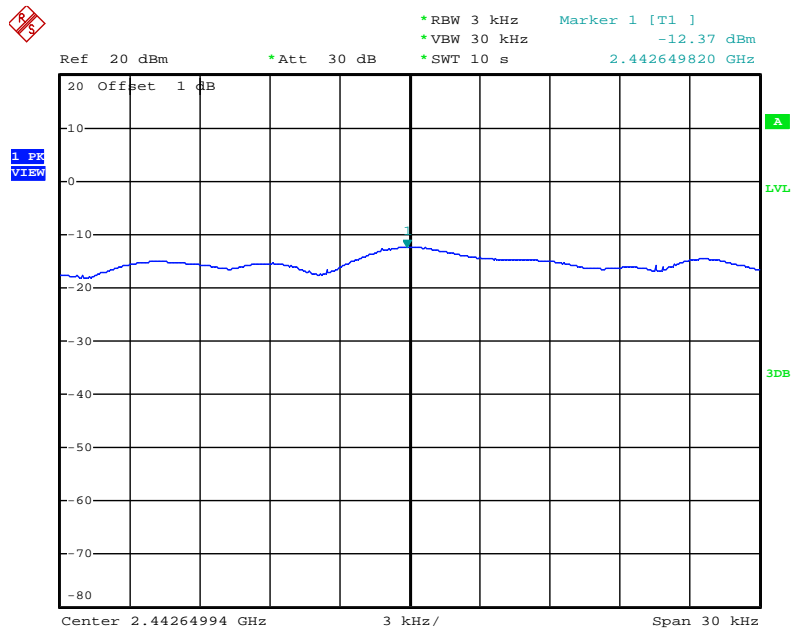

Date: 9.FEB.2012 04:53:50

<b>Temperature</b>	22°C	<b>Humidity</b>	65%
<b>Test Engineer</b>	Allen Liu	<b>Configurations</b>	IEEE 802.11n / Dipole & PIFA / Aux Port

**Configuration IEEE 802.11n MCS0 20MHz**

Channel	Frequency	Power Density (dBm/3kHz)	Power Density (mW/3kHz)	Max. Limit (dBm/3kHz)	Result
1	2412 MHz	-14.73	0.03	8.00	Complies
6	2437 MHz	-11.78	0.07	8.00	Complies
11	2462 MHz	-14.63	0.03	8.00	Complies

**Configuration IEEE 802.11n MCS0 40MHz**

Channel	Frequency	Power Density (dBm/3kHz)	Power Density (mW/3kHz)	Max. Limit (dBm/3kHz)	Result
3	2422 MHz	-15.34	0.03	8.00	Complies
6	2437 MHz	-15.56	0.03	8.00	Complies
9	2452 MHz	-15.57	0.03	8.00	Complies



<b>Temperature</b>	22°C	<b>Humidity</b>	65%
<b>Test Engineer</b>	Allen Liu	<b>Configurations</b>	IEEE 802.11b/g / Dipole & PIFA / Aux Port

**Configuration IEEE 802.11b**

Channel	Frequency	Power Density (dBm/3kHz)	Power Density (mW/3kHz)	Max. Limit (dBm/3kHz)	Result
1	2412 MHz	-13.40	0.05	8.00	Complies
6	2437 MHz	-13.49	0.04	8.00	Complies
11	2462 MHz	-13.58	0.04	8.00	Complies

**Configuration IEEE 802.11g**

Channel	Frequency	Power Density (dBm/3kHz)	Power Density (mW/3kHz)	Max. Limit (dBm/3kHz)	Result
1	2412 MHz	-14.14	0.04	8.00	Complies
6	2437 MHz	-12.19	0.06	8.00	Complies
11	2462 MHz	-13.99	0.04	8.00	Complies

**Power Density Plot on Configuration IEEE 802.11n MCS0 20MHz / 2437 MHz**

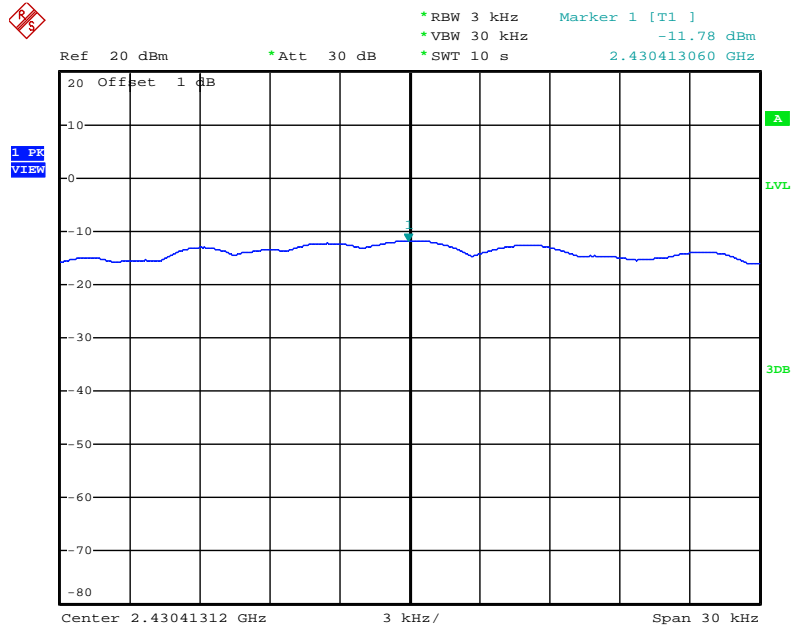

Date: 9.FEB.2012 05:25:25

**Power Density Plot on Configuration IEEE 802.11n MCS0 40MHz / 2422 MHz**

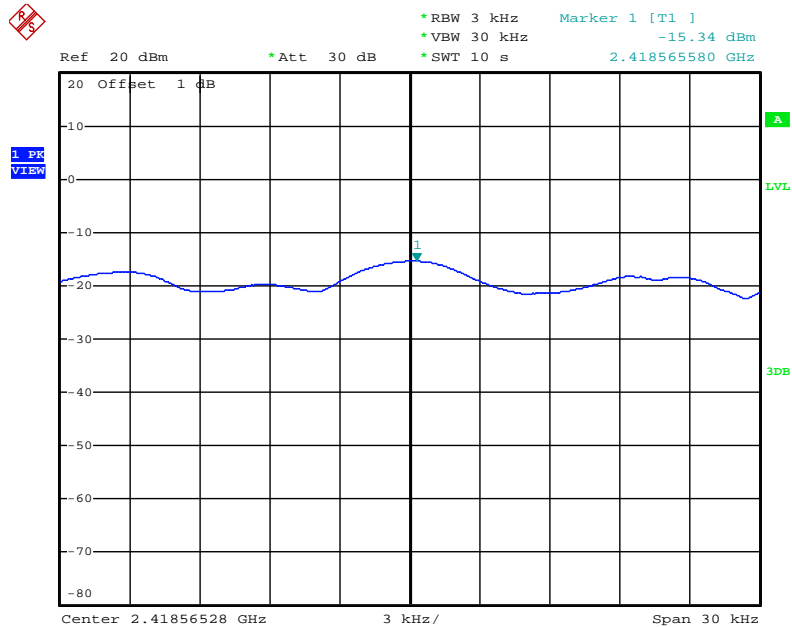

Date: 9.FEB.2012 05:17:18



## 4.5. 6dB Spectrum Bandwidth Measurement

### 4.5.1. Limit

For digital modulation systems, the minimum 6 dB bandwidth shall be at least 500 kHz.

### 4.5.2. Measuring Instruments and Setting

Please refer to section 5 of equipments list in this report. The following table is the setting of the Spectrum Analyzer.

Spectrum Parameters	Setting
Attenuation	Auto
Span Frequency	> 6dB Bandwidth
RB	100 kHz
VB	100 kHz
Detector	Peak
Trace	Max Hold
Sweep Time	Auto

### 4.5.3. Test Procedures

1. The transmitter output (antenna port) was connected to the spectrum analyzer in peak hold mode.
2. The resolution bandwidth of 100 kHz and the video bandwidth of 100 kHz were used.
3. Measured the spectrum width with power higher than 6dB below carrier.

### 4.5.4. Test Setup Layout

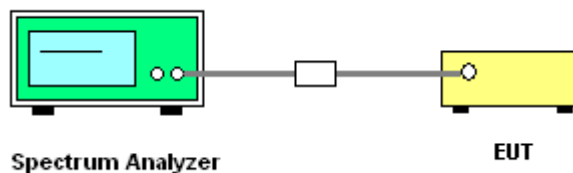

### 4.5.5. Test Deviation

There is no deviation with the original standard.

### 4.5.6. EUT Operation during Test

The EUT was programmed to be in continuously transmitting mode.

#### 4.5.7. Test Result of 6dB Spectrum Bandwidth

<b>Temperature</b>	22°C	<b>Humidity</b>	65%
<b>Test Engineer</b>	Allen Liu	<b>Configurations</b>	IEEE 802.11n / Dipole & PIFA / Main Port

##### Configuration IEEE 802.11n MCS0 20MHz

Channel	Frequency	6dB Bandwidth (MHz)	99% Occupied Bandwidth (MHz)	Min. Limit (kHz)	Test Result
1	2412 MHz	17.80	17.68	500	Complies
6	2437 MHz	17.84	17.72	500	Complies
11	2462 MHz	17.80	17.68	500	Complies

##### Configuration IEEE 802.11n MCS0 40MHz

Channel	Frequency	6dB Bandwidth (MHz)	99% Occupied Bandwidth (MHz)	Min. Limit (kHz)	Test Result
3	2422 MHz	36.40	36.08	500	Complies
6	2437 MHz	36.48	36.16	500	Complies
9	2452 MHz	36.48	36.16	500	Complies

<b>Temperature</b>	22°C	<b>Humidity</b>	65%
<b>Test Engineer</b>	Allen Liu	<b>Configurations</b>	IEEE 802.11b/g / Dipole & PIFA / Main Port

**Configuration IEEE 802.11b**

Channel	Frequency	6dB Bandwidth (MHz)	99% Occupied Bandwidth (MHz)	Min. Limit (kHz)	Test Result
1	2412 MHz	10.08	15.08	500	<b>Complies</b>
6	2437 MHz	10.08	15.04	500	<b>Complies</b>
11	2462 MHz	10.08	15.08	500	<b>Complies</b>

**Configuration IEEE 802.11g**

Channel	Frequency	6dB Bandwidth (MHz)	99% Occupied Bandwidth (MHz)	Min. Limit (kHz)	Test Result
1	2412 MHz	16.56	16.48	500	<b>Complies</b>
6	2437 MHz	16.56	16.52	500	<b>Complies</b>
11	2462 MHz	16.56	16.48	500	<b>Complies</b>

6 dB Bandwidth Plot on Configuration IEEE 802.11n MCS0 20MHz / 2462 MHz

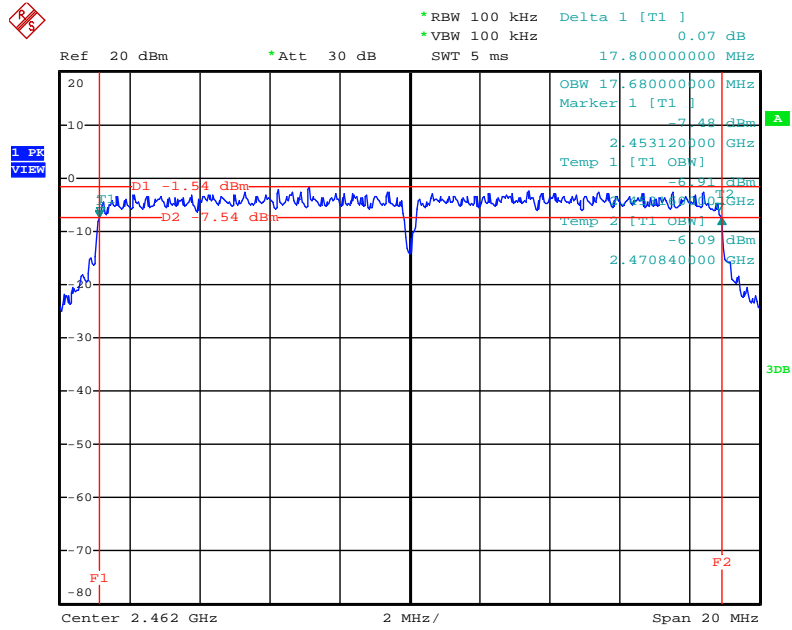

Date: 9.FEB.2012 05:04:12

6 dB Bandwidth Plot on Configuration IEEE 802.11n MCS0 40MHz / 2422 MHz

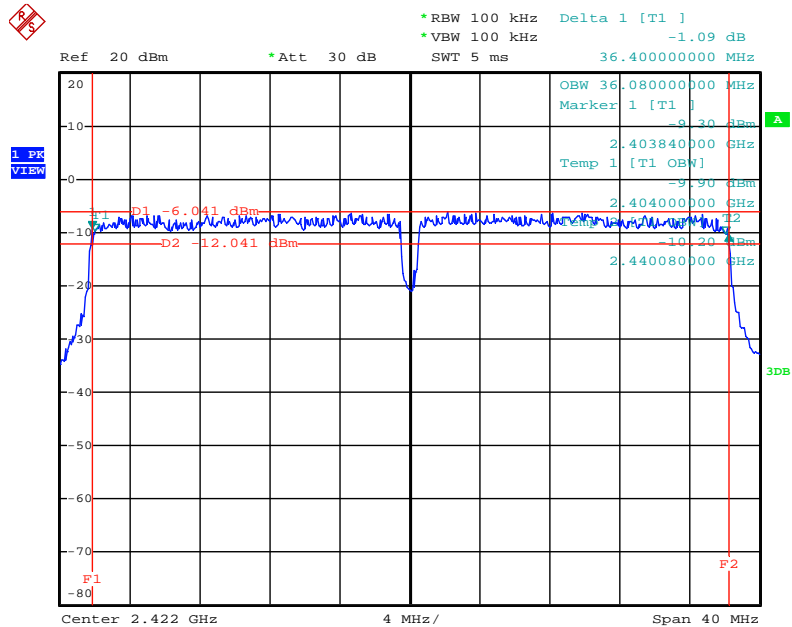

Date: 9.FEB.2012 05:10:14

### 6 dB Bandwidth Plot on Configuration IEEE 802.11b / 2437 MHz

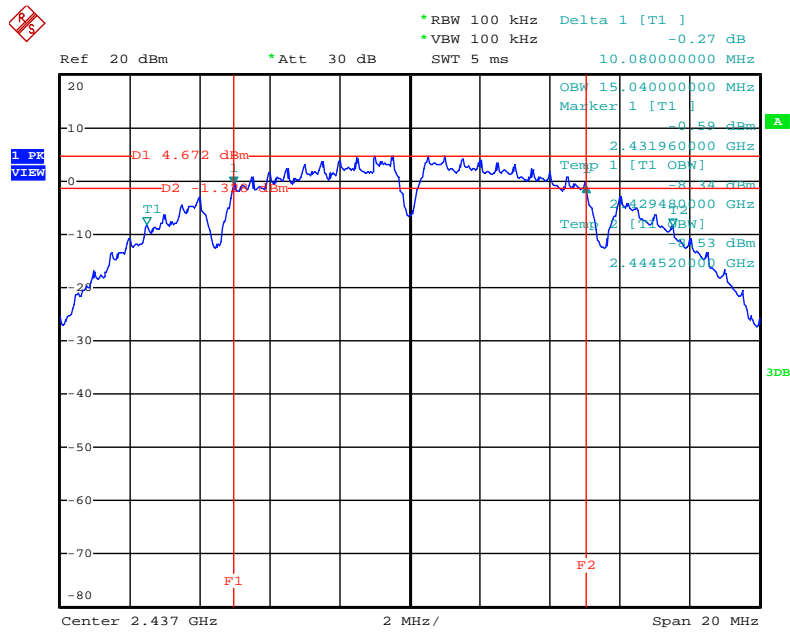

Date: 9.FEB.2012 04:46:23

### 6 dB Bandwidth Plot on Configuration IEEE 802.11g / 2437 MHz

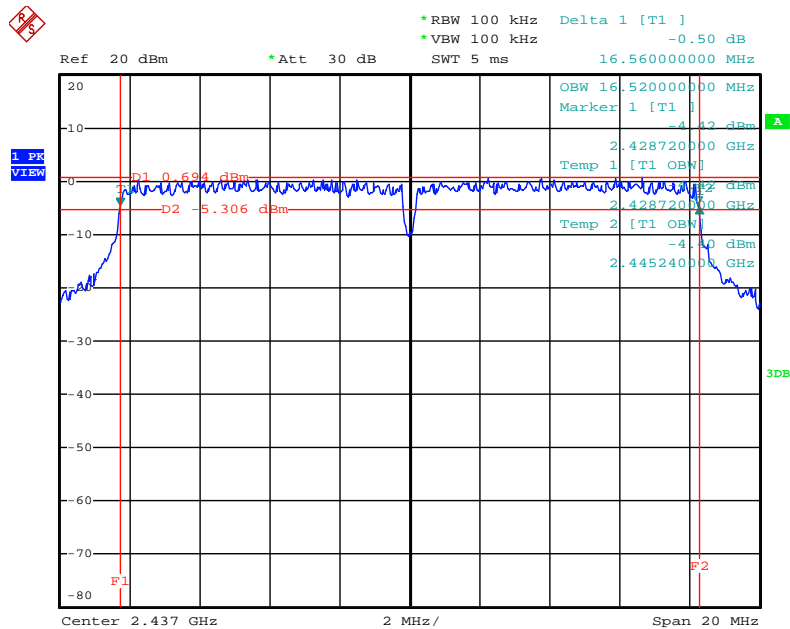

Date: 9.FEB.2012 04:52:22



<b>Temperature</b>	22°C	<b>Humidity</b>	65%
<b>Test Engineer</b>	Allen Liu	<b>Configurations</b>	IEEE 802.11n / Dipole & PIFA / Aux Port

**Configuration IEEE 802.11n MCS0 20MHz**

Channel	Frequency	6dB Bandwidth (MHz)	99% Occupied Bandwidth (MHz)	Min. Limit (kHz)	Test Result
1	2412 MHz	17.80	17.68	500	Complies
6	2437 MHz	17.84	17.72	500	Complies
11	2462 MHz	17.76	17.68	500	Complies

**Configuration IEEE 802.11n MCS0 40MHz**

Channel	Frequency	6dB Bandwidth (MHz)	99% Occupied Bandwidth (MHz)	Min. Limit (kHz)	Test Result
3	2422 MHz	36.40	36.08	500	Complies
6	2437 MHz	36.48	36.16	500	Complies
9	2452 MHz	36.48	36.16	500	Complies

<b>Temperature</b>	22°C	<b>Humidity</b>	65%
<b>Test Engineer</b>	Allen Liu	<b>Configurations</b>	IEEE 802.11b/g / Dipole & PIFA / Aux Port

**Configuration IEEE 802.11b**

Channel	Frequency	6dB Bandwidth (MHz)	99% Occupied Bandwidth (MHz)	Min. Limit (kHz)	Test Result
1	2412 MHz	10.08	15.04	500	Complies
6	2437 MHz	10.08	15.12	500	Complies
11	2462 MHz	10.08	15.04	500	Complies

**Configuration IEEE 802.11g**

Channel	Frequency	6dB Bandwidth (MHz)	99% Occupied Bandwidth (MHz)	Min. Limit (kHz)	Test Result
1	2412 MHz	16.56	16.48	500	Complies
6	2437 MHz	16.56	16.48	500	Complies
11	2462 MHz	16.56	16.48	500	Complies

### 6 dB Bandwidth Plot on Configuration IEEE 802.11n MCS0 20MHz / 2462 MHz

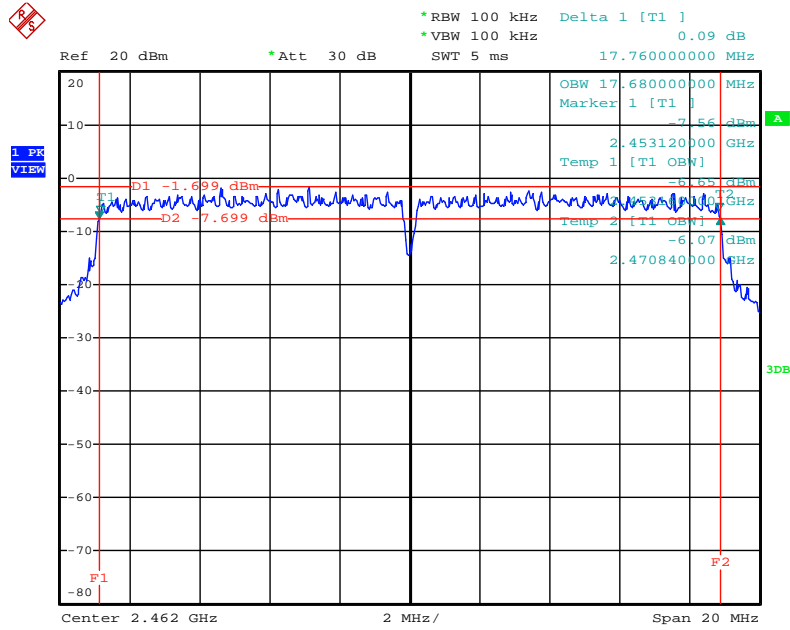

Date: 9.FEB.2012 05:25:47

### 6 dB Bandwidth Plot on Configuration IEEE 802.11n MCS0 40MHz / 2422 MHz

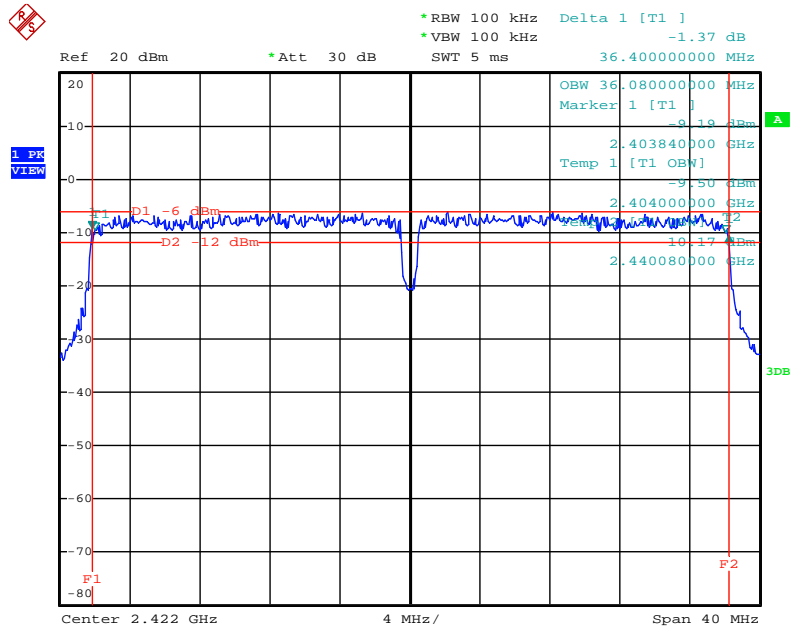

Date: 9.FEB.2012 05:15:51

### 6 dB Bandwidth Plot on Configuration IEEE 802.11b / 2437 MHz

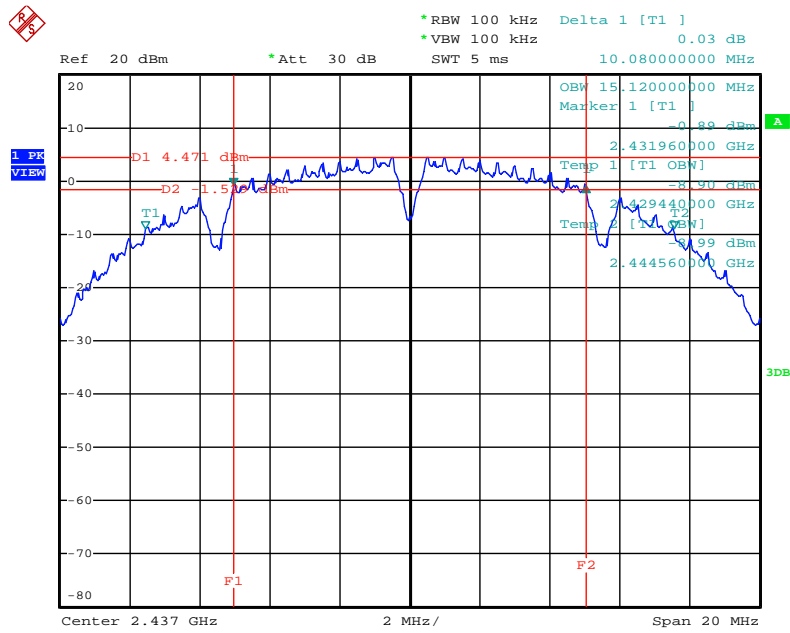

Date: 9.FEB.2012 05:36:27

### 6 dB Bandwidth Plot on Configuration IEEE 802.11g / 2437 MHz

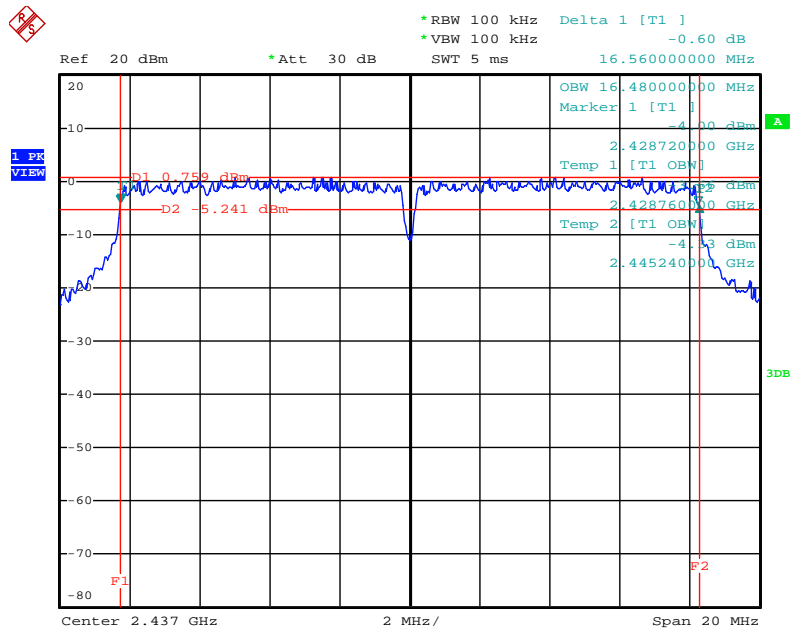

Date: 9.FEB.2012 05:30:23

## 4.6. Radiated Emissions Measurement

### 4.6.1. Limit

20dBc in any 100 kHz bandwidth outside the operating frequency band. In case the emission fall within the restricted band specified on 15.205(a), then the 15.209(a) limit in the table below has to be followed.

Frequencies (MHz)	Field Strength (micorvolts/meter)	Measurement Distance (meters)
0.009~0.490	2400/F(KHz)	300
0.490~1.705	24000/F(KHz)	30
1.705~30.0	30	30
30~88	100	3
88~216	150	3
216~960	200	3
Above 960	500	3

### 4.6.2. Measuring Instruments and Setting

Please refer to section 5 of equipments list in this report. The following table is the setting of spectrum analyzer and receiver.

Spectrum Parameter	Setting
Attenuation	Auto
Start Frequency	1000 MHz
Stop Frequency	10th carrier harmonic
RB / VB (Emission in restricted band)	1MHz / 3MHz for Peak, 1 MHz / 10Hz for Average
RB / VB (Emission in non-restricted band)	1MHz / 3MHz for peak

Receiver Parameter	Setting
Attenuation	Auto
Start ~ Stop Frequency	9kHz~150kHz / RB 200Hz for QP
Start ~ Stop Frequency	150kHz~30MHz / RB 9kHz for QP
Start ~ Stop Frequency	30MHz~1000MHz / RB 120kHz for QP

#### 4.6.3. Test Procedures

1. Configure the EUT according to ANSI C63.10. The EUT was placed on the top of the turntable 0.8 meter above ground. The phase center of the receiving antenna mounted on the top of a height-variable antenna tower was placed 3 meters far away from the turntable.
2. Power on the EUT and all the supporting units. The turntable was rotated by 360 degrees to determine the position of the highest radiation.
3. The height of the broadband receiving antenna was varied between one meter and four meters above ground to find the maximum emissions field strength of both horizontal and vertical polarization.
4. For each suspected emissions, the antenna tower was scan (from 1 m to 4 m) and then the turntable was rotated (from 0 degree to 360 degrees) to find the maximum reading.
5. Set the test-receiver system to Peak or CISPR quasi-peak Detect Function with specified bandwidth under Maximum Hold Mode.
6. For emissions above 1GHz, use 1MHz VBW and 3MHz RBW for peak reading. Then 1MHz RBW and 10Hz VBW for average reading in spectrum analyzer.
7. When the radiated emissions limits are expressed in terms of the average value of the emissions, and pulsed operation is employed, the measurement field strength shall be determined by averaging over one complete pulse train, including blanking intervals, as long as the pulse train does not exceed 0.1 seconds. As an alternative (provided the transmitter operates for longer than 0.1 seconds) or in cases where the pulse train exceeds 0.1 seconds, the measured field strength shall be determined from the average absolute voltage during a 0.1 second interval during which the field strength is at its maximum value.
8. If the emissions level of the EUT in peak mode was 3 dB lower than the average limit specified, then testing will be stopped and peak values of EUT will be reported, otherwise, the emissions which do not have 3 dB margin will be repeated one by one using the quasi-peak method for below 1GHz.
9. For testing above 1GHz, the emissions level of the EUT in peak mode was lower than average limit (that means the emissions level in peak mode also complies with the limit in average mode), then testing will be stopped and peak values of EUT will be reported, otherwise, the emissions will be measured in average mode again and reported.
10. In case the emission is lower than 30MHz, loop antenna has to be used for measurement and the recorded data should be QP measured by receiver. High – Low scan is not required in this case.

#### 4.6.4. Test Setup Layout

For Radiated Emissions below 1GHz

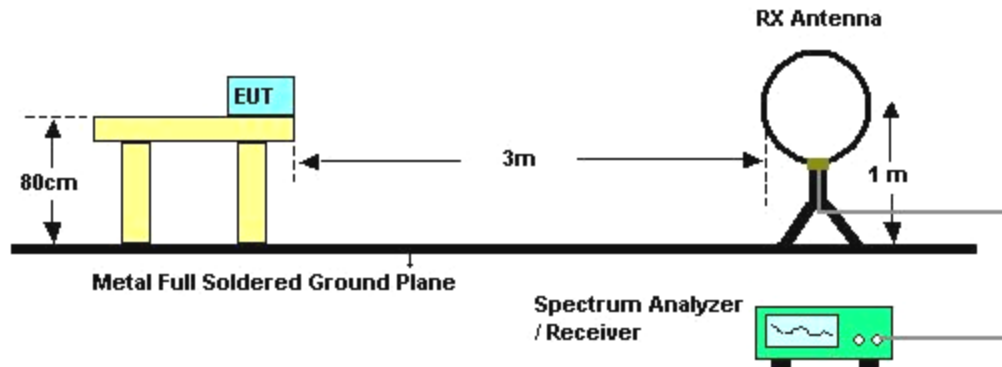

For Radiated Emissions above 1GHz

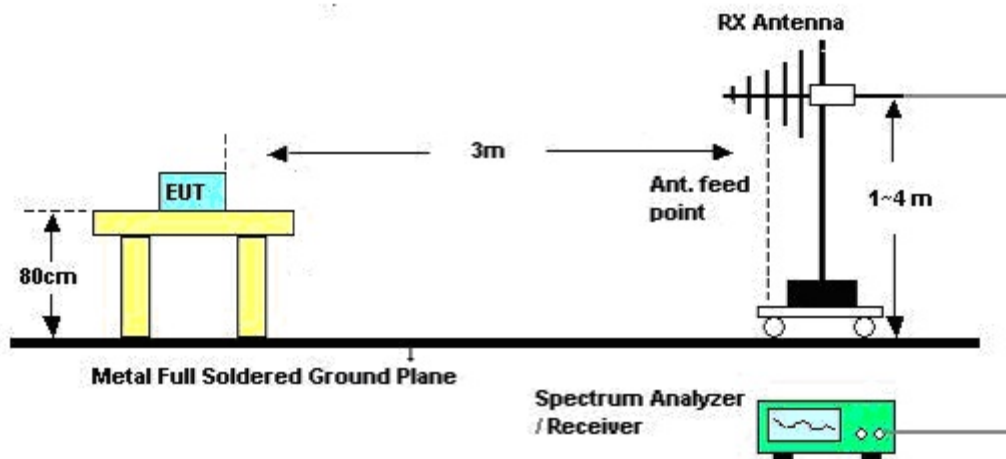

#### 4.6.5. Test Deviation

There is no deviation with the original standard.

#### 4.6.6. EUT Operation during Test

The EUT was programmed to be in continuously transmitting mode.

#### 4.6.7. Results of Radiated Emissions (9kHz~30MHz)

<b>Temperature</b>	26°C	<b>Humidity</b>	60%
<b>Test Engineer</b>	Magic Lai	<b>Configurations</b>	Normal Link
<b>Test Date</b>	Mar. 07, 2012		

<b>Freq. (MHz)</b>	<b>Level (dBuV)</b>	<b>Over Limit (dB)</b>	<b>Limit Line (dBuV)</b>	<b>Remark</b>
-	-	-	-	See Note

**Note:**

The amplitude of spurious emissions which are attenuated by more than 20 dB below the permissible value has no need to be reported.

Distance extrapolation factor =  $40 \log(\text{specific distance} / \text{test distance})$  (dB);

Limit line = specific limits (dBuV) + distance extrapolation factor.



4.6.8. Results of Radiated Emissions (30MHz~1GHz)

Temperature	26°C	Humidity	60%
Test Engineer	Magic Lai	Configurations	Normal Link / Mode 1 / Mode 2

Horizontal

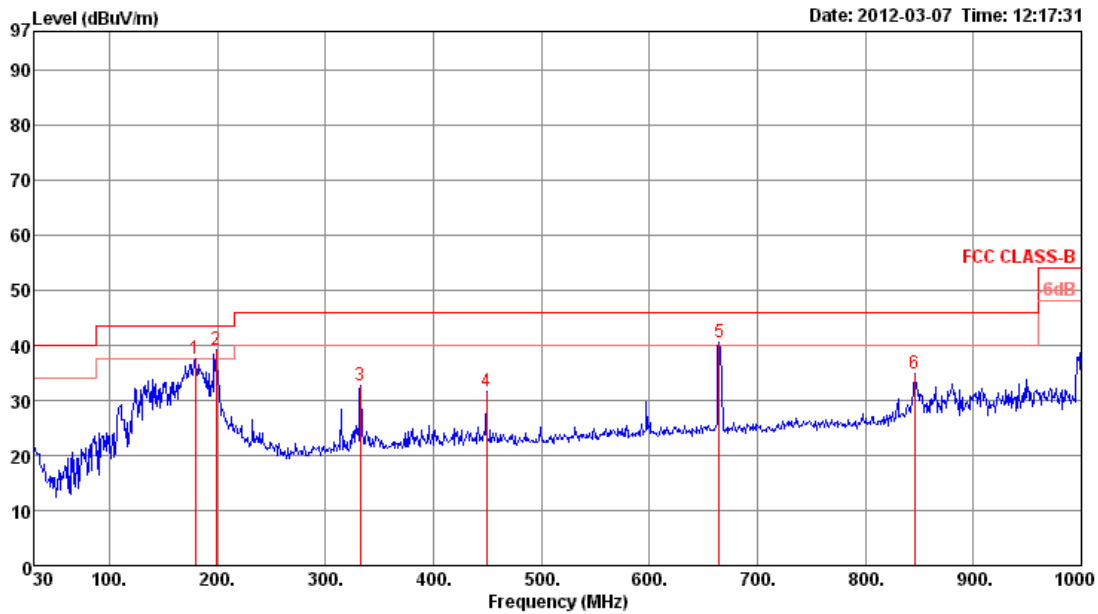

	Freq	Level	Limit	Over	Read	Cable	Antenna	Preamp	Remark	A/Pos	T/Pos	Pol/Phase
	MHz	dBuV/m	dBuV/m	dB	dBuV	dB	dB/m	dB		cm	deg	
1	179.38	37.46	43.50	-6.04	49.92	1.60	13.14	27.20	Peak	400	0	HORIZONTAL
2	198.78	39.30	43.50	-4.20	55.47	1.69	9.25	27.11	Peak	400	0	HORIZONTAL
3	332.64	32.78	46.00	-13.22	43.48	2.17	14.25	27.12	Peak	400	0	HORIZONTAL
4	449.04	31.65	46.00	-14.35	40.08	2.59	16.83	27.85	Peak	400	0	HORIZONTAL
5	664.38	40.40	46.00	-5.60	46.02	3.44	18.98	28.04	Peak	400	0	HORIZONTAL
6	845.77	34.87	46.00	-11.13	38.87	3.39	20.12	27.51	Peak	400	0	HORIZONTAL

**Vertical**

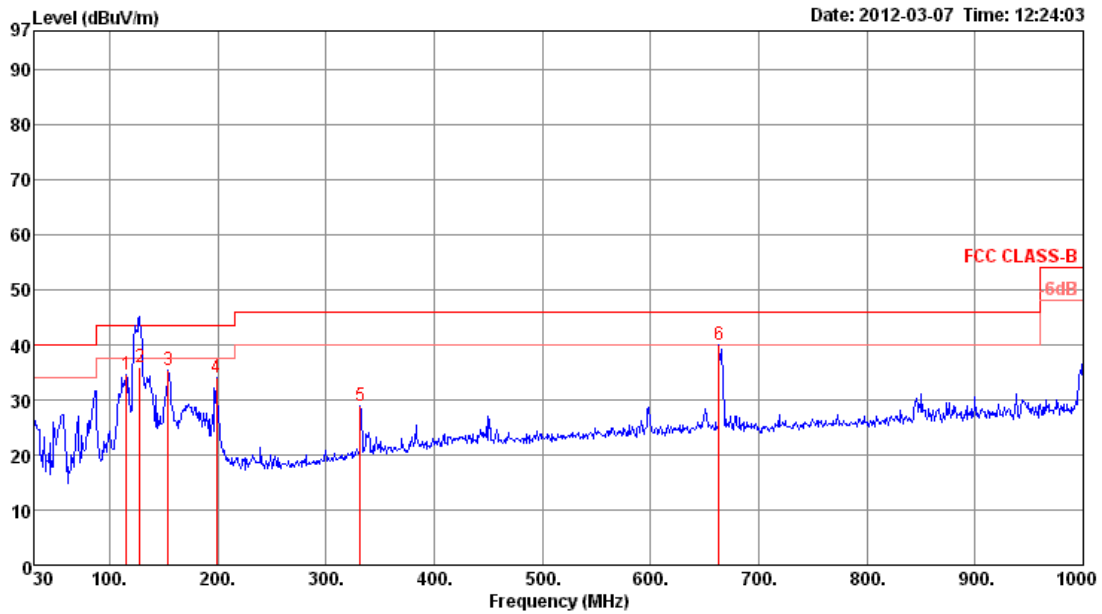

	Freq	Level	Limit	Over	Read	CableAntenna	Preamp		A/Pos	T/Pos	
	MHz	dBuV/m	dBuV/m	dB	dBuV	Loss	Factor	Factor	Remark	cm	deg
1	115.36	34.52	43.50	-8.98	48.68	1.20	12.16	27.52	Peak	400	0 VERTICAL
2	127.78	35.85	43.50	-7.65	49.80	1.27	12.24	27.46	QP	100	3 VERTICAL
3	154.16	35.39	43.50	-8.11	49.33	1.47	11.92	27.33	Peak	400	0 VERTICAL
4	198.78	34.01	43.50	-9.49	50.18	1.69	9.25	27.11	Peak	400	0 VERTICAL
5	331.67	28.90	46.00	-17.10	39.63	2.16	14.23	27.12	Peak	400	0 VERTICAL
6	663.41	39.88	46.00	-6.12	45.50	3.45	18.97	28.04	Peak	400	0 VERTICAL

Temperature	26°C	Humidity	60%
Test Engineer	Magic Lai	Configurations	Normal Link / Mode 5 / Mode 6

**Horizontal**

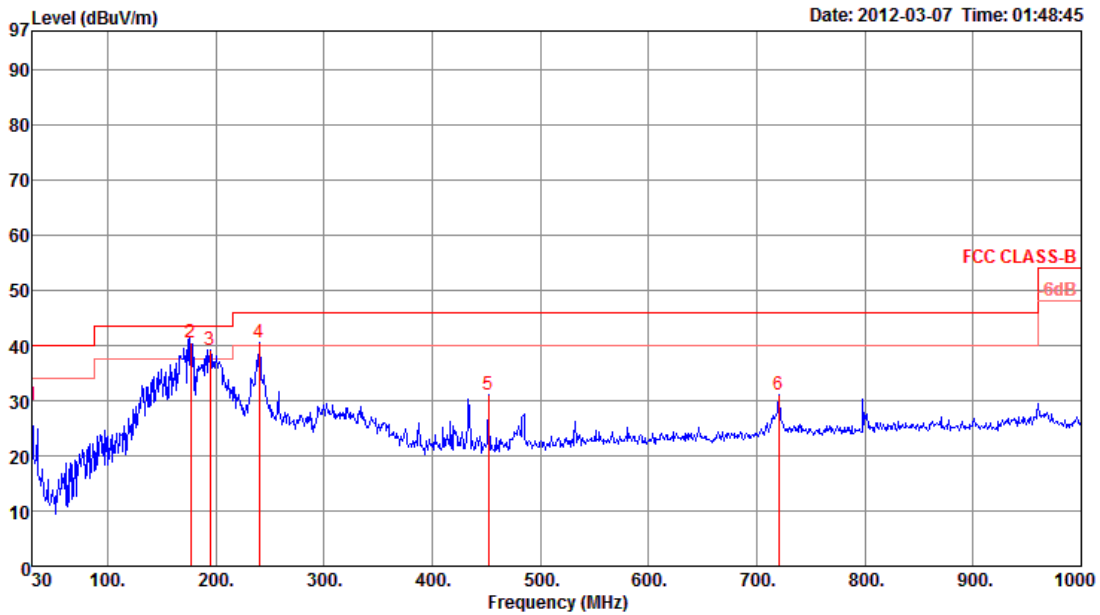

	Freq	Level	Limit	Over	Read	Cable	Preamp	Antenna	T/Pos	A/Pos	Remark	Pol/Phase
	MHz	dBuV/m	dBuV/m	dB	dBuV	dB	dB	dB/m	deg	cm		
1	30.00	29.07	40.00	-10.93	38.79	0.83	27.80	17.25	0	400	Peak	HORIZONTAL
2	176.77	40.46	43.50	-3.04	56.51	1.99	27.22	9.18	153	147	QP	HORIZONTAL
3	194.90	39.24	43.50	-4.26	54.70	2.07	27.13	9.60	0	400	Peak	HORIZONTAL
4	240.49	40.48	46.00	-5.52	53.51	2.31	27.02	11.68	0	400	Peak	HORIZONTAL
5	451.95	31.14	46.00	-14.86	38.75	3.25	27.86	17.00	0	400	Peak	HORIZONTAL
6	720.64	31.05	46.00	-14.95	34.46	4.18	27.91	20.32	0	400	Peak	HORIZONTAL

**Vertical**

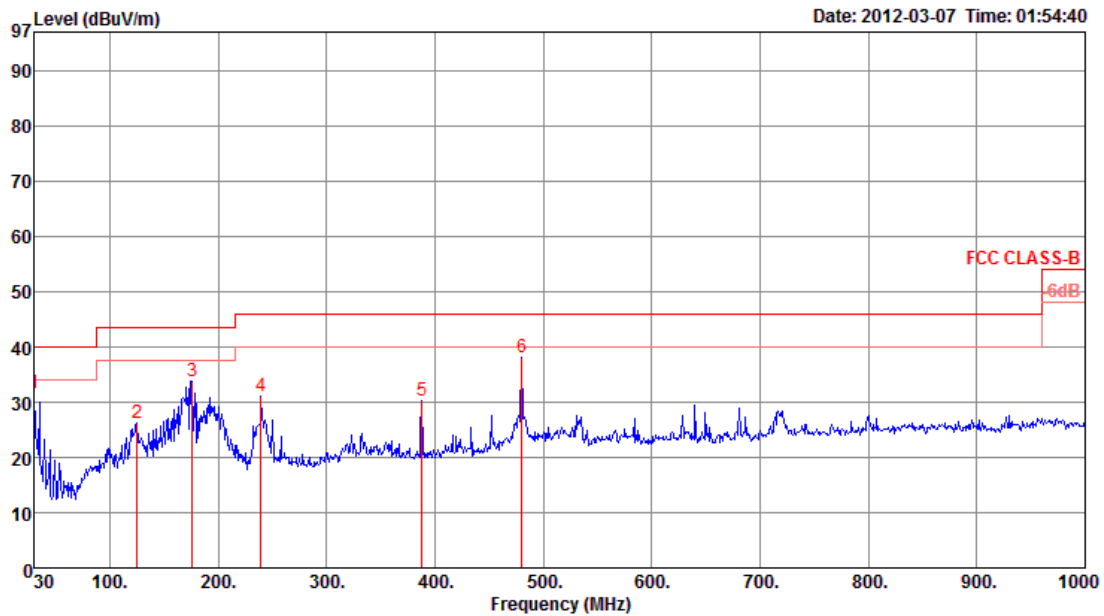

	Freq	Level	Limit Line	Over Limit	Read Level	Cable Loss	Preamp Factor	Antenna Factor	T/Pos	A/Pos	Remark	Pol/Phase
	MHz	dBuV/m	dBuV/m	dB	dBuV	dB	dB	dB/m	deg	cm		
1	30.00	31.52	40.00	-8.48	41.24	0.83	27.80	17.25	0	100	Peak	VERTICAL
2	125.06	26.33	43.50	-17.17	39.63	1.65	27.48	12.53	0	100	Peak	VERTICAL
3	176.47	33.90	43.50	-9.60	49.80	1.99	27.22	9.33	0	100	Peak	VERTICAL
4	239.52	31.17	46.00	-14.83	44.42	2.31	27.02	11.46	0	100	Peak	VERTICAL
5	387.93	30.33	46.00	-15.67	38.95	2.94	27.52	15.96	0	100	Peak	VERTICAL
6 p	480.08	38.13	46.00	-7.87	44.87	3.33	28.00	17.93	0	100	Peak	VERTICAL

**Note:**

The amplitude of spurious emissions which are attenuated by more than 20 dB below the permissible value has no need to be reported.

Emission level (dBuV/m) = 20 log Emission level (uV/m).

Corrected Reading: Antenna Factor + Cable Loss + Read Level - Preamp Factor = Level.

#### 4.6.9. Results for Radiated Emissions (1GHz~10<sup>th</sup> Harmonic)

<b>Temperature</b>	26°C	<b>Humidity</b>	60%
<b>Test Engineer</b>	Magic Lai	<b>Configurations</b>	IEEE 802.11n MCS0 20MHz Ch 1 / Mode 3
<b>Test Date</b>	Feb. 07, 2012		

##### *Horizontal*

	Freq	Level	Limit Line	Over Limit	Read Level	CableAntenna Loss	Antenna Factor	Preamp Factor	Remark	A/Pos	T/Pos	Pol/Phase
	MHz	dBuV/m	dBuV/m	dB	dBuV	dB	dB/m	dB		cm	deg	
1	4823.87	31.71	54.00	-22.29	30.37	3.31	33.06	35.03	Average	100	134	HORIZONTAL
2	4823.97	43.87	74.00	-30.13	42.53	3.31	33.06	35.03	Peak	100	134	HORIZONTAL

##### *Vertical*

	Freq	Level	Limit Line	Over Limit	Read Level	CableAntenna Loss	Antenna Factor	Preamp Factor	Remark	A/Pos	T/Pos	Pol/Phase
	MHz	dBuV/m	dBuV/m	dB	dBuV	dB	dB/m	dB		cm	deg	
1	4823.85	31.80	54.00	-22.20	30.46	3.31	33.06	35.03	Average	100	102	VERTICAL
2	4824.04	44.74	74.00	-29.26	43.40	3.31	33.06	35.03	Peak	100	102	VERTICAL

<b>Temperature</b>	26°C	<b>Humidity</b>	60%
<b>Test Engineer</b>	Magic Lai	<b>Configurations</b>	IEEE 802.11n MCS0 20MHz Ch 6 / Mode 3
<b>Test Date</b>	Feb. 08, 2012		

### Horizontal

	Freq	Level	Limit Line	Over Limit	Read Level	Cable Loss	Antenna Factor	Preamp Factor	Remark	A/Pos	T/Pos	Pol/Phase
	MHz	dBuV/m	dBuV/m	dB	dBuV	dB	dB/m	dB		cm	deg	
1	4873.91	31.01	54.00	-22.99	29.55	3.33	33.16	35.03	Average	100	224	HORIZONTAL
2	4873.99	43.60	74.00	-30.40	42.14	3.33	33.16	35.03	Peak	100	224	HORIZONTAL
3	7311.10	33.27	54.00	-20.73	28.65	4.06	35.96	35.40	Average	100	198	HORIZONTAL
4	7311.24	45.88	74.00	-28.12	41.26	4.06	35.96	35.40	Peak	100	198	HORIZONTAL

### Vertical

	Freq	Level	Limit Line	Over Limit	Read Level	Cable Loss	Antenna Factor	Preamp Factor	Remark	A/Pos	T/Pos	Pol/Phase
	MHz	dBuV/m	dBuV/m	dB	dBuV	dB	dB/m	dB		cm	deg	
1	4874.05	45.57	74.00	-28.43	44.11	3.33	33.16	35.03	Peak	100	105	VERTICAL
2	4874.15	31.77	54.00	-22.23	30.31	3.33	33.16	35.03	Average	100	105	VERTICAL
3	7310.36	46.26	74.00	-27.74	41.64	4.06	35.96	35.40	Peak	100	172	VERTICAL
4	7310.55	33.38	54.00	-20.62	28.76	4.06	35.96	35.40	Average	100	172	VERTICAL

<b>Temperature</b>	26°C	<b>Humidity</b>	60%
<b>Test Engineer</b>	Magic Lai	<b>Configurations</b>	IEEE 802.11n MCS0 20MHz Ch11 / Mode 3
<b>Test Date</b>	Feb. 08, 2012		

**Horizontal**

	Freq	Level	Limit Line	Over Limit	Read Level	CableAntenna Loss	Antenna Factor	Preamp Factor	Remark	A/Pos	T/Pos	Pol/Phase
	MHz	dBuV/m	dBuV/m	dB	dBuV	dB	dB/m	dB		cm	deg	
1	4922.75	30.86	54.00	-23.14	29.26	3.35	33.26	35.01	Average	100	294	HORIZONTAL
2	4924.14	42.80	74.00	-31.20	41.20	3.35	33.26	35.01	Peak	100	294	HORIZONTAL
3	7385.90	46.03	74.00	-27.97	41.28	4.06	36.09	35.40	Peak	100	165	HORIZONTAL
4	7386.95	33.61	54.00	-20.39	28.86	4.06	36.09	35.40	Average	100	165	HORIZONTAL

**Vertical**

	Freq	Level	Limit Line	Over Limit	Read Level	CableAntenna Loss	Antenna Factor	Preamp Factor	Remark	A/Pos	T/Pos	Pol/Phase
	MHz	dBuV/m	dBuV/m	dB	dBuV	dB	dB/m	dB		cm	deg	
1	4923.82	42.69	74.00	-31.31	41.09	3.35	33.26	35.01	Peak	100	124	VERTICAL
2	4923.90	31.35	54.00	-22.65	29.75	3.35	33.26	35.01	Average	100	124	VERTICAL
3	7385.81	33.50	54.00	-20.50	28.75	4.06	36.09	35.40	Average	100	204	VERTICAL
4	7386.08	46.01	74.00	-27.99	41.26	4.06	36.09	35.40	Peak	100	204	VERTICAL

<b>Temperature</b>	26°C	<b>Humidity</b>	60%
<b>Test Engineer</b>	Magic Lai	<b>Configurations</b>	IEEE 802.11n MCS0 40MHz Ch 3 / Mode 3
<b>Test Date</b>	Feb. 08, 2012		

### Horizontal

	Freq	Level	Limit Line	Over Limit	Read Level	CableAntenna Loss	Antenna Factor	Preamp Factor	Remark	A/Pos	T/Pos	Pol/Phase
	MHz	dBuV/m	dBuV/m	dB	dBuV	dB	dB/m	dB		cm	deg	
1	4843.87	43.24	74.00	-30.76	41.86	3.32	33.09	35.03	Peak	100	30	HORIZONTAL
2	4844.00	31.50	54.00	-22.50	30.12	3.32	33.09	35.03	Average	100	30	HORIZONTAL

### Vertical

	Freq	Level	Limit Line	Over Limit	Read Level	CableAntenna Loss	Antenna Factor	Preamp Factor	Remark	A/Pos	T/Pos	Pol/Phase
	MHz	dBuV/m	dBuV/m	dB	dBuV	dB	dB/m	dB		cm	deg	
1	4844.03	31.67	54.00	-22.33	30.29	3.32	33.09	35.03	Average	100	106	VERTICAL
2	4844.06	43.80	74.00	-30.20	42.42	3.32	33.09	35.03	Peak	100	106	VERTICAL



<b>Temperature</b>	26°C	<b>Humidity</b>	60%
<b>Test Engineer</b>	Magic Lai	<b>Configurations</b>	IEEE 802.11n MCS0 40MHz Ch 6 / Mode 3
<b>Test Date</b>	Feb. 08, 2012		

### Horizontal

	Freq	Level	Limit	Over	Read	CableAntenna	Preamp		A/Pos	T/Pos	
	MHz	dBuV/m	dBuV/m	dB	dBuV	dB	dB/m	dB	cm	deg	Pol/Phase
1	4873.99	29.86	54.00	-24.14	28.40	3.33	33.16	35.03	100	135	HORIZONTAL
2	4874.16	42.67	74.00	-31.33	41.21	3.33	33.16	35.03	100	135	HORIZONTAL
3	7310.62	46.19	74.00	-27.81	41.57	4.06	35.96	35.40	100	202	HORIZONTAL
4	7310.71	33.17	54.00	-20.83	28.55	4.06	35.96	35.40	100	202	HORIZONTAL

### Vertical

	Freq	Level	Limit	Over	Read	CableAntenna	Preamp		A/Pos	T/Pos	
	MHz	dBuV/m	dBuV/m	dB	dBuV	dB	dB/m	dB	cm	deg	Pol/Phase
1	4873.99	29.96	54.00	-24.04	28.50	3.33	33.16	35.03	100	17	VERTICAL
2	4874.27	42.50	74.00	-31.50	41.04	3.33	33.16	35.03	100	17	VERTICAL
3	7311.16	33.26	54.00	-20.74	28.64	4.06	35.96	35.40	100	226	VERTICAL
4	7311.32	45.63	74.00	-28.37	41.01	4.06	35.96	35.40	100	226	VERTICAL

<b>Temperature</b>	26°C	<b>Humidity</b>	60%
<b>Test Engineer</b>	Magic Lai	<b>Configurations</b>	IEEE 802.11n MCS0 40MHz Ch 9 / Mode 3
<b>Test Date</b>	Feb. 08, 2012		

### Horizontal

	Freq	Level	Limit Line	Over Limit	Read Level	CableAntenna Loss	Antenna Factor	Preamp Factor	Remark	A/Pos	T/Pos	Pol/Phase
	MHz	dBuV/m	dBuV/m	dB	dBuV	dB	dB/m	dB		cm	deg	
1	4903.98	29.95	54.00	-24.05	28.44	3.34	33.19	35.02	Average	100	303	HORIZONTAL
2	4904.31	43.07	74.00	-30.93	41.56	3.34	33.19	35.02	Peak	100	303	HORIZONTAL
3	7355.78	46.63	74.00	-27.37	41.95	4.06	36.02	35.40	Peak	100	203	HORIZONTAL
4	7355.87	33.05	54.00	-20.95	28.37	4.06	36.02	35.40	Average	100	203	HORIZONTAL

### Vertical

	Freq	Level	Limit Line	Over Limit	Read Level	CableAntenna Loss	Antenna Factor	Preamp Factor	Remark	A/Pos	T/Pos	Pol/Phase
	MHz	dBuV/m	dBuV/m	dB	dBuV	dB	dB/m	dB		cm	deg	
1	4903.88	42.47	74.00	-31.53	40.96	3.34	33.19	35.02	Peak	100	173	VERTICAL
2	4903.98	30.27	54.00	-23.73	28.76	3.34	33.19	35.02	Average	100	173	VERTICAL
3	7355.97	33.34	54.00	-20.66	28.66	4.06	36.02	35.40	Average	100	84	VERTICAL
4	7357.03	46.32	74.00	-27.68	41.64	4.06	36.02	35.40	Peak	100	84	VERTICAL

### Note:

The amplitude of spurious emissions which are attenuated by more than 20 dB below the permissible value has no need to be reported.

Emission level (dBuV/m) = 20 log Emission level (uV/m).

Corrected Reading: Antenna Factor + Cable Loss + Read Level - Preamp Factor = Level.

<b>Temperature</b>	26°C	<b>Humidity</b>	60%
<b>Test Engineer</b>	Magic Lai	<b>Configurations</b>	IEEE 802.11b CH 1 / Mode 3
<b>Test Date</b>	Feb. 08, 2012		

### Horizontal

	Freq	Level	Limit Line	Over Limit	Read Level	CableAntenna Loss	Antenna Factor	Preamp Factor	Remark	A/Pos	T/Pos	Pol/Phase
	MHz	dBuV/m	dBuV/m	dB	dBuV	dB	dB/m	dB		cm	deg	
1	4823.97	38.58	54.00	-15.42	37.24	3.31	33.06	35.03	Average	100	316	HORIZONTAL
2	4824.15	46.91	74.00	-27.09	45.57	3.31	33.06	35.03	Peak	100	316	HORIZONTAL

### Vertical

	Freq	Level	Limit Line	Over Limit	Read Level	CableAntenna Loss	Antenna Factor	Preamp Factor	Remark	A/Pos	T/Pos	Pol/Phase
	MHz	dBuV/m	dBuV/m	dB	dBuV	dB	dB/m	dB		cm	deg	
1	4823.80	48.22	74.00	-25.78	46.88	3.31	33.06	35.03	Peak	100	104	VERTICAL
2	4823.99	42.23	54.00	-11.77	40.89	3.31	33.06	35.03	Average	100	104	VERTICAL

<b>Temperature</b>	26°C	<b>Humidity</b>	60%
<b>Test Engineer</b>	Magic Lai	<b>Configurations</b>	IEEE 802.11b CH 6 / Mode 3
<b>Test Date</b>	Feb. 08, 2012		

### Horizontal

	Freq	Level	Limit Line	Over Limit	Read Level	CableAntenna Loss	Antenna Factor	Preamp Factor	Remark	A/Pos	T/Pos	Pol/Phase
	MHz	dBuV/m	dBuV/m	dB	dBuV	dB	dB/m	dB		cm	deg	
1	4873.79	46.25	74.00	-27.75	44.79	3.33	33.16	35.03	Peak	112	128	HORIZONTAL
2	4873.99	36.55	54.00	-17.45	35.09	3.33	33.16	35.03	Average	112	128	HORIZONTAL

### Vertical

	Freq	Level	Limit Line	Limit	Level	Loss	Factor	Factor	Remark	A/Pos	T/Pos	Pol/Phase
	MHz	dBuV/m	dBuV/m	dB	dBuV	dB	dB/m	dB		cm	deg	
1	4873.88	47.82	74.00	-26.18	46.36	3.33	33.16	35.03	Peak	100	108	VERTICAL
2	4873.99	42.27	54.00	-11.73	40.81	3.33	33.16	35.03	Average	100	108	VERTICAL

<b>Temperature</b>	26°C	<b>Humidity</b>	60%
<b>Test Engineer</b>	Magic Lai	<b>Configurations</b>	IEEE 802.11b CH 11 / Mode 3
<b>Test Date</b>	Feb. 08, 2012		

### Horizontal

	Freq	Level	Limit	Over	Read	CableAntenna	Preamp		A/Pos	T/Pos	Pol/Phase	
	MHz	dBuV/m	dBuV/m	dB	dBuV	dB	dB/m	dB	cm	deg		
1	4923.99	42.15	54.00	-11.85	40.55	3.35	33.26	35.01	Average	103	140	HORIZONTAL
2	4924.06	47.92	74.00	-26.08	46.32	3.35	33.26	35.01	Peak	103	140	HORIZONTAL

### Vertical

	Freq	Level	Limit	Over	Read	CableAntenna	Preamp		A/Pos	T/Pos	Pol/Phase	
	MHz	dBuV/m	dBuV/m	dB	dBuV	dB	dB/m	dB	cm	deg		
1	4923.92	49.07	74.00	-24.93	47.47	3.35	33.26	35.01	Peak	100	101	VERTICAL
2	4923.99	44.16	54.00	-9.84	42.56	3.35	33.26	35.01	Average	100	101	VERTICAL

<b>Temperature</b>	26°C	<b>Humidity</b>	60%
<b>Test Engineer</b>	Magic Lai	<b>Configurations</b>	IEEE 802.11g CH 1 / Mode 3
<b>Test Date</b>	Feb. 08, 2012		

### Horizontal

	Freq	Level	Limit	Over	Read	CableAntenna	Preamp		A/Pos	T/Pos	Pol/Phase
	MHz	dBuV/m	dBuV/m	dB	dBuV	dB	dB/m	dB	cm	deg	
1	4823.78	44.53	74.00	-29.47	43.19	3.31	33.06	35.03	100	304	HORIZONTAL
2	4823.89	31.57	54.00	-22.43	30.23	3.31	33.06	35.03	100	304	HORIZONTAL

### Vertical

	Freq	Level	Limit	Over	Read	CableAntenna	Preamp		A/Pos	T/Pos	Pol/Phase
	MHz	dBuV/m	dBuV/m	dB	dBuV	dB	dB/m	dB	cm	deg	
1	4823.89	45.66	74.00	-28.34	44.32	3.31	33.06	35.03	100	104	VERTICAL
2	4823.94	32.50	54.00	-21.50	31.16	3.31	33.06	35.03	100	104	VERTICAL

<b>Temperature</b>	26°C	<b>Humidity</b>	60%
<b>Test Engineer</b>	Magic Lai	<b>Configurations</b>	IEEE 802.11g CH 6 / Mode 3
<b>Test Date</b>	Feb. 07, 2012		

**Horizontal**

	Freq	Level	Limit	Over	Read	CableAntenna	Preamp		A/Pos	T/Pos	Pol/Phase
	MHz	dBuV/m	dBuV/m	dB	dBuV	dB	dB/m	dB	cm	deg	
1	4874.13	30.81	54.00	-23.19	29.35	3.33	33.16	35.03	100	289	HORIZONTAL
2	4874.88	42.28	74.00	-31.72	40.82	3.33	33.16	35.03	100	289	HORIZONTAL
3	7311.03	33.01	54.00	-20.99	28.39	4.06	35.96	35.40	100	178	HORIZONTAL
4	7311.24	45.83	74.00	-28.17	41.21	4.06	35.96	35.40	100	178	HORIZONTAL

**Vertical**

	Freq	Level	Limit	Over	Read	CableAntenna	Preamp		A/Pos	T/Pos	Pol/Phase
	MHz	dBuV/m	dBuV/m	dB	dBuV	dB	dB/m	dB	cm	deg	
1	4871.45	31.74	54.00	-22.26	30.28	3.33	33.16	35.03	100	74	VERTICAL
2	4874.80	45.33	74.00	-28.67	43.87	3.33	33.16	35.03	100	74	VERTICAL
3	7311.11	45.62	74.00	-28.38	41.00	4.06	35.96	35.40	100	303	VERTICAL
4	7311.26	33.68	54.00	-20.32	29.06	4.06	35.96	35.40	100	303	VERTICAL

<b>Temperature</b>	26°C	<b>Humidity</b>	60%
<b>Test Engineer</b>	Magic Lai	<b>Configurations</b>	IEEE 802.11g CH 11 / Mode 3
<b>Test Date</b>	Feb. 07, 2012		

#### Horizontal

	Freq	Level	Limit Line	Over Limit	Read Level	Cable Loss	Antenna Factor	Preamp Factor	Remark	A/Pos	T/Pos	Pol/Phase
	MHz	dBuV/m	dBuV/m	dB	dBuV	dB	dB/m	dB		cm	deg	
1	4923.81	42.21	74.00	-31.79	40.61	3.35	33.26	35.01	Peak	100	191	HORIZONTAL
2	4923.86	31.08	54.00	-22.92	29.48	3.35	33.26	35.01	Average	100	191	HORIZONTAL
3	7385.95	33.51	54.00	-20.49	28.76	4.06	36.09	35.40	Average	100	228	HORIZONTAL
4	7386.32	46.11	74.00	-27.89	41.36	4.06	36.09	35.40	Peak	100	228	HORIZONTAL

#### Vertical

	Freq	Level	Limit Line	Over Limit	Read Level	Cable Loss	Antenna Factor	Preamp Factor	Remark	A/Pos	T/Pos	Pol/Phase
	MHz	dBuV/m	dBuV/m	dB	dBuV	dB	dB/m	dB		cm	deg	
1	4923.58	42.80	74.00	-31.20	41.20	3.35	33.26	35.01	Peak	100	161	VERTICAL
2	4923.95	30.49	54.00	-23.51	28.89	3.35	33.26	35.01	Average	100	161	VERTICAL
3	7385.58	45.93	74.00	-28.07	41.18	4.06	36.09	35.40	Peak	100	238	VERTICAL
4	7385.97	33.74	54.00	-20.26	28.99	4.06	36.09	35.40	Average	100	238	VERTICAL

#### Note:

The amplitude of spurious emissions that are attenuated by more than 20dB below the permissible value has no need to be reported.

Emission level (dBuV/m) = 20 log Emission level (uV/m).

Corrected Reading: Antenna Factor + Cable Loss + Read Level - Preamp Factor = Level.



<b>Temperature</b>	26°C	<b>Humidity</b>	60%
<b>Test Engineer</b>	Magic Lai	<b>Configurations</b>	IEEE 802.11n MCS0 20MHz Ch 1 / Mode 4
<b>Test Date</b>	Feb. 07, 2012		

### Horizontal

	Freq	Level	Limit Line	Over Limit	Read Level	CableAntenna Loss	Antenna Factor	Preamp Factor	Remark	A/Pos	T/Pos	Pol/Phase
	MHz	dBuV/m	dBuV/m	dB	dBuV	dB	dB/m	dB		cm	deg	
1	4823.98	32.28	54.00	-21.72	30.94	3.31	33.06	35.03	Average	103	47	HORIZONTAL
2	4824.17	44.24	74.00	-29.76	42.90	3.31	33.06	35.03	Peak	103	47	HORIZONTAL

### Vertical

	Freq	Level	Limit Line	Over Limit	Read Level	CableAntenna Loss	Antenna Factor	Preamp Factor	Remark	A/Pos	T/Pos	Pol/Phase
	MHz	dBuV/m	dBuV/m	dB	dBuV	dB	dB/m	dB		cm	deg	
1	4823.94	44.03	74.00	-29.97	42.69	3.31	33.06	35.03	Peak	100	78	VERTICAL
2	4823.98	32.91	54.00	-21.09	31.57	3.31	33.06	35.03	Average	100	78	VERTICAL

<b>Temperature</b>	26°C	<b>Humidity</b>	60%
<b>Test Engineer</b>	Magic Lai	<b>Configurations</b>	IEEE 802.11n MCS0 20MHz Ch 6 / Mode 4
<b>Test Date</b>	Feb. 07, 2012		

### Horizontal

	Freq	Level	Limit Line	Over Limit	Read Level	CableAntenna Loss	Antenna Factor	Preamp Factor	Remark	A/Pos	T/Pos	Pol/Phase
	MHz	dBuV/m	dBuV/m	dB	dBuV	dB	dB/m	dB		cm	deg	
1	4874.06	32.60	54.00	-21.40	31.14	3.33	33.16	35.03	Average	119	44	HORIZONTAL
2	4875.01	47.98	74.00	-26.02	46.52	3.33	33.16	35.03	Peak	119	44	HORIZONTAL
3	7311.03	32.12	54.00	-21.88	27.50	4.06	35.96	35.40	Average	100	109	HORIZONTAL
4	7312.04	46.47	74.00	-27.53	41.85	4.06	35.96	35.40	Peak	100	109	HORIZONTAL

### Vertical

	Freq	Level	Limit Line	Over Limit	Read Level	CableAntenna Loss	Antenna Factor	Preamp Factor	Remark	A/Pos	T/Pos	Pol/Phase
	MHz	dBuV/m	dBuV/m	dB	dBuV	dB	dB/m	dB		cm	deg	
1	4873.98	31.24	54.00	-22.76	29.78	3.33	33.16	35.03	Average	100	325	VERTICAL
2	4874.01	46.39	74.00	-27.61	44.93	3.33	33.16	35.03	Peak	100	325	VERTICAL
3	7313.01	32.81	54.00	-21.19	28.19	4.06	35.96	35.40	Average	100	82	VERTICAL
4	7313.49	46.56	74.00	-27.44	41.94	4.06	35.96	35.40	Peak	100	82	VERTICAL

<b>Temperature</b>	26°C	<b>Humidity</b>	60%
<b>Test Engineer</b>	Magic Lai	<b>Configurations</b>	IEEE 802.11n MCS0 20MHz Ch11 / Mode 4
<b>Test Date</b>	Feb. 07, 2012		

### Horizontal

	Freq	Level	Limit Line	Over Limit	Read Level	CableAntenna Loss	Antenna Factor	Preamp Factor	Remark	A/Pos	T/Pos	Pol/Phase
	MHz	dBuV/m	dBuV/m	dB	dBuV	dB	dB/m	dB		cm	deg	
1	4924.04	29.90	54.00	-24.10	28.30	3.35	33.26	35.01	Average	102	60	HORIZONTAL
2	4924.08	43.11	74.00	-30.89	41.51	3.35	33.26	35.01	Peak	102	60	HORIZONTAL
3	7384.97	32.39	54.00	-21.61	27.64	4.06	36.09	35.40	Average	100	211	HORIZONTAL
4	7387.41	46.59	74.00	-27.41	41.84	4.06	36.09	35.40	Peak	100	211	HORIZONTAL

### Vertical

	Freq	Level	Limit Line	Over Limit	Read Level	CableAntenna Loss	Antenna Factor	Preamp Factor	Remark	A/Pos	T/Pos	Pol/Phase
	MHz	dBuV/m	dBuV/m	dB	dBuV	dB	dB/m	dB		cm	deg	
1	4922.85	43.03	74.00	-30.97	41.43	3.35	33.26	35.01	Peak	100	84	VERTICAL
2	4924.02	30.49	54.00	-23.51	28.89	3.35	33.26	35.01	Average	100	84	VERTICAL
3	7386.96	32.41	54.00	-21.59	27.66	4.06	36.09	35.40	Average	100	126	VERTICAL
4	7387.98	47.13	74.00	-26.87	42.38	4.06	36.09	35.40	Peak	100	126	VERTICAL



<b>Temperature</b>	26°C	<b>Humidity</b>	60%
<b>Test Engineer</b>	Magic Lai	<b>Configurations</b>	IEEE 802.11n MCS0 40MHz Ch 3 / Mode 4
<b>Test Date</b>	Feb. 08, 2012		

**Horizontal**

	Freq	Level	Limit Line	Over Limit	Read Level	CableAntenna Loss	Antenna Factor	Preamp Factor	Remark	A/Pos	T/Pos	Pol/Phase
	MHz	dBuV/m	dBuV/m	dB	dBuV	dB	dB/m	dB		cm	deg	
1	4843.96	30.97	54.00	-23.03	29.59	3.32	33.09	35.03	Average	100	48	HORIZONTAL
2	4844.05	43.13	74.00	-30.87	41.75	3.32	33.09	35.03	Peak	100	48	HORIZONTAL

**Vertical**

	Freq	Level	Limit Line	Over Limit	Read Level	CableAntenna Loss	Antenna Factor	Preamp Factor	Remark	A/Pos	T/Pos	Pol/Phase
	MHz	dBuV/m	dBuV/m	dB	dBuV	dB	dB/m	dB		cm	deg	
1	4843.88	43.29	74.00	-30.71	41.91	3.32	33.09	35.03	Peak	100	78	VERTICAL
2	4843.98	31.51	54.00	-22.49	30.13	3.32	33.09	35.03	Average	100	78	VERTICAL

<b>Temperature</b>	26°C	<b>Humidity</b>	60%
<b>Test Engineer</b>	Magic Lai	<b>Configurations</b>	IEEE 802.11n MCS0 40MHz Ch 6 / Mode 4
<b>Test Date</b>	Feb. 07, 2012		

### Horizontal

	Freq	Level	Limit Line	Over Limit	Read Level	CableAntenna Loss	Antenna Factor	Preamp Factor	Remark	A/Pos	T/Pos	PoI/Phase
	MHz	dBuV/m	dBuV/m	dB	dBuV	dB	dB/m	dB		cm	deg	
1	4872.01	42.64	74.00	-31.36	41.18	3.33	33.16	35.03	Peak	100	294	HORIZONTAL
2	4874.06	29.22	54.00	-24.78	27.76	3.33	33.16	35.03	Average	100	294	HORIZONTAL
3	7309.68	45.89	74.00	-28.11	41.27	4.06	35.96	35.40	Peak	100	210	HORIZONTAL
4	7311.18	32.26	54.00	-21.74	27.64	4.06	35.96	35.40	Average	100	210	HORIZONTAL

### Vertical

	Freq	Level	Limit Line	Over Limit	Read Level	CableAntenna Loss	Antenna Factor	Preamp Factor	Remark	A/Pos	T/Pos	PoI/Phase
	MHz	dBuV/m	dBuV/m	dB	dBuV	dB	dB/m	dB		cm	deg	
1	4873.76	42.70	74.00	-31.30	41.24	3.33	33.16	35.03	Peak	100	81	VERTICAL
2	4874.00	30.15	54.00	-23.85	28.69	3.33	33.16	35.03	Average	100	81	VERTICAL
3	7309.16	32.27	54.00	-21.73	27.65	4.06	35.96	35.40	Average	100	91	VERTICAL
4	7311.70	45.77	74.00	-28.23	41.15	4.06	35.96	35.40	Peak	100	91	VERTICAL

<b>Temperature</b>	26°C	<b>Humidity</b>	60%
<b>Test Engineer</b>	Magic Lai	<b>Configurations</b>	IEEE 802.11n MCS0 40MHz Ch 9 / Mode 4
<b>Test Date</b>	Feb. 07, 2012		

### Horizontal

	Freq	Level	Limit Line	Over Limit	Read Level	Cable Loss	Antenna Factor	Preamp Factor	Remark	A/Pos	T/Pos	PoI/Phase
	MHz	dBuV/m	dBuV/m	dB	dBuV	dB	dB/m	dB		cm	deg	
1	4903.86	42.91	74.00	-31.09	41.40	3.34	33.19	35.02	Peak	100	49	HORIZONTAL
2	4903.94	29.91	54.00	-24.09	28.40	3.34	33.19	35.02	Average	100	49	HORIZONTAL
3	7356.88	32.50	54.00	-21.50	27.82	4.06	36.02	35.40	Average	100	111	HORIZONTAL
4	7357.72	47.20	74.00	-26.80	42.52	4.06	36.02	35.40	Peak	100	111	HORIZONTAL

### Vertical

	Freq	Level	Limit Line	Over Limit	Read Level	Cable Loss	Antenna Factor	Preamp Factor	Remark	A/Pos	T/Pos	PoI/Phase
	MHz	dBuV/m	dBuV/m	dB	dBuV	dB	dB/m	dB		cm	deg	
1	4904.00	29.40	54.00	-24.60	27.89	3.34	33.19	35.02	Average	100	111	VERTICAL
2	4904.18	43.27	74.00	-30.73	41.76	3.34	33.19	35.02	Peak	100	111	VERTICAL
3	7355.25	32.56	54.00	-21.44	27.88	4.06	36.02	35.40	Average	100	222	VERTICAL
4	7357.89	46.55	74.00	-27.45	41.87	4.06	36.02	35.40	Peak	100	222	VERTICAL

### Note:

The amplitude of spurious emissions which are attenuated by more than 20 dB below the permissible value has no need to be reported.

Emission level (dBuV/m) = 20 log Emission level (uV/m).

Corrected Reading: Antenna Factor + Cable Loss + Read Level - Preamp Factor = Level.

<b>Temperature</b>	26°C	<b>Humidity</b>	60%
<b>Test Engineer</b>	Magic Lai	<b>Configurations</b>	IEEE 802.11b CH 1 / Mode 4
<b>Test Date</b>	Feb. 04, 2012		

**Horizontal**

	Freq	Level	Limit	Over	Read	Cable	Preamp	Antenna	T/Pos	A/Pos	Remark	Pol/Phase
	MHz	dBuV/m	dBuV/m	dB	dBuV	dB	dB	dB/m	deg	cm		
1 p	4823.92	48.87	74.00	-25.13	47.59	4.08	35.26	32.46	58	100	Peak	HORIZONTAL
2 a	4824.00	44.59	54.00	-9.41	43.31	4.08	35.26	32.46	58	100	Average	HORIZONTAL

**Vertical**

	Freq	Level	Limit	Over	Read	Cable	Preamp	Antenna	T/Pos	A/Pos	Remark	Pol/Phase
	MHz	dBuV/m	dBuV/m	dB	dBuV	dB	dB	dB/m	deg	cm		
1 a	4824.00	45.94	54.00	-8.06	44.66	4.08	35.26	32.46	332	100	Average	VERTICAL
2 p	4824.01	50.06	74.00	-23.94	48.78	4.08	35.26	32.46	332	100	Peak	VERTICAL

<b>Temperature</b>	26°C	<b>Humidity</b>	60%
<b>Test Engineer</b>	Magic Lai	<b>Configurations</b>	IEEE 802.11b CH 6 / Mode 4
<b>Test Date</b>	Feb. 04, 2012		

### Horizontal

	Freq	Level	Limit	Over	Read	Cable	Preamp	Antenna	T/Pos	A/Pos	Remark	Pol/Phase
	MHz	dBuV/m	dBuV/m	dB	dBuV	dB	dB	dB/m	deg	cm		
1 p	4873.95	47.29	74.00	-26.71	45.77	4.11	35.15	32.56	59	100	Peak	HORIZONTAL
2 a	4874.00	40.62	54.00	-13.38	39.10	4.11	35.15	32.56	59	100	Average	HORIZONTAL

### Vertical

	Freq	Level	Limit	Over	Read	Cable	Preamp	Antenna	T/Pos	A/Pos	Remark	Pol/Phase
	MHz	dBuV/m	dBuV/m	dB	dBuV	dB	dB	dB/m	deg	cm		
1 a	4873.99	42.70	54.00	-11.30	41.18	4.11	35.15	32.56	228	100	Average	VERTICAL
2 p	4874.08	47.75	74.00	-26.25	46.23	4.11	35.15	32.56	228	100	Peak	VERTICAL



<b>Temperature</b>	26°C	<b>Humidity</b>	60%
<b>Test Engineer</b>	Magic Lai	<b>Configurations</b>	IEEE 802.11b CH 11 / Mode 4
<b>Test Date</b>	Feb. 04, 2012		

**Horizontal**

	Freq	Level	Limit	Over	Read	Cable	Preamp	Antenna	T/Pos	A/Pos	Remark	Pol/Phase
	MHz	dBuV/m	dBuV/m	dB	dBuV	dB	dB	dB/m	deg	cm		
1 a	4924.00	37.26	54.00	-16.74	35.50	4.13	35.03	32.66	134	100	Average	HORIZONTAL
2 p	4924.03	45.45	74.00	-28.55	43.69	4.13	35.03	32.66	134	100	Peak	HORIZONTAL

**Vertical**

	Freq	Level	Limit	Over	Read	Cable	Preamp	Antenna	T/Pos	A/Pos	Remark	Pol/Phase
	MHz	dBuV/m	dBuV/m	dB	dBuV	dB	dB	dB/m	deg	cm		
1 p	4923.94	46.42	74.00	-27.58	44.66	4.13	35.03	32.66	181	100	Peak	VERTICAL
2 a	4923.99	39.65	54.00	-14.35	37.89	4.13	35.03	32.66	181	100	Average	VERTICAL



<b>Temperature</b>	26°C	<b>Humidity</b>	60%
<b>Test Engineer</b>	Magic Lai	<b>Configurations</b>	IEEE 802.11g CH 1 / Mode 4
<b>Test Date</b>	Feb. 07, 2012		

**Horizontal**

	Freq	Level	Limit Line	Over Limit	Read Level	CableAntenna Loss	Antenna Factor	Preamp Factor	Remark	A/Pos	T/Pos	Pol/Phase
	MHz	dBuV/m	dBuV/m	dB	dBuV	dB	dB/m	dB		cm	deg	
1	4823.99	31.62	54.00	-22.38	30.28	3.31	33.06	35.03	Average	100	46	HORIZONTAL
2	4825.00	44.31	74.00	-29.69	42.97	3.31	33.06	35.03	Peak	100	46	HORIZONTAL

**Vertical**

	Freq	Level	Limit Line	Over Limit	Read Level	CableAntenna Loss	Antenna Factor	Preamp Factor	Remark	A/Pos	T/Pos	Pol/Phase
	MHz	dBuV/m	dBuV/m	dB	dBuV	dB	dB/m	dB		cm	deg	
1	4823.98	32.60	54.00	-21.40	31.26	3.31	33.06	35.03	Average	100	77	VERTICAL
2	4824.00	46.16	74.00	-27.84	44.82	3.31	33.06	35.03	Peak	100	77	VERTICAL

<b>Temperature</b>	26°C	<b>Humidity</b>	60%
<b>Test Engineer</b>	Magic Lai	<b>Configurations</b>	IEEE 802.11g CH 6 / Mode 4
<b>Test Date</b>	Feb. 07, 2012		

### Horizontal

	Freq	Level	Limit	Over	Read	CableAntenna	Preamp	Remark	A/Pos	T/Pos	Pol/Phase	
	MHz	dBuV/m	dBuV/m	dB	dBuV	dB	dB/m	dB	cm	deg		
1	4874.02	31.80	54.00	-22.20	30.34	3.33	33.16	35.03	Average	108	49	HORIZONTAL
2	4874.45	45.64	74.00	-28.36	44.18	3.33	33.16	35.03	Peak	108	49	HORIZONTAL
3	7308.97	32.09	54.00	-21.91	27.47	4.06	35.96	35.40	Average	100	238	HORIZONTAL
4	7310.27	45.88	74.00	-28.12	41.26	4.06	35.96	35.40	Peak	100	238	HORIZONTAL

### Vertical

	Freq	Level	Limit	Over	Read	CableAntenna	Preamp	Remark	A/Pos	T/Pos	Pol/Phase	
	MHz	dBuV/m	dBuV/m	dB	dBuV	dB	dB/m	dB	cm	deg		
1	4873.64	44.94	74.00	-29.06	43.48	3.33	33.16	35.03	Peak	100	78	VERTICAL
2	4873.96	31.08	54.00	-22.92	29.62	3.33	33.16	35.03	Average	100	78	VERTICAL
3	7311.24	32.13	54.00	-21.87	27.51	4.06	35.96	35.40	Average	100	122	VERTICAL
4	7311.37	45.44	74.00	-28.56	40.82	4.06	35.96	35.40	Peak	100	122	VERTICAL

<b>Temperature</b>	26°C	<b>Humidity</b>	60%
<b>Test Engineer</b>	Magic Lai	<b>Configurations</b>	IEEE 802.11g CH 11 / Mode 4
<b>Test Date</b>	Feb. 07, 2012		

#### Horizontal

	Freq	Level	Limit Line	Over Limit	Read Level	Cable Loss	Antenna Factor	Preamp Factor	Remark	A/Pos	T/Pos	Pol/Phase
	MHz	dBuV/m	dBuV/m	dB	dBuV	dB	dB/m	dB		cm	deg	
1	4924.02	29.82	54.00	-24.18	28.22	3.35	33.26	35.01	Average	100	56	HORIZONTAL
2	4924.11	43.13	74.00	-30.87	41.53	3.35	33.26	35.01	Peak	100	56	HORIZONTAL
3	7384.84	47.18	74.00	-26.82	42.43	4.06	36.09	35.40	Peak	100	59	HORIZONTAL
4	7386.91	32.41	54.00	-21.59	27.66	4.06	36.09	35.40	Average	100	59	HORIZONTAL

#### Vertical

	Freq	Level	Limit Line	Over Limit	Read Level	Cable Loss	Antenna Factor	Preamp Factor	Remark	A/Pos	T/Pos	Pol/Phase
	MHz	dBuV/m	dBuV/m	dB	dBuV	dB	dB/m	dB		cm	deg	
1	4923.98	30.59	54.00	-23.41	28.99	3.35	33.26	35.01	Average	100	81	VERTICAL
2	4924.05	43.39	74.00	-30.61	41.79	3.35	33.26	35.01	Peak	100	81	VERTICAL
3	7386.83	32.39	54.00	-21.61	27.64	4.06	36.09	35.40	Average	100	216	VERTICAL
4	7387.66	46.10	74.00	-27.90	41.35	4.06	36.09	35.40	Peak	100	216	VERTICAL

#### Note:

The amplitude of spurious emissions that are attenuated by more than 20dB below the permissible value has no need to be reported.

Emission level (dBuV/m) = 20 log Emission level (uV/m).

Corrected Reading: Antenna Factor + Cable Loss + Read Level - Preamp Factor = Level.

<b>Temperature</b>	26°C	<b>Humidity</b>	60%
<b>Test Engineer</b>	Magic Lai	<b>Configurations</b>	IEEE 802.11n MCS0 20MHz Ch 1 / Mode 7
<b>Test Date</b>	Jan. 31, 2012		

### Horizontal

	Freq	Level	Limit Line	Over Limit	Read Level	CableAntenna Loss	Antenna Factor	Preamp Factor	A/Pos	T/Pos	Remark	Pol/Phase
	MHz	dBuV/m	dBuV/m	dB	dBuV	dB	dB/m	dB	cm	deg		
1	4823.77	44.33	74.00	-29.67	39.91	6.23	33.39	35.20	100	205	Peak	HORIZONTAL
2	4823.84	32.46	54.00	-21.54	28.04	6.23	33.39	35.20	100	205	Average	HORIZONTAL

### Vertical

	Freq	Level	Limit Line	Over Limit	Read Level	CableAntenna Loss	Antenna Factor	Preamp Factor	A/Pos	T/Pos	Remark	Pol/Phase
	MHz	dBuV/m	dBuV/m	dB	dBuV	dB	dB/m	dB	cm	deg		
1	4824.02	34.46	54.00	-19.54	30.04	6.23	33.39	35.20	100	270	Average	VERTICAL
2	4824.42	46.49	74.00	-27.51	42.07	6.23	33.39	35.20	100	270	Peak	VERTICAL

<b>Temperature</b>	26°C	<b>Humidity</b>	60%
<b>Test Engineer</b>	Magic Lai	<b>Configurations</b>	IEEE 802.11n MCS0 20MHz Ch 6 / Mode 7
<b>Test Date</b>	Jan. 031 2012		

### Horizontal

	Freq	Level	Limit Line	Over Limit	Read Level	CableAntenna Loss	Antenna Factor	Preamp Factor	A/Pos	T/Pos	Remark	Pol/Phase
	MHz	dBuV/m	dBuV/m	dB	dBuV	dB	dB/m	dB	cm	deg		
1	4873.96	33.24	54.00	-20.76	28.67	6.29	33.48	35.20	100	237	Average	HORIZONTAL
2	4874.28	46.33	74.00	-27.67	41.76	6.29	33.48	35.20	100	237	Peak	HORIZONTAL

### Vertical

	Freq	Level	Limit Line	Over Limit	Read Level	CableAntenna Loss	Antenna Factor	Preamp Factor	A/Pos	T/Pos	Remark	Pol/Phase
	MHz	dBuV/m	dBuV/m	dB	dBuV	dB	dB/m	dB	cm	deg		
1	4873.71	48.59	74.00	-25.41	44.02	6.29	33.48	35.20	100	188	Peak	VERTICAL
2	4873.88	35.86	54.00	-18.14	31.29	6.29	33.48	35.20	100	188	Average	VERTICAL

<b>Temperature</b>	26°C	<b>Humidity</b>	60%
<b>Test Engineer</b>	Magic Lai	<b>Configurations</b>	IEEE 802.11n MCS0 20MHz Ch11 / Mode 7
<b>Test Date</b>	Jan. 31, 2012		

### Horizontal

	Freq	Level	Limit Line	Over Limit	Read Level	CableAntenna Loss	Antenna Factor	Preamp Factor	A/Pos	T/Pos	Remark	Pol/Phase
	MHz	dBuV/m	dBuV/m	dB	dBuV	dB	dB/m	dB	cm	deg		
1	4923.67	32.35	54.00	-21.65	27.63	6.34	33.58	35.20	100	102	Average	HORIZONTAL
2	4923.76	45.30	74.00	-28.70	40.58	6.34	33.58	35.20	100	102	Peak	HORIZONTAL

### Vertical

	Freq	Level	Limit Line	Over Limit	Read Level	CableAntenna Loss	Antenna Factor	Preamp Factor	A/Pos	T/Pos	Remark	Pol/Phase
	MHz	dBuV/m	dBuV/m	dB	dBuV	dB	dB/m	dB	cm	deg		
1	4923.60	47.26	74.00	-26.74	42.54	6.34	33.58	35.20	100	188	Peak	VERTICAL
2	4923.92	35.13	54.00	-18.87	30.41	6.34	33.58	35.20	100	188	Average	VERTICAL

<b>Temperature</b>	26°C	<b>Humidity</b>	60%
<b>Test Engineer</b>	Magic Lai	<b>Configurations</b>	IEEE 802.11n MCS0 40MHz Ch 3 / Mode 7
<b>Test Date</b>	Jan. 31, 2012		

### Horizontal

	Freq	Level	Limit Line	Over Limit	Read Level	CableAntenna Loss	Antenna Factor	Preamp Factor	A/Pos	T/Pos	Remark	Pol/Phase
	MHz	dBuV/m	dBuV/m	dB	dBuV	dB	dB/m	dB	cm	deg		
1	4844.36	45.25	74.00	-28.75	40.77	6.26	33.42	35.20	100	127	Peak	HORIZONTAL
2	4844.49	32.03	54.00	-21.97	27.55	6.26	33.42	35.20	100	127	Average	HORIZONTAL

### Vertical

	Freq	Level	Limit Line	Over Limit	Read Level	CableAntenna Loss	Antenna Factor	Preamp Factor	A/Pos	T/Pos	Remark	Pol/Phase
	MHz	dBuV/m	dBuV/m	dB	dBuV	dB	dB/m	dB	cm	deg		
1	4843.93	33.35	54.00	-20.65	28.87	6.26	33.42	35.20	100	206	Average	VERTICAL
2	4844.32	45.32	74.00	-28.68	40.84	6.26	33.42	35.20	100	206	Peak	VERTICAL



<b>Temperature</b>	26°C	<b>Humidity</b>	60%
<b>Test Engineer</b>	Magic Lai	<b>Configurations</b>	IEEE 802.11n MCS0 40MHz Ch 6 / Mode 7
<b>Test Date</b>	Jan. 31, 2012		

### Horizontal

	Freq	Level	Limit Line	Over Limit	Read Level	CableAntenna Loss	Antenna Factor	Preamp Factor	A/Pos	T/Pos	Remark	Pol/Phase
	MHz	dBuV/m	dBuV/m	dB	dBuV	dB	dB/m	dB	cm	deg		
1	4873.75	44.92	74.00	-29.08	40.35	6.29	33.48	35.20	100	164	Peak	HORIZONTAL
2	4873.92	31.95	54.00	-22.05	27.38	6.29	33.48	35.20	100	164	Average	HORIZONTAL

### Vertical

	Freq	Level	Limit Line	Over Limit	Read Level	CableAntenna Loss	Antenna Factor	Preamp Factor	A/Pos	T/Pos	Remark	Pol/Phase
	MHz	dBuV/m	dBuV/m	dB	dBuV	dB	dB/m	dB	cm	deg		
1	4873.90	45.10	74.00	-28.90	40.53	6.29	33.48	35.20	100	254	Peak	VERTICAL
2	4874.00	33.95	54.00	-20.05	29.38	6.29	33.48	35.20	100	254	Average	VERTICAL

<b>Temperature</b>	26°C	<b>Humidity</b>	60%
<b>Test Engineer</b>	Magic Lai	<b>Configurations</b>	IEEE 802.11n MCS0 40MHz Ch 9 / Mode 7
<b>Test Date</b>	Jan. 31, 2012		

#### Horizontal

	Freq	Level	Limit Line	Over Limit	Read Level	Cable Loss	Antenna Factor	Preamp Factor	A/Pos	T/Pos	Remark	Pol/Phase
	MHz	dBuV/m	dBuV/m	dB	dBuV	dB	dB/m	dB	cm	deg		
1	4903.97	32.05	54.00	-21.95	27.43	6.31	33.51	35.20	100	316	Average	HORIZONTAL
2	4904.22	45.67	74.00	-28.33	41.05	6.31	33.51	35.20	100	316	Peak	HORIZONTAL

#### Vertical

	Freq	Level	Limit Line	Over Limit	Read Level	Cable Loss	Antenna Factor	Preamp Factor	A/Pos	T/Pos	Remark	Pol/Phase
	MHz	dBuV/m	dBuV/m	dB	dBuV	dB	dB/m	dB	cm	deg		
1	4903.96	34.42	54.00	-19.58	29.80	6.31	33.51	35.20	101	272	Average	VERTICAL
2	4904.21	48.97	74.00	-25.03	44.35	6.31	33.51	35.20	101	272	Peak	VERTICAL

#### Note:

The amplitude of spurious emissions which are attenuated by more than 20 dB below the permissible value has no need to be reported.

Emission level (dBuV/m) = 20 log Emission level (uV/m).

Corrected Reading: Antenna Factor + Cable Loss + Read Level - Preamp Factor = Level.

<b>Temperature</b>	26°C	<b>Humidity</b>	60%
<b>Test Engineer</b>	Magic Lai	<b>Configurations</b>	IEEE 802.11b CH 1 / Mode 7
<b>Test Date</b>	Jan. 31, 2012		

### Horizontal

	Freq	Level	Limit Line	Over Limit	Read Level	CableAntenna Loss	Antenna Factor	Preamp Factor	A/Pos	T/Pos	Remark	Pol/Phase
	MHz	dBuV/m	dBuV/m	dB	dBuV	dB	dB/m	dB	cm	deg		
1	4823.96	38.61	54.00	-15.39	34.19	6.23	33.39	35.20	100	48	Average	HORIZONTAL
2	4823.96	46.87	74.00	-27.13	42.45	6.23	33.39	35.20	100	48	Peak	HORIZONTAL

### Vertical

	Freq	Level	Limit Line	Over Limit	Read Level	CableAntenna Loss	Antenna Factor	Preamp Factor	A/Pos	T/Pos	Remark	Pol/Phase
	MHz	dBuV/m	dBuV/m	dB	dBuV	dB	dB/m	dB	cm	deg		
1	4823.96	51.25	74.00	-22.75	46.83	6.23	33.39	35.20	100	173	Peak	VERTICAL
2	4823.97	48.55	54.00	-5.45	44.13	6.23	33.39	35.20	100	173	Average	VERTICAL

<b>Temperature</b>	26°C	<b>Humidity</b>	60%
<b>Test Engineer</b>	Magic Lai	<b>Configurations</b>	IEEE 802.11b CH 6 / Mode 7
<b>Test Date</b>	Jan. 31, 2012		

### Horizontal

	Freq	Level	Limit Line	Over Limit	Read Level	CableAntenna Loss	Antenna Factor	Preamp Factor	A/Pos	T/Pos	Remark	Pol/Phase
	MHz	dBuV/m	dBuV/m	dB	dBuV	dB	dB/m	dB	cm	deg		
1	4873.96	47.86	74.00	-26.14	43.29	6.29	33.48	35.20	100	116	Peak	HORIZONTAL
2	4873.99	41.23	54.00	-12.77	36.66	6.29	33.48	35.20	100	116	Average	HORIZONTAL

### Vertical

	Freq	Level	Limit Line	Over Limit	Read Level	CableAntenna Loss	Antenna Factor	Preamp Factor	A/Pos	T/Pos	Remark	Pol/Phase
	MHz	dBuV/m	dBuV/m	dB	dBuV	dB	dB/m	dB	cm	deg		
1	4874.00	48.18	54.00	-5.82	43.61	6.29	33.48	35.20	117	250	Average	VERTICAL
2	4874.09	52.06	74.00	-21.94	47.49	6.29	33.48	35.20	117	250	Peak	VERTICAL

<b>Temperature</b>	26°C	<b>Humidity</b>	60%
<b>Test Engineer</b>	Magic Lai	<b>Configurations</b>	IEEE 802.11b CH 11 / Mode 7
<b>Test Date</b>	Jan. 31, 2012		

### Horizontal

	Freq	Level	Limit	Over	Read	CableAntenna	Preamp	A/Pos	T/Pos	Remark	Pol/Phase
	MHz	dBuV/m	dBuV/m	dB	dBuV	dB	dB/m	dB	cm	deg	
1	4923.95	48.43	74.00	-25.57	43.71	6.34	33.58	35.20	100	54 Peak	HORIZONTAL
2	4924.00	42.01	54.00	-11.99	37.29	6.34	33.58	35.20	100	54 Average	HORIZONTAL

### Vertical

	Freq	Level	Limit	Over	Read	CableAntenna	Preamp	A/Pos	T/Pos	Remark	Pol/Phase
	MHz	dBuV/m	dBuV/m	dB	dBuV	dB	dB/m	dB	cm	deg	
1	4923.95	53.83	74.00	-20.17	49.11	6.34	33.58	35.20	102	254 Peak	VERTICAL
2	4923.97	50.68	54.00	-3.32	45.96	6.34	33.58	35.20	102	254 Average	VERTICAL

<b>Temperature</b>	26°C	<b>Humidity</b>	60%
<b>Test Engineer</b>	Magic Lai	<b>Configurations</b>	IEEE 802.11g CH 1 / Mode 7
<b>Test Date</b>	Jan. 31, 2012		

### Horizontal

	Freq	Level	Limit Line	Over Limit	Read Level	CableAntenna Loss	Antenna Factor	Preamp Factor	A/Pos	T/Pos	Remark	Pol/Phase
	MHz	dBuV/m	dBuV/m	dB	dBuV	dB	dB/m	dB	cm	deg		
1	4824.04	44.79	74.00	-29.21	40.37	6.23	33.39	35.20	100	136	Peak	HORIZONTAL
2	4824.15	32.27	54.00	-21.73	27.85	6.23	33.39	35.20	100	136	Average	HORIZONTAL

### Vertical

	Freq	Level	Limit Line	Over Limit	Read Level	CableAntenna Loss	Antenna Factor	Preamp Factor	A/Pos	T/Pos	Remark	Pol/Phase
	MHz	dBuV/m	dBuV/m	dB	dBuV	dB	dB/m	dB	cm	deg		
1	4823.72	45.66	74.00	-28.34	41.24	6.23	33.39	35.20	100	21	Peak	VERTICAL
2	4824.00	34.56	54.00	-19.44	30.14	6.23	33.39	35.20	100	21	Average	VERTICAL

<b>Temperature</b>	26°C	<b>Humidity</b>	60%
<b>Test Engineer</b>	Magic Lai	<b>Configurations</b>	IEEE 802.11g CH 6 / Mode 7
<b>Test Date</b>	Jan. 31, 2012		

### Horizontal

	Freq	Level	Limit	Over	Read	CableAntenna	Preamp	A/Pos	T/Pos	Remark	Pol/Phase
	MHz	dBuV/m	dBuV/m	dB	dBuV	dB	dB/m	dB	cm	deg	
1	4873.99	32.96	54.00	-21.04	28.39	6.29	33.48	35.20	100	262 Average	HORIZONTAL
2	4874.01	44.27	74.00	-29.73	39.70	6.29	33.48	35.20	100	262 Peak	HORIZONTAL

### Vertical

	Freq	Level	Limit	Over	Read	CableAntenna	Preamp	A/Pos	T/Pos	Remark	Pol/Phase
	MHz	dBuV/m	dBuV/m	dB	dBuV	dB	dB/m	dB	cm	deg	
1	4873.72	48.79	74.00	-25.21	44.22	6.29	33.48	35.20	100	187 Peak	VERTICAL
2	4873.97	36.51	54.00	-17.49	31.94	6.29	33.48	35.20	100	187 Average	VERTICAL

<b>Temperature</b>	26°C	<b>Humidity</b>	60%
<b>Test Engineer</b>	Magic Lai	<b>Configurations</b>	IEEE 802.11g CH 11 / Mode 7
<b>Test Date</b>	Jan. 31, 2012		

### Horizontal

	Freq	Level	Limit Line	Over Limit	Read Level	Cable Loss	Antenna Factor	Preamp Factor	A/Pos	T/Pos	Remark	Pol/Phase
	MHz	dBuV/m	dBuV/m	dB	dBuV	dB	dB/m	dB	cm	deg		
1	4923.59	45.61	74.00	-28.39	40.89	6.34	33.58	35.20	100	117	Peak	HORIZONTAL
2	4923.94	33.04	54.00	-20.96	28.32	6.34	33.58	35.20	100	117	Average	HORIZONTAL

### Vertical

	Freq	Level	Limit Line	Over Limit	Read Level	Cable Loss	Antenna Factor	Preamp Factor	A/Pos	T/Pos	Remark	Pol/Phase
	MHz	dBuV/m	dBuV/m	dB	dBuV	dB	dB/m	dB	cm	deg		
1	4923.74	48.64	74.00	-25.36	43.92	6.34	33.58	35.20	100	254	Peak	VERTICAL
2	4923.94	36.44	54.00	-17.56	31.72	6.34	33.58	35.20	100	254	Average	VERTICAL

### Note:

The amplitude of spurious emissions that are attenuated by more than 20dB below the permissible value has no need to be reported.

Emission level (dBuV/m) = 20 log Emission level (uV/m).

Corrected Reading: Antenna Factor + Cable Loss + Read Level - Preamp Factor = Level.



<b>Temperature</b>	26°C	<b>Humidity</b>	60%
<b>Test Engineer</b>	Magic Lai	<b>Configurations</b>	IEEE 802.11n MCS0 20MHz Ch 1 / Mode 8
<b>Test Date</b>	Feb. 02, 2012		

### Horizontal

	Freq	Level	Limit Line	Over Limit	Read Level	CableAntenna Loss	Antenna Factor	Preamp Factor	Remark	A/Pos	T/Pos	Pol/Phase
	MHz	dBuV/m	dBuV/m	dB	dBuV	dB	dB/m	dB		cm	deg	
1	4823.71	43.73	74.00	-30.27	42.39	3.31	33.06	35.03	Peak	100	89	HORIZONTAL
2	4823.99	30.02	54.00	-23.98	28.68	3.31	33.06	35.03	Average	100	89	HORIZONTAL

### Vertical

	Freq	Level	Limit Line	Over Limit	Read Level	CableAntenna Loss	Antenna Factor	Preamp Factor	Remark	A/Pos	T/Pos	Pol/Phase
	MHz	dBuV/m	dBuV/m	dB	dBuV	dB	dB/m	dB		cm	deg	
1	4824.00	32.87	54.00	-21.13	31.53	3.31	33.06	35.03	Average	100	353	VERTICAL
2	4824.76	45.86	74.00	-28.14	44.52	3.31	33.06	35.03	Peak	100	353	VERTICAL

<b>Temperature</b>	26°C	<b>Humidity</b>	60%
<b>Test Engineer</b>	Magic Lai	<b>Configurations</b>	IEEE 802.11n MCS0 20MHz Ch 6 / Mode 8
<b>Test Date</b>	Feb. 02, 2012		

### Horizontal

	Freq	Level	Limit	Over	Read	CableAntenna	Preamp		A/Pos	T/Pos	PoI/Phase
	MHz	dBuV/m	dBuV/m	dB	dBuV	dB	dB/m	dB	cm	deg	
1	4873.10	48.35	74.00	-25.65	46.89	3.33	33.16	35.03	Peak	100	147 HORIZONTAL
2	4874.08	33.29	54.00	-20.71	31.83	3.33	33.16	35.03	Average	100	147 HORIZONTAL
3	7310.52	45.66	74.00	-28.34	41.04	4.06	35.96	35.40	Peak	100	89 HORIZONTAL
4	7311.27	31.76	54.00	-22.24	27.14	4.06	35.96	35.40	Average	100	89 HORIZONTAL

### Vertical

	Freq	Level	Limit	Over	Read	CableAntenna	Preamp		A/Pos	T/Pos	PoI/Phase
	MHz	dBuV/m	dBuV/m	dB	dBuV	dB	dB/m	dB	cm	deg	
1	4873.74	50.04	74.00	-23.96	48.58	3.33	33.16	35.03	Peak	100	95 VERTICAL
2	4874.04	35.75	54.00	-18.25	34.29	3.33	33.16	35.03	Average	100	95 VERTICAL
3	7311.66	31.95	54.00	-22.05	27.33	4.06	35.96	35.40	Average	100	261 VERTICAL
4	7311.68	45.95	74.00	-28.05	41.33	4.06	35.96	35.40	Peak	100	261 VERTICAL

<b>Temperature</b>	26°C	<b>Humidity</b>	60%
<b>Test Engineer</b>	Magic Lai	<b>Configurations</b>	IEEE 802.11n MCS0 20MHz Ch11 / Mode 8
<b>Test Date</b>	Feb. 02, 2012		

### Horizontal

	Freq	Level	Limit Line	Over Limit	Read Level	CableAntenna Loss	Antenna Factor	Preamp Factor	Remark	A/Pos	T/Pos	Pol/Phase
	MHz	dBuV/m	dBuV/m	dB	dBuV	dB	dB/m	dB		cm	deg	
1	4923.89	30.20	54.00	-23.80	28.60	3.35	33.26	35.01	Average	100	145	HORIZONTAL
2	4924.02	43.84	74.00	-30.16	42.24	3.35	33.26	35.01	Peak	100	145	HORIZONTAL
3	7385.06	32.40	54.00	-21.60	27.65	4.06	36.09	35.40	Average	100	312	HORIZONTAL
4	7386.81	45.64	74.00	-28.36	40.89	4.06	36.09	35.40	Peak	100	312	HORIZONTAL

### Vertical

	Freq	Level	Limit Line	Over Limit	Read Level	CableAntenna Loss	Antenna Factor	Preamp Factor	Remark	A/Pos	T/Pos	Pol/Phase
	MHz	dBuV/m	dBuV/m	dB	dBuV	dB	dB/m	dB		cm	deg	
1	4923.96	31.56	54.00	-22.44	29.96	3.35	33.26	35.01	Average	100	98	VERTICAL
2	4924.14	44.74	74.00	-29.26	43.14	3.35	33.26	35.01	Peak	100	98	VERTICAL
3	7385.25	32.50	54.00	-21.50	27.75	4.06	36.09	35.40	Average	100	171	VERTICAL
4	7386.49	45.79	74.00	-28.21	41.04	4.06	36.09	35.40	Peak	100	171	VERTICAL

<b>Temperature</b>	26°C	<b>Humidity</b>	60%
<b>Test Engineer</b>	Magic Lai	<b>Configurations</b>	IEEE 802.11n MCS0 40MHz Ch 3 / Mode 8
<b>Test Date</b>	Feb. 02, 2012		

### Horizontal

	Freq	Level	Limit	Over	Read	CableAntenna	Preamp		A/Pos	T/Pos	Pol/Phase	
	MHz	dBuV/m	dBuV/m	dB	dBuV	dB	dB/m	dB	cm	deg		
1	4843.96	29.49	54.00	-24.51	28.11	3.32	33.09	35.03	Average	100	268	HORIZONTAL
2	4844.80	42.95	74.00	-31.05	41.57	3.32	33.09	35.03	Peak	100	268	HORIZONTAL
3	7266.15	45.39	74.00	-28.61	40.88	4.06	35.85	35.40	Peak	100	251	HORIZONTAL
4	7266.25	31.65	54.00	-22.35	27.14	4.06	35.85	35.40	Average	100	251	HORIZONTAL

### Vertical

	Freq	Level	Limit	Over	Read	CableAntenna	Preamp		A/Pos	T/Pos	Pol/Phase	
	MHz	dBuV/m	dBuV/m	dB	dBuV	dB	dB/m	dB	cm	deg		
1	4843.72	44.19	74.00	-29.81	42.81	3.32	33.09	35.03	Peak	100	96	VERTICAL
2	4843.96	32.65	54.00	-21.35	31.27	3.32	33.09	35.03	Average	100	96	VERTICAL
3	7266.21	31.63	54.00	-22.37	27.12	4.06	35.85	35.40	Average	100	82	VERTICAL
4	7266.28	45.86	74.00	-28.14	41.35	4.06	35.85	35.40	Peak	100	82	VERTICAL



<b>Temperature</b>	26°C	<b>Humidity</b>	60%
<b>Test Engineer</b>	Magic Lai	<b>Configurations</b>	IEEE 802.11n MCS0 40MHz Ch 6 / Mode 8
<b>Test Date</b>	Feb. 02, 2012		

**Horizontal**

	Freq	Level	Limit Line	Over Limit	Read Level	CableAntenna Loss	Antenna Factor	Preamp Factor	Remark	A/Pos	T/Pos	Pol/Phase
	MHz	dBuV/m	dBuV/m	dB	dBuV	dB	dB/m	dB		cm	deg	
1	4874.06	30.51	54.00	-23.49	29.05	3.33	33.16	35.03	Average	100	266	HORIZONTAL
2	4874.16	43.90	74.00	-30.10	42.44	3.33	33.16	35.03	Peak	100	266	HORIZONTAL
3	7311.04	31.80	54.00	-22.20	27.18	4.06	35.96	35.40	Average	100	62	HORIZONTAL
4	7311.81	45.76	74.00	-28.24	41.14	4.06	35.96	35.40	Peak	100	62	HORIZONTAL

**Vertical**

	Freq	Level	Limit Line	Over Limit	Read Level	CableAntenna Loss	Antenna Factor	Preamp Factor	Remark	A/Pos	T/Pos	Pol/Phase
	MHz	dBuV/m	dBuV/m	dB	dBuV	dB	dB/m	dB		cm	deg	
1	4873.92	44.39	74.00	-29.61	42.93	3.33	33.16	35.03	Peak	100	95	VERTICAL
2	4873.96	32.24	54.00	-21.76	30.78	3.33	33.16	35.03	Average	100	95	VERTICAL
3	7310.18	45.24	74.00	-28.76	40.62	4.06	35.96	35.40	Peak	100	289	VERTICAL
4	7310.42	31.83	54.00	-22.17	27.21	4.06	35.96	35.40	Average	100	289	VERTICAL

<b>Temperature</b>	26°C	<b>Humidity</b>	60%
<b>Test Engineer</b>	Magic Lai	<b>Configurations</b>	IEEE 802.11n MCS0 40MHz Ch 9 / Mode 8
<b>Test Date</b>	Feb. 02, 2012		

### Horizontal

	Freq	Level	Limit Line	Over Limit	Read Level	Cable Loss	Antenna Factor	Preamp Factor	Remark	A/Pos	T/Pos	Pol/Phase
	MHz	dBuV/m	dBuV/m	dB	dBuV	dB	dB/m	dB		cm	deg	
1	4903.85	43.99	74.00	-30.01	42.48	3.34	33.19	35.02	Peak	100	143	HORIZONTAL
2	4903.97	31.67	54.00	-22.33	30.16	3.34	33.19	35.02	Average	100	143	HORIZONTAL
3	7355.84	32.42	54.00	-21.58	27.74	4.06	36.02	35.40	Average	100	317	HORIZONTAL
4	7356.26	46.44	74.00	-27.56	41.76	4.06	36.02	35.40	Peak	100	317	HORIZONTAL

### Vertical

	Freq	Level	Limit Line	Over Limit	Read Level	Cable Loss	Antenna Factor	Preamp Factor	Remark	A/Pos	T/Pos	Pol/Phase
	MHz	dBuV/m	dBuV/m	dB	dBuV	dB	dB/m	dB		cm	deg	
1	4903.99	34.84	54.00	-19.16	33.33	3.34	33.19	35.02	Average	100	355	VERTICAL
2	4904.27	45.79	74.00	-28.21	44.28	3.34	33.19	35.02	Peak	100	355	VERTICAL
3	7355.56	46.13	74.00	-27.87	41.45	4.06	36.02	35.40	Peak	100	89	VERTICAL
4	7355.79	32.47	54.00	-21.53	27.79	4.06	36.02	35.40	Average	100	89	VERTICAL

### Note:

The amplitude of spurious emissions which are attenuated by more than 20 dB below the permissible value has no need to be reported.

Emission level (dBuV/m) = 20 log Emission level (uV/m).

Corrected Reading: Antenna Factor + Cable Loss + Read Level - Preamp Factor = Level.

<b>Temperature</b>	26°C	<b>Humidity</b>	60%
<b>Test Engineer</b>	Magic Lai	<b>Configurations</b>	IEEE 802.11b CH 1 / Mode 8
<b>Test Date</b>	Jan. 31, 2012		

### Horizontal

	Freq	Level	Limit	Over	Read	Cable	Antenna	Preamp	A/Pos	T/Pos	Remark	PoI/Phase
	MHz	dBuV/m	dBuV/m	dB	dBuV	dB	dB/m	dB	cm	deg		
1	4823.95	42.49	54.00	-11.51	38.07	6.23	33.39	35.20	100	42	Average	HORIZONTAL
2	4823.96	48.40	74.00	-25.60	43.98	6.23	33.39	35.20	100	42	Peak	HORIZONTAL

### Vertical

	Freq	Level	Limit	Over	Read	Cable	Antenna	Preamp	A/Pos	T/Pos	Remark	PoI/Phase
	MHz	dBuV/m	dBuV/m	dB	dBuV	dB	dB/m	dB	cm	deg		
1	4823.94	52.54	74.00	-21.46	48.12	6.23	33.39	35.20	132	260	Peak	VERTICAL
2	4823.98	48.71	54.00	-5.29	44.29	6.23	33.39	35.20	132	260	Average	VERTICAL

<b>Temperature</b>	26°C	<b>Humidity</b>	60%
<b>Test Engineer</b>	Magic Lai	<b>Configurations</b>	IEEE 802.11b CH 6 / Mode 8
<b>Test Date</b>	Jan. 31, 2012		

### Horizontal

	Freq	Level	Limit Line	Over Limit	Read Level	CableAntenna Loss	Antenna Factor	Preamp Factor	A/Pos	T/Pos	Remark	Pol/Phase
	MHz	dBuV/m	dBuV/m	dB	dBuV	dB	dB/m	dB	cm	deg		
1	4873.99	48.14	74.00	-25.86	43.57	6.29	33.48	35.20	100	192	Peak	HORIZONTAL
2	4874.03	40.59	54.00	-13.41	36.02	6.29	33.48	35.20	100	192	Average	HORIZONTAL

### Vertical

	Freq	Level	Limit Line	Limit	Level	Loss	Factor	Factor		T/Pos	Remark	Pol/Phase
	MHz	dBuV/m	dBuV/m	dB	dBuV	dB	dB/m	dB	cm	deg		
1	4873.95	50.64	74.00	-23.36	46.07	6.29	33.48	35.20	101	32	Peak	VERTICAL
2	4874.00	46.45	54.00	-7.55	41.88	6.29	33.48	35.20	101	32	Average	VERTICAL



<b>Temperature</b>	26°C	<b>Humidity</b>	60%
<b>Test Engineer</b>	Magic Lai	<b>Configurations</b>	IEEE 802.11b CH 11 / Mode 8
<b>Test Date</b>	Feb. 02, 2012		

### Horizontal

	Freq	Level	Limit Line	Over Limit	Read Level	Cable Loss	Antenna Factor	Preamp Factor	A/Pos	T/Pos	Remark	PoI/Phase
	MHz	dBuV/m	dBuV/m	dB	dBuV	dB	dB/m	dB	cm	deg		
1	4923.96	47.09	74.00	-26.91	42.37	6.34	33.58	35.20	100	296	Peak	HORIZONTAL
2	4923.97	38.17	54.00	-15.83	33.45	6.34	33.58	35.20	100	296	Average	HORIZONTAL

### Vertical

	Freq	Level	Limit Line	Over Limit	Read Level	Cable Loss	Antenna Factor	Preamp Factor	A/Pos	T/Pos	Remark	PoI/Phase
	MHz	dBuV/m	dBuV/m	dB	dBuV	dB	dB/m	dB	cm	deg		
1	4924.00	44.88	54.00	-9.12	40.16	6.34	33.58	35.20	100	359	Average	VERTICAL
2	4924.03	50.56	74.00	-23.44	45.84	6.34	33.58	35.20	100	359	Peak	VERTICAL



<b>Temperature</b>	26°C	<b>Humidity</b>	60%
<b>Test Engineer</b>	Magic Lai	<b>Configurations</b>	IEEE 802.11g CH 1 / Mode 8
<b>Test Date</b>	Feb. 02, 2012		

**Horizontal**

	Freq	Level	Limit Line	Over Limit	Read Level	CableAntenna Loss	Antenna Factor	Preamp Factor	Remark	A/Pos	T/Pos	Pol/Phase
	MHz	dBuV/m	dBuV/m	dB	dBuV	dB	dB/m	dB		cm	deg	
1	4824.02	32.39	54.00	-21.61	31.05	3.31	33.06	35.03	Average	100	147	HORIZONTAL
2	4824.72	45.91	74.00	-28.09	44.57	3.31	33.06	35.03	Peak	100	147	HORIZONTAL

**Vertical**

	Freq	Level	Limit Line	Over Limit	Read Level	CableAntenna Loss	Antenna Factor	Preamp Factor	Remark	A/Pos	T/Pos	Pol/Phase
	MHz	dBuV/m	dBuV/m	dB	dBuV	dB	dB/m	dB		cm	deg	
1	4823.02	48.06	74.00	-25.94	46.72	3.31	33.06	35.03	Peak	100	355	VERTICAL
2	4823.97	34.32	54.00	-19.68	32.98	3.31	33.06	35.03	Average	100	355	VERTICAL

<b>Temperature</b>	26°C	<b>Humidity</b>	60%
<b>Test Engineer</b>	Magic Lai	<b>Configurations</b>	IEEE 802.11g CH 6 / Mode 8
<b>Test Date</b>	Feb. 02, 2012		

### Horizontal

	Freq	Level	Limit Line	Over Limit	Read Level	CableAntenna Loss	Antenna Factor	Preamp Factor	Remark	A/Pos	T/Pos	Pol/Phase
	MHz	dBuV/m	dBuV/m	dB	dBuV	dB	dB/m	dB		cm	deg	
1	4874.13	33.91	54.00	-20.09	32.45	3.33	33.16	35.03	Average	100	147	HORIZONTAL
2	4874.95	48.08	74.00	-25.92	46.62	3.33	33.16	35.03	Peak	100	147	HORIZONTAL
3	7311.31	31.81	54.00	-22.19	27.19	4.06	35.96	35.40	Average	100	277	HORIZONTAL
4	7311.92	45.65	74.00	-28.35	41.03	4.06	35.96	35.40	Peak	100	277	HORIZONTAL

### Vertical

	Freq	Level	Limit Line	Over Limit	Read Level	CableAntenna Loss	Antenna Factor	Preamp Factor	Remark	A/Pos	T/Pos	Pol/Phase
	MHz	dBuV/m	dBuV/m	dB	dBuV	dB	dB/m	dB		cm	deg	
1	4874.08	36.53	54.00	-17.47	35.07	3.33	33.16	35.03	Average	100	96	VERTICAL
2	4874.56	49.64	74.00	-24.36	48.18	3.33	33.16	35.03	Peak	100	96	VERTICAL
3	7310.84	45.62	74.00	-28.38	41.00	4.06	35.96	35.40	Peak	100	184	VERTICAL
4	7311.04	32.03	54.00	-21.97	27.41	4.06	35.96	35.40	Average	100	184	VERTICAL

<b>Temperature</b>	26°C	<b>Humidity</b>	60%
<b>Test Engineer</b>	Magic Lai	<b>Configurations</b>	IEEE 802.11g CH 11 / Mode 8
<b>Test Date</b>	Feb. 02, 2012		

### Horizontal

	Freq	Level	Limit Line	Over Limit	Read Level	Cable Loss	Antenna Factor	Preamp Factor	Remark	A/Pos	T/Pos	PoI/Phase
	MHz	dBuV/m	dBuV/m	dB	dBuV	dB	dB/m	dB		cm	deg	
1	4923.98	30.57	54.00	-23.43	28.97	3.35	33.26	35.01	Average	100	146	HORIZONTAL
2	4924.53	43.94	74.00	-30.06	42.34	3.35	33.26	35.01	Peak	100	146	HORIZONTAL
3	7385.18	32.50	54.00	-21.50	27.75	4.06	36.09	35.40	Average	100	288	HORIZONTAL
4	7385.89	46.67	74.00	-27.33	41.92	4.06	36.09	35.40	Peak	100	288	HORIZONTAL

### Vertical

	Freq	Level	Limit Line	Over Limit	Read Level	Cable Loss	Antenna Factor	Preamp Factor	Remark	A/Pos	T/Pos	PoI/Phase
	MHz	dBuV/m	dBuV/m	dB	dBuV	dB	dB/m	dB		cm	deg	
1	4923.88	45.70	74.00	-28.30	44.10	3.35	33.26	35.01	Peak	100	96	VERTICAL
2	4924.07	32.87	54.00	-21.13	31.27	3.35	33.26	35.01	Average	100	96	VERTICAL
3	7385.07	32.55	54.00	-21.45	27.80	4.06	36.09	35.40	Average	100	133	VERTICAL
4	7386.50	47.02	74.00	-26.98	42.27	4.06	36.09	35.40	Peak	100	133	VERTICAL

### Note:

The amplitude of spurious emissions that are attenuated by more than 20dB below the permissible value has no need to be reported.

Emission level (dBuV/m) = 20 log Emission level (uV/m).

Corrected Reading: Antenna Factor + Cable Loss + Read Level - Preamp Factor = Level.

## 4.7. Band Edge Emissions Measurement

### 4.7.1. Limit

20dBc in any 100 kHz bandwidth outside the operating frequency band. In case the emission fall within the restricted band specified on 15.205(a), then the 15.209(a) limit in the table below has to be followed.

Frequencies (MHz)	Field Strength (micovolts/meter)	Measurement Distance (meters)
0.009~0.490	2400/F(KHz)	300
0.490~1.705	24000/F(KHz)	30
1.705~30.0	30	30
30~88	100	3
88~216	150	3
216~960	200	3
Above 960	500	3

### 4.7.2. Measuring Instruments and Setting

Please refer to section 5 of equipments list in this report. The following table is the setting of the spectrum analyzer.

Spectrum Parameter	Setting
Attenuation	Auto
Span Frequency	100 MHz
RB / VB (Emission in restricted band)	1 MHz / 3MHz for Peak, 1 MHz / 10Hz for Average
RB / VB (Emission in non-restricted band)	100 KHz /100 KHz for Peak

### 4.7.3. Test Procedures

1. The test procedure is the same as section 4.5.3, only the frequency range investigated is limited to 100MHz around bandedges.
2. In case the emission is fail due to the used RB/VB is too wide, marker-delta method of FCC Public Notice DA00-705 will be followed.

### 4.7.4. Test Setup Layout

This test setup layout is the same as that shown in section 4.5.4.

### 4.7.5. Test Deviation

There is no deviation with the original standard.

### 4.7.6. EUT Operation during Test

The EUT was programmed to be in continuously transmitting mode.

#### 4.7.7. Test Result of Band Edge and Fundamental Emissions

Temperature	26°C	Humidity	60%
Test Engineer	Magic Lai	Configurations	IEEE 802.11n MCS0 20MHz CH 1, 6, 11 / Mode 3
Test Date	Feb. 08, 2012		

##### Channel 1

	Freq	Level	Limit Line	Over Limit	Read Level	CableAntenna Loss	Antenna Factor	Preamp Factor	Remark	A/Pos	T/Pos	Pol/Phase
	MHz	dBuV/m	dBuV/m	dB	dBuV	dB	dB/m	dB		cm	deg	
1	2390.00	46.95	54.00	-7.05	16.56	2.22	28.17	0.00	Average	122	88	HORIZONTAL
2	2390.00	60.73	74.00	-13.27	30.34	2.22	28.17	0.00	Peak	122	88	HORIZONTAL
3	2406.55	107.25	74.00			2.22	28.21	0.00	Peak	122	88	HORIZONTAL
4	2406.71	97.40	54.00			2.22	28.21	0.00	Average	122	88	HORIZONTAL

Item 3, 4 are the fundamental frequency at 2412 MHz.

##### Channel 6

	Freq	Level	Limit Line	Over Limit	Read Level	CableAntenna Loss	Antenna Factor	Preamp Factor	Remark	A/Pos	T/Pos	Pol/Phase
	MHz	dBuV/m	dBuV/m	dB	dBuV	dB	dB/m	dB		cm	deg	
1	2388.72	58.77	74.00	-15.23	28.39	2.21	28.17	0.00	Peak	172	260	HORIZONTAL
2	2389.20	45.98	54.00	-8.02	15.60	2.21	28.17	0.00	Average	172	260	HORIZONTAL
3	2431.39	100.64	54.00			2.23	28.25	0.00	Average	172	260	HORIZONTAL
4	2431.55	110.79	74.00			2.23	28.25	0.00	Peak	172	260	HORIZONTAL
5	2483.50	46.20	54.00	-7.80	15.56	2.26	28.38	0.00	Average	172	260	HORIZONTAL
6	2483.82	58.67	74.00	-15.33	28.03	2.26	28.38	0.00	Peak	172	260	HORIZONTAL

Item 3, 4 are the fundamental frequency at 2437MHz.

##### Channel 11

	Freq	Level	Limit Line	Over Limit	Read Level	CableAntenna Loss	Antenna Factor	Preamp Factor	Remark	A/Pos	T/Pos	Pol/Phase
	MHz	dBuV/m	dBuV/m	dB	dBuV	dB	dB/m	dB		cm	deg	
1	2463.76	105.46	74.00			2.24	28.33	0.00	Peak	175	127	HORIZONTAL
2	2465.05	96.06	54.00			2.24	28.33	0.00	Average	175	127	HORIZONTAL
3	2483.50	47.00	54.00	-7.00	16.36	2.26	28.38	0.00	Average	175	127	HORIZONTAL
4	2483.66	61.04	74.00	-12.96	30.40	2.26	28.38	0.00	Peak	175	127	HORIZONTAL

Item 1, 2 are the fundamental frequency at 2462 MHz.

<b>Temperature</b>	26°C	<b>Humidity</b>	60%
<b>Test Engineer</b>	Magic Lai	<b>Configurations</b>	IEEE 802.11n MCS0 40MHz Ch 3, 6, 9 / Mode 3
<b>Test Date</b>	Feb. 07, 2012		

### Channel 3

	Freq	Level	Limit Line	Over Limit	Read Level	CableAntenna Loss	Antenna Factor	Preamp Factor	Remark	A/Pos	T/Pos	Pol/Phase
	MHz	dBuV/m	dBuV/m	dB	dBuV	dB	dB/m	dB		cm	deg	
1	2389.04	48.87	54.00	-5.13	18.49	2.21	28.17	0.00	Average	184	82	HORIZONTAL
2	2389.68	61.70	74.00	-12.30	31.32	2.21	28.17	0.00	Peak	184	82	HORIZONTAL
3	2406.30	93.54	54.00			2.22	28.21	0.00	Average	184	82	HORIZONTAL
4	2407.26	102.83	74.00			2.22	28.21	0.00	Peak	184	82	HORIZONTAL

Item 3, 4 are the fundamental frequency at 2422 MHz.

### Channel 6

	Freq	Level	Limit Line	Over Limit	Read Level	CableAntenna Loss	Antenna Factor	Preamp Factor	Remark	A/Pos	T/Pos	Pol/Phase
	MHz	dBuV/m	dBuV/m	dB	dBuV	dB	dB/m	dB		cm	deg	
1	2389.04	57.48	74.00	-16.52	27.10	2.21	28.17	0.00	Peak	149	81	HORIZONTAL
2	2390.00	46.30	54.00	-7.70	15.91	2.22	28.17	0.00	Average	149	81	HORIZONTAL
3	2446.30	92.87	54.00			2.24	28.29	0.00	Average	149	81	HORIZONTAL
4	2447.58	103.09	74.00			2.24	28.29	0.00	Peak	149	81	HORIZONTAL
5	2483.50	46.96	54.00	-7.04	16.32	2.26	28.38	0.00	Average	149	81	HORIZONTAL
6	2483.82	58.82	74.00	-15.18	28.18	2.26	28.38	0.00	Peak	149	81	HORIZONTAL

Item 3, 4 are the fundamental frequency at 2437MHz.

### Channel 9

	Freq	Level	Limit Line	Over Limit	Read Level	CableAntenna Loss	Antenna Factor	Preamp Factor	Remark	A/Pos	T/Pos	Pol/Phase
	MHz	dBuV/m	dBuV/m	dB	dBuV	dB	dB/m	dB		cm	deg	
1	2460.65	102.13	74.00			2.24	28.33	0.00	Peak	180	76	HORIZONTAL
2	2461.30	93.07	54.00			2.24	28.33	0.00	Average	180	76	HORIZONTAL
3	2483.50	48.13	54.00	-5.87	17.49	2.26	28.38	0.00	Average	180	76	HORIZONTAL
4	2488.31	62.37	74.00	-11.63	31.69	2.26	28.42	0.00	Peak	180	76	HORIZONTAL

Item 1, 2 are the fundamental frequency at 2452 MHz.

Note:

Emission level (dBuV/m) = 20 log Emission level (uV/m).

Corrected Reading: Antenna Factor + Cable Loss + Read Level - Preamp Factor = Level.

<b>Temperature</b>	26°C	<b>Humidity</b>	60%
<b>Test Engineer</b>	Magic Lai	<b>Configurations</b>	IEEE 802.11b CH 1, 6, 11 / Mode 3
<b>Test Date</b>	Feb. 07, 2012		

### Channel 1

	Freq	Level	Limit Line	Over Limit	Read Level	CableAntenna Loss	Antenna Factor	Preamp Factor	Remark	A/Pos	T/Pos	Pol/Phase
	MHz	dBuV/m	dBuV/m	dB	dBuV	dB	dB/m	dB		cm	deg	
1	2372.69	47.24	54.00	-6.76	16.90	2.21	28.13	0.00	Average	147	86	HORIZONTAL
2	2373.49	58.01	74.00	-15.99	27.67	2.21	28.13	0.00	Peak	147	86	HORIZONTAL
3	2411.04	107.11	74.00			2.22	28.21	0.00	Peak	147	86	HORIZONTAL
4	2411.20	103.39	54.00			2.22	28.21	0.00	Average	147	86	HORIZONTAL

Item 3, 4 are the fundamental frequency at 2412 MHz.

### Channel 6

	Freq	Level	Limit Line	Over Limit	Read Level	CableAntenna Loss	Antenna Factor	Preamp Factor	Remark	A/Pos	T/Pos	Pol/Phase
	MHz	dBuV/m	dBuV/m	dB	dBuV	dB	dB/m	dB		cm	deg	
1	2388.40	57.54	74.00	-16.46	27.16	2.21	28.17	0.00	Peak	176	89	HORIZONTAL
2	2390.00	45.42	54.00	-8.58	15.03	2.22	28.17	0.00	Average	176	89	HORIZONTAL
3	2436.04	108.57	74.00			2.23	28.29	0.00	Peak	176	89	HORIZONTAL
4	2436.20	104.89	54.00			2.23	28.29	0.00	Average	176	89	HORIZONTAL
5	2483.50	45.77	54.00	-8.23	15.13	2.26	28.38	0.00	Average	176	89	HORIZONTAL
6	2483.50	56.88	74.00	-17.12	26.24	2.26	28.38	0.00	Peak	176	89	HORIZONTAL

Item 3, 4 are the fundamental frequency at 2437MHz.

### Channel 11

	Freq	Level	Limit Line	Over Limit	Read Level	CableAntenna Loss	Antenna Factor	Preamp Factor	Remark	A/Pos	T/Pos	Pol/Phase
	MHz	dBuV/m	dBuV/m	dB	dBuV	dB	dB/m	dB		cm	deg	
1	2461.04	107.04	74.00			2.24	28.33	0.00	Peak	123	88	HORIZONTAL
2	2461.20	103.33	54.00			2.24	28.33	0.00	Average	123	88	HORIZONTAL
3	2486.86	58.98	74.00	-15.02	28.30	2.26	28.42	0.00	Peak	123	88	HORIZONTAL
4	2492.31	46.57	54.00	-7.43	15.88	2.27	28.42	0.00	Average	123	88	HORIZONTAL

Item 1, 2 are the fundamental frequency at 2462 MHz.



<b>Temperature</b>	26°C	<b>Humidity</b>	60%
<b>Test Engineer</b>	Magic Lai	<b>Configurations</b>	IEEE 802.11 g CH 1, 6, 11 / Mode 3
<b>Test Date</b>	Feb. 07, 2012		

**Channel 1**

	Freq	Level	Limit Line	Over Limit	Read Level	CableAntenna Loss	Antenna Factor	Preamp Factor	Remark	A/Pos	T/Pos	PoI/Phase
	MHz	dBuV/m	dBuV/m	dB	dBuV	dB	dB/m	dB		cm	deg	
1	2389.68	62.59	74.00	-11.41	32.21	2.21	28.17	0.00	Peak	121	87	HORIZONTAL
2	2390.00	47.86	54.00	-6.14	17.47	2.22	28.17	0.00	Average	121	87	HORIZONTAL
3	2405.75	108.05	74.00			2.22	28.21	0.00	Peak	121	87	HORIZONTAL
4	2407.35	98.46	54.00			2.22	28.21	0.00	Average	121	87	HORIZONTAL

Item 3, 4 are the fundamental frequency at 2412 MHz.

**Channel 6**

	Freq	Level	Limit Line	Over Limit	Read Level	CableAntenna Loss	Antenna Factor	Preamp Factor	Remark	A/Pos	T/Pos	PoI/Phase
	MHz	dBuV/m	dBuV/m	dB	dBuV	dB	dB/m	dB		cm	deg	
1	2389.04	46.21	54.00	-7.79	15.83	2.21	28.17	0.00	Average	178	85	HORIZONTAL
2	2389.36	57.66	74.00	-16.34	27.28	2.21	28.17	0.00	Peak	178	85	HORIZONTAL
3	2444.53	99.95	54.00			2.24	28.29	0.00	Average	178	85	HORIZONTAL
4	2444.53	109.44	74.00			2.24	28.29	0.00	Peak	178	85	HORIZONTAL
5	2483.50	46.20	54.00	-7.80	15.56	2.26	28.38	0.00	Average	178	85	HORIZONTAL
6	2483.50	57.82	74.00	-16.18	27.18	2.26	28.38	0.00	Peak	178	85	HORIZONTAL

Item 3, 4 are the fundamental frequency at 2437 MHz.

**Channel 11**

	Freq	Level	Limit Line	Over Limit	Read Level	CableAntenna Loss	Antenna Factor	Preamp Factor	Remark	A/Pos	T/Pos	PoI/Phase
	MHz	dBuV/m	dBuV/m	dB	dBuV	dB	dB/m	dB		cm	deg	
1	2458.80	105.15	74.00			2.24	28.33	0.00	Peak	124	96	HORIZONTAL
2	2459.44	95.91	54.00			2.24	28.33	0.00	Average	124	96	HORIZONTAL
3	2483.50	48.08	54.00	-5.92	17.44	2.26	28.38	0.00	Average	124	96	HORIZONTAL
4	2483.50	63.33	74.00	-10.67	32.69	2.26	28.38	0.00	Peak	124	96	HORIZONTAL

Item 1, 2 are the fundamental frequency at 2462 MHz.

Note:

Emission level (dBuV/m) = 20 log Emission level (uV/m).

Corrected Reading: Antenna Factor + Cable Loss + Read Level - Preamp Factor = Level.

For Emission not in Restricted Band

Low Band Edge Plot on Configuration IEEE 802.11n MCS0 20MHz / 2412 MHz

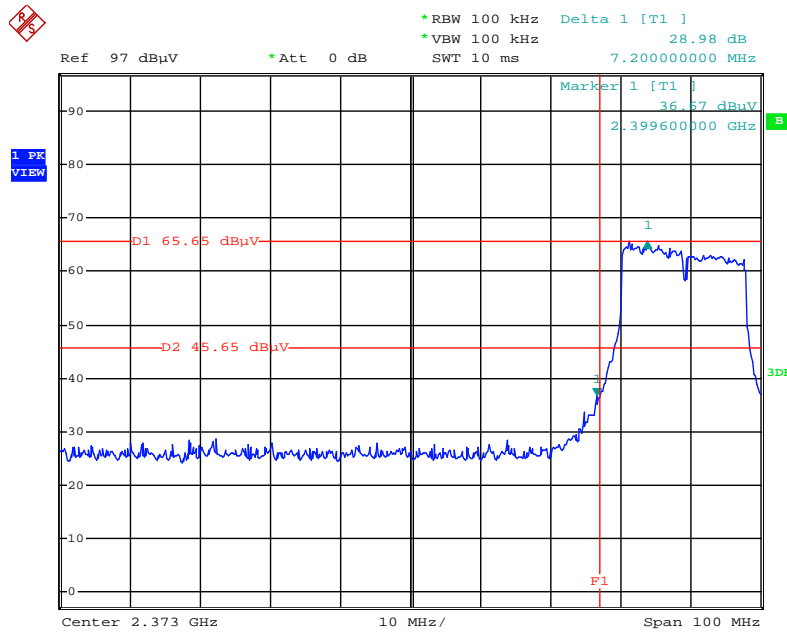

Date: 8.FEB.2012 18:27:50

High Band Edge Plot on Configuration IEEE 802.11n MCS0 20MHz / 2462 MHz

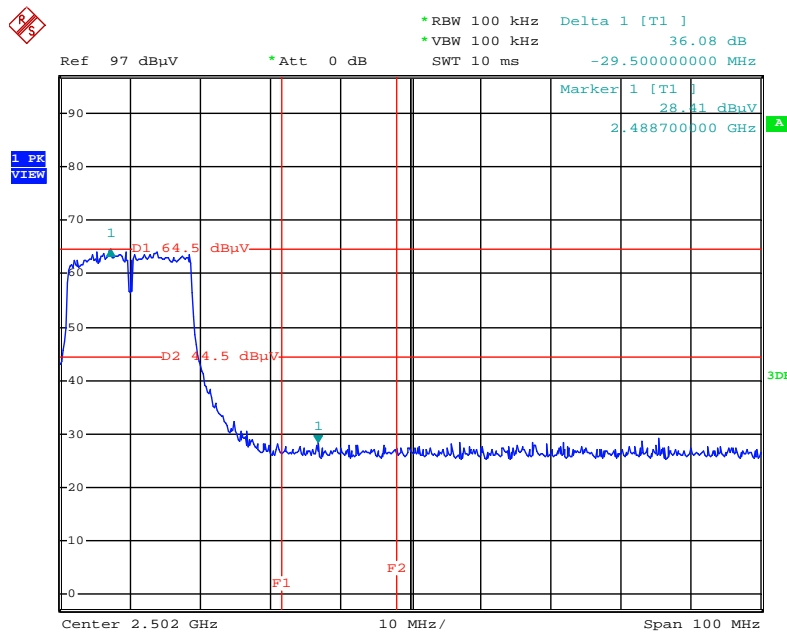

Date: 8.FEB.2012 18:25:00

For Emission not in Restricted Band

Low Band Edge Plot on Configuration IEEE 802.11n MCS0 40MHz / 2422 MHz

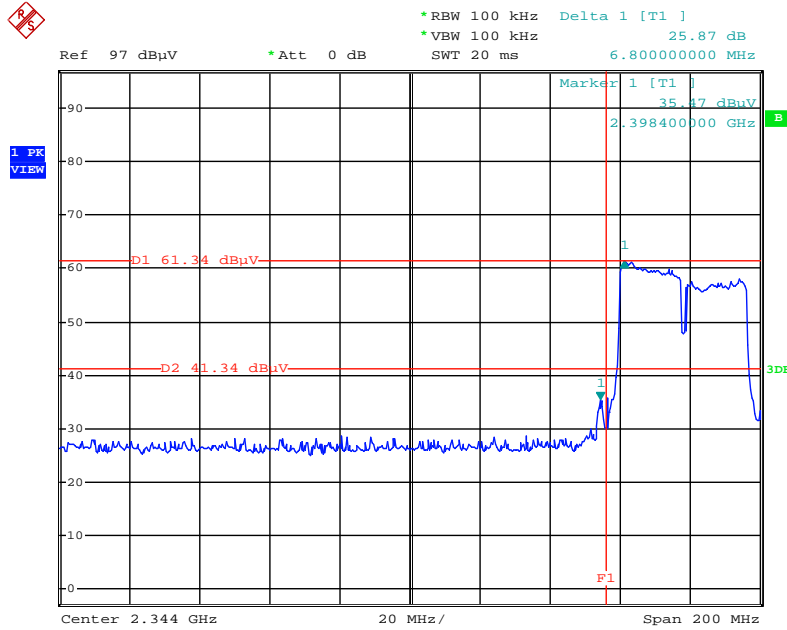

Date: 8.FEB.2012 18:32:41

High Band Edge Plot on Configuration IEEE 802.11n MCS0 40MHz / 2452 MHz

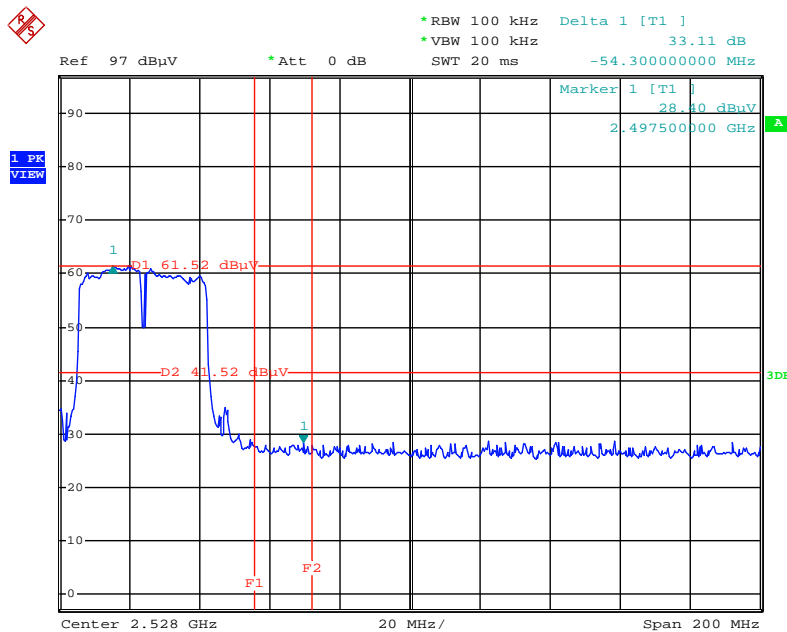

Date: 8.FEB.2012 18:36:08



### Low Band Edge Plot on Configuration IEEE 802.11g / 2412 MHz

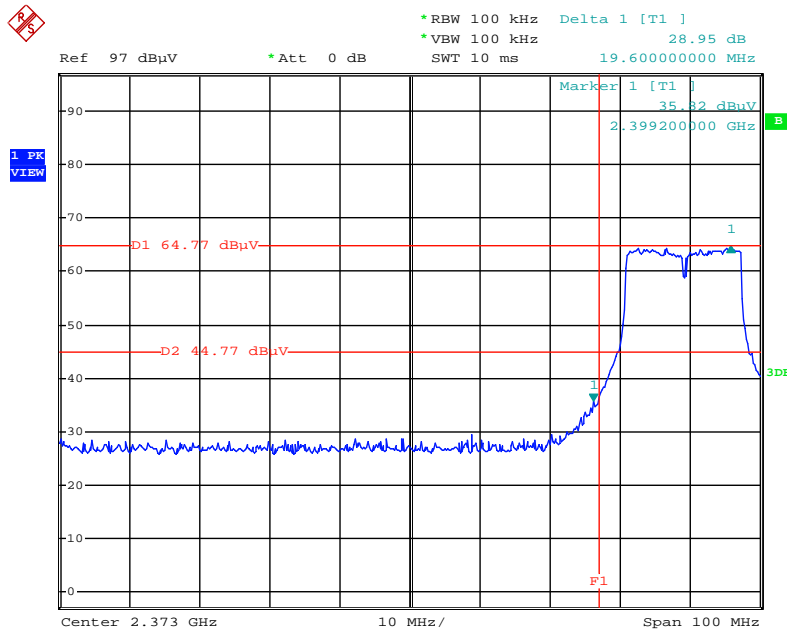

Date: 8.FEB.2012 18:23:32

### High Band Edge Plot on Configuration IEEE 802.11g / 2462 MHz

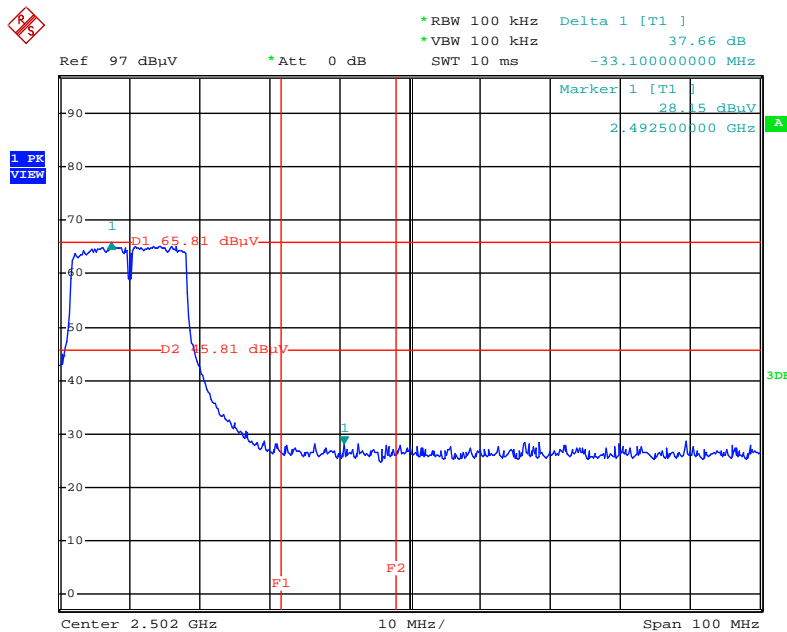

Date: 8.FEB.2012 18:19:38

<b>Temperature</b>	26°C	<b>Humidity</b>	60%
<b>Test Engineer</b>	Magic Lai	<b>Configurations</b>	IEEE 802.11n MCS0 20MHz CH 1, 6, 11 / Mode 4
<b>Test Date</b>	Feb. 07, 2012		

### Channel 1

	Freq	Level	Limit Line	Over Limit	Read Level	CableAntenna Loss	Antenna Factor	Preamp Factor	Remark	A/Pos	T/Pos	Pol/Phase
	MHz	dBuV/m	dBuV/m	dB	dBuV	dB	dB/m	dB		cm	deg	
1	2390.00	47.09	54.00	-6.91	16.70	2.22	28.17	0.00	Average	153	60	HORIZONTAL
2	2390.00	63.33	74.00	-10.67	32.94	2.22	28.17	0.00	Peak	153	60	HORIZONTAL
3	2406.39	96.78	54.00			2.22	28.21	0.00	Average	153	60	HORIZONTAL
4	2407.19	106.78	74.00			2.22	28.21	0.00	Peak	153	60	HORIZONTAL

Item 3, 4 are the fundamental frequency at 2412 MHz.

### Channel 6

	Freq	Level	Limit Line	Over Limit	Read Level	CableAntenna Loss	Antenna Factor	Preamp Factor	Remark	A/Pos	T/Pos	Pol/Phase
	MHz	dBuV/m	dBuV/m	dB	dBuV	dB	dB/m	dB		cm	deg	
1	2388.88	59.51	74.00	-14.49	29.13	2.21	28.17	0.00	Peak	177	70	HORIZONTAL
2	2390.00	45.75	54.00	-8.25	15.36	2.22	28.17	0.00	Average	177	70	HORIZONTAL
3	2431.71	100.20	54.00			2.23	28.25	0.00	Average	177	70	HORIZONTAL
4	2432.19	110.03	74.00			2.23	28.25	0.00	Peak	177	70	HORIZONTAL
5	2483.50	46.23	54.00	-7.77	15.59	2.26	28.38	0.00	Average	177	70	HORIZONTAL
6	2483.66	59.63	74.00	-14.37	28.99	2.26	28.38	0.00	Peak	177	70	HORIZONTAL

Item 3, 4 are the fundamental frequency at 2437MHz.

### Channel 11

	Freq	Level	Limit Line	Over Limit	Read Level	CableAntenna Loss	Antenna Factor	Preamp Factor	Remark	A/Pos	T/Pos	Pol/Phase
	MHz	dBuV/m	dBuV/m	dB	dBuV	dB	dB/m	dB		cm	deg	
1	2458.80	96.67	54.00			2.24	28.33	0.00	Average	149	60	HORIZONTAL
2	2458.96	107.35	74.00			2.24	28.33	0.00	Peak	149	60	HORIZONTAL
3	2483.50	48.28	54.00	-5.72	17.64	2.26	28.38	0.00	Average	149	60	HORIZONTAL
4	2483.50	64.63	74.00	-9.37	33.99	2.26	28.38	0.00	Peak	149	60	HORIZONTAL

Item 1, 2 are the fundamental frequency at 2462 MHz.

<b>Temperature</b>	26°C	<b>Humidity</b>	60%
<b>Test Engineer</b>	Magic Lai	<b>Configurations</b>	IEEE 802.11n MCS0 40MHz Ch 3, 6, 9 / Mode 4
<b>Test Date</b>	Feb. 07, 2012		

### Channel 3

	Freq	Level	Limit Line	Over Limit	Read Level	CableAntenna Loss	Antenna Factor	Preamp Factor	Remark	A/Pos	T/Pos	Pol/Phase
	MHz	dBuV/m	dBuV/m	dB	dBuV	dB	dB/m	dB		cm	deg	
1	2388.40	59.07	74.00	-14.93	28.69	2.21	28.17	0.00	Peak	177	98	HORIZONTAL
2	2390.00	46.45	54.00	-7.55	16.06	2.22	28.17	0.00	Average	177	98	HORIZONTAL
3	2420.08	94.20	54.00			2.23	28.25	0.00	Average	177	98	HORIZONTAL
4	2420.08	104.11	74.00			2.23	28.25	0.00	Peak	177	98	HORIZONTAL

Item 3, 4 are the fundamental frequency at 2422 MHz.

### Channel 6

	Freq	Level	Limit Line	Over Limit	Read Level	CableAntenna Loss	Antenna Factor	Preamp Factor	Remark	A/Pos	T/Pos	Pol/Phase
	MHz	dBuV/m	dBuV/m	dB	dBuV	dB	dB/m	dB		cm	deg	
1	2388.08	57.45	74.00	-16.55	27.07	2.21	28.17	0.00	Peak	177	68	HORIZONTAL
2	2390.00	45.63	54.00	-8.37	15.24	2.22	28.17	0.00	Average	177	68	HORIZONTAL
3	2430.59	103.51	74.00			2.23	28.25	0.00	Peak	177	68	HORIZONTAL
4	2431.23	93.92	54.00			2.23	28.25	0.00	Average	177	68	HORIZONTAL
5	2483.50	47.40	54.00	-6.60	16.76	2.26	28.38	0.00	Average	177	68	HORIZONTAL
6	2484.46	60.68	74.00	-13.32	30.04	2.26	28.38	0.00	Peak	177	68	HORIZONTAL

Item 3, 4 are the fundamental frequency at 2437MHz.

### Channel 9

	Freq	Level	Limit Line	Over Limit	Read Level	CableAntenna Loss	Antenna Factor	Preamp Factor	Remark	A/Pos	T/Pos	Pol/Phase
	MHz	dBuV/m	dBuV/m	dB	dBuV	dB	dB/m	dB		cm	deg	
1	2444.31	102.75	74.00			2.24	28.29	0.00	Peak	177	114	HORIZONTAL
2	2447.51	92.61	54.00			2.24	28.29	0.00	Average	177	114	HORIZONTAL
3	2483.50	49.97	54.00	-4.03	19.33	2.26	28.38	0.00	Average	177	114	HORIZONTAL
4	2488.31	64.55	74.00	-9.45	33.87	2.26	28.42	0.00	Peak	177	114	HORIZONTAL

Item 1, 2 are the fundamental frequency at 2452 MHz.

Note:

Emission level (dBuV/m) = 20 log Emission level (uV/m).

Corrected Reading: Antenna Factor + Cable Loss + Read Level - Preamp Factor = Level.

<b>Temperature</b>	26°C	<b>Humidity</b>	60%
<b>Test Engineer</b>	Magic Lai	<b>Configurations</b>	IEEE 802.11b CH 1, 6, 11 / Mode 4
<b>Test Date</b>	Feb. 04, 2012		

### Channel 1

	Freq	Level	Limit Line	Over Limit	Read Level	Cable Loss	Preamp Factor	Antenna Factor	T/Pos	A/Pos	Remark	Pol/Phase
	MHz	dBuV/m	dBuV/m	dB	dBuV	dB	dB	dB/m	deg	cm		
1	2368.80	56.18	74.00	-17.82	25.46	2.83	0.00	27.89	263	146	Peak	HORIZONTAL
2	2374.00	46.46	54.00	-7.54	15.74	2.83	0.00	27.89	263	146	Average	HORIZONTAL
3 a	2411.20	105.03	54.00			2.85	0.00	27.84	263	146	Average	HORIZONTAL
4 p	2413.00	109.01	74.00			2.85	0.00	27.84	263	146	Peak	HORIZONTAL

Item 3, 4 are the fundamental frequency at 2412 MHz.

### Channel 6

	Freq	Level	Limit Line	Over Limit	Read Level	Cable Loss	Preamp Factor	Antenna Factor	T/Pos	A/Pos	Remark	Pol/Phase
	MHz	dBuV/m	dBuV/m	dB	dBuV	dB	dB	dB/m	deg	cm		
1	2389.60	55.51	74.00	-18.49	24.80	2.84	0.00	27.87	122	146	Peak	HORIZONTAL
2	2390.00	43.36	54.00	-10.64	12.65	2.84	0.00	27.87	122	146	Average	HORIZONTAL
3 a	2437.80	105.43	54.00			2.87	0.00	27.78	122	146	Average	HORIZONTAL
4 p	2438.00	109.56	74.00			2.87	0.00	27.78	122	146	Peak	HORIZONTAL
5	2483.50	53.97	74.00	-20.03	23.34	2.90	0.00	27.73	122	146	Peak	HORIZONTAL
6	2483.50	43.32	54.00	-10.68	12.69	2.90	0.00	27.73	122	146	Average	HORIZONTAL

Item 3, 4 are the fundamental frequency at 2437MHz.

### Channel 11

	Freq	Level	Limit Line	Over Limit	Read Level	Cable Loss	Preamp Factor	Antenna Factor	T/Pos	A/Pos	Remark	Pol/Phase
	MHz	dBuV/m	dBuV/m	dB	dBuV	dB	dB	dB/m	deg	cm		
1 a	2461.20	102.38	54.00			2.89	0.00	27.76	206	104	Average	VERTICAL
2 p	2463.00	106.33	74.00			2.89	0.00	27.76	206	104	Peak	VERTICAL
3	2498.30	45.10	54.00	-8.90	14.49	2.91	0.00	27.70	206	104	Average	VERTICAL
4	2503.10	56.23	74.00	-17.77	25.62	2.91	0.00	27.70	206	104	Peak	VERTICAL

Item 1, 2 are the fundamental frequency at 2462 MHz.



<b>Temperature</b>	26°C	<b>Humidity</b>	60%
<b>Test Engineer</b>	Magic Lai	<b>Configurations</b>	IEEE 802.11 g CH 1, 6, 11 / Mode 4
<b>Test Date</b>	Feb. 07, 2012		

**Channel 1**

	Freq	Level	Limit Line	Over Limit	Read Level	Cable Loss	Antenna Factor	Preamp Factor	Remark	A/Pos	T/Pos	Pol/Phase
	MHz	dBuV/m	dBuV/m	dB	dBuV	dB	dB/m	dB		cm	deg	
1	2389.04	64.55	74.00	-9.45	34.17	2.21	28.17	0.00	Peak	152	63	HORIZONTAL
2	2390.00	48.56	54.00	-5.44	18.17	2.22	28.17	0.00	Average	152	63	HORIZONTAL
3	2405.75	107.98	74.00			2.22	28.21	0.00	Peak	152	63	HORIZONTAL
4	2407.03	98.02	54.00			2.22	28.21	0.00	Average	152	63	HORIZONTAL

Item 3, 4 are the fundamental frequency at 2412 MHz.

**Channel 6**

	Freq	Level	Limit Line	Over Limit	Read Level	Cable Loss	Antenna Factor	Preamp Factor	Remark	A/Pos	T/Pos	Pol/Phase
	MHz	dBuV/m	dBuV/m	dB	dBuV	dB	dB/m	dB		cm	deg	
1	2389.20	57.57	74.00	-16.43	27.19	2.21	28.17	0.00	Peak	179	67	HORIZONTAL
2	2390.00	45.68	54.00	-8.32	15.29	2.22	28.17	0.00	Average	179	67	HORIZONTAL
3	2430.75	109.84	74.00			2.23	28.25	0.00	Peak	179	67	HORIZONTAL
4	2432.35	100.57	54.00			2.23	28.25	0.00	Average	179	67	HORIZONTAL
5	2483.50	46.45	54.00	-7.55	15.81	2.26	28.38	0.00	Average	179	67	HORIZONTAL
6	2483.82	58.33	74.00	-15.67	27.69	2.26	28.38	0.00	Peak	179	67	HORIZONTAL

Item 3, 4 are the fundamental frequency at 2437 MHz.

**Channel 11**

	Freq	Level	Limit Line	Over Limit	Read Level	Cable Loss	Antenna Factor	Preamp Factor	Remark	A/Pos	T/Pos	Pol/Phase
	MHz	dBuV/m	dBuV/m	dB	dBuV	dB	dB/m	dB		cm	deg	
1	2458.15	107.08	74.00			2.24	28.33	0.00	Peak	147	62	HORIZONTAL
2	2459.44	97.47	54.00			2.24	28.33	0.00	Average	147	62	HORIZONTAL
3	2483.50	49.46	54.00	-4.54	18.82	2.26	28.38	0.00	Average	147	62	HORIZONTAL
4	2483.50	65.02	74.00	-8.98	34.38	2.26	28.38	0.00	Peak	147	62	HORIZONTAL

Item 1, 2 are the fundamental frequency at 2462 MHz.

Note:

Emission level (dBuV/m) = 20 log Emission level (uV/m).

Corrected Reading: Antenna Factor + Cable Loss + Read Level - Preamp Factor = Level.

For Emission not in Restricted Band

Low Band Edge Plot on Configuration IEEE 802.11n MCS0 20MHz / 2412 MHz

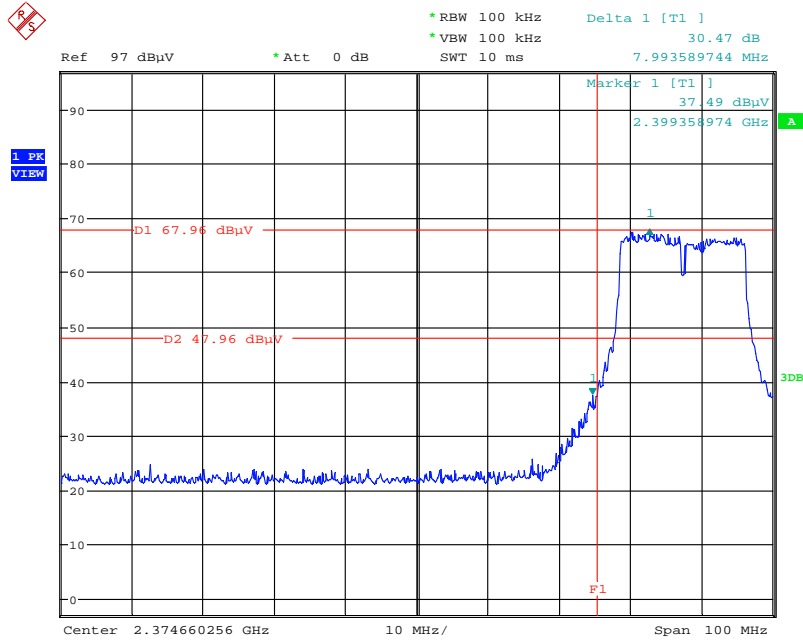

Date: 7.FEB.2012 19:58:14

High Band Edge Plot on Configuration IEEE 802.11n MCS0 20MHz / 2462 MHz

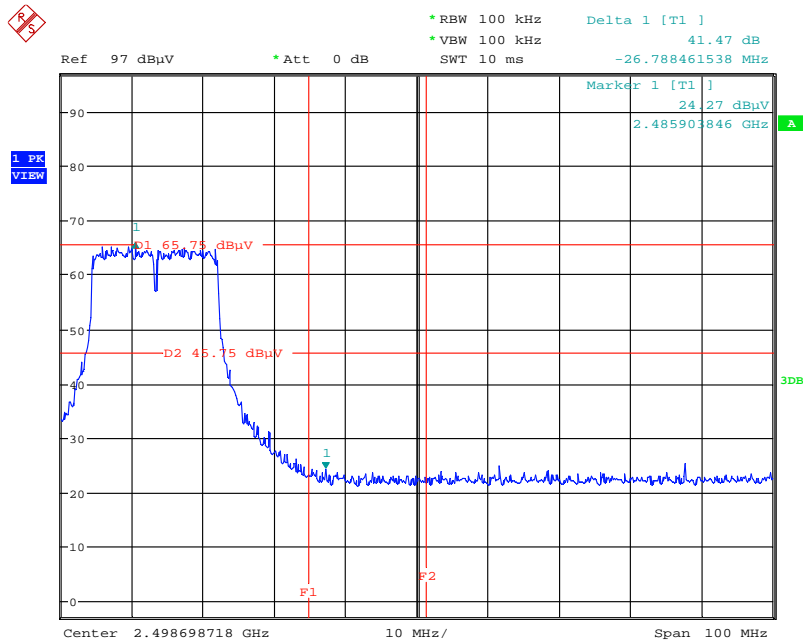

Date: 7.FEB.2012 19:55:42

For Emission not in Restricted Band

Low Band Edge Plot on Configuration IEEE 802.11n MCS0 40MHz / 2422 MHz

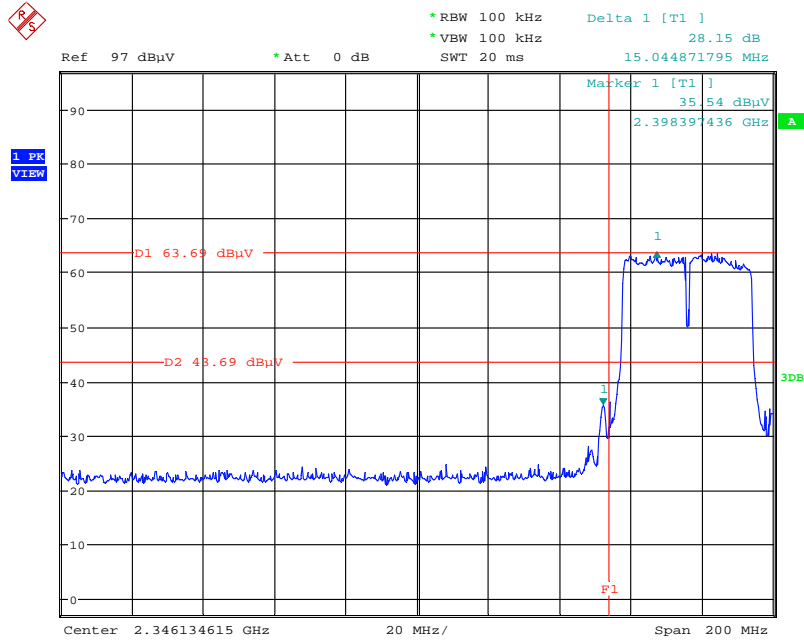

Date: 7.FEB.2012 20:00:35

High Band Edge Plot on Configuration IEEE 802.11n MCS0 40MHz / 2452 MHz

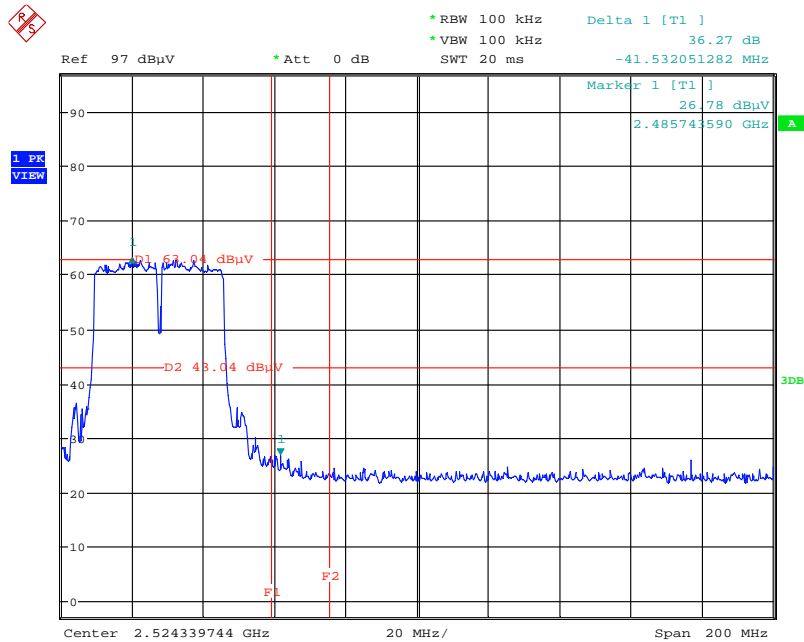

Date: 7.FEB.2012 20:03:02

### Low Band Edge Plot on Configuration IEEE 802.11b / 2412 MHz

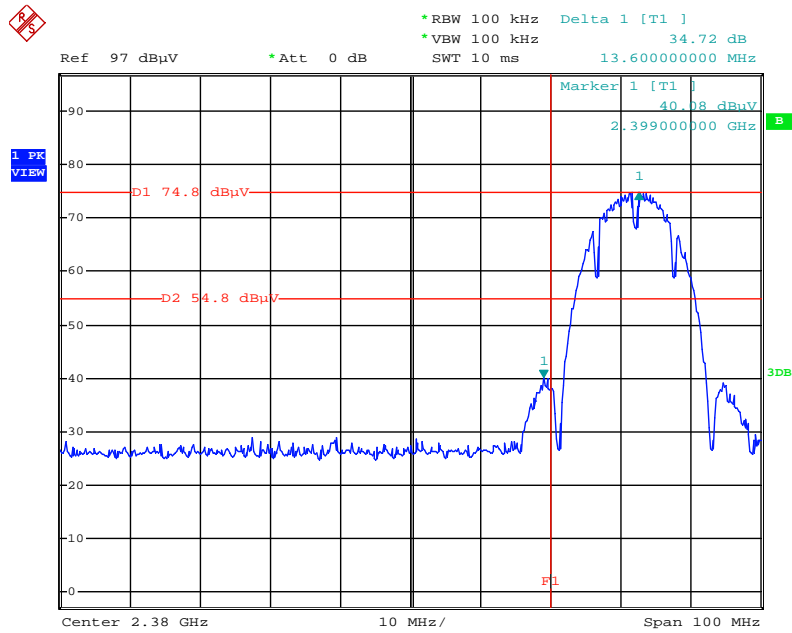

Date: 4.FEB.2012 01:46:06

### High Band Edge Plot on Configuration IEEE 802.11b / 2462 MHz

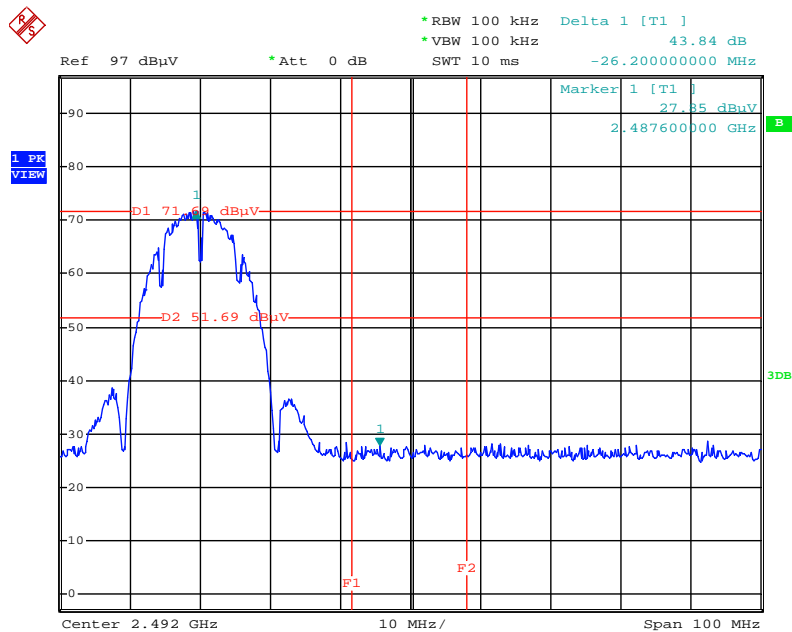

Date: 4.FEB.2012 01:34:14

### Low Band Edge Plot on Configuration IEEE 802.11g / 2412 MHz

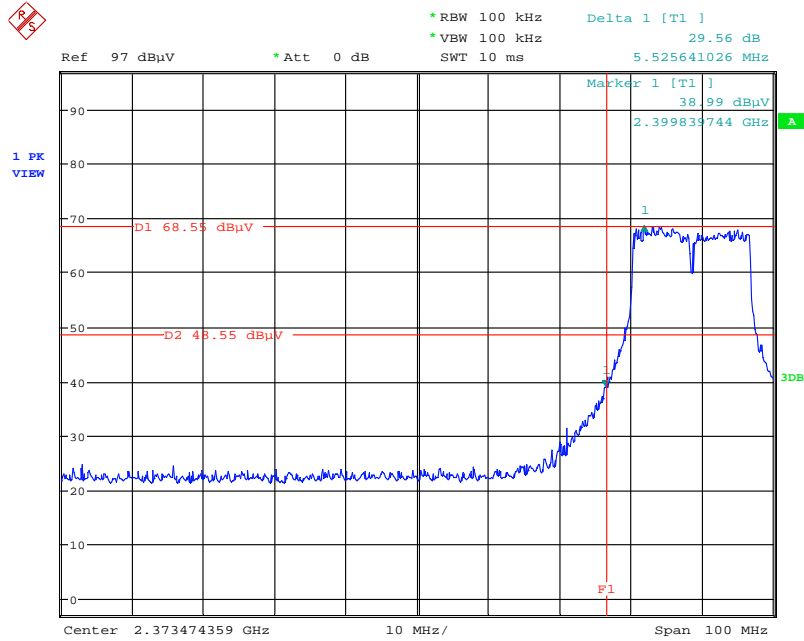

Date: 7.FEB.2012 19:49:54

### High Band Edge Plot on Configuration IEEE 802.11g / 2462 MHz

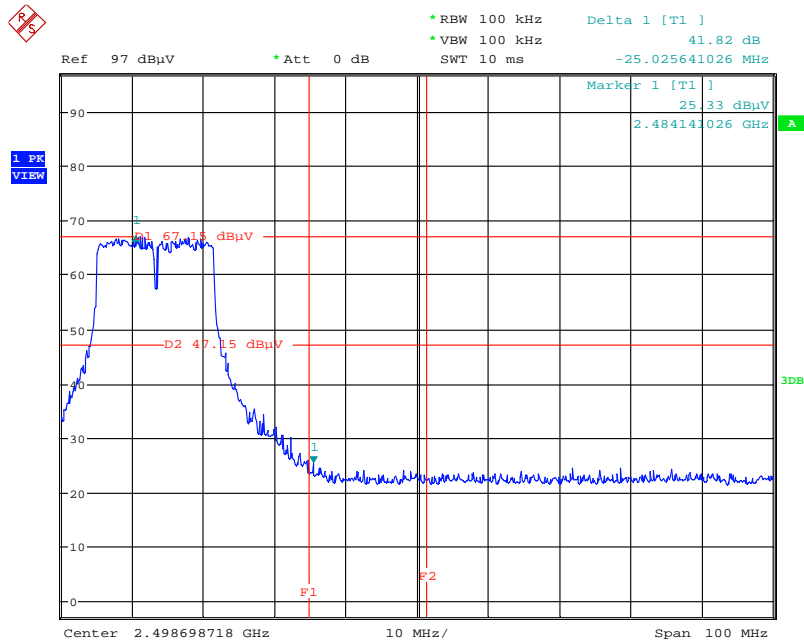

Date: 7.FEB.2012 19:52:50

<b>Temperature</b>	26°C	<b>Humidity</b>	60%
<b>Test Engineer</b>	Magic Lai	<b>Configurations</b>	IEEE 802.11n MCS0 20MHz CH 1, 6, 11 / Mode 7
<b>Test Date</b>	Jan. 31, 2012		

### Channel 1

	Freq	Level	Limit Line	Over Limit	Read Level	CableAntenna Loss	Antenna Factor	Preamp Factor	A/Pos	T/Pos	Remark	PoI/Phase
	MHz	dBuV/m	dBuV/m	dB	dBuV	dB	dB/m	dB	cm	deg		
1	2389.80	57.34	74.00	-16.66	25.15	4.14	28.05	0.00	101	254	Peak	VERTICAL
2	2390.00	45.41	54.00	-8.59	13.22	4.14	28.05	0.00	101	254	Average	VERTICAL
3	2406.60	94.48	54.00			4.14	28.09	0.00	101	254	Average	VERTICAL
4	2409.00	104.34	74.00			4.14	28.09	0.00	101	254	Peak	VERTICAL

Item 3, 4 are the fundamental frequency at 2412 MHz.

### Channel 6

	Freq	Level	Limit Line	Over Limit	Read Level	CableAntenna Loss	Antenna Factor	Preamp Factor	A/Pos	T/Pos	Remark	PoI/Phase
	MHz	dBuV/m	dBuV/m	dB	dBuV	dB	dB/m	dB	cm	deg		
1	2389.40	57.17	74.00	-16.83	24.98	4.14	28.05	0.00	100	270	Peak	VERTICAL
2	2390.00	45.12	54.00	-8.88	12.93	4.14	28.05	0.00	100	270	Average	VERTICAL
3	2433.80	98.82	54.00			4.16	28.13	0.00	100	270	Average	VERTICAL
4	2434.20	108.29	74.00			4.16	28.18	0.00	100	270	Peak	VERTICAL
5	2483.50	44.66	54.00	-9.34	12.19	4.21	28.26	0.00	100	270	Average	VERTICAL
6	2483.90	54.23	74.00	-19.77	21.76	4.21	28.26	0.00	100	270	Peak	VERTICAL

Item 3, 4 are the fundamental frequency at 2437MHz.

### Channel 11

	Freq	Level	Limit Line	Over Limit	Read Level	CableAntenna Loss	Antenna Factor	Preamp Factor	A/Pos	T/Pos	Remark	PoI/Phase
	MHz	dBuV/m	dBuV/m	dB	dBuV	dB	dB/m	dB	cm	deg		
1	2456.40	94.25	54.00			4.18	28.22	0.00	100	254	Average	VERTICAL
2	2459.00	104.30	74.00			4.18	28.22	0.00	100	254	Peak	VERTICAL
3	2483.50	46.94	54.00	-7.06	14.47	4.21	28.26	0.00	100	254	Average	VERTICAL
4	2484.10	61.76	74.00	-12.24	29.29	4.21	28.26	0.00	100	254	Peak	VERTICAL

Item 1, 2 are the fundamental frequency at 2462 MHz.

<b>Temperature</b>	26°C	<b>Humidity</b>	60%
<b>Test Engineer</b>	Magic Lai	<b>Configurations</b>	IEEE 802.11n MCS0 40MHz Ch 3, 6, 9 / Mode 7
<b>Test Date</b>	Jan. 31, 2012		

### Channel 3

	Freq	Level	Limit Line	Over Limit	Read Level	CableAntenna Loss	Antenna Factor	Preamp Factor	A/Pos	T/Pos	Remark	PoI/Phase
	MHz	dBuV/m	dBuV/m	dB	dBuV	dB	dB/m	dB	cm	deg		
1	2388.80	56.55	74.00	-17.45	24.36	4.14	28.05	0.00	100	37	Peak	VERTICAL
2	2390.00	44.96	54.00	-9.04	12.77	4.14	28.05	0.00	100	37	Average	VERTICAL
3	2431.20	92.12	54.00			4.16	28.13	0.00	100	37	Average	VERTICAL
4	2432.40	101.75	74.00			4.16	28.13	0.00	100	37	Peak	VERTICAL

Item 3, 4 are the fundamental frequency at 2422 MHz.

### Channel 6

	Freq	Level	Limit Line	Over Limit	Read Level	CableAntenna Loss	Antenna Factor	Preamp Factor	A/Pos	T/Pos	Remark	PoI/Phase
	MHz	dBuV/m	dBuV/m	dB	dBuV	dB	dB/m	dB	cm	deg		
1	2389.20	56.88	74.00	-17.12	24.69	4.14	28.05	0.00	100	271	Peak	VERTICAL
2	2390.00	45.42	54.00	-8.58	13.23	4.14	28.05	0.00	100	271	Average	VERTICAL
3	2430.20	101.10	74.00			4.16	28.13	0.00	100	271	Peak	VERTICAL
4	2433.40	92.24	54.00			4.16	28.13	0.00	100	271	Average	VERTICAL
5	2483.50	46.64	54.00	-7.36	14.17	4.21	28.26	0.00	100	271	Average	VERTICAL
6	2483.50	57.30	74.00	-16.70	24.83	4.21	28.26	0.00	100	271	Peak	VERTICAL

Item 3, 4 are the fundamental frequency at 2437MHz.

### Channel 9

	Freq	Level	Limit Line	Over Limit	Read Level	CableAntenna Loss	Antenna Factor	Preamp Factor	A/Pos	T/Pos	Remark	PoI/Phase
	MHz	dBuV/m	dBuV/m	dB	dBuV	dB	dB/m	dB	cm	deg		
1	2447.60	92.71	54.00			4.18	28.18	0.00	100	36	Average	VERTICAL
2	2462.40	102.46	74.00			4.18	28.22	0.00	100	36	Peak	VERTICAL
3	2483.50	49.84	54.00	-4.16	17.37	4.21	28.26	0.00	100	36	Average	VERTICAL
4	2488.30	64.63	74.00	-9.37	32.10	4.23	28.30	0.00	100	36	Peak	VERTICAL

Item 1, 2 are the fundamental frequency at 2452 MHz.

Note:

Emission level (dBuV/m) = 20 log Emission level (uV/m).

Corrected Reading: Antenna Factor + Cable Loss + Read Level - Preamp Factor = Level.

<b>Temperature</b>	26°C	<b>Humidity</b>	60%
<b>Test Engineer</b>	Magic Lai	<b>Configurations</b>	IEEE 802.11b CH 1, 6, 11 / Mode 7
<b>Test Date</b>	Jan. 31, 2012		

### Channel 1

	Freq	Level	Limit Line	Over Limit	Read Level	CableAntenna Loss	Antenna Factor	Preamp Factor	A/Pos	T/Pos	Remark	PoI/Phase
	MHz	dBuV/m	dBuV/m	dB	dBuV	dB	dB/m	dB	cm	deg		
1	2372.80	44.55	54.00	-9.45	12.43	4.11	28.01	0.00	100	271	Average	VERTICAL
2	2383.60	54.94	74.00	-19.06	22.78	4.11	28.05	0.00	100	271	Peak	VERTICAL
3	2412.80	102.13	54.00			4.16	28.09	0.00	100	271	Average	VERTICAL
4	2413.00	105.87	74.00			4.16	28.09	0.00	100	271	Peak	VERTICAL

Item 3, 4 are the fundamental frequency at 2412 MHz.

### Channel 6

	Freq	Level	Limit Line	Over Limit	Read Level	CableAntenna Loss	Antenna Factor	Preamp Factor	A/Pos	T/Pos	Remark	PoI/Phase
	MHz	dBuV/m	dBuV/m	dB	dBuV	dB	dB/m	dB	cm	deg		
1	2389.40	54.66	74.00	-19.34	22.47	4.14	28.05	0.00	100	36	Peak	VERTICAL
2	2390.00	43.80	54.00	-10.20	11.61	4.14	28.05	0.00	100	36	Average	VERTICAL
3	2436.20	103.77	54.00			4.16	28.18	0.00	100	36	Average	VERTICAL
4	2438.00	107.42	74.00			4.18	28.18	0.00	100	36	Peak	VERTICAL
5	2483.50	44.46	54.00	-9.54	11.99	4.21	28.26	0.00	100	36	Average	VERTICAL
6	2483.50	53.23	74.00	-20.77	20.76	4.21	28.26	0.00	100	36	Peak	VERTICAL

Item 3, 4 are the fundamental frequency at 2437MHz.

### Channel 11

	Freq	Level	Limit Line	Over Limit	Read Level	CableAntenna Loss	Antenna Factor	Preamp Factor	A/Pos	T/Pos	Remark	PoI/Phase
	MHz	dBuV/m	dBuV/m	dB	dBuV	dB	dB/m	dB	cm	deg		
1	2461.20	102.71	54.00			4.18	28.22	0.00	101	253	Average	VERTICAL
2	2463.00	106.25	74.00			4.21	28.22	0.00	101	253	Peak	VERTICAL
3	2484.50	54.84	74.00	-19.16	22.37	4.21	28.26	0.00	101	253	Peak	VERTICAL
4	2484.70	45.08	54.00	-8.92	12.61	4.21	28.26	0.00	101	253	Average	VERTICAL

Item 1, 2 are the fundamental frequency at 2462 MHz.



Temperature	26°C	Humidity	60%
Test Engineer	Magic Lai	Configurations	IEEE 802.11 g CH 1, 6, 11 / Mode 7
Test Date	Feb. 07, 2012		

**Channel 1**

	Freq	Level	Limit Line	Over Limit	Read Level	CableAntenna Loss	Antenna Factor	Preamp Factor	A/Pos	T/Pos	Remark	PoI/Phase
	MHz	dBuV/m	dBuV/m	dB	dBuV	dB	dB/m	dB	cm	deg		
1	2388.60	60.31	74.00	-13.69	28.12	4.14	28.05	0.00	100	254	Peak	VERTICAL
2	2390.00	46.21	54.00	-7.79	14.02	4.14	28.05	0.00	100	254	Average	VERTICAL
3	2407.20	95.80	54.00			4.14	28.09	0.00	100	254	Average	VERTICAL
4	2408.20	105.26	74.00			4.14	28.09	0.00	100	254	Peak	VERTICAL

Item 3, 4 are the fundamental frequency at 2412 MHz.

**Channel 6**

	Freq	Level	Limit Line	Over Limit	Read Level	CableAntenna Loss	Antenna Factor	Preamp Factor	A/Pos	T/Pos	Remark	PoI/Phase
	MHz	dBuV/m	dBuV/m	dB	dBuV	dB	dB/m	dB	cm	deg		
1	2390.00	45.39	54.00	-8.61	13.20	4.14	28.05	0.00	100	270	Average	VERTICAL
2	2390.00	55.33	74.00	-18.67	23.14	4.14	28.05	0.00	100	270	Peak	VERTICAL
3	2433.20	108.13	74.00			4.16	28.13	0.00	100	270	Peak	VERTICAL
4	2434.40	99.20	54.00			4.16	28.18	0.00	100	270	Average	VERTICAL
5	2483.50	44.66	54.00	-9.34	12.19	4.21	28.26	0.00	100	270	Average	VERTICAL
6	2483.70	53.76	74.00	-20.24	21.29	4.21	28.26	0.00	100	270	Peak	VERTICAL

Item 3, 4 are the fundamental frequency at 2437 MHz.

**Channel 11**

	Freq	Level	Limit Line	Over Limit	Read Level	CableAntenna Loss	Antenna Factor	Preamp Factor	A/Pos	T/Pos	Remark	PoI/Phase
	MHz	dBuV/m	dBuV/m	dB	dBuV	dB	dB/m	dB	cm	deg		
1	2455.60	105.29	74.00			4.18	28.22	0.00	100	253	Peak	VERTICAL
2	2459.40	95.41	54.00			4.18	28.22	0.00	100	253	Average	VERTICAL
3	2483.50	47.79	54.00	-6.21	15.32	4.21	28.26	0.00	100	253	Average	VERTICAL
4	2483.50	63.24	74.00	-10.76	30.77	4.21	28.26	0.00	100	253	Peak	VERTICAL

Item 1, 2 are the fundamental frequency at 2462 MHz.

Note:

Emission level (dBuV/m) = 20 log Emission level (uV/m).

Corrected Reading: Antenna Factor + Cable Loss + Read Level - Preamp Factor = Level.

For Emission not in Restricted Band

Low Band Edge Plot on Configuration IEEE 802.11n MCS0 20MHz / 2412 MHz

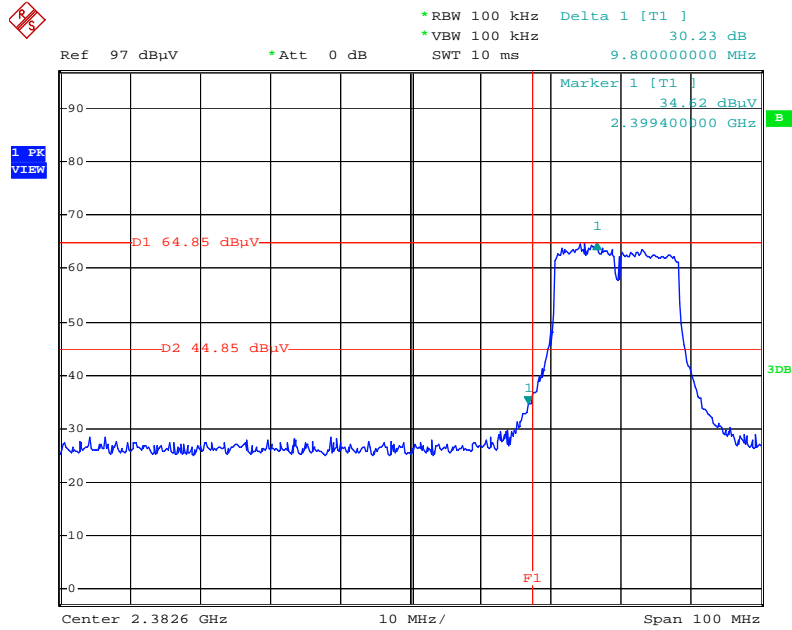

Date: 31.JAN.2012 15:17:57

High Band Edge Plot on Configuration IEEE 802.11n MCS0 20MHz / 2462 MHz

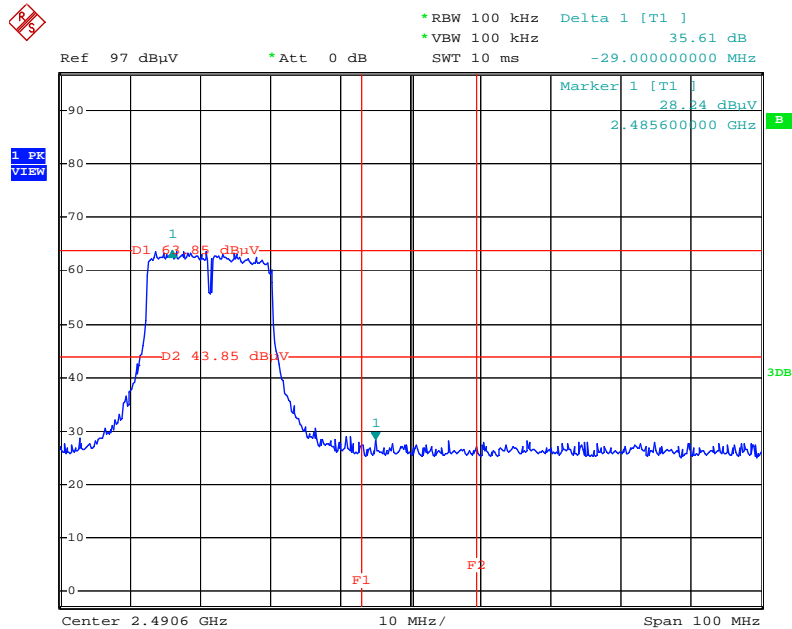

Date: 31.JAN.2012 15:32:08

For Emission not in Restricted Band

Low Band Edge Plot on Configuration IEEE 802.11n MCS0 40MHz / 2422 MHz

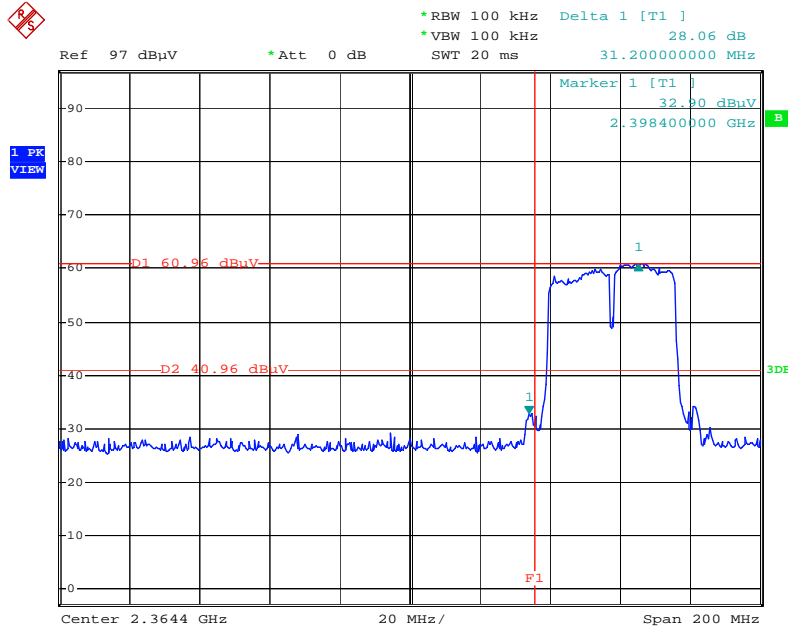

Date: 31.JAN.2012 15:40:33

High Band Edge Plot on Configuration IEEE 802.11n MCS0 40MHz / 2452 MHz

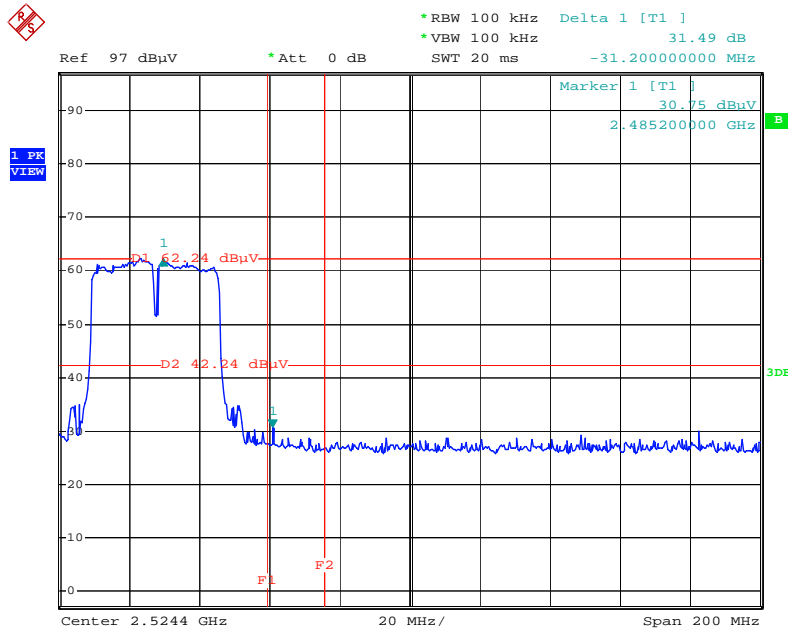

Date: 31.JAN.2012 13:35:55

### Low Band Edge Plot on Configuration IEEE 802.11b / 2412 MHz

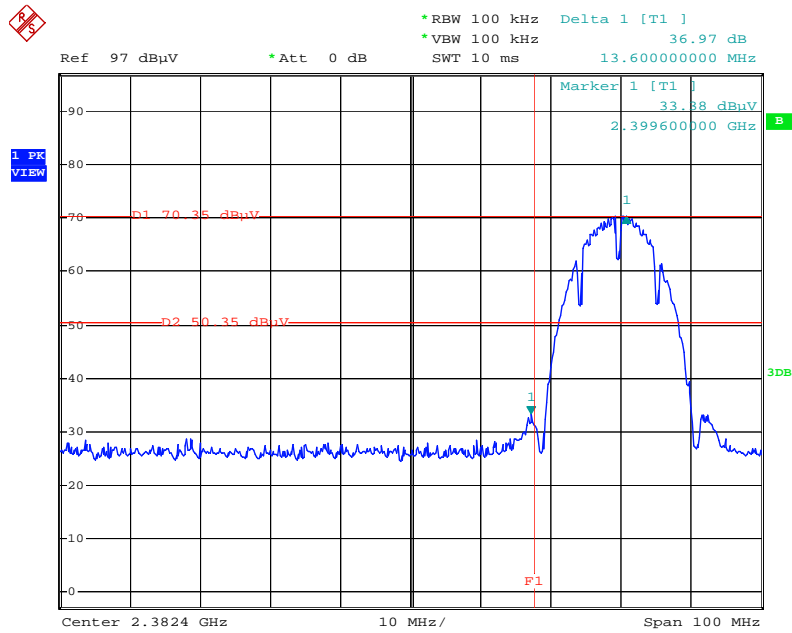

Date: 31.JAN.2012 13:55:41

### High Band Edge Plot on Configuration IEEE 802.11b / 2462 MHz

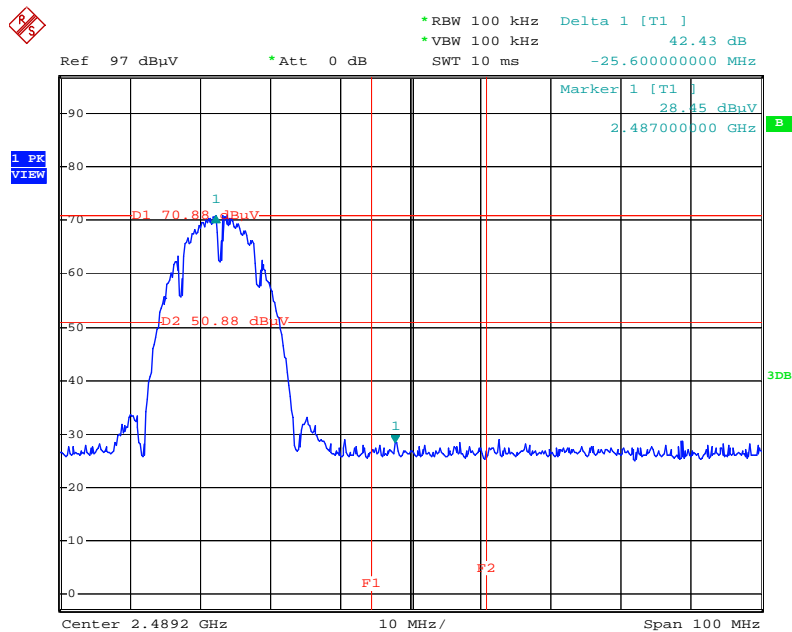

Date: 31.JAN.2012 14:46:46

### Low Band Edge Plot on Configuration IEEE 802.11g / 2412 MHz

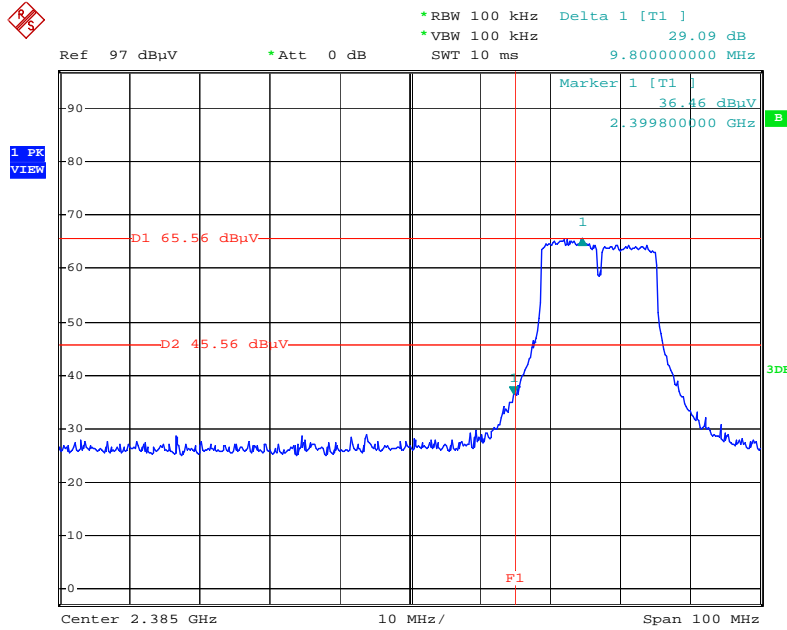

Date: 31.JAN.2012 14:53:13

### High Band Edge Plot on Configuration IEEE 802.11g / 2462 MHz

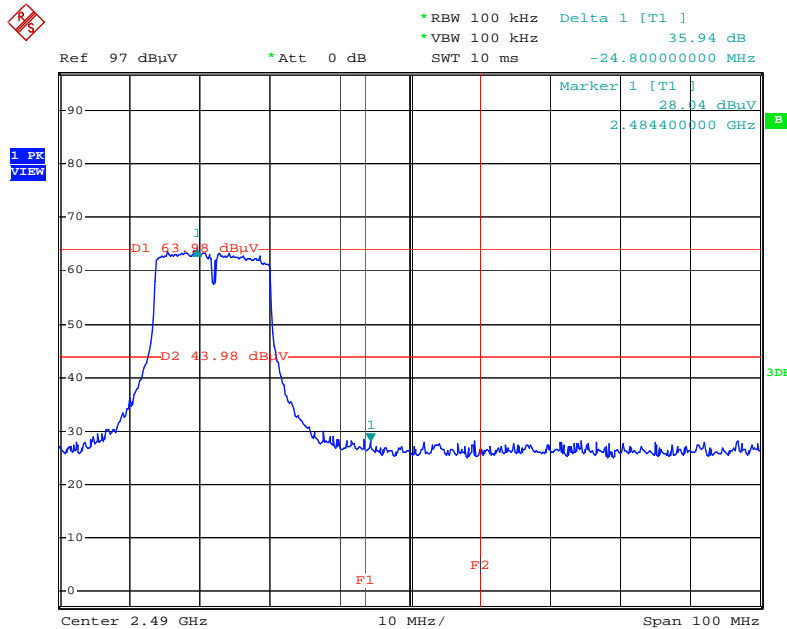

Date: 31.JAN.2012 15:12:16

<b>Temperature</b>	26°C	<b>Humidity</b>	60%
<b>Test Engineer</b>	Magic Lai	<b>Configurations</b>	IEEE 802.11n MCS0 20MHz CH 1, 6, 11 / Mode 8
<b>Test Date</b>	Feb. 02, 2012		

### Channel 1

	Freq	Level	Limit Line	Over Limit	Read Level	CableAntenna Loss	Antenna Factor	Preamp Factor	Remark	A/Pos	T/Pos	PoI/Phase
	MHz	dBuV/m	dBuV/m	dB	dBuV	dB	dB/m	dB		cm	deg	
1	2389.20	57.47	74.00	-16.53	27.09	2.21	28.17	0.00	Peak	100	39	VERTICAL
2	2390.00	44.43	54.00	-9.57	14.04	2.22	28.17	0.00	Average	100	39	VERTICAL
3	2408.80	94.33	54.00			2.22	28.21	0.00	Average	100	39	VERTICAL
4	2409.20	104.60	74.00			2.22	28.21	0.00	Peak	100	39	VERTICAL

Item 3, 4 are the fundamental frequency at 2412 MHz.

### Channel 6

	Freq	Level	Limit Line	Over Limit	Read Level	CableAntenna Loss	Antenna Factor	Preamp Factor	Remark	A/Pos	T/Pos	PoI/Phase
	MHz	dBuV/m	dBuV/m	dB	dBuV	dB	dB/m	dB		cm	deg	
1	2389.00	42.93	54.00	-11.07	12.55	2.21	28.17	0.00	Average	104	242	VERTICAL
2	2389.60	56.53	74.00	-17.47	26.15	2.21	28.17	0.00	Peak	104	242	VERTICAL
3	2433.80	107.36	74.00			2.23	28.25	0.00	Peak	104	242	VERTICAL
4	2440.00	97.84	54.00			2.23	28.29	0.00	Average	104	242	VERTICAL
5	2483.50	43.92	54.00	-10.08	13.29	2.26	28.37	0.00	Average	104	242	VERTICAL
6	2483.70	57.41	74.00	-16.59	26.78	2.26	28.37	0.00	Peak	104	242	VERTICAL

Item 3, 4 are the fundamental frequency at 2437MHz.

### Channel 11

	Freq	Level	Limit Line	Over Limit	Read Level	CableAntenna Loss	Antenna Factor	Preamp Factor	Remark	A/Pos	T/Pos	PoI/Phase
	MHz	dBuV/m	dBuV/m	dB	dBuV	dB	dB/m	dB		cm	deg	
1	2459.00	104.63	74.00			2.24	28.33	0.00	Peak	100	37	VERTICAL
2	2465.20	94.13	54.00			2.24	28.33	0.00	Average	100	37	VERTICAL
3	2483.50	44.81	54.00	-9.19	14.18	2.26	28.37	0.00	Average	100	37	VERTICAL
4	2483.70	58.82	74.00	-15.18	28.19	2.26	28.37	0.00	Peak	100	37	VERTICAL

Item 1, 2 are the fundamental frequency at 2462 MHz.

<b>Temperature</b>	26°C	<b>Humidity</b>	60%
<b>Test Engineer</b>	Magic Lai	<b>Configurations</b>	IEEE 802.11n MCS0 40MHz Ch 3, 6, 9 / Mode 8
<b>Test Date</b>	Feb. 02, 2012		

### Channel 3

	Freq	Level	Limit Line	Over Limit	Read Level	CableAntenna Loss	Antenna Factor	Preamp Factor	Remark	A/Pos	T/Pos	PoI/Phase
	MHz	dBuV/m	dBuV/m	dB	dBuV	dB	dB/m	dB		cm	deg	
1	2388.00	58.14	74.00	-15.86	27.76	2.21	28.17	0.00	Peak	103	242	VERTICAL
2	2388.40	45.02	54.00	-8.98	14.64	2.21	28.17	0.00	Average	103	242	VERTICAL
3	2431.20	91.31	54.00			2.23	28.25	0.00	Average	103	242	VERTICAL
4	2432.40	101.76	74.00			2.23	28.25	0.00	Peak	103	242	VERTICAL

Item 3, 4 are the fundamental frequency at 2422 MHz.

### Channel 6

	Freq	Level	Limit Line	Over Limit	Read Level	CableAntenna Loss	Antenna Factor	Preamp Factor	Remark	A/Pos	T/Pos	PoI/Phase
	MHz	dBuV/m	dBuV/m	dB	dBuV	dB	dB/m	dB		cm	deg	
1	2387.60	54.87	74.00	-19.13	24.49	2.21	28.17	0.00	Peak	100	243	VERTICAL
2	2390.00	42.71	54.00	-11.29	12.32	2.22	28.17	0.00	Average	100	243	VERTICAL
3	2432.60	90.36	54.00			2.23	28.25	0.00	Average	100	243	VERTICAL
4	2435.00	100.56	74.00			2.23	28.29	0.00	Peak	100	243	VERTICAL
5	2483.50	44.81	54.00	-9.19	14.18	2.26	28.37	0.00	Average	100	243	VERTICAL
6	2484.70	57.34	74.00	-16.66	26.71	2.26	28.37	0.00	Peak	100	243	VERTICAL

Item 3, 4 are the fundamental frequency at 2437MHz.

### Channel 9

	Freq	Level	Limit Line	Over Limit	Read Level	CableAntenna Loss	Antenna Factor	Preamp Factor	Remark	A/Pos	T/Pos	PoI/Phase
	MHz	dBuV/m	dBuV/m	dB	dBuV	dB	dB/m	dB		cm	deg	
1	2461.20	91.07	54.00			2.24	28.33	0.00	Average	100	37	VERTICAL
2	2462.00	100.95	74.00			2.24	28.33	0.00	Peak	100	37	VERTICAL
3	2483.50	46.15	54.00	-7.85	15.52	2.26	28.37	0.00	Average	100	37	VERTICAL
4	2485.10	59.86	74.00	-14.14	29.19	2.26	28.41	0.00	Peak	100	37	VERTICAL

Item 1, 2 are the fundamental frequency at 2452 MHz.

Note:

Emission level (dBuV/m) = 20 log Emission level (uV/m).

Corrected Reading: Antenna Factor + Cable Loss + Read Level - Preamp Factor = Level.

<b>Temperature</b>	26°C	<b>Humidity</b>	60%
<b>Test Engineer</b>	Magic Lai	<b>Configurations</b>	IEEE 802.11b CH 1, 6, 11 / Mode 8
<b>Test Date</b>	Jan. 31, 2012		

### Channel 1

	Freq	Level	Limit Line	Over Limit	Read Level	CableAntenna Loss	Antenna Factor	Preamp Factor	A/Pos	T/Pos	Remark	Pol/Phase
	MHz	dBuV/m	dBuV/m	dB	dBuV	dB	dB/m	dB	cm	deg		
1	2388.60	44.81	54.00	-9.19	12.62	4.14	28.05	0.00	100	271	Average	VERTICAL
2	2388.60	55.16	74.00	-18.84	22.97	4.14	28.05	0.00	100	271	Peak	VERTICAL
3	2411.20	103.76	54.00			4.14	28.09	0.00	100	271	Average	VERTICAL
4	2413.00	107.51	74.00			4.16	28.09	0.00	100	271	Peak	VERTICAL

Item 3, 4 are the fundamental frequency at 2412 MHz.

### Channel 6

	Freq	Level	Limit Line	Over Limit	Read Level	CableAntenna Loss	Antenna Factor	Preamp Factor	A/Pos	T/Pos	Remark	Pol/Phase
	MHz	dBuV/m	dBuV/m	dB	dBuV	dB	dB/m	dB	cm	deg		
1	2388.80	54.78	74.00	-19.22	22.59	4.14	28.05	0.00	100	270	Peak	VERTICAL
2	2390.00	43.58	54.00	-10.42	11.39	4.14	28.05	0.00	100	270	Average	VERTICAL
3	2436.20	103.29	54.00			4.16	28.18	0.00	100	270	Average	VERTICAL
4	2436.20	106.88	74.00			4.16	28.18	0.00	100	270	Peak	VERTICAL
5	2483.50	43.91	54.00	-10.09	11.44	4.21	28.26	0.00	100	270	Average	VERTICAL
6	2483.50	53.43	74.00	-20.57	20.96	4.21	28.26	0.00	100	270	Peak	VERTICAL

Item 3, 4 are the fundamental frequency at 2437MHz.

### Channel 11

	Freq	Level	Limit Line	Over Limit	Read Level	CableAntenna Loss	Antenna Factor	Preamp Factor	A/Pos	T/Pos	Remark	Pol/Phase
	MHz	dBuV/m	dBuV/m	dB	dBuV	dB	dB/m	dB	cm	deg		
1	2462.80	103.79	54.00			4.21	28.22	0.00	100	270	Average	VERTICAL
2	2463.00	107.66	74.00			4.21	28.22	0.00	100	270	Peak	VERTICAL
3	2483.50	54.31	74.00	-19.69	21.84	4.21	28.26	0.00	100	270	Peak	VERTICAL
4	2499.70	44.89	54.00	-9.11	12.36	4.23	28.30	0.00	100	270	Average	VERTICAL

Item 1, 2 are the fundamental frequency at 2462 MHz.



Temperature	26°C	Humidity	60%
Test Engineer	Magic Lai	Configurations	IEEE 802.11 g CH 1, 6, 11 / Mode 8
Test Date	Feb. 02, 2012		

**Channel 1**

	Freq	Level	Limit	Over	Read	Cable	Antenna	Preamp	Remark	A/Pos	T/Pos	PoI/Phase
	MHz	dBuV/m	dBuV/m	dB	dBuV	dB	dB/m	dB		cm	deg	
1	2388.00	59.31	74.00	-14.69	28.93	2.21	28.17	0.00	Peak	100	39	VERTICAL
2	2390.00	45.06	54.00	-8.94	14.67	2.22	28.17	0.00	Average	100	39	VERTICAL
3	2407.40	95.26	54.00			2.22	28.21	0.00	Average	100	39	VERTICAL
4	2408.20	104.93	74.00			2.22	28.21	0.00	Peak	100	39	VERTICAL

Item 3, 4 are the fundamental frequency at 2412 MHz.

**Channel 6**

	Freq	Level	Limit	Over	Read	Cable	Antenna	Preamp	Remark	A/Pos	T/Pos	PoI/Phase
	MHz	dBuV/m	dBuV/m	dB	dBuV	dB	dB/m	dB		cm	deg	
1	2388.60	54.45	74.00	-19.55	24.07	2.21	28.17	0.00	Peak	100	36	VERTICAL
2	2390.00	42.98	54.00	-11.02	12.59	2.22	28.17	0.00	Average	100	36	VERTICAL
3	2442.40	106.58	74.00			2.24	28.29	0.00	Peak	100	36	VERTICAL
4	2442.60	97.20	54.00			2.24	28.29	0.00	Average	100	36	VERTICAL
5	2483.50	43.12	54.00	-10.88	12.49	2.26	28.37	0.00	Average	100	36	VERTICAL
6	2486.10	55.09	74.00	-18.91	24.42	2.26	28.41	0.00	Peak	100	36	VERTICAL

Item 3, 4 are the fundamental frequency at 2437 MHz.

**Channel 11**

	Freq	Level	Limit	Over	Read	Cable	Antenna	Preamp	Remark	A/Pos	T/Pos	PoI/Phase
	MHz	dBuV/m	dBuV/m	dB	dBuV	dB	dB/m	dB		cm	deg	
1	2459.40	95.35	54.00			2.24	28.33	0.00	Average	100	38	VERTICAL
2	2463.80	104.78	74.00			2.24	28.33	0.00	Peak	100	38	VERTICAL
3	2483.50	45.60	54.00	-8.40	14.97	2.26	28.37	0.00	Average	100	38	VERTICAL
4	2483.50	60.65	74.00	-13.35	30.02	2.26	28.37	0.00	Peak	100	38	VERTICAL

Item 1, 2 are the fundamental frequency at 2462 MHz.

Note:

Emission level (dBuV/m) = 20 log Emission level (uV/m).

Corrected Reading: Antenna Factor + Cable Loss + Read Level - Preamp Factor = Level.

For Emission not in Restricted Band

Low Band Edge Plot on Configuration IEEE 802.11n MCS0 20MHz / 2412 MHz

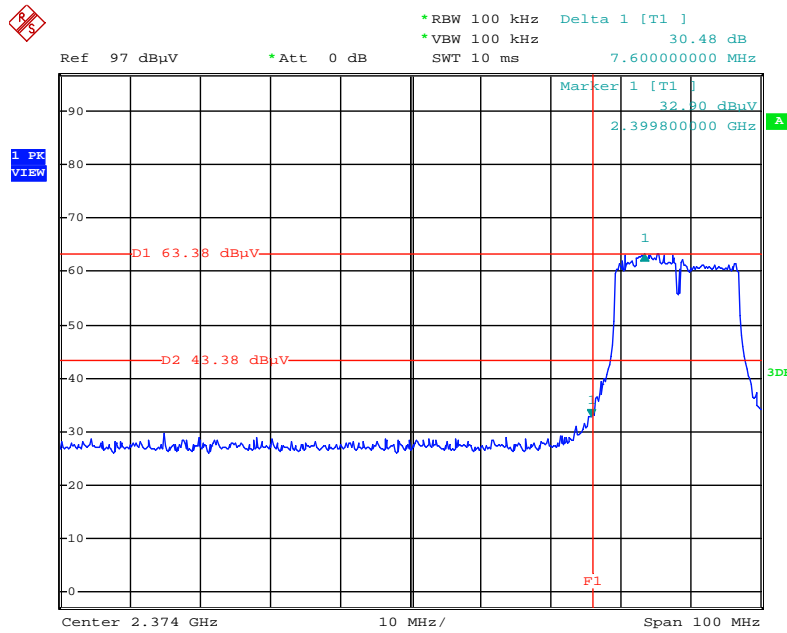

Date: 2.FEB.2012 16:14:01

High Band Edge Plot on Configuration IEEE 802.11n MCS0 20MHz / 2462 MHz

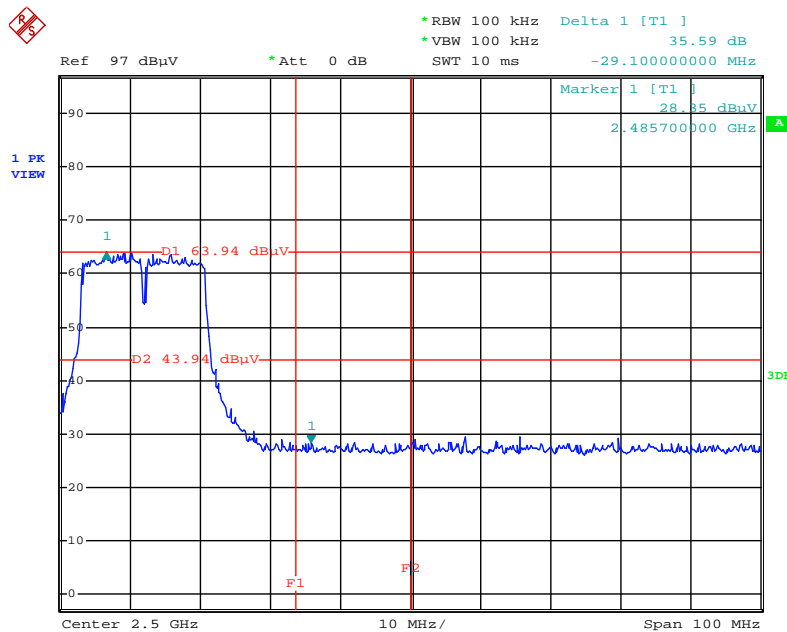

Date: 2.FEB.2012 16:10:39

For Emission not in Restricted Band

Low Band Edge Plot on Configuration IEEE 802.11n MCS0 40MHz / 2422 MHz

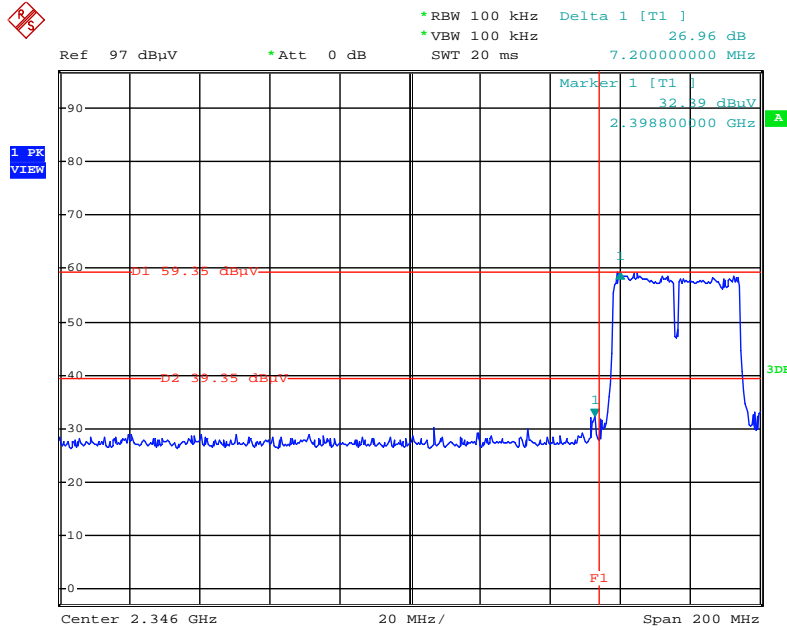

Date: 2.FEB.2012 16:18:37

High Band Edge Plot on Configuration IEEE 802.11n MCS0 40MHz / 2452 MHz

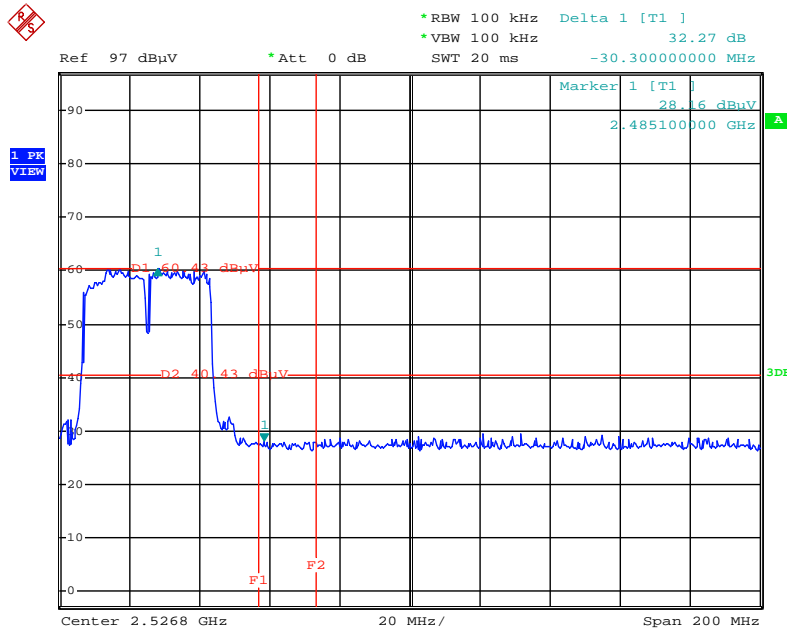

Date: 2.FEB.2012 16:21:38

### Low Band Edge Plot on Configuration IEEE 802.11b / 2412 MHz

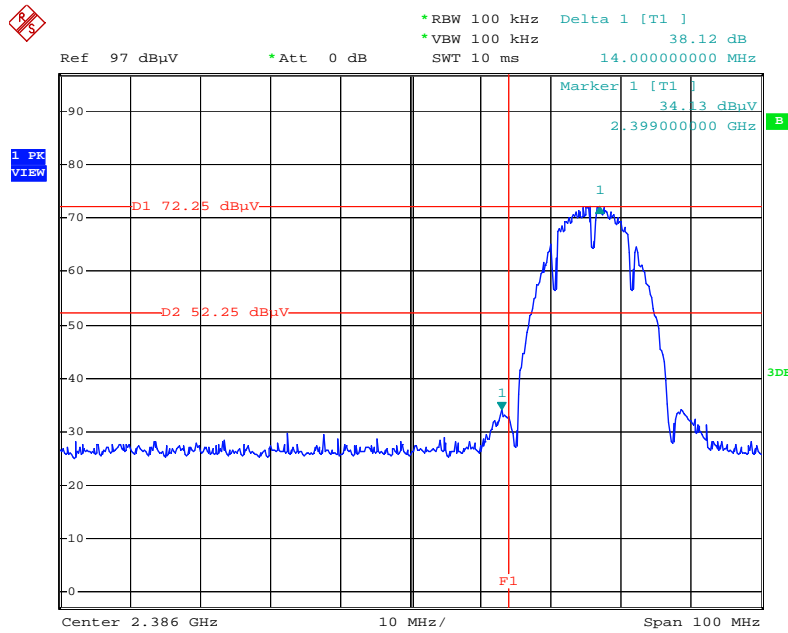

Date: 31.JAN.2012 16:23:18

### High Band Edge Plot on Configuration IEEE 802.11b / 2462 MHz

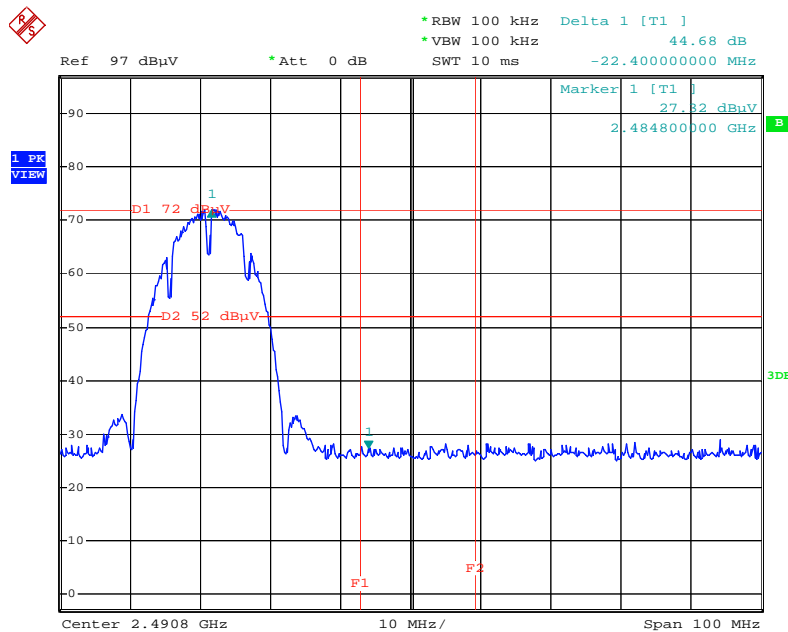

Date: 31.JAN.2012 16:07:23

### Low Band Edge Plot on Configuration IEEE 802.11g / 2412 MHz

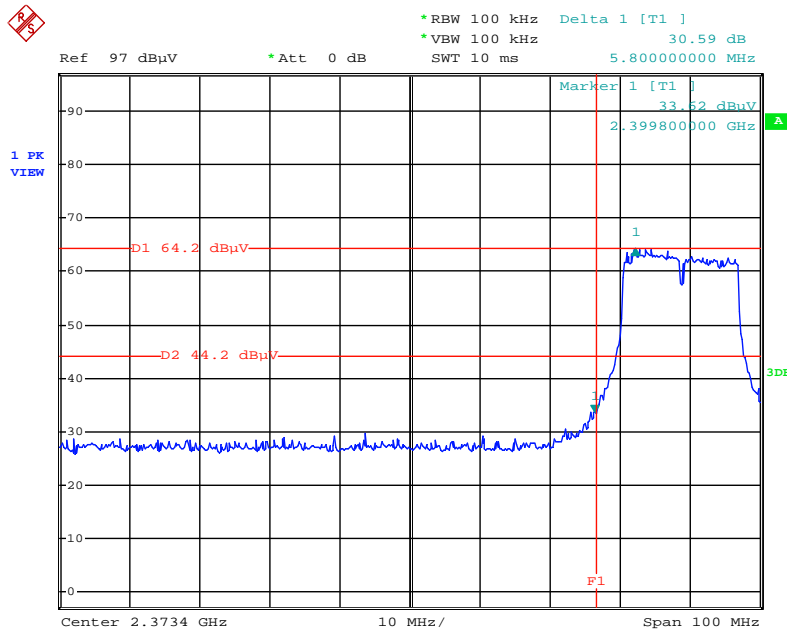

Date: 2.FEB.2012 16:03:46

### High Band Edge Plot on Configuration IEEE 802.11g / 2462 MHz

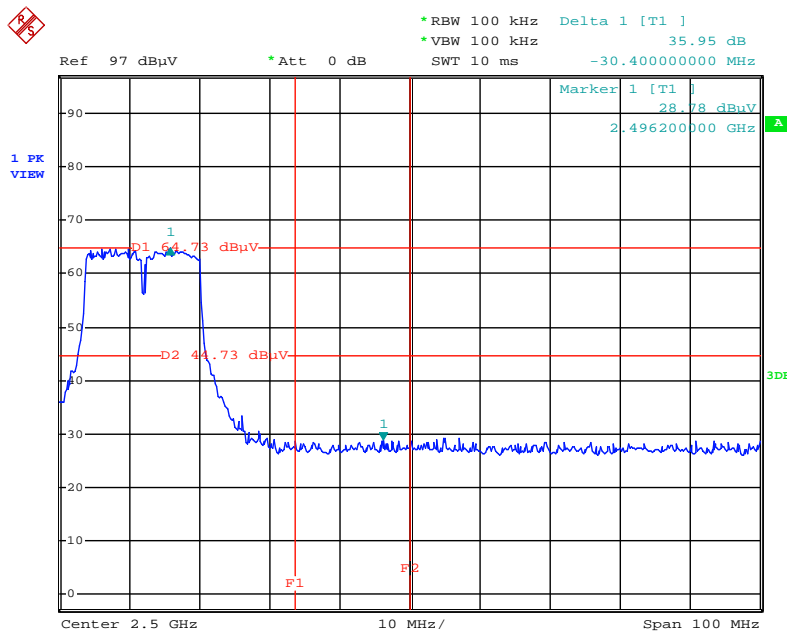

Date: 2.FEB.2012 16:07:01

## 4.8. Antenna Requirements

### 4.8.1. Limit

Except for special regulations, the Low-power Radio-frequency Devices must not be equipped with any jacket for installing an antenna with extension cable. An intentional radiator shall be designed to ensure that no antenna other than that furnished by the responsible party shall be used with the device. The use of a permanently attached antenna or of an antenna that uses a unique coupling to the intentional radiator shall be considered sufficient to comply with the provisions of this Section. The manufacturer may design the unit so that the user can replace a broken antenna, but the use of a standard antenna jack or electrical connector is prohibited. Further, this requirement does not apply to intentional radiators that must be professionally installed.

### 4.8.2. Antenna Connector Construction

Please refer to section 3.3 in this test report; antenna connector complied with the requirements.

## 5. LIST OF MEASURING EQUIPMENTS

Instrument	Manufacturer	Model No.	Serial No.	Characteristics	Calibration Date	Remark
EMI Test Receiver	R&S	ESCS 30	100377	9kHz ~ 2.75GHz	Sep. 14, 2011	Conduction (CO01-CB)
LISN	F.C.C.	FCC-LISN-50-16-2	04083	150kHz ~ 100MHz	Nov. 14, 2011	Conduction (CO01-CB)
V- LISN	Schwarzbeck	NSLK 8127	8127-478	9K ~ 30MHz	Nov. 30, 2011	Conduction (CO01-CB)
PULSE LIMITER	R&S	ESH3-Z2	100430	9K~30MHz	Jan. 04, 2012	Conduction (CO01-CB)
COND Cable	-	Cable	-	0.15MHz~30MHz	Dec. 04, 2011	Conduction (CO01-CB)
Signal analyzer	R&S	FSV40	100979	9KHz~40GHz	Sep. 26, 2011	Conducted (TH01-CB)
Thermo-Hygro Meter	N/A	HC 520	#1	15~70 degree	Nov. 02, 2011	Conducted (TH01-CB)
RF Power Divider	HP	11636A	00306	2GHz ~ 18GHz	N/A	Conducted (TH01-CB)
RF Power Splitter	Anaren	44100	1839	2GHz ~ 18GHz	N/A	Conducted (TH01-CB)
RF Power Splitter	Anaren	42100	17930	2GHz ~ 18GHz	N/A	Conducted (TH01-CB)
RF Cable-high	Woken	High Cable-7	-	1 GHz – 26.5 GHz	Nov. 17, 2011	Conducted (TH01-CB)
RF Cable-high	Woken	High Cable-8	-	1 GHz – 26.5 GHz	Nov. 17, 2011	Conducted (TH01-CB)
RF Cable-high	Woken	High Cable-9	-	1 GHz – 26.5 GHz	Nov. 17, 2011	Conducted (TH01-CB)
RF Cable-high	Woken	High Cable-10	-	1 GHz – 26.5 GHz	Nov. 17, 2011	Conducted (TH01-CB)
RF Cable-high	Woken	High Cable-11	-	1 GHz – 26.5 GHz	Nov. 17, 2011	Conducted (TH01-CB)
RF Cable-high	Woken	High Cable-12	-	1 GHz – 26.5 GHz	Nov. 17, 2011	Conducted (TH01-CB)
RF Cable-high	Woken	High Cable-13	-	1 GHz – 26.5 GHz	Nov. 17, 2011	Conducted (TH01-CB)
Power Sensor	Anritsu	MA2411B	0917223	300MHz~40GHz	Nov. 01, 2011	Conducted (TH01-CB)
Power Meter	Anritsu	ML2495A	1035008	300MHz~40GHz	Nov. 01, 2011	Conducted (TH01-CB)
BILOG ANTENNA	Schaffner	CBL6112D	22021	20MHz ~ 2GHz	Jan. 11, 2012	Radiation (03CH01-CB)
Horn Antenna	EMCO	3115	00075790	750MHz~18GHz	Nov. 25, 2011	Radiation (03CH01-CB)
Pre-Amplifier	Agilent	8447D	2944A10991	0.1MHz ~ 1.3GHz	Nov. 17, 2011	Radiation (03CH01-CB)
Pre-Amplifier	Agilent	8449B	3008A02310	1GHz ~ 26.5GHz	Nov. 29, 2011	Radiation (03CH01-CB)
Spectrum analyzer	R&S	FSP40	100056	9KHz~40GHz	Nov. 03, 2011	Radiation (03CH01-CB)
EMI Test Receiver	R&S	ESCS 30	100355	9KHz ~ 2.75GHz	Mar. 22, 2011	Radiation (03CH01-CB)
Loop Antenna	Teseq	HLA 6120	24155	9 kHz - 30 MHz	Sep. 09, 2010*	Radiation (03CH01-CB)

Instrument	Manufacturer	Model No.	Serial No.	Characteristics	Calibration Date	Remark
Turn Table	INN CO	CO 2000	N/A	0 ~ 360 degree	N/A	Radiation (03CH01-CB)
Antenna Mast	INN CO	CO2000	N/A	1 m - 4 m	N/A	Radiation (03CH01-CB)
RF Cable-low	Woken	Low Cable-1	N/A	30 MHz - 1 GHz	Nov. 17, 2011	Radiation (03CH01-CB)
RF Cable-high	Woken	High Cable-1	N/A	1 GHz – 26.5 GHz	Nov. 17, 2011	Radiation (03CH01-CB)
RF Cable-high	Woken	High Cable-2	N/A	1 GHz – 26.5 GHz	Nov. 17, 2011	Radiation (03CH01-CB)
RF Cable-high	Woken	High Cable-3	N/A	1 GHz - 40 GHz	Nov. 17, 2011	Radiation (03CH01-CB)
RF Cable-high	Woken	High Cable-4	N/A	1 GHz - 40 GHz	Nov. 17, 2011	Radiation (03CH01-CB)

Note: Calibration Interval of instruments listed above is one year.

Note: "\*" Calibration Interval of instruments listed above is two years.



## 6. TEST LOCATION

SHIJR	ADD : 6Fl., No. 106, Sec. 1, Shintai 5th Rd., Shijr City, Taipei, Taiwan 221, R.O.C. TEL : 886-2-2696-2468 FAX : 886-2-2696-2255
HWA YA	ADD : No. 52, Hwa Ya 1st Rd., Kwei-Shan Hsiang, Tao Yuan Hsien, Taiwan, R.O.C. TEL : 886-3-327-3456 FAX : 886-3-318-0055
LINKOU	ADD : No. 30-2, Dingfu Tsuen, Linkou Shiang, Taipei, Taiwan 244, R.O.C TEL : 886-2-2601-1640 FAX : 886-2-2601-1695
DUNGHU	ADD : No. 3, Lane 238, Kangle St., Neihu Chiu, Taipei, Taiwan 114, R.O.C. TEL : 886-2-2631-4739 FAX : 886-2-2631-9740
JUNGHE	ADD : 7Fl., No. 758, Jungjeng Rd., Junghe City, Taipei, Taiwan 235, R.O.C. TEL : 886-2-8227-2020 FAX : 886-2-8227-2626
NEIHU	ADD : 4Fl., No. 339, Hsin Hu 2 <sup>nd</sup> Rd., Taipei 114, Taiwan, R.O.C. TEL : 886-2-2794-8886 FAX : 886-2-2794-9777
JHUBEI	ADD : No.8, Lane 724, Bo-ai St., Jhubei City, HsinChu County 302, Taiwan, R.O.C. TEL : 886-3-656-9065 FAX : 886-3-656-9085

## 7. TAF CERTIFICATE OF ACCREDITATION



Certificate No. : L1190-110702

財團法人全國認證基金會  
Taiwan Accreditation Foundation

### Certificate of Accreditation

This is to certify that

**Sporton International Inc.**

**EMC & Wireless Communications Laboratory**

No.52, Hwa Ya 1st Road, Hwa Ya Technology Park, Kwei-Shan Hsiang, Tao Yuan Hsien,  
Taiwan, R.O.C.

**is accredited in respect of laboratory**

**Accreditation Criteria** : ISO/IEC 17025:2005  
**Accreditation Number** : 1190  
**Originally Accredited** : December 15, 2003  
**Effective Period** : January 10, 2010 to January 09, 2013  
**Accredited Scope** : Testing Field, see described in the Appendix  
**Specific Accreditation Program** : Accreditation Program for Designated Testing Laboratory for Commodities Inspection  
Accreditation Program for Telecommunication Equipment Testing Laboratory  
Accreditation Program for BSMI Mutual Recognition Arrangement with Foreign Authorities



Jay-San Chen  
President, Taiwan Accreditation Foundation  
Date : July 02, 2011

P1, total 22 pages

The Appendix forms an integral part of this Certificate, which shall be invalid when use without the Appendix