



# SPORTON International Inc.

No. 52, Hwa Ya 1st Rd., Kwei-Shan Hsiang, TaoYuan Hsien, Taiwan, R.O.C.  
Ph: 886-3-327-3456 / FAX: 886-3-327-0973 / www.sporton.com.tw

## FCC RADIO TEST REPORT

Applicant's company	Realtek Semiconductor Corp.
Applicant Address	No. 2, Innovation Road II, Hsinchu Science Park, Hsinchu 300, Taiwan
FCC ID	TX2-RTL8191SE
Manufacturer's company	Realtek Semiconductor Corp.
Manufacturer Address	No. 2, Innovation Road II, Hsinchu Science Park, Hsinchu 300, Taiwan

Product Name	802.11b/g/n RTL8191SE miniCard
Brand Name	Realtek
Model Name	RTL8191SE
Test Rule	47 CFR FCC Part 15 Subpart C § 15.247
Test Freq. Range	2400 ~ 2483.5MHz
Received Date	Dec. 25, 2008
Final Test Date	Jan. 15, 2009
Submission Type	Original Equipment

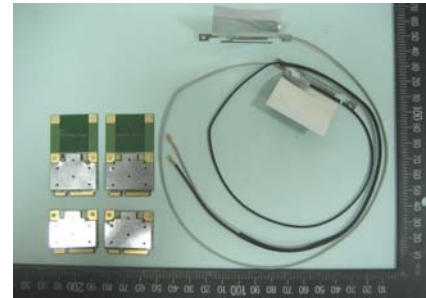

### Statement

**Test result included in this report is for the Draft n and 802.11b/g part of the product.**

The test result in this report refers exclusively to the presented test model / sample.

Without written approval of SPORTON International Inc., the test report shall not be reproduced except in full.

The measurements and test results shown in this test report were made in accordance with the procedures and found in compliance with the limit given in **ANSI C63.4-2003** and **47 CFR FCC Part 15 Subpart C**.

The test equipment used to perform the test is calibrated and traceable to NML/ROC.



## Table of Contents

<b>1. CERTIFICATE OF COMPLIANCE .....</b>	<b>1</b>
<b>2. SUMMARY OF THE TEST RESULT .....</b>	<b>2</b>
<b>3. GENERAL INFORMATION .....</b>	<b>3</b>
3.1. Product Details.....	3
3.2. Accessories.....	4
3.3. Table for Filed Antenna.....	5
3.4. Table for Carrier Frequencies .....	6
3.5. Table for Test Modes .....	6
3.6. Table for Testing Locations.....	7
3.7. Table for Supporting Units .....	7
3.8. Table for Parameters of Test Software Setting .....	8
3.9. Test Configurations .....	9
<b>4. TEST RESULT .....</b>	<b>11</b>
4.1. AC Power Line Conducted Emissions Measurement.....	11
4.2. Maximum Conducted Output Power Measurement.....	17
4.3. Power Spectral Density Measurement .....	26
4.4. 6dB Spectrum Bandwidth Measurement .....	35
4.5. Radiated Emissions Measurement .....	44
4.6. Band Edge Emissions Measurement .....	76
4.7. Antenna Requirements .....	85
<b>5. LIST OF MEASURING EQUIPMENTS .....</b>	<b>86</b>
<b>6. TEST LOCATION.....</b>	<b>88</b>
<b>7. TAF CERTIFICATE OF ACCREDITATION .....</b>	<b>89</b>
<b>APPENDIX A. PHOTOGRAPHS OF EUT.....</b>	<b>A1 ~ A19</b>
<b>APPENDIX B. TEST PHOTOS.....</b>	<b>B1 ~ B12</b>
<b>APPENDIX C. MAXIMUM PERMISSIBLE EXPOSURE.....</b>	<b>C1 ~C3</b>
<b>APPENDIX D. ANTENNA LIST.....</b>	<b>D1 ~ D5</b>





## 1. CERTIFICATE OF COMPLIANCE

Product Name : 802.11b/g/n RTL8191SE miniCard  
Brand Name : Realtek  
Model Name : RTL8191SE  
Applicant : Realtek Semiconductor Corp.  
Test Rule Part(s) : 47 CFR FCC Part 15 Subpart C § 15.247

Sporton International as requested by the applicant to evaluate the EMC performance of the product sample received on Dec. 25, 2008 would like to declare that the tested sample has been evaluated and found to be in compliance with the tested rule parts. The data recorded as well as the test configuration specified is true and accurate for showing the sample's EMC nature.

  
Wayne Hsu

SPORTON INTERNATIONAL INC.

## 2. SUMMARY OF THE TEST RESULT

Applied Standard: 47 CFR FCC Part 15 Subpart C				
Part	Rule Section	Description of Test	Result	Under Limit
4.1	15.207	AC Power Line Conducted Emissions	Complies	10.12 dB
4.2	15.247(b)(3)	Maximum Conducted Output Power	Complies	11.76 dB
4.3	15.247(e)	Power Spectral Density	Complies	19.62 dB
4.4	15.247(a)(2)	6dB Spectrum Bandwidth	Complies	-
4.5	15.247(d)	Radiated Emissions	Complies	1.11 dB
4.6	15.247(d)	Band Edge Emissions	Complies	0.37 dB
4.7	15.203	Antenna Requirements	Complies	-

Test Items	Uncertainty	Remark
AC Power Line Conducted Emissions	±2.3dB	Confidence levels of 95%
Maximum Conducted Output Power	±0.8dB	Confidence levels of 95%
Power Spectral Density	±0.5dB	Confidence levels of 95%
6dB Spectrum Bandwidth	±8.5×10 <sup>-8</sup>	Confidence levels of 95%
Radiated Emissions (9kHz~30MHz)	±0.8dB	Confidence levels of 95%
Radiated Emissions (30MHz~1000MHz)	±1.9dB	Confidence levels of 95%
Radiated / Band Edge Emissions (1GHz~18GHz)	±1.9dB	Confidence levels of 95%
Radiated Emissions (18GHz~40GHz)	±1.9dB	Confidence levels of 95%
Temperature	±0.7°C	Confidence levels of 95%
Humidity	±3.2%	Confidence levels of 95%
DC / AC Power Source	±1.4%	Confidence levels of 95%

### 3. GENERAL INFORMATION

#### 3.1. Product Details

##### Draft n

Items	Description
Product Type	WLAN (1TX, 2RX)
Radio Type	Intentional Transceiver
Power Type	From Host System
Modulation	see the below table for draft n
Data Modulation	OFDM (BPSK / QPSK / 16QAM / 64QAM)
Data Rate (Mbps)	see the below table for Draft n
Frequency Range	2400 ~ 2483.5MHz
Channel Number	11 for 20MHz bandwidth ; 7 for 40MHz bandwidth
Channel Band Width (99%)	MCS0 (20MHz): 17.62 MHz ; MCS0 (40MHz): 37.70 MHz
Conducted Output Power	MCS0 (20MHz): 16.58 dBm ; MCS0 (40MHz): 16.58 dBm
Carrier Frequencies	Please refer to section 3.4
Antenna	Please refer to section 3.3

##### 802.11b/g

Items	Description
Product Type	802.11b :WLAN (1TX, 2RX) 802.11g :WLAN (1TX, 2RX)
Radio Type	Intentional Transceiver
Power Type	From Host System
Modulation	DSSS for IEEE 802.11b ; OFDM for IEEE 802.11g
Data Modulation	DSSS (BPSK / QPSK / CCK) ; OFDM (BPSK / QPSK / 16QAM / 64QAM)
Data Rate (Mbps)	DSSS (1/ 2/ 5.5/11) ; OFDM (6/9/12/18/24/36/48/54)
Frequency Range	2400 ~ 2483.5MHz
Channel Number	11
Channel Band Width (99%)	11b: 14.80 MHz ; 11g: 16.44 MHz
Conducted Output Power	11b: 18.24 dBm ; 11g: 16.61 dBm
Carrier Frequencies	Please refer to section 3.4
Antenna	Please refer to section 3.3

**Antenna & Band width**

Antenna	Single (TX)	
Band width Mode	20 MHz	40 MHz
802.11b	V	X
802.11g	V	X
Draft n	V	V

**Draft n spec**

MCS Index	Nss	Modulation	R	NBPS	NCBPS		NDBPS		Datarate(Mbps)			
					20MHz	40MHz	20MHz	40MHz	800nsGI		400nsGI	
									20MHz	40MHz	20MHz	40MHz
0	1	BPSK	1/2	1	52	108	26	54	6.5	13.5	7.200	15
1	1	QPSK	1/2	2	104	216	52	108	13.0	27.0	14.400	30
2	1	QPSK	3/4	2	104	216	78	162	19.5	40.5	21.700	45
3	1	16-QAM	1/2	4	208	432	104	216	26.0	54.0	28.900	60
4	1	16-QAM	3/4	4	208	432	156	324	39.0	81.0	43.300	90
5	1	64-QAM	2/3	6	312	648	208	432	52.0	108.0	57.800	120
6	1	64-QAM	3/4	6	312	648	234	486	58.5	121.5	65.000	135
7	1	64-QAM	5/6	6	312	648	260	540	65.0	135.0	72.200	150

Symbol	Explanation
NSS	Number of spatial streams
R	Code rate
NBPS	Number of coded bits per single carrier
NCBPS	Number of coded bits per symbol
NDBPS	Number of data bits per symbol
GI	guard interval

**3.2. Accessories**

N/A

### 3.3. Table for Filed Antenna

Ant.	Brand	Model Name	Antenna Type	Connector	Gain (dBi)
A.(Main)	WNC	DQ661500301	PIFA Antenna	I-PEX	3.95
B. (Aux)	WNC	DQ661500301	PIFA Antenna	I-PEX	3.90

Note:

(1) There are four types of EUT.

EUT 1 : Full Size Module with one Antenna Connector

EUT 2 : Full Size Module with two Antenna Connectors

EUT 3 : Half Size Module with one Antenna Connector

EUT 4 : Half Size Module with two Antenna Connectors

Connector 1 : Ant. A

Connector 2 : Ant. B

The EUT 2 / EUT 4 have two antenna connectors, the Connector 1 have TX function , Connector 2 have only RX function.

The EUT 1 / EUT 3 have one antenna connector, the Connector 1 have both TX/RX function.

(2) Only one of all antennas is used as transmitting antenna.

Due to Ant. A is the highest gain value among PIFA antennas, only Ant. A was tested and recorded in this report.

Please refer to Appendix. D for all antennas.

1. EUT 1 / EUT 3 with one Connector :      2. EUT 2 / EUT 4 with two Connectors :

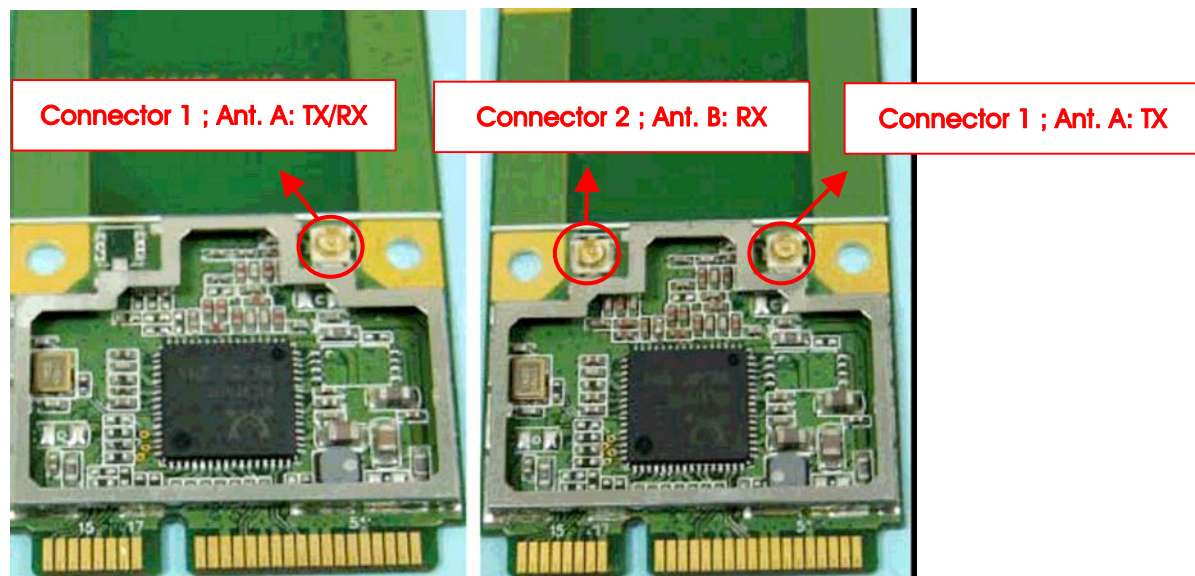



### 3.4. Table for Carrier Frequencies

There are two bandwidth systems for draft n.

For both 20MHz bandwidth systems, use Channel 1~Channel 11.

For both 40MHz bandwidth systems, use Channel 3~Channel 9.

Frequency Band	Channel No.	Frequency	Channel No.	Frequency
2400~2483.5MHz	1	2412 MHz	7	2442 MHz
	2	2417 MHz	8	2447 MHz
	3	2422 MHz	9	2452 MHz
	4	2427 MHz	10	2457 MHz
	5	2432 MHz	11	2462 MHz
	6	2437 MHz		

### 3.5. Table for Test Modes

Preliminary tests were performed in different data rate to find the worst radiated emission. The data rate shown in the table below is the worst-case rate with respect to the specific test item. Investigation has been done on all the possible configurations for searching the worst cases. The following table is a list of the test modes shown in this test report.

Test Items	Mode	Data Rate	Channel	Antenna
AC Power Line Conducted Emissions	Normal Link	-	-	-
Maximum Peak Conducted Output Power	MCS0/20MHz	6.5 Mbps	1/6/11	A
	MCS0/40MHz	13.5 Mbps	3/6/9	A
	11b/BPSK	1 Mbps	1/6/11	A
	11g/BPSK	6 Mbps	1/6/11	A
Power Spectral Density 6dB Spectrum Bandwidth	MCS0/20MHz	6.5 Mbps	1/6/11	A
	MCS0/40MHz	13.5 Mbps	3/6/9	A
	11b/BPSK	1 Mbps	1/6/11	A
	11g/BPSK	6 Mbps	1/6/11	A
Radiated Emissions 9kHz~1GHz	Normal Link	-	-	-
Radiated Emissions 1GHz~10 <sup>th</sup> Harmonic	MCS0/20MHz	6.5 Mbps	1/6/11	A
	MCS0/40MHz	13.5 Mbps	3/6/9	A
	11b/BPSK	1 Mbps	1/6/11	A
	11g/BPSK	6 Mbps	1/6/11	A
Band Edge Emissions	MCS0/20MHz	6.5 Mbps	1/11	A
	MCS0/40MHz	13.5 Mbps	3/9	A
	11b/BPSK	1 Mbps	1/11	A
	11g/BPSK	6 Mbps	1/11	A

**Note:**

There are four types of EUT , and have two different size.

The EUT 1 and EUT 3 have one antenna connectors, the EUT 2 and EUT 4 have two antenna connectors , but their internal circuit board are exactly identical.

All the test modes were listed as below.

Test Mode 1 (EUT 1) : Full Size Module with one Antenna Connector (with PCB board)

Test Mode 2 (EUT 2) : Full Size Module with two Antenna Connector (with PCB board)

Test Mode 3 (EUT 3) : Half Size Module with one Antenna Connector (without PCB board)

Test Mode 4 (EUT 4) : Half Size Module with two Antenna Connector (without PCB board)

<For Conducted Emissions Test>:

After pretest, it was selected Mode 3 and Mode 4 for for Conducted emission test.

<For Radiated Emissions Test> :

For Radiated Emissions Below 1GHz :

Radiated emissions below 1GHz, Mode 3 and Mode 4 were tested and recorded in this report.

For Radiated Emissions Above 1GHz :

After pretest, it was selected Mode 3 for Radiated emissions above 1GHz test as worse case and recorded the test data in the report.

### 3.6. Table for Testing Locations

Test Site No.	Site Category	Location	FCC Reg. No.	IC File No.	VCCI Reg. No
03CH03-HY	SAC	Hwa Ya	101377	IC 4088	-
CO04-HY	Conduction	Hwa Ya	101377	IC 4088	-
TH01-HY	OVEN Room	Hwa Ya	-	-	-

Open Area Test Site (OATS); Semi Anechoic Chamber (SAC); Fully Anechoic Chamber (FAC).

Please refer section 6 for Test Site Address.

### 3.7. Table for Supporting Units

Support Unit	Brand	Model	FCC ID
Notebook	DELL	M1330	E2KWM3945ABG
Notebook	DELL	PP25L	E2K4965AGNM
Modem	ACEEX	DM1414	IFAXDM1414
Mouse	HP	M-UAE96	DoC
Wireless AP	Planex	GW-AP54SGX	N/A

### 3.8. Table for Parameters of Test Software Setting

During testing, Channel & Power Controlling Software provided by the customer was used to control the operating channel as well as the output power level. The RF output power selection is for the setting of RF output power expected by the customer and is going to be fixed on the firmware of the final end product.

#### Power Parameters of Draft n MCS0 20MHz

Test Software Version	REALTEK		
Frequency	2412 MHz	2437 MHz	2462 MHz
Draft n MCS0 20MHz Ant. A	46	46	43

#### Power Parameters of Draft n MCS0 40MHz

Test Software Version	REALTEK		
Frequency	2422 MHz	2437 MHz	2452 MHz
Draft n MCS0 40MHz Ant. A	48	48	44

#### Power Parameters of IEEE 802.11b/g

Test Software Version	REALTEK		
Frequency	2412 MHz	2437 MHz	2462 MHz
IEEE 802.11b Ant. A	43	42	42
IEEE 802.11g Ant. A	46	46	45

An executive program, EMCTEST.EXE under WIN XP, which generates a complete line of continuously repeating " H " pattern was used as the test software.

The program was executed as follows :

- a. Turn on the power of all equipment.
- b. The NB sends " H " messages to the panel, and the panel displays " H " patterns on the screen.
- c. The NB sends " H " messages to the modem.
- d. Repeat the steps from b to c.

At the same time, "REALTEK" was executed the test program to control the EUT continuously transmit RF signal.

### 3.9. Test Configurations

#### 3.9.1. Radiation Emissions Test Configuration

Test Configuration: 9KHz~1GHz

Test Mode: Mode 3 / Mode 4

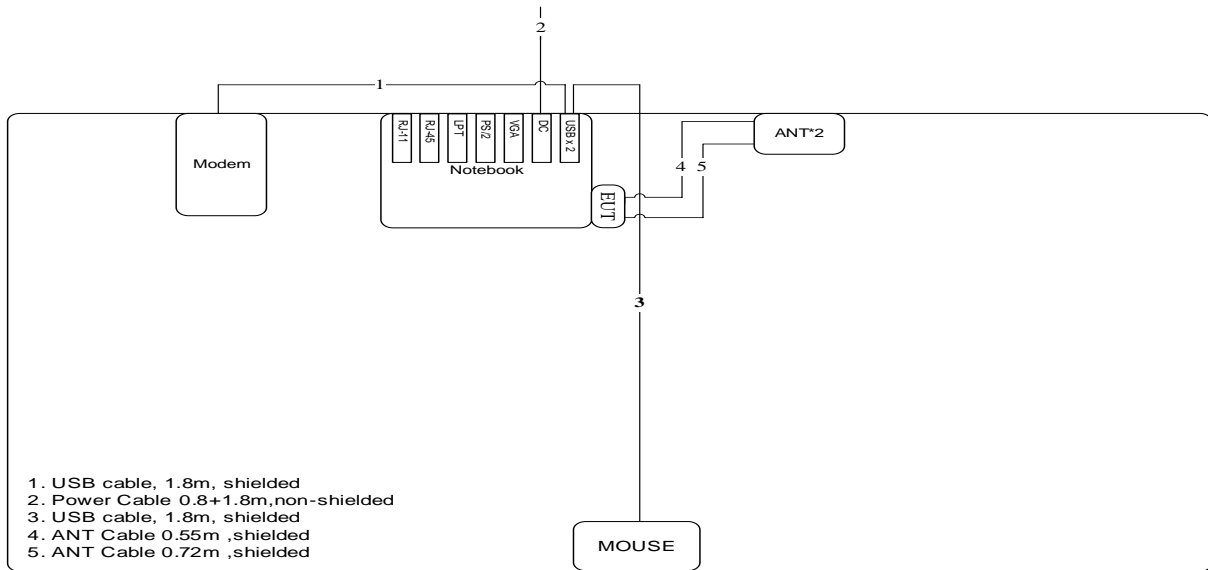

AP

Test Configuration: above 1GHz

Test Mode: Mode 3

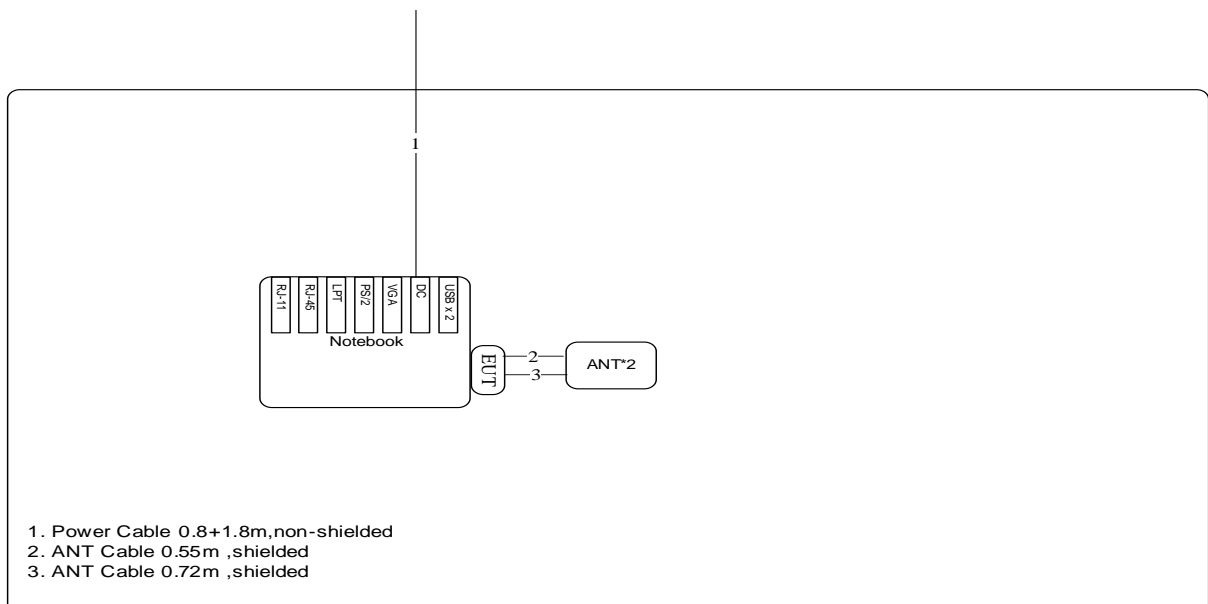

### 3.9.2. AC Power Line Conduction Emissions Test Configuration

Test Mode: Mode 3 / Mode 4

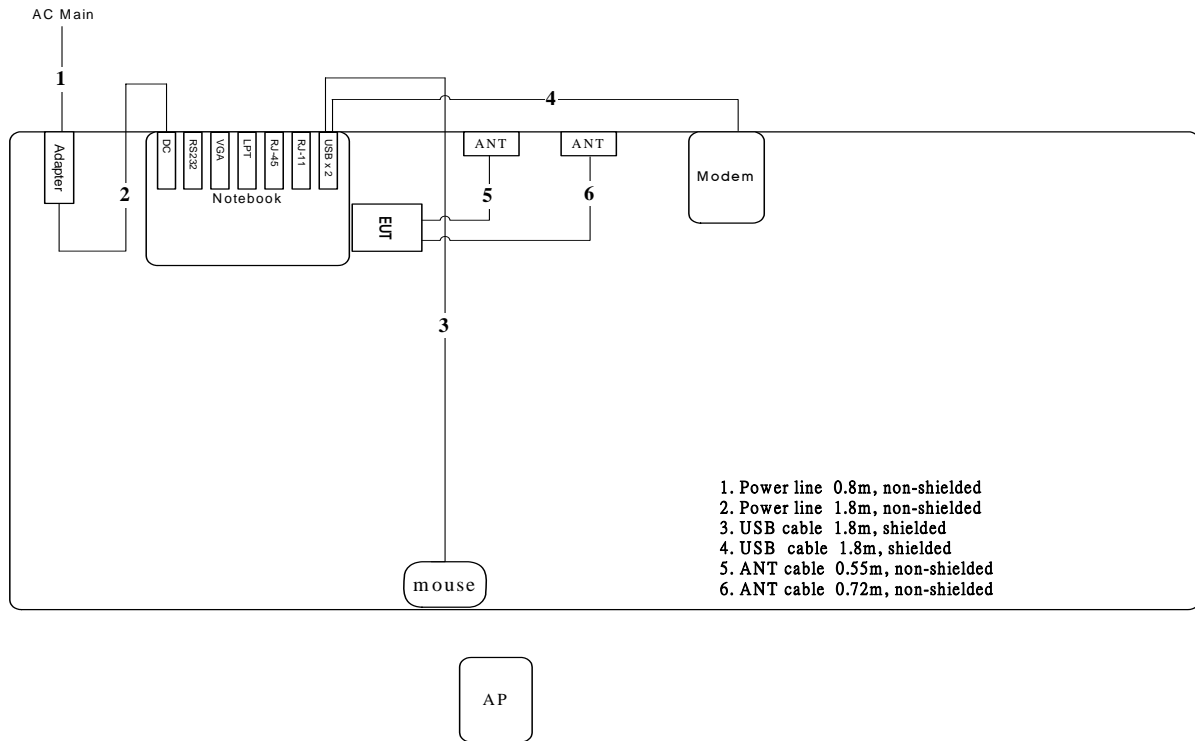

## 4. TEST RESULT

### 4.1. AC Power Line Conducted Emissions Measurement

#### 4.1.1. Limit

For this product which is designed to be connected to the AC power line, the radio frequency voltage that is conducted back onto the AC power line on any frequency or frequencies within the band 150 kHz to 30 MHz shall not exceed below limits table.

Frequency (MHz)	QP Limit (dBuV)	AV Limit (dBuV)
0.15~0.5	66~56	56~46
0.5~5	56	46
5~30	60	50

#### 4.1.2. Measuring Instruments and Setting

Please refer to section 5 of equipments list in this report. The following table is the setting of the receiver.

Receiver Parameters	Setting
Attenuation	10 dB
Start Frequency	0.15 MHz
Stop Frequency	30 MHz
IF Bandwidth	9 KHz

#### 4.1.3. Test Procedures

1. Configure the EUT according to ANSI C63.4. The EUT or host of EUT has to be placed 0.4 meter far from the conducting wall of the shielding room and at least 80 centimeters from any other grounded conducting surface.
2. Connect EUT or host of EUT to the power mains through a line impedance stabilization network (LISN).
3. All the support units are connected to the other LISNs. The LISN should provide 50uH/50ohms coupling impedance.
4. The frequency range from 150 KHz to 30 MHz was searched.
5. Set the test-receiver system to Peak Detect Function and Specified Bandwidth with Maximum Hold Mode.
6. The measurement has to be done between each power line and ground at the power terminal.

#### 4.1.4. Test Setup Layout

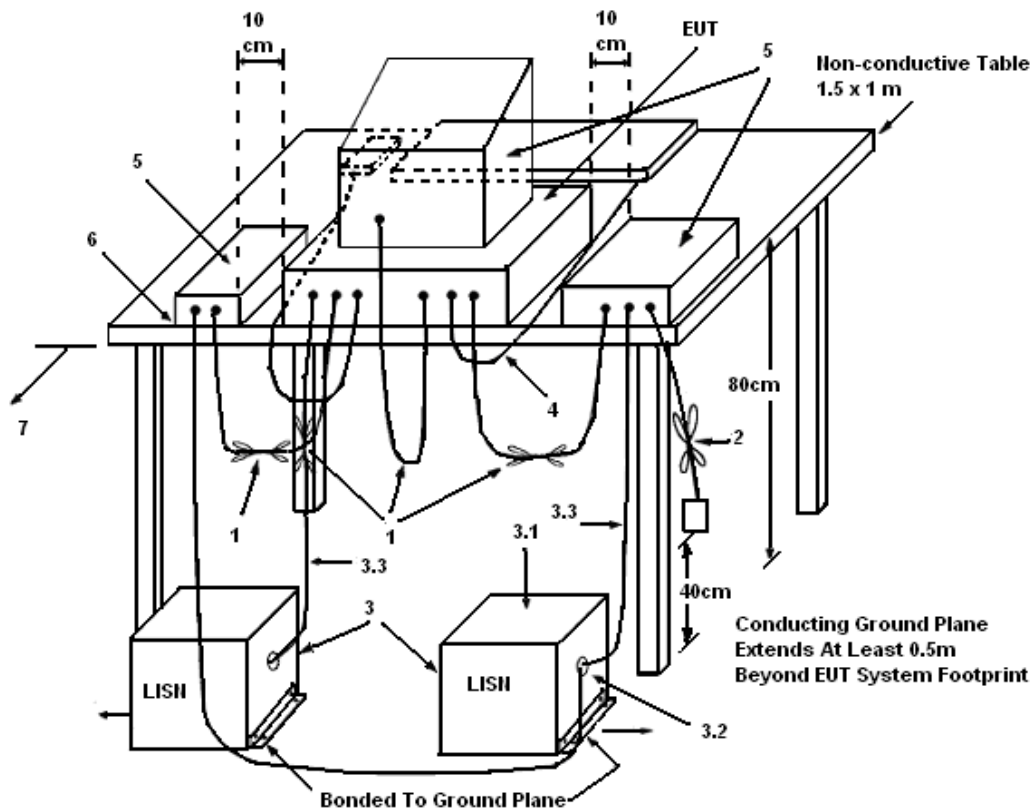

#### LEGEND:

- (1) Interconnecting cables that hang closer than 40 cm to the ground plane shall be folded back and forth in the center forming a bundle 30 to 40 cm long.
- (2) I/O cables that are not connected to a peripheral shall be bundled in the center. The end of the cable may be terminated, if required, using the correct terminating impedance. The overall length shall not exceed 1 m.
- (3) EUT connected to one LISN. Unused LISN measuring port connectors shall be terminated in 50  $\Omega$ . LISN can be placed on top of, or immediately beneath, reference ground plane.
  - (3.1) All other equipment powered from additional LISN(s).
  - (3.2) Multiple outlet strip can be used for multiple power cords of non-EUT equipment.
  - (3.3) LISN at least 80 cm from nearest part of EUT chassis.
- (4) Cables of hand-operated devices, such as keyboards, mice, etc., shall be placed as for normal use.
- (5) Non-EUT components of EUT system being tested.
- (6) Rear of EUT, including peripherals, shall all be aligned and flush with rear of tabletop.
- (7) Rear of tabletop shall be 40 cm removed from a vertical conducting plane that is bonded to the ground plane.

#### 4.1.5. Test Deviation

There is no deviation with the original standard.

4.1.6. EUT Operation during Test

The EUT was placed on the test table and programmed in normal function.

4.1.7. Results of AC Power Line Conducted Emissions Measurement

Temperature	23°C	Humidity	56%
Test Engineer	Peter Wu	Phase	Line
Configuration	Normal Link / Mode 3		

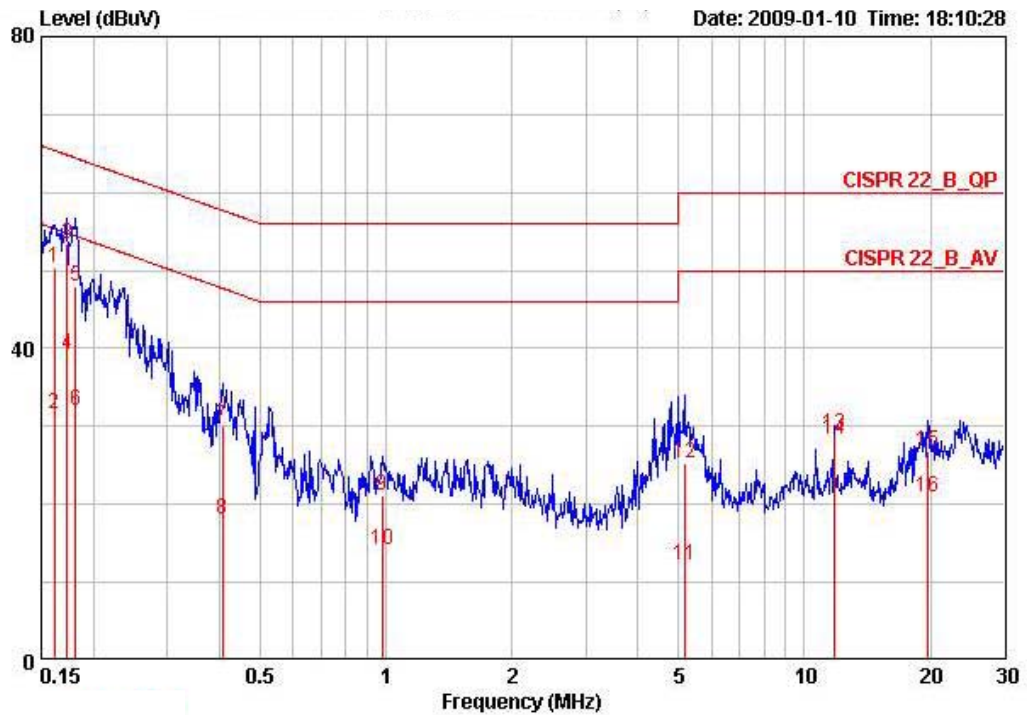

	Freq	Level	Over Limit	Limit Line	Read Level	LISN Factor	Cable Loss	Remark
	MHz	dBuV	dB	dBuV	dBuV	dB	dB	
1	0.16155	50.35	-15.04	65.38	50.08	0.07	0.20	QP
2	0.16155	31.67	-23.72	55.38	31.40	0.07	0.20	AVERAGE
3	0.17307	53.40	-11.41	64.81	53.14	0.06	0.20	QP
4	0.17307	39.17	-15.64	54.81	38.91	0.06	0.20	AVERAGE
5	0.18152	48.00	-16.42	64.42	47.74	0.06	0.20	QP
6	0.18152	32.13	-22.29	54.42	31.87	0.06	0.20	AVERAGE
7	0.40615	30.17	-27.56	57.73	29.94	0.03	0.20	QP
8	0.40615	18.10	-29.63	47.73	17.87	0.03	0.20	AVERAGE
9	0.97871	21.04	-34.96	56.00	20.81	0.03	0.20	QP
10	0.97871	14.17	-31.83	46.00	13.94	0.03	0.20	AVERAGE
11	5.166	12.14	-37.86	50.00	11.67	0.17	0.30	AVERAGE
12	5.166	25.18	-34.82	60.00	24.71	0.17	0.30	QP
13	11.760	28.96	-31.04	60.00	28.13	0.43	0.40	QP
14	11.760	28.44	-21.56	50.00	27.61	0.43	0.40	AVERAGE
15	19.631	26.86	-33.15	60.00	25.55	0.80	0.50	QP
16	19.631	21.00	-29.01	50.00	19.69	0.80	0.50	AVERAGE



Temperature	23°C	Humidity	56%
Test Engineer	Peter Wu	Phase	Neutral
Configuration	Normal Link / Mode 3		

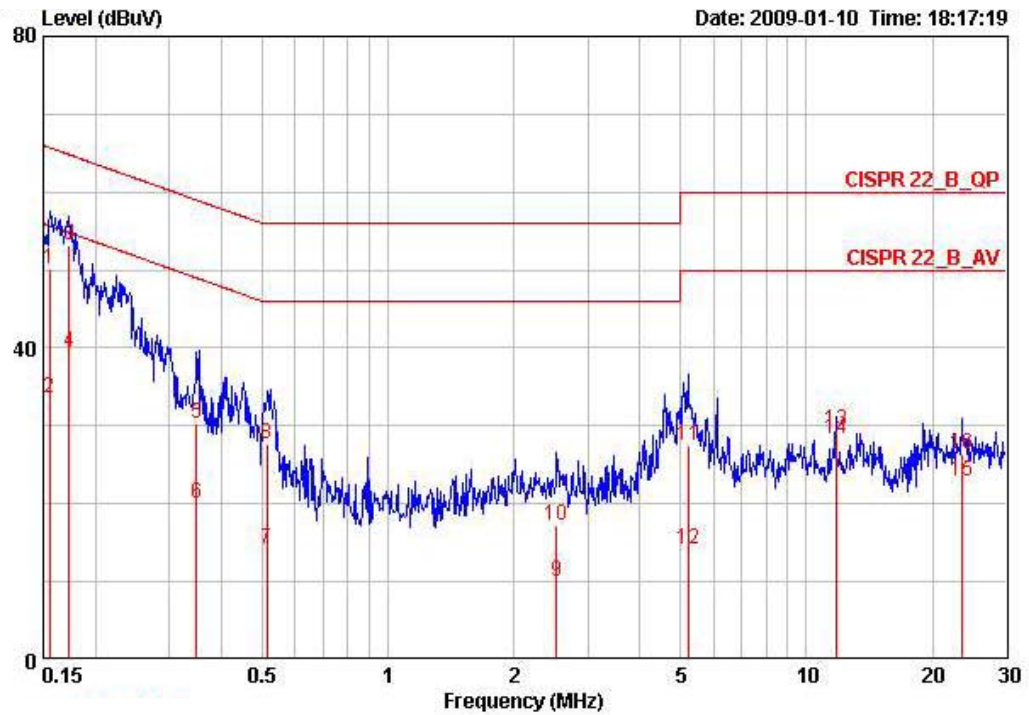

	Freq	Level	Over Limit	Limit Line	Read Level	LISN Factor	Cable Loss	Remark
	MHz	dBuV	dB	dBuV	dBuV	dB	dB	
1	0.15567	50.06	-15.63	65.69	49.76	0.10	0.20	QP
2	0.15567	33.51	-22.18	55.69	33.21	0.10	0.20	AVERAGE
3	0.17307	53.13	-11.68	64.81	52.84	0.09	0.20	QP
4	0.17307	39.37	-15.44	54.81	39.08	0.09	0.20	AVERAGE
5	0.34838	30.23	-28.77	59.00	29.96	0.07	0.20	QP
6	0.34838	20.14	-28.86	49.00	19.87	0.07	0.20	AVERAGE
7	0.51376	14.24	-31.76	46.00	13.97	0.07	0.20	AVERAGE
8	0.51376	27.58	-28.42	56.00	27.31	0.07	0.20	QP
9	2.527	10.10	-35.90	46.00	9.79	0.11	0.20	AVERAGE
10	2.527	17.20	-38.80	56.00	16.89	0.11	0.20	QP
11	5.221	27.56	-32.44	60.00	27.05	0.21	0.30	QP
12	5.221	14.09	-35.91	50.00	13.58	0.21	0.30	AVERAGE
13	11.760	29.33	-30.67	60.00	28.47	0.46	0.40	QP
14	11.760	28.38	-21.62	50.00	27.52	0.46	0.40	AVERAGE
15	23.520	22.89	-27.11	50.00	21.31	1.08	0.50	AVERAGE
16	23.520	26.46	-33.54	60.00	24.88	1.08	0.50	QP

Note:

Level = Read Level + LISN Factor + Cable Loss.

Temperature	23°C	Humidity	56%
Test Engineer	Peter Wu	Phase	Line
Configuration	Normal Link / Mode 4		

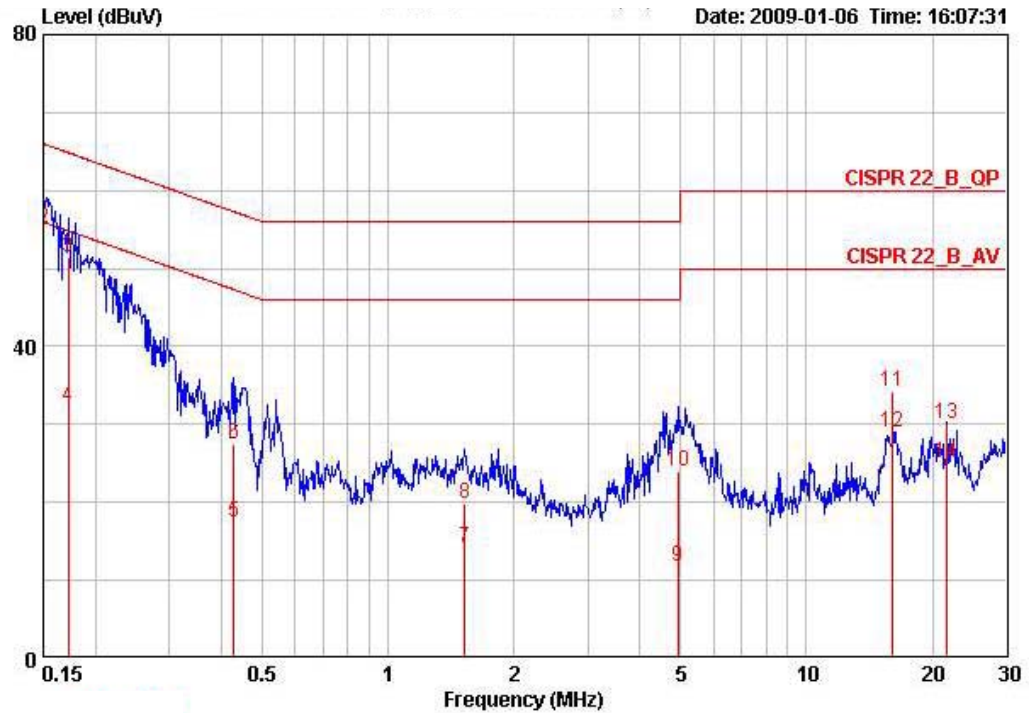

	Freq	Level	Over Limit	Limit Line	Read Level	LISN Factor	Cable Loss	Remark
	MHz	dBuV	dB	dBuV	dBuV	dB	dB	
1	0.15000	40.75	-15.25	56.00	40.47	0.08	0.20	AVERAGE
2	0.15000	55.19	-10.81	66.00	54.91	0.08	0.20	QP
3	0.17215	51.43	-13.42	64.86	51.17	0.06	0.20	QP
4	0.17215	32.22	-22.63	54.86	31.96	0.06	0.20	AVERAGE
5	0.42825	17.54	-29.75	47.29	17.31	0.03	0.20	AVERAGE
6	0.42825	27.57	-29.72	57.29	27.34	0.03	0.20	QP
7	1.527	14.09	-31.91	46.00	13.94	0.04	0.11	AVERAGE
8	1.527	19.88	-36.12	56.00	19.73	0.04	0.11	QP
9	4.926	11.68	-34.32	46.00	11.22	0.16	0.30	AVERAGE
10	4.926	23.98	-32.02	56.00	23.52	0.16	0.30	QP
11	16.055	34.17	-25.83	60.00	33.15	0.62	0.40	QP
12	16.055	29.02	-20.98	50.00	28.00	0.62	0.40	AVERAGE
13	21.715	30.09	-29.91	60.00	28.65	0.94	0.50	QP
14	21.715	25.15	-24.85	50.00	23.71	0.94	0.50	AVERAGE

Temperature	23°C	Humidity	56%
Test Engineer	Peter Wu	Phase	Neutral
Configuration	Normal Link / Mode 4		

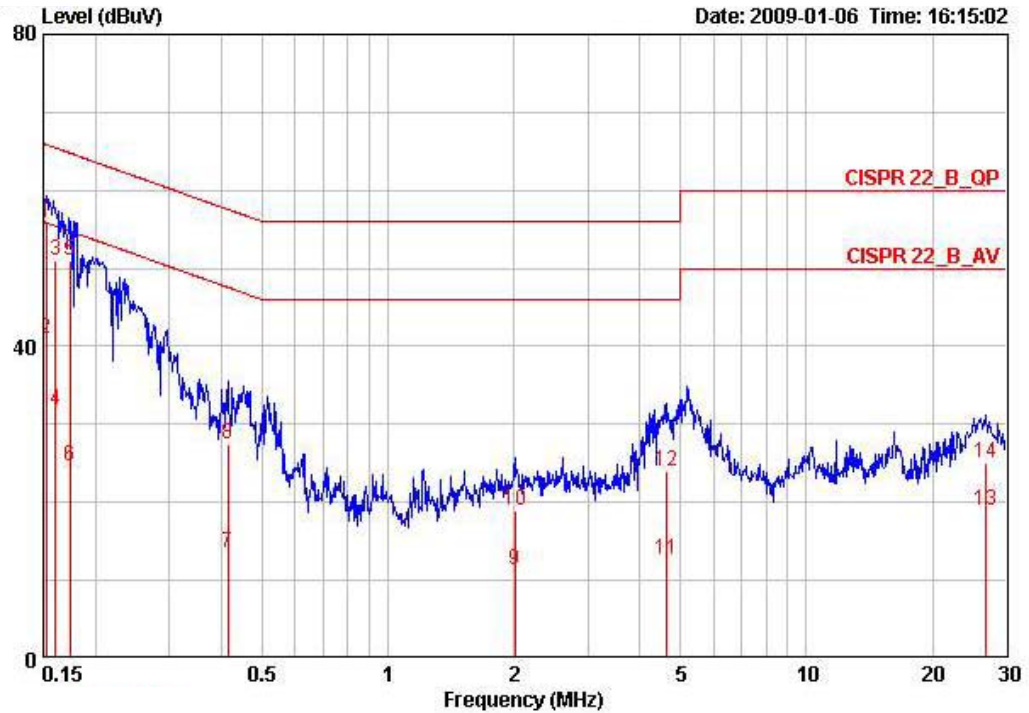

	Freq	Level	Over Limit	Limit Line	Read Level	LISN Factor	Cable Loss	Remark
	MHz	dBuV	dB	dBuV	dBuV	dB	dB	
1	0.15240	55.74	-10.12	65.87	55.44	0.10	0.20	QP
2	0.15240	40.96	-14.90	55.87	40.66	0.10	0.20	AVERAGE
3	0.16070	50.99	-14.44	65.43	50.69	0.10	0.20	QP
4	0.16070	31.78	-23.65	55.43	31.48	0.10	0.20	AVERAGE
5	0.17399	50.96	-13.81	64.77	50.67	0.09	0.20	QP
6	0.17399	24.60	-30.17	54.77	24.31	0.09	0.20	AVERAGE
7	0.41485	13.52	-34.03	47.55	13.25	0.07	0.20	AVERAGE
8	0.41485	27.48	-30.07	57.55	27.21	0.07	0.20	QP
9	2.012	11.34	-34.66	46.00	11.05	0.09	0.20	AVERAGE
10	2.012	18.92	-37.08	56.00	18.63	0.09	0.20	QP
11	4.622	12.69	-33.31	46.00	12.21	0.18	0.30	AVERAGE
12	4.622	23.88	-32.12	56.00	23.40	0.18	0.30	QP
13	26.699	18.99	-31.01	50.00	17.18	1.28	0.53	AVERAGE
14	26.699	25.10	-34.90	60.00	23.29	1.28	0.53	QP

Note:

Level = Read Level + LISN Factor + Cable Loss.

## 4.2. Maximum Conducted Output Power Measurement

### 4.2.1. Limit

For systems using digital modulation in the 2400-2483.5MHz, the limit for peak output power is 30dBm. The limited has to be reduced by the amount in dB that the gain of the antenna exceed 6dBi. In case of point-to-point operation, the limit has to be reduced by 1dB for every 3dB that the directional gain of the antenna exceeds 6dBi.

### 4.2.2. Measuring Instruments and Setting

Please refer to section 5 of equipments list in this report. The following table is the setting of the spectrum analyzer.

Spectrum Parameter	Setting
Attenuation	Auto
Span Frequency	Encompass the entire emissions bandwidth (EBW) of the signal
RB	1000 kHz
VB	3000 kHz
Detector	RMS
Trace	Max Hold
Sweep Time	Auto

### 4.2.3. Test Procedures

1. The transmitter output (antenna port) was connected to the spectrum analyzer.
2. Test was performed in accordance with Measurement of Digital Transmission Systems Operating under Section 15.247 March 23, 2005.

### 4.2.4. Test Setup Layout

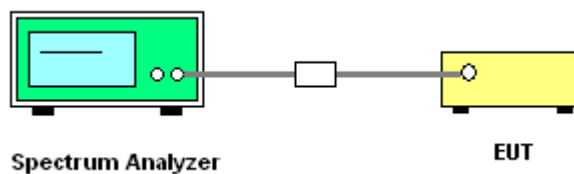

### 4.2.5. Test Deviation

There is no deviation with the original standard.

### 4.2.6. EUT Operation during Test

The EUT was programmed to be in continuously transmitting mode.

#### 4.2.7. Test Result of Maximum Conducted Output Power

<b>Temperature</b>	25°C	<b>Humidity</b>	60%
<b>Test Engineer</b>	Johnson Chang	<b>Configurations</b>	Draft n
<b>Test Date</b>	Jan. 13, 2009		

##### Configuration Draft n MCS0 20MHz Ant. A

Channel	Frequency	Conducted Power (dBm)	Max. Limit (dBm)	Result
1	2412 MHz	16.48	30.00	Complies
6	2437 MHz	16.58	30.00	Complies
11	2462 MHz	15.13	30.00	Complies

##### Configuration Draft n MCS0 40MHz Ant. A

Channel	Frequency	Conducted Power (dBm)	Max. Limit (dBm)	Result
3	2422 MHz	16.58	30.00	Complies
6	2437 MHz	16.56	30.00	Complies
9	2452 MHz	14.59	30.00	Complies

<b>Temperature</b>	25°C	<b>Humidity</b>	60%
<b>Test Engineer</b>	Johnson Chang	<b>Configurations</b>	802.11b/g
<b>Test Date</b>	Jan. 13, 2009		

**Configuration IEEE 802.11b Ant. A**

Channel	Frequency	Conducted Power (dBm)	Max. Limit (dBm)	Result
1	2412 MHz	18.24	30.00	<b>Complies</b>
6	2437 MHz	17.73	30.00	<b>Complies</b>
11	2462 MHz	17.78	30.00	<b>Complies</b>

**Configuration IEEE 802.11g Ant. A**

Channel	Frequency	Conducted Power (dBm)	Max. Limit (dBm)	Result
1	2412 MHz	16.60	30.00	<b>Complies</b>
6	2437 MHz	16.61	30.00	<b>Complies</b>
11	2462 MHz	15.22	30.00	<b>Complies</b>

### Conducted Output Power Plot on Configuration Draft n MCS0 20MHz Ant. A / 2412 MHz

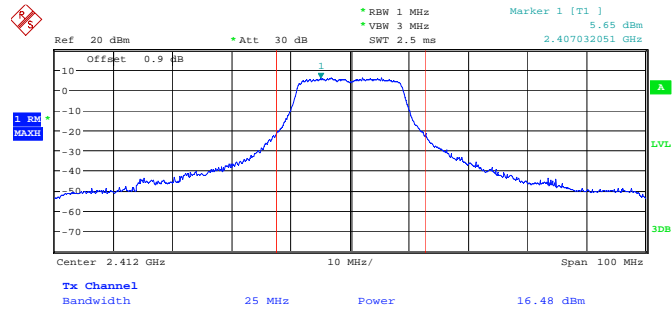

Date: 13.JAN.2009 13:45:02

### Conducted Output Power Plot on Configuration Draft n MCS0 20MHz Ant. A / 2437 MHz

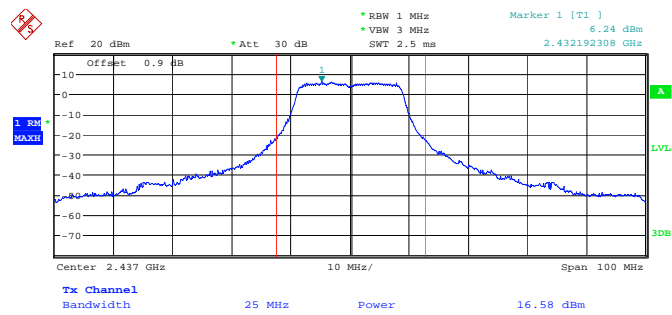

Date: 13.JAN.2009 13:44:15

**Conducted Output Power Plot on Configuration Draft n MCS0 20MHz Ant. A / 2462 MHz**

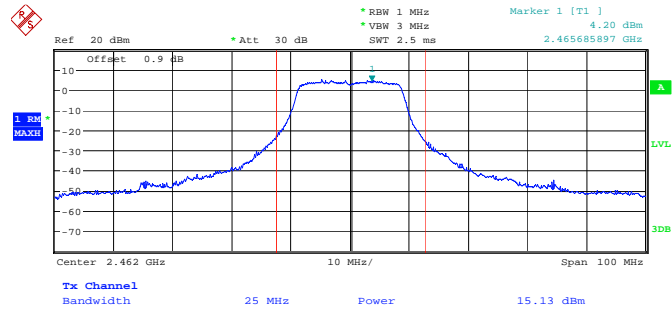

Date: 13.JAN.2009 13:43:21

**Conducted Output Power Plot on Configuration Draft n MCS0 40MHz Ant. A / 2422 MHz**

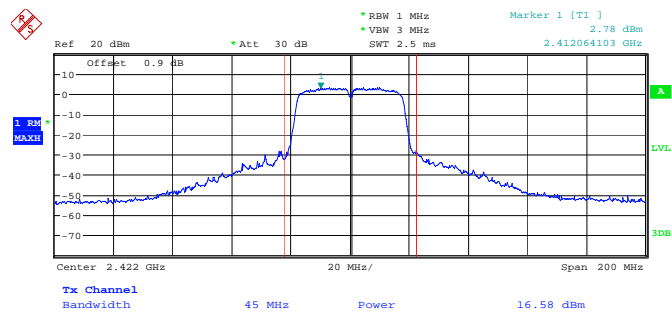

Date: 13.JAN.2009 13:51:45





### Conducted Output Power Plot on Configuration IEEE 802.11b Ant. A / 2412 MHz

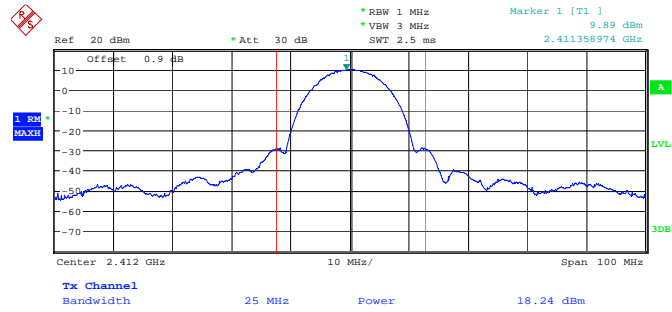

Date: 13.JAN.2009 13:50:05

### Conducted Output Power Plot on Configuration IEEE 802.11b Ant. A / 2437 MHz

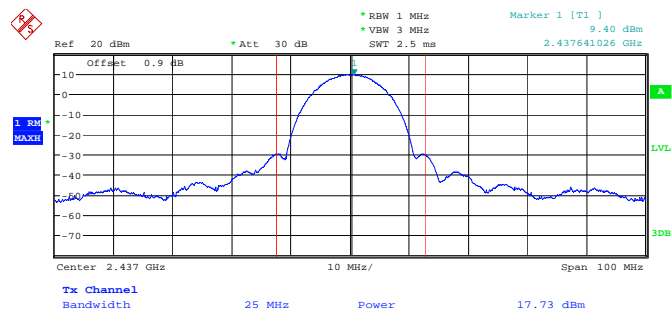

Date: 13.JAN.2009 13:49:38

### Conducted Output Power Plot on Configuration IEEE 802.11b Ant. A / 2462 MHz

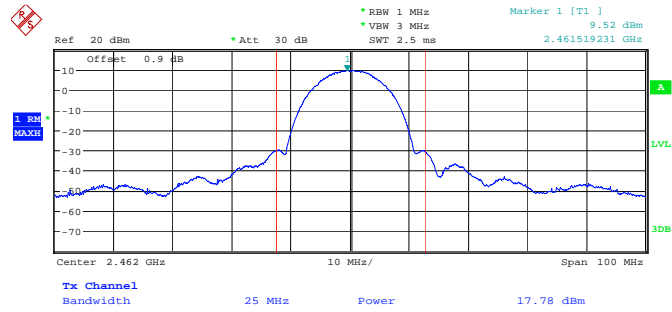

Date: 13.JAN.2009 13:49:05

### Conducted Output Power Plot on Configuration IEEE 802.11g Ant. A / 2412 MHz

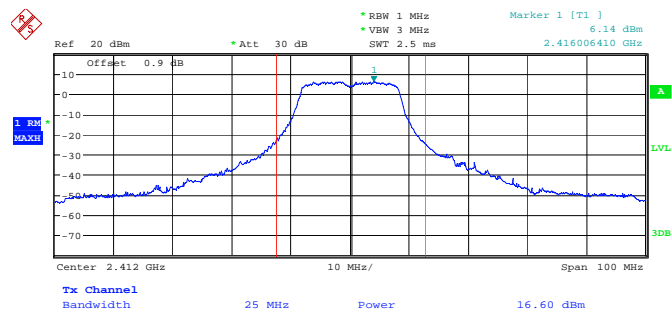

Date: 13.JAN.2009 13:45:58



### 4.3. Power Spectral Density Measurement

#### 4.3.1. Limit

For digitally modulated systems, the power spectral density conducted from the intentional radiator to the antenna shall not be greater than 8 dBm in any 3 kHz band during any time interval of continuous transmission.

#### 4.3.2. Measuring Instruments and Setting

Please refer to section 5 of equipments list in this report. The following table is the setting of Spectrum Analyzer.

Spectrum Parameter	Setting
Attenuation	Auto
Span Frequency	30MHz
RB	3 kHz
VB	30 kHz
Detector	Peak
Trace	Max Hold
Sweep Time	10s

#### 4.3.3. Test Procedures

1. The transmitter output (antenna port) was connected to the spectrum analyser.
2. Set RBW of spectrum analyzer to 3kHz and VBW to 30kHz. Set Detector to Peak, Trace to Max Hold.
3. Mark the frequency with maximum peak power as the center of the display of the spectrum.
4. Set the span to 1.5MHz and the sweep time to 500s and record the maximum peak value.

#### 4.3.4. Test Setup Layout

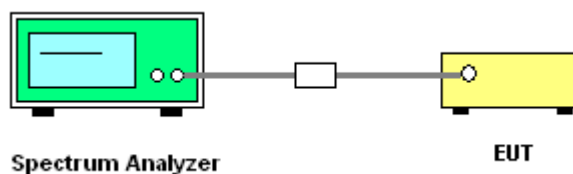

#### 4.3.5. Test Deviation

There is no deviation with the original standard.

#### 4.3.6. EUT Operation during Test

The EUT was programmed to be in continuously transmitting mode.

#### 4.3.7. Test Result of Power Spectral Density

<b>Temperature</b>	25°C	<b>Humidity</b>	60%
<b>Test Engineer</b>	Johnson Chang	<b>Configurations</b>	Draft n
<b>Test Date</b>	Jan. 13, 2009		

##### Configuration Draft n MCS0 20MHz Ant. A

Channel	Frequency	Power Density (dBm)	Max. Limit (dBm)	Result
1	2412 MHz	-11.86	8.00	Complies
6	2437 MHz	-11.87	8.00	Complies
11	2462 MHz	-11.88	8.00	Complies

##### Configuration Draft n MCS0 40MHz Ant. A

Channel	Frequency	Power Density (dBm)	Max. Limit (dBm)	Result
3	2422 MHz	-11.92	8.00	Complies
6	2437 MHz	-11.89	8.00	Complies
9	2452 MHz	-11.86	8.00	Complies

<b>Temperature</b>	25°C	<b>Humidity</b>	60%
<b>Test Engineer</b>	Johnson Chang	<b>Configurations</b>	802.11b/g
<b>Test Date</b>	Jan. 13, 2009		

**Configuration IEEE 802.11b Ant. A**

Channel	Frequency	Power Density (dBm)	Max. Limit (dBm)	Result
1	2412 MHz	-11.67	8.00	<b>Complies</b>
6	2437 MHz	-11.62	8.00	<b>Complies</b>
11	2462 MHz	-11.64	8.00	<b>Complies</b>

**Configuration IEEE 802.11g Ant. A**

Channel	Frequency	Power Density (dBm)	Max. Limit (dBm)	Result
1	2412 MHz	-11.89	8.00	<b>Complies</b>
6	2437 MHz	-11.85	8.00	<b>Complies</b>
11	2462 MHz	-11.76	8.00	<b>Complies</b>







**Power Density Plot on Configuration Drafft n MCS0 40MHz Ant. A / 2437 MHz**

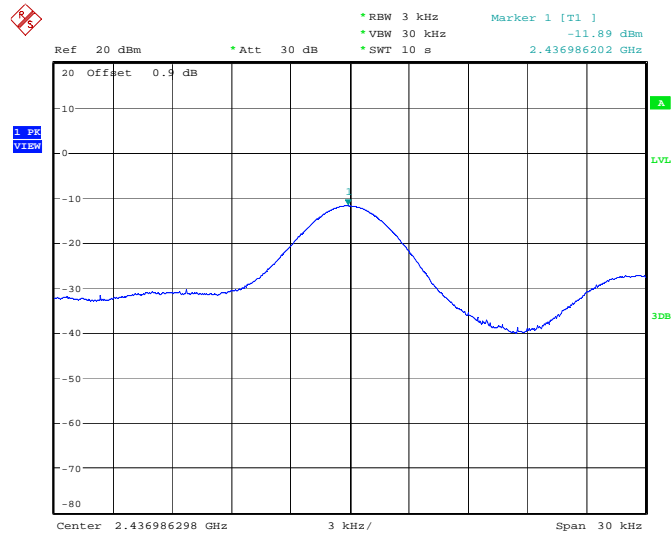

Date: 13.JAN.2009 13:32:27

**Power Density Plot on Configuration Drafft n MCS0 40MHz Ant. A / 2452 MHz**

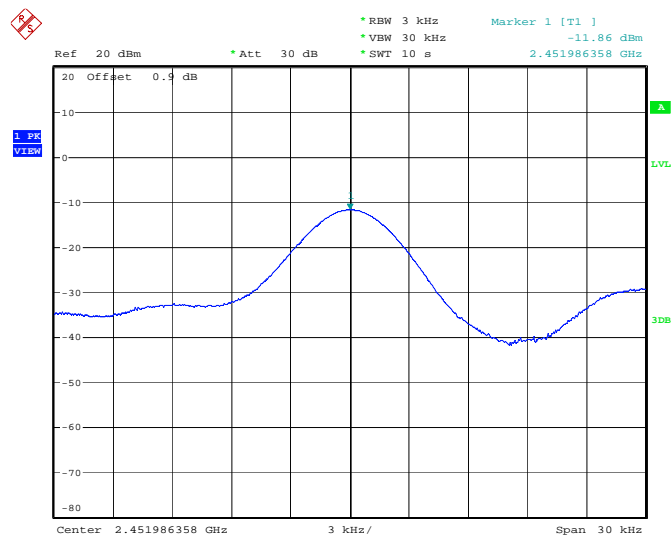

Date: 13.JAN.2009 13:30:14

### Power Density Plot on Configuration IEEE 802.11b Ant. A / 2412 MHz

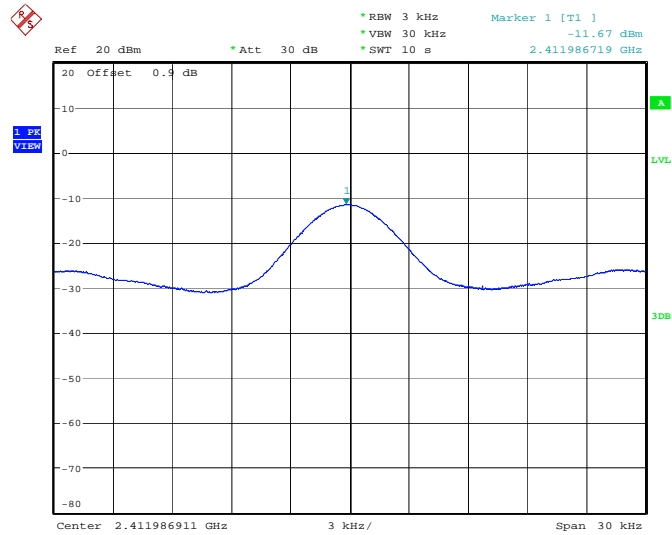

Date: 13.JAN.2009 13:08:03

### Power Density Plot on Configuration IEEE 802.11b Ant. A / 2437 MHz

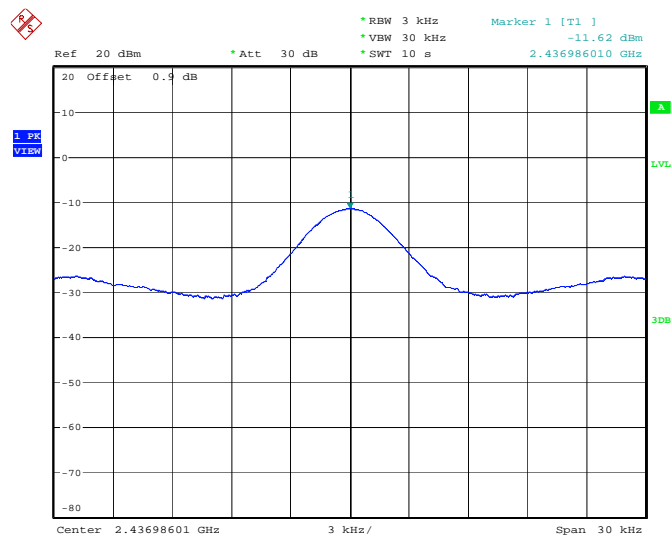

Date: 13.JAN.2009 14:51:18

### Power Density Plot on Configuration IEEE 802.11b Ant. A / 2462 MHz

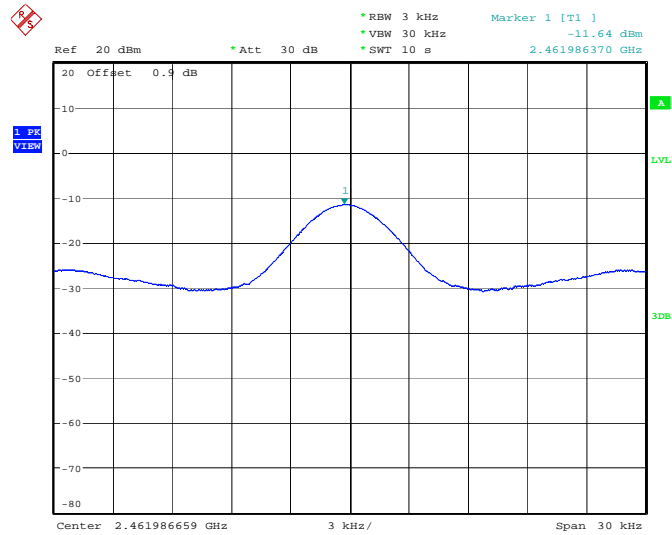

Date: 13.JAN.2009 14:02:37

### Power Density Plot on Configuration IEEE 802.11g Ant. A / 2412 MHz

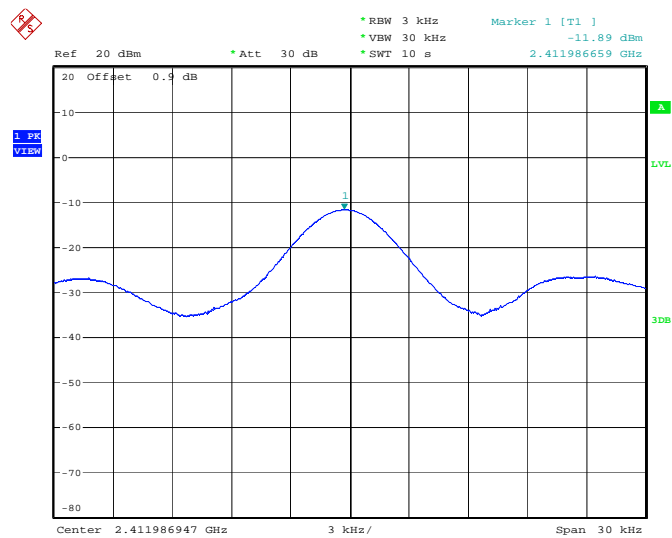

Date: 13.JAN.2009 14:14:27

### Power Density Plot on Configuration IEEE 802.11g Ant. A / 2437 MHz

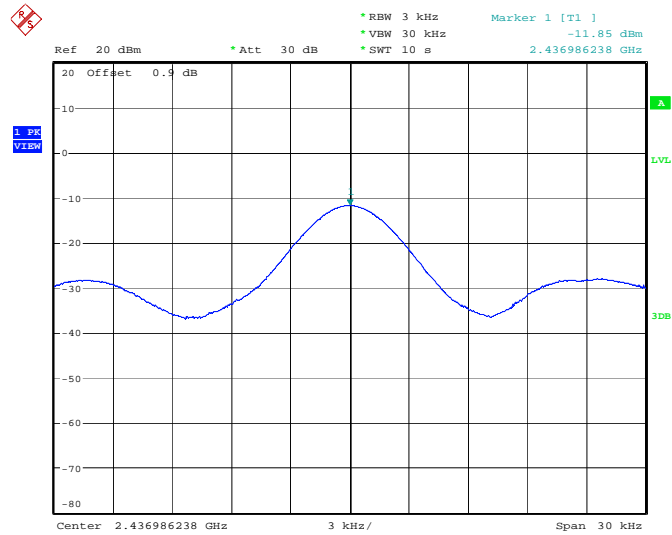

Date: 13.JAN.2009 14:41:29

### Power Density Plot on Configuration IEEE 802.11g Ant. A / 2462 MHz

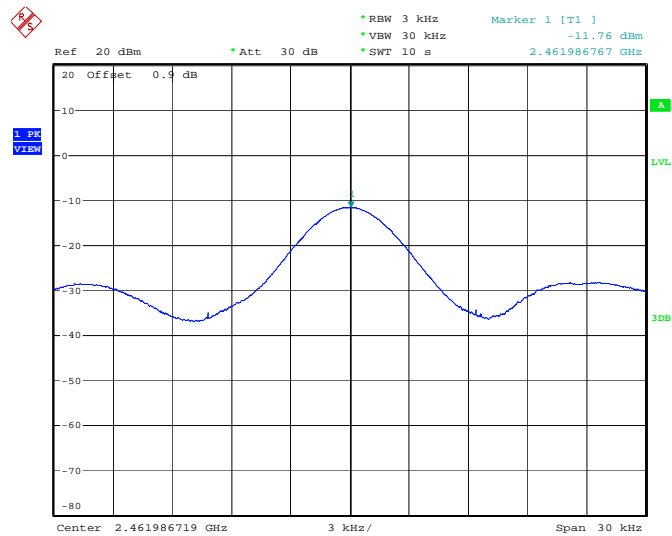

Date: 13.JAN.2009 13:15:56

#### 4.4. 6dB Spectrum Bandwidth Measurement

##### 4.4.1. Limit

For digital modulation systems, the minimum 6 dB bandwidth shall be at least 500 kHz.

##### 4.4.2. Measuring Instruments and Setting

Please refer to section 5 of equipments list in this report. The following table is the setting of the Spectrum Analyzer.

Spectrum Parameters	Setting
Attenuation	Auto
Span Frequency	> 6dB Bandwidth
RB	100 kHz
VB	100 kHz
Detector	Peak
Trace	Max Hold
Sweep Time	Auto

##### 4.4.3. Test Procedures

1. The transmitter output (antenna port) was connected to the spectrum analyser in peak hold mode.
2. The resolution bandwidth of 100 kHz and the video bandwidth of 100 kHz were used.
3. Measured the spectrum width with power higher than 6dB below carrier.

##### 4.4.4. Test Setup Layout

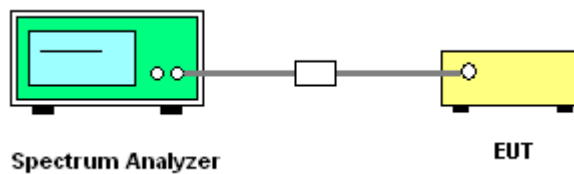

##### 4.4.5. Test Deviation

There is no deviation with the original standard.

##### 4.4.6. EUT Operation during Test

The EUT was programmed to be in continuously transmitting mode.

#### 4.4.7. Test Result of 6dB Spectrum Bandwidth

<b>Temperature</b>	25°C	<b>Humidity</b>	60%
<b>Test Engineer</b>	Johnson Chang	<b>Configurations</b>	Draft n
<b>Test Date</b>	Jan. 13, 2009		

##### Configuration Draft n MCS0 20MHz Ant. A

Channel	Frequency	6dB Bandwidth (MHz)	99% Occupied Bandwidth (MHz)	Min. Limit (kHz)	Test Result
1	2412 MHz	17.62	17.62	500	Complies
6	2437 MHz	17.62	17.62	500	Complies
11	2462 MHz	17.66	17.62	500	Complies

##### Configuration Draft n MCS0 40MHz Ant. A

Channel	Frequency	6dB Bandwidth (MHz)	99% Occupied Bandwidth (MHz)	Min. Limit (kHz)	Test Result
3	2422 MHz	35.57	37.70	500	Complies
6	2437 MHz	35.89	35.70	500	Complies
9	2452 MHz	35.96	35.64	500	Complies

<b>Temperature</b>	25°C	<b>Humidity</b>	60%
<b>Test Engineer</b>	Johnson Chang	<b>Configurations</b>	802.11b/g
<b>Test Date</b>	Jan. 13, 2009		

**Configuration IEEE 802.11b Ant. A**

Channel	Frequency	6dB Bandwidth (MHz)	99% Occupied Bandwidth (MHz)	Min. Limit (kHz)	Test Result
1	2412 MHz	10.60	14.80	500	Complies
6	2437 MHz	10.06	14.77	500	Complies
11	2462 MHz	10.09	14.77	500	Complies

**Configuration IEEE 802.11g Ant. A**

Channel	Frequency	6dB Bandwidth (MHz)	99% Occupied Bandwidth (MHz)	Min. Limit (kHz)	Test Result
1	2412 MHz	16.44	16.44	500	Complies
6	2437 MHz	16.47	16.44	500	Complies
11	2462 MHz	16.44	16.44	500	Complies



### 6 dB Bandwidth Plot on Configuration Draft n MCS0 20MHz Ant. A / 2412 MHz

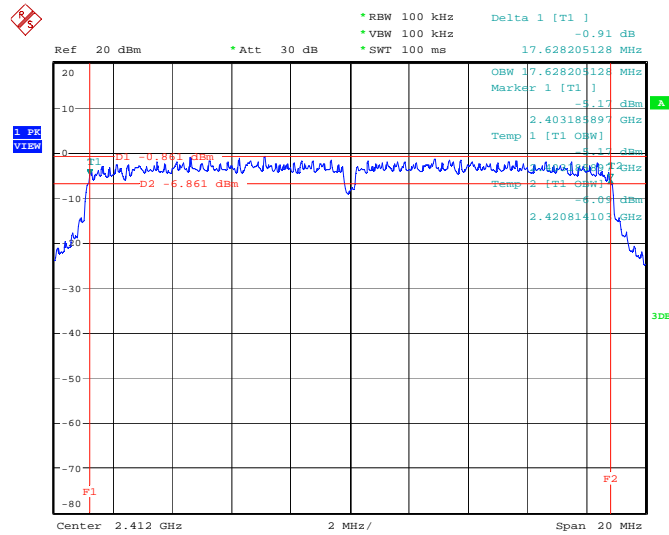

Date: 13.JAN.2009 14:56:07

### 6 dB Bandwidth Plot on Configuration Draft n MCS0 20MHz Ant. A / 2437 MHz

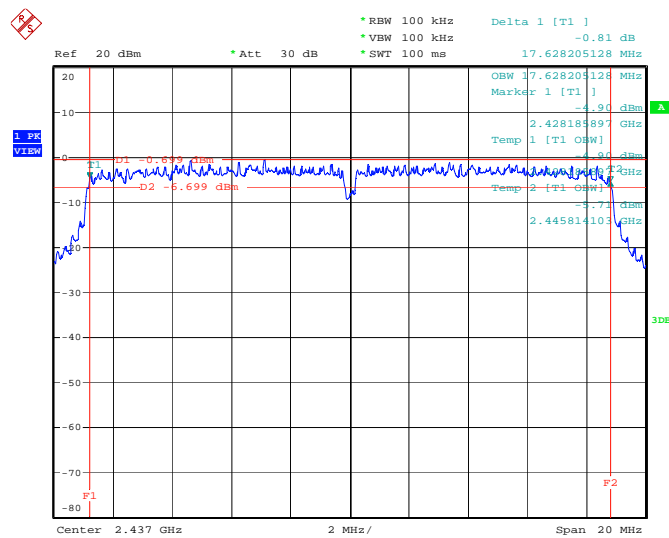

Date: 13.JAN.2009 15:01:24

6 dB Bandwidth Plot on Configuration Draft n MCS0 20MHz Ant. A / 2462 MHz

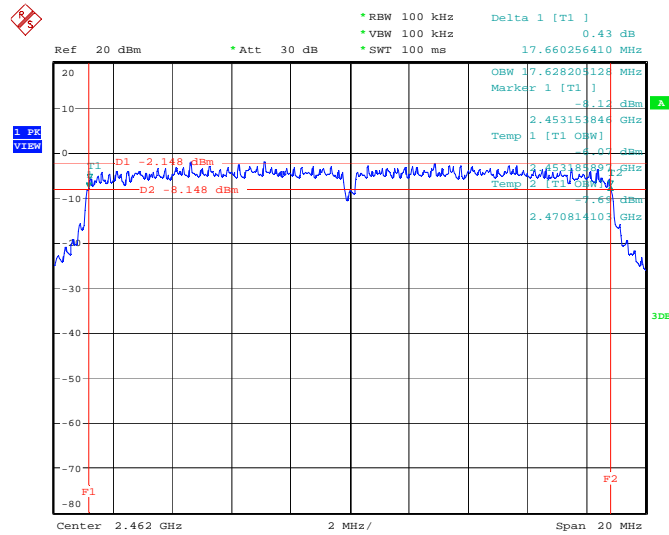

Date: 13.JAN.2009 13:26:29

6 dB Bandwidth Plot on Configuration Draft n MCS0 40MHz Ant. A / 2422 MHz

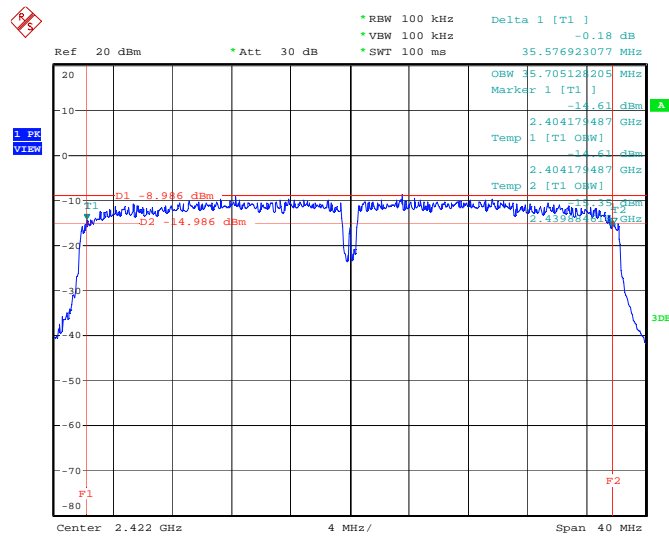

Date: 15.JAN.2009 13:47:01

6 dB Bandwidth Plot on Configuration Draft n MCS0 40MHz Ant. A / 2437 MHz

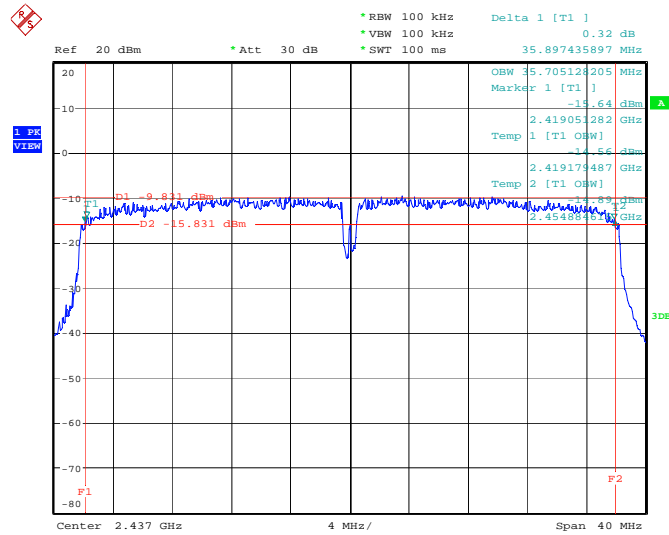

Date: 15.JAN.2009 13:50:18

6 dB Bandwidth Plot on Configuration Draft n MCS0 40MHz Ant. A / 2452 MHz

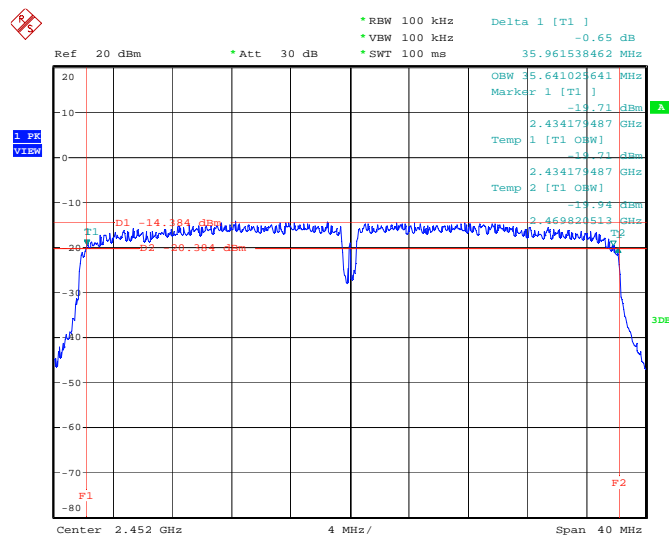

Date: 15.JAN.2009 13:53:10

### 6 dB Bandwidth Plot on Configuration IEEE 802.11b Ant. A / 2412 MHz

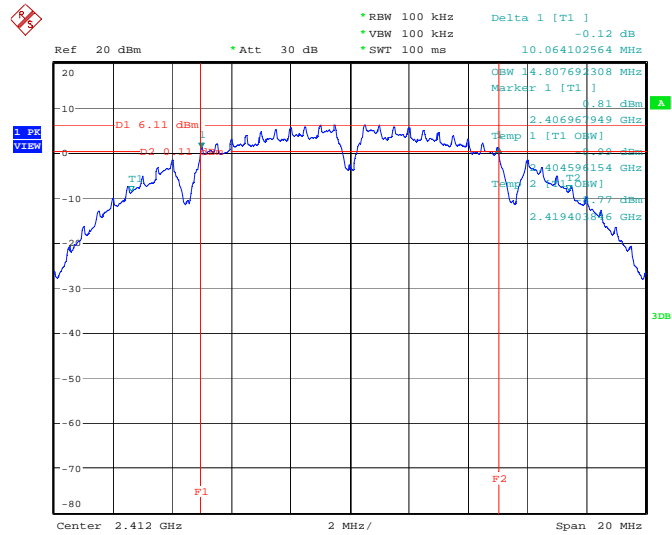

Date: 13.JAN.2009 13:06:35

### 6 dB Bandwidth Plot on Configuration IEEE 802.11b Ant. A / 2437 MHz

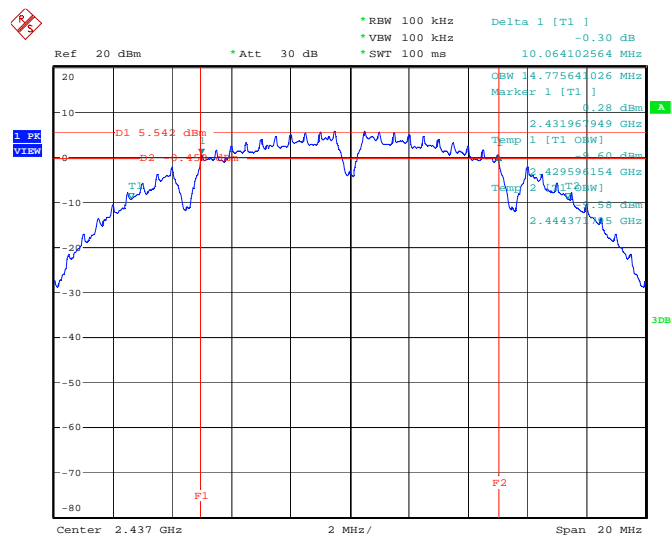

Date: 13.JAN.2009 14:49:49

### 6 dB Bandwidth Plot on Configuration IEEE 802.11b Ant. A / 2462 MHz

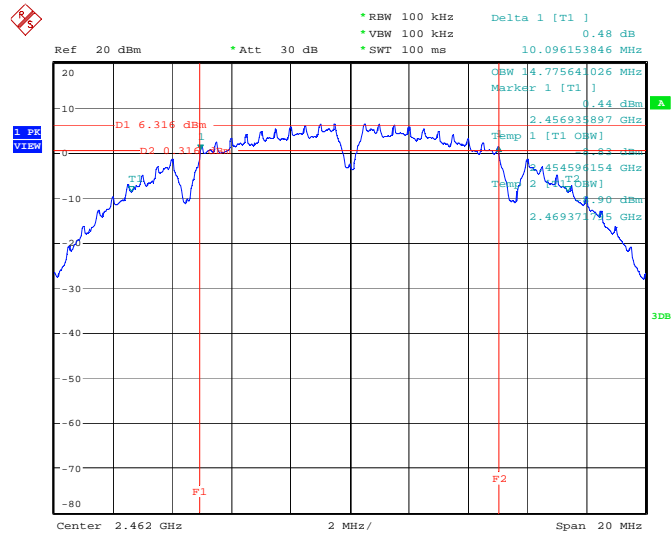

Date: 13.JAN.2009 14:01:10

### 6 dB Bandwidth Plot on Configuration IEEE 802.11g Ant. A / 2412 MHz

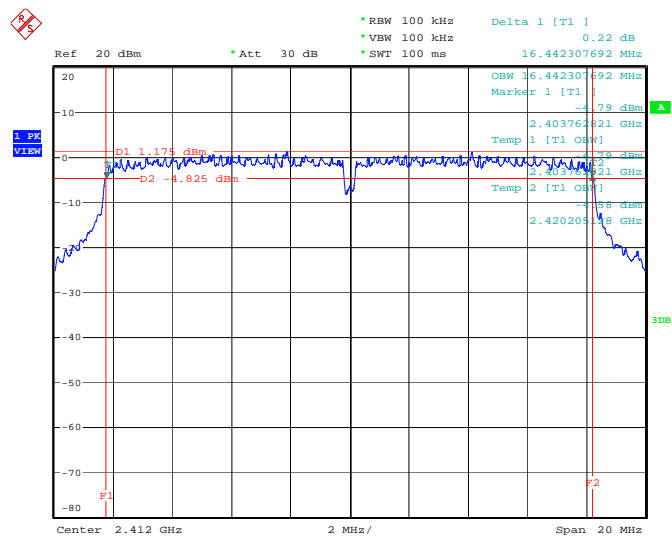

Date: 13.JAN.2009 14:13:00

### 6 dB Bandwidth Plot on Configuration IEEE 802.11g Ant. A / 2437 MHz

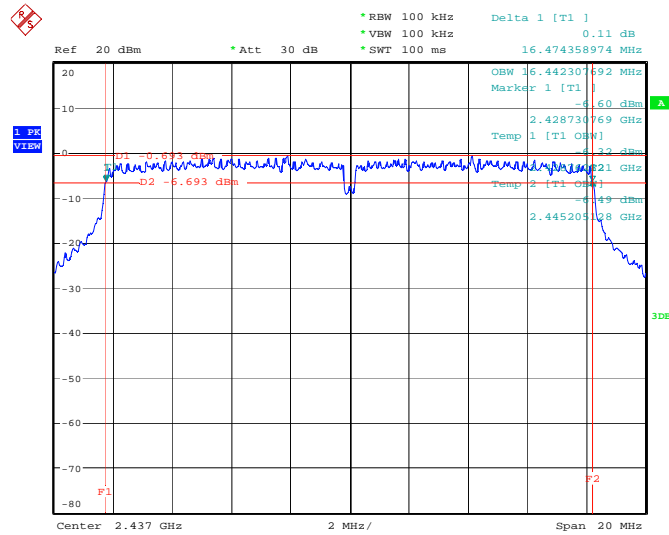

Date: 13.JAN.2009 14:40:00

### 6 dB Bandwidth Plot on Configuration IEEE 802.11g Ant. A / 2462 MHz

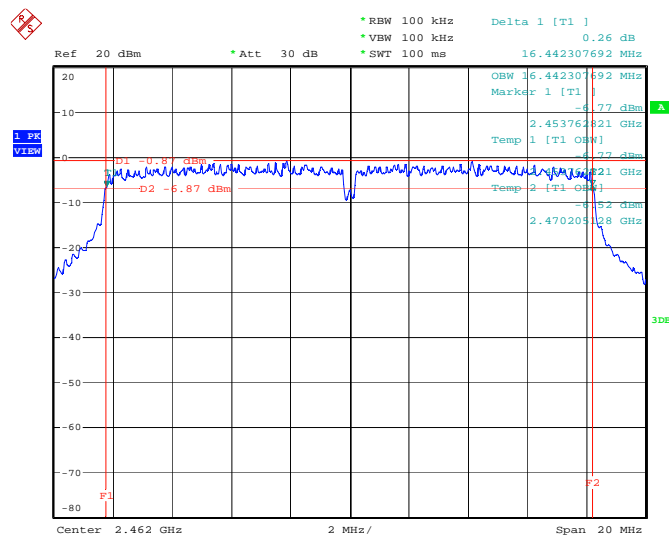

Date: 13.JAN.2009 13:14:29

## 4.5. Radiated Emissions Measurement

### 4.5.1. Limit

20dBc in any 100 kHz bandwidth outside the operating frequency band. In case the emission fall within the restricted band specified on 15.205(a), then the 15.209(a) limit in the table below has to be followed.

Frequencies (MHz)	Field Strength (micorvolts/meter)	Measurement Distance (meters)
0.009~0.490	2400/F(KHz)	300
0.490~1.705	24000/F(KHz)	30
1.705~30.0	30	30
30~88	100	3
88~216	150	3
216~960	200	3
Above 960	500	3

### 4.5.2. Measuring Instruments and Setting

Please refer to section 5 of equipments list in this report. The following table is the setting of spectrum analyzer and receiver.

Spectrum Parameter	Setting
Attenuation	Auto
Start Frequency	1000 MHz
Stop Frequency	10th carrier harmonic
RB / VB (Emission in restricted band)	1MHz / 1MHz for Peak, 1 MHz / 10Hz for Average
RB / VB (Emission in non-restricted band)	1000KHz / 1000KHz for peak

Receiver Parameter	Setting
Attenuation	Auto
Start ~ Stop Frequency	9kHz~150kHz / RB 200Hz for QP
Start ~ Stop Frequency	150kHz~30MHz / RB 9kHz for QP
Start ~ Stop Frequency	30MHz~1000MHz / RB 120kHz for QP

#### 4.5.3. Test Procedures

1. Configure the EUT according to ANSI C63.4. The EUT was placed on the top of the turntable 0.8 meter above ground. The phase center of the receiving antenna mounted on the top of a height-variable antenna tower was placed 3 meters far away from the turntable.
2. Power on the EUT and all the supporting units. The turntable was rotated by 360 degrees to determine the position of the highest radiation.
3. The height of the broadband receiving antenna was varied between one meter and four meters above ground to find the maximum emissions field strength of both horizontal and vertical polarization.
4. For each suspected emissions, the antenna tower was scan (from 1 m to 4 m) and then the turntable was rotated (from 0 degree to 360 degrees) to find the maximum reading.
5. Set the test-receiver system to Peak or CISPR quasi-peak Detect Function with specified bandwidth under Maximum Hold Mode.
6. For emissions above 1GHz, use 1MHz VBW and RBW for peak reading. Then 1MHz RBW and 10Hz VBW for average reading in spectrum analyzer.
7. When the radiated emissions limits are expressed in terms of the average value of the emissions, and pulsed operation is employed, the measurement field strength shall be determined by averaging over one complete pulse train, including blanking intervals, as long as the pulse train does not exceed 0.1 seconds. As an alternative (provided the transmitter operates for longer than 0.1 seconds) or in cases where the pulse train exceeds 0.1 seconds, the measured field strength shall be determined from the average absolute voltage during a 0.1 second interval during which the field strength is at its maximum value.
8. If the emissions level of the EUT in peak mode was 3 dB lower than the average limit specified, then testing will be stopped and peak values of EUT will be reported, otherwise, the emissions which do not have 3 dB margin will be repeated one by one using the quasi-peak method for below 1GHz.
9. For testing above 1GHz, the emissions level of the EUT in peak mode was lower than average limit (that means the emissions level in peak mode also complies with the limit in average mode), then testing will be stopped and peak values of EUT will be reported, otherwise, the emissions will be measured in average mode again and reported.
10. In case the emission is lower than 30MHz, loop antenna has to be used for measurement and the recorded data should be QP measured by receiver. High – Low scan is not required in this case.



#### 4.5.4. Test Setup Layout

For radiated emissions below 30MHz

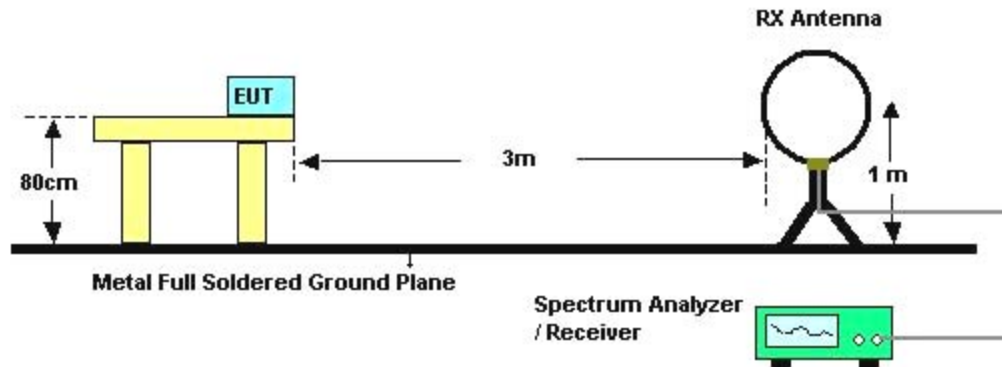

For radiated emissions above 30MHz

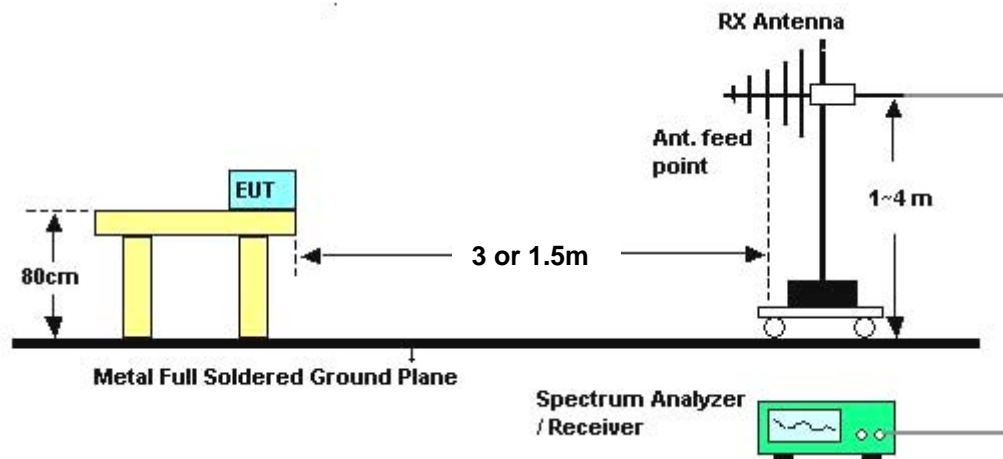

Above 10 GHz shall be extrapolated to the specified distance using an extrapolation factor of 20 dB/decade from 3m to 1.5m.

Distance extrapolation factor =  $20 \log (\text{specific distance [3m]} / \text{test distance [1.5m]})$  (dB);

Limit line = specific limits (dBuV) + distance extrapolation factor [6 dB].

#### 4.5.5. Test Deviation

There is no deviation with the original standard.

#### 4.5.6. EUT Operation during Test

The EUT was programmed to be in continuously transmitting mode.

#### 4.5.7. Results of Radiated Emissions (9kHz~30MHz)

<b>Temperature</b>	25°C	<b>Humidity</b>	56%
<b>Test Engineer</b>	Alan Huang	<b>Configurations</b>	Normal Link

<b>Freq. (MHz)</b>	<b>Level (dBuV)</b>	<b>Over Limit (dB)</b>	<b>Limit Line (dBuV)</b>	<b>Remark</b>
-	-	-	-	See Note

**Note:**

The amplitude of spurious emissions which are attenuated by more than 20 dB below the permissible value has no need to be reported.

Distance extrapolation factor =  $40 \log(\text{specific distance} / \text{test distance})$  (dB);

Limit line = specific limits (dBuV) + distance extrapolation factor.