

SAR TEST REPORT

Equipment Under Test	Notebook
Model Name of Host	ThinkPad X100e, ThinkPad Mini 11, ThinkPad Mini10
Model of WLAN Modular	RTL8191SE
FCC ID	TX2-RTL8191SE-L
IC	6317A-RTL8191SE
Company Name	Realtek Semiconductor Corp.
Company Address	No. 2, Innovation Road II, Hsinchu Science Park, Hsinchu 300, Taiwan
Date of Receipt	2009.10.29
Date of Test(s)	2009.11.19,2009.12.04
Date of Issue	2009.12.04

Standards:

**FCC OET Bulletin 65 supplement C,
ANSI/IEEE C95.1 , C95.3, IEEE 1528,
RSS102**

In the configuration tested, the EUT complied with the standards specified above.

Remarks:

This report details the results of the testing carried out on one sample, the results contained in this test report do not relate to other samples of the same product. The manufacturer should ensure that all products in series production are in conformity with the product sample detailed in this report.

This report may only be reproduced and distributed in full. If the product in this report is used in any configuration other than that detailed in the report, the manufacturer must ensure the new system complies with all relevant standards. Any mention of SGS Taiwan Electronic & Communication Laboratory or testing done by SGS Taiwan Electronic & Communication Laboratory in connection with distribution or use of the product described in this report must be approved by SGS Taiwan Electronic & Communication Laboratory in writing.

Tested by : Antony Wu Date : 2009.12.04
Engineer

Approved by : Robert Chang Date : 2009.12.04
Tech Manager

Unless otherwise stated the results shown in this test report refer only to the sample(s) tested and such sample(s) are retained for 90 days only. This test report cannot be reproduced, except in full, without prior written permission of the Company. 除非另有說明，此報告結果僅對測試之樣品負責，同時此樣品僅保留90天。本報告未經本公司書面許可，不可部份複製。

This document is issued by the Company subject to its General Conditions of Service (www.sgs.com/terms_and_conditions.htm) and Terms and Conditions for Electronic Documents (www.sgs.com/terms_e-document.htm). Attention is drawn to the limitations of liability, indemnification and jurisdictional issues established therein. Even if printed this electronic document is to be treated as an original within the meaning of UCP 600 article 20b. The authenticity of this document may be verified at www.sgsonsite.com/authentication. Any holder of this document is advised that information contained hereon reflects the Company's findings at the time of its intervention only and within the limits of client's instructions, if any. The Company's sole responsibility is to its Client and this document does not exonerate parties to a transaction from exercising all their rights and obligations under the transaction documents.

Contents

1. General Information	3
1.1 Testing Laboratory	3
1.2 Details of Applicant	3
1.3 Description of EUT	3
1.4 Test Environment	4
1.5 Operation description	4
1.6 The SAR Measurement System	5
1.7 System Components	7
1.8 SAR System Verification	8
1.9 Tissue Simulant Fluid for the Frequency Band	10
1.10 EVALUATION PROCEDURES	11
1.11 Test Standards and Limits	12
2. Summary of Results	14
3. Instruments List	15
4. Measurements	16
5. SAR System Performance Verification	19
6. DAE & Probe Calibration certificate	21
7. Uncertainty Analysis	31
8. Phantom Description	32
9. System Validation from Original equipment supplier	33

Unless otherwise stated the results shown in this test report refer only to the sample(s) tested and such sample(s) are retained for 90 days only. This test report cannot be reproduced, except in full, without prior written permission of the Company. 除非另有說明，此報告結果僅對測試之樣品負責，同時此樣品僅保留90天。本報告未經本公司書面許可，不可部份複製。

This document is issued by the Company subject to its General Conditions of Service (www.sgs.com/terms_and_conditions.htm) and Terms and Conditions for Electronic Documents (www.sgs.com/terms_e-document.htm). Attention is drawn to the limitations of liability, indemnification and jurisdictional issues established therein. Even if printed this electronic document is to be treated as an original within the meaning of UCP 600 article 20b. The authenticity of this document may be verified at www.sgsonsite.com/authentication. Any holder of this document is advised that information contained hereon reflects the Company's findings at the time of its intervention only and within the limits of client's instructions, if any. The Company's sole responsibility is to its Client and this document does not exonerate parties to a transaction from exercising all their rights and obligations under the transaction documents.

1. General Information

1.1 Testing Laboratory

SGS Taiwan Ltd. Electronics & Communication Laboratory	
134, Wu Kung Road, Wuku industrial zone	
Taipei county, Taiwan, R.O.C.	
Telephone	+886-2-2299-3279
Fax	+886-2-2298-0488
Internet	http://www.tw.sgs.com

1.2 Details of Applicant

Name	Realtek Semiconductor Corp.
Address	No. 2, Innovation Road II, Hsinchu Science Park, Hsinchu 300, Taiwan
Telephone	+886-3-5780211
Fax	+886-3-5776598
Contact Person	Kay Chang
E-mail	kaychang@realtek.com.tw

1.3 Description of EUT

EUT Name	Notebook
Model Name of Host	ThinkPad X100e, ThinkPad Mini 11, ThinkPad Mini10
Model No. of WLAN Modular	RTL8191SE
Brand Name	lenovo
FCC ID	TX2-RTL8191SE-L
IC ID	6317A-RTL8191SE

Unless otherwise stated the results shown in this test report refer only to the sample(s) tested and such sample(s) are retained for 90 days only. This test report cannot be reproduced, except in full, without prior written permission of the Company. 除非另有說明，此報告結果僅對測試之樣品負責，同時此樣品僅保留90天。本報告未經本公司書面許可，不可部份複製。

This document is issued by the Company subject to its General Conditions of Service (www.sgs.com/terms_and_conditions.htm) and Terms and Conditions for Electronic Documents (www.sgs.com/terms_e-document.htm). Attention is drawn to the limitations of liability, indemnification and jurisdictional issues established therein. Even if printed this electronic document is to be treated as an original within the meaning of UCP 600 article 20b. The authenticity of this document may be verified at www.sgs.com/authentication. Any holder of this document is advised that information contained hereon reflects the Company's findings at the time of its intervention only and within the limits of client's instructions, if any. The Company's sole responsibility is to its Client and this document does not exonerate parties to a transaction from exercising all their rights and obligations under the transaction documents.

Definition	Production unit			
Mode of Operation	WLAN 802.11 b/g/n band			
Duty Cycle	WLAN 802.11 b/g/n			
	1			
Maximum RF Conducted Power(Average)	WLAN 802.11 b	WLAN 802.11 g	WLAN 802.11n (20M)	WLAN 802.11n (40M)
	17.60 dbm	15.50 dbm	13.79 dbm	13.60 dbm
TX Frequency range (MHz)	WLAN 802.11b/g/n(20M)		WLAN 802.11n(40M)	
	2412-2462		2422-2452	
Channel Number (ARFCN)	WLAN 802.11b/g/n(20M)		WLAN 802.11n(40M)	
	1-11		3-9	
Power Supply	11.1Vdc re-chargeable battery or 20Vdc by AC/DC power adapter			
Antenna-to-user separation distance	19.3cm			
Max. SAR Measured (1g)	WLAN802.11b			
	0.00721 W/kg (WLAN802.11b _ CH6_ Configuration 1)			

1.4 Test Environment

Ambient Temperature: 22±2° C

Tissue Simulating Liquid: 22±2° C

1.5 Operation description

Use chipset specific software to control the EUT, and makes it transmit in maximum power. Measurements are performed respectively on the lowest, middle and highest channels of the operating band(s).

The EUT is set to maximum power level during all tests, and at the beginning of each test the battery is fully charged.

Unless otherwise stated the results shown in this test report refer only to the sample(s) tested and such sample(s) are retained for 90 days only. This test report cannot be reproduced, except in full, without prior written permission of the Company. 除非另有說明，此報告結果僅對測試之樣品負責，同時此樣品僅保留90天。本報告未經本公司書面許可，不可部份複製。

This document is issued by the Company subject to its General Conditions of Service (www.sgs.com/terms_and_conditions.htm) and Terms and Conditions for Electronic Documents (www.sgs.com/terms_e-document.htm). Attention is drawn to the limitations of liability, indemnification and jurisdictional issues established therein. Even if printed this electronic document is to be treated as an original within the meaning of UCP 600 article 20b. The authenticity of this document may be verified at www.sgs.com/authentication. Any holder of this document is advised that information contained hereon reflects the Company's findings at the time of its intervention only and within the limits of client's instructions, if any. The Company's sole responsibility is to its Client and this document does not exonerate parties to a transaction from exercising all their rights and obligations under the transaction documents.

The test configuration tested at the low, middle and high frequency channels. We will test it with following configuration:

Configuration : Bottom side of the Netbook is paralleled with flat phantom, open the panel with 90 degrees, bottom side is contact with flat phantom.
(Appendix-Fig.3 & Fig.4)

1.6 The SAR Measurement System

A photograph of the SAR measurement System is given in Fig. a. This SAR Measurement System uses a Computer-controlled 3-D stepper motor system (SPEAG DASY 5 professional system). A Model ES3DV3 field probe is used to determine the internal electric fields. The SAR can be obtained from the equation $SAR = \sigma (|E_i|^2) / \rho$ where σ and ρ are the conductivity and mass density of the tissue-simulant.

The DASY5 system for performing compliance tests consists of the following items:

- A standard high precision 6-axis robot (Staubli RX family) with controller, teach pendant and software. An arm extension is for accommodating the data acquisition electronics (DAE).
- A dosimetric probe, i.e., an isotropic E-field probe optimized and calibrated for usage in tissue simulating liquid. The probe is equipped with an optical surface detector system.
- A data acquisition electronics (DAE) which performs the signal amplification, signal multiplexing, AD-conversion, offset measurements, mechanical surface detection, collision detection, etc.

The unit is battery powered with standard or rechargeable batteries. The signal is optically transmitted to the EOC.

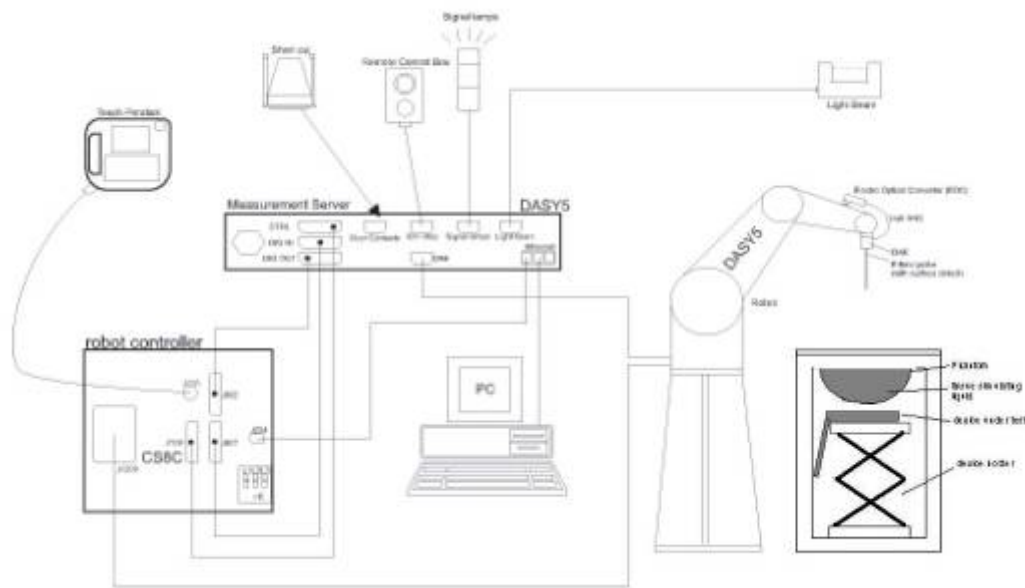

Fig.a The block diagram of SAR system

- The Electro-optical converter (EOC) performs the conversion between optical and electrical of the signals for the digital communication to the DAE and for the analog signal from the optical surface detection. The EOC is connected to the measurement server.
- The function of the measurement server is to perform the time critical tasks such as signal filtering, control of the robot operation and fast movement interrupts.
- A probe alignment unit which improves the (absolute) accuracy of the probe positioning.
 - A computer operating Windows 2000 or Windows XP.
 - DASY5 software.
- Remote control with teach pendant and additional circuitry for robot safety such as warning lamps, etc.
 - The SAM twin phantom enabling testing left-hand and right-hand usage.
 - The device holder for handheld mobile phones.
 - Tissue simulating liquid mixed according to the given recipes.
 - Validation dipole kits allowing to validate the proper functioning of the system.

Unless otherwise stated the results shown in this test report refer only to the sample(s) tested and such sample(s) are retained for 90 days only. This test report cannot be reproduced, except in full, without prior written permission of the Company. 除非另有說明，此報告結果僅對測試之樣品負責，同時此樣品僅保留90天。本報告未經本公司書面許可，不可部份複製。

This document is issued by the Company subject to its General Conditions of Service (www.sgs.com/terms_and_conditions.htm) and Terms and Conditions for Electronic Documents (www.sgs.com/terms_e-document.htm). Attention is drawn to the limitations of liability, indemnification and jurisdictional issues established therein. Even if printed this electronic document is to be treated as an original within the meaning of UCP 600 article 20b. The authenticity of this document may be verified at www.sgsonsite.com/authentication. Any holder of this document is advised that information contained hereon reflects the Company's findings at the time of its intervention only and within the limits of client's instructions, if any. The Company's sole responsibility is to its Client and this document does not exonerate parties to a transaction from exercising all their rights and obligations under the transaction documents.

1.7 System Components

ES3DV3 E-Field Probe

Construction	Symmetrical design with triangular core Built-in shielding against static charges PEEK enclosure material (resistant to organic solvents, e.g., DGBE)	
Calibration	Basic Broad Band Calibration in air Conversion Factors (CF) for HSL2450 MHZ Additional CF for other liquids and frequencies upon request	
Frequency	10 MHz to > 3 GHz, Linearity: ± 0.6 dB (30 MHz to 6 GHz)	
Directivity	± 0.3 dB in HSL (rotation around probe axis) ± 0.5 dB in tissue material (rotation normal to probe axis)	
Dynamic Range	10 μ W/g to > 100 mW/g Linearity: ± 0.6 dB (noise: typically < 1 μ W/g)	
Dimensions	Overall length: 330 mm (Tip: 10 mm) Tip diameter: 4 mm (Body: 10 mm) Typical distance from probe tip to dipole centers: 1 mm	
Application	High precision dosimetric measurements in any exposure scenario (e.g., very strong gradient fields). Only probe which enables compliance testing for frequencies up to 6 GHz with precision of better 30%.	

SAM PHANTOM V4.0C

Unless otherwise stated the results shown in this test report refer only to the sample(s) tested and such sample(s) are retained for 90 days only. This test report cannot be reproduced, except in full, without prior written permission of the Company. 除非另有說明，此報告結果僅對測試之樣品負責，同時此樣品僅保留90天。本報告未經本公司書面許可，不可部份複製。

This document is issued by the Company subject to its General Conditions of Service (www.sgs.com/terms_and_conditions.htm) and Terms and Conditions for Electronic Documents (www.sgs.com/terms_e-document.htm). Attention is drawn to the limitations of liability, indemnification and jurisdictional issues established therein. Even if printed this electronic document is to be treated as an original within the meaning of UCP 600 article 20b. The authenticity of this document may be verified at www.sgsonsite.com/authentication. Any holder of this document is advised that information contained hereon reflects the Company's findings at the time of its intervention only and within the limits of client's instructions, if any. The Company's sole responsibility is to its Client and this document does not exonerate parties to a transaction from exercising all their rights and obligations under the transaction documents.

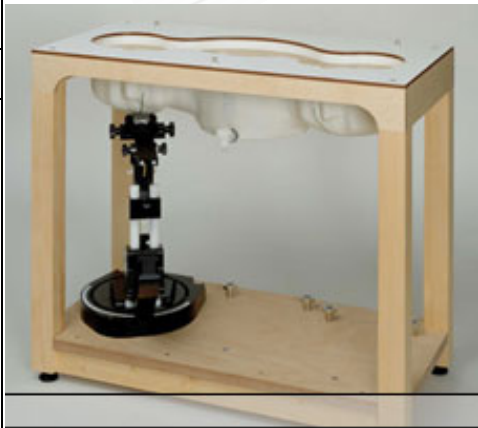
Construction	The shell corresponds to the specifications of the Specific Anthropomorphic Mannequin (SAM) phantom defined in IEEE 1528-200X, CENELEC 50361 and IEC 62209. It enables the dosimetric evaluation of left and right hand phone usage as well as body mounted usage at the flat phantom region. A cover prevents evaporation of the liquid. Reference markings on the phantom allow the complete setup of all predefined phantom positions and measurement grids by manually teaching three points with the robot.	
Shell Thickness	2 ± 0.2 mm	
Filling Volume	Approx. 25 liters	
Dimensions	Height: 850 mm; Length: 1000 mm; Width: 500 mm	

DEVICE HOLDER

Construction	The device holder (Supporter) for Notebook is made by POM (polyoxymethylene resin) , which is non-metal and non-conductive. The height can be adjusted to fit varies kind of notebooks.	 <p style="text-align: center;">Device Holder</p>
--------------	---	---

1.8 SAR System Verification

The microwave circuit arrangement for system verification is sketched in Fig. b. The daily system accuracy verification occurs within the flat section of the SAM phantom. A SAR

Unless otherwise stated the results shown in this test report refer only to the sample(s) tested and such sample(s) are retained for 90 days only. This test report cannot be reproduced, except in full, without prior written permission of the Company. 除非另有說明，此報告結果僅對測試之樣品負責，同時此樣品僅保留90天。本報告未經本公司書面許可，不可部份複製。

This document is issued by the Company subject to its General Conditions of Service (www.sgs.com/terms_and_conditions.htm) and Terms and Conditions for Electronic Documents (www.sgs.com/terms_e-document.htm). Attention is drawn to the limitations of liability, indemnification and jurisdictional issues established therein. Even if printed this electronic document is to be treated as an original within the meaning of UCP 600 article 20b. The authenticity of this document may be verified at www.sgs.com/authentication. Any holder of this document is advised that information contained hereon reflects the Company's findings at the time of its intervention only and within the limits of client's instructions, if any. The Company's sole responsibility is to its Client and this document does not exonerate parties to a transaction from exercising all their rights and obligations under the transaction documents.

measurement was performed to see if the measured SAR was within +/- 5% from the target SAR values. These tests were done at 2450 MHz. The tests were conducted on the same days as the measurement of the DUT. The obtained results from the system accuracy verification are displayed in the table 1 (SAR values are normalized to 1W forward power delivered to the dipole). During the tests, the ambient temperature of the laboratory was in the range 22.1°C, the relative humidity was in the range 62% and the liquid depth above the ear reference points was above 15 cm in all the cases. It is seen that the system is operating within its specification, as the results are within acceptable tolerance of the reference values.

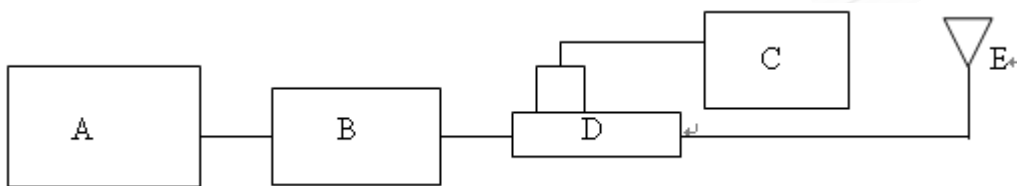
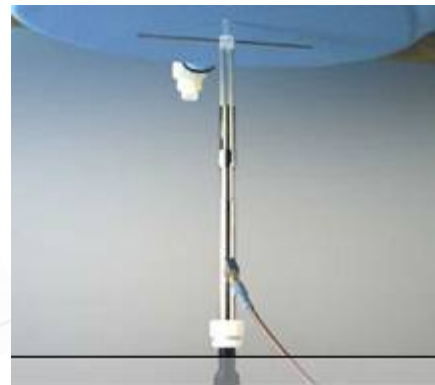

Fig.b The block diagram of system verification

- A. Agilent Model 8648D Signal Generator
- B. Mini circuits Model ZHL-42 Amplifier
- C. Agilent Model U2001B Power Sensor
- D. Agilent Model 777D Dual directional coupling
- E. Reference dipole antenna



Photograph of the dipole Antenna

Validation Kit	Frequency Hz	Target SAR (1g) (Pin=250mW)	Measured SAR (1g)	Measured Date
D2450V2 S/N: 727	2450 MHz (Body)	13.2m W/g	13.6mW/g	2009-11-19
D2450V2 S/N: 727	2450 MHz (Body)	13.2m W/g	13.4mW/g	2009-12-04

Table 1. Results of system validation

Unless otherwise stated the results shown in this test report refer only to the sample(s) tested and such sample(s) are retained for 90 days only. This test report cannot be reproduced, except in full, without prior written permission of the Company. 除非另有說明，此報告結果僅對測試之樣品負責，同時此樣品僅保留90天。本報告未經本公司書面許可，不可部份複製。

This document is issued by the Company subject to its General Conditions of Service (www.sgs.com/terms_and_conditions.htm) and Terms and Conditions for Electronic Documents (www.sgs.com/terms_e-document.htm). Attention is drawn to the limitations of liability, indemnification and jurisdictional issues established therein. Even if printed this electronic document is to be treated as an original within the meaning of UCP 600 article 20b. The authenticity of this document may be verified at www.sgs.com/authentication. Any holder of this document is advised that information contained hereon reflects the Company's findings at the time of its intervention only and within the limits of client's instructions, if any. The Company's sole responsibility is to its Client and this document does not exonerate parties to a transaction from exercising all their rights and obligations under the transaction documents.

1.9 Tissue Simulant Fluid for the Frequency Band

The dielectric properties for this body-simulant fluid were measured by using the Agilent Model 85070D Dielectric Probe (rates frequency band 200 MHz to 20 GHz) in conjunction with HP 8753D Network Analyzer (30 KHz-6000 MHz) by using a procedure detailed in Section V.

All dielectric parameters of tissue simulates were measured within 24 hours of SAR measurements. The depth of the tissue simulant in the ear reference point of the phantom was 15cm±5mm during all tests. (Fig .2)

Frequency (MHz)	Tissue type	Measurement date/ Limits	Dielectric Parameters		
			ρ	σ (S/m)	Simulated Tissue Temperature(° C)
2450	Body	Measured, 2009.11.19	54.2	1.99	21.7
		Recommended Limits	51.68-57.12	1.88-2.09	20-24
2450	Body	Measured, 2009.12.04	54.4	1.98	21.7
		Recommended Limits	51.68-57.12	1.88-2.09	20-24

Table 2. Dielectric Parameters of Tissue Simulant Fluid

The composition of the body tissue simulating liquid is:

Ingredient	2450MHz (Body)
DGMBE	301.7ml
Water	698.3ml
Salt	X
Preventol D-7	X
Cellulose	X
Sugar	X
Total amount	1 L (1.0kg)

Table 3. Recipes for tissue simulating liquid

1.10 EVALUATION PROCEDURES

The entire evaluation of the spatial peak values is performed within the Post-processing engine (SEMCAD). The system always gives the maximum values for the 1 g and 10 g cubes. The algorithm to find the cube with highest averaged SAR is divided into the following stages:

1. The extraction of the measured data (grid and values) from the Zoom Scan.
2. The calculation of the SAR value at every measurement point based on all stored data (A/D values and measurement parameters)
3. The generation of a high-resolution mesh within the measured volume
4. The interpolation of all measured values from the measurement grid to the high-resolution grid
5. The extrapolation of the entire 3-D field distribution to the phantom surface over the distance from sensor to surface
6. The calculation of the averaged SAR within masses of 1g and 10g.

The probe is calibrated at the center of the dipole sensors that is located 1 to 2.7mm away from the probe tip. During measurements, the probe stops shortly above the phantom surface, depending on the probe and the surface detecting system. Both distances are included as parameters in the probe configuration file. The software always knows exactly how far away the measured point is from the surface. As the probe cannot directly measure at the surface, the values between the deepest measured point and the surface must be extrapolated. The angle between the probe axis and the surface normal line is less than 30 degree.

In the Area Scan, the gradient of the interpolation function is evaluated to find all the extreme of the SAR distribution. The uncertainty on the locations of the extreme is less than 1/20 of the grid size. Only local maximum within -2 dB of the global maximum are searched and passed for the Cube Scan measurement. In the Cube Scan, the interpolation function is used to extrapolate the Peak SAR from the lowest measurement points to the inner phantom surface (the extrapolation distance). The uncertainty increases with the extrapolation distance. To keep the uncertainty within 1% for the 1 g and 10 g cubes, the extrapolation distance should not be larger than 5mm.

The maximum search is automatically performed after each area scan measurement. It is based on splines in two or three dimensions. The procedure can find the maximum for most SAR distributions even with relatively large grid spacing. After the area scanning measurement, the probe is automatically moved to a position at the interpolated maximum. The following scan can directly use this position for reference, e.g., for a finer resolution grid or the cube evaluations. The 1g and 10g peak evaluations are only available for the predefined cube 7x7x7 scans. The routines are verified and optimized for the grid dimensions used in these cube measurements. The measured volume of 30x30x30mm contains about 30g of tissue.

The first procedure is an extrapolation (incl. Boundary correction) to get the points between the lowest measured plane and the surface. The next step uses 3D interpolation to get all points within the measured volume. In the last step, a 1g cube is

Unless otherwise stated the results shown in this test report refer only to the sample(s) tested and such sample(s) are retained for 90 days only. This test report cannot be reproduced, except in full, without prior written permission of the Company. 除非另有說明，此報告結果僅對測試之樣品負責，同時此樣品僅保留90天。本報告未經本公司書面許可，不可部份複製。

This document is issued by the Company subject to its General Conditions of Service (www.sgs.com/terms_and_conditions.htm) and Terms and Conditions for Electronic Documents (www.sgs.com/terms_e-document.htm). Attention is drawn to the limitations of liability, indemnification and jurisdictional issues established therein. Even if printed this electronic document is to be treated as an original within the meaning of UCP 600 article 20b. The authenticity of this document may be verified at www.sgs.com/authentication. Any holder of this document is advised that information contained hereon reflects the Company's findings at the time of its intervention only and within the limits of client's instructions, if any. The Company's sole responsibility is to its Client and this document does not exonerate parties to a transaction from exercising all their rights and obligations under the transaction documents.

placed numerically into the volume and its averaged SAR is calculated. This cube is the moved around until the highest averaged SAR is found. If the highest SAR is found at the edge of the measured volume, the system will issue a warning: higher SAR values might be found outside of the measured volume. In that case the cube measurement can be repeated, using the new interpolated maximum as the center.

1.11 Test Standards and Limits

According to FCC 47CFR §2.1093(d) The limits to be used for evaluation are based generally on criteria published by the American National Standards Institute (ANSI) for localized specific absorption rate ("SAR") in Section 4.2 of "IEEE Standard for Safety Levels with Respect to Human Exposure to Radio Frequency Electromagnetic Fields, 3 kHz to 300 GHz," ANSI/IEEE C95.1-1992, Copyright 1992 by the Institute of Electrical and Electronics Engineers, Inc., New York, New York 10017. These criteria for SAR evaluation are similar to those recommended by the National Council on Radiation Protection and Measurements (NCRP) in "Biological Effects and Exposure Criteria for Radio frequency Electromagnetic Fields," NCRP Report No. 86, Section 17.4.5. Copyright NCRP, 1986, Bethesda, Maryland 20814.

SAR is a measure of the rate of energy absorption due to exposure to an RF transmitting source. SAR values have been related to threshold levels for potential biological hazards. The criteria to be used are specified in paragraphs (d)(1) and (d)(2) of this section and shall apply for portable devices transmitting in the frequency range from 100 kHz to 6 GHz. Portable devices that transmit at frequencies above 6 GHz are to be evaluated in terms of the MPE limits specified in § 1.1310 of this chapter. Measurements and calculations to demonstrate compliance with MPE field strength or power density limits for devices operating above 6 GHz should be made at a minimum distance of 5 cm from the radiating source.

(1) Limits for Occupational/Controlled exposure: 0.4 W/kg as averaged over the whole-body and spatial peak SAR not exceeding 8 W/kg as averaged over any 1 gram of tissue (defined as a tissue volume in the shape of a cube). Exceptions are the hands, wrists, feet and ankles where the spatial peak SAR shall not exceed 20 W/kg, as averaged over an 10 grams of tissue (defined as a tissue volume in the shape of a cube).

(2) Occupational/Controlled limits apply when persons are exposed as a consequence

Unless otherwise stated the results shown in this test report refer only to the sample(s) tested and such sample(s) are retained for 90 days only. This test report cannot be reproduced, except in full, without prior written permission of the Company. 除非另有說明，此報告結果僅對測試之樣品負責，同時此樣品僅保留90天。本報告未經本公司書面許可，不可部份複製。

This document is issued by the Company subject to its General Conditions of Service (www.sgs.com/terms_and_conditions.htm) and Terms and Conditions for Electronic Documents (www.sgs.com/terms_e-document.htm). Attention is drawn to the limitations of liability, indemnification and jurisdictional issues established therein. Even if printed this electronic document is to be treated as an original within the meaning of UCP 600 article 20b. The authenticity of this document may be verified at www.sgsonsite.com/authentication. Any holder of this document is advised that information contained hereon reflects the Company's findings at the time of its intervention only and within the limits of client's instructions, if any. The Company's sole responsibility is to its Client and this document does not exonerate parties to a transaction from exercising all their rights and obligations under the transaction documents.

of their employment provided these persons are fully aware of and exercise control over their exposure. Awareness of exposure can be accomplished by use of warning labels or by specific training or education through appropriate means, such as an RF safety program in a work environment.

- (3) Limits for General Population/Uncontrolled exposure: 0.08 W/kg as averaged over the whole-body and spatial peak SAR not exceeding 1.6 W/kg as averaged over any 1 gram of tissue (defined as a tissue volume in the shape of a cube). Exceptions are the hands, wrists, feet and ankles where the spatial peak SAR shall not exceed 4 W/kg, as averaged over any 10 grams of tissue (defined as a tissue volume in the shape of a cube). General Population/Uncontrolled limits apply when the general public may be exposed, or when persons that are exposed as a consequence of their employment may not be fully aware of the potential for exposure or do not exercise control over their exposure. Warning labels placed on consumer devices such as cellular telephones will not be sufficient reason to allow these devices to be evaluated subject to limits for occupational/controlled exposure in paragraph (d)(1) of this section.(Table .4)

Human Exposure	Uncontrolled Environment General Population	Controlled Environment Occupational
Spatial Peak SAR (Brain)	1.60 m W/g	8.00 m W/g
Spatial Average SAR (Whole Body)	0.08 m W/g	0.40 m W/g
Spatial Peak SAR (Hands/Feet/Ankle/Wrist)	4.00 m W/g	20.00 m W/g

Table .4 RF exposure limits

Notes:

1. Uncontrolled environments are defined as locations where there is potential exposure of individuals who have no knowledge or control of their potential exposure.
2. Controlled environments are defined as locations where there is potential exposure of individuals who have knowledge of their potential exposure and can exercise control over their exposure.

Unless otherwise stated the results shown in this test report refer only to the sample(s) tested and such sample(s) are retained for 90 days only. This test report cannot be reproduced, except in full, without prior written permission of the Company. 除非另有說明，此報告結果僅對測試之樣品負責，同時此樣品僅保留90天。本報告未經本公司書面許可，不可部份複製。

This document is issued by the Company subject to its General Conditions of Service (www.sgs.com/terms_and_conditions.htm) and Terms and Conditions for Electronic Documents (www.sgs.com/terms_e-document.htm). Attention is drawn to the limitations of liability, indemnification and jurisdictional issues established therein. Even if printed this electronic document is to be treated as an original within the meaning of UCP 600 article 20b. The authenticity of this document may be verified at www.sgsonsite.com/authentication. Any holder of this document is advised that information contained hereon reflects the Company's findings at the time of its intervention only and within the limits of client's instructions, if any. The Company's sole responsibility is to its Client and this document does not exonerate parties to a transaction from exercising all their rights and obligations under the transaction documents.

2. Summary of Results

WLAN802.11 b

Configuration 1: Bottom side of the Netbook is paralleled with flat phantom, open the panel with 90 degrees, bottom side is contact with flat phantom.

Frequency	Channel	MHz	Conducted Output Power (Average)	Measured(W/kg) 1g	Amb. Temp[°C]	Liquid Temp[°C]
2450MHz	6	2437	17.60 dbm	0.00721	22.1	21.7

Note:

Bluetooth antenna is located more than 20 cm to WLAN antenna thus co-located RF exposure assessment is not required.

Unless otherwise stated the results shown in this test report refer only to the sample(s) tested and such sample(s) are retained for 90 days only. This test report cannot be reproduced, except in full, without prior written permission of the Company. 除非另有說明，此報告結果僅對測試之樣品負責，同時此樣品僅保留90天。本報告未經本公司書面許可，不可部份複製。

This document is issued by the Company subject to its General Conditions of Service (www.sgs.com/terms_and_conditions.htm) and Terms and Conditions for Electronic Documents (www.sgs.com/terms_e-document.htm). Attention is drawn to the limitations of liability, indemnification and jurisdictional issues established therein. Even if printed this electronic document is to be treated as an original within the meaning of UCP 600 article 20b. The authenticity of this document may be verified at www.sgsonsite.com/authentication. Any holder of this document is advised that information contained hereon reflects the Company's findings at the time of its intervention only and within the limits of client's instructions, if any. The Company's sole responsibility is to its Client and this document does not exonerate parties to a transaction from exercising all their rights and obligations under the transaction documents.

3. Instruments List

Manufacturer	Device	Type	Serial number	Date of last calibration
Schmid & Partner Engineering AG	Dosimetric E-Field Probe	ES3DV3	3172	May.27.2009
Schmid & Partner Engineering AG	2450 MHz System Validation Dipole	D2450V2	727	Apr.27.2009
Schmid & Partner Engineering AG	Data acquisition Electronics	DAE4	856	May.26.2009
Schmid & Partner Engineering AG	Software	DASY 5 V5.0 Build125	N/A	Calibration not required
Schmid & Partner Engineering AG	Phantom	SAM	N/A	Calibration not required
Agilent	Network Analyzer	8753D	3410A05547	Mar.31.2009
Agilent	Dielectric Probe Kit	85070D	US01440168	Calibration not required
Agilent	Dual-directional coupler	777D	50114	Aug.27.2009
Agilent	RF Signal Generator	8648D	3847M00432	May.25.2009
Agilent	Power Sensor	U2001B	MY48100169	Apr.23.2009

Unless otherwise stated the results shown in this test report refer only to the sample(s) tested and such sample(s) are retained for 90 days only. This test report cannot be reproduced, except in full, without prior written permission of the Company. 除非另有說明，此報告結果僅對測試之樣品負責，同時此樣品僅保留90天。本報告未經本公司書面許可，不可部份複製。

This document is issued by the Company subject to its General Conditions of Service (www.sgs.com/terms_and_conditions.htm) and Terms and Conditions for Electronic Documents (www.sgs.com/terms_e-document.htm). Attention is drawn to the limitations of liability, indemnification and jurisdictional issues established therein. Even if printed this electronic document is to be treated as an original within the meaning of UCP 600 article 20b. The authenticity of this document may be verified at www.sgsonsite.com/authentication. Any holder of this document is advised that information contained hereon reflects the Company's findings at the time of its intervention only and within the limits of client's instructions, if any. The Company's sole responsibility is to its Client and this document does not exonerate parties to a transaction from exercising all their rights and obligations under the transaction documents.

4. Measurements

Date/Time: 11/19/2009 02:11:33

Configuration 1_ WLAN802.11b_CH6

DUT: ThinkPad X100e, ThinkPad Mini 11, ThinkPad Mini10;

Communication System: Wireless LAN; Frequency: 2437 MHz; Duty Cycle: 1:1

Medium: Body 2450 Medium parameters used: $f = 2437 \text{ MHz}$; $\sigma = 1.96 \text{ mho/m}$; $\epsilon_r = 54.3$; $\rho = 1000 \text{ kg/m}^3$

Phantom section: Flat Section

- Probe: ES3DV3 - SN3172; ConvF(4.02, 4.02, 4.02); Calibrated: 5/27/2009
- Sensor-Surface: 4mm (Mechanical Surface Detection)
- Electronics: DAE4 Sn856; Calibrated: 5/26/2009
- Phantom: SAM2; Type: SAM;
- Measurement SW: DASY5, V5.0 Build 125; SEMCAD X Version 13.4 Build 125

Body/Area Scan (71x71x1): Measurement grid: $dx=15\text{mm}$, $dy=15\text{mm}$

Maximum value of SAR (interpolated) = 0.00819 mW/g

Body/Zoom Scan (7x7x7) (5x5x7)/Cube 0: Measurement grid: $dx=8\text{mm}$, $dy=8\text{mm}$, $dz=5\text{mm}$

Reference Value = 1.98 V/m; Power Drift = 0.176 dB

Peak SAR (extrapolated) = 0.014 W/kg

SAR(1 g) = 0.00721 mW/g; SAR(10 g) = 0.00399 mW/g

Maximum value of SAR (measured) = 0.00841 mW/g

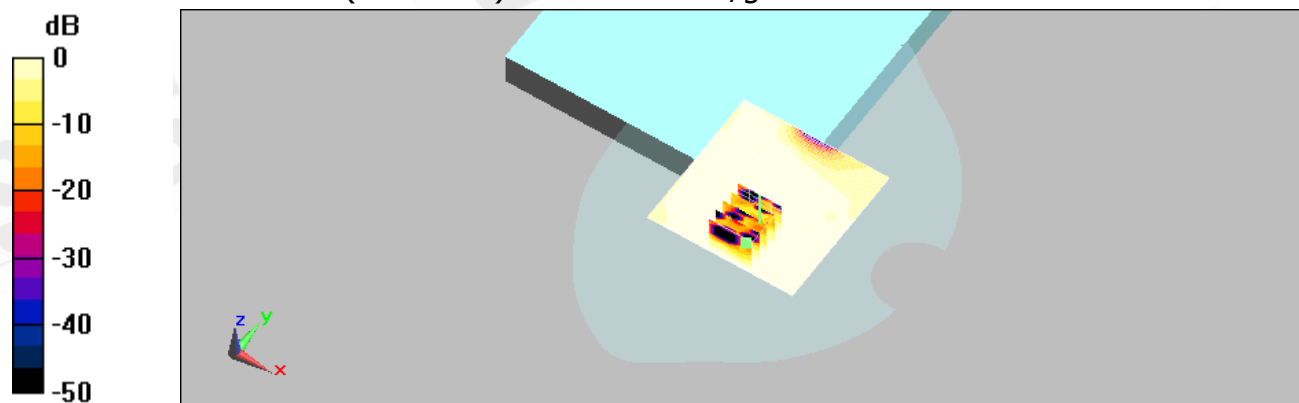

0 dB = 0.00841mW/g

Unless otherwise stated the results shown in this test report refer only to the sample(s) tested and such sample(s) are retained for 90 days only. This test report cannot be reproduced, except in full, without prior written permission of the Company. 除非另有說明，此報告結果僅對測試之樣品負責，同時此樣品僅保留90天。本報告未經本公司書面許可，不可部份複製。

This document is issued by the Company subject to its General Conditions of Service (www.sgs.com/terms_and_conditions.htm) and Terms and Conditions for Electronic Documents (www.sgs.com/terms_e-document.htm). Attention is drawn to the limitations of liability, indemnification and jurisdictional issues established therein. Even if printed this electronic document is to be treated as an original within the meaning of UCP 600 article 20b. The authenticity of this document may be verified at www.sgsonsite.com/authentication. Any holder of this document is advised that information contained hereon reflects the Company's findings at the time of its intervention only and within the limits of client's instructions, if any. The Company's sole responsibility is to its Client and this document does not exonerate parties to a transaction from exercising all their rights and obligations under the transaction documents.

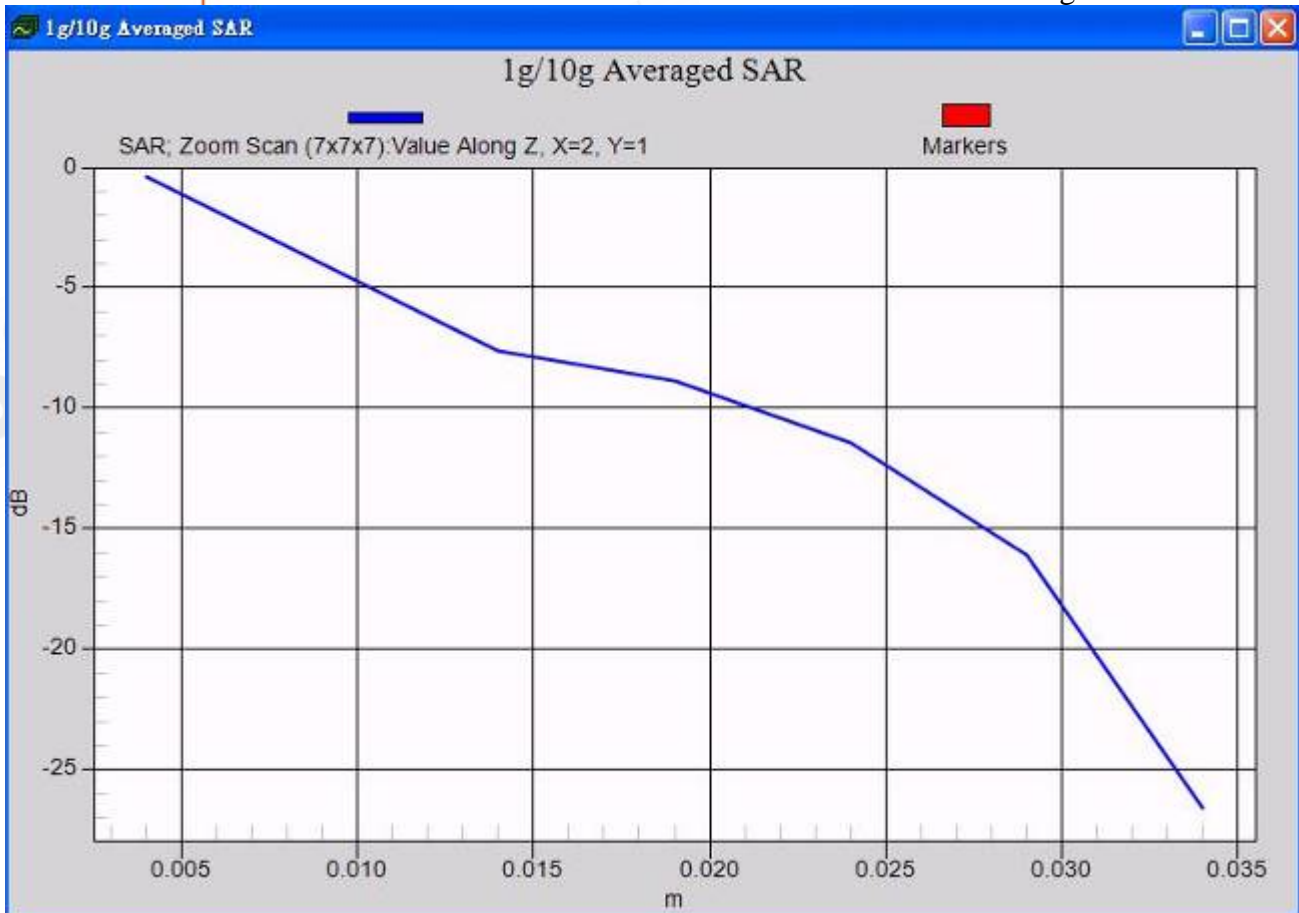

Unless otherwise stated the results shown in this test report refer only to the sample(s) tested and such sample(s) are retained for 90 days only. This test report cannot be reproduced, except in full, without prior written permission of the Company. 除非另有說明，此報告結果僅對測試之樣品負責，同時此樣品僅保留90天。本報告未經本公司書面許可，不可部份複製。

This document is issued by the Company subject to its General Conditions of Service (www.sgs.com/terms_and_conditions.htm) and Terms and Conditions for Electronic Documents (www.sgs.com/terms_e-document.htm). Attention is drawn to the limitations of liability, indemnification and jurisdictional issues established therein. Even if printed this electronic document is to be treated as an original within the meaning of UCP 600 article 20b. The authenticity of this document may be verified at www.sgsonsite.com/authentication. Any holder of this document is advised that information contained hereon reflects the Company's findings at the time of its intervention only and within the limits of client's instructions, if any. The Company's sole responsibility is to its Client and this document does not exonerate parties to a transaction from exercising all their rights and obligations under the transaction documents.

5. SAR System Performance Verification

Date/Time: 11/19/2009 00:31:22

DUT: Dipole 2450 MHz;

Communication System: CW; Frequency: 2450 MHz; Duty Cycle: 1:1
Medium: HSL2450 Medium parameters used: $f = 2450$ MHz; $\sigma = 1.99$ mho/m; $\epsilon_r = 54.2$; $\rho = 1000$ kg/m³
Phantom section: Flat Section

DASY5 Configuration:

- Probe: ES3DV3 - SN3172; ConvF(4.02, 4.02, 4.02); Calibrated: 5/27/2009
- Sensor-Surface: 3.4mm (Mechanical Surface Detection)
- Electronics: DAE4 Sn856; Calibrated: 5/26/2009
- Phantom: SAM1; Type: SAM; Serial:
- Measurement SW: DASY5, V5.0 Build 125; SEMCAD X Version 13.4 Build 125

d=10mm, Pin=250mW, dist=3.4mm: Measurement grid: dx=15mm, dy=15mm
Maximum value of SAR (interpolated) = 16 mW/g

d=10mm, Pin=250mW, dist=3.4mm: Measurement grid: dx=8mm, dy=8mm, dz=5mm
Reference Value = 96.4 V/m; Power Drift = 0.018 dB
Peak SAR (extrapolated) = 28.5 W/kg

SAR(1 g) = 13.6 mW/g; SAR(10 g) = 6.35 mW/g
Maximum value of SAR (measured) = 18 mW/g

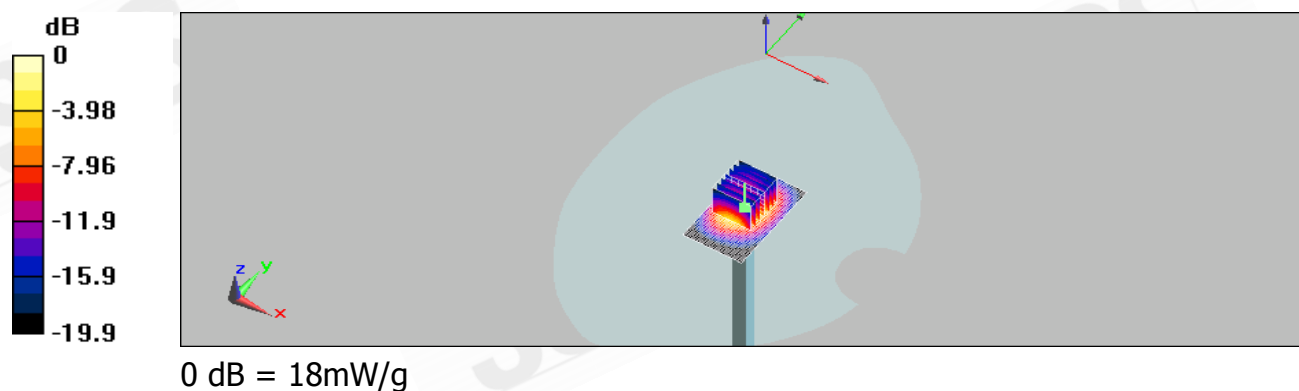

Unless otherwise stated the results shown in this test report refer only to the sample(s) tested and such sample(s) are retained for 90 days only. This test report cannot be reproduced, except in full, without prior written permission of the Company. 除非另有說明，此報告結果僅對測試之樣品負責，同時此樣品僅保留90天。本報告未經本公司書面許可，不可部份複製。

This document is issued by the Company subject to its General Conditions of Service (www.sgs.com/terms_and_conditions.htm) and Terms and Conditions for Electronic Documents (www.sgs.com/terms_e-document.htm). Attention is drawn to the limitations of liability, indemnification and jurisdictional issues established therein. Even if printed this electronic document is to be treated as an original within the meaning of UCP 600 article 20b. The authenticity of this document may be verified at www.sgsonsite.com/authentication. Any holder of this document is advised that information contained hereon reflects the Company's findings at the time of its intervention only and within the limits of client's instructions, if any. The Company's sole responsibility is to its Client and this document does not exonerate parties to a transaction from exercising all their rights and obligations under the transaction documents.

6. DAE & Probe Calibration certificate

**Calibration Laboratory of
Schmid & Partner
Engineering AG**
Zeughausstrasse 43, 8004 Zurich, Switzerland



S Schweizerischer Kalibrierdienst
C Service suisse d'étalonnage
S Servizio svizzero di taratura
S Swiss Calibration Service

Accredited by the Swiss Accreditation Service (SAS)
The Swiss Accreditation Service is one of the signatories to the EA
Multilateral Agreement for the recognition of calibration certificates

Accreditation No.: **SCS 108**

Client **SGS (Auden)**

Certificate No: **DAE4-856_May09**

CALIBRATION CERTIFICATE

Object: **DAE4 - SD 000 D04 BJ - SN: 856**

Calibration procedure(s): **QA CAL-06.v12
Calibration procedure for the data acquisition electronics (DAE)**

Calibration date: **May 26, 2009**

Condition of the calibrated item: **In Tolerance**

This calibration certificate documents the traceability to national standards, which realize the physical units of measurements (SI).
The measurements and the uncertainties with confidence probability are given on the following pages and are part of the certificate.

All calibrations have been conducted in the closed laboratory facility: environment temperature (22 ± 3)°C and humidity < 70%.

Calibration Equipment used (M&TE critical for calibration)

Primary Standards	ID #	Cal Date (Certificate No.)	Scheduled Calibration
Fluke Process Calibrator Type 702	SN: 6295803	30-Sep-08 (No: 7673)	Sep-09
Keithley Multimeter Type 2001	SN: 0810278	30-Sep-08 (No: 7670)	Sep-09
Secondary Standards	ID #	Check Date (in house)	Scheduled Check
Calibrator Box V1.1	SE UMS 006 AB 1004	06-Jun-08 (in house check)	In house check: Jun-09

Calibrated by:	Name	Function	Signature
	Dominique Steffen	Technician	
Approved by:	Name	Function	Signature
	Fin Bornholt	R&D Director	

Issued: May 26, 2009

This calibration certificate shall not be reproduced except in full without written approval of the laboratory.

Certificate No: DAE4-856_May09

Page 1 of 5

Unless otherwise stated the results shown in this test report refer only to the sample(s) tested and such sample(s) are retained for 90 days only. This test report cannot be reproduced, except in full, without prior written permission of the Company. 除非另有說明，此報告結果僅對測試之樣品負責，同時此樣品僅保留90天。本報告未經本公司書面許可，不可部份複製。

This document is issued by the Company subject to its General Conditions of Service (www.sgs.com/terms_and_conditions.htm) and Terms and Conditions for Electronic Documents (www.sgs.com/terms_e-document.htm). Attention is drawn to the limitations of liability, indemnification and jurisdictional issues established therein. Even if printed this electronic document is to be treated as an original within the meaning of UCP 600 article 20b. The authenticity of this document may be verified at www.sgs.com/authentication. Any holder of this document is advised that information contained hereon reflects the Company's findings at the time of its intervention only and within the limits of client's instructions, if any. The Company's sole responsibility is to its Client and this document does not exonerate parties to a transaction from exercising all their rights and obligations under the transaction documents.

**Calibration Laboratory of
Schmid & Partner
Engineering AG**
Zeughausstrasse 43, 8004 Zurich, Switzerland



S Schweizerischer Kalibrierdienst
C Service suisse d'étalonnage
S Servizio svizzero di taratura
S Swiss Calibration Service

Accredited by the Swiss Accreditation Service (SAS)
The Swiss Accreditation Service is one of the signatories to the EA
Multilateral Agreement for the recognition of calibration certificates

Accreditation No.: **SCS 108**

Client **SGS (Auden)**

Certificate No: **ES3-3172_May09**

CALIBRATION CERTIFICATE

Object **ES3DV3 - SN:3172**

Calibration procedure(s) **QA CAL-01.v6 and QA CAL-23.v3
Calibration procedure for dosimetric E-field probes**

Calibration date: **May 27, 2009**

Condition of the calibrated item **In Tolerance**

This calibration certificate documents the traceability to national standards, which realize the physical units of measurements (SI).
The measurements and the uncertainties with confidence probability are given on the following pages and are part of the certificate.

All calibrations have been conducted in the closed laboratory facility: environment temperature (22 ± 3)°C and humidity < 70%.

Calibration Equipment used (M&TE critical for calibration)

Primary Standards	ID #	Cal Date (Certificate No.)	Scheduled Calibration
Power meter E4419B	GB41293874	1-Apr-09 (No. 217-01030)	Apr-10
Power sensor E4412A	MY41495277	1-Apr-09 (No. 217-01030)	Apr-10
Power sensor E4412A	MY41498087	1-Apr-09 (No. 217-01030)	Apr-10
Reference 3 dB Attenuator	SN: S5054 (3c)	31-Mar-09 (No. 217-01026)	Mar-10
Reference 20 dB Attenuator	SN: S5086 (20b)	31-Mar-09 (No. 217-01028)	Mar-10
Reference 30 dB Attenuator	SN: S5129 (30b)	31-Mar-09 (No. 217-01027)	Mar-10
Reference Probe ES3DV2	SN: 3013	2-Jan-09 (No. ES3-3013_Jan09)	Jan-10
DAE4	SN: 660	9-Sep-08 (No. DAE4-660_Sep08)	Sep-09

Secondary Standards	ID #	Check Date (in house)	Scheduled Check
RF generator HP 8648C	US3642U01700	4-Aug-99 (in house check Oct-07)	In house check: Oct-09
Network Analyzer HP 8753E	US37390585	18-Oct-01 (in house check Oct-08)	In house check: Oct-09

Calibrated by:	Name Jeton Kastrati	Function Laboratory Technician	Signature
Approved by:	Name Katja Pokovic	Function Technical Manager	Signature

Issued: May 27, 2009

This calibration certificate shall not be reproduced except in full without written approval of the laboratory.

Certificate No: ES3-3172_May09

Page 1 of 9

Unless otherwise stated the results shown in this test report refer only to the sample(s) tested and such sample(s) are retained for 90 days only. This test report cannot be reproduced, except in full, without prior written permission of the Company. 除非另有說明，此報告結果僅對測試之樣品負責，同時此樣品僅保留90天。本報告未經本公司書面許可，不可部份複製。

This document is issued by the Company subject to its General Conditions of Service (www.sgs.com/terms_and_conditions.htm) and Terms and Conditions for Electronic Documents (www.sgs.com/terms_e-document.htm). Attention is drawn to the limitations of liability, indemnification and jurisdictional issues established therein. Even if printed this electronic document is to be treated as an original within the meaning of UCP 600 article 20b. The authenticity of this document may be verified at www.sgs.com/authentication. Any holder of this document is advised that information contained hereon reflects the Company's findings at the time of its intervention only and within the limits of client's instructions, if any. The Company's sole responsibility is to its Client and this document does not exonerate parties to a transaction from exercising all their rights and obligations under the transaction documents.

Calibration Laboratory of
Schmid & Partner
Engineering AG
Zeughausstrasse 43, 8004 Zurich, Switzerland



S Schweizerischer Kalibrierdienst
C Service suisse d'étalonnage
S Servizio svizzero di taratura
S Swiss Calibration Service

Accredited by the Swiss Accreditation Service (SAS)
The Swiss Accreditation Service is one of the signatories to the EA
Multilateral Agreement for the recognition of calibration certificates

Accreditation No.: **SCS 108**

Glossary:

TSL tissue simulating liquid
NORM_{x,y,z} sensitivity in free space
ConvF sensitivity in TSL / NORM_{x,y,z}
DCP diode compression point
Polarization φ φ rotation around probe axis
Polarization ϑ ϑ rotation around an axis that is in the plane normal to probe axis (at measurement center), i.e., $\vartheta = 0$ is normal to probe axis

Calibration is Performed According to the Following Standards:

- a) IEEE Std 1528-2003, "IEEE Recommended Practice for Determining the Peak Spatial-Averaged Specific Absorption Rate (SAR) in the Human Head from Wireless Communications Devices: Measurement Techniques", December 2003
- b) IEC 62209-1, "Procedure to measure the Specific Absorption Rate (SAR) for hand-held devices used in close proximity to the ear (frequency range of 300 MHz to 3 GHz)", February 2005

Methods Applied and Interpretation of Parameters:

- NORM_{x,y,z}: Assessed for E-field polarization $\vartheta = 0$ ($f \leq 900$ MHz in TEM-cell; $f > 1800$ MHz: R22 waveguide). NORM_{x,y,z} are only intermediate values, i.e., the uncertainties of NORM_{x,y,z} does not effect the E²-field uncertainty inside TSL (see below ConvF).
- NORM(f)_{x,y,z} = NORM_{x,y,z} * frequency_response (see Frequency Response Chart). This linearization is implemented in DASY4 software versions later than 4.2. The uncertainty of the frequency response is included in the stated uncertainty of ConvF.
- DCP_{x,y,z}: DCP are numerical linearization parameters assessed based on the data of power sweep (no uncertainty required). DCP does not depend on frequency nor media.
- ConvF and Boundary Effect Parameters: Assessed in flat phantom using E-field (or Temperature Transfer Standard for $f \leq 800$ MHz) and inside waveguide using analytical field distributions based on power measurements for $f > 800$ MHz. The same setups are used for assessment of the parameters applied for boundary compensation (alpha, depth) of which typical uncertainty values are given. These parameters are used in DASY4 software to improve probe accuracy close to the boundary. The sensitivity in TSL corresponds to NORM_{x,y,z} * ConvF whereby the uncertainty corresponds to that given for ConvF. A frequency dependent ConvF is used in DASY version 4.4 and higher which allows extending the validity from ± 50 MHz to ± 100 MHz.
- Spherical isotropy (3D deviation from isotropy): in a field of low gradients realized using a flat phantom exposed by a patch antenna.
- Sensor Offset: The sensor offset corresponds to the offset of virtual measurement center from the probe tip (on probe axis). No tolerance required.

Unless otherwise stated the results shown in this test report refer only to the sample(s) tested and such sample(s) are retained for 90 days only. This test report cannot be reproduced, except in full, without prior written permission of the Company. 除非另有說明，此報告結果僅對測試之樣品負責，同時此樣品僅保留90天。本報告未經本公司書面許可，不可部份複製。

This document is issued by the Company subject to its General Conditions of Service (www.sgs.com/terms_and_conditions.htm) and Terms and Conditions for Electronic Documents (www.sgs.com/terms_e-document.htm). Attention is drawn to the limitations of liability, indemnification and jurisdictional issues established therein. Even if printed this electronic document is to be treated as an original within the meaning of UCP 600 article 20b. The authenticity of this document may be verified at www.sgsonsite.com/authentication. Any holder of this document is advised that information contained hereon reflects the Company's findings at the time of its intervention only and within the limits of client's instructions, if any. The Company's sole responsibility is to its Client and this document does not exonerate parties to a transaction from exercising all their rights and obligations under the transaction documents.

ES3DV3 SN:3172

May 27, 2009

Probe ES3DV3

SN:3172

Manufactured:	January 23, 2008
Last calibrated:	June 23, 2008
Recalibrated:	May 27, 2009

Calibrated for DASY Systems

(Note: non-compatible with DASY2 system!)

ES3DV3 SN:3172

May 27, 2009

DASY - Parameters of Probe: ES3DV3 SN:3172

Sensitivity in Free Space ^A			Diode Compression ^B	
NormX	1.41 ± 10.1%	μV/(V/m) ²	DCP X	94 mV
NormY	1.17 ± 10.1%	μV/(V/m) ²	DCP Y	93 mV
NormZ	0.96 ± 10.1%	μV/(V/m) ²	DCP Z	94 mV

Sensitivity in Tissue Simulating Liquid (Conversion Factors)

Please see Page 8.

Boundary Effect

TSL	900 MHz	Typical SAR gradient: 5 % per mm	
	Sensor Center to Phantom Surface Distance	3.0 mm	4.0 mm
	SAR _{be} [%] Without Correction Algorithm	9.6	5.4
	SAR _{be} [%] With Correction Algorithm	0.9	0.7
TSL	1810 MHz	Typical SAR gradient: 10 % per mm	
	Sensor Center to Phantom Surface Distance	3.0 mm	4.0 mm
	SAR _{be} [%] Without Correction Algorithm	9.2	5.4
	SAR _{be} [%] With Correction Algorithm	0.7	0.4

Sensor Offset

Probe Tip to Sensor Center **2.0 mm**

The reported uncertainty of measurement is stated as the standard uncertainty of measurement multiplied by the coverage factor k=2, which for a normal distribution corresponds to a coverage probability of approximately 95%.

^A The uncertainties of NormX,Y,Z do not affect the E²-field uncertainty inside TSL (see Page 8).

^B Numerical linearization parameter: uncertainty not required.

ES3DV3 SN:3172

May 27, 2009

Frequency Response of E-Field

(TEM-Cell:ifi110 EXX, Waveguide: R22)

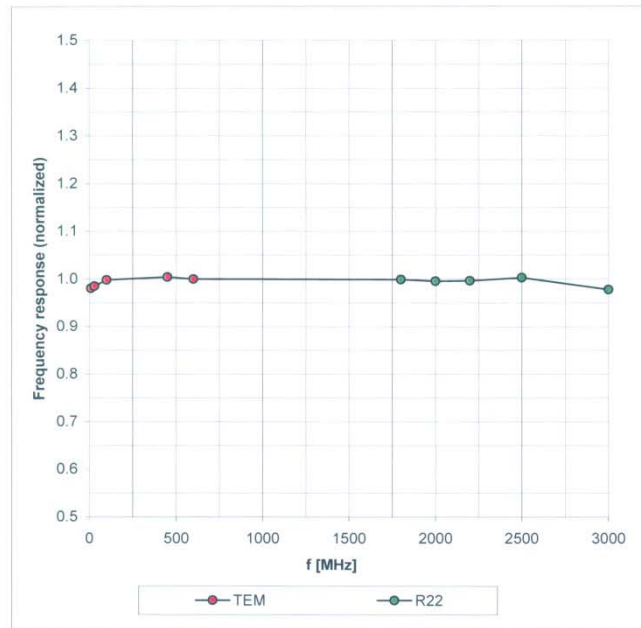

Uncertainty of Frequency Response of E-field: $\pm 6.3\%$ (k=2)

ES3DV3 SN:3172

May 27, 2009

Receiving Pattern (ϕ), $\theta = 0^\circ$

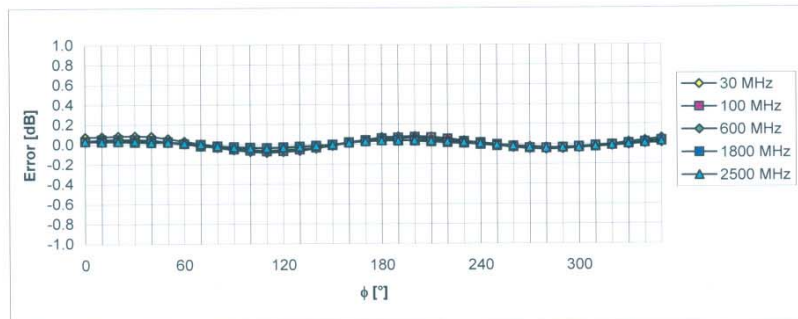
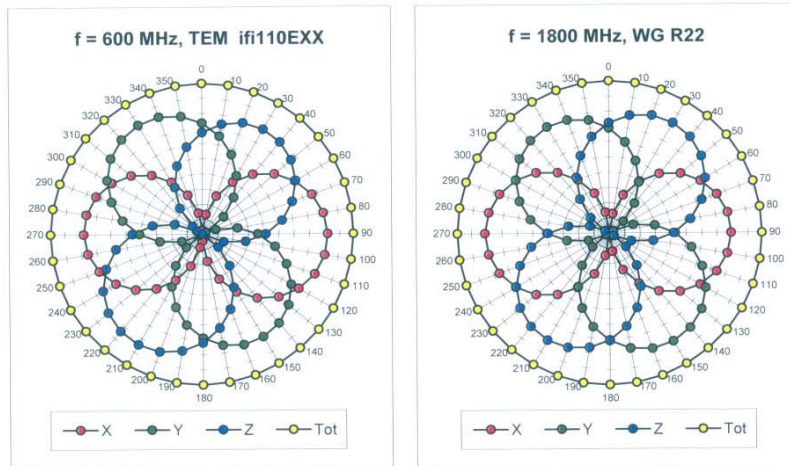

Uncertainty of Axial Isotropy Assessment: $\pm 0.5\%$ ($k=2$)

ES3DV3 SN:3172

May 27, 2009

Dynamic Range $f(SAR_{head})$ (Waveguide R22, $f = 1800$ MHz)

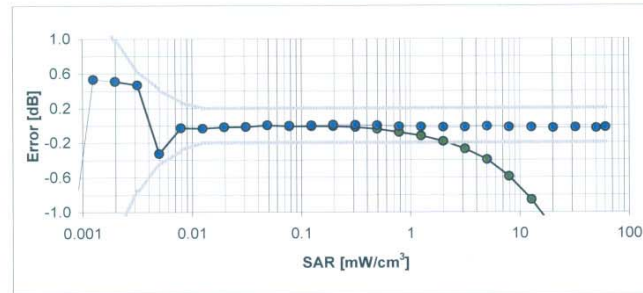
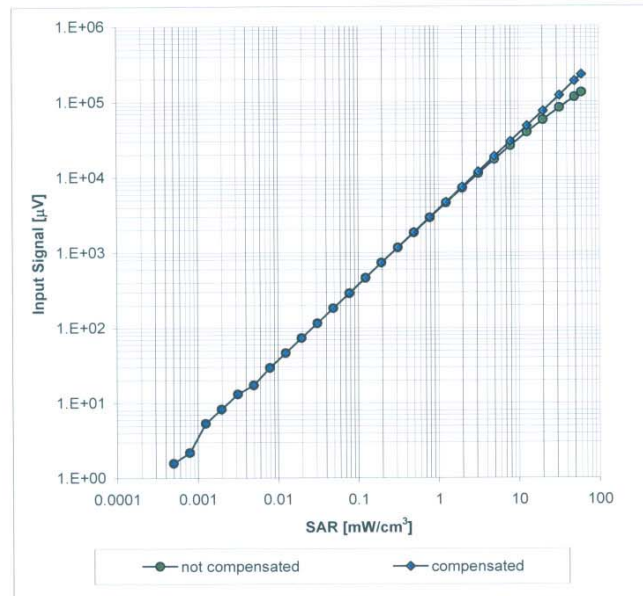

Uncertainty of Linearity Assessment: $\pm 0.6\%$ ($k=2$)

ES3DV3 SN:3172

May 27, 2009

Conversion Factor Assessment

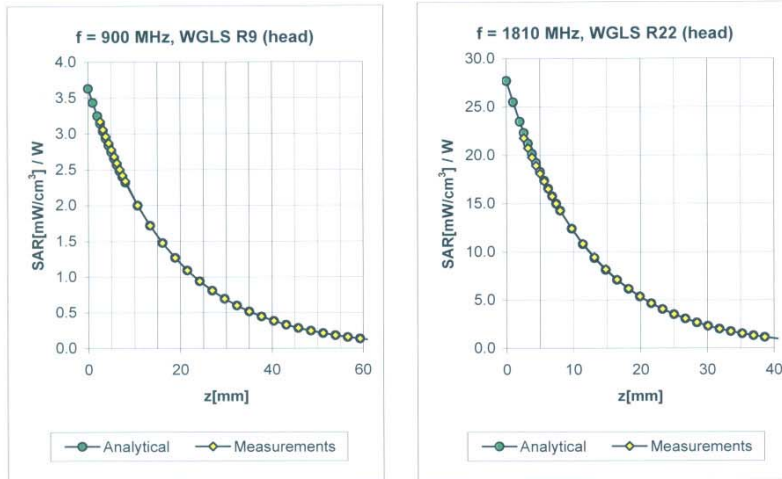

f [MHz]	Validity [MHz] ^c	TSL	Permittivity	Conductivity	Alpha	Depth	ConvF Uncertainty
835	± 50 / ± 100	Head	41.5 ± 5%	0.90 ± 5%	0.86	1.08	5.83 ± 11.0% (k=2)
900	± 50 / ± 100	Head	41.5 ± 5%	0.97 ± 5%	0.87	1.08	5.65 ± 11.0% (k=2)
1750	± 50 / ± 100	Head	40.1 ± 5%	1.37 ± 5%	0.35	1.81	4.99 ± 11.0% (k=2)
1810	± 50 / ± 100	Head	40.0 ± 5%	1.40 ± 5%	0.38	1.73	4.86 ± 11.0% (k=2)
1950	± 50 / ± 100	Head	40.0 ± 5%	1.40 ± 5%	0.48	1.51	4.71 ± 11.0% (k=2)
2450	± 50 / ± 100	Head	39.2 ± 5%	1.80 ± 5%	0.41	1.78	4.33 ± 11.0% (k=2)
835	± 50 / ± 100	Body	55.2 ± 5%	0.97 ± 5%	0.78	1.15	5.81 ± 11.0% (k=2)
900	± 50 / ± 100	Body	55.0 ± 5%	1.05 ± 5%	0.78	1.15	5.67 ± 11.0% (k=2)
1750	± 50 / ± 100	Body	53.4 ± 5%	1.49 ± 5%	0.45	1.75	4.69 ± 11.0% (k=2)
1810	± 50 / ± 100	Body	53.3 ± 5%	1.52 ± 5%	0.33	2.23	4.54 ± 11.0% (k=2)
1950	± 50 / ± 100	Body	53.3 ± 5%	1.52 ± 5%	0.27	2.99	4.53 ± 11.0% (k=2)
2450	± 50 / ± 100	Body	52.7 ± 5%	1.95 ± 5%	0.40	1.40	4.02 ± 11.0% (k=2)

^c The validity of ± 100 MHz only applies for DASY v4.4 and higher (see Page 2). The uncertainty is the RSS of the ConvF uncertainty at calibration frequency and the uncertainty for the indicated frequency band.

Unless otherwise stated the results shown in this test report refer only to the sample(s) tested and such sample(s) are retained for 90 days only. This test report cannot be reproduced, except in full, without prior written permission of the Company. 除非另有說明，此報告結果僅對測試之樣品負責，同時此樣品僅保留90天。本報告未經本公司書面許可，不可部份複製。

This document is issued by the Company subject to its General Conditions of Service (www.sgs.com/terms_and_conditions.htm) and Terms and Conditions for Electronic Documents (www.sgs.com/terms_e-document.htm). Attention is drawn to the limitations of liability, indemnification and jurisdictional issues established therein. Even if printed this electronic document is to be treated as an original within the meaning of UCP 600 article 20b. The authenticity of this document may be verified at www.sgs.com/site/authentication. Any holder of this document is advised that information contained hereon reflects the Company's findings at the time of its intervention only and within the limits of client's instructions, if any. The Company's sole responsibility is to its Client and this document does not exonerate parties to a transaction from exercising all their rights and obligations under the transaction documents.

ES3DV3 SN:3172

May 27, 2009

Deviation from Isotropy in HSL

Error (ϕ , θ), $f = 900$ MHz

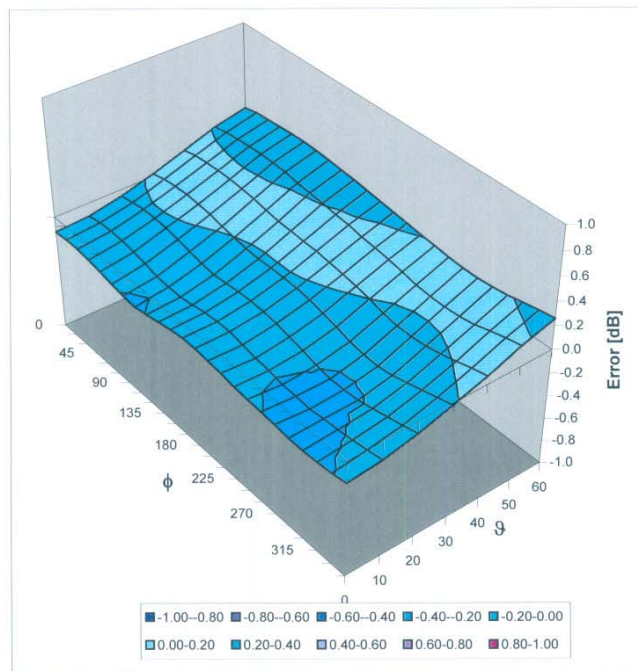

Uncertainty of Spherical Isotropy Assessment: $\pm 2.6\%$ ($k=2$)

7. Uncertainty Analysis

DASY5 Uncertainty Budget
According to IEEE 1528 [1]

Error Description	Uncertainty value	Prob. Dist.	Div.	(c ₁) 1g	(c ₂) 10g	Std. Unc. (1g)	Std. Unc. (10g)	(v _k) v _{eff}
Measurement System								
Probe Calibration	±5.9 %	N	1	1	1	±5.9 %	±5.9 %	∞
Axial Isotropy	±4.7 %	R	√3	0.7	0.7	±1.9 %	±1.9 %	∞
Hemispherical Isotropy	±9.6 %	R	√3	0.7	0.7	±3.9 %	±3.9 %	∞
Boundary Effects	±1.0 %	R	√3	1	1	±0.6 %	±0.6 %	∞
Linearity	±4.7 %	R	√3	1	1	±2.7 %	±2.7 %	∞
System Detection Limits	±1.0 %	R	√3	1	1	±0.6 %	±0.6 %	∞
Readout Electronics	±0.3 %	N	1	1	1	±0.3 %	±0.3 %	∞
Response Time	±0.8 %	R	√3	1	1	±0.5 %	±0.5 %	∞
Integration Time	±2.6 %	R	√3	1	1	±1.5 %	±1.5 %	∞
RF Ambient Noise	±3.0 %	R	√3	1	1	±1.7 %	±1.7 %	∞
RF Ambient Reflections	±3.0 %	R	√3	1	1	±1.7 %	±1.7 %	∞
Probe Positioner	±0.4 %	R	√3	1	1	±0.2 %	±0.2 %	∞
Probe Positioning	±2.9 %	R	√3	1	1	±1.7 %	±1.7 %	∞
Max. SAR Eval.	±1.0 %	R	√3	1	1	±0.6 %	±0.6 %	∞
Test Sample Related								
Device Positioning	±2.9 %	N	1	1	1	±2.9 %	±2.9 %	145
Device Holder	±3.6 %	N	1	1	1	±3.6 %	±3.6 %	5
Power Drift	±5.0 %	R	√3	1	1	±2.9 %	±2.9 %	∞
Phantom and Setup								
Phantom Uncertainty	±4.0 %	R	√3	1	1	±2.3 %	±2.3 %	∞
Liquid Conductivity (target)	±5.0 %	R	√3	0.64	0.43	±1.8 %	±1.2 %	∞
Liquid Conductivity (meas.)	±2.5 %	N	1	0.64	0.43	±1.6 %	±1.1 %	∞
Liquid Permittivity (target)	±5.0 %	R	√3	0.6	0.49	±1.7 %	±1.4 %	∞
Liquid Permittivity (meas.)	±2.5 %	N	1	0.6	0.49	±1.5 %	±1.2 %	∞
Combined Std. Uncertainty						±10.9 %	±10.7 %	387
Expanded STD Uncertainty						±21.9 %	±21.4 %	

Table 19.6: Worst-Case uncertainty budget for DASY5 assessed according to IEEE 1528 [1]. The budget is valid for the frequency range 300 MHz - 3 GHz and represents a worst-case analysis. For specific tests and configurations, the uncertainty could be considerable smaller.

Unless otherwise stated the results shown in this test report refer only to the sample(s) tested and such sample(s) are retained for 90 days only. This test report cannot be reproduced, except in full, without prior written permission of the Company. 除非另有說明，此報告結果僅對測試之樣品負責，同時此樣品僅保留90天。本報告未經本公司書面許可，不可部份複製。

This document is issued by the Company subject to its General Conditions of Service (www.sgs.com/terms_and_conditions.htm) and Terms and Conditions for Electronic Documents (www.sgs.com/terms_e-document.htm). Attention is drawn to the limitations of liability, indemnification and jurisdictional issues established therein. Even if printed this electronic document is to be treated as an original within the meaning of UCP 600 article 20b. The authenticity of this document may be verified at www.sgs.com/authentication. Any holder of this document is advised that information contained hereon reflects the Company's findings at the time of its intervention only and within the limits of client's instructions, if any. The Company's sole responsibility is to its Client and this document does not exonerate parties to a transaction from exercising all their rights and obligations under the transaction documents.

8. Phantom Description

Schmid & Partner Engineering AG

s p e a g

 Zeughausstrasse 43, 8004 Zurich, Switzerland
 Phone +41 1 245 9700, Fax +41 1 245 9779
 info@speag.com, http://www.speag.com

Certificate of Conformity / First Article Inspection

Item	SAM Twin Phantom V4.0
Type No	QD 000 P40 C
Series No	TP-1150 and higher
Manufacturer	SPEAG Zeughausstrasse 43 CH-8004 Zurich Switzerland

Tests

The series production process used allows the limitation to test of first articles. Complete tests were made on the pre-series Type No. QD 000 P40 AA, Serial No. TP-1001 and on the series first article Type No. QD 000 P40 BA, Serial No. TP-1006. Certain parameters have been retested using further series items (called samples) or are tested at each item.

Test	Requirement	Details	Units tested
Dimensions	Compliant with the geometry according to the CAD model.	IT'IS CAD File (*)	First article, Samples
Material thickness of shell	Compliant with the requirements according to the standards	2mm +/- 0.2mm in flat and specific areas of head section	First article, Samples, TP-1314 ff.
Material thickness at ERP	Compliant with the requirements according to the standards	6mm +/- 0.2mm at ERP	First article, All items
Material parameters	Dielectric parameters for required frequencies	300 MHz – 6 GHz: Relative permittivity < 5, Loss tangent < 0.05	Material samples
Material resistivity	The material has been tested to be compatible with the liquids defined in the standards if handled and cleaned according to the instructions. Observe technical Note for material compatibility.	DEGMBE based simulating liquids	Pre-series, First article, Material samples
Sagging	Compliant with the requirements according to the standards. Sagging of the flat section when filled with tissue simulating liquid.	< 1% typical < 0.8% if filled with 155mm of HSL900 and without DUT below	Prototypes, Sample testing

Standards

- [1] CENELEC EN 50361
- [2] IEEE Std 1528-2003
- [3] IEC 62209 Part 1
- [4] FCC OET Bulletin 65, Supplement C, Edition 01-01

(*) The IT'IS CAD file is derived from [2] and is also within the tolerance requirements of the shapes of the other documents.

Conformity

Based on the sample tests above, we certify that this item is in compliance with the uncertainty requirements of SAR measurements specified in standards [1] to [4].

Date 07.07.2005

s p e a g

Signature / Stamp

 Schmid & Partner Engineering AG
 Zeughausstrasse 43, 8004 Zurich, Switzerland
 Phone +41 1 245 9700, Fax +41 1 245 9779
 info@speag.com, http://www.speag.com

Doc No 881 - QD 000 P40 C - F

Page 1 (1)

Unless otherwise stated the results shown in this test report refer only to the sample(s) tested and such sample(s) are retained for 90 days only. This test report cannot be reproduced, except in full, without prior written permission of the Company. 除非另有說明，此報告結果僅對測試之樣品負責，同時此樣品僅保留90天。本報告未經本公司書面許可，不可部份複製。

This document is issued by the Company subject to its General Conditions of Service (www.sgs.com/terms_and_conditions.htm) and Terms and Conditions for Electronic Documents (www.sgs.com/terms_e-document.htm). Attention is drawn to the limitations of liability, indemnification and jurisdictional issues established therein. Even if printed this electronic document is to be treated as an original within the meaning of UCP 600 article 20b. The authenticity of this document may be verified at www.sgs.com/authentication. Any holder of this document is advised that information contained hereon reflects the Company's findings at the time of its intervention only and within the limits of client's instructions, if any. The Company's sole responsibility is to its Client and this document does not exonerate parties to a transaction from exercising all their rights and obligations under the transaction documents.

9. System Validation from Original equipment supplier

**Calibration Laboratory of
Schmid & Partner
Engineering AG**
Zeughausstrasse 43, 8004 Zurich, Switzerland



S Schweizerischer Kalibrierdienst
S Service suisse d'étalonnage
C Servizio svizzero di taratura
S Swiss Calibration Service

Accredited by the Swiss Accreditation Service (SAS)
The Swiss Accreditation Service is one of the signatories to the EA
Multilateral Agreement for the recognition of calibration certificates

Accreditation No.: SCS 108

Client **SGS (Auden)**

Certificate No: D2450V2-727_Apr09

CALIBRATION CERTIFICATE

Object **D2450V2 - SN: 727**

Calibration procedure(s) **QA CAL-05.v7
Calibration procedure for dipole validation kits**

Calibration date: **April 27, 2009**

Condition of the calibrated item **In Tolerance**

This calibration certificate documents the traceability to national standards, which realize the physical units of measurements (SI).
The measurements and the uncertainties with confidence probability are given on the following pages and are part of the certificate.

All calibrations have been conducted in the closed laboratory facility: environment temperature (22 ± 3)°C and humidity < 70%.

Calibration Equipment used (M&TE critical for calibration)

Primary Standards	ID #	Cal Date (Calibrated by, Certificate No.)	Scheduled Calibration
Power meter EPM-442A	GB37480704	08-Oct-08 (No. 217-00898)	Oct-09
Power sensor HP 8481A	US37292783	08-Oct-08 (No. 217-00898)	Oct-09
Reference 20 dB Attenuator	SN: 5086 (20g)	31-Mar-09 (No. 217-01025)	Mar-10
Type-N mismatch combination	SN: 5047.2 / 06327	31-Mar-09 (No. 217-01029)	Mar-10
Reference Probe ES3DV2	SN: 3025	28-Apr-08 (No. ES3-3025_Apr08)	Apr-09
DAE4	SN: 601	07-Mar-09 (No. DAE4-601_Mar09)	Mar-10

Secondary Standards	ID #	Check Date (in house)	Scheduled Check
Power sensor HP 8481A	MY41092317	18-Oct-02 (in house check Oct-07)	In house check: Oct-09
RF generator R&S SMT-06	100005	4-Aug-99 (in house check Oct-07)	In house check: Oct-09
Network Analyzer HP 8753E	US37390585 S4206	18-Oct-01 (in house check Oct-08)	In house check: Oct-09

Calibrated by:	Name Jeton Kastrati	Function Laboratory Technician	Signature
Approved by:	Name Katja Pokovic	Function Technical Manager	Signature

Issued: April 28, 2009

This calibration certificate shall not be reproduced except in full without written approval of the laboratory.

Calibration Laboratory of
Schmid & Partner
Engineering AG
Zeughausstrasse 43, 8004 Zurich, Switzerland



S Schweizerischer Kalibrierdienst
C Service suisse d'étalonnage
S Servizio svizzero di taratura
S Swiss Calibration Service

Accredited by the Swiss Accreditation Service (SAS)
The Swiss Accreditation Service is one of the signatories to the EA
Multilateral Agreement for the recognition of calibration certificates

Accreditation No.: **SCS 108**

Glossary:

TSL tissue simulating liquid
ConvF sensitivity in TSL / NORM x,y,z
N/A not applicable or not measured

Calibration is Performed According to the Following Standards:

- a) IEEE Std 1528-2003, "IEEE Recommended Practice for Determining the Peak Spatial-Averaged Specific Absorption Rate (SAR) in the Human Head from Wireless Communications Devices: Measurement Techniques", December 2003
- b) IEC 62209-1, "Procedure to measure the Specific Absorption Rate (SAR) for hand-held devices used in close proximity to the ear (frequency range of 300 MHz to 3 GHz)", February 2005
- c) Federal Communications Commission Office of Engineering & Technology (FCC OET), "Evaluating Compliance with FCC Guidelines for Human Exposure to Radiofrequency Electromagnetic Fields; Additional Information for Evaluating Compliance of Mobile and Portable Devices with FCC Limits for Human Exposure to Radiofrequency Emissions", Supplement C (Edition 01-01) to Bulletin 65

Additional Documentation:

- d) DASY4/5 System Handbook

Methods Applied and Interpretation of Parameters:

- *Measurement Conditions:* Further details are available from the Validation Report at the end of the certificate. All figures stated in the certificate are valid at the frequency indicated.
- *Antenna Parameters with TSL:* The dipole is mounted with the spacer to position its feed point exactly below the center marking of the flat phantom section, with the arms oriented parallel to the body axis.
- *Feed Point Impedance and Return Loss:* These parameters are measured with the dipole positioned under the liquid filled phantom. The impedance stated is transformed from the measurement at the SMA connector to the feed point. The Return Loss ensures low reflected power. No uncertainty required.
- *Electrical Delay:* One-way delay between the SMA connector and the antenna feed point. No uncertainty required.
- *SAR measured:* SAR measured at the stated antenna input power.
- *SAR normalized:* SAR as measured, normalized to an input power of 1 W at the antenna connector.
- *SAR for nominal TSL parameters:* The measured TSL parameters are used to calculate the nominal SAR result.

Measurement Conditions

DASY system configuration, as far as not given on page 1.

DASY Version	DASY5	V5.0
Extrapolation	Advanced Extrapolation	
Phantom	Modular Flat Phantom V5.0	
Distance Dipole Center - TSL	10 mm	with Spacer
Zoom Scan Resolution	dx, dy, dz = 5 mm	
Frequency	2450 MHz \pm 1 MHz	

Head TSL parameters

The following parameters and calculations were applied.

	Temperature	Permittivity	Conductivity
Nominal Head TSL parameters	22.0 °C	39.2	1.80 mho/m
Measured Head TSL parameters	(22.0 \pm 0.2) °C	38.0 \pm 6 %	1.82 mho/m \pm 6 %
Head TSL temperature during test	(21.6 \pm 0.2) °C	----	----

SAR result with Head TSL

SAR averaged over 1 cm ³ (1 g) of Head TSL	Condition	
SAR measured	250 mW input power	13.5 mW / g
SAR normalized	normalized to 1W	54.0 mW / g
SAR for nominal Head TSL parameters ¹	normalized to 1W	53.3 mW / g \pm 17.0 % (k=2)

SAR averaged over 10 cm ³ (10 g) of Head TSL	condition	
SAR measured	250 mW input power	6.28 mW / g
SAR normalized	normalized to 1W	25.1 mW / g
SAR for nominal Head TSL parameters ¹	normalized to 1W	24.9 mW / g \pm 16.5 % (k=2)

¹ Correction to nominal TSL parameters according to d), chapter "SAR Sensitivities"

Body TSL parameters

The following parameters and calculations were applied.

	Temperature	Permittivity	Conductivity
Nominal Body TSL parameters	22.0 °C	52.7	1.95 mho/m
Measured Body TSL parameters	(22.0 ± 0.2) °C	54.4 ± 6 %	1.98 mho/m ± 6 %
Body TSL temperature during test	(22.0 ± 0.2) °C	---	---

SAR result with Body TSL

SAR averaged over 1 cm ³ (1 g) of Body TSL	Condition	
SAR measured	250 mW input power	13.2 mW / g
SAR normalized	normalized to 1W	52.8 mW / g
SAR for nominal Body TSL parameters ²	normalized to 1W	52.8 mW / g ± 17.0 % (k=2)

SAR averaged over 10 cm ³ (10 g) of Body TSL	condition	
SAR measured	250 mW input power	6.18 mW / g
SAR normalized	normalized to 1W	24.7 mW / g
SAR for nominal Body TSL parameters ²	normalized to 1W	24.8 mW / g ± 16.5 % (k=2)

² Correction to nominal TSL parameters according to d), chapter "SAR Sensitivities"

Appendix

Antenna Parameters with Head TSL

Impedance, transformed to feed point	55.1 Ω + 1.2 j Ω
Return Loss	- 26.1 dB

Antenna Parameters with Body TSL

Impedance, transformed to feed point	49.5 Ω + 3.3 j Ω
Return Loss	- 29.6 dB

General Antenna Parameters and Design

Electrical Delay (one direction)	1.149 ns
----------------------------------	----------

After long term use with 100W radiated power, only a slight warming of the dipole near the feedpoint can be measured.

The dipole is made of standard semirigid coaxial cable. The center conductor of the feeding line is directly connected to the second arm of the dipole. The antenna is therefore short-circuited for DC-signals.

No excessive force must be applied to the dipole arms, because they might bend or the soldered connections near the feedpoint may be damaged.

Additional EUT Data

Manufactured by	SPEAG
Manufactured on	January 09, 2003

DASY5 Validation Report for Head TSL

Date/Time: 27.04.2009 13:40:04

Test Laboratory: SPEAG, Zurich, Switzerland

DUT: Dipole 2450 MHz; Type: D2450V2; Serial: D2450V2 - SN727

Communication System: CW; Frequency: 2450 MHz; Duty Cycle: 1:1

Medium: HSL U10 BB

Medium parameters used: $f = 2450$ MHz; $\sigma = 1.82$ mho/m; $\epsilon_r = 38$; $\rho = 1000$ kg/m³

Phantom section: Flat Section

Measurement Standard: DASY5 (IEEE/IEC)

DASY5 Configuration:

- Probe: ES3DV2 - SN3025; ConvF(4.4, 4.4, 4.4); Calibrated: 28.04.2008
- Sensor-Surface: 3mm (Mechanical Surface Detection)
- Electronics: DAE4 Sn601; Calibrated: 07.03.2009
- Phantom: Flat Phantom 5.0 (front); Type: QD000P50AA; Serial: 1001
- Measurement SW: DASY5, V5.0 Build 120; SEMCAD X Version 13.4 Build 45

Pin = 250 mW; d = 10 mm/Zoom Scan (7x7x7)/Cube 0: Measurement grid: dx=5mm, dy=5mm, dz=5mm

Reference Value = 100.3 V/m; Power Drift = 0.036 dB

Peak SAR (extrapolated) = 28.3 W/kg

SAR(1 g) = 13.5 mW/g; SAR(10 g) = 6.28 mW/g

Maximum value of SAR (measured) = 17.2 mW/g

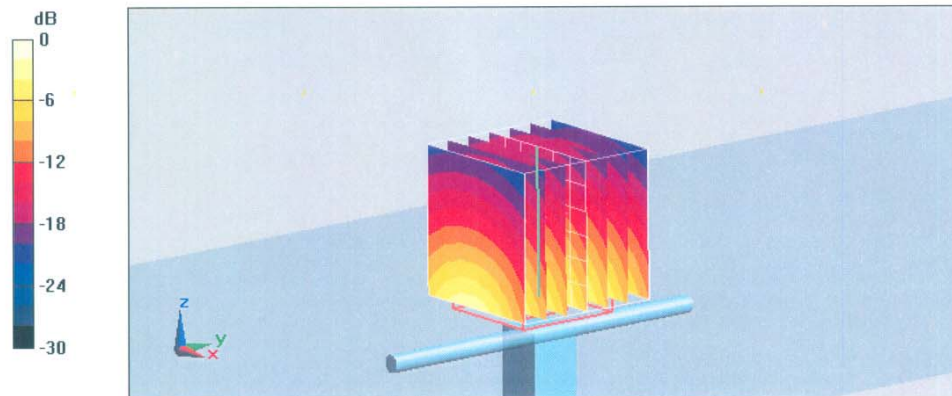

0 dB = 17.2mW/g

Impedance Measurement Plot for Head TSL

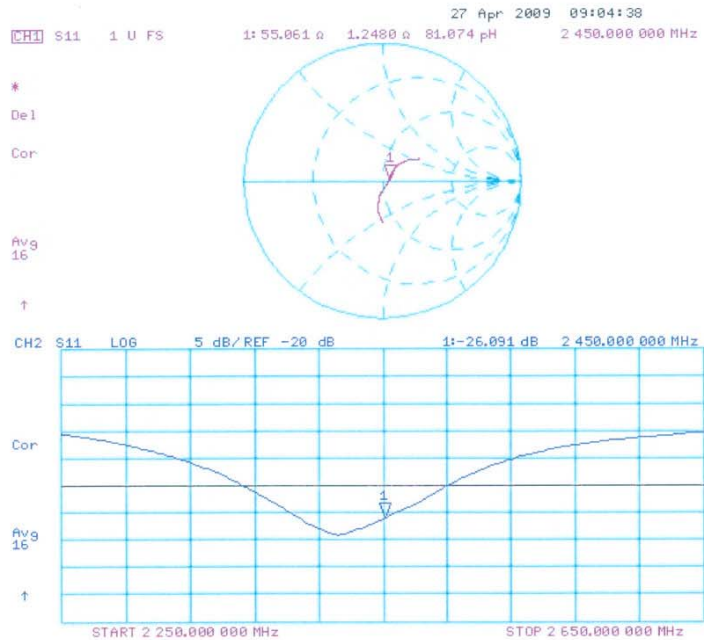

Unless otherwise stated the results shown in this test report refer only to the sample(s) tested and such sample(s) are retained for 90 days only. This test report cannot be reproduced, except in full, without prior written permission of the Company. 除非另有說明，此報告結果僅對測試之樣品負責，同時此樣品僅保留90天。本報告未經本公司書面許可，不可部份複製。

This document is issued by the Company subject to its General Conditions of Service (www.sgs.com/terms_and_conditions.htm) and Terms and Conditions for Electronic Documents (www.sgs.com/terms_e-document.htm). Attention is drawn to the limitations of liability, indemnification and jurisdictional issues established therein. Even if printed this electronic document is to be treated as an original within the meaning of UCP 600 article 20b. The authenticity of this document may be verified at www.sgsonsite.com/authentication. Any holder of this document is advised that information contained hereon reflects the Company's findings at the time of its intervention only and within the limits of client's instructions, if any. The Company's sole responsibility is to its Client and this document does not exonerate parties to a transaction from exercising all their rights and obligations under the transaction documents.

DASY5 Validation Report for Body TSL

Date/Time: 22.04.2009 13:12:14

Test Laboratory: SPEAG, Zurich, Switzerland

DUT: Dipole 2450 MHz; Type: D2450V2; Serial: D2450V2 - SN:727

Communication System: CW; Frequency: 2450 MHz; Duty Cycle: 1:1

Medium: MSL U10 BB

Medium parameters used: $f = 2450 \text{ MHz}$; $\sigma = 1.98 \text{ mho/m}$; $\epsilon_r = 54.4$; $\rho = 1000 \text{ kg/m}^3$

Phantom section: Flat Section

Measurement Standard: DASY5 (IEEE/IEC)

DASY5 Configuration:

- Probe: ES3DV2 - SN3025; ConvF(4.07, 4.07, 4.07); Calibrated: 28.04.2008
- Sensor-Surface: 3mm (Mechanical Surface Detection)
- Electronics: DAE4 Sn601; Calibrated: 07.03.2009
- Phantom: Flat Phantom 5.0 (back); Type: QD000P50AA; Serial: 1002
- Measurement SW: DASY5, V5.0 Build 120; SEMCAD X Version 13.4 Build 45

Pin = 250 mW; d = 10 mm/Zoom Scan (7x7x7)/Cube 0: Measurement grid: dx=5mm, dy=5mm, dz=5mm

Reference Value = 96.9 V/m; Power Drift = 0.031 dB

Peak SAR (extrapolated) = 26.5 W/kg

SAR(1 g) = 13.2 mW/g; SAR(10 g) = 6.18 mW/g

Maximum value of SAR (measured) = 17.3 mW/g

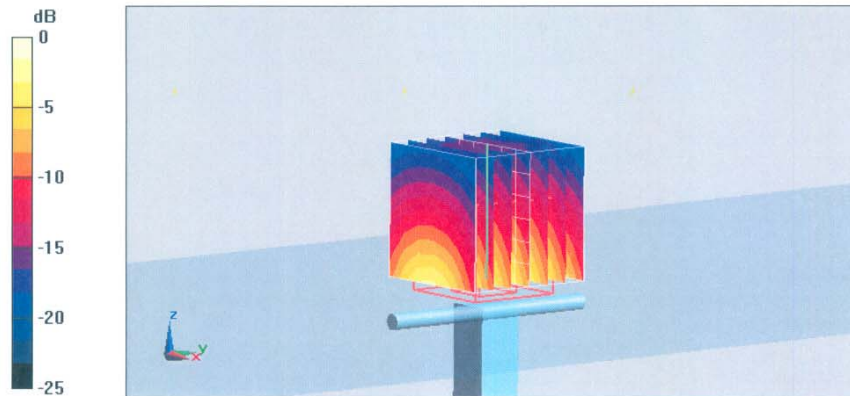

0 dB = 17.3mW/g

Impedance Measurement Plot for Body TSL

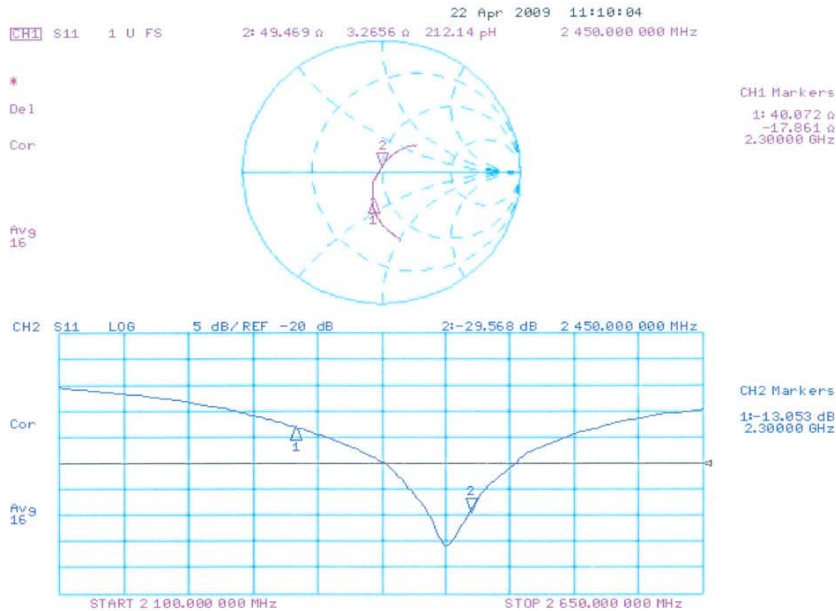

End of 1st part of report

Unless otherwise stated the results shown in this test report refer only to the sample(s) tested and such sample(s) are retained for 90 days only. This test report cannot be reproduced, except in full, without prior written permission of the Company. 除非另有說明，此報告結果僅對測試之樣品負責，同時此樣品僅保留90天。本報告未經本公司書面許可，不可部份複製。

This document is issued by the Company subject to its General Conditions of Service (www.sgs.com/terms_and_conditions.htm) and Terms and Conditions for Electronic Documents (www.sgs.com/terms_e-document.htm). Attention is drawn to the limitations of liability, indemnification and jurisdictional issues established therein. Even if printed this electronic document is to be treated as an original within the meaning of UCP 600 article 20b. The authenticity of this document may be verified at www.sgs.com/site/authentication. Any holder of this document is advised that information contained hereon reflects the Company's findings at the time of its intervention only and within the limits of client's instructions, if any. The Company's sole responsibility is to its Client and this document does not exonerate parties to a transaction from exercising all their rights and obligations under the transaction documents.