

Regulatory WLAN Antenna Information

(English Language Required for Intel Regulatory Review / Approval)

Platform	
Platform Owner	Lenovo(Beijing) Limited
Brand Name	Lenovo(Beijing) Limited
Model Name	ThinkPad Edge E445
ODM	Compal
Target Launch Date	2013/05/05
Antenna	
Manufacturer	WNC
Part Number	■ Tx1 Antenna: 81.EKG15.G30
	■ Tx2/ Rx2 Antenna: 81.EKG15.G29
Module	
With WLAN Module	■ RTL8188EE
(Check Box)	

Antenna Sample / Antenna Data Requirements for worldwide regulatory approval

Section	Description of Required OEM / ODM Antenna Information	US / IC	EU	Japan	Taiwan	S.Korea
1A	Part Number for Antenna only	Required	Required	Required	Required	Required
1B	Antenna Manufacturer Name	Required	Required	Required	Required	Required
1C	Description of Antenna Type	Required	N/A	N/A	N/A	N/A
1D	Part number of Antenna Assembly / cable impedance, length & diameter.	Required	Desired	Desired	Desired	Desired
1E	Tx1, Tx2 & Tx3 antenna (Peak Gain W/ cable loss) *	Required	Required	Required	Required	Required
	1E OR 1F, 1G, 1H					
1F	Tx1, Tx2 & Tx3 antenna (Peak Gain only) *	Required	Required	Required	Required	Required
1G	VSWR of cable including connector	Required	Required	Required	Required	Required
1H	Tx1, Tx2 & Tx3 antenna (Cable loss W/ connector) *	Required	Required	Required	Required	Required
2	Dimensioned Photographs and Drawings of Tx1, Tx2, and Tx3 (or Rx3) antennas	Required	Required	Required	Required	Required
3	Radiation patterns of antennas loaded in the host platform.	Required	Desired	Required	Required	Required
4	Platform model name / number - correlated to antenna manufacturer and antenna part number	Required	Required	Desired	Required	Desired
5	Photograph(s) or Drawings showing location of antennas in platform. (S. Korea requires photographs of antennas for approval submission). Taiwan requires pictures of each antenna type shown in the system.	Required	Required	Desired	Required (Photos)	Required (Photos)
6	Mech. drawings / photos with dimensions of antenna locations and distance from end-user (For evaluation of SAR testing requirement).	Required	N/A	N/A	N/A	N/A
7	Photograph(s) or Drawings showing the location of all antennas (WLAN, other) and distance between those transmitting antennas. Information will be used to evaluate whether co-location testing is required.	Required	N/A	N/A	N/A	N/A
8	Local representative contact information for LMA/ PARS process.	Required	N/A	N/A	N/A	N/A

Antenna Information

Section 1. Antenna Assembly Specifications

1A Antenna Part Number	1B Manufacture	1C Antenna Type	1D Cable Assembly Part Number and Information	1E *Peak Gain W/ Cable loss (dBi)	1F Peak Gain w/o Cable Loss (dBi)	1G VSWR	1H Cable Loss (dBi)
Compal P/N: DC33000YV20 WNC P/N 81.EKG15.G30 Main Antenna Tx1/ Rx1 Antenna	WNC Corporation	PIFA	P/N: 60.EKG0C.012 (2-9-1) GBE or compatible. 50 ohm Coaxial. Length:510mm diameter:1.37 mm	2400-2500MHz 1.15 dBi (peak)	2400-2500MHz 2.65 dBi (peak)	2400-2500MHz 3.00 max	2400-2500MHz 1.50 dBi (peak)
				5150-5350MHz -1.36 dBi (peak)	5150-5350MHz 0.66 dBi (peak)	5150-5350MHz 3.00 max	5150-5350MHz 2.02 dBi (peak)
				5470-5725MHz -1.13 dBi (peak)	5470-5725MHz 1.01 dBi (peak)	5470-5725MHz 3.00 max	5470-5725MHz 2.14 dBi (peak)
				5725-5850MHz -0.51 dBi (peak)	5725-5850MHz 1.66 dBi (peak)	5725-5850MHz 3.00 max	5725-5850MHz 2.17 dBi (peak)
Compal P/N: DC33000YV30 WNC P/N 81.EKG15.G29 Aux Antenna Tx2 / Rx2 Antenna	WNC Corporation	PIFA	P/N: 60.EKG0C.011 (2-5-1) GBE or compatible. 50 ohm Coaxial. Length:660mm diameter:1.37 mm	2400-2500MHz 0.59 dBi (peak)	2400-2500MHz 2.47 dBi (peak)	2400-2500MHz 3.00 max	2400-2500MHz 1.88 dBi (peak)
				5150-5350MHz -1.60 dBi (peak)	5150-5350MHz 0.94 dBi (peak)	5150-5350MHz 3.00 max	5150-5350MHz 2.54 dBi (peak)
				5470-5725MHz -0.04 dBi (peak)	5470-5725MHz 2.65 dBi (peak)	5470-5725MHz 3.00 max	5470-5725MHz 2.69 dBi (peak)
				5725-5850MHz -0.19 dBi (peak)	5725-5850MHz 2.54 dBi (peak)	5725-5850MHz 3.00 max	5725-5850MHz 2.73 dBi (peak)

- Antenna Peak Gain required being test in system basis.
- 1E frame contend absolutely peak antenna gain include H/V

Antenna Peak Gain Table:

Frequency (MHz)	Tx1 antenna		Tx2 (or Rx2) Antenna	
	Horizontal (dBi)	Vertical (dBi)	Horizontal (dBi)	Vertical (dBi)
2400	1.15	0.54	0.59	-0.51
2450	-0.15	-2.78	-0.91	-3.86
2500	0.53	-2.30	-0.17	-3.33
5150	-1.36	-3.33	-2.88	-2.70
5250	-2.10	-4.56	-1.78	-3.75
5350	-2.17	-3.92	-1.60	-4.19
5470	-1.13	-4.62	-0.04	-2.48
5600	-1.27	-3.97	-1.19	-1.34
5725	-2.69	-5.22	-1.53	-3.53
5785	-2.04	-4.28	-0.19	-2.10
5850	-0.51	-3.47	-0.34	-2.27

Section 2. Dimensioned Photos or Drawings of Antennas

Main Antenna Dimensioned Drawing:

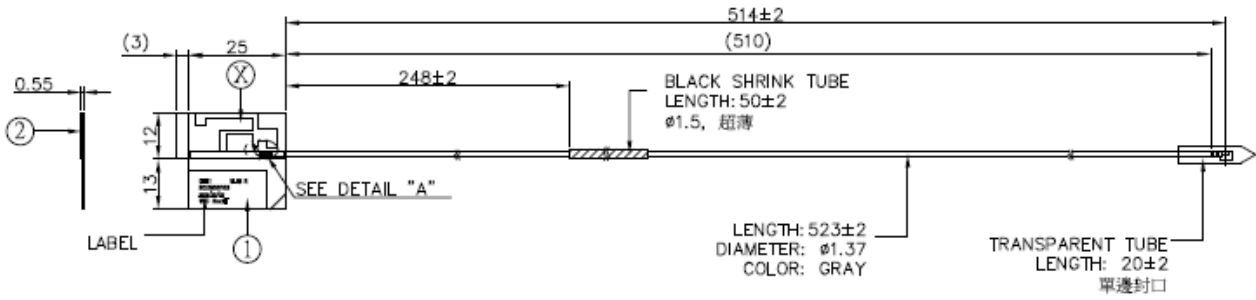

Main Antenna Photo:

Main (Front) - Far



Main (Front) - Near

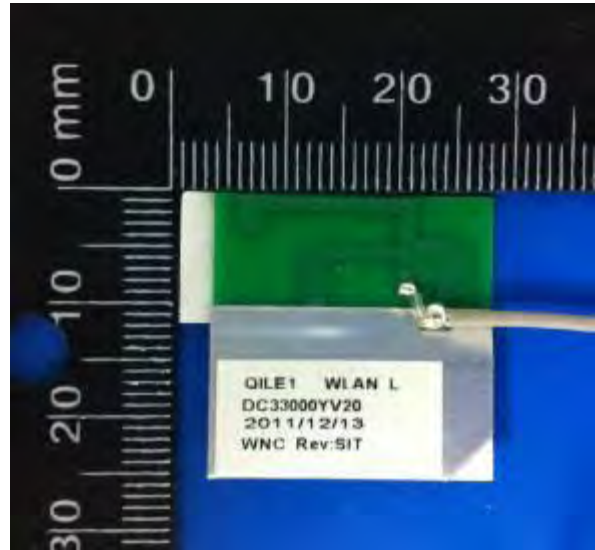

Main (Back) - Far

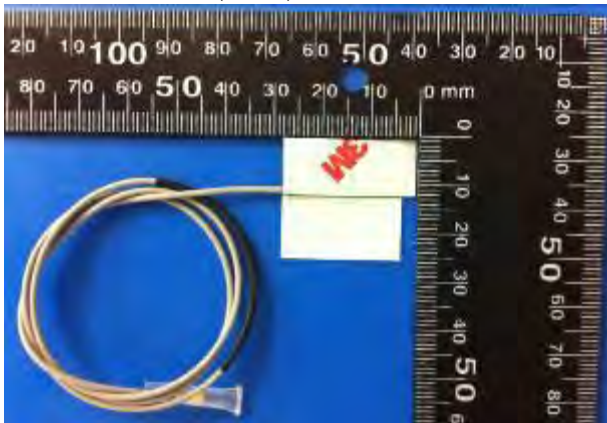

Main (Back) - Near

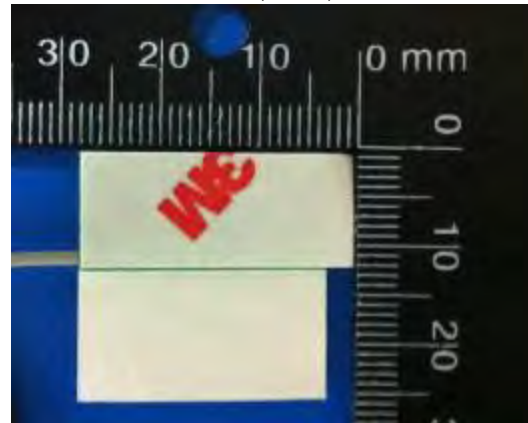

Aux Antenna Dimensioned Drawing:

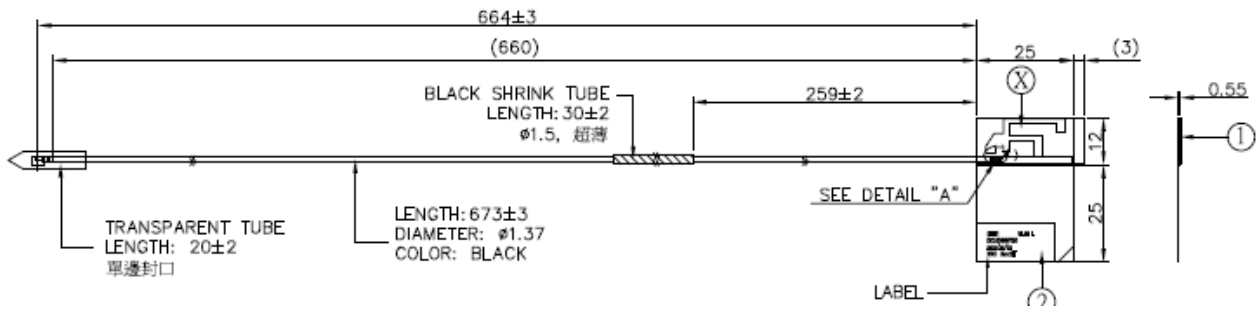

Aux Antenna Photo:

Aux (Front) - Far



Aux (Front) - Near

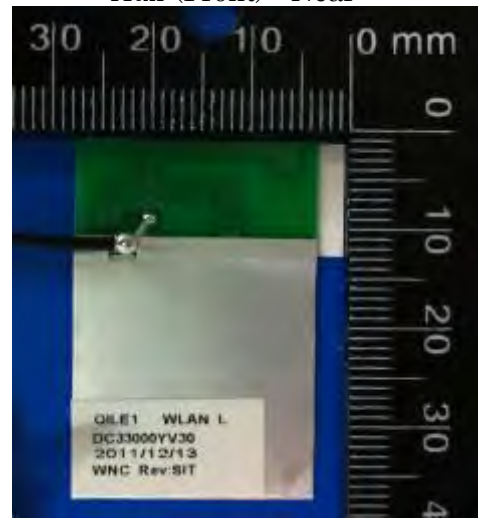

Aux (Back) - Far



Aux (Back) - Near

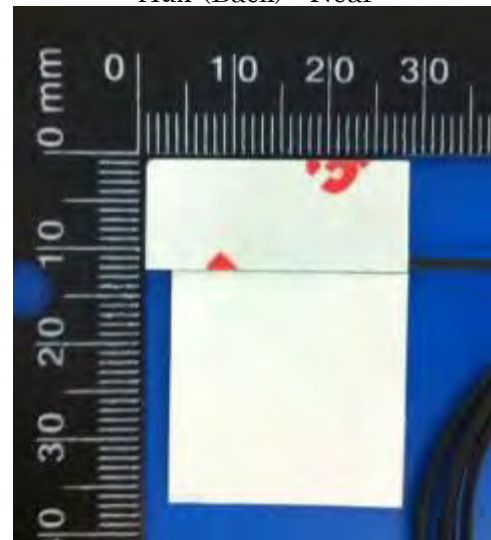

Trade Name: Compal
Model No.: DC33000YV30 (Main)
DC33000YV20 (Aux)

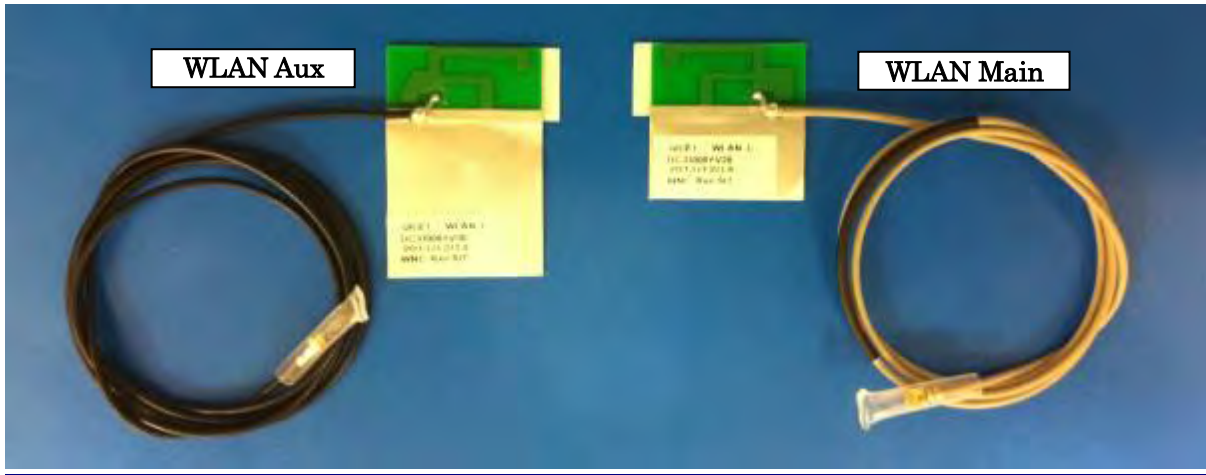

Trade Name: Compal
Model No.: DC33000YV30 (Main)
DC33000YV20 (Aux)



Section 3. Radiation characteristics of antennae Loaded in Host Platform

2400-2500MHz radiation characteristic

Tx1 antenna: 2400 MHz

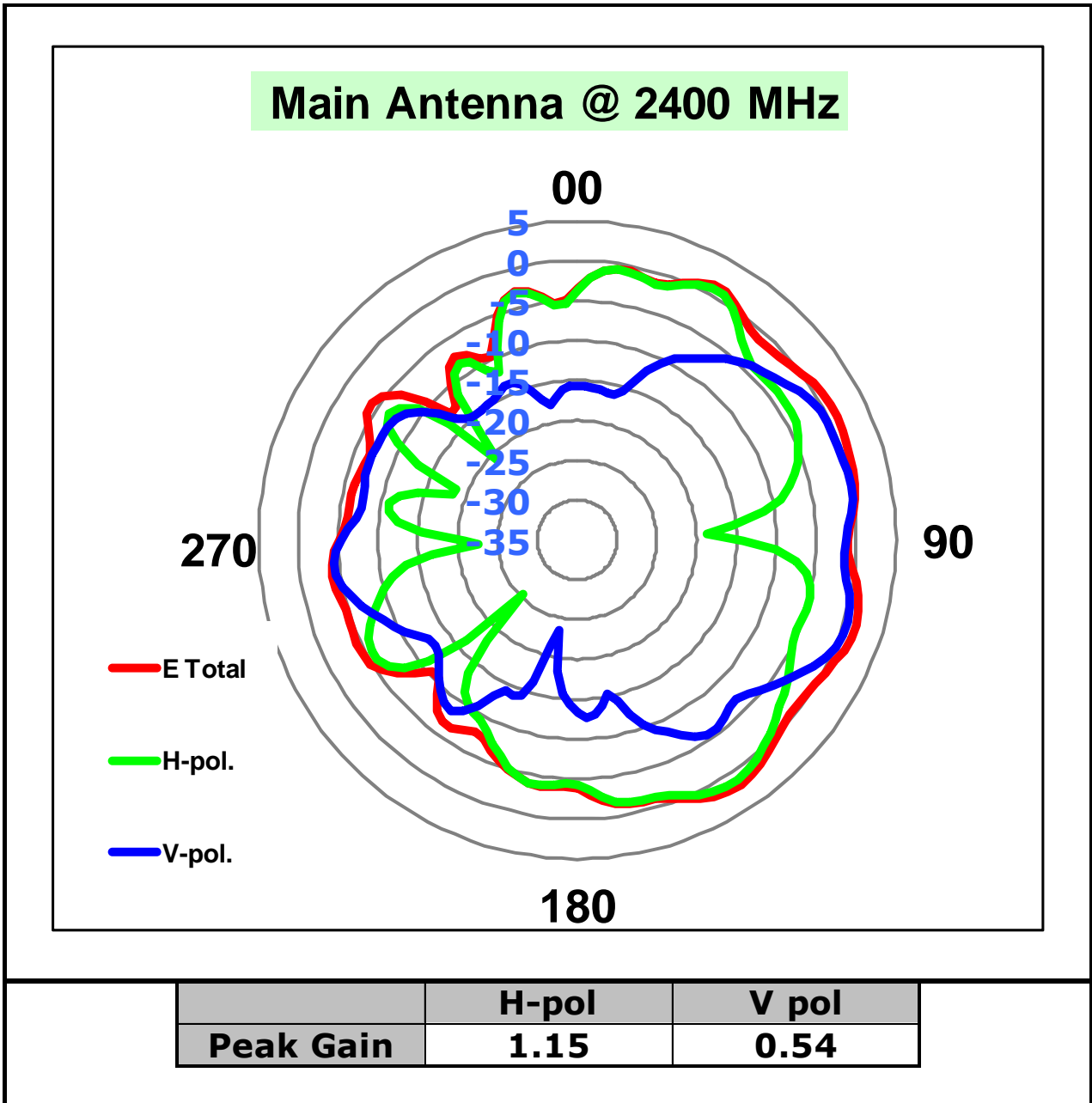

— Horizontal
— Vertical
— H + V

Center Frequency	2400 MHz
Horizontal (dBi) Peak	1.15
Vertical (dBi) Peak	0.54

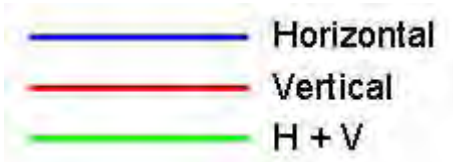
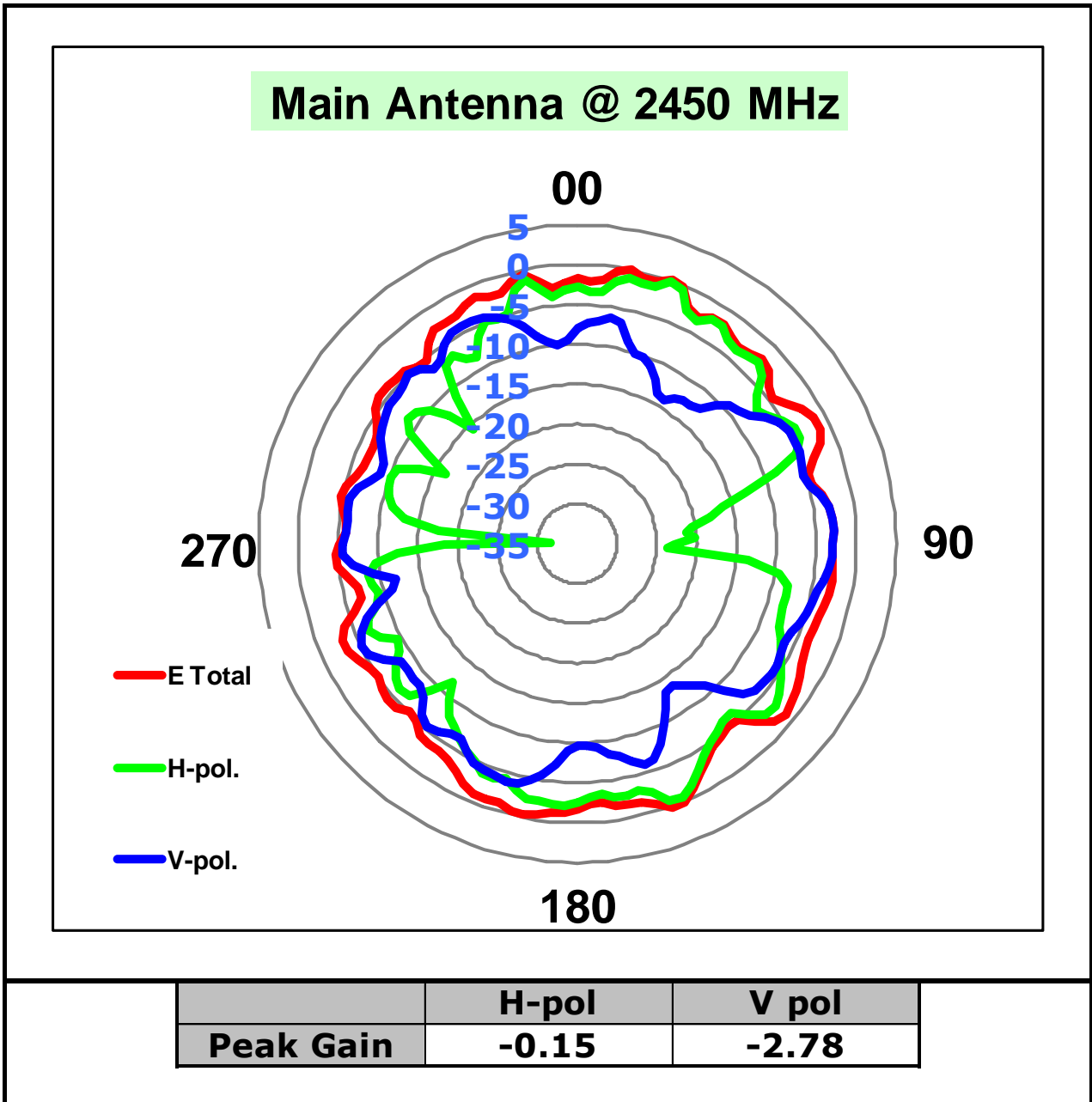

Center Frequency	2450 MHz
Horizontal (dBi) Peak	-0.15
Vertical (dBi) Peak	-2.78

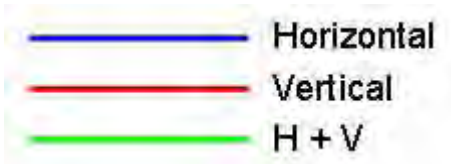
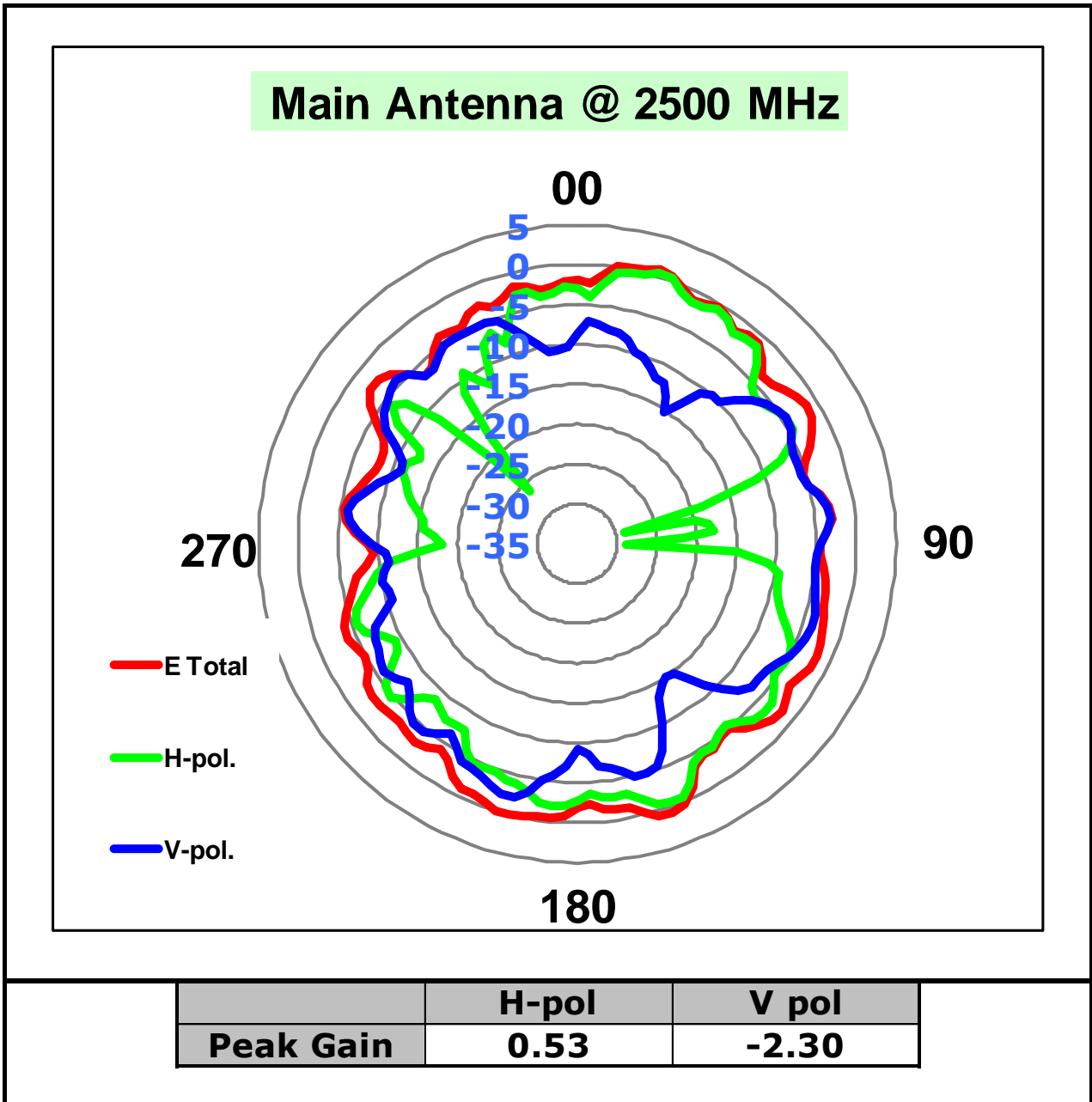

Center Frequency	2500 MHz
Horizontal (dBi) Peak	0.53
Vertical (dBi) Peak	-2.30

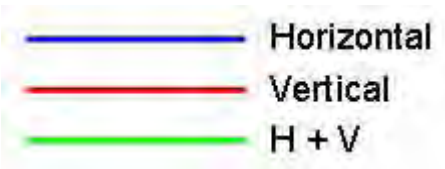
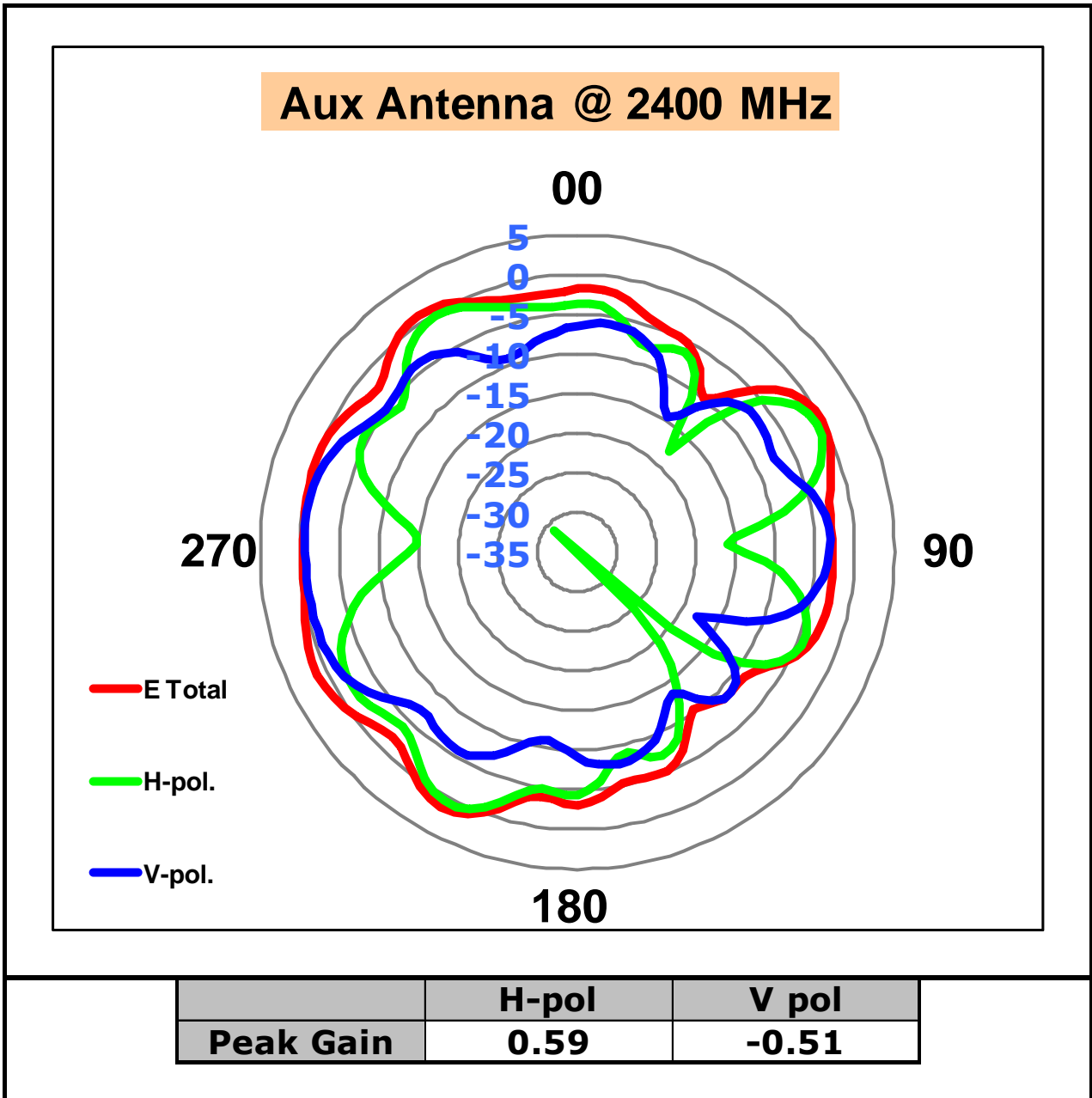

Center Frequency	2400 MHz
Horizontal (dBi) Peak	0.59
Vertical (dBi) Peak	-0.51

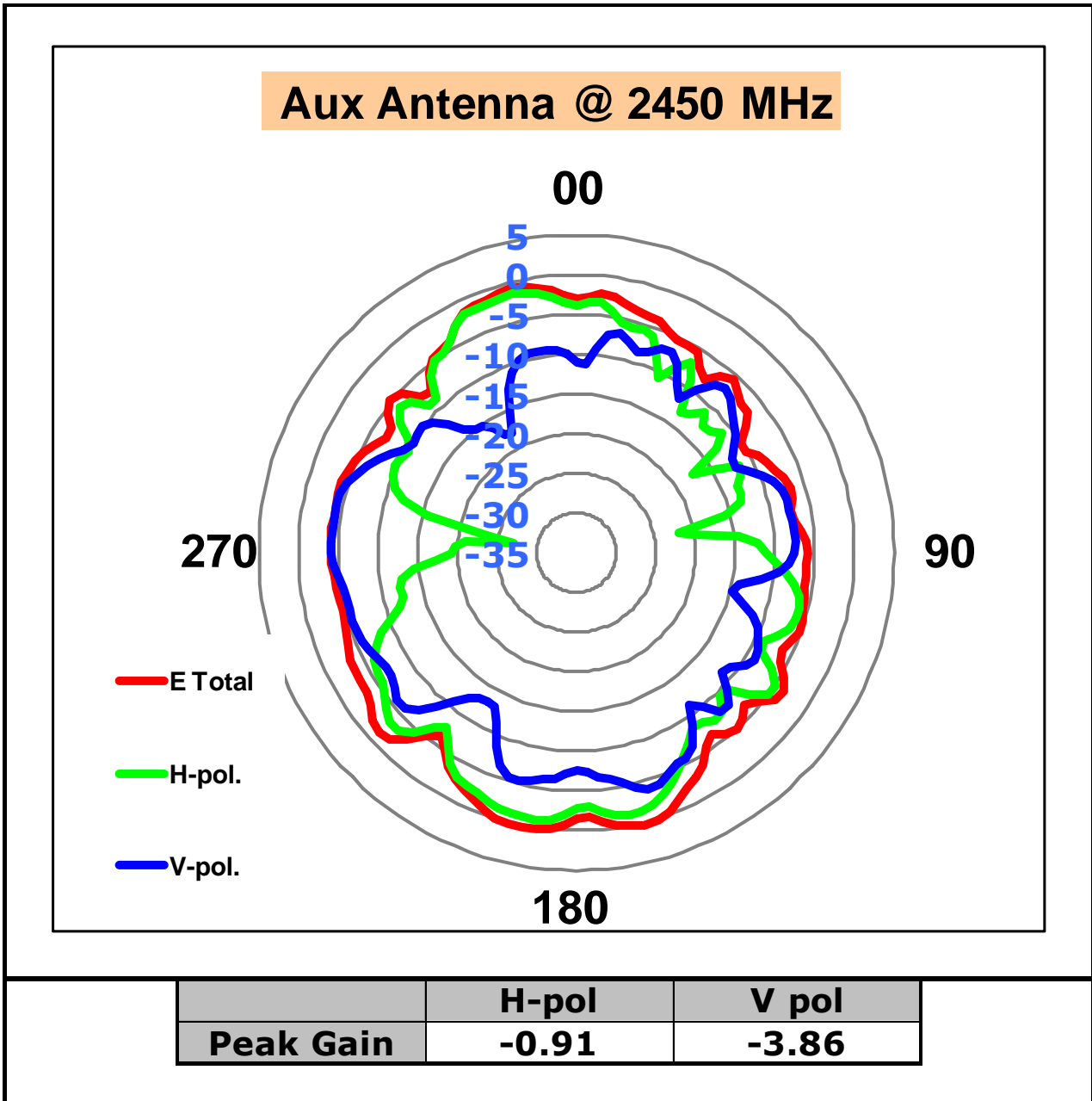

Center Frequency	2450 MHz
Horizontal (dBi) Peak	-0.91
Vertical (dBi) Peak	-3.86

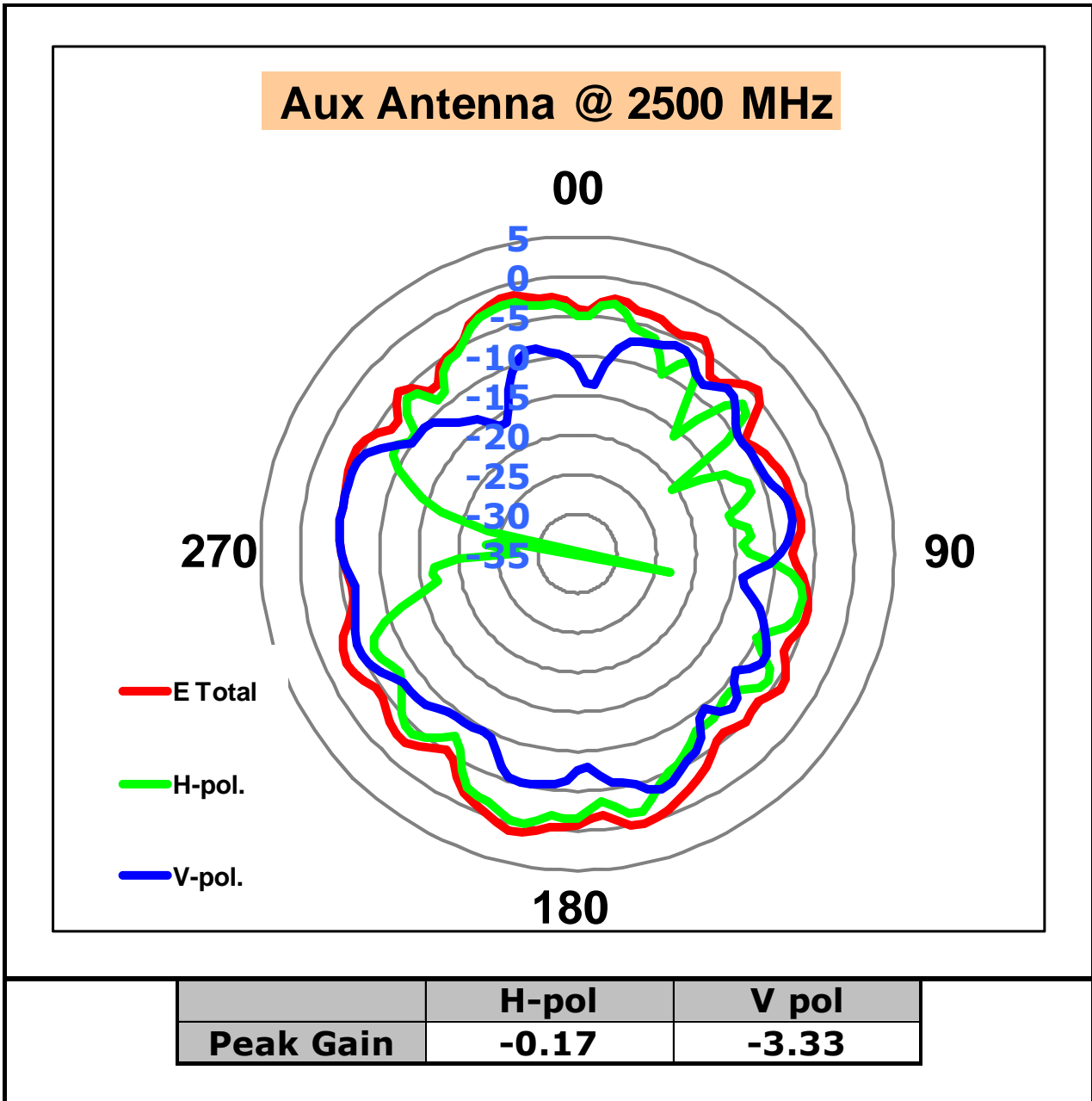

Center Frequency	2500 MHz
Horizontal (dBi) Peak	-0.17
Vertical (dBi) Peak	-3.33

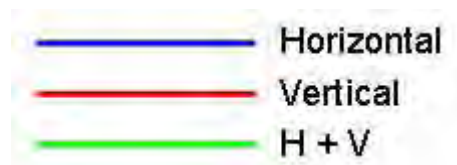
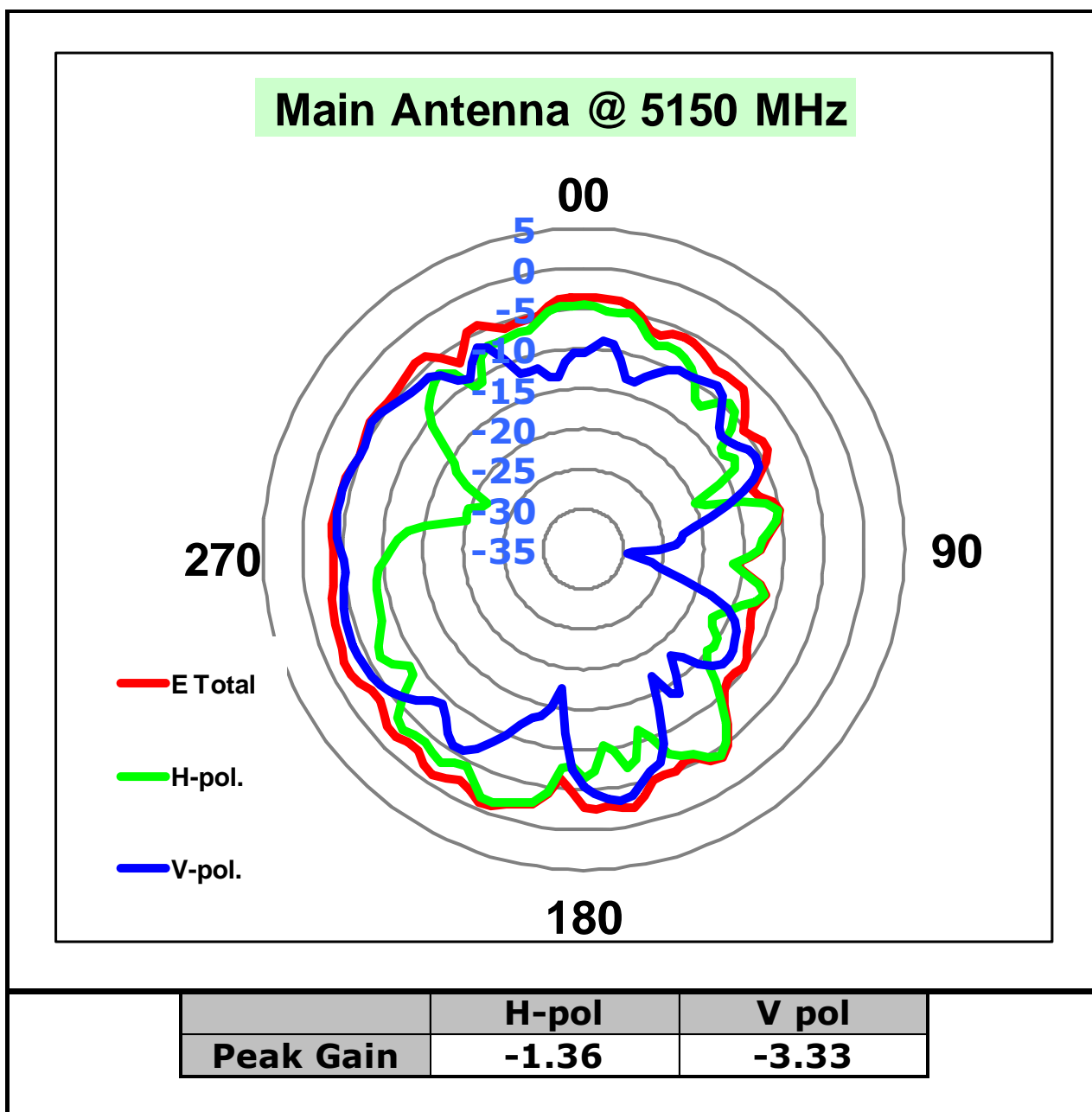

Center Frequency	5150 MHz
Horizontal (dBi) Peak	-1.36
Vertical (dBi) Peak	-3.33

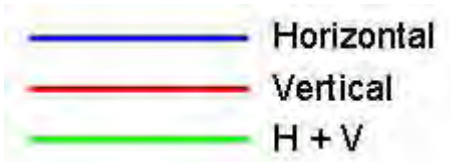
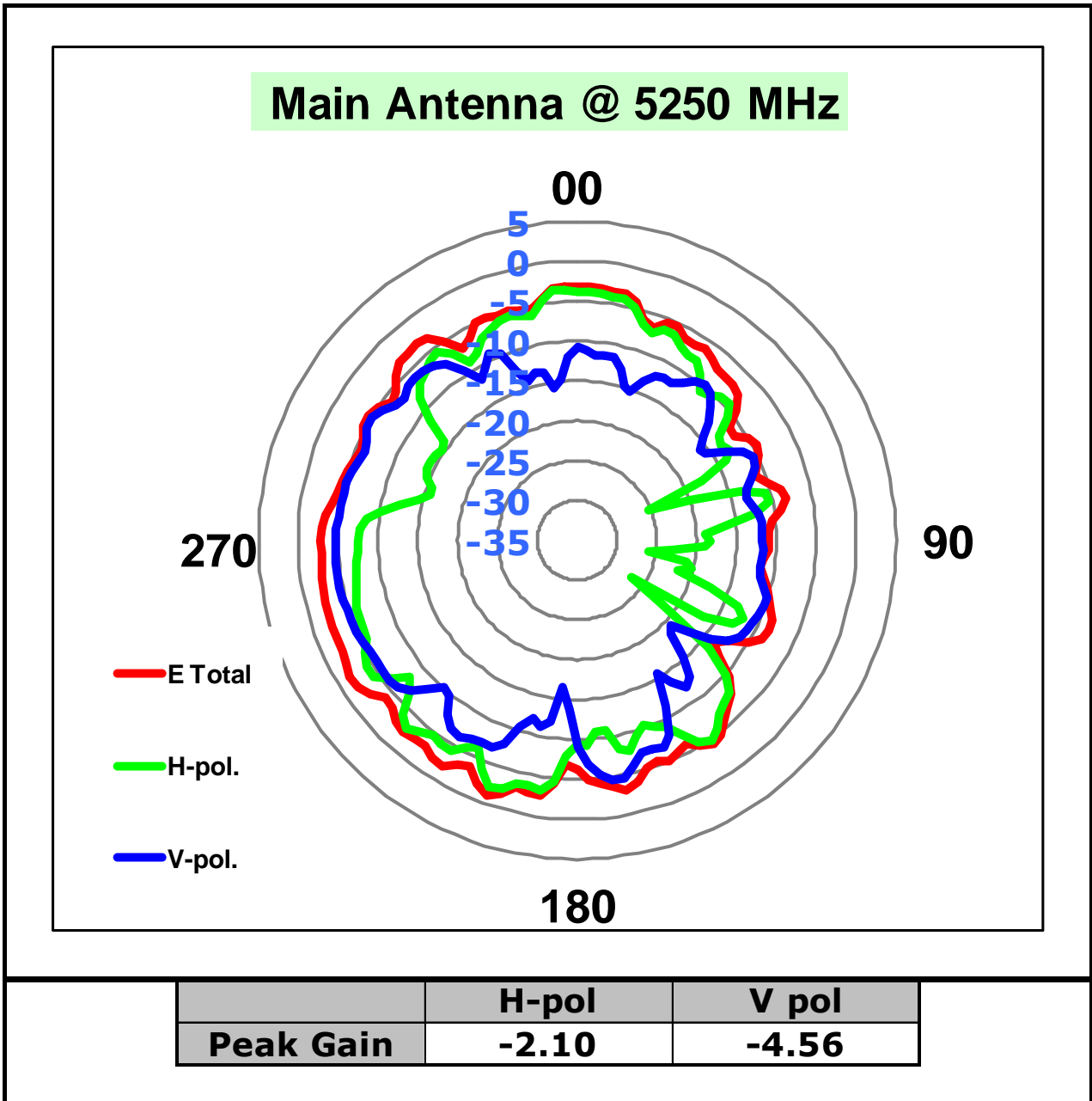

Center Frequency	5250 MHz
Horizontal (dBi) Peak	-2.10
Vertical (dBi) Peak	-4.56

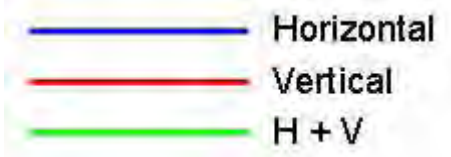
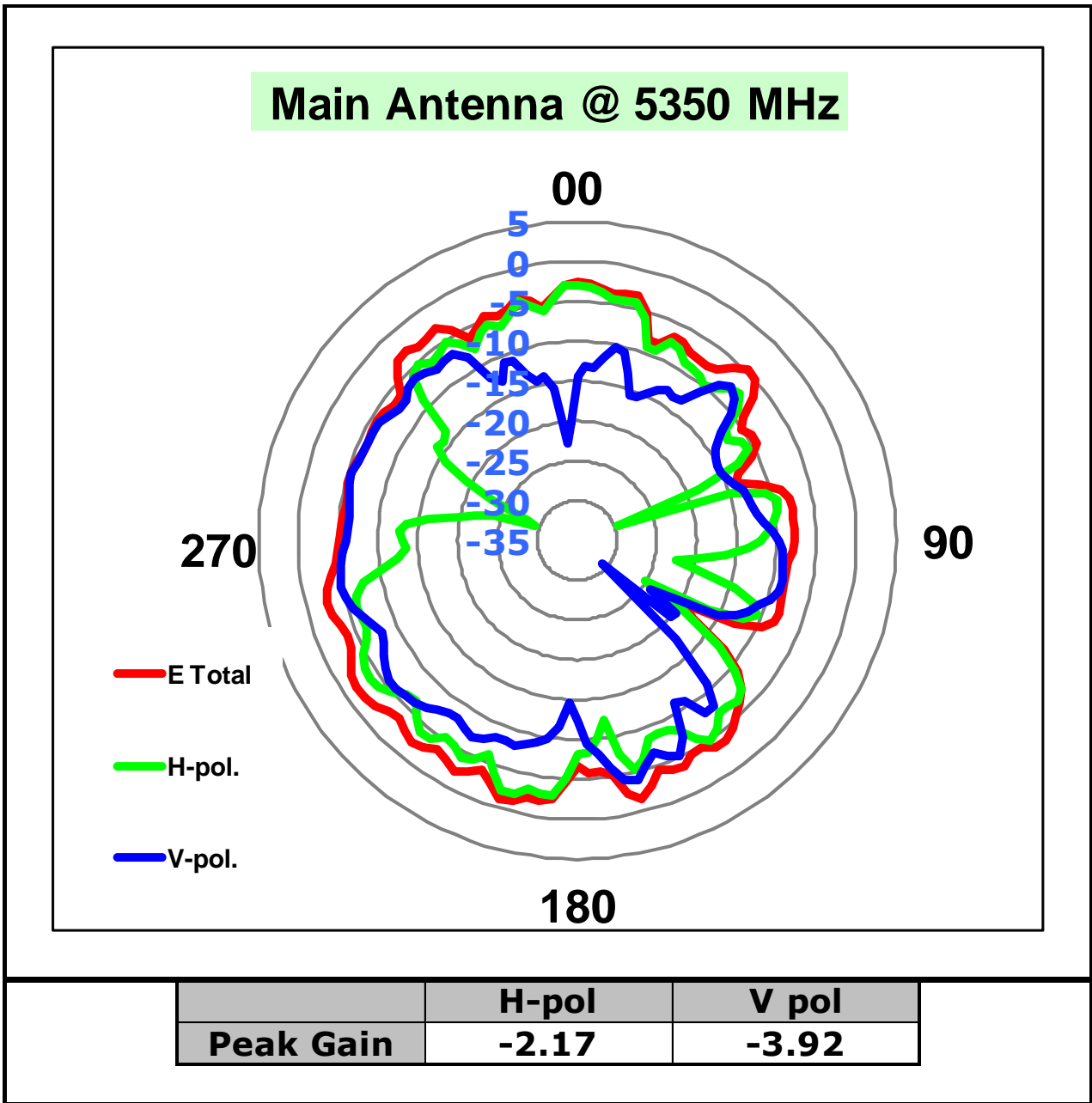

Center Frequency	5350 MHz
Horizontal (dBi) Peak	-2.17
Vertical (dBi) Peak	-3.92

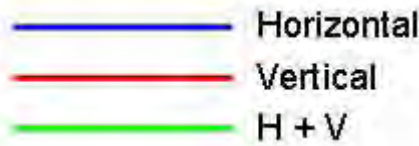
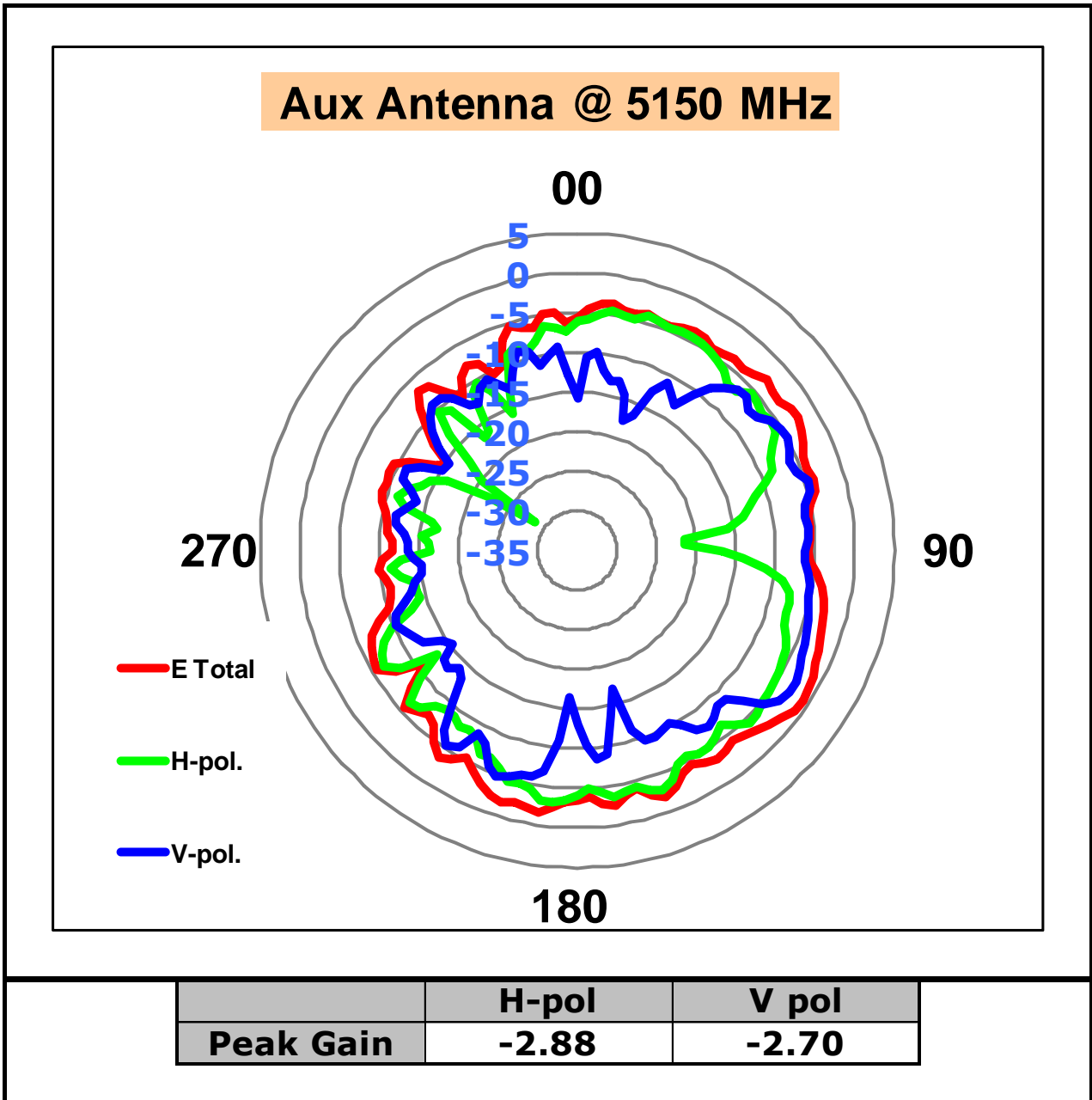

Center Frequency	5150 MHz
Horizontal (dBi) Peak	-2.88
Vertical (dBi) Peak	-2.70

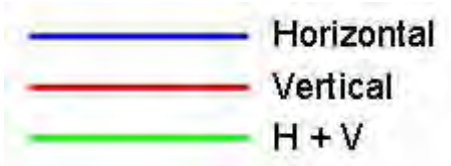
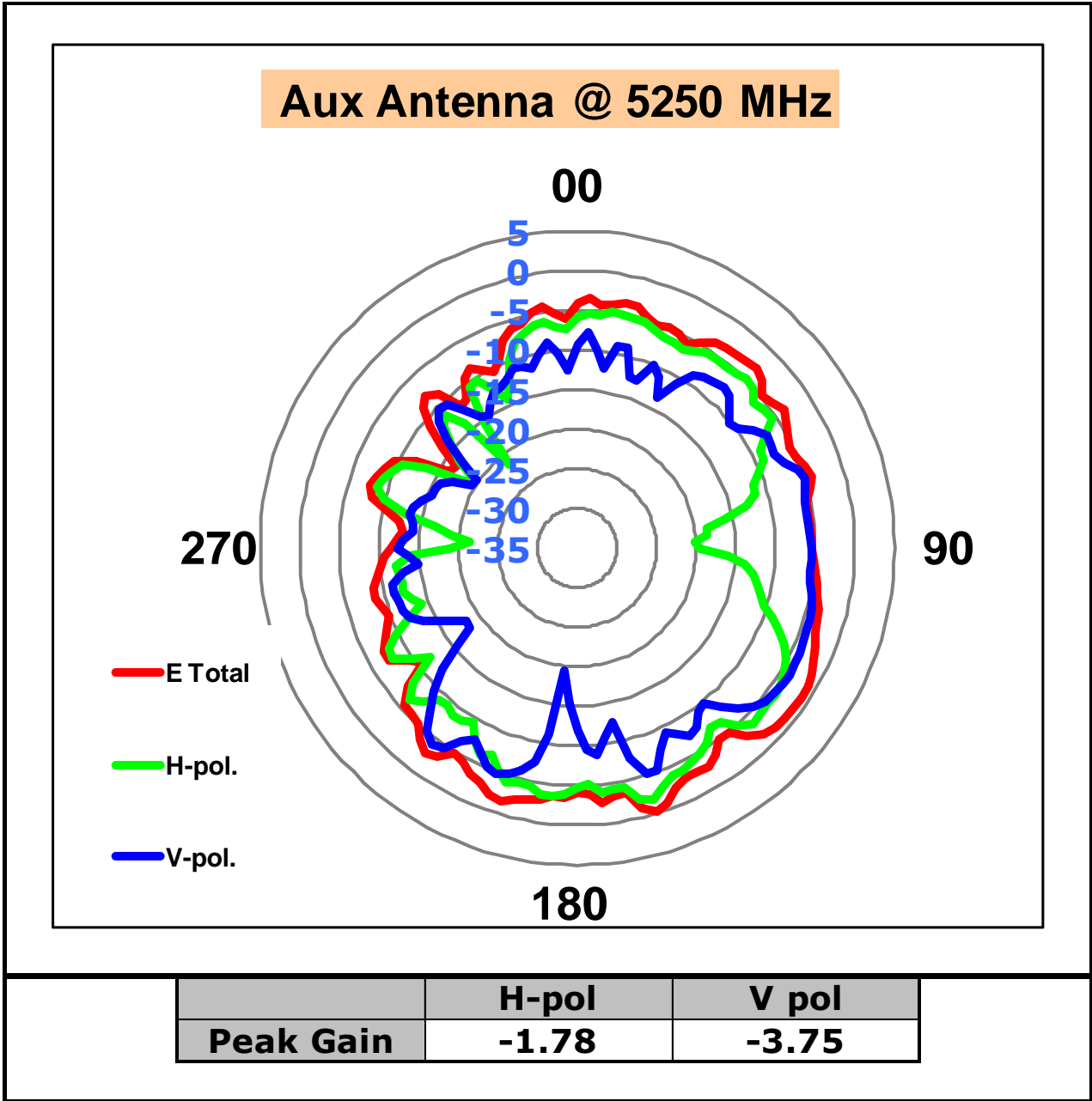

Center Frequency	5250 MHz
Horizontal (dBi) Peak	-1.78
Vertical (dBi) Peak	-3.75

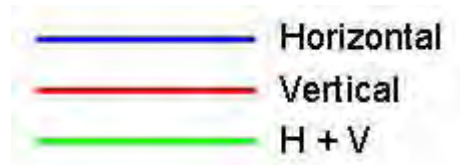
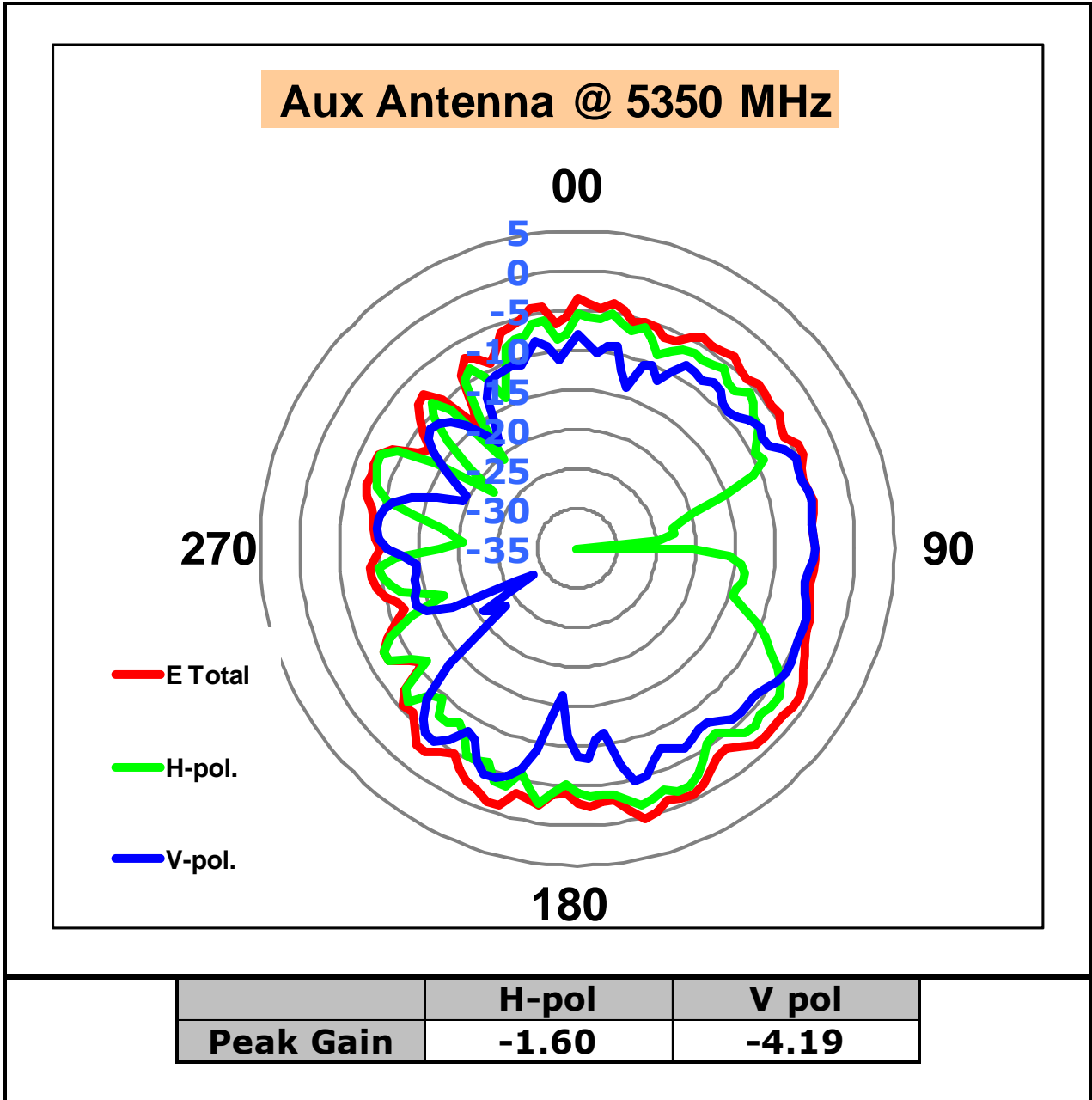

Center Frequency	5350 MHz
Horizontal (dBi) Peak	-1.60
Vertical (dBi) Peak	-4.19

Tx1 antenna: 5470 MHz

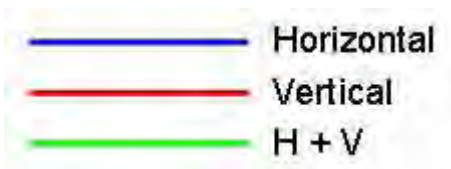
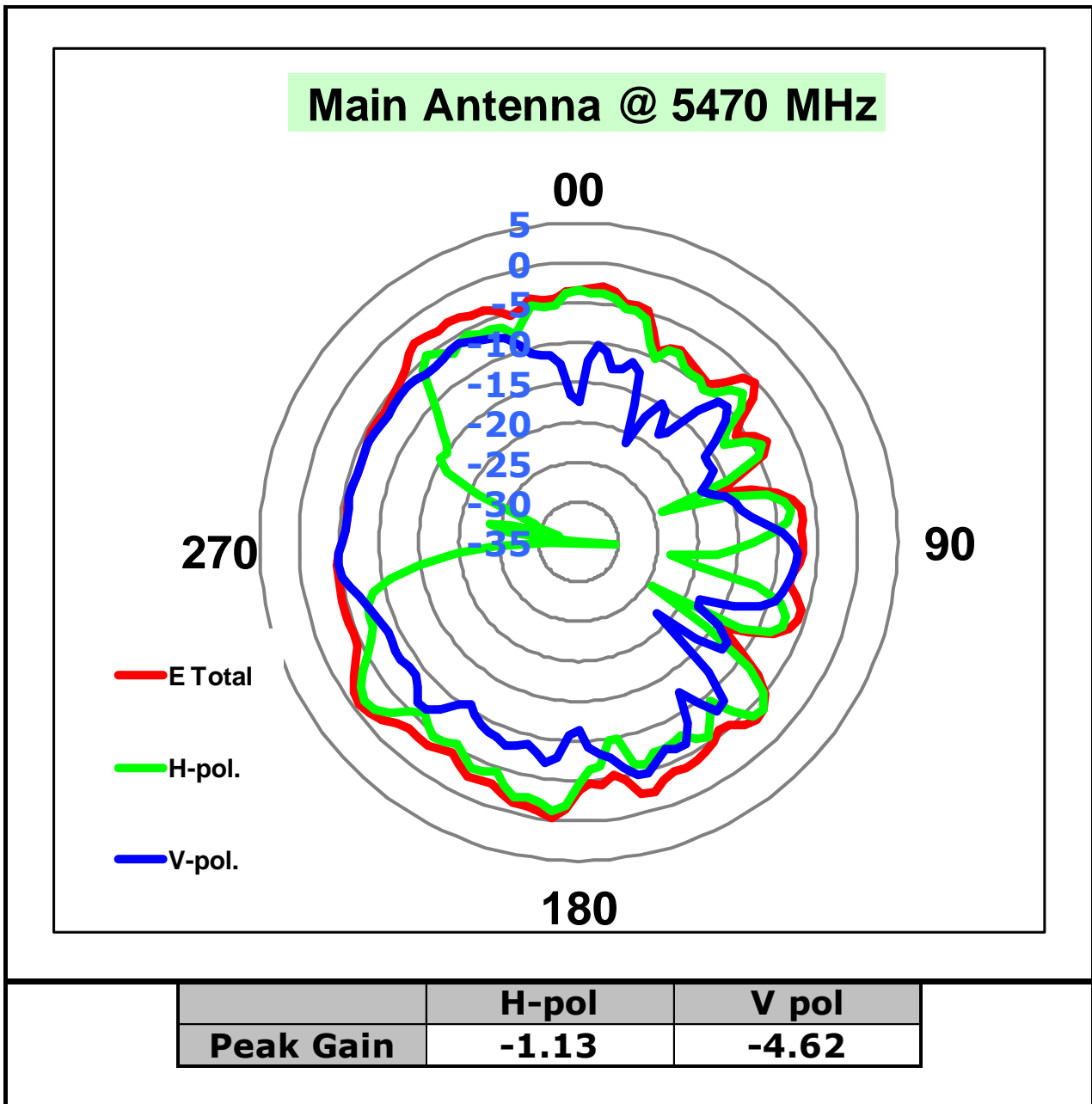

Center Frequency	5470 MHz
Horizontal (dBi) Peak	-1.13
Vertical (dBi) Peak	-4.62

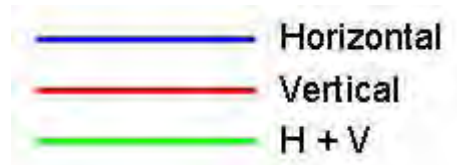
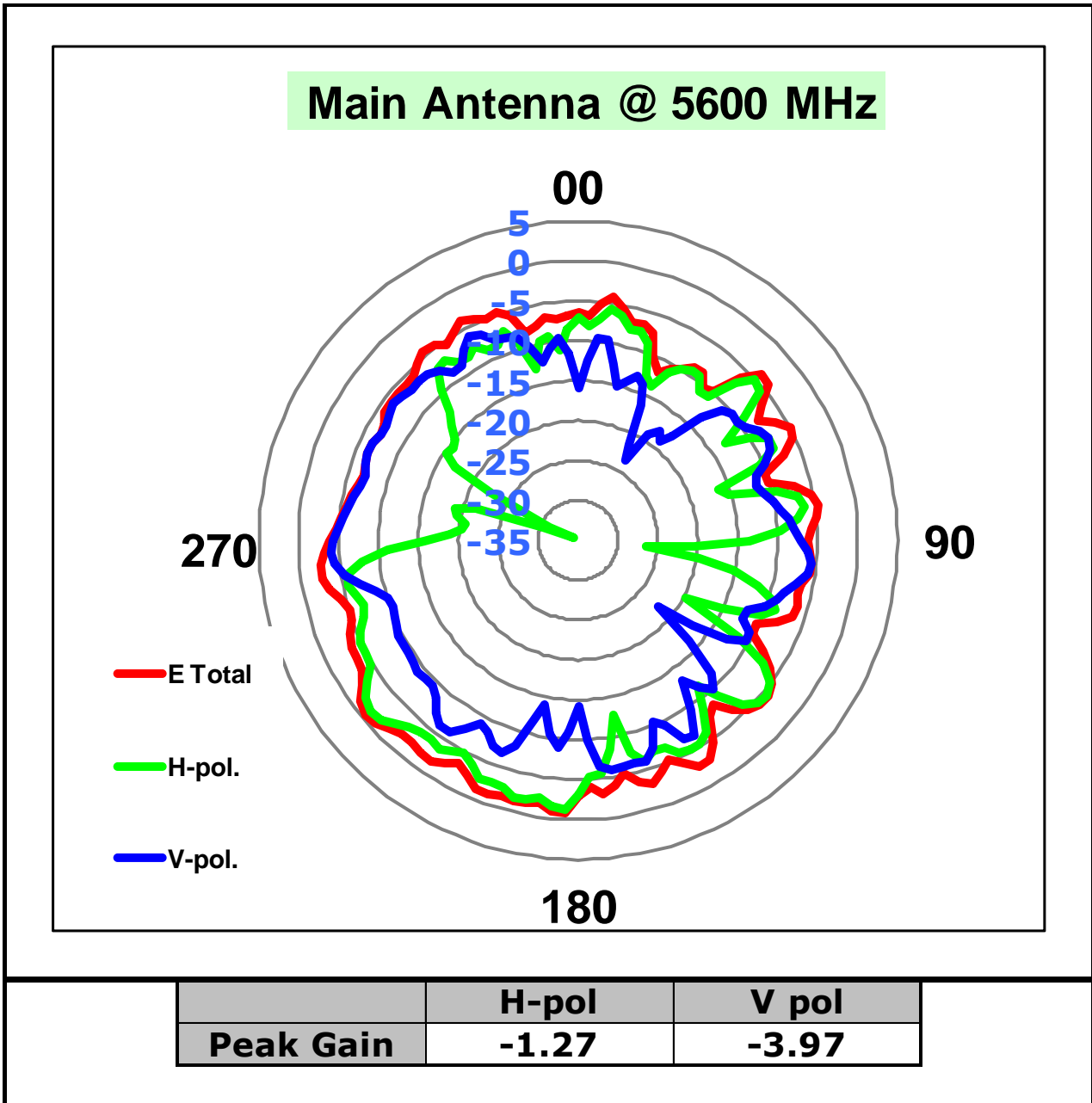

Center Frequency	5600 MHz
Horizontal (dBi) Peak	-1.27
Vertical (dBi) Peak	-3.97

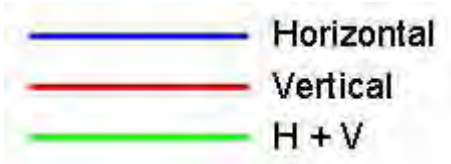
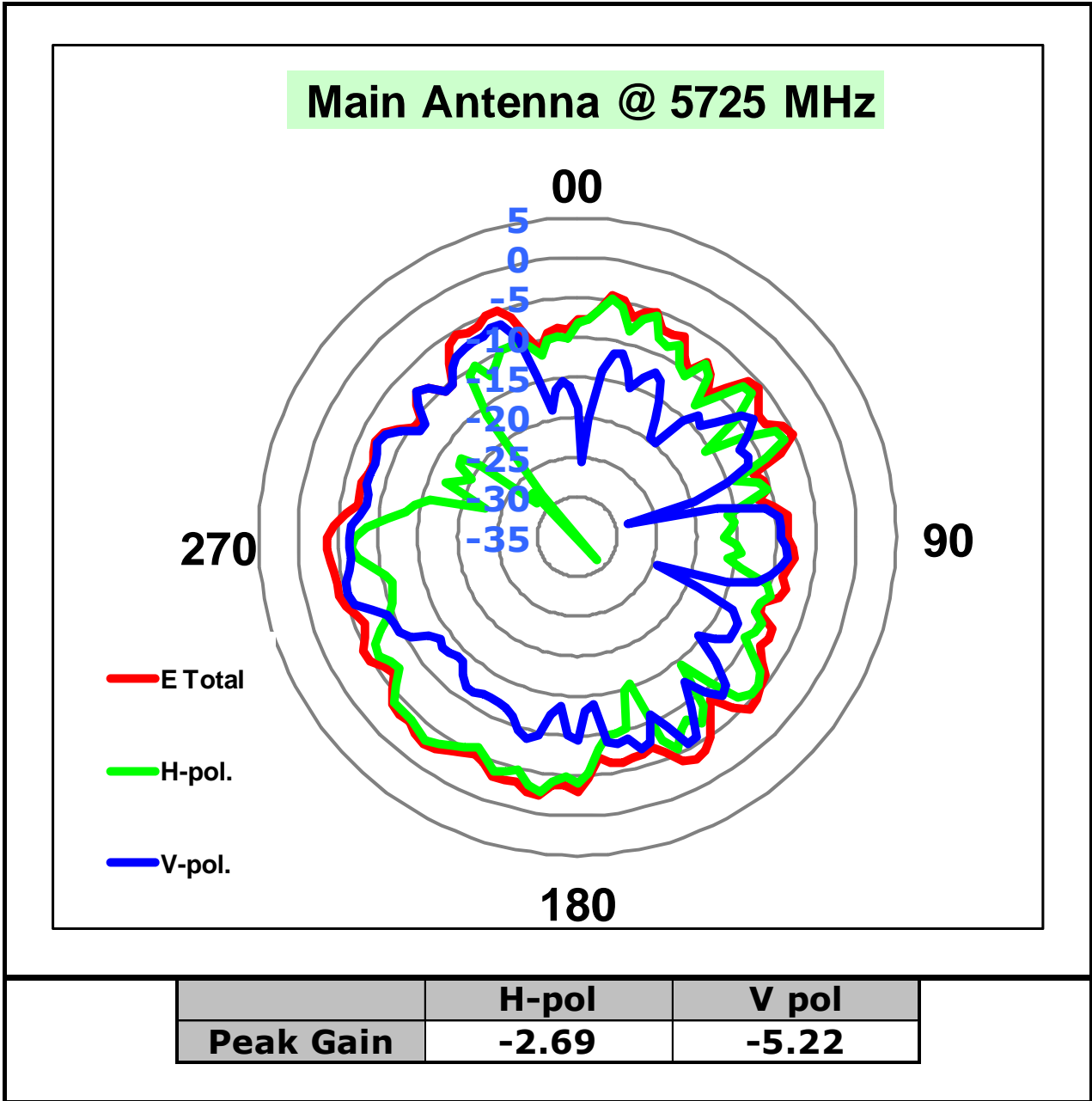

Center Frequency	5725 MHz
Horizontal (dBi) Peak	-2.69
Vertical (dBi) Peak	-5.22

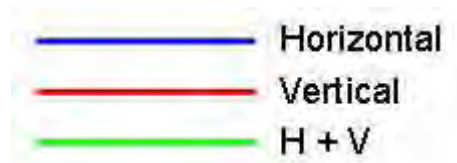
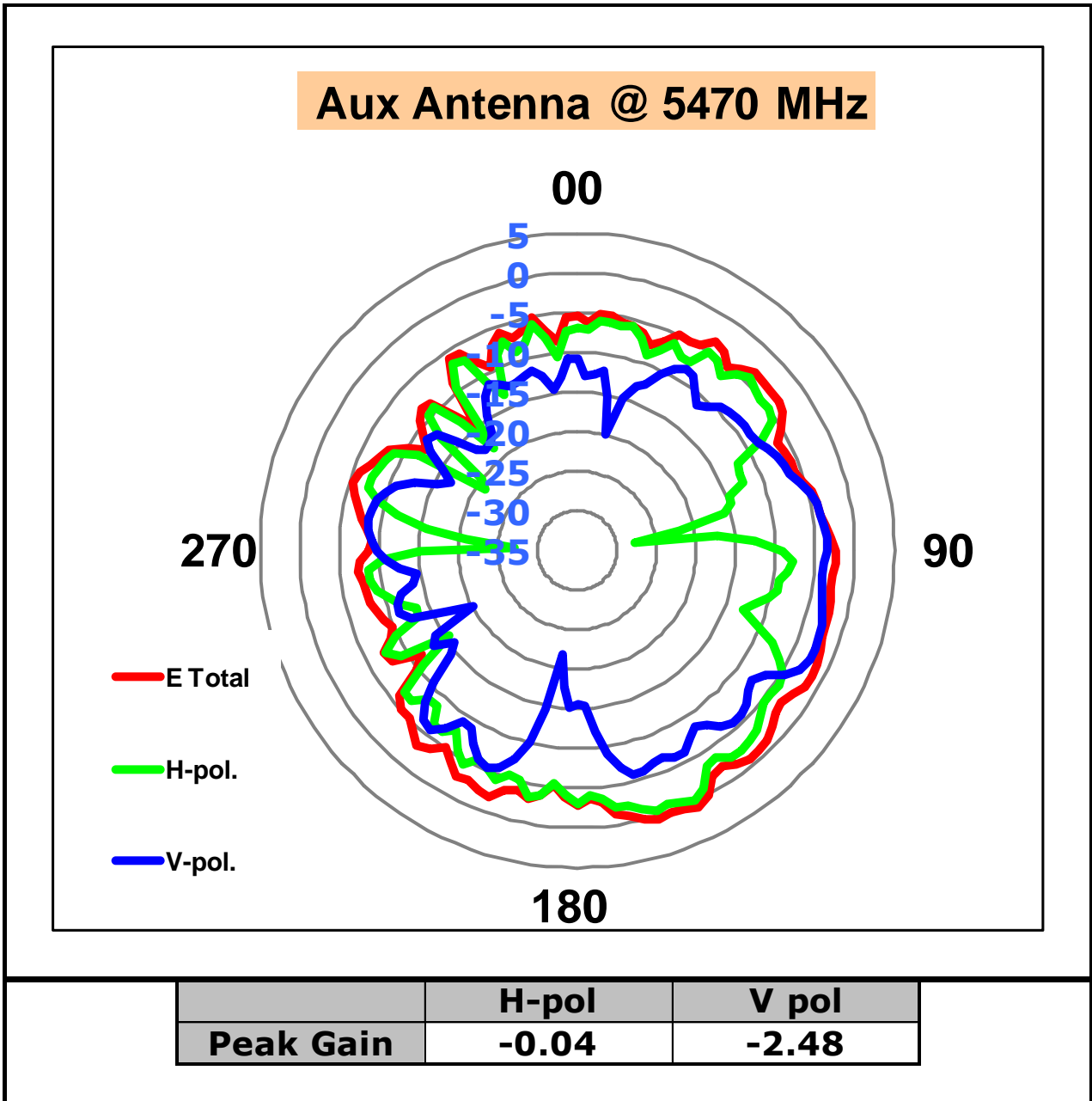

Center Frequency	5470 MHz
Horizontal (dBi) Peak	-0.04
Vertical (dBi) Peak	-2.48

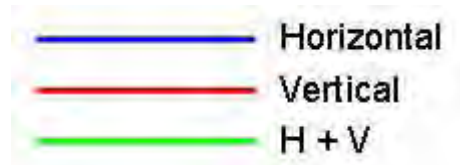
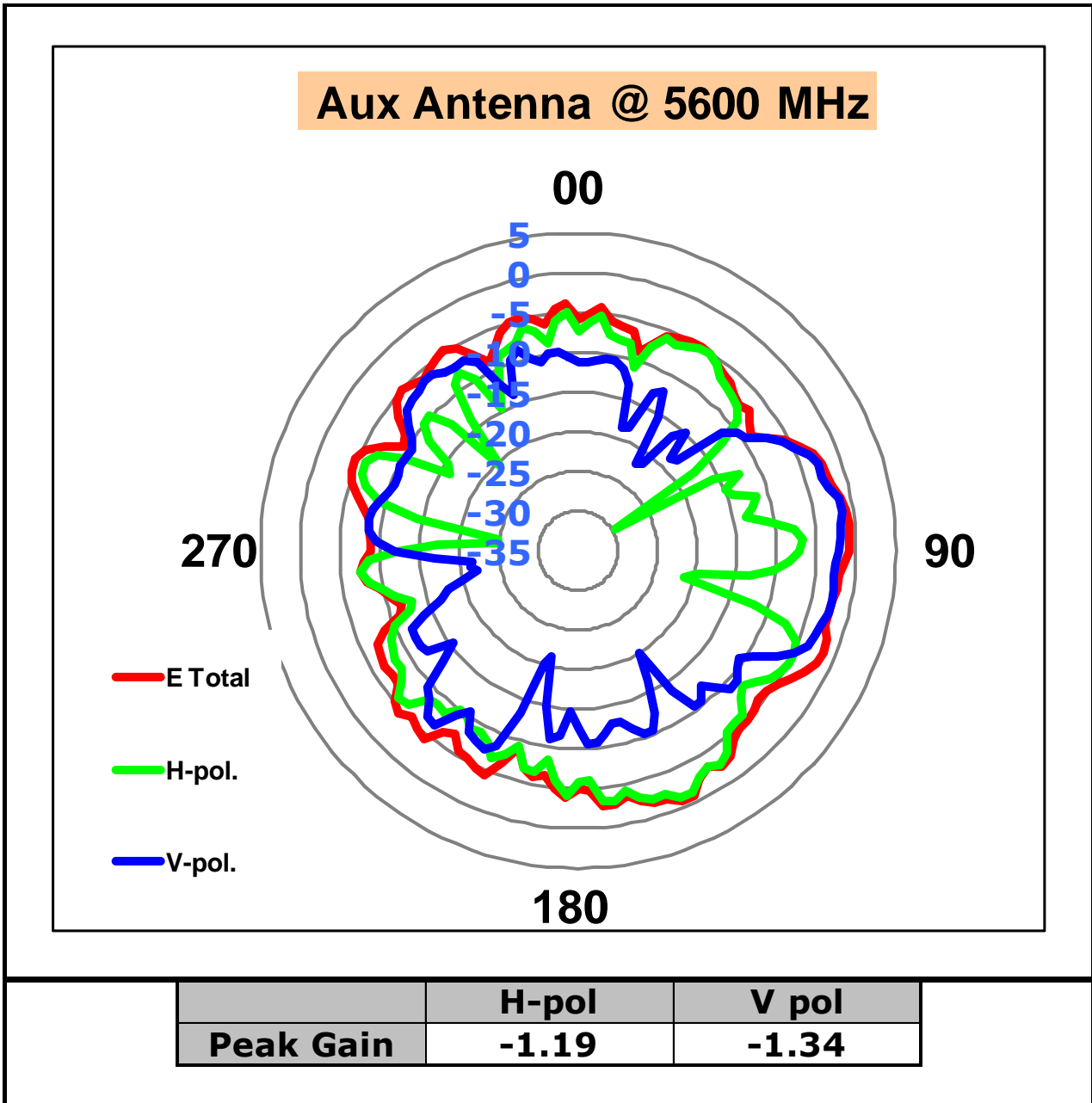

Center Frequency	5600 MHz
Horizontal (dBi) Peak	-1.19
Vertical (dBi) Peak	-1.34

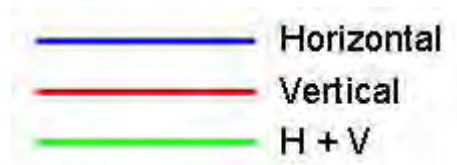
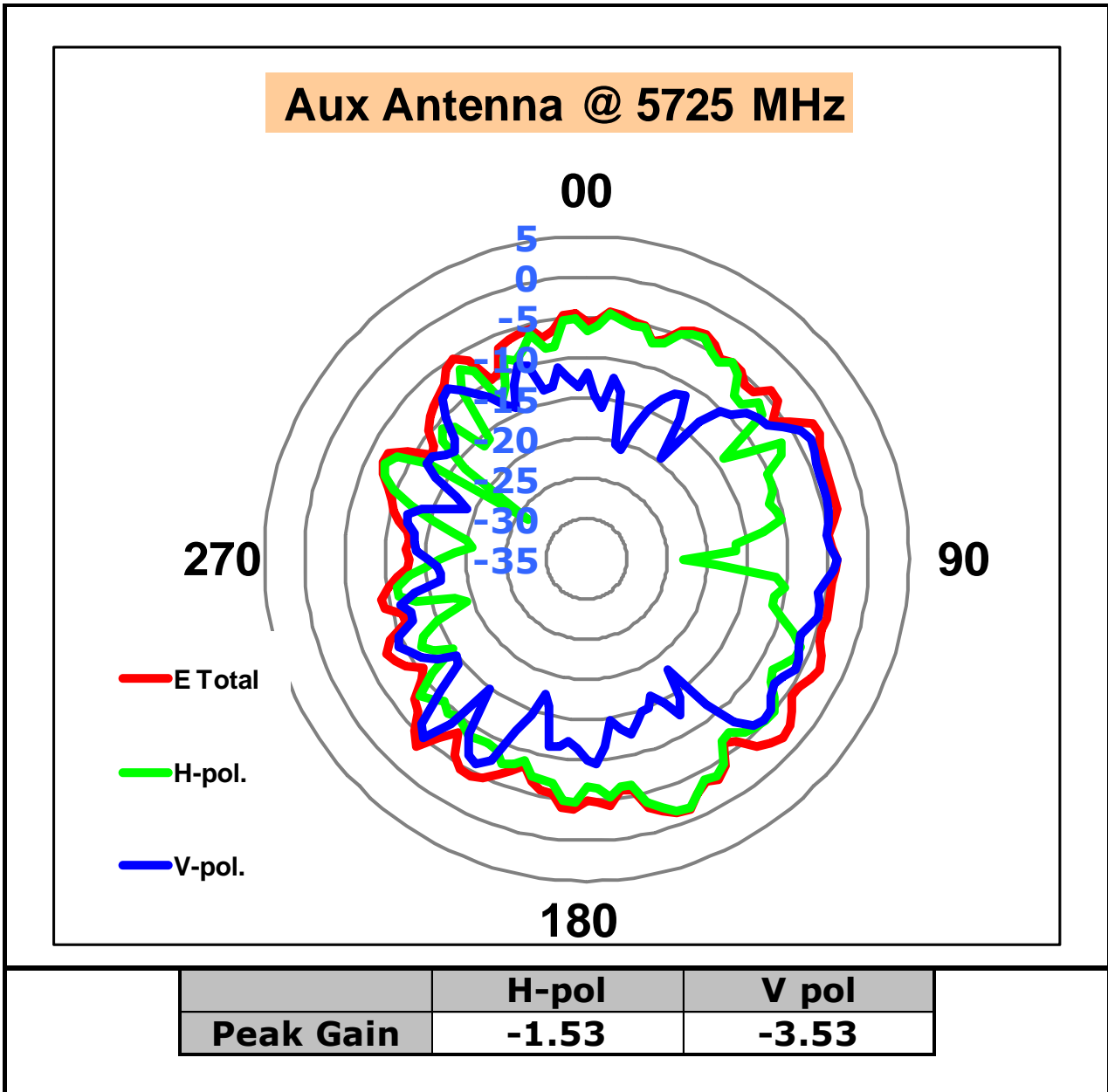

Center Frequency	5725 MHz
Horizontal (dBi) Peak	-1.53
Vertical (dBi) Peak	-3.53

5725-5850 MHz radiation characteristic

Tx1 antenna: 5725 MHz

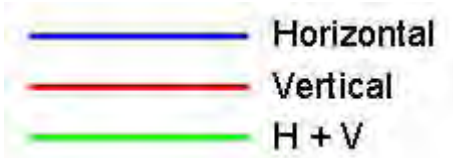
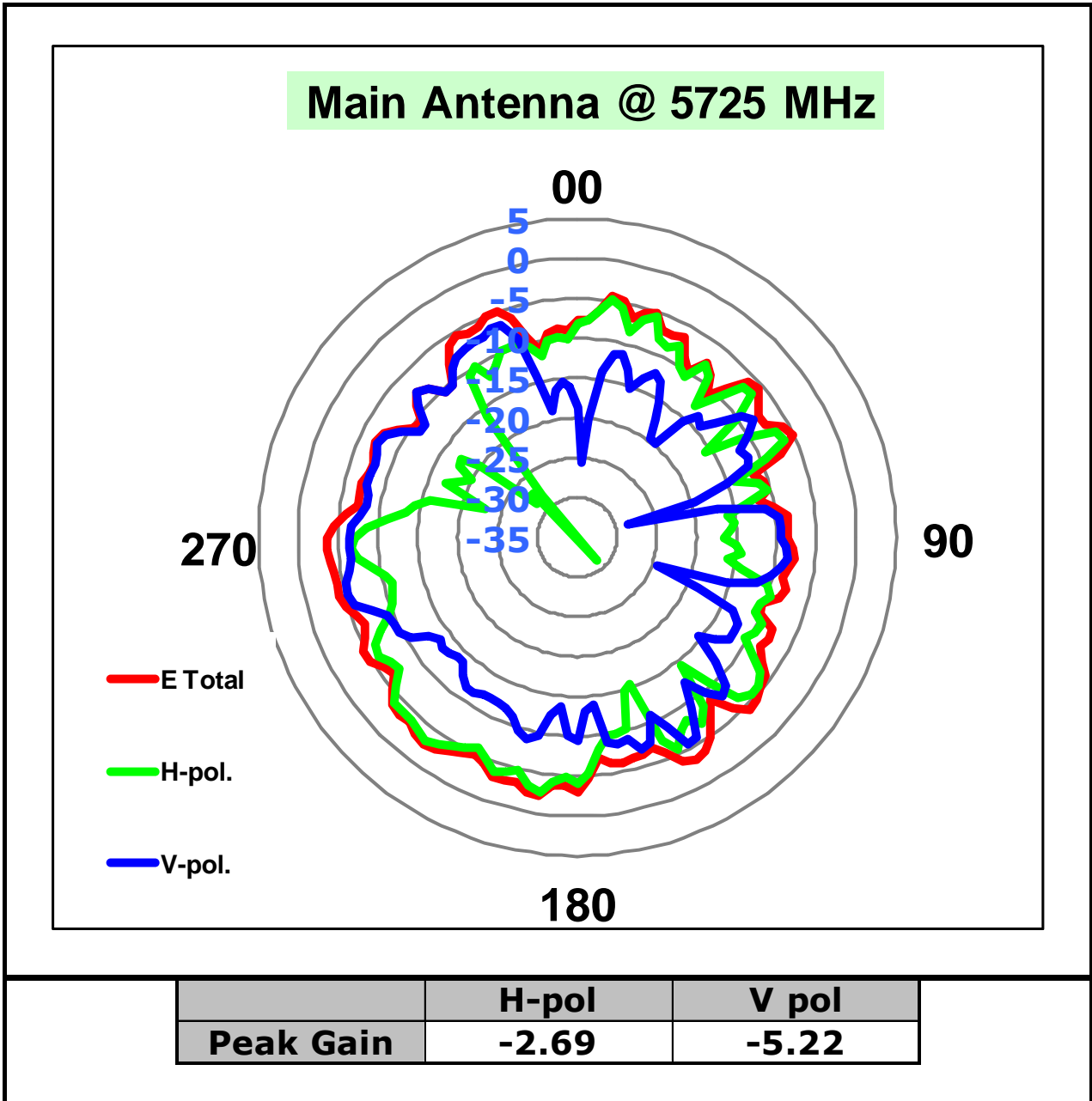

Center Frequency	5725 MHz
Horizontal (dBi) Peak	-2.69
Vertical (dBi) Peak	-5.22

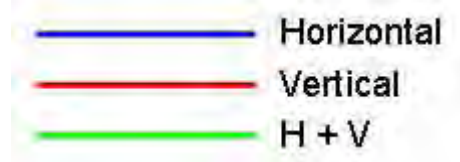
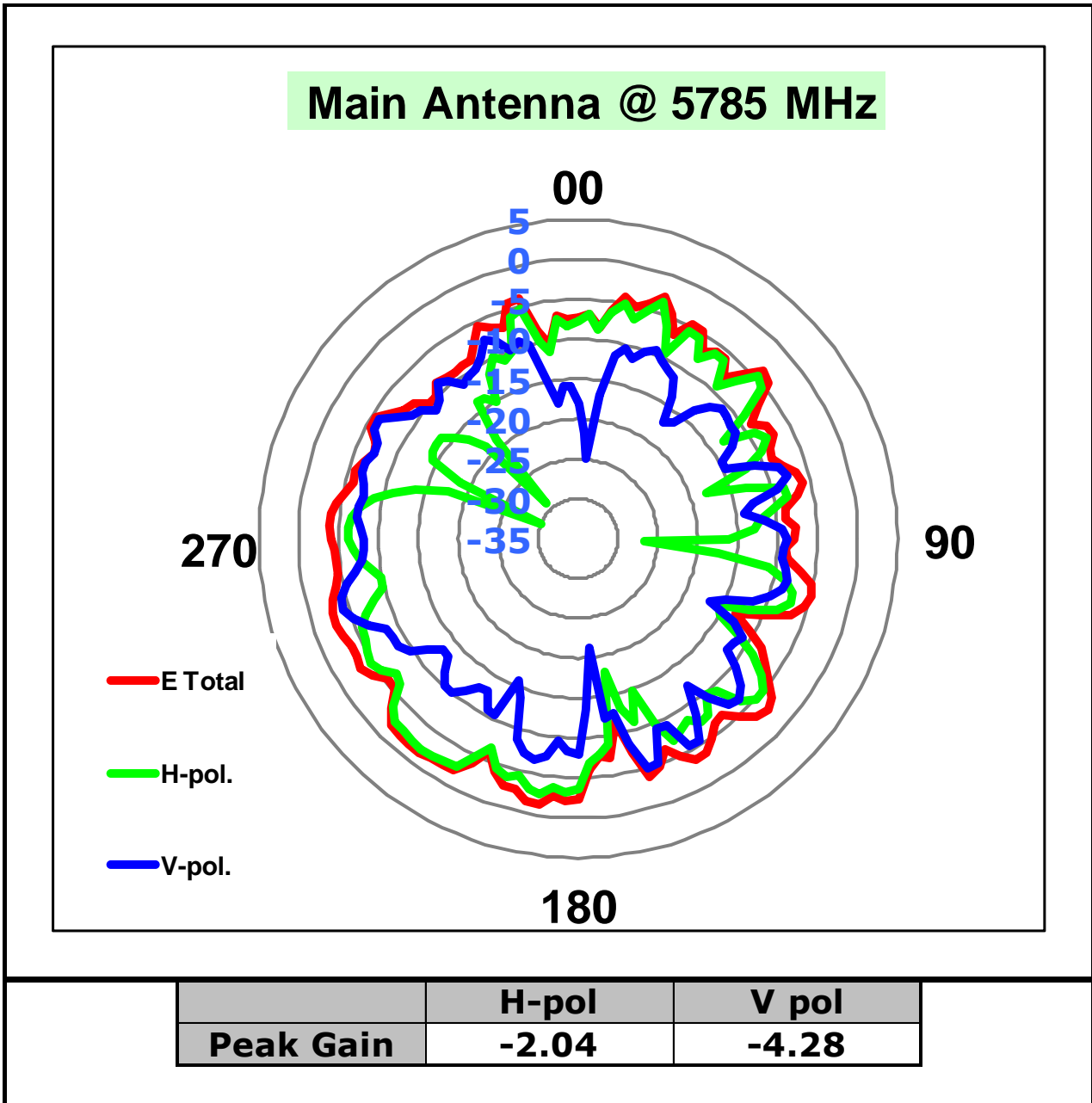

Center Frequency	5785 MHz
Horizontal (dBi) Peak	-2.04
Vertical (dBi) Peak	-4.28

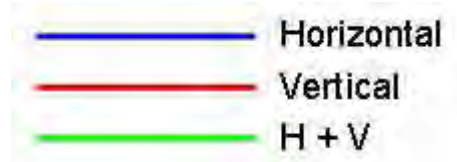
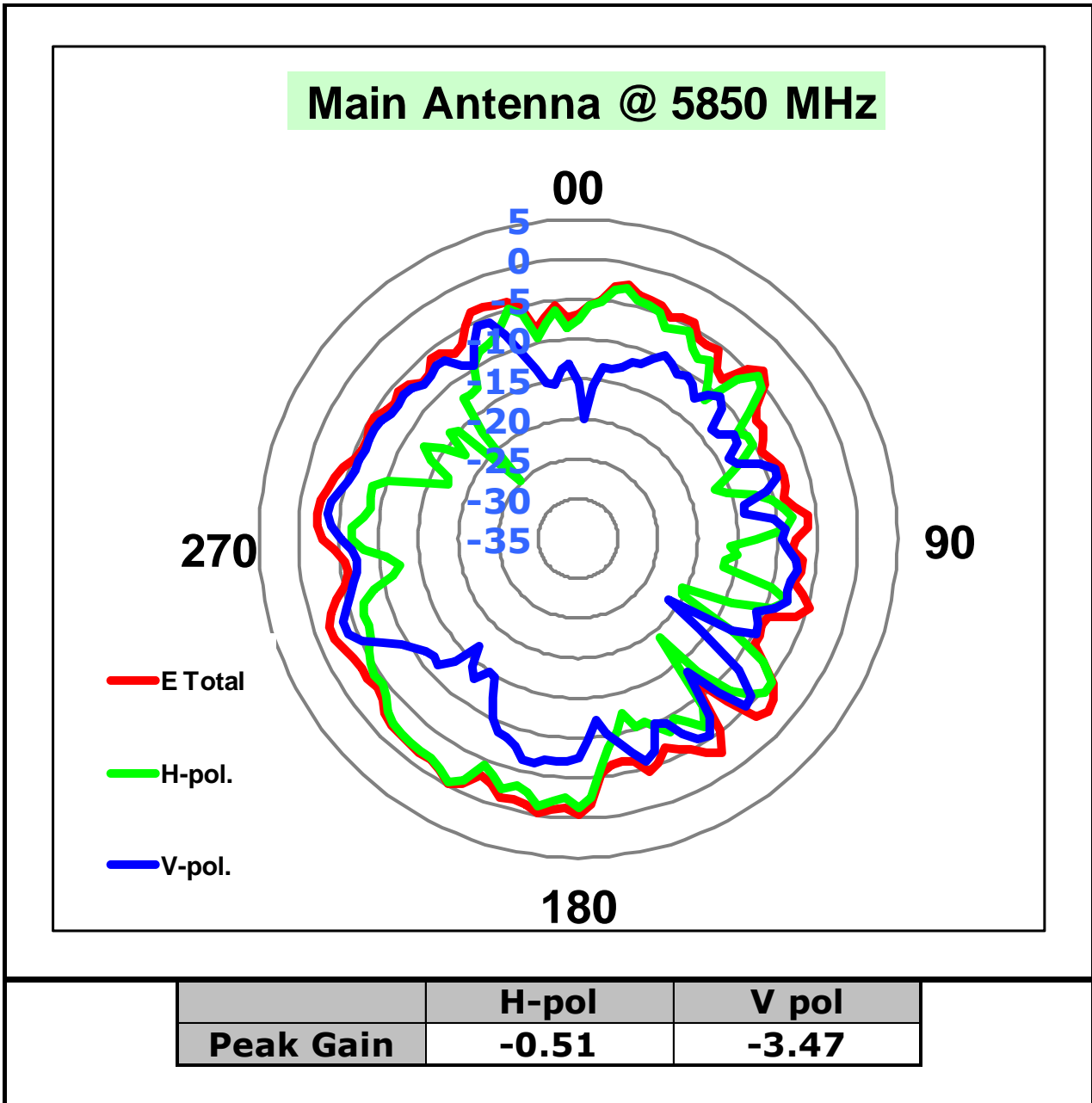

Center Frequency	5850 MHz
Horizontal (dBi) Peak	-0.51
Vertical (dBi) Peak	-3.47

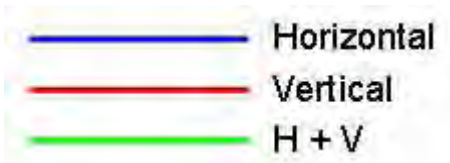
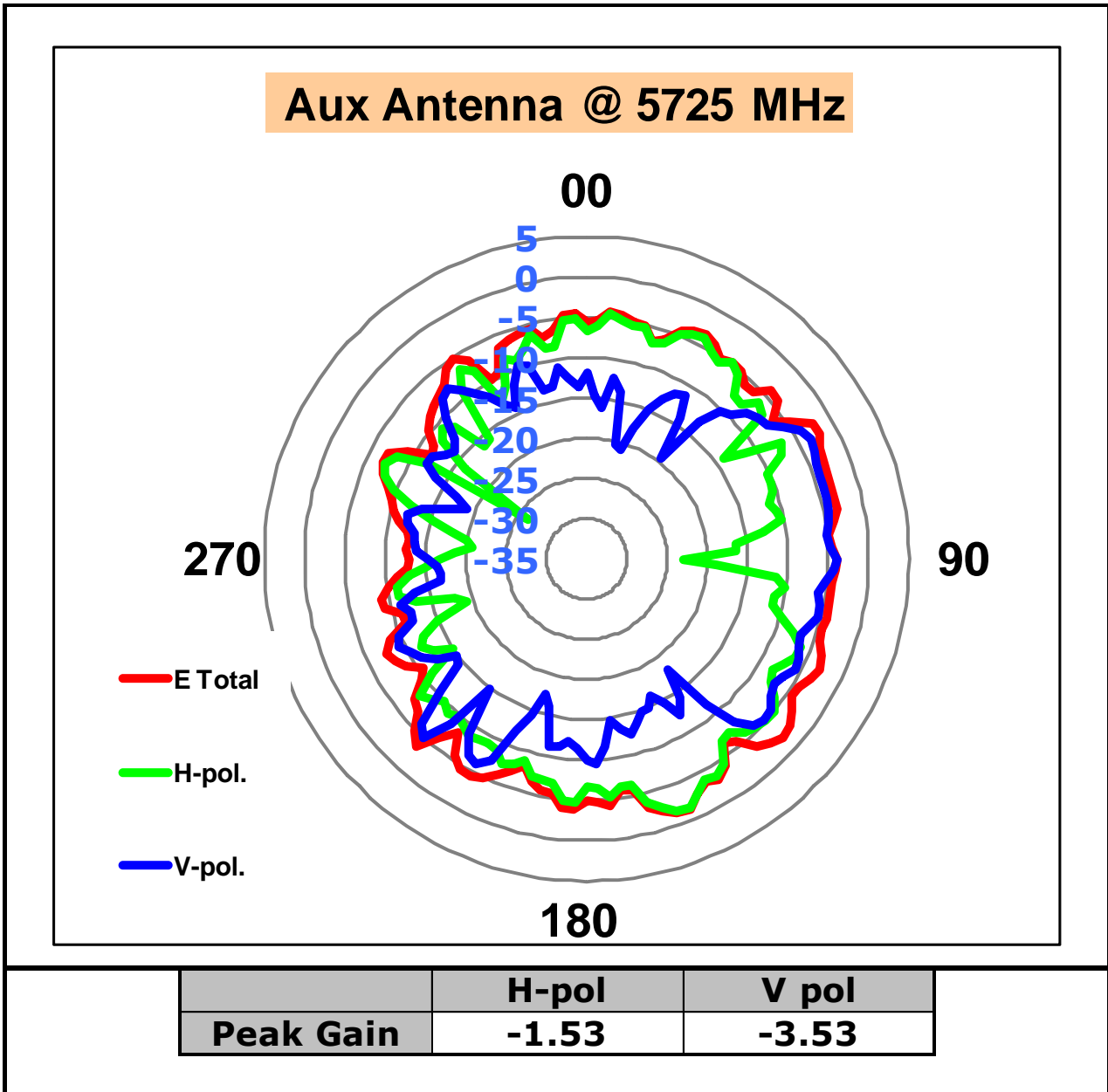

Center Frequency	5725 MHz
Horizontal (dBi) Peak	-1.53
Vertical (dBi) Peak	-3.53

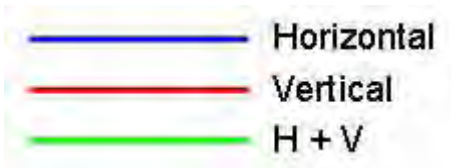
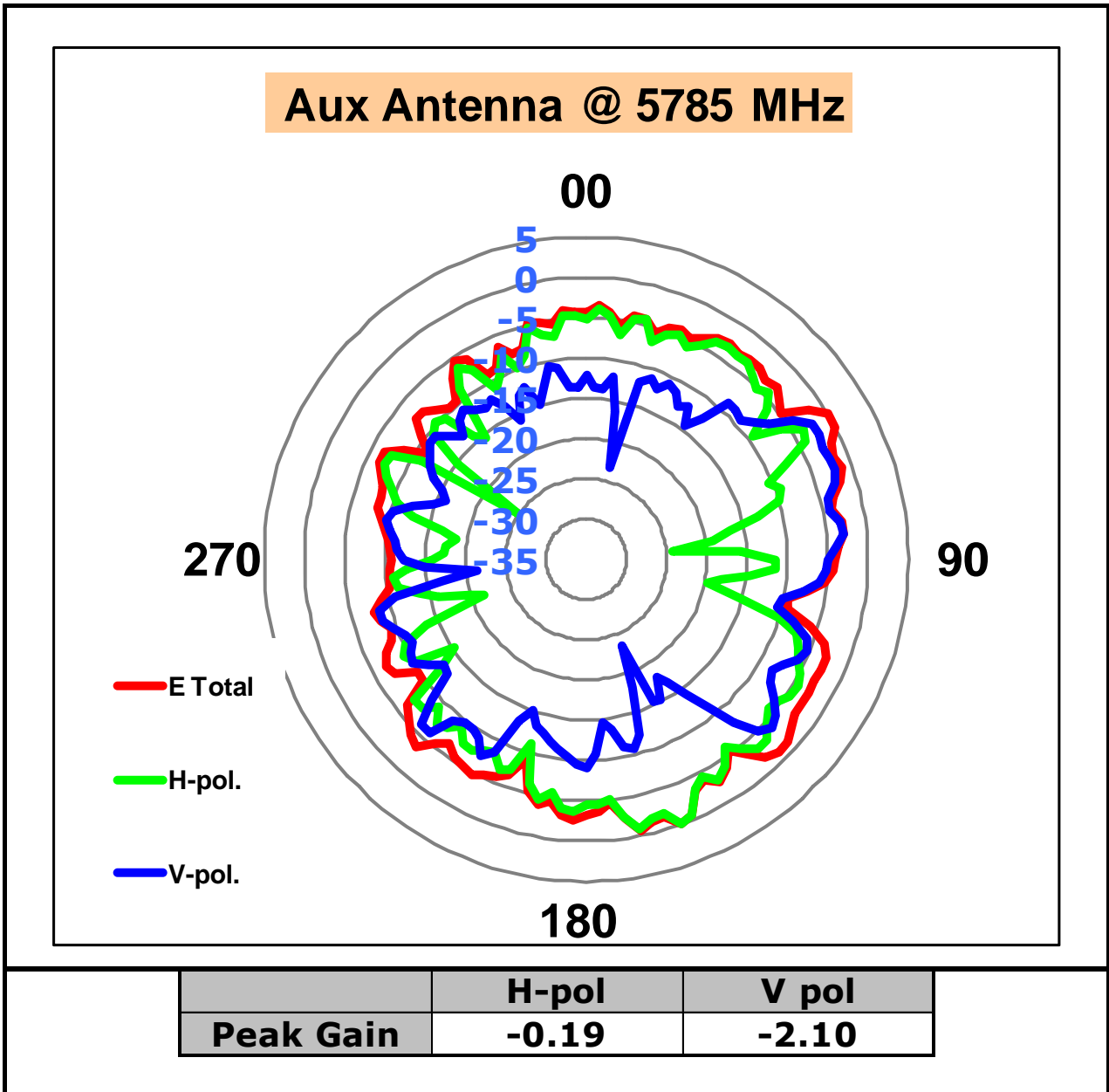

Center Frequency	5785 MHz
Horizontal (dBi) Peak	-0.19
Vertical (dBi) Peak	-2.10

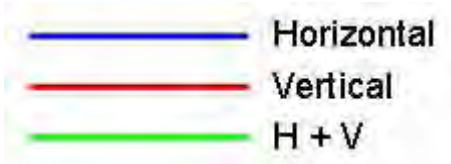
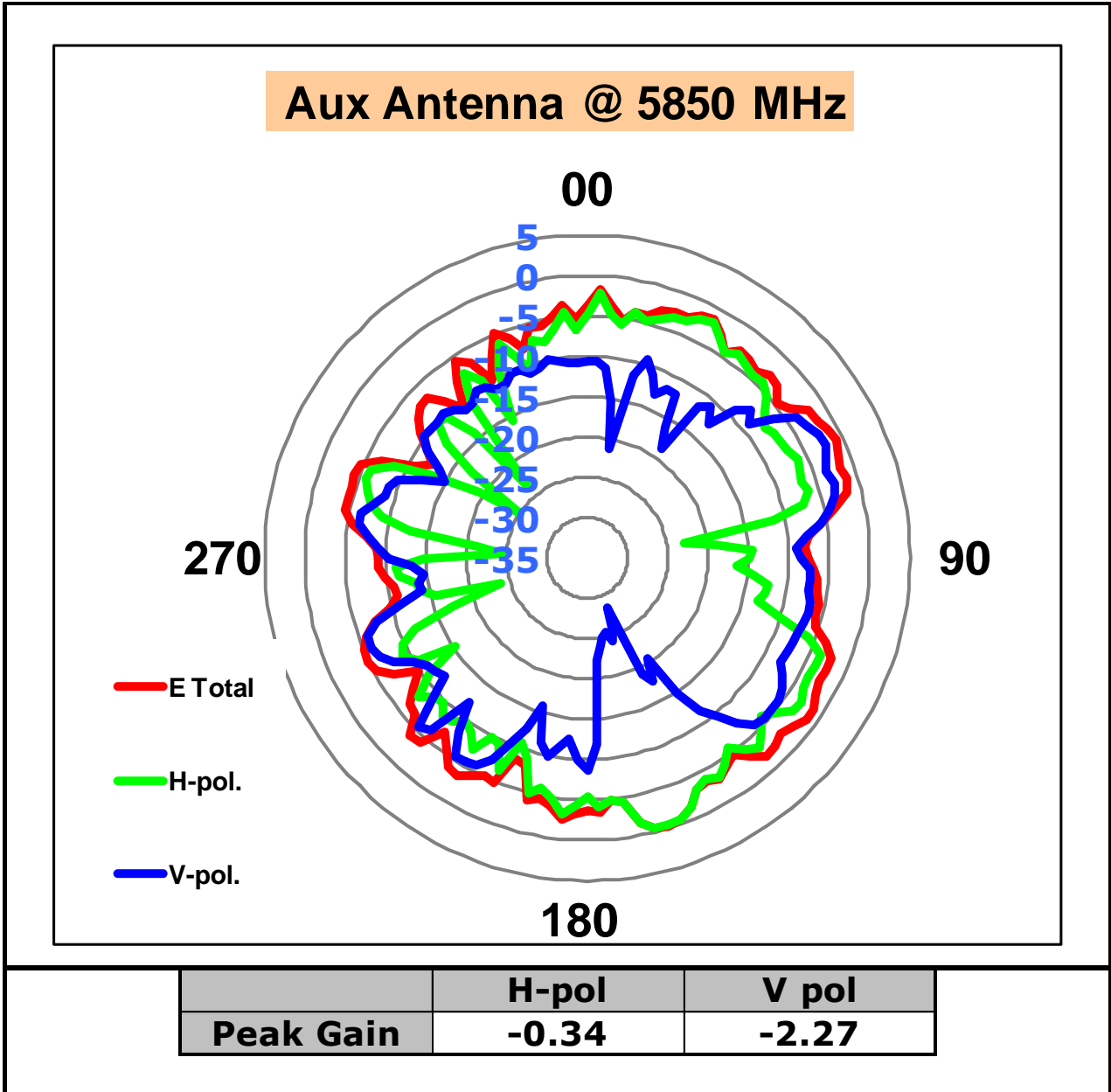

Center Frequency	5850 MHz
Horizontal (dBi) Peak	-0.34
Vertical (dBi) Peak	-2.27

Section 4. Host Platform Information

OEM / ODM Host platform: (Edge 14-Plastic) platform correlated to antenna data
Rating Label Photo:



Section 5. Antenna Host Platform Location Information

Include a **dimensioned photo or dimensioned drawing** of Tx1, Tx2 and Tx3 antenna placements (measurements are not required for receive-only antenna). Any antenna that transmits must show dimensions to bottom of laptop.



Section 6. Antenna dimensional information for SAR evaluation

Include a **dimensioned photo or dimensioned drawing** showing the distance (mm) between the transmit antennas and the user (excluding hands, wrist, feet, and ankle)

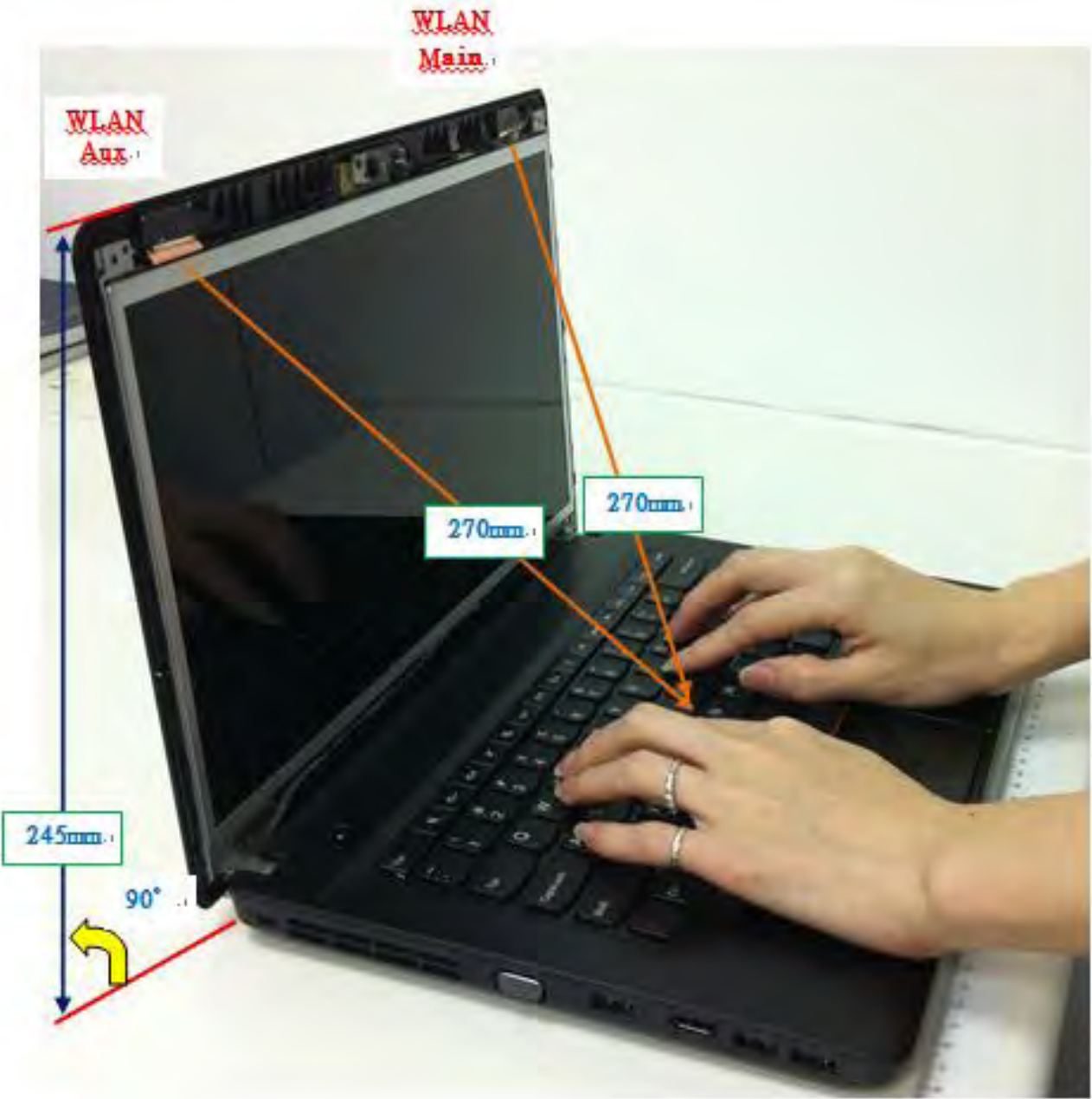

Section 7. Diagram Example of Co-Location Antenna Separation

Include a **dimensioned photo or dimensioned drawing** showing the distance (mm) between all WLAN transmit antennas and other co-located radiator transmit antenna such as Bluetooth, WWAN,..

(Note: Due to the evolving rules regarding co-location, each platform will need to be reviewed on a case by case basis)

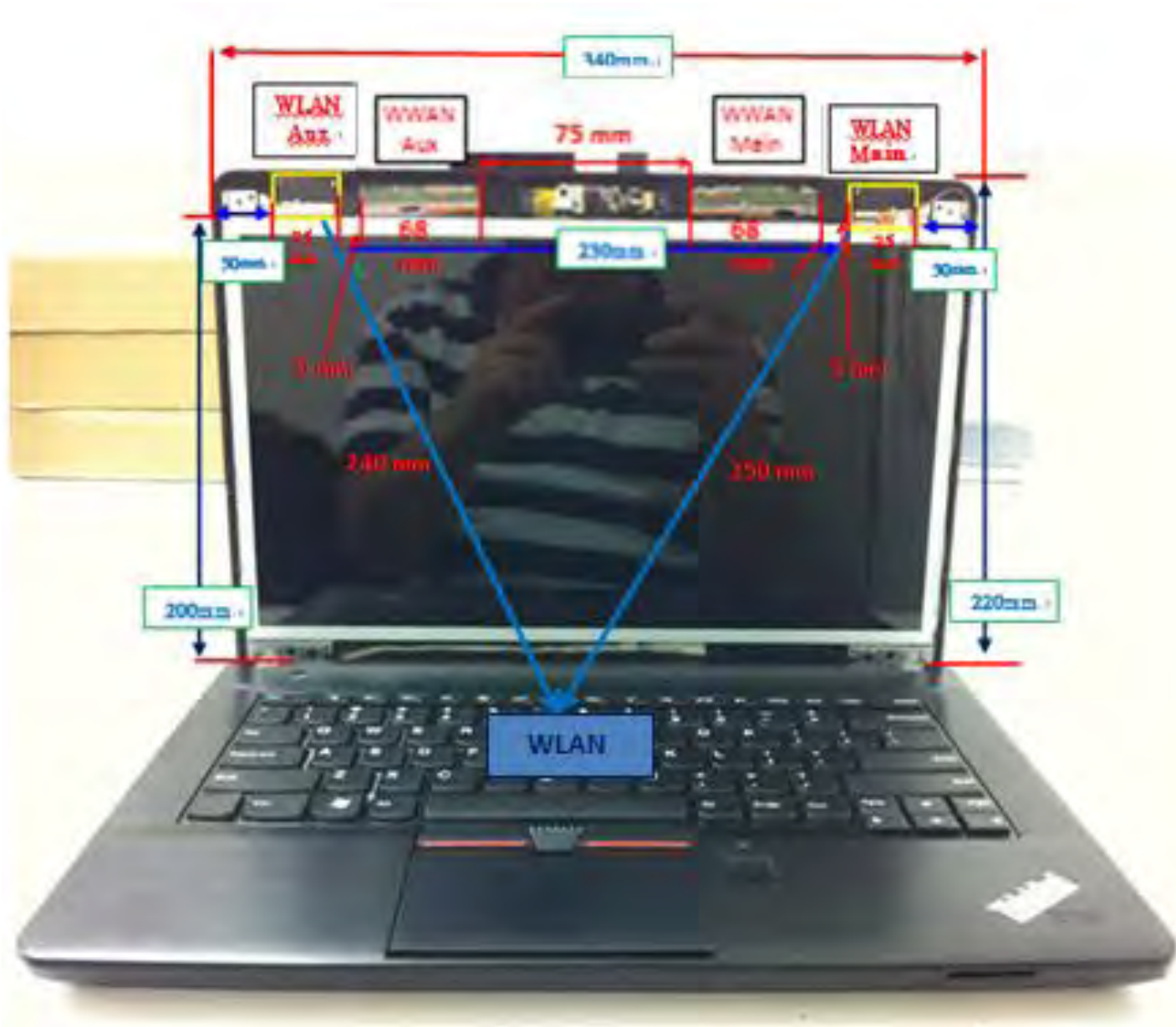

Section 8. Local representative contact information

Local representative contact information is required for regulatory support for target countries below.

	Local company name	Contact name	Phone number	FAX Number	e-Mail Address	Notes
Argentina						
Azerbaijan						
Cambodia						
Canada						
Croatia						
Indonesia						
Israel						
Malaysia						
Moldova						
Philippines						
Singapore						Telecommunication Equipment Dealer License Required
South Africa						
Taiwan						
USA						
Vietnam						