



SPORTON International Inc.

No. 52, Hwa Ya 1st Rd., Kwei-Shan Hsiang, TaoYuan Hsien, Taiwan, R.O.C.
Ph: 886-3-327-3456 / FAX: 886-3-327-0973 / www.sporton.com.tw

FCC RADIO TEST REPORT

Applicant's company	Realtek Semiconductor Corp.
Applicant Address	No. 2,Innovation Road II, Hsinchu Science Park, Hsinchu 300,Taiwan
FCC ID	TX2-RTL8188EE
Manufacturer's company	Realtek Semiconductor Corp.
Manufacturer Address	No. 2,Innovation Road II, Hsinchu Science Park, Hsinchu 300,Taiwan

Product Name	802.11b/g/n RTL8188EE miniCard
Brand Name	Realtek
Model Name	RTL8188EE
Test Rule	47 CFR FCC Part 15 Subpart C § 15.247
Test Freq. Range	2400 ~ 2483.5MHz
Received Date	Sep. 17, 2012
Final Test Date	Sep. 25, 2012
Submission Type	Class II Change

Statement

Test result included in this report is for the IEEE 802.11n and IEEE 802.11b/g part of the product.

The test result in this report refers exclusively to the presented test model / sample.

Without written approval of SPORTON International Inc., the test report shall not be reproduced except in full.

The measurements and test results shown in this test report were made in accordance with the procedures and found in compliance with the limit given in **ANSI C63.10-2009** and **47 CFR FCC Part 15 Subpart C** and KDB 558074 – 20120118 & KDB662911 D01-20110404.

The test equipment used to perform the test is calibrated and traceable to NML/ROC.



Table of Contents

1. CERTIFICATE OF COMPLIANCE	1
2. SUMMARY OF THE TEST RESULT	2
3. GENERAL INFORMATION	3
3.1. Product Details	3
3.2. Accessories	5
3.3. Table for Filed Antenna	6
3.4. Table for Carrier Frequencies	7
3.5. Table for Test Modes	7
3.6. Table for Testing Locations.....	8
3.7. Table for Class II Change	8
3.8. Table for Supporting Units	8
3.9. Table for Parameters of Test Software Setting	9
3.10. Test Configurations.....	10
4. TEST RESULT	14
4.1. Peak Output Power Measurement	14
4.2. Average Output Power Measurement.....	17
4.3. Power Spectral Density Measurement.....	20
4.4. 6dB Spectrum Bandwidth Measurement	26
4.5. Radiated Emissions Measurement.....	31
4.6. Band Edge Emissions Measurement.....	63
4.7. Antenna Requirements	80
5. LIST OF MEASURING EQUIPMENTS	81
6. TEST LOCATION	83
7. TAF CERTIFICATE OF ACCREDITATION	84
APPENDIX A. PHOTOGRAPHS OF EUT	A1 ~ A4
APPENDIX B. TEST PHOTOS	B1 ~ B6
APPENDIX C. MAXIMUM PERMISSIBLE EXPOSURE	C1 ~ C3



History of This Test Report

REPORT NO.	VERSION	DESCRIPTION	ISSUED DATE
FR211949-06	Rev. 01	Initial issue of report	Oct. 04, 2012



1. CERTIFICATE OF COMPLIANCE

Product Name : 802.11b/g/n RTL8188EE miniCard
Brand Name : Realtek
Model Name : RTL8188EE
Applicant : Realtek Semiconductor Corp.
Test Rule Part(s) : 47 CFR FCC Part 15 Subpart C § 15.247

Sporton International as requested by the applicant to evaluate the EMC performance of the product sample received on Sep. 17, 2012 would like to declare that the tested sample has been evaluated and found to be in compliance with the tested rule parts. The data recorded as well as the test configuration specified is true and accurate for showing the sample's EMC nature.

A handwritten signature in blue ink that reads 'Jordan Hsiao' is written over a horizontal line.

Jordan Hsiao

SPORTON INTERNATIONAL INC.

2. SUMMARY OF THE TEST RESULT

Applied Standard: 47 CFR FCC Part 15 Subpart C				
Part	Rule Section	Description of Test	Result	Under Limit
4.1	15.247(b)(3)	Peak Output Power	Complies	4.56 dB
4.2	-	Average Output Power	-	-
4.3	15.247(e)	Power Spectral Density	Complies	13.04 dB
4.4	15.247(a)(2)	6dB Spectrum Bandwidth	Complies	-
4.5	15.247(d)	Radiated Emissions	Complies	1.01 dB
4.6	15.247(d)	Band Edge Emissions	Complies	0.51 dB
4.7	15.203	Antenna Requirements	Complies	-

Test Items	Uncertainty	Remark
Peak Output Power	±0.8dB	Confidence levels of 95%
Power Spectral Density	±0.5dB	Confidence levels of 95%
6dB Spectrum Bandwidth	±8.5×10 ⁻⁸	Confidence levels of 95%
Radiated Emissions (9kHz~30MHz)	±0.8dB	Confidence levels of 95%
Radiated Emissions (30MHz~1000MHz)	±1.9dB	Confidence levels of 95%
Radiated / Band Edge Emissions (1GHz~18GHz)	±1.9dB	Confidence levels of 95%
Radiated Emissions (18GHz~40GHz)	±1.9dB	Confidence levels of 95%
Temperature	±0.7°C	Confidence levels of 95%
Humidity	±3.2%	Confidence levels of 95%
DC / AC Power Source	±1.4%	Confidence levels of 95%

3. GENERAL INFORMATION

3.1. Product Details

IEEE 802.11n

Items	Description
Product Type	Diversity : WLAN (1TX, 1RX) ; Fixed : WLAN (1TX, 2RX) ; Single : WLAN (1TX, 1RX)
Radio Type	Intentional Transceiver
Power Type	From Host System
Modulation	see the below table for IEEE 802.11n
Data Modulation	OFDM (BPSK / QPSK / 16QAM / 64QAM)
Data Rate (Mbps)	see the below table for IEEE 802.11n
Frequency Range	2400 ~ 2483.5MHz
Channel Number	11 for 20MHz bandwidth ; 7 for 40MHz bandwidth
Channel Band Width (99%)	MCS0 (20MHz): 18.04 MHz ; MCS0 (40MHz): 36.60 MHz
Peak Output Power	MCS0 (20MHz): 25.43 dBm ; MCS0 (40MHz): 24.12 dBm
Carrier Frequencies	Please refer to section 3.4
Antenna	Please refer to section 3.3

IEEE 802.11b/g

Items	Description
Product Type	802.11b : Diversity : WLAN (1TX, 1RX) ; Fixed : WLAN (1TX, 2RX) ; Single : WLAN (1TX, 1RX) 802.11g : Diversity : WLAN (1TX, 1RX) ; Fixed : WLAN (1TX, 2RX) ; Single : WLAN (1TX, 1RX)
Radio Type	Intentional Transceiver
Power Type	From Host System
Modulation	DSSS for IEEE 802.11b ; OFDM for IEEE 802.11g
Data Modulation	DSSS (BPSK / QPSK / CCK) ; OFDM (BPSK / QPSK / 16QAM / 64QAM)
Data Rate (Mbps)	DSSS (1/ 2/ 5.5/11) ; OFDM (6/9/12/18/24/36/48/54)
Frequency Range	2400 ~ 2483.5MHz
Channel Number	11
Channel Band Width (99%)	11b: 15.36 MHz ; 11g: 17.00 MHz
Peak Output Power	11b: 22.49 dBm ; 11g: 25.44 dBm
Carrier Frequencies	Please refer to section 3.4
Antenna	Please refer to section 3.3

Antenna & Band width

Antenna	Single (TX)	
	20 MHz	40 MHz
IEEE 802.11b	V	X
IEEE 802.11g	V	X
IEEE 802.11n	V	V

IEEE 802.11n spec

MCS Index	Nss	Modulation	R	NBPS	NCBPS		NDBPS		Datarate(Mbps)			
					20MHz	40MHz	20MHz	40MHz	800nsGI		400nsGI	
									20MHz	40MHz	20MHz	40MHz
0	1	BPSK	1/2	1	52	108	26	54	6.5	13.5	7.200	15
1	1	QPSK	1/2	2	104	216	52	108	13.0	27.0	14.400	30
2	1	QPSK	3/4	2	104	216	78	162	19.5	40.5	21.700	45
3	1	16-QAM	1/2	4	208	432	104	216	26.0	54.0	28.900	60
4	1	16-QAM	3/4	4	208	432	156	324	39.0	81.0	43.300	90
5	1	64-QAM	2/3	6	312	648	208	432	52.0	108.0	57.800	120
6	1	64-QAM	3/4	6	312	648	234	486	58.5	121.5	65.000	135
7	1	64-QAM	5/6	6	312	648	260	540	65.0	135.0	72.200	150
8	2	BPSK	1/2	1	104	216	52	108	13.0	27.0	14.444	30
9	2	QPSK	1/2	2	208	432	104	216	26.0	54.0	28.889	60
10	2	QPSK	3/4	2	208	432	156	324	39.0	81.0	43.333	90
11	2	16-QAM	1/2	4	416	864	208	432	52.0	108.0	57.778	120
12	2	16-QAM	3/4	4	416	864	312	648	78.0	162.0	86.667	180
13	2	64-QAM	2/3	6	624	1296	416	864	104.0	216.0	115.556	240
14	2	64-QAM	3/4	6	624	1296	468	972	117.0	243.0	130.000	270
15	2	64-QAM	5/6	6	624	1296	520	1080	130.0	270.0	144.444	300

Symbol	Explanation
NSS	Number of spatial streams
R	Code rate
NBPS	Number of coded bits per single carrier
NCBPS	Number of coded bits per symbol
NDBPS	Number of data bits per symbol
GI	guard interval

3.2. Accessories

N/A

3.3. Table for Filed Antenna

Ant.	Brand	Model Name	Antenna Type	Connector	Gain (dBi)
1	Joymax	TWF-614XMPXX-500	Dipole Antenna	I-PEX	3.0
2	LYNwave	ALA110-222050-300010	PIFA Antenna	I-PEX	3.5

Note: There are 3 configurations of EUT.

Configuration	Antenna Chain	Power Type	Description
Config.1 Diversity	2 chains	PCIE	The EUT supports 1TX/1RX function, and it supports TX/RX diversity function. Both Chain 1 and Chain 2 could be used as transmitting/receiving antenna, but only one of them could transmit/receive at the same time. Chain 2 generated higher output power than Chain 1, so it is tested and recorded in the report.
		USB	
Config. 2 Fixed	2 chains	PCIE	The EUT supports 1TX/2RX function. Only Chain 1 could be used as transmitting antenna. Both Chain 1 and Chain 2 could be used as receiving antenna, but only one of them could receive at the same time.
		USB	
Config. 3 Single	1 chain	PCIE	The EUT supports 1TX/1RX function. Only Chain 2 could be used as transmitting/receiving antenna.
		USB	

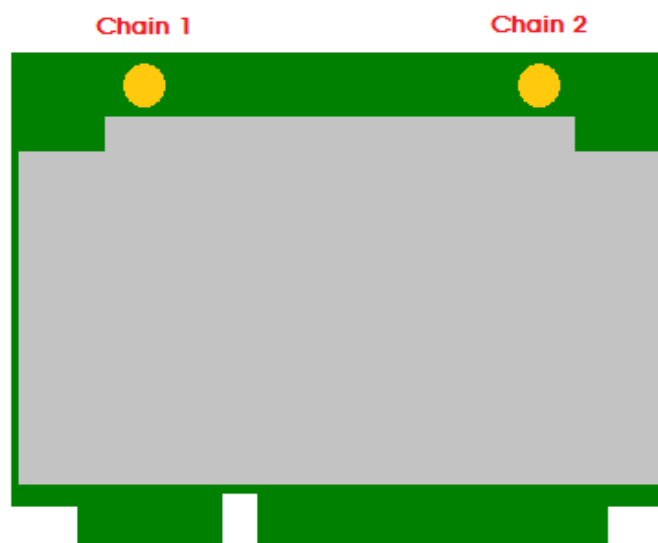

3.4. Table for Carrier Frequencies

For IEEE 802.11b/g, use Channel 1~Channel 11.

There are two bandwidth systems for IEEE 802.11n.

For both 20MHz bandwidth systems, use Channel 1~Channel 11.

For both 40MHz bandwidth systems, use Channel 3~Channel 9.

Frequency Band	Channel No.	Frequency	Channel No.	Frequency
2400~2483.5MHz	1	2412 MHz	7	2442 MHz
	2	2417 MHz	8	2447 MHz
	3	2422 MHz	9	2452 MHz
	4	2427 MHz	10	2457 MHz
	5	2432 MHz	11	2462 MHz
	6	2437 MHz	-	-

3.5. Table for Test Modes

Preliminary tests were performed in different data rate to find the worst radiated emission. The data rate shown in the table below is the worst-case rate with respect to the specific test item. Investigation has been done on all the possible configurations for searching the worst cases. The following table is a list of the test modes shown in this test report.

Test Items	Mode	Data Rate	Channel	Antenna
Peak Output Power Average Output Power Power Spectral Density	MCS0/20MHz	6.5 Mbps	1/6/11	1+2
	MCS0/40MHz	13.5 Mbps	3/6/9	1+2
	11b/BPSK	1 Mbps	1/6/11	1+2
	11g/BPSK	6 Mbps	1/6/11	1+2
6dB Spectrum Bandwidth	MCS0/20MHz	6.5 Mbps	1/6/11	1+2
	MCS0/40MHz	13.5 Mbps	3/6/9	1+2
	11b/BPSK	1 Mbps	1/6/11	1+2
	11g/BPSK	6 Mbps	1/6/11	1+2
Radiated Emissions 9kHz~1GHz	Normal Link	-	-	-
Radiated Emissions 1GHz~10 th Harmonic	MCS0/20MHz	6.5 Mbps	1/6/11	1+2
	MCS0/40MHz	13.5 Mbps	3/6/9	1+2
	11b/BPSK	1 Mbps	1/6/11	1+2
	11g/BPSK	6 Mbps	1/6/11	1+2
Band Edge Emissions	MCS0/20MHz	6.5 Mbps	1/11	1+2
	MCS0/40MHz	13.5 Mbps	3/9	1+2
	11b/BPSK	1 Mbps	1/11	1+2
	11g/BPSK	6 Mbps	1/11	1+2

Power from PCIE, generated the worst test result for original test report, so the measurement under for this test report will follow this same test mode.

The following test modes were performed for Radiated Emission test :

Mode 1. Config. 2 Fixed : PIFA antenna, power from PCIE.

Mode 2. Config. 2 Fixed : Dipole antenna, power from PCIE.

3.6. Table for Testing Locations

Test Site No.	Site Category	Location	FCC Reg. No.	IC File No.
03CH01-CB	SAC	Hsin Chu	262045	IC 4086D
TH01-CB	OVEN Room	Hsin Chu	-	-

Open Area Test Site (OATS); Semi Anechoic Chamber (SAC); Fully Anechoic Chamber (FAC).

Please refer section 6 for Test Site Address.

3.7. Table for Class II Change

This product is an extension of original report under Sporton project number: FR211949

There are 3 configurations of EUT.

Following are the modification only for configuration 2 Fixed type (1TX/2RX):

Modifications	Performance Checking
1. Change TX function from Chain 2 to Chain 1. 2. Addition one trace for change RX function from Chain 1 to Chain 2.	Peak Output Power, Average Output Power, Power Spectral Density, 6dB Spectrum Bandwidth, Radiated Emissions and Band Edge Emissions Data

3.8. Table for Supporting Units

Support Unit	Brand	Model	FCC ID
Mouse	Logitech	M-U0026	DoC
EARPHONES	E-books	E-EPC040	N/A
Wireless AP	BELKIN	WG7016G22-LF-AK	DoC
Notebook	DELL	M1330	E2KWM3945ABG

3.9. Table for Parameters of Test Software Setting

During testing, Channel & Power Controlling Software provided by the customer was used to control the operating channel as well as the output power level. The RF output power selection is for the setting of RF output power expected by the customer and is going to be fixed on the firmware of the final end product.

Config. 2 Fixed with Ant.1 (Dipole Antenna) and Ant.2 (PIFA Antenna)

Power Parameters of IEEE 802.11n

Test Software Version	Realtek 11n 8188E PCIE WLAN MP Diagnostic Program 0.0030.20120905		
	Frequency	2412 MHz	2437 MHz
MCS0 20MHz	55	57	51
Frequency	2422 MHz	2437 MHz	2452 MHz
MCS0 40MHz	53	52	51

Power Parameters of IEEE 802.11b/g

Test Software Version	Realtek 11n 8188E PCIE WLAN MP Diagnostic Program 0.0030.20120905		
	Frequency	2412 MHz	2437 MHz
IEEE 802.11b	48	49	49
IEEE 802.11g	55	57	51

During the test, "Realtek 11n 8188E PCIE WLAN MP Diagnostic Program 0.0030.20120905" under WIN XP was executed the test program to control the EUT continuously transmit RF signal.

3.10. Test Configurations

3.10.1. Radiation Emissions Test Configuration

Test Configuration: 30MHz~1GHz / Test Mode: Mode 1.

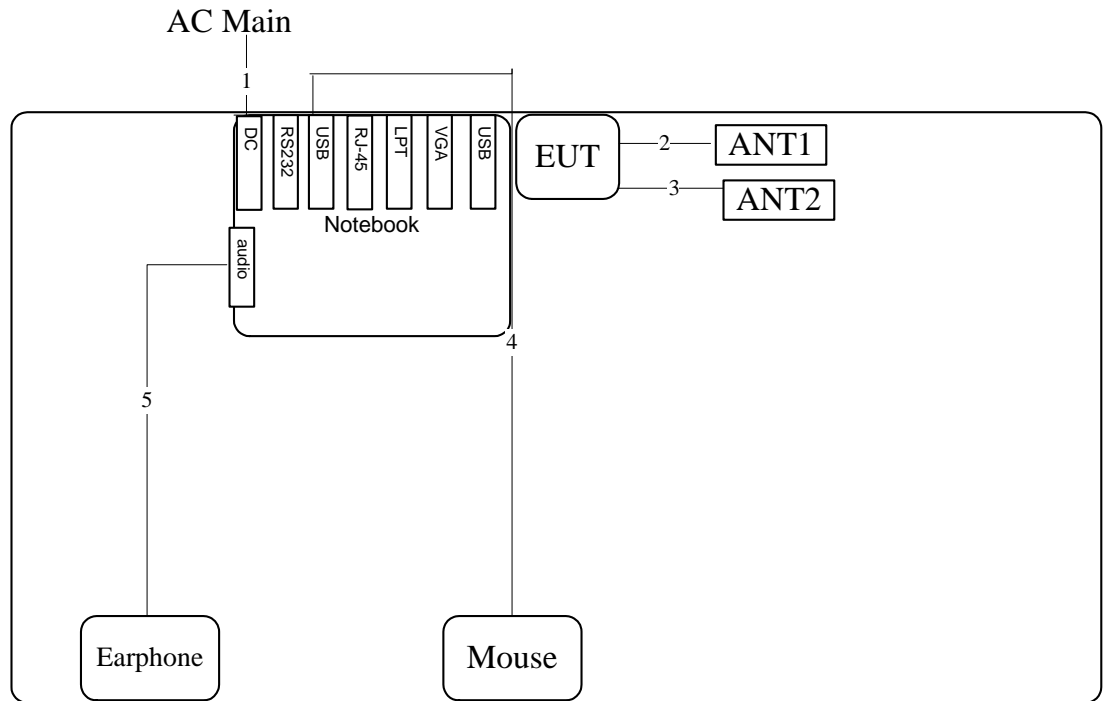

AP

Item	Connection	Shield	Length
1	Power Cable	No	2.6m
2	ANT Cable	No	0.3m
3	ANT Cable	No	0.3m
4	USB Cable	Yes	1.8m
5	Earphone Cable	NO	1.1m

Test Mode: Mode 2.

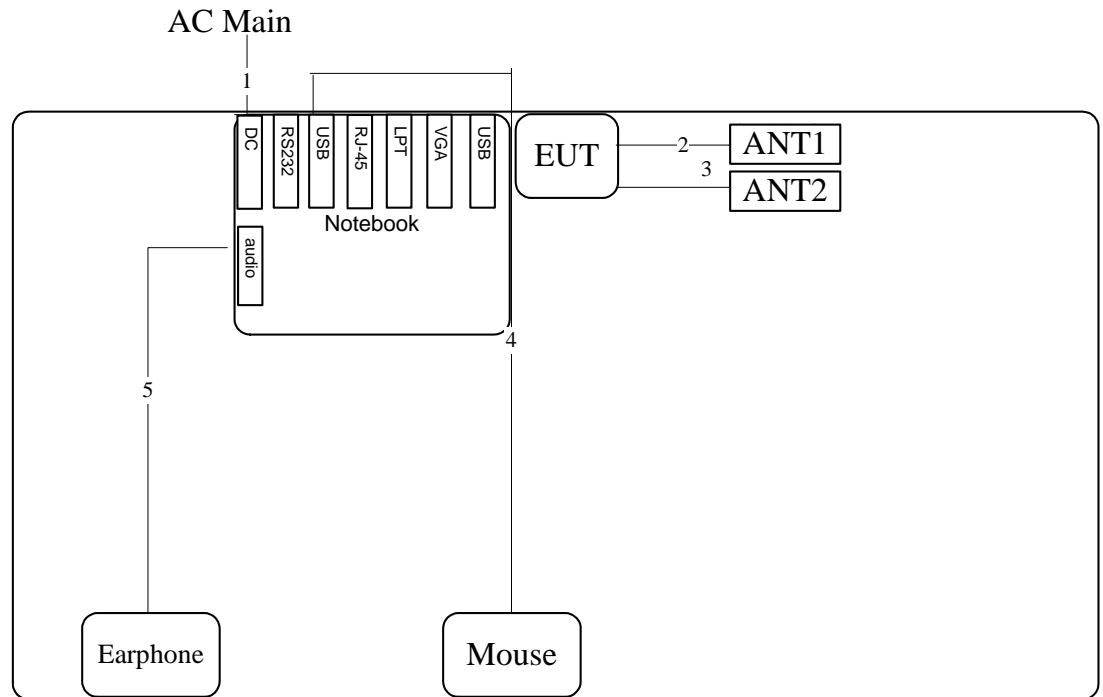

AP

Item	Connection	Shield	Length
1	Power Cable	No	2.6m
2	ANT Cable	No	0.2m
3	ANT Cable	No	0.2m
4	USB Cable	Yes	1.8m
5	Earphone Cable	NO	1.1m

Test Configuration: above 1GHz / Test Mode: Mode 1.

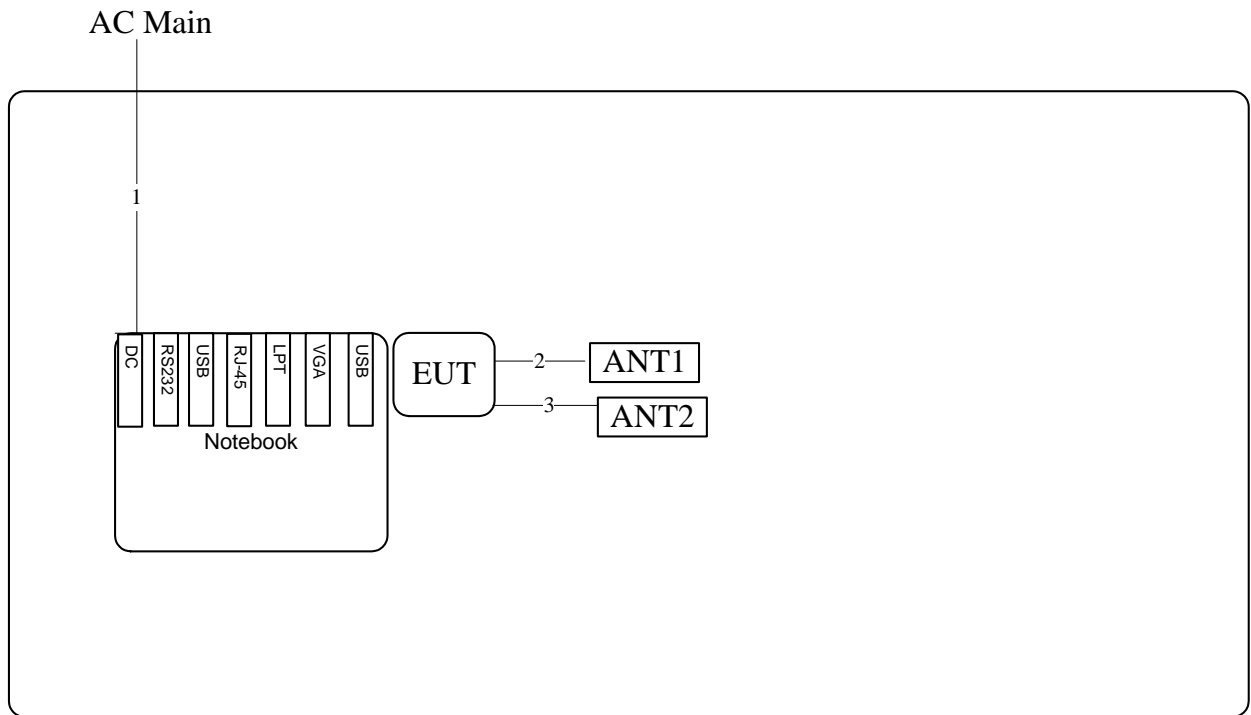

Item	Connection	Shield	Length
1	Power Cable	No	2.6m
2	ANT Cable	No	0.3m
3	ANT Cable	No	0.3m

Test Mode: Mode 2.

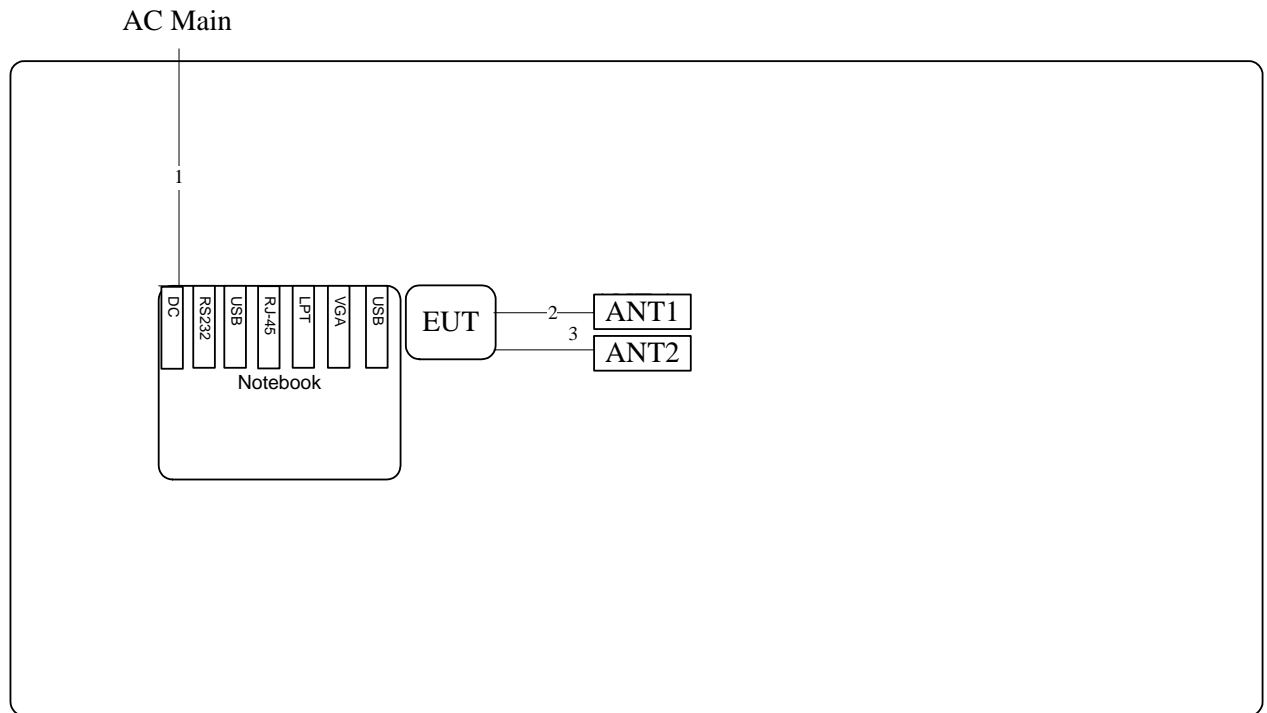

Item	Connection	Shield	Length
1	Power Cable	No	2.6m
2	ANT Cable	No	0.2m
3	ANT Cable	No	0.2m

4. TEST RESULT

4.1. Peak Output Power Measurement

4.1.1. Limit

For systems using digital modulation in the 2400-2483.5MHz, the limit for peak output power is 30dBm. The limited has to be reduced by the amount in dB that the gain of the antenna exceed 6dBi. In case of point-to-point operation, the limit has to be reduced by 1 dB for every 3dB that the directional gain of the antenna exceeds 6dBi.

4.1.2. Measuring Instruments and Setting

Please refer to section 5 of equipments list in this report. The following table is the setting of the peak power meter.

Power Meter Parameter	Setting
Bandwidth	50MHz bandwidth is greater than the EUT emission bandwidth
Detector	Peak

4.1.3. Test Procedures

Spectrum Parameter	Setting
RF Output Power Method	<input checked="" type="checkbox"/> ANSI C63.10 clause 6.10.2.1 (a) power meter method
RF Output Power Method	<input type="checkbox"/> ANSI C63.10 clause 6.10.2.1 (b) channel integration method
RF Output Power Method	<input type="checkbox"/> ANSI C63.10 clause 6.10.3.1 Method 1 - spectral trace averaging
RF Output Power Method	<input type="checkbox"/> ANSI C63.10 clause 6.10.3.2 Method 2 - zero-span mode with trace averaging

4.1.4. Test Setup Layout

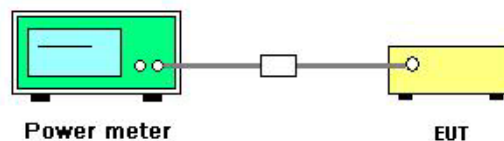

4.1.5. Test Deviation

There is no deviation with the original standard.

4.1.6. EUT Operation during Test

The EUT was programmed to be in continuously transmitting mode.

4.1.7. Test Result of Peak Output Power

Temperature	25°C	Humidity	56%
Test Engineer	Benson Peng	Configurations	IEEE 802.11n
Test Date	Sep. 25, 2012		

Config. 2 Fixed with Ant.1 (Dipole Antenna) and Ant.2 (PIFA Antenna)

Configuration IEEE 802.11n MCS0 20MHz / Chain 1

Channel	Frequency	Conducted Power (dBm)	Max. Limit (dBm)	Result
1	2412 MHz	24.92	30.00	Complies
6	2437 MHz	25.43	30.00	Complies
11	2462 MHz	24.53	30.00	Complies

Configuration IEEE 802.11n MCS0 40MHz / Chain 1

Channel	Frequency	Conducted Power (dBm)	Max. Limit (dBm)	Result
3	2422 MHz	24.12	30.00	Complies
6	2437 MHz	24.03	30.00	Complies
9	2452 MHz	23.78	30.00	Complies

Temperature	25°C	Humidity	56%
Test Engineer	Benson Peng	Configurations	IEEE 802.11b/g
Test Date	Sep. 25, 2012		

Config. 2 Fixed with Ant.1 (Dipole Antenna) and Ant.2 (PIFA Antenna)

Configuration IEEE 802.11b / Chain 1

Channel	Frequency	Conducted Power (dBm)	Max. Limit (dBm)	Result
1	2412 MHz	20.87	30.00	Complies
6	2437 MHz	22.12	30.00	Complies
11	2462 MHz	22.49	30.00	Complies

Configuration IEEE 802.11g / Chain 1

Channel	Frequency	Conducted Power (dBm)	Max. Limit (dBm)	Result
1	2412 MHz	25.08	30.00	Complies
6	2437 MHz	25.44	30.00	Complies
11	2462 MHz	24.92	30.00	Complies

4.2. Average Output Power Measurement

4.2.1. Measuring Instruments and Setting

Please refer to section 5 of equipments list in this report. The following table is the setting of the power meter.

Power Meter Parameter	Setting
Bandwidth	50MHz bandwidth is greater than the EUT emission bandwidth
Detector	Average

4.2.2. Test Procedures

Spectrum Parameter	Setting
RF Output Power Method	<input checked="" type="checkbox"/> ANSI C63.10 clause 6.10.2.1 (a) power meter method
RF Output Power Method	<input type="checkbox"/> ANSI C63.10 clause 6.10.2.1 (b) channel integration method
RF Output Power Method	<input type="checkbox"/> ANSI C63.10 clause 6.10.3.1 Method 1 - spectral trace averaging
RF Output Power Method	<input type="checkbox"/> ANSI C63.10 clause 6.10.3.2 Method 2 - zero-span mode with trace averaging

4.2.3. Test Setup Layout

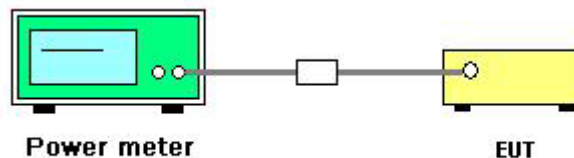

4.2.4. Test Deviation

There is no deviation with the original standard.

4.2.5. EUT Operation during Test

The EUT was programmed to be in continuously transmitting mode.

Note: Average output power is only for Maximum Permissible Exposure use.

4.2.6. Test Result of Average Output Power

Temperature	25°C	Humidity	56%
Test Engineer	Benson Peng	Configurations	IEEE 802.11n
Test Date	Sep. 25, 2012		

Config. 2 Fixed with Ant.1 (Dipole Antenna) and Ant.2 (PIFA Antenna)

Configuration IEEE 802.11n MCS0 20MHz / Chain 1

Channel	Frequency	Average Conducted Power (dBm)
1	2412 MHz	16.58
6	2437 MHz	17.94
11	2462 MHz	15.65

Configuration IEEE 802.11n MCS0 40MHz / Chain 1

Channel	Frequency	Average Conducted Power (dBm)
3	2422 MHz	15.41
6	2437 MHz	15.25
9	2452 MHz	14.77

Temperature	25°C	Humidity	56%
Test Engineer	Benson Peng	Configurations	IEEE 802.11b/g
Test Date	Sep. 25, 2012		

Config. 2 Fixed with Ant.1 (Dipole Antenna) and Ant.2 (PIFA Antenna)

Configuration IEEE 802.11b / Chain 1

Channel	Frequency	Average Conducted Power (dBm)
1	2412 MHz	18.56
6	2437 MHz	19.52
11	2462 MHz	19.78

Configuration IEEE 802.11g / Chain 1

Channel	Frequency	Average Conducted Power (dBm)
1	2412 MHz	16.51
6	2437 MHz	17.85
11	2462 MHz	15.45

4.3. Power Spectral Density Measurement

4.3.1. Limit

For digitally modulated systems, the power spectral density conducted from the intentional radiator to the antenna shall not be greater than 8 dBm in any 3 kHz band during any time interval of continuous transmission.

4.3.2. Measuring Instruments and Setting

Please refer to section 5 of equipments list in this report. The following table is the setting of Spectrum Analyzer.

Spectrum Parameter	Setting
Attenuation	Auto
Span Frequency	Set the analyzer span to 5-30% greater than the EBW.
RB	100 kHz
VB	300 kHz
Detector	Peak
Trace	Max Hold
Sweep Time	Auto.

4.3.3. Test Procedures

1. Use this procedure when the maximum conducted output power in the fundamental emission is used to demonstrate compliance. The EUT must be configured to transmit continuously at full power over the measurement duration.
2. Ensure that the number of measurement points in the sweep $\geq 2 \times \text{span}/\text{RBW}$ (use of a greater number of measurement points than this minimum requirement is recommended).
3. Use the peak marker function to determine the maximum level in any 100 kHz band segment within the fundamental EBW.
4. Scale the observed power level to an equivalent level in 3 kHz by adjusting (reducing) the measured power by a bandwidth correction factor (BWCF) where: $\text{BWCF} = 10\log(3 \text{ kHz}/100 \text{ kHz}) = -15.2 \text{ dB}$.
5. The resulting PSD level must be $\leq 8 \text{ dBm}$.

4.3.4. Test Setup Layout

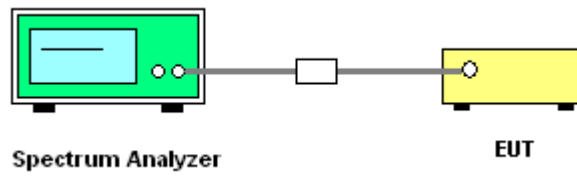

4.3.5. Test Deviation

There is no deviation with the original standard.

4.3.6. EUT Operation during Test

The EUT was programmed to be in continuously transmitting mode.

4.3.7. Test Result of Power Spectral Density

Temperature	25°C	Humidity	56%
Test Engineer	Benson Peng	Configurations	IEEE 802.11n

Config. 2 Fixed with Ant.1 (Dipole Antenna) and Ant.2 (PIFA Antenna)

Configuration IEEE 802.11n MCS0 20MHz / Chain 1

Channel	Frequency	Power Density (dBm/100kHz)	BWCF factor (100KHz to 3KHz)	Power Density (dBm/3kHz)	Single Port. Limit (dBm/3kHz)	Result
1	2412 MHz	1.94	-15.23	-13.29	8.00	Complies
6	2437 MHz	3.59	-15.23	-11.64	8.00	Complies
11	2462 MHz	0.90	-15.23	-14.33	8.00	Complies

Configuration IEEE 802.11n MCS0 40MHz / Chain 1

Channel	Frequency	Power Density (dBm/100kHz)	BWCF factor (100KHz to 3KHz)	Power Density (dBm/3kHz)	Single Port. Limit (dBm/3kHz)	Result
3	2422 MHz	-1.73	-15.23	-16.96	8.00	Complies
6	2437 MHz	-2.11	-15.23	-17.34	8.00	Complies
9	2452 MHz	-2.39	-15.23	-17.62	8.00	Complies

Temperature	25°C	Humidity	56%
Test Engineer	Benson Peng	Configurations	IEEE 802.11b/g

Config. 2 Fixed with Ant.1 (Dipole Antenna) and Ant.2 (PIFA Antenna)
Configuration IEEE 802.11b / Chain 1

Channel	Frequency	Power Density (dBm/100kHz)	BWCF factor (100KHz to 3KHz)	Power Density (dBm/3kHz)	Single Port. Limit (dBm/3kHz)	Result
1	2412 MHz	8.25	-15.23	-6.98	8.00	Complies
6	2437 MHz	9.31	-15.23	-5.92	8.00	Complies
11	2462 MHz	10.19	-15.23	-5.04	8.00	Complies

Configuration IEEE 802.11g / Chain 1

Channel	Frequency	Power Density (dBm/100kHz)	BWCF factor (100KHz to 3KHz)	Power Density (dBm/3kHz)	Single Port. Limit (dBm/3kHz)	Result
1	2412 MHz	1.44	-15.23	-13.79	8.00	Complies
6	2437 MHz	3.24	-15.23	-11.99	8.00	Complies
11	2462 MHz	0.51	-15.23	-14.72	8.00	Complies

Note: All the test values were listed in the report.

For plots, only the channel with maximum results was shown.

Power Density Plot on Configuration IEEE 802.11n MCS0 20MHz / Chain 1 / 2437 MHz

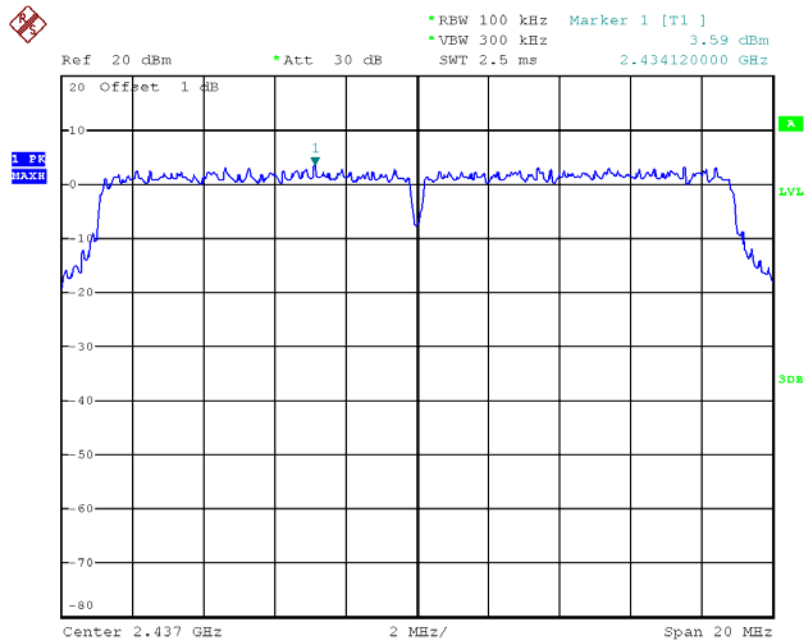

Date: 25.SEP.2012 08:30:58

Power Density Plot on Configuration IEEE 802.11n MCS0 40MHz / Chain 1 / 2422 MHz

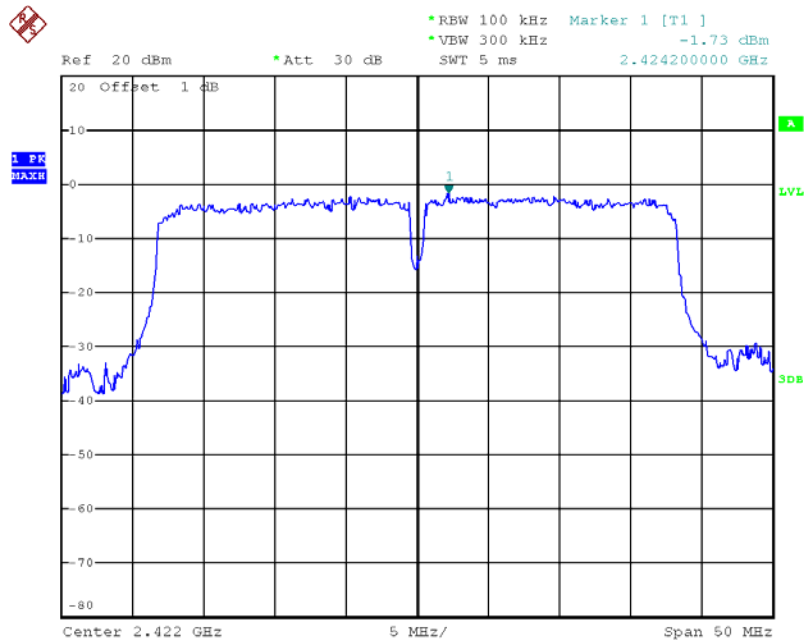

Date: 25.SEP.2012 08:32:25

4.4. 6dB Spectrum Bandwidth Measurement

4.4.1. Limit

For digital modulation systems, the minimum 6 dB bandwidth shall be at least 500 kHz.

4.4.2. Measuring Instruments and Setting

Please refer to section 5 of equipments list in this report. The following table is the setting of the Spectrum Analyzer.

Spectrum Parameters	Setting
Attenuation	Auto
Span Frequency	> 6dB Bandwidth
RB	1-5 % of the emission bandwidth (EBW)
VB	$\geq 3 \times \text{RBW}$
Detector	Peak
Trace	Max Hold
Sweep Time	Auto

4.4.3. Test Procedures

1. The transmitter output (antenna port) was connected to the spectrum analyzer in peak hold mode.
2. Test was performed in accordance with KDB 558074 Guidance for Performing Compliance Measurements on Digital Transmission Systems (DTS) Operating Under §15.247 section 5.1.1 EBW Measurement Procedure
3. Multiple antenna system was performed in accordance with KDB 662911 Emissions Testing of Transmitters with Multiple Outputs in the Same Band.
4. Measured the spectrum width with power higher than 6dB below carrier.

4.4.4. Test Setup Layout

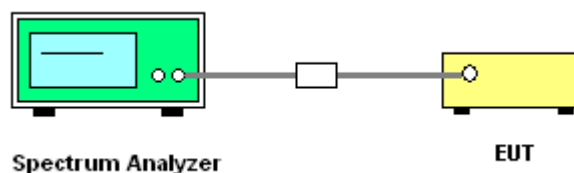

4.4.5. Test Deviation

There is no deviation with the original standard.

4.4.6. EUT Operation during Test

The EUT was programmed to be in continuously transmitting mode.

4.4.7. Test Result of 6dB Spectrum Bandwidth

Temperature	25°C	Humidity	56%
Test Engineer	Benson Peng	Configurations	IEEE 802.11n

Config. 2 Fixed with Ant.1 (Dipole Antenna) and Ant.2 (PIFA Antenna)

Configuration IEEE 802.11n MCS0 20MHz / Chain 1

Channel	Frequency	6dB Bandwidth (MHz)	99% Occupied Bandwidth (MHz)	Min. Limit (kHz)	Test Result
1	2412 MHz	17.80	18.00	500.00	Complies
6	2437 MHz	17.72	18.04	500.00	Complies
11	2462 MHz	17.72	17.92	500.00	Complies

Configuration IEEE 802.11n MCS0 40MHz / Chain 1

Channel	Frequency	6dB Bandwidth (MHz)	99% Occupied Bandwidth (MHz)	Min. Limit (kHz)	Test Result
3	2422 MHz	36.00	36.60	500.00	Complies
6	2437 MHz	36.00	36.36	500.00	Complies
9	2452 MHz	36.12	36.48	500.00	Complies

Temperature	25°C	Humidity	56%
Test Engineer	Benson Peng	Configurations	IEEE 802.11b/g

Config. 2 Fixed with Ant.1 (Dipole Antenna) and Ant.2 (PIFA Antenna)
Configuration IEEE 802.11b / Chain 1

Channel	Frequency	6dB Bandwidth (MHz)	99% Occupied Bandwidth (MHz)	Min. Limit (kHz)	Test Result
1	2412 MHz	10.12	14.88	500.00	Complies
6	2437 MHz	10.20	15.32	500.00	Complies
11	2462 MHz	10.20	15.36	500.00	Complies

Configuration IEEE 802.11g / Chain 1

Channel	Frequency	6dB Bandwidth (MHz)	99% Occupied Bandwidth (MHz)	Min. Limit (kHz)	Test Result
1	2412 MHz	16.52	16.88	500.00	Complies
6	2437 MHz	16.56	17.00	500.00	Complies
11	2462 MHz	16.48	16.92	500.00	Complies

Note: All the test values were listed in the report.

For plots, only the channel with maximum results was shown.

6 dB Bandwidth Plot on Configuration IEEE 802.11n MCS0 20MHz / Chain 1 / 2437 MHz

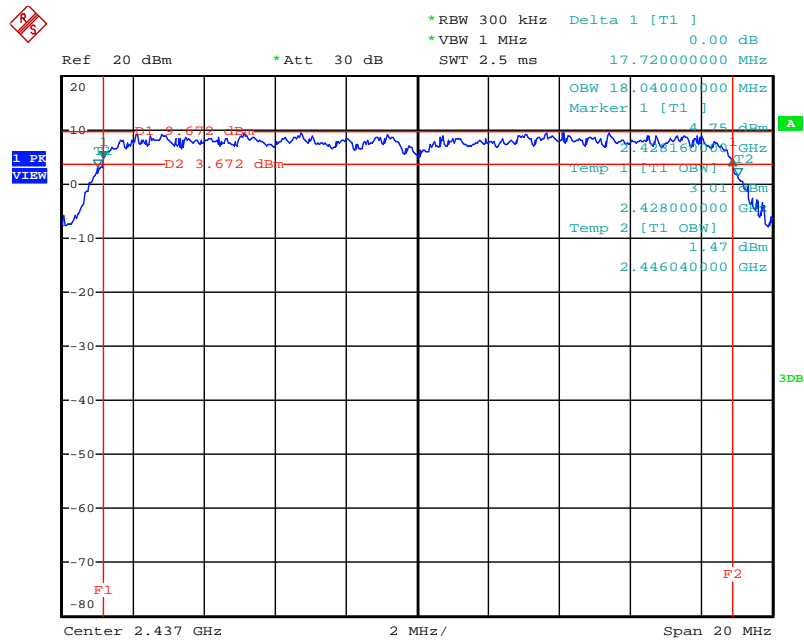

Date: 25.SEP.2012 08:07:33

6 dB Bandwidth Plot on Configuration IEEE 802.11n MCS0 40MHz / Chain 1 / 2422 MHz

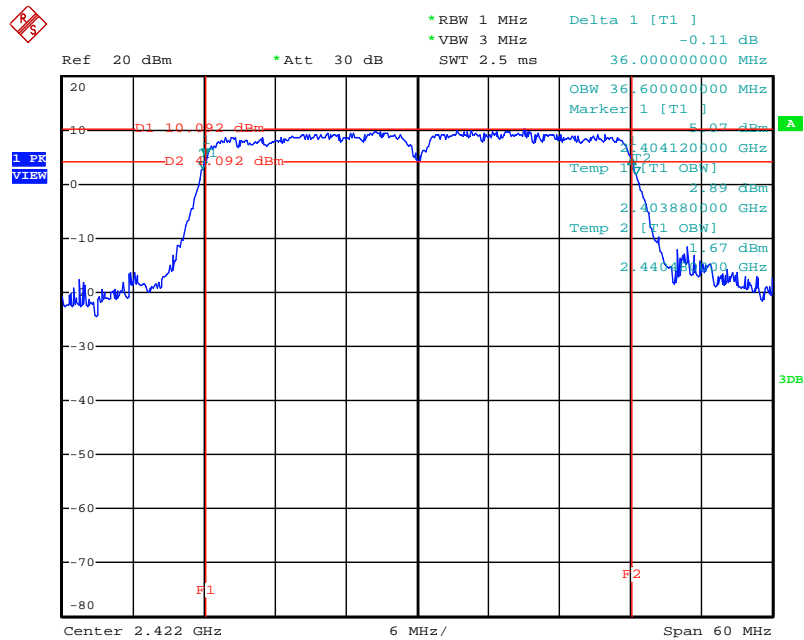

Date: 25.SEP.2012 08:08:36

6 dB Bandwidth Plot on Configuration IEEE 802.11b / Chain 1 / 2462 MHz

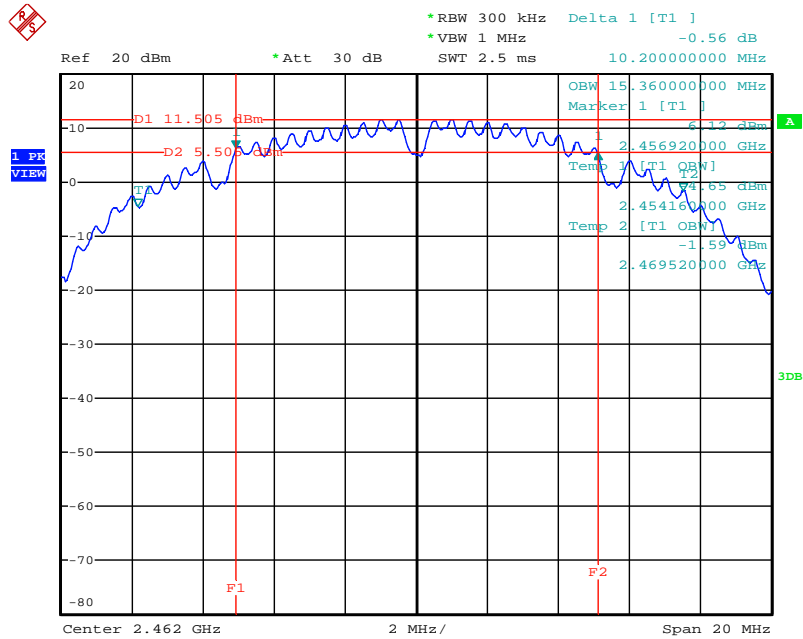

Date: 25.SEP.2012 08:04:57

6 dB Bandwidth Plot on Configuration IEEE 802.11g / Chain 1 / 2437 MHz

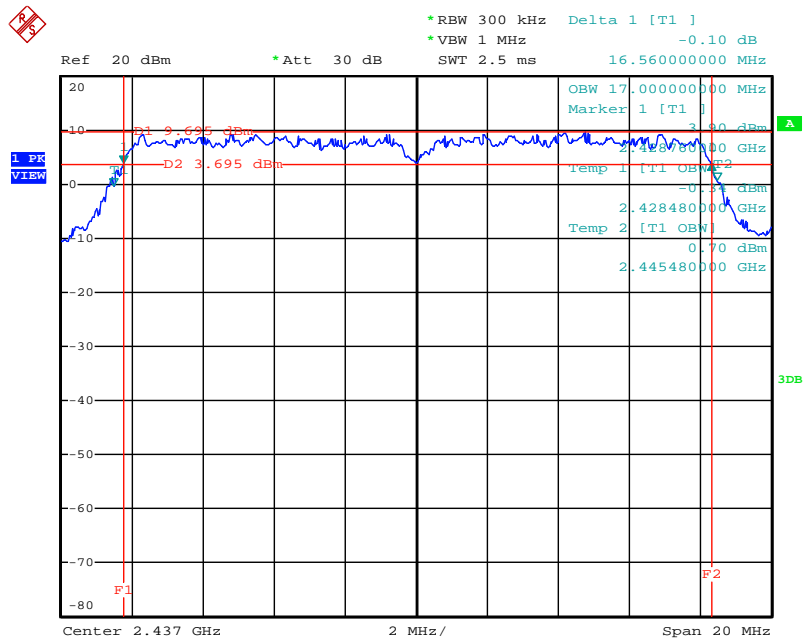

Date: 25.SEP.2012 08:06:05

4.5. Radiated Emissions Measurement

4.5.1. Limit

20dBc in any 100 kHz bandwidth outside the operating frequency band. In case the emission fall within the restricted band specified on 15.205(a), then the 15.209(a) limit in the table below has to be followed.

Frequencies (MHz)	Field Strength (micorvolts/meter)	Measurement Distance (meters)
0.009~0.490	2400/F(KHz)	300
0.490~1.705	24000/F(KHz)	30
1.705~30.0	30	30
30~88	100	3
88~216	150	3
216~960	200	3
Above 960	500	3

4.5.2. Measuring Instruments and Setting

Please refer to section 5 of equipments list in this report. The following table is the setting of spectrum analyzer and receiver.

Spectrum Parameter	Setting
Attenuation	Auto
Start Frequency	1000 MHz
Stop Frequency	10th carrier harmonic
RB / VB (Emission in restricted band)	1MHz / 3MHz for Peak, 1 MHz / 10Hz for Average
RB / VB (Emission in non-restricted band)	1MHz / 3MHz for peak

Receiver Parameter	Setting
Attenuation	Auto
Start ~ Stop Frequency	9kHz~150kHz / RB 200Hz for QP
Start ~ Stop Frequency	150kHz~30MHz / RB 9kHz for QP
Start ~ Stop Frequency	30MHz~1000MHz / RB 120kHz for QP

4.5.3. Test Procedures

1. Configure the EUT according to ANSI C63.10. The EUT was placed on the top of the turntable 0.8 meter above ground. The phase center of the receiving antenna mounted on the top of a height-variable antenna tower was placed 3 meters far away from the turntable.
2. Power on the EUT and all the supporting units. The turntable was rotated by 360 degrees to determine the position of the highest radiation.
3. The height of the broadband receiving antenna was varied between one meter and four meters above ground to find the maximum emissions field strength of both horizontal and vertical polarization.
4. For each suspected emissions, the antenna tower was scan (from 1 m to 4 m) and then the turntable was rotated (from 0 degree to 360 degrees) to find the maximum reading.
5. Set the test-receiver system to Peak or CISPR quasi-peak Detect Function with specified bandwidth under Maximum Hold Mode.
6. For emissions above 1GHz, use 1MHz VBW and 3MHz RBW for peak reading. Then 1MHz RBW and 10Hz VBW for average reading in spectrum analyzer.
7. When the radiated emissions limits are expressed in terms of the average value of the emissions, and pulsed operation is employed, the measurement field strength shall be determined by averaging over one complete pulse train, including blanking intervals, as long as the pulse train does not exceed 0.1 seconds. As an alternative (provided the transmitter operates for longer than 0.1 seconds) or in cases where the pulse train exceeds 0.1 seconds, the measured field strength shall be determined from the average absolute voltage during a 0.1 second interval during which the field strength is at its maximum value.
8. If the emissions level of the EUT in peak mode was 3 dB lower than the average limit specified, then testing will be stopped and peak values of EUT will be reported, otherwise, the emissions which do not have 3 dB margin will be repeated one by one using the quasi-peak method for below 1GHz.
9. For testing above 1GHz, the emissions level of the EUT in peak mode was lower than average limit (that means the emissions level in peak mode also complies with the limit in average mode), then testing will be stopped and peak values of EUT will be reported, otherwise, the emissions will be measured in average mode again and reported.
10. In case the emission is lower than 30MHz, loop antenna has to be used for measurement and the recorded data should be QP measured by receiver. High – Low scan is not required in this case.

4.5.4. Test Setup Layout

For Radiated Emissions below 1GHz

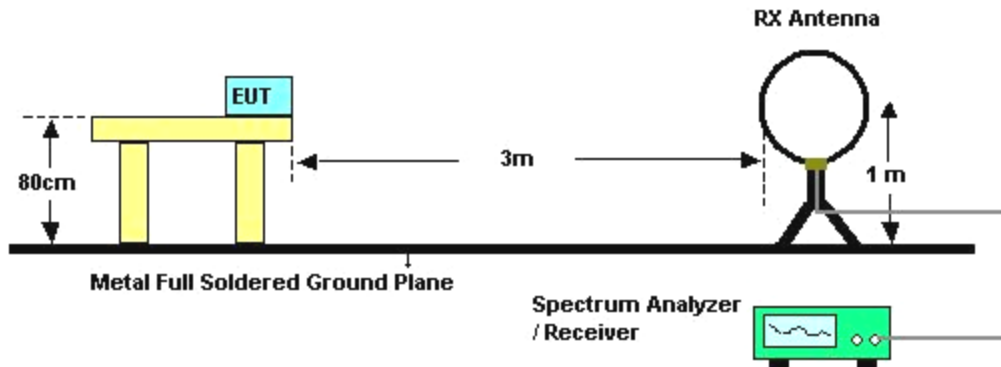

For Radiated Emissions above 1GHz

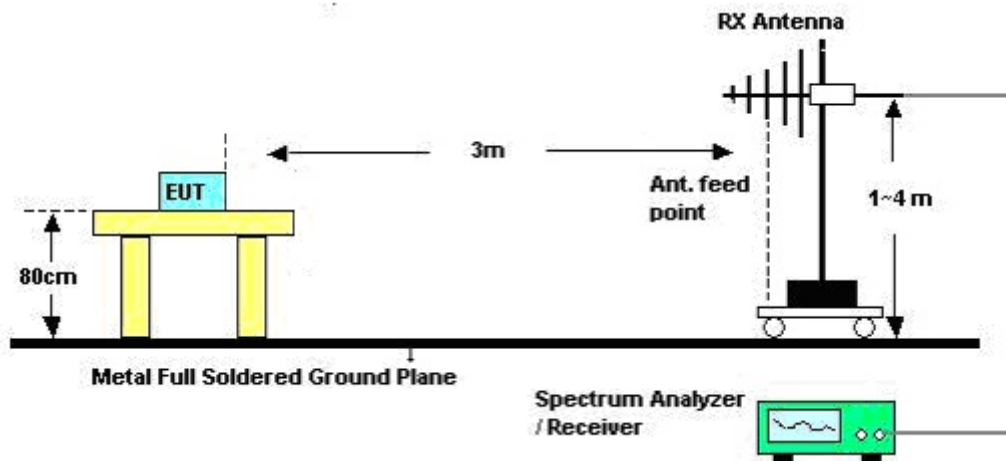

4.5.5. Test Deviation

There is no deviation with the original standard.

4.5.6. EUT Operation during Test

The EUT was programmed to be in continuously transmitting mode.

4.5.7. Results of Radiated Emissions (9kHz~30MHz)

Temperature	26°C	Humidity	60%
Test Engineer	Kenneth Huang	Configurations	Normal Link
Test Date	Sep. 18, 2012		

Freq. (MHz)	Level (dBuV)	Over Limit (dB)	Limit Line (dBuV)	Remark
-	-	-	-	See Note

Note:

The amplitude of spurious emissions which are attenuated by more than 20 dB below the permissible value has no need to be reported.

Distance extrapolation factor = $40 \log (\text{specific distance} / \text{test distance})$ (dB);

Limit line = specific limits (dBuV) + distance extrapolation factor.

4.5.8. Results of Radiated Emissions (30MHz~1GHz)

Temperature	26°C	Humidity	60%
Test Engineer	Kenneth Huang	Configurations	Normal Link
Test Mode	Mode 1.		

Horizontal

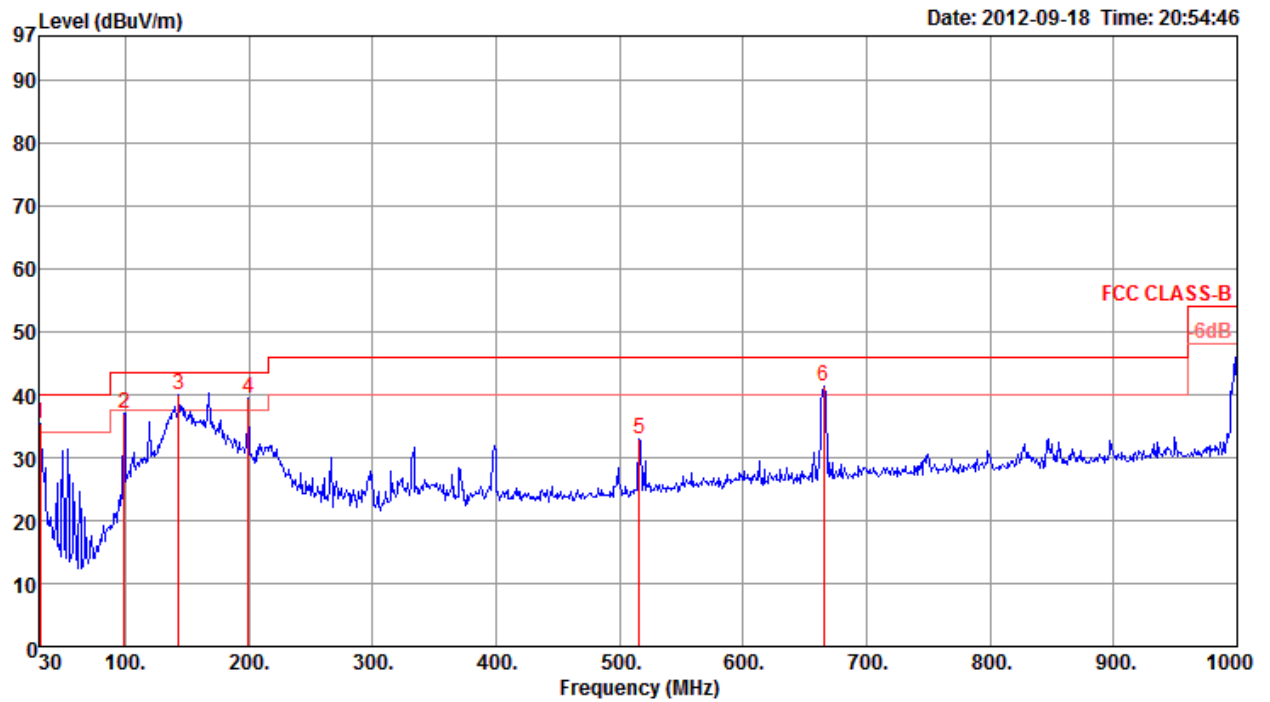

	Freq	Level	Limit	Over	Read	Cable	Preamp	Antenna	Remark	T/Pos	A/Pos	Pol/Phase
	MHz	dBuV/m	dBuV/m	dB	dBuV	dB	dB	dB/m		deg	cm	
1	30.97	35.51	40.00	-4.49	43.34	0.85	27.98	19.30	Peak	0	400	HORIZONTAL
2	98.87	37.09	43.50	-6.41	52.23	1.49	27.82	11.19	Peak	0	400	HORIZONTAL
3	143.49	40.11	43.50	-3.39	54.14	1.74	27.54	11.77	Peak	0	400	HORIZONTAL
4	199.75	39.45	43.50	-4.05	54.21	2.09	27.25	10.40	Peak	0	400	HORIZONTAL
5	515.97	32.95	46.00	-13.05	39.32	3.43	27.91	18.11	Peak	0	400	HORIZONTAL
6	665.35	41.42	46.00	-4.58	45.13	3.98	27.41	19.72	Peak	0	400	HORIZONTAL

Vertical

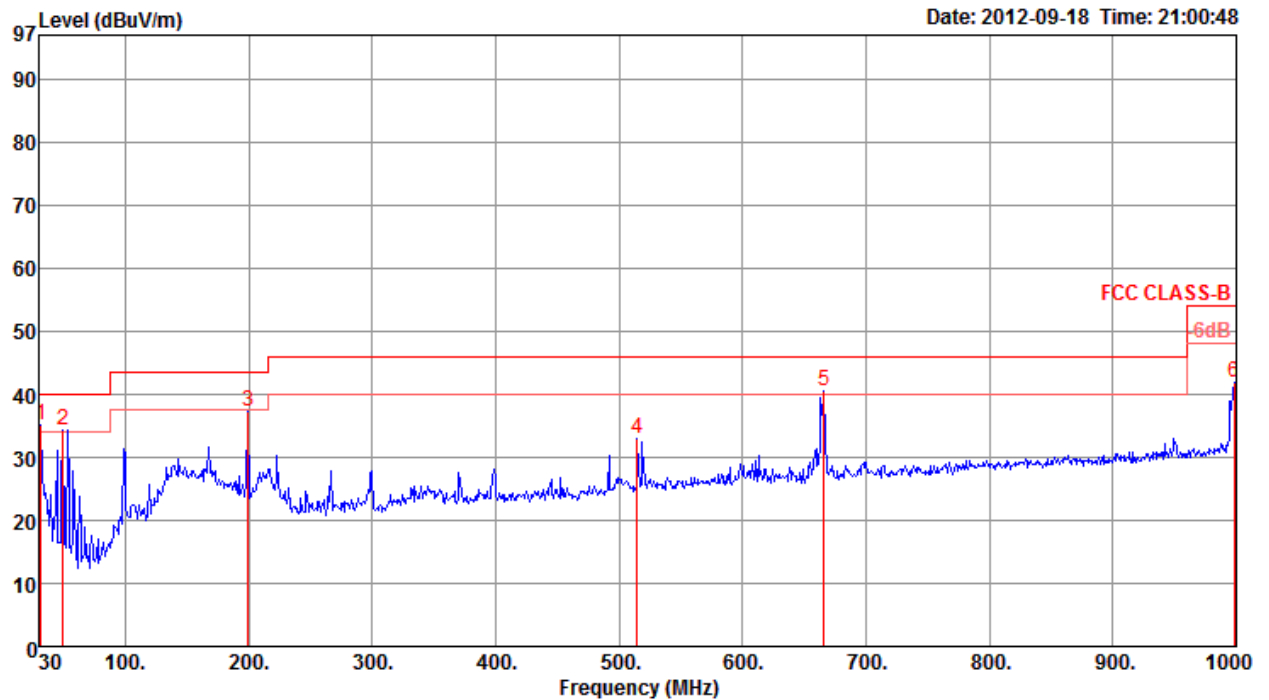

	Freq	Level	Limit	Over	Read	Cable	Preamp	Antenna	Remark	T/Pos	A/Pos	Pol/Phase
	MHz	dBuV/m	dBuV/m	dB	dBuV	dB	dB	dB/m		deg	cm	
1	p 31.94	35.11	40.00	-4.89	43.52	0.87	27.98	18.70	Peak	0	100	VERTICAL
2	! 49.40	34.28	40.00	-5.72	52.10	1.05	27.92	9.05	Peak	0	100	VERTICAL
3	199.75	37.38	43.50	-6.12	52.14	2.09	27.25	10.40	Peak	0	100	VERTICAL
4	515.00	32.98	46.00	-13.02	39.38	3.43	27.92	18.09	Peak	0	100	VERTICAL
5	! 666.32	40.48	46.00	-5.52	44.16	3.99	27.40	19.73	Peak	0	100	VERTICAL
6	998.06	41.80	54.00	-12.20	41.00	4.84	26.23	22.19	Peak	0	100	VERTICAL

Note:

The amplitude of spurious emissions which are attenuated by more than 20 dB below the permissible value has no need to be reported.

Emission level (dBuV/m) = 20 log Emission level (uV/m).

Corrected Reading: Antenna Factor + Cable Loss + Read Level - Preamp Factor = Level.

Temperature	26°C	Humidity	60%
Test Engineer	Kenneth Huang	Configurations	Normal Link
Test Mode	Mode 2.		

Horizontal

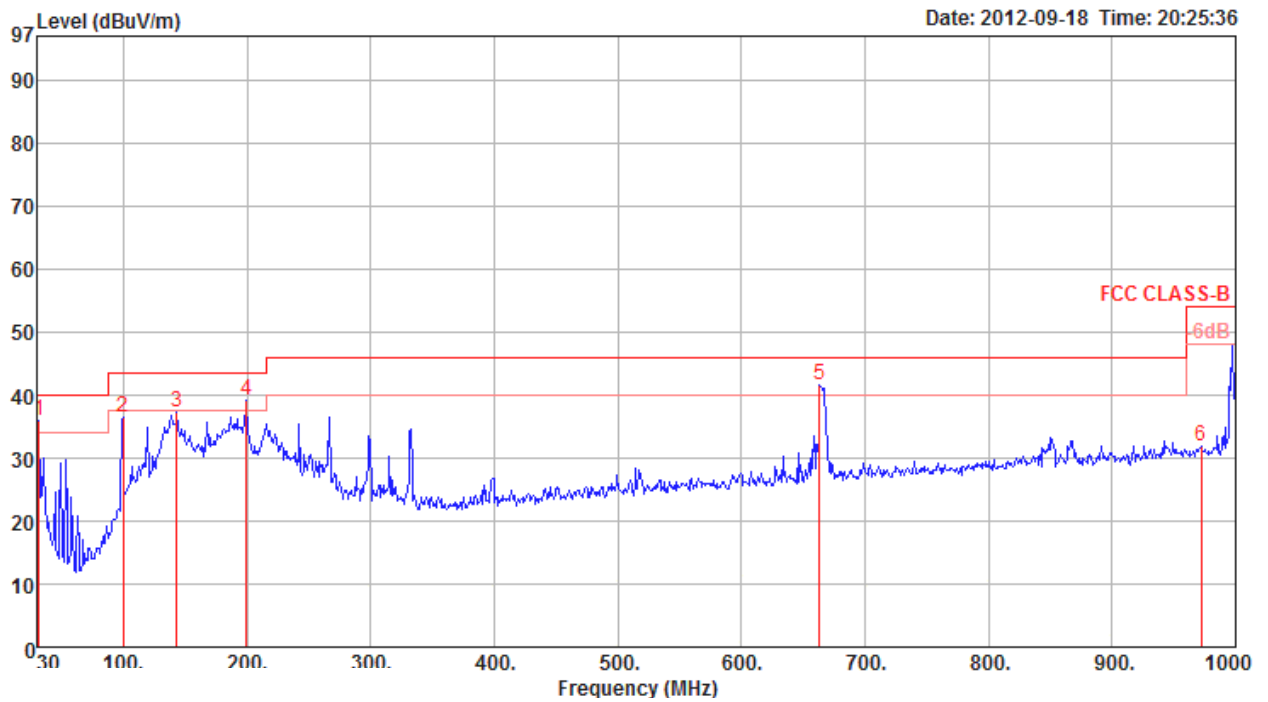

	Freq	Level	Limit	Over	Read	Cable	Preamp	Antenna	Remark	T/Pos	A/Pos	Pol/Phase
	MHz	dBuV/m	dBuV/m	dB	dBuV	dB	dB	dB/m		deg	cm	
1 p	31.94	36.02	40.00	-3.98	44.43	0.87	27.98	18.70	Peak	0	400	HORIZONTAL
2	99.84	36.49	43.50	-7.01	51.41	1.50	27.82	11.40	Peak	0	400	HORIZONTAL
3	143.49	37.24	43.50	-6.26	51.27	1.74	27.54	11.77	Peak	0	400	HORIZONTAL
4 !	199.75	39.16	43.50	-4.34	53.92	2.09	27.25	10.40	Peak	0	400	HORIZONTAL
5 !	663.41	41.55	46.00	-4.45	45.30	3.97	27.43	19.71	Peak	0	400	HORIZONTAL
6	971.87	32.01	54.00	-21.99	31.51	4.85	26.38	22.03	Peak	0	400	HORIZONTAL

Vertical

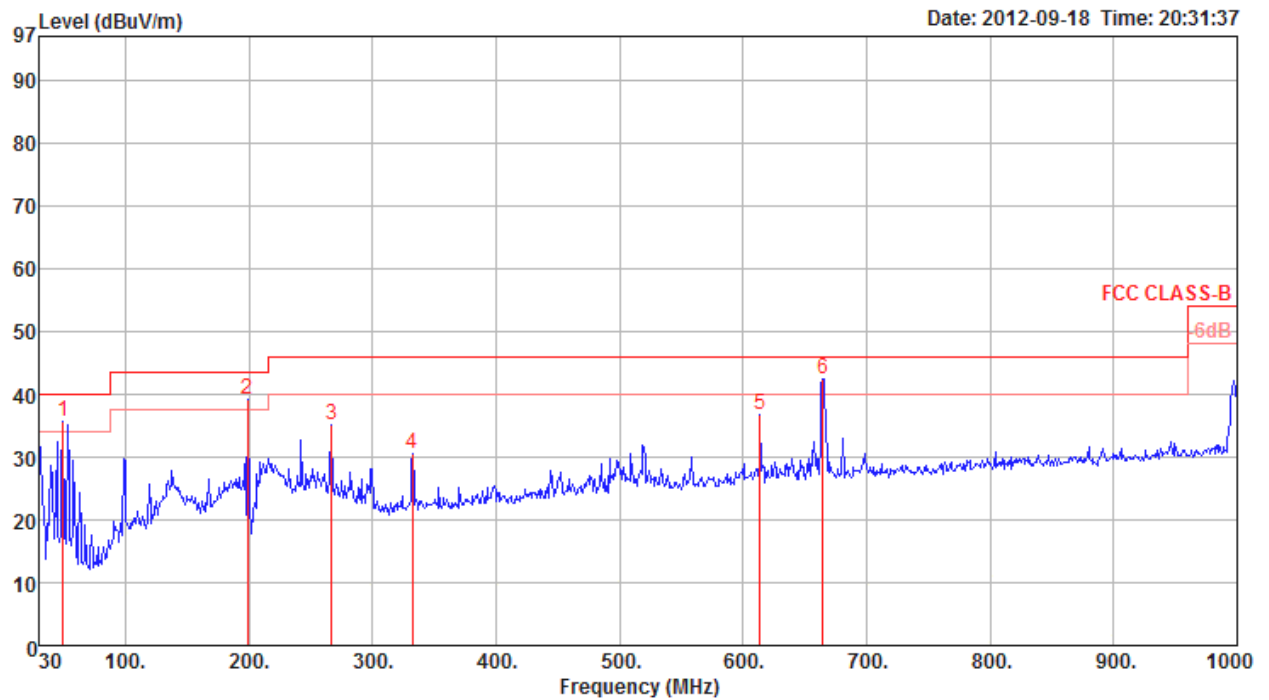

	Freq	Level	Limit	Over	Read	Cable	Preamp	Antenna	Remark	T/Pos	A/Pos	Pol/Phase
	MHz	dBuV/m	dBuV/m	dB	dBuV	dB	dB	dB/m		deg	cm	
1	!	49.40	35.60	40.00	-4.40	53.42	1.05	27.92	9.05	Peak	0	100 VERTICAL
2	!	198.78	39.05	43.50	-4.45	53.88	2.09	27.26	10.34	Peak	0	100 VERTICAL
3		266.68	35.18	46.00	-10.82	46.16	2.47	26.91	13.46	Peak	0	100 VERTICAL
4		332.64	30.44	46.00	-15.56	39.93	2.70	26.97	14.78	Peak	0	100 VERTICAL
5		613.94	36.64	46.00	-9.36	41.07	3.78	27.59	19.38	Peak	0	100 VERTICAL
6	p	664.38	42.50	46.00	-3.50	46.22	3.98	27.42	19.72	Peak	0	100 VERTICAL

Note:

The amplitude of spurious emissions which are attenuated by more than 20dB below the permissible value has no need to be reported.

Corrected Reading: Antenna Factor + Cable Loss + Read Level - Preamp Factor = Level.

4.5.9. Results for Radiated Emissions (1GHz~10th Harmonic)

Temperature	25°C	Humidity	63%
Test Engineer	Serway Li	Configurations	IEEE 802.11n MCS0 20MHz Ch 1
Test Date	Sep. 10, 2012	Test Mode	Mode 1.

Horizontal

	Freq	Level	Limit Line	Over Limit	Read Level	Cable Loss	Antenna Factor	Preamp Factor	Remark	A/Pos	T/Pos	Pol/Phase
	MHz	dBuV/m	dBuV/m	dB	dBuV	dB	dB/m	dB		cm	deg	
1	4823.88	43.46	74.00	-30.54	42.12	3.31	33.06	35.03	Peak	100	21	HORIZONTAL
2	4824.02	36.38	54.00	-17.62	35.04	3.31	33.06	35.03	Average	100	21	HORIZONTAL

Vertical

	Freq	Level	Limit Line	Over Limit	Read Level	Cable Loss	Antenna Factor	Preamp Factor	Remark	A/Pos	T/Pos	Pol/Phase
	MHz	dBuV/m	dBuV/m	dB	dBuV	dB	dB/m	dB		cm	deg	
1	4823.98	38.06	54.00	-15.94	36.72	3.31	33.06	35.03	Average	100	332	VERTICAL
2	4823.98	44.95	74.00	-29.05	43.61	3.31	33.06	35.03	Peak	100	332	VERTICAL

Temperature	25°C	Humidity	63%
Test Engineer	Serway Li	Configurations	IEEE 802.11n MCS0 20MHz Ch 6
Test Date	Sep. 10, 2012	Test Mode	Mode 1.

Horizontal

	Freq	Level	Limit	Over	Read	Cable	Antenna	Preamp	Remark	A/Pos	T/Pos	Pol/Phase
	MHz	dBuV/m	dBuV/m	dB	dBuV	Loss	Factor	Factor		cm	deg	
1	4873.93	43.16	74.00	-30.84	41.70	3.33	33.16	35.03	Peak	100	134	HORIZONTAL
2	4873.93	34.40	54.00	-19.60	32.94	3.33	33.16	35.03	Average	100	134	HORIZONTAL
3	7310.08	43.30	74.00	-30.70	38.68	4.06	35.96	35.40	Peak	100	223	HORIZONTAL
4	7310.63	30.32	54.00	-23.68	25.70	4.06	35.96	35.40	Average	100	223	HORIZONTAL

Vertical

	Freq	Level	Limit	Over	Read	Cable	Antenna	Preamp	Remark	A/Pos	T/Pos	Pol/Phase
	MHz	dBuV/m	dBuV/m	dB	dBuV	Loss	Factor	Factor		cm	deg	
1	4874.00	38.39	54.00	-15.61	36.93	3.33	33.16	35.03	Average	100	314	VERTICAL
2	4874.02	45.95	74.00	-28.05	44.49	3.33	33.16	35.03	Peak	100	314	VERTICAL
3	7311.70	31.67	54.00	-22.33	27.05	4.06	35.96	35.40	Average	100	343	VERTICAL
4	7311.94	45.32	74.00	-28.68	40.70	4.06	35.96	35.40	Peak	100	343	VERTICAL

Temperature	25°C	Humidity	63%
Test Engineer	Serway Li	Configurations	IEEE 802.11n MCS0 20MHz Ch 11
Test Date	Sep. 10, 2012	Test Mode	Mode 1.

Horizontal

	Freq	Level	Limit Line	Over Limit	Read Level	Cable Loss	Antenna Factor	Preamp Factor	Remark	A/Pos	T/Pos	Pol/Phase
	MHz	dBuV/m	dBuV/m	dB	dBuV	dB	dB/m	dB		cm	deg	
1	4923.94	41.32	74.00	-32.68	39.72	3.35	33.26	35.01	Peak	109	106	HORIZONTAL
2	4923.97	32.59	54.00	-21.41	30.99	3.35	33.26	35.01	Average	109	106	HORIZONTAL
3	7386.06	30.97	54.00	-23.03	26.22	4.06	36.09	35.40	Average	100	178	HORIZONTAL
4	7386.16	43.57	74.00	-30.43	38.82	4.06	36.09	35.40	Peak	100	178	HORIZONTAL

Vertical

	Freq	Level	Limit Line	Over Limit	Read Level	Cable Loss	Antenna Factor	Preamp Factor	Remark	A/Pos	T/Pos	Pol/Phase
	MHz	dBuV/m	dBuV/m	dB	dBuV	dB	dB/m	dB		cm	deg	
1	4923.97	38.91	54.00	-15.09	37.31	3.35	33.26	35.01	Average	109	314	VERTICAL
2	4923.99	45.67	74.00	-28.33	44.07	3.35	33.26	35.01	Peak	109	314	VERTICAL
3	7385.49	30.77	54.00	-23.23	26.02	4.06	36.09	35.40	Average	100	295	VERTICAL
4	7386.09	43.29	74.00	-30.71	38.54	4.06	36.09	35.40	Peak	100	295	VERTICAL

Temperature	25°C	Humidity	63%
Test Engineer	Serway Li	Configurations	IEEE 802.11n MCS0 40MHz Ch 3
Test Date	Sep. 10, 2012	Test Mode	Mode 1.

Horizontal

	Freq	Level	Limit	Over	Read	CableAntenna	Preamp	Remark	A/Pos	T/Pos	Pol/Phase
	MHz	dBuV/m	dBuV/m	dB	dBuV	dB	dB/m	dB	cm	deg	
1	4843.96	34.71	54.00	-19.29	33.33	3.32	33.09	35.03	100	23	HORIZONTAL
2	4844.16	42.25	74.00	-31.75	40.87	3.32	33.09	35.03	100	23	HORIZONTAL

Vertical

	Freq	Level	Limit	Over	Read	CableAntenna	Preamp	Remark	A/Pos	T/Pos	Pol/Phase
	MHz	dBuV/m	dBuV/m	dB	dBuV	dB	dB/m	dB	cm	deg	
1	4844.00	38.07	54.00	-15.93	36.69	3.32	33.09	35.03	100	333	VERTICAL
2	4844.00	43.71	74.00	-30.29	42.33	3.32	33.09	35.03	100	333	VERTICAL

Temperature	25°C	Humidity	63%
Test Engineer	Serway Li	Configurations	IEEE 802.11n MCS0 40MHz Ch 6
Test Date	Sep. 10, 2012	Test Mode	Mode 1.

Horizontal

	Freq	Level	Limit	Over	Read	Cable	Antenna	Preamp	Remark	A/Pos	T/Pos	Pol/Phase
	MHz	dBuV/m	dBuV/m	dB	dBuV	dB	dB/m	dB		cm	deg	
1	4873.96	34.69	54.00	-19.31	33.23	3.33	33.16	35.03	Average	100	138	HORIZONTAL
2	4874.02	42.45	74.00	-31.55	40.99	3.33	33.16	35.03	Peak	100	138	HORIZONTAL
3	7324.80	30.40	54.00	-23.60	25.75	4.06	35.99	35.40	Average	100	17	HORIZONTAL
4	7338.00	42.57	74.00	-31.43	37.92	4.06	35.99	35.40	Peak	100	17	HORIZONTAL

Vertical

	Freq	Level	Limit	Over	Read	Cable	Antenna	Preamp	Remark	A/Pos	T/Pos	Pol/Phase
	MHz	dBuV/m	dBuV/m	dB	dBuV	dB	dB/m	dB		cm	deg	
1	4873.99	38.35	54.00	-15.65	36.89	3.33	33.16	35.03	Average	100	314	VERTICAL
2	4874.04	44.53	74.00	-29.47	43.07	3.33	33.16	35.03	Peak	100	314	VERTICAL
3	7324.60	43.40	74.00	-30.60	38.75	4.06	35.99	35.40	Peak	100	180	VERTICAL
4	7334.60	30.58	54.00	-23.42	25.93	4.06	35.99	35.40	Average	100	180	VERTICAL

Temperature	25°C	Humidity	63%
Test Engineer	Serway Li	Configurations	IEEE 802.11n MCS0 40MHz Ch 9
Test Date	Sep. 10, 2012	Test Mode	Mode 1.

Horizontal

	Freq	Level	Limit Line	Over Limit	Read Level	Cable Loss	Antenna Factor	Preamp Factor	Remark	A/Pos	T/Pos	PoI/Phase
	MHz	dBuV/m	dBuV/m	dB	dBuV	dB	dB/m	dB		cm	deg	
1	4903.99	34.94	54.00	-19.06	33.43	3.34	33.19	35.02	Average	100	143	HORIZONTAL
2	4904.29	40.53	74.00	-33.47	39.02	3.34	33.19	35.02	Peak	100	143	HORIZONTAL
3	7355.08	42.42	74.00	-31.58	37.74	4.06	36.02	35.40	Peak	100	32	HORIZONTAL
4	7356.61	30.01	54.00	-23.99	25.33	4.06	36.02	35.40	Average	100	32	HORIZONTAL

Vertical

	Freq	Level	Limit Line	Over Limit	Read Level	Cable Loss	Antenna Factor	Preamp Factor	Remark	A/Pos	T/Pos	PoI/Phase
	MHz	dBuV/m	dBuV/m	dB	dBuV	dB	dB/m	dB		cm	deg	
1	4903.95	37.51	54.00	-16.49	36.00	3.34	33.19	35.02	Average	100	318	VERTICAL
2	4904.07	44.09	74.00	-29.91	42.58	3.34	33.19	35.02	Peak	100	318	VERTICAL
3	7355.09	42.74	74.00	-31.26	38.06	4.06	36.02	35.40	Peak	100	246	VERTICAL
4	7356.59	29.95	54.00	-24.05	25.27	4.06	36.02	35.40	Average	100	246	VERTICAL

Note:

The amplitude of spurious emissions which are attenuated by more than 20 dB below the permissible value has no need to be reported.

Emission level (dBuV/m) = 20 log Emission level (uV/m).

Corrected Reading: Antenna Factor + Cable Loss + Read Level - Preamp Factor = Level.

Temperature	25°C	Humidity	63%
Test Engineer	Serway Li	Configurations	IEEE 802.11b Ch 1
Test Date	Sep. 10, 2012	Test Mode	Mode 1.

Horizontal

	Freq	Level	Limit Line	Over Limit	Read Level	Cable Loss	Preamp Factor	Antenna Factor	Remark	Pol/Phase	T/Pos	A/Pos
	MHz	dBuV/m	dBuV/m	dB	dBuV	dB	dB	dB/m			deg	cm
1 p	4823.93	50.55	74.00	-23.45	48.47	4.21	34.69	32.56	Peak	HORIZONTAL	308	130
2 a	4823.98	48.68	54.00	-5.32	46.60	4.21	34.69	32.56	Average	HORIZONTAL	308	130

Vertical

	Freq	Level	Limit Line	Over Limit	Read Level	Cable Loss	Preamp Factor	Antenna Factor	Remark	Pol/Phase	T/Pos	A/Pos
	MHz	dBuV/m	dBuV/m	dB	dBuV	dB	dB	dB/m			deg	cm
1 a	4823.99	50.13	54.00	-3.87	48.05	4.21	34.69	32.56	Average	VERTICAL	84	130
2 p	4824.03	52.33	74.00	-21.67	50.25	4.21	34.69	32.56	Peak	VERTICAL	84	130

Temperature	25°C	Humidity	63%
Test Engineer	Serway Li	Configurations	IEEE 802.11b Ch 6
Test Date	Sep. 10, 2012	Test Mode	Mode 1.

Horizontal

	Freq	Level	Limit Line	Over Limit	Read Level	Cable Loss	Preamp Factor	Antenna Factor	Remark	Pol/Phase	T/Pos	A/Pos
	MHz	dBuV/m	dBuV/m	dB	dBuV	dB	dB	dB/m			deg	cm
1 a	4873.97	46.39	54.00	-7.61	44.18	4.22	34.67	32.66	Average	HORIZONTAL	313	135
2 p	4873.97	49.69	74.00	-24.31	47.48	4.22	34.67	32.66	Peak	HORIZONTAL	313	135

Vertical

	Freq	Level	Limit Line	Over Limit	Read Level	Cable Loss	Preamp Factor	Antenna Factor	Remark	Pol/Phase	T/Pos	A/Pos
	MHz	dBuV/m	dBuV/m	dB	dBuV	dB	dB	dB/m			deg	cm
1 a	4873.95	50.00	54.00	-4.00	47.79	4.22	34.67	32.66	Average	VERTICAL	83	127
2 p	4873.98	52.46	74.00	-21.54	50.25	4.22	34.67	32.66	Peak	VERTICAL	83	127

Temperature	25°C	Humidity	63%
Test Engineer	Serway Li	Configurations	IEEE 802.11b Ch 11
Test Date	Sep. 10, 2012	Test Mode	Mode 1.

Horizontal

	Freq	Level	Limit Line	Over Limit	Read Level	Cable Loss	Preamp Factor	Antenna Factor	Remark	Pol/Phase	T/Pos	A/Pos
	MHz	dBuV/m	dBuV/m	dB	dBuV	dB	dB	dB/m			deg	cm
1 a	4923.98	45.49	54.00	-8.51	43.15	4.23	34.65	32.76	Average	HORIZONTAL	314	133
2 p	4924.07	49.07	74.00	-24.93	46.73	4.23	34.65	32.76	Peak	HORIZONTAL	314	133

Vertical

	Freq	Level	Limit Line	Over Limit	Read Level	Cable Loss	Preamp Factor	Antenna Factor	Remark	Pol/Phase	T/Pos	A/Pos
	MHz	dBuV/m	dBuV/m	dB	dBuV	dB	dB	dB/m			deg	cm
1 p	4923.99	53.57	74.00	-20.43	51.23	4.23	34.65	32.76	Peak	VERTICAL	83	125
2 a	4924.00	50.77	54.00	-3.23	48.43	4.23	34.65	32.76	Average	VERTICAL	83	125

Temperature	25.6°C	Humidity	56%
Test Engineer	Will Tung	Configurations	IEEE 802.11g Ch 1
Test Date	Sep. 17, 2012	Test Mode	Mode 1.

Horizontal

	Freq	Level	Limit Line	Over Limit	Read Level	Cable Loss	Antenna Factor	Preamp Factor	Remark	A/Pos	T/Pos	PoI/Phase
	MHz	dBuV/m	dBuV/m	dB	dBuV	dB	dB/m	dB		cm	deg	
1	4823.98	43.75	74.00	-30.25	42.41	3.31	33.06	35.03	Peak	100	24	HORIZONTAL
2	4823.99	36.45	54.00	-17.55	35.11	3.31	33.06	35.03	Average	100	24	HORIZONTAL

Vertical

	Freq	Level	Limit Line	Over Limit	Read Level	Cable Loss	Antenna Factor	Preamp Factor	Remark	A/Pos	T/Pos	PoI/Phase
	MHz	dBuV/m	dBuV/m	dB	dBuV	dB	dB/m	dB		cm	deg	
1	4823.87	44.78	74.00	-29.22	43.44	3.31	33.06	35.03	Peak	100	114	VERTICAL
2	4824.00	39.55	54.00	-14.45	38.21	3.31	33.06	35.03	Average	100	114	VERTICAL

Temperature	25.6°C	Humidity	56%
Test Engineer	Will Tung	Configurations	IEEE 802.11g Ch 6
Test Date	Sep. 17, 2012	Test Mode	Mode 1.

Horizontal

	Freq	Level	Limit	Over	Read	Cable	Antenna	Preamp	Remark	A/Pos	T/Pos	Pol/Phase
	MHz	dBuV/m	dBuV/m	dB	dBuV	Loss	Factor	Factor		cm	deg	
1	4873.98	34.86	54.00	-19.14	33.40	3.33	33.16	35.03	Average	100	135	HORIZONTAL
2	4874.04	42.98	74.00	-31.02	41.52	3.33	33.16	35.03	Peak	100	135	HORIZONTAL
3	7310.10	43.51	74.00	-30.49	38.89	4.06	35.96	35.40	Peak	100	13	HORIZONTAL
4	7310.62	30.52	54.00	-23.48	25.90	4.06	35.96	35.40	Average	100	13	HORIZONTAL

Vertical

	Freq	Level	Limit	Over	Read	Cable	Antenna	Preamp	Remark	A/Pos	T/Pos	Pol/Phase
	MHz	dBuV/m	dBuV/m	dB	dBuV	Loss	Factor	Factor		cm	deg	
1	4873.96	38.63	54.00	-15.37	37.17	3.33	33.16	35.03	Average	100	314	VERTICAL
2	4874.05	45.23	74.00	-28.77	43.77	3.33	33.16	35.03	Peak	100	314	VERTICAL
3	7310.31	32.71	54.00	-21.29	28.09	4.06	35.96	35.40	Average	100	115	VERTICAL
4	7311.11	42.96	74.00	-31.04	38.34	4.06	35.96	35.40	Peak	100	115	VERTICAL

Temperature	25.6°C	Humidity	56%
Test Engineer	Will Tung	Configurations	IEEE 802.11g Ch 11
Test Date	Sep. 17, 2012	Test Mode	Mode 1.

Horizontal

	Freq	Level	Limit Line	Over Limit	Read Level	Cable Loss	Antenna Factor	Preamp Factor	Remark	A/Pos	T/Pos	Pol/Phase
	MHz	dBuV/m	dBuV/m	dB	dBuV	dB	dB/m	dB		cm	deg	
1	4923.96	38.82	54.00	-15.18	37.22	3.35	33.26	35.01	Average	100	315	VERTICAL
2	4923.98	45.30	74.00	-28.70	43.70	3.35	33.26	35.01	Peak	100	315	VERTICAL
3	7385.10	43.10	74.00	-30.90	38.35	4.06	36.09	35.40	Peak	100	209	VERTICAL
4	7386.60	30.71	54.00	-23.29	25.96	4.06	36.09	35.40	Average	100	209	VERTICAL

Vertical

	Freq	Level	Limit Line	Over Limit	Read Level	Cable Loss	Antenna Factor	Preamp Factor	Remark	A/Pos	T/Pos	Pol/Phase
	MHz	dBuV/m	dBuV/m	dB	dBuV	dB	dB/m	dB		cm	deg	
1	4923.99	40.32	74.00	-33.68	38.72	3.35	33.26	35.01	Peak	100	61	HORIZONTAL
2	4924.01	35.24	54.00	-18.76	33.64	3.35	33.26	35.01	Average	100	61	HORIZONTAL
3	7385.76	43.20	74.00	-30.80	38.45	4.06	36.09	35.40	Peak	100	94	HORIZONTAL
4	7386.26	30.74	54.00	-23.26	25.99	4.06	36.09	35.40	Average	100	94	HORIZONTAL

Note:

The amplitude of spurious emissions that are attenuated by more than 20dB below the permissible value has no need to be reported.

Emission level (dBuV/m) = 20 log Emission level (uV/m).

Corrected Reading: Antenna Factor + Cable Loss + Read Level - Preamp Factor = Level.

Temperature	25.6°C	Humidity	56%
Test Engineer	Will Tung	Configurations	IEEE 802.11n MCS0 20MHz Ch 1
Test Date	Sep. 17, 2012	Test Mode	Mode 2.

Horizontal

	Freq	Level	Limit Line	Over Limit	Read Level	Cable Loss	Antenna Factor	Preamp Factor	Remark	A/Pos	T/Pos	Pol/Phase
	MHz	dBuV/m	dBuV/m	dB	dBuV	dB	dB/m	dB		cm	deg	
1	4823.76	46.42	74.00	-27.58	45.08	3.31	33.06	35.03	Peak	100	139	VERTICAL
2	4823.96	39.69	54.00	-14.31	38.35	3.31	33.06	35.03	Average	100	139	VERTICAL

Vertical

	Freq	Level	Limit Line	Over Limit	Read Level	Cable Loss	Antenna Factor	Preamp Factor	Remark	A/Pos	T/Pos	Pol/Phase
	MHz	dBuV/m	dBuV/m	dB	dBuV	dB	dB/m	dB		cm	deg	
1	4824.00	27.72	54.00	-26.28	26.38	3.31	33.06	35.03	Average	100	321	HORIZONTAL
2	4824.24	40.72	74.00	-33.28	39.38	3.31	33.06	35.03	Peak	100	321	HORIZONTAL

Temperature	25.6°C	Humidity	56%
Test Engineer	Will Tung	Configurations	IEEE 802.11n MCS0 20MHz Ch 6
Test Date	Sep. 17, 2012	Test Mode	Mode 2.

Horizontal

	Freq	Level	Limit Line	Over Limit	Read Level	Cable Loss	Antenna Factor	Preamp Factor	Remark	A/Pos	T/Pos	Pol/Phase
	MHz	dBuV/m	dBuV/m	dB	dBuV	dB	dB/m	dB		cm	deg	
1	4873.64	40.34	74.00	-33.66	38.88	3.33	33.16	35.03	Peak	100	354	HORIZONTAL
2	4874.06	28.29	54.00	-25.71	26.83	3.33	33.16	35.03	Average	100	354	HORIZONTAL

Vertical

	Freq	Level	Limit Line	Over Limit	Read Level	Cable Loss	Antenna Factor	Preamp Factor	Remark	A/Pos	T/Pos	Pol/Phase
	MHz	dBuV/m	dBuV/m	dB	dBuV	dB	dB/m	dB		cm	deg	
1	4873.96	39.76	54.00	-14.24	38.30	3.33	33.16	35.03	Average	100	139	VERTICAL
2	4874.09	45.67	74.00	-28.33	44.21	3.33	33.16	35.03	Peak	100	139	VERTICAL



Temperature	25.6°C	Humidity	56%
Test Engineer	Will Tung	Configurations	IEEE 802.11n MCS0 20MHz Ch 11
Test Date	Sep. 17, 2012	Test Mode	Mode 2.

Horizontal

	Freq	Level	Limit Line	Over Limit	Read Level	CableAntenna Loss	Antenna Factor	Preamp Factor	Remark	A/Pos	T/Pos	Pol/Phase
	MHz	dBuV/m	dBuV/m	dB	dBuV	dB	dB/m	dB		cm	deg	
1	4873.96	39.76	54.00	-14.24	38.30	3.33	33.16	35.03	Average	100	139	VERTICAL
2	4874.09	45.67	74.00	-28.33	44.21	3.33	33.16	35.03	Peak	100	139	VERTICAL

Vertical

	Freq	Level	Limit Line	Over Limit	Read Level	CableAntenna Loss	Antenna Factor	Preamp Factor	Remark	A/Pos	T/Pos	Pol/Phase
	MHz	dBuV/m	dBuV/m	dB	dBuV	dB	dB/m	dB		cm	deg	
1	4873.64	40.34	74.00	-33.66	38.88	3.33	33.16	35.03	Peak	100	354	HORIZONTAL
2	4874.06	28.29	54.00	-25.71	26.83	3.33	33.16	35.03	Average	100	354	HORIZONTAL

Temperature	25.6°C	Humidity	56%
Test Engineer	Will Tung	Configurations	IEEE 802.11n MCS0 40MHz Ch 3
Test Date	Sep. 17, 2012	Test Mode	Mode 2.

Horizontal

	Freq	Level	Limit Line	Over Limit	Read Level	Cable Loss	Antenna Factor	Preamp Factor	Remark	A/Pos	T/Pos	Pol/Phase
	MHz	dBuV/m	dBuV/m	dB	dBuV	dB	dB/m	dB		cm	deg	
1	4843.93	28.43	54.00	-25.57	27.05	3.32	33.09	35.03	Average	100	2	HORIZONTAL
2	4844.14	39.80	74.00	-34.20	38.42	3.32	33.09	35.03	Peak	100	2	HORIZONTAL

Vertical

	Freq	Level	Limit Line	Over Limit	Read Level	Cable Loss	Antenna Factor	Preamp Factor	Remark	A/Pos	T/Pos	Pol/Phase
	MHz	dBuV/m	dBuV/m	dB	dBuV	dB	dB/m	dB		cm	deg	
1	4843.99	40.67	54.00	-13.33	39.29	3.32	33.09	35.03	Average	100	213	VERTICAL
2	4844.04	45.40	74.00	-28.60	44.02	3.32	33.09	35.03	Peak	100	213	VERTICAL



Temperature	25.6°C	Humidity	56%
Test Engineer	Will Tung	Configurations	IEEE 802.11n MCS0 40MHz Ch 6
Test Date	Sep. 17, 2012	Test Mode	Mode 2.

Horizontal

	Freq	Level	Limit Line	Over Limit	Read Level	CableAntenna Loss	Antenna Factor	Preamp Factor	Remark	A/Pos	T/Pos	Pol/Phase
	MHz	dBuV/m	dBuV/m	dB	dBuV	dB	dB/m	dB		cm	deg	
1	4903.94	40.20	74.00	-33.80	38.69	3.34	33.19	35.02	Peak	100	345	HORIZONTAL
2	4904.08	28.72	54.00	-25.28	27.21	3.34	33.19	35.02	Average	100	345	HORIZONTAL

Vertical

	Freq	Level	Limit Line	Over Limit	Read Level	CableAntenna Loss	Antenna Factor	Preamp Factor	Remark	A/Pos	T/Pos	Pol/Phase
	MHz	dBuV/m	dBuV/m	dB	dBuV	dB	dB/m	dB		cm	deg	
1	4903.95	39.82	54.00	-14.18	38.31	3.34	33.19	35.02	Average	100	207	VERTICAL
2	4903.96	44.98	74.00	-29.02	43.47	3.34	33.19	35.02	Peak	100	207	VERTICAL



Temperature	25.6°C	Humidity	56%
Test Engineer	Will Tung	Configurations	IEEE 802.11n MCS0 40MHz Ch 9
Test Date	Sep. 17, 2012	Test Mode	Mode 2.

Horizontal

	Freq	Level	Limit Line	Over Limit	Read Level	Cable Loss	Antenna Factor	Preamp Factor	Remark	A/Pos	T/Pos	Pol/Phase
	MHz	dBuV/m	dBuV/m	dB	dBuV	dB	dB/m	dB		cm	deg	
1	4903.94	40.20	74.00	-33.80	38.69	3.34	33.19	35.02	Peak	100	345	HORIZONTAL
2	4904.08	28.72	54.00	-25.28	27.21	3.34	33.19	35.02	Average	100	345	HORIZONTAL

Vertical

	Freq	Level	Limit Line	Over Limit	Read Level	Cable Loss	Antenna Factor	Preamp Factor	Remark	A/Pos	T/Pos	Pol/Phase
	MHz	dBuV/m	dBuV/m	dB	dBuV	dB	dB/m	dB		cm	deg	
1	4903.95	39.82	54.00	-14.18	38.31	3.34	33.19	35.02	Average	100	207	VERTICAL
2	4903.96	44.98	74.00	-29.02	43.47	3.34	33.19	35.02	Peak	100	207	VERTICAL

Note:

The amplitude of spurious emissions which are attenuated by more than 20 dB below the permissible value has no need to be reported.

Emission level (dBuV/m) = 20 log Emission level (uV/m).

Corrected Reading: Antenna Factor + Cable Loss + Read Level - Preamp Factor = Level.

Temperature	25°C	Humidity	63%
Test Engineer	Serway Li	Configurations	IEEE 802.11b Ch 1
Test Date	Sep. 10, 2012	Test Mode	Mode 2.

Horizontal

	Freq	Level	Limit Line	Over Limit	Read Level	Cable Loss	Preamp Factor	Antenna Factor	Remark	Pol/Phase	T/Pos	A/Pos
	MHz	dBuV/m	dBuV/m	dB	dBuV	dB	dB	dB/m			deg	cm
1 a	4823.96	36.49	54.00	-17.51	34.41	4.21	34.69	32.56	Average	HORIZONTAL	237	131
2 p	4824.14	43.84	74.00	-30.16	41.76	4.21	34.69	32.56	Peak	HORIZONTAL	237	131

Vertical

	Freq	Level	Limit Line	Over Limit	Read Level	Cable Loss	Preamp Factor	Antenna Factor	Remark	Pol/Phase	T/Pos	A/Pos
	MHz	dBuV/m	dBuV/m	dB	dBuV	dB	dB	dB/m			deg	cm
1 p	4823.95	52.98	74.00	-21.02	50.90	4.21	34.69	32.56	Peak	VERTICAL	86	114
2 a	4823.99	50.83	54.00	-3.17	48.75	4.21	34.69	32.56	Average	VERTICAL	86	114

Temperature	25°C	Humidity	63%
Test Engineer	Serway Li	Configurations	IEEE 802.11b Ch 6
Test Date	Sep. 10, 2012	Test Mode	Mode 2.

Horizontal

	Freq	Level	Limit	Over	Read	Cable	Preamp	Antenna	Remark	Pol/Phase	T/Pos	A/Pos
	MHz	dBuV/m	dBuV/m	dB	dBuV	dB	dB	dB/m			deg	cm
1 p	4873.95	44.18	74.00	-29.82	41.97	4.22	34.67	32.66	Peak	HORIZONTAL	236	126
2 a	4874.01	36.31	54.00	-17.69	34.10	4.22	34.67	32.66	Average	HORIZONTAL	236	126

Vertical

	Freq	Level	Limit	Over	Read	Cable	Preamp	Antenna	Remark	Pol/Phase	T/Pos	A/Pos
	MHz	dBuV/m	dBuV/m	dB	dBuV	dB	dB	dB/m			deg	cm
1 a	4873.97	52.96	54.00	-1.04	50.75	4.22	34.67	32.66	Average	VERTICAL	98	114
2 p	4873.98	55.05	74.00	-18.95	52.84	4.22	34.67	32.66	Peak	VERTICAL	98	114

Temperature	25°C	Humidity	63%
Test Engineer	Serway Li	Configurations	IEEE 802.11b Ch 11
Test Date	Sep. 10, 2012	Test Mode	Mode 2.

Horizontal

	Freq	Level	Limit	Over	Read	Cable	Preamp	Antenna	Remark	Pol/Phase	T/Pos	A/Pos
	MHz	dBuV/m	dBuV/m	dB	dBuV	dB	dB	dB/m			deg	cm
1 p	4923.96	46.09	74.00	-27.91	43.75	4.23	34.65	32.76	Peak	HORIZONTAL	166	139
2 a	4923.97	39.14	54.00	-14.86	36.80	4.23	34.65	32.76	Average	HORIZONTAL	166	139

Vertical

	Freq	Level	Limit	Over	Read	Cable	Preamp	Antenna	Remark	Pol/Phase	T/Pos	A/Pos
	MHz	dBuV/m	dBuV/m	dB	dBuV	dB	dB	dB/m			deg	cm
1 a	4923.97	52.99	54.00	-1.01	50.65	4.23	34.65	32.76	Average	VERTICAL	84	126
2 p	4924.10	54.16	74.00	-19.84	51.82	4.23	34.65	32.76	Peak	VERTICAL	314	102

Temperature	25.6°C	Humidity	56%
Test Engineer	Will Tung	Configurations	IEEE 802.11g Ch 1
Test Date	Sep. 17, 2012	Test Mode	Mode 2.

Horizontal

	Freq	Level	Limit Line	Over Limit	Read Level	Cable Loss	Antenna Factor	Preamp Factor	Remark	A/Pos	T/Pos	Pol/Phase
	MHz	dBuV/m	dBuV/m	dB	dBuV	dB	dB/m	dB		cm	deg	
1	4823.92	27.96	54.00	-26.04	26.62	3.31	33.06	35.03	Average	100	321	HORIZONTAL
2	4824.75	39.57	74.00	-34.43	38.23	3.31	33.06	35.03	Peak	100	321	HORIZONTAL

Vertical

	Freq	Level	Limit Line	Over Limit	Read Level	Cable Loss	Antenna Factor	Preamp Factor	Remark	A/Pos	T/Pos	Pol/Phase
	MHz	dBuV/m	dBuV/m	dB	dBuV	dB	dB/m	dB		cm	deg	
1	4823.98	40.05	54.00	-13.95	38.71	3.31	33.06	35.03	Average	100	198	VERTICAL
2	4824.08	45.76	74.00	-28.24	44.42	3.31	33.06	35.03	Peak	100	198	VERTICAL



Temperature	25.6°C	Humidity	56%
Test Engineer	Will Tung	Configurations	IEEE 802.11g Ch 6
Test Date	Sep. 17, 2012	Test Mode	Mode 2.

Horizontal

	Freq	Level	Limit Line	Over Limit	Read Level	Cable Loss	Antenna Factor	Preamp Factor	Remark	A/Pos	T/Pos	Pol/Phase
	MHz	dBuV/m	dBuV/m	dB	dBuV	dB	dB/m	dB		cm	deg	
1	4923.51	39.60	74.00	-34.40	38.00	3.35	33.26	35.01	Peak	100	175	HORIZONTAL
2	4923.97	33.65	54.00	-20.35	32.05	3.35	33.26	35.01	Average	100	175	HORIZONTAL

Vertical

	Freq	Level	Limit Line	Over Limit	Read Level	Cable Loss	Antenna Factor	Preamp Factor	Remark	A/Pos	T/Pos	Pol/Phase
	MHz	dBuV/m	dBuV/m	dB	dBuV	dB	dB/m	dB		cm	deg	
1	4923.96	45.31	74.00	-28.69	43.71	3.35	33.26	35.01	Peak	100	355	VERTICAL
2	4923.97	40.40	54.00	-13.60	38.80	3.35	33.26	35.01	Average	100	355	VERTICAL

Temperature	25.6°C	Humidity	56%
Test Engineer	Will Tung	Configurations	IEEE 802.11g Ch 11
Test Date	Sep. 17, 2012	Test Mode	Mode 2.

Horizontal

	Freq	Level	Limit Line	Over Limit	Read Level	Cable Loss	Antenna Factor	Preamp Factor	Remark	A/Pos	T/Pos	PoI/Phase
	MHz	dBuV/m	dBuV/m	dB	dBuV	dB	dB/m	dB		cm	deg	
1	4923.51	39.60	74.00	-34.40	38.00	3.35	33.26	35.01	Peak	100	175	HORIZONTAL
2	4923.97	33.65	54.00	-20.35	32.05	3.35	33.26	35.01	Average	100	175	HORIZONTAL

Vertical

	Freq	Level	Limit Line	Over Limit	Read Level	Cable Loss	Antenna Factor	Preamp Factor	Remark	A/Pos	T/Pos	PoI/Phase
	MHz	dBuV/m	dBuV/m	dB	dBuV	dB	dB/m	dB		cm	deg	
1	4923.96	45.31	74.00	-28.69	43.71	3.35	33.26	35.01	Peak	100	355	VERTICAL
2	4923.97	40.40	54.00	-13.60	38.80	3.35	33.26	35.01	Average	100	355	VERTICAL

Note:

The amplitude of spurious emissions that are attenuated by more than 20dB below the permissible value has no need to be reported.

Emission level (dBuV/m) = 20 log Emission level (uV/m).

Corrected Reading: Antenna Factor + Cable Loss + Read Level - Preamp Factor = Level.

4.6. Band Edge Emissions Measurement

4.6.1. Limit

20dBc in any 100 kHz bandwidth outside the operating frequency band. In case the emission fall within the restricted band specified on 15.205(a), then the 15.209(a) limit in the table below has to be followed.

Frequencies (MHz)	Field Strength (micorvolts/meter)	Measurement Distance (meters)
0.009~0.490	2400/F(KHz)	300
0.490~1.705	24000/F(KHz)	30
1.705~30.0	30	30
30~88	100	3
88~216	150	3
216~960	200	3
Above 960	500	3

4.6.2. Measuring Instruments and Setting

Please refer to section 5 of equipments list in this report. The following table is the setting of the spectrum analyzer.

Spectrum Parameter	Setting
Attenuation	Auto
Span Frequency	100 MHz
RB / VB (Emission in restricted band)	1 MHz / 3MHz for Peak, 1 MHz / 10Hz for Average
RB / VB (Emission in non-restricted band)	100 KHz / 300 KHz for Peak

4.6.3. Test Procedures

- The test procedure is the same as section 4.5.3, only the frequency range investigated is limited to 100MHz around bandedges.

4.6.4. Test Setup Layout

This test setup layout is the same as that shown in section 4.5.4.

4.6.5. Test Deviation

There is no deviation with the original standard.

4.6.6. EUT Operation during Test

The EUT was programmed to be in continuously transmitting mode.

4.6.7. Test Result of Band Edge and Fundamental Emissions

Temperature	25°C	Humidity	63%
Test Engineer	Serway Li	Configurations	IEEE 802.11n MCS0 20MHz Ch 1, 6, 11
Test Date	Sep. 10, 2012	Test Mode	Mode 1.

Channel 1

	Freq	Level	Limit Line	Over Limit	Read Level	Cable Loss	Preamp Factor	Antenna Factor	Remark	Pol/Phase	T/Pos	A/Pos	
	MHz	dBuV/m	dBuV/m	dB	dBuV	dB	dB	dB/m			deg	cm	
1	!	2388.80	71.80	74.00	-2.20	41.02	2.91	0.00	27.87	Peak	HORIZONTAL	135	128
2	!	2390.00	52.69	54.00	-1.31	21.91	2.91	0.00	27.87	Average	HORIZONTAL	135	128
3	a	2408.80				66.38	2.92	0.00	27.84	Average	HORIZONTAL	135	128
4	p	2409.00				77.11	2.92	0.00	27.84	Peak	HORIZONTAL	135	128

Item 3, 4 are the fundamental frequency at 2412 MHz.

Channel 6

	Freq	Level	Limit Line	Over Limit	Read Level	Cable Loss	Antenna Factor	Preamp Factor	Remark	A/Pos	T/Pos	Pol/Phase
	MHz	dBuV/m	dBuV/m	dB	dBuV	dB	dB/m	dB		cm	deg	
1		2390.00	48.70	54.00	-5.30	18.31	2.22	28.17	0.00	Average	126	304 HORIZONTAL
2		2390.00	62.68	74.00	-11.32	32.29	2.22	28.17	0.00	Peak	126	304 HORIZONTAL
3		2433.80				76.49	2.23	28.25	0.00	Peak	126	304 HORIZONTAL
4		2445.00				66.46	2.24	28.29	0.00	Average	126	304 HORIZONTAL
5		2483.50	51.22	54.00	-2.78	20.58	2.26	28.38	0.00	Average	126	304 HORIZONTAL
6		2485.50	67.99	74.00	-6.01	37.31	2.26	28.42	0.00	Peak	126	304 HORIZONTAL

Item 3, 4 are the fundamental frequency at 2437MHz.

Channel 11

	Freq	Level	Limit Line	Over Limit	Read Level	Cable Loss	Preamp Factor	Antenna Factor	Remark	Pol/Phase	T/Pos	A/Pos	
	MHz	dBuV/m	dBuV/m	dB	dBuV	dB	dB	dB/m			deg	cm	
1	p	2469.20				77.26	2.95	0.00	27.76	Peak	HORIZONTAL	93	122
2	a	2470.20				68.15	2.95	0.00	27.76	Average	HORIZONTAL	93	122
3	!	2483.50	73.12	74.00	-0.88	42.43	2.96	0.00	27.73	Peak	HORIZONTAL	93	122
4	!	2483.50	51.79	54.00	-2.21	21.10	2.96	0.00	27.73	Average	HORIZONTAL	93	122

Item 1, 2 are the fundamental frequency at 2462 MHz.

Temperature	25°C	Humidity	63%
Test Engineer	Serway Li	Configurations	IEEE 802.11n MCS0 40MHz Ch 3, 6, 9
Test Date	Sep. 10, 2012	Test Mode	Mode 1.

Channel 3

	Freq	Level	Limit Line	Over Limit	Read Level	Cable Loss	Preamp Factor	Antenna Factor	Remark	Pol/Phase	T/Pos	A/Pos
	MHz	dBuV/m	dBuV/m	dB	dBuV	dB	dB	dB/m			deg	cm
1	2386.00	70.65	74.00	-3.35	39.87	2.91	0.00	27.87	Peak	HORIZONTAL	138	153
2	2390.00	52.83	54.00	-1.17	22.05	2.91	0.00	27.87	Average	HORIZONTAL	138	153
3 a	2420.40				61.87	2.93	0.00	27.81	Average	HORIZONTAL	138	153
4 p	2424.80				70.99	2.93	0.00	27.81	Peak	HORIZONTAL	138	153

Item 3, 4 are the fundamental frequency at 2422 MHz.

Channel 6

	Freq	Level	Limit Line	Over Limit	Read Level	Cable Loss	Antenna Factor	Preamp Factor	Remark	A/Pos	T/Pos	Pol/Phase
	MHz	dBuV/m	dBuV/m	dB	dBuV	dB	dB/m	dB		cm	deg	
1	2388.80	64.48	74.00	-9.52	34.10	2.21	28.17	0.00	Peak	129	321	HORIZONTAL
2	2390.00	45.73	54.00	-8.27	15.34	2.22	28.17	0.00	Average	129	321	HORIZONTAL
3	2432.60				62.13	2.23	28.25	0.00	Average	129	321	HORIZONTAL
4	2435.00				72.13	2.23	28.29	0.00	Peak	129	321	HORIZONTAL
5	2483.50	52.58	54.00	-1.42	21.94	2.26	28.38	0.00	Average	129	321	HORIZONTAL
6	2484.70	69.97	74.00	-4.03	39.33	2.26	28.38	0.00	Peak	129	321	HORIZONTAL

Item 3, 4 are the fundamental frequency at 2437MHz.

Channel 9

	Freq	Level	Limit Line	Over Limit	Read Level	Cable Loss	Preamp Factor	Antenna Factor	Remark	Pol/Phase	T/Pos	A/Pos
	MHz	dBuV/m	dBuV/m	dB	dBuV	dB	dB	dB/m			deg	cm
1 p	2462.40				73.76	2.95	0.00	27.76	Peak	HORIZONTAL	94	124
2 a	2468.00				63.46	2.95	0.00	27.76	Average	HORIZONTAL	94	124
3	2484.30	51.50	54.00	-2.50	20.81	2.96	0.00	27.73	Average	HORIZONTAL	94	124
4	2493.50	72.54	74.00	-1.46	41.87	2.97	0.00	27.70	Peak	HORIZONTAL	94	124

Item 1, 2 are the fundamental frequency at 2452 MHz.

Note:

Emission level (dBuV/m) = 20 log Emission level (uV/m).

Corrected Reading: Antenna Factor + Cable Loss + Read Level - Preamp Factor = Level.

Temperature	25°C	Humidity	63%
Test Engineer	Serway Li	Configurations	IEEE 802.11b CH 1, 6, 11
Test Date	Sep. 10, 2012	Test Mode	Mode 1.

Channel 1

	Freq	Level	Limit Line	Over Limit	Read Level	Cable Loss	Preamp Factor	Antenna Factor	Remark	Pol/Phase	T/Pos	A/Pos
	MHz	dBuV/m	dBuV/m	dB	dBuV	dB	dB	dB/m			deg	cm
1	2389.20	60.96	74.00	-13.04	30.18	2.91	0.00	27.87	Peak	HORIZONTAL	85	182
2	2389.60	52.17	54.00	-1.83	21.39	2.91	0.00	27.87	Average	HORIZONTAL	85	182
3	2411.20				77.16	2.92	0.00	27.84	Average	HORIZONTAL	85	182
4	2413.20				81.12	2.92	0.00	27.84	Peak	HORIZONTAL	85	182

Item 3, 4 are the fundamental frequency at 2412 MHz.

Channel 6

	Freq	Level	Limit Line	Over Limit	Read Level	Cable Loss	Preamp Factor	Antenna Factor	Remark	Pol/Phase	T/Pos	A/Pos
	MHz	dBuV/m	dBuV/m	dB	dBuV	dB	dB	dB/m			deg	cm
1	2389.60	55.45	74.00	-18.55	24.67	2.91	0.00	27.87	Peak	HORIZONTAL	93	185
2	2390.00	43.63	54.00	-10.37	12.85	2.91	0.00	27.87	Average	HORIZONTAL	93	185
3	2436.20				74.68	2.93	0.00	27.81	Average	HORIZONTAL	93	185
4	2437.80				78.66	2.94	0.00	27.78	Peak	HORIZONTAL	93	185
5	2483.50	44.29	54.00	-9.71	13.60	2.96	0.00	27.73	Average	HORIZONTAL	93	185
6	2483.90	55.31	74.00	-18.69	24.62	2.96	0.00	27.73	Peak	HORIZONTAL	93	185

Item 3, 4 are the fundamental frequency at 2437MHz.

Channel 11

	Freq	Level	Limit Line	Over Limit	Read Level	Cable Loss	Preamp Factor	Antenna Factor	Remark	Pol/Phase	T/Pos	A/Pos
	MHz	dBuV/m	dBuV/m	dB	dBuV	dB	dB	dB/m			deg	cm
1	2461.20				76.05	2.95	0.00	27.76	Average	HORIZONTAL	95	146
2	2463.00				80.01	2.95	0.00	27.76	Peak	HORIZONTAL	95	146
3	2487.70	52.46	54.00	-1.54	21.79	2.97	0.00	27.70	Average	HORIZONTAL	95	146
4	2488.10	62.39	74.00	-11.61	31.72	2.97	0.00	27.70	Peak	HORIZONTAL	95	146

Item 1, 2 are the fundamental frequency at 2462 MHz.

Temperature	25°C	Humidity	63%
Test Engineer	Serway Li	Configurations	IEEE 802.11g CH 1, 6, 11
Test Date	Sep. 10, 2012	Test Mode	Mode 1.

Channel 1

	Freq	Level	Limit Line	Over Limit	Read Level	Cable Loss	Preamp Factor	Antenna Factor	Remark	Pol/Phase	T/Pos	A/Pos
	MHz	dBuV/m	dBuV/m	dB	dBuV	dB	dB	dB/m			deg	cm
1	2389.00	73.43	74.00	-0.57	42.65	2.91	0.00	27.87	Peak	HORIZONTAL	56	157
2	2390.00	52.12	54.00	-1.88	21.34	2.91	0.00	27.87	Average	HORIZONTAL	56	157
3	2408.80				78.15	2.92	0.00	27.84	Peak	HORIZONTAL	56	157
4	2409.40				68.74	2.92	0.00	27.84	Average	HORIZONTAL	56	157

Item 3, 4 are the fundamental frequency at 2412 MHz.

Channel 6

	Freq	Level	Limit Line	Over Limit	Read Level	Cable Loss	Antenna Factor	Preamp Factor	Remark	A/Pos	T/Pos	Pol/Phase
	MHz	dBuV/m	dBuV/m	dB	dBuV	dB	dB/m	dB		cm	deg	
1	2386.40	58.23	74.00	-15.77	27.85	2.21	28.17	0.00	Peak	100	306	HORIZONTAL
2	2390.00	45.78	54.00	-8.22	15.39	2.22	28.17	0.00	Average	100	306	HORIZONTAL
3	2433.00				75.86	2.23	28.25	0.00	Peak	100	306	HORIZONTAL
4	2434.20				66.39	2.23	28.29	0.00	Average	100	306	HORIZONTAL
5	2483.50	50.96	54.00	-3.04	20.32	2.26	28.38	0.00	Average	100	306	HORIZONTAL
6	2485.50	65.13	74.00	-8.87	34.45	2.26	28.42	0.00	Peak	100	306	HORIZONTAL

Item 3, 4 are the fundamental frequency at 2437 MHz.

Channel 11

	Freq	Level	Limit Line	Over Limit	Read Level	Cable Loss	Preamp Factor	Antenna Factor	Remark	Pol/Phase	T/Pos	A/Pos
	MHz	dBuV/m	dBuV/m	dB	dBuV	dB	dB	dB/m			deg	cm
1	2468.80				68.01	2.95	0.00	27.76	Average	HORIZONTAL	94	120
2	2469.60				76.77	2.95	0.00	27.76	Peak	HORIZONTAL	94	120
3	2483.50	51.63	54.00	-2.37	20.94	2.96	0.00	27.73	Average	HORIZONTAL	94	120
4	2488.10	72.74	74.00	-1.26	42.07	2.97	0.00	27.70	Peak	HORIZONTAL	94	120

Item 1, 2 are the fundamental frequency at 2462 MHz.

Note:

Emission level (dBuV/m) = 20 log Emission level (uV/m).

Corrected Reading: Antenna Factor + Cable Loss + Read Level - Preamp Factor = Level.

Temperature	25°C	Humidity	63%
Test Engineer	Serway Li	Configurations	IEEE 802.11n MCS0 20MHz Ch 1, 6, 11
Test Date	Sep. 10, 2012	Test Mode	Mode 2.

Channel 1

	Freq	Level	Limit Line	Over Limit	Read Level	Cable Loss	Preamp Factor	Antenna Factor	Remark	Pol/Phase	T/Pos	A/Pos
	MHz	dBuV/m	dBuV/m	dB	dBuV	dB	dB	dB/m			deg	cm
1	! 2389.40	72.83	74.00	-1.17	42.05	2.91	0.00	27.87	Peak	VERTICAL	87	100
2	! 2390.00	50.51	54.00	-3.49	19.73	2.91	0.00	27.87	Average	VERTICAL	87	100
3	a 2408.80				70.71	2.92	0.00	27.84	Average	VERTICAL	87	100
4	p 2409.00				81.13	2.92	0.00	27.84	Peak	VERTICAL	87	100

Item 3, 4 are the fundamental frequency at 2412 MHz.

Channel 6

	Freq	Level	Limit Line	Over Limit	Read Level	Cable Loss	Antenna Factor	Preamp Factor	Remark	A/Pos	T/Pos	Pol/Phase
	MHz	dBuV/m	dBuV/m	dB	dBuV	dB	dB/m	dB		cm	deg	
1	2356.80	48.30	54.00	-5.70	18.01	2.19	28.10	0.00	Average	100	214	VERTICAL
2	2388.80	63.65	74.00	-10.35	33.27	2.21	28.17	0.00	Peak	100	214	VERTICAL
3	2431.40				69.69	2.23	28.25	0.00	Average	100	214	VERTICAL
4	2432.20				79.50	2.23	28.25	0.00	Peak	100	214	VERTICAL
5	2483.50	46.61	54.00	-7.39	15.98	2.26	28.37	0.00	Average	100	214	VERTICAL
6	2486.70	63.76	74.00	-10.24	33.09	2.26	28.41	0.00	Peak	100	214	VERTICAL

Item 3, 4 are the fundamental frequency at 2437MHz.

Channel 11

	Freq	Level	Limit Line	Over Limit	Read Level	Cable Loss	Preamp Factor	Antenna Factor	Remark	Pol/Phase	T/Pos	A/Pos
	MHz	dBuV/m	dBuV/m	dB	dBuV	dB	dB	dB/m			deg	cm
1	p 2459.20				79.17	2.95	0.00	27.76	Peak	VERTICAL	87	100
2	a 2465.00				69.33	2.95	0.00	27.76	Average	VERTICAL	87	100
3	2483.50	66.11	74.00	-7.89	35.42	2.96	0.00	27.73	Peak	VERTICAL	87	100
4	! 2483.50	48.06	54.00	-5.94	17.37	2.96	0.00	27.73	Average	VERTICAL	87	100

Item 1, 2 are the fundamental frequency at 2462 MHz.

Temperature	25°C	Humidity	63%
Test Engineer	Serway Li	Configurations	IEEE 802.11n MCS0 40MHz Ch 3, 6, 9
Test Date	Sep. 10, 2012	Test Mode	Mode 2.

Channel 3

	Freq	Level	Limit Line	Over Limit	Read Level	Cable Loss	Preamp Factor	Antenna Factor	Remark	Pol/Phase	T/Pos	A/Pos
	MHz	dBuV/m	dBuV/m	dB	dBuV	dB	dB	dB/m			deg	cm
1	2385.60	67.97	74.00	-6.03	37.19	2.91	0.00	27.87	Peak	VERTICAL	88	100
2	2390.00	48.69	54.00	-5.31	17.91	2.91	0.00	27.87	Average	VERTICAL	88	100
3	2412.40				66.18	2.92	0.00	27.84	Average	VERTICAL	88	100
4	2414.00				76.06	2.92	0.00	27.84	Peak	VERTICAL	88	100

Item 3, 4 are the fundamental frequency at 2422 MHz.

Channel 6

	Freq	Level	Limit Line	Over Limit	Read Level	Cable Loss	Antenna Factor	Preamp Factor	Remark	A/Pos	T/Pos	Pol/Phase
	MHz	dBuV/m	dBuV/m	dB	dBuV	dB	dB/m	dB		cm	deg	
1	2365.60	44.15	54.00	-9.85	13.84	2.21	28.10	0.00	Average	100	216	VERTICAL
2	2389.60	63.14	74.00	-10.86	32.76	2.21	28.17	0.00	Peak	100	216	VERTICAL
3	2432.60				64.04	2.23	28.25	0.00	Average	100	216	VERTICAL
4	2447.40				74.28	2.24	28.29	0.00	Peak	100	216	VERTICAL
5	2483.50	46.02	54.00	-7.98	15.39	2.26	28.37	0.00	Average	100	216	VERTICAL
6	2483.50	62.67	74.00	-11.33	32.04	2.26	28.37	0.00	Peak	100	216	VERTICAL

Item 3, 4 are the fundamental frequency at 2437MHz.

Channel 9

	Freq	Level	Limit Line	Over Limit	Read Level	Cable Loss	Preamp Factor	Antenna Factor	Remark	Pol/Phase	T/Pos	A/Pos
	MHz	dBuV/m	dBuV/m	dB	dBuV	dB	dB	dB/m			deg	cm
1	2461.20				65.75	2.95	0.00	27.76	Average	VERTICAL	88	100
2	2462.40				76.04	2.95	0.00	27.76	Peak	VERTICAL	88	100
3	2483.50	49.52	54.00	-4.48	18.83	2.96	0.00	27.73	Average	VERTICAL	88	100
4	2487.50	68.09	74.00	-5.91	37.42	2.97	0.00	27.70	Peak	VERTICAL	88	100

Item 1, 2 are the fundamental frequency at 2452 MHz.

Note:

Emission level (dBuV/m) = 20 log Emission level (uV/m).

Corrected Reading: Antenna Factor + Cable Loss + Read Level - Preamp Factor = Level.

Temperature	25°C	Humidity	63%
Test Engineer	Serway Li	Configurations	IEEE 802.11b CH 1, 6, 11
Test Date	Sep. 10, 2012	Test Mode	Mode 2.

Channel 1

	Freq	Level	Limit Line	Over Limit	Read Level	Cable Loss	Preamp Factor	Antenna Factor	Remark	Pol/Phase	T/Pos	A/Pos
	MHz	dBuV/m	dBuV/m	dB	dBuV	dB	dB	dB/m			deg	cm
1	2388.40	57.41	74.00	-16.59	26.63	2.91	0.00	27.87	Peak	VERTICAL	25	103
2	2389.20	46.58	54.00	-7.42	15.80	2.91	0.00	27.87	Average	VERTICAL	25	103
3 p	2411.00				81.64	2.92	0.00	27.84	Peak	VERTICAL	25	103
4 a	2411.20				77.68	2.92	0.00	27.84	Average	VERTICAL	25	103

Item 3, 4 are the fundamental frequency at 2412 MHz.

Channel 6

	Freq	Level	Limit Line	Over Limit	Read Level	Cable Loss	Preamp Factor	Antenna Factor	Remark	Pol/Phase	T/Pos	A/Pos	Aux Factor F
	MHz	dBuV/m	dBuV/m	dB	dBuV	dB	dB	dB/m			deg	cm	dB
1	2357.20	46.82	54.00	-7.18	16.01	2.89	0.00	27.92	Average	VERTICAL	26	101	0.00
2	2358.40	57.57	74.00	-16.43	26.76	2.89	0.00	27.92	Peak	VERTICAL	26	101	0.00
3 a	2436.20				79.12	2.93	0.00	27.81	Average	VERTICAL	26	101	0.00
4 p	2438.20				83.16	2.94	0.00	27.78	Peak	VERTICAL	26	101	0.00
5	2483.50	44.56	54.00	-9.44	13.87	2.96	0.00	27.73	Average	VERTICAL	26	101	0.00
6	2489.10	57.21	74.00	-16.79	26.54	2.97	0.00	27.70	Peak	VERTICAL	26	101	0.00

Item 3, 4 are the fundamental frequency at 2437MHz.

Channel 11

	Freq	Level	Limit Line	Over Limit	Read Level	Cable Loss	Preamp Factor	Antenna Factor	Remark	Pol/Phase	T/Pos	A/Pos
	MHz	dBuV/m	dBuV/m	dB	dBuV	dB	dB	dB/m			deg	cm
1 a	2461.20				78.27	2.95	0.00	27.76	Average	VERTICAL	87	100
2 p	2463.00				82.40	2.95	0.00	27.76	Peak	VERTICAL	87	100
3	2483.50	56.81	74.00	-17.19	26.12	2.96	0.00	27.73	Peak	VERTICAL	87	100
4	2487.10	46.35	54.00	-7.65	15.66	2.96	0.00	27.73	Average	VERTICAL	87	100

Item 1, 2 are the fundamental frequency at 2462 MHz.

Temperature	25°C	Humidity	63%
Test Engineer	Serway Li	Configurations	IEEE 802.11g CH 1, 6, 11
Test Date	Sep. 10, 2012	Test Mode	Mode 2.

Channel 1

	Freq	Level	Limit Line	Over Limit	Read Level	Cable Loss	Preamp Factor	Antenna Factor	Remark	Pol/Phase	T/Pos	A/Pos
	MHz	dBuV/m	dBuV/m	dB	dBuV	dB	dB	dB/m			deg	cm
1 !	2389.20	73.05	74.00	-0.95	42.27	2.91	0.00	27.87	Peak	VERTICAL	88	100
2 !	2390.00	50.30	54.00	-3.70	19.52	2.91	0.00	27.87	Average	VERTICAL	88	100
3 p	2408.20				81.02	2.92	0.00	27.84	Peak	VERTICAL	88	100
4 a	2409.40				71.43	2.92	0.00	27.84	Average	VERTICAL	88	100

Item 3, 4 are the fundamental frequency at 2412 MHz.

Channel 6

	Freq	Level	Limit Line	Over Limit	Read Level	Cable Loss	Antenna Factor	Preamp Factor	Remark	A/Pos	T/Pos	Pol/Phase
	MHz	dBuV/m	dBuV/m	dB	dBuV	dB	dB/m	dB		cm	deg	
1	2356.80	48.33	54.00	-5.67	18.04	2.19	28.10	0.00	Average	100	215	VERTICAL
2	2389.20	61.19	74.00	-12.81	30.81	2.21	28.17	0.00	Peak	100	215	VERTICAL
3	2430.60				79.69	2.23	28.25	0.00	Peak	100	215	VERTICAL
4	2432.20				69.86	2.23	28.25	0.00	Average	100	215	VERTICAL
5	2483.50	46.10	54.00	-7.90	15.47	2.26	28.37	0.00	Average	100	215	VERTICAL
6	2484.30	61.02	74.00	-12.98	30.39	2.26	28.37	0.00	Peak	100	215	VERTICAL

Item 3, 4 are the fundamental frequency at 2437 MHz.

Channel 11

	Freq	Level	Limit Line	Over Limit	Read Level	Cable Loss	Preamp Factor	Antenna Factor	Remark	Pol/Phase	T/Pos	A/Pos
	MHz	dBuV/m	dBuV/m	dB	dBuV	dB	dB	dB/m			deg	cm
1 p	2463.40				79.05	2.95	0.00	27.76	Peak	VERTICAL	86	100
2 a	2464.00				69.56	2.95	0.00	27.76	Average	VERTICAL	86	100
3	2483.50	65.59	74.00	-8.41	34.90	2.96	0.00	27.73	Peak	VERTICAL	86	100
4	2483.50	47.52	54.00	-6.48	16.83	2.96	0.00	27.73	Average	VERTICAL	86	100

Item 1, 2 are the fundamental frequency at 2462 MHz.

Note:

Emission level (dBuV/m) = 20 log Emission level (uV/m).

Corrected Reading: Antenna Factor + Cable Loss + Read Level - Preamp Factor = Level.

For Emission not in Restricted Band

Plot on Configuration IEEE 802.11n MCS0 20MHz / Reference Level

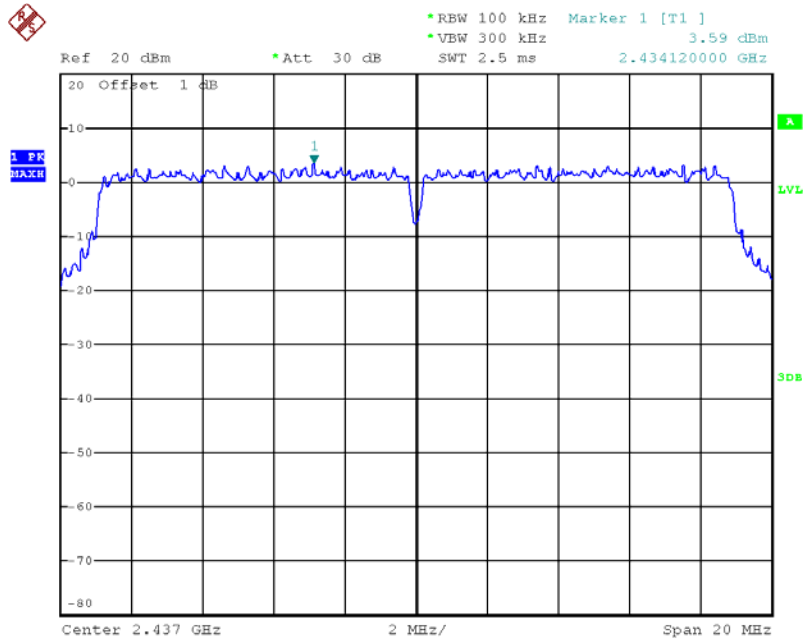

Date: 25.SEP.2012 08:30:58

Plot on Configuration IEEE 802.11n MCS0 20MHz / CH 1 (down 20dBc)

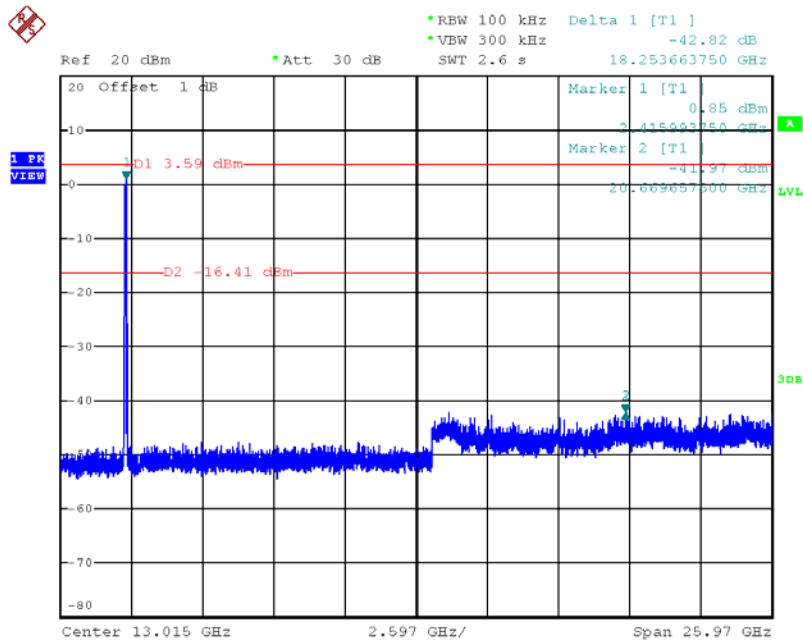

Date: 25.SEP.2012 08:37:32

Plot on Configuration IEEE 802.11n MCS0 20MHz / CH 6 (down 20dBc)

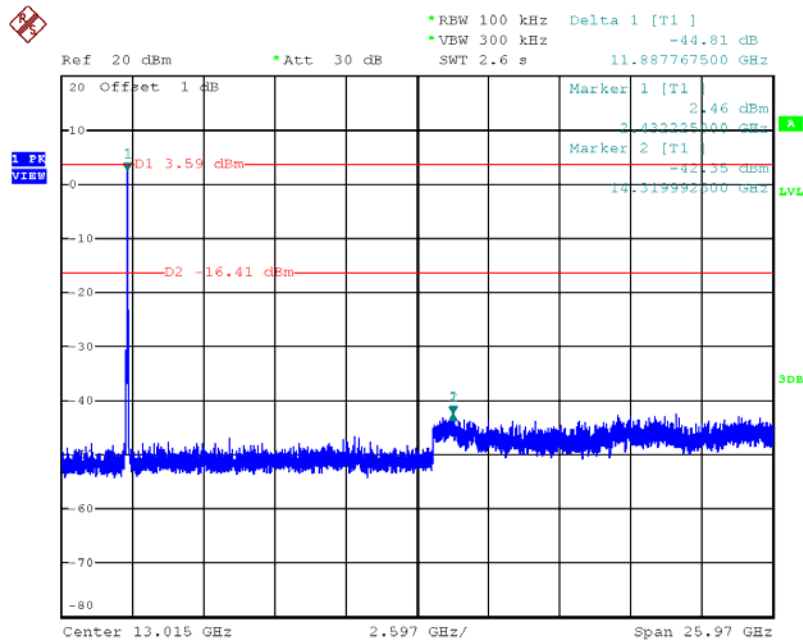

Date: 25.SEP.2012 08:38:18

Plot on Configuration IEEE 802.11n MCS0 20MHz / CH 11 (down 20dBc)

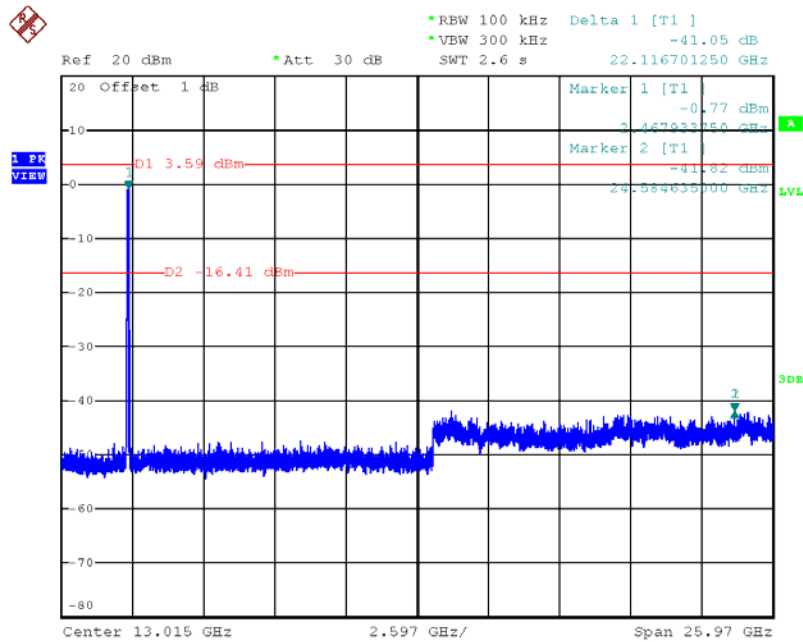

Date: 25.SEP.2012 08:38:57

Plot on Configuration IEEE 802.11n MCS0 40MHz / Reference Level

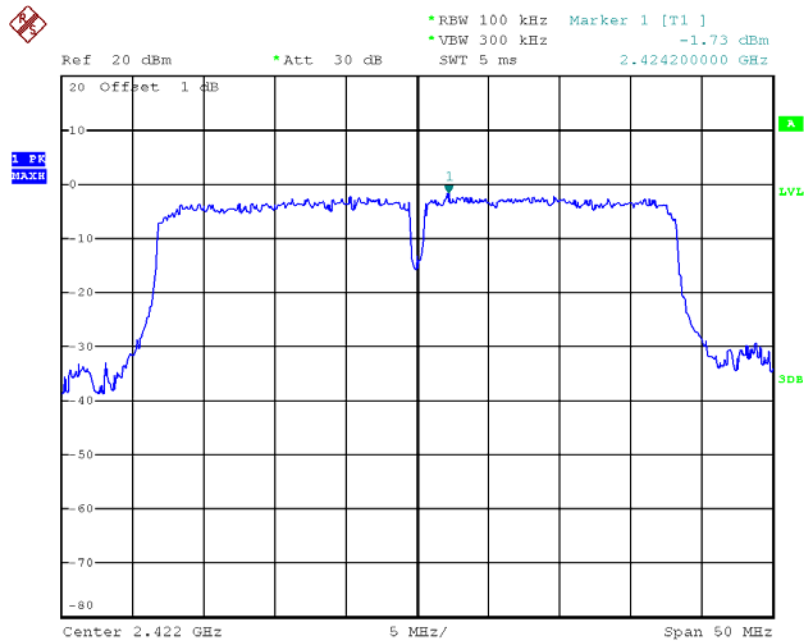

Date: 25.SEP.2012 08:32:25

Plot on Configuration IEEE 802.11n MCS0 40MHz / CH 3 (down 20dBc)

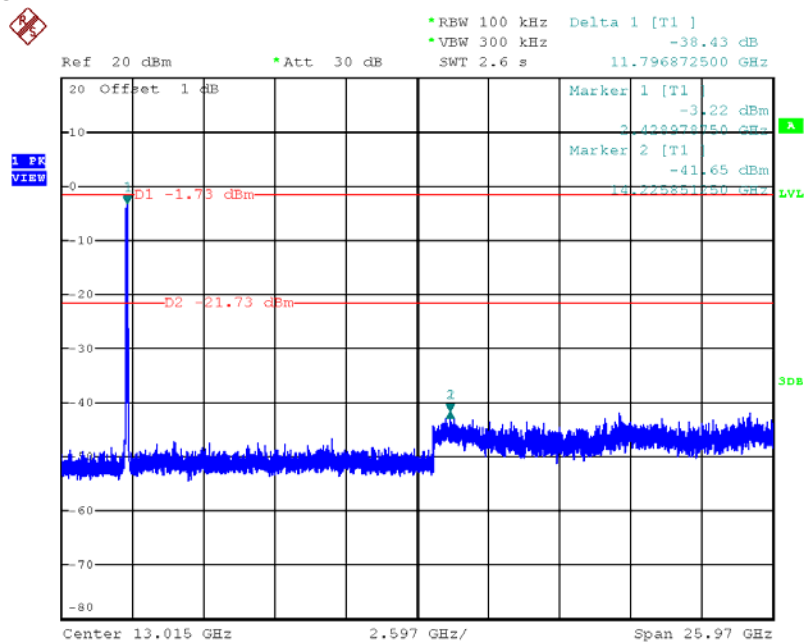

Date: 25.SEP.2012 08:36:42

Plot on Configuration IEEE 802.11n MCS0 40MHz / CH 6 (down 20dBc)

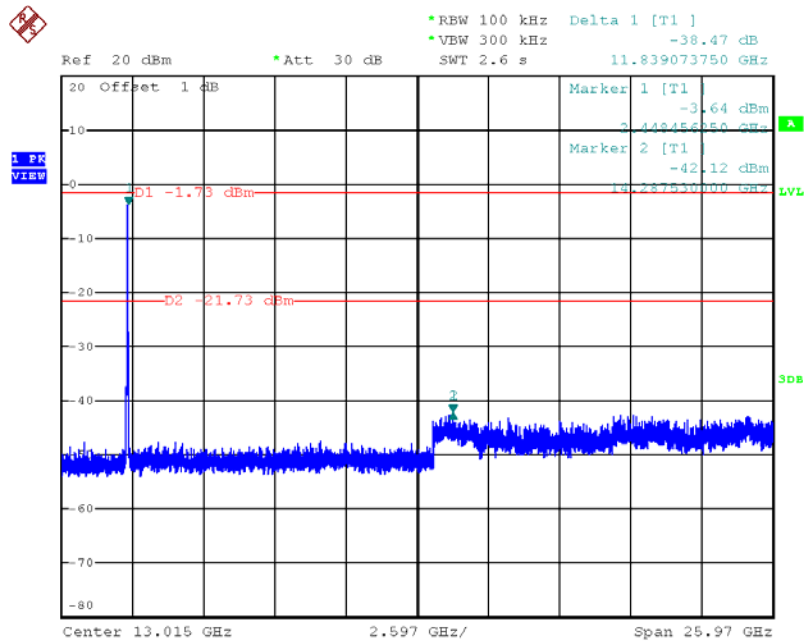

Date: 25.SEP.2012 08:36:15

Plot on Configuration IEEE 802.11n MCS0 40MHz / CH 9 (down 20dBc)

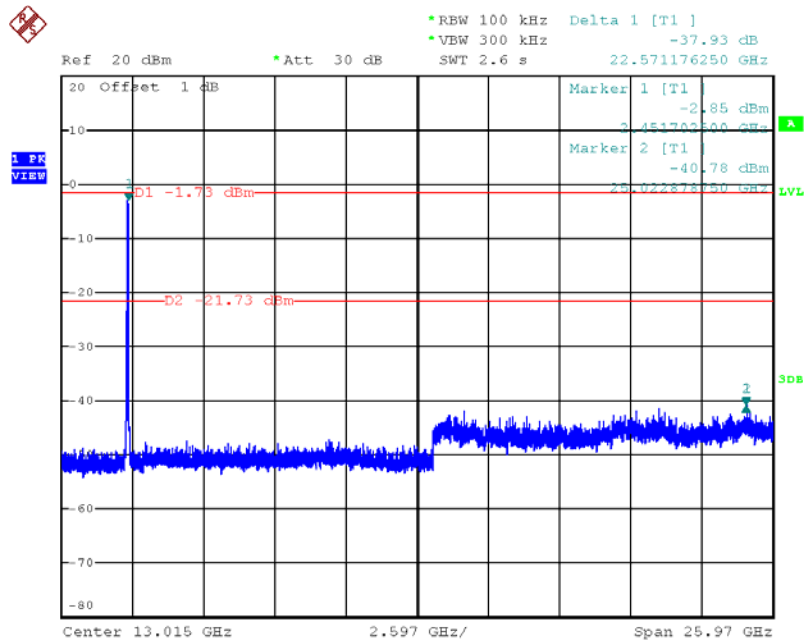

Date: 25.SEP.2012 08:35:22

Plot on Configuration IEEE 802.11b / Reference Level

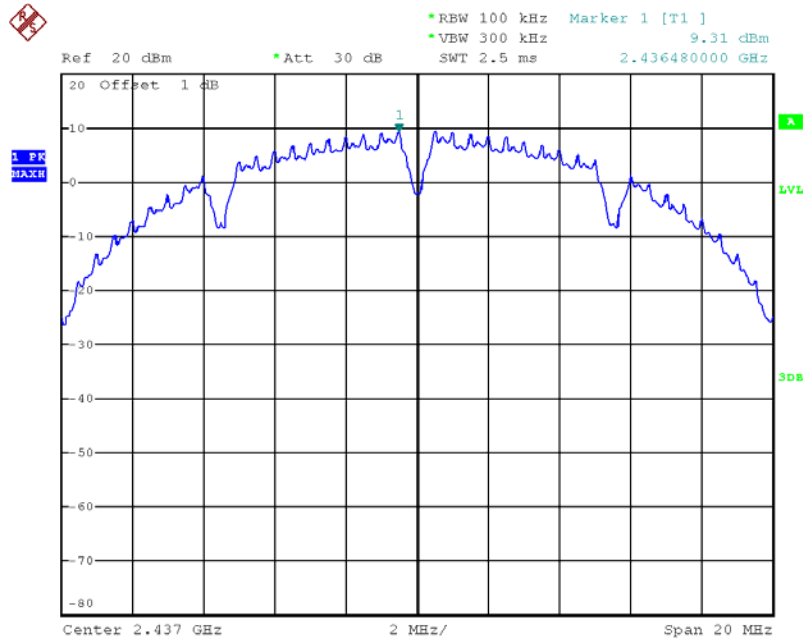

Date: 25.SEP.2012 08:17:30

Plot on Configuration IEEE 802.11b / CH 1 (down 20dBc)

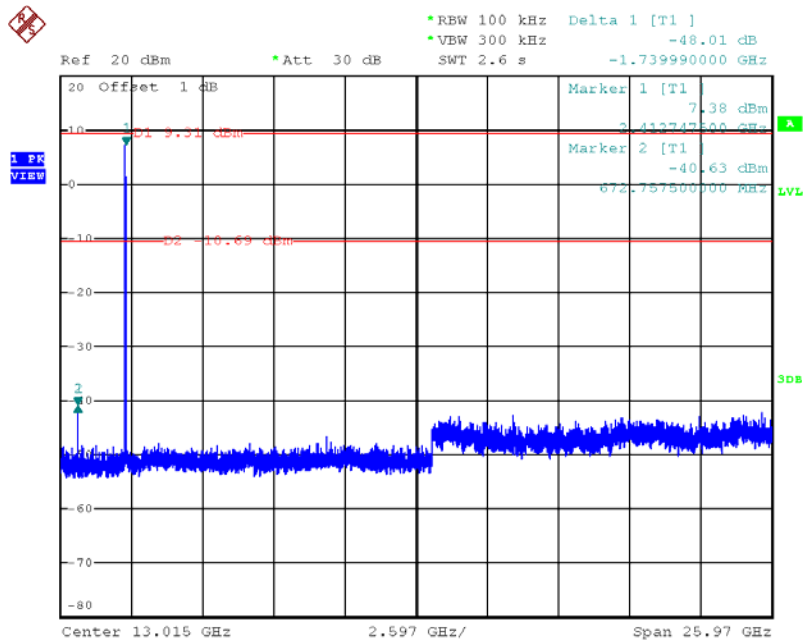

Date: 25.SEP.2012 08:42:46

Plot on Configuration IEEE 802.11b / CH 6 (down 20dBc)

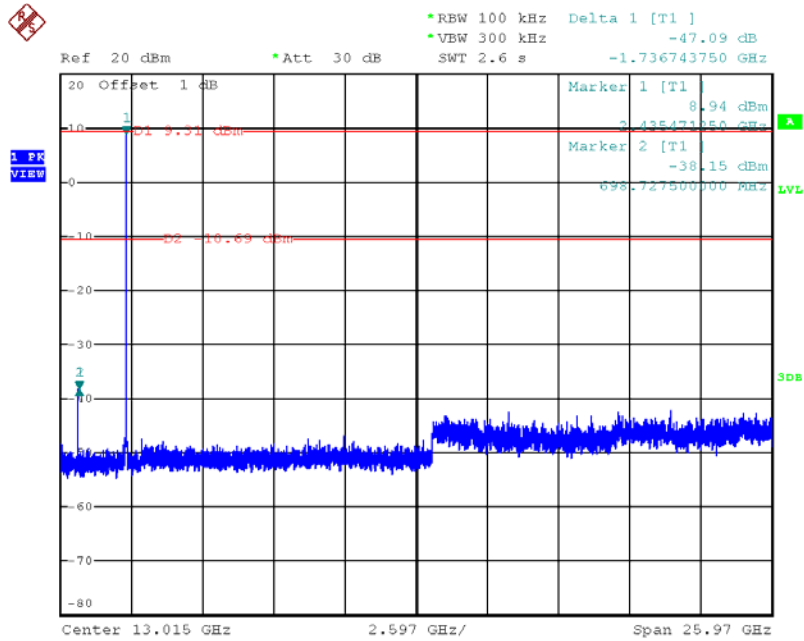

Date: 25.SEP.2012 08:42:14

Plot on Configuration IEEE 802.11b / CH 11 (down 20dBc)

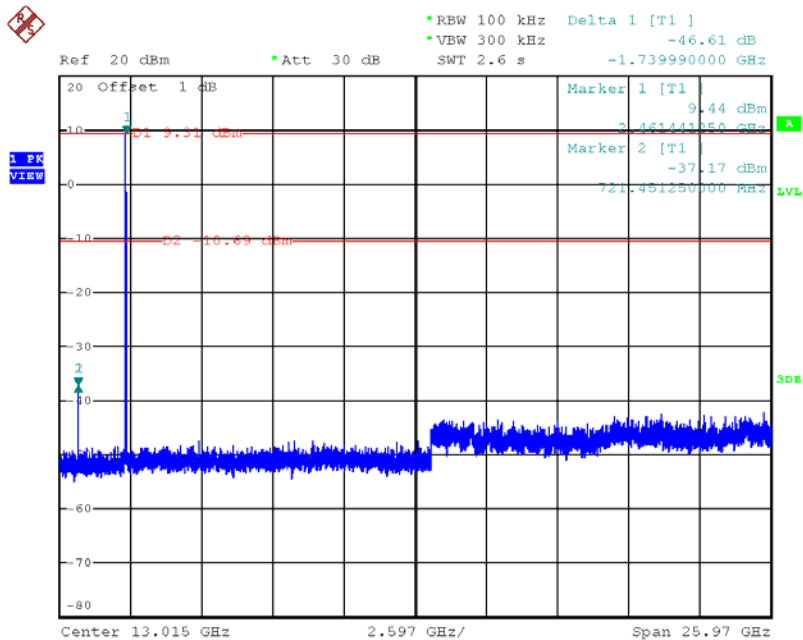

Date: 25.SEP.2012 08:41:45

Plot on Configuration IEEE 802.11g / Reference Level

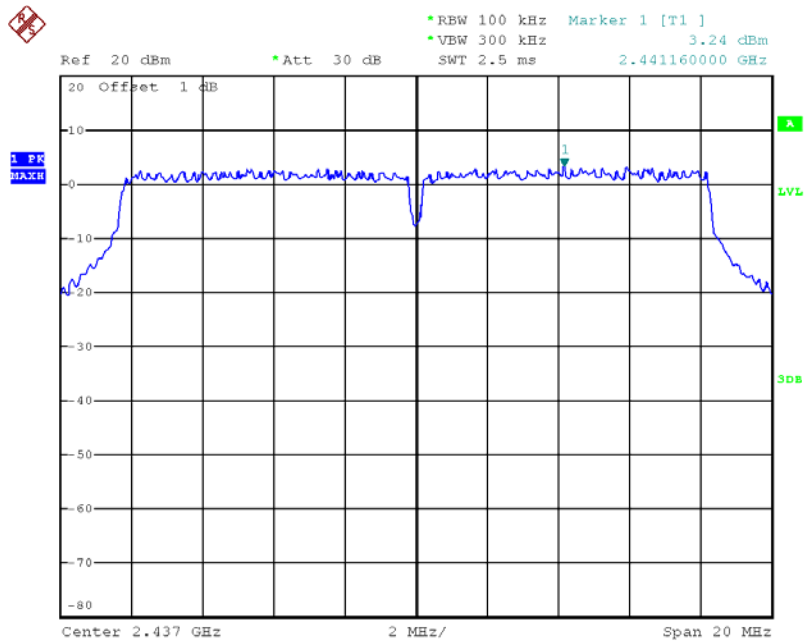

Date: 25.SEP.2012 08:26:06

Plot on Configuration IEEE 802.11g / CH 1 (down 20dBc)

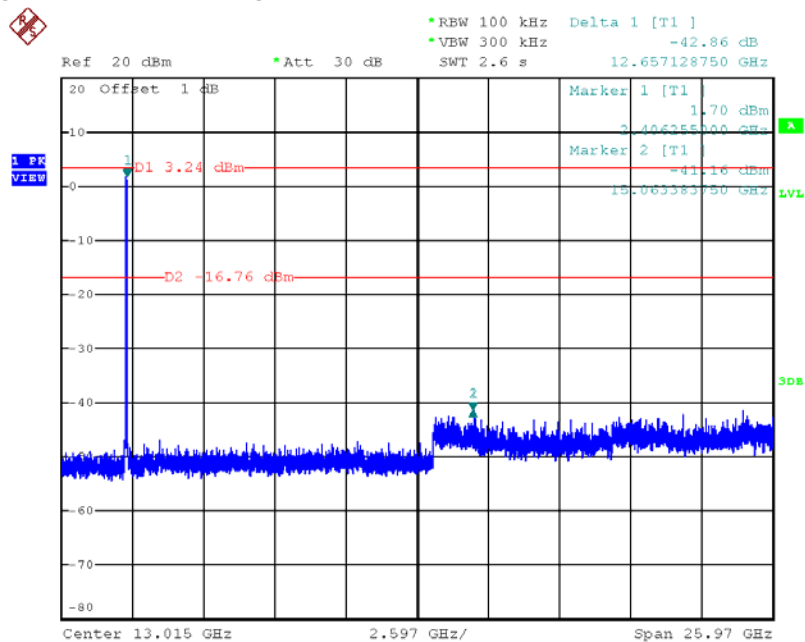

Date: 25.SEP.2012 08:39:41

Plot on Configuration IEEE 802.11g / CH 6 (down 20dBc)

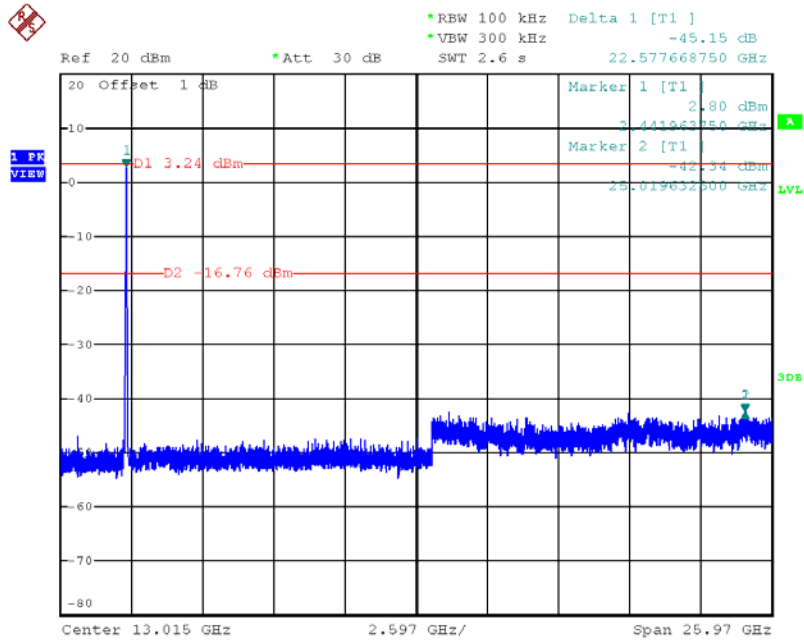

Date: 25.SEP.2012 08:40:11

Plot on Configuration IEEE 802.11g / CH 11 (down 20dBc)

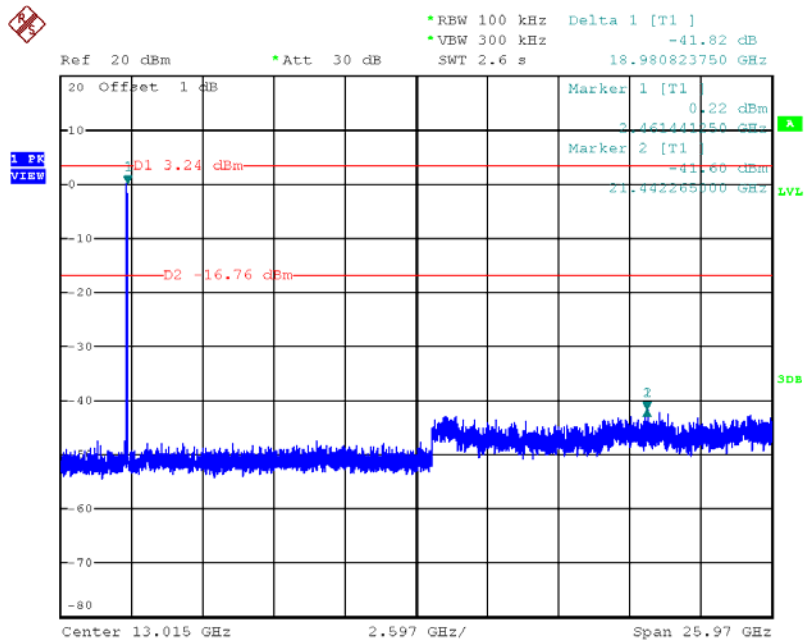

Date: 25.SEP.2012 08:40:44

4.7. Antenna Requirements

4.7.1. Limit

Except for special regulations, the Low-power Radio-frequency Devices must not be equipped with any jacket for installing an antenna with extension cable. An intentional radiator shall be designed to ensure that no antenna other than that furnished by the responsible party shall be used with the device. The use of a permanently attached antenna or of an antenna that uses a unique coupling to the intentional radiator shall be considered sufficient to comply with the provisions of this Section. The manufacturer may design the unit so that the user can replace a broken antenna, but the use of a standard antenna jack or electrical connector is prohibited. Further, this requirement does not apply to intentional radiators that must be professionally installed.

4.7.2. Antenna Connector Construction

Please refer to section 3.3 in this test report; antenna connector complied with the requirements.

5. LIST OF MEASURING EQUIPMENTS

Instrument	Manufacturer	Model No.	Serial No.	Characteristics	Calibration Date	Remark
BILOG ANTENNA	Schaffner	CBL6112D	22021	20MHz ~ 2GHz	Jan. 11, 2012	Radiation (03CH01-CB)
Horn Antenna	EMCO	3115	00075790	750MHz~18GHz	Nov. 25, 2011	Radiation (03CH01-CB)
Horn Antenna	SCHWARZBEAK	BBHA 9170	BBHA9170252	15GHz ~ 40GHz	Nov. 22, 2011	Radiation (03CH01-CB)
Pre-Amplifier	Agilent	8447D	2944A10991	0.1MHz ~ 1.3GHz	Nov. 17, 2011	Radiation (03CH01-CB)
Pre-Amplifier	Agilent	8449B	3008A02310	1GHz ~ 26.5GHz	Nov. 29, 2011	Radiation (03CH01-CB)
Pre-Amplifier	WM	TF-130N-R1	923365	26.5GHz ~ 40GHz	Jul. 31, 2012	Radiation (03CH01-CB)
Spectrum analyzer	R&S	FSP40	100056	9KHz~40GHz	Nov. 03, 2011	Radiation (03CH01-CB)
EMI Test Receiver	R&S	ESCS 30	100355	9KHz ~ 2.75GHz	Mar. 20, 2012	Radiation (03CH01-CB)
Loop Antenna	Teseq	HLA 6120	24155	9 kHz - 30 MHz	Sep. 09, 2012*	Radiation (03CH01-CB)
Turn Table	INN CO	CO 2000	N/A	0 ~ 360 degree	N/A	Radiation (03CH01-CB)
Antenna Mast	INN CO	CO2000	N/A	1 m - 4 m	N/A	Radiation (03CH01-CB)
RF Cable-low	Woken	Low Cable-1	N/A	30 MHz - 1 GHz	Nov. 17, 2011	Radiation (03CH01-CB)
RF Cable-high	Woken	High Cable-1	N/A	1 GHz – 26.5 GHz	Nov. 17, 2011	Radiation (03CH01-CB)
RF Cable-high	Woken	High Cable-2	N/A	1 GHz – 26.5 GHz	Nov. 17, 2011	Radiation (03CH01-CB)
RF Cable-high	Woken	High Cable-3	N/A	1 GHz - 40 GHz	Nov. 17, 2011	Radiation (03CH01-CB)
RF Cable-high	Woken	High Cable-4	N/A	1 GHz - 40 GHz	Nov. 17, 2011	Radiation (03CH01-CB)
EMI Test Receiver	R&S	ESCS 30	100377	9kHz ~ 2.75GHz	Sep. 14, 2012	Conduction (CO01-CB)
LISN	F.C.C.	FCC-LISN-50-16-2	04083	150kHz ~ 100MHz	Nov. 14, 2011	Conduction (CO01-CB)
V- LISN	Schwarzbeck	NSLK 8127	8127-478	9K ~ 30MHz	Jun. 22, 2012	Conduction (CO01-CB)
PULSE LIMITER	R&S	ESH3-Z2	100430	9K~30MHz	Feb. 03, 2012	Conduction (CO01-CB)
COND Cable	Woken	Cable	01	0.15MHz~30MHz	Dec. 4, 2011	Conduction (CO01-CB)
Signal analyzer	R&S	FSV40	100979	9KHz~40GHz	Sep. 26, 2011	Conducted (TH01-CB)
Temp. and Humidity Chamber	Ten Billion	TTH-D3SP	TBN-931011	-30~100 degree	Jun. 05, 2012	Conducted (TH01-CB)
Thermo-Hygro Meter	N/A	HC 520	#1	15~70 degree	Nov. 02, 2011	Conducted (TH01-CB)
Signal Generator	R&S	SMR40	100302	10MHz-40GHz	Nov. 22, 2011	Conducted (TH01-CB)
RF Power Divider	HP	11636A	00306	2GHz ~ 18GHz	N/A	Conducted (TH01-CB)
RF Power Splitter	Anaren	44100	1839	2GHz ~ 18GHz	N/A	Conducted (TH01-CB)
RF Power Splitter	Anaren	42100	17930	2GHz ~ 18GHz	N/A	Conducted (TH01-CB)
Signal generator	R&S	SMU200A	102782	10MHz-40GHz	Jun. 07, 2012	Conducted (TH01-CB)
Horn Antenna	COM-POWER	AH-118	071187	1GHz – 18GHz	May 09, 2012	Conducted (TH01-CB)
Horn Antenna	COM-POWER	AH-118	071042	1GHz – 18GHz	Nov. 01, 2011	Radiation (05CH01-CB)
RF Cable-high	Woken	High Cable-7	-	1 GHz – 26.5 GHz	Nov. 17, 2011	Conducted (TH01-CB)

Instrument	Manufacturer	Model No.	Serial No.	Characteristics	Calibration Date	Remark
RF Cable-high	Woken	High Cable-8	-	1 GHz – 26.5 GHz	Nov. 17, 2011	Conducted (TH01-CB)
RF Cable-high	Woken	High Cable-9	-	1 GHz – 26.5 GHz	Nov. 17, 2011	Conducted (TH01-CB)
RF Cable-high	Woken	High Cable-10	-	1 GHz – 26.5 GHz	Nov. 17, 2011	Conducted (TH01-CB)
RF Cable-high	Woken	High Cable-11	-	1 GHz – 26.5 GHz	Nov. 17, 2011	Conducted (TH01-CB)
RF Cable-high	Woken	High Cable-12	-	1 GHz – 26.5 GHz	Nov. 17, 2011	Conducted (TH01-CB)
RF Cable-high	Woken	High Cable-13	-	1 GHz – 26.5 GHz	Nov. 17, 2011	Conducted (TH01-CB)
Power Sensor	Anritsu	MA2411B	0917223	300MHz~40GHz	Nov. 01, 2011	Conducted (TH01-CB)
Power Meter	Anritsu	ML2495A	1035008	300MHz~40GHz	Nov. 01, 2011	Conducted (TH01-CB)

Note: Calibration Interval of instruments listed above is one year.

Note: "*" Calibration Interval of instruments listed above is two years.

6. TEST LOCATION

SHIJR	ADD : 6Fl., No. 106, Sec. 1, Shintai 5th Rd., Shijr City, Taipei, Taiwan 221, R.O.C. TEL : 886-2-2696-2468 FAX : 886-2-2696-2255
HWA YA	ADD : No. 52, Hwa Ya 1st Rd., Kwei-Shan Hsiang, Tao Yuan Hsien, Taiwan, R.O.C. TEL : 886-3-327-3456 FAX : 886-3-318-0055
LINKOU	ADD : No. 30-2, Dingfu Tsuen, Linkou Shiang, Taipei, Taiwan 244, R.O.C TEL : 886-2-2601-1640 FAX : 886-2-2601-1695
DUNGHU	ADD : No. 3, Lane 238, Kangle St., Neihu Chiu, Taipei, Taiwan 114, R.O.C. TEL : 886-2-2631-4739 FAX : 886-2-2631-9740
JUNGHE	ADD : 7Fl., No. 758, Jungjeng Rd., Junghe City, Taipei, Taiwan 235, R.O.C. TEL : 886-2-8227-2020 FAX : 886-2-8227-2626
NEIHU	ADD : 4Fl., No. 339, Hsin Hu 2 nd Rd., Taipei 114, Taiwan, R.O.C. TEL : 886-2-2794-8886 FAX : 886-2-2794-9777
JHUBEI	ADD : No.8, Lane 724, Bo-ai St., Jhubei City, HsinChu County 302, Taiwan, R.O.C. TEL : 886-3-656-9065 FAX : 886-3-656-9085

7. TAF CERTIFICATE OF ACCREDITATION



Certificate No. : L1190-110702

財團法人全國認證基金會
Taiwan Accreditation Foundation

Certificate of Accreditation

This is to certify that

Sporton International Inc.
EMC & Wireless Communications Laboratory
No.52, Hwa Ya 1st Road, Hwa Ya Technology Park, Kwei-Shan Hsiang, Tao Yuan Hsien,
Taiwan, R.O.C.

is accredited in respect of laboratory

Accreditation Criteria	: ISO/IEC 17025:2005
Accreditation Number	: 1190
Originally Accredited	: December 15, 2003
Effective Period	: January 10, 2010 to January 09, 2013
Accredited Scope	: Testing Field, see described in the Appendix
Specific Accreditation Program	: Accreditation Program for Designated Testing Laboratory for Commodities Inspection Accreditation Program for Telecommunication Equipment Testing Laboratory Accreditation Program for BSMI Mutual Recognition Arrangement with Foreign Authorities

Jay-San Chen
President, Taiwan Accreditation Foundation
Date : July 02, 2011

P1, total 22 pages

The Appendix forms an integral part of this Certificate, which shall be invalid when use without the Appendix