

FCC C2PC Test Report

FCC ID : TWG-SDCWB40NBT
Equipment : 802.11abgn 1x with BT
Model No. : SDC-WB40NBT
Brand Name : Summit
Applicant : Summit Data Communications, Inc.
Address : 526 South Main Street Suite 805 Akron, OH
44311
Standard : 47 CFR FCC Part 15.407
Received Date : Apr. 14, 2015
Tested Date : Apr. 14 ~ May 04, 2015

We, International Certification Corp., would like to declare that the tested sample has been evaluated and in compliance with the requirement of the above standards. The test results contained in this report refer exclusively to the product. It may be duplicated completely for legal use with the approval of the applicant. It shall not be reproduced except in full without the written approval of our laboratory.

Approved & Reviewed by:



Gary Chang / Manager



Table of Contents

1	GENERAL DESCRIPTION	5
1.1	Information.....	5
1.2	Local Support Equipment List	7
1.3	Test Setup Chart	7
1.4	The Equipment List	8
1.5	Testing Applied Standards	9
1.6	Measurement Uncertainty	9
2	TEST CONFIGURATION	10
2.1	Testing Condition	10
2.2	The Worst Test Modes and Channel Details	10
3	TRANSMITTER TEST RESULTS.....	11
3.1	Conducted Emissions.....	11
3.2	Emission Bandwidth	14
3.3	RF Output Power	16
3.4	Peak Power Spectral Density	17
3.5	Transmitter Radiated and Band Edge Emissions	19
3.6	Frequency Stability	36
4	TEST LABORATORY INFORMATION	38

Release Record

Report No.	Version	Description	Issued Date
FR542801	Rev. 01	Initial issue	May 29, 2015

Summary of Test Results

FCC Rules	Test Items	Measured	Result
15.207	Conducted Emissions	[dBuV]: 24.001MHz 30.42 (Margin -19.58dB) - AV	Pass
15.407(b) 15.209	Radiated Emissions	[dBuV/m at 3m]: 5715.00MHz 65.01 (Margin -3.19dB) - PK	Pass
15.407(a)	Emission Bandwidth	Meet the requirement of limit	Pass
15.407(e)	6dB bandwidth	Meet the requirement of limit	Pass
15.407(a)	RF Output Power	Max Power [dBm]: 10.51	Pass
15.407(a)	Peak Power Spectral Density	Meet the requirement of limit	Pass
15.407(g)	Frequency Stability	Meet the requirement of limit	Pass
15.203	Antenna Requirement	Meet the requirement of limit	Pass

1 General Description

1.1 Information

This report is prepared for FCC class II change.

This report is issued as a FCC Class II Permissive Change for complying with New U-NII rule requirement. In this test report, all test items has been re-tested and its data was recorded in the following sections.

1.1.1 Specification of the Equipment under Test (EUT)

RF General Information					
Frequency Range (MHz)	IEEE Std. 802.11	Ch. Freq. (MHz)	Channel Number	Transmit Chains (N _{TX})	Data Rate / MCS
5725-5850	a	5745-5805	149-161 [4]	1	6-54 Mbps
5725-5850	n (HT20)	5745-5805	149-161 [4]	1	MCS 0-7

Note 1: RF output power specifies that Maximum Conducted Output Power.
 Note 2: 802.11a/n uses a combination of OFDM-BPSK, QPSK, 16QAM, 64QAM modulation.

1.1.2 Antenna Details

Ant. No.	Brand	Model	Type	Connector	Gain (dBi)
1	Radiall Larsen	R380.500.314	Dipole	RP-TNC plug	5

1.1.3 Power Supply Type of Equipment under Test (EUT)

Power Supply Type	3.3Vdc from host
--------------------------	------------------

1.1.4 Accessories

N/A

1.1.5 Channel List

802.11 a / HT20	
Channel	Frequency(MHz)
149	5745
153	5765
157	5785
161	5805

1.1.6 Test Tool and Duty Cycle

Test Tool	Hyperterminal, Version: 5.1		
Duty Cycle and Duty Factor	Mode	Duty cycle (%)	Duty factor (dB)
	11a	96.08%	0.17
	HT20	95.11%	0.22

1.1.7 Power Setting

Modulation Mode	Test Frequency (MHz)	Power Set
11a	5745	Default
11a	5785	Default
11a	5805	Default
HT20	5745	Default
HT20	5785	Default
HT20	5805	Default

1.2 Local Support Equipment List

Support Equipment List					
No.	Equipment	Brand	Model	FCC ID	Signal cable / Length (m)
1	DC Power Source	GW INSTEK	GPC-3060D	---	---

1.3 Test Setup Chart

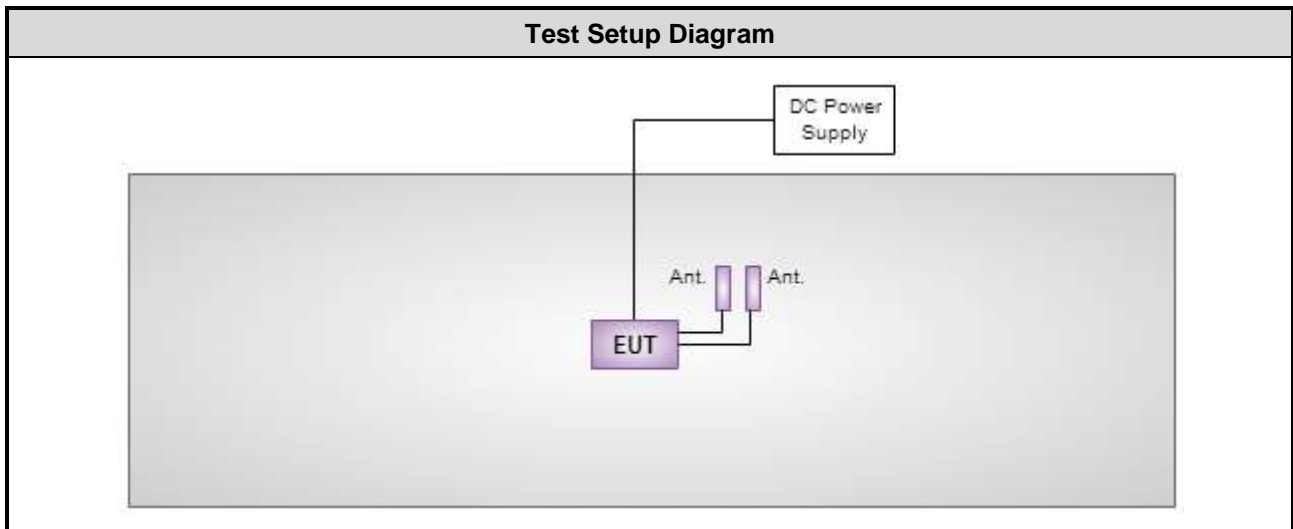

1.4 The Equipment List

Test Item	Conducted Emission				
Test Site	Conduction room 1 / (CO01-WS)				
Instrument	Manufacturer	Model No.	Serial No.	Calibration Date	Calibration Until
EMC Receiver	R&S	ESCS 30	100169	Oct. 17, 2014	Oct. 16, 2015
LISN	SCHWARZBECK	Schwarzbeck 8127	8127-667	Nov. 17, 2014	Nov. 16, 2015
RF Cable-CON	Woken	CFD200-NL	CFD200-NL-001	Dec. 31, 2014	Dec. 30, 2015
Measurement Software	AUDIX	e3	6.120210k	NA	NA

Note: Calibration Interval of instruments listed above is one year.

Test Item	Radiated Emission				
Test Site	966 chamber 3 / (03CH03-WS)				
Instrument	Manufacturer	Model No.	Serial No.	Calibration Date	Calibration Until
Spectrum Analyzer	Agilent	N9010A	MY53400091	Sep. 16, 2014	Sep. 15, 2015
Receiver	Agilent	N9038A	MY53290044	Oct. 21, 2014	Oct. 20, 2015
Bilog Antenna	SCHWARZBECK	VULB9168	VULB9168-562	Jan. 19, 2015	Jan. 18, 2016
Horn Antenna 1G-18G	SCHWARZBECK	BBHA 9120 D	BBHA 9120 D 1206	Feb. 03, 2015	Feb. 02, 2016
Horn Antenna 18G-40G	SCHWARZBECK	BBHA 9170	BBHA 9170517	Nov. 10, 2014	Nov. 09, 2015
Loop Antenna	R&S	HFH2-Z2	11900	Nov. 10, 2014	Nov. 09, 2015
Preamplifier	EMC	EMC02325	980187	Sep. 26, 2014	Sep. 25, 2015
Preamplifier	Agilent	83017A	MY53270014	Sep. 17, 2014	Sep. 16, 2015
Preamplifier	EMC	EMC184045B	980192	Aug. 26, 2014	Aug. 25, 2015
RF cable-3M	HUBER+SUHNER	SUCOFLEX104	MY22620/4	Feb. 09, 2015	Feb. 08, 2016
RF cable-8M	HUBER+SUHNER	SUCOFLEX104	MY22601/4	Feb. 09, 2015	Feb. 08, 2016
RF cable-1M	HUBER+SUHNER	SUCOFLEX104	MY22624/4	Feb. 09, 2015	Feb. 08, 2016
LF cable-0.8M	EMC	EMC8D-NM-NM-800	EMC8D-NM-NM-800-001	Feb. 09, 2015	Feb. 08, 2016
LF cable-3M	EMC	EMC8D-NM-NM-3000	131103	Feb. 09, 2015	Feb. 08, 2016
LF cable-13M	EMC	EMC8D-NM-NM-13000	131104	Feb. 09, 2015	Feb. 08, 2016
Measurement Software	AUDIX	e3	6.120210g	NA	NA

Note: Calibration Interval of instruments listed above is one year.

Test Item	RF Conducted				
Test Site	(TH01-WS)				
Instrument	Manufacturer	Model No.	Serial No.	Calibration Date	Calibration Until
Spectrum Analyzer	R&S	FSV40	101063	Feb. 03, 2015	Feb. 02, 2016
TEMP&HUMIDITY CHAMBER	GIANT FORCE	GCT-225-40-SP-SD	MAF1212-002	Dec. 03, 2014	Dec. 02, 2015
Power Meter	Anritsu	ML2495A	1241002	Sep. 29, 2014	Sep. 28, 2015
Power Sensor	Anritsu	MA2411B	1207366	Sep. 29, 2014	Sep. 28, 2015
Measurement Software	Sporton	Sporton_1	1.3.30	NA	NA
Note: Calibration Interval of instruments listed above is one year.					

1.5 Testing Applied Standards

According to the specification of EUT, the EUT must comply with following standards and KDB documents.

47 CFR FCC Part 15.407

ANSI C63.10-2009

FCC 789033 D02 General UNII Test Procedures New Rules v01

FCC KDB 412172 D01 Determining ERP and EIRP v01

Note: FCC's permission to use 1.5m as an alternative per TCBC Conf call of Dec. 02, 2014.

1.6 Measurement Uncertainty

ISO/IEC 17025 requires that an estimate of the measurement uncertainties associated with the emissions test results be included in the report. The measurement uncertainties given below are based on a 95% confidence level (based on a coverage factor (k=2))

Measurement Uncertainty	
Parameters	Uncertainty
Bandwidth	±34.134 Hz
Conducted power	±0.808 dB
Frequency error	±34.134 Hz
Power density	±0.463 dB
Conducted emission	±2.670 dB
AC conducted emission	±2.92 dB
Radiated emission ≤ 1GHz	±3.99 dB
Radiated emission > 1GHz	±5.52 dB
Time	±0.1%
Temperature	±0.6 °C

2 Test Configuration

2.1 Testing Condition

Test Item	Test Site	Ambient Condition	Tested By
AC Conduction	CO01-WS	23°C / 64%	Kevin Ma
Radiated Emissions	03CH03-WS	20-21°C / 61-71%	Warren Lee Aska Huang
RF Conducted	TH01-WS	23°C / 64%	Felix Sung

➤ FCC site registration No.: 390588

➤ IC site registration No.: 10807C-1

2.2 The Worst Test Modes and Channel Details

For Frequency band 5725-5850 MHz				
Test item	Modulation Mode	Test Frequency (MHz)	Data Rate (Mbps) / MCS	Test Configuration
Conducted Emissions	HT20	5745	MCS 0	---
Radiated Emissions ≤1GHz	HT20	5745	MCS 0	---
RF Output Power	11a	5745 / 5785 / 5805	6 Mbps	---
	HT20	5745 / 5785 / 5805	MCS 0	
Radiated Emissions >1GHz	11a	5745 / 5785 / 5805	6 Mbps	---
Emission Bandwidth			MCS 0	
6dB bandwidth	HT20	5745 / 5785 / 5805	MCS 0	---
Peak Power Spectral Density				
Frequency Stability	Un-modulation	5785	---	---

NOTE: The EUT was pretested with 3 orientations placed on the table for the radiated emission measurement – X, Y, and Z-plane. The **Y-plane** results were found as the worst case and were shown in this report.

3 Transmitter Test Results

3.1 Conducted Emissions

3.1.1 Limit of Conducted Emissions

Conducted Emissions Limit		
Frequency Emission (MHz)	Quasi-Peak	Average
0.15-0.5	66 - 56 *	56 - 46 *
0.5-5	56	46
5-30	60	50

Note 1: * Decreases with the logarithm of the frequency.

3.1.2 Test Procedures

1. The device is placed on a test table, raised 80 cm above the reference ground plane. The vertical conducting plane is located 40 cm to the rear of the device.
2. The device is connected to line impedance stabilization network (LISN) and other accessories are connected to other LISN. Measured levels of AC power line conducted emission are across the 50 Ω LISN port.
3. AC conducted emission measurements is made over frequency range from 150 kHz to 30 MHz.
4. This measurement was performed with AC 120V / 60Hz.

3.1.3 Test Setup



- Note: 1. Support units were connected to second LISN.
 2. Both of LISNs (AMN) are 80 cm from EUT and at least 80 cm from other units and other metal planes

3.1.4 Test Result of Conducted Emissions

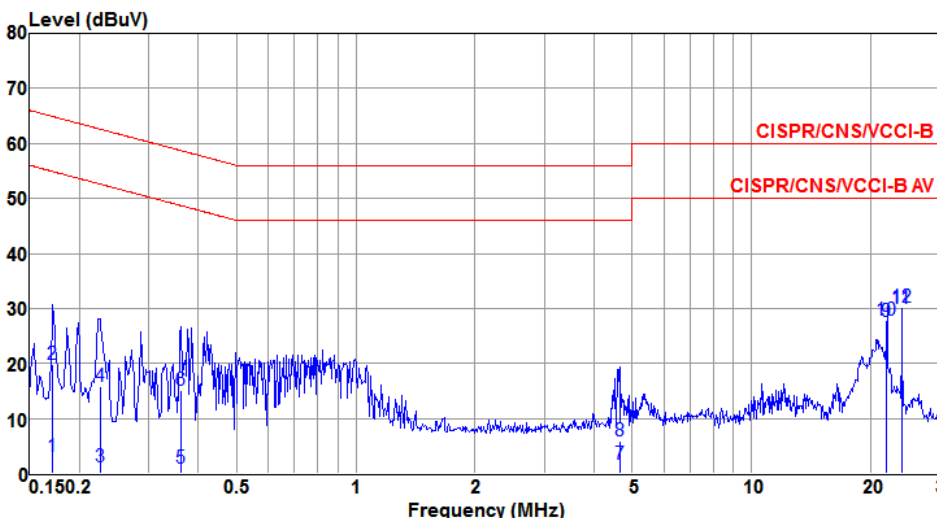
Modulation	HT20	Test Freq. (MHz)	5745																																																																																																																														
Power Phase	Line																																																																																																																																
																																																																																																																																	
<table border="1"> <thead> <tr> <th></th> <th>Freq</th> <th>Level</th> <th>Limit</th> <th>Over</th> <th>Read</th> <th>LISN</th> <th>cable</th> <th>Remark</th> </tr> <tr> <th></th> <th>MHz</th> <th>dBuV</th> <th>dBuV</th> <th>dB</th> <th>dBuV</th> <th>dB</th> <th>dB</th> <th></th> </tr> </thead> <tbody> <tr><td>1</td><td>0.171</td><td>3.17</td><td>54.90</td><td>-51.73</td><td>3.02</td><td>0.07</td><td>0.08</td><td>Average</td></tr> <tr><td>2</td><td>0.171</td><td>19.73</td><td>64.90</td><td>-45.17</td><td>19.58</td><td>0.07</td><td>0.08</td><td>QP</td></tr> <tr><td>3</td><td>0.226</td><td>1.25</td><td>52.61</td><td>-51.36</td><td>1.09</td><td>0.07</td><td>0.09</td><td>Average</td></tr> <tr><td>4</td><td>0.226</td><td>15.73</td><td>62.61</td><td>-46.88</td><td>15.57</td><td>0.07</td><td>0.09</td><td>QP</td></tr> <tr><td>5</td><td>0.361</td><td>1.04</td><td>48.69</td><td>-47.65</td><td>0.86</td><td>0.07</td><td>0.11</td><td>Average</td></tr> <tr><td>6</td><td>0.361</td><td>15.09</td><td>58.69</td><td>-43.60</td><td>14.91</td><td>0.07</td><td>0.11</td><td>QP</td></tr> <tr><td>7</td><td>4.647</td><td>1.58</td><td>46.00</td><td>-44.42</td><td>1.14</td><td>0.13</td><td>0.31</td><td>Average</td></tr> <tr><td>8</td><td>4.647</td><td>5.90</td><td>56.00</td><td>-50.10</td><td>5.46</td><td>0.13</td><td>0.31</td><td>QP</td></tr> <tr><td>9</td><td>22.015</td><td>27.63</td><td>50.00</td><td>-22.37</td><td>27.25</td><td>0.33</td><td>0.05</td><td>Average</td></tr> <tr><td>10</td><td>22.015</td><td>27.93</td><td>60.00</td><td>-32.07</td><td>27.55</td><td>0.33</td><td>0.05</td><td>QP</td></tr> <tr><td>11*</td><td>24.001</td><td>29.95</td><td>50.00</td><td>-20.05</td><td>29.52</td><td>0.35</td><td>0.08</td><td>Average</td></tr> <tr><td>12</td><td>24.001</td><td>30.32</td><td>60.00</td><td>-29.68</td><td>29.89</td><td>0.35</td><td>0.08</td><td>QP</td></tr> </tbody> </table>					Freq	Level	Limit	Over	Read	LISN	cable	Remark		MHz	dBuV	dBuV	dB	dBuV	dB	dB		1	0.171	3.17	54.90	-51.73	3.02	0.07	0.08	Average	2	0.171	19.73	64.90	-45.17	19.58	0.07	0.08	QP	3	0.226	1.25	52.61	-51.36	1.09	0.07	0.09	Average	4	0.226	15.73	62.61	-46.88	15.57	0.07	0.09	QP	5	0.361	1.04	48.69	-47.65	0.86	0.07	0.11	Average	6	0.361	15.09	58.69	-43.60	14.91	0.07	0.11	QP	7	4.647	1.58	46.00	-44.42	1.14	0.13	0.31	Average	8	4.647	5.90	56.00	-50.10	5.46	0.13	0.31	QP	9	22.015	27.63	50.00	-22.37	27.25	0.33	0.05	Average	10	22.015	27.93	60.00	-32.07	27.55	0.33	0.05	QP	11*	24.001	29.95	50.00	-20.05	29.52	0.35	0.08	Average	12	24.001	30.32	60.00	-29.68	29.89	0.35	0.08	QP
	Freq	Level	Limit	Over	Read	LISN	cable	Remark																																																																																																																									
	MHz	dBuV	dBuV	dB	dBuV	dB	dB																																																																																																																										
1	0.171	3.17	54.90	-51.73	3.02	0.07	0.08	Average																																																																																																																									
2	0.171	19.73	64.90	-45.17	19.58	0.07	0.08	QP																																																																																																																									
3	0.226	1.25	52.61	-51.36	1.09	0.07	0.09	Average																																																																																																																									
4	0.226	15.73	62.61	-46.88	15.57	0.07	0.09	QP																																																																																																																									
5	0.361	1.04	48.69	-47.65	0.86	0.07	0.11	Average																																																																																																																									
6	0.361	15.09	58.69	-43.60	14.91	0.07	0.11	QP																																																																																																																									
7	4.647	1.58	46.00	-44.42	1.14	0.13	0.31	Average																																																																																																																									
8	4.647	5.90	56.00	-50.10	5.46	0.13	0.31	QP																																																																																																																									
9	22.015	27.63	50.00	-22.37	27.25	0.33	0.05	Average																																																																																																																									
10	22.015	27.93	60.00	-32.07	27.55	0.33	0.05	QP																																																																																																																									
11*	24.001	29.95	50.00	-20.05	29.52	0.35	0.08	Average																																																																																																																									
12	24.001	30.32	60.00	-29.68	29.89	0.35	0.08	QP																																																																																																																									
<p>Note 1: Level (dBuV) = Read Level (dBuV) + LISN Factor (dB) + Cable Loss (dB). Note 2: Over Limit (dB) = Level (dBuV) – Limit Line (dBuV).</p>																																																																																																																																	

Modulation	HT20	Test Freq. (MHz)	5745
Power Phase	Neutral		

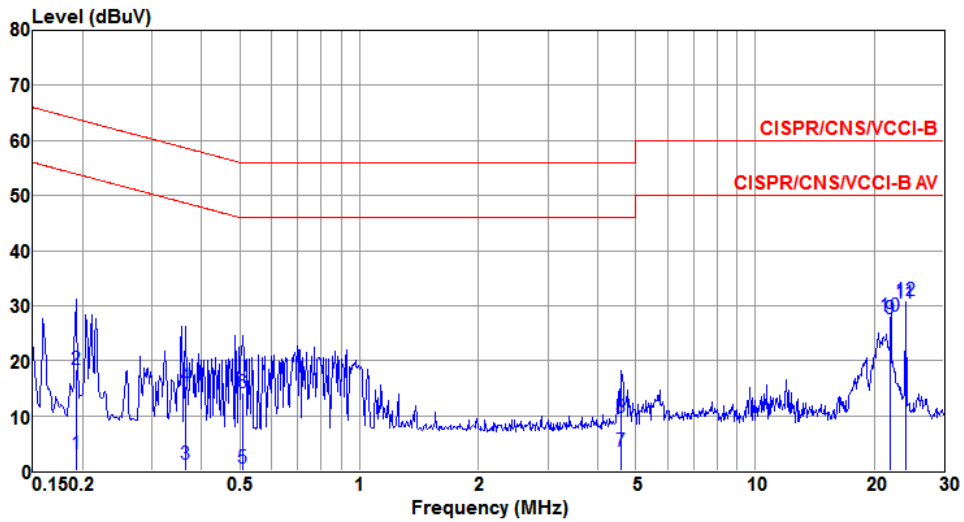

	Freq	Level	Limit	Over	Read	LISN	cable	
	MHz	dBuV	Line	Limit	Level	factor	loss	Remark
			dBuV	dB	dBuV	dB	dB	
1	0.192	3.19	53.93	-50.74	3.03	0.07	0.09	Average
2	0.192	18.45	63.93	-45.48	18.29	0.07	0.09	QP
3	0.363	1.27	48.65	-47.38	1.09	0.07	0.11	Average
4	0.363	15.28	58.65	-43.37	15.10	0.07	0.11	QP
5	0.507	0.51	46.00	-45.49	0.32	0.07	0.12	Average
6	0.507	14.16	56.00	-41.84	13.97	0.07	0.12	QP
7	4.598	3.45	46.00	-42.55	2.99	0.15	0.31	Average
8	4.598	9.62	56.00	-46.38	9.16	0.15	0.31	QP
9	22.016	27.60	50.00	-22.40	27.19	0.36	0.05	Average
10	22.016	27.98	60.00	-32.02	27.57	0.36	0.05	QP
11*	24.001	30.42	50.00	-19.58	29.96	0.38	0.08	Average
12	24.001	30.85	60.00	-29.15	30.39	0.38	0.08	QP

Note 1: Level (dBuV) = Read Level (dBuV) + LISN Factor (dB) + Cable Loss (dB).
 2: Over Limit (dB) = Level (dBuV) – Limit Line (dBuV).

3.2 Emission Bandwidth

3.2.1 Limit of Emission bandwidth

Within the 5.725-5.85 GHz band, the minimum 6 dB bandwidth of U-NII devices shall be at least 500 kHz.

3.2.2 Test Procedures

Occupied Bandwidth

1. Set RBW = 1 % to 5 % of the OBW
2. Set VBW \geq 3 RBW
3. Sample detection and single sweep mode shall be used
4. Use the 99 % power bandwidth function of the instrument

6dB Bandwidth

1. Set RBW = 100kHz, VBW = 300kHz
2. Detector = Peak, Trace mode = max hold.
3. Allow the trace to stabilize.
4. Measure the maximum width of the emission that is constrained by the frequencies associated with the two outermost amplitude points (upper and lower frequencies) that are attenuated by 6 dB relative to the maximum level measured in the fundamental emission

3.2.3 Test Setup

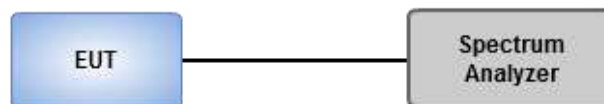

3.2.4 Test Result of Emission Bandwidth

Emission Bandwidth											
Mode	N _{TX}	Freq. (MHz)	OBW Bandwidth (MHz)				6dB Bandwidth (MHz)				
			Chain 0	Chain 1	Chain 2	Chain 3	Chain 0	Chain 1	Chain 2	Chain 3	6dB BW Limit (MHz)
11a	1	5745	16.55	---	---	---	13.86	---	---	---	0.5
11a	1	5785	16.53	---	---	---	15.13	---	---	---	0.5
11a	1	5805	16.53	---	---	---	13.91	---	---	---	0.5
HT20	1	5745	17.74	---	---	---	16.00	---	---	---	0.5
HT20	1	5785	17.71	---	---	---	15.13	---	---	---	0.5
HT20	1	5805	17.78	---	---	---	13.86	---	---	---	0.5

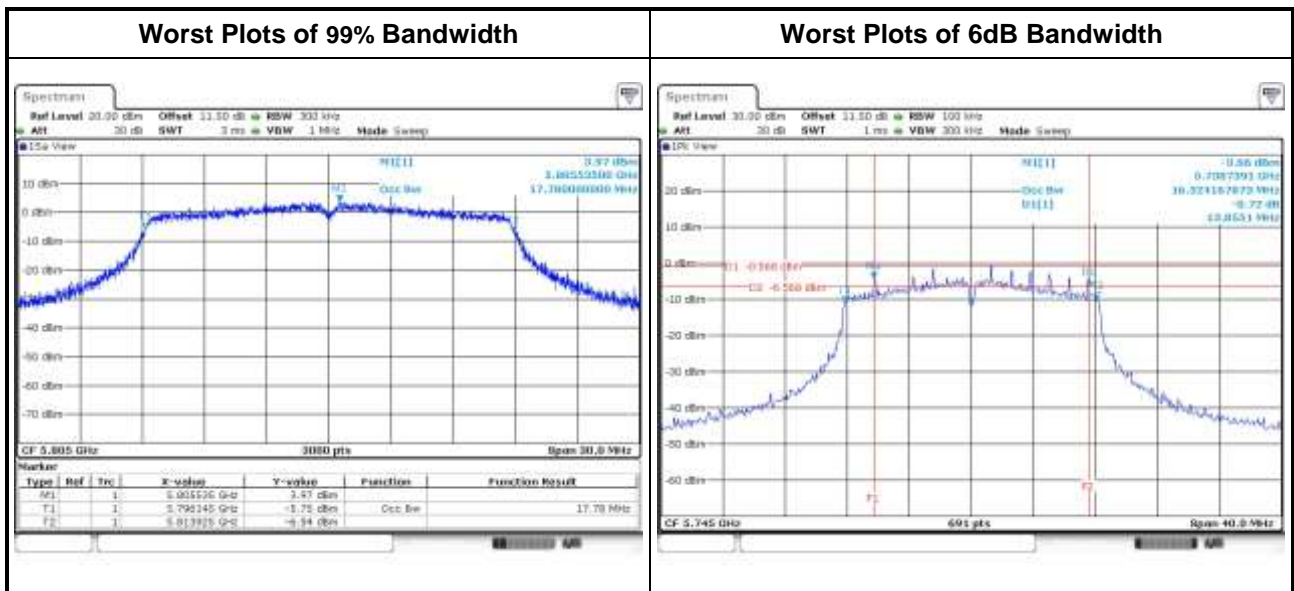

3.3 RF Output Power

3.3.1 Limit of RF Output Power

The maximum conducted output power over the frequency band of operation shall not exceed 1 W

3.3.2 Test Procedures

- Method PM-G (Measurement using a gated RF average power meter)**
 - Measurements may is performed using a wideband gated RF power meter provided that the gate parameters are adjusted such that the power is measured only when the EUT is transmitting at its maximum power control level. Since the measurement is made only during the ON time of the transmitter, no duty cycle correction factor is required.

3.3.3 Test Setup



3.3.4 Test Result of Maximum Conducted Output Power

Mode	N _{TX}	Freq. (MHz)	Conducted Power (dBm)				Total Power (mW)	Total Power (dBm)	Limit (dBm)
			Chain 0	Chain 1	Chain 2	Chain 3			
11a	1	5745	7.45	---	---	---	5.559	7.45	30.00
11a	1	5785	7.6	---	---	---	5.754	7.60	30.00
11a	1	5805	7.55	---	---	---	5.689	7.55	30.00
HT20	1	5745	10.51	---	---	---	11.246	10.51	30.00
HT20	1	5785	10.22	---	---	---	10.520	10.22	30.00
HT20	1	5805	10.12	---	---	---	10.280	10.12	30.00

3.4 Peak Power Spectral Density

3.4.1 Limit of Peak Power Spectral Density

The maximum power spectral density shall not exceed 30 dBm in any 500 kHz band.

3.4.2 Test Procedures

Method SA-1

1. Set RBW = 500 kHz, VBW = 2 MHz, Sweep time = auto, Detector = RMS.
2. Trace average 100 traces.
3. Use the peak marker function to determine the maximum amplitude level.

Method SA-2 Alternative

1. Set RBW = 500 kHz, VBW = 2 MHz, Detector = RMS.
2. Set sweep time $\geq 10 * (\text{number of points in sweep}) * (\text{total on/off period of the transmitted signal})$.
3. Perform a single sweep.
4. Use the peak marker function to determine the maximum amplitude level.
5. Add $10 \log(1/x)$, where x is the duty cycle.

3.4.3 Test Setup

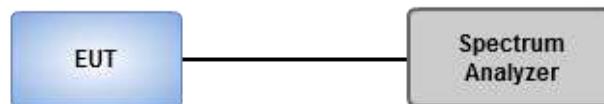

3.4.4 Test Result of Peak Power Spectral Density

For Frequency band 5725-5850 MHz						
Condition			Peak Power Spectral Density (dBm/500kHz)			
Modulation Mode	N _{TX}	Freq. (MHz)	PPSD w/o D.F (dBm/500kHz)	Duty Factor (dB)	PPSD with D.F (dBm/500kHz)	PPSD Limit (dBm/500kHz)
11a	1	5745	-4.65	0.17	-4.48	30.00
11a	1	5785	-4.32	0.17	-4.15	30.00
11a	1	5805	-4.50	0.17	-4.33	30.00
HT20	1	5745	-3.19	0.22	-2.97	30.00
HT20	1	5785	-3.09	0.22	-2.87	30.00
HT20	1	5805	-2.19	0.22	-1.97	30.00

Note: D.F is duty factor.

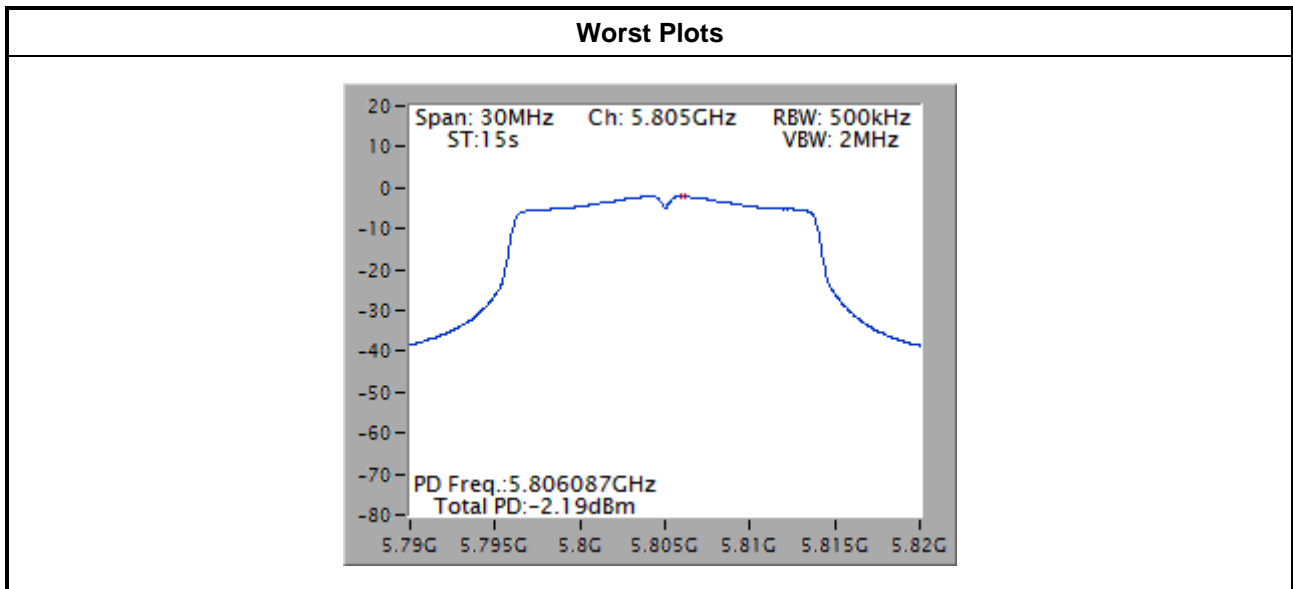

Note: The plot without duty factor.

3.5 Transmitter Radiated and Band Edge Emissions

3.5.1 Limit of Transmitter Radiated and Band Edge Emissions

Restricted Band Emissions Limit			
Frequency Range (MHz)	Field Strength (uV/m)	Field Strength (dBuV/m)	Measure Distance (m)
0.009~0.490	2400/F(kHz)	48.5 - 13.8	300
0.490~1.705	24000/F(kHz)	33.8 - 23	30
1.705~30.0	30	29	30
30~88	100	40	3
88~216	150	43.5	3
216~960	200	46	3
Above 960	500	54	3

Note 1:
Qusai-Peak value is measured for frequency below 1GHz except for 9–90 kHz, 110–490 kHz frequency band. Peak and average value are measured for frequency above 1GHz. The limit on average radio frequency emission is as above table. The limit on peak radio frequency emissions is 20 dB above the maximum permitted average emission limit

Note 2:
Measurements may be performed at a distance other than what is specified provided. When performing measurements at a distance other than that specified, the results shall be extrapolated to the specified distance using an extrapolation factor as below, Frequency at or above 30 MHz: 20 dB/decade Frequency below 30 MHz: 40 dB/decade.

Un-restricted band emissions above 1GHz Limit	
Operating Band	Limit
5.15 - 5.25 GHz	e.i.r.p. -27 dBm [68.2 dBuV/m@3m]
5.25 - 5.35 GHz	e.i.r.p. -27 dBm [68.2 dBuV/m@3m]
5.47 - 5.725 GHz	e.i.r.p. -27 dBm [68.2 dBuV/m@3m]
5.725 - 5.850 GHz	5.715 5.725 GHz: e.i.r.p. -17 dBm [78.2 dBuV/m@3m] 5.85 5.86 GHz: e.i.r.p. -17 dBm [78.2 dBuV/m@3m] Other un-restricted band: e.i.r.p. -27 dBm [68.2 dBuV/m@3m]

Note 1: Measurements may be performed at a distance other than the limit distance provided they are not performed in the near field and the emissions to be measured can be detected by the measurement equipment. When performing measurements at a distance other than that specified, the results shall be extrapolated to the specified distance using an extrapolation factor of 20 dB/decade (inverse of linear distance for field-strength measurements, inverse of linear distance-squared for power-density measurements).

3.5.2 Test Procedures

1. Measurement is made at a semi-anechoic chamber that incorporates a turntable allowing a EUT rotation of 360°. A continuously-rotating, remotely-controlled turntable is installed at the test site to support the EUT and facilitate determination of the direction of maximum radiation for each EUT emission frequency. The EUT is placed at test table. For emissions testing at or below 1 GHz, the table height is 80 cm above the reference ground plane. For emission measurements above 1 GHz, the table height is 1.5 m
2. Measurement is made with the antenna positioned in both the horizontal and vertical planes of polarization. The measurement antenna is varied in height (1m ~ 4m) above the reference ground plane to obtain the maximum signal strength. Distance between EUT and antenna is 3 m.
3. This investigation is performed with the EUT rotated 360°, the antenna height scanned between 1 m and 4 m, and the antenna rotated to repeat the measurements for both the horizontal and vertical antenna polarizations.

Note:

1. 120kHz measurement bandwidth of test receiver and Quasi-peak detector is for radiated emission below 1GHz.
2. RBW=1MHz, VBW=3MHz and Peak detector is for peak measured value of radiated emission above 1GHz.
3. RBW=1MHz, VBW=1/T and Peak detector is for average measured value of radiated emission above 1GHz.

3.5.3 Test Setup

Radiated Emissions below 1 GHz

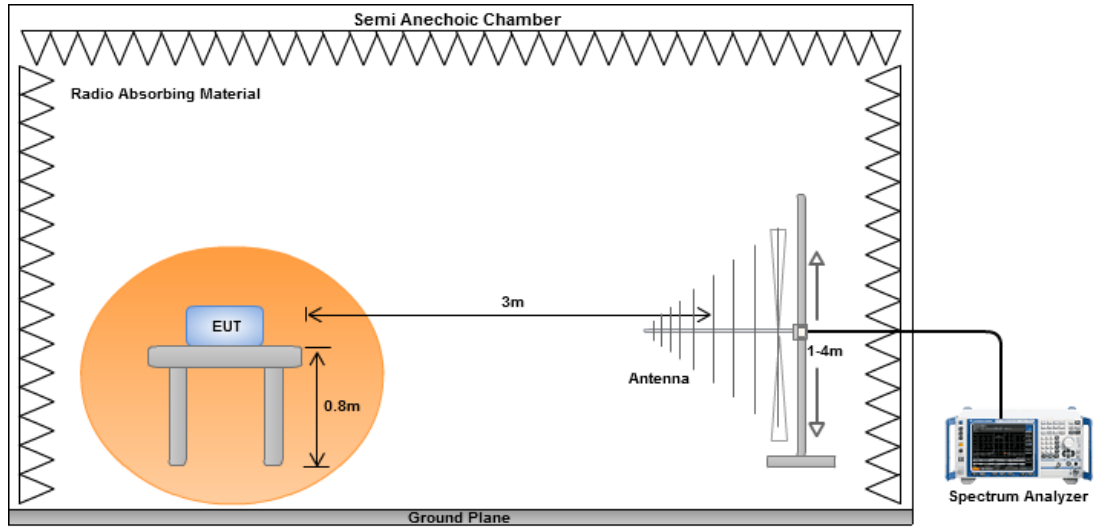

Radiated Emissions above 1 GHz

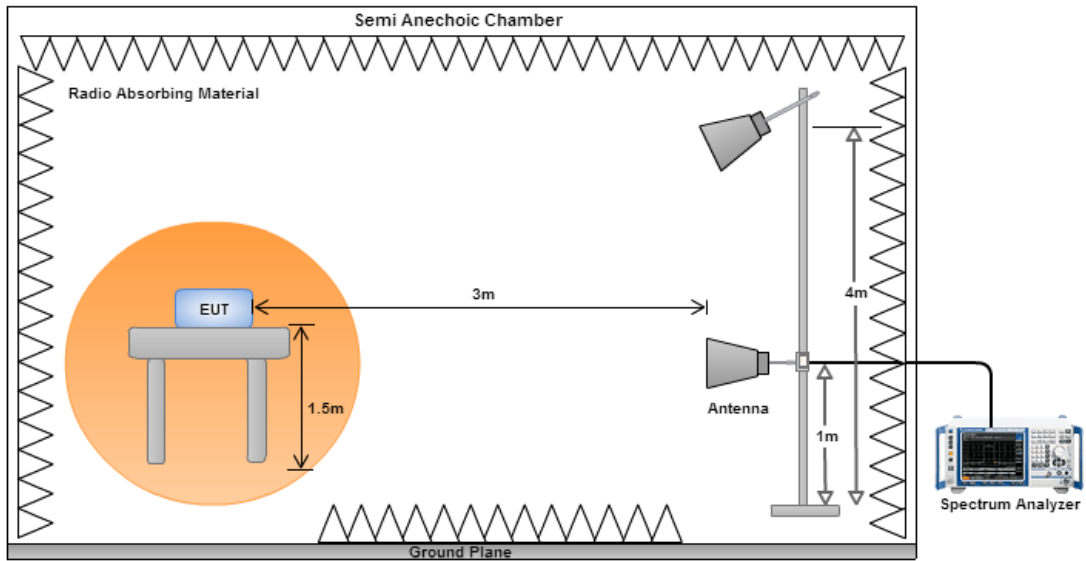

3.5.4 Transmitter Radiated Unwanted Emissions (Below 1GHz)

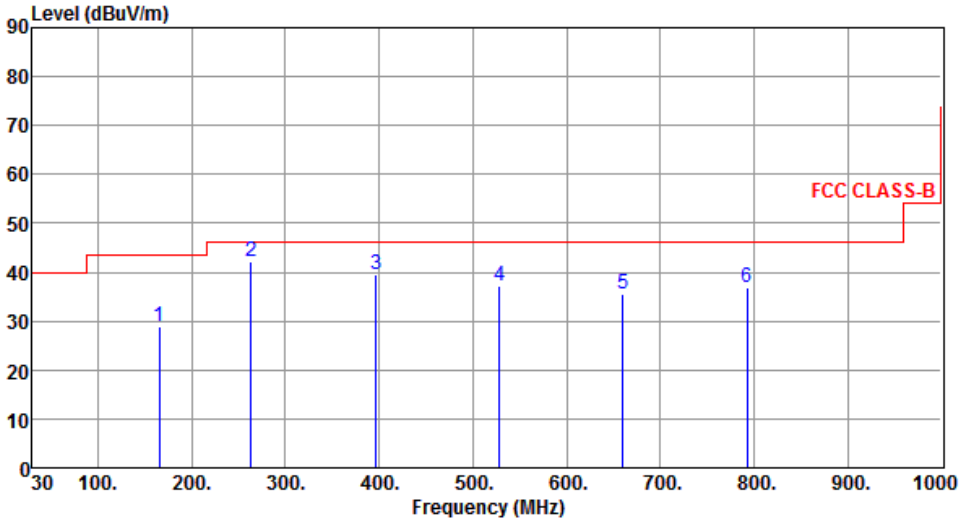
Modulation	HT20	Test Freq. (MHz)	5745																																																																									
Polarization	Horizontal																																																																											
																																																																												
	<table border="1"> <thead> <tr> <th>Freq.</th> <th>Emission level</th> <th>Limit</th> <th>Margin</th> <th>SA reading</th> <th>Factor</th> <th>Remark</th> <th>ANT High cm</th> <th>Turn Table deg</th> </tr> <tr> <th>MHz</th> <th>dBuV/m</th> <th>dBuV/m</th> <th>dB</th> <th>dBuV</th> <th>dB</th> <th></th> <th></th> <th></th> </tr> </thead> <tbody> <tr> <td>1</td> <td>28.85</td> <td>43.50</td> <td>-14.65</td> <td>42.74</td> <td>-13.89</td> <td>Peak</td> <td>---</td> <td>---</td> </tr> <tr> <td>2</td> <td>42.30</td> <td>46.00</td> <td>-3.70</td> <td>56.48</td> <td>-14.18</td> <td>Peak</td> <td>---</td> <td>---</td> </tr> <tr> <td>3</td> <td>39.37</td> <td>46.00</td> <td>-6.63</td> <td>49.49</td> <td>-10.12</td> <td>Peak</td> <td>---</td> <td>---</td> </tr> <tr> <td>4</td> <td>37.20</td> <td>46.00</td> <td>-8.80</td> <td>44.51</td> <td>-7.31</td> <td>Peak</td> <td>---</td> <td>---</td> </tr> <tr> <td>5</td> <td>35.54</td> <td>46.00</td> <td>-10.46</td> <td>40.36</td> <td>-4.82</td> <td>Peak</td> <td>---</td> <td>---</td> </tr> <tr> <td>6</td> <td>36.79</td> <td>46.00</td> <td>-9.21</td> <td>39.45</td> <td>-2.66</td> <td>Peak</td> <td>---</td> <td>---</td> </tr> </tbody> </table>	Freq.	Emission level	Limit	Margin	SA reading	Factor	Remark	ANT High cm	Turn Table deg	MHz	dBuV/m	dBuV/m	dB	dBuV	dB				1	28.85	43.50	-14.65	42.74	-13.89	Peak	---	---	2	42.30	46.00	-3.70	56.48	-14.18	Peak	---	---	3	39.37	46.00	-6.63	49.49	-10.12	Peak	---	---	4	37.20	46.00	-8.80	44.51	-7.31	Peak	---	---	5	35.54	46.00	-10.46	40.36	-4.82	Peak	---	---	6	36.79	46.00	-9.21	39.45	-2.66	Peak	---	---			
Freq.	Emission level	Limit	Margin	SA reading	Factor	Remark	ANT High cm	Turn Table deg																																																																				
MHz	dBuV/m	dBuV/m	dB	dBuV	dB																																																																							
1	28.85	43.50	-14.65	42.74	-13.89	Peak	---	---																																																																				
2	42.30	46.00	-3.70	56.48	-14.18	Peak	---	---																																																																				
3	39.37	46.00	-6.63	49.49	-10.12	Peak	---	---																																																																				
4	37.20	46.00	-8.80	44.51	-7.31	Peak	---	---																																																																				
5	35.54	46.00	-10.46	40.36	-4.82	Peak	---	---																																																																				
6	36.79	46.00	-9.21	39.45	-2.66	Peak	---	---																																																																				
<p>Note 1: Emission Level (dBuV/m) = SA Reading (dBuV/m) + Factor* (dB) *Factor includes antenna factor , cable loss and amplifier gain Note 2: Margin (dB) = Emission level (dBuV/m) – Limit (dBuV/m). Note 3: All spurious emissions below 30MHz are more than 20 dB below the limit.</p>																																																																												

Modulation	HT20	Test Freq. (MHz)	5745
Polarization	Vertical		

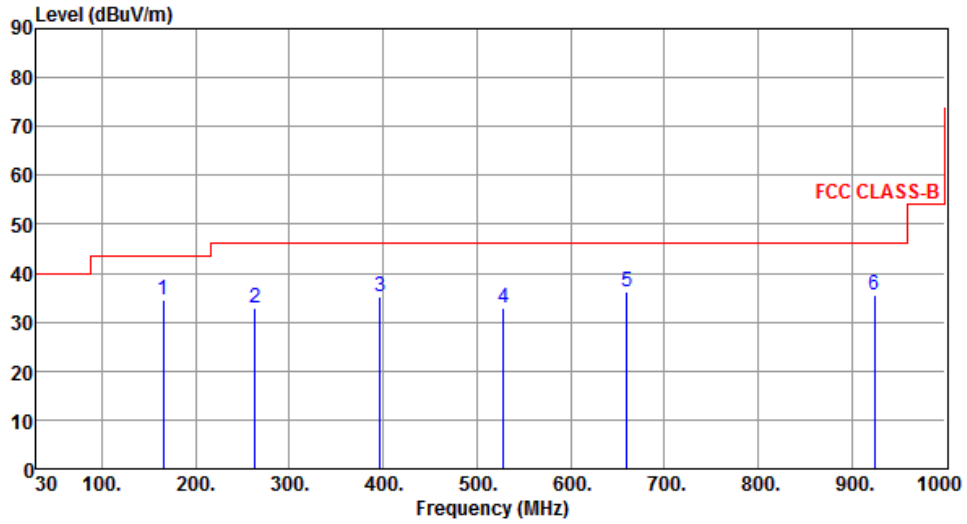

	Freq. MHz	Emission level dBuV/m	Limit dBuV/m	Margin dB	SA reading dBuV	Factor dB	Remark	ANT High cm	Turn Table deg
1	165.80	34.61	43.50	-8.89	48.50	-13.89	Peak	---	---
2	263.77	32.74	46.00	-13.26	46.92	-14.18	Peak	---	---
3	396.66	35.17	46.00	-10.83	45.29	-10.12	Peak	---	---
4	528.58	32.98	46.00	-13.02	40.29	-7.31	Peak	---	---
5	660.50	36.18	46.00	-9.82	41.00	-4.82	QP	---	---
6	924.34	35.43	46.00	-10.57	35.65	-0.22	Peak	---	---

Note 1: Emission Level (dBuV/m) = SA Reading (dBuV/m) + Factor* (dB)

*Factor includes antenna factor , cable loss and amplifier gain

Note 2: Margin (dB) = Emission level (dBuV/m) – Limit (dBuV/m).

Note 3: All spurious emissions below 30MHz are more than 20 dB below the limit.

3.5.5 Transmitter Radiated Unwanted Emissions (Above 1GHz) for 11a

Modulation	11a	Test Freq. (MHz)	5745
Polarization	Horizontal		

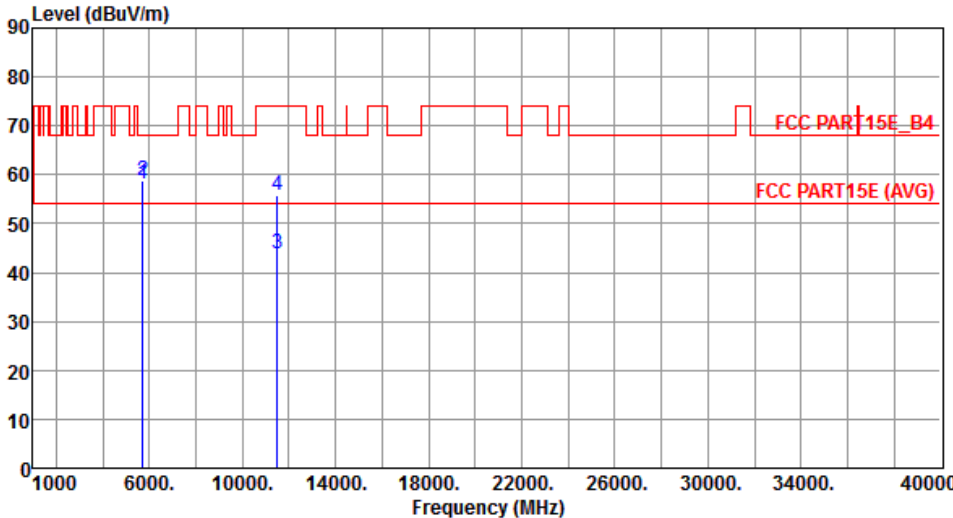

	Freq. MHz	Emission level dBuV/m	Limit dBuV/m	Margin dB	SA reading dBuV	Factor dB	Remark	ANT High cm	Turn Table deg
1	5715.00	57.97	68.20	-10.23	50.44	7.53	Peak	---	---
2	5725.00	58.66	78.20	-19.54	51.09	7.57	Peak	---	---
3	11490.00	43.81	54.00	-10.19	26.54	17.27	Average	---	---
4	11490.00	55.75	74.00	-18.25	38.48	17.27	Peak	---	---

Note 1: Emission Level (dBuV/m) = SA Reading (dBuV/m) + Factor* (dB)
*Factor includes antenna factor , cable loss and amplifier gain
Note 2: Margin (dB) = Emission level (dBuV/m) – Limit (dBuV/m).

Modulation	11a	Test Freq. (MHz)	5745
Polarization	Vertical		

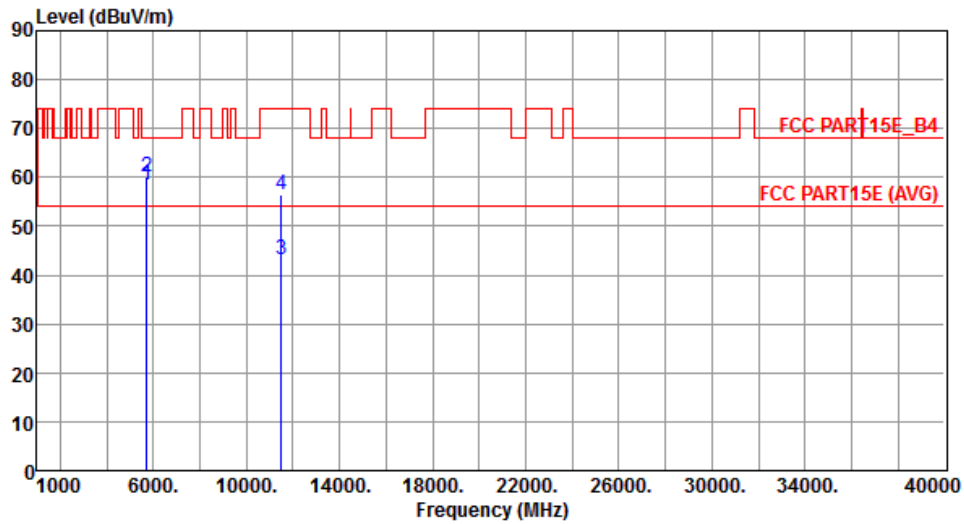

	Freq. MHz	Emission level dBuV/m	Limit dBuV/m	Margin dB	SA reading dBuV	Factor dB	Remark	ANT High cm	Turn Table deg
1	5715.00	58.51	68.20	-9.69	50.98	7.53	Peak	---	---
2	5725.00	60.20	78.20	-18.00	52.63	7.57	Peak	---	---
3	11490.00	43.28	54.00	-10.72	26.01	17.27	Average	---	---
4	11490.00	56.46	74.00	-17.54	39.19	17.27	Peak	---	---

Note 1: Emission Level (dBuV/m) = SA Reading (dBuV/m) + Factor* (dB)

*Factor includes antenna factor , cable loss and amplifier gain

Note 2: Margin (dB) = Emission level (dBuV/m) – Limit (dBuV/m).

Modulation	11a	Test Freq. (MHz)	5785
Polarization	Horizontal		

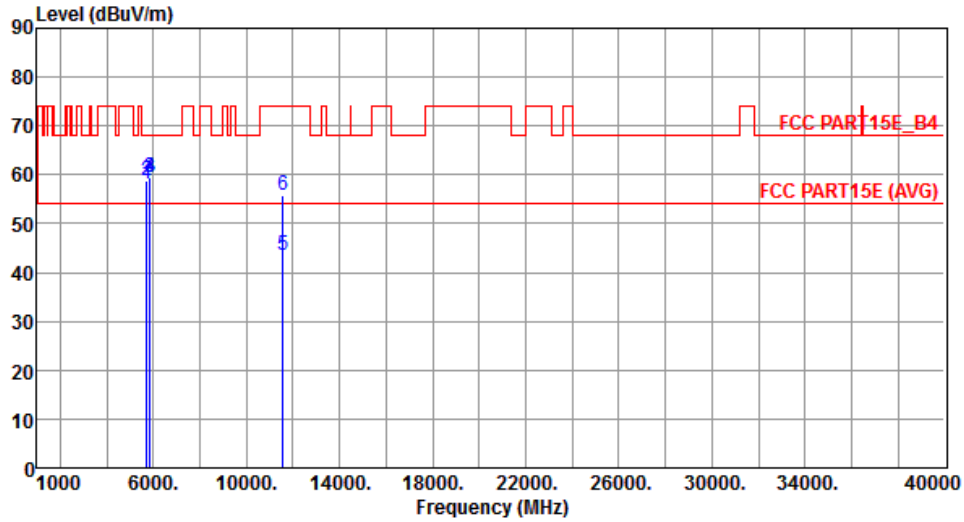

	Freq. MHz	Emission level dBuV/m	Limit dBuV/m	Margin dB	SA reading dBuV	Factor dB	Remark	ANT High cm	Turn Table deg
1	5715.00	57.95	68.20	-10.25	50.42	7.53	Peak	---	---
2	5725.00	58.91	78.20	-19.29	51.34	7.57	Peak	---	---
3	5850.00	59.54	78.20	-18.66	51.65	7.89	Peak	---	---
4	5860.00	59.35	68.20	-8.85	51.44	7.91	Peak	---	---
5	11570.00	43.42	54.00	-10.58	26.24	17.18	Average	---	---
6	11570.00	55.70	74.00	-18.30	38.52	17.18	Peak	---	---

Note 1: Emission Level (dBuV/m) = SA Reading (dBuV/m) + Factor* (dB)

*Factor includes antenna factor , cable loss and amplifier gain

Note 2: Margin (dB) = Emission level (dBuV/m) – Limit (dBuV/m).

Modulation	11a	Test Freq. (MHz)	5785
Polarization	Vertical		

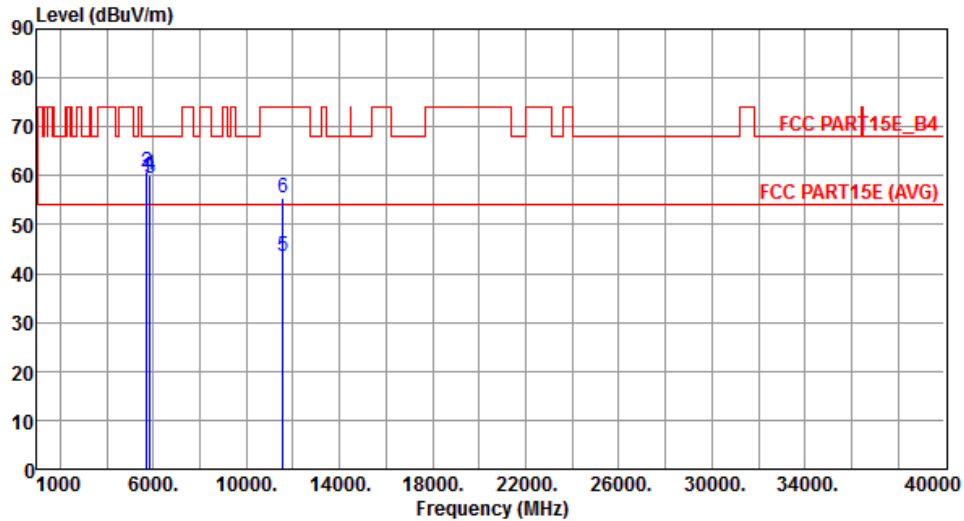

	Freq. MHz	Emission level dBuV/m	Limit dBuV/m	Margin dB	SA reading dBuV	Factor dB	Remark	ANT High cm	Turn Table deg
1	5715.00	59.64	68.20	-8.56	52.11	7.53	Peak	---	---
2	5725.00	60.71	78.20	-17.49	53.14	7.57	Peak	---	---
3	5850.00	59.55	78.20	-18.65	51.66	7.89	Peak	---	---
4	5860.00	60.16	68.20	-8.04	52.25	7.91	Peak	---	---
5	11570.00	43.53	54.00	-10.47	26.35	17.18	Average	---	---
6	11570.00	55.61	74.00	-18.39	38.43	17.18	Peak	---	---

Note 1: Emission Level (dBuV/m) = SA Reading (dBuV/m) + Factor* (dB)

*Factor includes antenna factor , cable loss and amplifier gain

Note 2: Margin (dB) = Emission level (dBuV/m) – Limit (dBuV/m).

Modulation	11a	Test Freq. (MHz)	5805
Polarization	Horizontal		

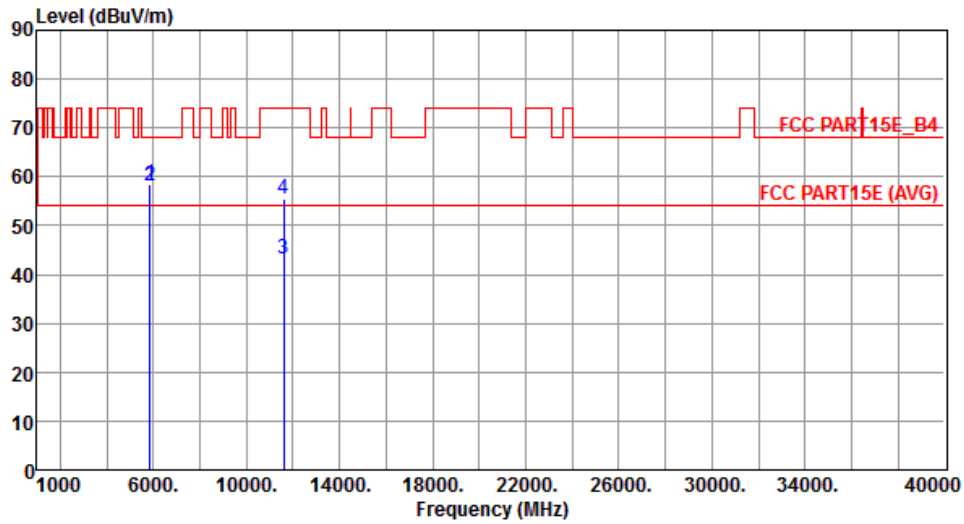

	Freq. MHz	Emission level dBuV/m	Limit dBuV/m	Margin dB	SA reading dBuV	Factor dB	Remark	ANT High cm	Turn Table deg
1	5850.00	58.32	78.20	-19.88	50.43	7.89	Peak	---	---
2	5860.00	58.04	68.20	-10.16	50.13	7.91	Peak	---	---
3	11610.00	43.28	54.00	-10.72	26.15	17.13	Average	---	---
4	11610.00	55.55	74.00	-18.45	38.42	17.13	Peak	---	---

Note 1: Emission Level (dBuV/m) = SA Reading (dBuV/m) + Factor* (dB)

*Factor includes antenna factor , cable loss and amplifier gain

Note 2: Margin (dB) = Emission level (dBuV/m) – Limit (dBuV/m).

Modulation	11a	Test Freq. (MHz)	5805
Polarization	Vertical		

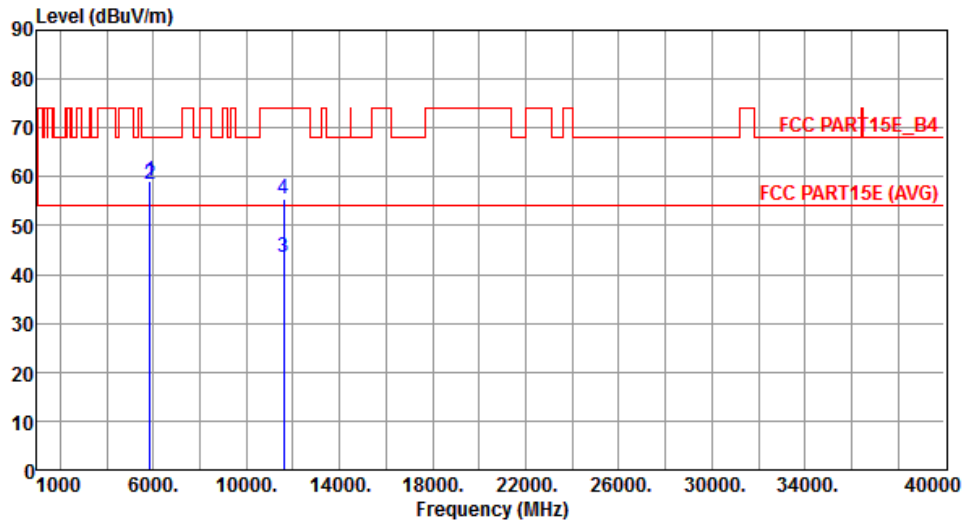

	Freq. MHz	Emission level dBuV/m	Limit dBuV/m	Margin dB	SA reading dBuV	Factor dB	Remark	ANT High cm	Turn Table deg
1	5850.00	59.20	78.20	-19.00	51.31	7.89	Peak	---	---
2	5860.00	58.35	68.20	-9.85	50.44	7.91	Peak	---	---
3	11610.00	43.37	54.00	-10.63	26.24	17.13	Average	---	---
4	11610.00	55.39	74.00	-18.61	38.26	17.13	Peak	---	---

Note 1: Emission Level (dBuV/m) = SA Reading (dBuV/m) + Factor* (dB)

*Factor includes antenna factor , cable loss and amplifier gain

Note 2: Margin (dB) = Emission level (dBuV/m) – Limit (dBuV/m).

3.5.6 Transmitter Radiated Unwanted Emissions (Above 1GHz) for HT20

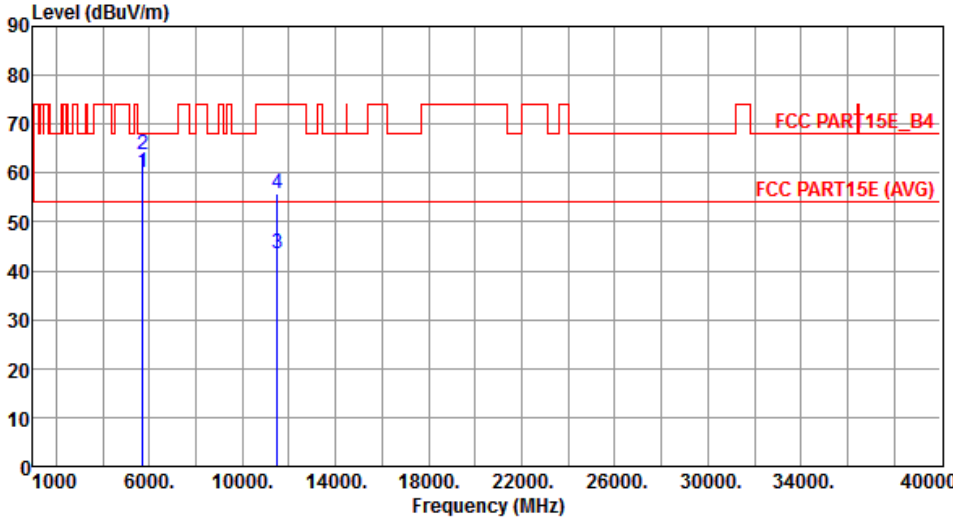
Modulation	HT20	Test Freq. (MHz)	5745						
Polarization	Horizontal								
									
	Freq.	Emission level	Limit	Margin	SA reading	Factor	Remark	ANT High	Turn Table
	MHz	dBuV/m	dBuV/m	dB	dBuV	dB		cm	deg
1	5715.00	60.17	68.20	-8.03	52.64	7.53	Peak	---	---
2	5725.00	63.72	78.20	-14.48	56.15	7.57	Peak	---	---
3	11490.00	43.56	54.00	-10.44	26.29	17.27	Average	---	---
4	11490.00	55.84	74.00	-18.16	38.57	17.27	Peak	---	---
<p>Note 1: Emission Level (dBuV/m) = SA Reading (dBuV/m) + Factor* (dB) *Factor includes antenna factor , cable loss and amplifier gain Note 2: Margin (dB) = Emission level (dBuV/m) – Limit (dBuV/m).</p>									

Modulation	HT20	Test Freq. (MHz)	5745
Polarization	Vertical		

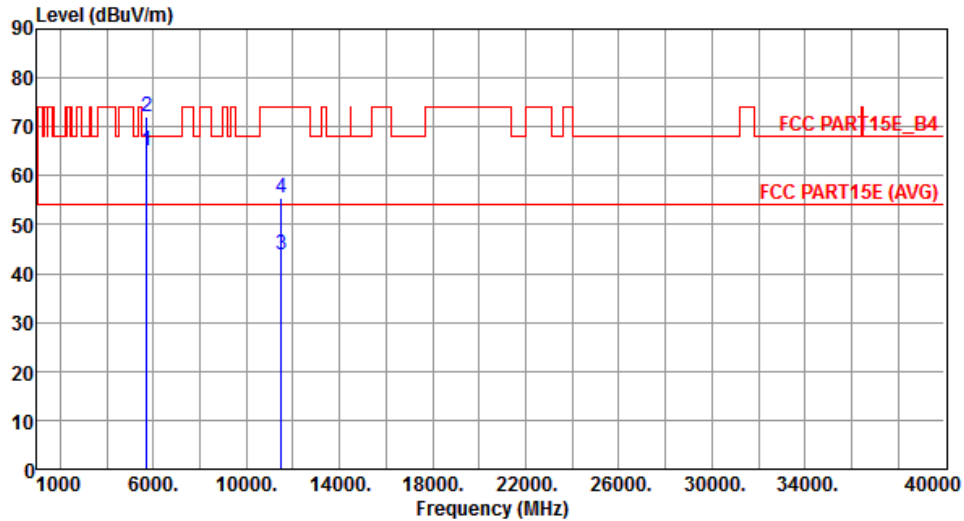

	Freq. MHz	Emission level dBuV/m	Limit dBuV/m	Margin dB	SA reading dBuV	Factor dB	Remark	ANT High cm	Turn Table deg
1	5715.00	65.01	68.20	-3.19	57.48	7.53	Peak	---	---
2	5725.00	72.04	78.20	-6.16	64.47	7.57	Peak	---	---
3	11490.00	43.80	54.00	-10.20	26.53	17.27	Average	---	---
4	11490.00	55.61	74.00	-18.39	38.34	17.27	Peak	---	---

Note 1: Emission Level (dBuV/m) = SA Reading (dBuV/m) + Factor* (dB)

*Factor includes antenna factor , cable loss and amplifier gain

Note 2: Margin (dB) = Emission level (dBuV/m) – Limit (dBuV/m).

Modulation	HT20	Test Freq. (MHz)	5785
Polarization	Horizontal		

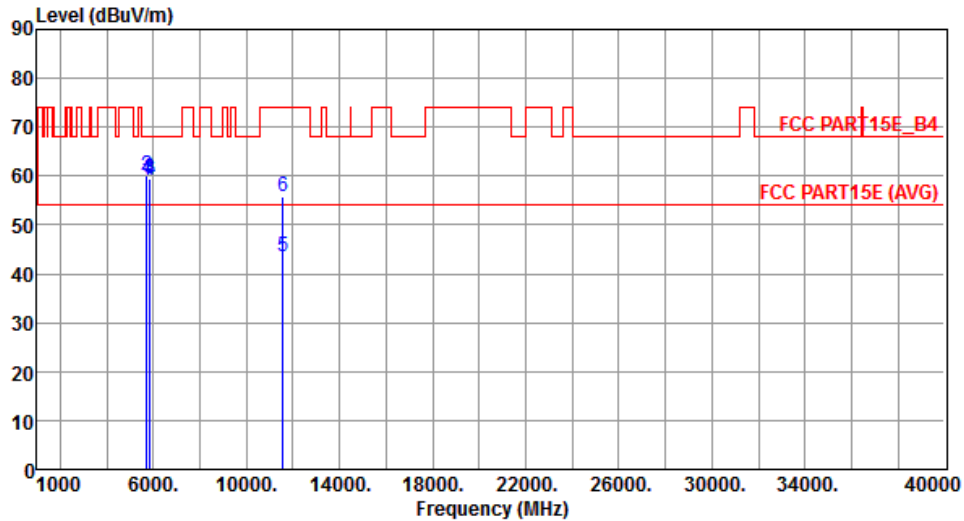

	Freq. MHz	Emission level dBuV/m	Limit dBuV/m	Margin dB	SA reading dBuV	Factor dB	Remark	ANT High cm	Turn Table deg
1	5715.00	59.06	68.20	-9.14	51.53	7.53	Peak	---	---
2	5725.00	60.21	78.20	-17.99	52.64	7.57	Peak	---	---
3	5850.00	59.32	78.20	-18.88	51.43	7.89	Peak	---	---
4	5860.00	58.97	68.20	-9.23	51.06	7.91	Peak	---	---
5	11570.00	43.45	54.00	-10.55	26.27	17.18	Average	---	---
6	11570.00	55.72	74.00	-18.28	38.54	17.18	Peak	---	---

Note 1: Emission Level (dBuV/m) = SA Reading (dBuV/m) + Factor* (dB)

*Factor includes antenna factor , cable loss and amplifier gain

Note 2: Margin (dB) = Emission level (dBuV/m) – Limit (dBuV/m).

Modulation	HT20	Test Freq. (MHz)	5785
Polarization	Vertical		

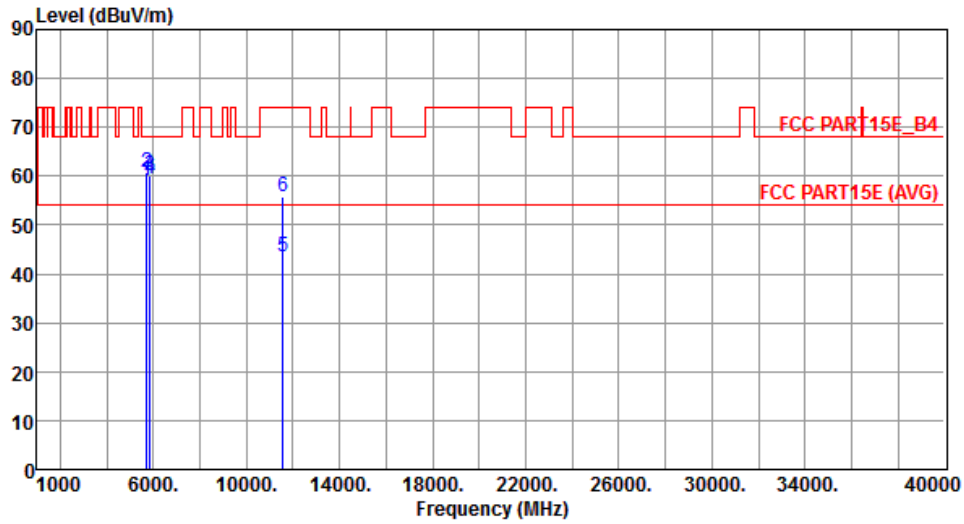

	Freq. MHz	Emission level dBuV/m	Limit dBuV/m	Margin dB	SA reading dBuV	Factor dB	Remark	ANT High cm	Turn Table deg
1	5715.00	59.21	68.20	-8.99	51.68	7.53	Peak	---	---
2	5725.00	60.90	78.20	-17.30	53.33	7.57	Peak	---	---
3	5850.00	60.10	78.20	-18.10	52.21	7.89	Peak	---	---
4	5860.00	59.40	68.20	-8.80	51.49	7.91	Peak	---	---
5	11570.00	43.42	54.00	-10.58	26.24	17.18	Average	---	---
6	11570.00	55.71	74.00	-18.29	38.53	17.18	Peak	---	---

Note 1: Emission Level (dBuV/m) = SA Reading (dBuV/m) + Factor* (dB)

*Factor includes antenna factor , cable loss and amplifier gain

Note 2: Margin (dB) = Emission level (dBuV/m) – Limit (dBuV/m).

Modulation	HT20	Test Freq. (MHz)	5805
Polarization	Horizontal		

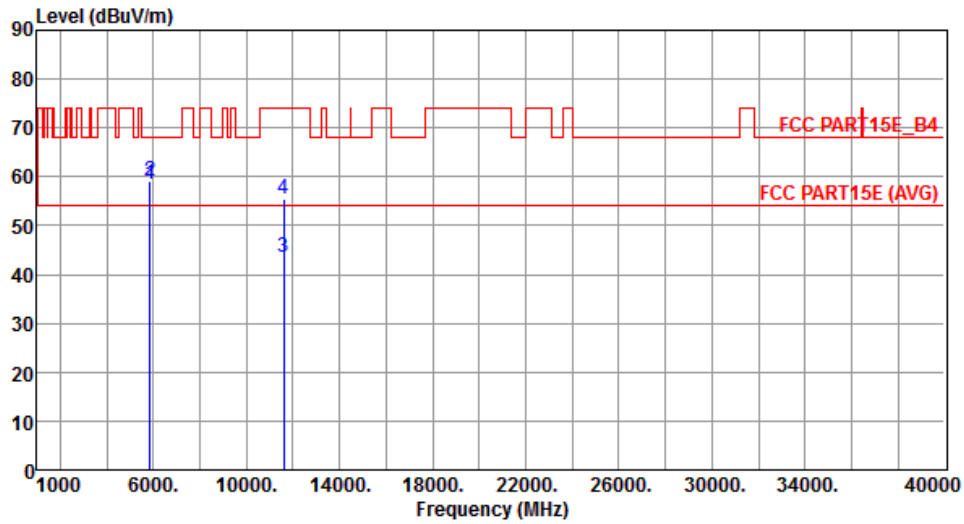

	Freq. MHz	Emission level dBuV/m	Limit dBuV/m	Margin dB	SA reading dBuV	Factor dB	Remark	ANT High cm	Turn Table deg
1	5850.00	58.29	78.20	-19.91	50.40	7.89	Peak	---	---
2	5860.00	59.05	68.20	-9.15	51.14	7.91	Peak	---	---
3	11610.00	43.62	54.00	-10.38	26.49	17.13	Average	---	---
4	11610.00	55.49	74.00	-18.51	38.36	17.13	Peak	---	---

Note 1: Emission Level (dBuV/m) = SA Reading (dBuV/m) + Factor* (dB)

*Factor includes antenna factor , cable loss and amplifier gain

Note 2: Margin (dB) = Emission level (dBuV/m) – Limit (dBuV/m).

Modulation	HT20	Test Freq. (MHz)	5805
Polarization	Vertical		

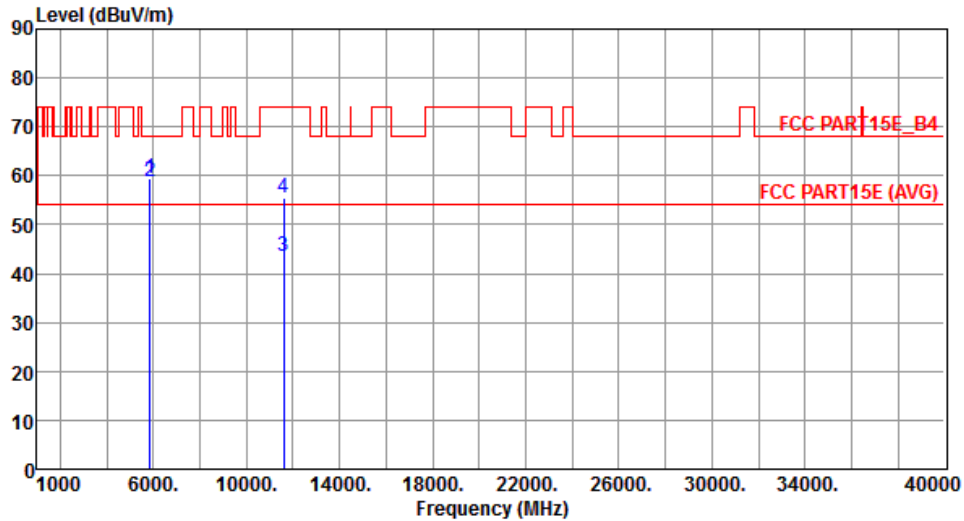

	Freq. MHz	Emission level dBuV/m	Limit dBuV/m	Margin dB	SA reading dBuV	Factor dB	Remark	ANT High cm	Turn Table deg
1	5850.00	59.49	78.20	-18.71	51.60	7.89	Peak	---	---
2	5860.00	58.77	68.20	-9.43	50.86	7.91	Peak	---	---
3	11610.00	43.54	54.00	-10.46	26.41	17.13	Average	---	---
4	11610.00	55.59	74.00	-18.41	38.46	17.13	Peak	---	---

Note 1: Emission Level (dBuV/m) = SA Reading (dBuV/m) + Factor* (dB)

*Factor includes antenna factor , cable loss and amplifier gain

Note 2: Margin (dB) = Emission level (dBuV/m) – Limit (dBuV/m).

3.6 Frequency Stability

3.6.1 Limit of Frequency Stability

Manufacturers of U-NII devices are responsible for ensuring frequency stability such that an emission is maintained within the band of operation under all conditions of normal operation as specified in the user's manual.

3.6.2 Test Procedures

1. The EUT is installed in an environment test chamber with external power source.
2. Set the chamber to operate at 50 centigrade and external power source to output at nominal voltage of EUT.
3. A sufficient stabilization period at each temperature is used prior to each frequency measurement.
4. When temperature is stabled, measure the frequency stability.
5. The test shall be performed under -30 to 50 centigrade and 85 to 115 percent of the nominal voltage. Change setting of chamber and external power source to complete all conditions.

3.6.3 Test Setup

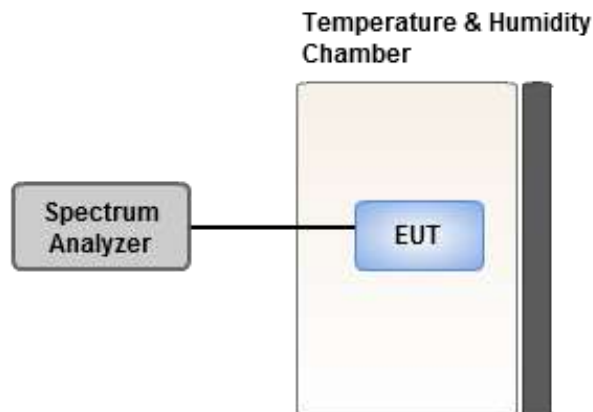

3.6.4 Test Result of Frequency Stability

Frequency: 5785 MHz	Frequency Drift (ppm)			
Temperature (°C)	0 minute	2 minutes	5 minutes	10 minutes
T20°CVmax	1.60	1.50	1.45	1.26
T20°CVmin	3.65	3.10	3.70	4.08
T60°CVnom	1.60	2.00	2.34	2.14
T50°CVnom	2.27	2.95	2.22	2.20
T40°CVnom	3.03	2.57	2.69	2.47
T30°CVnom	2.38	1.83	1.78	1.87
T20°CVnom	0.81	1.81	1.55	1.24
T10°CVnom	3.58	3.09	3.10	3.07
T0°CVnom	2.40	1.93	1.40	1.75
T-10°CVnom	0.81	0.40	0.73	0.88
T-20°CVnom	0.91	0.90	0.28	1.28
T-30°CVnom	0.37	0.39	0.52	0.52
Vnom [Vac]: 120		Vmax [Vac]: 138		Vmin [Vac]: 102
Tnom [°C]: 20		Tmax [°C]: 60		Tmin [°C]: -30

4 Test laboratory information

Established in 2012, ICC provides foremost EMC & RF Testing and advisory consultation services by our skilled engineers and technicians. Our services employ a wide variety of advanced edge test equipment and one of the widest certification extents in the business.

International Certification Corp, it is our definitive objective is to institute long term, trust-based associations with our clients. The expectation we set up with our clients is based on outstanding service, practical expertise and devotion to a certified value structure. Our passion is to grant our clients with best EMC / RF services by oriented knowledgeable and accommodating staff.

Our Test sites are located at Linkou District and Kwei Shan Hsiang. Location map can be found on our website <http://www.icertifi.com.tw>.

Linkou

Tel: 886-2-2601-1640

No. 30-2, Ding Fwu Tsuen, Lin Kou
District, New Taipei City, Taiwan,
R.O.C.

Kwei Shan

Tel: 886-3-271-8666

No. 3-1, Lane 6, Wen San 3rd
St., Kwei Shan Hsiang, Tao Yuan
Hsien 333, Taiwan, R.O.C.

Kwei Shan Site II

Tel: 886-3-271-8640

No. 14-1, Lane 19, Wen San 3rd
St., Kwei Shan Hsiang, Tao Yuan
Hsien 333, Taiwan, R.O.C.

If you have any suggestion, please feel free to contact us as below information

Tel: 886-3-271-8666

Fax: 886-3-318-0155

Email: ICC_Service@icertifi.com.tw

==END==