

*EMC Test Report*

*Application for Grant of Equipment Authorization*

*Industry Canada RSS-Gen Issue 3 / RSS 210 Issue 8  
FCC Part 15 Subpart C*

*Model: SDC-SSD40L*

IC CERTIFICATION #: 6616A-SDC SSD40L  
FCC ID: TWG-SDC SSD40L

APPLICANT: Summit Data Communications  
526 South Main St. Suite 805  
Akron, OH 44311

TEST SITE(S): Elliott Laboratories  
41039 Boyce Road.  
Fremont, CA. 94538-2435

IC SITE REGISTRATION #: 2845B-4, 2845B-5, 2845B-7

REPORT DATE: January 30, 2012

FINAL TEST DATES: November 8, 9 and 10, 2011

TOTAL NUMBER OF PAGES: 72

PROGRAM MGR /  
TECHNICAL REVIEWER:



Mark E Hill  
Staff Engineer

QUALITY ASSURANCE DELEGATE /  
FINAL REPORT PREPARER:



David Guidotti  
Senior Technical Writer



Testing Cert #2016.01

Elliott Laboratories is accredited by the A2LA, certificate number 2016.01, to perform the test(s) listed in this report, except where noted otherwise. This report and the information contained herein represent the results of testing test articles identified and selected by the client performed to specifications and/or procedures selected by the client. National Technical Systems (NTS) makes no representations, expressed or implied, that such testing is adequate (or inadequate) to demonstrate efficiency, performance, reliability, or any other characteristic of the articles being tested, or similar products. This report should not be relied upon as an endorsement or certification by NTS of the equipment tested, nor does it represent any statement whatsoever as to its merchantability or fitness of the test article, or similar products, for a particular purpose. This report shall not be reproduced except in full

**REVISION HISTORY**

Rev#	Date	Comments	Modified By
-	1/18/2012	First release	-
1	1/30/2012	Revised to add clarification about the ac conducted emissions test configuration	Dave Guidotti

**TABLE OF CONTENTS**

<b>REVISION HISTORY .....</b>	<b>2</b>
<b>TABLE OF CONTENTS .....</b>	<b>3</b>
<b>SCOPE.....</b>	<b>4</b>
<b>OBJECTIVE .....</b>	<b>4</b>
<b>STATEMENT OF COMPLIANCE.....</b>	<b>5</b>
<b>DEVIATIONS FROM THE STANDARDS.....</b>	<b>5</b>
<b>TEST RESULTS SUMMARY .....</b>	<b>6</b>
DIGITAL TRANSMISSION SYSTEMS (2400 – 2483.5MHZ).....	6
GENERAL REQUIREMENTS APPLICABLE TO ALL BANDS.....	7
MEASUREMENT UNCERTAINTIES.....	8
<b>EQUIPMENT UNDER TEST (EUT) DETAILS.....</b>	<b>9</b>
GENERAL.....	9
OTHER EUT DETAILS.....	9
ANTENNA SYSTEM.....	9
ENCLOSURE.....	9
MODIFICATIONS.....	9
SUPPORT EQUIPMENT.....	9
EUT INTERFACE PORTS.....	10
EUT OPERATION.....	10
<b>TEST SITE.....</b>	<b>11</b>
GENERAL INFORMATION.....	11
CONDUCTED EMISSIONS CONSIDERATIONS.....	11
RADIATED EMISSIONS CONSIDERATIONS.....	11
<b>MEASUREMENT INSTRUMENTATION .....</b>	<b>12</b>
RECEIVER SYSTEM.....	12
INSTRUMENT CONTROL COMPUTER.....	12
LINE IMPEDANCE STABILIZATION NETWORK (LISN).....	12
FILTERS/ATTENUATORS.....	13
ANTENNAS.....	13
ANTENNA MAST AND EQUIPMENT TURNTABLE.....	13
INSTRUMENT CALIBRATION.....	13
<b>TEST PROCEDURES .....</b>	<b>14</b>
EUT AND CABLE PLACEMENT.....	14
CONDUCTED EMISSIONS.....	14
RADIATED EMISSIONS.....	14
RADIATED EMISSIONS.....	15
CONDUCTED EMISSIONS FROM ANTENNA PORT.....	17
BANDWIDTH MEASUREMENTS.....	17
SPECIFICATION LIMITS AND SAMPLE CALCULATIONS.....	18
CONDUCTED EMISSIONS SPECIFICATION LIMITS: FCC 15.207; FCC 15.107(A), RSS GEN.....	18
GENERAL TRANSMITTER RADIATED EMISSIONS SPECIFICATION LIMITS.....	19
RECEIVER RADIATED SPURIOUS EMISSIONS SPECIFICATION LIMITS.....	19
OUTPUT POWER LIMITS – DIGITAL TRANSMISSION SYSTEMS.....	20
TRANSMIT MODE SPURIOUS RADIATED EMISSIONS LIMITS – FHSS AND DTS SYSTEMS.....	20
SAMPLE CALCULATIONS - CONDUCTED EMISSIONS.....	20
SAMPLE CALCULATIONS - RADIATED EMISSIONS.....	21
SAMPLE CALCULATIONS - FIELD STRENGTH TO EIRP CONVERSION.....	22
<b>APPENDIX A TEST EQUIPMENT CALIBRATION DATA .....</b>	<b>23</b>
<b>APPENDIX B TEST DATA .....</b>	<b>24</b>
<b>END OF REPORT .....</b>	<b>72</b>

## SCOPE

An electromagnetic emissions test has been performed on the Summit Data Communications model SDC-SSD40L, pursuant to the following rules:

Industry Canada RSS-Gen Issue 3  
RSS 210 Issue 8 "Low-power Licence-exempt Radiocommunication Devices (All Frequency Bands): Category I Equipment"  
FCC Part 15 Subpart C

Conducted and radiated emissions data has been collected, reduced, and analyzed within this report in accordance with measurement guidelines set forth in the following reference standards and as outlined in Elliott Laboratories test procedures:

ANSI C63.4:2003  
FCC DTS Measurement Procedure KDB558074, March 2005

The intentional radiator above has been tested in a simulated typical installation to demonstrate compliance with the relevant Industry Canada performance and procedural standards.

Final system data was gathered in a mode that tended to maximize emissions by varying orientation of EUT, orientation of power and I/O cabling, antenna search height, and antenna polarization.

Every practical effort was made to perform an impartial test using appropriate test equipment of known calibration. All pertinent factors have been applied to reach the determination of compliance.

## OBJECTIVE

The primary objective of the manufacturer is compliance with the regulations outlined in the previous section.

Prior to marketing in the USA, all unlicensed transmitters and transceivers require certification. Receive-only devices operating between 30 MHz and 960 MHz are subject to either certification or a manufacturer's declaration of conformity, with all other receive-only devices exempt from the technical requirements.

Prior to marketing in Canada, Class I transmitters, receivers and transceivers require certification. Class II devices are required to meet the appropriate technical requirements but are exempt from certification requirements.

Certification is a procedure where the manufacturer submits test data and technical information to a certification body and receives a certificate or grant of equipment authorization upon successful completion of the certification body's review of the submitted documents. Once the equipment authorization has been obtained, the label indicating compliance must be attached to all identical units, which are subsequently manufactured.

Maintenance of compliance is the responsibility of the manufacturer. Any modification of the product which may result in increased emissions should be checked to ensure compliance has been maintained (i.e., printed circuit board layout changes, different line filter, different power supply, harnessing or I/O cable changes, etc.).

#### ***STATEMENT OF COMPLIANCE***

The tested sample of Summit Data Communications model SDC-SSD40L complied with the requirements of the following regulations:

Industry Canada RSS-Gen Issue 3  
RSS 210 Issue 8 “Low-power Licence-exempt Radiocommunication Devices (All Frequency Bands): Category I Equipment”  
FCC Part 15 Subpart C

Maintenance of compliance is the responsibility of the manufacturer. Any modifications to the product should be assessed to determine their potential impact on the compliance status of the device with respect to the standards detailed in this test report.

The test results recorded herein are based on a single type test of Summit Data Communications model SDC-SSD40L and therefore apply only to the tested sample. The sample was selected and prepared by Sue White of Summit Data Communications.

#### ***DEVIATIONS FROM THE STANDARDS***

No deviations were made from the published requirements listed in the scope of this report.

**TEST RESULTS SUMMARY****DIGITAL TRANSMISSION SYSTEMS (2400 – 2483.5MHz)**

FCC Rule Part	RSS Rule Part	Description	Measured Value / Comments	Limit / Requirement	Result
15.247(a)	RSS 210 A8.2	Digital Modulation	Systems uses OFDM / DSSS techniques	System must utilize a digital transmission technology	Complies
15.247 (a) (2)	RSS 210 A8.2 (1)	6dB Bandwidth	802.11b: 8.1 MHz 802.11g: 13.9 MHz 802.11n20: 16.0 MHz	>500kHz	Complies
15.247 (b) (3)	RSS 210 A8.2 (4)	Output Power (multipoint systems)	802.11b: 16.4 dBm (0.044 Watts) 802.11g: 13.8 dBm (0.024 Watts) 802.11n20: 12.3 dBm (0.017Watts) EIRP = 0.069 W <sup>Note 1</sup>	1Watt, EIRP limited to 4 Watts.	Complies
15.247(d)	RSS 210 A8.2 (2)	Power Spectral Density	802.11b: 6.7 dBm 802.11g: -12.7 dBm 802.11n20: -10.9 dBm	8dBm/3kHz	Complies
15.247(c)	RSS 210 A8.5	Antenna Port Spurious Emissions 30MHz – 25 GHz	All emissions below -30dBc limit	< -30dBc <sup>Note 2</sup>	Complies
15.247(c) / 15.209	RSS 210 A8.5	Radiated Spurious Emissions 30MHz – 25 GHz	53.9dB $\mu$ V/m @ 2483.5MHz (-0.1dB)	15.207 in restricted bands, all others <-30dBc <sup>Note 2</sup>	Complies
<p>Note 1: EIRP calculated using antenna gain of 2.0 dBi for the highest EIRP system.</p> <p>Note 2: Limit of -30dBc used because the power was measured using the UNII test procedure (maximum power averaged over a transmission burst).</p>					

**GENERAL REQUIREMENTS APPLICABLE TO ALL BANDS**

FCC Rule Part	RSS Rule part	Description	Measured Value / Comments	Limit / Requirement	Result (margin)
15.203	-	RF Connector	The RF output of the module is via a PCB pad. The RF connection to the antenna is provided by the host system.	Unique or integral antenna required	Complies
15.207	RSS GEN Table 2	AC Conducted Emissions	37.5dB $\mu$ V @ 0.193MHz (-16.4dB)	Refer to page 18	Complies
15.109	RSS GEN 7.2.3 Table 1	Receiver spurious emissions	47.7dB $\mu$ V/m @ 1033.5MHz (-6.3dB)	Refer to page 19	Complies
15.247 (b) (5) 15.407 (f)	RSS 102	RF Exposure Requirements	Refer to MPE calculations in Exhibit 11, RSS 102 declaration and User Manual statements.	Refer to OET 65, FCC Part 1 and RSS 102	Complies
-	RSP 100 RSS GEN 7.1.5	User Manual	Refer to manual	Statement required regarding non-interference	Complies
-	RSP 100 RSS GEN 7.1.5	User Manual	Refer to manual	Statement for products with detachable antenna	Complies
-	RSP 100 RSS GEN 4.4.1	99% Bandwidth	802.11 b: 12.9 MHz 802.11g: 16.7 MHz 802.11n20: 18.6 MHz	Information only	N/A

**MEASUREMENT UNCERTAINTIES**

ISO/IEC 17025 requires that an estimate of the measurement uncertainties associated with the emissions test results be included in the report. The measurement uncertainties given below are based on a 95% confidence level and were calculated in accordance with UKAS document LAB 34.

Measurement Type	Measurement Unit	Frequency Range	Expanded Uncertainty
RF power, conducted (power meter)	dBm	25 to 7000 MHz	± 0.52 dB
RF power, conducted (Spectrum analyzer)	dBm	25 to 7000 MHz	± 0.7 dB
Conducted emission of transmitter	dBm	25 to 26500 MHz	± 0.7 dB
Conducted emission of receiver	dBm	25 to 26500 MHz	± 0.7 dB
Radiated emission (substitution method)	dBm	25 to 26500 MHz	± 2.5 dB
Radiated emission (field strength)	dB $\mu$ V/m	25 to 1000 MHz	± 3.6 dB
		1000 to 40000 MHz	± 6.0 dB
Conducted Emissions (AC Power)	dB $\mu$ V	0.15 to 30 MHz	± 2.4 dB



**EQUIPMENT UNDER TEST (EUT) DETAILS****GENERAL**

The Summit Data Communications model SDC-SSD40L is an 802.11bgn 1x1 module.

The sample was received on November 3, 2011 and tested on November 8, 9 and 10, 2011. The EUT consisted of the following component(s):

Company	Model	Description	Serial Number	FCC ID
Summit Data Communication s	SDC-SSD40L	1x1 802.11bgn module	2011-1053	TWG- SDC SSD40L

**OTHER EUT DETAILS**

Device supports 20MHz operation only.

The EUT was mounted to a PCB to simulate a host system and connected to an extender board.

During AC conducted emission testing, the EUT was installed into a host device (Datalogic, microPDA).

**ANTENNA SYSTEM**

The RF output of the SDC-SSD40L is via a pcb pad on the bottom of the module. This would be soldered to a host system which would provide the RF connector for the antenna.

**ENCLOSURE**

The EUT has no enclosure. It is designed to be installed within the enclosure of a host computer.

**MODIFICATIONS**

No modifications were made to the EUT during the time the product was at Elliott.

**SUPPORT EQUIPMENT**

The following equipment was used as support equipment for testing:

Company	Model	Description	Serial Number	FCC ID
HP	iPaq	Handheld PDA	2CK7250TC5	N/A
Delta Electronics	EADP-10BB	AC/DC Adapter	592A401Z9SK0 B4	N/A
Datalogic	microPDA	Handheld PDA	PM50DVT1239	N/A
KTec	KSAS01005001 80D5	AC/DC Adapter	-	N/A

Note: The Datalogic and KTec devices were used for the AC conducted emissions test only. All other testing was performed with the HP and Delta devices.

**EUT INTERFACE PORTS**

The I/O cabling configuration during testing was as follows:

Port	Connected To	Description	Cable(s)	
			Shielded or Unshielded	Length(m)
Host System – DC power in	AC/DC Adapter	Multiconductor	Unshielded	1.5m

**EUT OPERATION**

During testing, the EUT was configured to transmit continuously at the lowest data rate for each mode, as this resulted in the highest output power.

**TEST SITE****GENERAL INFORMATION**

Final test measurements were taken at the test sites listed below. Pursuant to section 2.948 of the FCC's Rules and section 3.3 of RSP-100, construction, calibration, and equipment data has been filed with the Commission and with industry Canada.

Site	Registration Numbers		Location
	FCC	Canada	
Chamber 4	211948	2845B-4	41039 Boyce Road Fremont, CA 94538-2435
Chamber 5	211948	2845B-5	
Chamber 7	A2LA accreditation	2845B-7	

ANSI C63.4:2003 recommends that ambient noise at the test site be at least 6 dB below the allowable limits. Ambient levels are below this requirement. The test site(s) contain separate areas for radiated and conducted emissions testing. Considerable engineering effort has been expended to ensure that the facilities conform to all pertinent requirements of ANSI C63.4:2003.

**CONDUCTED EMISSIONS CONSIDERATIONS**

Conducted emissions tests are performed in conformance with ANSI C63.4:2003. Measurements are made with the EUT connected to the public power network through nominal, standardized RF impedance, which is provided by a line impedance stabilization network, known as a LISN. A LISN is inserted in series with each current-carrying conductor in the EUT power cord.

**RADIATED EMISSIONS CONSIDERATIONS**

The FCC has determined that radiation measurements made in a shielded enclosure are not suitable for determining levels of radiated emissions. Radiated measurements are performed in an open field environment or in a semi-anechoic chamber. The test sites are maintained free of conductive objects within the CISPR defined elliptical area incorporated in ANSI C63.4:2003 guidelines and meet the Normalized Site Attenuation (NSA) requirements of ANSI C63.4:2003.

## **MEASUREMENT INSTRUMENTATION**

### **RECEIVER SYSTEM**

An EMI receiver as specified in CISPR 16-1-1 is used for emissions measurements. The receivers used can measure over the frequency range of 9 kHz up to 2000 MHz. These receivers allow both ease of measurement and high accuracy to be achieved. The receivers have Peak, Average, and CISPR (Quasi-peak) detectors built into their design so no external adapters are necessary. The receiver automatically sets the required bandwidth for the CISPR detector used during measurements. If the repetition frequency of the signal being measured is below 20 Hz, peak measurements are made in lieu of Quasi-Peak measurements.

For measurements above the frequency range of the receivers, a spectrum analyzer is utilized because it provides visibility of the entire spectrum along with the precision and versatility required to support engineering analysis. Average measurements above 1000 MHz are performed on the spectrum analyzer using the linear-average method with a resolution bandwidth of 1 MHz and a video bandwidth of 10 Hz, unless the signal is pulsed in which case the average (or video) bandwidth of the measuring instrument is reduced to onset of pulse desensitization and then increased.

### **INSTRUMENT CONTROL COMPUTER**

The receivers utilize either a Rohde & Schwarz EZM Spectrum Monitor/Controller or contain an internal Spectrum Monitor/Controller to view and convert the receiver measurements to the field strength at an antenna or voltage developed at the LISN measurement port, which is then compared directly with the appropriate specification limit. This provides faster, more accurate readings by performing the conversions described under Sample Calculations within the Test Procedures section of this report. Results are printed in a graphic and/or tabular format, as appropriate. A personal computer is used to record all measurements made with the receivers.

The Spectrum Monitor provides a visual display of the signal being measured. In addition, the controller or a personal computer run automated data collection programs which control the receivers. This provides added accuracy since all site correction factors, such as cable loss and antenna factors are added automatically.

### **LINE IMPEDANCE STABILIZATION NETWORK (LISN)**

Line conducted measurements utilize a fifty microhenry Line Impedance Stabilization Network as the monitoring point. The LISN used also contains a 250 uH CISPR adapter. This network provides for calibrated radio frequency noise measurements by the design of the internal low pass and high pass filters on the EUT and measurement ports, respectively.

#### *FILTERS/ATTENUATORS*

External filters and precision attenuators are often connected between the receiving antenna or LISN and the receiver. This eliminates saturation effects and non-linear operation due to high amplitude transient events.

#### *ANTENNAS*

A loop antenna is used below 30 MHz. For the measurement range 30 MHz to 1000 MHz either a combination of a biconical antenna and a log periodic or a bi-log antenna is used. Above 1000 MHz, horn antennas are used. The antenna calibration factors to convert the received voltage to an electric field strength are included with appropriate cable loss and amplifier gain factors to determine an overall site factor, which is then programmed into the test receivers or incorporated into the test software.

#### *ANTENNA MAST AND EQUIPMENT TURNTABLE*

The antennas used to measure the radiated electric field strength are mounted on a non-conductive antenna mast equipped with a motor-drive to vary the antenna height. Measurements below 30 MHz are made with the loop antenna at a fixed height of 1m above the ground plane.

ANSI C63.4:2003 specifies that the test height above ground for table mounted devices shall be 80 centimeters. Floor mounted equipment shall be placed on the ground plane if the device is normally used on a conductive floor or separated from the ground plane by insulating material from 3 to 12 mm if the device is normally used on a non-conductive floor. During radiated measurements, the EUT is positioned on a motorized turntable in conformance with this requirement.

#### *INSTRUMENT CALIBRATION*

All test equipment is regularly checked to ensure that performance is maintained in accordance with the manufacturer's specifications. All antennas are calibrated at regular intervals with respect to tuned half-wave dipoles. An exhibit of this report contains the list of test equipment used and calibration information.

## TEST PROCEDURES

### EUT AND CABLE PLACEMENT

The regulations require that interconnecting cables be connected to the available ports of the unit and that the placement of the unit and the attached cables simulate the worst case orientation that can be expected from a typical installation, so far as practicable. To this end, the position of the unit and associated cabling is varied within the guidelines of ANSI C63.4:2003, and the worst-case orientation is used for final measurements.

### CONDUCTED EMISSIONS

Conducted emissions are measured at the plug end of the power cord supplied with the EUT. Excess power cord length is wrapped in a bundle between 30 and 40 centimeters in length near the center of the cord. Preliminary measurements are made to determine the highest amplitude emission relative to the specification limit for all the modes of operation. Placement of system components and varying of cable positions are performed in each mode. A final peak mode scan is then performed in the position and mode for which the highest emission was noted on all current carrying conductors of the power cord.

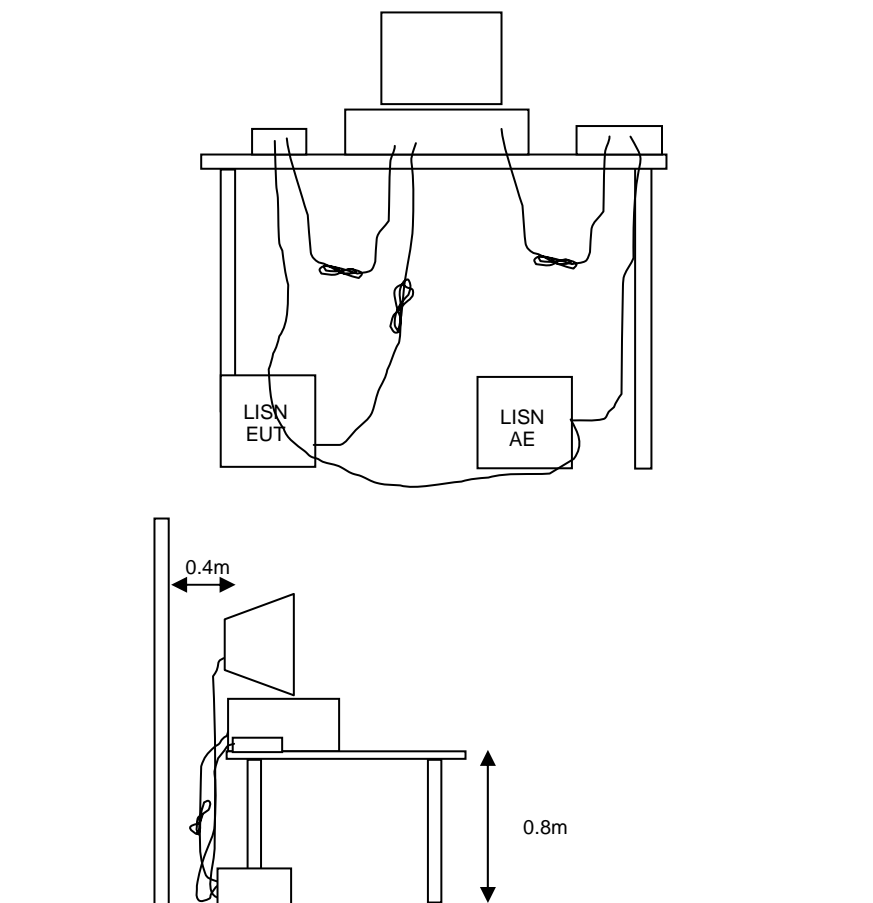

**Figure 1 Typical Conducted Emissions Test Configuration**

**RADIATED EMISSIONS**

A preliminary scan of the radiated emissions is performed in which all significant EUT frequencies are identified with the system in a nominal configuration. At least two scans are performed, one scan for each antenna polarization (horizontal and vertical; loop parallel and perpendicular to the EUT). During the preliminary scans, the EUT is rotated through 360°, the antenna height is varied (for measurements above 30 MHz) and cable positions are varied to determine the highest emission relative to the limit. Preliminary scans may be performed in a fully anechoic chamber for the purposes of identifying the frequencies of the highest emissions from the EUT.

A speaker is provided in the receiver to aid in discriminating between EUT and ambient emissions. Other methods used during the preliminary scan for EUT emissions involve scanning with near field magnetic loops, monitoring I/O cables with RF current clamps, and cycling power to the EUT.

Final maximization is a phase in which the highest amplitude emissions identified in the spectral search are viewed while the EUT azimuth angle is varied from 0 to 360 degrees relative to the receiving antenna. The azimuth, which results in the highest emission is then maintained while varying the antenna height from one to four meters (for measurements above 30 MHz, measurements below 30 MHz are made with the loop antenna at a fixed height of 1m). The result is the identification of the highest amplitude for each of the highest peaks. Each recorded level is corrected in the receiver using appropriate factors for cables, connectors, antennas, and preamplifier gain.

When testing above 18 GHz, the receive antenna is located at 1 meter from the EUT and the antenna height is restricted to a maximum of 2.5 meters.

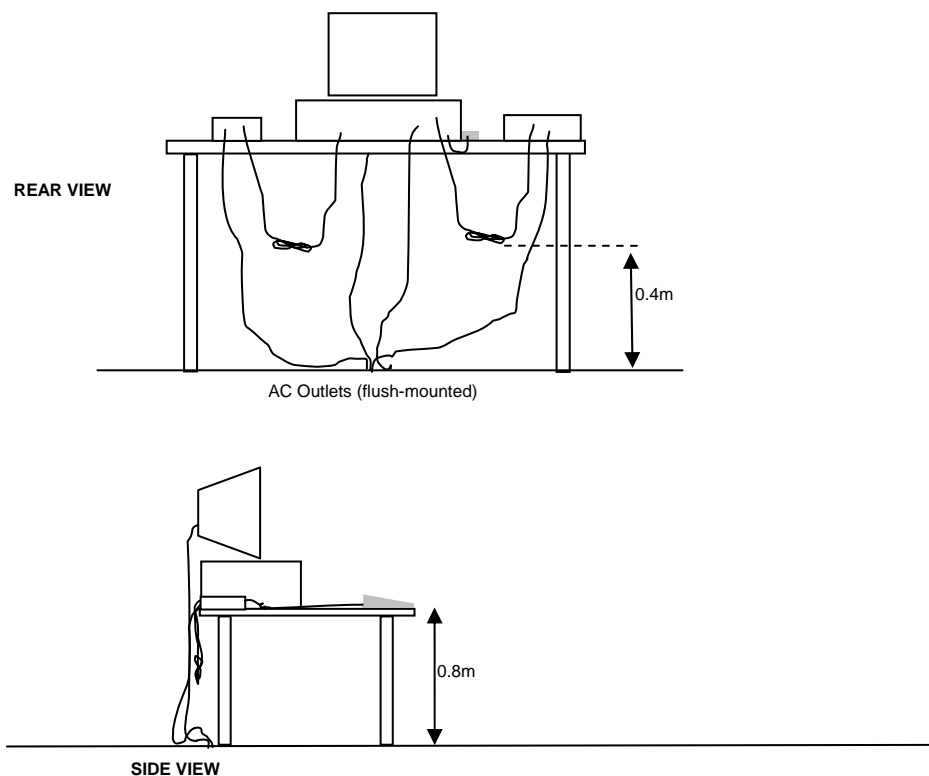

Typical Test Configuration for Radiated Field Strength Measurements

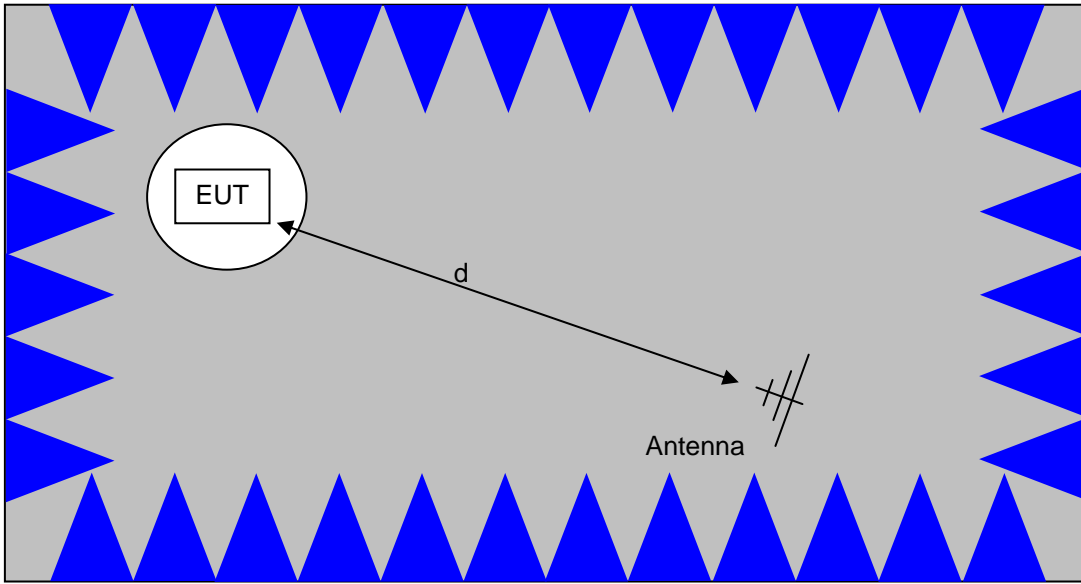

The anechoic materials on the walls and ceiling ensure compliance with the normalized site attenuation requirements of CISPR 16 / CISPR 22 / ANSI C63.4 for an alternate test site at the measurement distances used.

Floor-standing equipment is placed on the floor with insulating supports between the unit and the ground plane.

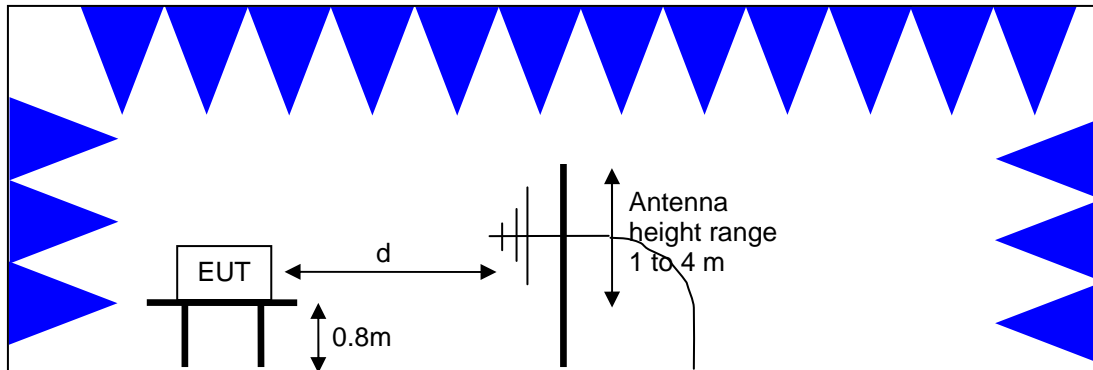

Test Configuration for Radiated Field Strength Measurements  
Semi-Anechoic Chamber, Plan and Side Views



**CONDUCTED EMISSIONS FROM ANTENNA PORT**

Direct measurements of power, bandwidth and power spectral density are performed, where possible, with the antenna port of the EUT connected to either the power meter or spectrum analyzer via a suitable attenuator and/or filter. These are used to ensure that the front end of the measurement instrument is not overloaded by the fundamental transmission.

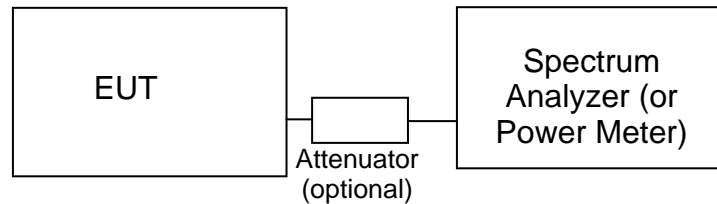
**Test Configuration for Antenna Port Measurements**

Measurement bandwidths (video and resolution) are set in accordance with the relevant standards and Elliott's test procedures for the type of radio being tested. When power measurements are made using a resolution bandwidth less than the signal bandwidth the power is calculated by summing the power across the signal bandwidth using either the analyzer channel power function or by capturing the trace data and calculating the power using software. In both cases the summed power is corrected to account for the equivalent noise bandwidth (ENBW) of the resolution bandwidth used.

If power averaging is used (typically for certain digital modulation techniques), the EUT is configured to transmit continuously. Power averaging is performed using either the built-in function of the analyzer or, if the analyzer does not feature power averaging, using external software. In both cases the average power is calculated over a number of sweeps (typically 100). When the EUT cannot be configured to continuously transmit then either the analyzer is configured to perform a gated sweep to ensure that the power is averaged over periods that the device is transmitting or power averaging is disabled and a max-hold feature is used.

If a power meter is used to make output power measurements the sensor head type (peak or average) is stated in the test data table.

**BANDWIDTH MEASUREMENTS**

The 6dB, 20dB and/or 26dB signal bandwidth is measured in using the bandwidths recommended by ANSI C63.4. When required, the 99% bandwidth is measured using the methods detailed in RSS GEN.

**SPECIFICATION LIMITS AND SAMPLE CALCULATIONS**

The limits for conducted emissions are given in units of microvolts, and the limits for radiated emissions are given in units of microvolts per meter at a specified test distance. Data is measured in the logarithmic form of decibels relative to one microvolt, or dB microvolts (dBuV). For radiated emissions, the measured data is converted to the field strength at the antenna in dB microvolts per meter (dBuV/m). The results are then converted to the linear forms of uV and uV/m for comparison to published specifications.

For reference, converting the specification limits from linear to decibel form is accomplished by taking the base ten logarithm, then multiplying by 20. These limits in both linear and logarithmic form are as follows:

**CONDUCTED EMISSIONS SPECIFICATION LIMITS: FCC 15.207; FCC 15.107(a), RSS GEN**

The table below shows the limits for the emissions on the AC power line from an intentional radiator and a receiver.

Frequency (MHz)	Average Limit (dBuV)	Quasi Peak Limit (dBuV)
0.150 to 0.500	Linear decrease on logarithmic frequency axis between 56.0 and 46.0	Linear decrease on logarithmic frequency axis between 66.0 and 56.0
0.500 to 5.000	46.0	56.0
5.000 to 30.000	50.0	60.0

**GENERAL TRANSMITTER RADIATED EMISSIONS SPECIFICATION LIMITS**

The table below shows the limits for the spurious emissions from transmitters that fall in restricted bands<sup>1</sup> (with the exception of transmitters operating under FCC Part 15 Subpart D and RSS 210 Annex 9), the limits for all emissions from a low power device operating under the general rules of RSS 310 (tables 3 and 4), RSS 210 (table 2) and FCC Part 15 Subpart C section 15.209.

Frequency Range (MHz)	Limit (uV/m)	Limit (dBuV/m @ 3m)
0.009-0.490	2400/F <sub>KHz</sub> @ 300m	67.6-20*log <sub>10</sub> (F <sub>KHz</sub> ) @ 300m
0.490-1.705	24000/F <sub>KHz</sub> @ 30m	87.6-20*log <sub>10</sub> (F <sub>KHz</sub> ) @ 30m
1.705 to 30	30 @ 30m	29.5 @ 30m
30 to 88	100 @ 3m	40 @ 3m
88 to 216	150 @ 3m	43.5 @ 3m
216 to 960	200 @ 3m	46.0 @ 3m
Above 960	500 @ 3m	54.0 @ 3m

**RECEIVER RADIATED SPURIOUS EMISSIONS SPECIFICATION LIMITS**

The table below shows the limits for the spurious emissions from receivers as detailed in FCC Part 15.109, RSS 210 Table 2, RSS GEN Table 1 and RSS 310 Table 3. Note that receivers operating outside of the frequency range 30 MHz – 960 MHz are exempt from the requirements of 15.109.

Frequency Range (MHz)	Limit (uV/m @ 3m)	Limit (dBuV/m @ 3m)
30 to 88	100	40
88 to 216	150	43.5
216 to 960	200	46.0
Above 960	500	54.0

<sup>1</sup> The restricted bands are detailed in FCC 15.203, RSS 210 Table 1 and RSS 310 Table 2

**OUTPUT POWER LIMITS – DIGITAL TRANSMISSION SYSTEMS**

The table below shows the limits for output power and output power density. Where the signal bandwidth is less than 20 MHz the maximum output power is reduced to the power spectral density limit plus 10 times the log of the bandwidth (in MHz).

Operating Frequency (MHz)	Output Power	Power Spectral Density
902 – 928	1 Watt (30 dBm)	8 dBm/3kHz
2400 – 2483.5	1 Watt (30 dBm)	8 dBm/3kHz
5725 – 5850	1 Watt (30 dBm)	8 dBm/3kHz

The maximum permitted output power is reduced by 1dB for every dB the antenna gain exceeds 6dBi. Fixed point-to-point applications using the 5725 – 5850 MHz band are not subject to this restriction.

**TRANSMIT MODE SPURIOUS RADIATED EMISSIONS LIMITS – FHSS and DTS SYSTEMS**

The limits for unwanted (spurious) emissions from the transmitter falling in the restricted bands are those specified in the general limits sections of FCC Part 15 and RSS 210. All other unwanted (spurious) emissions shall be at least 20dB below the level of the highest in-band signal level (30dB if the power is measured using the sample detector/power averaging method).

**SAMPLE CALCULATIONS - CONDUCTED EMISSIONS**

Receiver readings are compared directly to the conducted emissions specification limit (decibel form) as follows:

$$R_r - S = M$$

where:

$R_r$  = Receiver Reading in dBuV

$S$  = Specification Limit in dBuV

$M$  = Margin to Specification in +/- dB

**SAMPLE CALCULATIONS - RADIATED EMISSIONS**

Receiver readings are compared directly to the specification limit (decibel form). The receiver internally corrects for cable loss, preamplifier gain, and antenna factor. The calculations are in the reverse direction of the actual signal flow, thus cable loss is added and the amplifier gain is subtracted. The Antenna Factor converts the voltage at the antenna coaxial connector to the field strength at the antenna elements.

A distance factor, when used for electric field measurements above 30MHz, is calculated by using the following formula:

$$F_d = 20 * \text{LOG}_{10} (D_m/D_s)$$

where:

$$F_d = \text{Distance Factor in dB}$$

$$D_m = \text{Measurement Distance in meters}$$

$$D_s = \text{Specification Distance in meters}$$

For electric field measurements below 30MHz the extrapolation factor is either determined by making measurements at multiple distances or a theoretical value is calculated using the formula:

$$F_d = 40 * \text{LOG}_{10} (D_m/D_s)$$

Measurement Distance is the distance at which the measurements were taken and Specification Distance is the distance at which the specification limits are based. The antenna factor converts the voltage at the antenna coaxial connector to the field strength at the antenna elements.

The margin of a given emission peak relative to the limit is calculated as follows:

$$R_c = R_r + F_d$$

and

$$M = R_c - L_s$$

where:

$$R_r = \text{Receiver Reading in dBuV/m}$$

$$F_d = \text{Distance Factor in dB}$$

$$R_c = \text{Corrected Reading in dBuV/m}$$

$$L_s = \text{Specification Limit in dBuV/m}$$

$$M = \text{Margin in dB Relative to Spec}$$

**SAMPLE CALCULATIONS - FIELD STRENGTH TO EIRP CONVERSION**

Where the radiated electric field strength is expressed in terms of the equivalent isotropic radiated power (eirp), or where a field strength measurement of output power is made in lieu of a direct measurement, the following formula is used to convert between eirp and field strength at a distance of d (meters) from the equipment under test:

$$E = \frac{1000000 \sqrt{30 P}}{d} \quad \text{microvolts per meter}$$

where P is the eirp (Watts)

For a measurement at 3m the conversion from a logarithmic value for field strength (dBuV/m) to an eirp power (dBm) is -95.3dB.

**Appendix A Test Equipment Calibration Data**

T85260

**Radiated Emissions, 1000 - 26,500 MHz, 09-Nov-11**

<u>Manufacturer</u>	<u>Description</u>	<u>Model</u>	<u>Asset #</u>	<u>Cal Due</u>
Hewlett Packard	Microwave Preamplifier, 1-26.5GHz	8449B	785	5/18/2012
EMCO	Antenna, Horn, 1-18 GHz	3115	786	12/11/2011
Hewlett Packard	SpecAn 9 kHz - 40 GHz, FT (SA40) Blue	8564E (84125C)	1393	8/9/2012
Hewlett Packard	Head (Inc W1-W4, 1742 , 1743) Blue	84125C	1620	5/9/2012
A.H. Systems	Blue System Horn, 18-40GHz	SAS-574, p/n: 2581	2159	3/23/2012
Micro-Tronics	Band Reject Filter, 2400-2500 MHz	BRM50702-02	2249	10/11/2012

**Radiated Emissions, 1000 - 26,500 MHz, 10-Nov-11**

<u>Manufacturer</u>	<u>Description</u>	<u>Model</u>	<u>Asset #</u>	<u>Cal Due</u>
Hewlett Packard	Microwave Preamplifier, 1-26.5GHz	8449B	263	12/8/2011
Hewlett Packard	Head (Inc flex cable, 1143, 2198) Red	84125C	1145	2/17/2012
Hewlett Packard	SpecAn 30 Hz -40 GHz, SV (SA40) Red	8564E (84125C)	1148	8/15/2012
EMCO	Antenna, Horn, 1-18 GHz	3115	1561	6/22/2012
A.H. Systems	Purple System Horn, 18-40GHz	SAS-574, p/n: 2581	2160	2/9/2012
Micro-Tronics	Band Reject Filter, 2400-2500 MHz	BRM50702-02	2238	10/4/2012

T85340

**Conducted Emissions - AC Power Ports, 23-Dec-11**

<u>Manufacturer</u>	<u>Description</u>	<u>Model</u>	<u>Asset #</u>	<u>Cal Due</u>
EMCO	LISN, 10 kHz-100 MHz, 25A	3825/2	1292	3/1/2012
Rohde & Schwarz	EMI Test Receiver, 20 Hz-7 GHz	ESIB7	1538	12/6/2012
Rohde & Schwarz	Pulse Limiter	ESH3 Z2	1594	5/17/2012

## *Appendix B Test Data*

T85260 Pages 25 - 62

T85340 Pages 63 - 71





## EMC Test Data

Client:	Summit Data Communications	Job Number:	J85128
Model:	SDC-SSD40L (802.11b/g/n)	T-Log Number:	T85260
		Account Manager:	Christine Krebill
Contact:	Sue White		-
Emissions Standard(s):	FCC 15.247/RSS-210	Class:	-
Immunity Standard(s):	-	Environment:	-

# EMC Test Data

For The

## Summit Data Communications

Model

SDC-SSD40L (802.11b/g/n)

Date of Last Test: 1/12/2012

Client:	Summit Data Communications	Job Number:	J85128
Model:	SDC-SSD40L (802.11b/g/n)	T-Log Number:	T85260
		Account Manager:	Christine Krebill
Contact:	Sue White		
Standard:	FCC 15.247/RSS-210	Class:	N/A

### RSS 210 and FCC 15.247 (DTS) Radiated Spurious Emissions

#### Test Specific Details

Objective: The objective of this test session is to perform final qualification testing of the EUT with respect to the specification listed above.

#### General Test Configuration

The EUT and all local support equipment were located on the turntable for radiated spurious emissions testing.

For radiated emissions testing the measurement antenna was located 3 meters from the EUT.

#### Ambient Conditions:

Temperature: 20.5 °C  
Rel. Humidity: 36 %

#### Summary of Results - Device Operating in the 2400-2483.5 MHz Band

Run #	Mode	Channel	Power Setting	Measured Power	Test Performed	Limit	Result / Margin
Run #1	802.11b Chain Main	#1 2412MHz	-	-	Restricted Band Edge at 2390 MHz	15.209	50.7dBµV/m @ 2386.3MHz (-3.3dB)
		#11 2462MHz	-	-	Restricted Band Edge at 2483.5 MHz	15.209	53.9dBµV/m @ 2483.5MHz (-0.1dB)
Run # 2	802.11g Chain Main	#1 2412MHz	-	-	Restricted Band Edge at 2390 MHz	15.209	53.8dBµV/m @ 2390.0MHz (-0.2dB)
		#11 2462MHz	-	-	Restricted Band Edge at 2483.5 MHz	15.209	53.5dBµV/m @ 2483.5MHz (-0.5dB)
Run # 3	802.11n20 Chain Main	#1 2412MHz	-	-	Restricted Band Edge at 2390 MHz	15.209	53.3dBµV/m @ 2389.9MHz (-0.7dB)
		#11 2462MHz	-	-	Restricted Band Edge at 2483.5 MHz	15.209	53.7dBµV/m @ 2483.5MHz (-0.3dB)

Client:	Summit Data Communications	Job Number:	J85128
Model:	SDC-SSD40L (802.11b/g/n)	T-Log Number:	T85260
Contact:	Sue White	Account Manager:	Christine Krebill
Standard:	FCC 15.247/RSS-210	Class:	N/A

**Modifications Made During Testing**

No modifications were made to the EUT during testing

**Deviations From The Standard**

No deviations were made from the requirements of the standard.

**Run #1, Band Edge Field Strength - 802.11b, Chain Main**

Date of Test: 11/8/2011

Test Engineer: Rafael Varelas

Test Location: FT Chamber #7

Config Change: none

**Run #1a, EUT on Channel #1 2412MHz - 802.11b, Chain Main**

	Target (dBm)	Power Settings Measured (dBm)	Software Setting
Chain Main	100%	-	100%

**2390 MHz Band Edge Signal Field Strength**

Frequency MHz	Level dB $\mu$ V/m	Pol v/h	15.209 / 15.247		Detector Pk/QP/Avg	Azimuth degrees	Height meters	Comments
			Limit	Margin				
2386.270	50.7	V	54.0	-3.3	AVG	112	1.0	RB 1 MHz;VB 10 Hz;Pk
2389.780	59.7	V	74.0	-14.3	PK	112	1.0	RB 1 MHz;VB 3 MHz;Pk
2386.470	45.7	H	54.0	-8.3	AVG	124	1.3	RB 1 MHz;VB 10 Hz;Pk
2387.270	56.8	H	74.0	-17.2	PK	124	1.3	RB 1 MHz;VB 3 MHz;Pk

RB 1 MHz; VB 10 Hz Avg; RBW=VBW=1MHz PK, H

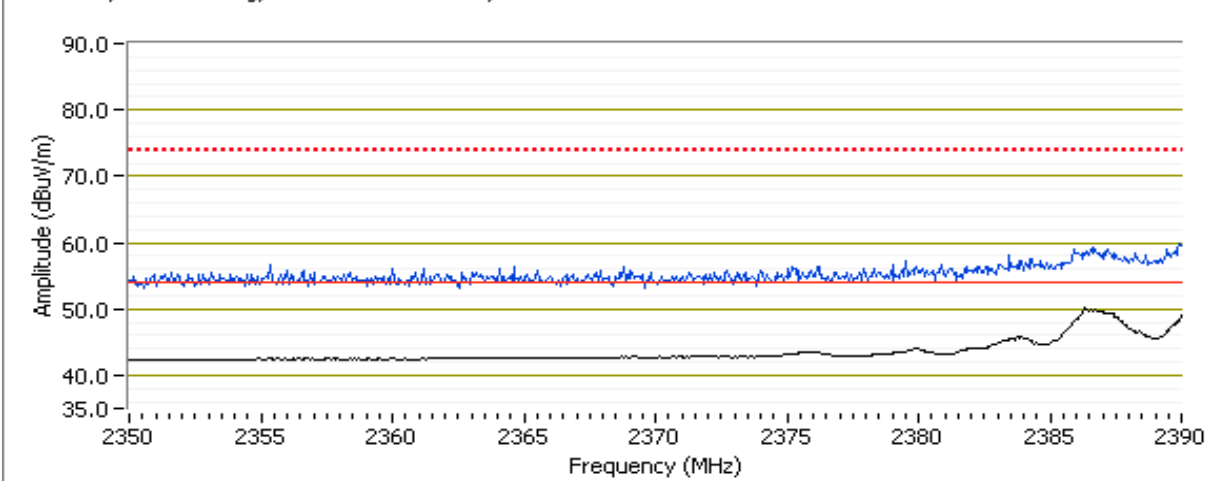

Note: Vertical Plot

Client:	Summit Data Communications	Job Number:	J85128
Model:	SDC-SSD40L (802.11b/g/n)	T-Log Number:	T85260
Contact:	Sue White	Account Manager:	Christine Krebill
Standard:	FCC 15.247/RSS-210	Class:	N/A

**Run #1b, EUT on Channel #11 2462MHz - 802.11b, Chain Main**

	Target (dBm)	Power Settings Measured (dBm)	Software Setting
Chain Main	100%	-	90%

**2483.5 MHz Band Edge Signal Radiated Field Strength**

Frequency	Level	Pol	15.209 / 15.247		Detector	Azimuth	Height	Comments
MHz	dB $\mu$ V/m	v/h	Limit	Margin	PK/QP/Avg	degrees	meters	
2483.510	53.9	V	54.0	-0.1	AVG	143	1.0	RB 1 MHz;VB 10 Hz;Pk
2486.120	60.8	V	74.0	-13.2	PK	143	1.0	RB 1 MHz;VB 3 MHz;Pk
2483.510	46.3	H	54.0	-7.7	AVG	168	1.0	RB 1 MHz;VB 10 Hz;Pk
2485.320	57.4	H	74.0	-16.6	PK	168	1.0	RB 1 MHz;VB 3 MHz;Pk

RB 1 MHz; VB 10 Hz Avg; RBW=VBW=1MHz PK, V

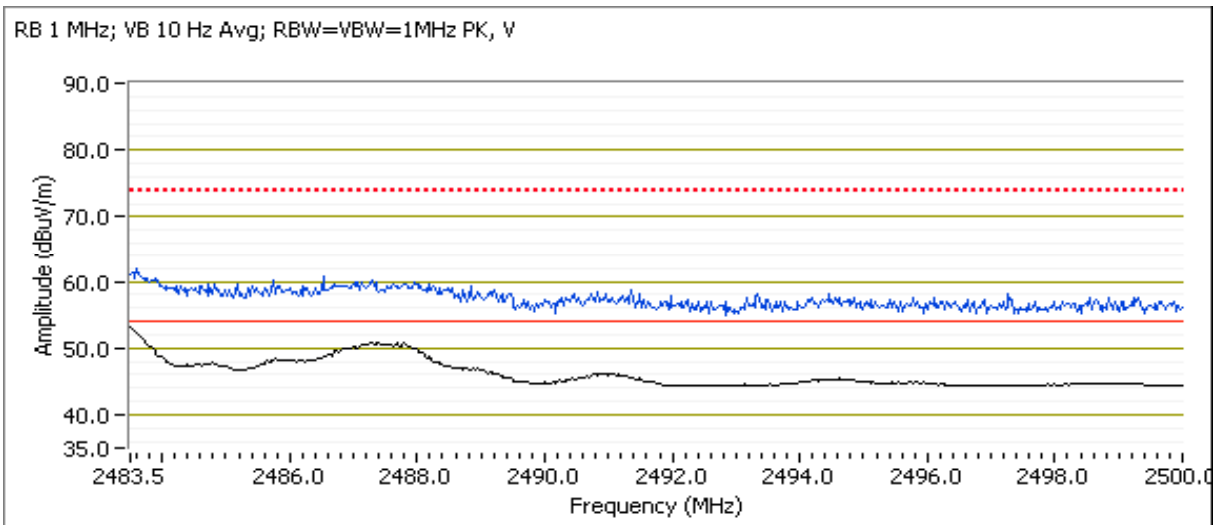

Client:	Summit Data Communications	Job Number:	J85128
Model:	SDC-SSD40L (802.11b/g/n)	T-Log Number:	T85260
Contact:	Sue White	Account Manager:	Christine Krebill
Standard:	FCC 15.247/RSS-210	Class:	N/A

**Run # 2, Band Edge Field Strength - 802.11g, Chain Main**

Date of Test: 11/8/2011

Test Location: FT Chamber #7

Test Engineer: Rafael Varelas

Config Change: none

**Run # 2a, EUT on Channel #1 2412MHz - 802.11g, Chain Main**

	Target (dBm)	Power Settings Measured (dBm)	Software Setting
Chain Main	100%	-	90%

**2390 MHz Band Edge Signal Field Strength**

Frequency	Level	Pol	15.209 / 15.247		Detector	Azimuth	Height	Comments
MHz	dB $\mu$ V/m	v/h	Limit	Margin	Pk/QP/Avg	degrees	meters	
2389.970	53.8	V	54.0	-0.2	AVG	118	1.0	RB 1 MHz;VB 10 Hz;Pk
2389.880	67.4	V	74.0	-6.6	PK	118	1.0	RB 1 MHz;VB 3 MHz;Pk
2389.950	46.6	H	54.0	-7.4	AVG	198	1.0	RB 1 MHz;VB 10 Hz;Pk
2389.650	59.1	H	74.0	-14.9	PK	198	1.0	RB 1 MHz;VB 3 MHz;Pk

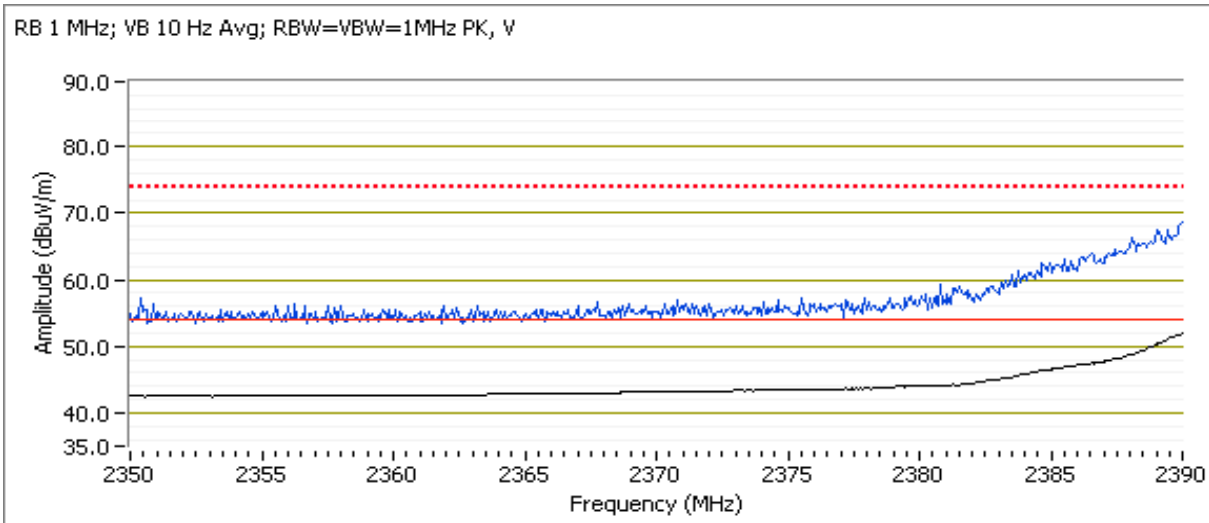

Client:	Summit Data Communications	Job Number:	J85128
Model:	SDC-SSD40L (802.11b/g/n)	T-Log Number:	T85260
Contact:	Sue White	Account Manager:	Christine Krebill
Standard:	FCC 15.247/RSS-210	Class:	N/A

**Run # 2b, EUT on Channel #11 2462MHz - 802.11g, Chain Main**

	Target (dBm)	Power Settings Measured (dBm)	Software Setting
Chain Main	100%	-	75%

**2483.5 MHz Band Edge Signal Radiated Field Strength**

Frequency	Level	Pol	15.209 / 15.247		Detector	Azimuth	Height	Comments
MHz	dB $\mu$ V/m	v/h	Limit	Margin	PK/QP/Avg	degrees	meters	
2483.500	53.5	V	54.0	-0.5	AVG	142	1.0	RB 1 MHz;VB 10 Hz;Pk
2483.530	68.3	V	74.0	-5.7	PK	142	1.0	RB 1 MHz;VB 3 MHz;Pk
2483.520	46.5	H	54.0	-7.5	AVG	166	1.0	RB 1 MHz;VB 10 Hz;Pk
2483.800	59.5	H	74.0	-14.5	PK	166	1.0	RB 1 MHz;VB 3 MHz;Pk

RB 1 MHz; VB 10 Hz Avg; RBW=VBW=1MHz PK, V

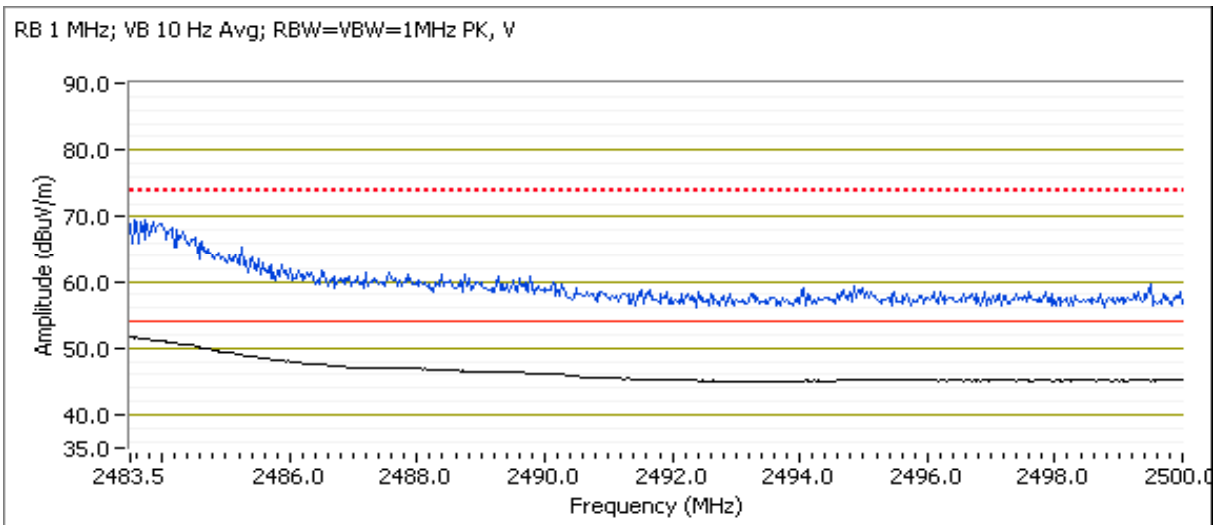

Client:	Summit Data Communications	Job Number:	J85128
Model:	SDC-SSD40L (802.11b/g/n)	T-Log Number:	T85260
Contact:	Sue White	Account Manager:	Christine Krebill
Standard:	FCC 15.247/RSS-210	Class:	N/A

**Run # 3, Band Edge Field Strength - 802.11n20, Chain Main**

Date of Test: 11/8/2011

Test Location: FT Chamber #7

Test Engineer: Rafael Varelas

Config Change: none

**Run # 3a, EUT on Channel #1 2412MHz - 802.11n20, Chain Main**

	Target (dBm)	Power Settings Measured (dBm)	Software Setting
Chain Main	100%	-	95%

**2390 MHz Band Edge Signal Field Strength**

Frequency	Level	Pol	15.209 / 15.247		Detector	Azimuth	Height	Comments
MHz	dB $\mu$ V/m	v/h	Limit	Margin	Pk/QP/Avg	degrees	meters	
2389.930	53.3	V	54.0	-0.7	AVG	121	1.0	RB 1 MHz;VB 10 Hz;Pk
2389.870	69.5	V	74.0	-4.5	PK	121	1.0	RB 1 MHz;VB 3 MHz;Pk
2389.990	46.5	H	54.0	-7.5	AVG	168	1.4	RB 1 MHz;VB 10 Hz;Pk
2389.730	59.7	H	74.0	-14.3	PK	168	1.4	RB 1 MHz;VB 3 MHz;Pk

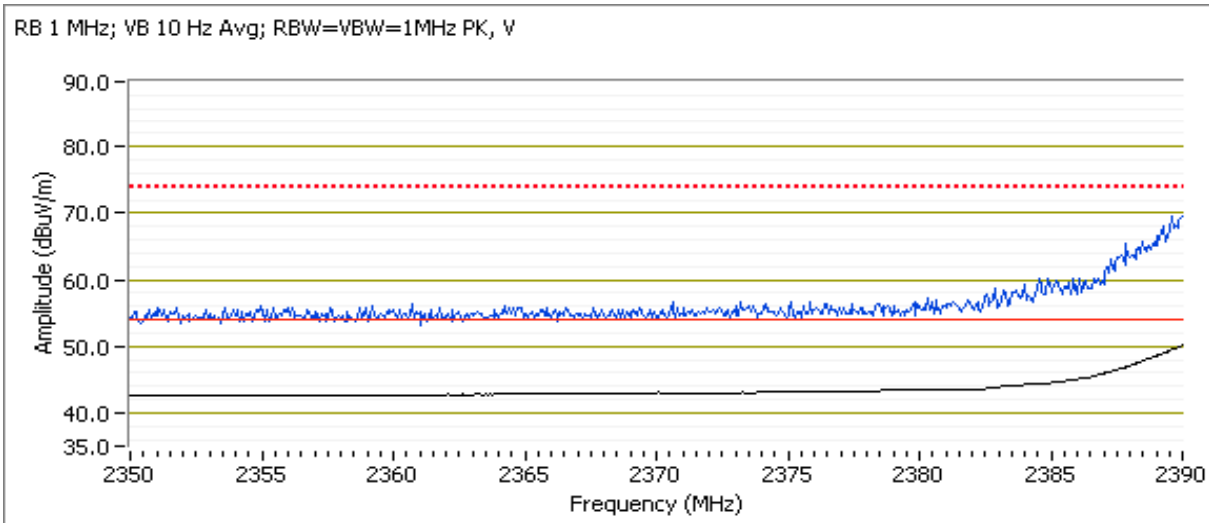

Client:	Summit Data Communications	Job Number:	J85128
Model:	SDC-SSD40L (802.11b/g/n)	T-Log Number:	T85260
Contact:	Sue White	Account Manager:	Christine Krebill
Standard:	FCC 15.247/RSS-210	Class:	N/A

**Run # 3b, EUT on Channel #11 2462MHz - 802.11n20, Chain Main**

	Target (dBm)	Power Settings Measured (dBm)	Software Setting
Chain Main	100%	-	85%

**2483.5 MHz Band Edge Signal Radiated Field Strength**

Frequency	Level	Pol	15.209 / 15.247		Detector	Azimuth	Height	Comments
MHz	dB $\mu$ V/m	v/h	Limit	Margin	PK/QP/Avg	degrees	meters	
2483.500	53.7	V	54.0	-0.3	AVG	136	1.0	RB 1 MHz;VB 10 Hz;Pk
2483.690	67.2	V	74.0	-6.8	PK	136	1.0	RB 1 MHz;VB 3 MHz;Pk
2483.720	46.6	H	54.0	-7.4	AVG	165	1.0	RB 1 MHz;VB 10 Hz;Pk
2483.820	58.4	H	74.0	-15.6	PK	165	1.0	RB 1 MHz;VB 3 MHz;Pk

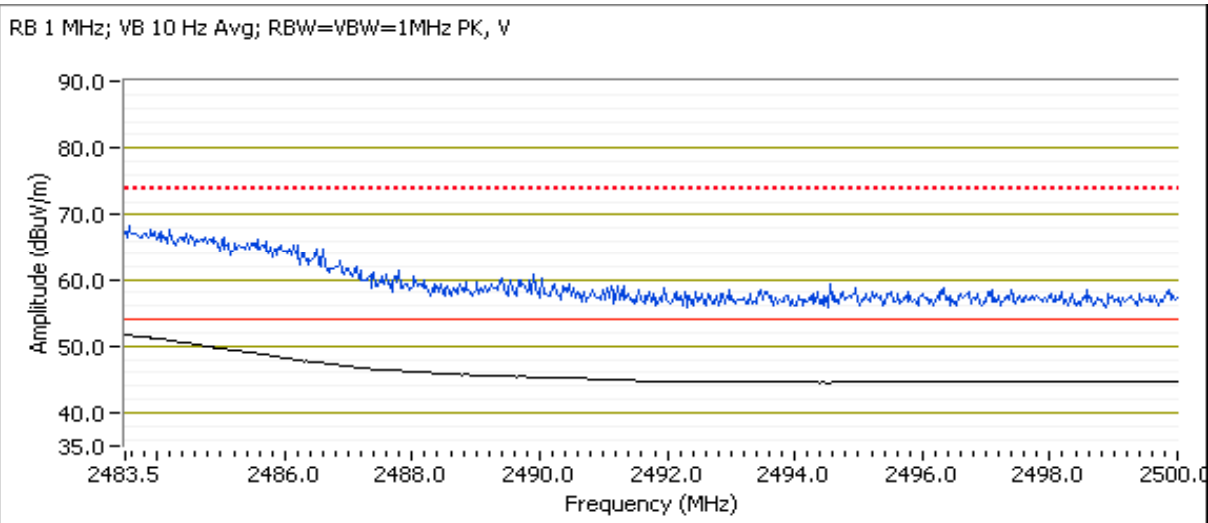



Client:	Summit Data Communications	Job Number:	J85128
Model:	SDC-SSD40L (802.11b/g/n)	T-Log Number:	T85260
		Account Manager:	Christine Krebill
Contact:	Sue White		
Standard:	FCC 15.247/RSS-210	Class:	N/A

### RSS 210 and FCC 15.247 (DTS) Radiated Spurious Emissions

#### Test Specific Details

Objective: The objective of this test session is to perform final qualification testing of the EUT with respect to the specification listed above.

#### General Test Configuration

The EUT and all local support equipment were located on the turntable for radiated spurious emissions testing.

For radiated emissions testing the measurement antenna was located 3 meters from the EUT.

#### Ambient Conditions:

Temperature: 20.5 °C  
Rel. Humidity: 36 %

#### Summary of Results - Device Operating in the 2400-2483.5 MHz Band

Run #	Mode	Channel	Power Setting	Measured Power	Test Performed	Limit	Result / Margin
Run #1	802.11b Chain Main	#1 2412MHz	-	-	Radiated Emissions, 1 - 26 GHz	FCC 15.209 / 15.247	48.1dBµV/m @ 4823.9MHz (-5.9dB)
		#6 2437MHz	-	-			44.4dBµV/m @ 1111.5MHz (-9.6dB)
		#11 2462MHz	-	-			50.0dBµV/m @ 7383.9MHz (-4.0dB)
Run # 2	802.11g Chain Main	#1 2412MHz	-	-	Radiated Emissions, 1 - 26 GHz	FCC 15.209 / 15.247	46.1dBµV/m @ 1228.5MHz (-7.9dB)
		#6 2437MHz	-	-			45.9dBµV/m @ 1228.5MHz (-8.1dB)
		#11 2462MHz	-	-			45.9dBµV/m @ 1228.5MHz (-8.1dB)
Run # 3	802.11n20 Chain Main	#1 2412MHz	-	-	Radiated Emissions, 1 - 26 GHz	FCC 15.209 / 15.247	46.2dBµV/m @ 1111.4MHz (-7.8dB)
		#6 2437MHz	-	-			46.4dBµV/m @ 1111.5MHz (-7.6dB)
		#11 2462MHz	-	-			46.2dBµV/m @ 1111.4MHz (-7.8dB)
Run #5	RX	#6 2437MHz	-	-	Radiated Emissions, 1 - 8 GHz	RSS-GEN	47.7dBµV/m @ 1033.5MHz (-6.3dB)

Client:	Summit Data Communications	Job Number:	J85128
Model:	SDC-SSD40L (802.11b/g/n)	T-Log Number:	T85260
		Account Manager:	Christine Krebill
Contact:	Sue White		
Standard:	FCC 15.247/RSS-210	Class:	N/A

**Modifications Made During Testing**

No modifications were made to the EUT during testing

**Deviations From The Standard**

No deviations were made from the requirements of the standard.

**Notes**

Preliminary testing showed no radio related emissions below 1GHz.

**Run #1, Radiated Spurious Emissions, 1-26GHz, 802.11b, Chain Main**

Date of Test: 11/8/2011

Test Location: FT Chamber #7

Test Engineer: Rafael Varelas

Config Change: none

**Run #1a, EUT on Channel #1 2412MHz - 802.11b, Chain Main**

	Target (dBm)	Power Settings	
		Measured (dBm)	Software Setting
Chain Main	-	-	-

**Fundamental Signal Field Strength**

Frequency MHz	Level dB $\mu$ V/m	Pol v/h	15.209 / 15.247		Detector PK/QP/Avg	Azimuth degrees	Height meters	Comments
			Limit	Margin				
2408.100	103.9	V	-	-	PK	354	1.0	RB 100 kHz;VB 100 kHz;Pk
2414.070	92.0	H	-	-	PK	167	1.1	RB 100 kHz;VB 100 kHz;Pk

Client:	Summit Data Communications	Job Number:	J85128
Model:	SDC-SSD40L (802.11b/g/n)	T-Log Number:	T85260
Contact:	Sue White	Account Manager:	Christine Krebill
Standard:	FCC 15.247/RSS-210	Class:	N/A

**Spurious Radiated Emissions:**

Frequency	Level	Pol	15.209/15.247		Detector	Azimuth	Height	Comments
MHz	dB $\mu$ V/m	v/h	Limit	Margin	PK/QP/Avg	degrees	meters	
4823.930	48.1	V	54.0	-5.9	AVG	68	1.0	RB 1 MHz;VB 10 Hz;Pk
4824.130	51.1	V	74.0	-22.9	PK	68	1.0	RB 1 MHz;VB 3 MHz;Pk
1111.470	45.4	H	54.0	-8.6	AVG	45	1.3	RB 1 MHz;VB 10 Hz;Pk
1111.460	47.4	H	74.0	-26.6	PK	45	1.3	RB 1 MHz;VB 3 MHz;Pk
7242.500	43.9	V	72.0	-28.1	Peak	110	1.3	Peak reading vs ave limit, 100kHz.

Note 1: For emissions in restricted bands, the limit of 15.209 was used. For all other emissions, the limit is -30dBc for peak measurements in a measurement bandwidth of 100kHz.

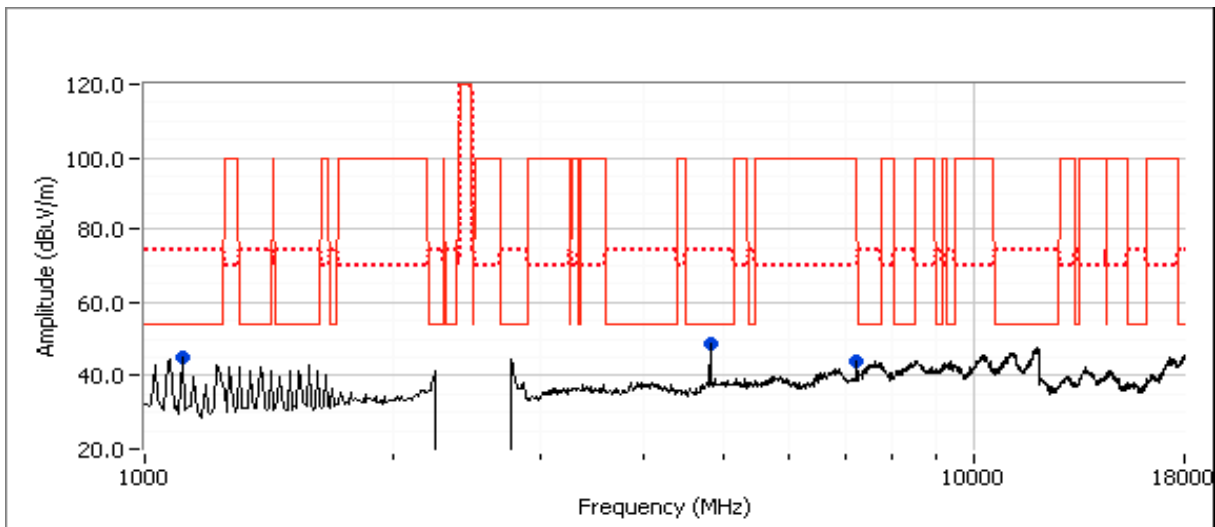

Client:	Summit Data Communications	Job Number:	J85128
Model:	SDC-SSD40L (802.11b/g/n)	T-Log Number:	T85260
Contact:	Sue White	Account Manager:	Christine Krebill
Standard:	FCC 15.247/RSS-210	Class:	N/A

**Run #1b: , EUT on Channel #6 2437MHz - 802.11b, Chain Main**

	Target (dBm)	Power Settings Measured (dBm)	Software Setting
Chain Main	-	-	-

**Fundamental Signal Field Strength**

Frequency	Level	Pol	15.209 / 15.247		Detector	Azimuth	Height	Comments
MHz	dB $\mu$ V/m	v/h	Limit	Margin	PK/QP/Avg	degrees	meters	
2437.830	103.3	V	-	-	PK	88	1.0	RB 100 kHz;VB 100 kHz;Pk
2436.470	90.1	H	-	-	PK	252	1.0	RB 100 kHz;VB 100 kHz;Pk

**Spurious Radiated Emissions:**

Frequency	Level	Pol	15.209/15.247		Detector	Azimuth	Height	Comments
MHz	dB $\mu$ V/m	v/h	Limit	Margin	PK/QP/Avg	degrees	meters	
1111.540	44.4	H	54.0	-9.6	AVG	50	1.3	RB 1 MHz;VB 10 Hz;Pk
1111.460	46.3	H	74.0	-27.7	PK	50	1.3	RB 1 MHz;VB 3 MHz;Pk
4873.980	41.5	H	54.0	-12.5	AVG	334	1.0	RB 1 MHz;VB 10 Hz;Pk
4874.230	47.4	H	74.0	-26.6	PK	334	1.0	RB 1 MHz;VB 3 MHz;Pk
7311.870	44.0	V	54.0	-10.0	AVG	142	1.0	RB 1 MHz;VB 10 Hz;Pk
7310.300	49.4	V	74.0	-24.6	PK	142	1.0	RB 1 MHz;VB 3 MHz;Pk

- Note 1: For emissions in restricted bands, the limit of 15.209 was used. For all other emissions, the limit is -30dBc for peak measurements in a measurement bandwidth of 100kHz.
- Note 2: Scans made between 18 - 25GHz with the measurement antenna moved around the card and its antennas 20-50cm from the device indicated there were no significant emissions in this frequency range

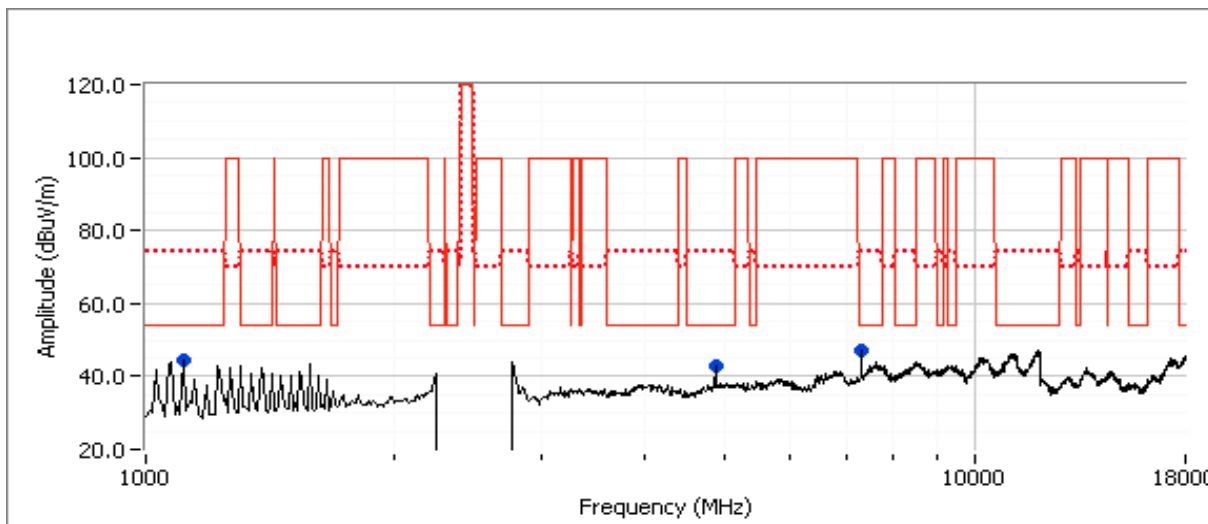

Client:	Summit Data Communications	Job Number:	J85128
Model:	SDC-SSD40L (802.11b/g/n)	T-Log Number:	T85260
Contact:	Sue White	Account Manager:	Christine Krebill
Standard:	FCC 15.247/RSS-210	Class:	N/A

**Run #1c: , EUT on Channel #11 2462MHz - 802.11b, Chain Main**

	Target (dBm)	Power Settings Measured (dBm)	Software Setting
Chain Main	-	-	-

**Fundamental Signal Field Strength**

Frequency	Level	Pol	15.209 / 15.247		Detector	Azimuth	Height	Comments
MHz	dB $\mu$ V/m	v/h	Limit	Margin	Pk/QP/Avg	degrees	meters	
2461.670	105.9	V	-	-	PK	114	1.0	RB 100 kHz;VB 100 kHz;Pk
2461.230	91.7	H	-	-	PK	163	1.0	RB 100 kHz;VB 100 kHz;Pk

**Spurious Radiated Emissions:**

Frequency	Level	Pol	15.209/15.247		Detector	Azimuth	Height	Comments
MHz	dB $\mu$ V/m	v/h	Limit	Margin	Pk/QP/Avg	degrees	meters	
7383.900	50.0	V	54.0	-4.0	AVG	109	1.6	RB 1 MHz;VB 10 Hz;Pk
7387.130	55.0	V	74.0	-19.0	PK	109	1.6	RB 1 MHz;VB 3 MHz;Pk
1072.540	43.2	H	54.0	-10.8	AVG	32	1.3	RB 1 MHz;VB 10 Hz;Pk
1072.740	45.4	H	74.0	-28.6	PK	32	1.3	RB 1 MHz;VB 3 MHz;Pk
4924.000	35.3	V	54.0	-18.7	AVG	110	1.0	RB 1 MHz;VB 10 Hz;Pk
4924.060	45.4	V	74.0	-28.6	PK	110	1.0	RB 1 MHz;VB 3 MHz;Pk

Note 1: For emissions in restricted bands, the limit of 15.209 was used. For all other emissions, the limit is -30dBc for peak measurements in a measurement bandwidth of 100kHz.

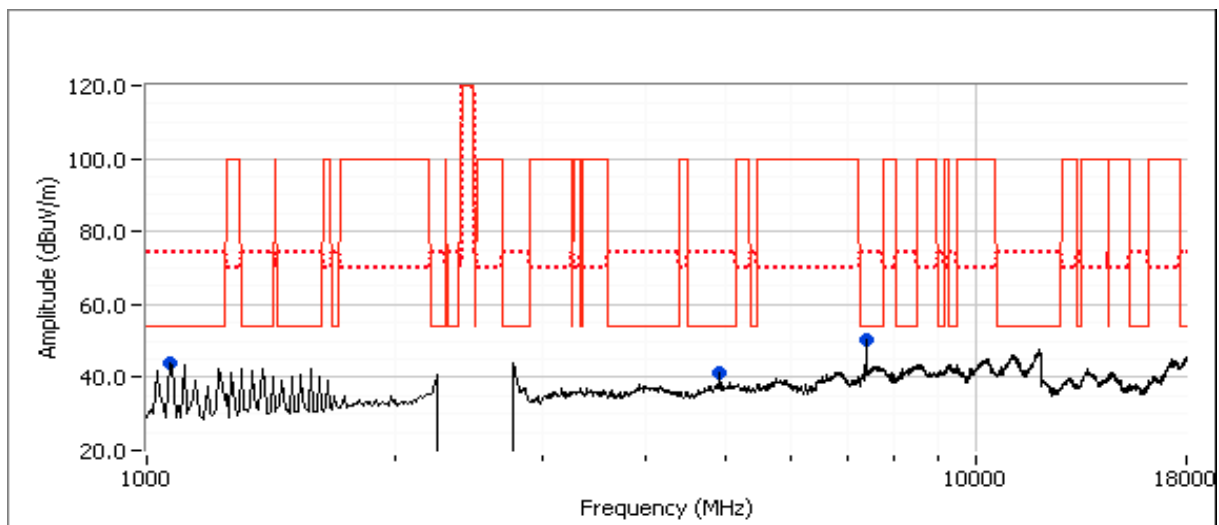

Client:	Summit Data Communications	Job Number:	J85128
Model:	SDC-SSD40L (802.11b/g/n)	T-Log Number:	T85260
Contact:	Sue White	Account Manager:	Christine Krebill
Standard:	FCC 15.247/RSS-210	Class:	N/A

**Run # 2, Radiated Spurious Emissions, 1-26GHz, 802.11g, Chain Main**

Date of Test: 11/9/2011

Test Location: FT Chamber #5

Test Engineer: Rafael Varelas

Config Change: none

**Run # 2a, EUT on Channel #1 2412MHz - 802.11g, Chain Main**

	Target (dBm)	Power Settings Measured (dBm)	Software Setting
Chain Main	-	-	-

**Fundamental Signal Field Strength**

Frequency	Level	Pol	15.209 / 15.247		Detector	Azimuth	Height	Comments
MHz	dB $\mu$ V/m	v/h	Limit	Margin	Pk/QP/Avg	degrees	meters	
2414.700	90.6	V	-	-	PK	108	1.0	RB 100 kHz;VB 100 kHz;Pk
2409.670	83.9	H	-	-	PK	166	1.0	RB 100 kHz;VB 100 kHz;Pk

**Spurious Radiated Emissions:**

Frequency	Level	Pol	15.209/15.247		Detector	Azimuth	Height	Comments
MHz	dB $\mu$ V/m	v/h	Limit	Margin	Pk/QP/Avg	degrees	meters	
1228.480	46.1	H	54.0	-7.9	AVG	206	1.9	RB 1 MHz;VB 10 Hz;Pk
1228.640	48.6	H	74.0	-25.4	PK	206	1.9	RB 1 MHz;VB 3 MHz;Pk
4826.010	36.8	V	54.0	-17.2	AVG	68	1.0	RB 1 MHz;VB 10 Hz;Pk
4832.170	47.7	V	74.0	-26.3	PK	68	1.0	RB 1 MHz;VB 3 MHz;Pk

Note 1: For emissions in restricted bands, the limit of 15.209 was used. For all other emissions, the limit is -30dBc for peak measurements in a measurement bandwidth of 100kHz.

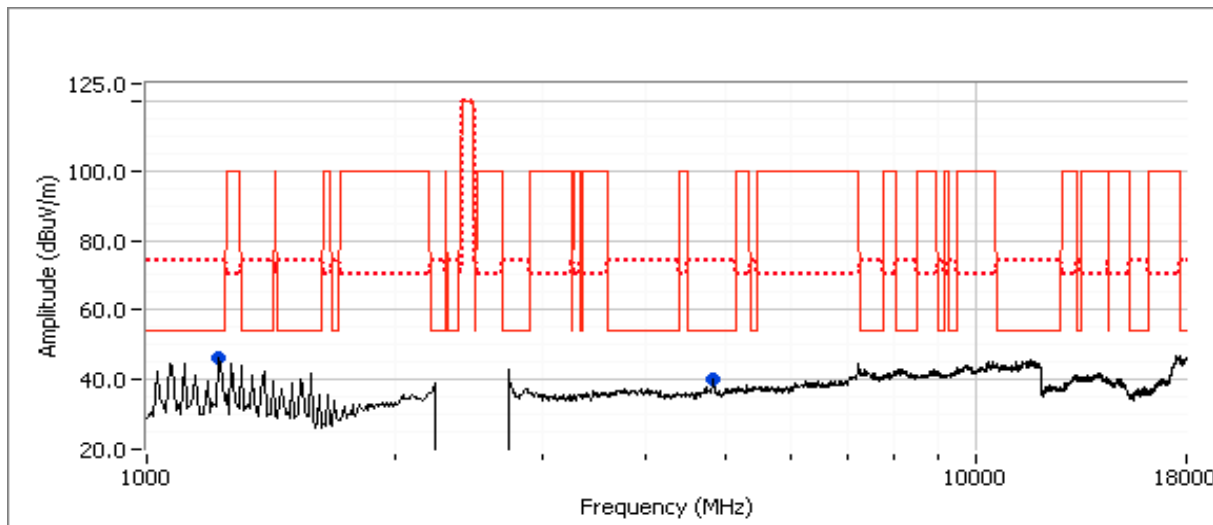

Client:	Summit Data Communications	Job Number:	J85128
Model:	SDC-SSD40L (802.11b/g/n)	T-Log Number:	T85260
Contact:	Sue White	Account Manager:	Christine Krebill
Standard:	FCC 15.247/RSS-210	Class:	N/A

**Run # 2b: , EUT on Channel #6 2437MHz - 802.11g, Chain Main**

	Target (dBm)	Power Settings Measured (dBm)	Software Setting
Chain Main	-	-	-

**Fundamental Signal Field Strength**

Frequency	Level	Pol	15.209 / 15.247		Detector	Azimuth	Height	Comments
MHz	dB $\mu$ V/m	v/h	Limit	Margin	PK/QP/Avg	degrees	meters	
2433.370	90.3	V	-	-	PK	176	1.0	RB 100 kHz;VB 100 kHz;Pk
2436.000	80.9	H	-	-	PK	169	1.0	RB 100 kHz;VB 100 kHz;Pk

**Spurious Radiated Emissions:**

Frequency	Level	Pol	15.209/15.247		Detector	Azimuth	Height	Comments
MHz	dB $\mu$ V/m	v/h	Limit	Margin	PK/QP/Avg	degrees	meters	
1228.540	45.9	H	54.0	-8.1	AVG	212	1.9	RB 1 MHz;VB 10 Hz;Pk
1228.400	48.6	H	74.0	-25.4	PK	212	1.9	RB 1 MHz;VB 3 MHz;Pk
7312.580	40.7	V	54.0	-13.3	AVG	261	1.9	RB 1 MHz;VB 10 Hz;Pk
7311.050	54.3	V	74.0	-19.7	PK	261	1.9	RB 1 MHz;VB 3 MHz;Pk

- Note 1: For emissions in restricted bands, the limit of 15.209 was used. For all other emissions, the limit is -30dBc for peak measurements in a measurement bandwidth of 100kHz.
- Note 2: Scans made between 18 - 25GHz with the measurement antenna moved around the card and its antennas 20-50cm from the device indicated there were no significant emissions in this frequency range

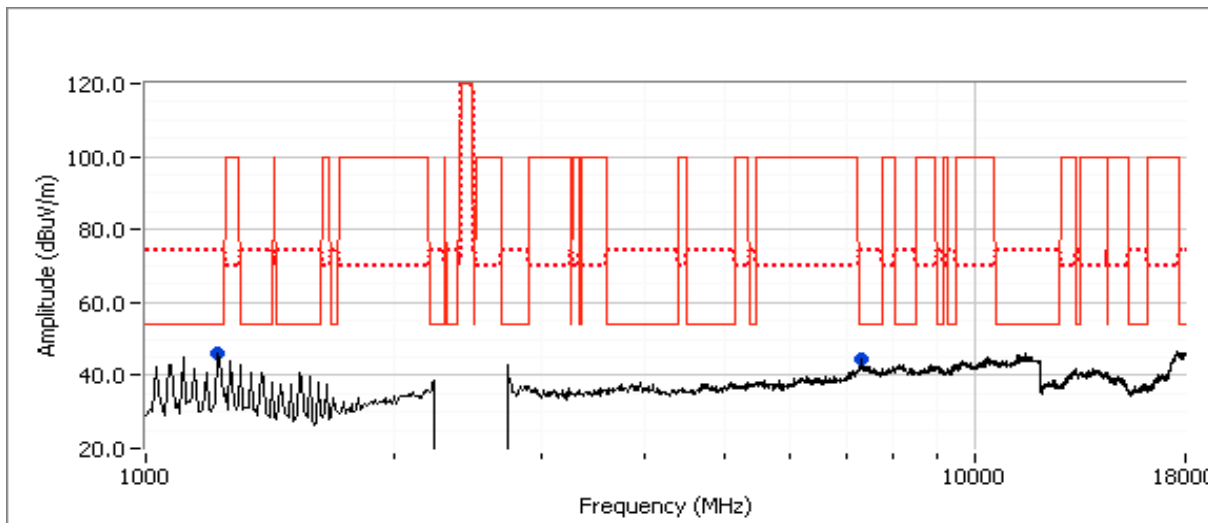

Client:	Summit Data Communications	Job Number:	J85128
Model:	SDC-SSD40L (802.11b/g/n)	T-Log Number:	T85260
Contact:	Sue White	Account Manager:	Christine Krebill
Standard:	FCC 15.247/RSS-210	Class:	N/A

**Run # 2c : EUT on Channel #11 2462MHz - 802.11g, Chain Main**

	Target (dBm)	Power Settings Measured (dBm)	Software Setting
Chain Main	-	-	-

**Fundamental Signal Field Strength**

Frequency	Level	Pol	15.209 / 15.247		Detector	Azimuth	Height	Comments
MHz	dB $\mu$ V/m	v/h	Limit	Margin	Pk/QP/Avg	degrees	meters	
2463.470	93.8	V	-	-	PK	125	1.0	RB 100 kHz;VB 100 kHz;Pk
2457.130	83.3	H	-	-	PK	167	1.0	RB 100 kHz;VB 100 kHz;Pk

**Spurious Radiated Emissions:**

Frequency	Level	Pol	15.209/15.247		Detector	Azimuth	Height	Comments
MHz	dB $\mu$ V/m	v/h	Limit	Margin	Pk/QP/Avg	degrees	meters	
1228.530	45.9	H	54.0	-8.1	AVG	211	1.9	RB 1 MHz;VB 10 Hz;Pk
1228.660	48.0	H	74.0	-26.0	PK	211	1.9	RB 1 MHz;VB 3 MHz;Pk
7385.340	43.3	V	54.0	-10.7	AVG	131	1.3	RB 1 MHz;VB 10 Hz;Pk
7385.760	56.7	V	74.0	-17.3	PK	131	1.3	RB 1 MHz;VB 3 MHz;Pk
1111.490	45.9	H	54.0	-8.1	AVG	220	1.3	RB 1 MHz;VB 10 Hz;Pk
1111.410	47.9	H	74.0	-26.1	PK	220	1.3	RB 1 MHz;VB 3 MHz;Pk

Note 1: For emissions in restricted bands, the limit of 15.209 was used. For all other emissions, the limit is -30dBc for peak measurements in a measurement bandwidth of 100kHz.

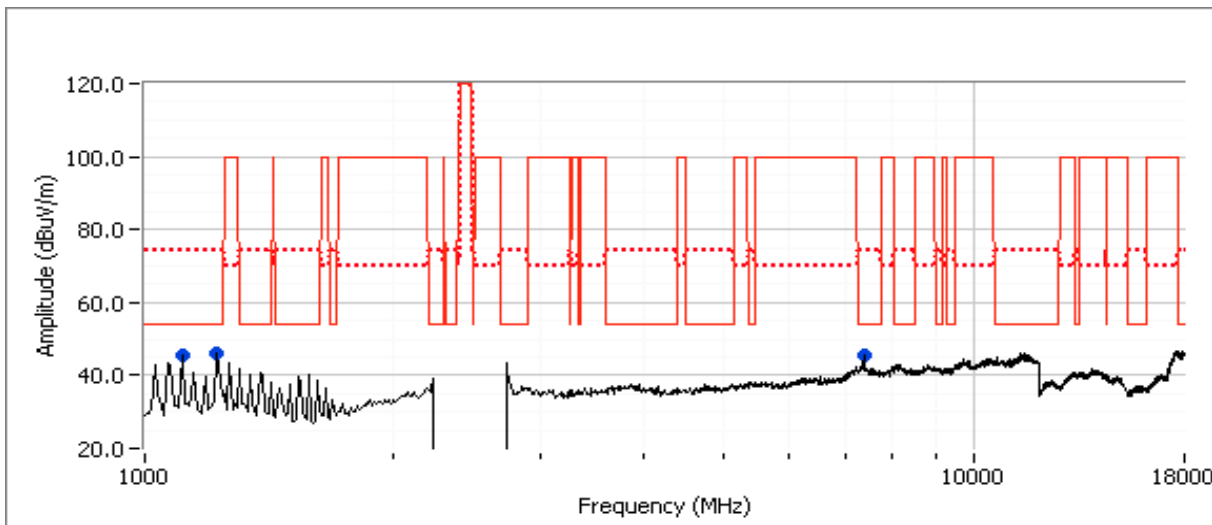



Client:	Summit Data Communications	Job Number:	J85128
Model:	SDC-SSD40L (802.11b/g/n)	T-Log Number:	T85260
Contact:	Sue White	Account Manager:	Christine Krebill
Standard:	FCC 15.247/RSS-210	Class:	N/A

**Run # 3, Radiated Spurious Emissions, 1-26GHz, 802.11n20, Chain Main**

Date of Test: 11/9/2011      Test Location: Chamber #5  
 Test Engineer: Vishal Narayan      Config Change: None

**Run # 3a, EUT on Channel #1 2412MHz - 802.11n20, Chain Main**

	Target (dBm)	Power Settings Measured (dBm)	Software Setting
Chain Main	-	-	-

**Fundamental Signal Field Strength**

Frequency	Level	Pol	15.209 / 15.247		Detector	Azimuth	Height	Comments
MHz	dB $\mu$ V/m	v/h	Limit	Margin	Pk/QP/Avg	degrees	meters	
2409.630	87.5	V	-	-	PK	123	1.0	RB 100 kHz;VB 100 kHz;Pk
2408.400	79.1	H	-	-	PK	167	1.1	RB 100 kHz;VB 100 kHz;Pk

**Spurious Radiated Emissions:**

Frequency	Level	Pol	15.209/15.247		Detector	Azimuth	Height	Comments
MHz	dB $\mu$ V/m	v/h	Limit	Margin	Pk/QP/Avg	degrees	meters	
1111.420	46.2	H	54.0	-7.8	AVG	210	1.3	RB 1 MHz;VB 10 Hz;Pk
1111.350	47.9	H	74.0	-26.1	PK	210	1.3	RB 1 MHz;VB 3 MHz;Pk
1228.480	44.6	H	54.0	-9.4	AVG	217	1.3	RB 1 MHz;VB 10 Hz;Pk
1228.420	47.4	H	74.0	-26.6	PK	217	1.3	RB 1 MHz;VB 3 MHz;Pk

Note 1: For emissions in restricted bands, the limit of 15.209 was used. For all other emissions, the limit is -30dBc for peak measurements in a measurement bandwidth of 100kHz.

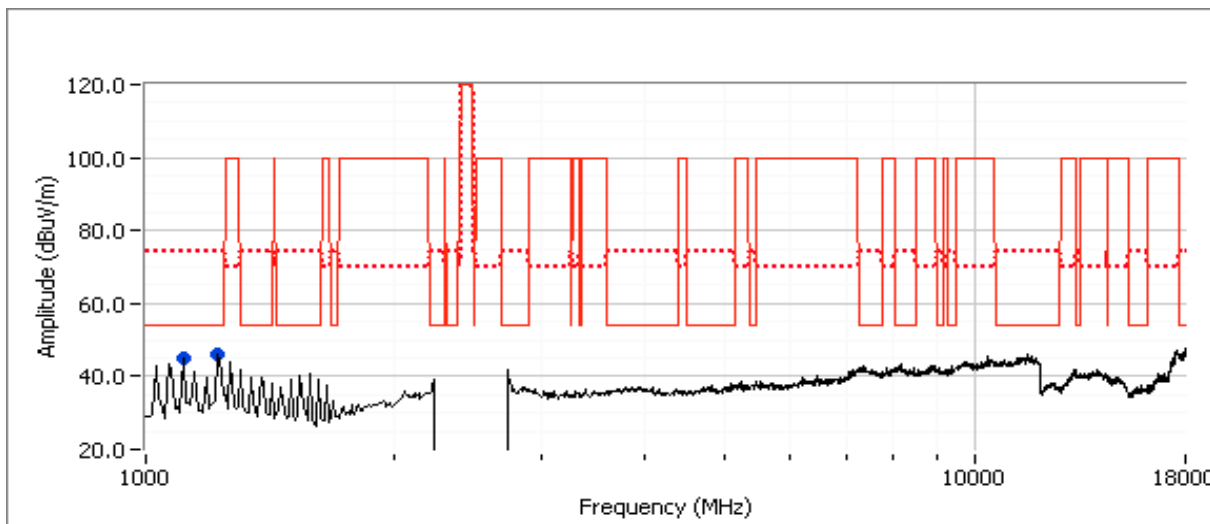

Client:	Summit Data Communications	Job Number:	J85128
Model:	SDC-SSD40L (802.11b/g/n)	T-Log Number:	T85260
Contact:	Sue White	Account Manager:	Christine Krebill
Standard:	FCC 15.247/RSS-210	Class:	N/A

**Run # 3b: , EUT on Channel #6 2437MHz - 802.11n20, Chain Main**

	Target (dBm)	Power Settings Measured (dBm)	Software Setting
Chain Main	-	-	-

**Fundamental Signal Field Strength**

Frequency	Level	Pol	15.209 / 15.247		Detector	Azimuth	Height	Comments
MHz	dB $\mu$ V/m	v/h	Limit	Margin	Pk/QP/Avg	degrees	meters	
2441.000	88.5	V	-	-	PK	170	1.0	RB 100 kHz;VB 100 kHz;Pk
2438.470	80.2	H	-	-	PK	170	1.0	RB 100 kHz;VB 100 kHz;Pk

**Spurious Radiated Emissions:**

Frequency	Level	Pol	15.209/15.247		Detector	Azimuth	Height	Comments
MHz	dB $\mu$ V/m	v/h	Limit	Margin	Pk/QP/Avg	degrees	meters	
1111.520	46.4	H	54.0	-7.6	AVG	220	1.3	RB 1 MHz;VB 10 Hz;Pk
1111.700	48.4	H	74.0	-25.6	PK	220	1.3	RB 1 MHz;VB 3 MHz;Pk
1228.530	45.4	H	54.0	-8.6	AVG	206	1.9	RB 1 MHz;VB 10 Hz;Pk
1229.270	48.2	H	74.0	-25.8	PK	206	1.9	RB 1 MHz;VB 3 MHz;Pk

- Note 1: For emissions in restricted bands, the limit of 15.209 was used. For all other emissions, the limit is -30dBc for peak measurements in a measurement bandwidth of 100kHz.
- Note 2: Scans made between 18 - 25GHz with the measurement antenna moved around the card and its antennas 20-50cm from the device indicated there were no significant emissions in this frequency range

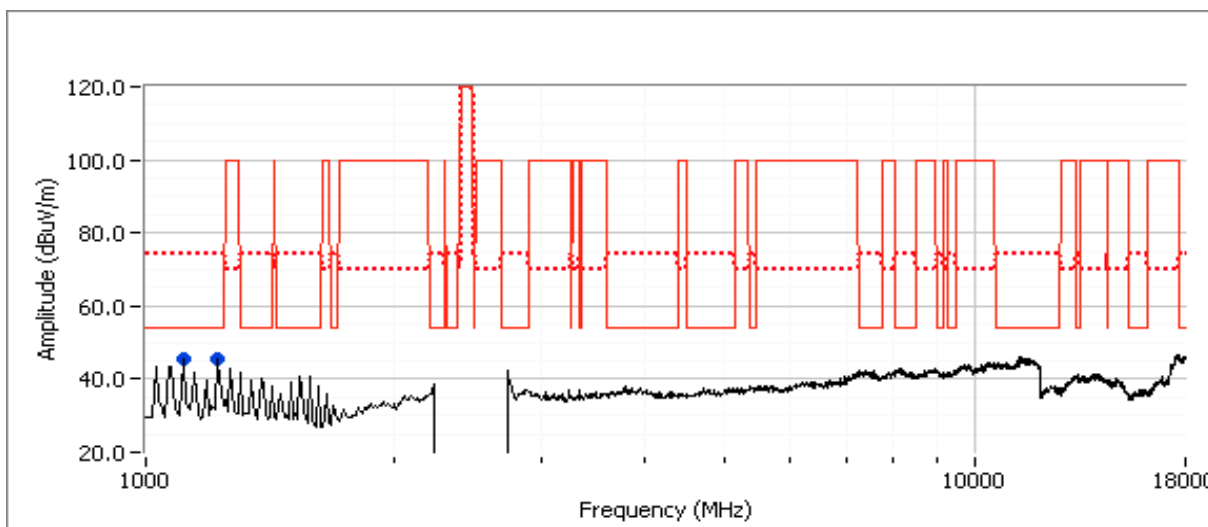

Client:	Summit Data Communications	Job Number:	J85128
Model:	SDC-SSD40L (802.11b/g/n)	T-Log Number:	T85260
Contact:	Sue White	Account Manager:	Christine Krebill
Standard:	FCC 15.247/RSS-210	Class:	N/A

**Run # 3c : EUT on Channel #11 2462MHz - 802.11n20, Chain Main**

	Target (dBm)	Power Settings Measured (dBm)	Software Setting
Chain Main	-	-	-

**Fundamental Signal Field Strength**

Frequency	Level	Pol	15.209 / 15.247		Detector	Azimuth	Height	Comments
MHz	dB $\mu$ V/m	v/h	Limit	Margin	Pk/QP/Avg	degrees	meters	
2460.900	91.0	V	-	-	PK	131	1.0	RB 100 kHz;VB 100 kHz;Pk
2458.370	79.8	H	-	-	PK	157	1.0	RB 100 kHz;VB 100 kHz;Pk

**Spurious Radiated Emissions:**

Frequency	Level	Pol	15.209/15.247		Detector	Azimuth	Height	Comments
MHz	dB $\mu$ V/m	v/h	Limit	Margin	Pk/QP/Avg	degrees	meters	
1111.430	46.2	H	54.0	-7.8	AVG	210	1.3	RB 1 MHz;VB 10 Hz;Pk
1111.640	48.1	H	74.0	-25.9	PK	210	1.3	RB 1 MHz;VB 3 MHz;Pk
1228.490	43.9	H	54.0	-10.1	AVG	203	1.3	RB 1 MHz;VB 10 Hz;Pk
1228.720	46.6	H	74.0	-27.4	PK	203	1.3	RB 1 MHz;VB 3 MHz;Pk

Note 1: For emissions in restricted bands, the limit of 15.209 was used. For all other emissions, the limit is -30dBc for peak measurements in a measurement bandwidth of 100kHz.

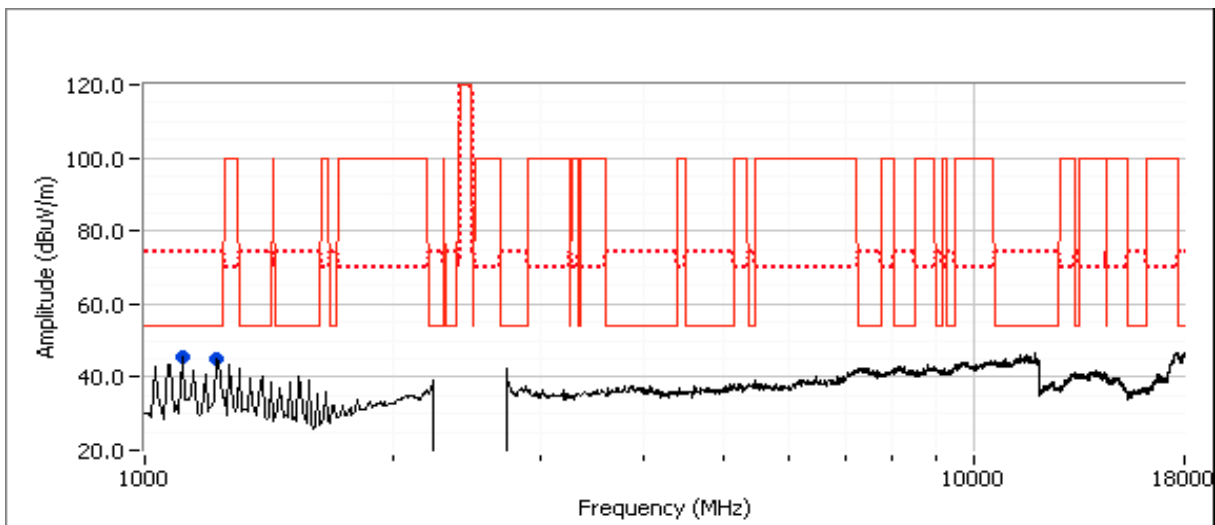

Client:	Summit Data Communications	Job Number:	J85128
Model:	SDC-SSD40L (802.11b/g/n)	T-Log Number:	T85260
Contact:	Sue White	Account Manager:	Christine Krebill
Standard:	FCC 15.247/RSS-210	Class:	N/A

**Run #5, Radiated Spurious Emissions, 1-8GHz, RX Mode**

Date of Test: 11/9/2011  
Test Engineer: Vishal Narayan

Test Location: Chamber #5  
Config Change: None

**Spurious Radiated Emissions:**

Frequency MHz	Level dB $\mu$ V/m	Pol v/h	RSS-GEN		Detector Pk/QP/Avg	Azimuth degrees	Height meters	Comments
			Limit	Margin				
1033.480	47.7	H	54.0	-6.3	AVG	148	1.3	RB 1 MHz;VB 10 Hz;Pk
1033.320	48.9	H	74.0	-25.1	PK	148	1.3	RB 1 MHz;VB 3 MHz;Pk
1072.520	46.5	H	54.0	-7.5	AVG	127	1.3	RB 1 MHz;VB 10 Hz;Pk
1072.420	48.5	H	74.0	-25.5	PK	127	1.3	RB 1 MHz;VB 3 MHz;Pk
1111.490	46.5	H	54.0	-7.5	AVG	123	1.3	RB 1 MHz;VB 10 Hz;Pk
1111.350	48.6	H	74.0	-25.4	PK	123	1.3	RB 1 MHz;VB 3 MHz;Pk

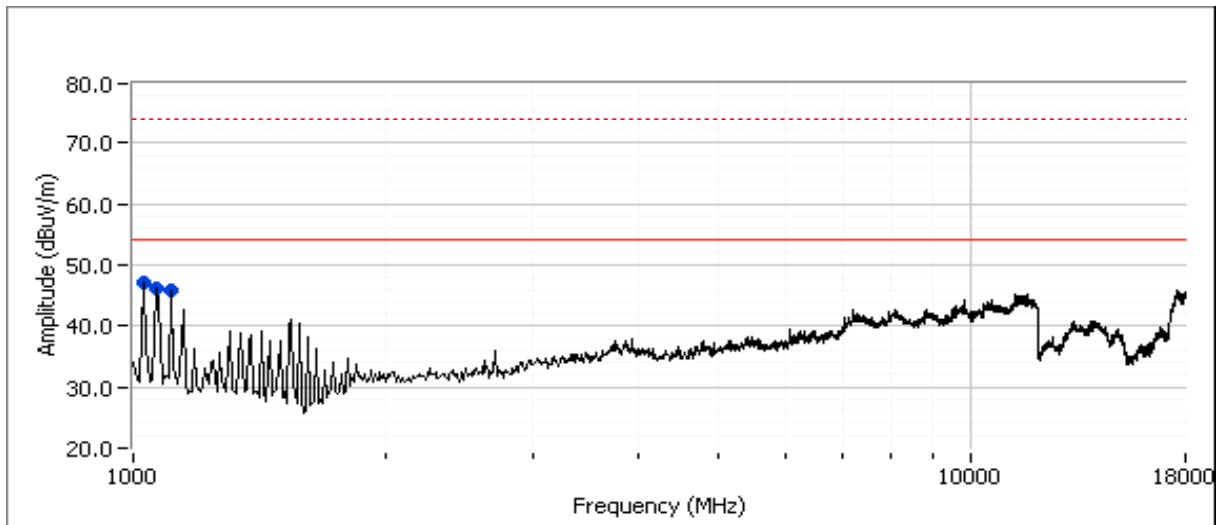

Client:	Summit Data Communications	Job Number:	J85128
Model:	SDC-SSD40L (802.11b/g/n)	T-Log Number:	T85260
		Account Manager:	Christine Krebill
Contact:	Sue White		
Standard:	FCC 15.247/RSS-210	Class:	N/A

**RSS 210 and FCC 15.247 (DTS) Antenna Port Measurements**  
Power, PSD, Bandwidth and Spurious Emissions  
802.11b Operation

**Test Specific Details**

Objective: The objective of this test session is to perform final qualification testing of the EUT with respect to the specification listed above.

Date of Test: 11/10/2011  
Test Engineer: Rafael Varelas  
Test Location: FT Lab #4

Config. Used: 1  
Config Change: None  
EUT Voltage: 120V/60Hz

**General Test Configuration**

The EUT was connected to the spectrum analyzer or power meter via a suitable attenuator. All measurements were made on a single chain.

All measurements have been corrected to allow for the external attenuators used.

**Ambient Conditions:**

Temperature: 20.7 °C  
Rel. Humidity: 36 %

**Summary of Results**

Run #	Test Performed	Limit	Pass / Fail	Result / Margin
1	Output Power	15.247(b)	Pass	16.4 dBm
2	Power spectral Density (PSD)	15.247(d)	Pass	6.7 dBm/3kHz
3	Minimum 6dB Bandwidth	15.247(a)	Pass	8.1 MHz
3	99% Bandwidth	RSS GEN	-	12.9 MHz
4	Spurious emissions	15.247(b)	Pass	All emissions below -30dBc limit

**Modifications Made During Testing**

No modifications were made to the EUT during testing

**Deviations From The Standard**

No deviations were made from the requirements of the standard.

Client:	Summit Data Communications	Job Number:	J85128
Model:	SDC-SSD40L (802.11b/g/n)	T-Log Number:	T85260
Contact:	Sue White	Account Manager:	Christine Krebill
Standard:	FCC 15.247/RSS-210	Class:	N/A

**Run #1: Output Power**

Power Setting <sup>2</sup>	Frequency (MHz)	Output Power		Antenna Gain (dBi)	Result	EIRP		Output Power	
		(dBm) <sup>1</sup>	mW			dBm	W	(dBm) <sup>3</sup>	mW
-	2412	15.6	36.3	2.0	Pass	17.6	0.058	17.9	61.7
-	2437	16.4	43.7	2.0	Pass	18.4	0.069	18.5	70.8
-	2462	14.8	30.2	2.0	Pass	16.8	0.048	17.1	51.3

- Note 1: Output power measured using a spectrum analyzer (see plots below) with RBW=1MHz, VB=3 MHz, sample detector, power averaging on (transmitted signal was continuous) and power integration over **50 MHz** (option #2, method 1 in KDB 558074, equivalent to method 1 of DA-02-2138A1 for U-NII devices). Spurious limit becomes **-30dBc**.
- Note 2: Power setting - the software power setting used during testing, included for reference only.
- Note 3: Power measured using a peak power meter for reference.

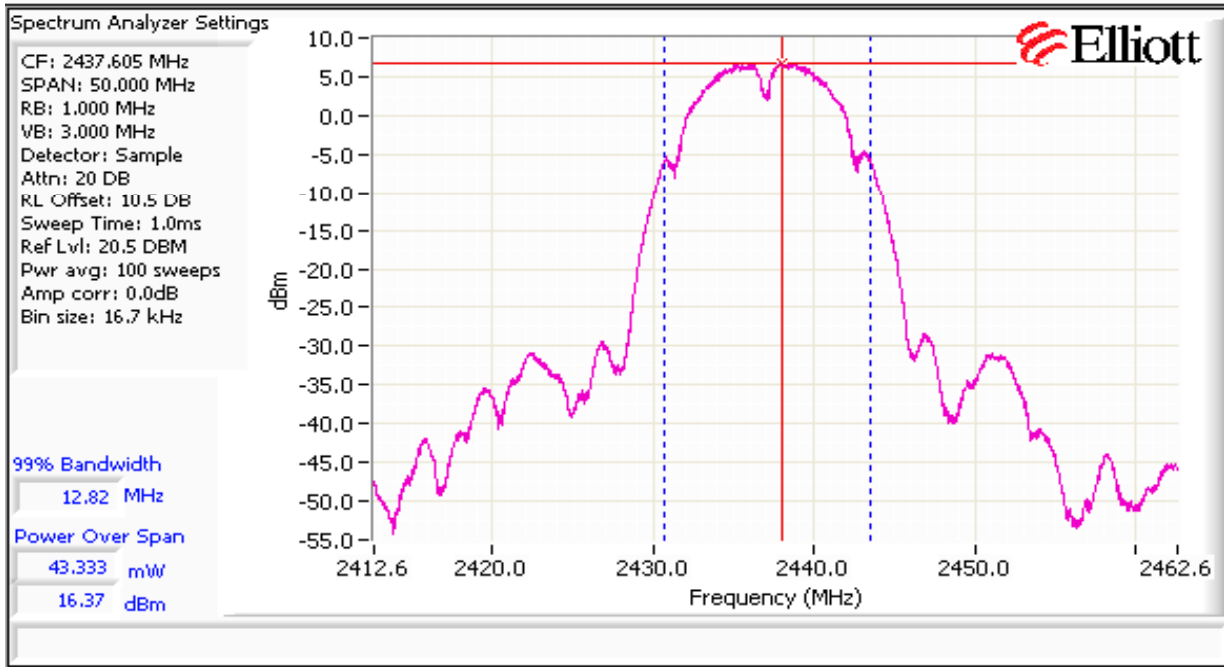

Client:	Summit Data Communications	Job Number:	J85128
Model:	SDC-SSD40L (802.11b/g/n)	T-Log Number:	T85260
Contact:	Sue White	Account Manager:	Christine Krebill
Standard:	FCC 15.247/RSS-210	Class:	N/A

**Run #2: Power spectral Density**

Power Setting	Frequency (MHz)	PSD	Limit dBm/3kHz	Result
		(dBm/3kHz) <sup>Note 1</sup>		
-	2412.9831	4.6	8.0	Pass
-	2437.6803	-7.9	8.0	Pass
-	2462.9816	6.7	8.0	Pass

Note 1: Power spectral density measured using RB=3 kHz, VB=10kHz, analyzer with peak detector and with a sweep time set to ensure a dwell time of at least 1 second per 3kHz. The measurement is made at the frequency of PPSD determined from preliminary scans using RB=3kHz using multiple sweeps at a faster rate over the 6dB bandwidth of the signal.

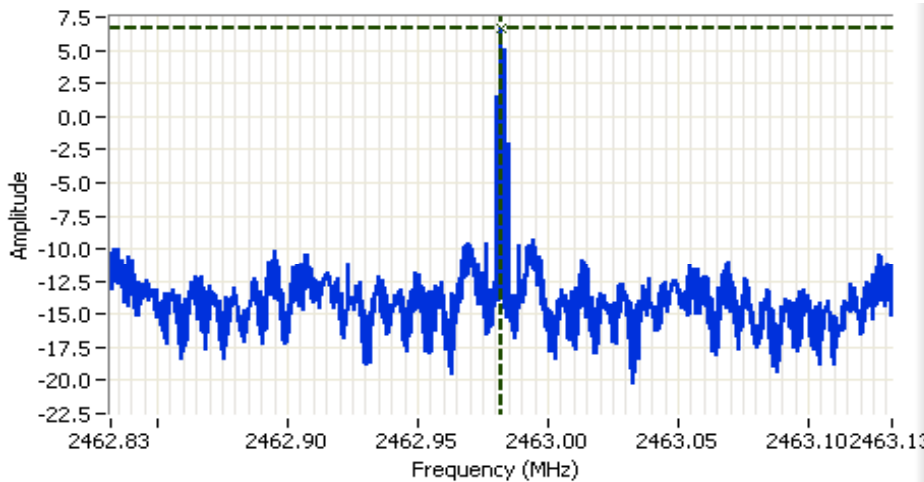

**Analyzer Settings**  
 Agilent Technologies, E4446A  
 CF: 2462.982 MHz  
 SPAN: 300 kHz  
 RB: 3.00 kHz  
 VB: 10.0 kHz  
 Detector: POS  
 Attn: 20 DB  
 RL Offset: 10.5 DB  
 Sweep Time: 100.0s  
 Ref Lvl: -2.5 DBM

**Comments**  
 PSD: 6.7 dBm/3kHz  
 802.11b

Cursor 1 2462.9816 6.65 

0.0000 0.00 

Client: Summit Data Communications	Job Number: J85128
Model: SDC-SSD40L (802.11b/g/n)	T-Log Number: T85260
	Account Manager: Christine Krebill
Contact: Sue White	
Standard: FCC 15.247/RSS-210	Class: N/A

### Run #3: Signal Bandwidth

Power Setting	Frequency (MHz)	Resolution Bandwidth	Bandwidth (MHz)	
			6dB	99%
-	2412	100kHz	9.1	12.9
-	2437	100kHz	8.1	12.8
-	2462	100kHz	8.1	12.9

Note 1: 99% bandwidth measured in accordance with RSS GEN, with RB > 1% of the span and VB > 3xRB



**Analyzer Settings**  
 Agilent Technologies, E4446A  
 CF: 2437.605 MHz  
 SPAN: 50.000 MHz  
 RB: 100 kHz  
 VB: 100 kHz  
 Detector: POS  
 Attn: 20 DB  
 RL Offset: 10.5 DB  
 Sweep Time: 6.2ms  
 Ref Lvl: 14.5 DBM

**Comments**  
 6dB BW: 8.086 MHz  
 802.11b

Cursor 1	2441.0309	7.87	
Cursor 2	2432.9448	1.87	

Delta Freq. 8.086  
 Delta Amplitude 6.00





Client:	Summit Data Communications	Job Number:	J85128
Model:	SDC-SSD40L (802.11b/g/n)	T-Log Number:	T85260
Contact:	Sue White	Account Manager:	Christine Krebill
Standard:	FCC 15.247/RSS-210	Class:	N/A

### Run #4: Out of Band Spurious Emissions

Frequency (MHz)	Limit	Result
2412	-30dBc	Pass
2437	-30dBc	Pass
2462	-30dBc	Pass

Plots for low channel, power setting(s) = 100%

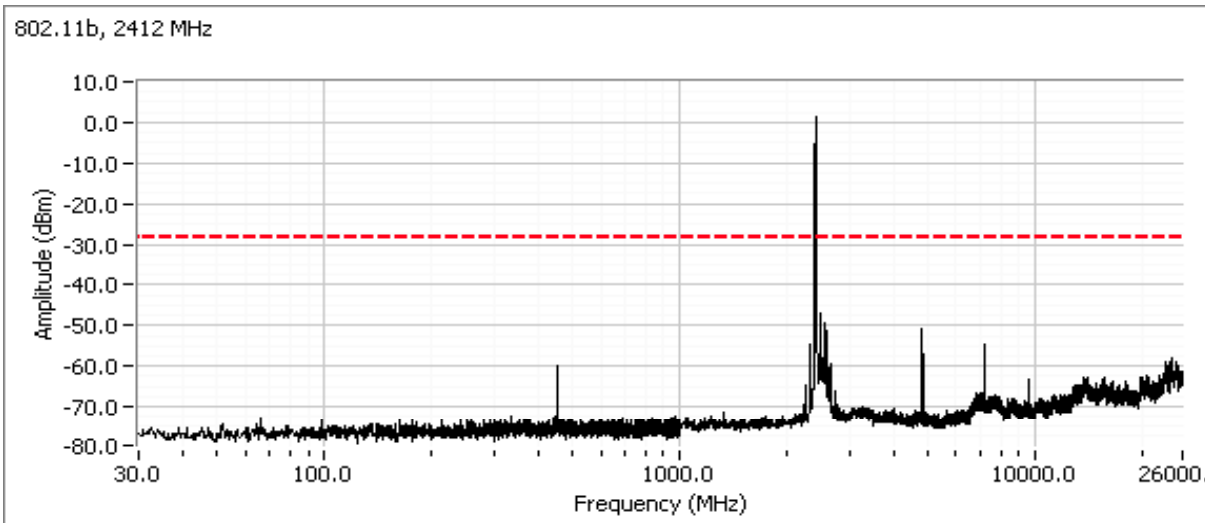

Additional plot showing compliance with -30dBc limit from 2390 MHz to 2400 MHz. Radiated measurements used to show compliance with the limits in the restricted band below 2390 MHz.

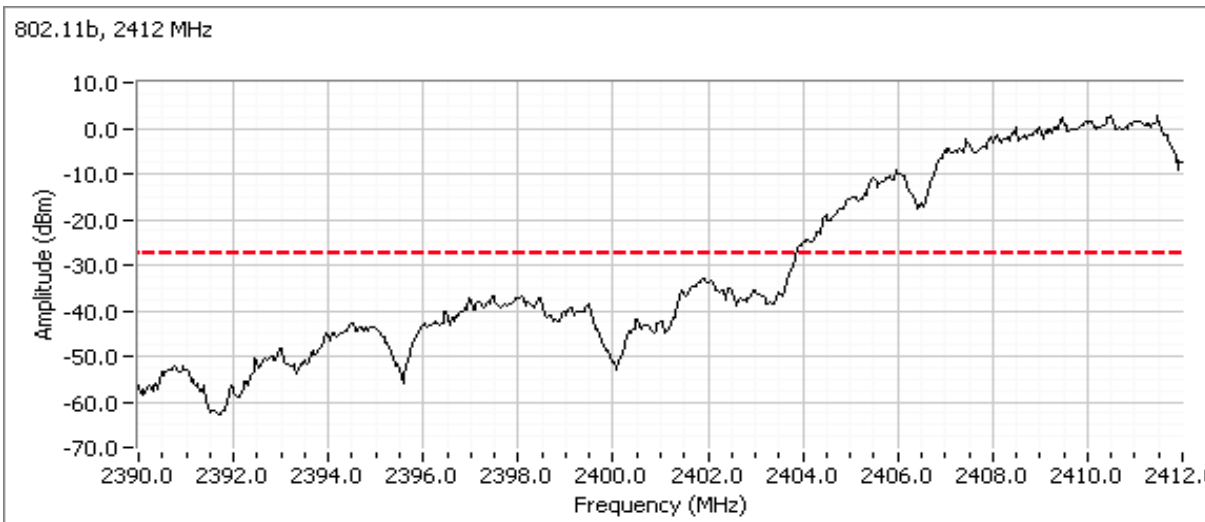

Client:	Summit Data Communications	Job Number:	J85128
Model:	SDC-SSD40L (802.11b/g/n)	T-Log Number:	T85260
Contact:	Sue White	Account Manager:	Christine Krebill
Standard:	FCC 15.247/RSS-210	Class:	N/A

Plots for center channel, power setting(s) = 100%

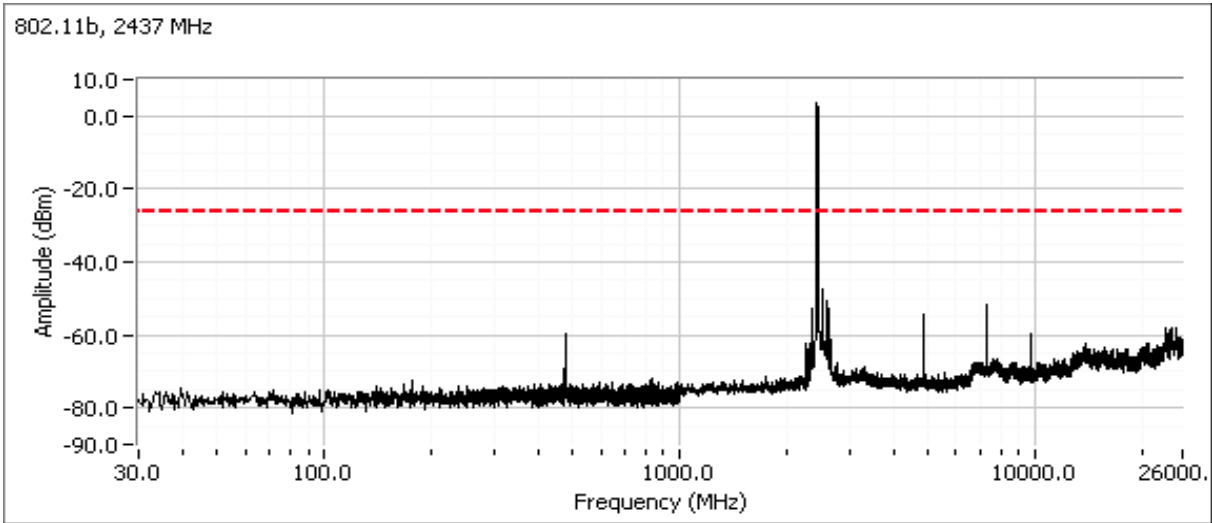

Plots for high channel, power setting(s) = 100%

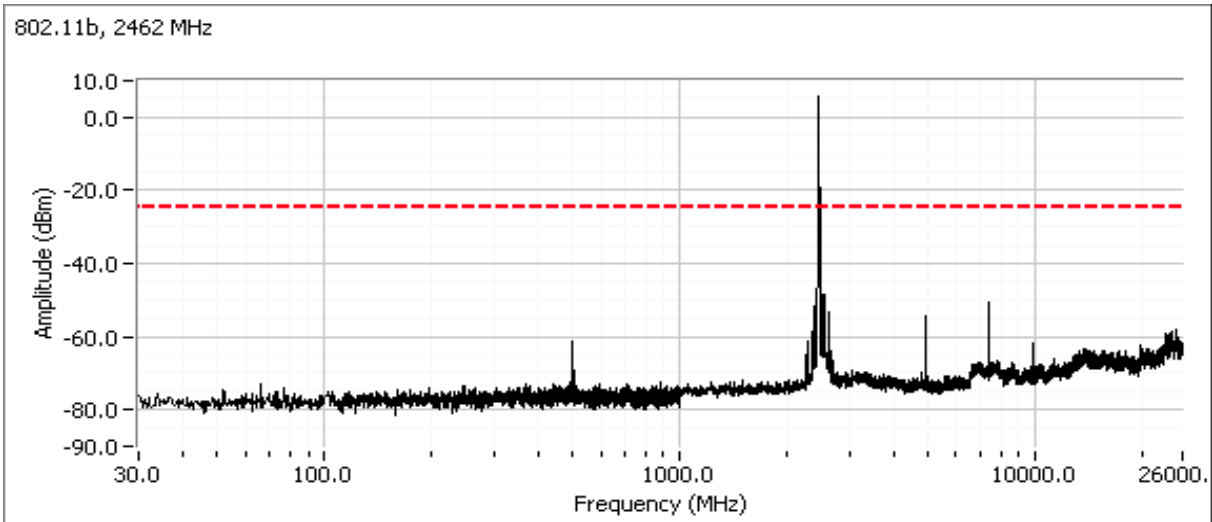

Client:	Summit Data Communications	Job Number:	J85128
Model:	SDC-SSD40L (802.11b/g/n)	T-Log Number:	T85260
		Account Manager:	Christine Krebill
Contact:	Sue White		
Standard:	FCC 15.247/RSS-210	Class:	N/A

**RSS 210 and FCC 15.247 (DTS) Antenna Port Measurements**  
Power, PSD, Bandwidth and Spurious Emissions  
802.11g Operation

**Test Specific Details**

Objective: The objective of this test session is to perform final qualification testing of the EUT with respect to the specification listed above.

Date of Test: 11/10/2011  
Test Engineer: Rafael Varelas  
Test Location: FT Lab #4

Config. Used: 1  
Config Change: None  
EUT Voltage: 120V/60Hz

**General Test Configuration**

The EUT was connected to the spectrum analyzer or power meter via a suitable attenuator. All measurements were made on a single chain.

All measurements have been corrected to allow for the external attenuators used.

**Ambient Conditions:**

Temperature: 20.7 °C  
Rel. Humidity: 36 %

**Summary of Results**

Run #	Test Performed	Limit	Pass / Fail	Result / Margin
1	Output Power	15.247(b)	Pass	13.8 dBm
2	Power spectral Density (PSD)	15.247(d)	Pass	-12.7 dBm/3kHz
3	Minimum 6dB Bandwidth	15.247(a)	Pass	13.9 MHz
3	99% Bandwidth	RSS GEN	-	16.7 MHz
4	Spurious emissions	15.247(b)	Pass	All emissions below -30dBc limit

**Modifications Made During Testing**

No modifications were made to the EUT during testing

**Deviations From The Standard**

No deviations were made from the requirements of the standard.

Client:	Summit Data Communications	Job Number:	J85128
Model:	SDC-SSD40L (802.11b/g/n)	T-Log Number:	T85260
Contact:	Sue White	Account Manager:	Christine Krebill
Standard:	FCC 15.247/RSS-210	Class:	N/A

**Run #1: Output Power**

Power Setting <sup>2</sup>	Frequency (MHz)	Output Power		Antenna Gain (dBi)	Result	EIRP		Output Power	
		(dBm) <sup>1</sup>	mW			dBm	W	(dBm) <sup>3</sup>	mW
-	2412	12.3	17.0	2.0	Pass	14.3	0.027	18.4	69.2
-	2437	13.8	24.0	2.0	Pass	15.8	0.038	20.3	107.2
-	2462	11.1	12.9	2.0	Pass	13.1	0.020	18.2	66.1

- Note 1: Output power measured using a spectrum analyzer (see plots below) with RBW=1MHz, VB=3 MHz, sample detector, power averaging on (transmitted signal was continuous) and power integration over **50 MHz** (option #2, method 1 in KDB 558074, equivalent to method 1 of DA-02-2138A1 for U-NII devices). Spurious limit becomes **-30dBc**.
- Note 2: Power setting - the software power setting used during testing, included for reference only.
- Note 3: Power measured using a peak power meter for reference.

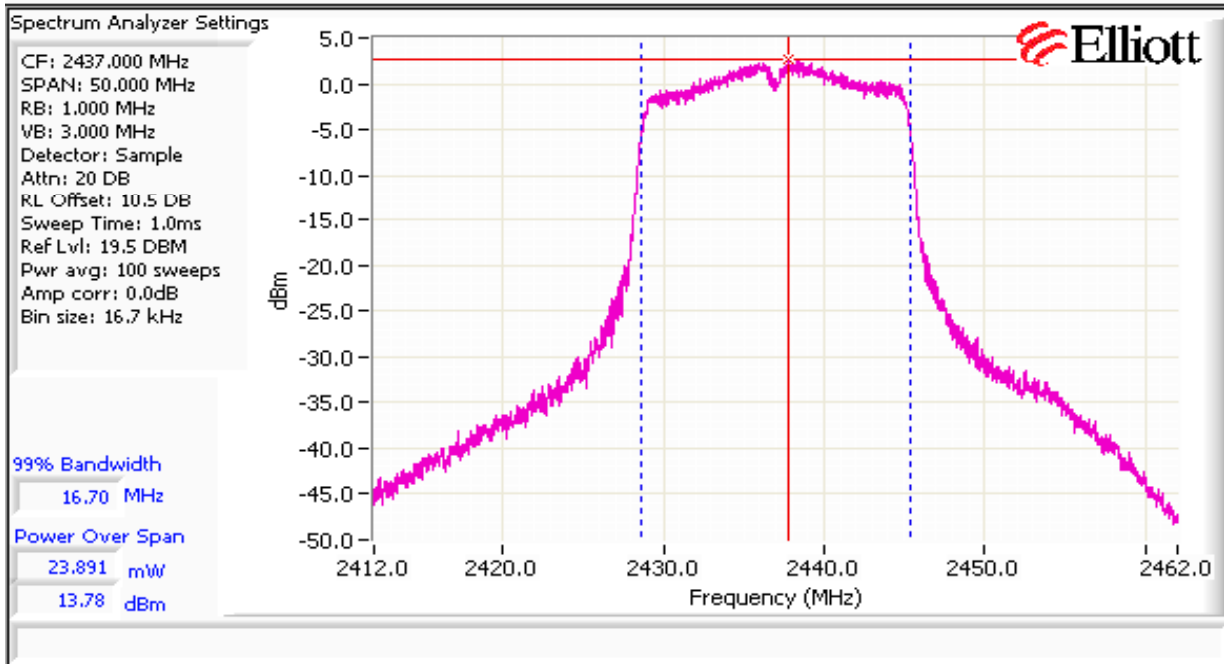

Client: Summit Data Communications	Job Number: J85128
Model: SDC-SSD40L (802.11b/g/n)	T-Log Number: T85260
Contact: Sue White	Account Manager: Christine Krebill
Standard: FCC 15.247/RSS-210	Class: N/A

**Run #2: Power spectral Density**

Power Setting	Frequency (MHz)	PSD	Limit dBm/3kHz	Result
		(dBm/3kHz) <sup>Note 1</sup>		
-	2411.7015	-13.4	8.0	Pass
-	2437.2782	-12.7	8.0	Pass
-	2462.2715	-15.0	8.0	Pass

Note 1: Power spectral density measured using RB=3 kHz, VB=10kHz, analyzer with peak detector and with a sweep time set to ensure a dwell time of at least 1 second per 3kHz. The measurement is made at the frequency of PPSD determined from preliminary scans using RB=3kHz using multiple sweeps at a faster rate over the 6dB bandwidth of the signal.

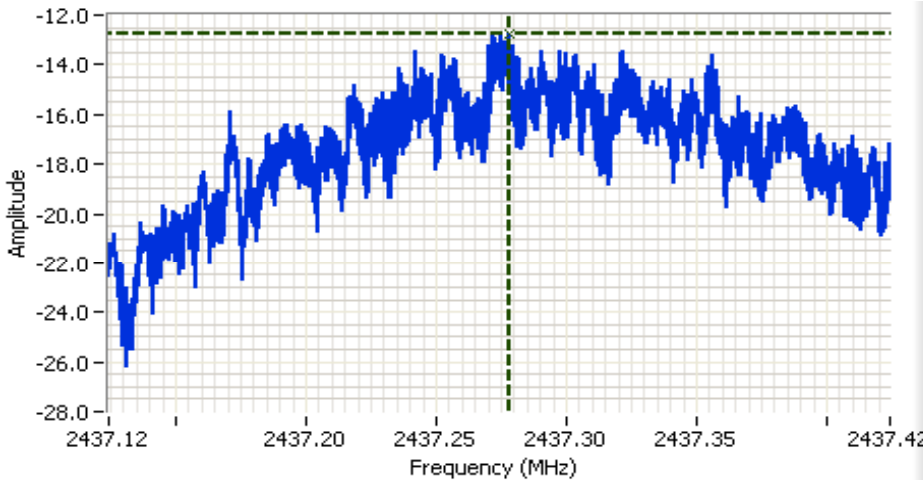

**Analyzer Settings**  
 Agilent Technologies, E4446A  
 CF: 2437.274 MHz  
 SPAN: 300 kHz  
 RB: 3.00 kHz  
 VB: 10.0 kHz  
 Detector: POS  
 Attn: 20 DB  
 RL Offset: 10.5 DB  
 Sweep Time: 100.0s  
 Ref Lvl: 0.5 DBM

**Comments**  
 PSD: -12.7 dBm/3kHz  
 802.11g

Cursor 1 2437.2782 -12.72 

0.0000 0.00 



Client:	Summit Data Communications	Job Number:	J85128
Model:	SDC-SSD40L (802.11b/g/n)	T-Log Number:	T85260
Contact:	Sue White	Account Manager:	Christine Krebill
Standard:	FCC 15.247/RSS-210	Class:	N/A

**Run #3: Signal Bandwidth**

Power Setting	Frequency (MHz)	Resolution Bandwidth	Bandwidth (MHz)	
			6dB	99%
-	2412	100kHz	13.9	16.7
-	2437	100kHz	15.1	16.7
-	2462	100kHz	15.3	16.7

Note 1: 99% bandwidth measured in accordance with RSS GEN, with RB > 1% of the span and VB > 3xRB

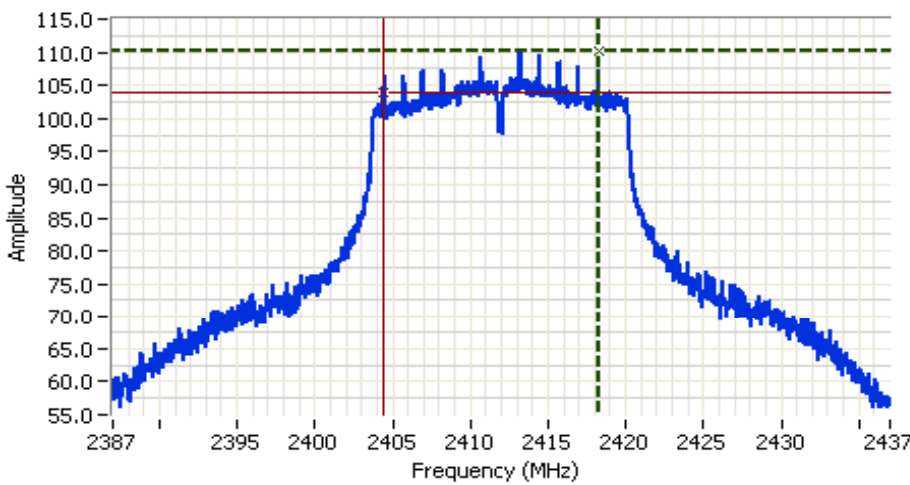

**Analyzer Settings**  
 Agilent Technologies, E4446A  
 CF: 2412.000 MHz  
 SPAN: 50.000 MHz  
 RB: 100 kHz  
 VB: 100 kHz  
 Detector: POS  
 Attn: 10 DB  
 RL Offset: 10.5 DB  
 Sweep Time: 6.2ms  
 Ref Lvl: 115.5 DBUV

**Comments**  
 6dB BW: 13.855 MHz  
 802.11g

Cursor 1	2418.2938	110.0E	
Cursor 2	2404.4391	104.0E	

Delta Freq. 13.855  
 Delta Amplitude 6.00



Client:	Summit Data Communications	Job Number:	J85128
Model:	SDC-SSD40L (802.11b/g/n)	T-Log Number:	T85260
Contact:	Sue White	Account Manager:	Christine Krebill
Standard:	FCC 15.247/RSS-210	Class:	N/A

**Run #4: Out of Band Spurious Emissions**

Frequency (MHz)	Limit	Result
2412	-30dBc	Pass
2437	-30dBc	Pass
2462	-30dBc	Pass

Plots for low channel, power setting(s) = 100%

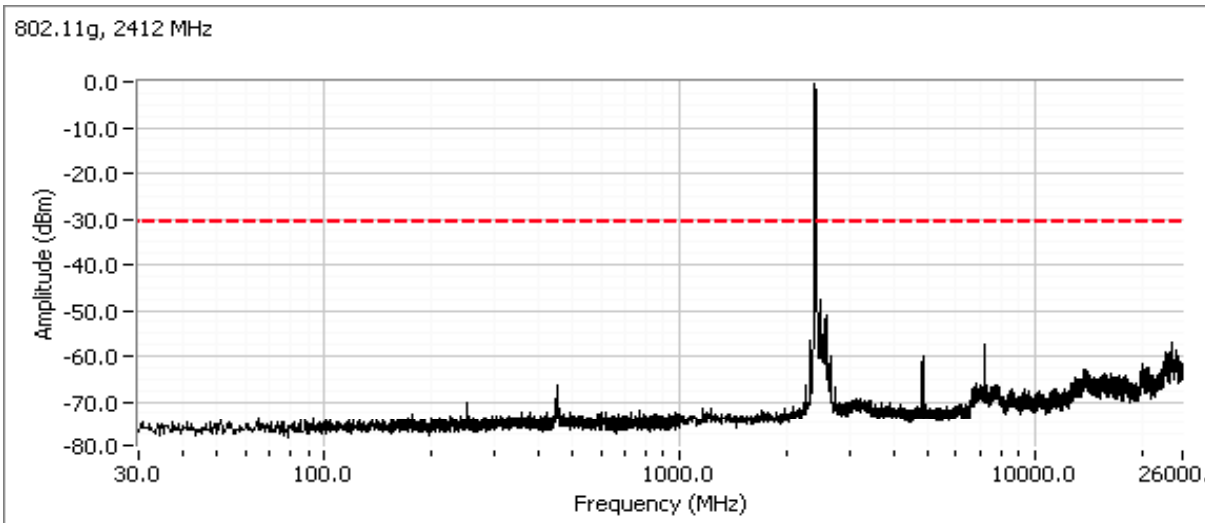

Additional plot showing compliance with -30dBc limit from 2390 MHz to 2400 MHz. Radiated measurements used to show compliance with the limits in the restricted band below 2390 MHz.

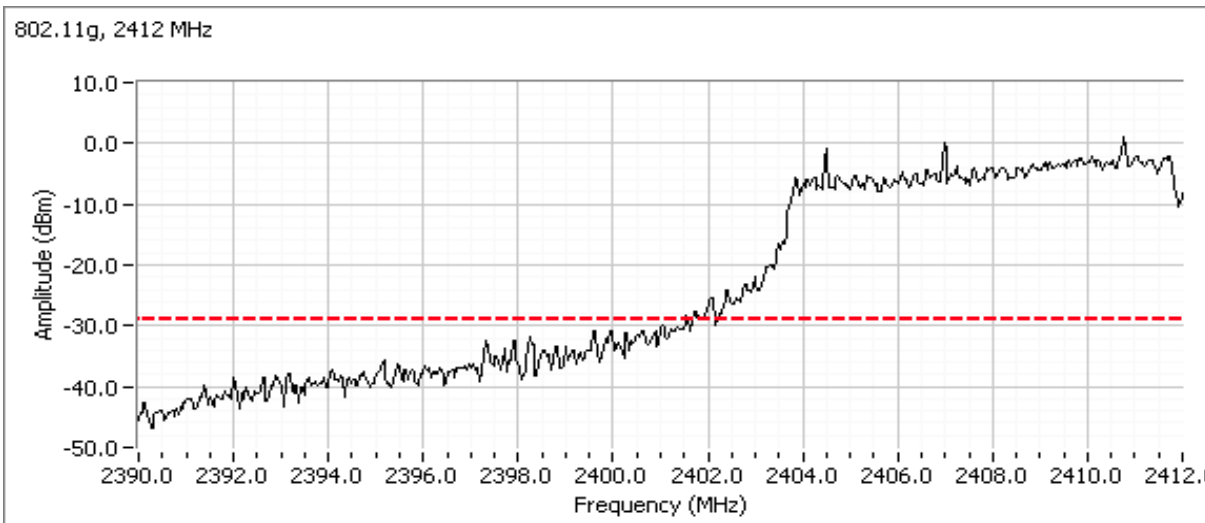

Client:	Summit Data Communications	Job Number:	J85128
Model:	SDC-SSD40L (802.11b/g/n)	T-Log Number:	T85260
Contact:	Sue White	Account Manager:	Christine Krebill
Standard:	FCC 15.247/RSS-210	Class:	N/A

Plots for center channel, power setting(s) = 100%

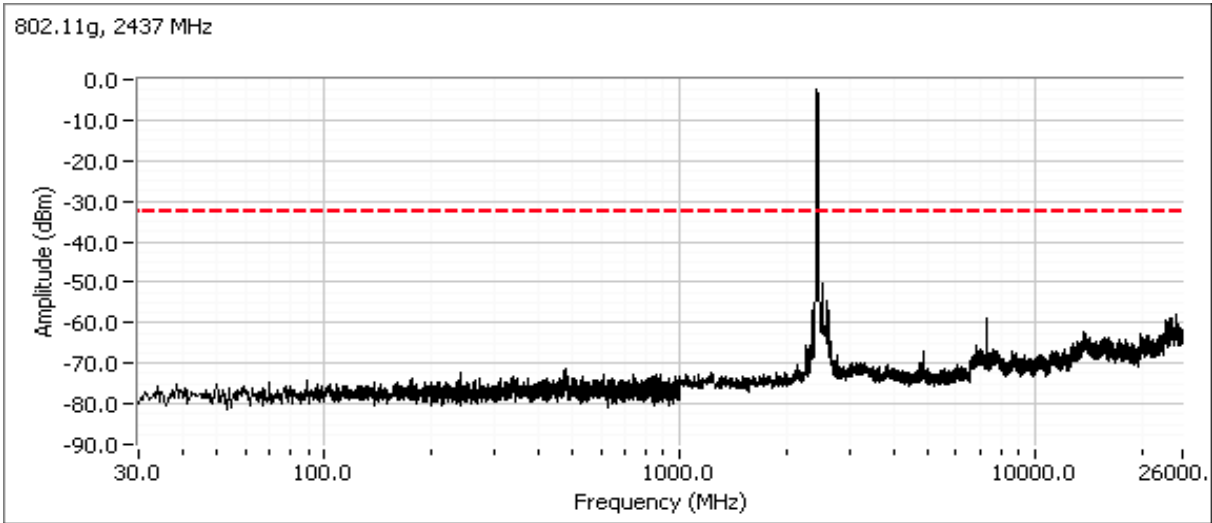

Plots for high channel, power setting(s) = 100%

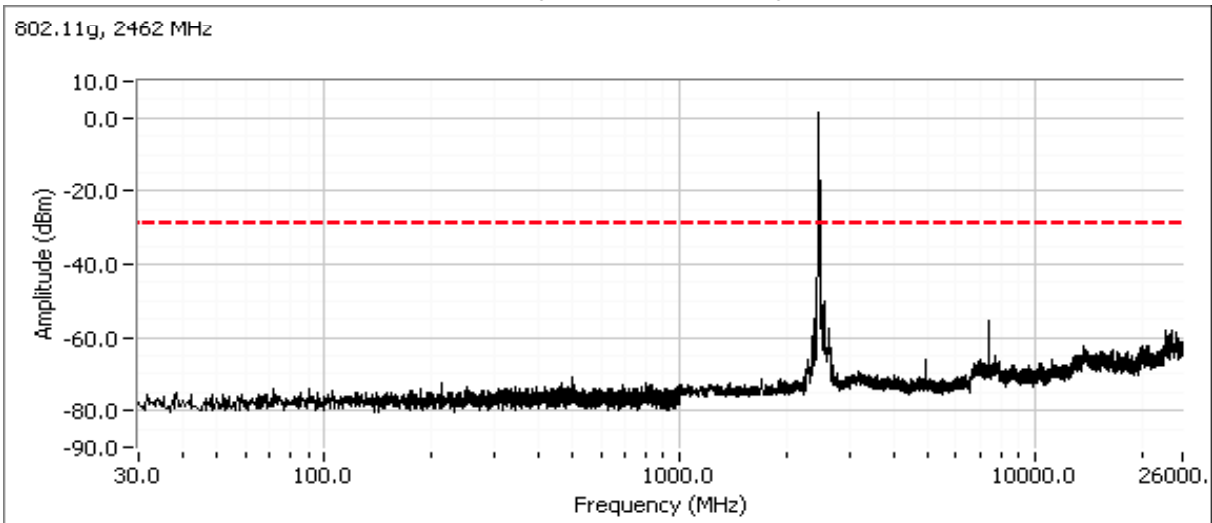



Client:	Summit Data Communications	Job Number:	J85128
Model:	SDC-SSD40L (802.11b/g/n)	T-Log Number:	T85260
		Account Manager:	Christine Krebill
Contact:	Sue White		
Standard:	FCC 15.247/RSS-210	Class:	N/A

**RSS 210 and FCC 15.247 (DTS) Antenna Port Measurements**  
Power, PSD, Bandwidth and Spurious Emissions  
802.11n20 Operation

**Test Specific Details**

Objective: The objective of this test session is to perform final qualification testing of the EUT with respect to the specification listed above.

Date of Test: 11/9/2011  
Test Engineer: Rafael Varelas  
Test Location: FT Chamber #5

Config. Used: 1  
Config Change: None  
EUT Voltage: 120V/60Hz

**General Test Configuration**

The EUT was connected to the spectrum analyzer or power meter via a suitable attenuator. All measurements were made on a single chain.

All measurements have been corrected to allow for the external attenuators used.

**Ambient Conditions:**

Temperature: 20.6 °C  
Rel. Humidity: 38 %

**Summary of Results**

Run #	Test Performed	Limit	Pass / Fail	Result / Margin
1	Output Power	15.247(b)	Pass	12.3 dBm
2	Power spectral Density (PSD)	15.247(d)	Pass	-10.9 dBm/3kHz
3	Minimum 6dB Bandwidth	15.247(a)	Pass	16.0 MHz
3	99% Bandwidth	RSS GEN	-	18.6 MHz
4	Spurious emissions	15.247(b)	Pass	All emissions below -30dBc limit

**Modifications Made During Testing**

No modifications were made to the EUT during testing

**Deviations From The Standard**

No deviations were made from the requirements of the standard.

Client:	Summit Data Communications	Job Number:	J85128
Model:	SDC-SSD40L (802.11b/g/n)	T-Log Number:	T85260
Contact:	Sue White	Account Manager:	Christine Krebill
Standard:	FCC 15.247/RSS-210	Class:	N/A

### Run #1: Output Power

Power Setting <sup>2</sup>	Frequency (MHz)	Output Power		Antenna Gain (dBi)	Result	EIRP		Output Power	
		(dBm) <sup>1</sup>	mW			dBm	W	(dBm) <sup>3</sup>	mW
-	2412	10.3	10.7	2.0	Pass	12.3	0.017	17.1	51.3
-	2437	12.3	17.0	2.0	Pass	14.3	0.027	17.8	60.3
-	2462	8.9	7.8	2.0	Pass	10.9	0.012	15.9	38.9

- Note 1: Output power measured using a spectrum analyzer (see plots below) with RBW=1MHz, VB=3 MHz, sample detector, power averaging on (transmitted signal was continuous) and power integration over **50 MHz** (option #2, method 1 in KDB 558074, equivalent to method 1 of DA-02-2138A1 for U-NII devices). Spurious limit becomes **-30dBc**.
- Note 2: Power setting - the software power setting used during testing, included for reference only.
- Note 3: Power measured using a peak power meter for reference.

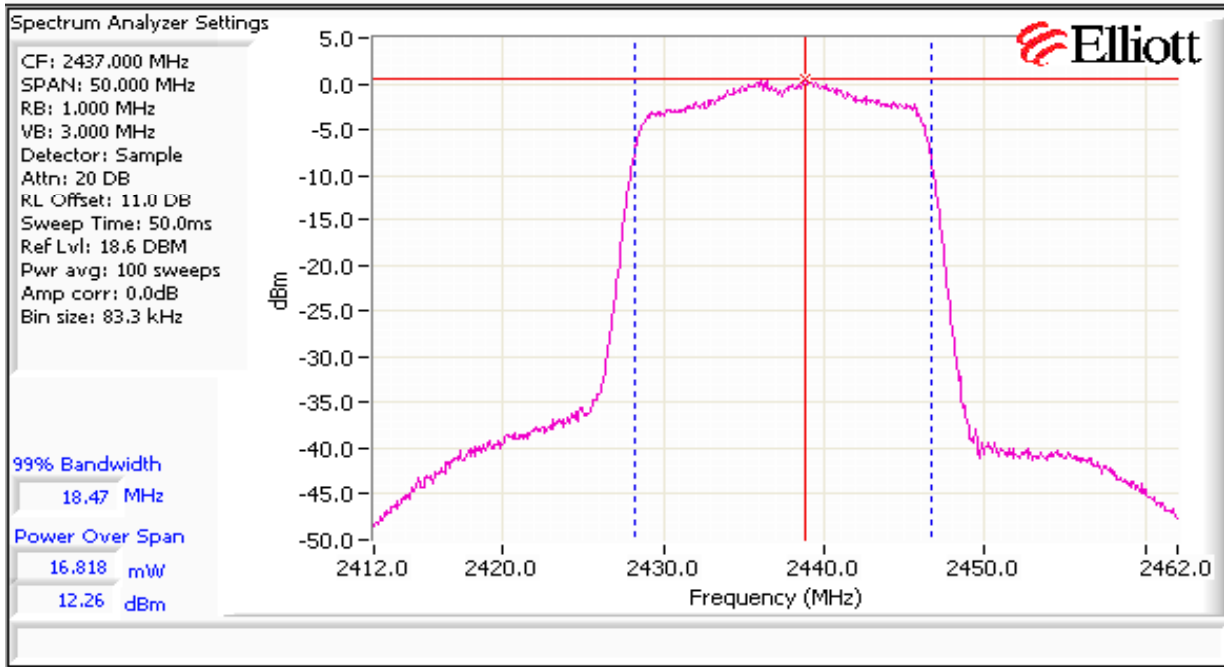

Client:	Summit Data Communications	Job Number:	J85128
Model:	SDC-SSD40L (802.11b/g/n)	T-Log Number:	T85260
Contact:	Sue White	Account Manager:	Christine Krebill
Standard:	FCC 15.247/RSS-210	Class:	N/A

**Run #2: Power spectral Density**

Power Setting	Frequency (MHz)	PSD	Limit dBm/3kHz	Result
		(dBm/3kHz) <sup>Note 1</sup>		
-	2411.6357	-13.2	8.0	Pass
-	2437.5783	-10.9	8.0	Pass
-	2462.5795	-14.7	8.0	Pass

Note 1: Power spectral density measured using RB=3 kHz, VB=10kHz, analyzer with peak detector and with a sweep time set to ensure a dwell time of at least 1 second per 3kHz. The measurement is made at the frequency of PPSD determined from preliminary scans using RB=3kHz using multiple sweeps at a faster rate over the 6dB bandwidth of the signal.

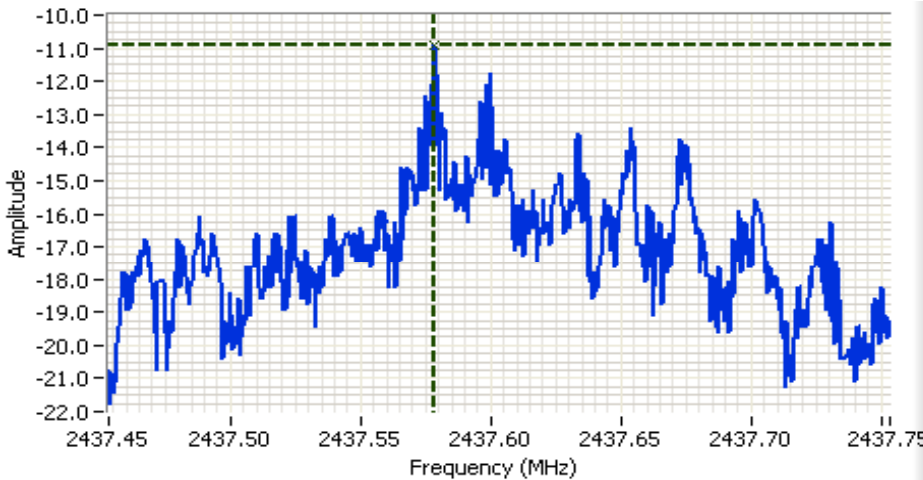

**Analyzer Settings**

HP8564E  
 CF: 2437.603 MHz  
 SPAN: 300 kHz  
 RB: 3.00 kHz  
 VB: 10.0 kHz  
 Detector: POS  
 Attn: 10 DB  
 RL Offset: 11.0 DB  
 Sweep Time: 100.0s  
 Ref Lvl: 10.4 DBM

**Comments**

PSD: -10.9 dBm/3kHz  
 802.11n20

Cursor 1 2437.5783 -10.93

0.0000 0.00



Client:	Summit Data Communications	Job Number:	J85128
Model:	SDC-SSD40L (802.11b/g/n)	T-Log Number:	T85260
Contact:	Sue White	Account Manager:	Christine Krebill
Standard:	FCC 15.247/RSS-210	Class:	N/A

**Run #3: Signal Bandwidth**

Power Setting	Frequency (MHz)	Resolution Bandwidth	Bandwidth (MHz)	
			6dB	99%
-	2412	100kHz	16.6	18.6
-	2437	100kHz	16.1	18.5
-	2462	100kHz	16.0	18.5

Note 1: 99% bandwidth measured in accordance with RSS GEN, with RB > 1% of the span and VB > 3xRB

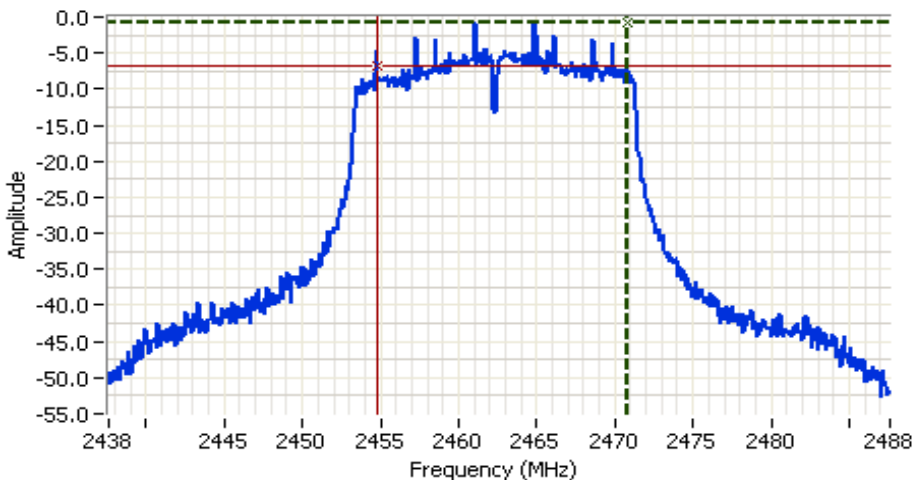

**Analyzer Settings**

HP8564E  
CF: 2462.610 MHz  
SPAN: 50.000 MHz  
RB: 100 kHz  
VB: 100 kHz  
Detector: POS  
Attn: 10 DB  
RL Offset: 11.0 DB  
Sweep Time: 50.0ms  
Ref Lvl: 1.6 DBM

**Comments**

6dB BW: 16.000 MHz  
802.11n20

Cursor 1	2470.7767	-0.73	
Cursor 2	2454.7767	-6.73	

Delta Freq. 16.000  
Delta Amplitude 6.00



Client:	Summit Data Communications	Job Number:	J85128
Model:	SDC-SSD40L (802.11b/g/n)	T-Log Number:	T85260
Contact:	Sue White	Account Manager:	Christine Krebill
Standard:	FCC 15.247/RSS-210	Class:	N/A

**Run #4: Out of Band Spurious Emissions**

Frequency (MHz)	Limit	Result
2412	-30dBc	Pass
2437	-30dBc	Pass
2462	-30dBc	Pass

Plots for low channel, power setting(s) = 100%

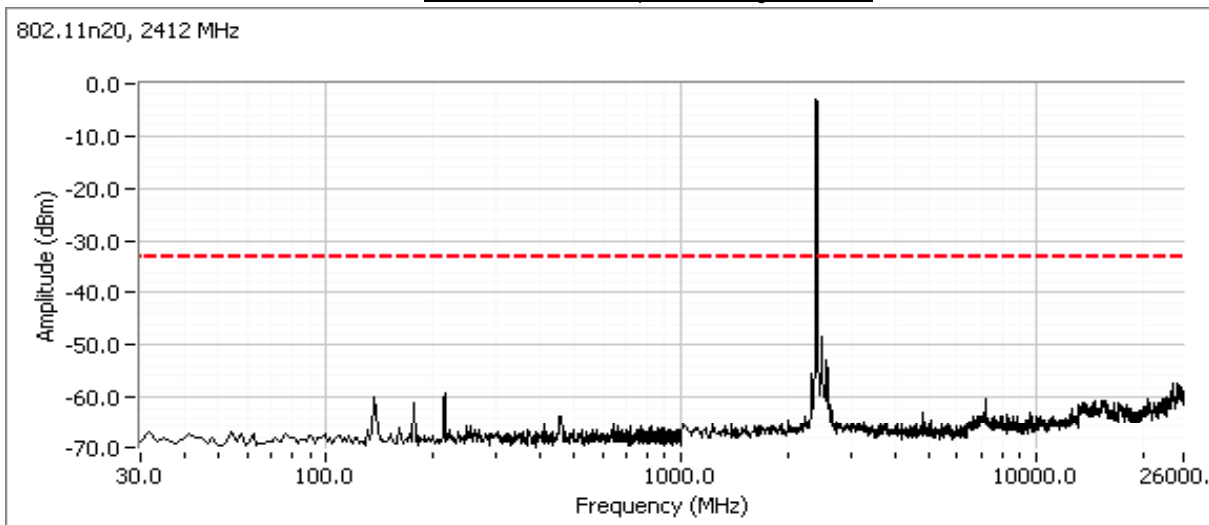

Additional plot showing compliance with -30dBc limit from 2390 MHz to 2400 MHz. Radiated measurements used to show compliance with the limits in the restricted band below 2390 MHz.

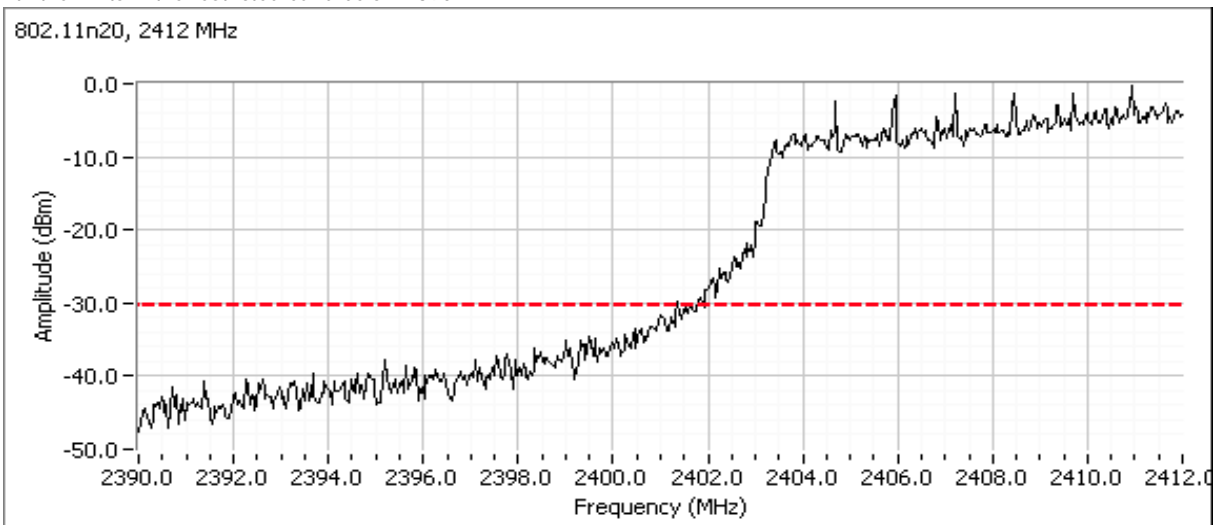

Client:	Summit Data Communications	Job Number:	J85128
Model:	SDC-SSD40L (802.11b/g/n)	T-Log Number:	T85260
Contact:	Sue White	Account Manager:	Christine Krebill
Standard:	FCC 15.247/RSS-210	Class:	N/A

Plots for center channel, power setting(s) = 100%

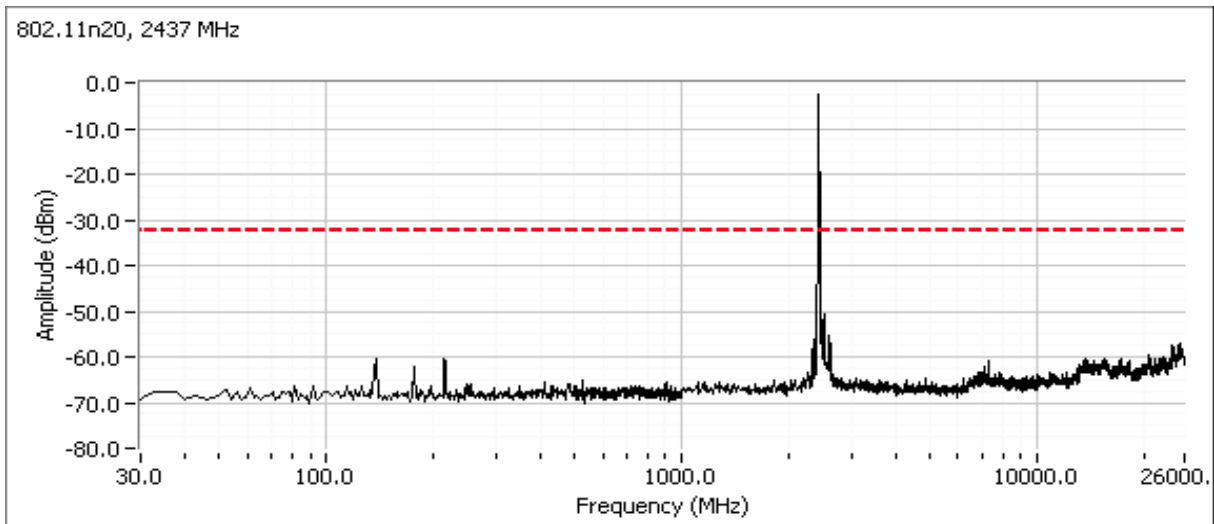

Plots for high channel, power setting(s) = 100%

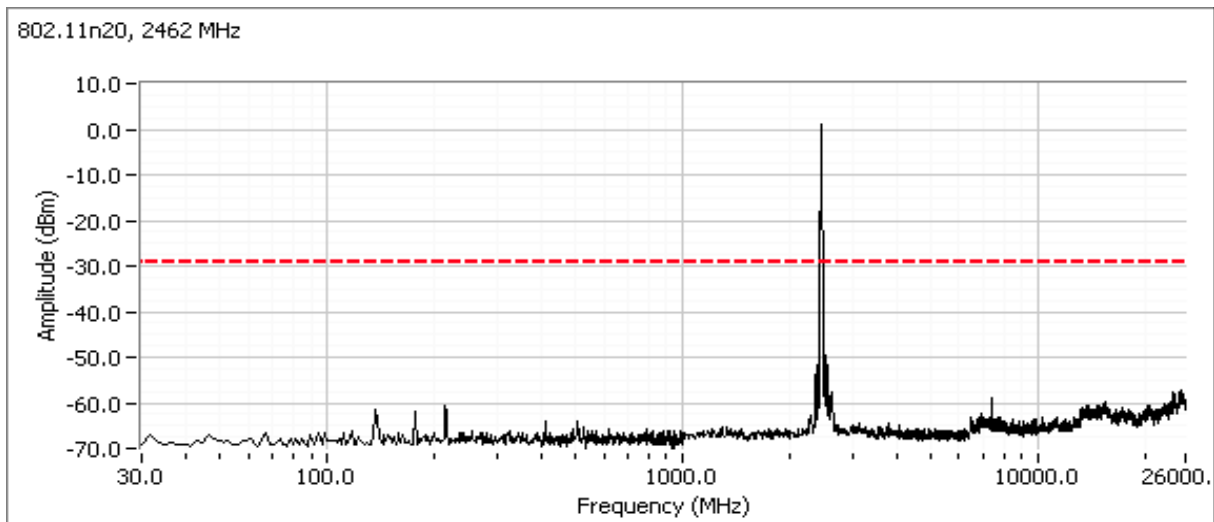



## EMC Test Data

Client:	Summit Data Communications	Job Number:	J85128
Model:	SSD40L (802.11b/g/n)	T-Log Number:	T85340
		Account Manager:	Christine Krebill
Contact:	Sue White		-
Emissions Standard(s):	FCC Part 15B, EN 301489-1 v1.8.1 & -17 v1.3.2	Class:	B
Immunity Standard(s):	-	Environment:	-

# EMC Test Data

For The

## Summit Data Communications

Model

SSD40L (802.11b/g/n)

Date of Last Test: 12/23/2011

Client:	Summit Data Communications	Job Number:	J85128
Model:	SSD40L (802.11b/g/n)	T-Log Number:	T85340
		Account Manager:	Christine Krebill
Contact:	Sue White		
Standard:	FCC Part 15B, EN 301489-1 v1.8.1 & -17 v1.3.2	Class:	B

### Conducted Emissions

*(Elliott Laboratories Fremont Facility, Semi-Anechoic Chamber)*

#### Test Specific Details

Objective: The objective of this test session is to perform final qualification testing of the EUT with respect to the specification listed above.

Date of Test: 12/22/2011	Config. Used: 1
Test Engineer: Rafael Varelas	Config Change: None
Test Location: Fremont Chamber #4	EUT Voltage: 230V/50Hz

#### General Test Configuration

For tabletop equipment, the EUT was located on a wooden table inside the semi-anechoic chamber, 40 cm from a vertical coupling plane and 80cm from the LISN.

**Ambient Conditions:**

Temperature:	21.5 °C
Rel. Humidity:	34 %

#### Summary of Results

Run #	Test Performed	Limit	Result	Margin
1	CE, AC Power, 230V/50Hz	Class B	Pass	33.0dBµV @ 0.547MHz (-13.0dB)
2	CE, AC Power, 120V/60Hz	Class B	Pass	37.5dBµV @ 0.193MHz (-16.4dB)

#### Modifications Made During Testing

No modifications were made to the EUT during testing

#### Deviations From The Standard

No deviations were made from the requirements of the standard.

#### Notes:

EUT installed within the Datalogic, microPDA handheld PDA



Client: Summit Data Communications	Job Number: J85128
Model: SSD40L (802.11b/g/n)	T-Log Number: T85340
Contact: Sue White	Account Manager: Christine Krebill
Standard: FCC Part 15B, EN 301489-1 v1.8.1 & -17 v1.3.2	Class: B

Run #1: AC Power Port Conducted Emissions, 0.15 - 30MHz, 230V/50Hz

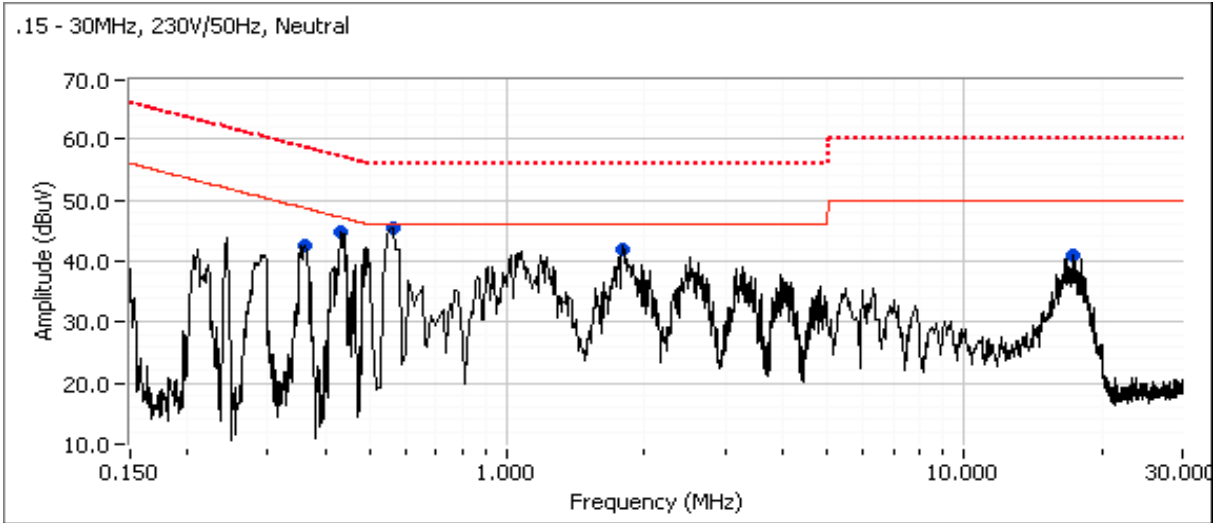
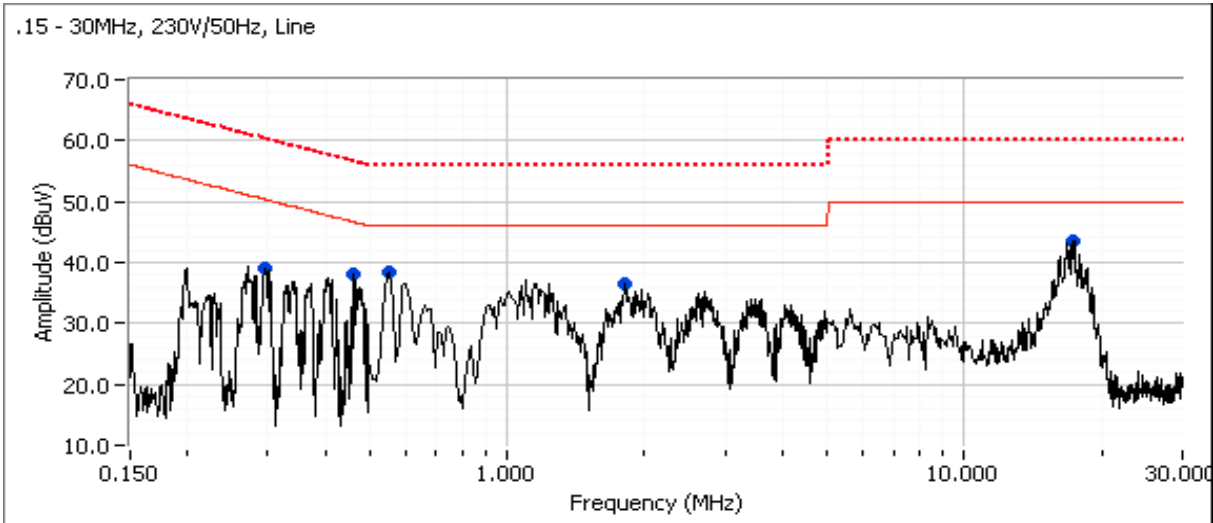

Client:	Summit Data Communications	Job Number:	J85128
Model:	SSD40L (802.11b/g/n)	T-Log Number:	T85340
Contact:	Sue White	Account Manager:	Christine Krebill
Standard:	FCC Part 15B, EN 301489-1 v1.8.1 & -17 v1.3.2	Class:	B

**Preliminary peak readings captured during pre-scan (peak readings vs. average limit)**

Frequency MHz	Level dB $\mu$ V	AC Line	EN55022 Limit	Class B Margin	Detector QP/Ave	Comments
0.361	42.6	Neutral	48.7	-6.1	Peak	
0.433	44.7	Neutral	47.2	-2.5	Peak	
0.547	45.5	Neutral	46.0	-0.5	Peak	
1.802	41.8	Neutral	46.0	-4.2	Peak	
17.282	41.0	Neutral	50.0	-9.0	Peak	
0.296	39.1	Line	50.4	-11.3	Peak	
0.462	38.2	Line	46.6	-8.4	Peak	
0.569	38.5	Line	46.0	-7.5	Peak	
1.814	36.4	Line	46.0	-9.6	Peak	
17.184	43.4	Line	50.0	-6.6	Peak	

**Final quasi-peak and average readings**

Frequency MHz	Level dB $\mu$ V	AC Line	EN55022 Limit	Class B Margin	Detector QP/Ave	Comments
<b>0.547</b>	<b>33.0</b>	Neutral	46.0	<b>-13.0</b>	AVG	AVG (0.10s)
0.569	32.6	Line	46.0	-13.4	AVG	AVG (0.10s)
0.547	39.8	Neutral	56.0	-16.2	QP	QP (1.00s)
0.569	39.7	Line	56.0	-16.3	QP	QP (1.00s)
0.462	37.3	Line	56.7	-19.4	QP	QP (1.00s)
17.184	29.8	Line	50.0	-20.2	AVG	AVG (0.10s)
1.802	25.7	Neutral	46.0	-20.3	AVG	AVG (0.10s)
1.802	35.7	Neutral	56.0	-20.3	QP	QP (1.00s)
17.184	39.2	Line	60.0	-20.8	QP	QP (1.00s)
1.814	23.2	Line	46.0	-22.8	AVG	AVG (0.10s)
0.361	24.5	Neutral	48.7	-24.2	AVG	AVG (0.10s)
1.814	31.8	Line	56.0	-24.2	QP	QP (1.00s)
0.462	19.3	Line	46.7	-27.4	AVG	AVG (0.10s)
0.433	28.4	Neutral	57.2	-28.8	QP	QP (1.00s)
0.361	26.8	Neutral	58.7	-31.9	QP	QP (1.00s)
0.433	14.8	Neutral	47.2	-32.4	AVG	AVG (0.10s)

Client: Summit Data Communications	Job Number: J85128
Model: SSD40L (802.11b/g/n)	T-Log Number: T85340
Contact: Sue White	Account Manager: Christine Krebill
Standard: FCC Part 15B, EN 301489-1 v1.8.1 & -17 v1.3.2	Class: B

Run #2: AC Power Port Conducted Emissions, 0.15 - 30MHz, 120V/60Hz

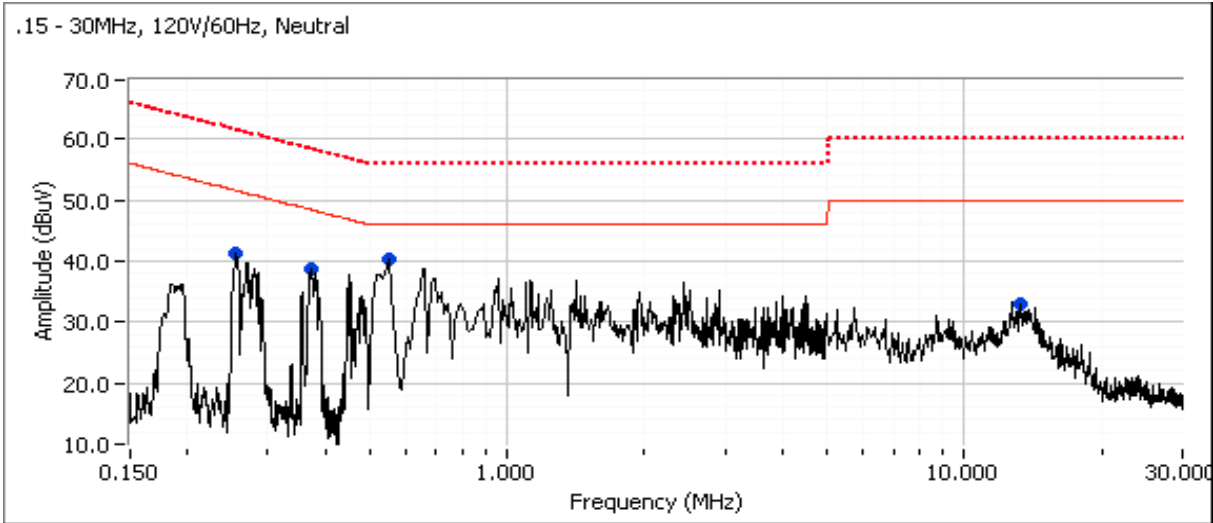
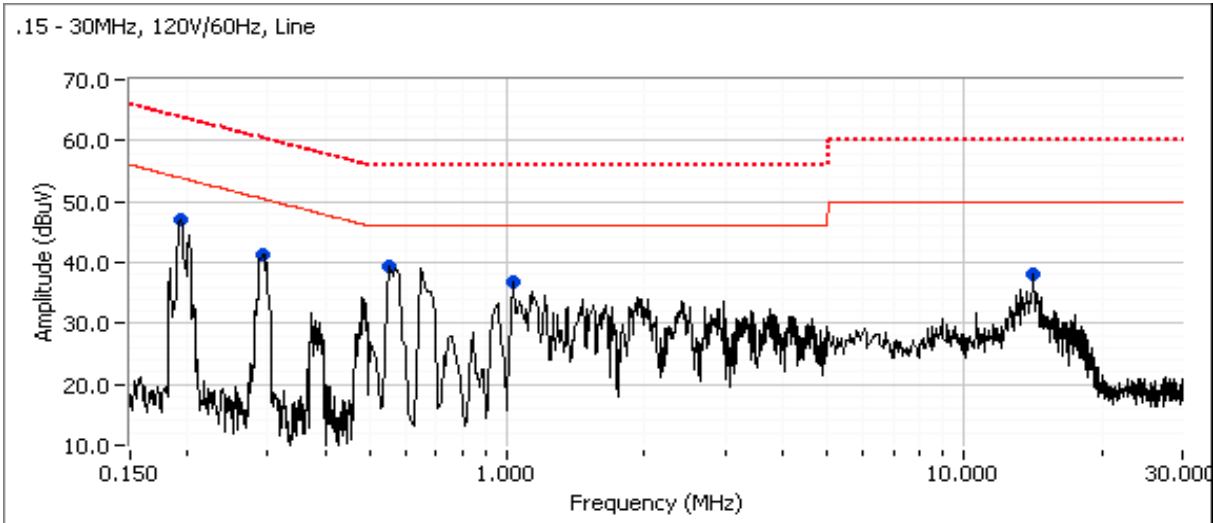

Client:	Summit Data Communications	Job Number:	J85128
Model:	SSD40L (802.11b/g/n)	T-Log Number:	T85340
Contact:	Sue White	Account Manager:	Christine Krebill
Standard:	FCC Part 15B, EN 301489-1 v1.8.1 & -17 v1.3.2	Class:	B

**Preliminary peak readings captured during pre-scan (peak readings vs. average limit)**

Frequency MHz	Level dB $\mu$ V	AC Line	EN55022 Limit	Class B Margin	Detector QP/Ave	Comments
0.193	47.0	Line	53.9	-6.9	Peak	
0.295	41.4	Line	50.4	-9.0	Peak	
0.563	39.5	Line	46.0	-6.5	Peak	
1.046	36.7	Line	46.0	-9.3	Peak	
14.047	38.2	Line	50.0	-11.8	Peak	
0.256	41.3	Neutral	51.6	-10.3	Peak	
0.373	38.7	Neutral	48.4	-9.7	Peak	
0.538	40.2	Neutral	46.0	-5.8	Peak	
13.140	33.1	Neutral	50.0	-16.9	Peak	

**Final quasi-peak and average readings**

Frequency MHz	Level dB $\mu$ V	AC Line	EN55022 Limit	Class B Margin	Detector QP/Ave	Comments
<b>0.193</b>	<b>37.5</b>	Line	53.9	<b>-16.4</b>	AVG	AVG (0.10s)
0.538	39.1	Neutral	56.0	-16.9	QP	QP (1.00s)
0.193	46.9	Line	63.9	-17.0	QP	QP (1.00s)
0.256	44.2	Neutral	61.6	-17.4	QP	QP (1.00s)
0.256	33.1	Neutral	51.6	-18.5	AVG	AVG (0.10s)
0.563	37.5	Line	56.0	-18.5	QP	QP (1.00s)
0.563	26.8	Line	46.0	-19.2	AVG	AVG (0.10s)
0.295	38.0	Line	60.4	-22.4	QP	QP (1.00s)
1.046	31.4	Line	56.0	-24.6	QP	QP (1.00s)
0.538	19.8	Neutral	46.0	-26.2	AVG	AVG (0.10s)
0.373	31.8	Neutral	58.4	-26.6	QP	QP (1.00s)
0.373	19.8	Neutral	48.4	-28.6	AVG	AVG (0.10s)
13.140	21.1	Neutral	50.0	-28.9	AVG	AVG (0.10s)
1.046	17.0	Line	46.0	-29.0	AVG	AVG (0.10s)
13.140	27.6	Neutral	60.0	-32.4	QP	QP (1.00s)
0.295	16.2	Line	50.4	-34.2	AVG	AVG (0.10s)

Client:	Summit Data Communications	Job Number:	J85128
Model:	SSD40L (802.11b/g/n)	T-Log Number:	T85340
Contact:	Sue White	Account Manager:	Christine Krebill
Standard:	FCC Part 15B, EN 301489-1 v1.8.1 & -17 v1.3.2	Class:	B

## Radiated Emissions

*(Elliott Laboratories Fremont Facility, Semi-Anechoic Chamber)*

### Test Specific Details

Objective: The objective of this test session is to perform final qualification testing of the EUT with respect to the specification listed above.

Date of Test: 12/22/2011  
 Test Engineer: Rafael Varelas  
 Test Location: Fremont Chamber #4

Config. Used: 1  
 Config Change: None  
 EUT Voltage: 230V/50Hz

### General Test Configuration

The EUT and any local support equipment were located on the turntable for radiated emissions testing.

The test distance and extrapolation factor (if applicable) are detailed under each run description.

Note, preliminary testing indicates that the emissions were maximized by orientation of the EUT and elevation of the measurement antenna. Maximized testing indicated that the emissions were maximized by orientation of the EUT, elevation of the measurement antenna, and manipulation of the EUT's interface cables.

### Ambient Conditions:

Temperature: 21.5 °C  
 Rel. Humidity: 34 %

### Summary of Results

Run #	Test Performed	Limit	Result	Margin
2	Radiated Emissions 30 - 1000 MHz, Maximized	Class B	Pass	20.6dB $\mu$ V/m @ 38.82MHz (-9.4dB)

### Modifications Made During Testing

No modifications were made to the EUT during testing

### Deviations From The Standard

No deviations were made from the requirements of the standard.

Client:	Summit Data Communications	Job Number:	J85128
Model:	SSD40L (802.11b/g/n)	T-Log Number:	T85340
Contact:	Sue White	Account Manager:	Christine Krebill
Standard:	FCC Part 15B, EN 301489-1 v1.8.1 & -17 v1.3.2	Class:	B

### Run #1: Preliminary Radiated Emissions, 30 - 1000 MHz

Frequency Range	Test Distance	Limit Distance	Extrapolation Factor
30 - 1000 MHz	5	10	-6.0

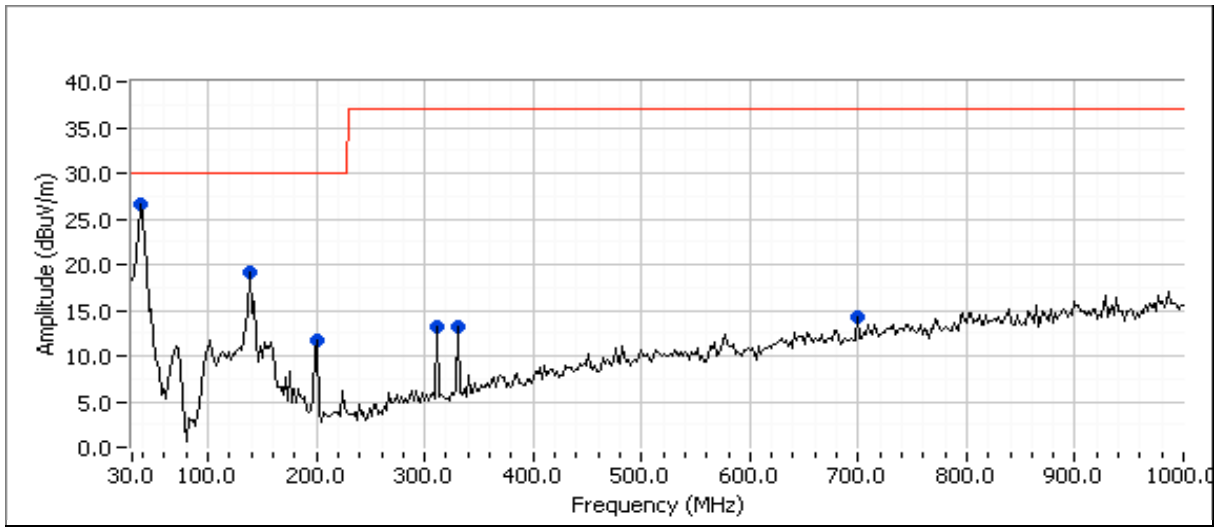

### Preliminary peak readings captured during pre-scan

Frequency MHz	Level dBµV/m	Pol v/h	EN55022 Class B		Detector Pk/QP/Avg	Azimuth degrees	Height meters	Comments
			Limit	Margin				
38.824	26.5	V	30.0	-3.5	Peak	216	1.0	
139.634	19.2	V	30.0	-10.8	Peak	249	1.5	
200.477	11.7	V	30.0	-18.3	Peak	261	1.0	
311.986	13.1	V	37.0	-23.9	Peak	282	1.0	
331.480	13.1	V	37.0	-23.9	Peak	301	1.0	
700.752	14.2	H	37.0	-22.8	Peak	268	3.5	

### Preliminary quasi-peak readings (no manipulation of EUT interface cables)

Frequency MHz	Level dBµV/m	Pol v/h	EN55022 Class B		Detector Pk/QP/Avg	Azimuth degrees	Height meters	Comments
			Limit	Margin				
331.480	13.4	V	37.0	-23.6	QP	271	1.0	QP (1.00s)
311.969	11.4	V	37.0	-25.6	QP	273	1.0	QP (1.00s)
700.752	8.0	H	37.0	-29.0	QP	264	1.0	QP (1.00s)
200.477	-0.2	V	30.0	-30.2	QP	247	1.0	QP (1.00s)
139.634	6.7	V	30.0	-23.3	QP	222	1.9	QP (1.00s)
38.824	20.6	V	30.0	-9.4	QP	211	1.0	QP (1.00s)



# EMC Test Data

Client:	Summit Data Communications	Job Number:	J85128
Model:	SSD40L (802.11b/g/n)	T-Log Number:	T85340
Contact:	Sue White	Account Manager:	Christine Krebill
Standard:	FCC Part 15B, EN 301489-1 v1.8.1 & -17 v1.3.2	Class:	B

**Run #2: Maximized Readings From Run #1**  
 Maximized quasi-peak readings (includes manipulation of EUT interface cables)

Frequency	Level	Pol	EN55022 Class B		Detector	Azimuth	Height	Comments
MHz	dB $\mu$ V/m	v/h	Limit	Margin	Pk/QP/Avg	degrees	meters	
38.824	20.6	V	30.0	-9.4	QP	211	1.0	QP (1.00s)
139.634	6.7	V	30.0	-23.3	QP	222	1.9	QP (1.00s)
331.480	13.4	V	37.0	-23.6	QP	271	1.0	QP (1.00s)
311.969	11.4	V	37.0	-25.6	QP	273	1.0	QP (1.00s)
700.752	8.0	H	37.0	-29.0	QP	264	1.0	QP (1.00s)
200.477	-0.2	V	30.0	-30.2	QP	247	1.0	QP (1.00s)

*End of Report*

This page is intentionally blank and marks the last page of this test report.