



**TEST REPORT**  
**FCC ID: TW8DGHP-5640**  
For  
dreamGEAR, LLC  
BT FIT BLUETOOTH EARBUDS-BLK

Model No. : DGHP-5640, EP-015, DGHP-5640S

Trade name : N/A

Prepared for : dreamGEAR, LLC  
Address : 20001 S. Western Avenue. Torrance, CA 90501,USA

Prepared by : Shenzhen Alpha Product Testing Co., Ltd.  
Address : Building B, East Area of Nanchang Second, Industrial Zone,  
Gushu 2nd Road, Bao'an, Shenzhen, China

Report No. : T1870825 09

Date of Receipt : May 20, 2017

Date of Test : May 20-June 04, 2017

Date of Report : June 04, 2017

Version Number : REV0

## TABLE OF CONTENT

Description	Page
<b>1 General Information -----</b>	<b>5</b>
1.1 Description of Device (EUT)-----	5
1.2 Description of Test Facility-----	6
<b>2 EMC Equipment List -----</b>	<b>6</b>
<b>3 Test Procedure-----</b>	<b>7</b>
<b>4 Summary of Measurement -----</b>	<b>8</b>
4.1 Summary of test result-----	8
4.2 Test connection-----	8
4.3 Assistant equipment used for test-----	9
4.4 Test mode-----	9
4.5 Test Conditions-----	9
4.6 Measurement Uncertainty (95% confidence levels, k=2)-----	10
<b>5 Spurious Emission-----</b>	<b>11</b>
5.1 Radiation Emission-----	11
5.1.1 Radiation Emission Limits(15.209)-----	11
5.1.2 Test Setup-----	11
5.1.3 Test Procedure-----	13
5.1.4 Test Equipment Setting For emission test Result-----	14
5.1.5 Test Condition-----	14
5.1.6 Test Result-----	14
<b>6 POWER LINE CONDUCTED EMISSION-----</b>	<b>20</b>
6.1 Conducted Emission Limits(15.207)-----	20
6.2 Test Setup-----	20
6.3 Test Procedure-----	21
6.4 Test Results-----	21
<b>7 Conducted Maximum Output Power-----</b>	<b>24</b>
7.1 Test limit-----	24
7.2 Test Procedure-----	24
7.3 Test Setup-----	24
7.4 Test Results-----	24
<b>8 PEAK POWER SPECTRAL DENSITY -----</b>	<b>25</b>
8.1 Test limit-----	25
8.2 Method of measurement-----	25
8.3 Test Setup-----	25
8.4 Test Results-----	26
<b>9 Bandwidth-----</b>	<b>29</b>
9.1 Test limit-----	29
9.2 Method of measurement-----	29
9.3 Test Setup-----	29
9.4 Test Results-----	29
<b>10 Band Edge Check -----</b>	<b>32</b>
10.1 Test limit-----	32
10.2 Test Procedure-----	32
10.3 Test Setup-----	32

---

10.4	Test Result	32
<b>11</b>	<b>Antenna Requirement</b>	<b>36</b>
11.1	Standard Requirement	36
11.2	Antenna Connected Construction	36
11.3	Result	36
<b>12</b>	<b>Photographs of Setup</b>	<b>37</b>
<b>13</b>	<b>Photographs of EUT</b>	<b>39</b>

# DECLARATION

Applicant : dreamGEAR, LLC  
 Manufacturer : Shenzhen Ground Enterprises Co.,Ltd  
 Product : BT FIT BLUETOOTH EARBUDS-BLK  
 (A)Model No. : DGHP-5640, EP-015, DGHP-5640S  
 (B)Trade Name : N/A  
 (C)Power supply : DC 3.7V from internal battery or DC 5V From USB port

Measurement Standard Used:

**FCC Rules and Regulations Part 15 Subpart C Section 15.247: 2016,**

**ANSI C 63.4-2014, ANSI C63.10-2013**

The device described above is tested by Shenzhen Alpha Product Testing Co., Ltd. to determine the maximum emission levels emanating from the device. The maximum emission levels are compared to the FCC Part 15 Subpart B Class B limits both conducted and radiated emissions. The test results are contained in this test report and Shenzhen Alpha Product Testing Co., Ltd. is assumed of full responsibility for the accuracy and completeness of these tests.

After the test, our opinion is that EUT compliance with the requirement of the above standards. This report applies to above tested sample only. This report shall not be reproduced in parts without written approval of Shenzhen Alpha Product Testing Co., Ltd.

Tested by (name + signature).....: Eric Huang  
 Project Engineer

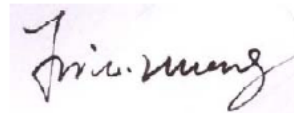

Approved by (name + signature).....: Simple Guan  
 Project Manager

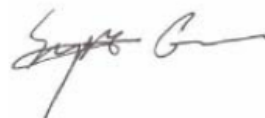

Date of issue..... : June 04, 2017

# 1 General Information

## 1.1 Description of Device (EUT)

Trade Name : N/A

EUT : BT FIT BLUETOOTH EARBUDS-BLK

Model No. : DGHP-5640, EP-015, DGHP-5640S

DIFF : Only mode name different

Radio Technology : Bluetooth 4.2

Antenna Type : PCB Antenna, Maximum Gain is 0dBi

Operation Frequency : 2402-2480MHz

Channel number : 40 Channels

Modulation type : GFSK

Power Supply : DC 3.7V from internal battery or DC 5V From USB port

Applicant : dreamGEAR, LLC

Address : 88A, Tanjong Pagar Road, Singapore 088509

Manufacturer : Shenzhen Ground Enterprises Co., Ltd

Address : RM 607, Building F, MingYueHuaDu, Gonghe Industrial Rd, Xixiang, Bao An District, Shenzhen, China 518102

## 1.2 Description of Test Facility

Shenzhen Alpha Product Testing Co., Ltd  
 Building B, East Area of Nanchang Second, Industrial Zone, Gushu 2nd Road,  
 Bao'an, Shenzhen, China

March 25, 2015 File on Federal Communication Commission  
 Registration Number: 203110

July 18, 2014 Certificated by IC  
 Registration Number: 12135A

## 2 EMC Equipment List

Equipment	Manufacture	Model No.	Serial No.	Last cal.	Cal Interval
3m Semi-Anechoic	ETS-LINDGREN	N/A	SEL0017	2016.09.29	1Year
Spectrum analyzer	Agilent	E4407B	MY46185649	2016.09.29	1Year
Receiver	R&S	ESCI	1166.5950K03-1011	2016.09.29	1Year
Receiver	R&S	ESCI	101202	2016.09.29	1Year
Bilog Antenna	Schwarzbeck	VULB 9168	VULB9168-438	2016.09.30	2Year
Horn Antenna	EMCO	3115	640201028-06	2016.09.30	2Year
Active Loop Antenna	Beijing Daze	ZN30900A	SEL0097	2016.09.30	2Year
Cable	Resenberger	N/A	No.1	2016.09.29	1Year
Cable	SCHWARZBECK	N/A	No.2	2016.09.29	1Year
Cable	SCHWARZBECK	N/A	No.3	2016.09.29	1Year
Pre-amplifier	Schwarzbeck	BBV9743	9743-019	2016.09.29	1Year
Pre-amplifier	R&S	AFS33-18002650-30-8P-44	SEL0080	2016.09.29	1Year
Base station	Agilent	E5515C	GB44300243	2016.09.29	1 Year
Temperature controller	Terchy	MHQ	120	2016.09.29	1Year

Power divider	Anritsu	K240C	020346	2016.09.29	1 Year
Signal Generator	HP	83732B	VS3449051	2016.09.29	1 Year
Power Meter	Anritsu	ML2487A	6K00001491	2016.09.29	1 Year
Power sensor	Anritsu	ML2491A	32516	2016.09.29	1 Year
L.I.S.N.#1	Schwarzbeck	NSLK8126	8126466	2016.09.29	1 Year
L.I.S.N.#2	ROHDE&SCHWARZ	ENV216	101043	2016.09.29	1 Year

### 3 Test Procedure

**POWER LINE CONDUCTED INTERFERENCE:** The test procedure used was ANSI Standard ANSI C63.4:2014 using a 50 u H LISN. Both Lines were observed. The bandwidth of the receiver was 10kHz with an appropriate sweep speed. The ambient temperature of the EUT was 25°C with a humidity of 58%.

**RADIATION INTERFERENCE:** The test procedure used was ANSI Standard ANSI C63.4:2014 using a ANRITSU spectrum analyzer with a pre-selector. The analyzer was calibrated in dB above a micro volt at the output of the antenna. The resolution bandwidth was 100kHz and the video bandwidth was 300 kHz up to 1 GHz and 1 MHz with a video BW of 3MHz above 1 GHz. The ambient temperature of the EUT was 25°C with a humidity of 58%.

**FORMULA OF CONVERSION FACTORS:** The Field Strength at 3m was established by adding the meter reading of the spectrum analyzer (which is set to read in units of dBuV) to the antenna correction factor supplied by the antenna manufacturer and cable loss. The antenna correction factors and cable loss are stated in terms of dB. The gain of the Pre-selector was accounted for in the Spectrum Analyzer Meter Reading.

Example:

Freq (MHz) METER READING + ACF + CABLE = FS

33.20 dBuV + 10.36 dB + 0.9 dB= 44.46 dBuV/m @ 3m

**ANSI STANDARD ANSI C63.4:2014 10.1.7 MEASUREMENT PROCEDURES:** The EUT was placed on a table 80 cm high and with dimensions of 1m by 1.5m. The EUT was placed in the center of the table (1.5m side). The table used for radiated measurements is capable of continuous rotation. When an emission was found, the table was rotated to produce the maximum signal strength. At this point, the antenna was raised and lowered from 1m to 4m. The antenna was placed in both the horizontal and vertical planes. The situation was similar for the conducted measurement except that the table did not rotate. The EUT was setup as described in ANSI Standard ANSI C63.4:2014 10.1.7 with the EUT 40 cm from the vertical ground wall.

## 4 Summary of Measurement

### 4.1 Summary of test result

Test Item	Test Requirement	Standards Paragraph	Result
Spurious Emission	FCC PART 15:2016	Section 15.247&15.209	Compliance
Conduction Emission	FCC PART 15:2016	Section 15.207	Compliance
Bandwidth Test	FCC PART 15:2016	Section 15.247	Compliance
Peak Power	FCC PART 15:2016	Section 15.247	Compliance
Power Density	FCC PART 15:2016	Section 15.247	Compliance
Band Edge	FCC PART 15:2016	Section 15.247	Compliance
Antenna Requirement	FCC PART 15:2016	Section 15.203	Compliance

Note: The EUT has been tested as an independent unit. And Continual Transmitting in maximum power (The adapter be used during Test)

### 4.2 Assistant equipment used for test

Description	:	Notebook
Manufacturer	:	ACER
Model No.	:	ZQT
Remark: FCC DOC approved		



### 4.3 Test connection

1. For radiated emissions test: EUT was placed on a turn table, which is 0.8 meter high above ground. EUT was be set into BT test mode by adb.exe software before test.

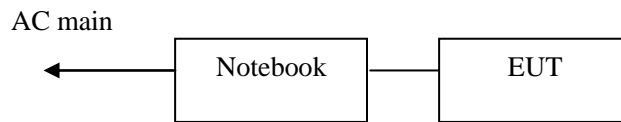

2. For Power Line Conducted Emissions Test: EUT was connected to notebook by 0.6m USB line

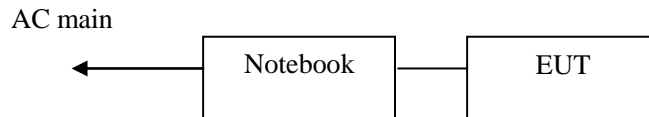

### 4.4 Assistant equipment used for test

Description : N/A  
 Manufacturer : N/A  
 Model No. : N/A  
 Remark: N/A

### 4.5 Test mode

Tested mode, channel, and data rate information		
Mode	Channel	Frequency (MHz)
GFSK	Low :CH1	2402
	Middle: CH20	2440
	High: CH40	2480

### 4.6 Test Conditions

Temperature range	21-25°C
Humidity range	40-75%
Pressure range	86-106kPa

## 4.7 Measurement Uncertainty (95% confidence levels, k=2)

Item	MU	Remark
Uncertainty for Power point Conducted Emissions Test	2.71dB	
Uncertainty for Radiation Emission test in 3m chamber (below 30MHz)	2.13 dB	Polarize: V
	2.57dB	Polarize: H
Uncertainty for Radiation Emission test in 3m chamber (30MHz to 1GHz)	3.90 dB	Polarize: V
	3.92dB	Polarize: H
Uncertainty for Radiation Emission test in 3m chamber (1GHz to 25GHz)	4.26 dB	Polarize: H
	4.28 dB	Polarize: V
Uncertainty for radio frequency	$1 \times 10^{-9}$	
Uncertainty for DC and low frequency voltages	0.06%	

## 5 Spurious Emission

### 5.1 Radiation Emission

#### 5.1.1 Radiation Emission Limits(15.209)

Frequencies (MHz)	Field Strength (micorvolts/meter)	Measurement Distance (meters)
0.009~0.490	2400/F(KHz)	300
0.490~1.705	24000/F(KHz)	30
1.705~30.0	30	30
30~88	100	3
88~216	150	3
216~960	200	3
Above 960	500	3

Harmonic emissions limits comply with below 54 dBuV/m at 3m. Other emissions radiated outside of the specified frequency bands, except for harmonics, shall be attenuated by at least 50 dB below the level of the fundamental or comply with the radiated emissions limits specified in section 15.209(a) limit in the table below has to be followed.

**NOTE:**

- a) The tighter limit applies at the band edges.
- b) Emission Level(dB uV/m)=20log Emission Level(uv/m)

#### 5.1.2 Test Setup

See the next page

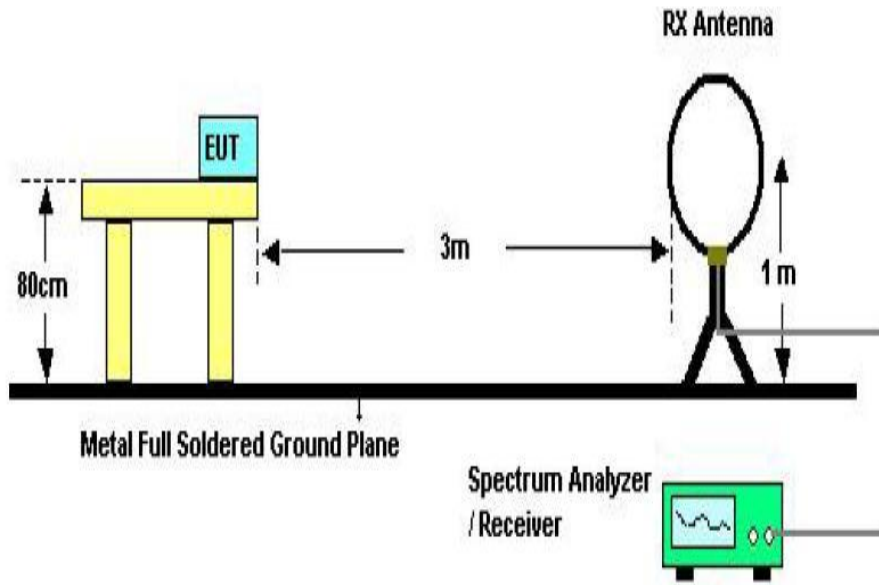

Below 30MHz Test Setup

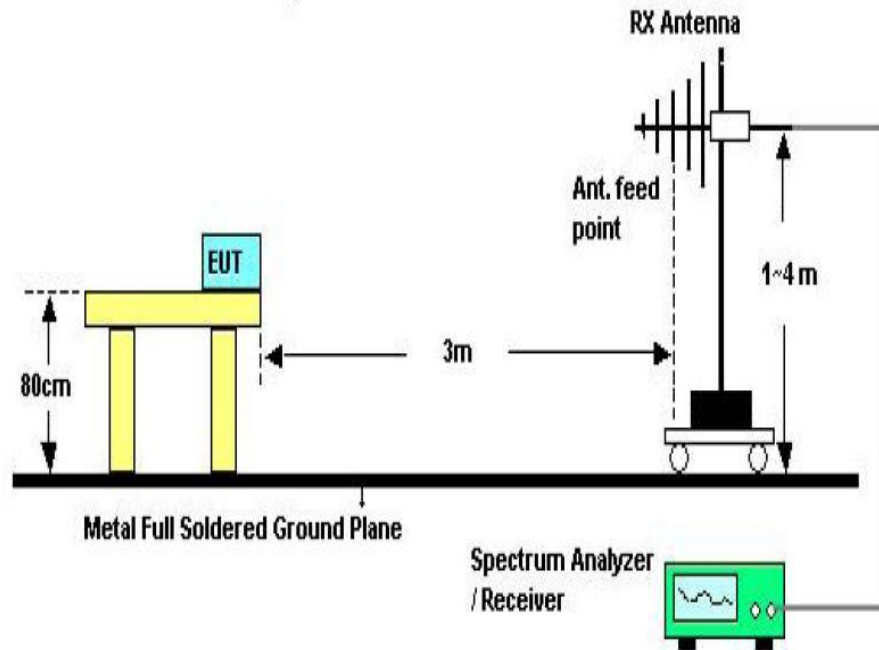

Above 30MHz Test Setup

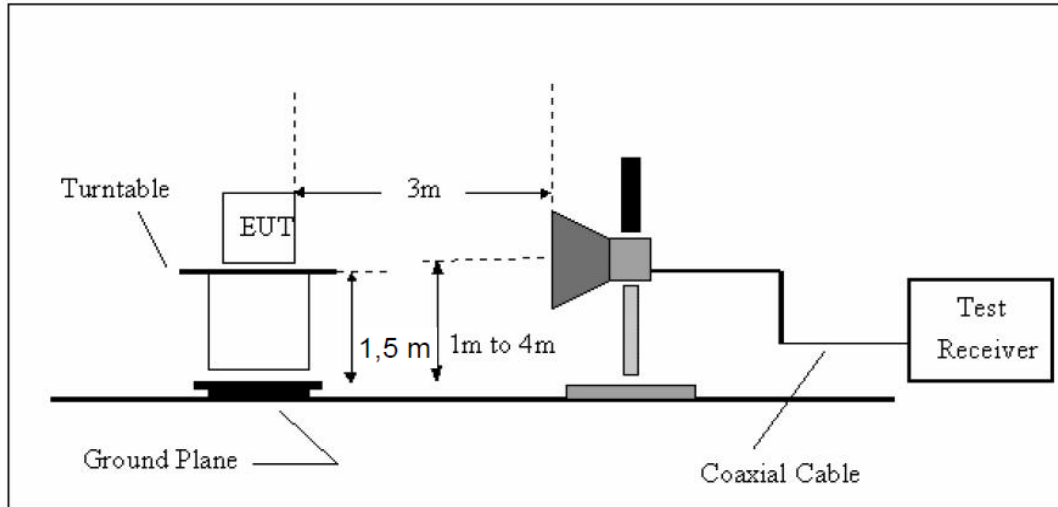

Above 1GHz Test Setup

### 5.1.3 Test Procedure

- a) The measuring distance of 3m shall be used for measurements at frequency up to 1GHz and above 1GHz, The EUT was placed on a rotating 0.8 m high above ground for below 1GHz and 1.5m high for above 1GHz testing, The table was rotated 360 degrees to determine the position of the highest radiation
- b) The Test antenna shall vary between 1m and 4m, Both Horizontal and Vertical antenna are set of make measurement.
- c) The initial step in collecting conducted emission data is a spectrum analyzer Peak detector mode pre-scanning the measurement frequency range. Significant Peaks are then marked. and then Qusia Peak Detector mode premeasured
- d) If Peak value comply with QP limit Below 1GHz. The EUT deemed to comply with QP limit. But the Peak value and average value both need to comply with applicable limit above 1GHz.
- e) For the actual test configuration, please see the test setup photo.

#### 5.1.4 Test Equipment Setting For emission test Result

9KHz~150KHz	RBW 200Hz	VBW1KHz
150KHz~30MHz	RBW 9KHz	VBW 30KHz
30MHz~1GHz	RBW 120KHz	VBW 300KHz
Above 1GHz	RBW 1MHz	VBW 3MHz

#### 5.1.5 Test Condition

Continual Transmitting in maximum power.

#### 5.1.6 Test Result

We have scanned the 10th harmonic from 9KHz to the EUT.  
Detailed information please see the following page.

From 9KHz to 30MHz: Conclusion: PASS

Note: The amplitude of spurious emissions which are attenuated by more than 20dB below the permissible value has no need to be reported.

Remark: Only show the test data of the worst Channel in this report.

From 30MHz to 1000MHz: Conclusion: PASS



Site: LAB	Polarization: <b>Horizontal</b>	Temperature: 23.5
Limit: FCC Part15 Class B Radiation	Power:	Humidity: 51 %
EUT:	Distance: 3m	
M/N: DGHP-5640		
Mode:		
Note:		

**Radiated Emission Measurement**

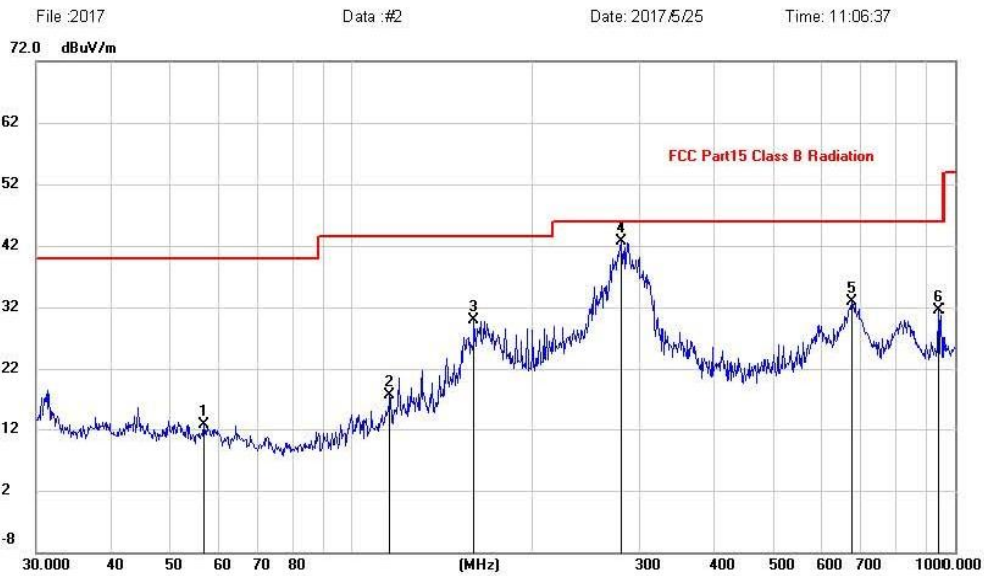

No.	Mk.	Freq.	Reading Level	Correct Factor	Measurement	Limit	Margin	Antenna Height	Table Degree	
		MHz	dBuV	dB	dBuV/m	dBuV/m	dB	cm	degree	Comment
1		56.7917	-0.40	13.08	12.68	40.00	-27.32			peak
2		115.7256	5.52	12.14	17.66	43.50	-25.84			peak
3		159.7844	15.25	14.58	29.83	43.50	-13.67			peak
4	*	280.0237	29.70	12.97	42.67	46.00	-3.33			peak
5		675.2080	12.09	20.82	32.91	46.00	-13.09			peak
6		942.1305	8.28	23.18	31.46	46.00	-14.54			peak

**Notes:** Above is below 1GHz test data. This report only shall the worst case mode for TX 2402MHz.



From 1G-25GHz

<b>EUT</b>	BT FIT BLUETOOTH EARBUDS-BLK	<b>Model Name</b>	DGHP-5640
<b>Temperature</b>	24°C	<b>Relative Humidity</b>	56%
<b>Pressure</b>	960hPa	<b>Test voltage</b>	DC 3.7V From battery
<b>Test Mode</b>	TX Low		

Antenna Polarity: Vertical									
No	Freq (MHz)	Read Level (dBuV/m)	Antenna Factor (dB/m)	Cable loss(d B)	Amp Factor (dB)	Result (dBuV/m)	Limit (dBuV/m)	Margin (dB)	Remark
1	4804	42.22	33.95	10.18	34.26	52.09	74	21.91	PK
2	4804	32.52	33.95	10.18	34.26	42.39	54	11.61	AV
3	7206	/							
4	9608	/							
5	12010	/							
Antenna Polarity: Horizontal									
1	4804	42.44	33.95	10.18	34.26	52.31	74	21.69	PK
2	4804	33.28	33.95	10.18	34.26	43.15	54	10.85	AV
3	7206	/							
4	9608	/							
5	12010	/							
<b>Note:</b> 1, Measuring frequency from 1GHz to 25GHz 2, Spectrum Set for PK measure: RBW=1MHz, VBW=1MHz, Sweep time=Auto, Detector: PK 2, Spectrum Set for AV measure: RBW=1MHz, VBW=3MHz, Sweep time=Auto, Detector: RMS 3, Result = Read level + Antenna factor + cable loss - Amp factor 4, All the other emissions not reported were too low to read and deemed to comply with FCC limit.									

<b>EUT</b>	BT FIT BLUETOOTH EARBUDS-BLK	<b>Model Name</b>	DGHP-5640
<b>Temperature</b>	24°C	<b>Relative Humidity</b>	56%
<b>Pressure</b>	960hPa	<b>Test voltage</b>	DC 3.7V From battery
<b>Test Mode</b>	TX Mid		

Antenna Polarity: Vertical									
No	Freq (MHz)	Read Level (dBuV/m)	Antenna Factor (dB/m)	Cable loss(dB)	Amp Factor (dB)	Result (dBuV/m)	Limit (dBuV/m)	Margin (dB)	Remark
1	4880	41.93	33.93	10.2	34.29	51.77	74	22.23	PK
2	4880	30.82	33.93	10.2	34.29	40.66	54	13.34	AV
3	7320	/							
4	9760	/							
5	12200	/							
Antenna Polarity: Horizontal									
1	4880	41.6	33.93	10.2	34.29	51.44	74	22.56	PK
2	4880	32.85	33.93	10.2	34.29	42.69	54	11.31	AV
3	7320	/							
4	9760	/							
5	12200	/							
<p>Note:</p> <p>1, Measuring frequency from 1GHz to 25GHz</p> <p>2,Spectrum Set for PK measure: RBW=1MHz, VBW=1MHz, Sweep time=Auto, Detector: PK</p> <p>2,Spectrum Set for AV measure: RBW=1MHz, VBW=3MHz, Sweep time=Auto, Detector: RMS</p> <p>3, Result = Read level + Antenna factor + cable loss-Amp factor</p> <p>4, All the other emissions not reported were too low to read and deemed to comply with FCC limit.</p>									

<b>EUT</b>	BT FIT BLUETOOTH EARBUDS-BLK	<b>Model Name</b>	DGHP-5640
<b>Temperature</b>	26°C	<b>Relative Humidity</b>	56%
<b>Pressure</b>	960hPa	<b>Test voltage</b>	DC 3.7V From battery
<b>Test Mode</b>	TX High		

Antenna Polarity: Vertical									
No	Freq (MHz)	Read Level (dBUV/m)	Antenna Factor (dB/m)	Cable loss (dB)	Amp Factor (dB)	Result (dBUV/m)	Limit (dBUV/m)	Margin (dB)	Remark
1	4960	41.35	33.98	10.22	34.25	51.3	74	22.7	PK
2	4960	31.4	33.98	10.22	34.25	41.35	54	12.65	AV
3	7440	/							
4	9920	/							
5	12400	/							
Antenna Polarity: Horizontal									
1	4960	41.55	33.98	10.22	34.25	51.5	74	22.5	PK
2	4960	30.72	33.98	10.22	34.25	40.67	54	13.33	AV
3	7440	/							
4	9920	/							
5	12400	/							
<p>Note:</p> <p>1, Measuring frequency from 1GHz to 25GHz</p> <p>2, Spectrum Set for PK measure: RBW=1MHz, VBW=1MHz, Sweep time=Auto, Detector: PK</p> <p>2, Spectrum Set for AV measure: RBW=1MHz, VBW=3MHz, Sweep time=Auto, Detector: RMS</p> <p>3, Result = Read level + Antenna factor + cable loss - Amp factor</p> <p>4, All the other emissions not reported were too low to read and deemed to comply with FCC limit.</p>									

## 6 POWER LINE CONDUCTED EMISSION

### 6.1 Conducted Emission Limits(15.207)

Frequency MHz	Limits dB( $\mu$ V)	
	Quasi-peak Level	Average Level
0.15 -0.50	66 -56*	56 - 46*
0.50 -5.00	56	46
5.00 -30.00	60	50

Notes: 1. \*Decreasing linearly with logarithm of frequency.

2. The lower limit shall apply at the transition frequencies.

3. The limit decreases in line with the logarithm of the frequency in the rang of 0.15 to 0.50 MHz.

### 6.2 Test Setup

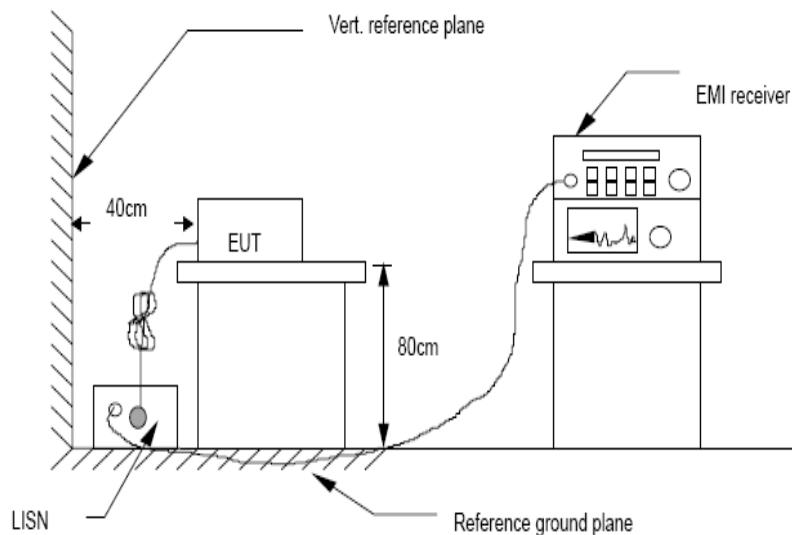

### 6.3 Test Procedure

The EUT is put on the plane 0.8m high above the ground by insulating support and is connected to the power mains through a line impedance stabilization network (L.I.S.N.). This provides a 50ohm coupling impedance for the EUT system. Please refer the block diagram of the test setup and photographs. Both sides of AC lines are checked to find out the maximum conducted emission. In order to find the maximum emission levels, the relative positions of equipment and all of the interface cables shall be changed according to ANSI C63.4:2014 on Conducted Emission Measurement. The bandwidth of test receiver (R & S ESCDLB ECHO 50) is set at 9 kHz.

### 6.4 Test Results

PASS. (See below detailed test data)

Site: LAB Phase: **L1** Temperature: 24.2  
 Limit: FCC Part 15 CLASS B QP Power: Humidity: 53 %  
 EUT: BT FIT BLUE TOOTH EARBUDS-BLK  
 M/N: DGHP-5640  
 Mode:  
 Note:

**Conducted Emission Measurement**

File: BT FIT BLUE TOOTH EARBUD Data: #3 Date: 2017-5-23 Time: 22:03:57

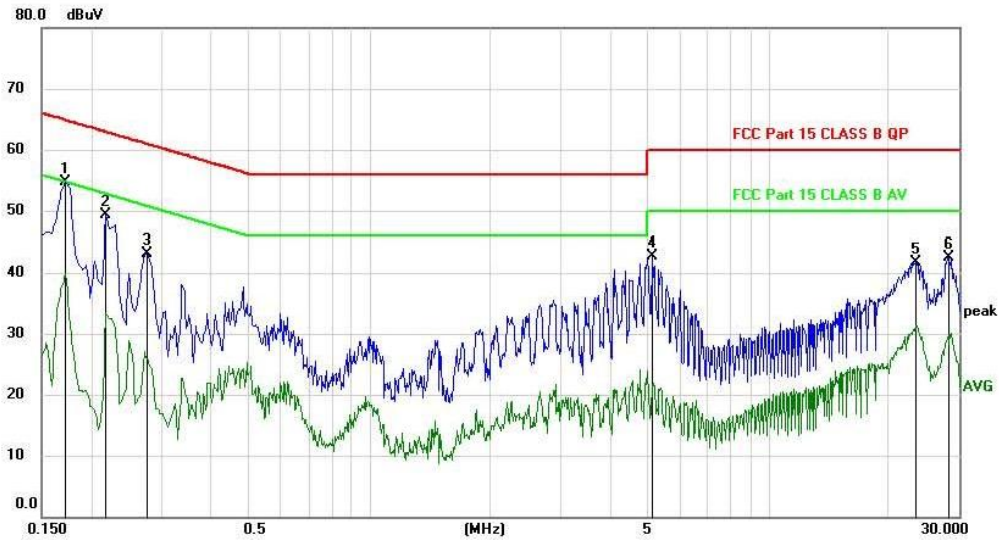

No.	Mk.	Freq. MHz	Reading Level dBuV	Correct Factor dB	Measure- ment dBuV	Limit dBuV	Margin dB	Detector	Comment
1	*	0.1725	45.05	9.66	54.71	64.84	-10.13	peak	
2		0.2175	39.62	9.68	49.30	62.91	-13.61	peak	
3		0.2760	33.43	9.69	43.12	60.94	-17.82	peak	
4		5.1270	32.58	10.16	42.74	60.00	-17.26	peak	
5		23.3295	31.10	10.67	41.77	60.00	-18.23	peak	
6		28.2525	31.51	10.91	42.42	60.00	-17.58	peak	

Site: LAB Phase: **N** Temperature: 24.2  
 Limit: FCC Part 15 CLASS B QP Power: DC 5V Humidity: 53 %  
 EUT: BT FIT BLUE TOOTH EARBUDS-BLK  
 M/N: DGHP-5640  
 Mode:  
 Note:

**Conducted Emission Measurement**

File: BT FIT BLUE TOOTH EARBUD Data: #4 Date: 2017-5-23 Time: 22:05:33

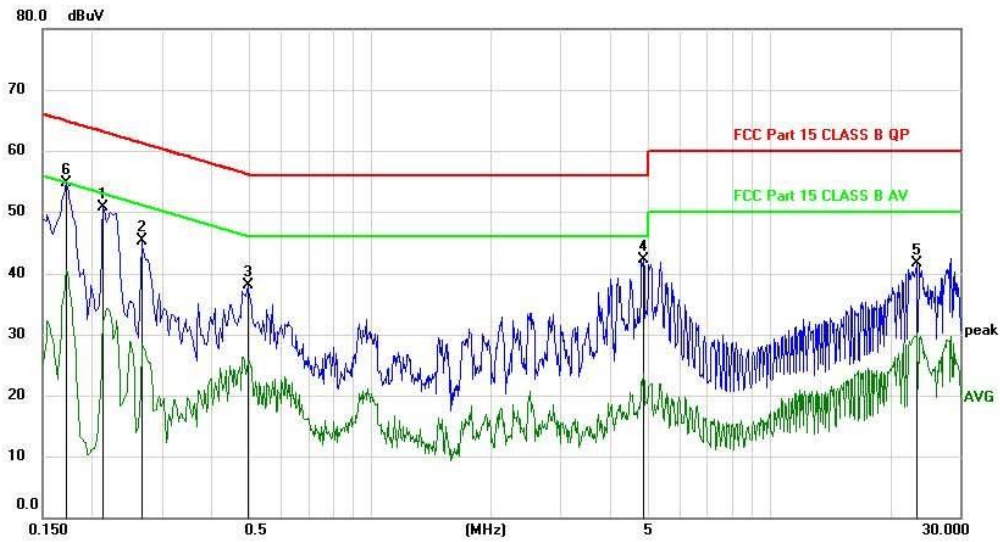

No.	Mk.	Freq. MHz	Reading Level dBuV	Correct Factor dB	Measure- ment dBuV	Limit dBuV	Margin dB	Detector	Comment
1		0.2130	41.05	9.68	50.73	63.09	-12.36	peak	
2		0.2670	35.59	9.69	45.28	61.21	-15.93	peak	
3		0.4920	28.35	9.71	38.06	56.13	-18.07	peak	
4		4.8345	32.21	10.15	42.36	56.00	-13.64	peak	
5		23.3835	31.01	10.67	41.68	60.00	-18.32	peak	
6	*	0.1725	45.05	9.66	54.71	64.84	-10.13	peak	

## 7 Conducted Maximum Output Power

### 7.1 Test limit

Please refer section RSS-247 & 15.247.

### 7.2 Test Procedure

Details see the KDB558074 Meas Guidance V03

7.2.1 Place the EUT on the table and set it in transmitting mode.

7.2.2 Measure out each mode and each bands peak output power of EUT.

Note: The cable loss and attenuator loss were offset into measure device as amplitude offset.

Details see the KDB558074 DTS Meas Guidance V03

### 7.3 Test Setup

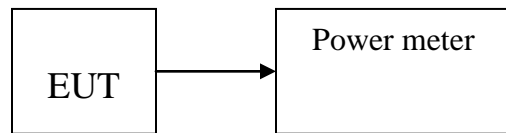

### 7.4 Test Results

**PASS**

Detailed information please see the following page.

Channel	Frequency (MHz)	PK Output Power (dBm)	PK Output Power (mW)	Limit (dBm)
CH1	2402	1.40	1.38	30
CH20	2440	1.88	1.54	30
CH40	2480	1.61	1.45	30



## 8 PEAK POWER SPECTRAL DENSITY

### 8.1 Test limit

8.1.1 Please refer section RSS-247 & 15.247.

8.1.2 For direct sequence systems, the peak power spectral density conducted from the intentional radiator to the antenna shall not be greater than 8dBm in any 3kHz band during any time interval of continuous transmission.

8.1.3 The direct sequence operating of the hybrid system, with the frequency hopping operation turned off, shall comply with the power density requirements of paragraph (d) of this section.

### 8.2 Method of measurement

Details see the KDB558074 DTS Meas Guidance V03

8.2.1 Place the EUT on the table and set it in transmitting mode.

8.2.2 Remove the antenna from the EUT and then connect a low loss RF cable from the antenna port to the spectrum analyzer.

8.2.3 Set the spectrum analyzer as RBW = 3kHz, VBW = 10kHz, span=5-30%EBW, detail see the test plot.

8.2.4 Record the max reading.

8.2.5 Repeat the above procedure until the measurements for all frequencies are completed.

### 8.3 Test Setup

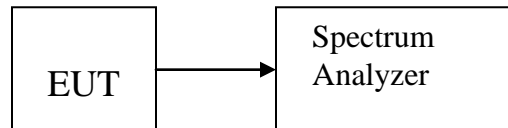

## 8.4 Test Results

PASS.

Detailed information please see the following page.

Channel	Frequency (MHz)	Power Spectral Density (dBm)	Limit (dBm)	Result
CH1	2402	-20.136	8	PASS
CH20	2440	-19.777	8	PASS
CH40	2480	-19.982	8	PASS

CH Low :

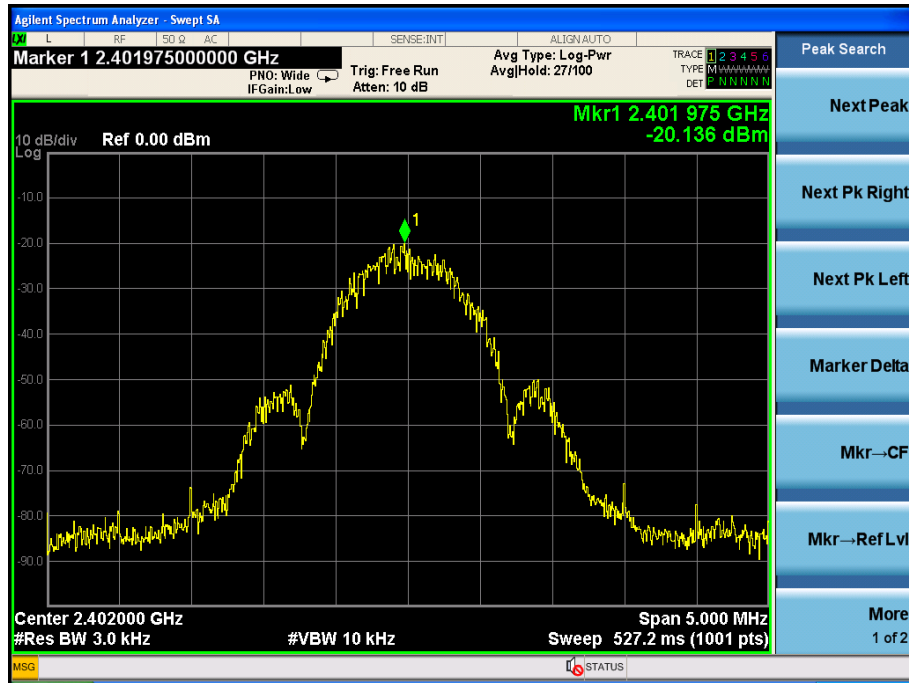

CH Mid:

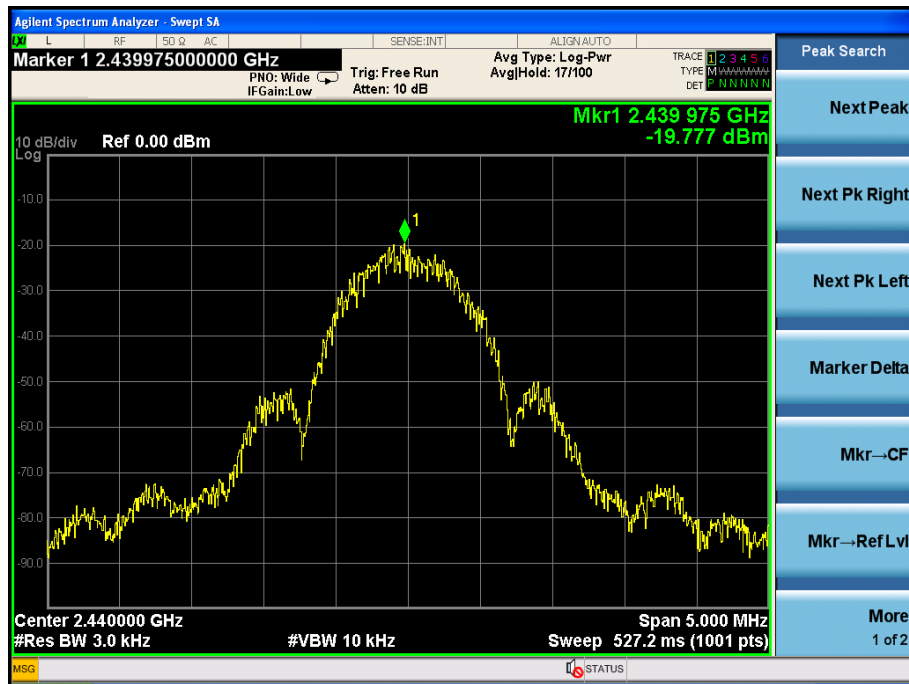

CH Hig:

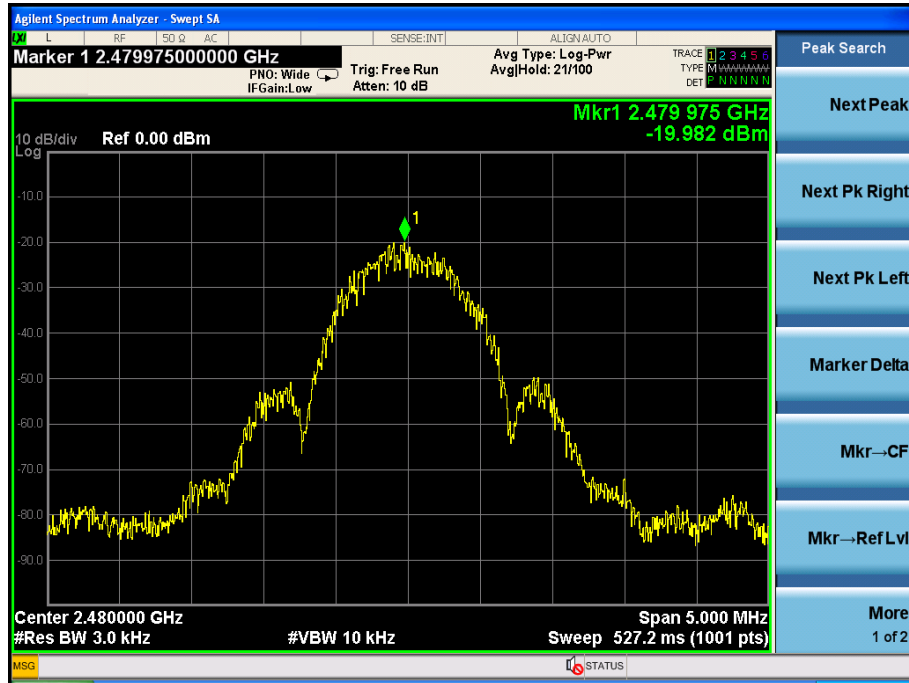

## 9 Bandwidth

### 9.1 Test limit

Please refer section RSS-247 & 15.247

For direct sequence systems, the minimum 6dB bandwidth shall be at least 500 kHz.

### 9.2 Method of measurement

Details see the KDB558074 D01 Meas Guidance

- a) The bandwidth is measured at an amplitude level reduced 20dB from the reference level. The reference level is the level of the highest amplitude signal observed from the transmitter at the fundamental frequency. Once the reference level is established, the equipment is conditioned with typical modulating signal to produce the worst-case (i.e. the widest) bandwidth.
- b) The test receiver set RBW = 100kHz, VBW  $\geq$  3RBW, Sweep time set auto, detail see the test plot.

### 9.3 Test Setup

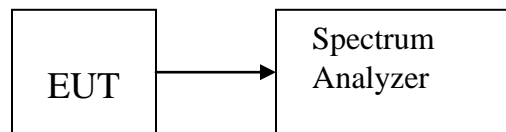

### 9.4 Test Results

PASS.

Detailed information please see the following page.

Channel	Frequency (MHz)	6dB Bandwidth (MHz)	Limit (MHz)	Result
CH1	2402	0.6958	0.5	PASS
CH20	2440	0.6918	0.5	PASS
CH40	2480	0.6964	0.5	PASS

:  
CH Low :

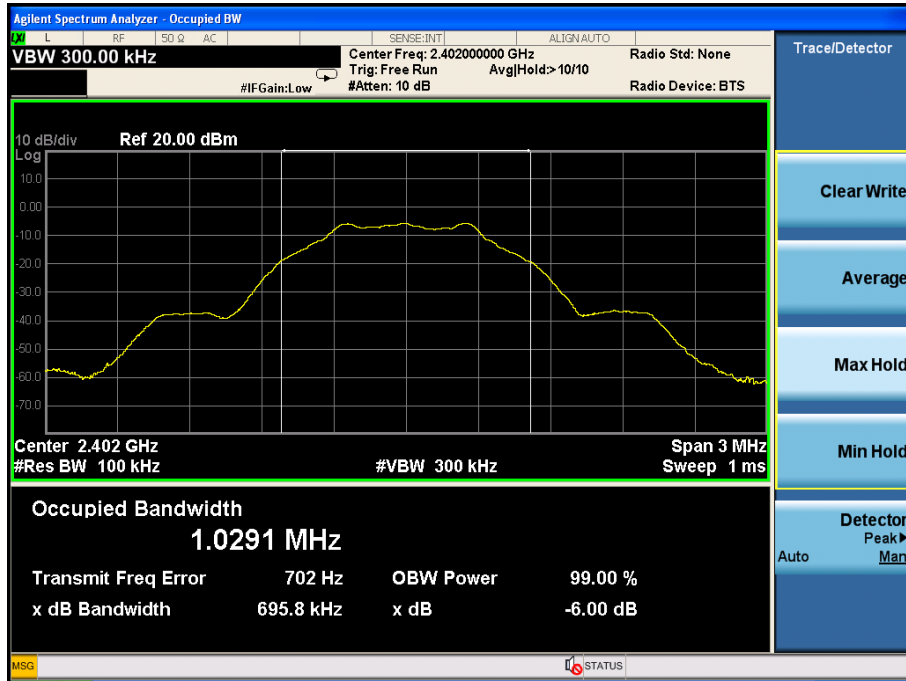

CH Mid :

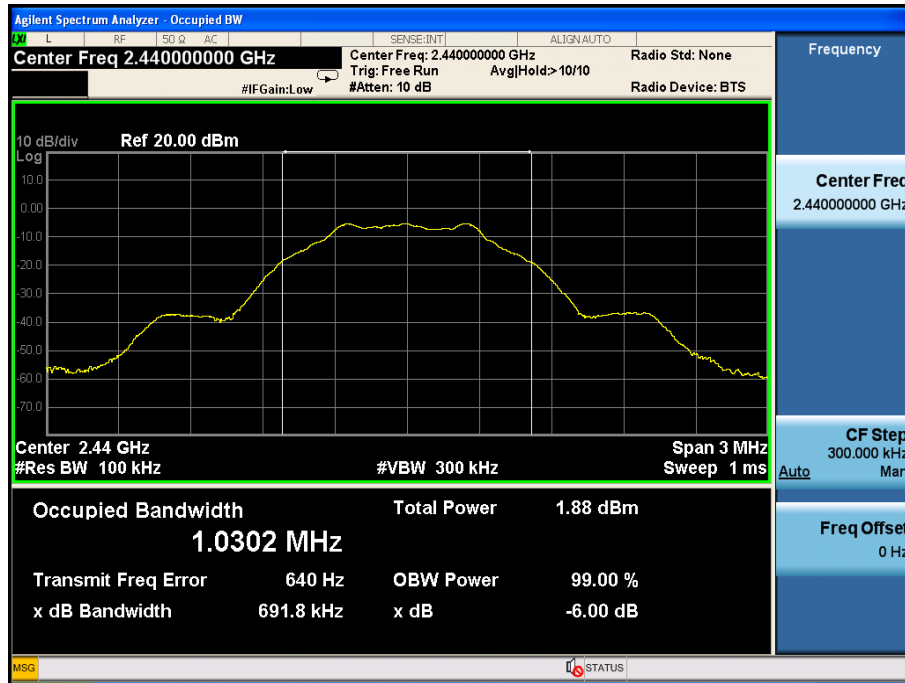

CH High :

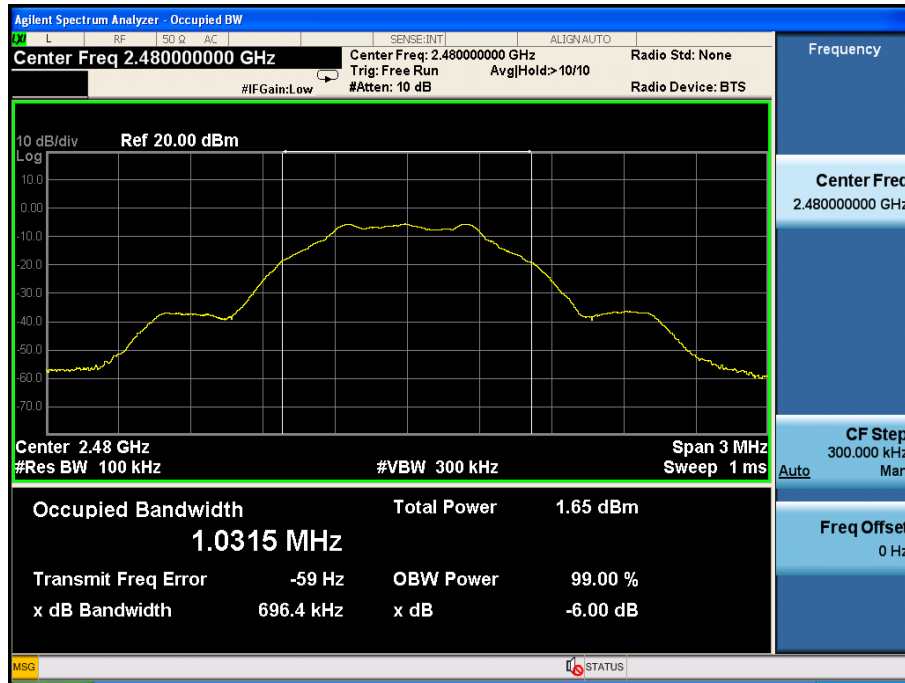

## 10 Band Edge Check

### 10.1 Test limit

Please refer section RSS-GEN&15.247.

### 10.2 Test Procedure

12.2.1 Put the EUT on a 0.8m high table, power on the EUT. Emissions were scanned and measured rotating the EUT to 360 degrees, Find the maximum Emission

12.2.2 Check the spurious emissions out of band.

12.2.3 RBW 1MHz ,VBW 3MHz ,peak detector for peak value , RBW 1MHz ,VBW 3MHz ,RMS detector for AV value.

### 10.3 Test Setup

Same as 5.2.2.

### 10.4 Test Result

PASS.

Detailed information please see the following page.



Radiated Method:  
GFSK

Band Edge Test result								
EUT: BT FIT BLUETOOTH EARBUDS-BLK					M/N: DGHP-5640			
Power: DC 3.7V From battery								
Test date: 2017-05-20 Test site: 3m Chamber Tested by: Reak								
Test mode: Tx Low								
Antenna polarity: Vertical								
Freq (MHz)	Read Level (dBUV/m)	Antenna Factor (dB/m)	Cable loss(dB)	Amp Factor (dB)	Result (dBUV/m)	Limit (dBUV/m)	Margin (dB)	Remark
2390	43.29	27.62	3.94	34.97	39.88	74	34.12	<b>PK</b>
2390	--	27.62	3.94	34.97	--	54	--	<b>AV</b>
Antenna Polarity: Horizontal								
2390	42.65	27.62	3.94	34.97	39.24	74	34.76	<b>PK</b>
2390	--	27.62	3.94	34.97	--	54	--	<b>AV</b>
Note:								
1, Spectrum Set for PK measure: RBW=1MHz, VBW=1MHz, Sweep time=Auto, Detector: PK								
2, Spectrum Set for AV measure: RBW=1MHz, VBW=3MHz, Sweep time=Auto, Detector: RMS								
3, Result = Read level + Antenna factor + cable loss-Amp factor								
4, All the other emissions not reported were too low to read and deemed to comply with FCC limit.								

Band Edge Test result								
EUT: BT FIT BLUETOOTH EARBUDS-BLK					M/N: DGHP-5640			
Power: DC 3.7V From battery								
Test date: 2017-05-20 Test site: 3m Chamber Tested by: Reak								
Test mode: Tx High								
Antenna polarity: Vertical								
Freq (MHz)	Read Level (dBUV/m)	Antenna Factor (dB/m)	Cable loss(dB)	Amp Factor (dB)	Result (dBUV/m)	Limit (dBUV/m)	Margin (dB)	Remark
2483.5	43.97	27.89	4	34.97	40.89	74	33.11	<b>PK</b>
2483.5		--	--	--	--	54	--	AV
Antenna Polarity: Horizontal								
2483.5	42.35	27.89	4	34.97	39.27	74	34.73	<b>PK</b>
2483.5		--	--	--	--	54	--	AV
Note:								
1, Spectrum Set for PK measure: RBW=1MHz, VBW=1MHz, Sweep time=Auto, Detector: PK								
2, Spectrum Set for AV measure: RBW=1MHz, VBW=3MHz, Sweep time=Auto, Detector: RMS								
3, Result = Read level + Antenna factor + cable loss-Amp factor								
4, All the other emissions not reported were too low to read and deemed to comply with FCC limit.								

Conducted Method:  
GFSK

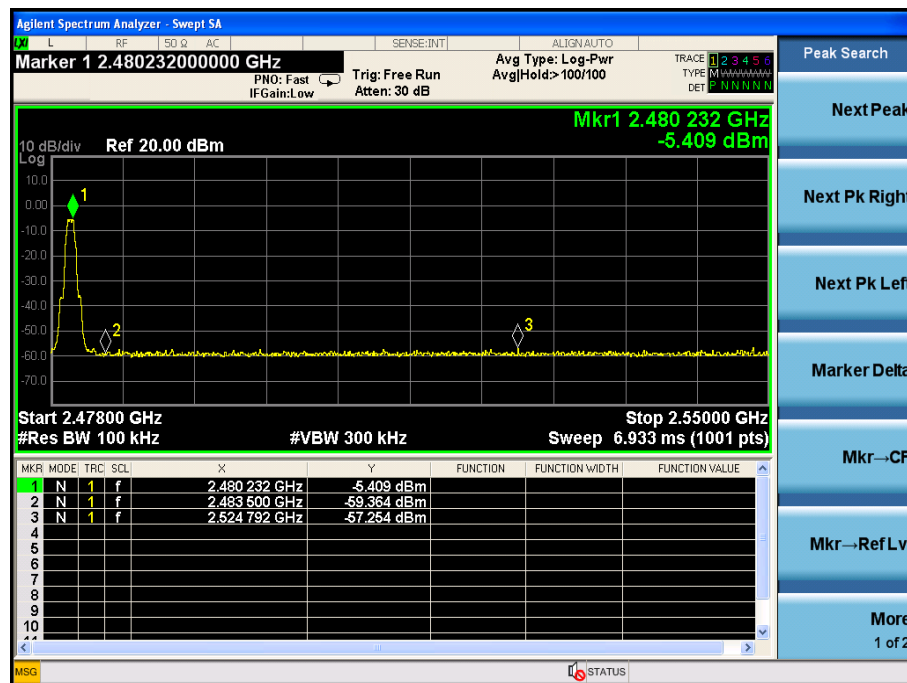
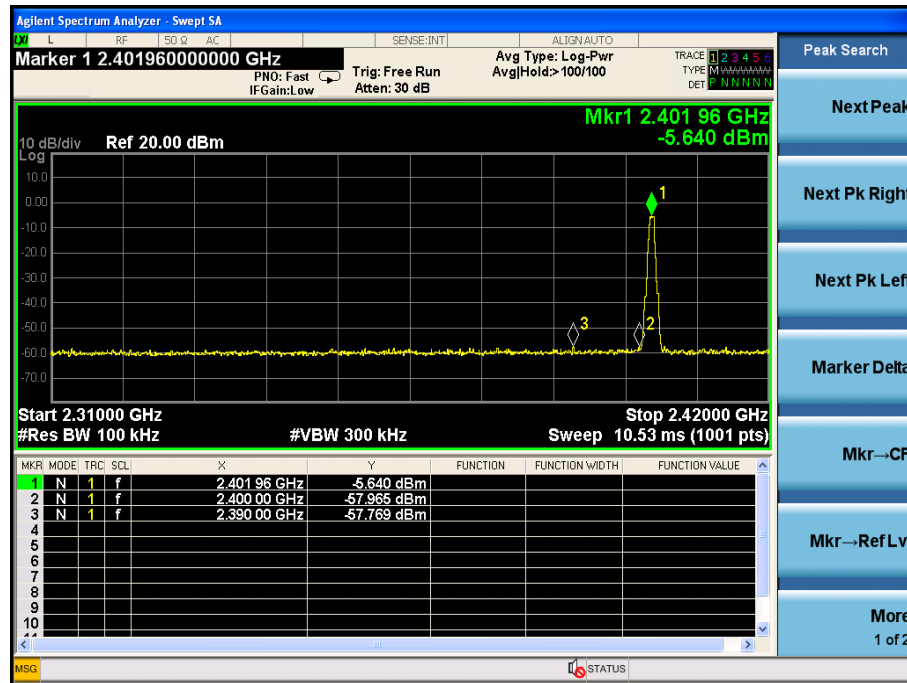

## 11 Antenna Requirement

### 11.1 Standard Requirement

An intentional radiator shall be designed to ensure that no antenna other than that furnished by the responsible party shall be used with the device. The use of a permanently attached antenna or of an antenna that uses a unique coupling to the intentional radiator shall be considered sufficient to comply with the provisions of this Section. The manufacturer may design the unit so that a broken antenna can be replaced by the user, but the use of a standard antenna jack or electrical connector is prohibited.

### 11.2 Antenna Connected Construction

The antenna is PCB antenna and no consideration of replacement. Please see EUT photo for details.

### 11.3 Result

The EUT antenna is PCB Antenna. It comply with the standard requirement.

## 12 Photographs of Setup

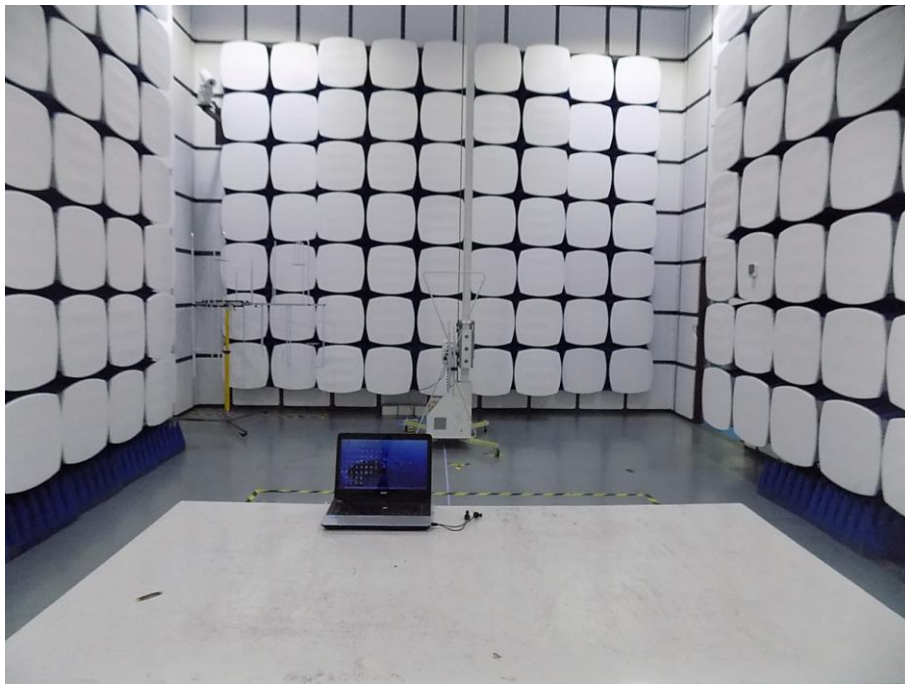
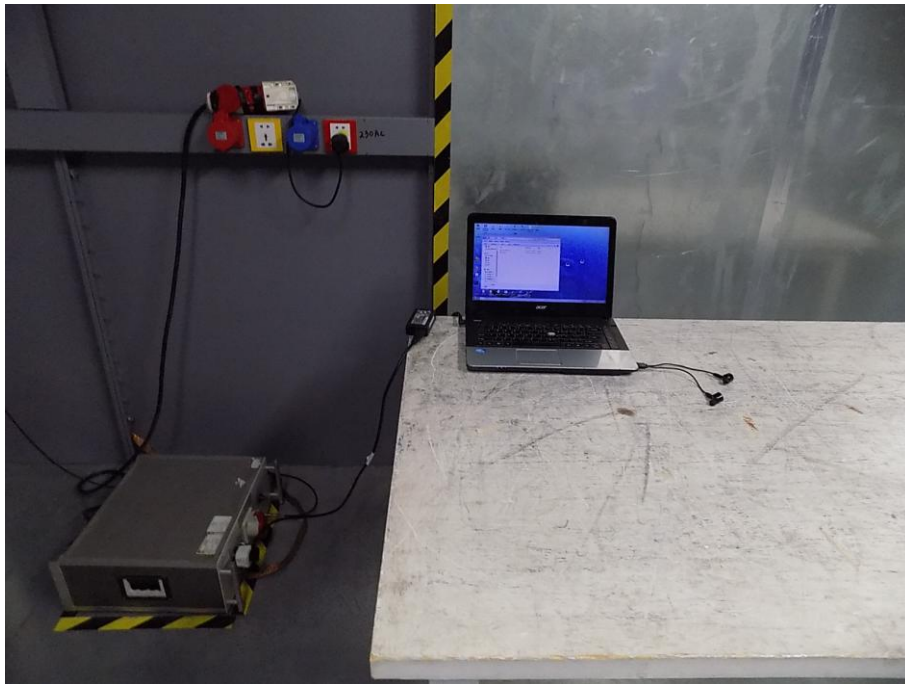

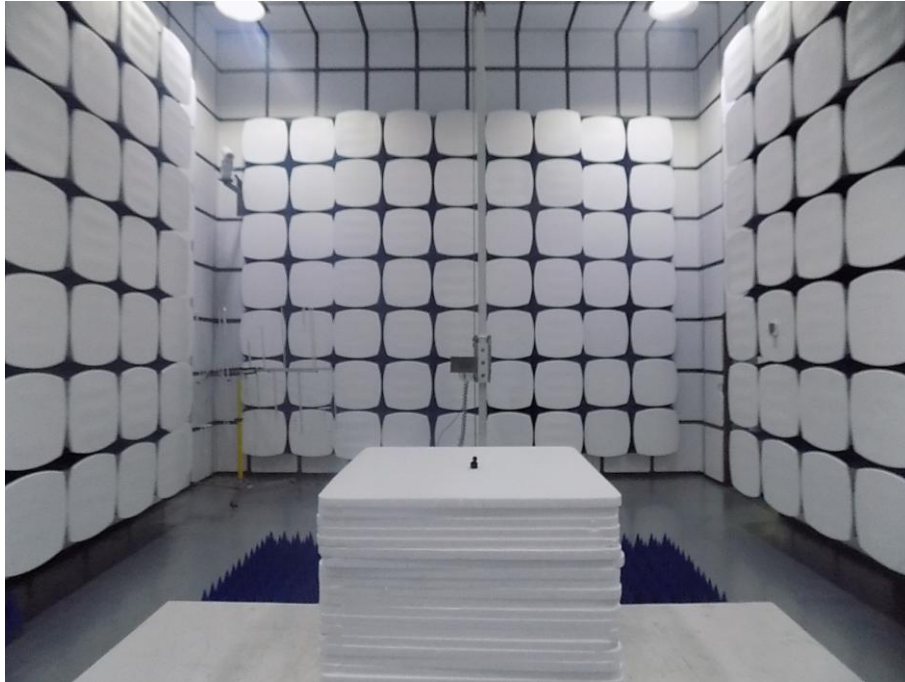

### 13 Photographs of EUT









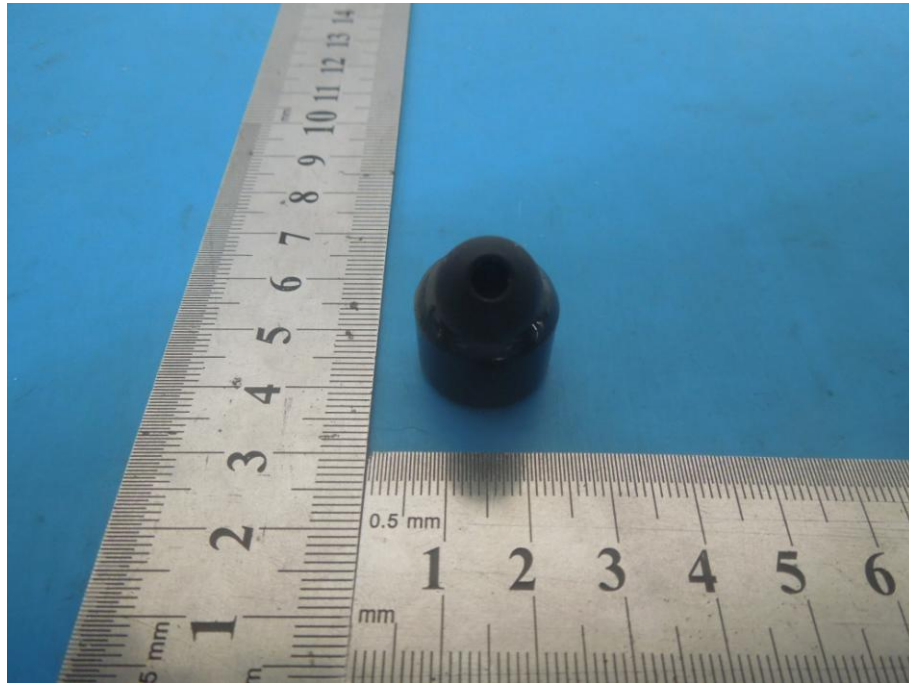



-----END OF REPORT-----