

dreamGEAR, LLC

PS3 WIRELESS RECEIVER A



Main Model: HP5296

December 30, 2011
Report No.: 11070134
(This report supersedes NONE)



Modifications made to the product : None

This Test Report is Issued Under the Authority of:

	
Peter Cai Compliance Engineer	Alex Liu Technical Manager

This test report may be reproduced in full only.
Test result presented in this test report is applicable to the representative sample only.

RF Test Report

To: FCC 15.249:2011

SIEMIC, INC.
Accessing global markets



Laboratory Introduction

SIEMIC, headquartered in the heart of Silicon Valley, with superior facilities in US and Asia, is one of the leading independent testing and certification facilities providing customers with one-stop shop services for Compliance Testing and Global Certifications.



In addition to [testing](#) and [certification](#), SIEMIC provides initial design reviews and [compliance management](#) through out a project. Our extensive experience with [China](#), [Asia Pacific](#), [North America](#), [European](#), and [international](#) compliance requirements, assures the fastest, most cost effective way to attain regulatory compliance for the [global markets](#).

Accreditations for Conformity Assessment

Country/Region	Accreditation Body	Scope
USA	FCC, A2LA	EMC , RF/Wireless , Telecom
Canada	IC, A2LA, NIST	EMC, RF/Wireless , Telecom
Taiwan	BSMI , NCC , NIST	EMC, RF, Telecom , Safety
Hong Kong	OFTA , NIST	RF/Wireless ,Telecom
Australia	NATA, NIST	EMC, RF, Telecom , Safety
Korea	KCC/RRA, NIST	EMI, EMS, RF , Telecom, Safety
Japan	VCCI, JATE, TELEC, RFT	EMI, RF/Wireless, Telecom
Mexico	NOM, COFETEL, Caniety	Safety, EMC , RF/Wireless, Telecom
Europe	A2LA, NIST	EMC, RF, Telecom , Safety

Accreditations for Product Certifications

Country/Region	Accreditation Body	Scope
USA	FCC TCB, NIST	EMC , RF , Telecom
Canada	IC FCB , NIST	EMC , RF , Telecom
Singapore	iDA, NIST	EMC , RF , Telecom
EU	NB	EMC & R&TTE Directive
Japan	MIC, (RCB 208)	RF , Telecom
Hong Kong	OFTA (US002)	RF , Telecom



SIEMIC, INC.

Accessing global markets

Title: RF Test Report for PS3 WIRELESS RECEIVER A
Main Model: HP5296
To: FCC 15.249:2011

Report No: 11070134
Issue Date: December 30, 2011
Page: 3 of 29
www.siemie.com.cn

This page has been left blank intentionally.



SIEMIC, INC.

Accessing global markets

Title: RF Test Report for PS3 WIRELESS RECEIVER A
Main Model: HP5296
To: FCC 15.249:2011

Report No: 11070134
Issue Date: December 30, 2011
Page: 4 of 29
www.siemic.com.cn

CONTENTS

1	EXECUTIVE SUMMARY & EUT INFORMATION	5
2	TECHNICAL DETAILS.....	6
3	MODIFICATION.....	7
4	TEST SUMMARY.....	8
5	MEASUREMENTS, EXAMINATION AND DERIVED RESULTS.....	9
	ANNEX A. TEST INSTRUMENT & METHOD	18
	ANNEX B. EUT AND TEST SETUP PHOTOGRAPHS	24
	ANNEX C. TEST SETUP AND SUPPORTING EQUIPMENT.....	25
	ANNEX D. USER MANUAL / BLOCK DIAGRAM / SCHEMATICS / PART LIST	29



SIEMIC, INC.

Accessing global markets

Title: RF Test Report for PS3 WIRELESS RECEIVER A
Main Model: HP5296
To: FCC 15.249:2011

Report No: 11070134
Issue Date: December 30, 2011
Page: 5 of 29
www.siemic.com.cn

1 EXECUTIVE SUMMARY & EUT INFORMATION

The purpose of this test programme was to demonstrate compliance of the dreamGEAR, LLC, PS3 WIRELESS RECEIVER A, and model: HP5296 against the current Stipulated Standards. The PS3 WIRELESS RECEIVER A has demonstrated compliance with the FCC 15.249:2011.

EUT Information

EUT : PS3 WIRELESS RECEIVER A
Description

Main Model : HP5296

Serial Model : N/A

Input Power : USB 5V

Classification
Per Stipulated : FCC 15.249:2011
Test Standard



SIEMIC, INC.

Accessing global markets

Title: RF Test Report for PS3 WIRELESS RECEIVER A
Main Model: HP5296
To: FCC 15.249:2011

Report No: 11070134
Issue Date: December 30, 2011
Page: 6 of 29
www.siemic.com.cn

2 TECHNICAL DETAILS

Purpose	Compliance testing of PS3 WIRELESS RECEIVER A with stipulated standard
Applicant / Client	dreamGEAR, LLC 20001 S. WESTERN AVE TORRANCE, CA 90501 U.S.A.
Manufacturer	E-Core Technology(China) Co.,Ltd 3rdBuilding, WeidonglongIndustry, HepingEastRoad, LongHua, Shenzhen, China
Laboratory performing the tests	SIEMIC Nanjing (China) Laboratories NO.2-1,Longcang Dadao, Yuhua Economic Development Zone, Nanjing, China Tel:+86(25)86730128/86730129 Fax:+86(25)86730127 Email:info@siemic.com
Test report reference number	11070134
Date EUT received	December 20, 2011
Standard applied	FCC 15.249:2011
Dates of test (from – to)	December 27 to December 30, 2011
No of Units	#1
Equipment Category	DXT
Trade Name	N/A
RF Operating Frequency (ies)	2409.98MHz - 2469.99MHz
Number of Hopping Channels	74
Modulation	MSK
FCC ID	TW8-PS3RX



SIEMIC, Inc.

Accessing global markets

Title: RF Test Report for PS3 WIRELESS RECEIVER A
Main Model: HP5296
To: FCC 15.249:2011

Report No: 11070134
Issue Date: December 30, 2011
Page: 7 of 29
www.siemie.com.cn

3 MODIFICATION

NONE



SIEMIC, INC.

Accessing global markets

Title: RF Test Report for PS3 WIRELESS RECEIVER A
Main Model: HP5296
To: FCC 15.249:2011

Report No: 11070134
Issue Date: December 30, 2011
Page: 8 of 29
www.siemie.com.cn

4 TEST SUMMARY

The product was tested in accordance with the following specifications.
All testing has been performed according to below product classification:

DXT

Test Results Summary

Test Standard	Description	Pass / Fail
CFR 47 Part 15.249: 2011		
15.203	Antenna Requirement	Pass
15.207(a)	Conducted Emissions Voltage	Pass
15.209;15.249	Radiated Spurious Emissions	Pass

ANSI C63.4: 2009

PS: All measurement uncertainties are not taken into consideration for all presented test result.



SIEMIC, INC.

Accessing global markets

Title: RF Test Report for PS3 WIRELESS RECEIVER A
Main Model: HP5296
To: FCC 15.249:2011

Report No: 11070134
Issue Date: December 30, 2011
Page: 9 of 29
www.siemic.com.cn

5 MEASUREMENTS, EXAMINATION AND DERIVED RESULTS

5.1 Antenna Requirement

Standard Requirement: 47 CFR §15.203

An intentional radiator shall be designed to ensure that no antenna other than that furnished by the responsible party shall be used with the device.

Antenna requirement must meet at least one of the following:

- a) Antenna must be permanently attached to the device.
- b) Antenna must use a unique type of connector to attach to the device.
- c) Device must be professionally installed. Installer shall be responsible for ensuring that the correct antenna is employed with the device.

The antenna is integral antenna, antenna gain is 0dBi.

5.2 Conducted Emissions Voltage

Standard Requirement:

Frequency of emission (MHz)	Conducted limit (dBμV)	
	Quasi-peak	Average
0.15–0.5	66 to 56*	56 to 46*
0.5–5	56	46
5–30	60	50

*Decreases with the logarithm of the frequency.

Procedures:

1. All possible modes of operation were investigated. Only the 6 worst case emissions measured, using the correct CISPR and Average detectors, are reported. All other emissions were relatively insignificant.
2. A "-ve" margin indicates a PASS as it refers to the margin present below the limit line at the particular frequency.
3. Conducted Emissions Measurement Uncertainty
All test measurements carried out are traceable to national standards. The uncertainty of the measurement at a confidence level of approximately 95% (in the case where distributions are normal), with a coverage factor of 2, in the range 9kHz – 30MHz (Average & Quasi-peak) is ±3.5dB.
4. Environmental Conditions

Temperature	15°C
Relative Humidity	50%
Atmospheric Pressure	1019mbar
5. Test date : December 27, 2011
Tested By : Peter Cai

Test Result: Pass



SIEMIC, INC.

Accessing global markets

Title: RF Test Report for PS3 WIRELESS RECEIVER A
Main Model: HP5296
To: FCC 15.249:2011

Report No: 11070134
Issue Date: December 30, 2011
Page: 11 of 29
www.siemie.com.cn

Test Mode: Continuous Transmitting Power-- Line

Peak Detector  **Quasi Peak Limit** 
Average Detector  **Average Limit** 

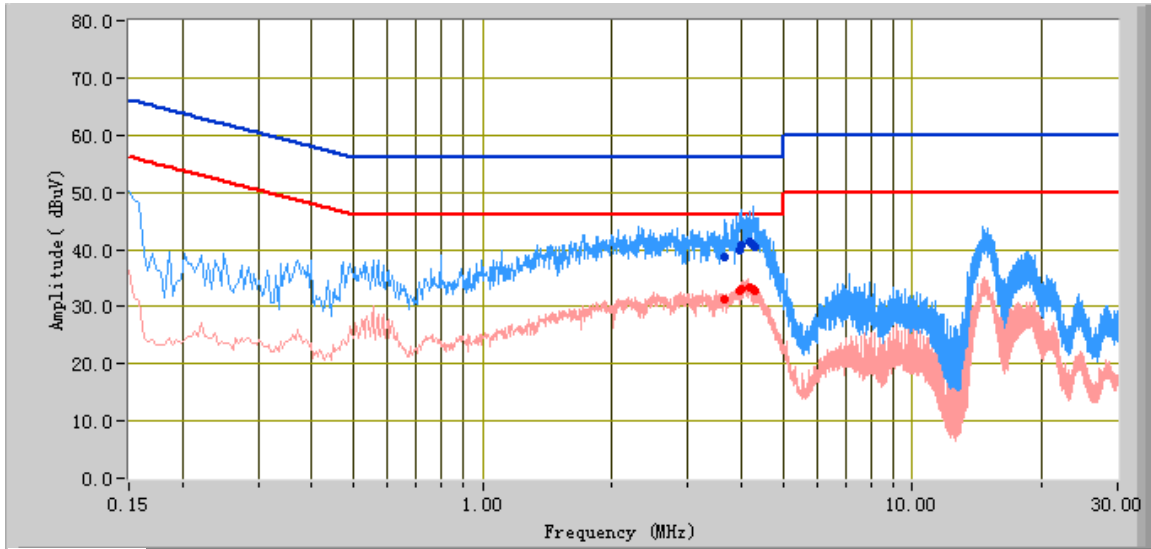

Test Data

Phase Line Plot at 120Vac, 60Hz

Frequency (MHz)	Quasi Peak (dBµV)	Limit (dBµV)	Margin (dB)	Average (dBµV)	Limit (dBµV)	Margin (dB)	Factors (dB)
4.26	40.85	56.00	-15.15	32.96	46.00	-13.04	10.46
4.00	40.86	56.00	-15.14	33.20	46.00	-12.80	10.51
4.17	41.26	56.00	-14.74	33.36	46.00	-12.64	10.48
3.95	39.82	56.00	-16.18	32.87	46.00	-13.13	10.50
4.28	40.37	56.00	-15.63	32.67	46.00	-13.33	10.46
3.65	38.63	56.00	-17.37	31.21	46.00	-14.79	10.40



SIEMIC, INC.

Accessing global markets

Title: RF Test Report for PS3 WIRELESS RECEIVER A
Main Model: HP5296
To: FCC 15.249:2011

Report No: 11070134
Issue Date: December 30, 2011
Page: 12 of 29
www.siemie.com.cn

Test Mode: Continuous Transmitting Power-- Neutral

Peak Detector  Quasi Peak Limit 
Average Detector  Average Limit 

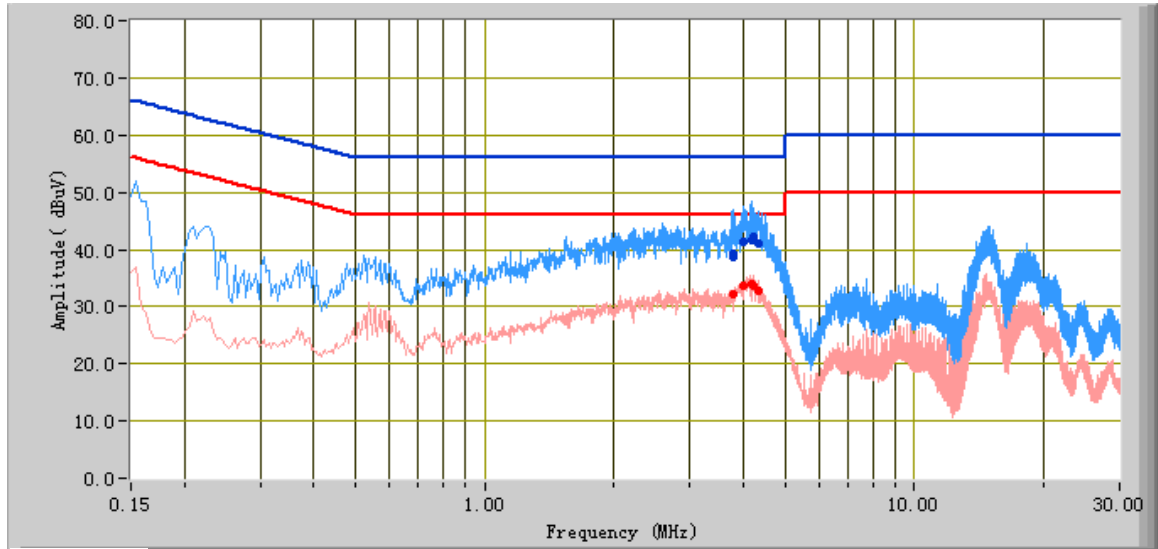

Test Data

Phase Neutral Plot at 120Vac, 60Hz

Frequency (MHz)	Quasi Peak (dBµV)	Limit (dBµV)	Margin (dB)	Average (dBµV)	Limit (dBµV)	Margin (dB)	Factors (dB)
4.18	41.60	56.00	-14.40	33.84	46.00	-12.16	10.48
4.00	41.18	56.00	-14.82	33.58	46.00	-12.42	10.51
4.21	42.31	56.00	-13.69	33.67	46.00	-12.33	10.47
3.80	38.67	56.00	-17.33	32.12	46.00	-13.88	10.45
4.31	41.01	56.00	-14.99	32.85	46.00	-13.15	10.45
3.79	39.22	56.00	-16.78	32.22	46.00	-13.78	10.44



5.3 Radiated Spurious Emission<1GHz

1. All possible modes of operation were investigated. Only the 6 worst case emissions measured, using the correct CISPR detectors, are reported. All other emissions were relatively insignificant.
2. A "-ve" margin indicates a PASS as it refers to the margin present below the limit line at the particular frequency.
3. **Radiated Emissions Measurement Uncertainty**
All test measurements carried out are traceable to national standards. The uncertainty of the measurement at a confidence level of approximately 95% (in the case where distributions are normal), with a coverage factor of 2, in the range 30MHz – 1GHz & 1GHz above (3m & 10m) is +5.6/-4.5dB.
4.

Environmental Conditions	Temperature	15°C
	Relative Humidity	50%
	Atmospheric Pressure	1019mbar
5. Test date : December 27, 2011
Tested By : Peter Cai

Standard Requirement:

The emissions from the Low-power radio-frequency devices shall not exceed the field strength levels specified in the following table and the level of any unwanted emissions shall not exceed the level of the fundamental emission. The tighter limit applies at the band edges.

Test Result: Pass



SIEMIC, INC.

Accessing global markets

Title: RF Test Report for PS3 WIRELESS RECEIVER A
Main Model: HP5296
To: FCC 15.249:2011

Report No: 11070134
Issue Date: December 30, 2011
Page: 14 of 29
www.siemic.com.cn

Test Mode:	Continuous Transmitting
-------------------	--------------------------------

Below 1GHz

Peak Detector 

Quasi Peak Limit 

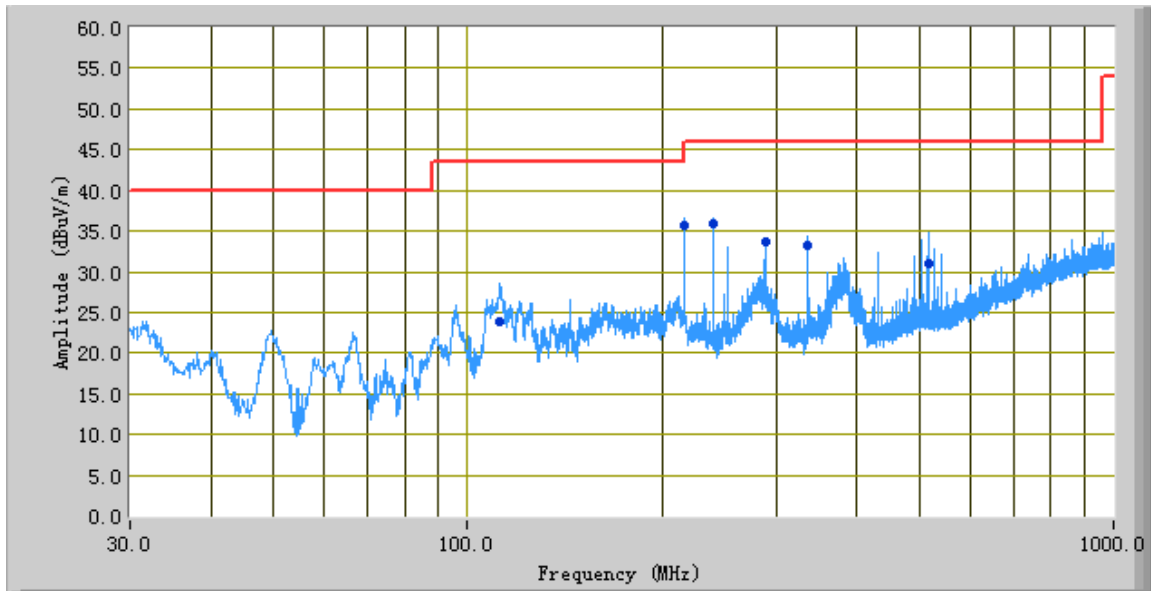

Test Data

@ 3m

Frequency (MHz)	Quasi Peak (dBµV/m)	Azimuth	Polarity (H/V)	Height (cm)	Factors (dB)	Limit (dBµV/m)	Margin (dB)
216.43	35.62	284.00	H	169.00	-32.14	46.00	-10.38
240.00	35.90	21.00	H	115.00	-31.42	46.00	-10.10
515.97	31.06	245.00	H	176.00	-26.03	46.00	-14.94
335.99	33.33	275.00	H	103.00	-29.33	46.00	-12.67
288.58	33.72	246.00	H	100.00	-30.22	46.00	-12.28
112.05	23.77	191.00	V	104.00	-30.84	43.50	-19.73



5.4 Radiated Spurious Emissions >1GHz

1. All possible modes of operation were investigated. Only the 6 worst case emissions measured, using the correct CISPR detectors, are reported. All other emissions were relatively insignificant.
2. A "-ve" margin indicates a PASS as it refers to the margin present below the limit line at the particular frequency.
3. Radiated Emissions Measurement Uncertainty
All test measurements carried out are traceable to national standards. The uncertainty of the measurement at a confidence level of approximately 95% (in the case where distributions are normal), with a coverage factor of 2, in the range 30MHz – 1GHz & 1GHz above (3m & 10m) is +5.6/-4.5dB.
4. Environmental Conditions

Temperature	15°C
Relative Humidity	50%
Atmospheric Pressure	1019mbar
5. Test date : December 30, 2011
Tested By : Peter Cai

Standard Requirement:

The emissions from the Low-power radio-frequency devices shall not exceed the field strength levels specified in the following table and the level of any unwanted emissions shall not exceed the level of the fundamental emission. The tighter limit applies at the band edges.

Test Result: Pass



SIEMIC, INC.

Accessing global markets

Title: RF Test Report for PS3 WIRELESS RECEIVER A
Main Model: HP5296
To: FCC 15.249:2011

Report No: 11070134
Issue Date: December 30, 2011
Page: 16 of 29
www.siemmic.com.cn

Test Mode:

Continuous Transmitting

Fundamental

Low channel

Frequency (MHz)	Direction Degree	Height (cm)	Polar (H / V)	Cable loss (dB)	Amplifier (dB)	Corrected Reading (dBμV/m)	Limit (dBμV/m)	Margin(dB)	Comments
2409.98	0	102	V	5.15	55.00	73.50	114.00	-40.50	PK
2409.98	15	133	H	5.15	55.00	77.83	114.00	-36.17	PK
2409.98	0	102	V	5.15	55.00	69.55	94.00	-24.45	AV
2409.98	15	133	H	5.15	55.00	71.18	94.00	-22.82	AV

Middle channel

Frequency (MHz)	Direction Degree	Height (cm)	Polar (H / V)	Cable loss (dB)	Amplifier (dB)	Corrected Reading (dBμV/m)	Limit (dBμV/m)	Margin(dB)	Comments
2439.99	2	115	V	5.15	55.00	72.83	114.00	-41.17	PK
2439.99	23	101	H	5.15	55.00	75.17	114.00	-38.83	PK
2439.99	2	115	V	5.15	55.00	69.21	94.00	-24.79	AV
2439.99	23	101	H	5.15	55.00	71.63	94.00	-22.37	AV

High channel

Frequency (MHz)	Direction Degree	Height (cm)	Polar (H / V)	Cable loss (dB)	Amplifier (dB)	Corrected Reading (dBμV/m)	Limit (dBμV/m)	Margin(dB)	Comments
2469.99	0	136	V	5.15	55.00	72.00	114.00	-42.00	PK
2469.99	16	114	H	5.15	55.00	74.67	114.00	-39.33	PK
2469.99	0	136	V	5.15	55.00	69.57	94.00	-24.43	AV
2469.99	16	114	H	5.15	55.00	70.02	94.00	-23.92	AV



SIEMIC, INC.

Accessing global markets

Title: RF Test Report for PS3 WIRELESS RECEIVER A
Main Model: HP5296
To: FCC 15.249:2011

Report No: 11070134
Issue Date: December 30, 2011
Page: 17 of 29
www.sieminc.com.cn

Test Mode:	Continuous Transmitting
------------	--------------------------------

Harmonic

@ 2409.98MHz @ 3 Meter

Frequency (MHz)	Direction Degree	Height (cm)	Polar (H / V)	Cable loss (dB)	Amplifier (dB)	Corrected Reading (dBµV/m)	Limit (dBµV/m)	Margin(dB)	Comments
4819.96	0	100	V	5.15	55.00	58.42	74.00	-15.58	Peak
4819.96	7	118	H	5.15	55.00	61.04	74.00	-12.96	Peak
4819.96	0	100	V	5.15	55.00	48.37	54.00	-5.63	Ave
4819.96	7	118	H	5.15	55.00	47.62	54.00	-6.38	Ave

Emission was scanned up to 25GHz.

@ 2439.99MHz @ 3 Meter

Frequency (MHz)	Direction Degree	Height (cm)	Polar (H / V)	Cable loss (dB)	Amplifier (dB)	Corrected Reading (dBµV/m)	Limit (dBµV/m)	Margin(dB)	Comments
4879.98	0	100	V	5.16	55.00	60.02	74.00	-13.98	Peak
4879.98	4	116	H	5.16	55.00	61.52	74.00	-12.48	Peak
4879.98	0	100	V	5.16	55.00	47.44	54.00	-6.56	Ave
4879.98	4	116	H	5.16	55.00	46.25	54.00	-7.75	Ave

Emission was scanned up to 25GHz.

@ 2469.99MHz @ 3 Meter

Frequency (MHz)	Direction Degree	Height (cm)	Polar (H / V)	Cable loss (dB)	Amplifier (dB)	Corrected Reading (dBµV/m)	Limit (dBµV/m)	Margin(dB)	Comments
4939.98	0	100	V	5.17	55.00	61.29	74.00	-12.71	Peak
4939.98	18	117	H	5.17	55.00	58.51	74.00	-15.49	Peak
4939.98	0	100	V	5.17	55.00	47.37	54.00	-6.63	Ave
4939.98	18	117	H	5.17	55.00	46.61	54.00	-7.39	Ave

Emission was scanned up to 25GHz.

Band Edge

Frequency (MHz)	Direction Degree	Height (cm)	Polar (H / V)	Cable loss (dB)	Amplifier (dB)	Corrected Reading (dBµV/m)	Limit (dBµV/m)	Margin(dB)	Comments
2400	0	12	V	3.81	55.00	41.2	74.00	-32.8	Peak
2400	0	119	H	3.81	55.00	41.9	74.00	-32.1	Peak
2400	0	12	V	3.81	55.00	37.6	54.00	-16.4	Ave
2400	0	119	H	3.81	55.00	36.2	54.00	-17.8	Ave
2483.5	0	112	V	3.90	55.00	42.8	74.00	-31.2	Peak
2483.5	0	119	H	3.90	55.00	42.5	74.00	-31.5	Peak
2483.5	0	112	V	3.90	55.00	36.8	54.00	-17.2	Ave
2483.5	0	119	H	3.90	55.00	36.7	54.00	-17.3	Ave



SIEMIC, INC.

Accessing global markets

Title: RF Test Report for PS3 WIRELESS RECEIVER A
Main Model: HP5296
To: FCC 15.249:2011

Report No: 11070134
Issue Date: December 30, 2011
Page: 18 of 29
www.siemie.com.cn

Annex A. TEST INSTRUMENT & METHOD

Annex A.i. TEST INSTRUMENTATION & GENERAL PROCEDURES

Instrument	Model	Calibration Date	Calibration Due Date
AC Line Conducted Emissions			
R&S EMI Test Receiver	ESPI3	05/25/2011	05/25/2012
Com-Power LISN	LI-115	05/25/2011	05/25/2012
Com-Power Limiter	LIT-153	05/25/2011	05/25/2012
Radiated Emissions			
Hp Spectrum Analyzer	8563E	01/10/2011	01/10/2012
R&S EMI Receiver	ESPI3	05/18/2011	05/18/2012
Sunol Sciences, Inc. antenna (30MHz~3GHz)	JB3	05/25/2011	05/25/2012
ETS-Lindgren Antenna(1 ~18GHz)	3115	06/02/2011	06/02/2012
A-INFOMW Antenna(1 ~18GHz)	JXTXLB-10180	06/02/2011	06/02/2012
Horn Antenna (18~40GHz)	AH-840	07/23/2011	07/23/2013
Microwave Pre-Amp (18~40GHz)	PA-840	Every 2000 Hours	
Hp Agilent Pre-Amplifier	8447F	05/25/2011	05/25/2012
MITEQ Pre-Amplifier(1 ~ 18GHz)	AMF-7D-00101800-30-10P	05/25/2011	05/25/2012

Annex A.ii. CONDUCTED EMISSIONS TEST DESCRIPTION

Test Set-up

1. The EUT and supporting equipment were set up in accordance with the requirements of the standard on top of a 1.5m x 1m x 0.8m high, non-metallic table, as shown in Annex B.
2. The power supply for the EUT was fed through a 50Ω/50μH EUT LISN, connected to filtered mains.
3. The RF OUT of the EUT LISN was connected to the EMI test receiver via a low-loss coaxial cable.
4. All other supporting equipments were powered separately from another main supply.

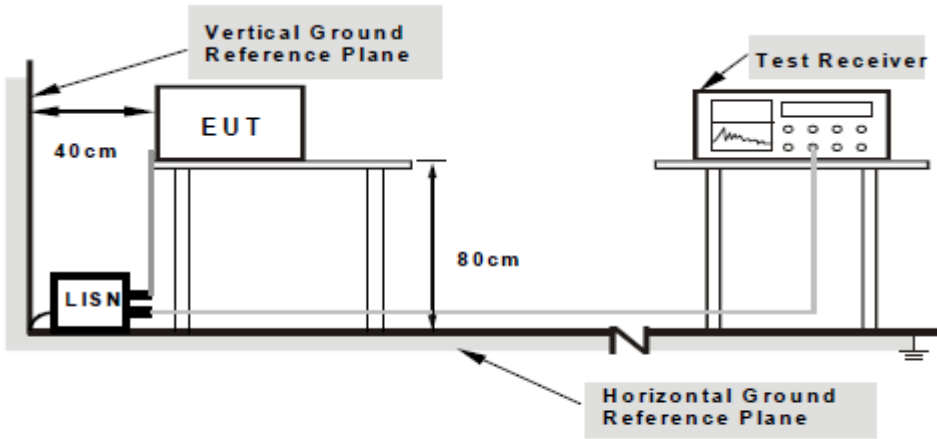

**Note: 1. Support units were connected to second LISN.
2. Both of LISNs (AMN) are 80cm from EUT and at least 80cm from other units and other metal planes support units.**

For the actual test configuration, please refer to the related item – Photographs of the Test Configuration1.

Test Method

1. The EUT was switched on and allowed to warm up to its normal operating condition.
2. A scan was made on the NEUTRAL line (for AC mains) or Earth line (for DC power) over the required frequency range using an EMI test receiver.
3. High peaks, relative to the limit line, were then selected.
4. The EMI test receiver was then tuned to the selected frequencies and the necessary measurements made with a receiver bandwidth setting of 10 KHz. For FCC tests, only Quasi-peak measurements were made; while for CISPR/EN tests, both Quasi-peak and Average measurements were made.
5. Steps 2 to 4 were then repeated for the LIVE line (for AC mains) or DC line (for DC power).

Description of Conducted Emission Program

This EMC Measurement software run LabView automation software and offers a common user interface for electromagnetic interference (EMI) measurements. This software is a modern and powerful tool for controlling and monitoring EMI test receivers and EMC test systems. It guarantees reliable collection, evaluation, and documentation of measurement results. Basically, this program will run a pre-scan measurement before it proceeds with the final measurement. The pre-scan routine will run the common scan range from 150 kHz to 30 MHz; the program will first start a peak and average scan on selectable measurement time and step size. After the program complete the pre-scan, this program will perform the Quasi Peak and Average measurement, based on the pre-scan peak data reduction result.



SIEMIC, INC.

Accessing global markets

Title: RF Test Report for PS3 WIRELESS RECEIVER A
Main Model: HP5296
To: FCC 15.249:2011

Report No: 11070134
Issue Date: December 30, 2011
Page: 20 of 29
www.siemic.com.cn

Sample Calculation Example

At 20 MHz

limit = $250 \mu\text{V} = 47.96 \text{ dB}\mu\text{V}$

Transducer factor of LISN, pulse limiter & cable loss at 20 MHz = 11.20 dB

Q-P reading obtained directly from EMI Receiver = 40.00 dB μV
(Calibrated for system losses)

Therefore, Q-P margin = $40.00 - 47.96 = -7.96$

i.e. **7.96 dB below limit**

Annex A. iii. RADIATED EMISSIONS TEST DESCRIPTION

Limit

1. Except as provided elsewhere in this Subpart, the emissions from an intentional radiator shall not exceed the field strength levels specified in the following table:

Frequency (MHz)	Field Strength (mV/m)	Measurement Distance (m)
30-88	100*	3
88-216	150*	3
216-960	200*	3
Above 960	500	3

Remark: Except as provided in paragraph (g), fundamental emissions from intentional radiators operating under this Section shall not be located in the frequency bands 54-72 MHz, 76-88 MHz, 174-216 MHz or 470-806 MHz. However, operation within these frequency bands is permitted under other sections of this Part, e.g., Sections 15.231 and 15.241.

2. In the above emission table, the tighter limit applies at the band edges.

Frequency (Hz)	Field Strength (µV/m at 3-meter)	Field Strength (dBµV/m at 3-meter)
30-88	100	40
88-216	150	43.5
216-960	200	46
Above 960	500	54

EUT Characterisation

EUT characterisation, over the frequency range from 30MHz to 10th Harmonic , was done in order to minimise radiated emissions testing time while still maintaining high confidence in the test results.

The EUT was placed in the chamber, at a height of about 0.8m on a turntable. Its radiated emissions frequency profile was observed, using a spectrum analyzer /receiver with the appropriate broadband antenna placed 3m away from the EUT. Radiated emissions from the EUT were maximised by rotating the turntable manually, changing the antenna polarisation and manipulating the EUT cables while observing the frequency profile on the spectrum analyzer / receiver. Frequency points at which maximum emissions occurred, clock frequencies and operating frequencies were then noted for the formal radiated emissions test at the Open Area Test Site (OATS) or 3m EMC chamber.

Test Set-up

1. The EUT and supporting equipment were set up in accordance with the requirements of the standard on top of a 1.5m X 1.0m X 0.8m high, non-metallic table.
2. The filtered power supply for the EUT and supporting equipment were tapped from the appropriate power sockets located on the turntable.
3. The relevant broadband antenna was set at the required test distance away from the EUT and supporting equipment boundary.

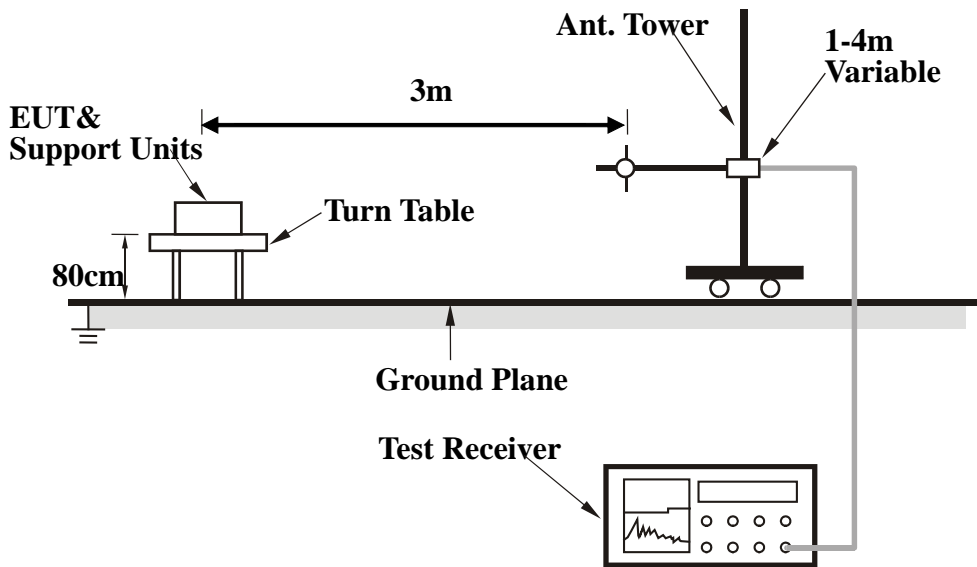

Test Method

The following procedure was performed to determine the maximum emission axis of EUT:

1. With the receiving antenna is H polarization, rotate the EUT in turns with three orthogonal axes to determine the axis of maximum emission.
2. With the receiving antenna is V polarization, rotate the EUT in turns with three orthogonal axes to determine the axis of maximum emission.
3. Compare the results derived from above two steps. So, the axis of maximum emission from EUT was determined and the configuration was used to perform the final measurement.

Final Radiated Emission Measurement

1. Setup the configuration according to figure 1. Turn on EUT and make sure that it is in normal function.
2. For emission frequencies measured below 1 GHz, a pre-scan is performed in a shielded chamber to determine the accurate frequencies of higher emissions will be checked on a open test site. As the same purpose, for emission frequencies measured above 1 GHz, a pre-scan also be performed with a 1 meter measuring distance before final test.
3. For emission frequencies measured below and above 1 GHz, set the spectrum analyzer on a 100 kHz and 1 MHz resolution bandwidth respectively for each frequency measured in step 2.
4. The search antenna is to be raised and lowered over a range from 1 to 4 meters in horizontally polarized orientation. Position the highness when the highest value is indicated on spectrum analyzer, then change the orientation of EUT on test table over a range from 0 ° to 360 ° with a speed as slow as possible, and keep the azimuth that highest emission is indicated on the spectrum analyzer. Vary the antenna position again and record the highest value as a final reading.
5. Repeat step 4 until all frequencies need to be measured were complete.
6. Repeat step 5 with search antenna in vertical polarized orientations.

During the radiated emission test, the Spectrum Analyzer was set with the following configurations:

Frequency Band (MHz)	Function	Resolution bandwidth	Video Bandwidth
30 to 1000	Peak	100 kHz	100 kHz
Above 1000	Peak	1 MHz	1 MHz
	Average	1 MHz	10 Hz

Description of Radiated Emission Program

This EMC Measurement software run LabView automation software and offers a common user interface for electromagnetic interference (EMI) measurements. This software is a modern and powerful tool for controlling and monitoring EMI test receivers and EMC test systems. It guarantees reliable collection, evaluation, and documentation of measurement results. Basically, this program will run a pre-scan measurement before it proceeds with the final measurement. The pre-scan routine will run the scan on four different antenna heights, 2 antenna polarity, and 360 degrees table rotation. For example, the program was set to run 30 MHz to 1 GHz scan; the program will first start from a meter antenna height and divide the 30 MHz to 1 GHz into 10 separate parts of maximum hold sweeps. Each parts of maximum hold sweep, the program will collect the data from 0 degree to 360 degrees table rotation. After the program complete the 1m scan, the antenna continues to rise to 2m and continue the scan. The step will repeated for all specified antenna height and polarity. This program will perform the Quasi Peak measurement after the signal maximization process and pre-scan routine. The final measurement will be base on the pre-scan data reduction result.

Sample Calculation Example

The field strength is calculated by adding the Antenna Factor and Cable Factor, and subtracting the Amplifier Gain (if any) from the measured reading. For the limit is employed average value, therefore the peak value can be transferred to average value by subtracting the duty factor. The basic equation with a sample calculation is as follows:

$$\text{Peak} = \text{Reading} + \text{Corrected Factor}$$

where

$$\text{Corr. Factor} = \text{Antenna Factor} + \text{Cable Factor} - \text{Amplifier Gain (if any)}$$

And the average value is

$$\text{Average} = \text{Peak Value} + \text{Duty Factor or}$$

$$\text{Set RBW} = 1\text{MHz, VBW} = 10\text{Hz.}$$

Note:

If the measured frequencies are fall in the restricted frequency band, the limit employed must be quasi peak value when frequencies are below or equal to 1 GHz. And the measuring instrument is set to quasi peak detector function.



SIEMIC, Inc.

Accessing global markets

Title: RF Test Report for PS3 WIRELESS RECEIVER A
Main Model: HP5296
To: FCC 15.249:2011

Report No: 11070134
Issue Date: December 30, 2011
Page: 24 of 29
www.siemie.com.cn

Annex B. EUT AND TEST SETUP PHOTOGRAPHS

Please see attachment



SIEMIC, INC.

Accessing global markets

Title: RF Test Report for PS3 WIRELESS RECEIVER A
Main Model: HP5296
To: FCC 15.249:2011

Report No: 11070134
Issue Date: December 30, 2011
Page: 25 of 29
www.siemie.com.cn

Annex C. TEST SETUP AND SUPPORTING EQUIPMENT

EUT TEST CONDITIONS

Annex C. i. SUPPORTING EQUIPMENT DESCRIPTION

The following is a description of supporting equipment and details of cables used with the EUT.

Equipment Description (Including Brand Name)	Model & Serial Number	Cable Description (List Length, Type & Purpose)
Laptop Gateway	MS2288	N/A



Block Configuration Diagram for Conducted Emissions

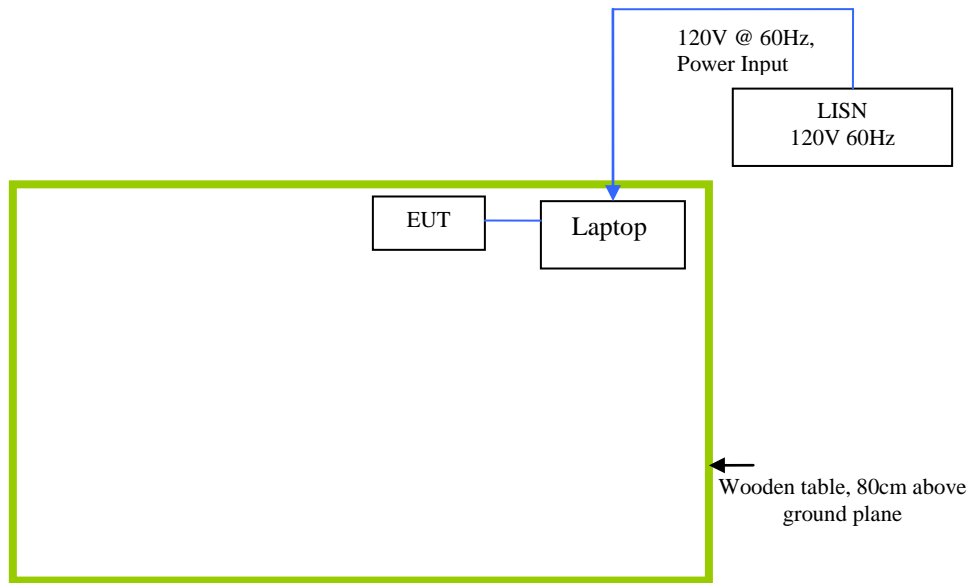



SIEMIC, INC.

Accessing global markets

Title: RF Test Report for PS3 WIRELESS RECEIVER A
Main Model: HP5296
To: FCC 15.249:2011

Report No: 11070134
Issue Date: December 30, 2011
Page: 27 of 29
www.siemic.com.cn

Block Configuration Diagram for Radiated Emissions

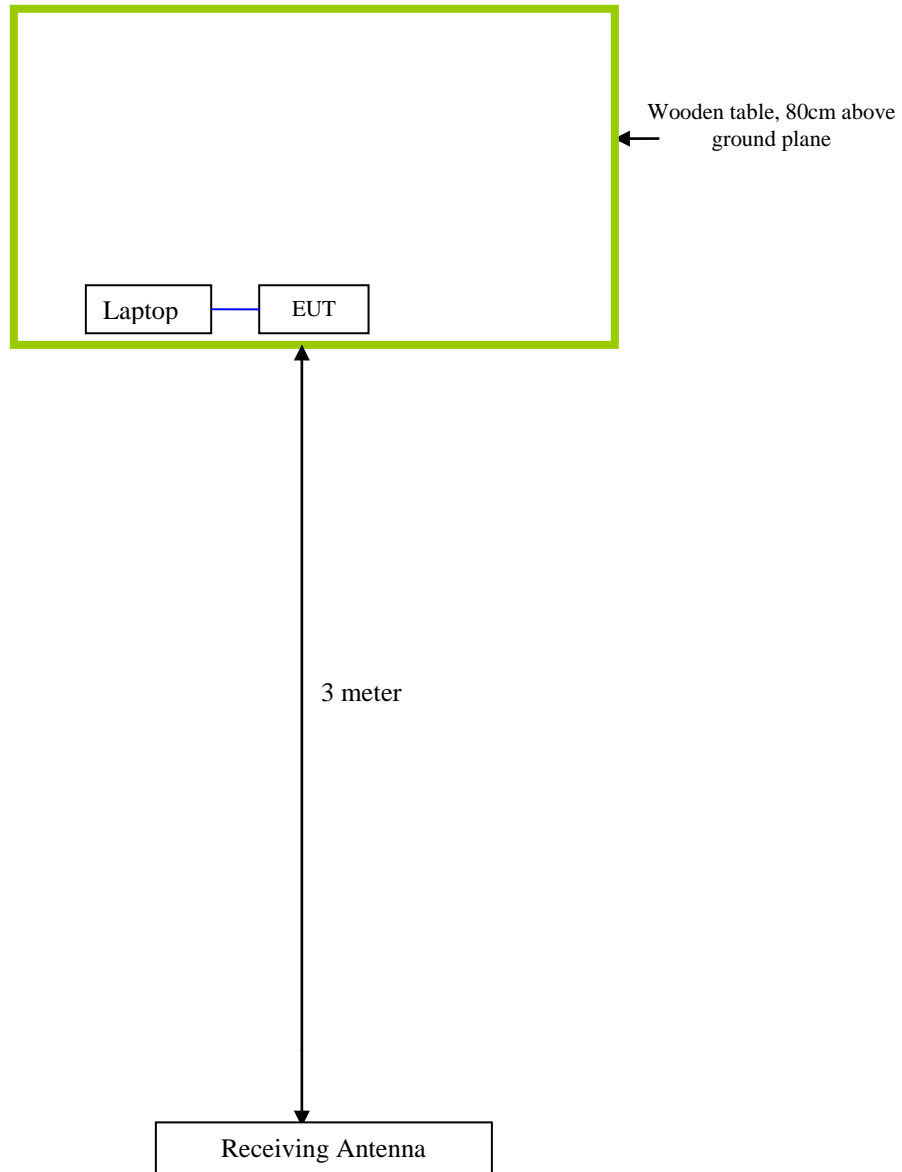



SIEMIC, INC.

Accessing global markets

Title: RF Test Report for PS3 WIRELESS RECEIVER A
Main Model: HP5296
To: FCC 15.249:2011

Report No: 11070134
Issue Date: December 30, 2011
Page: 28 of 29
www.siemie.com.cn

Annex C.ii. EUT OPERATING CONDITIONS

The following is the description of how the EUT is exercised during testing.

Test	Description Of Operation
Emissions Testing	The EUT was continuous working to stimulate the worst case.



SIEMIC, INC.

Accessing global markets

Title: RF Test Report for PS3 WIRELESS RECEIVER A
Main Model: HP5296
To: FCC 15.249:2011

Report No: 11070134
Issue Date: December 30, 2011
Page: 29 of 29
www.siemie.com.cn

Annex D. USER MANUAL / BLOCK DIAGRAM / SCHEMATICS / PART LIST

Please see attachment