

Recognized by the
Federal Communications Commission
Anechoic chamber registration no.: 90462 (FCC)
Anechoic chamber registration no.: 3463 (IC)
TCB ID: DE 0001



Accredited by the
German Accreditation Council
DAR-Registration Number
DAT-P-176/94-D1



Independent ETSI
compliance test house



Accredited Bluetooth[®] Test Facility (BQTF)

Test report no. : 2-4189-01-02/05
Applicant : Siemens Home and Office
Communication
Type : Gigaset S450 / E450
Test Standard : FCC Part 15.319
RSS-213 Issue 2
FCC ID : TVU-S450-E450
Certification No. IC : 267U-S450E450

Table of contents

1. ADMINISTRATIVE DATA	5
1.1. ADMINISTRATIVE DATA OF THE TEST FACILITY	5
1.1.1 Identification of the testing laboratory	5
1.1.2 Organizational items	5
1.1.3 Applicant's details	6
1.2 ADMINISTRATIVE DATA OF MANUFACTURER / MEMBER	6
1.3 DESCRIPTION OF THE EQUIPMENT UNDER TEST (EUT)	7
1.3.1 EUT: Type, S/N etc.	7
1.3.2 Technical specifications	7
1.3.3 Additional EUT information - Test Report Cover Sheet/Performance Test Data	8
1.3.4 RF Technical Brief Cover Sheet acc. to RSS-102	Fehler! Textmarke nicht definiert.
2. TESTSTANDARD & SUMMARY LIST OF ALL PERFORMED TEST CASES	10
2.1 TEST AND EVALUATION RESULTS	10
2.2 ADDITIONAL INFORMATION ABOUT THE SAMPLE	12
3. DESCRIPTION OF TEST SET-UP	13
3.1 RADIATED MEASUREMENTS	13
3.2 CONDUCTED MEASUREMENTS	14
4. DETAILED TEST PROCEDURES AND RESULTS	15
4.1 EMISSION BANDWIDTH	15
4.1.1 Test Criteria	15
4.1.2 Test Procedure	16
4.1.3 Test Results	17
4.2 CONDUCTED EMISSIONS	19
4.2.1 Test Criteria	19
4.2.2 Test Procedure	20
4.2.3 Test Results	21
4.3 ANTENNA REQUIREMENTS	22
4.3.1 Test Criteria	22
4.3.2 Procedure	22
4.3.3 Attestation	22
4.4 USE OF DIGITAL MODULATION	23
4.4.1 Test Criteria	23
4.4.2 Procedure	23
4.4.3 Attestation	23
4.5 PEAK TRANSMIT POWER	24
4.5.1 Test Criteria	24
4.5.2 Test Procedure	24
4.5.3 Test results	25
4.6 POWER SPECTRAL DENSITY	28
4.6.1 Test Criteria	28
4.6.2 Test procedure	28
4.6.3 Test Results	29
4.7 POWER ADJUSTMENT FOR ANTENNA GAIN	31
4.7.1 Test Criteria	31
4.7.2 Test Procedure	31
4.7.3 Test Results	31
4.8 AUTOMATICALLY DISCONTINUED TRANSMISSION	33
4.8.1 Test Criteria	33
4.8.2 Test Procedure	33
4.8.3 Test Result	33

4.9	SPURIOUS EMISSIONS & OUT OF BAND EMISSIONS	34
4.9.1	Test Criteria.....	34
4.9.1.1	Out of Band Emissions.....	34
4.9.1.2	Spurious and In-Band Unwanted Emissions.....	34
4.9.2	Test Procedure.....	35
4.9.3	Test Results	36
4.9.3.1	Out of Band Emissions.....	36
4.9.3.2	Spurious and In-Band Unwanted Emissions.....	37
4.10	LISTEN BEFORE TALK	40
4.10.1	Test Criteria.....	40
4.10.2	Test Procedure.....	40
4.10.3	Attestation.....	40
4.11	MONITORING TIME.....	41
4.11.1	Test Criteria.....	41
4.11.2	Test Procedure.....	41
4.11.3	Test results.....	42
4.12	MONITORING THRESHOLD.....	43
4.12.1	Test Criteria	43
4.12.2	Test Procedure.....	43
4.12.3	Test Results	43
4.13	MAXIMUM TRANSMIT TIME	44
4.13.1	Test Criteria.....	44
4.13.2	Test Procedure.....	44
4.13.3	Test Results	45
4.14	SYSTEM ACKNOWLEDGEMENT	46
4.14.1	Test criteria.....	46
4.14.2	Test procedure	46
4.14.3	Test results.....	47
4.15	LEAST INTERFERED CHANNEL.....	49
4.15.1	Test Criteria.....	49
4.15.2	Test procedure	49
4.15.3	Test Results	51
4.16	CHANNEL CONFIRMATION.....	54
4.16.1	Test Criteria.....	54
4.16.2	Test Procedure.....	54
4.16.3	Test results.....	54
4.17	POWER MEASUREMENT RESOLUTION.....	55
4.17.1	Test Criteria.....	55
4.17.2	Test procedure	55
4.17.3	Test Result.....	55
4.18	SEGMENT OCCUPANCY	56
4.18.1	Test Criteria.....	56
4.18.2	Test Procedure.....	56
4.18.3	Attestation.....	56
4.19	RANDOM WAITING	57
4.19.1	Test Criteria.....	57
4.19.2	Test Procedure.....	57
4.19.3	Attestation.....	57
4.20	MONITORING BANDWIDTH.....	58
4.20.1	Test Criteria.....	58
4.20.2	Test Procedure.....	58
4.21	MONITORING REACTION TIME.....	59
4.21.1	Test Criteria.....	59
4.21.2	Test Procedure.....	59
4.21.3	Attestation.....	59

4.22	MONITORING ANTENNA	60
4.22.1	Test Criteria.....	60
4.22.2	Test Procedure.....	60
4.22.3	Attestation.....	60
4.23	MONITORING THRESHOLD RELAXATION	62
4.23.1	Test Criteria.....	62
4.23.2	Test Procedure.....	62
4.23.3	Test Results	62
4.24	DUPLEX SYSTEM LBT	63
4.24.1	Test Criteria.....	63
4.24.2	Procedure	63
4.24.3	Attestation.....	63
4.25	ALTERNATE MONITORING CHANNEL	64
4.25.1	Test Criteria.....	64
4.25.2	Test Procedure.....	64
4.25.3	Attestation.....	64
4.26	FAIR ACCESS	65
4.26.1	Test Criteria.....	65
4.26.2	Procedure	65
4.26.3	Attestation.....	65
4.27	FRAME PERIOD	66
4.27.1	Test Criteria.....	66
4.27.2	Test Procedure.....	67
4.27.3	Test Results	69
4.28	FREQUENCY STABILITY	70
4.28.1	Test Criteria.....	70
4.28.2	Test Procedure.....	70
4.29	RADIATED EMISSIONS.....	71
4.29.1	Test Criteria.....	71
4.29.2	Test Procedure.....	71
4.29.3	Test Results	72
4.30	RF EXPOSURE.....	78
4.31	USED TEST EQUIPMENT.....	79
5	PHOTOGRAPHS OF TEST SET-UP	81
6	PHOTOGRAPHS OF EUT	84

1. Administrative data

1.1. Administrative data of the test facility

1.1.1 Identification of the testing laboratory

Company name:	Cetecom ICT Services GmbH
Address:	Untertürkheimerstr. 6-10 D-66117 Saarbruecken Germany
Laboratory accreditation:	DAR-Registration No. DAT-P-176/94-D1 Bluetooth Qualification Test Facility (BQTF)
Responsible for testing laboratory:	Dirk Hausknecht Phone: +49 681 598 0 Fax: +49 681 598 9075 email: info@ict.cetecom.de



.....
Responsible for testing
(Harro Ames)

1.1.2 Organizational items

Reference No.:	2-4189-01-02/05
Order No.:	
Receipt of EUT:	2006-01-26
Date(s) of test:	2006-01-26 to 2006-02-03
Date of report:	2006-02-08
Number of report pages:	91
Number of diagram pages (annex):	

Version of template:	1.8

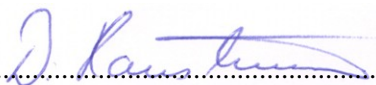

.....
Responsible for laboratory
(Dirk Hausknecht)

Note:

The test results of this test report relate exclusively to the item tested as specified in this report. The CETECOM ICT Services GmbH does not assume responsibility for any conclusions and generalizations drawn from the test results with regard to other specimens or samples of the type of the equipment represented by the test item.

The test report may only be reproduced or published in full. Reproduction or publication of extracts from the report requires the prior written approval of the CETECOM ICT Services GmbH.

During the test no hardware and software changes are allowed to be performed at the EUT.

1.1.3 Applicant's details

Name : Siemens Home and Office Communication Devices GmbH & Co KG
Address : Frankenstr. 2
City : 46395 Bocholt
Country : Germany
Phone : +49-2871-912857
Fax : +49-2871-9162857
Contact : Mr. Uwe Alt
Phone : +49-2871-912857
Fax : +49-2871-9162857
e-mail : uwe.alt@siemens.com

1.2 Administrative data of manufacturer / member

Manufacturer's name:	Siemens Home and Office Communication Devices GmbH & Co KG
Address:	Frankenstr. 2 46395 Bocholt Germany

1.3 Description of the Equipment under test (EUT)

1.3.1 EUT: Type, S/N etc.

Product name : Gigaset S450 / E450
 Description : UPCS Base station according to FCC part15.319
 S/N serial number : -
 HW hardware status : -
 SW software status : -
 Frequency Band [MHz] : 1921.536 – 1928.448 MHz
 Type of Modulation : TDMA
 Number of channels : 5
 Antenna : 1 printed board antenna / 1 inverted F
 Power Supply : 115 V AC via external power supply
 Temperature Range : -20°C - +50°C

Max. power radiated: 19.7 dBm

Max. power conducted: 19.4 dBm

FCC ID: TVU-S450-E450

IC: 267U-S450E450

1.3.2 Technical specifications

The technical specifications of this device are listed below:

Specification	Value
Operating Standard	DECT
Operating Mode	TDMA
Frame Period	10ms
Time Slot Length	416.67µs
Slots per Frame	24 slots / 12 RX, 12 TX
Slot Structure	6 active duplex pairs per frame
Bit Rate	1.152MHz
Bit Period	868.1ns
Number of Frequency Channels	5
Frequency Band	1920 – 1930 MHz
Peak Transmission Power	19.4 dBm maximal conducted 19.7 dBm maximal radiated
Emission Bandwidth	2.3 MHz maximal
Gaussian Frequency Shift Keying	B*T = 0.5 nominal
Deviation	400KHz nominal
Speech Codec	32kBit/s ADPCM
Receiver Sensitivity	-93dBm for BER of 1.10exp-3

Frequency Channel	Frequency
CH1	1921.536MHz
CH2	1923.264MHz
CH3	1924.992MHz
CH4	1926.720MHz
CH5	1928.448MHz

1.3.3 Additional EUT information - Test Report Cover Sheet/Performance Test Data

Company Number:	267U
Certification Number:	267U-S450E450
Model Name:	Gigaset S450 / E450
Manufacturer:	Siemens Home and Office Communication Devices GmbH & Co KG Frankenstr. 2 46395 Bocholt Germany
Tested to Radio Standards Specification (RSS) No.:	RSS-213 Issue 2 / December 2005
Open Area Test Site Industry Canada Number:	3463
Frequency Range (or fixed frequency) [MHz]:	1921.536 – 1928.448 MHz
RF: Power [W] (max):	Rad. EIRP: 19.7 dBm, 93.3 mW Conducted :19.4 dBm, 87.1 mW
Antenna Type:	1 printed board antenna / 1 inverted F
Occupied Bandwidth (99% BW) [kHz]:	2.3 MHz
Type of Modulation:	GFSK
Emission Designator (TRC-43):	2M30FXD
Transmitter Spurious (worst case) [μ V/m in 3m]:	>20 dB below limit
Receiver Spurious (worst case) [μ V/m in 3m]:	>20 dB below limit

ATTESTATION: I attest that the testing was performed or supervised by me; that the test measurements were made in accordance with the above-mentioned departmental standard(s), and that the radio equipment identified in this application has been subject to all the applicable test conditions specified in the departmental standards and all of the requirements of the standards have been met.

Signature:

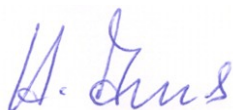

Date: 2006-02-08

Testengineer: Harro Ames

Test report no.: 2-4189-01-02/05

Date: 2006-02-08

Page 9 of 91

1.3.4 Additional EUT information - Test Report Cover Sheet/Performance Test Data

Company Number:	267U
Certification Number:	267U-S450E450
Model Name:	Gigaset S450 / E450
Manufacturer:	Siemens Home and Office Communication Devices GmbH & Co KG Frankenstr. 2 46395 Bocholt Germany
Type of evaluation:	
Evaluated against exposure limits:	<input checked="" type="checkbox"/> General Public Use: <input type="checkbox"/> Controlled Use:
Duty Cycle used in evaluation:	100 %
Standard used for evaluation:	RSS-102 Issue 2 (2005-11)
Measurement distance:	0.2 m
RF value:	0.24 mW/cm ²
	<input checked="" type="checkbox"/> measured
	<input type="checkbox"/> computed
	<input type="checkbox"/> calculated

ATTESTATION: I attest that the information provided in **Fehler! Verweisquelle konnte nicht gefunden werden.** is correct; that a Technical Brief was prepared and the information it contains is correct; that the device evaluation was performed or supervised by me; that applicable measurement methods and evaluation methodologies have been followed and that the device meets the SAR and/or RF exposure limits of RSS-102.

Signature:

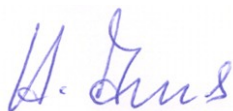

Date: 2006-02-08

Testengineer: Harro Ames

2. Teststandard & summary list of all performed test cases

TC identifier	Description	verdict	date	Remark
RF-Testing	FCC Part 15 - CANADA RSS-213 Draft ANSI-C63.17-2005	PASS	2006-02-08	PASS

2.1 Test and evaluation results:

General Requirements				
Requirement	FCC Part / IC Part	Test Procedure <small>(Section numbers refer to ANSI C63.17 unless otherwise noted)</small>	Result	Detailed Results
Emission Bandwidth	15.303(c) & 15.323 (a) / RSS-213 Clause 6.3	6.1.3	PASS	4.1
Labeling Requirements	15.311 & 15.19(a)(3) / RSS-213 Clause 5.1		PASS	Separate Attachment
Conducted Emissions	15.315 & 15.207 / RSS-213 Clause 10.0	ANSI C63.4	PASS	4.2
Antenna Requirements	15.317 & 15.203 / RSS-213 Clause 5.5	Declaration	Attestation	4.3
Use digital modulation	15.319 (b) / RSS-213 Clause 5.4	6.1.4	Attestation	4.4
Peak transmit power	15.303(f) & 15.319 (c) / RSS-213 Clause 7.1	6.1.2	PASS	4.5
Power spectral density	15.319 (d) & 15.107 / RSS-213 Clause 7.2	6.1.5	PASS	4.6
Power adjustment for antenna gain	15.319 (e)	4	Attestation	4.7
Automatically discontinue transmission	15.319 (f) / RSS-213 Clause 7.4.a		PASS	4.8
Spurious emissions conducted	15.319 (g) & 15.209 / RSS-213 Clause 7.3	6.1.6	PASS	4.9
SAR Testing of Handset	15.319 (i) & 1.1307(b), 2.1091 and 2.1093	ANSI/IEEE C95.1	Attestation	See separate Test report

Isochronous Requirements				
Requirement	FCC Part	Test Procedure (Section numbers refer to ANSI C63.17 unless otherwise noted)	Result	Detailed Results
Listen before talk	15.323 (c)	7	PASS	4.10
Monitoring time	15.323 (c)(1) / RSS-213 Clause 8.4	7.3.4	PASS	4.11
Monitoring threshold	15.323 (c)(2) / RSS-213 Clause 8.4	7.3.1	PASS	4.12
Maximum transmit time	15.323 (c)(3) / RSS-213 Clause 8.4	8.2.2	PASS	4.13
System acknowledgement	15.323 (c)(4) / RSS-213 Clause 8.4(c)(4)	8.1.1 & 8.1.2	PASS	4.14
Least Interfered Channel	15.323 (c)(5.1)	7.3.2 & 7.3.3	PASS	4.15
Channel confirmation	15.323 (c)(5.2)	7.3.3 & 7.3.4	PASS	4.16
Power measurement resolution	15.323 (c)(5.3) / RSS-213 Clause 8.4(c)(5)	7.3.3	PASS	4.17
Segment occupancy	15.323 (c)(5.4)	Declaration	Attestation	4.18
Random waiting	15.323 (c)(6) / RSS-213 Clause 8.4	8.1.3	Attestation	4.19
Monitoring bandwidth	15.323 (c)(7.1) / RSS-213 Clause 8.4(c)(7)	7.4	PASS	4.20
Monitoring reaction time	15.323 (c)(7.2) / RSS-213 Clause 8.4(c)(7)	7.5	Attestation	4.21
Monitoring antenna	15.323 (c)(8) / RSS-213 Clause 8.4(c)(8)	4	PASS	4.22
Monitoring threshold relaxation	15.323 (c)(9) / RSS-213 Clause 8.4(c)(9)	4	PASS	4.23
Duplex system LBT	15.323 (c)(10) / RSS-213 Clause 8.4(c)(10)	8.3	Attestation	4.24
Alternate monitoring interval	15.323 (c)(11) / RSS-213 Clause 8.4(c)(11)	8.4	Attestation	4.25

Requirement	FCC Part	Test Procedure (Section numbers refer to ANSI C63.17 unless otherwise noted)	Result	Detailed Results
Fair access	15.323 (c)(12) / RSS-213 Clause 8.4(c)(12)	Declaration	Attestation	4.26
Frame period	15.323 (e) / RSS-213 Clause 8.4(d)	6.2.2 & 6.2.3	PASS	4.27
Frequency stability	15.323 (f) / RSS-213 Clause 8.4(d)	6.2.1	PASS	4.28
Radiated Out of Band Emissions	15.309 (b) & FCC Part 15 Subpart B, 15.109 and 15.209 / RSS-213 Clause 6.2		PASS	4.29

2.2 Additional information about the sample

The tested sample is a base station for a Wireless Phone according to FCC part15, subpart D (UPCS)

There are two type of base stations, S450 and E450. The only difference is the colour of the housing. S450 is silver, E450 is dark-blue.

For testing the sample was equipped with a temporary added coax connector to simplify the measurement.

For some measurements it was necessary to use a connection to a Handset. Hereby we used the dedicated Handset S45.

The complete test report for the Handset S45 is 2-4189-01-04/05 from our house.

3. Description of test set-up

3.1 Radiated measurements

The radiated measurements are performed in vertical and horizontal plane in the frequency range from 9 kHz to 25 GHz in semi-anechoic chambers. The EUT is positioned on a non-conductive support with a height of 0.80 m above a conductive ground plane that covers the whole chamber. The receiving antennas are conform with specifications ANSI C63.2-1987 clause 15 and ANSI C63.4-2003 clause 4.1.5. These antennas can be moved over the height range between 1.0 m and 4.0 m in order to search for maximum field strength emitted from EUT. The measurement distances between EUT and receiving antennas are indicated in the test setups for the various frequency ranges. For each measurement, the EUT is rotated in all three axes until the maximum field strength is received. The wanted and unwanted emissions are received by spectrum analysers where the detector modes and resolution bandwidths over various frequency ranges are set according to requirement ANSI C63-4-2003 clause 4.2.

Antennas are conform with ANSI C63.2-1996 item 15.

9 kHz - 150 MHz: Quasi Peak measurement, 200 Hz Bandwidth, passive loop antenna.

150 kHz - 30 MHz: Quasi Peak measurement, 9kHz Bandwidth, passive loop antenna.

30 MHz - 200 MHz: Quasi Peak measurement, 120KHz Bandwidth, biconical antenna

200MHz - 1GHz: Quasi Peak measurement, 120KHz Bandwidth, log periodic antenna

1GHz: Average, RBW 1MHz, VBW 10 MHz, waveguide horn

The EUT is powered by a dedicated power supply with nominal voltage.

3.2 Conducted measurements

The EUT's RF signal is coupled out by the antenna connector which is supplied by the manufacturer. The signal is first 10dB attenuated before it is power divided (Multicoupler up to 9 branches). One of the signal path is connected to the communication simulator (CMD65 or other), the other one is connected to the spectrum analyzer, others are connected to signal generators an/or handsets . The specific losses for all signal paths are first checked within a calibration. The measuerment readings on the signaling unit/spectrum analyzer are corrected by the specific test set-up loss. All measuring equipment is impedance matched on 50 Ohm.

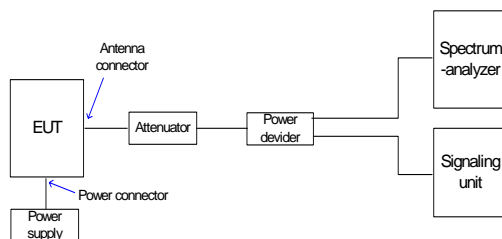

A dedicated description of test setups can be found at the related tests.

4 Detailed Test Procedures and Results

4.1 Emission Bandwidth

4.1.1 Test Criteria

§ 15.303 Definitions.

(c) Emission bandwidth. For purposes of this subpart the emission bandwidth shall be determined by measuring the width of the signal between two points, one below the carrier center frequency and one above the carrier center frequency, that are 26 dB down relative to the maximum level of the modulated carrier. Compliance with the emissions limits is based on the use of measurement instrumentation employing a peak detector function with an instrument resolutions bandwidth approximately equal to 1.0 percent of the emission bandwidth of the device under measurement.

§ 15.323 Specific requirements for isochronous devices operating in the 1920–1930 MHz sub-band.

(a) Operation shall be contained within the 1920-1930 MHz band. The emission bandwidth shall be less than 2.5 MHz. The power level shall be as specified in §15.319(c), but in no event shall the emission bandwidth be less than 50 kHz

4.1.2 Test Procedure

Testing to ANSI C63.17 draft ballot 3.0 Clause 6.1.3, which provides the test methodology for this provision.

In order to achieve pseudo random data transfer, as in reality, a connection was setup between the EUT and a Rhode and Schwarz DECT Test Device the CMD 65.

Test setup:

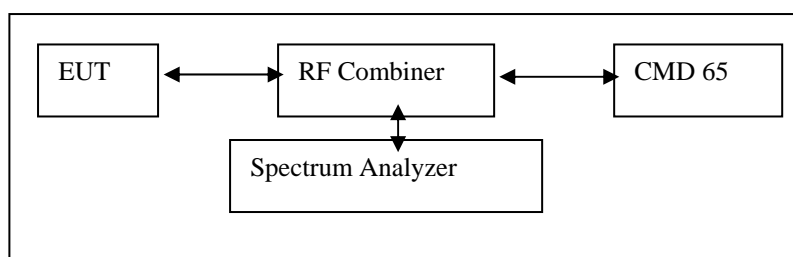

The CMD settings are shown below:

Traffic Carrier Offset	-20
Frequency Channel	4
Traffic Slot	2
RF Level	-70dBm
Data Type	PRBS

The spectrum analyzer is setup according to ANSI C63.17 Clause 6.1.3:

Centre Frequency	CH1, CH3, CH5
RBW	20KHz
VBW	100KHz
Trigger	Free Run
Span	5MHz
Detection	Peak Detection
Sweep Rate	auto
Amplitude Scale	Log
Peak Hold	On

The emission bandwidth of the BS is measured at 23°C and frequency channel CH1, CH3 and CH5.

Limits:

According to Part 15.323 (a) the maximum allowable emission bandwidth is 2.5MHz.

4.1.3 Test Results

Emission Bandwidth of BS at Ch1

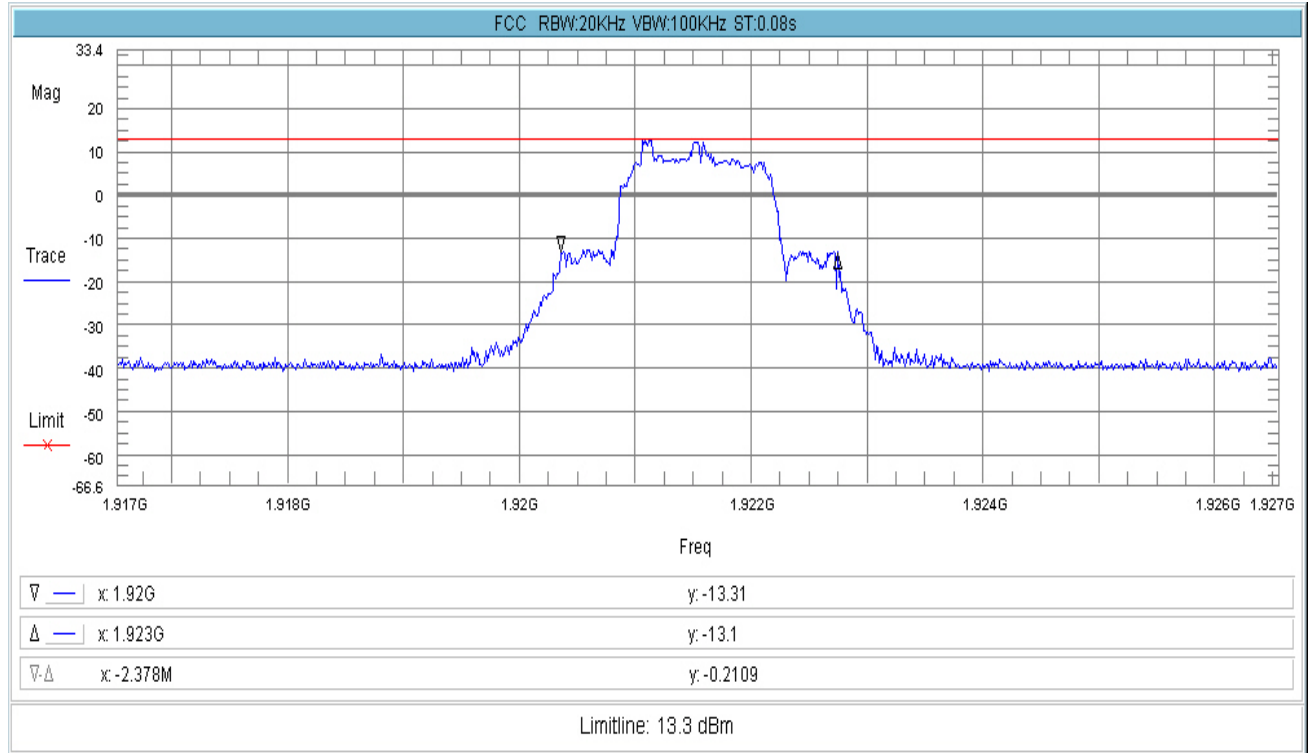

Emission Bandwidth of BS at Ch3

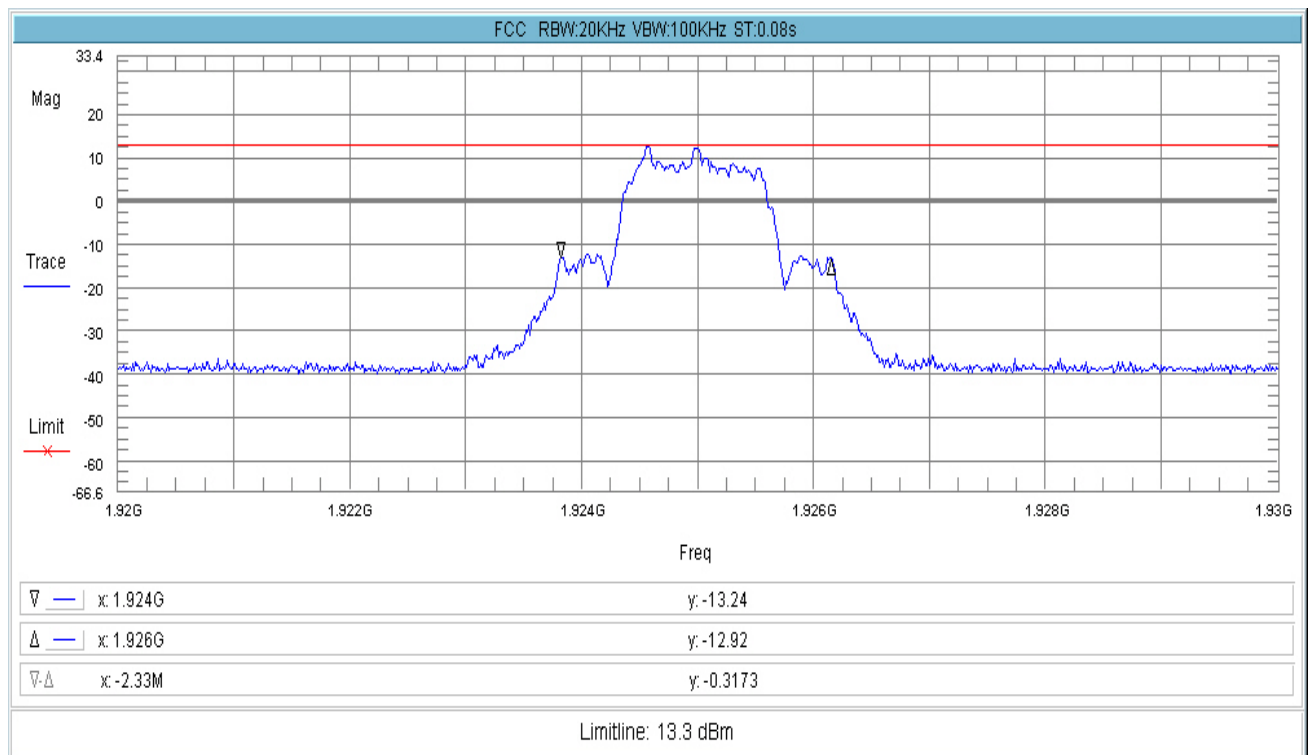

Emission Bandwidth of BS at Ch5

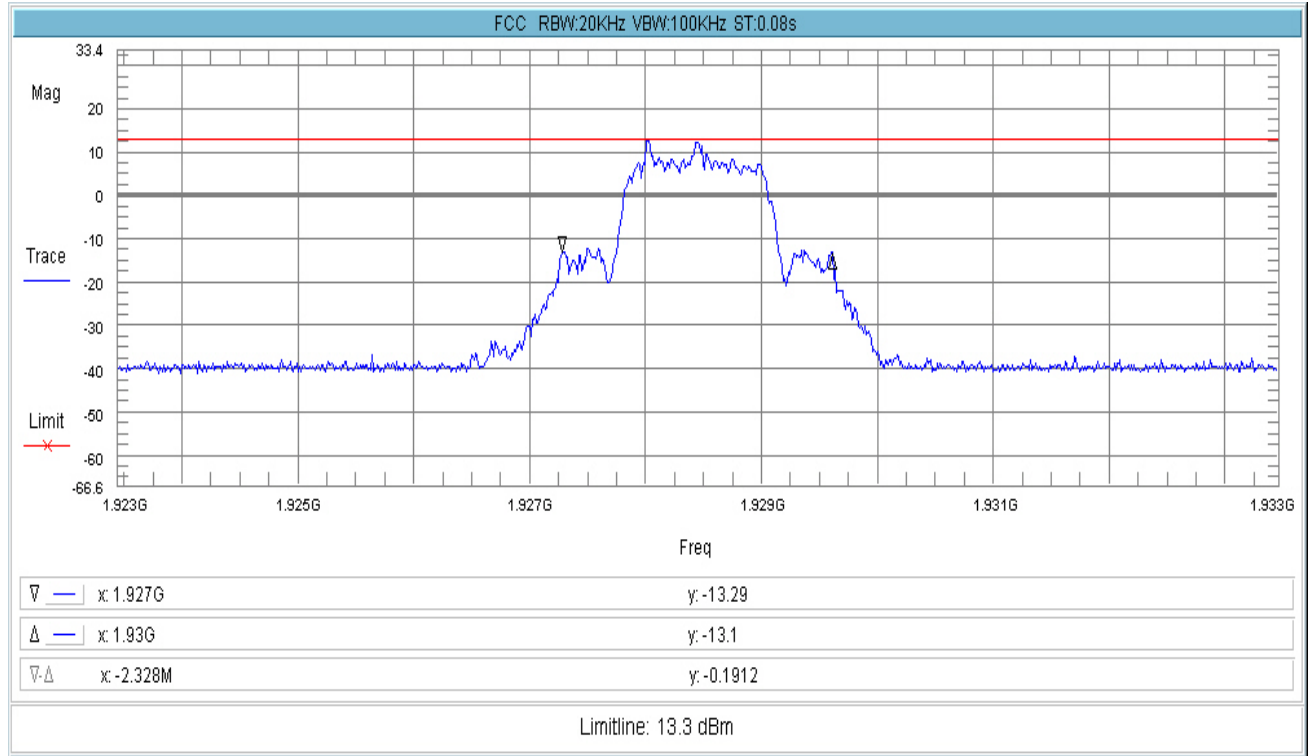

The following results are measured:

Emission Bandwidth	Measurement	Result
CH1	2.38 MHz	Pass
CH2	2.33 MHz	Pass
CH3	2.33 MHz	Pass

Result: Pass

4.2 Conducted Emissions

4.2.1 Test Criteria

§ 15.315 Conducted limits.

An unlicensed PCS device that is designed to be connected to the public utility (AC) power line must meet the limits specified in § 15.207.

§ 15.207 Conducted limits.

(a) Except as shown in paragraphs (b) and (c) of this section, for an intentional radiator that is designed to be connected to the public utility (AC) power line, the radio frequency voltage that is conducted back onto the AC power line on any frequency or frequencies, within the band 150 kHz to 30 MHz, shall not exceed the limits in the following table, as measured using a 50 μ H/50 ohms line impedance stabilization network (LISN). Compliance with the provisions of this paragraph shall be based on the measurement of the radio frequency voltage between each power line and ground at the power terminal. The lower limit applies at the boundary between the frequency ranges.

Frequency of emission (MHz)	Conducted limit (dB μ V)	Quasi-peak Average
0.15–0.5	66 to 56*	56 to 46*
0.5–5	56	46
5–30	60	50

*Decreases with the logarithm of the frequency.

(b) The limit shown in paragraph (a) of this section shall not apply to carrier current systems operating as intentional radiators on frequencies below 30MHz. In lieu thereof, these carrier current systems shall be subject to the following standards:

(1) For carrier current system containing their fundamental emission within the frequency band 535–1705 kHz and intended to be received using a standard AM broadcast receiver: no limit on conducted emissions.

(2) For all other carrier current systems: 1000 μ V within the frequency band 535–1705 kHz, as measured using a 50 μ H/50 ohms LISN.

(3) Carrier current systems operating below 30 MHz are also subject to the radiated emission limits in § 15.205, § 15.209, § 15.221, § 15.223, or § 15.227, as appropriate.

(c) Measurements to demonstrate compliance with the conducted limits are not required for devices which only employ battery power for operation and which do not operate from the AC power lines or contain provisions for operation while connected to the AC power lines. Devices that include, or make provisions for, the use of battery chargers which permit operating while charging, AC adapters or battery eliminators or that connect to the AC power lines indirectly, obtaining their power through another device which is connected to the AC power lines, shall be tested to demonstrate compliance with the conducted limits.

4.2.2 Test Procedure

This test is performed according to ANSI C63.4.

Principle setup for Conducted Emissions at ac power line:

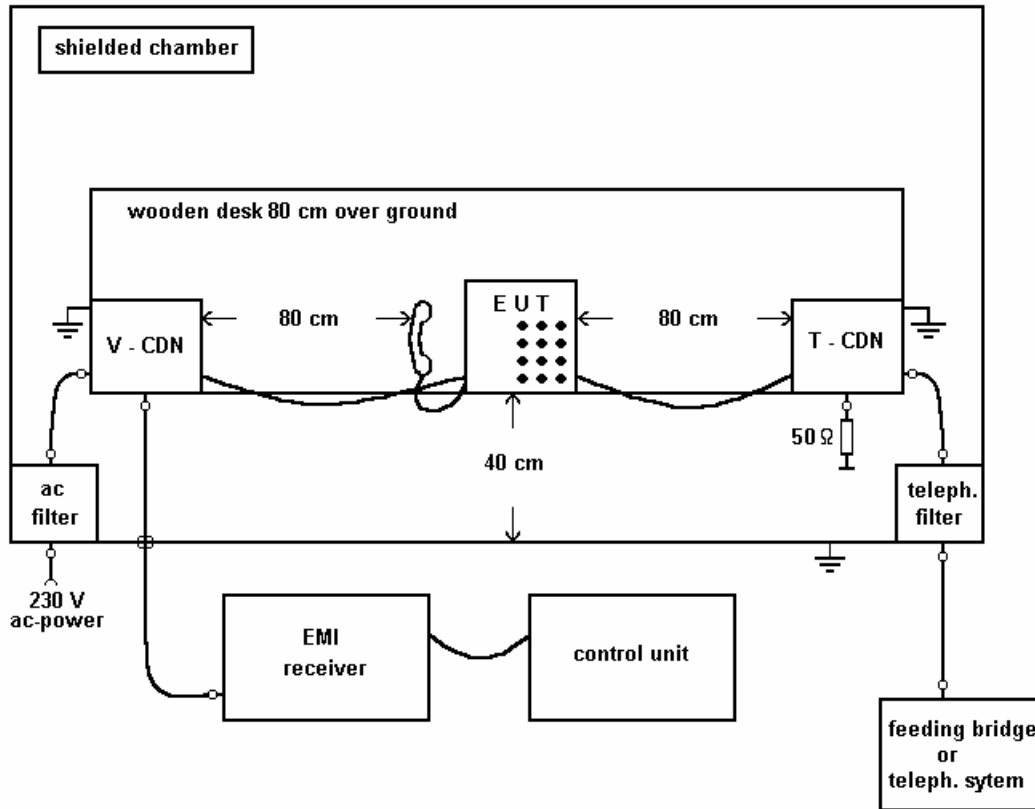

principle set up: conducted emission at ac power line

The following test procedure is applied:

Setup	Test Procedure
1	The EUT was connected to a PBX via CDN-T and filter unit.
2	The power supply was connected to a CDN-M2. During measuring at the CDN-M2, the CDN-T was terminated with 50 ohm.
3	A communication link is setup. (Operating Mode)
4	The EUT is set into Standby mode. (Standby Mode)

4.2.3 Test Results

Measured in operating and stand-by mode, max hold

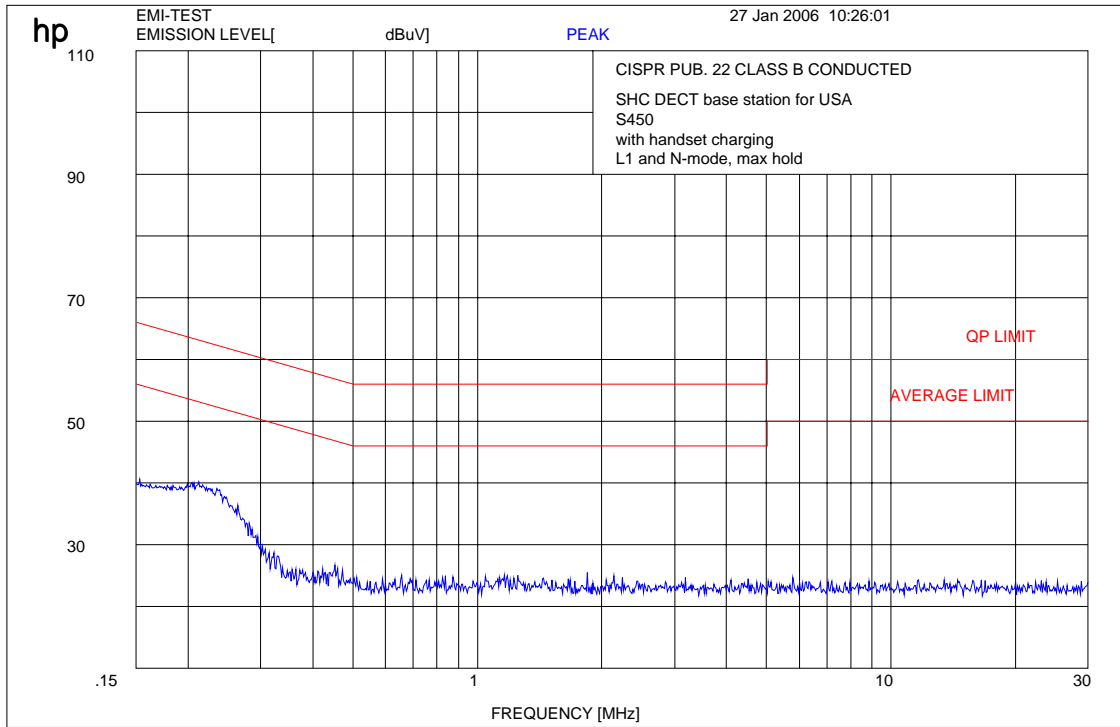

All emissions are below the limits.

Result: Pass

4.3 Antenna Requirements

4.3.1 Test Criteria

47CFR15.203 Antenna requirement.

An intentional radiator shall be designed to ensure that no antenna other than that furnished by the responsible party shall be used with the device. The use of a permanently attached antenna or of an antenna that uses a unique coupling to the intentional radiator shall be considered sufficient to comply with the provisions of this Section. The manufacturer may design the unit so that a broken antenna can be replaced by the user, but the use of a standard antenna jack or electrical connector is prohibited. This requirement does not apply to carrier current devices or to devices operated under the provisions of Sections 15.211, 15.213, 15.217, 15.219, or 15.221. Further, this requirement does not apply to intentional radiators that must be professionally installed, such as perimeter protection systems and some field disturbance sensors, or to other intentional radiators which, in accordance with Section 15.31(d), must be measured at the installation site. However, the installer shall be responsible for ensuring that the proper antenna is employed so that the limits in this Part are not exceeded.

4.3.2 Procedure

Attestation of manufacturer supported by photos and/or description of the antenna to allow visual confirmation.

4.3.3 Attestation

The BS uses permanently attached antennae. The BS uses two antennas, a PCB antenna and an inverted-F antenna, for antenna diversity.

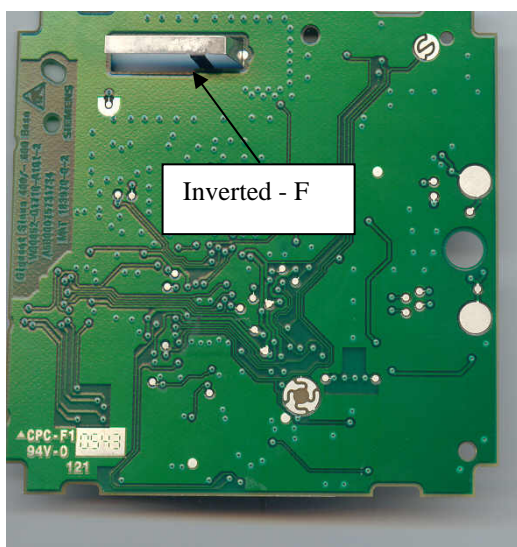

No external antenna can be attached to the device.

4.4 Use of Digital Modulation

4.4.1 Test Criteria

Section 15.319 General technical requirements.

(b) All transmissions must use only digital modulation techniques.

4.4.2 Procedure

Attestation of manufacturer supported by reference to relevant DECT specifications.

4.4.3 Attestation

This device is compliant with the DECT standards described in European Standards EN 300 175-2 and EN 300 175-3. DECT transmissions are MC/TDMA/TDD (Multi carrier / Time Division Multiple Access / Time Division Duplex) using Digital GFSK modulation.

For further details see operational description or relevant portions of the DECT standards.

4.5 Peak Transmit Power

4.5.1 Test Criteria

Section 15.319 General technical requirements.

(c) Peak transmit power shall not exceed 100 microwatts multiplied by the square root of the emission bandwidth in hertz. Peak transmit power must be measured over any interval of continuous transmission using instrumentation calibrated in terms of an rms equivalent voltage. The measurement results shall be properly adjusted for any instrument limitations, such as detector response times, limited resolution bandwidth capability when compared to the emission bandwidth, sensitivity, etc., so as to obtain a true peak measurement for the emission in question over the full bandwidth of the channel.

4.5.2 Test Procedure

Testing to ANSI C63.17 draft ballot 3.0 Clause 6.1.2, which provides the test methodology for this provision. The EUT is controlled from a personal computer and set into continuous transmission mode.

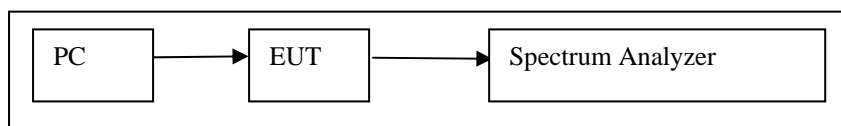

The spectrum analyzer is setup according to ANSI C63.17 Clause 6.1.2:

Centre Frequency	CH1, CH3, CH5
RBW	3MHz
VBW	7MHz
Trigger	Video
Span	zero
Detection	Peak Detection
Sweep Rate	1ms
Amplitude Scale	Log
Peak Hold	On

The peak transmit power of the BS is measured at 23°C and frequency channel CH1, CH3 and CH5.

The maximum peak transmit power is described in ANSI C63.17 Clause 4.3.1.

The antenna gain of both BS antennas is < 3dBi.

Therefore $P_{\text{limit}} = P_{\text{max}}$

The emission bandwidth = 2.33 MHz and therefore:

$$\begin{aligned}
 P_{\text{max}} &= 5 \log B - 10\text{dBm} \\
 &= 5 \log (2.33 \text{ exp}6) - 10\text{dBm} \\
 &= 21.8\text{dBm}
 \end{aligned}$$

The maximum peak transmit power is 21.8dBm.

4.5.3 Test results

Peak Transmit Power of BS at CH1

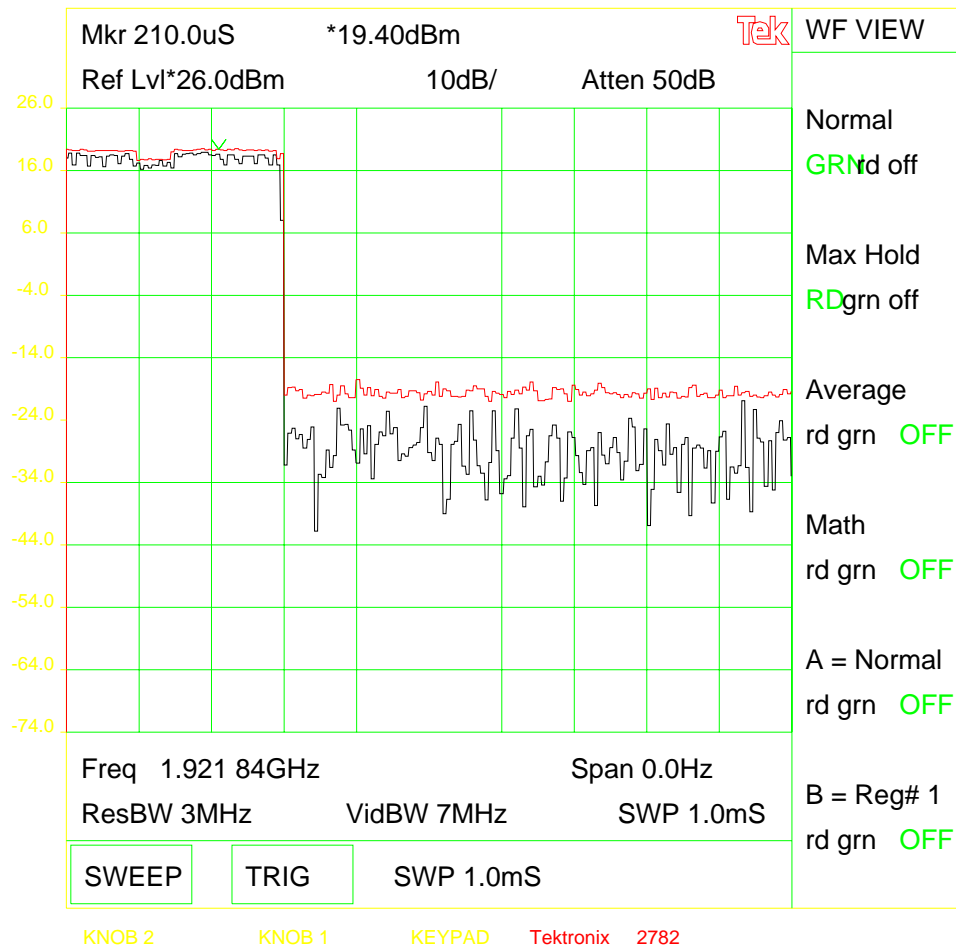

Peak Transmit Power of BS at CH3

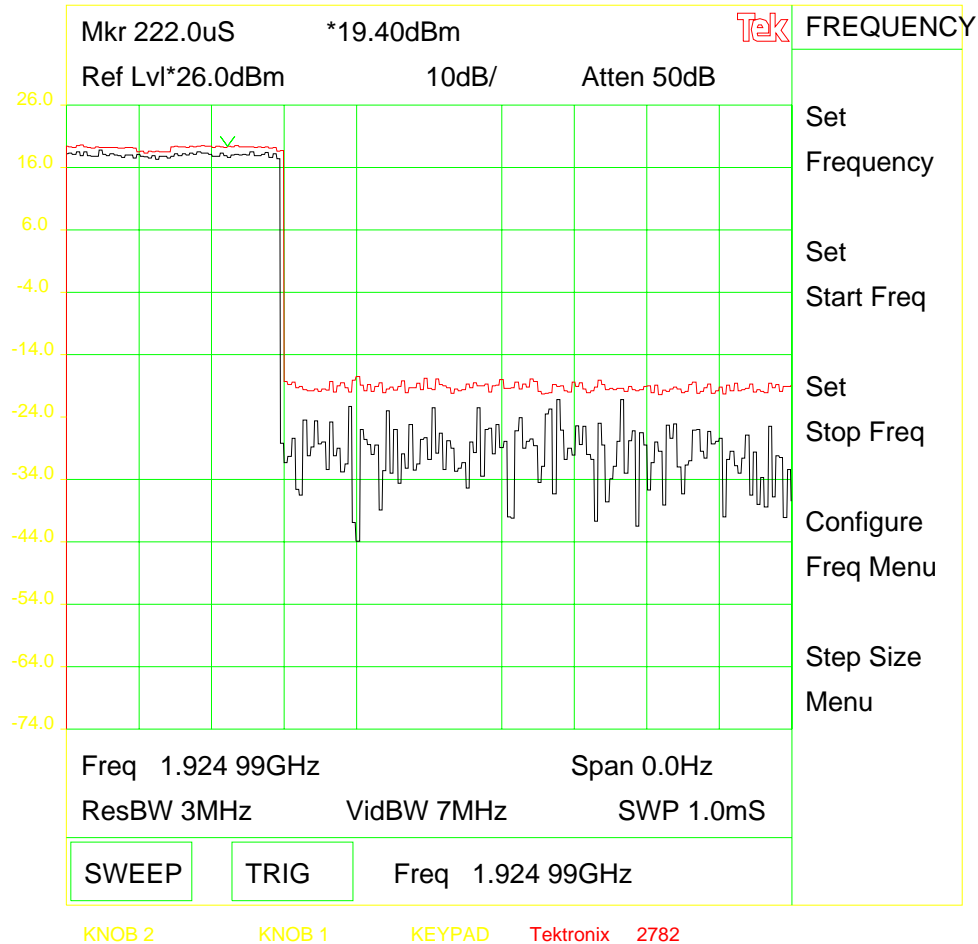

Peak Transmit Power of BS at CH5

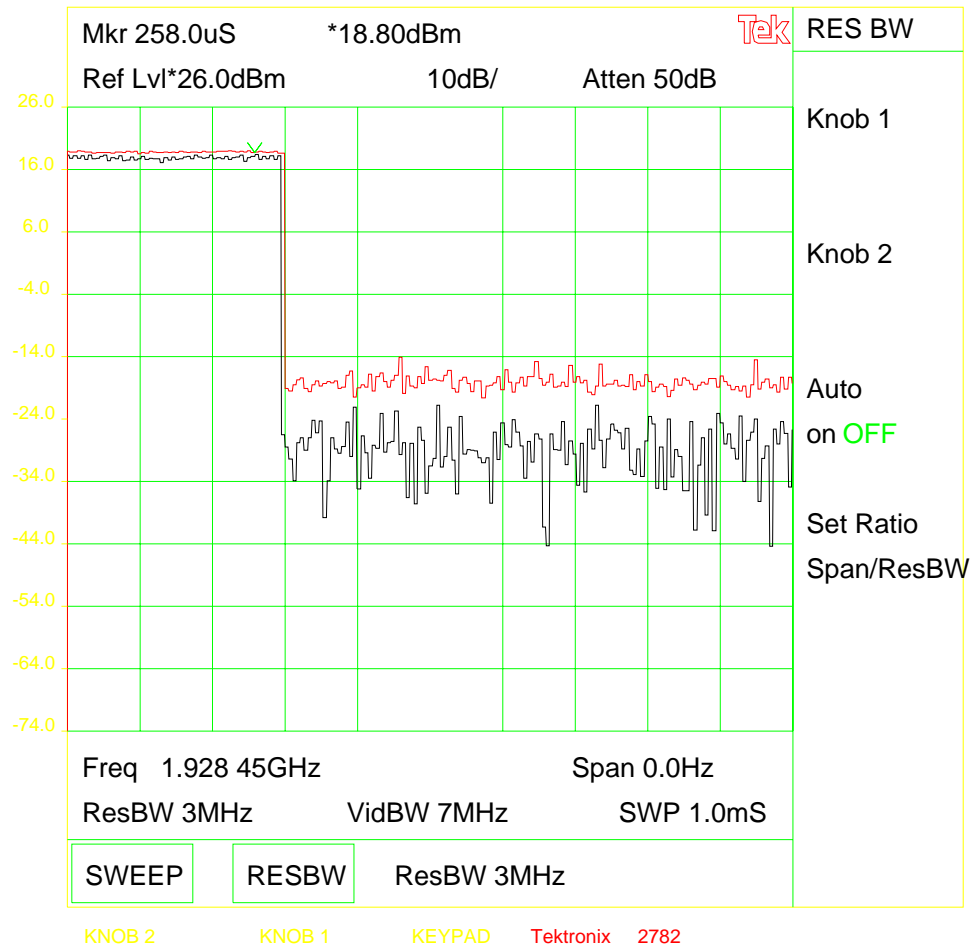

The following results are measured:

Peak Transmit Power	Measurement	Result
CH1	19.4 dBm	Pass
CH3	19.4 dBm	Pass
CH5	18.8 dBm	Pass

Result: Pass

4.6 Power Spectral density

4.6.1 Test Criteria

§ 15.319 General technical requirements.

(d) Power spectral density shall not exceed 3 milliwatts in any 3 kHz bandwidth as measured with a spectrum analyzer having a resolution bandwidth of 3 kHz.

4.6.2 Test procedure

Testing to ANSI C63.17 draft ballot 3.0 Clause 6.1.5, which provides the test methodology for this provision. In order to achieve pseudo random data transfer, as in reality, a connection is setup between the EUT and a Rhode and Schwarz DECT Test Device, the CMD 65.

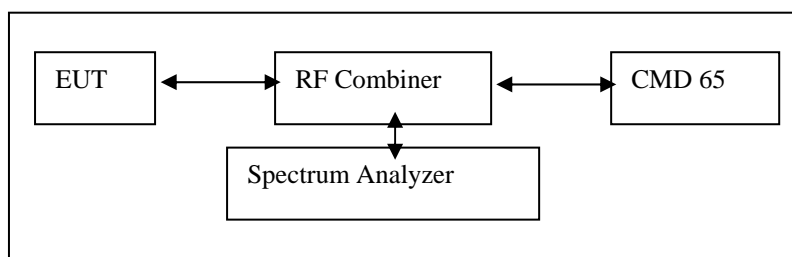

The CMD settings are shown below:

Traffic Carrier Offset	-20
Frequency Channel	4
Traffic Slot	2
RF Level	-70dBm
Data Type	PRBS

The spectrum analyzer is setup according to ANSI C63.17 Clause 6.1.5:

Centre Frequency	CH1, CH3, CH5
RBW	3KHz
VBW	3KHz
Trigger	Free Run
Span	10KHz
Detection	Peak Detection
Sweep Rate	20ms
Amplitude Scale	Log
Peak Hold	On

The power spectral density of the BS is measured at 25°C and frequency channel CH1, CH3 and CH5.

According to Part 15.319 (d) the maximum allowable Power Spectral Density is 3mW

$$PSD_{\text{limit}} = 3\text{mW} = 4,8\text{dBm}$$

4.6.3 Test Results

CH1:

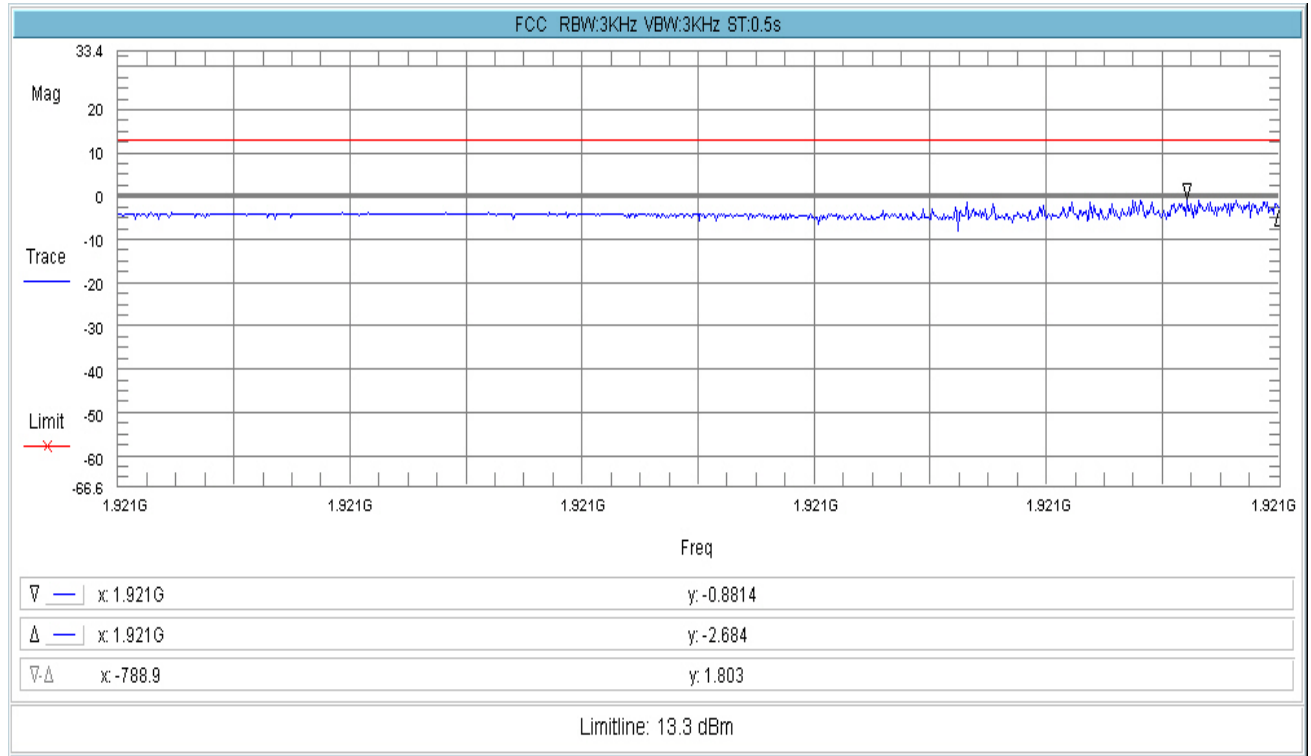

CH3:

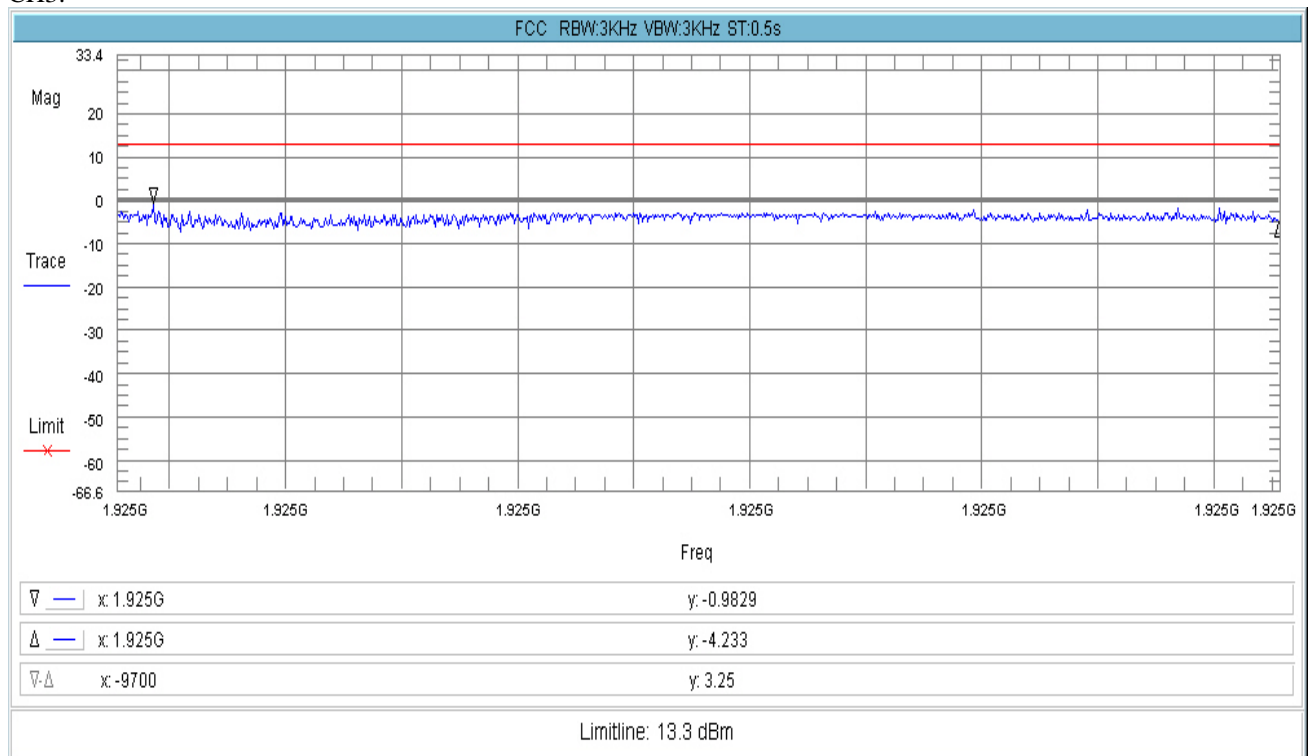

CH5:

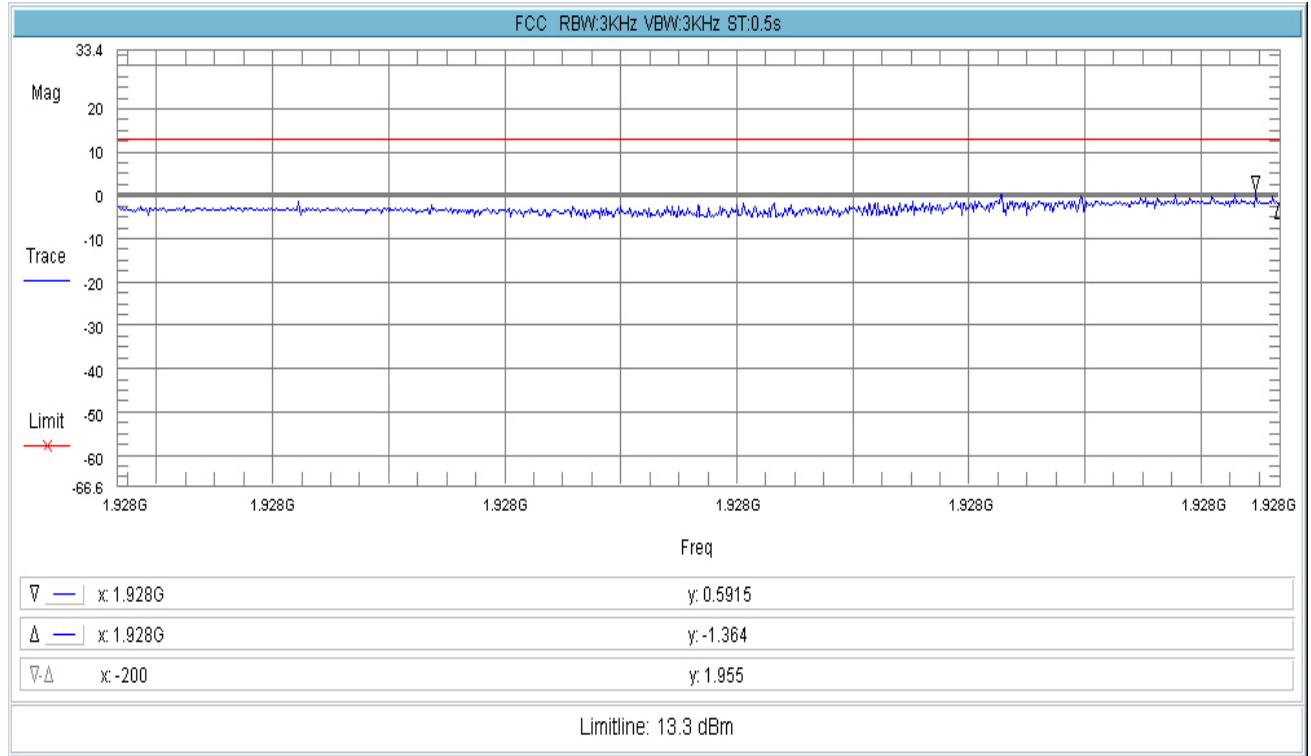

The following results are measured:

Power Spectral Density	Measurement	Result
CH1	0.82 mW/3KHz	Pass
CH3	0.80 mW/3KHz	Pass
CH5	1.15 mW/3KHz	Pass

Result: Pass

4.7 Power Adjustment for Antenna Gain

4.7.1 Test Criteria

§ 15.319 General technical requirements.

(e) The peak transmit power shall be reduced by the amount in decibels that the maximum directional gain of the antenna exceeds 3 dBi.

4.7.2 Test Procedure

The antenna gain of the BS is measured in an anechoic room.

4.7.3 Test Results

The antennas are separated from the rf frontend and connected to external coax cable.

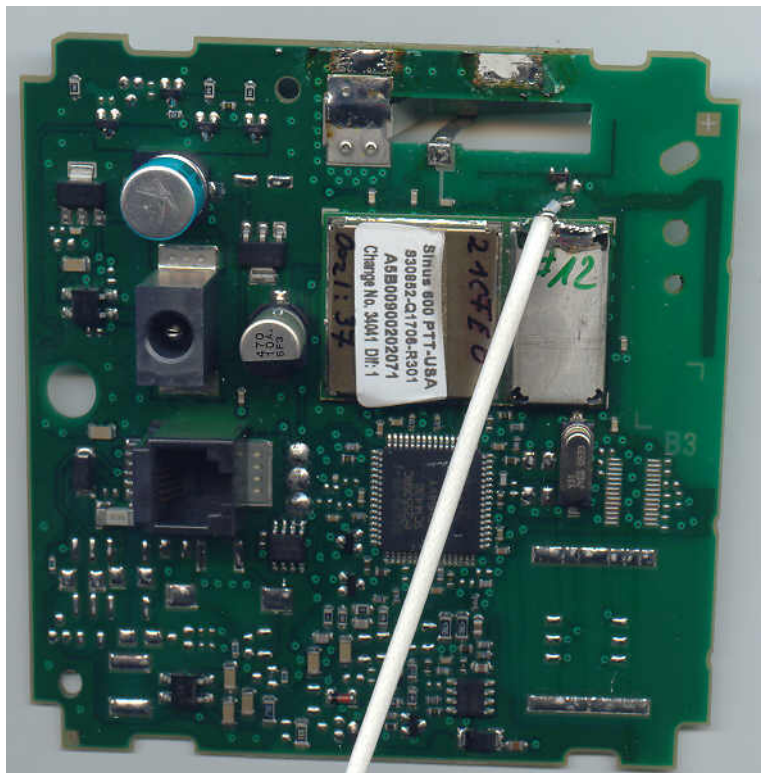

Inverted-F BS Antenna

	Vert. Ant	Hor. Ant
Min.	-18	-14
Max.	-5,2	0,3

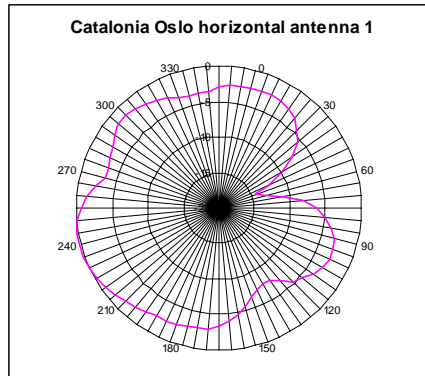
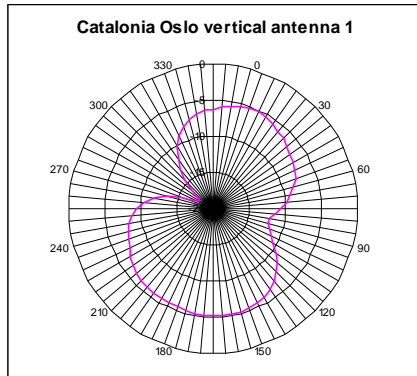

PCB BS Antenna

	Vert. Ant	Hor. Ant
Min.	-7,0	-26
Max.	-1,8	-2,1

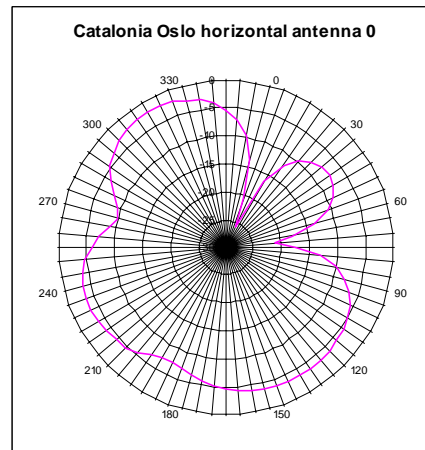
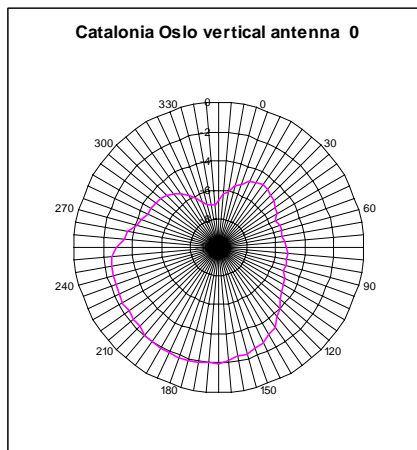

The antenna measurements are summarized below:

	Inverted-F Antenna	PCB Antenna
Max Vert. Gain	-5.2 dBi	-1.8 dBi
Max Hor. Gain	0.3 dBi	-2.1 dBi

Result: The maximum antenna gain < 3dBi.

4.8 Automatically Discontinued Transmission

4.8.1 Test Criteria

Section 15.319 General technical requirements.

(f) The device shall automatically discontinue transmission in case of either absence of information to transmit or operational failure. These provisions are not intended to preclude transmission of control and signaling information or use of repetitive codes used by certain digital technologies to complete frame or burst intervals.

4.8.2 Test Procedure

Attestation of manufacturer supported by test results. The statement shall include a description of how the EUT operates when there is no data to transmit. This may be met by reference to relevant portions of the DECT standards. The supporting testing is as follows:

The following tests are performed after a connection is first established between the EUT and its companion device.

	Test	Reaction at EUT	Result
1	Remove Power from companion device.	A/B/C	Pass/Fail
2	Switch off the companion device.	A/B/C	Pass/Fail
3	Terminate call at the companion device.	A/B/C	Pass/Fail
4	Switch off the EUT.	A/B/C	Pass/Fail
5	Terminate call at the EUT.	A/B/C	Pass/Fail

A – Connection is terminated and transmission ceases.

B – Connection is terminated but the EUT transmits control or signaling information

C – Connection is terminated but the companion device transmits control or signaling information

4.8.3 Test Result

The following testing is performed to confirm compliance with this provision :

	Test	Reaction at EUT	Result
1	Remove Power from companion device.	B	PASS
2	Switch off the companion device.	B	PASS
3	Terminate call at the companion device.	B	PASS
4	Switch off the EUT.	A	PASS
5	Terminate call at the EUT.	B	PASS

This device meets the requirement for automatic discontinuous operation. Its compliance with the DECT standards assures that transmissions are stopped when data is not available. See:

- ETSI EN 300 173-3, chapter 11.5.1: RFPI handshake
- ETSI EN 301 406, chapter 4.5.10.3: Channel release

Result: PASS

4.9 Spurious Emissions & Out of Band Emissions

4.9.1 Test Criteria

4.9.1.1 Out of Band Emissions

§ 15.323 Specific requirements for isochronous devices operating in the 1920–1930 MHz sub-band.

(d)(1) Emissions shall be attenuated below a reference power of 112 milliwatts as follows: 30 dB between the band edge and 1.25 MHz above or below the band; 50 dB between 1.25 and 2.5 MHz above or below the band; and 60 dB at 2.5 MHz or greater above or below the band.

4.9.1.2 Spurious and In-Band Unwanted Emissions

(d)(2) Emissions inside the band must comply with the following emission mask: In the bands between 1B and 2B measured from the center of the emission bandwidth, the total power emitted by the device shall be at least 30 dB below the transmit power permitted for that device; in the bands between 2B and 3B measured from the center of the emission bandwidth, the total power emitted by an intentional radiator shall be at least 50 dB below the transmit power permitted for that radiator; in the bands between 3B and the band edge, the total power emitted by an intentional radiator in the measurement bandwidth shall be at least 60 dB below the transmit power permitted for that radiator. “B” is defined as the emission bandwidth of the device in hertz. Compliance with the emission limits is based on the use of measurement instrumentation employing peak detector function with an instrument resolution bandwidth approximately equal to 1.0 percent of the emission bandwidth of the device under measurement.

4.9.2 Test Procedure

Testing to ANSI C63.17 draft ballot 3.0 Clause 6.1.6, which provides the test methodology for this provision.¹

This test procedure for the spurious in-band and out-of-band emissions evaluates the frequency range 1905MHz to 1945MHz. The whole frequency range 9KHz up to 25GHz is supplied in a separate document.

The EUT is controlled from a personal computer and set into continuous transmission mode.

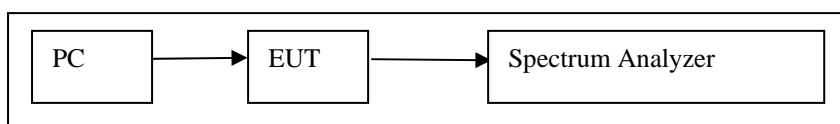

The spectrum analyzer is setup according to ANSI C63.17 Clause 6.1.6:

Centre Frequency	CH1, CH3, CH5
RBW	20KHz
VBW	100KHz
Trigger	Free Run
Span	20MHz in-band, 40MHz out-of-band
Detection	Peak Detection
Sweep Rate	auto
Amplitude Scale	Log
Peak Hold	On

The spurious emission of the BS is measured at 25°C and frequency channels CH1, CH3 and CH5.

The following limits apply:

	Out of Band Emissions	Spurious and In Band Unwanted Emissions
B	2.3 MHz	2 MHz
Peak Power	20.5 dBm	21.8 dBm
-30dB	Band Edge - 1.25MHz	2 – 4MHz
-50dB	1.25 – 2.5MHz	4 – 6MHz
-60dB	> 2.5MHz	> 6MHz

¹ Where these limits are more stringent than 47 CFR 15, Subpart C, §15.209, the limits of 47 CFR 15, Subpart C, §15.209 take precedence as indicated in 47 CFR 15, Subpart D, §15.319 (g).

4.9.3 Test Results

4.9.3.1 Out of Band Emissions

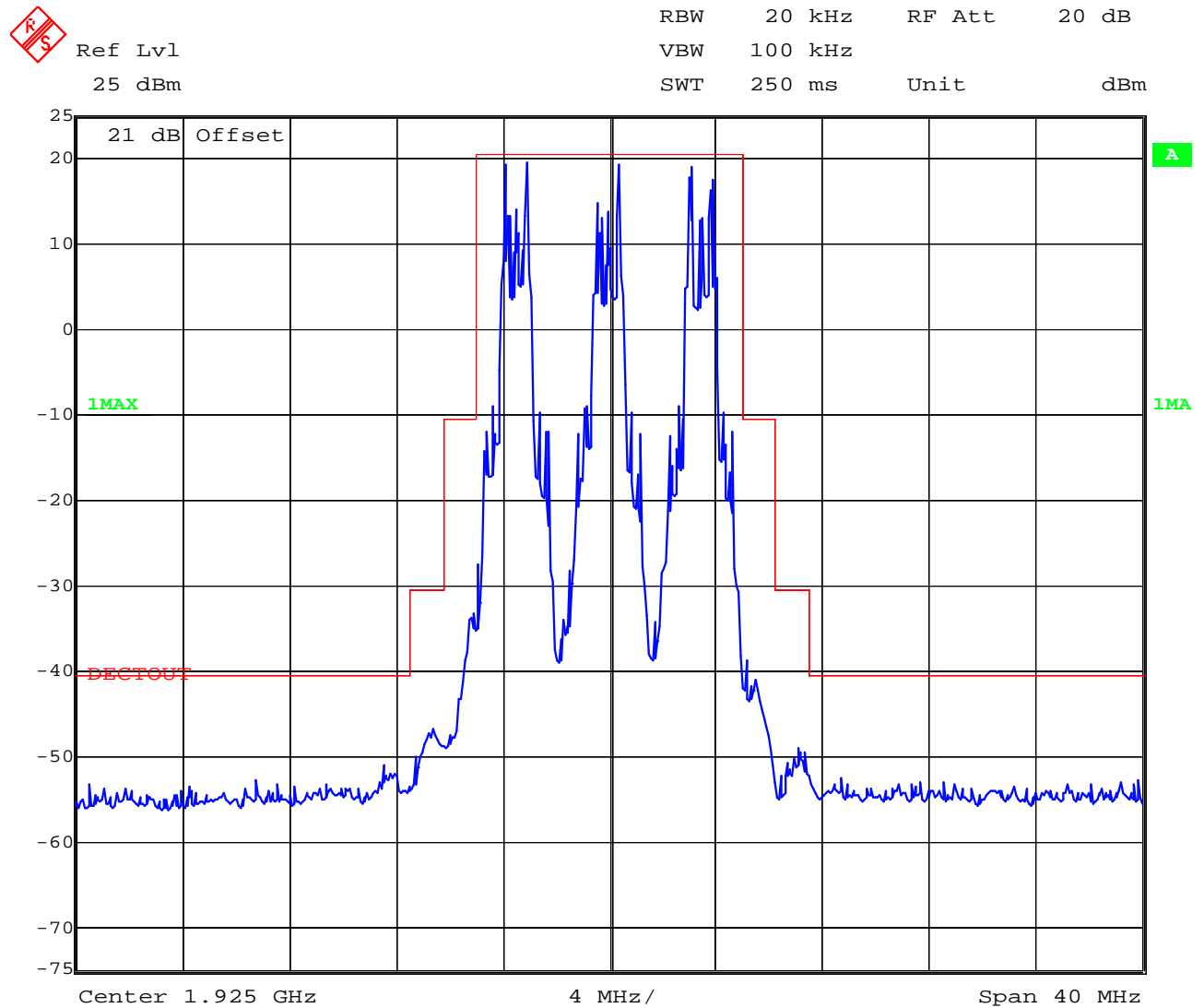

Date: 31.JAN.2006 10:13:41

The BS spurious out-of-band transmission level is below the indicated limit.

Result: Pass

4.9.3.2 Spurious and In-Band Unwanted Emissions

CH1:



Ref Lvl
25 dBm

RBW 20 kHz RF Att 20 dB
VBW 100 kHz
SWT 125 ms Unit dBm

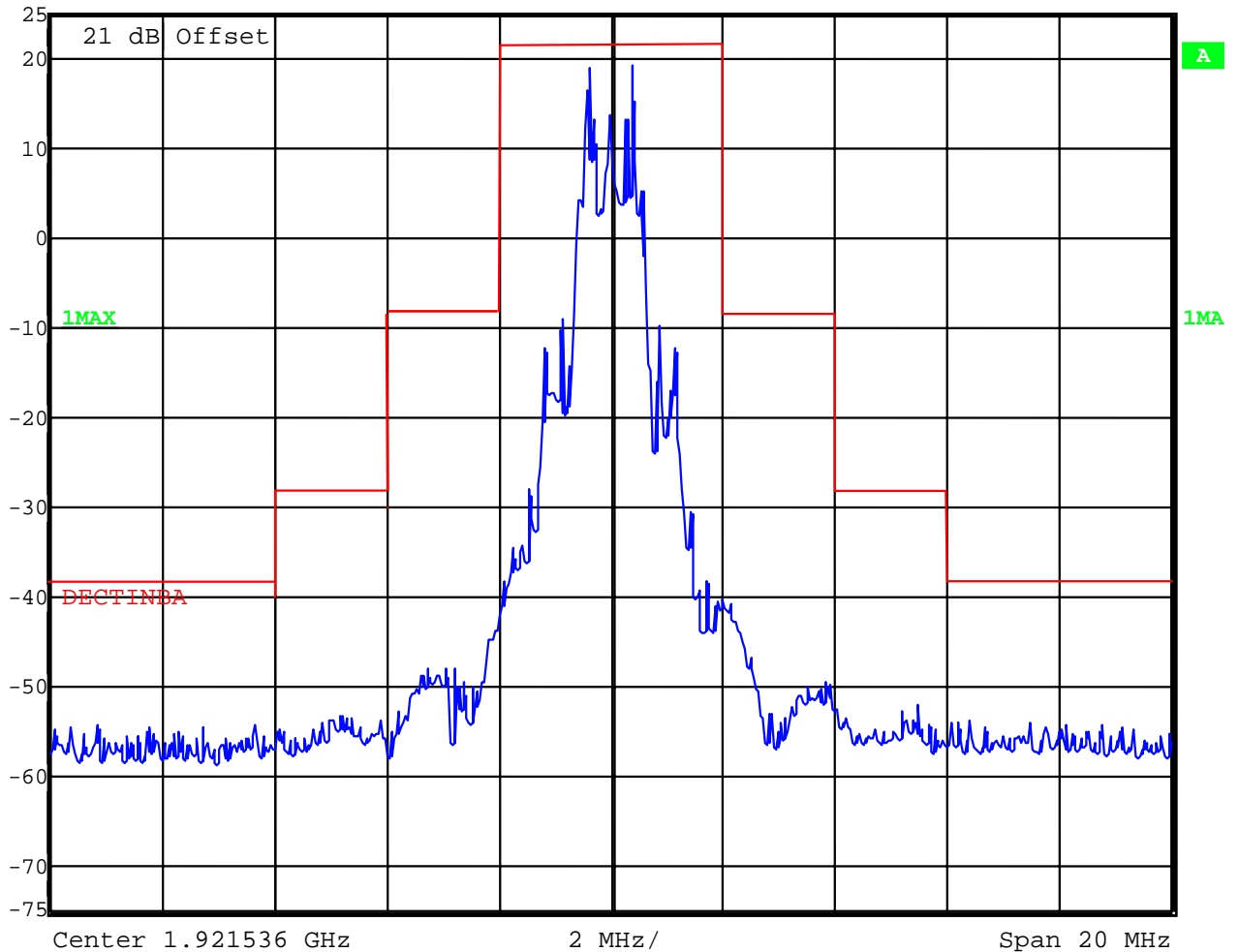

Date: 31.JAN.2006 10:15:47

CH3:



Ref Lvl
25 dBm

RBW 20 kHz RF Att 20 dB
VBW 100 kHz
SWT 125 ms Unit dBm

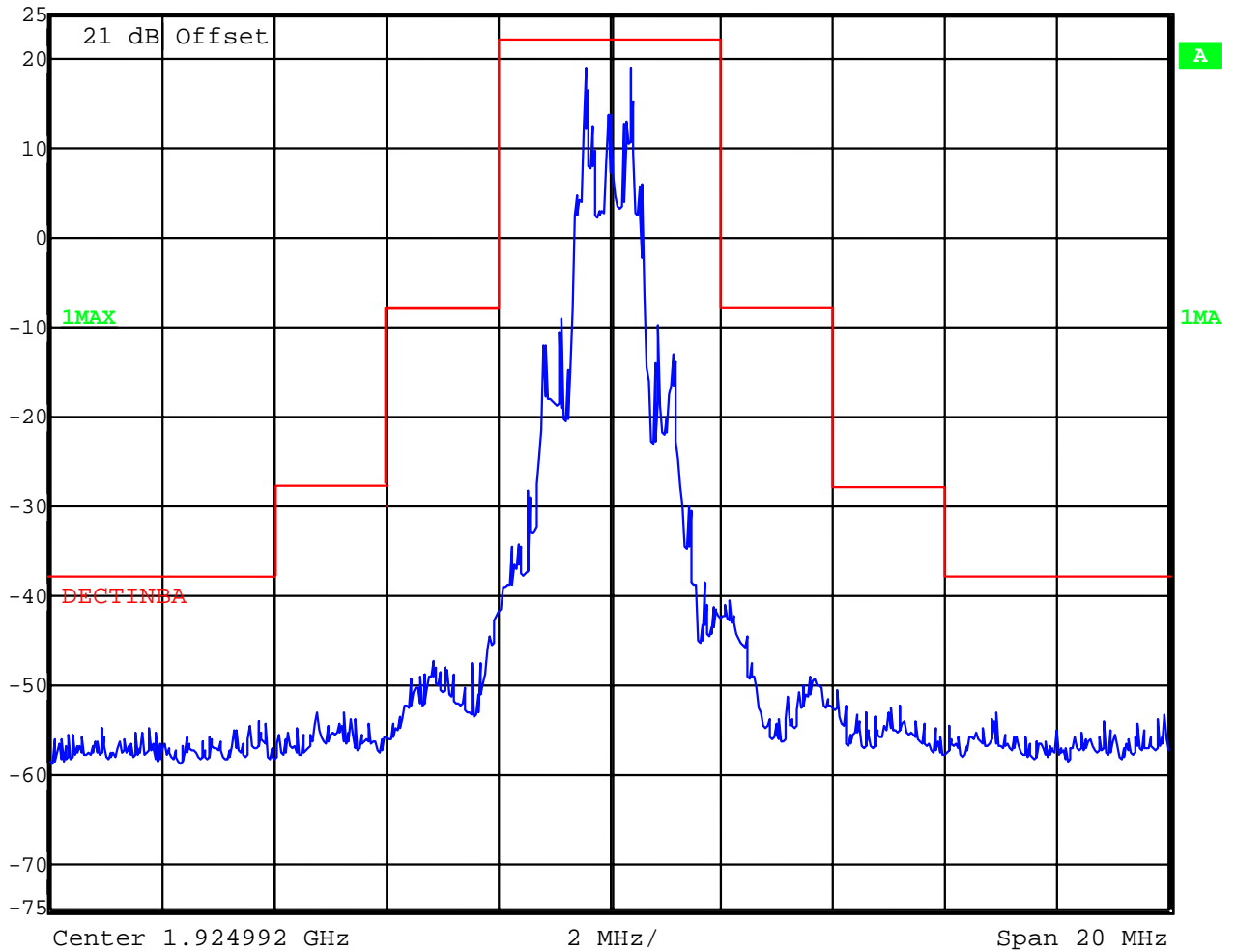

Date: 31.JAN.2006 10:14:59

CH5:

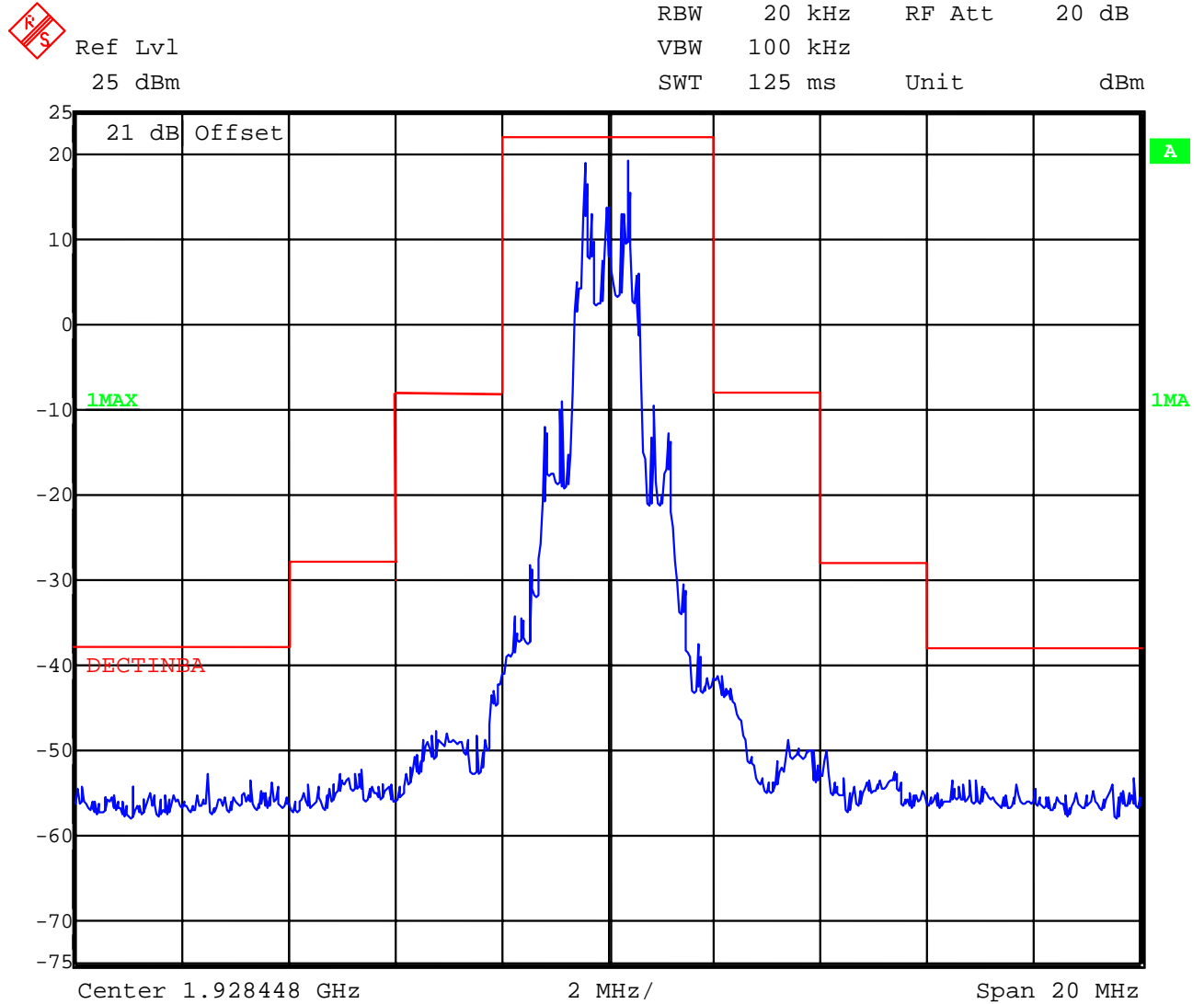

Date: 31.JAN.2006 10:17:26

The BS spurious in-band transmission level is below the indicated limit.

Result: Pass

4.10 Listen Before Talk

4.10.1 Test Criteria

§ 15.323 Specific requirements for isochronous devices operating in the 1920–1930 MHz sub-band.

4.10.2 Test Procedure

This requirement is split up into separate requirements which are covered by section 4.9 and sections 4.11 – 4.28.

4.10.3 Attestation

This requirement is met by section 4.9 and sections 4.11 – 4.28.

Result: Pass

4.11 Monitoring Time

4.11.1 Test Criteria

§ 15.323 Specific requirements for isochronous devices operating in the 1920–1930 MHz sub-band.

(c) Isochronous devices must incorporate a mechanism for monitoring the time and spectrum windows that its transmission is intended to occupy. The following criteria must be met:

(1) Immediately prior to initiating transmission, devices must monitor the combined time and spectrum windows in which they intend to transmit for a period of at least 10 milliseconds for systems designed to use a 10 milliseconds or shorter frame period or at least 20 milliseconds for systems designed to use a 20 milliseconds frame period.

4.11.2 Test Procedure

Testing to ANSI C63.17 draft ballot 3.0 Clause 7.3.4, which provides the test methodology for this provision.

The following test setup is used:

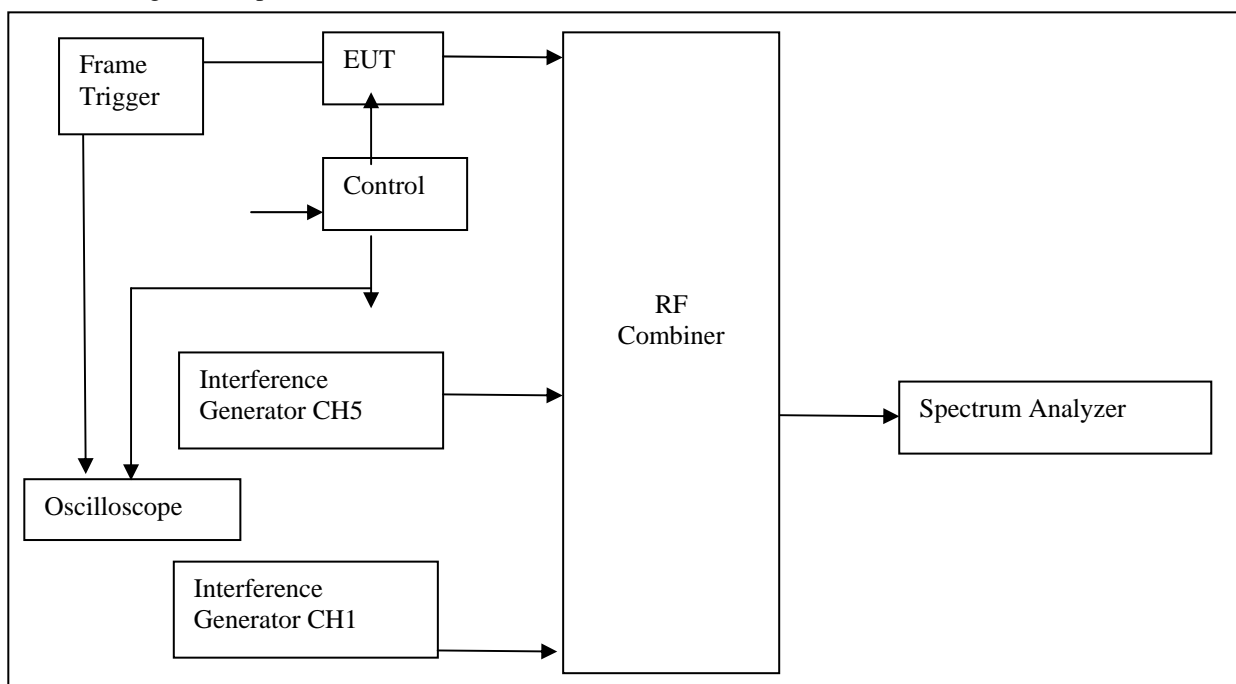

The following test procedure is applied:

ANSI C63.17	Description
Clause 7.3.4 (a)	Restrict transmission to CH1 and CH5 only. Set CW interference on CH5 to a level of -60dBm. (T_U+1 dB)
Clause 7.3.4 (b)	Switch ON BS and verify transmission of control signals on CH1. Switch OFF BS.
Clause 7.3.4 (c)	Apply CW interference on CH1 at a level of -60dBm (T_U+1 dB).
Clause 7.3.4 (d)	Remove interference from CH5 and immediately switch ON BS. Verify transmission of control signals on CH5 within 20ms.

The oscilloscope display is showing the CH5 rf disable signal and the frame sync signal from the BS. As soon as the frame sync signal appears a communication link should be setup on CH5. The communication link frequency is seen on the spectrum analyzer.

4.11.3 Test results

The oscilloscope display is shown below:

Tek Running: Waiting for Trigger

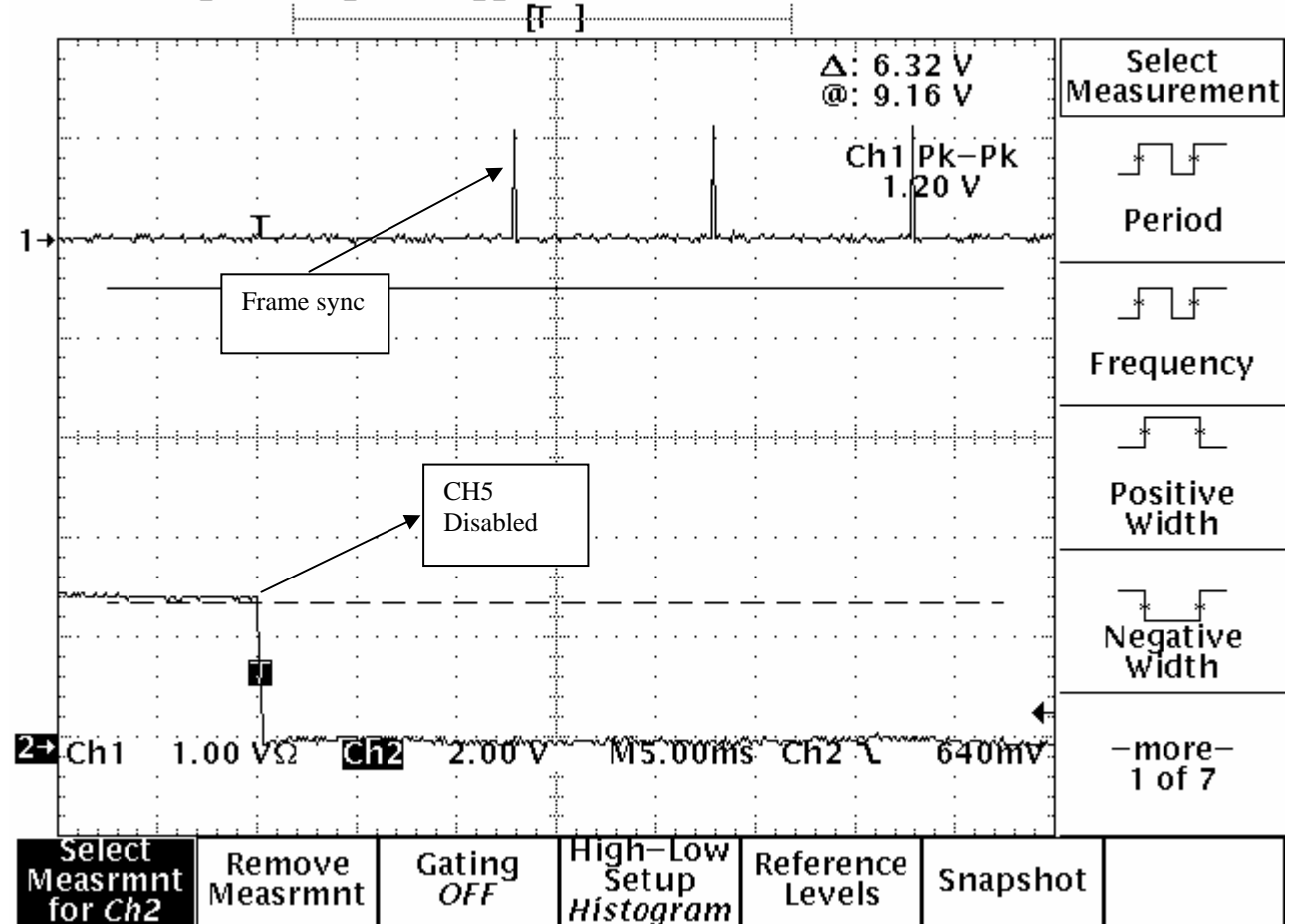

The difference between interference on CH4 disabled and starting of frames sync is 13ms.

The following test results are obtained:

ANSI C63.17	Description	Result
Clause 7.3.4 (a)	Transmission is restricted to CH1 and CH5 only. CW Interference on CH5 to a level of -60dBm.	Pass
Clause 7.3.4 (b)	BS transmits control signals on CH1. Switch OFF BS.	Pass
Clause 7.3.4 (c)	Apply interference on CH1 at a level of -60dBm.	Pass
Clause 7.3.4 (d)	Remove interference from CH5 and immediately switch ON BS. 17ms after rf disable the frame sync signal appears, indicating control signal transmission on CH5.	Pass

Result: Pass

4.12 Monitoring Threshold

4.12.1 Test Criteria

§ 15.323 Specific requirements for isochronous devices operating in the 1920–1930 MHz sub-band.

(c) Isochronous devices must incorporate a mechanism for monitoring the time and spectrum windows that its transmission is intended to occupy. The following criteria must be met:

(2) The monitoring threshold must not be more than 30 dB above the thermal noise power for a bandwidth equivalent to the emission bandwidth used by the device.

5.12.2 Test Procedure

Testing to ANSI C63.17 draft ballot 3.0 Clause 7.3.1, which provides the test methodology for this provision. The Clause states that the lower threshold is for devices that do not use the LIC procedure.

The equation for the lower monitoring threshold is given in ANSI C63.17 Clause 4.3.4.

$$T_L \leq (-174 + 10\log B + M_L + P_{\max} - P_{EUT}) \text{ dBm}$$

$$B = 2.3 \text{ MHz}$$

$$M_L = +30\text{dB}$$

$$P_{\max} = P_{EUT}$$

$$T_L = -80.4\text{dBm}$$

5.12.3 Test Results

The GIGASET S445 utilizes a LIC procedure and transmits on the least interfered channel.

The Rf sensitivity of the product for a BER of 1.10×10^{-3} is measured at -93dBm. The LIC procedure will be applied starting at -93dBm input power.

The current product offers 12 duplex channels per frequency channel and therefore $12 \times 5 = 60$ duplex channels in total. Hence Part §15.323(c)(5) applies.

Result: Pass

4.13 Maximum Transmit Time

4.13.1 Test Criteria

§ 15.323 Specific requirements for isochronous devices operating in the 1920–1930 MHz sub-band.

(c) Isochronous devices must incorporate a mechanism for monitoring the time and spectrum windows that its transmission is intended to occupy. The following criteria must be met:

(3) If no signal above the threshold level is detected, transmission may commence and continue with the same emission bandwidth in the monitored time and spectrum windows without further monitoring. However, occupation of the same combined time and spectrum windows by a device or group of cooperating devices continuously over a period of time longer than 8 hours is not permitted without repeating the access criteria.

4.13.2 Test Procedure

Testing to ANSI C63.17 draft ballot 3.0 Clause 8.2.2, which provides the test methodology for this provision.

A communication link is established between BS and MS in an anechoic room to prevent influence from other transmissions.

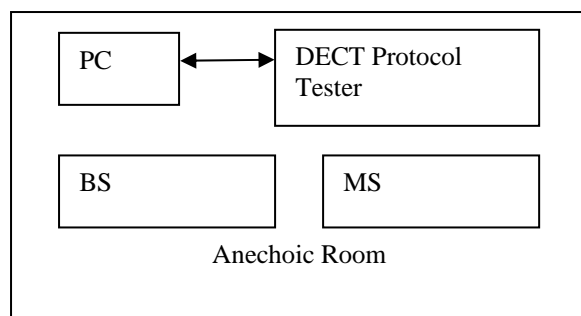

According to FCC Part 15.323 (c) (3), the access criteria have to be verified at least every 8 hours. The following test is performed:

ANSIC 63.17	Description
Clause 8.2.2 (a)	Initiate a communication link between BS and MS.
Clause 8.2.2 (b)	Monitor the communication channel. This link is monitored by a DECT protocol tester in an anechoic room to ensure no other DECT influence except for the existing communication link.

4.13.3 Test Results

	Absolute Time	Time Difference	Result
Initiate setup	17h30		n.a.
New Channel Access	17h47	2h55	n.a.
New Channel Access	20h42	2h55	Pass
New Channel Access	23h37	2h55	Pass
New Channel Access	2h32	2h55	Pass
New Channel Access	5h27	2h55	Pass
New Channel Access	8h22	2h55	Pass

The access criteria are verified every 2:55 hour. During this procedure the channel is changed.

Result: Pass

4.14 System Acknowledgement

4.14.1 Test criteria

§ 15.323 Specific requirements for isochronous devices operating in the 1920–1930 MHz sub-band.

(c) Isochronous devices must incorporate a mechanism for monitoring the time and spectrum windows that its transmission is intended to occupy. The following criteria must be met:

(4) Once access to specific combined time and spectrum windows is obtained an acknowledgment from a system participant must be received by the initiating transmitter within one second or transmission must cease. Periodic acknowledgments must be received at least every 30 seconds or transmission must cease. Channels used exclusively for control and signaling information may transmit continuously for 30 seconds without receiving an acknowledgment, at which time the access criteria must be repeated.

4.14.2 Test procedure

Testing to ANSI C63.17 draft ballot 3.0 Clause 8.1.1. & 8.1.2., which provides the test methodology for this provision.

The following test setup is used:

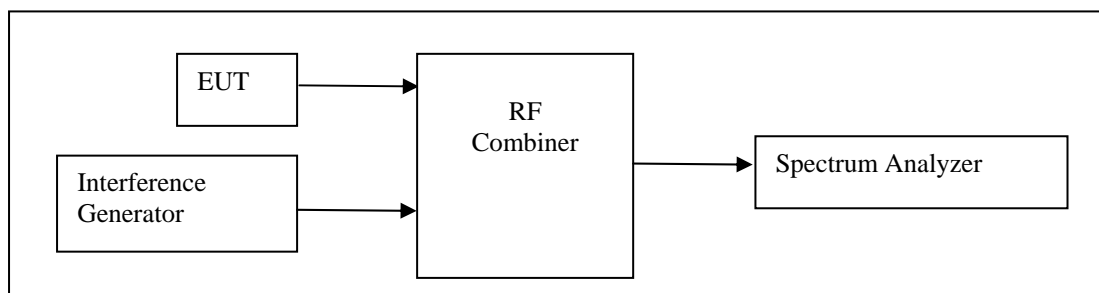

The following test procedure is performed:

ANSIC 63.17	Description
Clause 8.1.1 (a)	Restrict transmission on BS to CH3.
Clause 8.1.1 (b)	Verify that the BS terminates its transmission of control signals at least every 30s to verify access criteria. On the BS a Frame Sync and RSSI signal are recorded on an oscilloscope indicating the verification process. At certain frame sync positions no frame sync and no control signals are transmitted. At those positions the BS verifies the channel by measuring the RSSI level of the channel.
Clause 8.1.2 (a)	The BS is restricted to operate on CH1 or CH5 only.
Clause 8.1.2 (b)	The BS is switched on to transmit its control signals. When transmitting on either CH1 or CH5 a interference signal is introduced at the active frequency channel and level $> T_U$. It is to be verified 5 times that the control transmission signals are changing to the other available frequency channel within 30s.

4.14.3 Test results

The following test results are obtained:

ANSIC 63.17	Description	Result
Clause 8.1.1 (a)	Transmission on BS is restricted to CH3.	Pass
Clause 8.1.1 (b)	After each frame sync signal the BS measures the RSSI level and therefore normally 6 channels are verified. At the cursor of the oscilloscope a missing frame sync is indicated. At this position a single RSSI measurement is done to measure the channel to renew its channel access criteria. This verification is performed every 5s.	Pass
Clause 8.1.2 (a)	Transmission on BS is restricted to CH1 or CH5.	Pass
Clause 8.1.2 (b)	Without any interference signal the BS is transmitting on CH5. After applying interference at -61dBm on CH5, within 5s the control signals are changing transmission from CH5 to CH1.	Pass

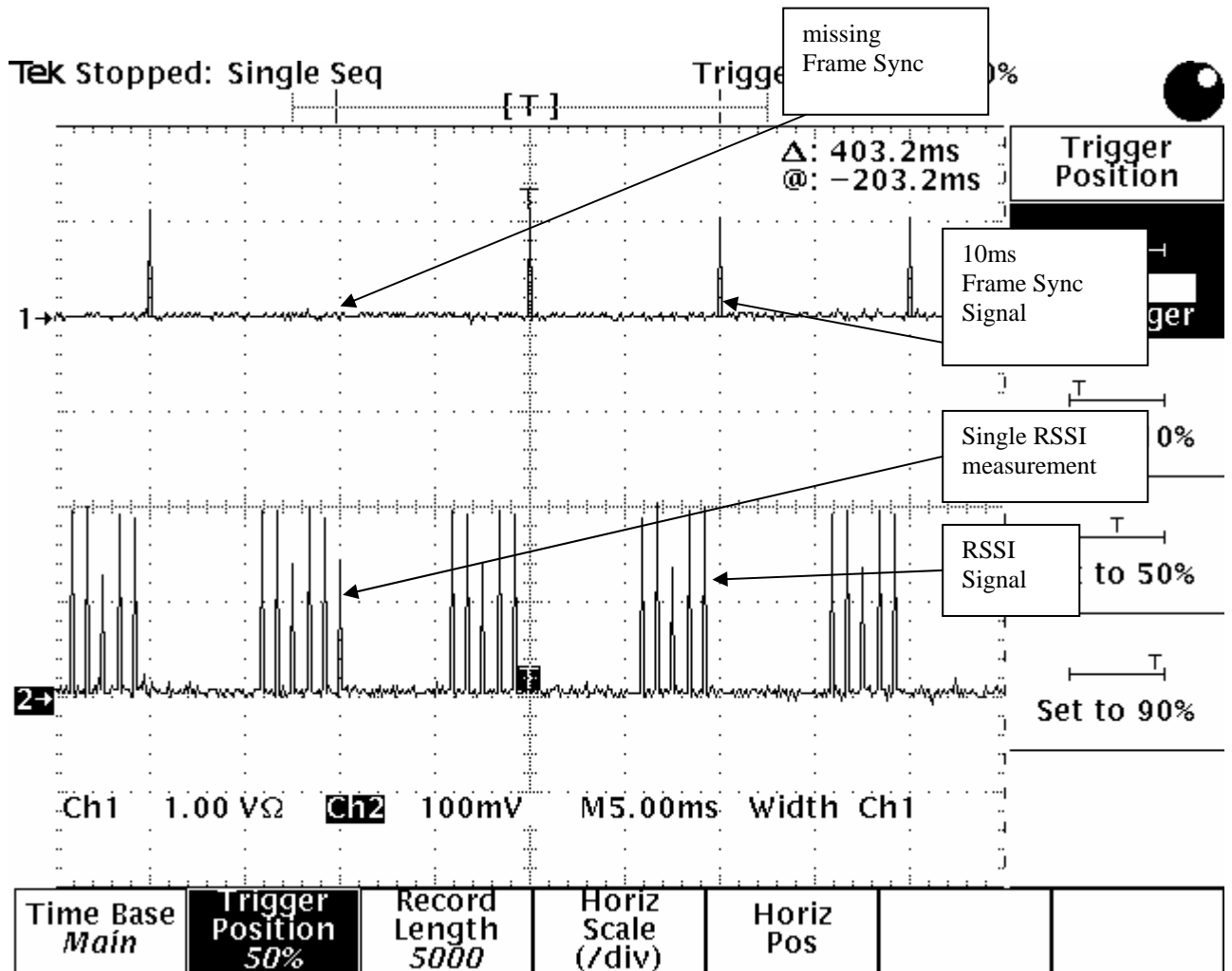

Result: Pass

The next plot shows the changing of the control signal after detection of an interferer (Clause 8.1.2 (b))

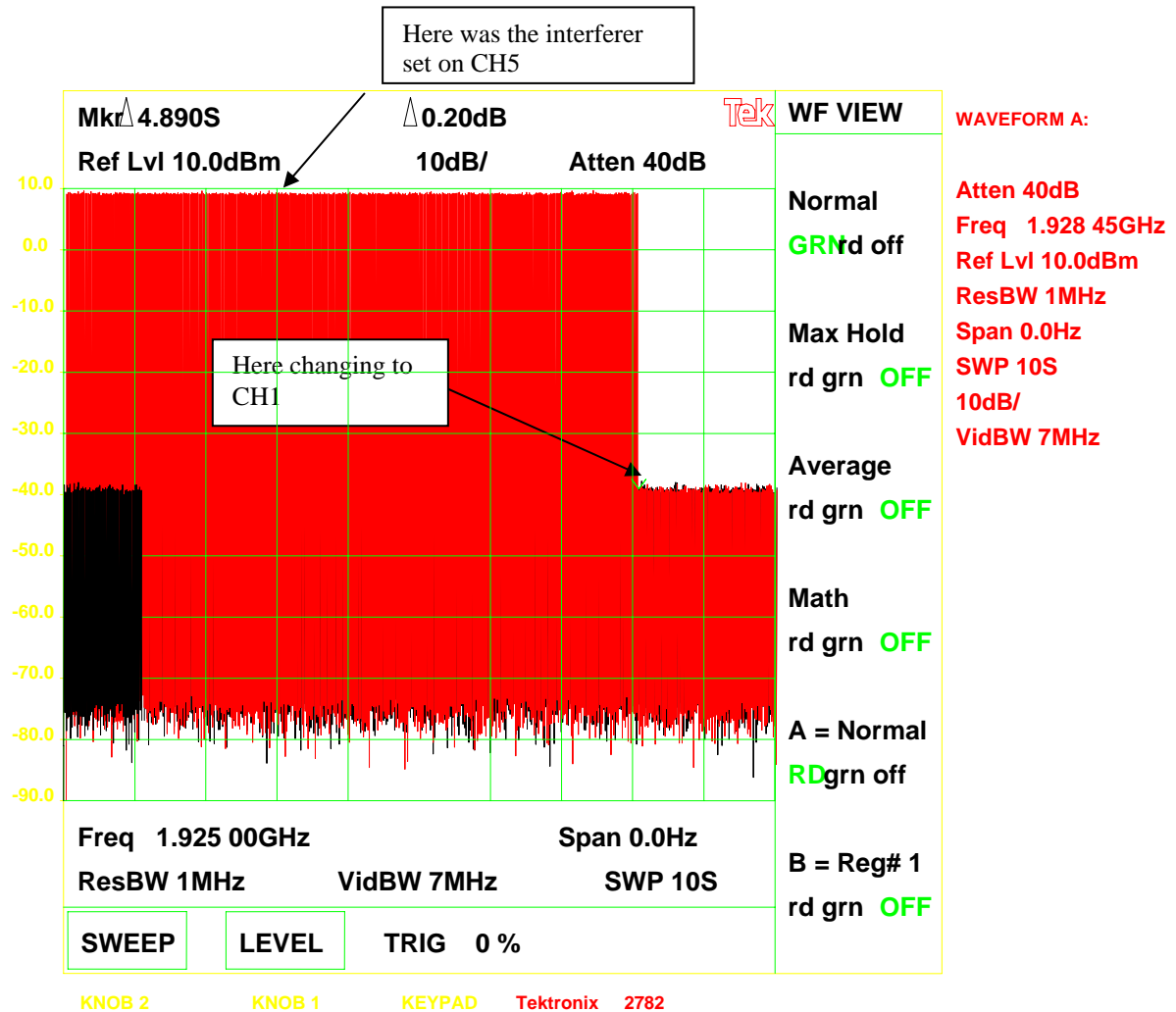

The time between the applying of the interferer and the reaction of the BS is 4.89s.

Limit is 30s

Result: Pass

4.15 Least Interfered Channel

4.15.1 Test Criteria

§ 15.323 Specific requirements for isochronous devices operating in the 1920–1930 MHz sub-band.

(c) Isochronous devices must incorporate a mechanism for monitoring the time and spectrum windows that its transmission is intended to occupy. The following criteria must be met:

(5) If access to spectrum is not available as determined by the above, and a minimum of 40 duplex system access channels are defined for the system, the time and spectrum windows with the lowest power level below a monitoring threshold of 50 dB above the thermal noise power determined for the emission bandwidth may be accessed.

4.15.2 Test procedure

Testing to ANSI C63.17 draft ballot 3.0 Clause 7.3.2. & 7.3.3, which provides the test methodology for this provision.

The current product offers 12 duplex channels per frequency channel and therefore 12x5=60 duplex channels in total. Hence Part §15.323(c)(5) applies.

The equation for the upper monitoring threshold is given in ANSI C63.17 Clause 4.3.3.

$$T_U \leq (-174 + 10\log B + M_U + P_{\max} - P_{EUT}) \text{ dBm}$$

$$B = 2.3 \text{ MHz}$$

$$M_U = 50\text{dB}$$

$$P_{\max} = P_{EUT}$$

$$T_U = -60.4 \text{ dBm}$$

4.15.2.1 Upper Threshold

Testing to ANSI C63.17 draft ballot 3.0 Clause 7.3.2 (a), which provides the test methodology for this provision.

The following test setup is used:

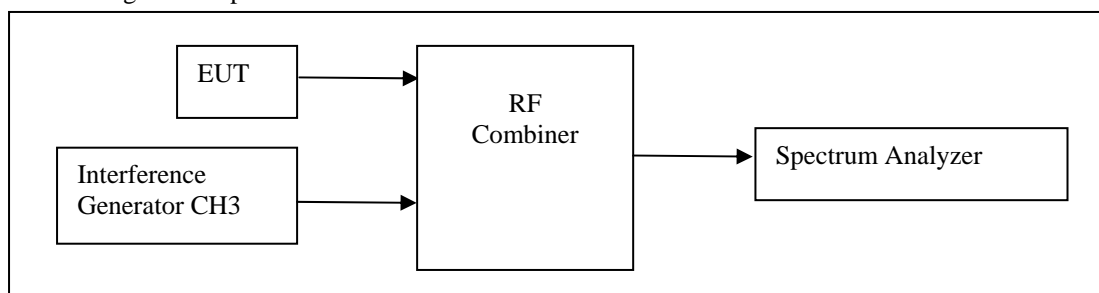

The following test procedure is applied:

ANSI C63.17	Description
Clause 7.3.2 (a)	<p>The BS is forced to operate on frequency channel CH3 only.</p> <p>Apply CW interference at CH3 and at level -51dBm ($T_U + 10\text{dB}$).</p> <p>The BS is switched ON.</p> <p>Lower the interference level until the BS can transmit its control signals.</p> <p>Verify the communication link on spectrum analyzer.</p>

4.15.2.2 LIC Procedure

Testing to ANSI C63.17 draft ballot 3.0 Clause 7.3.3, which provides the test methodology for this provision.

The following test setup is used:

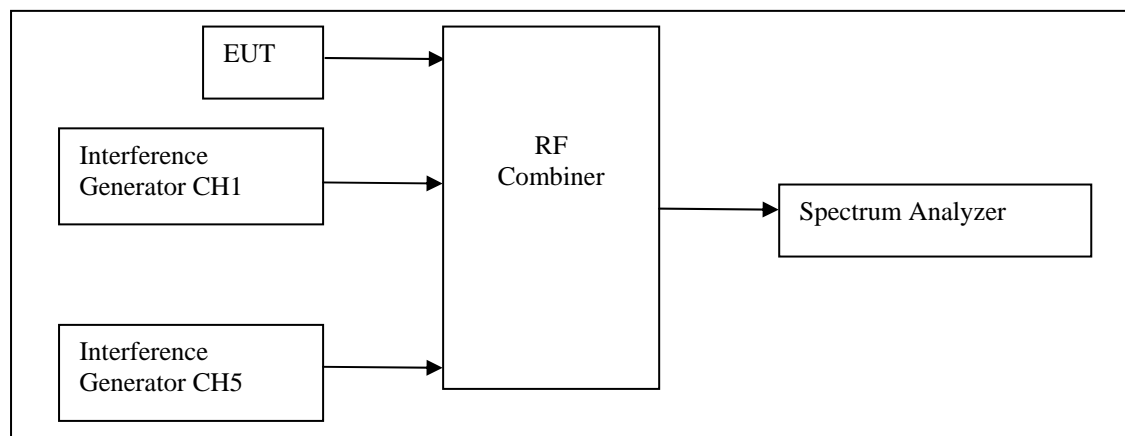

The following test procedure is applied:

ANSI C63.17	Description
Clause 7.3.3 (a)	The EUT is restricted to transmit on either CH1 or CH5.
Clause 7.3.3. (b)	Apply interference on CH1 at level $-74\text{dBm} (T_L + 7\text{dB})$. Apply interference on CH5 at level $-81\text{dBm} (T_L)$. Switch ON the BS 5 times and verify transmission on CH5.
Clause 7.3.3. (c)	Apply interference on CH1 at level $-81\text{dBm} (T_L)$. Apply interference on CH5 at level $-74\text{dBm} (T_L + 7\text{dB})$. Switch ON the BS 5 times and verify transmission on CH1.
Clause 7.3.3. (d)	Apply interference on CH1 at level $-80\text{dBm} (T_L + 1\text{dB})$. Apply interference on CH5 at level $-87\text{dBm} (T_L - 6\text{dB})$. Switch ON the BS 5 times and verify transmission on CH5.
Clause 7.3.3. (e)	Apply interference on CH1 at level $-87\text{dBm} (T_L - 6\text{dB})$. Apply interference on CH5 at level $-80\text{dBm} (T_L + 1\text{dB})$. Switch ON the BS 5 times and verify transmission on CH1.

Verify the communication on the spectrum analyzer.

4.15.3 Test Results

4.15.3.1 Upper Threshold

The BS is switched ON and the transmission of control signals is verified:

Interference Signal	Control Signal	Result
< -60.4 dBm (-66 dBm)	YES	Pass
> -60.4 dBm	NO	Pass

This plot shows the transmission of the control signal during an interferer.

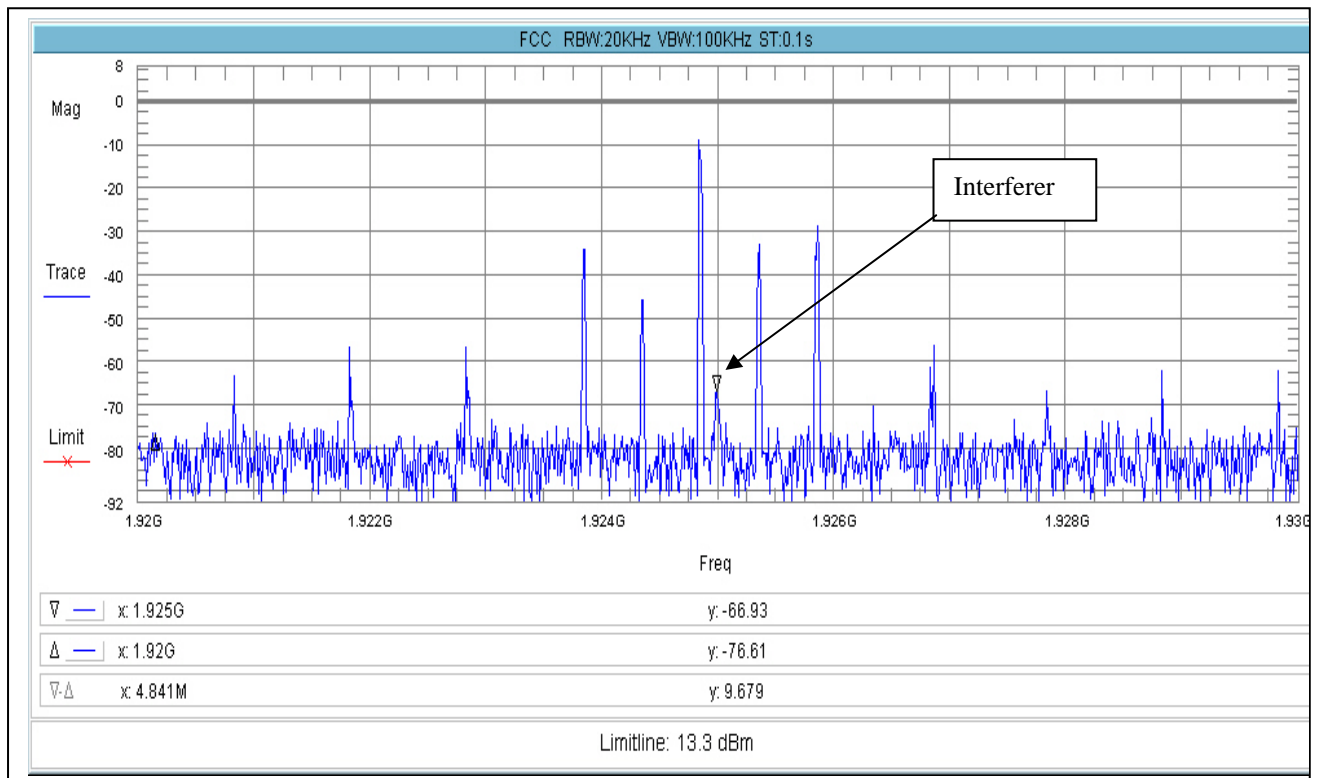

Result: Pass

4.15.3.2 LIC Procedure

The plot shows the two interferer with required level.

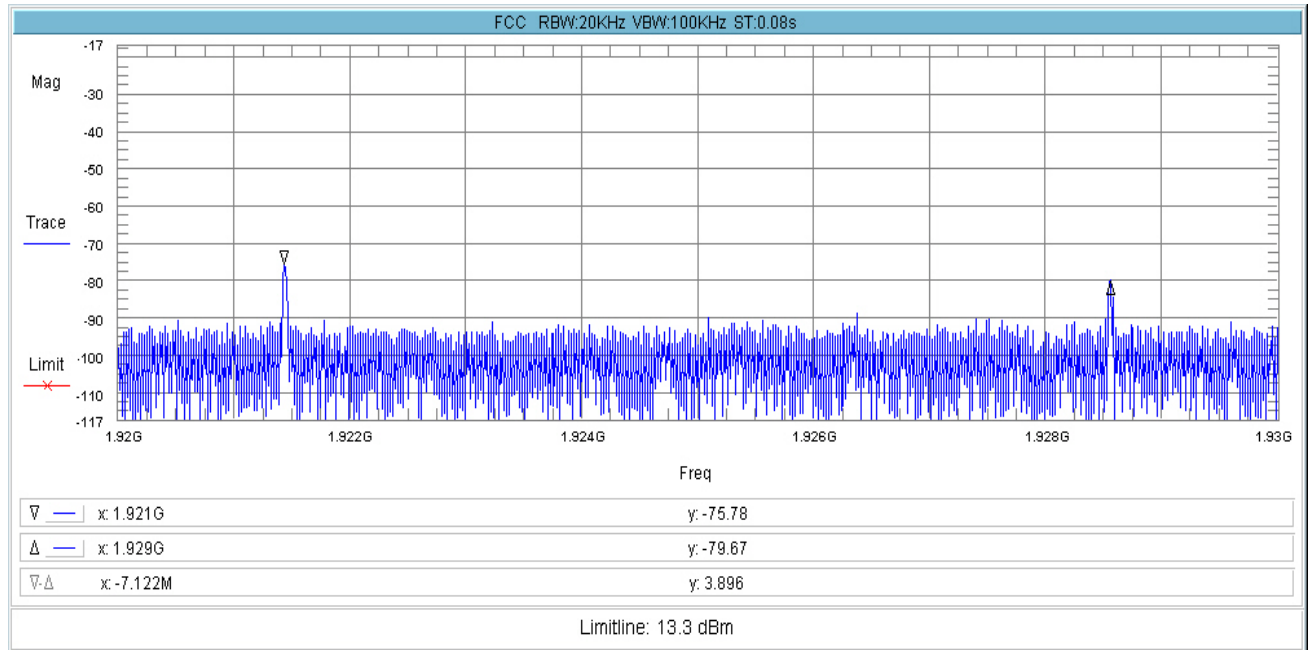

Here you see the communication on the least interfered channel including the interferer

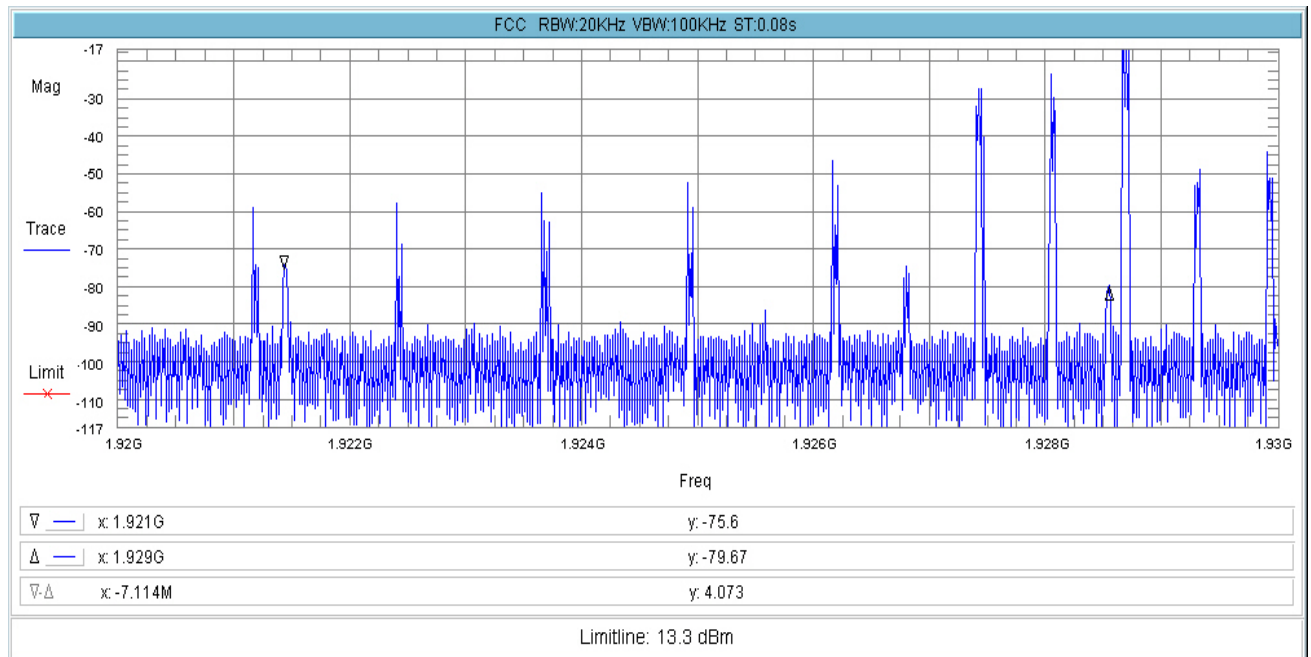

The upper plot shows the two interference sources at CH1 and CH5. Interference source at CH1 is at -74dBm ($T_L + 7dB$) and CH5 is at -81dBm (T_L). The lower plot the BS accessing CH5 (LIC).

The following test results are measured:

ANSI C63.17	Description	Result
Clause 7.3.3. (a)	The BS is restricted to CH1 or CH5.	Pass
Clause 7.3.3. (b)	5 x CH5 transmission of control signals	Pass
Clause 7.3.3. (c)	5 x CH1 transmission of control signals	Pass
Clause 7.3.3. (c)	5 x CH5 transmission of control signals	Pass
Clause 7.3.3. (d)	5 x CH1 transmission of control signals	Pass

Result: Pass

4.16 Channel Confirmation

4.16.1 Test Criteria

§ 15.323 Specific requirements for isochronous devices operating in the 1920–1930 MHz sub-band.

(c) Isochronous devices must incorporate a mechanism for monitoring the time and spectrum windows that its transmission is intended to occupy. The following criteria must be met:

(5) A device utilizing the provisions of this paragraph must have monitored all access channels defined for its system within the last 10 seconds and must verify, within the 20 milliseconds (40 milliseconds for devices designed to use a 20 milliseconds frame period) immediately preceding actual channel access that the detected power of the selected time and spectrum windows is no higher than the previously detected value.

4.16.2 Test Procedure

Testing to ANSI C63.17 draft ballot 3.0 Clause 7.3.3 & 7.3.4, which provides the test methodology for this provision.

4.16.3 Test results

This test was performed in section 4.11 and 4.15

Result: Pass

4.17 Power Measurement Resolution

4.17.1 Test Criteria

§ 15.323 Specific requirements for isochronous devices operating in the 1920–1930 MHz sub-band.

(c) Isochronous devices must incorporate a mechanism for monitoring the time and spectrum windows that its transmission is intended to occupy. The following criteria must be met:

(5) The power measurement resolution for this comparison must be accurate to within 6 dB.

4.17.2 Test procedure

Testing to ANSI C63.17 draft ballot 3.0 Clause 7.3.3, which provides the test methodology for this provision.

4.17.3 Test Result

The accuracy of the upper threshold is -5 dB

Result: Pass

4.18 Segment Occupancy

4.18.1 Test Criteria

§ 15.323 Specific requirements for isochronous devices operating in the 1920–1930 MHz sub-band.

(c) Isochronous devices must incorporate a mechanism for monitoring the time and spectrum windows that its transmission is intended to occupy. The following criteria must be met:

(5) No device or group of cooperating devices located within 1 meter of each other shall occupy more than three 1.25 MHz channels during any frame period

4.18.2 Test Procedure

Attestation of manufacturer supported by reference to relevant DECT specifications.

4.18.3 Attestation

This device is compliant with the DECT standards described in European Standards EN 300 175-2 and EN 300 175-3. DECT transmissions are MC/TDMA/TDD (Multi carrier / Time Division Multiple Access / Time Division Duplex) using Digital GFSK modulation.

During any frame period cooperating devices will not occupy more than one channel bandwidth.

For further details see operational description or relevant portions of the DECT standards.

4.19 Random Waiting

4.19.1 Test Criteria

§ 15.323 Specific requirements for isochronous devices operating in the 1920–1930 MHz sub-band.

(c) Isochronous devices must incorporate a mechanism for monitoring the time and spectrum windows that its transmission is intended to occupy. The following criteria must be met:

(6) If the selected combined time and spectrum windows are unavailable, the device may either monitor and select different windows or seek to use the same windows after waiting an amount of time, randomly chosen from a uniform random distribution between 10 and 150 milliseconds, commencing when the channel becomes available.

4.19.2 Test Procedure

Testing to ANSI C63.17 draft ballot 3.0 Clause 8.1.3, which provides the test methodology for this provision.

4.19.3 Attestation

The option 15.323(c) (6) is not implemented by this product.

4.20 Monitoring Bandwidth

4.20.1 Test Criteria

§ 15.323 Specific requirements for isochronous devices operating in the 1920–1930 MHz sub-band.

(c) Isochronous devices must incorporate a mechanism for monitoring the time and spectrum windows that its transmission is intended to occupy. The following criteria must be met:

(7) The monitoring system bandwidth must be equal to or greater than the emission bandwidth of the intended transmission and have a maximum reaction time less than $50 \times \text{SQRT}$ ($1.25 / \text{emission bandwidth in MHz}$) microseconds for signals at the applicable threshold level but shall not be required to be less than 50 microseconds.

4.20.2 Test Procedure

Testing to ANSI C63.17 draft ballot 3.0 Clause 7.4, which provides the test methodology for this provision.

The BS uses a transceiver with the following block diagram.

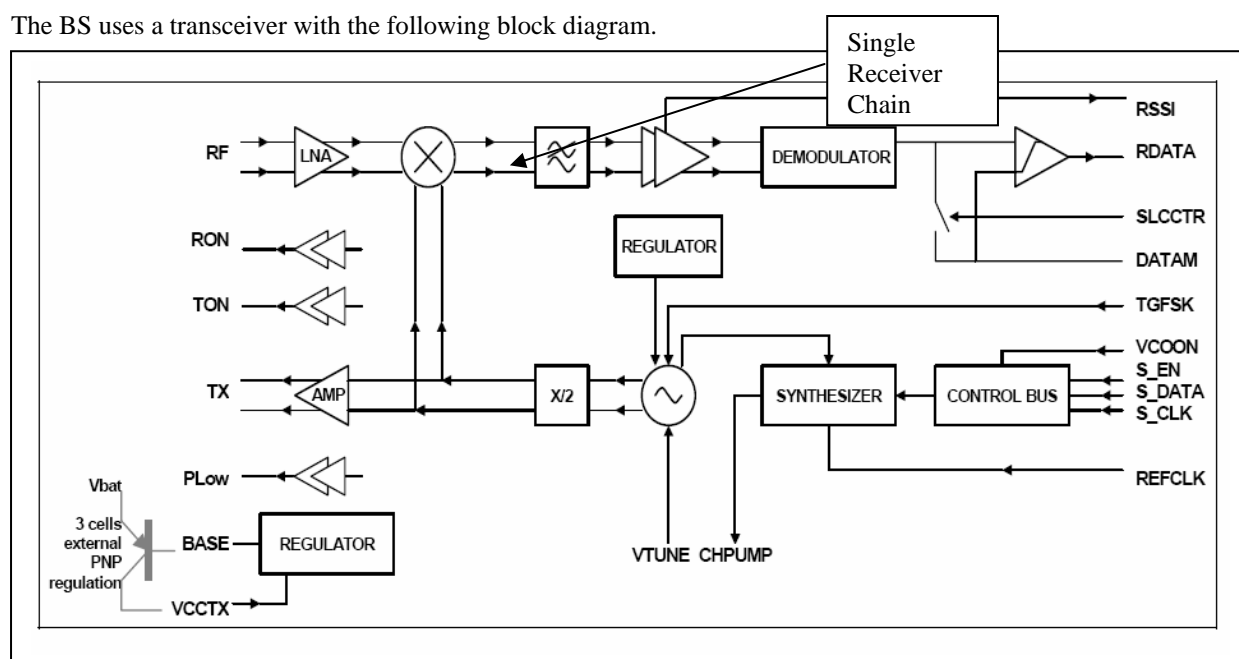

The monitoring feature is realized by the actual receiver and therefore the receiver bandwidth equals the monitoring bandwidth.

Result: PASS

4.21 Monitoring Reaction Time

4.21.1 Test Criteria

§ 15.323 Specific requirements for isochronous devices operating in the 1920–1930 MHz sub-band.

(c) Isochronous devices must incorporate a mechanism for monitoring the time and spectrum windows that its transmission is intended to occupy. The following criteria must be met:

(7) If a signal is detected that is 6 dB or more above the applicable threshold level, the maximum reaction time shall be $35 \times \sqrt{1.25 / \text{emission bandwidth in MHz}}$ microseconds but shall not be required to be less than 35 microseconds.

4.21.2 Test Procedure

Testing to ANSI C63.17 draft ballot 3.0 Clause 7.5, which provides the test methodology for this provision.

4.21.3 Attestation

The MS is the initiating device and the BS is the companion device. The BS never initiates a communication link. This test is described in the Test Report for the MS.

4.22 Monitoring Antenna

4.22.1 Test Criteria

§ 15.323 Specific requirements for isochronous devices operating in the 1920–1930 MHz sub-band.

(c) Isochronous devices must incorporate a mechanism for monitoring the time and spectrum windows that its transmission is intended to occupy. The following criteria must be met:

(8) The monitoring system shall use the same antenna used for transmission, or an antenna that yields equivalent reception at that location.

4.22.2 Test Procedure

Testing to ANSI C63.17 draft ballot 3.0 Clause 4, which provides the test methodology for this provision.

4.22.3 Attestation

The BS uses two permanently attached antennae for antenna diversity, a PCB antenna and an inverted-F antenna.

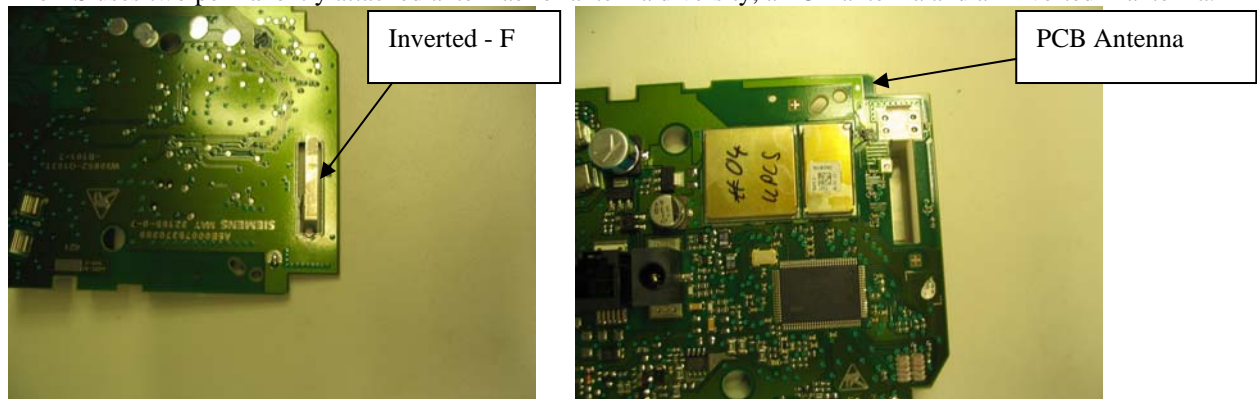

A block diagram indicates the selection process between one of the two antennas:

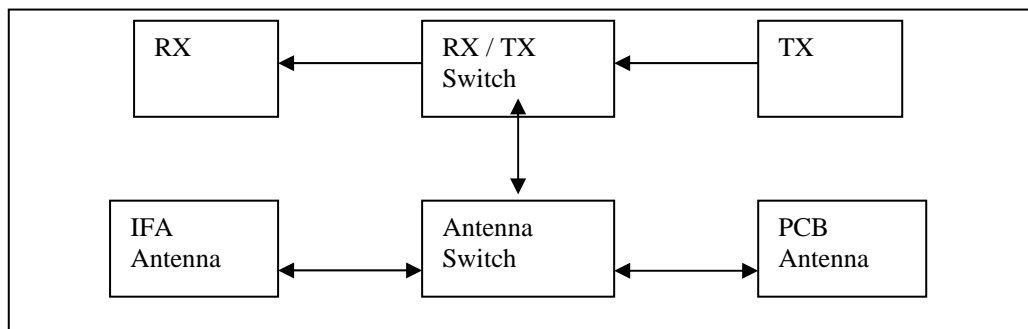

In this product fast antenna diversity is implemented. During the receive burst an antenna is selected which then also is used during the transmit burst. If for instance ANT 1 is selected during the receive burst ANT 1 will also be enabled during the transmission burst.

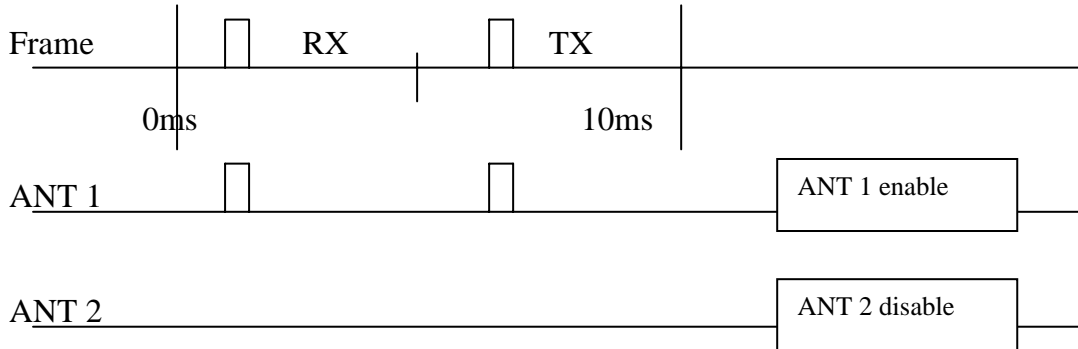

Within the preamble, which occurs at the beginning of each receiver burst the RSSI value of each antenna is measured. The preamble is 32 bits long and 16 bits, 8 bits for each antenna, are used for the antenna selection process.

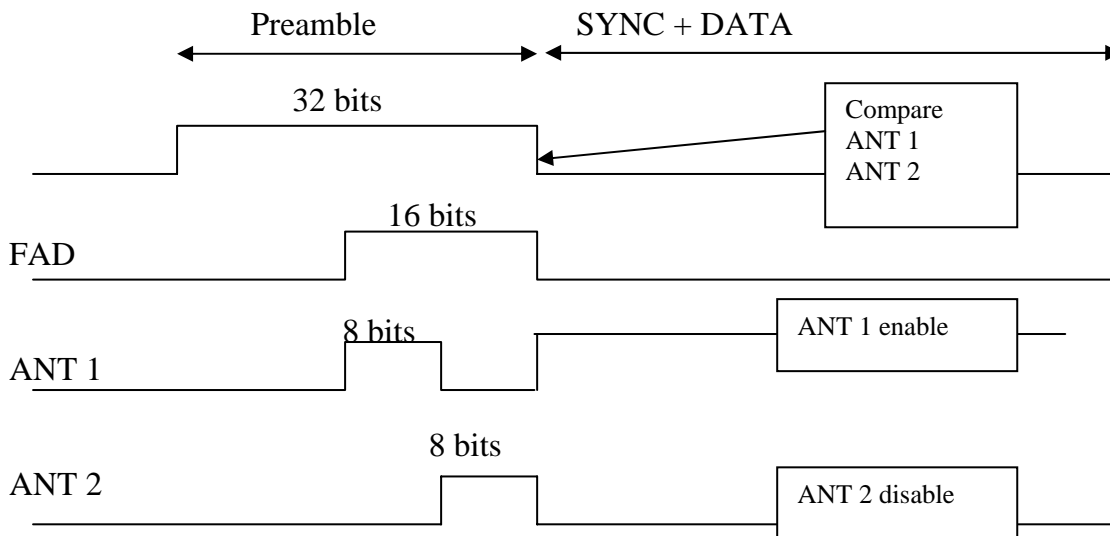

During the 8 bits the RSSI of each antenna is measured and compared at the end of the Fast Antenna Diversity (FAD) signal. If ANT 1 proved to have a larger RSSI value it would stay active after the selection process.

4.23 Monitoring Threshold Relaxation

4.23.1 Test Criteria

§ 15.323 Specific requirements for isochronous devices operating in the 1920–1930 MHz sub-band.

(c) Isochronous devices must incorporate a mechanism for monitoring the time and spectrum windows that its transmission is intended to occupy. The following criteria must be met:

(9) Devices that have a power output lower than the maximum permitted under this subpart may increase their monitoring detection threshold by one decibel for each one decibel that the transmitter power is below the maximum permitted.

4.23.2 Test Procedure

Testing to ANSI C63.17 draft ballot 3.0 Clause 4, which provides the test methodology for this provision.

4.23.3 Test Results

The monitoring threshold of this product is not linked to the output power level.

Description	Value
Permitted Upper Monitoring Threshold	-60.4dBm + 6dB
Measured Upper Monitoring Threshold	-64dBm
Permitted Peak Transmitter Power	21.8 dBm
Measured Peak Transmitter Power	19.4 dBm

The upper threshold of the BS may be increased with up to 2.4dB.

Result: Pass

4.24 Duplex System LBT

4.24.1 Test Criteria

§ 15.323 Specific requirements for isochronous devices operating in the 1920–1930 MHz sub-band.

(c) Isochronous devices must incorporate a mechanism for monitoring the time and spectrum windows that its transmission is intended to occupy. The following criteria must be met:

(10) An initiating device may attempt to establish a duplex connection by monitoring both its intended transmit and receive time and spectrum windows.

If both the intended transmit and receive time and spectrum windows meet the access criteria, then the initiating device can initiate a transmission in the intended transmit time and spectrum window. If the power detected by the responding device can be decoded as a duplex connection signal from the initiating device, then the responding device may immediately begin transmitting on the receive time and spectrum window monitored by the initiating device.

4.24.2 Procedure

Testing to ANSI C63.17 draft ballot 3.0 Clause 8.3.2, which provides the test methodology for this provision.

4.24.3 Attestation

The MS is the initiating device and the BS is the companion device. The BS never initiates a communication link. This test is described in the Test Report for the MS.

4.25 Alternate Monitoring Channel

4.25.1 Test Criteria

§ 15.323 Specific requirements for isochronous devices operating in the 1920–1930 MHz sub-band.

(c) Isochronous devices must incorporate a mechanism for monitoring the time and spectrum windows that its transmission is intended to occupy. The following criteria must be met:

(11) An initiating device that is prevented from monitoring during its intended transmit window due to monitoring system blocking from the transmissions of a co-located (within one meter) transmitter of the same system, may monitor the portions of the time and spectrum windows in which they intend to receive over a period of at least 10 milliseconds. The monitored time and spectrum window must total at least 50 percent of the 10 millisecond frame interval and the monitored spectrum must be within the 1.25 MHz frequency channel(s) already occupied by that device or co-located co-operating devices. If the access criteria is met for the intended receive time and spectrum window under the above conditions, then transmission in the intended transmit window by the initiating device may commence.

4.25.2 Test Procedure

Testing to ANSI C63.17 draft ballot 3.0 Clause 8.4, which provides the test methodology for this provision.

4.25.3 Attestation

The MS is the initiating device and the BS is the companion device. The BS never initiates a communication link. This test is described in the Test Report for the MS.

4.26 Fair Access

4.26.1 Test Criteria

§ 15.323 Specific requirements for isochronous devices operating in the 1920–1930 MHz sub-band.

(c) Isochronous devices must incorporate a mechanism for monitoring the time and spectrum windows that its transmission is intended to occupy. The following criteria must be met:

(12) The provisions of (c)(10) or (c)(11) of this section shall not be used to extend the range of spectrum occupied over space or time for the purpose of denying fair access to spectrum to other devices

4.26.2 Procedure

The manufacturer supplies an attestation.

4.26.3 Attestation

This device does not use any mechanisms as provided by Part 15.323(c)(10) or (c)(11) to deny fair access to spectrum to other devices.

4.27 Frame Period

4.27.1 Test Criteria

4.27.1.1 Frame Repetition Stability

§ 15.323 Specific requirements for isochronous devices operating in the 1920–1930 MHz sub-band.

(e) The frame period (a set of consecutive time slots in which the position of each time slot can be identified by reference to a synchronizing source) of an intentional radiator operating in these sub-bands shall be 20 milliseconds or 10 milliseconds/X where X is a positive whole number. Each device that implements time division for the purposes of maintaining a duplex connection on a given frequency carrier shall maintain a frame repetition rate with a frequency stability of at least 50 parts per million (ppm). Each device which further divides access in time in order to support multiple communication links on a given frequency carrier shall maintain a frame repetition rate with a frequency stability of at least 10 ppm.

4.27.1.2 Timing Jitter

§ 15.323 Specific requirements for isochronous devices operating in the 1920–1930 MHz sub-band.

The jitter (time-related, abrupt, spurious variations in the duration of the frame interval) introduced at the two ends of such a communication link shall not exceed 25 microseconds for any two consecutive transmissions. Transmissions shall be continuous in every time and spectrum window during the frame period defined for the device.

4.27.2 Test Procedure

4.27.2.1 Frame Repetition Stability

Testing to ANSI C63.17 draft ballot 3.0 Clause 6.2.2, which provides the test methodology for this provision.

The EUT is controlled from a personal computer and set into continuous transmission mode. The Spectrum Analyzer is acting as a video detector, by using zero span, and the video output of the spectrum analyzer is monitored by a frequency counter.

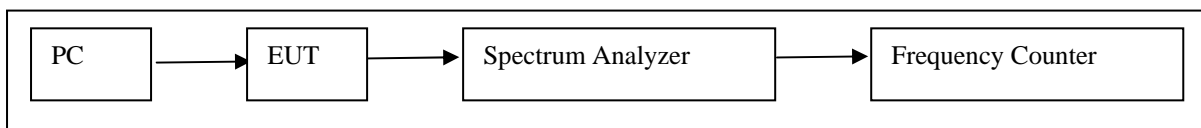

The spectrum analyzer is setup according to ANSI C63.17 Clause 6.2.2:

Centre Frequency	CH3
RBW	3MHz
VBW	3MHz
Trigger	Video
Span	Zero
Detection	Peak Detection
Sweep Rate	2ms
Amplitude Scale	Log
Peak Hold	Off

The GIGASET S450 uses TDMA and a frame period of 10ms.

The frequency counter is gated every 10s and measurements are recorded over 1hour.

The test is performed at 23°C with the EUT set to frequency Channel CH3.

According to ANSI C63.17 Clause 6.2.2, 3 x the standard deviation of the frame-repetition stability should be smaller than 10ppm.

4.27.2.2 Timing Jitter

Testing to ANSI C63.17 draft ballot 3.0 Clause 6.2.3, which provides the test methodology for this provision.

The EUT is controlled from a personal computer and set into continuous transmission mode. The Spectrum Analyzer is acting as a video detector, by using zero span, and the video output of the spectrum analyzer is monitored by a frequency counter.

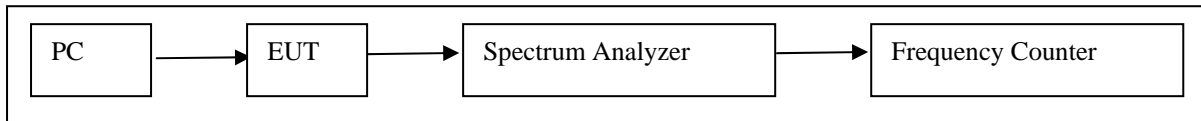

The spectrum analyzer is setup according to ANSI C63.17 Clause 6.2.3:

Centre Frequency	CH3
RBW	3MHz
VBW	3MHz
Trigger	Video
Span	Zero
Detection	Peak Detection
Sweep Rate	2ms
Amplitude Scale	Log
Peak Hold	Off

The frequency counter is gated every 10s and measurements are recorded over 1hour.

The test is performed at 23°C with the EUT set to frequency Channel CH3.

According to ANSI C63.17 Clause 6.2.3, the timing jitter should be smaller than 25µs.

4.27.3 Test Results

4.27.3.1 Frame Repetition Stability

The mean, standard deviation and 3 x SD as the frame-repetition stability is calculated.

Limit is 10 ppm regarding 100Hz.

Mean Frame Repetition	Standard Deviation	Frame Repetition Stability	Result
99.999 965 4Hz	0.000 26475Hz	7.9 ppm	Pass

Result: Pass

4.27.3.2 Timing Jitter

The following timing jitter was recorded:

Mean Period	Timing Jitter	Result
10,000 0035 ms	0.0035 μ s	Pass

Result: Pass

4.28 Frequency Stability

4.28.1 Test Criteria

§ 15.323 Specific requirements for isochronous devices operating in the 1920–1930 MHz sub-band.
(f) The frequency stability of the carrier frequency of the intentional radiator shall be maintained within +/- 10 ppm over 1 hour or the interval between channel access monitoring, whichever is shorter. The frequency stability shall be maintained over a temperature variation of -20° to +50 °C at normal supply voltage, and over a variation in the primary supply voltage of 85 percent to 115 percent of the rated supply voltage at a temperature of 20 °C. For equipment that is capable only of operating from a battery, the frequency stability tests shall be performed using a new battery without any further requirement to vary supply voltage

4.28.2 Test Procedure

Testing to ANSI C63.17 draft ballot 3.0 Clause 6.2.1, which provides the test methodology for this provision.

The EUT is controlled from a personal computer and set into continuous transmission mode.

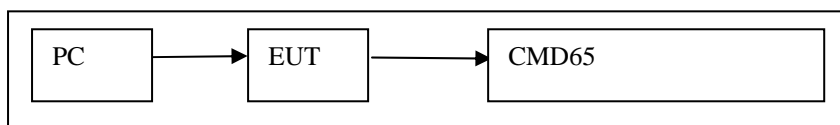

The CMD65 is setup according to ANSI C63.17 Clause 6.2.1:

Centre Frequency	CH3
Mode	Vector Analyzer – DECT Demodulation

The frequency stability of the BS is measured at frequency channel CH3.

A +/-10ppm frequency shift is allowed at 1924.992Hz.

$$\begin{aligned} \text{Frequency Shift} &= 10/1\text{exp}6 * 1925\text{exp}6 \\ &= 19.25\text{KHz} \end{aligned}$$

The following Frequency Offset was measured:

+20°C 85-115% Supply		-20°C Normal Supply		+50°C Normal Supply		Result
KHz	ppm	KHz	ppm	KHz	ppm	
-1	-0.52	+1	+0.52	-3	-1.56	Pass

Result: Pass

4.29 Radiated emissions

4.29.1 Test Criteria

**Radiated emissions according to 15.109 and 15.209.
Measured for TX and RX**

4.29.2 Test Procedure

The radiated measurements are performed in vertical and horizontal plane in the frequency range from 9 kHz to 25 GHz in semi-anechoic chambers. The EUT is positioned on a non-conductive support with a height of 0.80 m above a conductive ground plane that covers the whole chamber. The receiving antennas are conform with specifications ANSI C63.2-1987 clause 15 and ANSI C63.4-2003 clause 4.1.5. These antennas can be moved over the height range between 1.0 m and 4.0 m in order to search for maximum field strength emitted from EUT. The measurement distances between EUT and receiving antennas are indicated in the test setups for the various frequency ranges. For each measurement, the EUT is rotated in all three axes until the maximum field strength is received. The wanted and unwanted emissions are received by spectrum analysers where the detector modes and resolution bandwidths over various frequency ranges are set according to requirement ANSI C63-4-2003 clause 4.2.

Antennas are conform with ANSI C63.2-1996 item 15.

9 kHz - 150 MHz: Quasi Peak measurement, 200 Hz Bandwidth, passive loop antenna.

150 kHz - 30 MHz: Quasi Peak measurement, 9kHz Bandwidth, passive loop antenna.

30 MHz - 200 MHz: Quasi Peak measurement, 120KHz Bandwidth, biconical antenna

200MHz - 1GHz: Quasi Peak measurement, 120KHz Bandwidth, log periodic antenna

1GHz: Average, RBW 1MHz, VBW 10 MHz, waveguide horn

4.29.3 Test Results

Carrier was notched to avoid overload of the low noise preamp.

S450/E450 CH1 up to 4 GHz Traffic mode

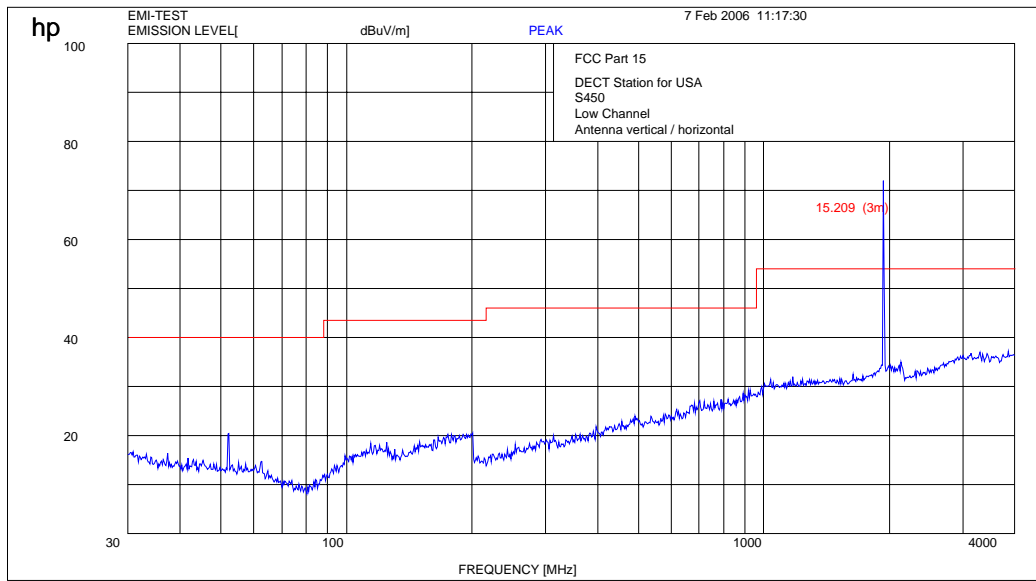

S450/E450 CH1 4 to 12 GHz Traffic mode

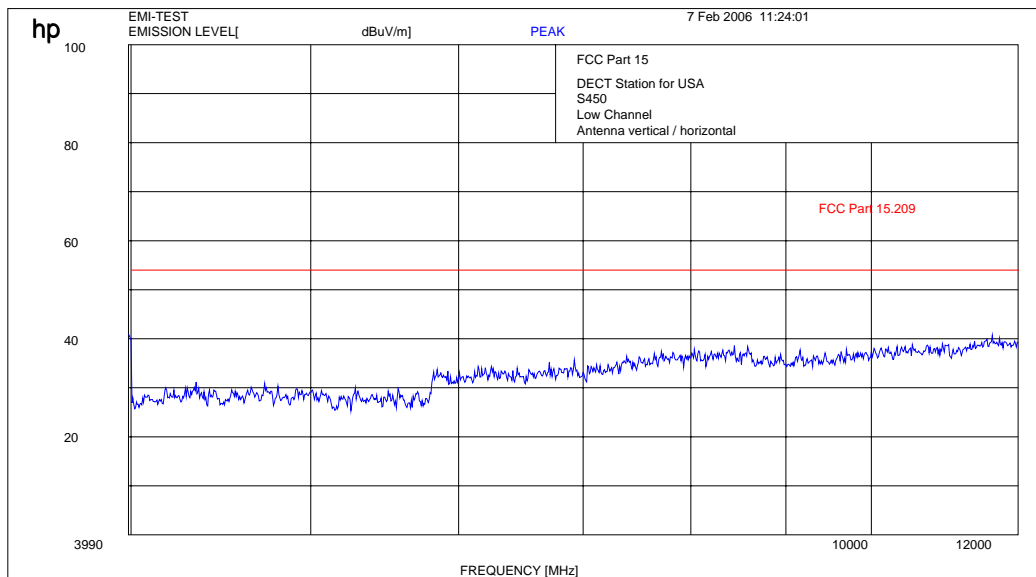

S450/E450 CH3 up to 4 GHz Traffic mode

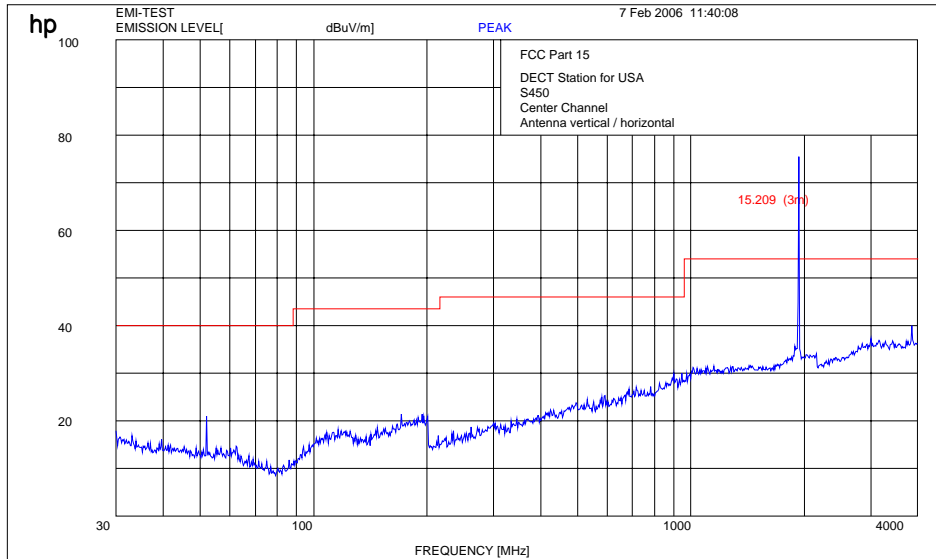

S450/E450 CH3 4 to 12 GHz Traffic mode

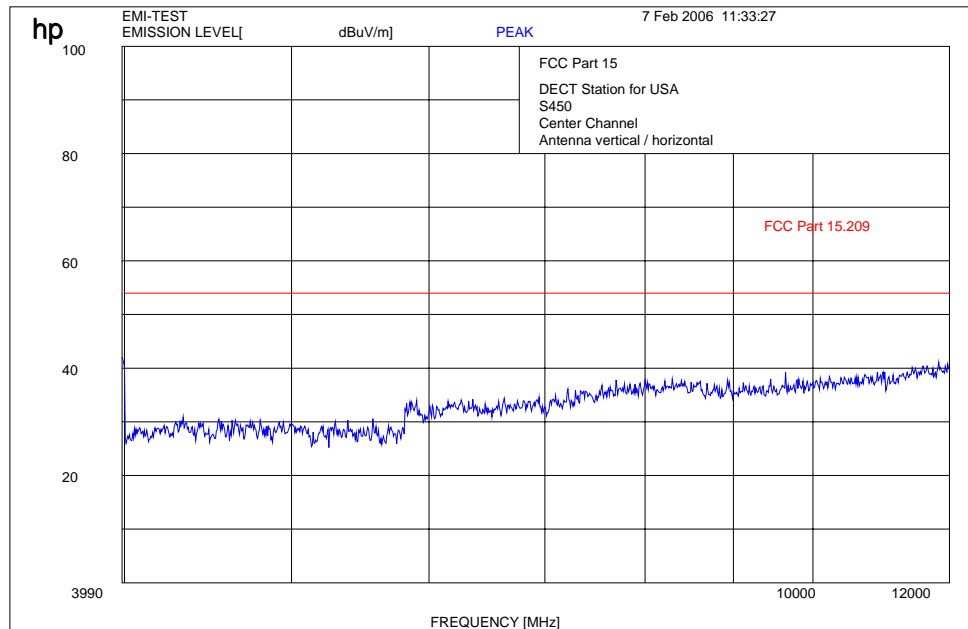

S450/E450 CH5 up to 4 GHz Traffic mode

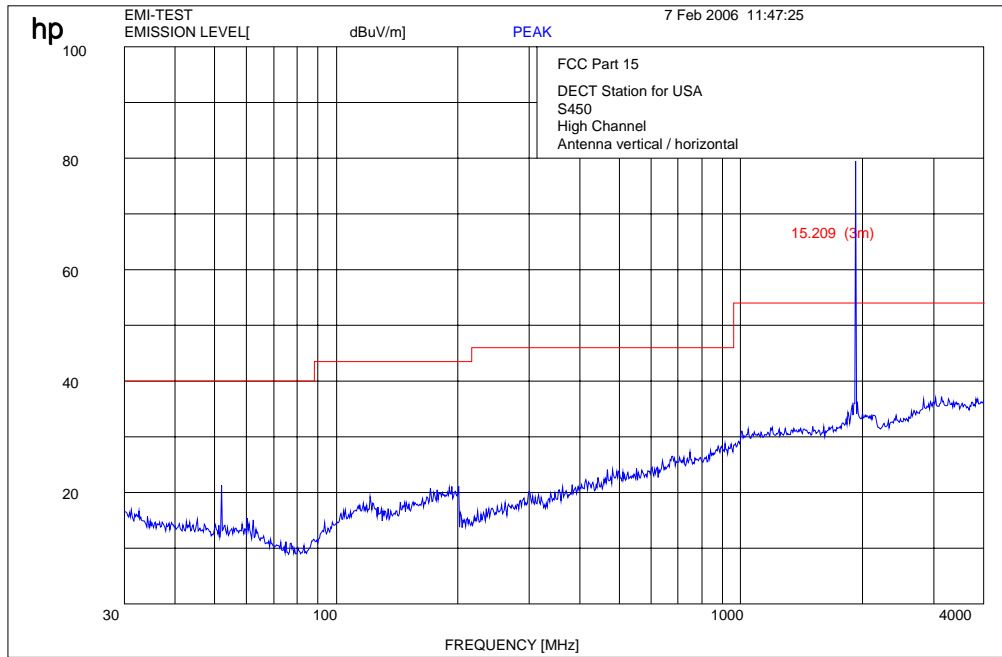

S450/E450 CH5 4 to 12 GHz Traffic mode

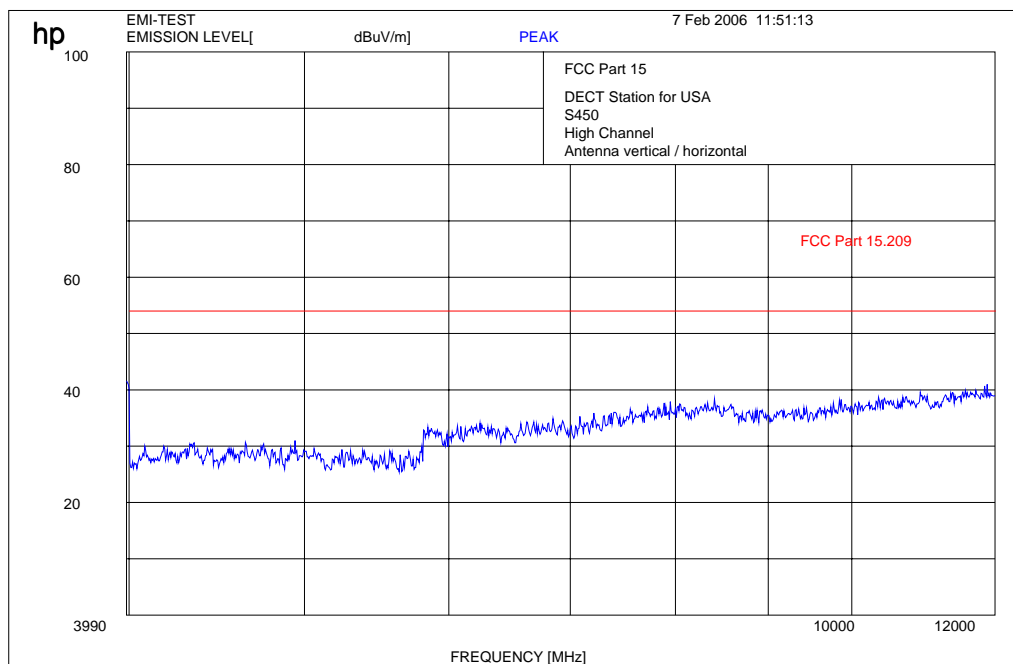

S450/E450 CH3 12 to 25 GHz , valid for all three channels , Traffic and RX only mode



Ref Lvl
93.4 dBµV

RBW	1 MHz	RF Att	0 dB
VBW	1 MHz	Mixer	-20 dBm
SWT	74 ms	Unit	dBµV

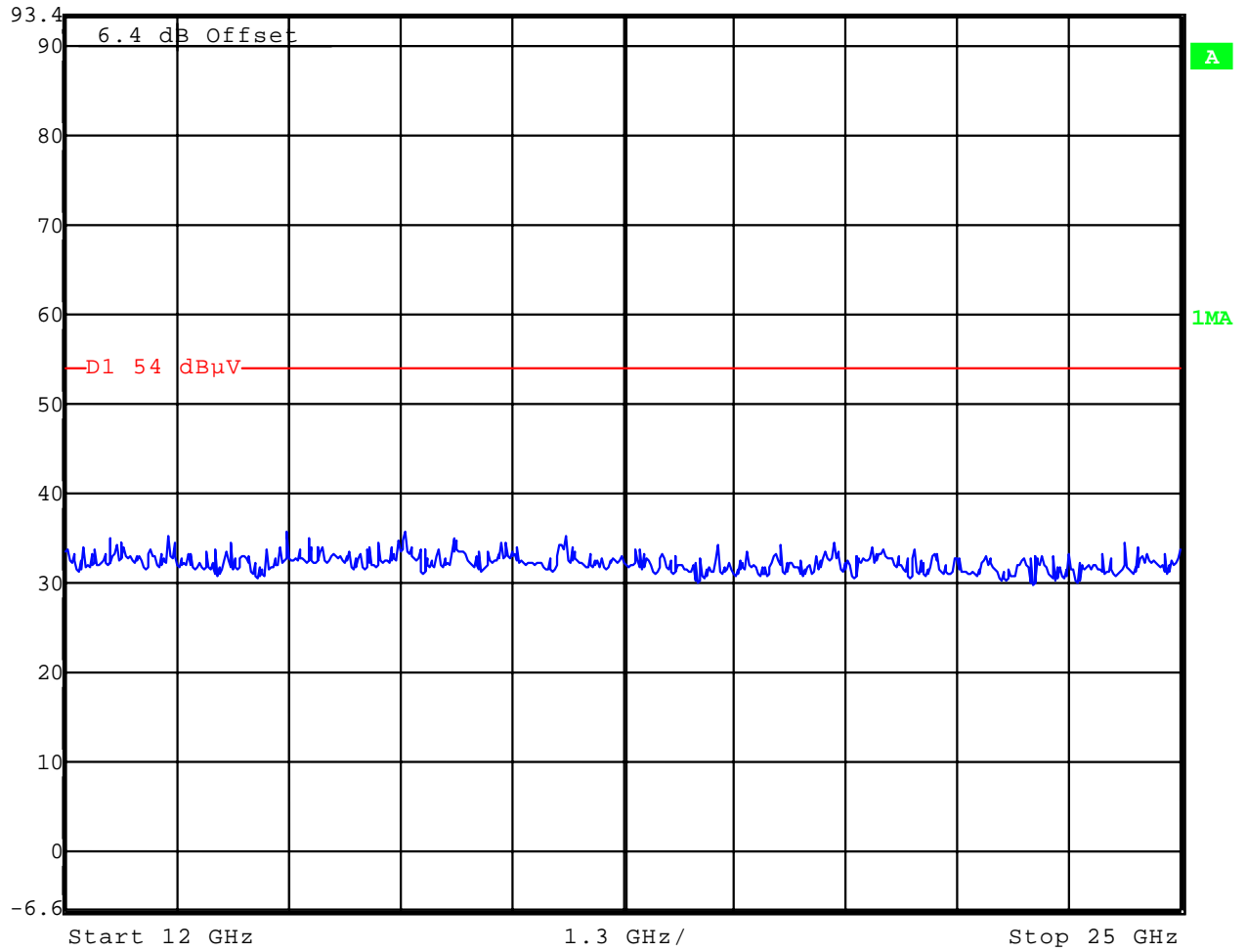

Date: 7.FEB.2006 11:20:55

S450/E450 up to 4 GHz RX only

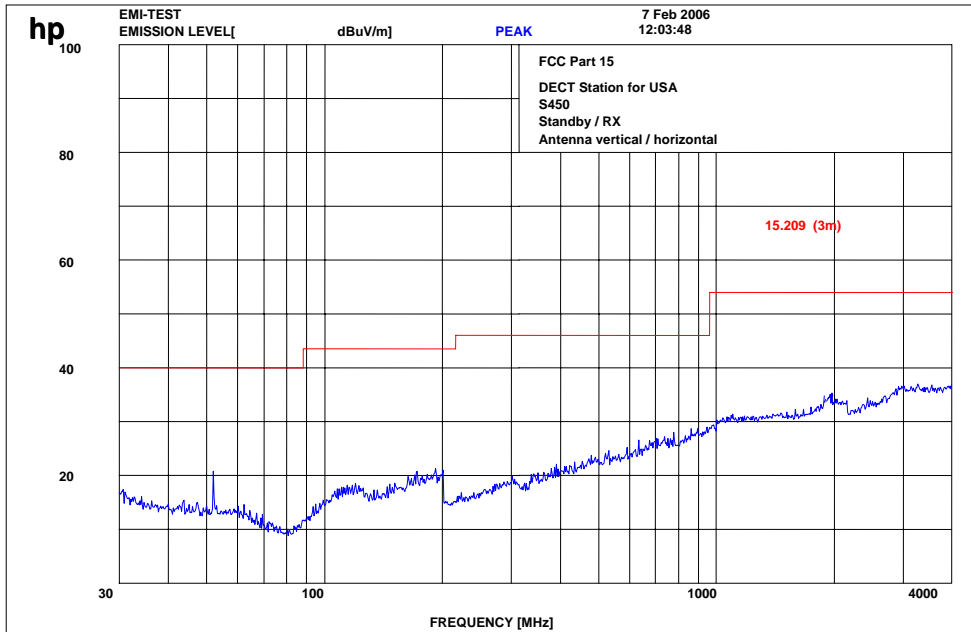

S450/E450 4 to 12 GHz RX only

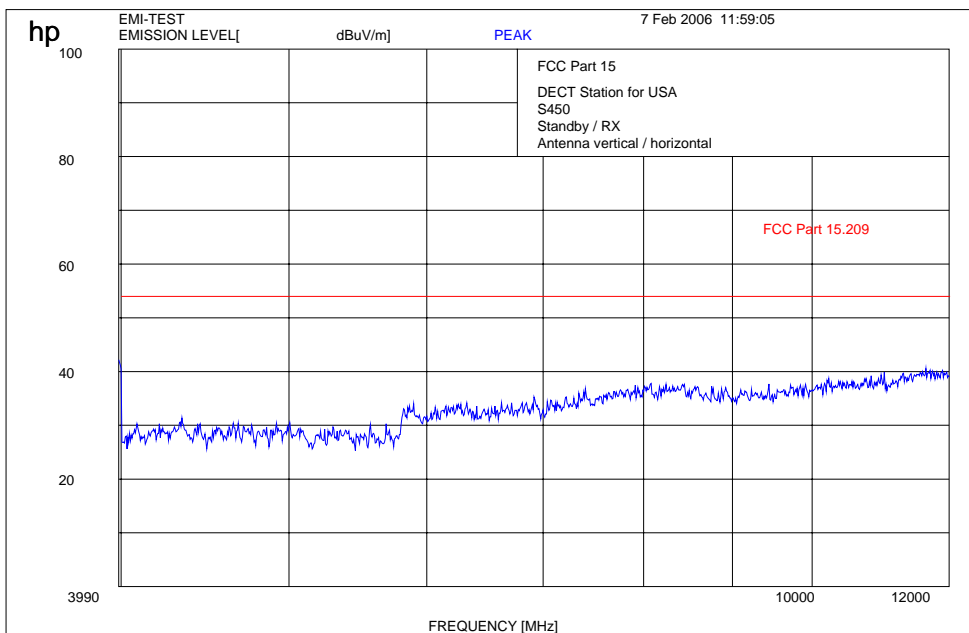

S450/E450 CH3 9 kHz to 30 MHz, valid for all three channels , Traffic and RX only mode

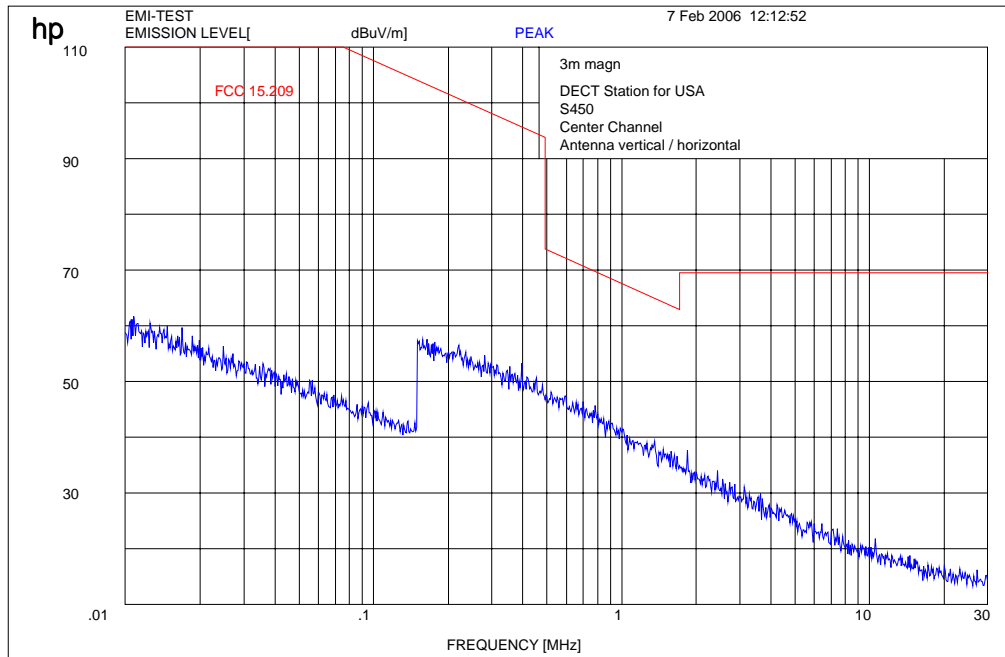

4.30 RF Exposure

RF EXPOSURE INFO

Environmental evaluation measurements of Maximum Permissible Exposure (MPE) to radio frequency (RF) radiation from transmitting devices for compliance with the technical rules and regulations of the U.S. Federal Communications Commission and Industry Canada.

Description of EUT

Model: DECT Base Station S450 / E450

- 1) The probe was positioned on a table at a separation distance of 20 cm from the radiating antenna and at a starting height of 5 cm to the center of the probe.
- 2) The table was positioned so that the initial start angle was 0 degrees.
- 3) The EUT was powered on and allowed sufficient time to stabilize. The EUT was operated at full power on a desired frequency.
- 4) The analyzer and the field probe was set for maximum hold, and set on the appropriate power range.
- 5) The table was rotated 360 degrees and the maximum reading was obtained for that elevation.
- 6) The antennas were lifted and lowered at maximum value in the horizontal plane to find the maximum in vertical position.

Result:

The max measured MPE value on a distance of 20 cm is:

0.22 mW/cm² by measurement with the analyzer
0.24 mW/cm² by measurement with the field probe

MPE System Specification:

- Electromagnetic Radiation Field probe, PMM Model 8053
Frequency Range: 1 MHz to 40 GHz
Calibration date: 05/2005
- Signal analyzer FSIQ26 from R&S
Frequency range: 10 Hz to 26.5 GHz
Calibration date: 02/2005



Limit:

1mW/ cm² is the reference level for general public exposure according to the OET Bulletin 65, Edition 97-01 Table 1.

4.31 Used Test Equipment

Anechoic chamber :

Device	Manufacturer	Type	S/N Number	Inv. No. Cetecom
Spektrum Analyser	HP	8566B	2747A05306	300001000
Spektrum Analyser Display	HP	85662A	2816A16541	300002297
Quasi-Peak-Adapter	HP	85650A	2811A01131	300000999
Power Supply	HP	6032A	2818A03450	300001040
Power Attenuator	Byrd	8325	1530	300001595
Biconical Antenna	EMCO	3104	3758	300001602
Log. Period. Antenna	EMCO	3146	2130	300001603
Double Ridged Antenna	EMCO	HP 3115P	3088	300001032
Active Loop Antenna	EMCO	6502	2210	300001015
Antenna VDE/FCC		HP11965B		300002298
SRM-Drive	HP	9144A	2823e46556	300001044
Software	HP	EMI		300000983
Busisolator	Kontron			300001056
Absorberhalle	MWB		87400/02	300000996
Salzsäule	Kontron			300001055
Antenna	R&S	HMO20	832211/003	300002243
Indukt.Tast Antenna	R&S	HFH 2 Z4	881468/026	300001464
System-Rack	HP I.V.	85900	*	300000222
Spectrum Analyzer	HP	8566B	2747A05275	300000219
Quasi-Peak-Adapter	HP	85650A	2811A01135	300000216
RF-Preselector	HP	85685A	2837A00779	300000218
Rahmen Antenne	R&S	HFH2-Z2	891847-35	300001169
Leitungsteiler	HP	11850C		300000997
Breitband-Hornantenne EMI	HP	35155P		300002300
PC	HP	Vectra VL		300001688
VHF Meßantenne	Schwarzbeck	VHA 9103		300001778
Spectrum Analyzer Display	HP	85662A	2816A16497	300001690
VHF Meßantenna	Schwarzbeck	VHA 9103		300001780
Biconical Antenna	EMCO	3104 C	9909-4868	300002590

SRD Laboratory: (Bluetooth System)

No	Equipment/Type	Manufact.	Serial Nr.	Inv. No. Cetecom
1	System Controller PSM 12	R&S	835259/007	3000002681
2	Memory Extension PSM-K10	R&S	To 1	3000002681
3	Operating Software PSM-B2	R&S	To 1	3000002681
4	19'' Monitor		22759020-ED	3000002681
5	Mouse		LZE 0095/6639	3000002681
6	Keyboard		G00013834L461	3000002681
7	Spectrum Analyser FSIQ 26	R&S	835540/018	3000002681
8	Tracking Generator FSIQ-B10	R&S	835107/015	3000002681
10	RF-Generator SMIQ03 (B1 Signal)	R&S	835541/056	3000002681
11	Modulation Coder SMIQ-B20	R&S	To 10	3000002681
12	Data Generator SMIQ-B11	R&S	To 10	3000002681
13	RF Rear Connection SMIQ-B19	R&S	To 10	3000002681
14	Fast CPU SM-B50	R&S	To 10	3000002681
15	FM Modulator SM-B5	R&S	835676/033	3000002681
16	RF-Generator SMIQ03 (B2 Signal)	R&S	835541/055	3000002681
17	Modulation Coder SMIQ-B20	R&S	To 16	3000002681
18	Data Generator SMIQ-B11	R&S	To 16	3000002681
19	RF Rear Connection SMIQ-B19	R&S	To 16	3000002681
20	Fast CPU SM-B50	R&S	To 16	3000002681
21	FM Modulator SM-B5	R&S	836061/022	3000002681
22	RF-Generator SMP03 (B3 Signal)	R&S	835133/011	3000002681
23	Attenuator SMP-B15	R&S	835136/014	3000002681
24	RF Rear Connection SMP-B19	R&S	834745/007	3000002681
25	Power Meter NRVD	R&S	835430/044	3000002681
26	Power Sensor NRVD-Z1	R&S	833894/012	3000002681
27	Power Sensor NRVD-Z1	R&S	833894/011	3000002681
28	Rubidium Standard RUB	R&S	6197	3000002681
29	Switching and Signal Conditioning Unit SSCU	R&S	338864/003	3000002681
30	Laser Printer HP Deskjet 2100	HP	N/A	3000002681
31	19'' Rack	R&S	11138363000004	3000002681
32	RF-cable set	R&S	N/A	3000002681
33	IEEE-cables	R&S	N/A	3000002681
34	Sampling System FSIQ-B70	R&S	835355/009	3000002681
35	RSP programmable attenuator	R&S	834500/010	3000002681
36	Signalling Unit	R&S	838312/011	3000002681
37	NGPE programmable Power Supply for EUT	R&S	192.033.41	3000002681

SRD Laboratory:

Device	Manufacturer	Type	S/N Number	Inv. No. Cetecom
Climatic box	Heraeus Vötsch	VT 4002	--	300003019
Signaling Unit	R&S	CMU200	832221/0055	300002862
Power Splitter	Inmet Corp.	6005-3	none	300002841
SMA Cables	Insulated Wire	SPS-1151-985-SPS	different	different
Spectrum analyzer	Tektronix	2882	B020259	300001401
Frequency counter	HP	5386A	-	300000998
Digitising Scope	Tektronix	TDS520	-	300001436

5 Photographs of Test Set-up

Photo 1: Radiated Emissions

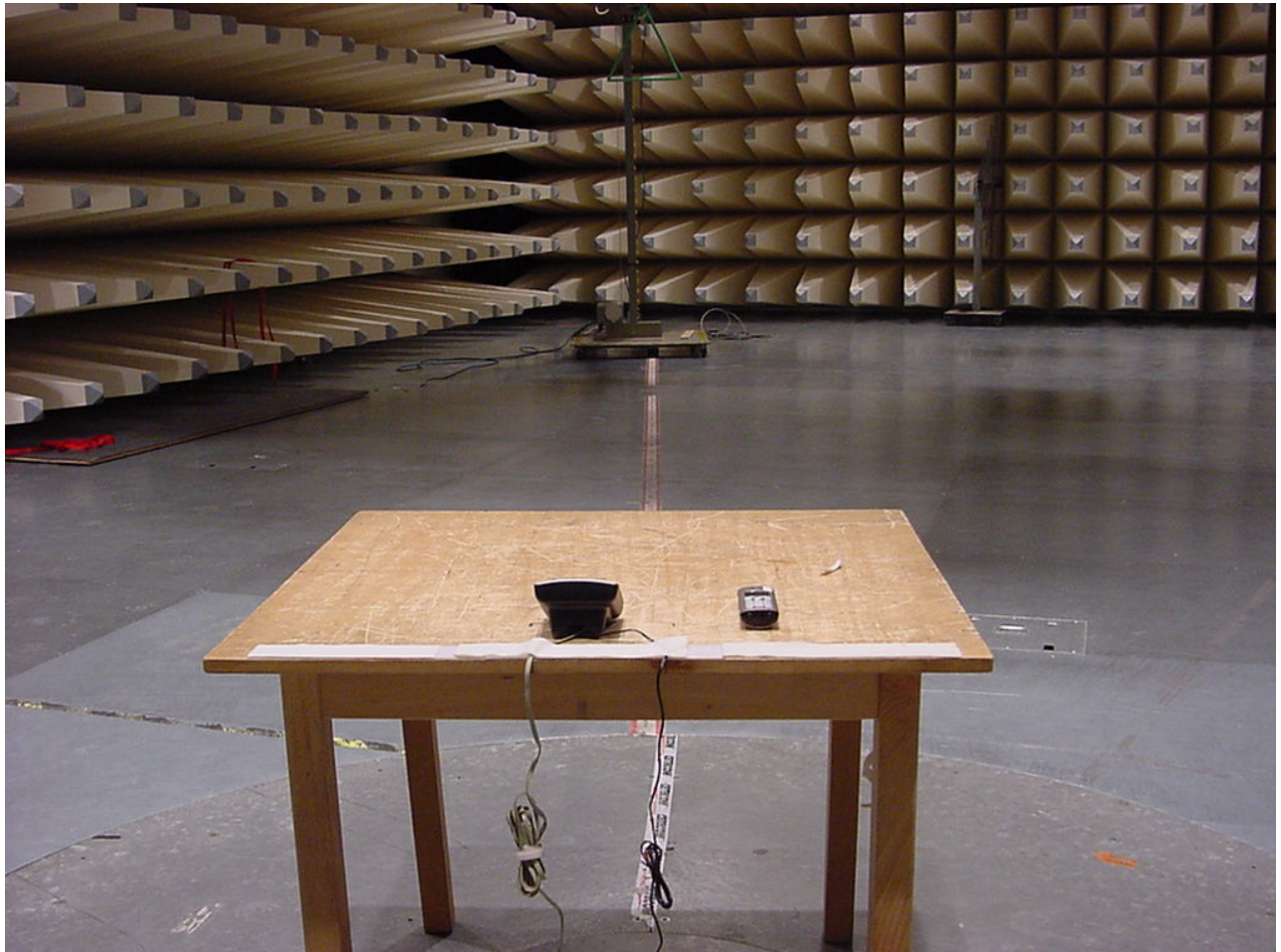

Photo 2: Radiated Emissions



Photo 3: Conducted Emissions



6 Photographs of EUT

Photo 1: S450



Photo 2:

E 450



Photo 3:



Photo 4:



Photo 5:

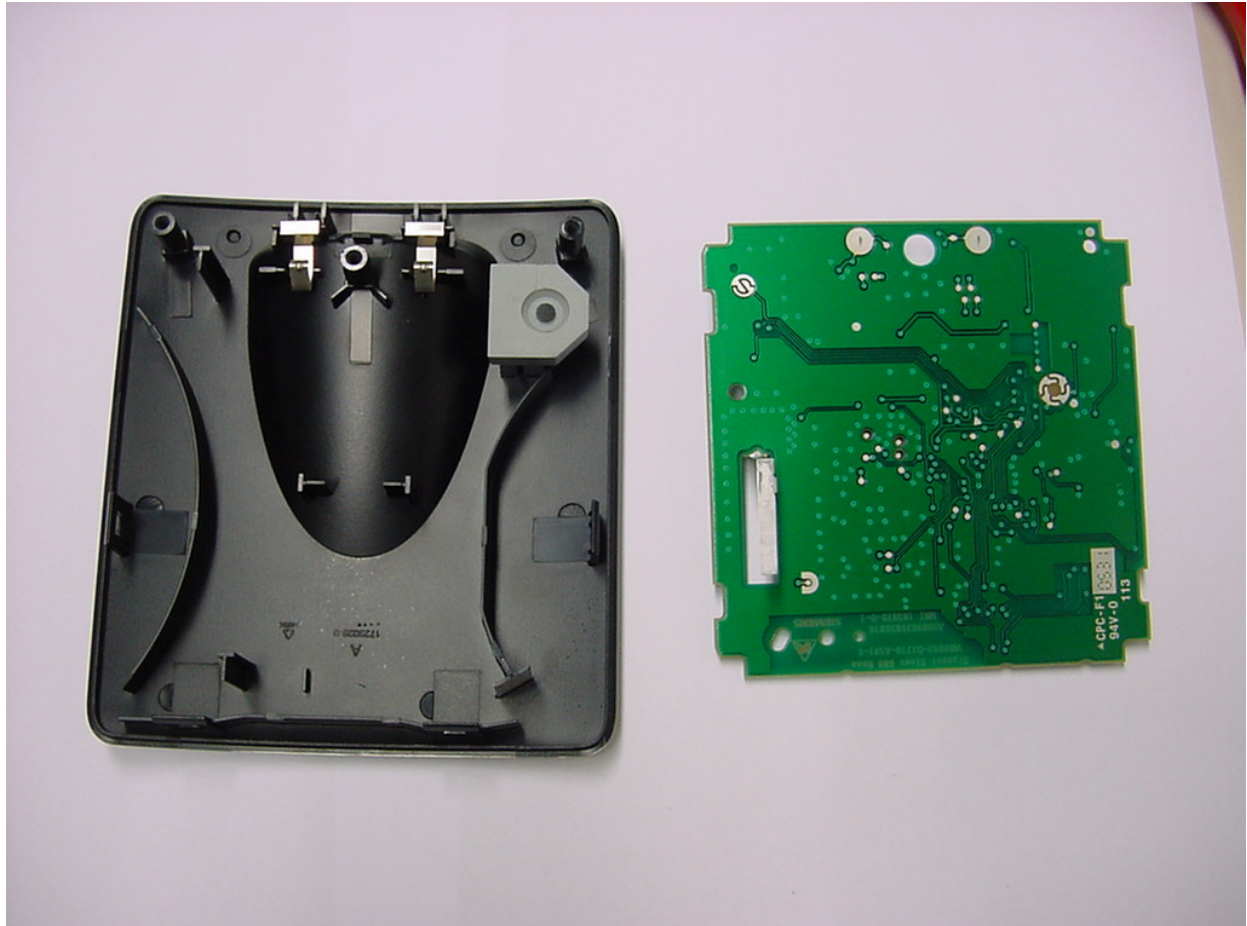

Photo 6:



Photo 7:

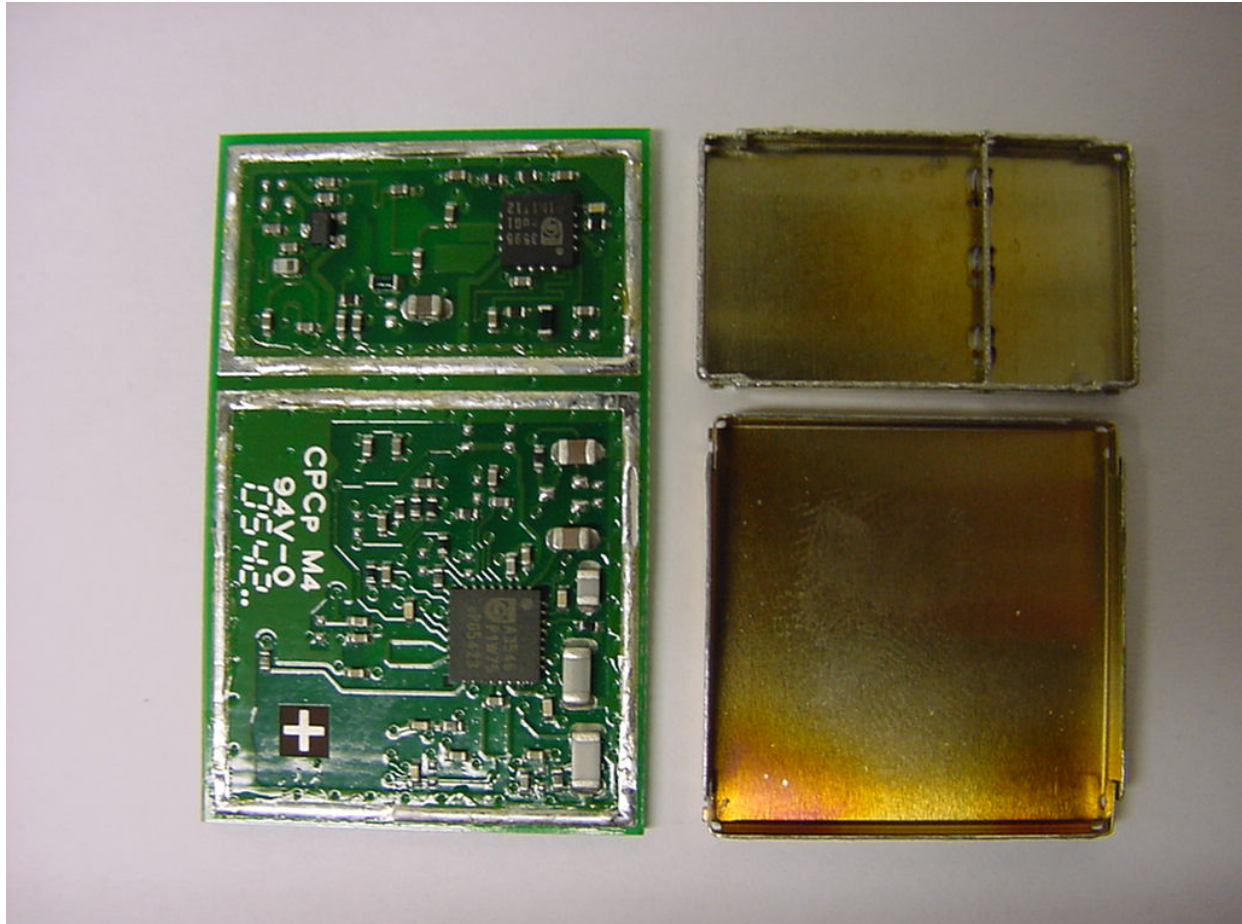

Photo 8:

