



TEST REPORT

Test report no.: 1-4813_22-01-05

BNetzA-CAB-02/21-102

Testing laboratory

CTC advanced GmbH

Untertuerkheimer Strasse 6 – 10

66117 Saarbruecken / Germany

Phone: + 49 681 5 98 - 0

Fax: + 49 681 5 98 - 9075

Internet: <https://www.ctcadvanced.com>

e-mail: mail@ctcadvanced.com

Accredited Testing Laboratory:

The testing laboratory (area of testing) is accredited according to DIN EN ISO/IEC 17025 (2018-03) by the Deutsche Akkreditierungsstelle GmbH (DAkkS)

The accreditation is valid for the scope of testing procedures as stated in the accreditation certificate starting with the registration number: D-PL-12076-01.

Applicant

Gigaset Communications GmbH

Frankenstr. 2

46395 Bocholt / GERMANY

Phone: +49 2871 91-0

Contact: Uwe Alt

e-mail: uwe.alt@gigaset.com

Manufacturer

Gigaset Communications GmbH

Frankenstr. 2

46395 Bocholt / GERMANY

Test standard/s

FCC - Title 47 CFR Part 15 FCC - Title 47 of the Code of Federal Regulations; Chapter I; Part 15 - Radio frequency devices

RSS - 247 Issue 2 Digital Transmission Systems (DTSs), Frequency Hopping Systems (FHSs) and Licence - Exempt Local Area Network (LE-LAN) Devices

For further applied test standards please refer to section 3 of this test report.

Test Item

Kind of test item: **IP-Telephone**

Model name:  **OpenScape Desk Phone CP710**

FCC ID: **TVU-DPCP710**

ISED certification number: **267V-DPCP710**

Frequency: 2400 MHz to 2483.5 MHz

Technology tested: Bluetooth® LE

Antenna: Integrated antenna

Power supply: 38 V DC, by AC/DC Adapter

Temperature range: 5°C to +35°C

This test report is electronically signed and valid without handwritten signature. For verification of the electronic signatures, the public keys can be requested at the testing laboratory.

Test report authorized:



Michael Dorongovski
Lab Manager
Radio Labs

Test performed:



Andreas Curette
Testing Manager
Radio Labs

1 Table of contents

| | | |
|-------|---|----|
| 1 | Table of contents..... | 2 |
| 2 | General information..... | 4 |
| 2.1 | Notes and disclaimer..... | 4 |
| 2.2 | Application details..... | 4 |
| 2.3 | Test laboratories sub-contracted..... | 4 |
| 3 | Test standard/s, references and accreditations..... | 5 |
| 4 | Reporting statements of conformity – decision rule..... | 6 |
| 5 | Test environment..... | 7 |
| 6 | Test item..... | 7 |
| 6.1 | General description..... | 7 |
| 6.2 | Additional information..... | 7 |
| 7 | Sequence of testing..... | 8 |
| 7.1 | Sequence of testing radiated spurious 9 kHz to 30 MHz..... | 8 |
| 7.2 | Sequence of testing radiated spurious 30 MHz to 1 GHz..... | 9 |
| 7.3 | Sequence of testing radiated spurious 1 GHz to 18 GHz..... | 10 |
| 7.4 | Sequence of testing radiated spurious above 18 GHz..... | 11 |
| 8 | Description of the test setup..... | 12 |
| 8.1 | Shielded semi anechoic chamber..... | 13 |
| 8.2 | Shielded fully anechoic chamber..... | 14 |
| 8.3 | Radiated measurements > 18 GHz..... | 16 |
| 8.4 | Conducted measurements Bluetooth system..... | 17 |
| 8.5 | AC conducted..... | 18 |
| 9 | Measurement uncertainty..... | 19 |
| 10 | Additional comments..... | 20 |
| 11 | Summary of measurement results..... | 21 |
| 12 | Measurement results..... | 22 |
| 12.1 | System gain..... | 22 |
| 12.2 | Power spectral density..... | 23 |
| 12.3 | DTS bandwidth – 6 dB bandwidth..... | 24 |
| 12.4 | Occupied bandwidth – 99% emission bandwidth..... | 25 |
| 12.5 | Maximum output power..... | 26 |
| 12.6 | Band edge compliance radiated..... | 27 |
| 12.7 | TX spurious emissions conducted..... | 29 |
| 12.8 | Spurious emissions radiated below 30 MHz..... | 30 |
| 12.9 | Spurious emissions radiated 30 MHz to 1 GHz..... | 33 |
| 12.10 | Spurious emissions radiated above 1 GHz..... | 35 |
| 12.11 | Spurious emissions conducted below 30 MHz (AC conducted)..... | 38 |
| 13 | Glossary..... | 41 |
| 14 | Document history..... | 42 |

| | | |
|----|---|----|
| 15 | Accreditation Certificate – D-PL-12076-01-04..... | 42 |
| 16 | Accreditation Certificate – D-PL-12076-01-05..... | 43 |

2 General information

2.1 Notes and disclaimer

The test results of this test report relate exclusively to the test item specified in this test report. CTC advanced GmbH does not assume responsibility for any conclusions and generalizations drawn from the test results with regard to other specimens or samples of the type of the equipment represented by the test item.

The test report may only be reproduced or published in full. Reproduction or publication of extracts from the report requires the prior written approval of CTC advanced GmbH.

The testing service provided by CTC advanced GmbH has been rendered under the current "General Terms and Conditions for CTC advanced GmbH".

CTC advanced GmbH will not be liable for any loss or damage resulting from false, inaccurate, inappropriate or incomplete product information provided by the customer.

Under no circumstances does the CTC advanced GmbH test report include any endorsement or warranty regarding the functionality, quality or performance of any other product or service provided.

Under no circumstances does the CTC advanced GmbH test report include or imply any product or service warranties from CTC advanced GmbH, including, without limitation, any implied warranties of merchantability, fitness for purpose, or non-infringement, all of which are expressly disclaimed by CTC advanced GmbH.

All rights and remedies regarding vendor's products and services for which CTC advanced GmbH has prepared this test report shall be provided by the party offering such products or services and not by CTC advanced GmbH. In no case this test report can be considered as a Letter of Approval.

This test report is electronically signed and valid without handwritten signature. For verification of the electronic signatures, the public keys can be requested at the testing laboratory.

2.2 Application details

| | |
|------------------------------------|------------|
| Date of receipt of order: | 2022-12-01 |
| Date of receipt of test item: | 2022-12-13 |
| Start of test:* | 2022-12-19 |
| End of test:* | 2023-01-31 |
| Person(s) present during the test: | -/- |

*Date of each measurement, if not shown in the plot, can be requested. Dates are stored in the measurement software.

2.3 Test laboratories sub-contracted

None

3 Test standard/s, references and accreditations

| Test standard | Date | Description |
|---|---------------|--|
| FCC - Title 47 CFR Part 15 | | FCC - Title 47 of the Code of Federal Regulations; Chapter I; Part 15 - Radio frequency devices |
| RSS - 247 Issue 2 | February 2017 | Digital Transmission Systems (DTs), Frequency Hopping Systems (FHSs) and Licence - Exempt Local Area Network (LE-LAN) Devices |
| RSS - Gen Issue 5 incl. Amendment 1 & 2 | February 2021 | Spectrum Management and Telecommunications Radio Standards Specification - General Requirements for Compliance of Radio Apparatus |

| Guidance | Version | Description |
|------------------|---------|--|
| KDB 558074 D01 | v05r02 | GUIDANCE FOR COMPLIANCE MEASUREMENTS ON DIGITAL TRANSMISSION SYSTEM, FREQUENCY HOPPING SPREAD SPECTRUM SYSTEM, AND HYBRID SYSTEM DEVICES OPERATING UNDER SECTION 15.247 OF THE FCC RULES |
| ANSI C63.4-2014 | -/- | American National Standard for Methods of Measurement of Radio-Noise Emissions from Low-Voltage Electrical and Electronic Equipment in the Range of 9 kHz to 40 GHz |
| ANSI C63.10-2013 | -/- | American National Standard of Procedures for Compliance Testing of Unlicensed Wireless Devices |

| Accreditation | Description | |
|------------------|---|---|
| D-PL-12076-01-04 | Telecommunication and EMC Canada https://www.dakks.de/as/ast/d/D-PL-12076-01-04e.pdf |   Deutsche Akkreditierungsstelle D-PL-12076-01-04 |
| D-PL-12076-01-05 | Telecommunication FCC requirements https://www.dakks.de/as/ast/d/D-PL-12076-01-05e.pdf |   Deutsche Akkreditierungsstelle D-PL-12076-01-05 |

ISED Testing Laboratory Recognized Listing Number: DE0001
FCC designation number: DE0002

4 Reporting statements of conformity – decision rule

Only the measured values related to their corresponding limits will be used to decide whether the equipment under test meets the requirements of the test standards listed in chapter 3. The measurement uncertainty is mentioned in this test report, see chapter 9, but is not taken into account - neither to the limits nor to the measurement results. Measurement results with a smaller margin to the corresponding limits than the measurement uncertainty have a potential risk of more than 5% that the decision might be wrong."

measured value, measurement uncertainty, verdict

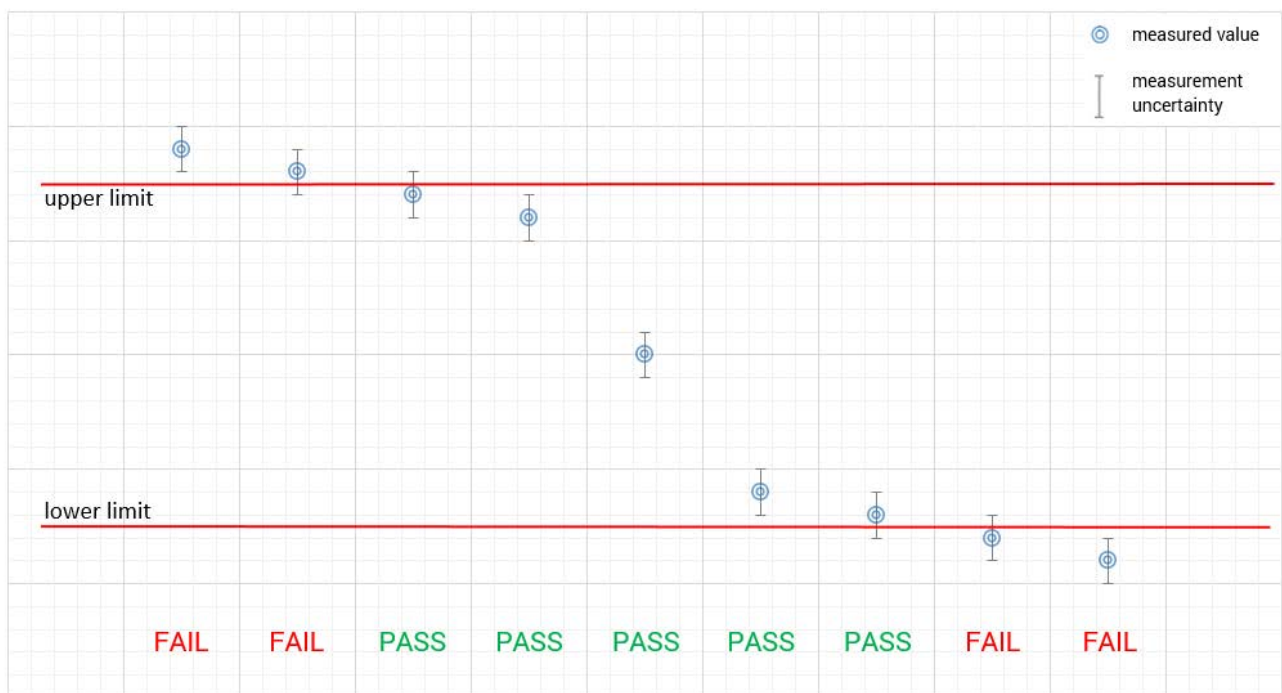

5 Test environment

| | | | |
|---------------------------|---|-------------------------------------|--|
| Temperature | : | T_{nom} T_{max} T_{min} | +22 °C during room temperature tests No tests under extreme environmental conditions required. No tests under extreme environmental conditions required. |
| Relative humidity content | : | | 55 % |
| Barometric pressure | : | | 1021 hpa |
| Power supply | : | V_{nom} V_{max} V_{min} | 38.0 V DC, by AC/DC Adapter No tests under extreme voltage conditions performed. No tests under extreme voltage conditions performed. |

6 Test item

6.1 General description

| | | |
|----------------------------|---|--|
| Kind of test item | : | IP-Telephone |
| Model name | : |  OpenScape Desk Phone CP710 |
| HMN | : | -/- |
| PMN | : | OpenScape Desk Phone CP710 |
| HVIN | : | OpenScape Desk Phone CP710 |
| FVIN | : | -/- |
| S/N serial number | : | Rad. BT-Address: A8 D1 E1 E8 1A 00 Cond. BT-Address: 4F 92 E1 E8 1A 00 |
| Hardware status | : | A5B00901054766 Version: 56465 |
| Software status | : | V2.R0_6.70 SIP |
| Firmware status | : | N/A |
| Frequency band | : | 2400 MHz to 2483.5 MHz |
| Type of radio transmission | : | Other than FHSS |
| Use of frequency spectrum | : | |
| Type of modulation | : | GFSK |
| Number of channels | : | 40 |
| Antenna | : | Integrated antenna |
| Power supply | : | 38 V DC, by AC/DC Adapter |
| Temperature range | : | 5°C to +35°C |

6.2 Additional information

The content of the following annexes is defined in the QA. It may be that not all of the listed annexes are necessary for this report, thus some values in between may be missing.

Test setup and EUT photos are included in test report:

- 1-4813_22-01-05_AnnexA
- 1-4813_22-01-05_AnnexC
- 1-4813_22-01-05_AnnexD

7 Sequence of testing

7.1 Sequence of testing radiated spurious 9 kHz to 30 MHz

Setup

- The equipment is set up to simulate normal operation mode as described in the user manual or defined by the manufacturer.
- If the EUT is a tabletop system, it is placed on a table with 0.8 m height.
- If the EUT is a floor standing device, it is placed directly on the turn table.
- Auxiliary equipment and cables are positioned to simulate normal operation conditions as described in ANSI C 63.4.
- The AC power port of the EUT (if available) is connected to a power outlet below the turntable.
- Measurement distance is 3 m (see ANSI C 63.4) – see test details.
- EUT is set into operation.

Premeasurement*

- The turntable rotates from 0° to 315° using 45° steps.
- The antenna height is 1 m.
- At each turntable position the analyzer sweeps with positive-peak detector to find the maximum of all emissions.

Final measurement

- Identified emissions during the pre-measurement are maximized by the software by rotating the turntable from 0° to 360°.
- Loop antenna is rotated about its vertical axis for maximum response at each azimuth about the EUT. (For certain applications, the loop antenna plane may also need to be positioned horizontally at the specified distance from the EUT)
- The final measurement is done in the position (turntable and elevation) causing the highest emissions with quasi-peak (as described in ANSI C 63.4).
- Final levels, frequency, measuring time, bandwidth, turntable position, correction factor, margin to the limit and limit will be recorded. A plot with the graph of the premeasurement and the limit is stored.

*Note: The sequence will be repeated three times with different EUT orientations.

7.2 Sequence of testing radiated spurious 30 MHz to 1 GHz

Setup

- The equipment is set up to simulate normal operation mode as described in the user manual or defined by the manufacturer.
- If the EUT is a tabletop system, a table with 0.8 m height is used, which is placed on the ground plane.
- If the EUT is a floor standing device, it is placed on the ground plane with insulation between both.
- Auxiliary equipment and cables are positioned to simulate normal operation conditions as described in ANSI C 63.4.
- The AC power port of the EUT (if available) is connected to a power outlet below the turntable.
- Measurement distance is 10 m or 3 m (see ANSI C 63.4) – see test details.
- EUT is set into operation.

Premeasurement

- The turntable rotates from 0° to 315° using 45° steps.
- The antenna is polarized vertical and horizontal.
- The antenna height changes from 1 m to 3 m.
- At each turntable position, antenna polarization and height the analyzer sweeps three times in peak to find the maximum of all emissions.

Final measurement

- The final measurement is performed for at least six highest peaks according to the requirements of the ANSI C63.4.
- Based on antenna and turntable positions at which the peak values are measured the software maximize the peaks by changing turntable position $\pm 45^\circ$ and antenna height between 1 and 4 m.
- The final measurement is done with quasi-peak detector (as described in ANSI C 63.4).
- Final levels, frequency, measuring time, bandwidth, antenna height, antenna polarization, turntable angle, correction factor, margin to the limit and limit are recorded. A plot with the graph of the premeasurement with marked maximum final results and the limit is stored.

7.3 Sequence of testing radiated spurious 1 GHz to 18 GHz

Setup

- The equipment is set up to simulate normal operation mode as described in the user manual or defined by the manufacturer.
- If the EUT is a tabletop system, a 2-axis positioner with 1.5 m height is used.
- If the EUT is a floor standing device, it is placed directly on the turn table.
- Auxiliary equipment and cables are positioned to simulate normal operation conditions as described in ANSI C 63.4.
- The AC power port of the EUT (if available) is connected to a power outlet below the turntable.
- Measurement distance is 3 m (see ANSI C 63.4) – see test details.
- EUT is set into operation.

Premeasurement

- The turntable rotates from 0° to 315° using 45° steps.
- The antenna is polarized vertical and horizontal.
- The antenna height is 1.5 m.
- At each turntable position and antenna polarization the analyzer sweeps with positive peak detector to find the maximum of all emissions.

Final measurement

- The final measurement is performed for at least six highest peaks according to the requirements of the ANSI C63.4.
- Based on antenna and turntable positions at which the peak values are measured the software maximizes the peaks by rotating the turntable from 0° to 360°. This measurement is repeated for different EUT-table positions (0° to 150° in 30°-steps) and for both antenna polarizations.
- The final measurement is done in the position (turntable, EUT-table and antenna polarization) causing the highest emissions with Peak and RMS detector (as described in ANSI C 63.4).
- Final levels, frequency, measuring time, bandwidth, turntable position, EUT-table position, antenna polarization, correction factor, margin to the limit and limit are recorded. A plot with the graph of the premeasurement with marked maximum final results and the limit is stored.

7.4 Sequence of testing radiated spurious above 18 GHz

Setup

- The equipment is set up to simulate normal operation mode as described in the user manual or defined by the manufacturer.
- Auxiliary equipment and cables are positioned to simulate normal operation conditions as described in ANSI C 63.4.
- The AC power port of the EUT (if available) is connected to a power outlet.
- The measurement distance is as appropriate (e.g. 0.5 m).
- The EUT is set into operation.

Premeasurement

- The test antenna is handheld and moved carefully over the EUT to cover the EUT's whole sphere and different polarizations of the antenna.

Final measurement

- The final measurement is performed at the position and antenna orientation causing the highest emissions with Peak and RMS detector (as described in ANSI C 63.4).
- Final levels, frequency, measuring time, bandwidth, correction factor, margin to the limit and limit are recorded. A plot with the graph of the premeasurement and the limit is stored.

8 Description of the test setup

Typically, the calibrations of the test apparatus are commissioned to and performed by an accredited calibration laboratory. The calibration intervals are determined in accordance with the DIN EN ISO/IEC 17025. In addition to the external calibrations, the laboratory executes comparison measurements with other calibrated test systems or effective verifications. Weekly chamber inspections and range calibrations are performed. Where possible, RF generating and signaling equipment as well as measuring receivers and analyzers are connected to an external high-precision 10 MHz reference (GPS-based or rubidium frequency standard).

In order to simplify the identification of the equipment used at some special tests, some items of test equipment and ancillaries can be provided with an identifier or number in the equipment list below (Lab/Item).

Each block diagram listed can contain several test setup configurations. All devices belonging to a test setup are identified with the same letter syntax. For example: Column Setup and all devices with an A.

Agenda: Kind of Calibration

| | | | |
|------|--|-----|--|
| k | calibration / calibrated | EK | limited calibration |
| ne | not required (k, ev, izw, zw not required) | zw | cyclical maintenance (external cyclical maintenance) |
| ev | periodic self verification | izw | internal cyclical maintenance |
| Ve | long-term stability recognized | g | blocked for accredited testing |
| vlk! | Attention: extended calibration interval | | |
| NK! | Attention: not calibrated | *) | next calibration ordered / currently in progress |

8.1 Shielded semi anechoic chamber

The radiated measurements are performed in vertical and horizontal plane in the frequency range from 30 MHz to 1 GHz in semi-anechoic chambers. The EUT is positioned on a non-conductive support with a height of 0.80 m above a conductive ground plane that covers the whole chamber. The receiving antennas are conform to specifications ANSI C63. These antennas can be moved over the height range between 1.0 m and 4.0 m in order to search for maximum field strength emitted from EUT. The measurement distances between EUT and receiving antennas are indicated in the test setups for the various frequency ranges. For each measurement, the EUT is rotated in all three axes until the maximum field strength is received. The wanted and unwanted emissions are received by spectrum analyzers where the detector modes and resolution bandwidths over various frequency ranges are set according to requirement ANSI C63.

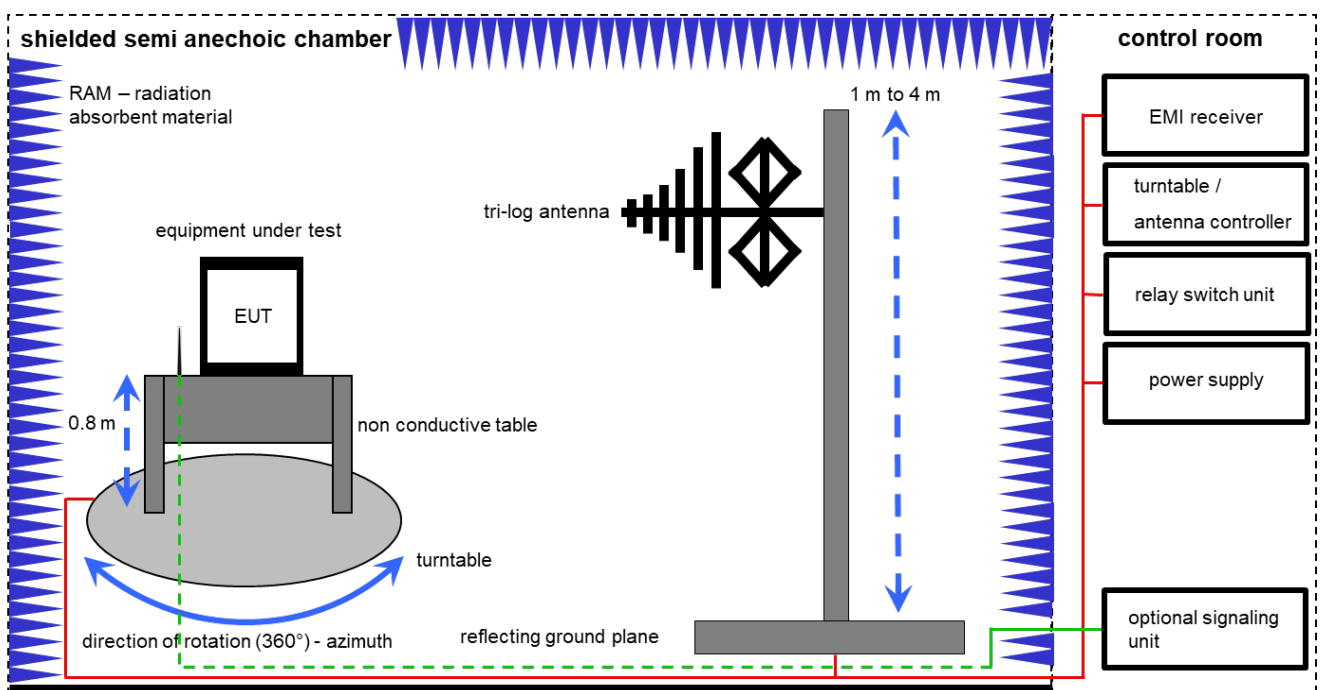

Measurement distance: tri-log antenna 10 meter

EMC32 software version: 10.59.00

FS = UR + CL + AF

(FS-field strength; UR-voltage at the receiver; CL-loss of the cable; AF-antenna factor)

Example calculation:

FS [dB μ V/m] = 12.35 [dB μ V/m] + 1.90 [dB] + 16.80 [dB/m] = 31.05 [dB μ V/m] (35.69 μ V/m)

Equipment table:

| No. | Setup | Equipment | Type | Manufacturer | Serial No. | INV. No. | Kind of Calibration | Last Calibration | Next Calibration |
|-----|-------|--|------------|-----------------------------|------------|-----------|---------------------|------------------|------------------|
| 1 | A | Semi anechoic chamber | 3000023 | MWB AG | | 300000551 | ne | -/- | -/- |
| 2 | A | Antenna Tower | Model 2175 | ETS-Lindgren | 64762 | 300003745 | izw | -/- | -/- |
| 3 | A | Positioning Controller | Model 2090 | ETS-Lindgren | 64672 | 300003746 | izw | -/- | -/- |
| 4 | A | PC | Tecline | F+W | | 300004388 | ne | -/- | -/- |
| 5 | A | EMI Test Receiver | ESR3 | Rohde & Schwarz | 102587 | 300005771 | k | 09.12.2022 | 31.12.2023 |
| 6 | A | TRILOG Broadband Test-Antenna 30 MHz - 3 GHz | VULB9163 | Schwarzbeck Mess-Elektronik | 318 | 300003696 | vKI! | 30.09.2021 | 29.09.2023 |

8.2 Shielded fully anechoic chamber

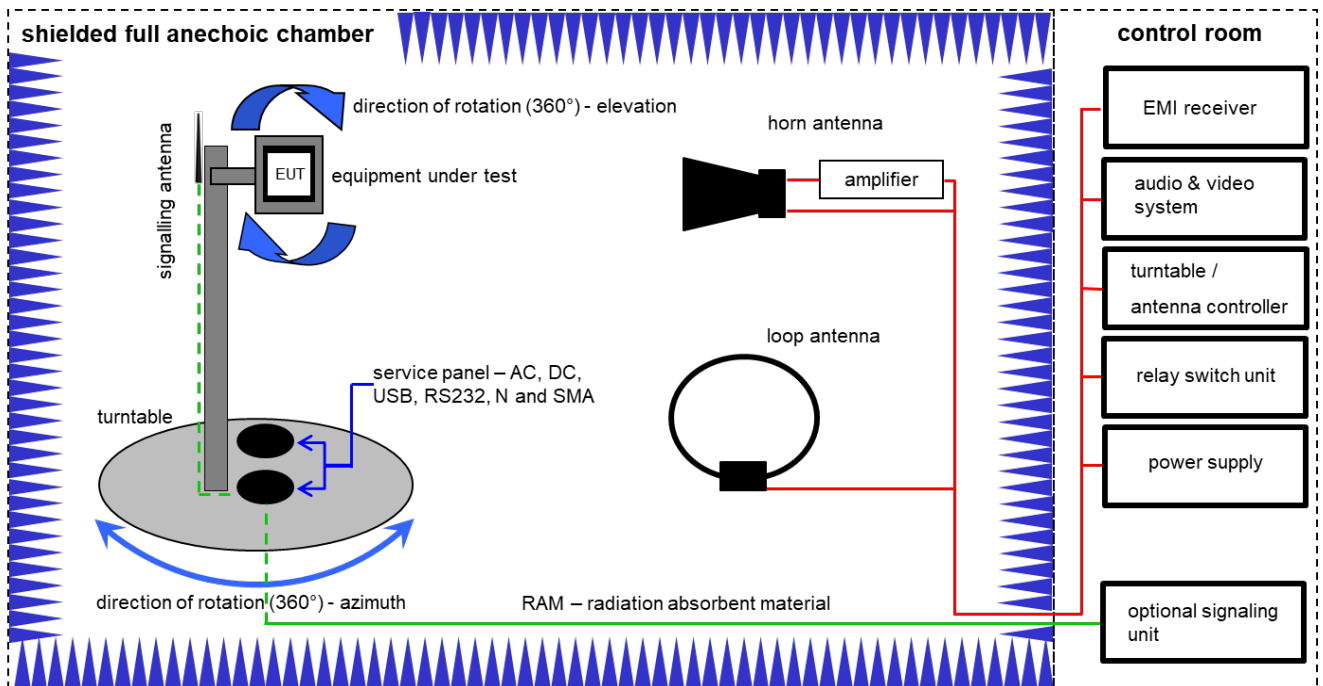

Measurement distance: horn antenna 3 meter; loop antenna 3 meter / 1 meter

$$FS = UR + CA + AF$$

(FS-field strength; UR-voltage at the receiver; CA-loss of the signal path; AF-antenna factor)

Example calculation:

$$FS \text{ [dB}\mu\text{V/m]} = 40.0 \text{ [dB}\mu\text{V/m]} + (-35.8) \text{ [dB]} + 32.9 \text{ [dB/m]} = 37.1 \text{ [dB}\mu\text{V/m]} (71.61 \mu\text{V/m})$$

$$OP = AV + D - G + CA$$

(OP-radiated output power; AV-analyzer value; D-free field attenuation of measurement distance; G-antenna gain+amplifier gain; CA-loss signal path)

Example calculation:

$$OP \text{ [dBm]} = -39.0 \text{ [dBm]} + 57.0 \text{ [dB]} - 12.0 \text{ [dBi]} + (-36.0) \text{ [dB]} = -30 \text{ [dBm]} (1 \mu\text{W})$$

Equipment table:

| No. | Setup | Equipment | Type | Manufacturer | Serial No. | INV. No. | Kind of Calibration | Last Calibration | Next Calibration |
|-----|---------|---|-------------------------|----------------------|------------|-----------|---------------------|------------------|------------------|
| 1 | A, B, C | EMI Test Receiver 20Hz- 26,5GHz | ESU26 | R&S | 100037 | 300003555 | k | 07.12.2022 | 31.12.2023 |
| 2 | A, B | Highpass Filter | WHKX7.0/18G-8SS | Wainwright | 19 | 300003790 | ne | -/- | -/- |
| 3 | A | High Pass Filter | VHF-3500+ | Mini Circuits | -/- | 400000193 | ne | -/- | -/- |
| 4 | A | Broadband Amplifier 0.5-18 GHz | CBLU5184540 | CERNEX | 22049 | 300004481 | ev | -/- | -/- |
| 5 | A, B, C | 4U RF Switch Platform | L4491A | Agilent Technologies | MY50000037 | 300004509 | ne | -/- | -/- |
| 6 | A, B, C | NEXIO EMV-Software | BAT EMC V2022.0.22.0 | Nexio | | 300004682 | ne | -/- | -/- |
| 7 | A | RF-Amplifier | AMF-6F06001800-30-10P-R | NARDA-MITEQ Inc | 2011572 | 300005241 | ev | -/- | -/- |
| 8 | A, B | Double-Ridged Waveguide Horn Antenna 1-18 GHz | 3315 | EMCO | 8812-3089 | 300000307 | vKl! | 11.02.2022 | 29.02.2024 |
| 9 | A, B, C | Switch-Unit | 3488A | HP | 2719A14505 | 300000368 | ev | -/- | -/- |
| 10 | A | Band Reject Filter | WRCG2400/2483- | Wainwright | 26 | 300003792 | ne | -/- | -/- |

| | | | | | | | | | |
|----|---|---|-------------------|------|------|-----------|-------|------------|------------|
| | | | 2375/2505-50/10SS | | | | | | |
| 11 | C | Active Loop Antenna 9 kHz to 30 MHz | 6502 | EMCO | 2210 | 300001015 | vIKI! | 01.07.2021 | 31.07.2023 |

8.3 Radiated measurements > 18 GHz

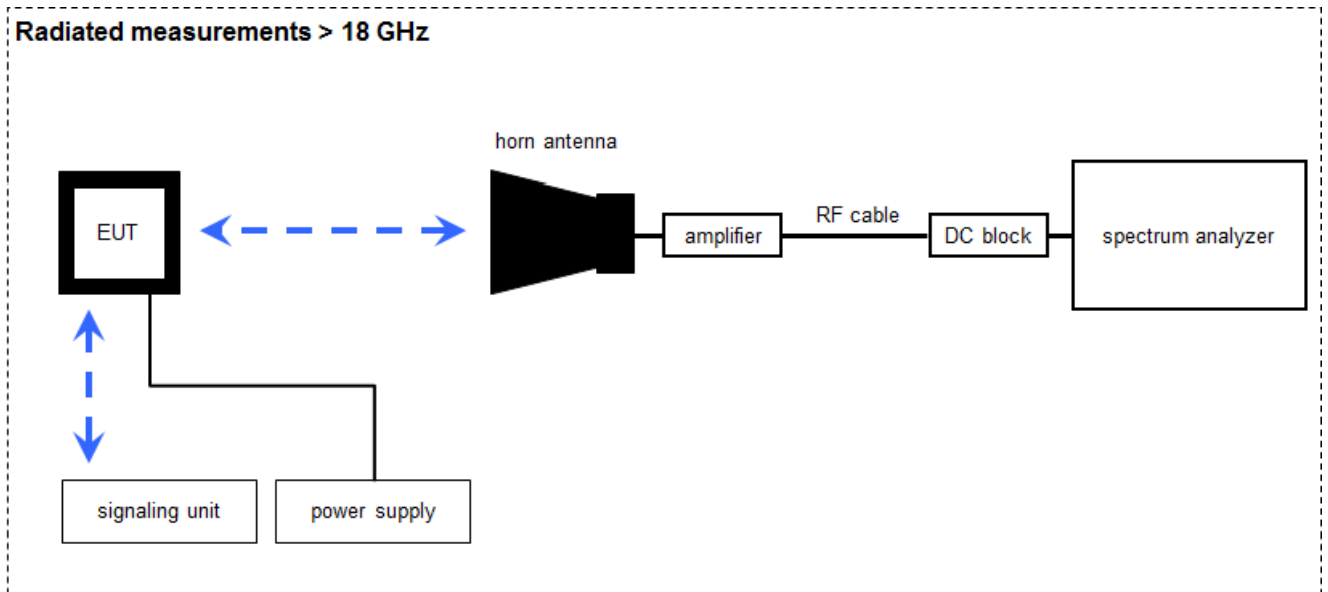

Measurement distance: horn antenna 50 cm

$$FS = UR + CA + AF$$

(FS-field strength; UR-voltage at the receiver; CA-loss signal path & distance correction; AF-antenna factor)

Example calculation:

$$FS [dB\mu V/m] = 40.0 [dB\mu V/m] + (-60.1) [dB] + 36.74 [dB/m] = 16.64 [dB\mu V/m] (6.79 \mu V/m)$$

$$OP = AV + D - G + CA$$

(OP-radiated output power; AV-analyzer value; D-free field attenuation of measurement distance; G-antenna gain+amplifier gain; CA-loss signal path)

Example calculation:

$$OP [dBm] = -65.0 [dBm] + 50.0 [dB] - 20.0 [dBi] + 5.0 [dB] = -30 [dBm] (1 \mu W)$$

Equipment table:

| No. | Setup | Equipment | Type | Manufacturer | Serial No. | INV. No. | Kind of Calibration | Last Calibration | Next Calibration |
|-----|-------|--------------------------------------|---------------------|----------------|---------------------|-----------|---------------------|------------------|------------------|
| 1 | A | Std. Gain Horn Antenna 18.0-26.5 GHz | 638 | Narda | 8205 | 300002442 | k | 17.01.2022 | 31.01.2024 |
| 2 | A | Amplifier 2-40 GHz | JS32-02004000-57-5P | MITEQ | 1777200 | 300004541 | ev | -/- | -/- |
| 3 | A | RF-Cable | ST18/SMAm/SMAm/48 | Huber & Suhner | Batch no. 127377 | 400001183 | ev | -/- | -/- |
| 4 | A | DC-Blocker 0.1-40 GHz | 8141A | Inmet | -/- | 400001185 | ev | -/- | -/- |
| 5 | A | Signal analyzer | FSV30 | Rohde&Schwarz | 1321.3008K30/103809 | 300005359 | vIKI! | 14.12.2022 | 31.12.2024 |

8.4 Conducted measurements Bluetooth system

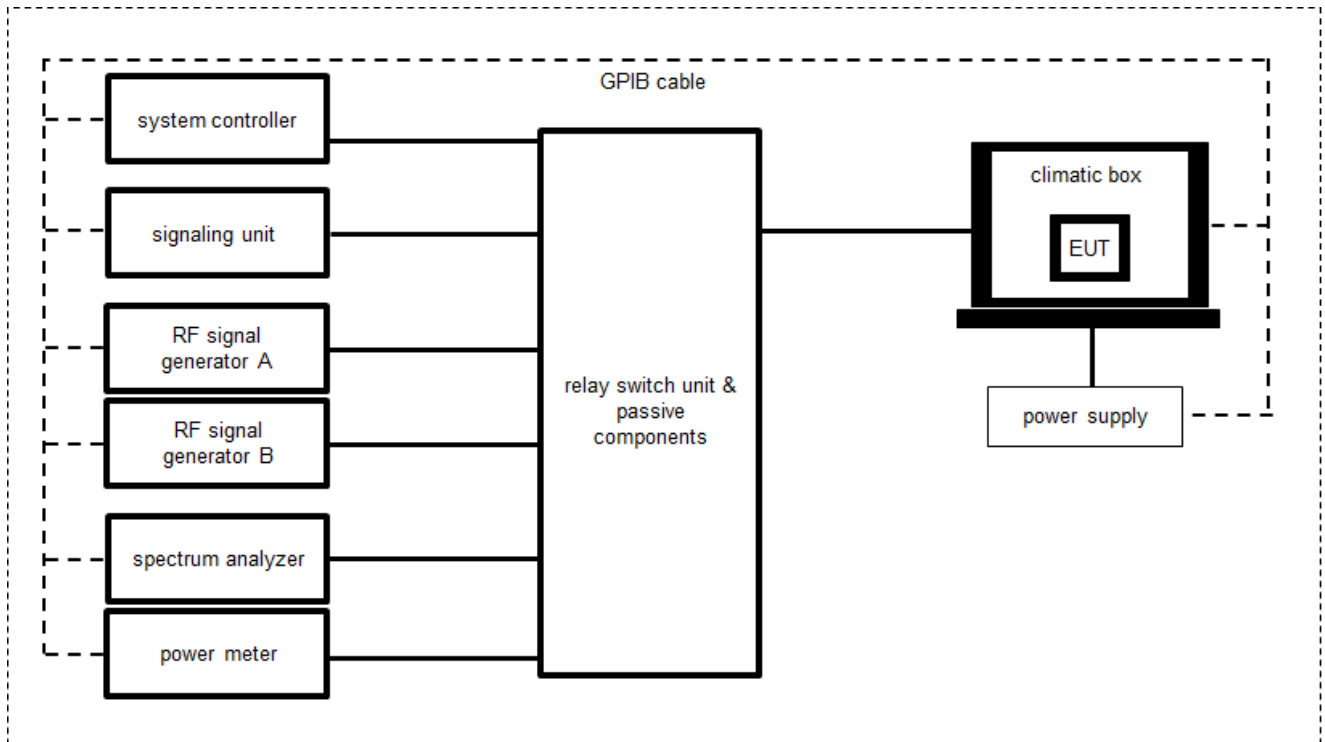

OP = AV + CA
 (OP-output power; AV-analyzer value; CA-loss signal path)

Example calculation:

OP [dBm] = 6.0 [dBm] + 11.7 [dB] = 17.7 [dBm] (58.88 mW)

Equipment table:

| No. | Setup | Equipment | Type | Manufacturer | Serial No. | INV. No. | Kind of Calibration | Last Calibration | Next Calibration |
|-----|-------|---|-----------------------|-------------------|---------------------|-----------|---------------------|------------------|------------------|
| 1 | A | Hygro-Thermometer | -/, 5-45°C, 20-100%rF | Thies Clima | -/- | 400000109 | ev | 15.09.2022 | 14.09.2024 |
| 2 | A | PC Laboratory | Exone | Fröhlich + Walter | S2642279-03 / 10 | 300004179 | ne | -/- | -/- |
| 3 | A | Signal analyzer | FSV30 | Rohde&Schwarz | 1321.3008K30/103809 | 300005359 | vKI! | 14.12.2022 | 31.12.2024 |
| 4 | A | Switch matrix | RSM-1 | CTC advanced GmbH | 29655273 | 400001355 | ev | 20.09.2022 | 19.09.2023 |
| 5 | A | Tester Software RadioStar (C.BER2 for BT Conformance) | Version 1.0.0.X | CTC advanced GmbH | 0001 | 400001380 | ne | -/- | -/- |
| 6 | A | Wideband Radio Communication Tester | CMW270 | Rohde & Schwarz | 1201.0002k75/102550 | 300006253 | k | 17.09.2021 | 30.09.2023 |

8.5 AC conducted

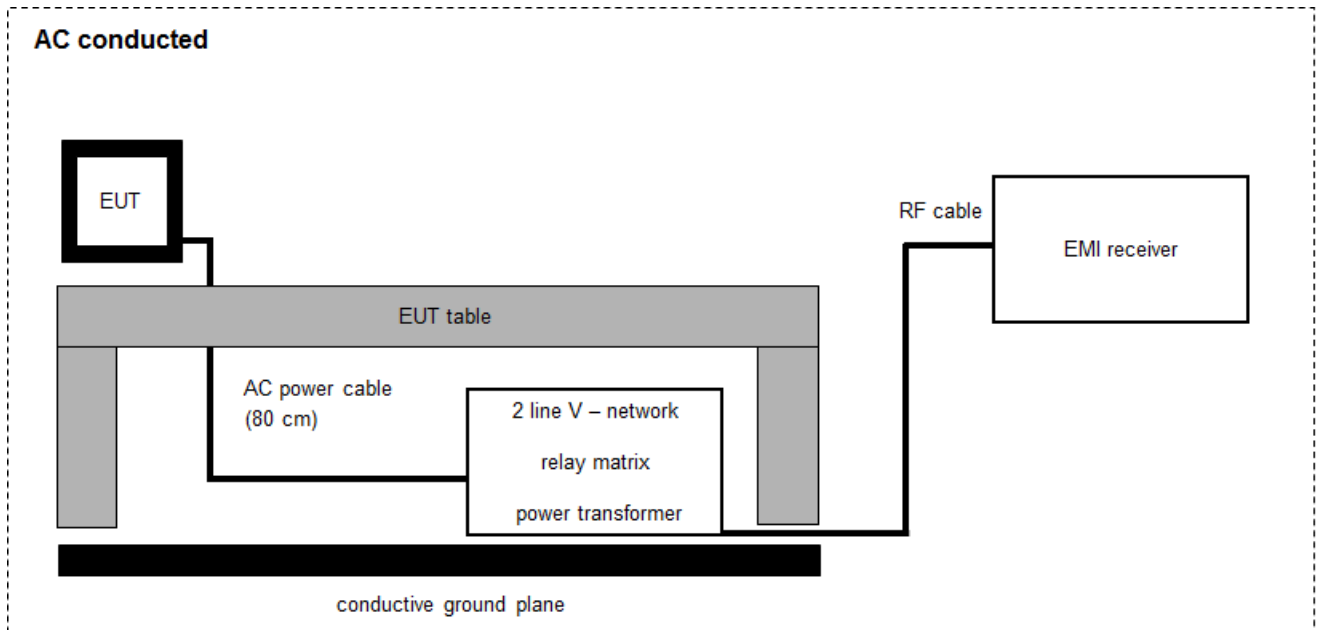

$$FS = UR + CF + VC$$

(FS-field strength; UR-voltage at the receiver; CR-loss of the cable and filter; VC-correction factor of the ISN)

Example calculation:

$$FS [dB\mu V/m] = 37.62 [dB\mu V/m] + 9.90 [dB] + 0.23 [dB] = 47.75 [dB\mu V/m] (244.06 \mu V/m)$$

Equipment table:

| No. | Setup | Equipment | Type | Manufacturer | Serial No. | INV. No. | Kind of Calibration | Last Calibration | Next Calibration |
|-----|-------|---|----------|-----------------|-----------------|-----------|---------------------|------------------|------------------|
| 1 | A | Two-line V-Network (LISN) 9 kHz to 30 MHz | ESH3-Z5 | Rohde & Schwarz | 892475/017 | 300002209 | vIK! | 14.12.2021 | 31.12.2023 |
| 2 | A | RF-Filter-section | 85420E | HP | 3427A00162 | 300002214 | NK! | -/- | -/- |
| 3 | A | Analyzer-Reference-System (Harmonics and Flicker) | ARS 16/1 | SPS | A3509 07/0 0205 | 300003314 | vIK! | 29.12.2021 | 31.12.2023 |
| 4 | A | Hochpass 150 kHz | EZ-25 | R&S | 100010 | 300003798 | ev | -/- | -/- |
| 5 | A | PC | TecLine | F+W | | 300003532 | ne | -/- | -/- |
| 6 | A | EMI Test Receiver 3.6 GHz | ESR3 | Rohde & Schwarz | 102981 | 300006318 | k | 09.12.2022 | 31.12.2023 |

9 Measurement uncertainty

| Measurement uncertainty | |
|--|--|
| Test case | Uncertainty |
| Antenna gain | ± 3 dB |
| Spectrum bandwidth | ± 21.5 kHz absolute; ± 15.0 kHz relative |
| Maximum output power | ± 1 dB |
| Detailed conducted spurious emissions @ the band edge | ± 1 dB |
| Band edge compliance radiated | ± 3 dB |
| Band edge compliance conducted | ± 1.5 dB |
| Spurious emissions conducted | ± 3 dB |
| Spurious emissions radiated below 30 MHz | ± 3 dB |
| Spurious emissions radiated 30 MHz to 1 GHz | ± 3 dB |
| Spurious emissions radiated 1 GHz to 12.75 GHz | ± 3.7 dB |
| Spurious emissions radiated above 12.75 GHz | ± 4.5 dB |
| Spurious emissions conducted below 30 MHz (AC conducted) | ± 2.6 dB |

10 Additional comments

The Bluetooth® word mark and logos are owned by the Bluetooth SIG Inc. and any use of such marks by CTC advanced GmbH is under license.

Reference documents: 1-4813_22-01-05_Annex_MR.pdf
 Test report no. 1-4813_22-01-04

Special test descriptions: None

Configuration descriptions:

| Bluetooth Low Energy | |
|---|----------------|
| Longest Supported payload (37 – 255 Byte) | Tx: 37, RX: 37 |
| LE 1M PHY supported | Yes |
| LE 2M PHY supported | No |
| Stable Modulation Index supported (SMI) | No |
| LE Coded PHY supported (S=2) | No |
| LE Coded PHY supported (S=8) | No |

Test mode: Bluetooth LE Test mode enabled
 (EUT is controlled by CMW)

Special software is used.
 EUT is transmitting pseudo random data by itself

Antennas and transmit operating modes:

Operating mode 1 (single antenna)

- Equipment with 1 antenna,
- Equipment with 2 diversity antennas operating in switched diversity mode by which at any moment in time only 1 antenna is used,
- Smart antenna system with 2 or more transmit/receive chains, but operating in a mode where only 1 transmit/receive chain is used)

Operating mode 2 (multiple antennas, no beamforming)

- Equipment operating in this mode contains a smart antenna system using two or more transmit/receive chains simultaneously but without beamforming.

Operating mode 3 (multiple antennas, with beamforming)

- Equipment operating in this mode contains a smart antenna system using two or more transmit/receive chains simultaneously with beamforming.
 In addition to the antenna assembly gain (G), the beamforming gain (Y) may have to be taken into account when performing the measurements.

11 Summary of measurement results

| | |
|-------------------------------------|--|
| <input checked="" type="checkbox"/> | No deviations from the technical specifications were ascertained |
| <input type="checkbox"/> | There were deviations from the technical specifications ascertained |
| <input type="checkbox"/> | This test report is only a partial test report. The content and verdict of the performed test cases are listed below. |

| TC Identifier | Description | Verdict | Date | Remark |
|---------------|-----------------------------------|------------|------------|--------|
| RF-Testing | CFR Part 15 RSS - 247, Issue 2 | See table! | 2023-03-09 | -/- |

| Test specification clause | Test case | Guideline | Temperature conditions | Power source voltages | Mode | C | NC | NA | NP | Remark |
|--|--|---|------------------------|-----------------------|--------|-------------------------------------|--------------------------|--------------------------|--------------------------|--------|
| §15.247(b)(4) RSS - 247 / 5.4 (4) | System gain | -/- | Nominal | Nominal | 1 Msps | <input checked="" type="checkbox"/> | <input type="checkbox"/> | <input type="checkbox"/> | <input type="checkbox"/> | -/- |
| §15.247(e) RSS - 247 / 5.2 (b) | Power spectral density | KDB 558074 DTS clause: 8.4 | Nominal | Nominal | 1 Msps | <input checked="" type="checkbox"/> | <input type="checkbox"/> | <input type="checkbox"/> | <input type="checkbox"/> | -/- |
| §15.247(a)(2) RSS - 247 / 5.2 (a) | DTS bandwidth – 6 dB bandwidth | KDB 558074 DTS clause: 8.2 | Nominal | Nominal | 1 Msps | <input checked="" type="checkbox"/> | <input type="checkbox"/> | <input type="checkbox"/> | <input type="checkbox"/> | -/- |
| RSS Gen clause 4.6.1 | Occupied bandwidth | -/- | Nominal | Nominal | 1 Msps | <input checked="" type="checkbox"/> | <input type="checkbox"/> | <input type="checkbox"/> | <input type="checkbox"/> | -/- |
| §15.247(b)(3) RSS - 247 / 5.4 (4) | Maximum output power | KDB 558074 DTS clause: 8.3.1.1 | Nominal | Nominal | 1 Msps | <input checked="" type="checkbox"/> | <input type="checkbox"/> | <input type="checkbox"/> | <input type="checkbox"/> | -/- |
| §15.205 RSS - 247 / 5.5 RSS - Gen | Band edge compliance rad. | KDB 558074 DTS clause: 8.7.2 or 8.7.3 | Nominal | Nominal | 1 Msps | <input checked="" type="checkbox"/> | <input type="checkbox"/> | <input type="checkbox"/> | <input type="checkbox"/> | -/- |
| §15.247(d) RSS - 247 / 5.5 | TX spurious emissions conducted | KDB 558074 DTS clause: 8.5 | Nominal | Nominal | 1 Msps | <input checked="" type="checkbox"/> | <input type="checkbox"/> | <input type="checkbox"/> | <input type="checkbox"/> | -/- |
| §15.209(a) RSS - Gen | Spurious emissions radiated below 30 MHz | -/- | Nominal | Nominal | 1 Msps | <input checked="" type="checkbox"/> | <input type="checkbox"/> | <input type="checkbox"/> | <input type="checkbox"/> | -/- |
| §15.247(d) RSS - 247 / 5.5 §15.109 RSS - Gen | Spurious emissions radiated 30 MHz to 1 GHz | -/- | Nominal | Nominal | 1 Msps | <input checked="" type="checkbox"/> | <input type="checkbox"/> | <input type="checkbox"/> | <input type="checkbox"/> | -/- |
| §15.247(d) RSS - 247 / 5.5 §15.109 RSS - Gen | Spurious emissions radiated above 1 GHz | -/- | Nominal | Nominal | 1 Msps | <input checked="" type="checkbox"/> | <input type="checkbox"/> | <input type="checkbox"/> | <input type="checkbox"/> | -/- |
| §15.107(a) §15.207 | Conducted emissions below 30 MHz (AC conducted) | -/- | Nominal | Nominal | 1 Msps | <input checked="" type="checkbox"/> | <input type="checkbox"/> | <input type="checkbox"/> | <input type="checkbox"/> | -/- |

Note: C = Compliant; NC = Not compliant; NA = Not applicable; NP = Not performed

12 Measurement results

12.1 System gain

Limits:

| FCC | ISED |
|---|------|
| 6 dBi / > 6 dBi output power and power density reduction required | |

Results:

| T _{nom} | V _{nom} | 2402 MHz | 2441 MHz | 2480 MHz |
|--------------------------|------------------|----------|----------|----------|
| Gain [dBi] Calculated | | 2.1 | 1.8 | 0.5 |

Note: Antenna gain calculation extracted from test report no. 1-4813_22-01-04

12.2 Power spectral density

Description:

Measurement of the power spectral density of a digital modulated system.

| Measurement parameters | |
|-------------------------|---|
| External result file | 1-4813_22-01-05_Annex_MR.pdf FCC Part 15.247 Peak Power Spectral Density DTS |
| Test setup | See sub clause 8.4 A |
| Measurement uncertainty | See sub clause 9 |

Limits:

| FCC | ISED |
|--|------|
| Power spectral density | |
| For digitally modulated systems the transmitter power spectral density conducted from the transmitter to the antenna shall not be greater than 8 dBm in any 3 kHz band during any time interval of continuous transmission or over 1.0 second if the transmission exceeds 1.0-second duration. | |

Results:

| | Frequency | | |
|---|-----------|----------|----------|
| | 2402 MHz | 2440 MHz | 2480 MHz |
| Power spectral density [dBm / 3kHz] 1 Msps | -12.9 | -12.0 | -11.5 |

12.3 DTS bandwidth – 6 dB bandwidth

Description:

Measurement of the 6 dB bandwidth of the modulated signal.

| Measurement parameters | |
|-------------------------|---|
| External result file | 1-4813_22-01-05_Annex_MR.pdf FCC Part 15.247 Bandwidth 6dB DTS |
| Test setup | See sub clause 8.4 A |
| Measurement uncertainty | See sub clause 9 |

Limits:

| FCC | ISED |
|---|------|
| DTS bandwidth – 6 dB bandwidth | |
| Systems using digital modulation techniques may operate in the 2400–2483.5 MHz band. The minimum 6 dB bandwidth shall be at least 500 kHz. | |

Results:

| | Frequency | | |
|--|-----------|----------|----------|
| | 2402 MHz | 2440 MHz | 2480 MHz |
| 6 dB bandwidth [kHz] 1 Msps | 667 | 672 | 671 |

12.4 Occupied bandwidth – 99% emission bandwidth

Description:

Measurement of the 99% bandwidth of the modulated signal acc. RSS-GEN.

| Measurement parameters | |
|-------------------------|--|
| External result file | 1-4813_22-01-05_Annex_MR.pdf FCC Part 15.247 Bandwidth 99PCT-20dB |
| Test setup | See sub clause 8.4 A |
| Measurement uncertainty | See sub clause 9 |

Usage:

| -/- | ISED |
|---|------|
| Occupied bandwidth – 99% emission bandwidth | |
| OBW is necessary for emission designator | |

Results:

| | Frequency | | |
|---------------------------------------|-----------|----------|----------|
| | 2402 MHz | 2440 MHz | 2480 MHz |
| 99% bandwidth [kHz] 1 Msps | 1055 | 1055 | 1056 |

12.5 Maximum output power

Description:

Measurement of the maximum output power conducted. EUT in single channel mode.

| Measurement parameters | |
|-------------------------|---|
| External result file | 1-4813_22-01-05_Annex_MR.pdf FCC Part 15.247 Maximum Peak Conducted Output Power DTS |
| Test setup | See sub clause 8.4 A |
| Measurement uncertainty | See sub clause 9 |

Limits:

| FCC | ISED |
|--|------|
| Maximum output power | |
| Conducted: 1.0 W – antenna gain max. 6 dBi | |

Results:

| | Frequency | | |
|--|-----------|----------|----------|
| | 2402 MHz | 2440 MHz | 2480 MHz |
| Maximum output power conducted [dBm] 1 Msps | 2.9 | 3.7 | 4.3 |

12.6 Band edge compliance radiated

Description:

Measurement of the radiated band edge compliance. The EUT is turned in the position that results in the maximum level at the band edge. Then a sweep over the corresponding restricted band is performed. The EUT is set to single channel mode and the transmit frequency 2402 MHz for the lower restricted band and 2480 MHz for the upper restricted band. Measurement distance is 3m.

| Measurement parameters | |
|-------------------------|---|
| Detector | Peak / RMS |
| Sweep time | Auto |
| Resolution bandwidth | 1 MHz |
| Video bandwidth | 3 MHz |
| Span | Lower Band: 2300 – 2400 MHz higher Band: 2480 – 2500 MHz |
| Trace mode | Max hold |
| Test setup | See sub clause 8.2 B |
| Measurement uncertainty | See sub clause 9 |

Limits:

| FCC | ISED |
|---|------|
| Band edge compliance radiated | |
| <p>In any 100 kHz bandwidth outside the frequency band in which the spread spectrum or digitally modulated intentional radiator is operating, the radio frequency power that is produced by the intentional radiator shall be at least 20 dB below that in the 100 kHz bandwidth within the band that contains the highest level of the desired power, based on either an RF conducted or a radiated measurement. Attenuation below the general limits specified in Section 15.209(a) is not required. In addition, radiated emissions which fall in the restricted bands, as defined in Section 15.205(a), must also comply with the radiated emission limits specified in Section 15.209(a) (see Section 5.205(c)).</p> | |
| 54 dB μ V/m AVG 74 dB μ V/m Peak | |

Result:

| Scenario | Band edge compliance radiated [dB μ V/m] |
|-----------------------|---|
| Data rate | 1 Msps |
| Lower restricted band | 31.9 dB μ V/m AVG 43.1 dB μ V/m Peak |
| Upper restricted band | 34.2 dB μ V/m AVG 45.1 dB μ V/m Peak |

Plots:

Plot 1: Lower restricted band, 1 Msp

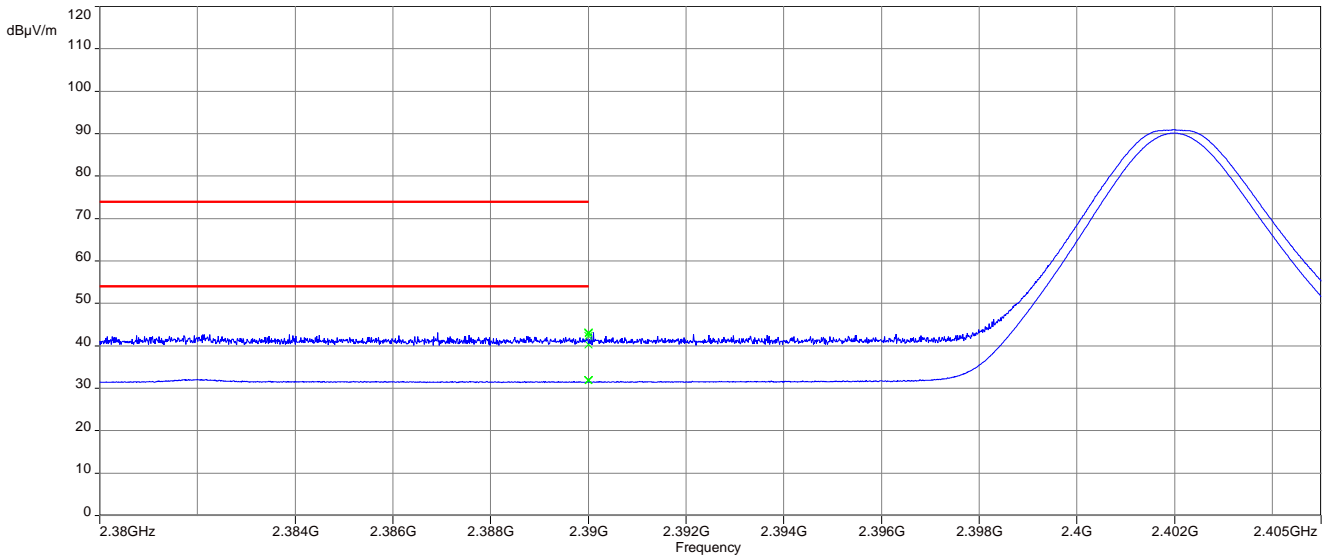

Plot 2: Upper restricted band, 1 Msp

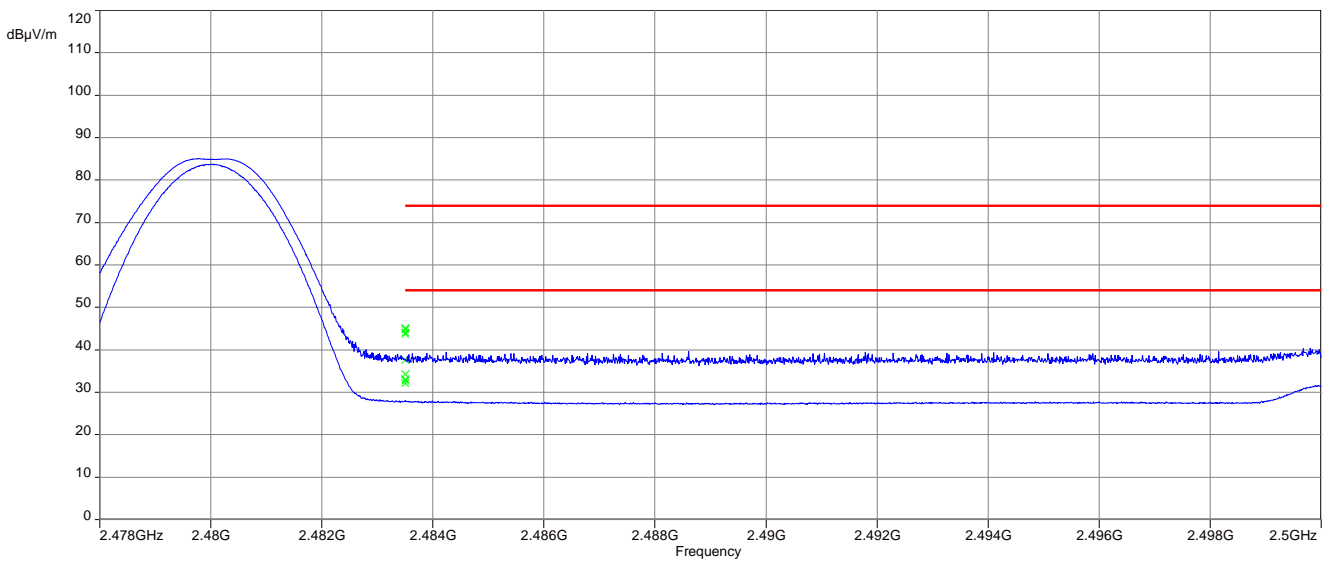

12.7 TX spurious emissions conducted

Description:

Measurement of the conducted spurious emissions in transmit mode. The EUT is set to single channel mode and the transmit frequencies are 2402 MHz, 2440 MHz and 2480 MHz.

| Measurement parameters | |
|-------------------------|---|
| External result file | 1-4813_22-01-05_Annex_MR.pdf FCC Part 15.247 TX Spurious Conducted |
| Test setup | See sub clause 8.4 A |
| Measurement uncertainty | See sub clause 9 |

Limits:

| FCC | ISED |
|--|------|
| TX spurious emissions conducted | |
| In any 100 kHz bandwidth outside the frequency band in which the spread spectrum or digitally modulated intentional radiator is operating, the radio frequency power that is produced by the intentional radiator shall be at least 20 dB below that in the 100 kHz bandwidth within the band that contains the highest level of the desired power, based on either an RF conducted or a radiated measurement. Attenuation below the general limits specified in Section 15.209(a) is not required | |

Results: Compliant (see external result file)

12.8 Spurious emissions radiated below 30 MHz

Description:

Measurement of the radiated spurious emissions in transmit mode below 30 MHz. The EUT is set to single channel mode and the transmit frequencies are 2402 MHz, 2440 MHz and 2480 MHz. The limits are recalculated to a measurement distance of 3 m according the ANSI C63.10.

| Measurement parameters | |
|-------------------------|---|
| Detector | Peak / Quasi peak |
| Sweep time | Auto |
| Resolution bandwidth | F < 150 kHz: 200 Hz F > 150 kHz: 9 kHz |
| Video bandwidth | F < 150 kHz: 1 kHz F > 150 kHz: 30 kHz |
| Span | 9 kHz to 30 MHz |
| Trace mode | Max hold |
| Test setup | See sub clause 8.2 C |
| Measurement uncertainty | See sub clause 9 |

Limits:

| FCC | | ISED |
|---|-------------------------------|----------------------|
| TX spurious emissions radiated below 30 MHz | | |
| Frequency (MHz) | Field strength (dB μ V/m) | Measurement distance |
| 0.009 – 0.490 | 2400/F(kHz) | 300 |
| 0.490 – 1.705 | 24000/F(kHz) | 30 |
| 1.705 – 30.0 | 30 | 30 |

Results:

| TX spurious emissions radiated below 30 MHz [dB μ V/m] | | |
|---|----------|----------------------|
| F [MHz] | Detector | Level [dB μ V/m] |
| All detected emissions are more than 20 dB below the limit. | | |

Plots:

Plot 1: 9 kHz to 30 MHz, 2402 MHz, transmit mode, 1 Msps

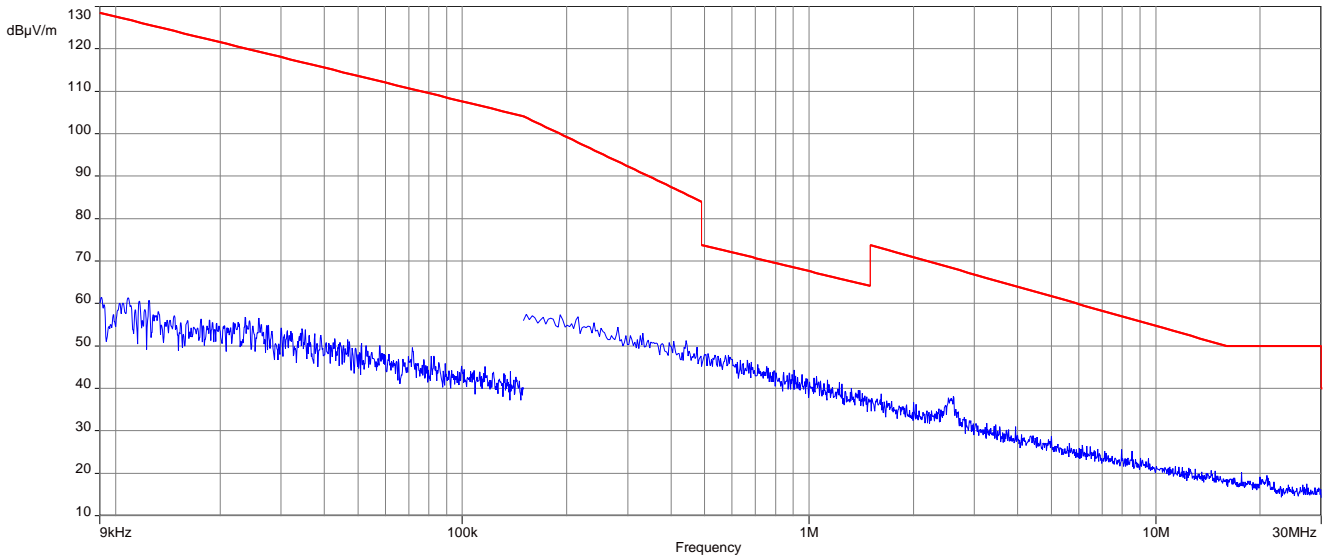

Plot 2: 9 kHz to 30 MHz, 2440 MHz, transmit mode, 1 Msps

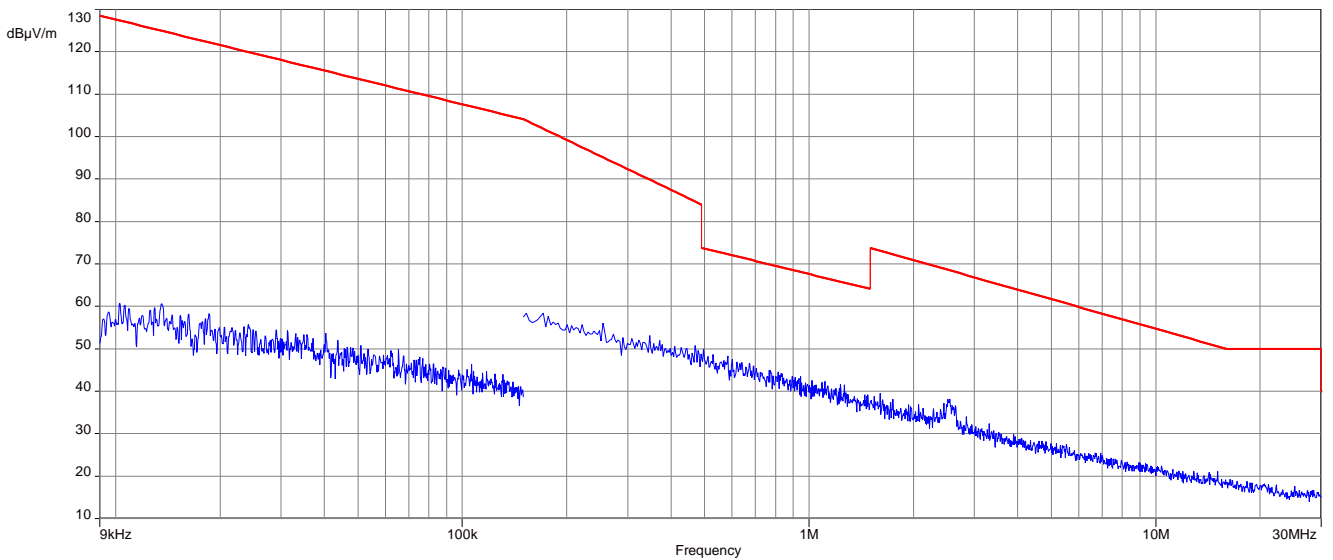

Plot 3: 9 kHz to 30 MHz, 2480 MHz, transmit mode, 1 Msps

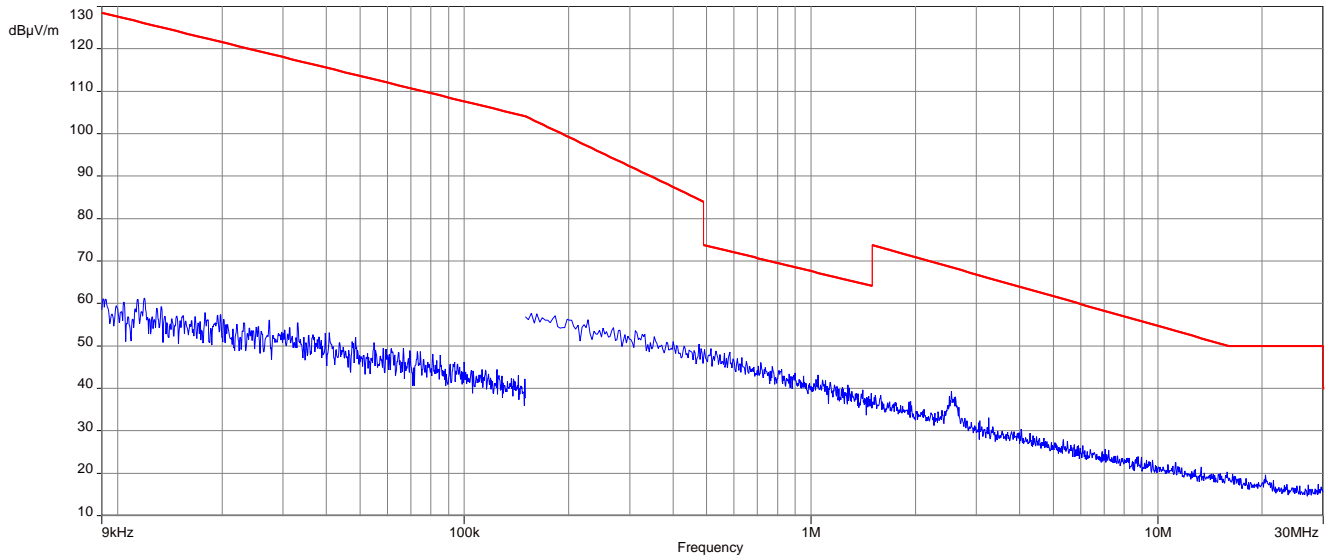

12.9 Spurious emissions radiated 30 MHz to 1 GHz

| Measurement parameters | |
|-------------------------|----------------------|
| Detector | Peak / Quasi Peak |
| Sweep time | Auto |
| Resolution bandwidth | 120 kHz |
| Video bandwidth | 3 x RBW |
| Span | 30 MHz to 1 GHz |
| Trace mode | Max hold |
| Measured modulation | GFSK |
| Test setup | See sub clause 8.1 A |
| Measurement uncertainty | See sub clause 9 |

Limits:

| FCC | ISED | |
|---|-------------------------|----------------------|
| TX spurious emissions radiated | | |
| <p>In any 100 kHz bandwidth outside the frequency band in which the spread spectrum or digitally modulated intentional radiator is operating, the radio frequency power that is produced by the intentional radiator shall be at least 20 dB below that in the 100 kHz bandwidth within the band that contains the highest level of the desired power, based on either an RF conducted or a radiated measurement. Attenuation below the general limits specified in Section 15.209(a) is not required. In addition, radiated emissions which fall in the restricted bands, as defined in §15.205(a), must also comply with the radiated emission limits specified in §15.209(a) (see §15.205(c)).</p> | | |
| §15.209 | | |
| Frequency (MHz) | Field strength (dBµV/m) | Measurement distance |
| 30 - 88 | 30.0 | 10 |
| 88 – 216 | 33.5 | 10 |
| 216 – 960 | 36.0 | 10 |
| Above 960 | 54.0 | 3 |

Plots: Transmit mode

Plot 1: 30 MHz to 1 GHz, TX mode, valid for all channels, vertical & horizontal polarization, 1 Msps

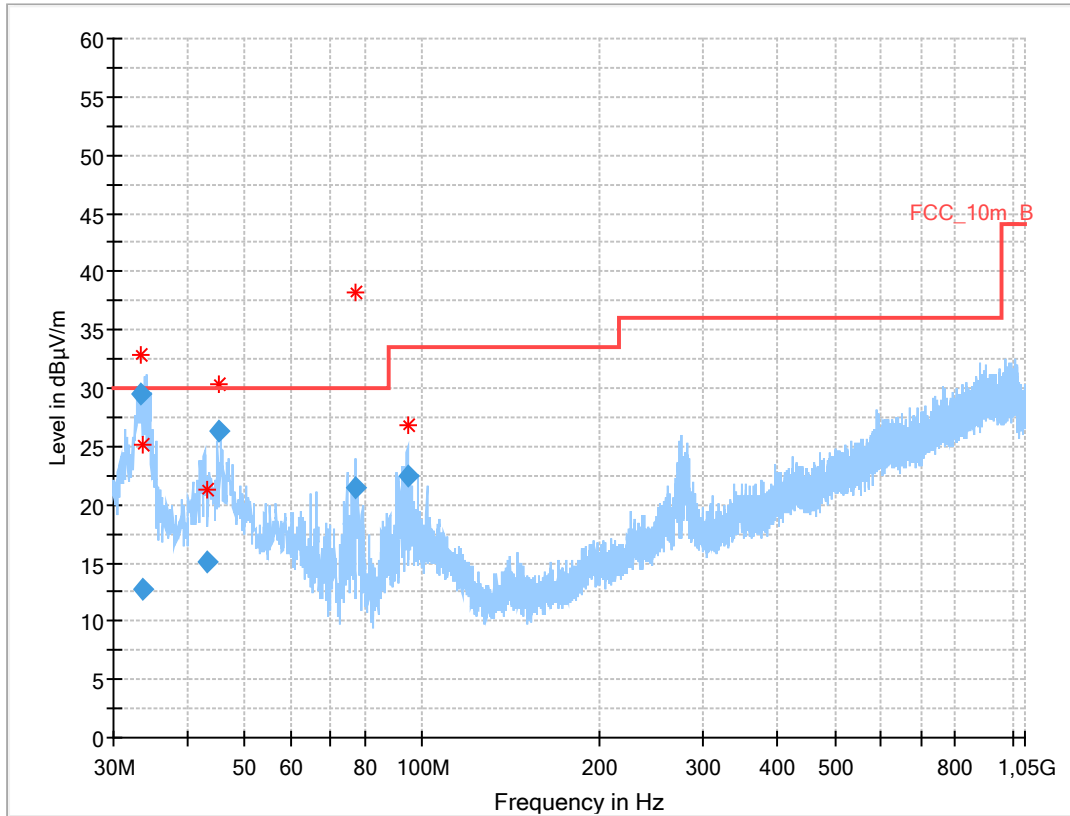

Final results:

| Frequency (MHz) | QuasiPeak (dBµV/m) | Limit (dBµV/m) | Margin (dB) | Meas. Time (ms) | Bandwidth (kHz) | Height (cm) | Pol | Azimuth (deg) | Corr. (dB) |
|-----------------|--------------------|----------------|-------------|-----------------|-----------------|-------------|-----|---------------|------------|
| 33.454 | 29.46 | 30.0 | 0.5 | 1000 | 120.0 | 112.0 | V | 248 | 14 |
| 33.661 | 12.82 | 30.0 | 17.2 | 1000 | 120.0 | 108.0 | V | 75 | 14 |
| 43.277 | 15.13 | 30.0 | 14.9 | 1000 | 120.0 | 137.0 | V | 9 | 16 |
| 45.251 | 26.37 | 30.0 | 3.6 | 1000 | 120.0 | 114.0 | V | 279 | 16 |
| 77.207 | 21.45 | 30.0 | 8.6 | 1000 | 120.0 | 400.0 | V | 135 | 8 |
| 94.378 | 22.38 | 33.5 | 11.1 | 1000 | 120.0 | 164.0 | V | 28 | 13 |

12.10 Spurious emissions radiated above 1 GHz

| Measurement parameters | |
|-------------------------|---|
| Detector | Peak / RMS |
| Sweep time | Auto |
| Resolution bandwidth | 1 MHz |
| Video bandwidth | 3 x RBW |
| Span | 1 GHz to 26 GHz |
| Trace mode | Max hold |
| Measured modulation | GFSK |
| Test setup | See sub clause 8.2 A (1 GHz - 18 GHz) See sub clause 8.3 A (18 GHz - 26 GHz) |
| Measurement uncertainty | See sub clause 9 |

Limits:

| FCC | ISED | |
|---|-------------------------------|----------------------|
| TX spurious emissions radiated | | |
| <p>In any 100 kHz bandwidth outside the frequency band in which the spread spectrum or digitally modulated intentional radiator is operating, the radio frequency power that is produced by the intentional radiator shall be at least 20 dB below that in the 100 kHz bandwidth within the band that contains the highest level of the desired power, based on either an RF conducted or a radiated measurement. Attenuation below the general limits specified in Section 15.209(a) is not required. In addition, radiated emissions which fall in the restricted bands, as defined in §15.205(a), must also comply with the radiated emission limits specified in §15.209(a) (see §15.205(c)).</p> | | |
| §15.209 | | |
| Frequency (MHz) | Field strength (dB μ V/m) | Measurement distance |
| Above 960 | 54.0 (Average) | 3 |
| Above 960 | 74.0 (Peak) | 3 |

Results: Transmitter mode, 1 Msps

| TX spurious emissions radiated [dB μ V/m] | | | | | | | | |
|---|----------|----------------------|----------|----------|----------------------|----------|----------|----------------------|
| 2402 MHz | | | 2440 MHz | | | 2480 MHz | | |
| F [MHz] | Detector | Level [dB μ V/m] | F [MHz] | Detector | Level [dB μ V/m] | F [MHz] | Detector | Level [dB μ V/m] |
| 4374.9 | Peak | 48.1 | -/- | Peak | -/- | -/- | Peak | -/- |
| | AVG | 40.1 | | AVG | -/- | | AVG | -/- |

Plots: Transmitter mode

Plot 1: 1 GHz to 18 GHz, TX mode, 2402 MHz, vertical & horizontal polarization, 1 Msps

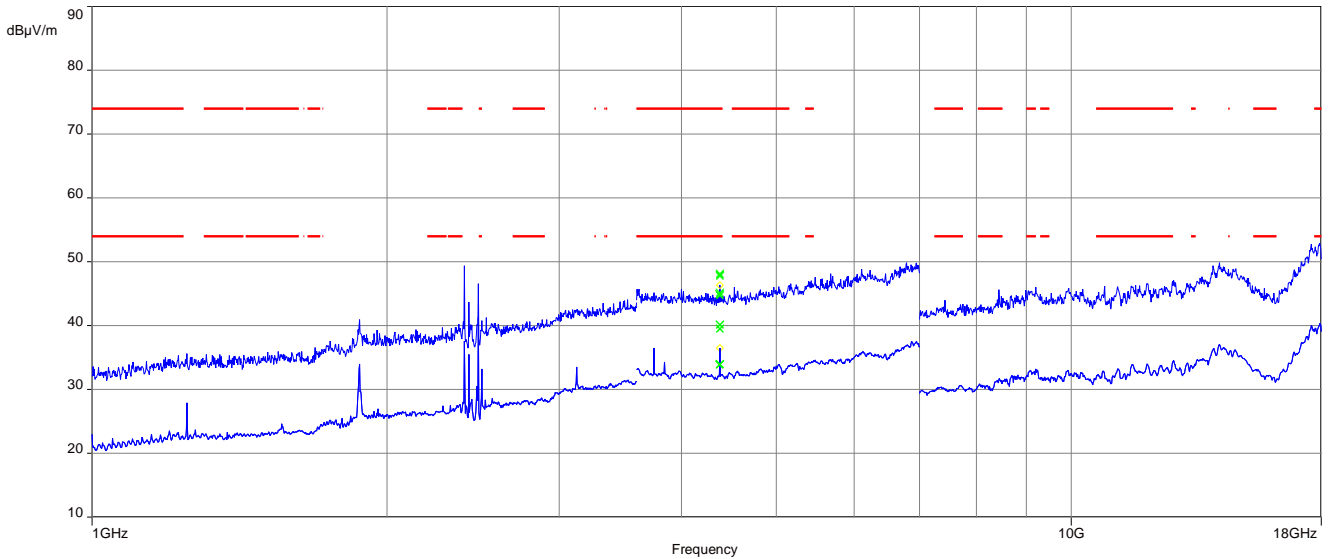

The carrier signal is notched with a 2.4 GHz band rejection filter.

Plot 2: 1 GHz to 18 GHz, TX mode, 2440 MHz, vertical & horizontal polarization, 1 Msps

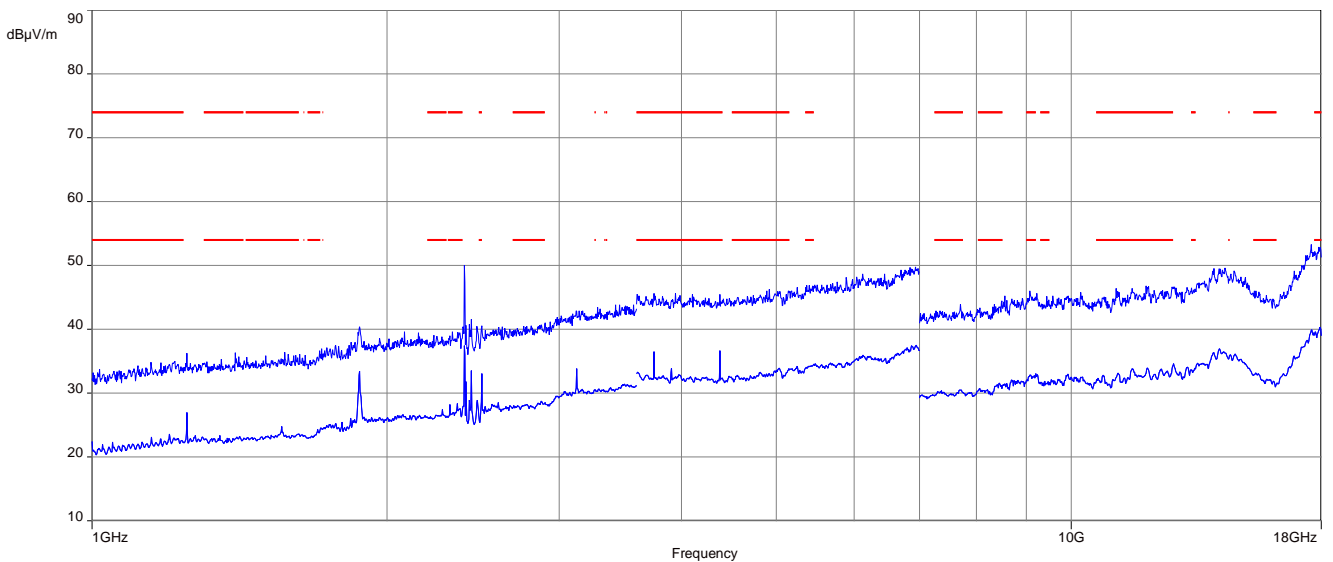

The carrier signal is notched with a 2.4 GHz band rejection filter.

Plot 3: 1 GHz to 18 GHz, TX mode, 2480 MHz, vertical & horizontal polarization, 1 Msp

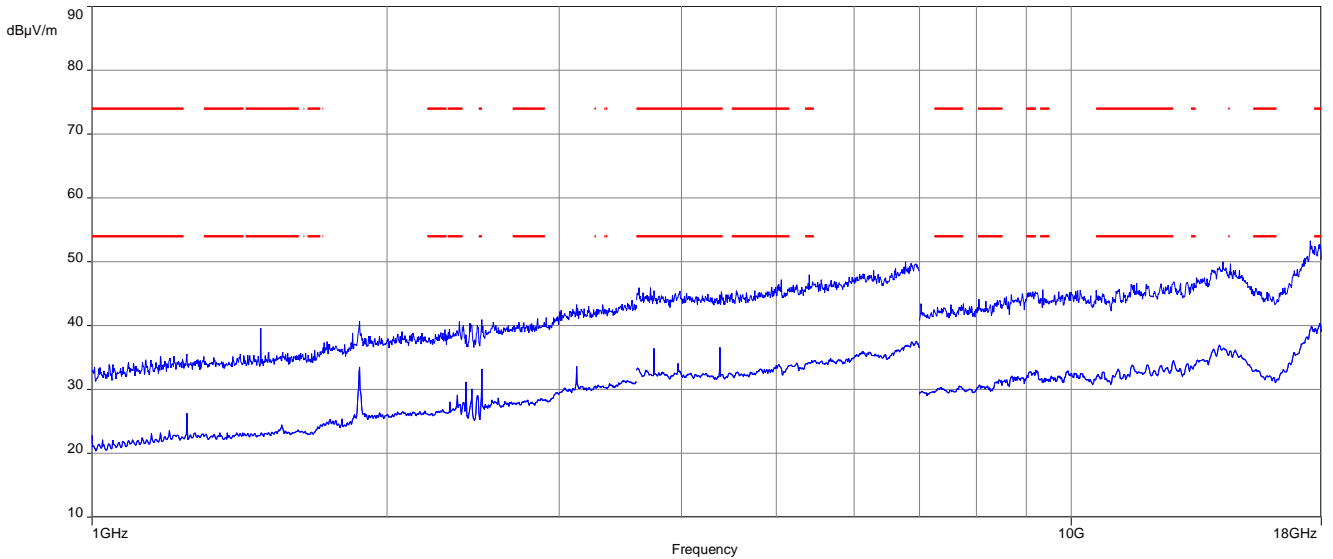

The carrier signal is notched with a 2.4 GHz band rejection filter.

Plot 4: 18 GHz to 26 GHz, TX mode, valid for all channels, vertical & horizontal polarization, 1 Msp

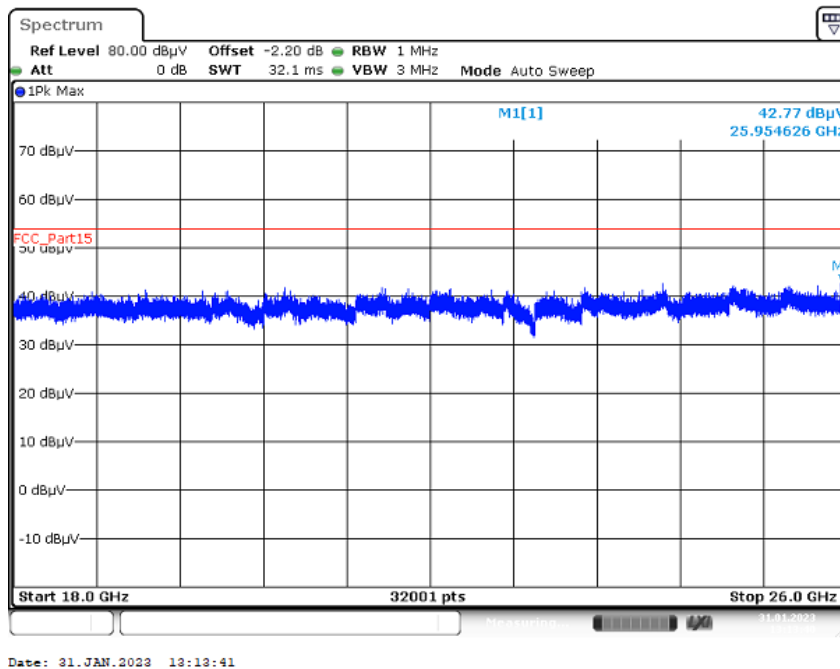

12.11 Spurious emissions conducted below 30 MHz (AC conducted)

Description:

Measurement of the conducted spurious emissions in transmit mode below 30 MHz. The EUT is set to single channel mode and the transmit frequency is 2440 MHz. This measurement is representative for all channels and modes. If critical peaks are found frequency 2402 MHz and 2480 MHz will be measured too. The measurement is performed in the mode with the highest output power. Both power lines, phase and neutral line, are measured. Found peaks are remeasured with average and quasi peak detection to show compliance to the limits.

| Measurement parameters | |
|-------------------------|--|
| Detector | Peak - Quasi peak / average |
| Sweep time | Auto |
| Resolution bandwidth | F < 150 kHz: 200 Hz F > 150 kHz: 9 kHz |
| Video bandwidth | F < 150 kHz: 1 kHz F > 150 kHz: 100 kHz |
| Span: | 9 kHz to 30 MHz |
| Trace mode: | Max hold |
| Test setup | See sub clause 8.5. A |
| Measurement uncertainty | See sub clause 9 |

Limits:

| FCC | ISED | |
|--|---------------------------|------------------------|
| TX spurious emissions conducted < 30 MHz | | |
| Frequency (MHz) | Quasi-peak (dB μ V/m) | Average (dB μ V/m) |
| 0.15 – 0.5 | 66 to 56* | 56 to 46* |
| 0.5 – 5 | 56 | 46 |
| 5 – 30.0 | 60 | 50 |

*Decreases with the logarithm of the frequency

Results:

| Spurious emissions conducted < 30 MHz [dB μ V/m] | | |
|--|----------|----------------------|
| F [MHz] | Detector | Level [dB μ V/m] |
| No emissions detected | | |
| | | |
| | | |

Plots:

Plot 1: 150 kHz to 30 MHz, phase line

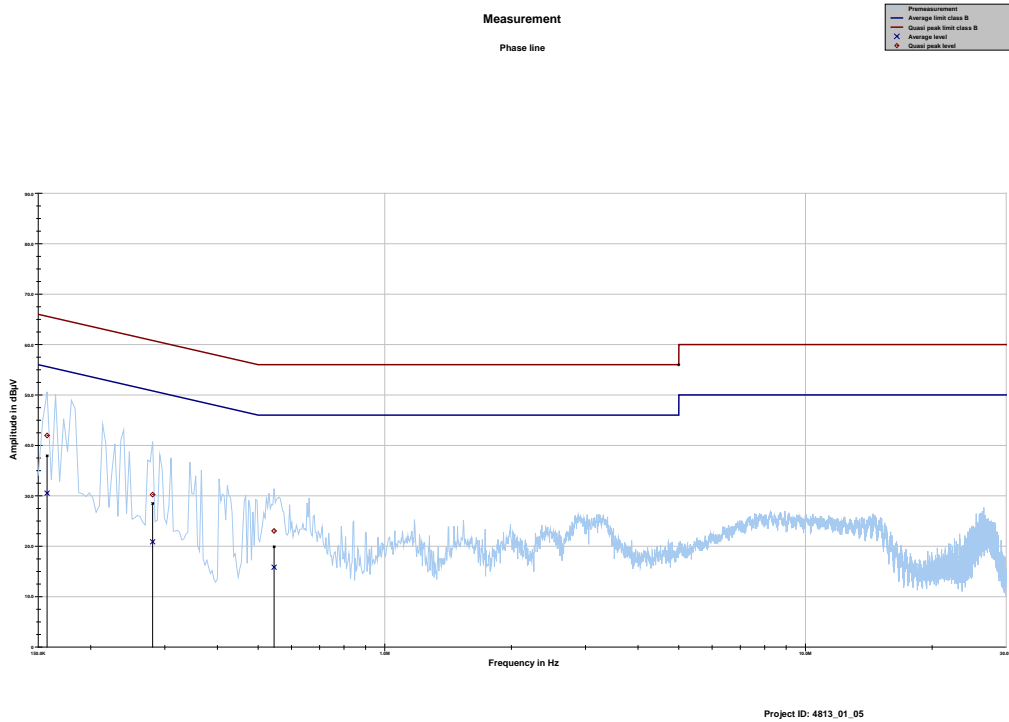

Final results:

| Frequency | Quasi peak level | Margin quasi peak | Limit QP | Average level | Margin average | Limit AV |
|-----------|------------------|-------------------|----------|---------------|----------------|----------|
| MHz | dBµV | dB | dBµV | dBµV | dB | dBµV |
| 0.157463 | 41.96 | 23.64 | 65.597 | 30.53 | 25.26 | 55.787 |
| 0.280594 | 30.23 | 30.57 | 60.798 | 20.87 | 31.40 | 52.269 |
| 0.545512 | 23.04 | 32.96 | 56.000 | 15.83 | 30.17 | 46.000 |

Plot 2: 150 kHz to 30 MHz, neutral line

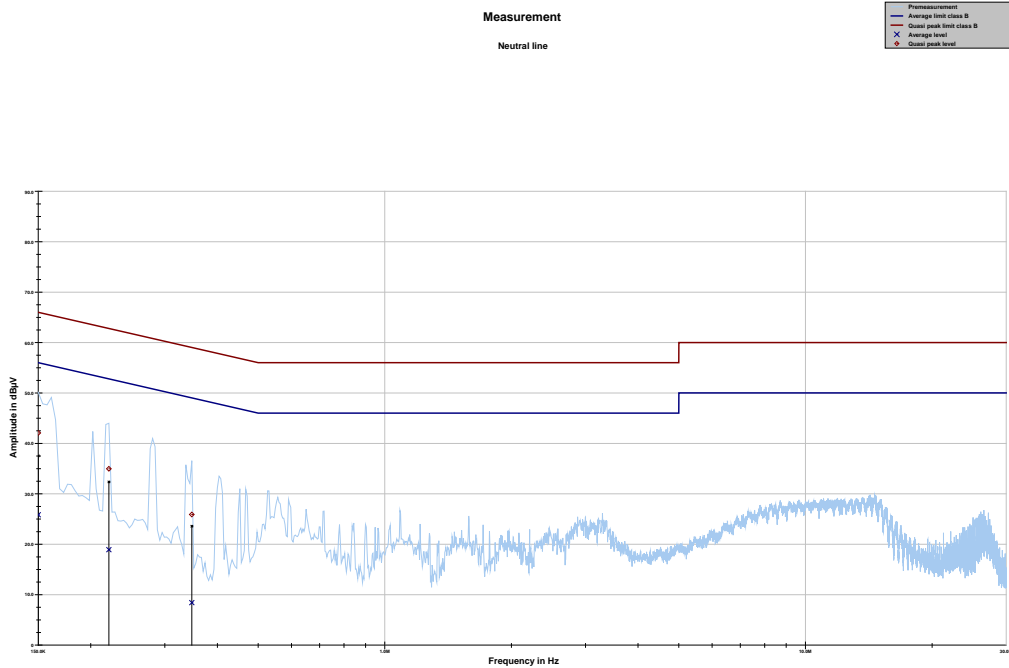

Project ID: 4813_01_05

Final results:

| Frequency | Quasi peak level | Margin quasi peak | Limit QP | Average level | Margin average | Limit AV |
|-----------|------------------|-------------------|----------|---------------|----------------|----------|
| MHz | dBµV | dB | dBµV | dBµV | dB | dBµV |
| 0.150000 | 42.06 | 23.94 | 66.000 | 25.84 | 30.16 | 56.000 |
| 0.220894 | 34.95 | 27.83 | 62.785 | 18.91 | 35.07 | 53.974 |
| 0.347756 | 25.89 | 33.13 | 59.016 | 8.41 | 41.94 | 50.350 |

13 Glossary

| | |
|------------------------|--|
| EUT | Equipment under test |
| DUT | Device under test |
| UUT | Unit under test |
| GUE | GNSS User Equipment |
| ETSI | European Telecommunications Standards Institute |
| EN | European Standard |
| FCC | Federal Communications Commission |
| FCC ID | Company Identifier at FCC |
| IC | Industry Canada |
| PMN | Product marketing name |
| HMN | Host marketing name |
| HVIN | Hardware version identification number |
| FVIN | Firmware version identification number |
| EMC | Electromagnetic Compatibility |
| HW | Hardware |
| SW | Software |
| Inv. No. | Inventory number |
| S/N or SN | Serial number |
| C | Compliant |
| NC | Not compliant |
| NA | Not applicable |
| NP | Not performed |
| PP | Positive peak |
| QP | Quasi peak |
| AVG | Average |
| OC | Operating channel |
| OCW | Operating channel bandwidth |
| OBW | Occupied bandwidth |
| OOB | Out of band |
| DFS | Dynamic frequency selection |
| CAC | Channel availability check |
| OP | Occupancy period |
| NOP | Non occupancy period |
| DC | Duty cycle |
| PER | Packet error rate |
| CW | Clean wave |
| MC | Modulated carrier |
| WLAN | Wireless local area network |
| RLAN | Radio local area network |
| DSSS | Dynamic sequence spread spectrum |
| OFDM | Orthogonal frequency division multiplexing |
| FHSS | Frequency hopping spread spectrum |
| GNSS | Global Navigation Satellite System |
| C/N₀ | Carrier to noise-density ratio, expressed in dB-Hz |

14 Document history

| Version | Applied changes | Date of release |
|---------|-----------------|-----------------|
| -/- | Initial release | 2023-03-09 |

15 Accreditation Certificate – D-PL-12076-01-04

| first page | last page |
|---|---|
|  <p>The first page of the accreditation certificate features the DAKKS logo (Deutsche Akkreditierungsstelle) and the text: "Deutsche Akkreditierungsstelle GmbH", "Entrusted according to Section 8 subsection 1 AkkStelleG in connection with Section 1 subsection 1 AkkStelleGBV Signatory to the Multilateral Agreements of EA, ILAC and IAF for Mutual Recognition", "Accreditation" with the German eagle emblem, and "The Deutsche Akkreditierungsstelle GmbH attests that the testing laboratory CTC advanced GmbH Untertürkheimer Straße 6-10, 66117 Saarbrücken is competent under the terms of DIN EN ISO/IEC 17025:2018 to carry out tests in the following fields: Telecommunication (TC) and Electromagnetic Compatibility (EMC) for Canadian Standards". It also includes the registration number "D-PL-12076-01-04", a signature of the Head of Division, and a note about the certificate's status and database location.</p> |  <p>The last page of the accreditation certificate lists the office addresses: "Office Berlin Spittelmarkt 10 10117 Berlin", "Office Frankfurt am Main Europa-Allee 52 60327 Frankfurt am Main", and "Office Braunschweig Bundesallee 100 38116 Braunschweig". It contains a disclaimer: "The publication of extracts of the accreditation certificate is subject to the prior written approval by Deutsche Akkreditierungsstelle GmbH (DAKKS). Exempted is the unchanged form of separate disseminations of the cover sheet by the conformity assessment body mentioned overleaf." and "No impression shall be made that the accreditation also extends to fields beyond the scope of accreditation attested by DAKKS." It also provides details on the accreditation's legal basis and the up-to-date state of membership retrieval from EA, ILAC, and IAF websites.</p> |

Note: The current certificate annex is published on the websites (link see below).

<https://www.dakks.de/files/data/as/pdf/D-PL-12076-01-04e.pdf>

OR

https://ctcadvanced.com/app/uploads/2020/06/D-PL-12076-01-04_Canada_TCEMC.pdf

16 Accreditation Certificate – D-PL-12076-01-05

| first page | last page | | | |
|--|---|--|--|--|
|  <p>Deutsche Akkreditierungsstelle GmbH</p> <p>Entrusted according to Section 8 subsection 1 AkkStelleG in connection with Section 1 subsection 1 AkkStelleGBV Signatory to the Multilateral Agreements of EA, ILAC and IAF for Mutual Recognition</p> <p>Accreditation </p> <p>The Deutsche Akkreditierungsstelle GmbH attests that the testing laboratory</p> <p>CTC advanced GmbH Untertürkheimer Straße 6-10, 66117 Saarbrücken</p> <p>is competent under the terms of DIN EN ISO/IEC 17025:2018 to carry out tests in the following fields:</p> <p>Telecommunication (FCC Requirements)</p> <p>The accreditation certificate shall only apply in connection with the notice of accreditation of 09.06.2020 with the accreditation number D-PL-12076-01. It comprises the cover sheet, the reverse side of the cover sheet and the following annex with a total of 05 pages.</p> <p>Registration number of the certificate: D-PL-12076-01-05</p> <p>Frankfurt am Main, 09.06.2020  by order: Dipl.-Ing. (FH) Ralf Eigner Head of Division</p> <p><small>The certificate together with its annex reflects the status at the time of the date of issue. The current status of the scope of accreditation can be found in the database of accredited bodies of Deutsche Akkreditierungsstelle GmbH. https://www.dakks.de/en/content/accredited-bodies-dakks See notes annex 1.</small></p> | <p>Deutsche Akkreditierungsstelle GmbH</p> <table border="0"> <tr> <td>Office Berlin Spittelmarkt 10 10117 Berlin</td> <td>Office Frankfurt am Main Europa-Allee 52 60327 Frankfurt am Main</td> <td>Office Braunschweig Bundesallee 100 38116 Braunschweig</td> </tr> </table> <p>The publication of extracts of the accreditation certificate is subject to the prior written approval by Deutsche Akkreditierungsstelle GmbH (DAkkS). Exempted is the unchanged form of separate disseminations of the cover sheet by the conformity assessment body mentioned overleaf.</p> <p>No impression shall be made that the accreditation also extends to fields beyond the scope of accreditation attested by DAkkS.</p> <p>The accreditation was granted pursuant to the Act on the Accreditation Body (AkkStelleG) of 31 July 2009 (Federal Law Gazette I p. 2625) and the Regulation (EC) No 765/2008 of the European Parliament and of the Council of 9 July 2008 setting out the requirements for accreditation and market surveillance relating to the marketing of products (Official Journal of the European Union L 218 of 9 July 2008, p. 30). DAkkS is a signatory to the Multilateral Agreements for Mutual Recognition of the European co-operation for Accreditation (EA), International Accreditation Forum (IAF) and International Laboratory Accreditation Cooperation (ILAC). The signatories to these agreements recognise each other's accreditations.</p> <p>The up-to-date state of membership can be retrieved from the following websites: EA: www.european-accreditation.org ILAC: www.ilac.org IAF: www.iaf.nu</p> | Office Berlin Spittelmarkt 10 10117 Berlin | Office Frankfurt am Main Europa-Allee 52 60327 Frankfurt am Main | Office Braunschweig Bundesallee 100 38116 Braunschweig |
| Office Berlin Spittelmarkt 10 10117 Berlin | Office Frankfurt am Main Europa-Allee 52 60327 Frankfurt am Main | Office Braunschweig Bundesallee 100 38116 Braunschweig | | |

Note: The current certificate annex is published on the websites (link see below).

<https://www.dakks.de/files/data/as/pdf/D-PL-12076-01-05e.pdf>

or

https://ctcadvanced.com/app/uploads/2020/06/D-PL-12076-01-05_TCB_USA.pdf

END OF TEST REPORT