



Test Report

Product Name : NETWORK SHARING CAMERA
Model No. : NSC-GC1
FCC ID : TVRNSCGC1

Applicant : Hon Hai Precision Industry Co., Ltd. Nei-Hu Branch Office
Address : 1~11 F., No.32, Ji-hu Rd., Nei-hu, Taipei 114, Taiwan,
R.O.C.

Date of Receipt : 2007/06/12
Issued Date : 2007/06/26
Report No. : 076046R-ITUSP01V02

The test results relate only to the samples tested.

The test results shown in the test report are traceable to the national/international standard through the calibration of the equipment and evaluated measurement uncertainty herein.

This report must not be used to claim product endorsement by CNLA, NVLAP, NIST or any agency of the Government.

The test report shall not be reproduced except in full without the written approval of QuieTek Corporation.

Test Report Certification

Issued Date : 2007/06/26
 Report No. : 076046R-ITUSP01V02



Product Name : NETWORK SHARING CAMERA
 Applicant : Hon Hai Precision Industry Co., Ltd. Nei-Hu Branch Office
 Address : 1~11 F., No.32, Ji-hu Rd., Nei-hu, Taipei 114, Taiwan, R.O.C.
 Manufacturer : Hon Hai Precision Industry Co., Ltd. Nei-Hu Branch Office
 Model No. : NSC-GC1
 Rated Voltage : AC 120 V / 60 Hz
 EUT Voltage : AC 120 V / 60 Hz
 Trade Name : SONY
 Applicable Standard : FCC CFR Title 47 Part 15 Subpart B: 2005 Class B,
 CISPR 22: 2005
 Test Result : Complied
 Performed Location : Hsinchu EMC Laboratory
 N0. 75-2, 3rd Lin, Wangye Keng, Yonghxing Tsuen, Qionglin
 Shiang, Hsinchu County 307, Taiwan, R.O.C.
 TEL:+886-3-592-8858 / FAX:+886-3-592-8859

Documented By : Carol Tsai
 (Carol Tsai / Engineering Adm. Specialist)
 Reviewed By : Gavin chen
 (Gavin Chen / Engineer)
 Approved By : Arthur Liu
 (Arthur Liu / Deputy Manager)

Laboratory Information

We , **Quietek Corporation**, are an independent EMC and safety consultancy that was established the whole facility in our laboratories. The test facility has been accredited by the following accreditation Bodies in compliance with ISO 17025, EN 45001 and Guide 25:

Taiwan R.O.C.	:	BSMI, DGT, CNLA
Germany	:	TUV Rheinland
Norway	:	Nemko, DNV
USA	:	FCC, NVLAP
Japan	:	VCCI

The related certificate for our laboratories about the test site and management system can be downloaded from Quietek Corporation's Web Site : <http://tw.quietek.com/modules/myalbum/>

The address and introduction of Quietek Corporation's laboratories can be founded in our Web site : <http://www.quietek.com/>

If you have any comments, Please don't hesitate to contact us. Our contact information is as below:

HsinChu Testing Laboratory :

No.75-2, 3rd Lin, Wangye Keng, Yonghxing Tsuen, Qionglin Shiang, Hsinchu County 307, Taiwan, R.O.C.

TEL:+886-3-592-8858 / FAX:+886-3-592-8859

E-Mail : service@quietek.com



LinKou Testing Laboratory :

No. 5, Ruei-Shu Valley, Ruei-Ping Tsuen, Lin-Kou Shiang, Taipei, Taiwan, R.O.C.

TEL : 886-2-8601-3788 / FAX : 886-2-8601-3789

E-Mail : service@quietek.com



TABLE OF CONTENTS

Description	Page
1. General Information	5
1.1. EUT Description	5
1.2. Mode of Operation	6
1.3. Tested System Details.....	7
1.4. Configuration of Tested System	8
1.5. EUT Exercise Software	9
2. Technical Test.....	10
2.1. Summary of Test Result	10
2.2. List of Test Equipment.....	10
2.3. Measurement Uncertainty	11
2.4. Test Environment	11
3. Conducted Emission	12
3.1. Test Specification	12
3.2. Test Setup	12
3.3. Limit.....	12
3.4. Test Procedure	13
3.5. Test Result	14
3.6. Test Photograph	18
4. Radiated Emission	19
4.1. Test Specification	19
4.2. Test Setup	19
4.3. Limit.....	20
4.4. Test Procedure	21
4.5. Test Result	22
4.6. Test Photograph	38
5. Attachment.....	46
EUT Photograph.....	46

1. General Information

1.1. EUT Description

Product Name	NETWORK SHARING CAMERA
Trade Name	SONY
Model No.	NSC-GC1

Component	
USB Cable	Shielded, 0.5m, one ferrite core bonded.
AV Cable	Non-Shielded, 1.6m, one ferrite core bonded.
Power Adapter	SONY, UPA-AC05 Cable Out: Non-Shielded, 1.9m, one ferrite core bonded. Power Cord: Non-Shielded, 1m

Note:

This EUT is a NETWORK SHARING CAMERA.

1.2. Mode of Operation

QuieTek has verified the construction and function in typical operation. All the test modes were carried out with the EUT in normal operation, which was shown in this test report and defined as:

Pre-Test Mode		
Mode 1: USB		
Mode 2: REC		
Mode 3: Preview		
Mode 4: Slide Show		
Final Test Mode		
Emission	Conducted Emission	Mode 2: REC
	Radiated Emission	Mode 1: USB Mode 2: REC Mode 3: Preview Mode 4: Slide Show

1.3. Tested System Details

The types for all equipments, plus descriptions of all cables used in the tested system (including inserted cards) are:

Product	Manufacturer	Model No.	Serial No.	FCC ID	Power Cord
1 Monitor	CHI MEI	A170E1-09	3UC120955SA1249	DoC	Non-Shielded, 1.8m
2 Notebook PC	DELL	PP10L	3Y220	E2K24BN HM	Non-Shielded, 1.8m
3 Digital 8 (D8)	SONY	DCR-TRV110	P35209	DoC	--
4 Microphone & Earphone	Ronald	MOE060	N/A	DoC	--
5 USB 2.0 Flash Memory	Ridata	PEN000-DP065-23	N/A	DoC	--
6 Modem	ACEEX	DM-1414	0102027545	DoC	Non-Shielded, 1.6m
7 Monitor	SONY	PVM-14M2U	2111376	DoC	Non-Shielded, 1.8m
8 Printer	HP	C2642A	TH86M1M34W	DoC	Non-Shielded, 0.7m

1.4. Configuration of Tested System

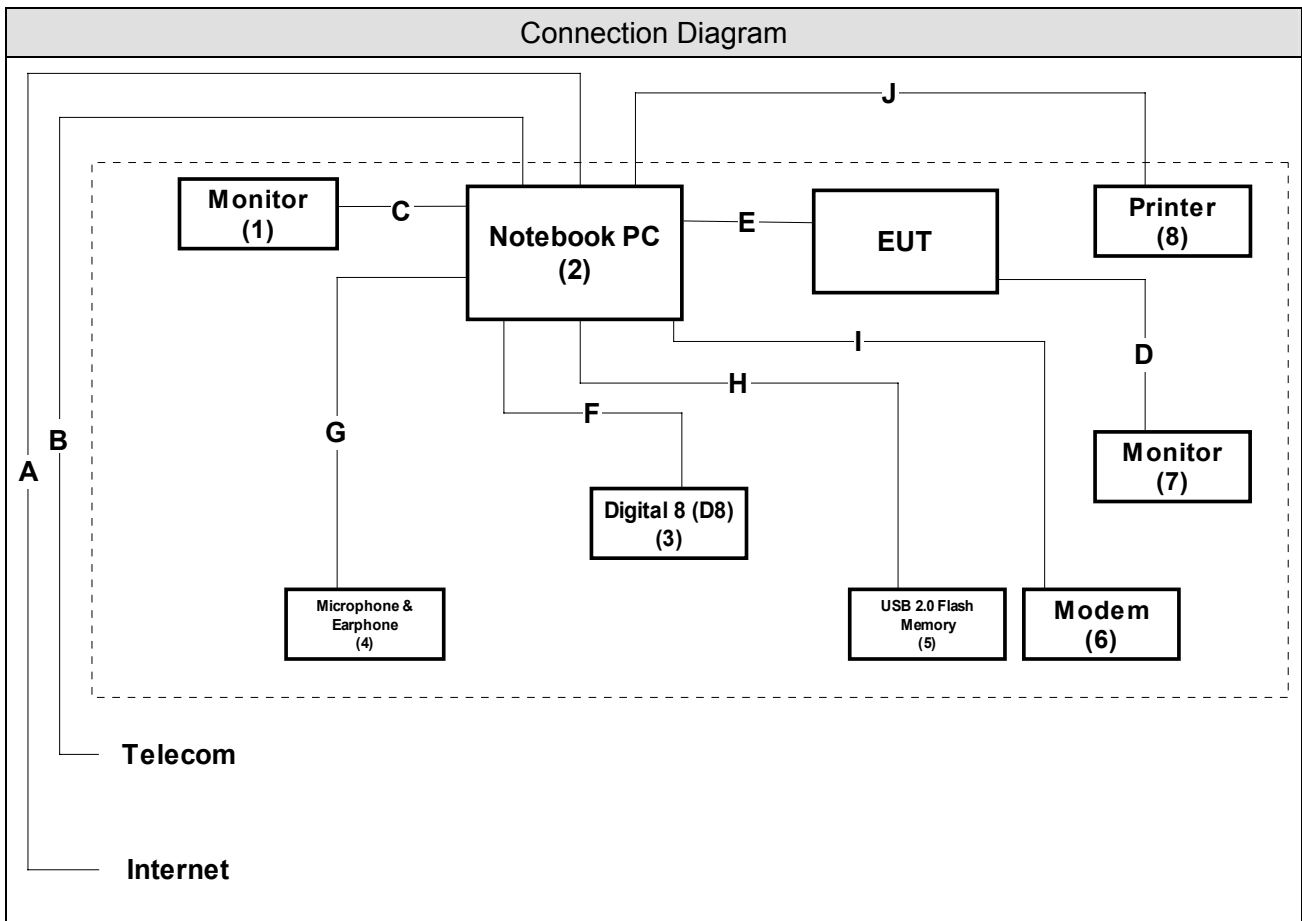

Signal Cable Type	Signal cable Description	Interface
A	LAN Cable	Non-Shielded, 10m LAN Port
B	Telecom Cable	Non-Shielded, 10m Telecom Port
C	VGA Cable	Shielded, 1.6m, two ferrite cores bonded VGA Port
D	AV Cable	Non-Shielded, 1.6m, one ferrite core bonded AV Port
E	USB Cable	Shielded, 0.5m, one ferrite cores bonded USB Port
F	1394 Cable	Shielded, 0.6m 1394 Port
G	Microphone & Earphone Cable	Non-Shielded, 2.2m Earphone Port
H	USB 2.0 Flash Memory Cable	Shielded, 1.5m USB Port
I	Modem Cable	Shielded, 1.5m RS232 Port
J	Printer Cable	Shielded, 1.2m Printer Port

2. Technical Test

2.1. Summary of Test Result

- No deviations from the test standards
 Deviations from the test standards as below description:

Emission			
Performed Item	Normative References	Test Performed	Deviation
Conducted Emission	FCC CFR Title 47 Part 15 Subpart B: 2005 Class B, CISPR 22: 2005, ANSI C63.4: 2003	Yes	No
Radiated Emission	FCC CFR Title 47 Part 15 Subpart B: 2005 Class B, CISPR 22: 2005, ANSI C63.4: 2003	Yes	No

2.2. List of Test Equipment

Conducted Emission / SR3

Instrument	Manufacturer	Type No.	Serial No	Cal. Date
4-Wire ISN	R & S	ENY 41	837032/001	2007/04/15
Double 2-Wire ISN	R & S	ENY 22	835354/008	2007/04/15
LISN	R&S	ESH3-Z5	836679/022	2006/06/17
LISN	R & S	ESH3-Z5	836679/013	2006/12/30
Pulse Limiter	R & S	ESH3-Z2	100411	2006/11/16
Test Receiver	R & S	ESCS 30	100149	2006/11/15

Radiated Emission / Site2

Instrument	Manufacturer	Type No.	Serial No	Cal. Date
Bilog Antenna	Schaffner Chase	CBL6112B	2708	2006/09/03
Horn Antenna	Electro Metrics	EM-6961	103325	2007/03/15
Pre-Amplifier	HP	8449B	3008A01123	2006/11/15
Pre-Amplifier	QuieTek	AP-025C	002	N/A
Spectrum Analyzer	R & S	FSP40	100005	2006/08/25
Spectrum Analyzer	Advantest	R3162	121200166	2007/02/19
Test Receiver	R & S	ESCS 30	836858/023	2007/04/01

2.3. Measurement Uncertainty

Conducted Emission

The measurement uncertainty is evaluated as ± 2.26 dB.

Radiated Emission

The measurement uncertainty is evaluated as ± 3.19 dB.

2.4. Test Environment

Performed Item	Items	Required	Actual
Conducted Emission	Temperature (°C)	15-35	25
	Humidity (%RH)	25-75	50
	Barometric pressure (mbar)	860-1060	950-1000
Radiated Emission	Temperature (°C)	15-35	25
	Humidity (%RH)	25-75	65
	Barometric pressure (mbar)	860-1060	950-1000

3. Conducted Emission

3.1. Test Specification

According to Standard: FCC Part 15 Subpart B, ANSI C63.4

3.2. Test Setup

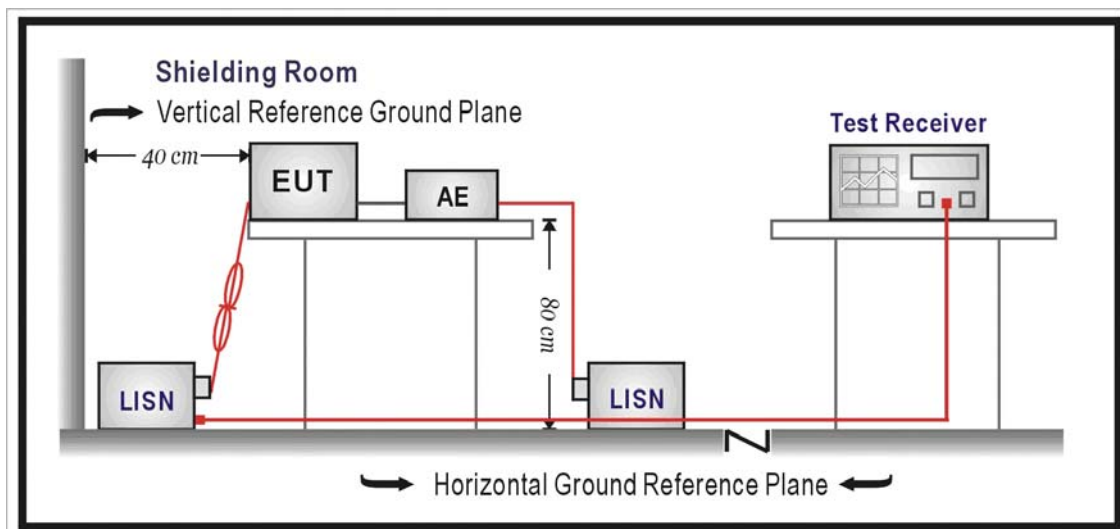

3.3. Limit

Limits		
Frequency (MHz)	QP (dBuV)	AV (dBuV)
0.15 - 0.50	66 - 56	56 - 46
0.50-5.0	56	46
5.0 - 30	60	50

Remarks: In the above table, the tighter limit applies at the band edges.

3.4. Test Procedure

The EUT and simulators are connected to the main power through a line impedance stabilization network (L.I.S.N.). This provides a 50 ohm /50uH coupling impedance for the measuring equipment. The peripheral devices are also connected to the main power through a LISN that provides a 50ohm/50uH coupling impedance with 50ohm termination.

(Please refers to the block diagram of the test setup and photographs.)

Both sides of A.C. line are checked for maximum conducted interference. In order to find the maximum emission, the relative positions of equipment and all of the interface cables must be changed on conducted measurement.

Conducted emissions were invested over the frequency range from 0.15MHz to 30MHz using a receiver bandwidth of 9kHz.

3.5. Test Result

Site : Quietek Shielding Room3	Time : 2007/06/05 - 00:07
Limit : CISPR_B_00M_QP	Margin : 0
EUT : NETWORK SHARING CAMERA	Probe : SR3_LISN(16A) - Line1
Power : AC 120V/60Hz	Note : Mode 2: REC

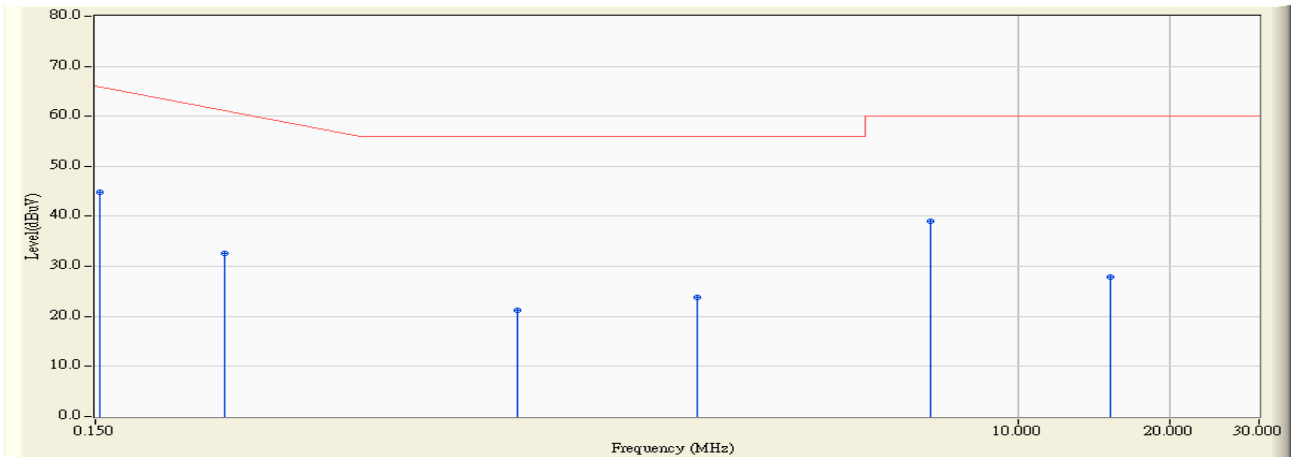

	Frequency (MHz)	Correct Factor (dB)	Reading Level (dBuV)	Measure Level (dBuV)	Margin (dB)	Limit (dBuV)	Detector Type
1	0.153	0.138	44.650	44.788	-21.126	65.914	QUASIPeAK
2	0.271	0.167	32.340	32.507	-30.036	62.543	QUASIPeAK
3	1.026	0.230	21.060	21.290	-34.710	56.000	QUASIPeAK
4	2.330	0.400	23.470	23.870	-32.130	56.000	QUASIPeAK
5	* 6.713	0.570	38.430	39.000	-21.000	60.000	QUASIPeAK
6	15.232	0.869	27.080	27.948	-32.052	60.000	QUASIPeAK

Note:

1. All Reading Levels are Quasi-Peak and average value.
2. " * ", means this data is the worst emission level.
3. Measurement Level = Reading Level + Correct Factor.

Site : Quietek Shielding Room3	Time : 2007/06/05 - 00:07
Limit : CISPR_B_00M_AV	Margin : 0
EUT : NETWORK SHARING CAMERA	Probe : SR3_LISN(16A) - Line1
Power : AC 120V/60Hz	Note : Mode 2: REC

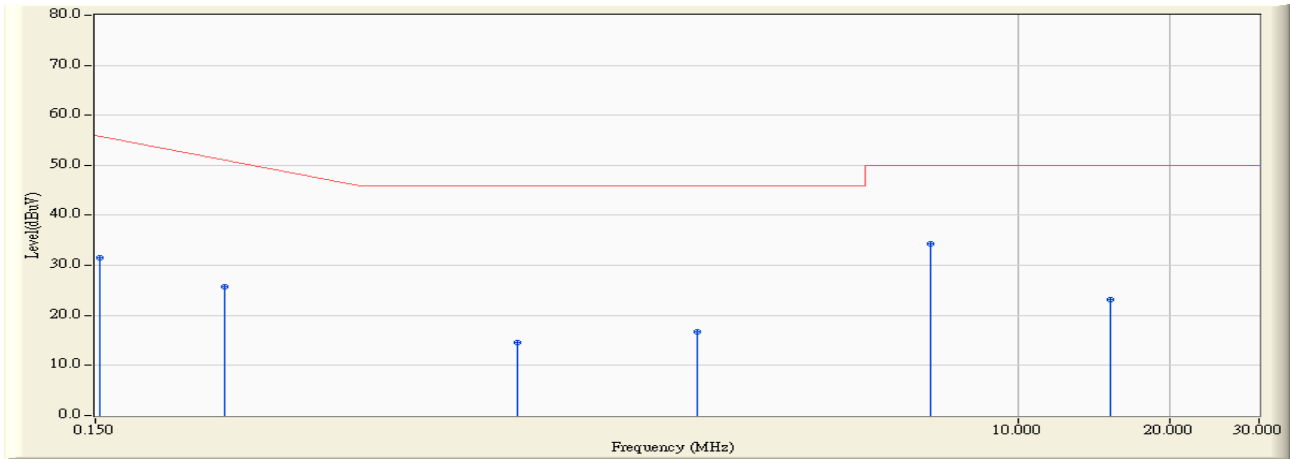

		Frequency (MHz)	Correct Factor (dB)	Reading Level (dBuV)	Measure Level (dBuV)	Margin (dB)	Limit (dBuV)	Detector Type
1		0.153	0.138	31.410	31.548	-24.366	55.914	AVERAGE
2		0.271	0.167	25.470	25.637	-26.906	52.543	AVERAGE
3		1.026	0.230	14.430	14.660	-31.340	46.000	AVERAGE
4		2.330	0.400	16.320	16.720	-29.280	46.000	AVERAGE
5	*	6.713	0.570	33.830	34.400	-15.600	50.000	AVERAGE
6		15.232	0.869	22.280	23.148	-26.852	50.000	AVERAGE

Note:

1. All Reading Levels are Quasi-Peak and average value.
2. " * ", means this data is the worst emission level.
3. Measurement Level = Reading Level + Correct Factor.

Site : Quietek Shielding Room3	Time : 2007/06/05 - 00:13
Limit : CISPR_B_00M_QP	Margin : 0
EUT : NETWORK SHARING CAMERA	Probe : SR3_LISN(16A) - Line2
Power : AC 120V/60Hz	Note : Mode 2: REC

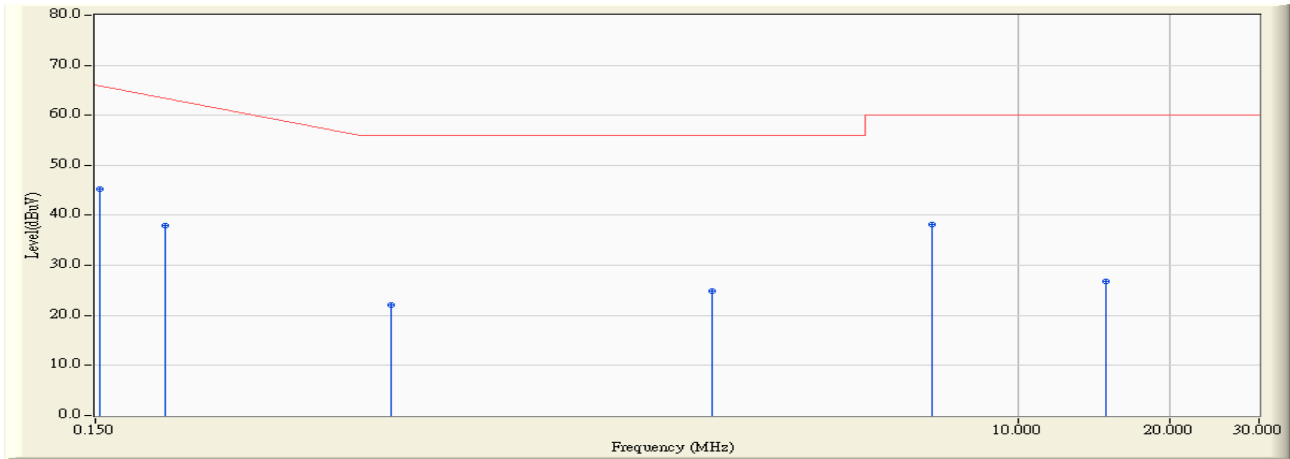

		Frequency (MHz)	Correct Factor (dB)	Reading Level (dBuV)	Measure Level (dBuV)	Margin (dB)	Limit (dBuV)	Detector Type
1	*	0.153	0.138	45.090	45.228	-20.686	65.914	QUASIPeAK
2		0.206	0.156	37.700	37.856	-26.544	64.400	QUASIPeAK
3		0.575	0.210	21.780	21.990	-34.010	56.000	QUASIPeAK
4		2.490	0.400	24.470	24.870	-31.130	56.000	QUASIPeAK
5		6.787	0.530	37.560	38.090	-21.910	60.000	QUASIPeAK
6		14.920	0.860	26.010	26.870	-33.130	60.000	QUASIPeAK

Note:

1. All Reading Levels are Quasi-Peak and average value.
2. " * ", means this data is the worst emission level.
3. Measurement Level = Reading Level + Correct Factor.

Site : Quietek Shielding Room3	Time : 2007/06/05 - 00:13
Limit : CISPR_B_00M_AV	Margin : 0
EUT : NETWORK SHARING CAMERA	Probe : SR3_LISN(16A) - Line2
Power : AC 120V/60Hz	Note : Mode 2: REC

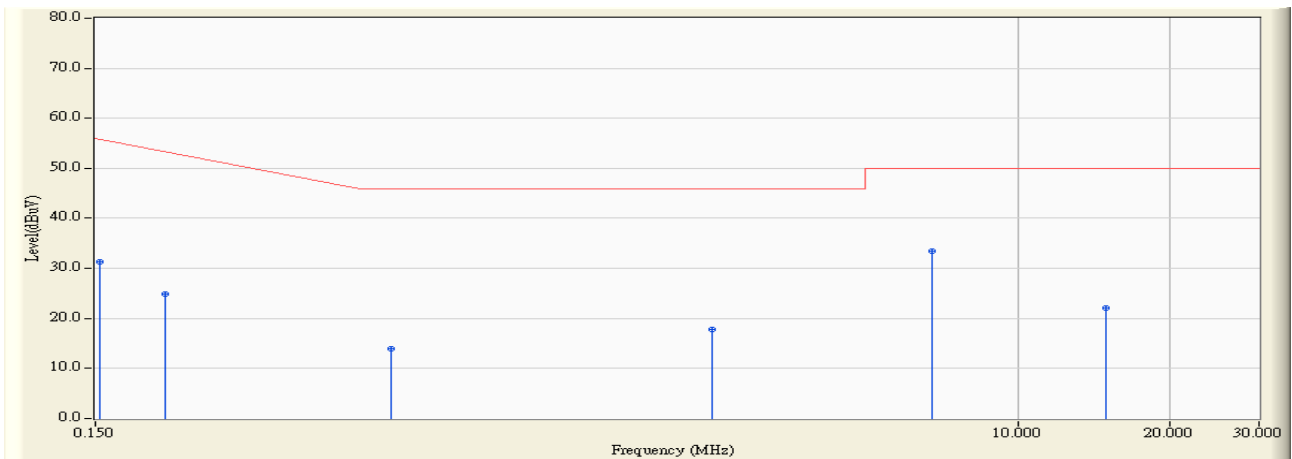

		Frequency (MHz)	Correct Factor (dB)	Reading Level (dBuV)	Measure Level (dBuV)	Margin (dB)	Limit (dBuV)	Detector Type
1		0.153	0.138	31.280	31.418	-24.496	55.914	AVERAGE
2		0.206	0.156	24.650	24.806	-29.594	54.400	AVERAGE
3		0.575	0.210	13.650	13.860	-32.140	46.000	AVERAGE
4		2.490	0.400	17.340	17.740	-28.260	46.000	AVERAGE
5	*	6.787	0.530	32.980	33.510	-16.490	50.000	AVERAGE
6		14.920	0.860	21.280	22.140	-27.860	50.000	AVERAGE

Note:

1. All Reading Levels are Quasi-Peak and average value.
2. " * ", means this data is the worst emission level.
3. Measurement Level = Reading Level + Correct Factor.

4. Radiated Emission

4.1. Test Specification

According to EMC Standard: FCC Part 15 Subpart B, ANSI C63.4

4.2. Test Setup

Under 1GHz Test Setup:

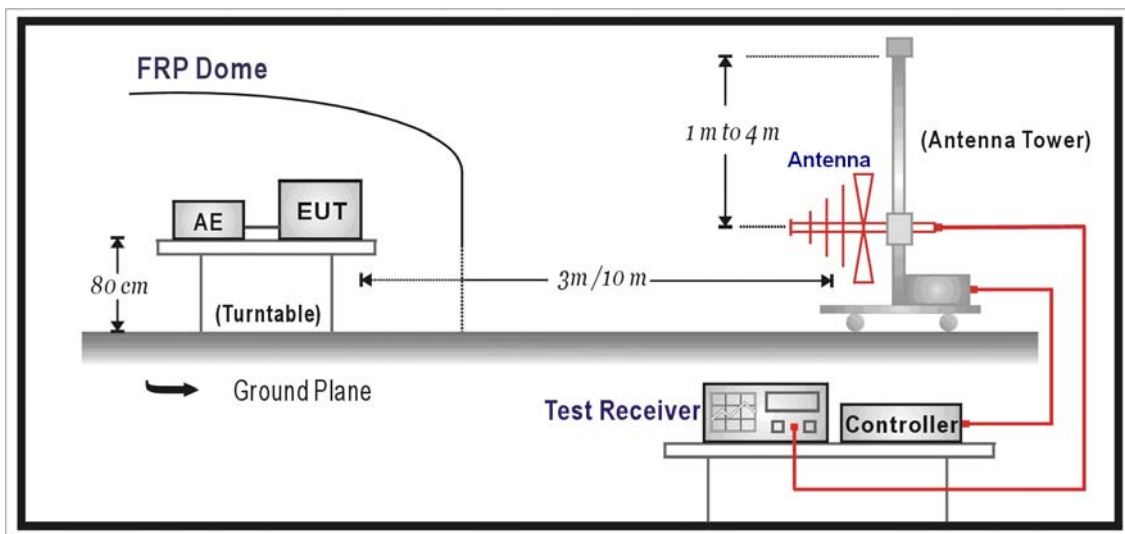

Above 1GHz Test Setup:

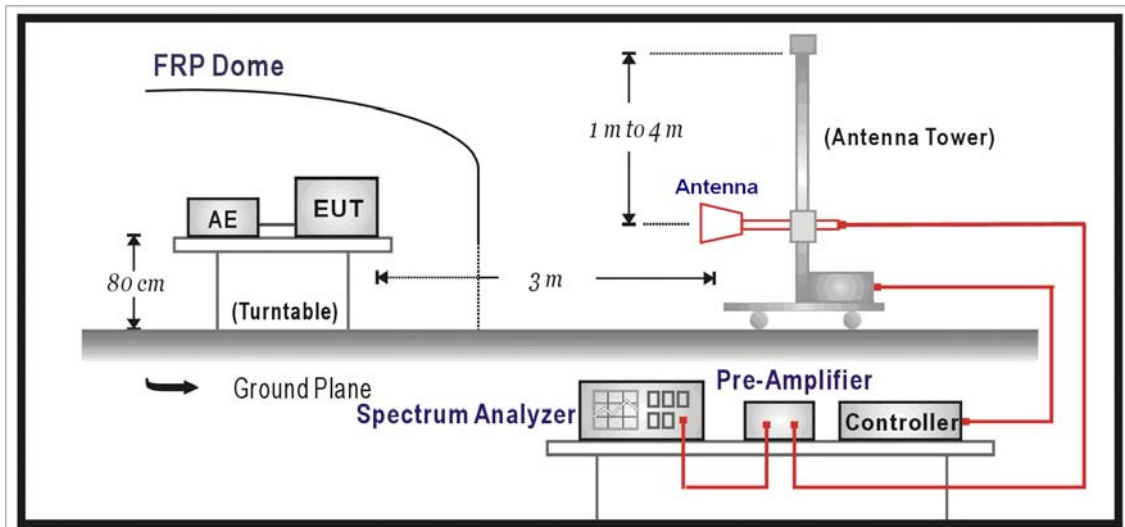

4.3. Limit

FCC Part 15 Subpart B Paragraph 15.109 Limits (dBuV/m)		
Frequency (MHz)	Distance (m)	dBuV/m
30-88	3	40
88-216	3	43.5
216-960	3	46
Above 960	3	54

Remark:

1. The tighter limit shall apply at the edge between two frequency bands.
2. Distance refers to the distance in meters between the measuring instrument antenna and the closed point of any part of the device or system.
3. RF Voltage (dBuV/m) = 20 log RF Voltage (uV/m)

4.4. Test Procedure

The EUT and its simulators are placed on a turn table which is 0.8 meter above ground.

The turn table can rotate 360 degrees to determine the position of the maximum emission level and the antenna can move up and down between 1 meter and 4 meters to find out the maximum emission level.

Both horizontal and vertical polarization of the antenna are set on measurement. In order to find the maximum emission, all of the interface cables must be manipulated on radiated measurement.

For an unintentional radiator, including a digital device, the spectrum shall be investigated from the lowest radio frequency signal generated or used in the device, without going below the lowest frequency for which a radiated emission limit is specified, up to the frequency shown in the following table:

Highest frequency generated or used in the device or on which the device operates or tunes (MHz)	Upper frequency of measurement range (MHz)
Below 1.705	30
1.705 – 108	1000
108 – 500	2000
500 – 1000	5000
Above 1000	5 th harmonic of the highest frequency or 40 GHz, whichever is lower

On any frequency or frequencies below or equal to 1000 MHz, the radiated limits shown are based on measuring equipment employing a quasi-peak detector function and above 1000 MHz, the radiated limits shown are based measuring equipment employing an average detector function.

When average radiated emission measurement are included emission measurement Above 1000 MHz, there also is a limit on the radio frequency emissions, as measured using instrumentation with a peak detector function, corresponding to 20 dB above the maximum permitted average limit.

For class A, the measurement distance between the EUT and antenna is 10 meters for under 1GHz and above 1GHz.

For class B, the measurement distance between the EUT and antenna is 3 meters for under 1GHz and 3 meters for above 1GHz.

The bandwidth below 1GHz setting on the field strength meter (R&S Test Receiver ESCS 30) is 120 kHz and above 1GHz is 1MHz.

4.5. Test Result

Site : Site 2	Time : 2007/06/05 - 11:50
Limit : FCC_CLASS_B_03M_QP	Margin : 6
EUT : NETWORK SHARING CAMERA	Probe : PRO 06-03-29 ST2 - HORIZONTAL
Power : AC 120V/60Hz	Note : Mode 1: USB

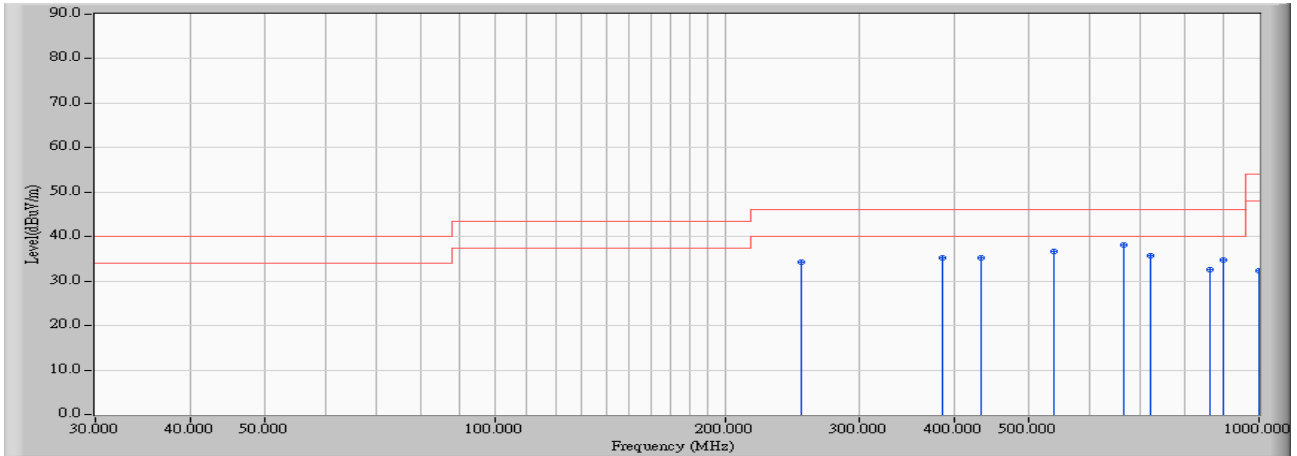

	Frequency (MHz)	Correct Factor (dB)	Reading Level (dBuV)	Measure Level (dBuV/m)	Margin (dB)	Limit (dBuV/m)	Detector Type
1	252.000	14.641	19.540	34.180	-11.820	46.000	QUASIPeAK
2	386.000	18.549	16.700	35.249	-10.751	46.000	QUASIPeAK
3	432.000	18.665	16.660	35.325	-10.675	46.000	QUASIPeAK
4	540.000	20.501	16.140	36.641	-9.359	46.000	QUASIPeAK
5	* 664.625	22.663	15.380	38.043	-7.957	46.000	QUASIPeAK
6	720.000	24.554	11.250	35.804	-10.196	46.000	QUASIPeAK
7	864.000	24.920	7.640	32.560	-13.440	46.000	QUASIPeAK
8	900.000	26.520	8.210	34.730	-11.270	46.000	QUASIPeAK
9	998.275	26.988	5.310	32.298	-21.702	54.000	QUASIPeAK

Note:

1. All Reading Levels are Quasi-Peak value.
2. “ * ”, means this data is the worst emission level.
3. Measurement Level = Reading Level + Correct Factor.

Site : Site 2	Time : 2007/06/26 - 10:14
Limit : FCC_B_(Above_1G)_3M_PEAK	Margin : 6
EUT : NETWORK SHARING CAMERA	Probe : FCC_RF_1G-18G(2005-3) - HORIZONTAL
Power : AC 120V/60Hz	Note : Mode 1: USB

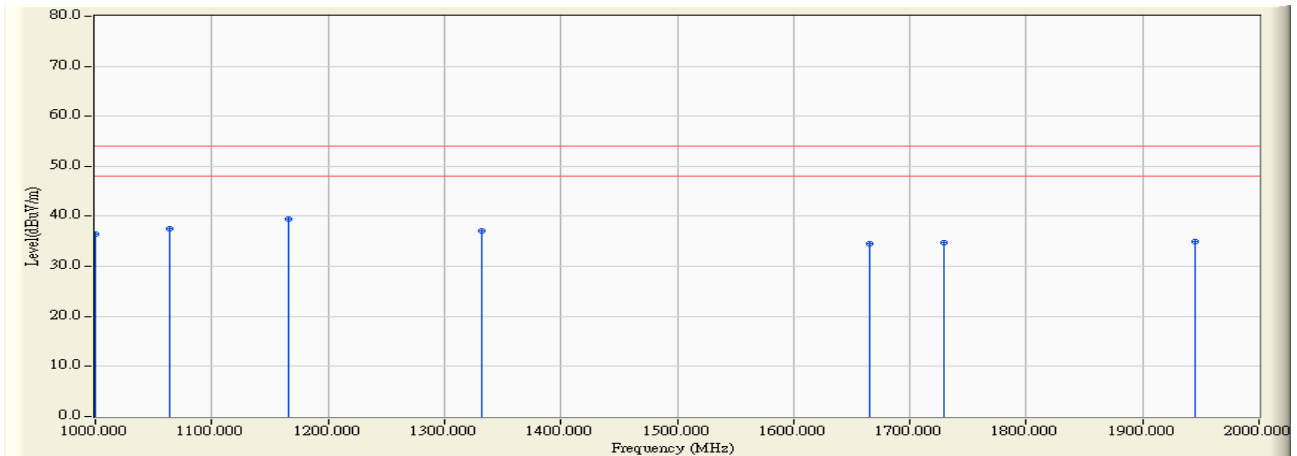

	Frequency (MHz)	Correct Factor (dB)	Reading Level (dBuV)	Measure Level (dBuV/m)	Margin (dB)	Limit (dBuV/m)	Detector Type
1	1000.000	-13.470	50.000	36.530	-17.470	54.000	PEAK
2	1064.000	-9.724	47.320	37.596	-16.404	54.000	PEAK
3	* 1166.000	-9.286	48.830	39.545	-14.455	54.000	PEAK
4	1332.000	-8.701	45.770	37.068	-16.932	54.000	PEAK
5	1665.000	-7.640	42.080	34.440	-19.560	54.000	PEAK
6	1729.000	-7.021	41.690	34.669	-19.331	54.000	PEAK
7	1945.000	-4.824	39.790	34.966	-19.034	54.000	PEAK

Note:

1. All Readings below 1GHz are Quasi-Peak, above are performed with peak and/or average measurements as necessary.
2. “ * ”, means this data is the worst emission level.
3. Measurement Level = Reading Level + Correct Factor.
4. The average measurement was not performed when the peak measured data under the limit of average detection. If the readings given are average, peak measurement should also be supplied.

Site : Site 2	Time : 2007/06/05 - 11:40
Limit : FCC_CLASS_B_03M_QP	Margin : 6
EUT : NETWORK SHARING CAMERA	Probe : PRO 06-03-29 ST2 - VERTICAL
Power : AC 120V/60Hz	Note : Mode 1: USB

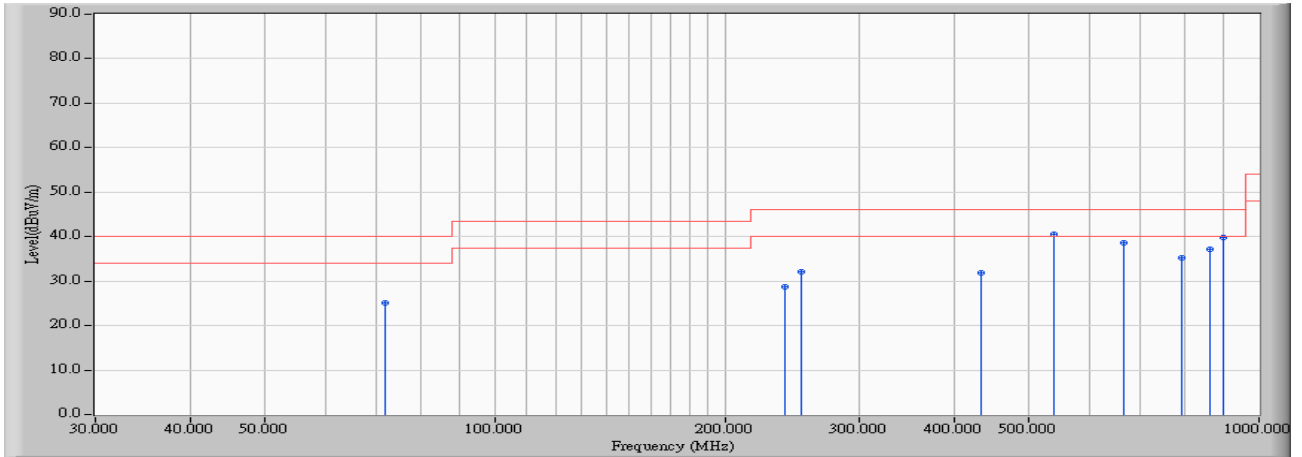

	Frequency (MHz)	Correct Factor (dB)	Reading Level (dBuV)	Measure Level (dBuV/m)	Margin (dB)	Limit (dBuV/m)	Detector Type
1	72.000	10.155	15.050	25.205	-14.795	40.000	QUASIPeAK
2	240.000	14.740	13.990	28.730	-17.270	46.000	QUASIPeAK
3	252.000	15.209	16.820	32.028	-13.972	46.000	QUASIPeAK
4	432.000	16.366	15.540	31.906	-14.094	46.000	QUASIPeAK
5 *	540.000	22.608	18.010	40.617	-5.383	46.000	QUASIPeAK
6	664.625	20.528	18.120	38.648	-7.352	46.000	QUASIPeAK
7	792.000	21.035	14.310	35.344	-10.656	46.000	QUASIPeAK
8	864.000	25.383	11.850	37.233	-8.767	46.000	QUASIPeAK
9	900.000	25.318	14.450	39.768	-6.232	46.000	QUASIPeAK

Note:

1. All Reading Levels are Quasi-Peak value.
2. “ * ”, means this data is the worst emission level.
3. Measurement Level = Reading Level + Correct Factor.

Site : Site 2	Time : 2007/06/26 - 10:18
Limit : FCC_B_(Above_1G)_3M_PEAK	Margin : 6
EUT : NETWORK SHARING CAMERA	Probe : FCC_RF_1G-18G(2005-3) - VERTICAL
Power : AC 120V/60Hz	Note : Mode 1: USB

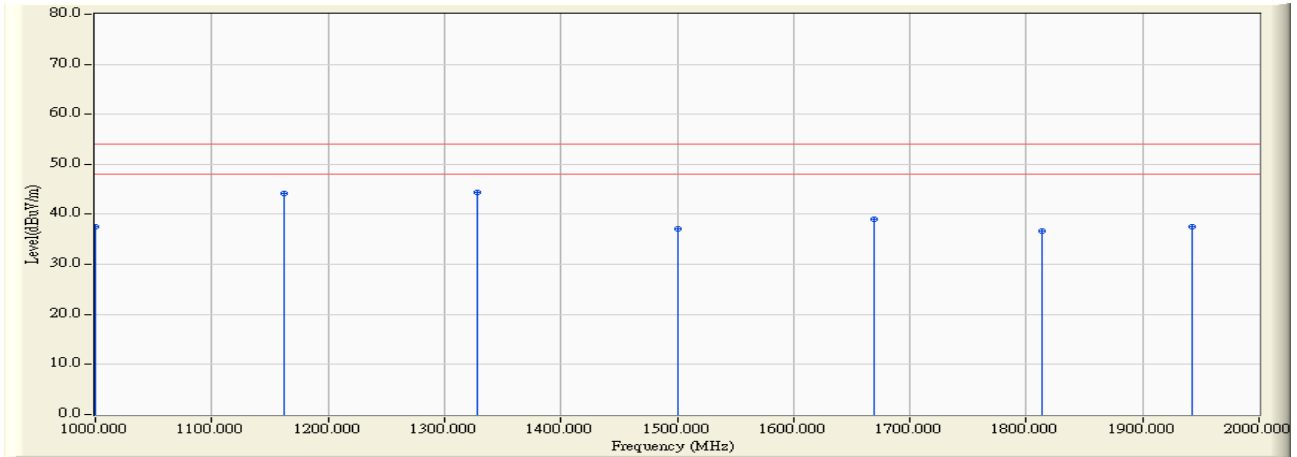

	Frequency (MHz)	Correct Factor (dB)	Reading Level (dBuV)	Measure Level (dBuV/m)	Margin (dB)	Limit (dBuV/m)	Detector Type
1	1000.000	-13.470	50.920	37.450	-16.550	54.000	PEAK
2	1162.000	-8.480	52.570	44.089	-9.911	54.000	PEAK
3	* 1328.000	-7.888	52.390	44.502	-9.498	54.000	PEAK
4	1501.000	-7.314	44.420	37.106	-16.894	54.000	PEAK
5	1669.000	-6.799	45.750	38.950	-15.050	54.000	PEAK
6	1813.000	-6.032	42.660	36.628	-17.372	54.000	PEAK
7	1943.000	-5.748	43.340	37.592	-16.408	54.000	PEAK

Note:

1. All Readings below 1GHz are Quasi-Peak, above are performed with peak and/or average measurements as necessary.
2. “ * ”, means this data is the worst emission level.
3. Measurement Level = Reading Level + Correct Factor.
4. The average measurement was not performed when the peak measured data under the limit of average detection. If the readings given are average, peak measurement should also be supplied.

Site : Site 2	Time : 2007/06/05 - 10:05
Limit : FCC_CLASS_B_03M_QP	Margin : 6
EUT : NETWORK SHARING CAMERA	Probe : PRO 06-03-29 ST2 - HORIZONTAL
Power : AC 120V/60Hz	Note : Mode 2: REC

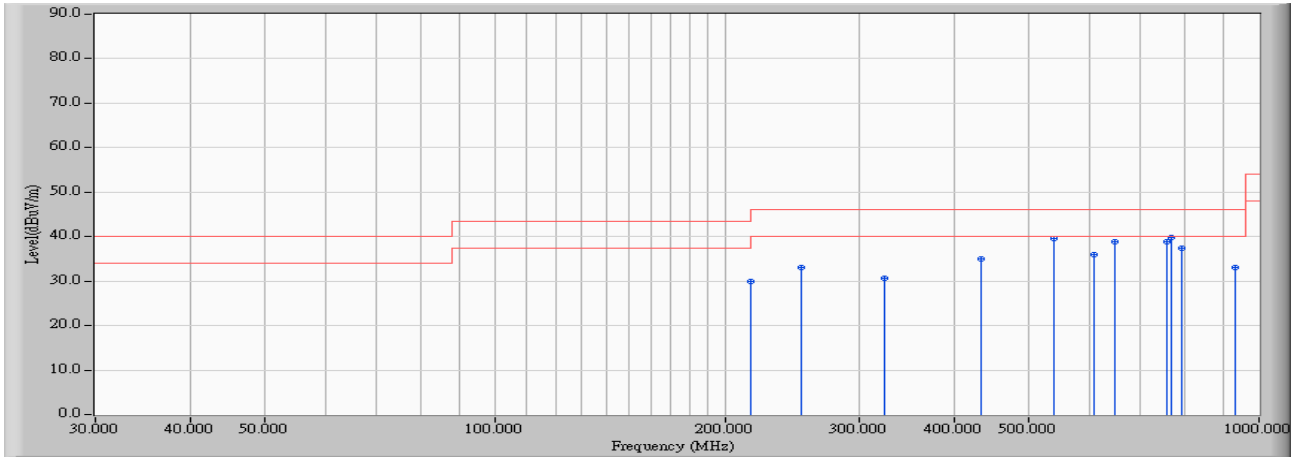

	Frequency (MHz)	Correct Factor (dB)	Reading Level (dBuV)	Measure Level (dBuV/m)	Margin (dB)	Limit (dBuV/m)	Detector Type
1	216.000	11.873	17.950	29.822	-13.678	43.500	QUASIPeAK
2	252.000	14.641	18.450	33.090	-12.910	46.000	QUASIPeAK
3	324.000	16.991	13.600	30.591	-15.409	46.000	QUASIPeAK
4	432.000	18.665	16.370	35.035	-10.965	46.000	QUASIPeAK
5	540.000	20.501	18.950	39.451	-6.549	46.000	QUASIPeAK
6	607.500	21.766	14.260	36.026	-9.974	46.000	QUASIPeAK
7	648.000	24.192	14.570	38.762	-7.238	46.000	QUASIPeAK
8	756.000	23.057	15.690	38.747	-7.253	46.000	QUASIPeAK
9	* 769.500	24.146	15.760	39.905	-6.095	46.000	QUASIPeAK
10	792.000	22.764	14.540	37.304	-8.696	46.000	QUASIPeAK
11	931.500	27.406	5.600	33.006	-12.994	46.000	QUASIPeAK

Note:

1. All Reading Levels are Quasi-Peak value.
2. “ * ”, means this data is the worst emission level.
3. Measurement Level = Reading Level + Correct Factor.

Site : Site 2	Time : 2007/06/26 - 09:46
Limit : FCC_B_(Above_1G)_3M_PEAK	Margin : 6
EUT : NETWORK SHARING CAMERA	Probe : FCC_RF_1G-18G(2005-3) - HORIZONTAL
Power : AC 120V/60Hz	Note : Mode 2: REC

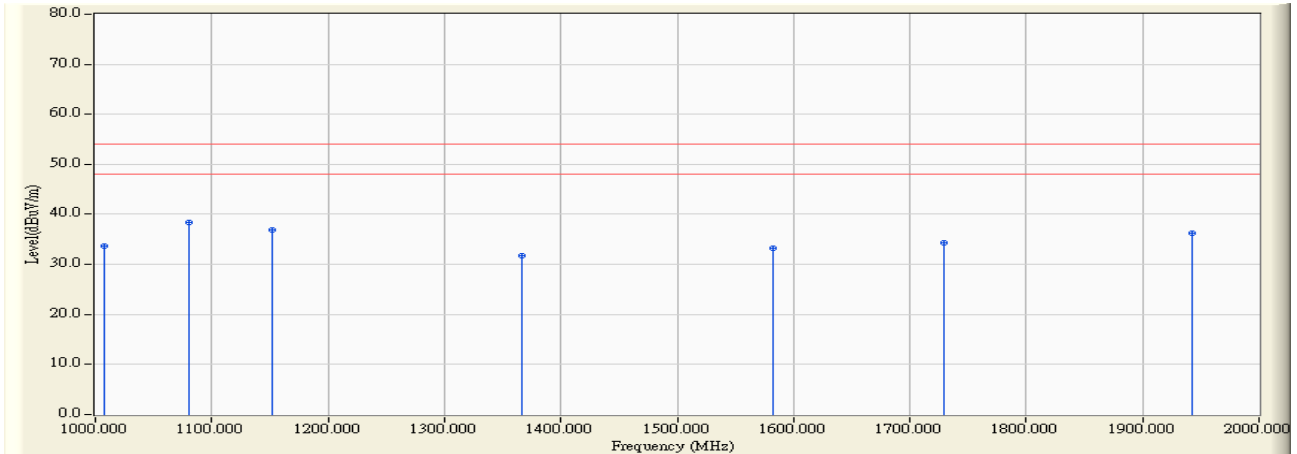

		Frequency (MHz)	Correct Factor (dB)	Reading Level (dBuV)	Measure Level (dBuV/m)	Margin (dB)	Limit (dBuV/m)	Detector Type
1		1008.000	-11.828	45.530	33.702	-20.298	54.000	PEAK
2	*	1080.000	-9.658	48.000	38.342	-15.658	54.000	PEAK
3		1152.000	-9.277	46.060	36.783	-17.217	54.000	PEAK
4		1366.000	-8.620	40.320	31.699	-22.301	54.000	PEAK
5		1583.000	-7.790	40.990	33.200	-20.800	54.000	PEAK
6		1729.000	-7.021	41.420	34.399	-19.601	54.000	PEAK
7		1943.000	-4.839	41.020	36.181	-17.819	54.000	PEAK

Note:

1. All Readings below 1GHz are Quasi-Peak, above are performed with peak and/or average measurements as necessary.
2. “ * ”, means this data is the worst emission level.
3. Measurement Level = Reading Level + Correct Factor.
4. The average measurement was not performed when the peak measured data under the limit of average detection. If the readings given are average, peak measurement should also be supplied.

Site : Site 2	Time : 2007/06/05 - 09:52
Limit : FCC_CLASS_B_03M_QP	Margin : 6
EUT : NETWORK SHARING CAMERA	Probe : PRO 06-03-29 ST2 - VERTICAL
Power : AC 120V/60Hz	Note : Mode 2: REC

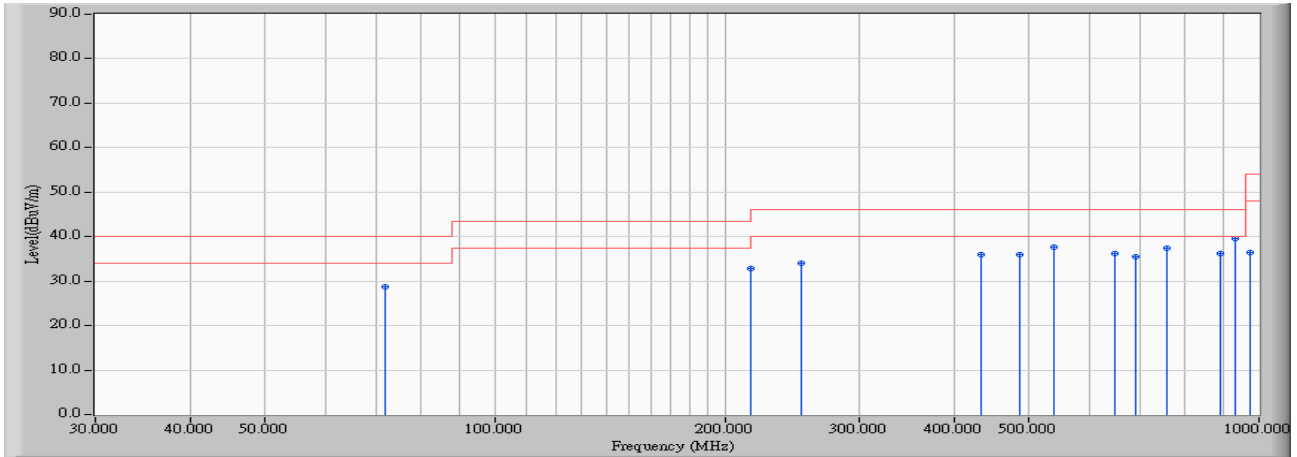

	Frequency (MHz)	Correct Factor (dB)	Reading Level (dBuV)	Measure Level (dBuV/m)	Margin (dB)	Limit (dBuV/m)	Detector Type
1	72.000	10.155	18.470	28.625	-11.375	40.000	QUASIPeAK
2	216.000	11.779	20.950	32.728	-10.772	43.500	QUASIPeAK
3	252.000	15.209	18.910	34.118	-11.882	46.000	QUASIPeAK
4	432.000	16.366	19.580	35.946	-10.054	46.000	QUASIPeAK
5	486.000	21.331	14.540	35.871	-10.129	46.000	QUASIPeAK
6	540.000	22.608	15.040	37.647	-8.353	46.000	QUASIPeAK
7	648.000	22.144	13.960	36.104	-9.896	46.000	QUASIPeAK
8	688.500	22.774	12.730	35.504	-10.496	46.000	QUASIPeAK
9	756.000	21.630	15.650	37.280	-8.720	46.000	QUASIPeAK
10	891.000	25.801	10.410	36.211	-9.789	46.000	QUASIPeAK
11	* 931.500	26.411	13.200	39.611	-6.389	46.000	QUASIPeAK
12	972.000	26.123	10.220	36.344	-17.656	54.000	QUASIPeAK

Note:

1. All Reading Levels are Quasi-Peak value.
2. “ * ”, means this data is the worst emission level.
3. Measurement Level = Reading Level + Correct Factor.

Site : Site 2	Time : 2007/06/26 - 09:51
Limit : FCC_B_(Above_1G)_3M_PEAK	Margin : 6
EUT : NETWORK SHARING CAMERA	Probe : FCC_RF_1G-18G(2005-3) - VERTICAL
Power : AC 120V/60Hz	Note : Mode 2: REC

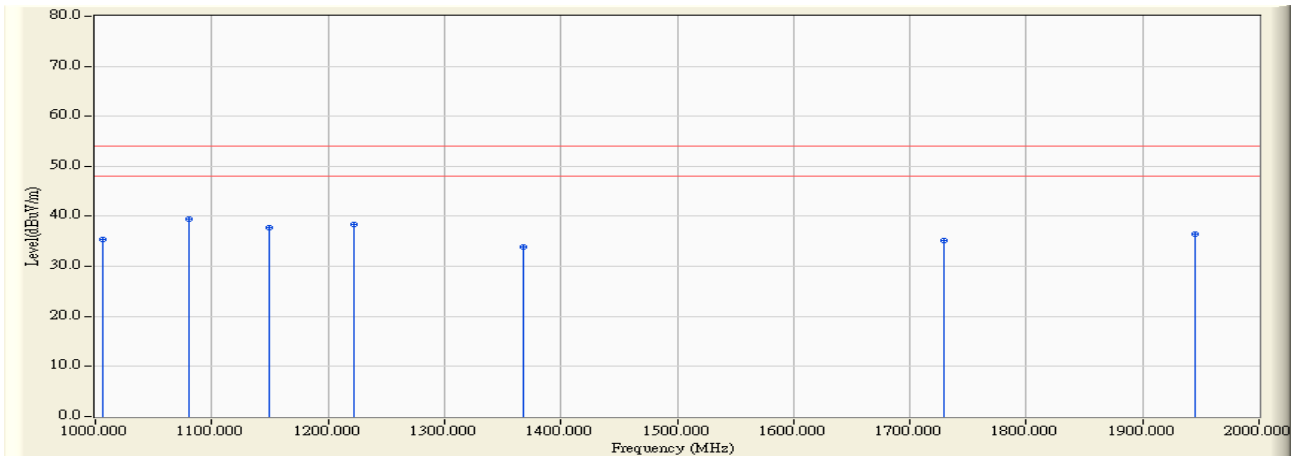

		Frequency (MHz)	Correct Factor (dB)	Reading Level (dBuV)	Measure Level (dBuV/m)	Margin (dB)	Limit (dBuV/m)	Detector Type
1		1006.000	-11.964	47.260	35.297	-18.703	54.000	PEAK
2	*	1080.000	-8.858	48.300	39.442	-14.558	54.000	PEAK
3		1150.000	-8.491	46.180	37.689	-16.311	54.000	PEAK
4		1222.000	-8.641	47.030	38.389	-15.611	54.000	PEAK
5		1368.000	-7.822	41.640	33.817	-20.183	54.000	PEAK
6		1729.000	-6.221	41.460	35.239	-18.761	54.000	PEAK
7		1945.000	-5.757	42.140	36.383	-17.617	54.000	PEAK

Note:

1. All Readings below 1GHz are Quasi-Peak, above are performed with peak and/or average measurements as necessary.
2. “ * ”, means this data is the worst emission level.
3. Measurement Level = Reading Level + Correct Factor.
4. The average measurement was not performed when the peak measured data under the limit of average detection. If the readings given are average, peak measurement should also be supplied.

Site : Site 2	Time : 2007/06/05 - 10:32
Limit : FCC_CLASS_B_03M_QP	Margin : 6
EUT : NETWORK SHARING CAMERA	Probe : PRO 06-03-29 ST2 - HORIZONTAL
Power : AC 120V/60Hz	Note : Mode 3: Preview

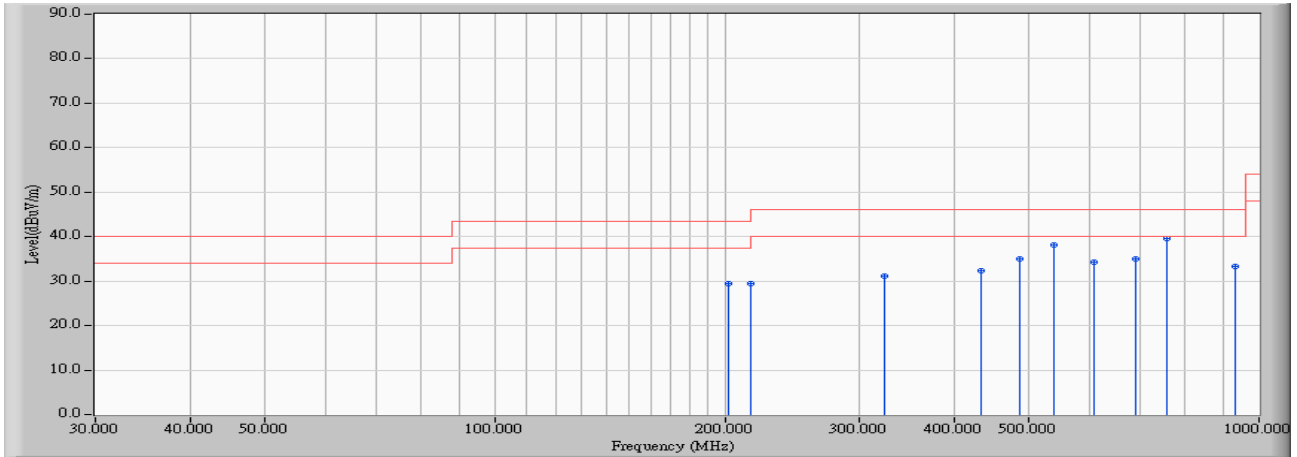

	Frequency (MHz)	Correct Factor (dB)	Reading Level (dBuV)	Measure Level (dBuV/m)	Margin (dB)	Limit (dBuV/m)	Detector Type
1	202.500	12.841	16.670	29.511	-13.989	43.500	QUASIPeAK
2	216.000	11.873	17.680	29.552	-13.948	43.500	QUASIPeAK
3	324.000	16.991	14.200	31.191	-14.809	46.000	QUASIPeAK
4	432.000	18.665	13.600	32.265	-13.735	46.000	QUASIPeAK
5	486.000	19.923	15.130	35.053	-10.947	46.000	QUASIPeAK
6	540.000	20.501	17.540	38.041	-7.959	46.000	QUASIPeAK
7	607.500	21.766	12.600	34.366	-11.634	46.000	QUASIPeAK
8	688.500	24.127	10.900	35.026	-10.974	46.000	QUASIPeAK
9	* 756.000	23.057	16.590	39.647	-6.353	46.000	QUASIPeAK
10	931.500	27.406	5.980	33.386	-12.614	46.000	QUASIPeAK

Note:

1. All Reading Levels are Quasi-Peak value.
2. “ * ”, means this data is the worst emission level.
3. Measurement Level = Reading Level + Correct Factor.

Site : Site 2	Time : 2007/06/26 - 09:39
Limit : FCC_B_(Above_1G)_3M_PEAK	Margin : 6
EUT : NETWORK SHARING CAMERA	Probe : FCC_RF_1G-18G(2005-3) - HORIZONTAL
Power : AC 120V/60Hz	Note : Mode 3: Preview

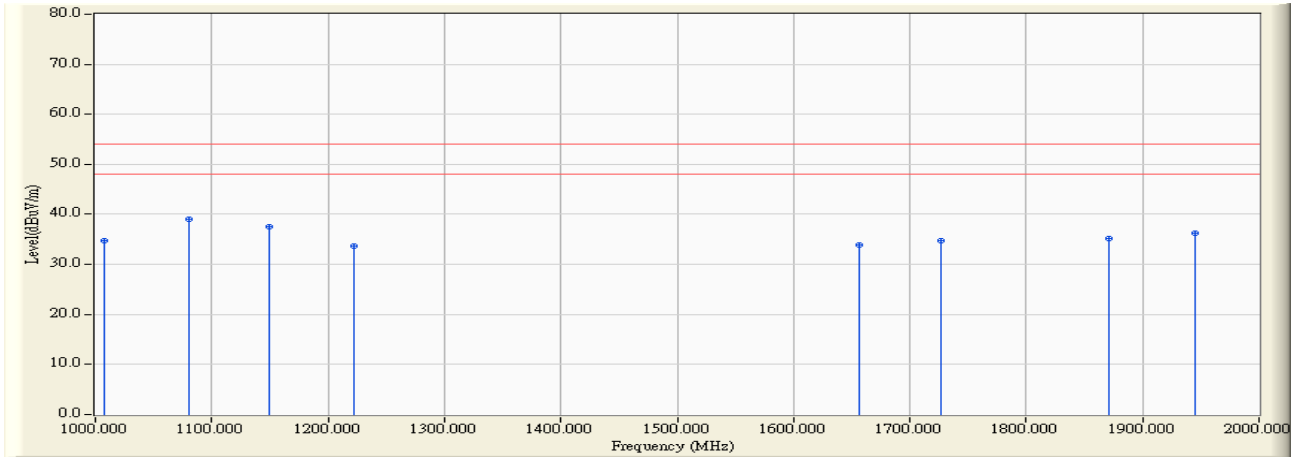

		Frequency (MHz)	Correct Factor (dB)	Reading Level (dBuV)	Measure Level (dBuV/m)	Margin (dB)	Limit (dBuV/m)	Detector Type
1		1008.000	-11.828	46.600	34.772	-19.228	54.000	PEAK
2	*	1080.000	-9.658	48.620	38.962	-15.038	54.000	PEAK
3		1150.000	-9.291	46.790	37.499	-16.501	54.000	PEAK
4		1222.000	-9.441	43.210	33.769	-20.231	54.000	PEAK
5		1657.000	-7.625	41.560	33.935	-20.065	54.000	PEAK
6		1727.000	-7.062	41.890	34.828	-19.172	54.000	PEAK
7		1871.000	-6.266	41.470	35.205	-18.795	54.000	PEAK
8		1945.000	-4.824	41.150	36.326	-17.674	54.000	PEAK

Note:

1. All Readings below 1GHz are Quasi-Peak, above are performed with peak and/or average measurements as necessary.
2. “ * ”, means this data is the worst emission level.
3. Measurement Level = Reading Level + Correct Factor.
4. The average measurement was not performed when the peak measured data under the limit of average detection. If the readings given are average, peak measurement should also be supplied.

Site : Site 2	Time : 2007/06/05 - 10:20
Limit : FCC_CLASS_B_03M_QP	Margin : 6
EUT : NETWORK SHARING CAMERA	Probe : PRO 06-03-29 ST2 - VERTICAL
Power : AC 120V/60Hz	Note : Mode 3: Preview

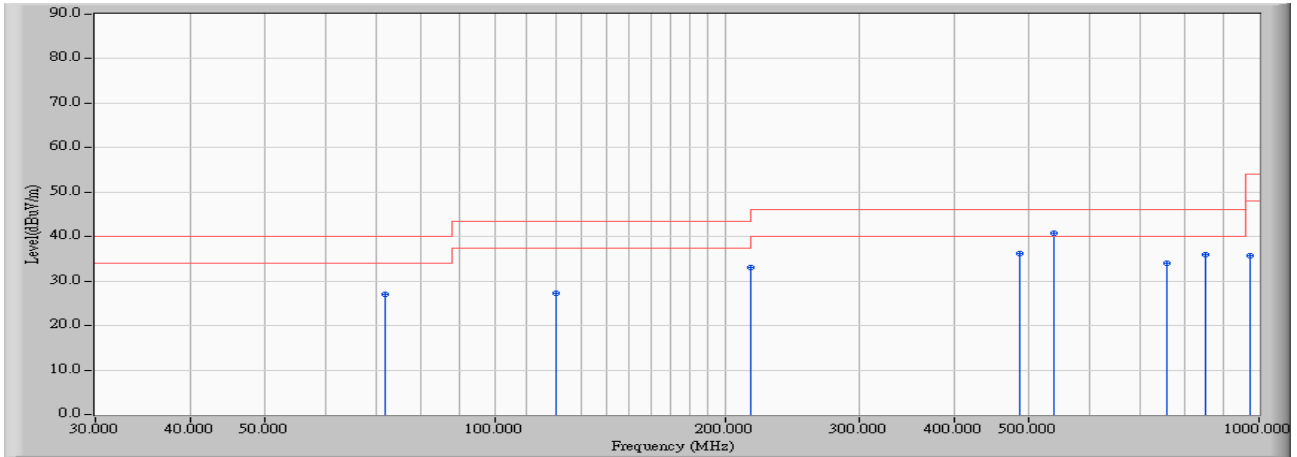

	Frequency (MHz)	Correct Factor (dB)	Reading Level (dBuV)	Measure Level (dBuV/m)	Margin (dB)	Limit (dBuV/m)	Detector Type
1	72.000	10.155	16.760	26.915	-13.085	40.000	QUASIPeAK
2	120.000	13.662	13.600	27.262	-16.238	43.500	QUASIPeAK
3	216.000	11.779	21.250	33.028	-10.472	43.500	QUASIPeAK
4	486.000	21.331	14.890	36.221	-9.779	46.000	QUASIPeAK
5	* 540.000	22.608	18.150	40.757	-5.243	46.000	QUASIPeAK
6	756.000	21.630	12.420	34.050	-11.950	46.000	QUASIPeAK
7	850.500	25.090	10.900	35.990	-10.010	46.000	QUASIPeAK
8	972.000	26.123	9.630	35.754	-18.246	54.000	QUASIPeAK

Note:

1. All Reading Levels are Quasi-Peak value.
2. “ * ”, means this data is the worst emission level.
3. Measurement Level = Reading Level + Correct Factor.

Site : Site 2	Time : 2007/06/26 - 09:35
Limit : FCC_B_(Above_1G)_3M_PEAK	Margin : 6
EUT : NETWORK SHARING CAMERA	Probe : FCC_RF_1G-18G(2005-3) - VERTICAL
Power : AC 120V/60Hz	Note : Mode 3: Preview

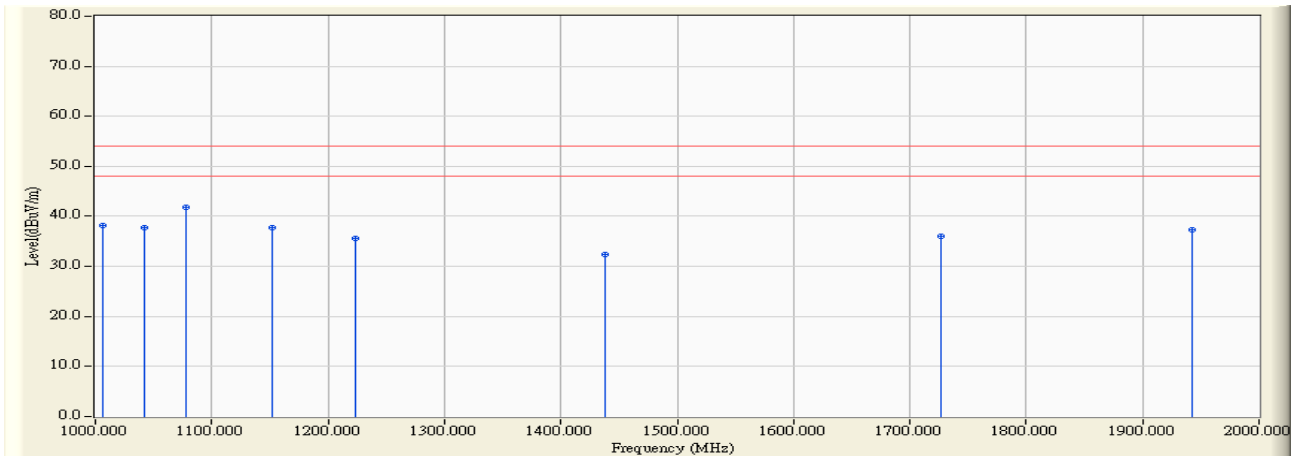

		Frequency (MHz)	Correct Factor (dB)	Reading Level (dBuV)	Measure Level (dBuV/m)	Margin (dB)	Limit (dBuV/m)	Detector Type
1		1006.000	-11.964	50.210	38.247	-15.753	54.000	PEAK
2		1042.000	-8.973	46.710	37.736	-16.264	54.000	PEAK
3	*	1078.000	-8.864	50.620	41.755	-12.245	54.000	PEAK
4		1152.300	-8.475	46.280	37.805	-16.195	54.000	PEAK
5		1224.000	-8.601	44.270	35.668	-18.332	54.000	PEAK
6		1438.000	-7.710	40.000	32.289	-21.711	54.000	PEAK
7		1727.000	-6.262	42.400	36.138	-17.862	54.000	PEAK
8		1943.000	-5.748	43.100	37.352	-16.648	54.000	PEAK

Note:

1. All Readings below 1GHz are Quasi-Peak, above are performed with peak and/or average measurements as necessary.
2. “ * ”, means this data is the worst emission level.
3. Measurement Level = Reading Level + Correct Factor.
4. The average measurement was not performed when the peak measured data under the limit of average detection. If the readings given are average, peak measurement should also be supplied.

Site : Site 2	Time : 2007/06/05 - 10:57
Limit : FCC_CLASS_B_03M_QP	Margin : 6
EUT : NETWORK SHARING CAMERA	Probe : PRO 06-03-29 ST2 - HORIZONTAL
Power : AC 120V/60Hz	Note : Mode 4: Slide Show

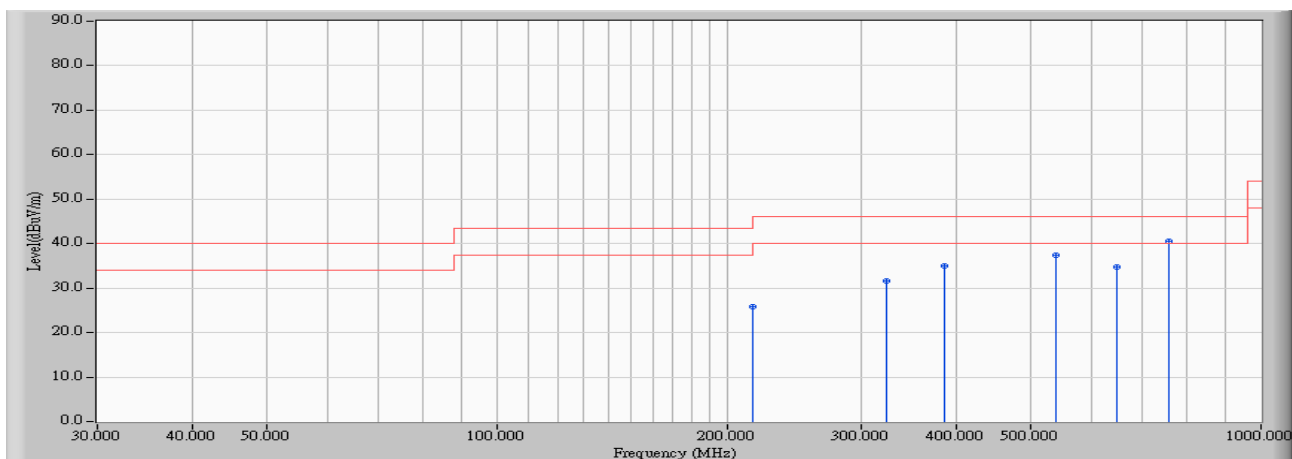

		Frequency (MHz)	Correct Factor (dB)	Reading Level (dBuV)	Measure Level (dBuV/m)	Margin (dB)	Limit (dBuV/m)	Detector Type
1		216.000	11.873	14.030	25.902	-17.598	43.500	QUASIPeAK
2		324.000	16.991	14.690	31.681	-14.319	46.000	QUASIPeAK
3		386.000	18.549	16.540	35.089	-10.911	46.000	QUASIPeAK
4		540.000	20.501	16.930	37.431	-8.569	46.000	QUASIPeAK
5		648.000	24.192	10.560	34.752	-11.248	46.000	QUASIPeAK
6	*	756.000	23.057	17.500	40.557	-5.443	46.000	QUASIPeAK

Note:

1. All Reading Levels are Quasi-Peak value.
2. “ * ”, means this data is the worst emission level.
3. Measurement Level = Reading Level + Correct Factor.

Site : Site 2	Time : 2007/06/26 - 10:06
Limit : FCC_B_(Above_1G)_3M_PEAK	Margin : 6
EUT : NETWORK SHARING CAMERA	Probe : FCC_RF_1G-18G(2005-3) - HORIZONTAL
Power : AC 120V/60Hz	Note : Mode 4: Slide Show

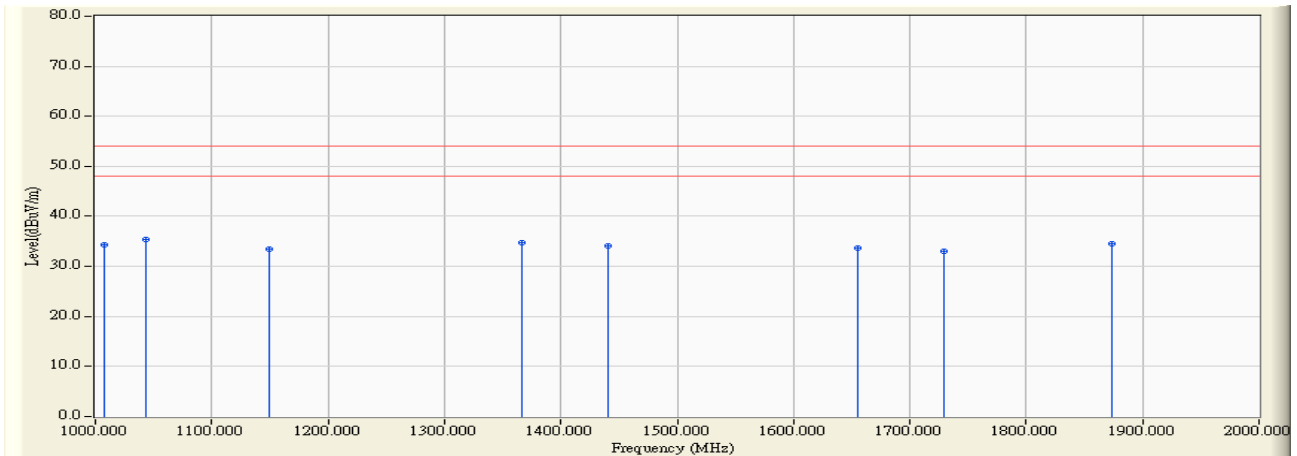

		Frequency (MHz)	Correct Factor (dB)	Reading Level (dBuV)	Measure Level (dBuV/m)	Margin (dB)	Limit (dBuV/m)	Detector Type
1		1008.000	-11.828	46.160	34.332	-19.668	54.000	PEAK
2	*	1044.000	-9.857	45.260	35.402	-18.598	54.000	PEAK
3		1150.000	-9.291	42.720	33.429	-20.571	54.000	PEAK
4		1366.000	-8.620	43.260	34.639	-19.361	54.000	PEAK
5		1440.000	-8.516	42.520	34.005	-19.995	54.000	PEAK
6		1655.000	-7.613	41.310	33.697	-20.303	54.000	PEAK
7		1729.000	-7.021	40.000	32.979	-21.021	54.000	PEAK
8		1873.000	-6.243	40.670	34.427	-19.573	54.000	PEAK

Note:

1. All Readings below 1GHz are Quasi-Peak, above are performed with peak and/or average measurements as necessary.
2. “ * ”, means this data is the worst emission level.
3. Measurement Level = Reading Level + Correct Factor.
4. The average measurement was not performed when the peak measured data under the limit of average detection. If the readings given are average, peak measurement should also be supplied.

Site : Site 2	Time : 2007/06/05 - 10:48
Limit : FCC_CLASS_B_03M_QP	Margin : 6
EUT : NETWORK SHARING CAMERA	Probe : PRO 06-03-29 ST2 - VERTICAL
Power : AC 120V/60Hz	Note : Mode 4: Slide Show

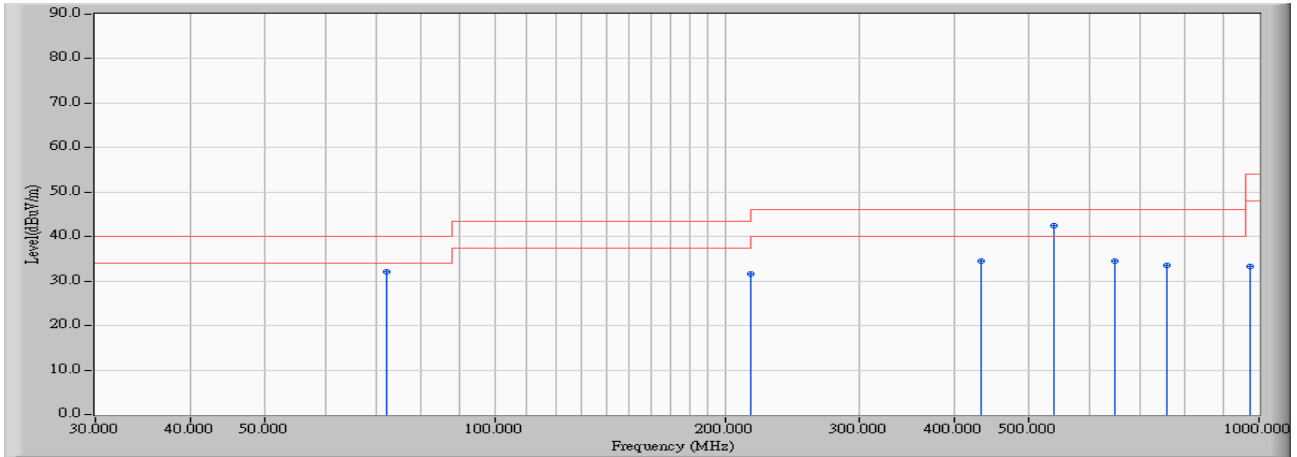

	Frequency (MHz)	Correct Factor (dB)	Reading Level (dBuV)	Measure Level (dBuV/m)	Margin (dB)	Limit (dBuV/m)	Detector Type
1	72.300	9.993	22.160	32.154	-7.846	40.000	QUASIPeAK
2	216.000	11.779	19.720	31.498	-12.002	43.500	QUASIPeAK
3	432.000	16.366	18.100	34.466	-11.534	46.000	QUASIPeAK
4	* 540.000	22.608	19.840	42.447	-3.553	46.000	QUASIPeAK
5	648.000	22.144	12.370	34.514	-11.486	46.000	QUASIPeAK
6	756.000	21.630	11.950	33.580	-12.420	46.000	QUASIPeAK
7	972.000	26.123	7.200	33.324	-20.676	54.000	QUASIPeAK

Note:

1. All Reading Levels are Quasi-Peak value.
2. “ * ”, means this data is the worst emission level.
3. Measurement Level = Reading Level + Correct Factor.

Site : Site 2	Time : 2007/06/26 - 10:01
Limit : FCC_B_(Above_1G)_3M_PEAK	Margin : 6
EUT : NETWORK SHARING CAMERA	Probe : FCC_RF_1G-18G(2005-3) - VERTICAL
Power : AC 120V/60Hz	Note : Mode 4: Slide Show

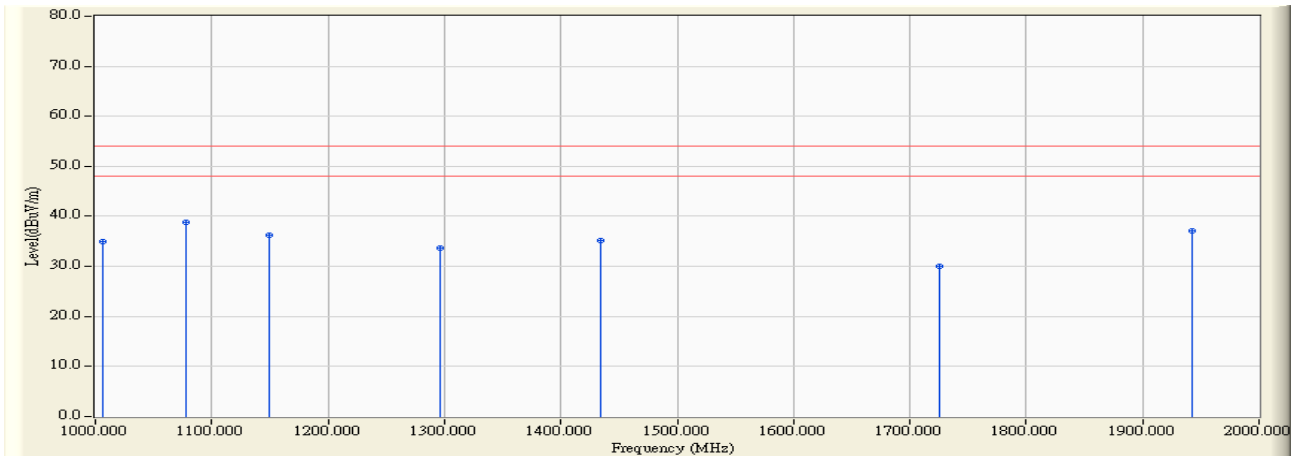

		Frequency (MHz)	Correct Factor (dB)	Reading Level (dBuV)	Measure Level (dBuV/m)	Margin (dB)	Limit (dBuV/m)	Detector Type
1		1006.000	-11.964	46.980	35.017	-18.983	54.000	PEAK
2	*	1078.000	-8.864	47.650	38.785	-15.215	54.000	PEAK
3		1150.000	-8.491	44.800	36.309	-17.691	54.000	PEAK
4		1296.000	-8.056	41.650	33.594	-20.406	54.000	PEAK
5		1434.000	-7.701	42.940	35.239	-18.761	54.000	PEAK
6		1725.000	-6.304	36.430	30.126	-23.874	54.000	PEAK
7		1943.000	-5.748	42.760	37.012	-16.988	54.000	PEAK

Note:

1. All Readings below 1GHz are Quasi-Peak, above are performed with peak and/or average measurements as necessary.
2. “ * ”, means this data is the worst emission level.
3. Measurement Level = Reading Level + Correct Factor.
4. The average measurement was not performed when the peak measured data under the limit of average detection. If the readings given are average, peak measurement should also be supplied.