



## Test Report

Product Name : Digital Still Camera

Model No. : DSC-S800

FCC ID : TVRDSCS800

Applicant : Hon Hai Precision Industry Co., Ltd. Nei-Hu Branch Office

Address : 1~11 F., No.32, Ji-hu Rd., Nei-hu, Taipei 114, Taiwan,  
R.O.C.

Date of Receipt : 2007/02/07

Issued Date : 2007/03/02

Report No. : 072H034-ITUSP01V02

The test results relate only to the samples tested.

The test results shown in the test report are traceable to the national/international standard through the calibration of the equipment and evaluated measurement uncertainty herein.

This report must not be used to claim product endorsement by CNLA, NVLAP, NIST or any agency of the Government.

The test report shall not be reproduced except in full without the written approval of QuieTek Corporation.

# Test Report Certification

Issued Date : 2007/03/02  
 Report No. : 072H034-ITUSP01V02



Product Name : Digital Still Camera  
 Applicant : Hon Hai Precision Industry Co., Ltd. Nei-Hu Branch Office  
 Address : 1~11 F., No.32, Ji-hu Rd., Nei-hu, Taipei 114, Taiwan, R.O.C.  
 Manufacturer : Hon Hai Precision Industry Co., Ltd. Nei-Hu Branch Office  
 Model No. : DSC-S800  
 Rated Voltage : AC 120 V / 60 Hz  
 EUT Voltage : AC 120 V / 60 Hz  
 Trade Name : SONY  
 Applicable Standard : FCC CFR Title 47 Part 15 Subpart B: 2005 Class B,  
 CISPR 22: 2005  
 Test Result : Complied  
 Performed Location : Hsinchu EMC Laboratory  
 N0. 75-2, 3rd Lin, Wangye Keng, Yonghxing Tsuen, Qionglin  
 Shiang, Hsinchu County 307, Taiwan, R.O.C.  
 TEL:+886-3-592-8858 / FAX:+886-3-592-8859

Documented By : Demi Chang  
 ( Demi Chang )  
 Reviewed By : hornet Liu  
 ( Hornet Liu )  
 Approved By : Arthur Liu  
 ( Arthur Liu )

## Laboratory Information

We , **Quietek Corporation**, are an independent EMC and safety consultancy that was established the whole facility in our laboratories. The test facility has been accredited by the following accreditation Bodies in compliance with ISO 17025, EN 45001 and Guide 25:

Taiwan R.O.C.	: BSMI, DGT, CNLA
Germany	: TÜV Rheinland
Norway	: Nemko, DNV
USA	: FCC, NVLAP
Japan	: VCCI

The related certificate for our laboratories about the test site and management system can be downloaded from Quietek Corporation's Web Site : <http://tw.quietek.com/modules/myalbum/>

The address and introduction of Quietek Corporation's laboratories can be founded in our Web site : <http://www.quietek.com/>

If you have any comments, Please don't hesitate to contact us. Our contact information is as below:

### HsinChu Testing Laboratory :

No.75-2, 3rd Lin, Wangye Keng, Yonghxing Tsuen, Qionglin Shiang, Hsinchu County 307, Taiwan, R.O.C.

TEL:+886-3-592-8858 / FAX:+886-3-592-8859

E-Mail : [service@quietek.com](mailto:service@quietek.com)



### LinKou Testing Laboratory :

No. 5, Ruei-Shu Valley, Ruei-Ping Tsuen, Lin-Kou Shiang, Taipei, Taiwan, R.O.C.

TEL : 886-2-8601-3788 / FAX : 886-2-8601-3789

E-Mail : [service@quietek.com](mailto:service@quietek.com)



**TABLE OF CONTENTS**

Description	Page
1. General Information .....	5
1.1. EUT Description .....	5
1.2. Mode of Operation .....	6
1.3. Tested System Details.....	7
1.4. Configuration of Tested System .....	8
1.5. EUT Exercise Software .....	10
2. Technical Test.....	11
2.1. Summary of Test Result .....	11
2.2. List of Test Equipment.....	11
2.3. Measurement Uncertainty .....	12
2.4. Test Environment .....	12
3. Conducted Emission .....	13
3.1. Test Specification .....	13
3.2. Test Setup .....	13
3.3. Limit.....	13
3.4. Test Procedure .....	14
3.5. Test Result .....	15
3.6. Test Photograph .....	19
4. Radiated Emission .....	20
4.1. Test Specification .....	20
4.2. Test Setup .....	20
4.3. Limit.....	21
4.4. Test Procedure .....	22
4.5. Test Result .....	23
4.6. Test Photograph .....	39
5. Attachment.....	47
EUT Photograph.....	47

## 1. General Information

### 1.1. EUT Description

Product Name	Digital Still Camera
Trade Name	SONY
Model No.	DSC-S800
Max Resolution	8.1 Mega Pixels

Component	
USB Cable	Shielded, 1.5m, one ferrite core bonded.
AV Cable	Non-Shielded, 1.5m, one ferrite core bonded.
Battery Cable	Non-Shielded, 0.15m
Power Adapter	SONY, AC-LS5 Cable Out: Non-Shielded, 1.8m Power Cord: Non-Shielded, 1m

**Note:**

This EUT is a Digital Still Camera.

## 1.2. Mode of Operation

Quietek has verified the construction and function in typical operation. All the test modes were carried out with the EUT in normal operation, which was shown in this test report and defined as:

Pre-Test Mode		
Mode 1: Slide Show		
Mode 2: REC		
Mode 3: USB LCD on		
Mode 4: Preview		
Final Test Mode		
Emission	Conducted Emission	Mode 3: USB LCD on
	Radiated Emission	Mode 1: Slide Show Mode 2: REC Mode 3: USB LCD on Mode 4: Preview

### 1.3. Tested System Details

The types for all equipments, plus descriptions of all cables used in the tested system (including inserted cards) are:

Test Mode		Mode 1: Slide Show Mode 2: REC Mode 4: Preview				
Product		Manufacturer	Model No.	Serial No.	FCC ID	Power Cord
1	Monitor	SONY	PVM-14M2U	2013141	DoC	Non-Shielded, 1.8m

Test Mode		Mode 3: USB LCD on				
Product		Manufacturer	Model No.	Serial No.	FCC ID	Power Cord
1	Notebook PC	DELL	PP10L	3Y220	E2K24BNHM	Non-Shielded, 1.8m
2	Monitor	CHI MEI	A170E1-09	3UC120955S A1250	DoC	Non-Shielded, 1.8m
3	Digital 8 (D8)	SONY	DCR-TRV110	P35209	DoC	--
4	Microphone & Earphone	Ronald	MOE060	N/A	DoC	--
5	USB 2.0 Flash Memory	Ridata	PEN000-DP0 65-37	N/A	DoC	--
6	Modem	ACEEX	DM-1414	0102027546	DoC	Non-Shielded, 1.6m
7	TV	THOMSON	15LCDMO3B SN	15LCDMO3B SN FRD100085	DoC	Non-Shielded, 1.8m
8	Printer	HP	C2642A	MY75L1D2X N	DoC	Non-Shielded, 0.7m

**1.4. Configuration of Tested System**

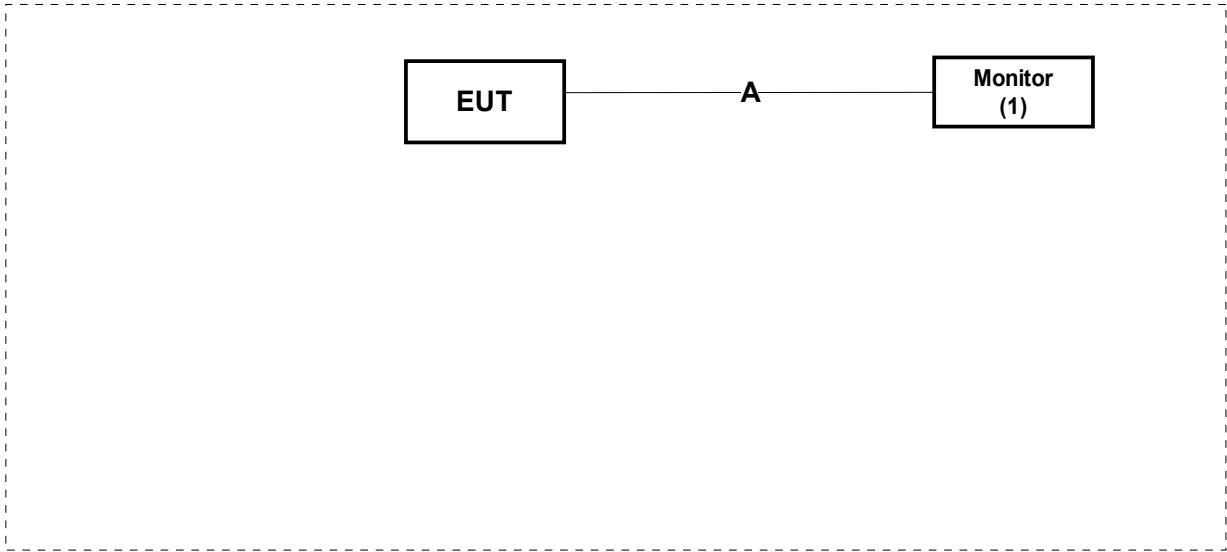
Test Mode	Mode 1: Slide Show Mode 2: REC Mode 4: Preview		
Connection Diagram			
 <pre> graph LR     EUT[EUT] --- A[A] --- Monitor["Monitor (1)"]             </pre>			
Signal Cable Type		Signal cable Description	Interface
A	AV Cable	Non-Shielded, 1.5m, one ferrite core bonded.	AV Port



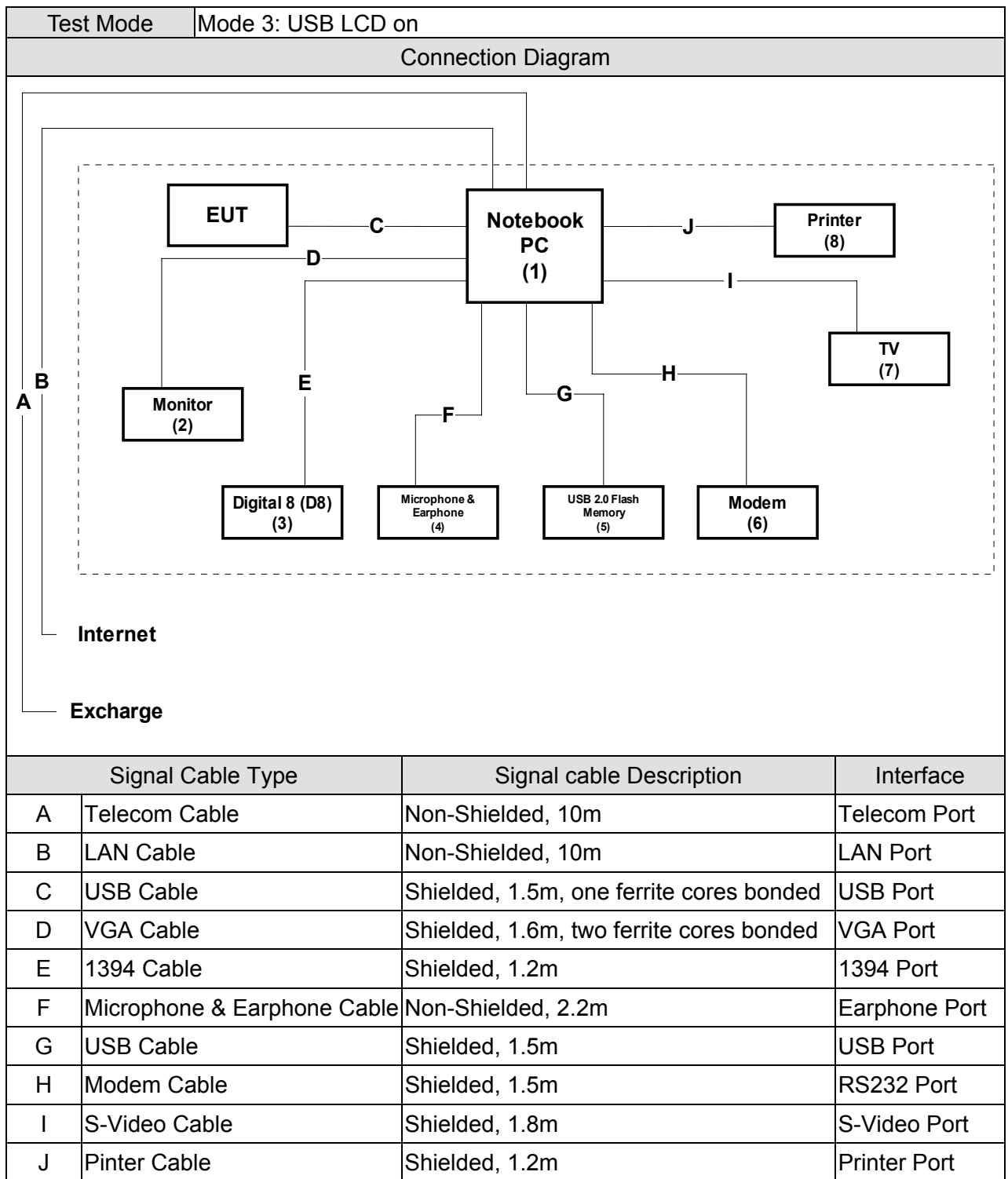

## 1.5. EUT Exercise Software

Test Mode	Mode 1: Slide Show
1	Setup EUT and Monitor as shown on 1.4.
2	Play REC file (black loop).
3	Turn on the power.
4	Select play key.
5	Press MENU.
6	Press left key to select play OK.
7	Select START OK.
8	Show word of slide show on LCD display.
9	Test.

Test Mode	Mode 2: REC
1	Setup EUT and Monitor as shown on 1.4.
2	The lens of EUT was covered with black tape.
3	Turn on the power of all equipment.
4	Press REC key.
5	Save black file.

Test Mode	Mode 3: USB LCD on
1	Setup EUT and PC as shown on 1.4.
2	Loop transmit REC file with USB cable.
3	Turn on the power.
4	Write DSC file to PC for example.

Test Mode	Mode 4: Preview
1	Setup EUT and Monitor as shown on 1.4.
2	The lens of EUT was covered with black tape.
3	Turn on the power of all equipment.
4	Select capture preview mode.
5	Test.

## 2. Technical Test

### 2.1. Summary of Test Result

- No deviations from the test standards  
 Deviations from the test standards as below description:

Emission			
Performed Item	Normative References	Test Performed	Deviation
Conducted Emission	FCC CFR Title 47 Part 15 Subpart B: 2005 Class B, CISPR 22: 2005, ANSI C63.4: 2003	Yes	No
Radiated Emission	FCC CFR Title 47 Part 15 Subpart B: 2005 Class B, CISPR 22: 2005, ANSI C63.4: 2003	Yes	No

### 2.2. List of Test Equipment

#### Conducted Emission / SR2

Instrument	Manufacturer	Type No.	Serial No	Cal. Date
4-Wire ISN	R & S	ENY 41	837032/001	2006/02/25
Artificial Mains Network	R & S	ENV4200	848411/010	2006/02/18
Double 2-Wire ISN	R & S	ENY 22	835354/008	2006/02/25
LISN	R & S	ESH3-Z5	825562/002	2006/02/18
Pulse Limiter	R & S	ZSH3Z2	357.8810.52	2006/02/12
Test Receiver	R & S	ESCS 30	825442/018	2006/09/16

#### Radiated Emission / Site2

Instrument	Manufacturer	Type No.	Serial No	Cal. Date
Bilog Antenna	Schaffner Chase	CBL6112B	2708	2006/09/03
Horn Antenna	Schwarzbeck	BBHA 9120D	BBHA9120D312	2006/07/29
Pre-Amplifier	Quietek	QTK-AMP	AMP1	N/A
Pre-Amplifier	HP	8449B	3008A01123	2006/02/15
Spectrum Analyzer	Advantest	R3261C	81720471	2006/02/17
Spectrum Analyzer	R & S	FSP40	100005	2006/08/25
Test Receiver	R & S	ESCS 30	836858/023	2006/02/17

**2.3. Measurement Uncertainty**

Conducted Emission

The measurement uncertainty is evaluated as  $\pm 2.26$  dB.

Radiated Emission

The measurement uncertainty is evaluated as  $\pm 3.19$  dB.

**2.4. Test Environment**

Performed Item	Items	Required	Actual
Conducted Emission	Temperature (°C)	15-35	25
	Humidity (%RH)	25-75	50
	Barometric pressure (mbar)	860-1060	950-1000
Radiated Emission	Temperature (°C)	15-35	25
	Humidity (%RH)	25-75	65
	Barometric pressure (mbar)	860-1060	950-1000

### 3. Conducted Emission

#### 3.1. Test Specification

According to Standard: FCC Part 15 Subpart B, ANSI C63.4

#### 3.2. Test Setup

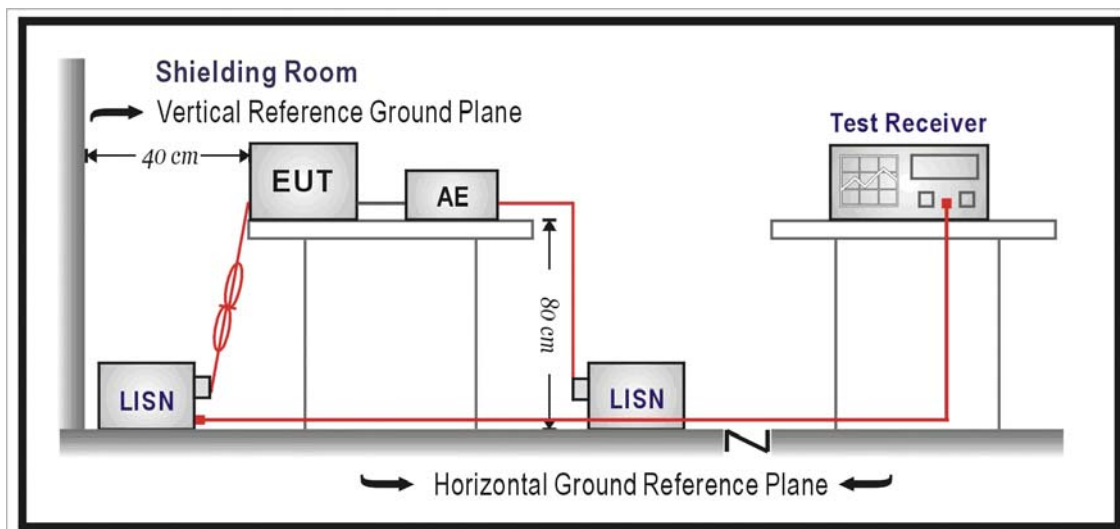

#### 3.3. Limit

Limits		
Frequency (MHz)	QP (dBuV)	AV (dBuV)
0.15 - 0.50	66 - 56	56 - 46
0.50-5.0	56	46
5.0 - 30	60	50

Remarks: In the above table, the tighter limit applies at the band edges.

### **3.4. Test Procedure**

The EUT and simulators are connected to the main power through a line impedance stabilization network (L.I.S.N.). This provides a 50 ohm /50uH coupling impedance for the measuring equipment. The peripheral devices are also connected to the main power through a LISN that provides a 50ohm/50uH coupling impedance with 50ohm termination.

(Please refers to the block diagram of the test setup and photographs.)

Both sides of A.C. line are checked for maximum conducted interference. In order to find the maximum emission, the relative positions of equipment and all of the interface cables must be changed on conducted measurement.

Conducted emissions were invested over the frequency range from 0.15MHz to 30MHz using a receiver bandwidth of 9kHz.

### 3.5. Test Result

Site : Quietek Shielding Room 2	Time : 2007/02/08 - 15:51
Limit : CISPR_B_00M_QP	Margin : 0
EUT : Digital Still Camera	Probe : QTK-LISN-SR2 - Line1
Power : AC 120V/60Hz	Note : Mode 3: USB LCD on

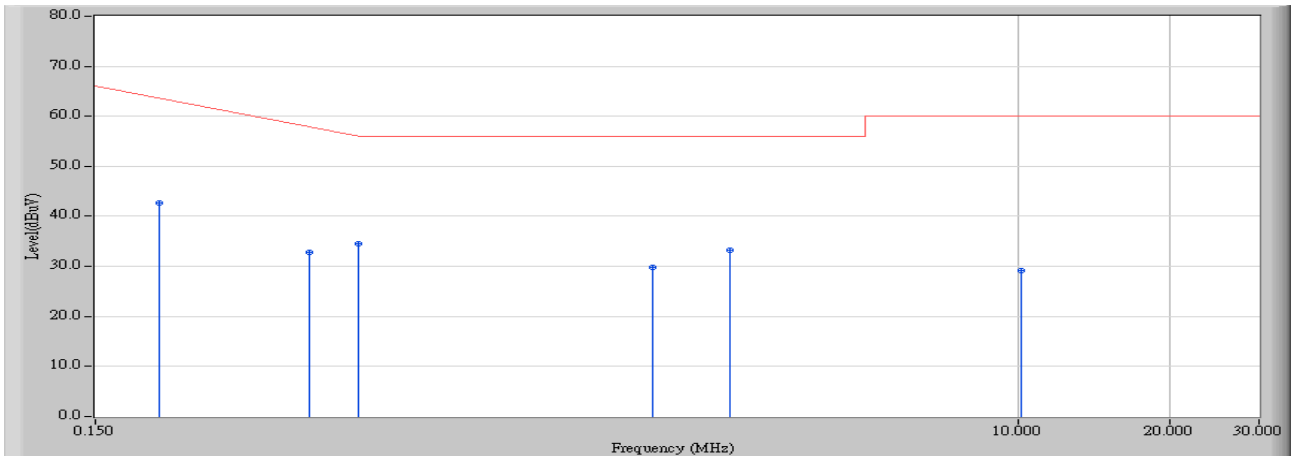

		Frequency (MHz)	Correct Factor (dB)	Reading Level (dBuV)	Measure Level (dBuV)	Margin (dB)	Limit (dBuV)	Detector Type
1		0.200	0.200	42.560	42.760	-21.811	64.571	QUASIPeAK
2		0.397	0.200	32.640	32.840	-26.103	58.943	QUASIPeAK
3	*	0.498	0.210	34.380	34.590	-21.467	56.057	QUASIPeAK
4		1.892	0.220	29.610	29.830	-26.170	56.000	QUASIPeAK
5		2.689	0.264	32.990	33.254	-22.746	56.000	QUASIPeAK
6		10.158	0.740	28.390	29.130	-30.870	60.000	QUASIPeAK

Note:

1. All Reading Levels are Quasi-Peak and average value.
2. " \* ", means this data is the worst emission level.
3. Measurement Level = Reading Level + Correct Factor.

Site : Quietek Shielding Room 2	Time : 2007/02/08 - 15:51
Limit : CISPR_B_00M_AV	Margin : 0
EUT : Digital Still Camera	Probe : QTK-LISN-SR2 - Line1
Power : AC 120V/60Hz	Note : Mode 3: USB LCD on

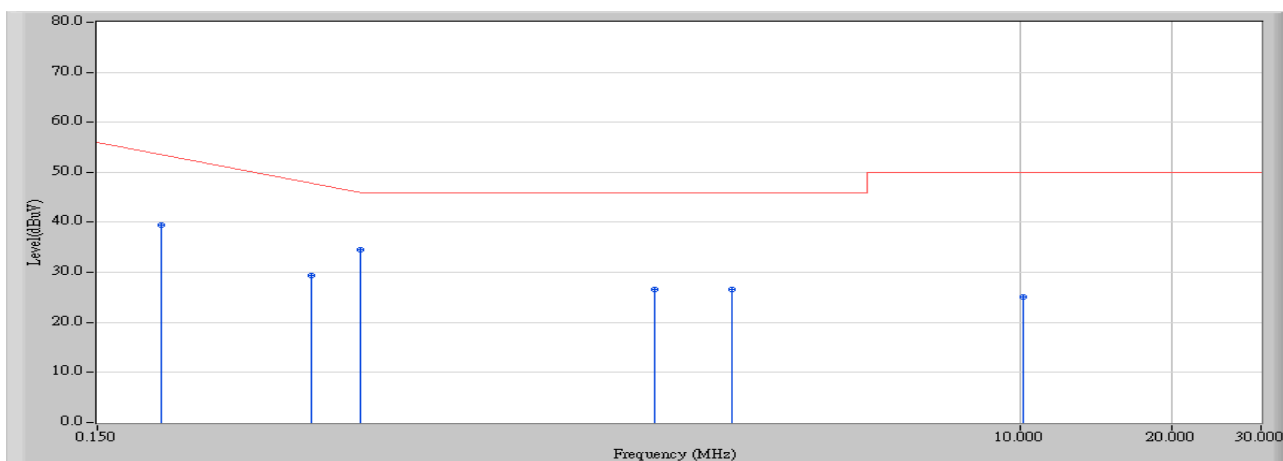

		Frequency (MHz)	Correct Factor (dB)	Reading Level (dBuV)	Measure Level (dBuV)	Margin (dB)	Limit (dBuV)	Detector Type
1		0.200	0.200	39.320	39.520	-15.051	54.571	AVERAGE
2		0.397	0.200	29.210	29.410	-19.533	48.943	AVERAGE
3	*	0.498	0.210	34.370	34.580	-11.477	46.057	AVERAGE
4		1.892	0.220	26.410	26.630	-19.370	46.000	AVERAGE
5		2.689	0.264	26.360	26.624	-19.376	46.000	AVERAGE
6		10.158	0.740	24.280	25.020	-24.980	50.000	AVERAGE

Note:

1. All Reading Levels are Quasi-Peak and average value.
2. " \* ", means this data is the worst emission level.
3. Measurement Level = Reading Level + Correct Factor.



Site : Quietek Shielding Room 2	Time : 2007/02/08 - 15:54
Limit : CISPR_B_00M_QP	Margin : 0
EUT : Digital Still Camera	Probe : QTK-LISN-SR2 - Line2
Power : AC 120V/60Hz	Note : Mode 3: USB LCD on

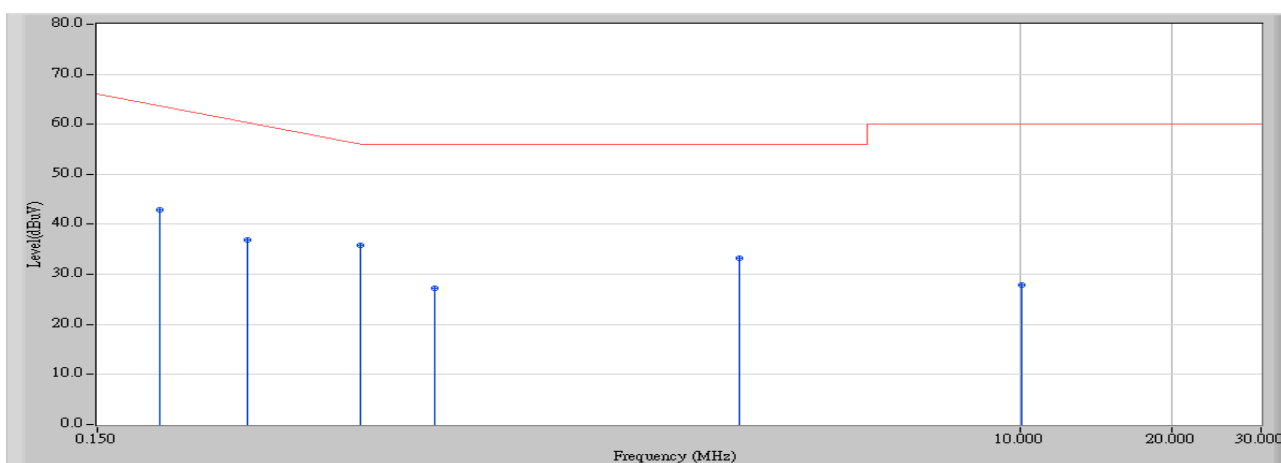

		Frequency (MHz)	Correct Factor (dB)	Reading Level (dBuV)	Measure Level (dBuV)	Margin (dB)	Limit (dBuV)	Detector Type
1		0.199	0.200	42.720	42.920	-21.680	64.600	QUASPEAK
2		0.298	0.200	36.700	36.900	-24.871	61.771	QUASPEAK
3	*	0.498	0.210	35.550	35.760	-20.297	56.057	QUASPEAK
4		0.697	0.210	27.110	27.320	-28.680	56.000	QUASPEAK
5		2.789	0.230	33.030	33.260	-22.740	56.000	QUASPEAK
6		10.067	0.530	27.280	27.810	-32.190	60.000	QUASPEAK

Note:

1. All Reading Levels are Quasi-Peak and average value.
2. " \* ", means this data is the worst emission level.
3. Measurement Level = Reading Level + Correct Factor.

Site : Quietek Shielding Room 2	Time : 2007/02/08 - 15:54
Limit : CISPR_B_00M_AV	Margin : 0
EUT : Digital Still Camera	Probe : QTK-LISN-SR2 - Line2
Power : AC 120V/60Hz	Note : Mode 3: USB LCD on

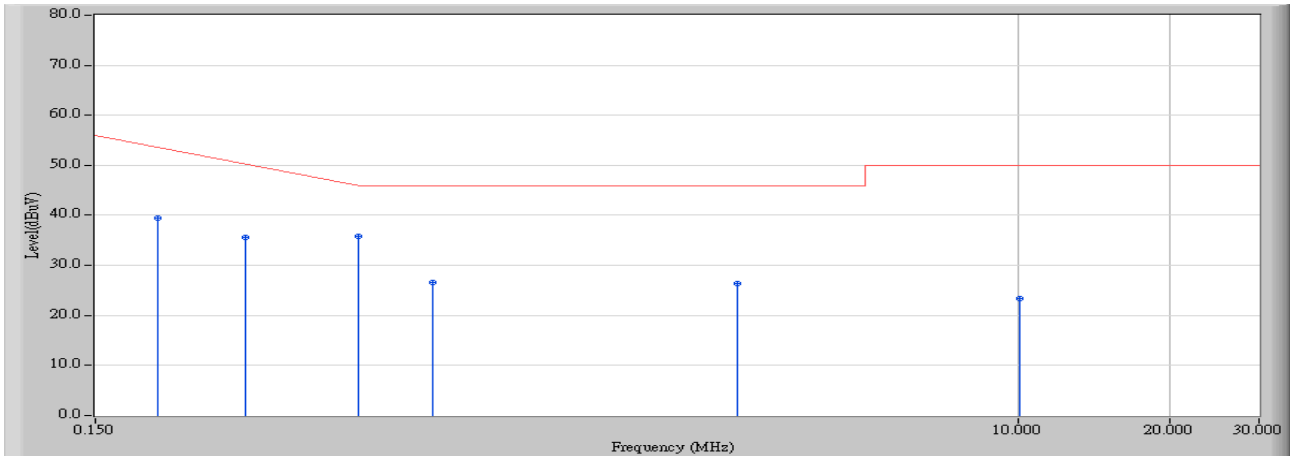

		Frequency (MHz)	Correct Factor (dB)	Reading Level (dBuV)	Measure Level (dBuV)	Margin (dB)	Limit (dBuV)	Detector Type
1		0.199	0.200	39.160	39.360	-15.240	54.600	AVERAGE
2		0.298	0.200	35.510	35.710	-16.061	51.771	AVERAGE
3	*	0.498	0.210	35.540	35.750	-10.307	46.057	AVERAGE
4		0.697	0.210	26.320	26.530	-19.470	46.000	AVERAGE
5		2.789	0.230	26.090	26.320	-19.680	46.000	AVERAGE
6		10.067	0.530	22.790	23.320	-26.680	50.000	AVERAGE

Note:

1. All Reading Levels are Quasi-Peak and average value.
2. " \* ", means this data is the worst emission level.
3. Measurement Level = Reading Level + Correct Factor.

**4. Radiated Emission**

**4.1. Test Specification**

According to EMC Standard: FCC Part 15 Subpart B, ANSI C63.4

**4.2. Test Setup**

Under 1GHz Test Setup:

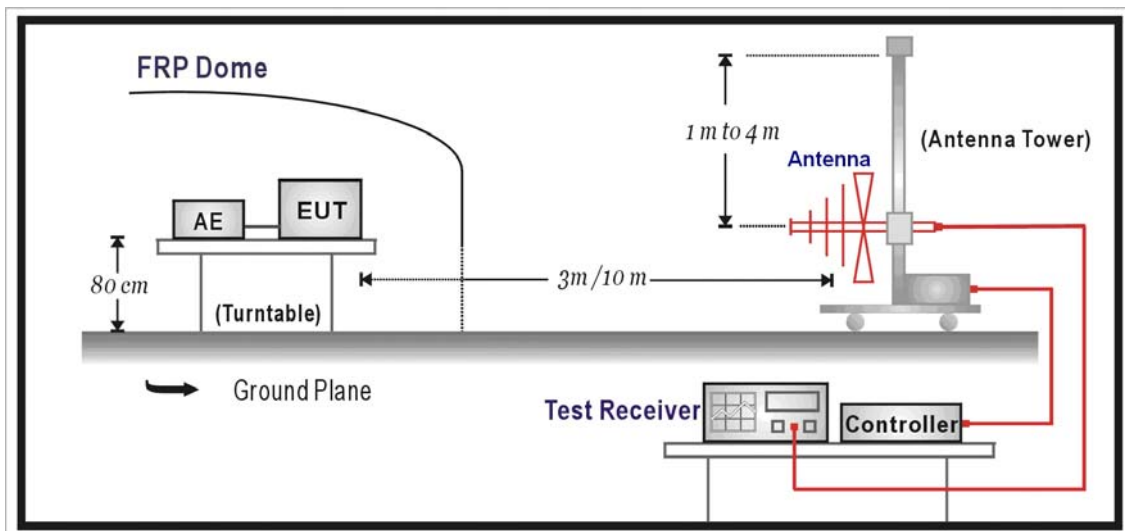

Above 1GHz Test Setup:

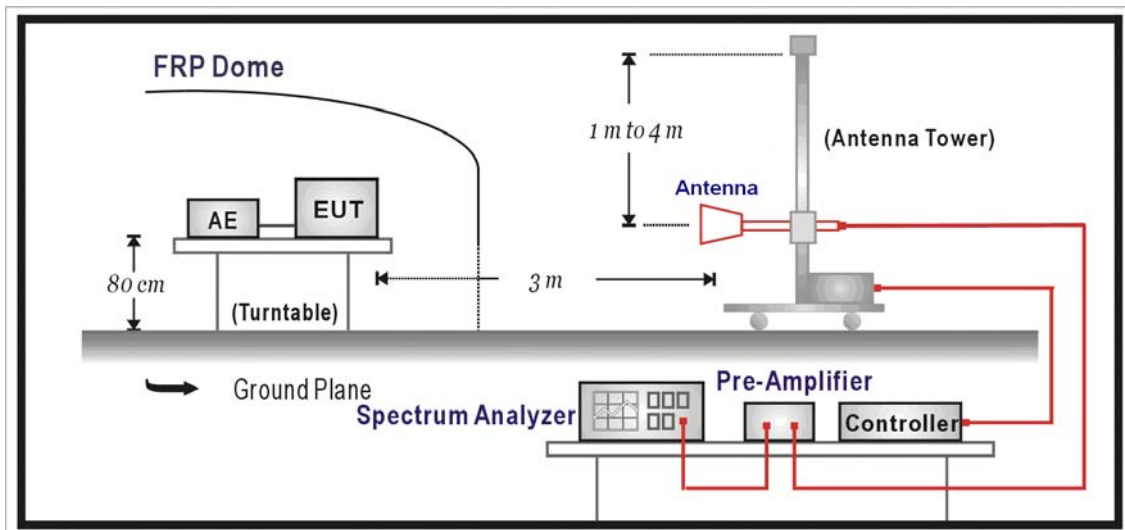

**4.3. Limit**

<b>FCC Part 15 Subpart B Paragraph 15.109 Limits (dBuV/m)</b>		
<b>Frequency (MHz)</b>	<b>Distance (m)</b>	<b>dBuV/m</b>
30-88	3	40
88-216	3	43.5
216-960	3	46
Above 960	3	54

Remark:

1. The tighter limit shall apply at the edge between two frequency bands.
2. Distance refers to the distance in meters between the measuring instrument antenna and the closed point of any part of the device or system.
3. RF Voltage (dBuV/m) = 20 log RF Voltage (uV/m)

**4.4. Test Procedure**

The EUT and its simulators are placed on a turn table which is 0.8 meter above ground.

The turn table can rotate 360 degrees to determine the position of the maximum emission level and the antenna can move up and down between 1 meter and 4 meters to find out the maximum emission level.

Both horizontal and vertical polarization of the antenna are set on measurement. In order to find the maximum emission, all of the interface cables must be manipulated on radiated measurement.

For an unintentional radiator, including a digital device, the spectrum shall be investigated from the lowest radio frequency signal generated or used in the device, without going below the lowest frequency for which a radiated emission limit is specified, up to the frequency shown in the following table:

Highest frequency generated or used in the device or on which the device operates or tunes (MHz)	Upper frequency of measurement range (MHz)
Below 1.705	30
1.705 – 108	1000
108 – 500	2000
500 – 1000	5000
Above 1000	5 <sup>th</sup> harmonic of the highest frequency or 40 GHz, whichever is lower

On any frequency or frequencies below or equal to 1000 MHz, the radiated limits shown are based on measuring equipment employing a quasi-peak detector function and above 1000 MHz, the radiated limits shown are based measuring equipment employing an average detector function.

When average radiated emission measurement are included emission measurement Above 1000 MHz, there also is a limit on the radio frequency emissions, as measured using instrumentation with a peak detector function, corresponding to 20 dB above the maximum permitted average limit.

For class A, the measurement distance between the EUT and antenna is 10 meters for under 1GHz and above 1GHz.

For class B, the measurement distance between the EUT and antenna is 3 meters for under 1GHz and 3 meters for above 1GHz.

The bandwidth below 1GHz setting on the field strength meter (R&S Test Receiver ESCS 30) is 120 kHz and above 1GHz is 1MHz.

## 4.5. Test Result

Site : Site 2	Time : 2007/02/09 - 17:20
Limit : FCC_CLASS_B_03M_QP	Margin : 6
EUT : Digital Still Camera	Probe : PRO 06-03-29 ST2 - HORIZONTAL
Power : AC 120V/60Hz	Note : Mode 1: Slide Show

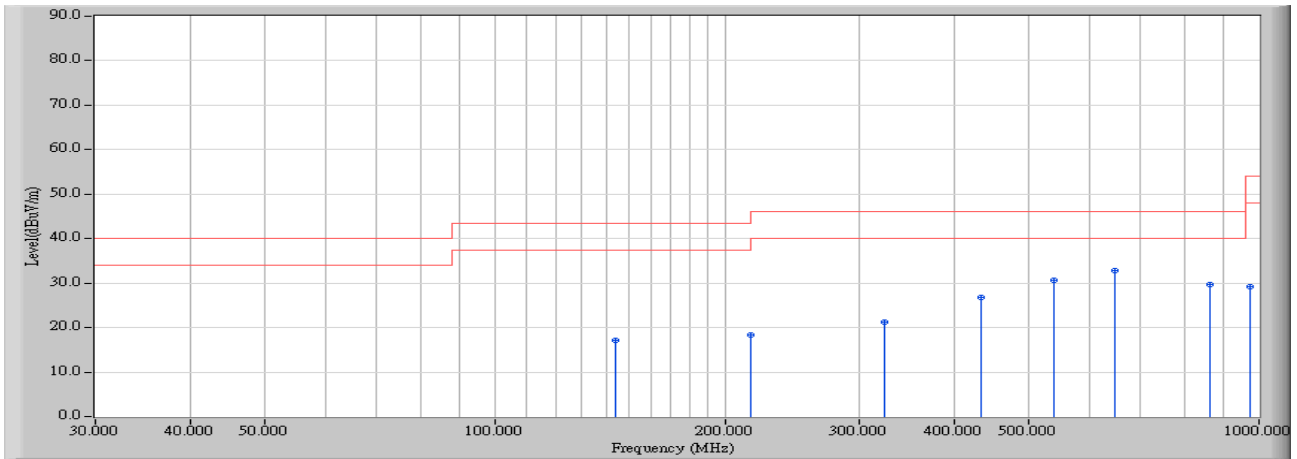

	Frequency (MHz)	Correct Factor (dB)	Reading Level (dBuV)	Measure Level (dBuV/m)	Margin (dB)	Limit (dBuV/m)	Detector Type
1	144.000	13.286	3.930	17.216	-26.284	43.500	QUASIPeAK
2	216.000	11.873	6.570	18.442	-25.058	43.500	QUASIPeAK
3	324.000	16.991	4.220	21.211	-24.789	46.000	QUASIPeAK
4	432.000	18.665	8.100	26.765	-19.235	46.000	QUASIPeAK
5	540.000	20.501	10.080	30.581	-15.419	46.000	QUASIPeAK
6	* 648.000	24.192	8.670	32.862	-13.138	46.000	QUASIPeAK
7	864.000	24.920	4.850	29.770	-16.230	46.000	QUASIPeAK
8	972.000	27.596	1.490	29.086	-24.914	54.000	QUASIPeAK

**Note:**

1. All Reading Levels are Quasi-Peak value.
2. “ \* ”, means this data is the worst emission level.
3. Measurement Level = Reading Level + Correct Factor.

Site : CB3	Time : 2007/03/02 - 10:34
Limit : FCC_B_(Above_1G)_3M_AV	Margin : 6
EUT : Digital Still Camera	Probe : FCC_RF_1G-18G(2005-3) - HORIZONTAL
Power : AC 120V / 60Hz	Note : Mode 1: Slide Show

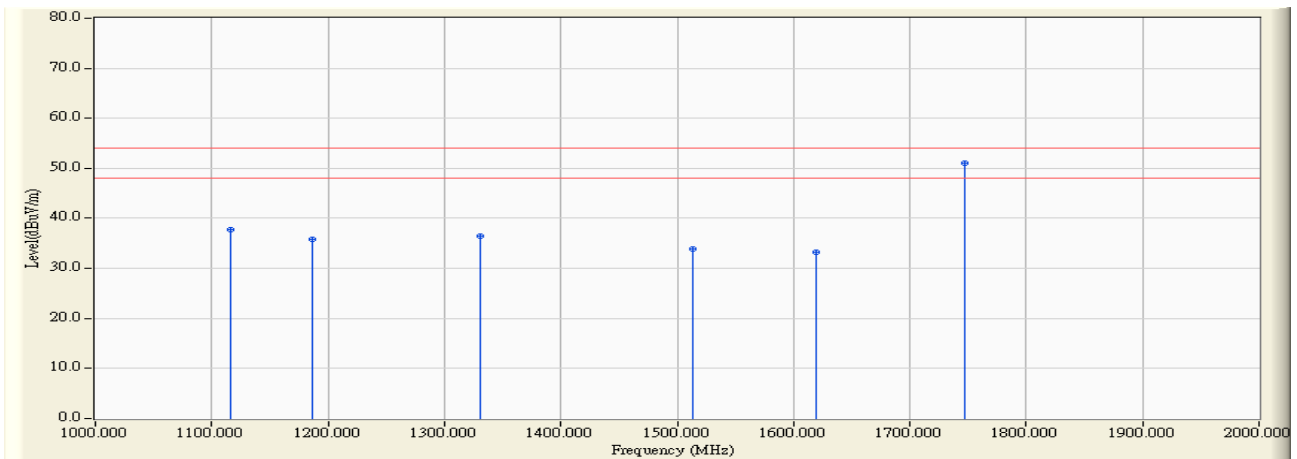

	Frequency (MHz)	Correct Factor (dB)	Reading Level (dBuV)	Measure Level (dBuV/m)	Margin (dB)	Limit (dBuV/m)	Detector Type	Ant Pos (cm)	Table Pos (deg)
1	1116.200	-9.507	47.300	37.792	-16.208	54.000	PEAK	0.000	0.000
2	1186.400	-9.088	44.920	35.833	-18.167	54.000	PEAK	0.000	0.000
3	1330.660	-8.697	45.180	36.483	-17.517	54.000	PEAK	0.000	0.000
4	1513.026	-8.019	41.920	33.901	-20.099	54.000	PEAK	0.000	0.000
5	1619.230	-7.778	40.980	33.203	-20.797	54.000	PEAK	0.000	0.000
6	* 1747.500	-6.970	57.930	50.960	-3.040	54.000	PEAK	0.000	0.000

**Note:**

1. All Readings below 1GHz are Quasi-Peak, above are performed with peak and/or average measurements as necessary.
2. “ \* ”, means this data is the worst emission level.
3. Measurement Level = Reading Level + Correct Factor.
4. The average measurement was not performed when the peak measured data under the limit of average detection. If the readings given are average, peak measurement should also be supplied.

Site : Site 2	Time : 2007/02/09 - 17:08
Limit : FCC_CLASS_B_03M_QP	Margin : 6
EUT : Digital Still Camera	Probe : PRO 06-03-29 ST2 - VERTICAL
Power : AC 120V/60Hz	Note : Mode 1: Slide Show

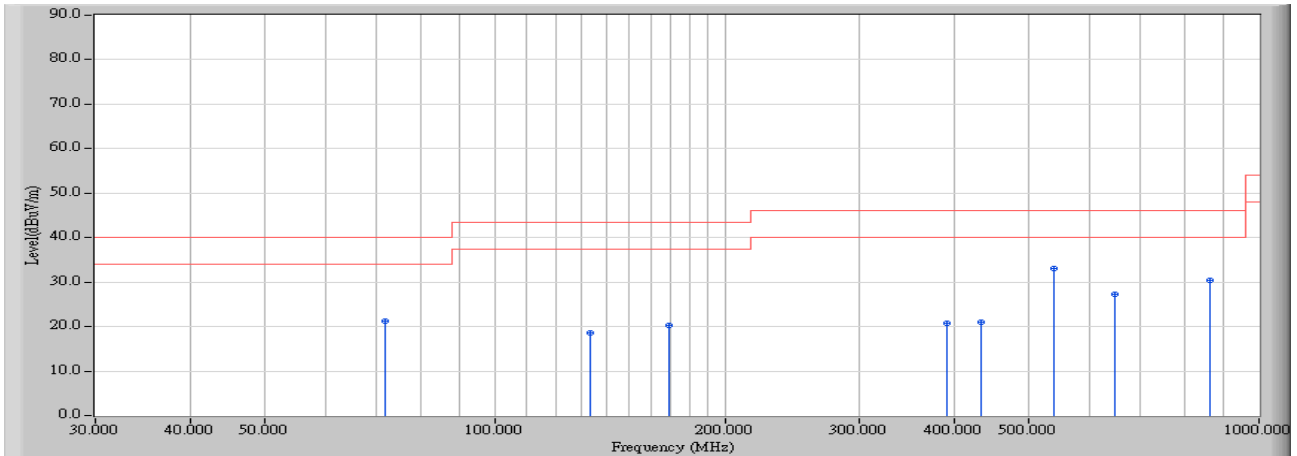

	Frequency (MHz)	Correct Factor (dB)	Reading Level (dBuV)	Measure Level (dBuV/m)	Margin (dB)	Limit (dBuV/m)	Detector Type
1	72.000	10.155	10.980	21.135	-18.865	40.000	QUASPEAK
2	133.000	12.692	6.000	18.691	-24.809	43.500	QUASPEAK
3	168.850	12.009	8.360	20.369	-23.131	43.500	QUASPEAK
4	390.075	16.973	3.870	20.843	-25.157	46.000	QUASPEAK
5	432.000	16.366	4.720	21.086	-24.914	46.000	QUASPEAK
6	* 540.000	22.608	10.380	32.987	-13.013	46.000	QUASPEAK
7	648.000	22.144	5.170	27.314	-18.686	46.000	QUASPEAK
8	864.000	25.383	4.910	30.293	-15.707	46.000	QUASPEAK

Note:

1. All Reading Levels are Quasi-Peak value.
2. “ \* ”, means this data is the worst emission level.
3. Measurement Level = Reading Level + Correct Factor.



Site : CB3	Time : 2007/03/02 - 10:40
Limit : FCC_B_(Above_1G)_3M_AV	Margin : 6
EUT : Digital Still Camera	Probe : FCC_RF_1G-18G(2005-3) - VERTICAL
Power : AC 120V / 60Hz	Note : Mode 1: Slide Show

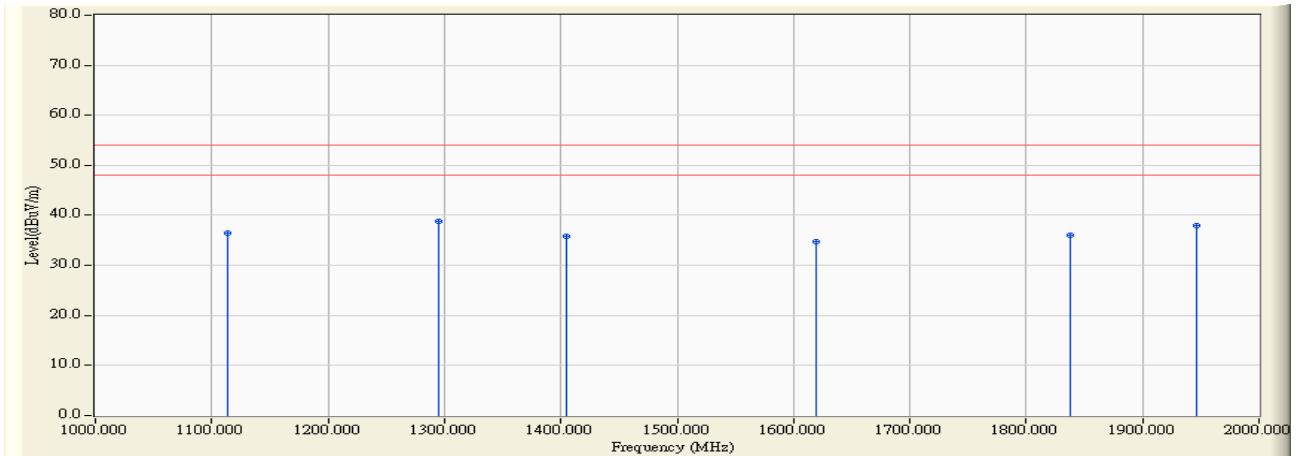

		Frequency (MHz)	Correct Factor (dB)	Reading Level (dBuV)	Measure Level (dBuV/m)	Margin (dB)	Limit (dBuV/m)	Detector Type	Ant Pos (cm)	Table Pos (deg)
1		1114.220	-8.735	45.170	36.435	-17.565	54.000	PEAK	0.000	0.000
2	*	1294.600	-8.056	46.840	38.783	-15.217	54.000	PEAK	0.000	0.000
3		1404.800	-7.686	43.510	35.824	-18.176	54.000	PEAK	0.000	0.000
4		1619.200	-6.978	41.800	34.822	-19.178	54.000	PEAK	0.000	0.000
5		1837.700	-6.238	42.330	36.092	-17.908	54.000	PEAK	0.000	0.000
6		1945.890	-5.761	43.740	37.979	-16.021	54.000	PEAK	0.000	0.000

**Note:**

1. All Readings below 1GHz are Quasi-Peak, above are performed with peak and/or average measurements as necessary.
2. “ \* ”, means this data is the worst emission level.
3. Measurement Level = Reading Level + Correct Factor.
4. The average measurement was not performed when the peak measured data under the limit of average detection. If the readings given are average, peak measurement should also be supplied.

Site : Site 2	Time : 2007/02/09 - 15:14
Limit : FCC_CLASS_B_03M_QP	Margin : 6
EUT : Digital Still Camera	Probe : PRO 06-03-29 ST2 - HORIZONTAL
Power : AC 120V/60Hz	Note : Mode 2: REC

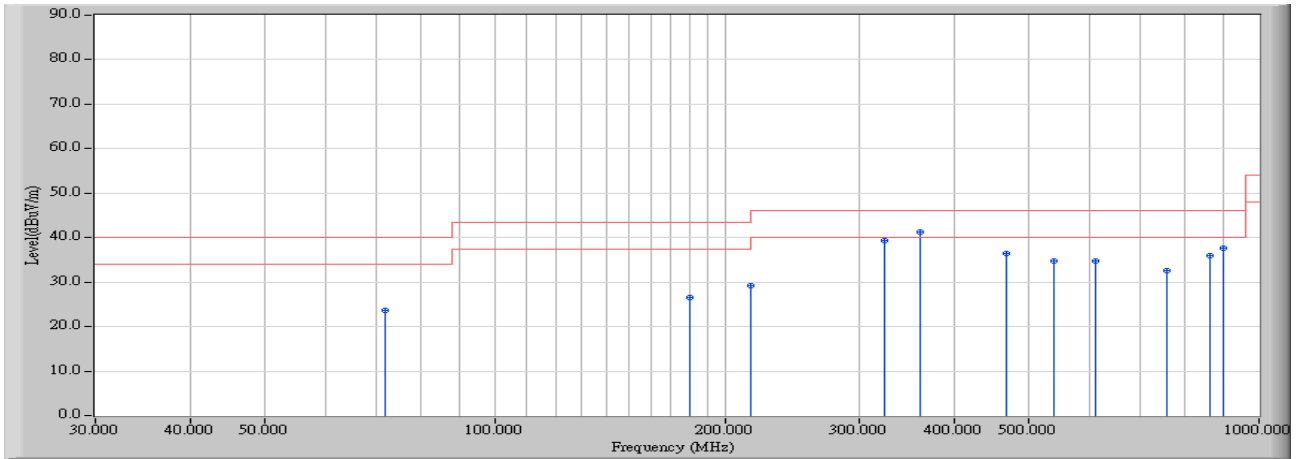

	Frequency (MHz)	Correct Factor (dB)	Reading Level (dBuV)	Measure Level (dBuV/m)	Margin (dB)	Limit (dBuV/m)	Detector Type
1	72.000	7.897	15.800	23.697	-16.303	40.000	QUASPEAK
2	180.000	10.453	16.140	26.593	-16.907	43.500	QUASPEAK
3	216.000	11.873	17.310	29.182	-14.318	43.500	QUASPEAK
4	324.000	16.991	22.350	39.341	-6.659	46.000	QUASPEAK
5	* 360.000	18.306	22.910	41.216	-4.784	46.000	QUASPEAK
6	468.000	19.460	16.980	36.440	-9.560	46.000	QUASPEAK
7	540.000	20.501	14.190	34.691	-11.309	46.000	QUASPEAK
8	612.000	22.710	12.000	34.710	-11.290	46.000	QUASPEAK
9	756.013	23.058	9.500	32.558	-13.442	46.000	QUASPEAK
10	864.013	24.920	11.060	35.980	-10.020	46.000	QUASPEAK
11	900.000	26.520	11.040	37.560	-8.440	46.000	QUASPEAK

Note:

1. All Reading Levels are Quasi-Peak value.
2. “ \* ”, means this data is the worst emission level.
3. Measurement Level = Reading Level + Correct Factor.

Site : CB3	Time : 2007/03/02 - 10:21
Limit : FCC_B_(Above_1G)_3M_AV	Margin : 6
EUT : Digital Still Camera	Probe : FCC_RF_1G-18G(2005-3) - HORIZONTAL
Power : AC 120V / 60Hz	Note : Mode 2: REC

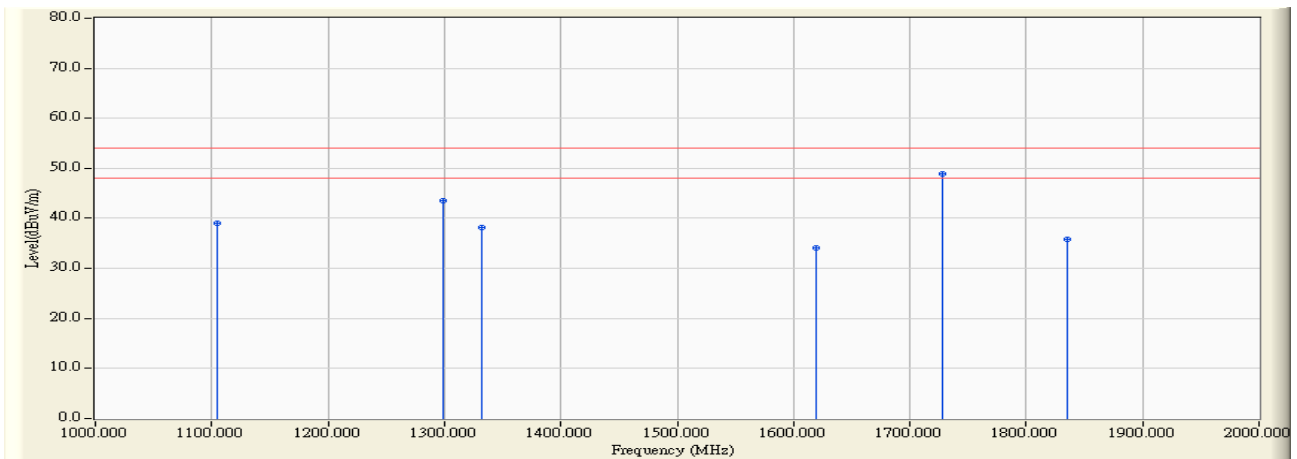

	Frequency (MHz)	Correct Factor (dB)	Reading Level (dBuV)	Measure Level (dBuV/m)	Margin (dB)	Limit (dBuV/m)	Detector Type	Ant Pos (cm)	Table Pos (deg)
1	1104.200	-9.670	48.700	39.030	-14.970	54.000	PEAK	0.000	0.000
2	1298.600	-8.855	52.420	43.566	-10.434	54.000	PEAK	0.000	0.000
3	1332.660	-8.704	46.910	38.206	-15.794	54.000	PEAK	0.000	0.000
4	1619.200	-7.778	41.950	34.172	-19.828	54.000	PEAK	0.000	0.000
5	* 1727.500	-7.052	55.920	48.868	-5.132	54.000	PEAK	0.000	0.000
6	1835.670	-6.614	42.380	35.767	-18.233	54.000	PEAK	0.000	0.000

**Note:**

1. All Readings below 1GHz are Quasi-Peak, above are performed with peak and/or average measurements as necessary.
2. “ \* ”, means this data is the worst emission level.
3. Measurement Level = Reading Level + Correct Factor.
4. The average measurement was not performed when the peak measured data under the limit of average detection. If the readings given are average, peak measurement should also be supplied.

Site : Site 2	Time : 2007/02/09 - 14:55
Limit : FCC_CLASS_B_03M_QP	Margin : 6
EUT : Digital Still Camera	Probe : PRO 06-03-29 ST2 - VERTICAL
Power : AC 120V/60Hz	Note : Mode 2: REC

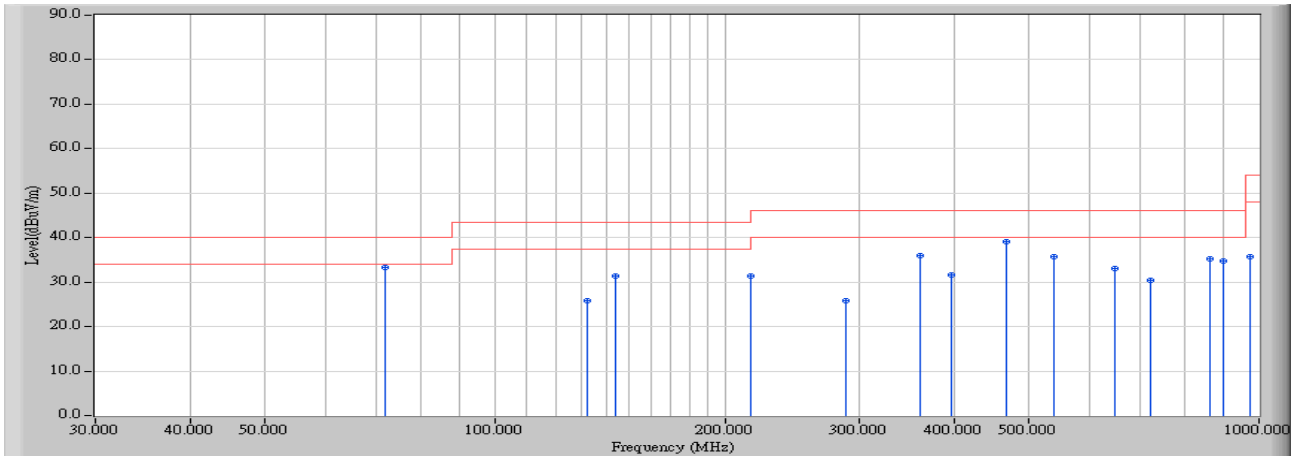

		Frequency (MHz)	Correct Factor (dB)	Reading Level (dBuV)	Measure Level (dBuV/m)	Margin (dB)	Limit (dBuV/m)	Detector Type
1	*	72.000	10.155	23.250	33.405	-6.595	40.000	QUASIPeAK
2		132.000	12.803	13.010	25.813	-17.687	43.500	QUASIPeAK
3		144.000	11.896	19.510	31.406	-12.094	43.500	QUASIPeAK
4		216.000	11.779	19.470	31.248	-12.252	43.500	QUASIPeAK
5		288.000	16.592	9.200	25.792	-20.208	46.000	QUASIPeAK
6		360.000	19.291	16.720	36.011	-9.989	46.000	QUASIPeAK
7		396.000	17.844	13.700	31.544	-14.456	46.000	QUASIPeAK
8		468.000	19.117	19.880	38.997	-7.003	46.000	QUASIPeAK
9		540.000	22.608	13.090	35.697	-10.303	46.000	QUASIPeAK
10		648.000	22.144	10.840	32.984	-13.016	46.000	QUASIPeAK
11		720.000	22.703	7.760	30.463	-15.537	46.000	QUASIPeAK
12		864.000	25.383	9.900	35.283	-10.717	46.000	QUASIPeAK
13		900.000	25.318	9.460	34.778	-11.222	46.000	QUASIPeAK
14		972.130	26.088	9.660	35.748	-18.252	54.000	QUASIPeAK

Note:

1. All Reading Levels are Quasi-Peak value.
2. " \* ", means this data is the worst emission level.
3. Measurement Level = Reading Level + Correct Factor.

Site : CB3	Time : 2007/03/02 - 10:27
Limit : FCC_B_(Above_1G)_3M_AV	Margin : 6
EUT : Digital Still Camera	Probe : FCC_RF_1G-18G(2005-3) - VERTICAL
Power : AC 120V / 60Hz	Note : Mode 2: REC

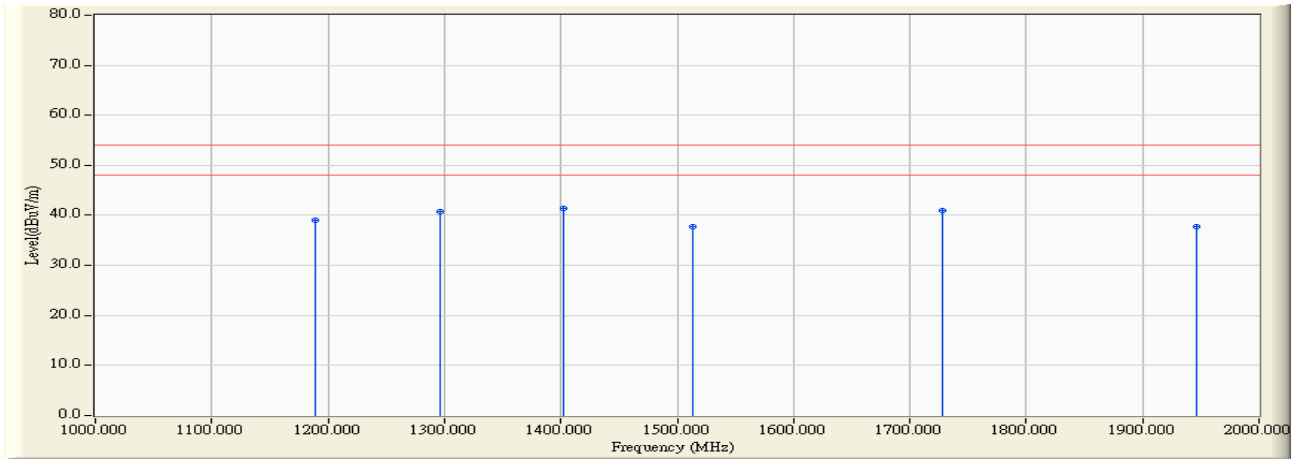

	Frequency (MHz)	Correct Factor (dB)	Reading Level (dBuV)	Measure Level (dBuV/m)	Margin (dB)	Limit (dBuV/m)	Detector Type	Ant Pos (cm)	Table Pos (deg)
1	1188.400	-8.286	47.230	38.944	-15.056	54.000	PEAK	0.000	0.000
2	1296.600	-8.055	48.750	40.694	-13.306	54.000	PEAK	0.000	0.000
3	* 1402.800	-7.689	48.990	41.301	-12.699	54.000	PEAK	0.000	0.000
4	1513.030	-7.219	45.010	37.791	-16.209	54.000	PEAK	0.000	0.000
5	1727.450	-6.253	47.170	40.917	-13.083	54.000	PEAK	0.000	0.000
6	1945.890	-5.761	43.610	37.849	-16.151	54.000	PEAK	0.000	0.000

**Note:**

1. All Readings below 1GHz are Quasi-Peak, above are performed with peak and/or average measurements as necessary.
2. “ \* ”, means this data is the worst emission level.
3. Measurement Level = Reading Level + Correct Factor.
4. The average measurement was not performed when the peak measured data under the limit of average detection. If the readings given are average, peak measurement should also be supplied.

Site : Site 2	Time : 2007/02/09 - 18:01
Limit : FCC_CLASS_B_03M_QP	Margin : 6
EUT : Digital Still Camera	Probe : PRO 06-03-29 ST2 - HORIZONTAL
Power : AC 120V/60Hz	Note : Mode 3: USB LCD on

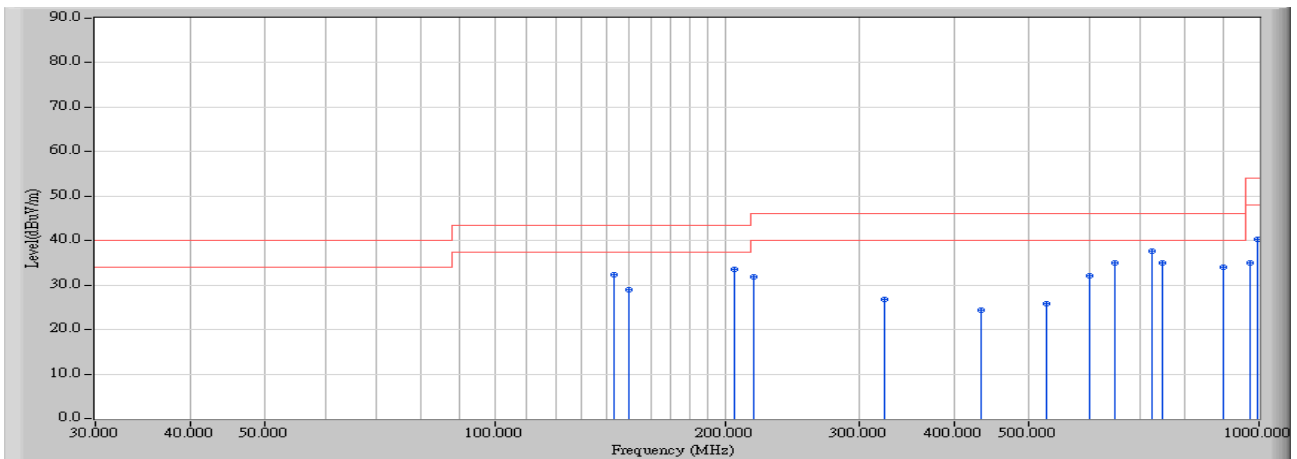

	Frequency (MHz)	Correct Factor (dB)	Reading Level (dBuV)	Measure Level (dBuV/m)	Margin (dB)	Limit (dBuV/m)	Detector Type
1	143.300	13.107	19.120	32.227	-11.273	43.500	QUASIPeAK
2	149.525	13.197	15.860	29.057	-14.443	43.500	QUASIPeAK
3	205.650	12.396	21.190	33.586	-9.914	43.500	QUASIPeAK
4	218.100	11.620	20.200	31.820	-14.180	46.000	QUASIPeAK
5	324.000	16.991	9.710	26.701	-19.299	46.000	QUASIPeAK
6	432.000	18.665	5.720	24.385	-21.615	46.000	QUASIPeAK
7	527.925	21.021	4.830	25.851	-20.149	46.000	QUASIPeAK
8	601.450	20.552	11.500	32.052	-13.948	46.000	QUASIPeAK
9	648.000	24.192	10.760	34.952	-11.048	46.000	QUASIPeAK
10	* 722.775	24.596	12.970	37.566	-8.434	46.000	QUASIPeAK
11	747.700	23.018	11.950	34.968	-11.032	46.000	QUASIPeAK
12	897.225	26.078	7.950	34.028	-11.972	46.000	QUASIPeAK
13	972.000	27.596	7.450	35.046	-18.954	54.000	QUASIPeAK
14	996.925	27.232	12.960	40.192	-13.808	54.000	QUASIPeAK

**Note:**

1. All Reading Levels are Quasi-Peak value.
2. " \* ", means this data is the worst emission level.
3. Measurement Level = Reading Level + Correct Factor.

Site : CB3	Time : 2007/03/02 - 10:08
Limit : FCC_B_(Above_1G)_3M_AV	Margin : 6
EUT : Digital Still Camera	Probe : FCC_RF_1G-18G(2005-3) - HORIZONTAL
Power : AC 120V / 60Hz	Note : Mode 3: USB LCD on

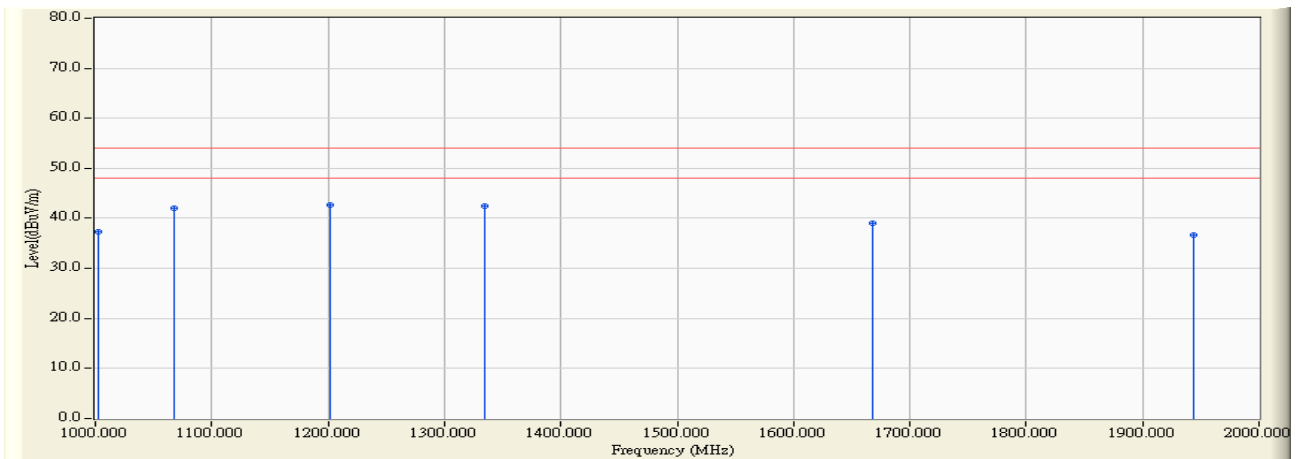

	Frequency (MHz)	Correct Factor (dB)	Reading Level (dBuV)	Measure Level (dBuV/m)	Margin (dB)	Limit (dBuV/m)	Detector Type	Ant Pos (cm)	Table Pos (deg)
1	1002.004	-13.058	50.350	37.291	-16.709	54.000	PEAK	0.000	0.000
2	1068.140	-9.700	51.820	42.120	-11.880	54.000	PEAK	0.000	0.000
3	* 1202.410	-9.144	51.760	42.617	-11.383	54.000	PEAK	0.000	0.000
4	1334.670	-8.711	51.250	42.539	-11.461	54.000	PEAK	0.000	0.000
5	1667.330	-7.616	46.730	39.113	-14.887	54.000	PEAK	0.000	0.000
6	1943.890	-4.832	41.480	36.648	-17.352	54.000	PEAK	0.000	0.000

**Note:**

1. All Readings below 1GHz are Quasi-Peak, above are performed with peak and/or average measurements as necessary.
2. “ \* ”, means this data is the worst emission level.
3. Measurement Level = Reading Level + Correct Factor.
4. The average measurement was not performed when the peak measured data under the limit of average detection. If the readings given are average, peak measurement should also be supplied.

Site : Site 2	Time : 2007/02/09 - 17:48
Limit : FCC_CLASS_B_03M_QP	Margin : 6
EUT : Digital Still Camera	Probe : PRO 06-03-29 ST2 - VERTICAL
Power : AC 120V/60Hz	Note : Mode 3: USB LCD on

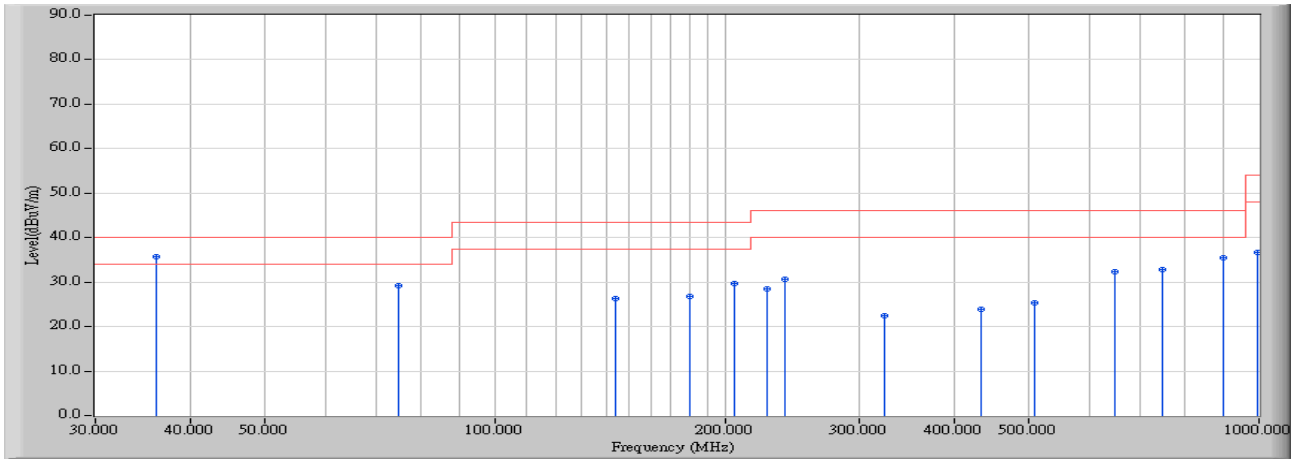

		Frequency (MHz)	Correct Factor (dB)	Reading Level (dBuV)	Measure Level (dBuV/m)	Margin (dB)	Limit (dBuV/m)	Detector Type
1	*	36.000	15.323	20.300	35.623	-4.377	40.000	QUASIPeAK
2		74.775	8.743	20.390	29.134	-10.866	40.000	QUASIPeAK
3		144.000	11.896	14.300	26.196	-17.304	43.500	QUASIPeAK
4		180.000	11.054	15.700	26.754	-16.746	43.500	QUASIPeAK
5		205.600	8.928	20.800	29.729	-13.771	43.500	QUASIPeAK
6		226.925	15.033	13.470	28.503	-17.497	46.000	QUASIPeAK
7		239.975	14.739	15.790	30.529	-15.471	46.000	QUASIPeAK
8		324.000	14.263	8.120	22.383	-23.617	46.000	QUASIPeAK
9		432.000	16.366	7.540	23.906	-22.094	46.000	QUASIPeAK
10		508.075	20.319	5.090	25.409	-20.591	46.000	QUASIPeAK
11		648.000	22.144	10.140	32.284	-13.716	46.000	QUASIPeAK
12		747.700	22.085	10.620	32.705	-13.295	46.000	QUASIPeAK
13		897.225	25.556	9.960	35.516	-10.484	46.000	QUASIPeAK
14		996.925	24.620	12.040	36.660	-17.340	54.000	QUASIPeAK

Note:

1. All Reading Levels are Quasi-Peak value.
2. " \* ", means this data is the worst emission level.
3. Measurement Level = Reading Level + Correct Factor.



Site : CB3	Time : 2007/03/02 - 10:14
Limit : FCC_B_(Above_1G)_3M_AV	Margin : 6
EUT : Digital Still Camera	Probe : FCC_RF_1G-18G(2005-3) - VERTICAL
Power : AC 120V / 60Hz	Note : Mode 3: USB LCD on

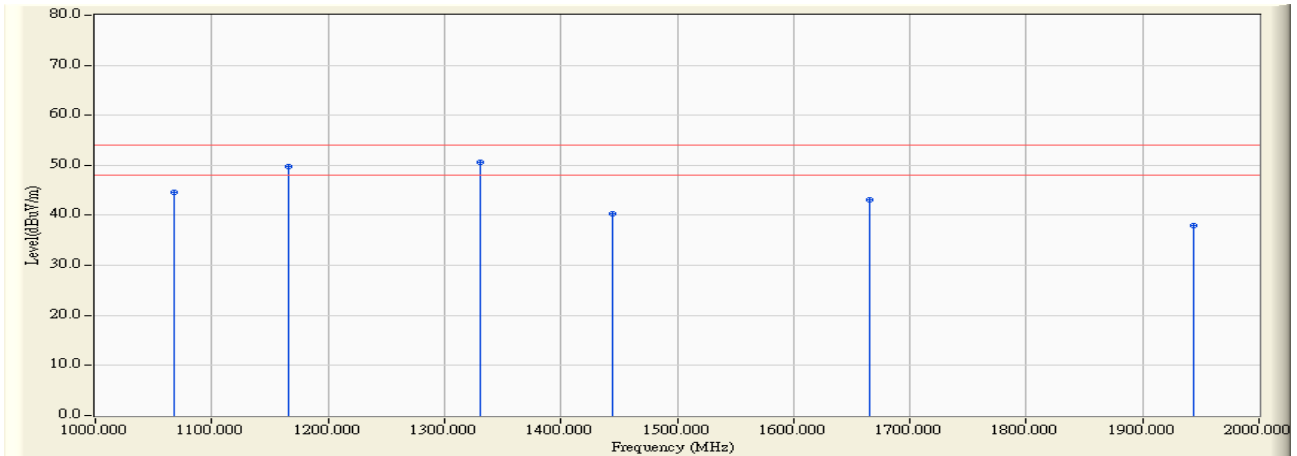

	Frequency (MHz)	Correct Factor (dB)	Reading Level (dBuV)	Measure Level (dBuV/m)	Margin (dB)	Limit (dBuV/m)	Detector Type	Ant Pos (cm)	Table Pos (deg)
1	1068.140	-8.900	53.470	44.570	-9.430	54.000	PEAK	0.000	0.000
2	1166.330	-8.485	58.150	49.664	-4.336	54.000	PEAK	0.000	0.000
3	* 1330.660	-7.897	58.560	50.663	-3.337	54.000	PEAK	0.000	0.000
4	1444.890	-7.669	47.980	40.311	-13.689	54.000	PEAK	0.000	0.000
5	1665.330	-6.837	49.940	43.103	-10.897	54.000	PEAK	0.000	0.000
6	1943.890	-5.752	43.640	37.888	-16.112	54.000	PEAK	0.000	0.000

**Note:**

1. All Readings below 1GHz are Quasi-Peak, above are performed with peak and/or average measurements as necessary.
2. “ \* ”, means this data is the worst emission level.
3. Measurement Level = Reading Level + Correct Factor.
4. The average measurement was not performed when the peak measured data under the limit of average detection. If the readings given are average, peak measurement should also be supplied.

Site : Site 2	Time : 2007/02/09 - 16:55
Limit : FCC_CLASS_B_03M_QP	Margin : 6
EUT : Digital Still Camera	Probe : PRO 06-03-29 ST2 - HORIZONTAL
Power : AC 120V/60Hz	Note : Mode 4: Preview

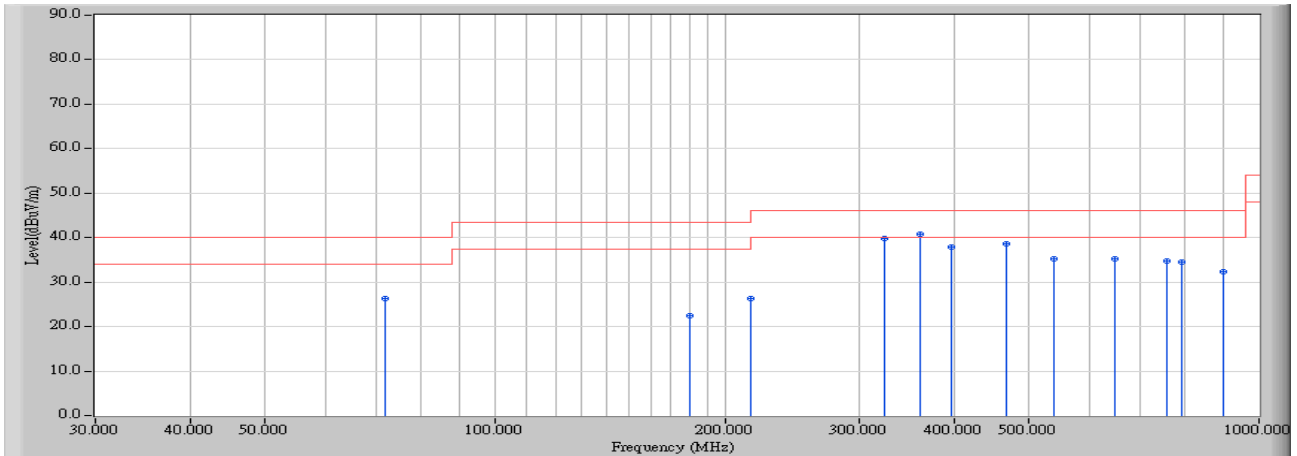

	Frequency (MHz)	Correct Factor (dB)	Reading Level (dBuV)	Measure Level (dBuV/m)	Margin (dB)	Limit (dBuV/m)	Detector Type
1	72.000	7.897	18.420	26.317	-13.683	40.000	QUASPEAK
2	180.000	10.453	11.950	22.403	-21.097	43.500	QUASPEAK
3	216.000	11.873	14.540	26.412	-17.088	43.500	QUASPEAK
4	324.000	16.991	22.800	39.791	-6.209	46.000	QUASPEAK
5	* 360.000	18.306	22.360	40.666	-5.334	46.000	QUASPEAK
6	396.000	19.153	18.630	37.783	-8.217	46.000	QUASPEAK
7	468.000	19.460	19.180	38.640	-7.360	46.000	QUASPEAK
8	540.000	20.501	14.790	35.291	-10.709	46.000	QUASPEAK
9	648.000	24.192	10.940	35.132	-10.868	46.000	QUASPEAK
10	756.000	23.057	11.630	34.687	-11.313	46.000	QUASPEAK
11	792.000	22.764	11.820	34.584	-11.416	46.000	QUASPEAK
12	900.000	26.520	5.910	32.430	-13.570	46.000	QUASPEAK

Note:

1. All Reading Levels are Quasi-Peak value.
2. “ \* ”, means this data is the worst emission level.
3. Measurement Level = Reading Level + Correct Factor.

Site : CB3	Time : 2007/03/02 - 10:47
Limit : FCC_B_(Above_1G)_3M_AV	Margin : 6
EUT : Digital Still Camera	Probe : FCC_RF_1G-18G(2005-3) - HORIZONTAL
Power : AC 120V / 60Hz	Note : Mode 4: Preview

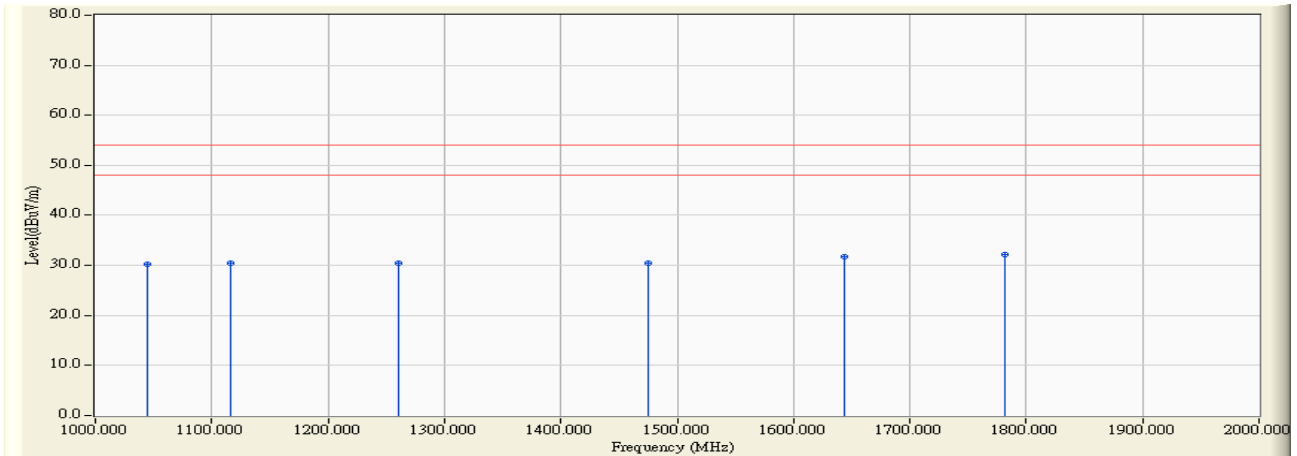

	Frequency (MHz)	Correct Factor (dB)	Reading Level (dBuV)	Measure Level (dBuV/m)	Margin (dB)	Limit (dBuV/m)	Detector Type	Ant Pos (cm)	Table Pos (deg)
1	1044.088	-9.857	40.000	30.143	-23.857	54.000	PEAK	0.000	0.000
2	1116.230	-9.507	39.930	30.423	-23.577	54.000	PEAK	0.000	0.000
3	1260.520	-8.969	39.390	30.421	-23.579	54.000	PEAK	0.000	0.000
4	1474.900	-8.155	38.580	30.425	-23.575	54.000	PEAK	0.000	0.000
5	1643.300	-7.586	39.310	31.725	-22.275	54.000	PEAK	0.000	0.000
6	* 1781.560	-7.035	39.100	32.065	-21.935	54.000	PEAK	0.000	0.000

**Note:**

1. All Readings below 1GHz are Quasi-Peak, above are performed with peak and/or average measurements as necessary.
2. “ \* ”, means this data is the worst emission level.
3. Measurement Level = Reading Level + Correct Factor.
4. The average measurement was not performed when the peak measured data under the limit of average detection. If the readings given are average, peak measurement should also be supplied.

Site : Site 2	Time : 2007/02/09 - 16:39
Limit : FCC_CLASS_B_03M_QP	Margin : 6
EUT : Digital Still Camera	Probe : PRO 06-03-29 ST2 - VERTICAL
Power : AC 120V/60Hz	Note : Mode 4: Preview

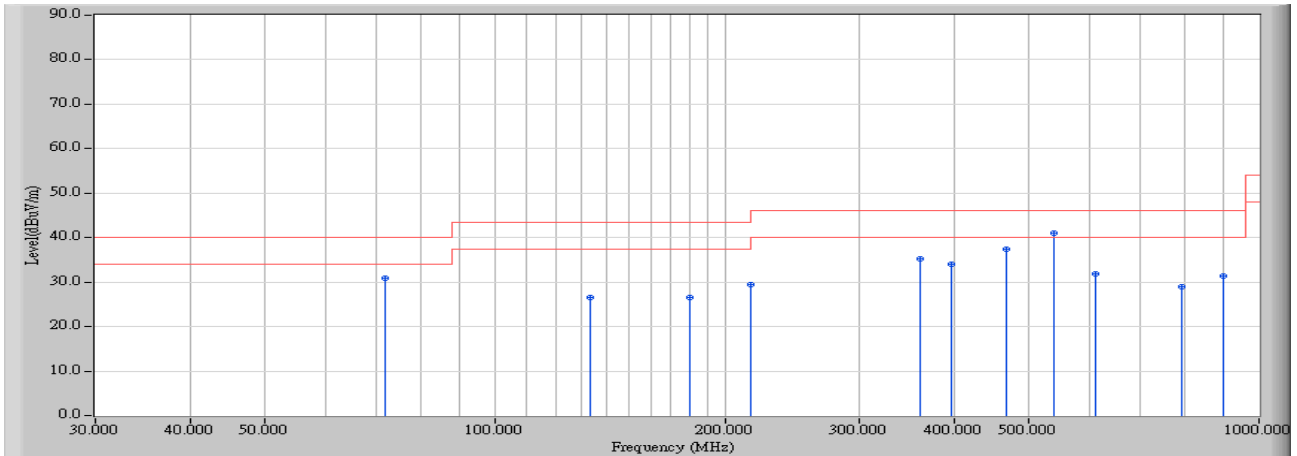

	Frequency (MHz)	Correct Factor (dB)	Reading Level (dBuV)	Measure Level (dBuV/m)	Margin (dB)	Limit (dBuV/m)	Detector Type
1	72.000	10.155	20.780	30.935	-9.065	40.000	QUASPEAK
2	133.550	12.635	13.870	26.505	-16.995	43.500	QUASPEAK
3	180.000	11.054	15.470	26.524	-16.976	43.500	QUASPEAK
4	216.000	11.779	17.610	29.388	-14.112	43.500	QUASPEAK
5	360.000	19.291	15.900	35.191	-10.809	46.000	QUASPEAK
6	396.000	17.844	16.290	34.134	-11.866	46.000	QUASPEAK
7	468.000	19.117	18.220	37.337	-8.663	46.000	QUASPEAK
8	* 540.000	22.608	18.340	40.947	-5.053	46.000	QUASPEAK
9	612.000	21.270	10.610	31.880	-14.120	46.000	QUASPEAK
10	792.000	21.035	8.000	29.034	-16.966	46.000	QUASPEAK
11	900.000	25.318	5.950	31.268	-14.732	46.000	QUASPEAK

**Note:**

1. All Reading Levels are Quasi-Peak value.
2. “ \* ”, means this data is the worst emission level.
3. Measurement Level = Reading Level + Correct Factor.

Site : CB3	Time : 2007/03/02 - 10:51
Limit : FCC_B_(Above_1G)_3M_AV	Margin : 6
EUT : Digital Still Camera	Probe : FCC_RF_1G-18G(2005-3) - VERTICAL
Power : AC 120V / 60Hz	Note : Mode 4: Preview

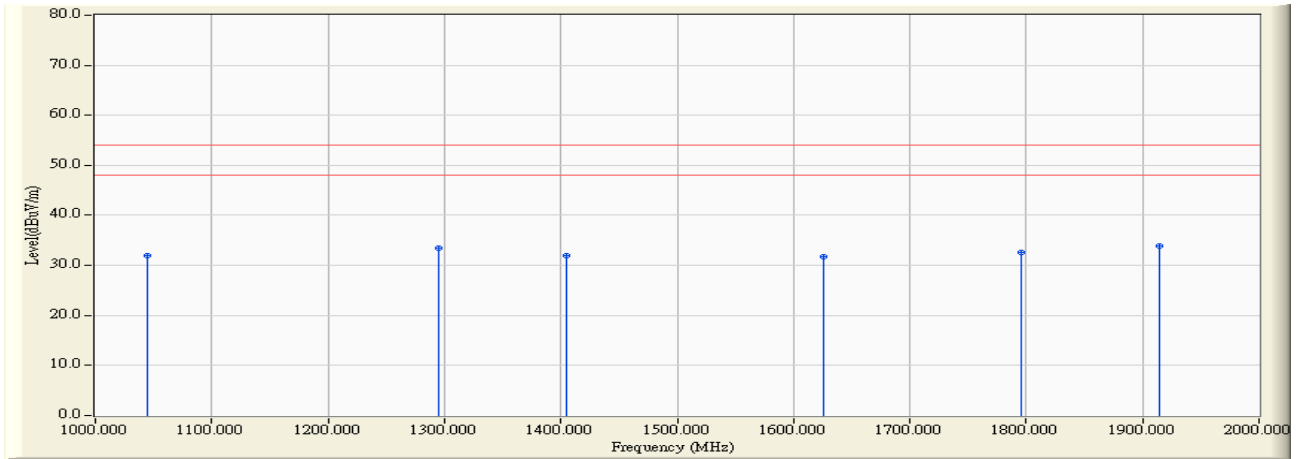

	Frequency (MHz)	Correct Factor (dB)	Reading Level (dBuV)	Measure Level (dBuV/m)	Margin (dB)	Limit (dBuV/m)	Detector Type	Ant Pos (cm)	Table Pos (deg)
1	1044.100	-8.980	40.860	31.880	-22.120	54.000	PEAK	0.000	0.000
2	1294.600	-8.056	41.500	33.443	-20.557	54.000	PEAK	0.000	0.000
3	1404.800	-7.686	39.730	32.044	-21.956	54.000	PEAK	0.000	0.000
4	1625.300	-6.942	38.750	31.808	-22.192	54.000	PEAK	0.000	0.000
5	1795.600	-6.078	38.690	32.612	-21.388	54.000	PEAK	0.000	0.000
6	* 1913.800	-5.647	39.570	33.923	-20.077	54.000	PEAK	0.000	0.000

**Note:**

1. All Readings below 1GHz are Quasi-Peak, above are performed with peak and/or average measurements as necessary.
2. “ \* ”, means this data is the worst emission level.
3. Measurement Level = Reading Level + Correct Factor.
4. The average measurement was not performed when the peak measured data under the limit of average detection. If the readings given are average, peak measurement should also be supplied.