

YAMAGATA INTECH

SONY®

CX60830/840 再校提出

DRAFT 2

- ・ 10/9「CX60830/840_Handbook_再校CHKB」の内容を出来る限り盛り込みました。
- ・ 修正、ご確認、ご連絡箇所にコメント記しております。
- ・ 差替え対応したイラストをマーキング致しました。

以上、ご確認の程よろしくお願い致します。

Cyber-shot

Digital Still Camera

機種名

挿入致しました。ご確認ください

Instruction Manual

GB

DSC-S750/S780



LITHIUM ION ロゴマーク

「仮」で「Type G」のロゴを入れてあります。
データ入手いたしましたらご連絡ください。

ロゴライブラリーへのアップよろしく
お願いします。
(10/18までに)



For details on advanced operations, please read **“Cyber-shot Handbook”** (PDF) and **“Cyber-shot Step-up Guide”** on the CD-ROM (supplied) using a computer.

Operating Instructions

Before operating the unit, please read this manual thoroughly, and retain it for future reference.

特に、ご確認いただきたい箇所には
コメントを入れています。
ご確認をお願い致します。(菊池)

機種名
挿入致しました。ご確認ください

Item 3001

Owner's Record

The model and serial numbers are located on the bottom. Record the serial number in the space provided below. Refer to these numbers whenever you call upon your Sony dealer regarding this product.

Model No. DSC-S750/S780

Serial No. _____

Item 0050

WARNING

To reduce fire or shock hazard, do not expose the unit to rain or moisture.

Item 0060

For Customers in the U.S.A.



CAUTION
RISK OF ELECTRIC SHOCK
DO NOT OPEN



CAUTION: TO REDUCE THE RISK OF ELECTRIC SHOCK,
DO NOT REMOVE COVER (OR BACK).
NO USER-SERVICEABLE PARTS INSIDE.
REFER SERVICING TO QUALIFIED SERVICE PERSONNEL.



This symbol is intended to alert the user to the presence of uninsulated "dangerous voltage" within the product's enclosure that may be of sufficient magnitude to constitute a risk of electric shock to persons.



This symbol is intended to alert the user to the presence of important operating and maintenance (servicing) instructions in the literature accompanying the appliance.

製安課 松本さん

正規Item 記載の確認を
よろしくお願いします。

Item 0680

IMPORTANT SAFEGUARDS

For your protection, please read these safety instructions completely before operating the appliance, and keep this manual for future reference.

Carefully observe all warnings, precautions and instructions on the appliance, or the one described in the operating instructions and adhere to them.

Use

Power Sources

This set should be operated only from the type of power source indicated on the marking label. If you are not sure of the type of electrical power supplied to your home, consult your dealer or local power company. For those sets designed to operate from battery power, or other sources, refer to the operating instructions.

Polarization

This set may be equipped with a polarized ac power cord plug (a plug having one blade wider than the other).

This plug will fit into the power outlet only one way. This is a safety feature. If you are unable to insert the plug fully into the outlet, try reversing the plug. If the plug should still fail to fit, contact your electrician to have a suitable outlet installed. Do not defeat the safety purpose of the polarized plug by forcing it in.

Overloading

Do not overload wall outlets, extension cords or convenience receptacles beyond their capacity, since this can result in fire or electric shock.

Object and Liquid Entry

Never push objects of any kind into the set through openings as they may touch dangerous voltage points or short out parts that could result in a fire or electric shock. Never spill liquid of any kind on the set.

Attachments

Do not use attachments not recommended by the manufacturer, as they may cause hazards.

Item 0680

Cleaning

Unplug the set from the wall outlet before cleaning or polishing it. Do not use liquid cleaners or aerosol cleaners. Use a cloth lightly dampened with water for cleaning the exterior of the set.

Installation

Water and Moisture

Do not use power-line operated sets near water – for example, near a bathtub, washbowl, kitchen sink, or laundry tub, in a wet basement, or near a swimming pool, etc.

Power-Cord Protection

Route the power cord so that it is not likely to be walked on or pinched by items placed upon or against them, paying particular attention to the plugs, receptacles, and the point where the cord exits from the appliance.

Accessories

Do not place the set on an unstable cart, stand, tripod, bracket, or table. The set may fall, causing serious injury to a child or an adult, and serious damage to the set. Use only a cart, stand, tripod, bracket, or table recommended by the manufacturer.

Ventilation

The slots and openings in the cabinet are provided for necessary ventilation. To ensure reliable operation of the set, and to protect it from overheating, these slots and openings must never be blocked or covered.

- Never cover the slots and openings with a cloth or other materials.
- Never block the slots and openings by placing the set on a bed, sofa, rug, or other similar surface.
- Never place the set in a confined space, such as a bookcase, or built-in cabinet, unless proper ventilation is provided.
- Do not place the set near or over a radiator or heat register, or where it is exposed to direct sunlight.

Lightning

For added protection for this set during a lightning storm, or when it is left unattended and unused for

long periods of time, unplug it from the wall outlet and disconnect the antenna or cable system. This will prevent damage to the set due to lightning and power-line surges.

Service

Damage Requiring Service

Unplug the set from the wall outlet and refer servicing to qualified service personnel under the following conditions:

- When the power cord or plug is damaged or frayed.
- If liquid has been spilled or objects have fallen into the set.
- If the set has been exposed to rain or water.
- If the set has been subject to excessive shock by being dropped, or the cabinet has been damaged.
- If the set does not operate normally when following the operating instructions. Adjust only those controls that are specified in the operating instructions. Improper adjustment of other controls may result in damage and will often require extensive work by a qualified technician to restore the set to normal operation.
- When the set exhibits a distinct change in performance – this indicates a need for service.

Servicing

Do not attempt to service the set yourself as opening or removing covers may expose you to dangerous voltage or other hazards. Refer all servicing to qualified service personnel.

Replacement parts

When replacement parts are required, be sure the service technician has used replacement parts specified by the manufacturer that have the same characteristics as the original parts. Unauthorized substitutions may result in fire, electric shock, or other hazards.

Safety Check

Upon completion of any service or repairs to the set, ask the service technician to perform routine safety checks (as specified by the manufacturer) to determine that the set is in safe operating condition.

Read this first

Item 0230

CAUTION

Replace the battery with the specified type only. Otherwise, fire or injury may result.

Item 0740

Do not expose the batteries to excessive heat such as sunshine, fire or the like.

Item 2002

For Customers in the U.S.A. and Canada

RECYCLING LITHIUM-ION BATTERIES

Lithium-Ion batteries are recyclable.

You can help preserve our environment by returning your used rechargeable batteries to the collection and recycling location nearest you.

For more information regarding recycling of rechargeable batteries, call toll free 1-800-822-8837, or visit <http://www.rbrc.org/>

Caution: Do not handle damaged or leaking Lithium-Ion batteries.



Item 0410

Battery pack

This device complies with Part 15 of the FCC Rules. Operation is subject to the following two conditions:

(1) This device may not cause harmful interference, and (2) this device must accept any interference received, including interference that may cause undesired operation.

This Class B digital apparatus complies with Canadian ICES-003.

Item 0720

Battery charger

This power unit is intended to be correctly orientated in a vertical or floor mount position.

For Customers in the U.S.A.

This device complies with Part 15 of the FCC Rules. Operation is subject to the following two conditions: (1) This device may not cause harmful interference, and (2) this device must accept any interference received, including interference that may cause undesired operation.

CAUTION

You are cautioned that any changes or modifications not expressly approved in this manual could void your authority to operate this equipment.

Note:

This equipment has been tested and found to comply with the limits for a Class B digital device, pursuant to Part 15 of the FCC Rules. These limits are designed to provide reasonable protection against harmful interference in a residential installation. This equipment generates, uses, and can radiate radio frequency energy and, if not installed and used in accordance with the instructions, may cause harmful interference to radio communications. However, there is no guarantee that interference will not occur in a particular installation. If this equipment does cause harmful interference to radio or television reception, which can be determined by turning the equipment off and on, the user is encouraged to try to correct the interference by one or more of the following measures:

- Reorient or relocate the receiving antenna.
- Increase the separation between the equipment and receiver.
- Connect the equipment into an outlet on a circuit different from that to which the receiver is connected.
- Consult the dealer or an experienced radio/TV technician for help.

The supplied interface cable must be used with the equipment in order to comply with the limits for a digital device pursuant to Subpart B of Part 15 of FCC Rules.

Item 009a

Item 0070

Item 0090

Item 0100

大変失礼致しました。
ピリオド挿入致しました。
ご確認ください。

Item 2007

For the State of California, USA only

Perchlorate Material - special handling may apply, See www.dtsc.ca.gov/hazardouswaste/perchlorate
Perchlorate Material : Lithium battery contains perchlorate.

Item 0450

For Customers in Europe

This product has been tested and found compliant with the limits set out in the EMC Directive for using connection cables shorter than 3 meters (9.8 feet).

Item 0350

Attention

The electromagnetic fields at the specific frequencies may influence the picture and sound of this unit.

Item 0630

Notice

If static electricity or electromagnetism causes data transfer to discontinue midway (fail), restart the application or disconnect and connect the communication cable (USB, etc.) again.

Item 2001

Disposal of Old Electrical & Electronic Equipment (Applicable in the European Union and other European countries with separate collection systems)



This symbol on the product or on its packaging indicates that this product shall not be treated as household waste. Instead it shall be handed over to the applicable collection point for the recycling of electrical and electronic equipment. By ensuring this product is disposed of correctly, you will help prevent potential negative consequences for the environment and human health, which could otherwise be caused by inappropriate waste handling of this product. The recycling of materials will help to conserve natural resources. For more detailed information about recycling of this product, please contact your local Civic Office, your household waste disposal service or the shop where you purchased the product.

EU 電池指令

Disposal of waste batteries (applicable in the European Union and other European countries with separate collection systems)



This symbol on the battery or on the packaging indicates that the battery provided with this product shall not be treated as household waste.

By ensuring these batteries are disposed of correctly, you will prevent potentially negative consequences for the environment and human health which could otherwise be caused by inappropriate waste handling of the battery. The recycling of the materials will help to conserve natural resources.

In case of products that for safety, performance or data integrity reasons require a permanent connection with an incorporated battery, this battery should be replaced by qualified service staff only.

To ensure that the battery will be treated properly, hand over the product at end-of-life to the applicable collection point for the recycling of electrical and electronic equipment.

For all other batteries, please view the section on how to remove the battery from the product safely. Hand the battery over to the applicable collection point for the recycling of waste batteries.

For more detailed information about recycling of this product or battery, please contact your local Civic Office, your household waste disposal service or the shop where you purchased the product.

Notice for the customers in the countries applying EU Directives

Item 0730

The manufacturer of this product is Sony Corporation, 1-7-1 Konan Minato-ku Tokyo, 108-0075 Japan. The Authorized Representative for EMC and product safety is Sony Deutschland GmbH, Hedelfinger Strasse 61, 70327 Stuttgart, Germany. For any service or guarantee matters please refer to the addresses given in separate service or guarantee documents.

Notice for customers in the United Kingdom

Item 0180

A moulded plug complying with BS 1363 is fitted to this equipment for your safety and convenience.

Should the fuse in the plug supplied need to be replaced, a fuse of the same rating as the supplied one and approved by ASTA or BSI to BS 1362, (i.e., marked with an ⬠ or ⬡ mark) must be used.

If the plug supplied with this equipment has a detachable fuse cover, be sure to attach the fuse cover after you change the fuse. Never use the plug without the fuse cover. If you should lose the fuse cover, please contact your nearest Sony service station.

Table of contents

IMPORTANT SAFEGUARDS	2
Read this first	4
Notes on using your camera	8
Getting started	9
Checking the accessories supplied	9
1 Preparing the battery pack	10
2 Inserting the battery pack/a "Memory Stick Duo" (not supplied)	11
3 Turning the camera on/setting the clock	13
Shooting images easily	14
Mode dial/Zoom/Flash/Macro/Self-timer/Display/Image size	15
Viewing/deleting images	17
Indicators on the screen	19
Changing the settings – Menu/Setup	21
Menu items	22
Setup items	23
Enjoying your computer	24
Supported Operating Systems for USB connection and application software (supplied)	24
Viewing "Cyber-shot Handbook"	25
Battery life and memory capacity	26
Battery life and number of images you can record/view	26
Number of still images and recording time of movies	27
Troubleshooting	29
Battery pack and power	29
Shooting still images/movies	30
Viewing images	30
Precautions	31
Specifications	32

Notes on using your camera

Internal memory and “Memory Stick Duo” back up

Do not turn off the camera, remove the battery pack, or remove the “Memory Stick Duo” while the access lamp is lit. Otherwise, the internal memory data or “Memory Stick Duo” may be damaged. Be sure to make a backup copy to protect your data.

Notes on recording/playback

- Before you start recording, make a trial recording to make sure that the camera is working correctly.
- The camera is neither dust-proof, nor splash-proof, nor water-proof. Read “Precautions” (page 31) before operating the camera.
- Avoid exposing the camera to water. If water enters inside the camera, a malfunction may occur. In some cases, the camera cannot be repaired.
- Do not aim the camera at the sun or other bright light. It may cause the malfunction of the camera.
- Do not use the camera near a location that generates strong radio waves or emits radiation. Otherwise, the camera may not properly record or play back images.
- Using the camera in sandy or dusty locations may cause malfunctions.
- If moisture condensation occurs, remove it before using the camera (page 31).
- Do not shake or strike the camera. It may cause a malfunction and you may not be able to record images. Furthermore, the recording media may become unusable or image data may be damaged.
- Clean the flash surface before use. The heat of flash emission may cause dirt on the flash surface to become discolored or to stick to the flash surface, resulting in insufficient light emission.

Notes on the LCD screen and lens

- The LCD screen is manufactured using extremely high-precision technology, so over 99.99% of the pixels are operational for effective use. However, some tiny black and/or bright dots (white, red, blue or green) may appear on the LCD screen. These dots are a normal result of the manufacturing process, and do not affect the recording.
- When the battery level becomes low, the lens might stop moving. Insert a charged battery pack and turn on the camera again.

On image data compatibility

- The camera conforms with DCF (Design rule for Camera File system) universal standard established by JEITA (Japan Electronics and Information Technology Industries Association).
- Sony does not guarantee that the camera will play back images recorded or edited with other equipment, or that other equipment will play back images recorded with the camera.

Warning on copyright

Television programs, films, videotapes, and other materials may be copyrighted. Unauthorized recording of such materials may be contrary to the provisions of the copyright laws.

No compensation for damaged content or recording failure

Sony cannot compensate for failure to record or loss or damage of recorded content due to a malfunction of the camera or recording media, etc.

On illustrations

Illustrations used in this manual are of the DSC-S750 unless noted otherwise.

DSC-S750を挿入致しました。
ご確認ください。

イラスト、最終チェックになります。ご確認ください。

同梱物
ご確認をお願い致します。

Getting started

バッテリーパック
機種名、挿入致しました。ご確認ください。

Checking the accessories supplied

- Battery charger BC-CSK (1)

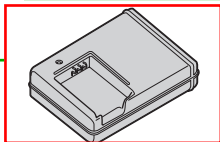

- Power cord (mains lead) (1)
(not supplied in the USA and Canada)



- Rechargeable battery pack NP-BK1 (1)

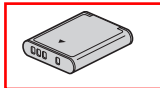

- Dedicated USB cable (1)

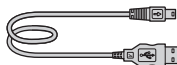

- Dedicated A/V cable (1)

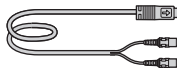

- Wrist strap (1)



- CD-ROM (1)
 - Cyber-shot application software
 - “Cyber-shot Handbook”
 - “Cyber-shot Step-up Guide”
- Instruction Manual (this manual) (1)

Attach the strap to prevent the camera from damage by being dropped.

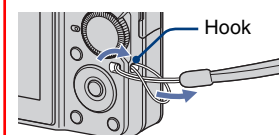

カテゴリーマニュアルより、H3の文言を現在の文言に修正致しました。ご確認ください。

1 Preparing the battery pack

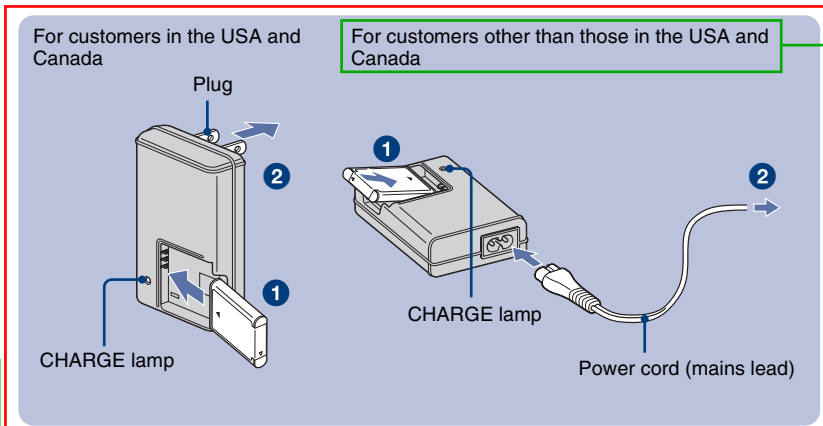

ご支給頂きました文言の「battery」を「battery pack」に修正して挿入いたしました。ご確認ください。

1 Insert the battery pack into the battery charger.

- Insert the battery pack as far as it will go, then press the back of the battery pack gently until it clicks.

2 Connect the battery charger to the wall outlet (wall socket).

The CHARGE lamp lights up, and charging starts.

When the CHARGE lamp turns off, charging is finished (Practical charge). Also, the CHARGE lamp may turn off when the temperature is outside of the recommended operating temperature (0 to 40°C), as the charger is on standby.

10~ 30

Normal charge

Charging time

Full charge time	Practical charge time
Approx. xxx min.	Approx. xxx min.

数値
ご確認ください。

バッテリー充電時間 (満充電/実用充電) 決まり次第ご連絡ください。

- The table above shows the time required to charge a fully depleted battery pack at a temperature of 25 °C (77 °F). Charging may take longer depending on conditions of use and circumstances.
- See page 26 for the number of images that can be recorded.
- Connect the battery charger to the nearest wall outlet (wall socket).

Item 0280

- Even if the CHARGE lamp is not lit, the battery charger is not disconnected from the AC power source (mains) as long as it is connected to the wall outlet (wall socket). If some trouble occurs while using the battery charger, immediately shut off the power by disconnecting the plug from the wall outlet (wall socket).

- When charging is finished, disconnect the power cord (mains lead) from the wall outlet (wall socket), and remove the battery pack from the battery charger.

- Designed for use with compatible Sony batteries.

< 質問 >

・「推奨温度範囲外では充電待機状態になってしまう」「推奨温度範囲内に戻れば充電は再開される」と判断してよろしいでしょうか？

・スペックの「動作温度」は「0-40」となっております。「動作温度」は0-40。「推奨温度」は10-30。ということよろしいでしょうか？

ご支給頂きました日本語を英訳（ネイティブチェック済み）して挿入致しました。ご確認ください。

< 日本語 >

推奨温度範囲外の場合、充電待機状態となってCHARGEランプが消灯していることがあります。(推奨温度範囲 : 10~ 30)

バッテリー側の マークについて、他機種では「～側にある マーク」とマークの箇所を示していましたが、このバッテリーにおいて、マークがある箇所を「～側」と説明することが出来ませんでしたので、あえて、「バッテリーの マーク」とボカして説明しております。ご確認ください。

2 Inserting the battery pack/a “Memory Stick Duo” (not supplied)

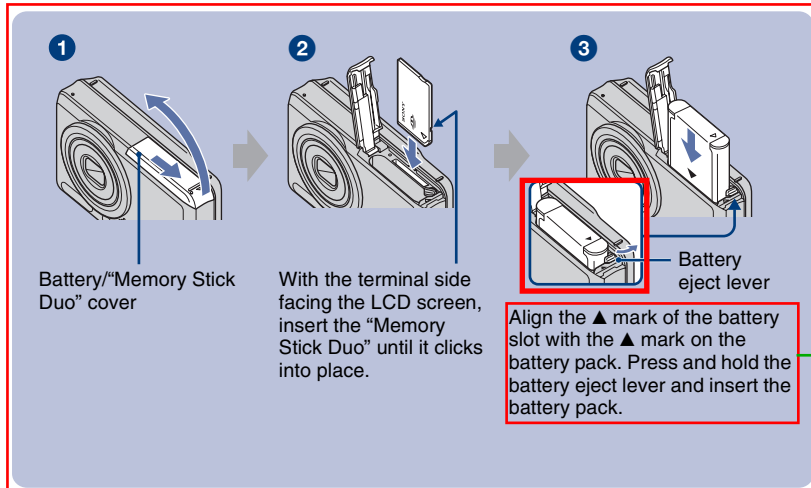

- ① Open the battery/“Memory Stick Duo” cover.
- ② Insert the “Memory Stick Duo” (not supplied).
- ③ Insert the battery pack.
- ④ Close the battery/“Memory Stick Duo” cover.

9/21のイラストチェックより、バッテリーエジェクトレバー及び、マークの位置が変更になったため、イラスト修正しております。ご確認ください。

When there is no “Memory Stick Duo” inserted

The camera records/plays back images using the internal memory (approx. 22 MB).

内蔵メモリー
どちらの機種も22MBのため、初校提出の状態に戻しました。ご確認ください。

To check the remaining battery charge

Press POWER to turn on and check the remaining battery charge on the LCD screen.

Remaining charge indicator					
Status	Sufficient power remaining	Battery almost fully charged	Battery half full	Battery low, recording/playback will stop soon.	Change the battery to a fully charged one, or charge the battery. (The warning indicator flashes.)

P社ご指摘の文章に変更致しました（ネイティブチェック済み）。ご確認ください。

- It takes about one minute until the correct remaining charge indicator appears.
- The remaining charge indicator may not be correct depending on conditions of use and circumstances.
- The Clock Set screen appears when you turn on the camera for the first time (page 13).

To remove the battery pack/“Memory Stick Duo”

Open the battery/“Memory Stick Duo” cover.

レイアウト
H3に合わせました。

“Memory Stick Duo”

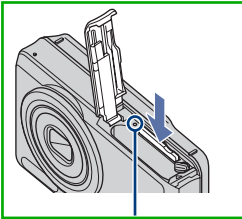

Make sure that **the access lamp** is not lit, then push the “Memory Stick Duo” in once.

Battery pack

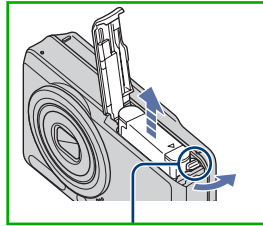

Slide **the battery eject lever**.
Be sure not to drop the battery pack.

- Never remove the battery pack/“Memory Stick Duo” when the access lamp is lit. This may cause damage to data in the “Memory Stick Duo”/internal memory.

3 Turning the camera on/setting the clock

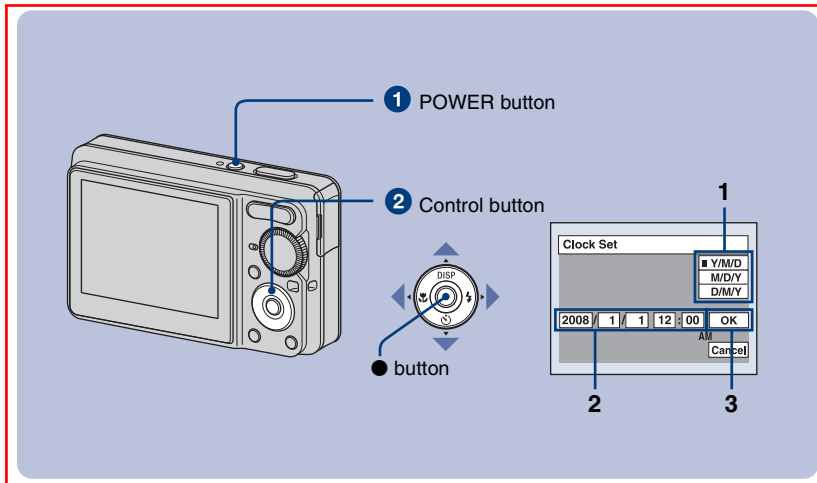

1 Press POWER.

2 Set the clock with the control button.

- 1 Select the date display format with ▲/▼, then press ●.
- 2 Select each item with ◀/▶ and set the numeric value with ▲/▼, then press ●.
- 3 Select [OK] with ▶, then press ●.

To change the date and time

Select [Clock Set] in the (Setup) screen (page 21).

When you turn on the power

- Unless you set the clock, the Clock Set screen appears each time the camera is turned on.
- If the camera is running on battery power and you do not operate the camera for about three minutes, the camera turns off automatically to prevent wearing down the battery pack (Auto power-off function).

<081Hブラッシュアップ>
により追加をお願いします。

・本機には像に日付を挿入する機能はありません。「Picture Motion Browser」を使用すると、日付を入れて保存/印刷ができます。
・真夜中は12:00AM、正午は12:00PMです。

・ The camera does not have a feature for superimposing dates on images. By using "Picture Motion Browser", you can print or save images with the date.
・ Midnight is indicated as 12:00 AM, and noon as 12:00 PM.

Shooting images easily

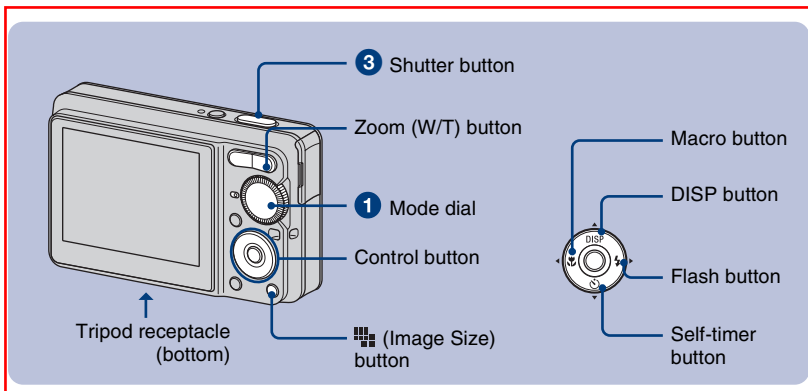

1 Select a mode with the mode dial.

Still image (auto adjustment mode): Select .

Movie: Select .

2 Hold the camera steady, keeping your arms at your side.



Position the subject in the center of the focus frame.

3 Shoot with the shutter button.

Still image:

1 Press and hold the shutter button halfway down to focus.

The ● (AE/AF lock) indicator (green) flashes, a beep sounds, the indicator stops flashing and remains lit.

2 Press the shutter button fully down.

The shutter sounds.

AE/AF lock indicator

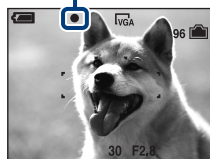

Movie:

Press the shutter button fully down.

To stop recording, press the shutter button fully down again.

Mode dial/Zoom/Flash/Macro/Self-timer/Display/Image size

Using the mode dial

Set the mode dial to the desired function.

Auto Adjustment

Allows easy shooting with the settings adjusted automatically.

P Program Auto

Allows you to shoot with the exposure adjusted automatically (both the shutter speed and the aperture value). You can adjust other settings using the menu.

Movie

Allows you to record movies.

High Sensitivity

Shoots images without a flash even in low lighting.

Soft Snap

Shoots a person's skin with a warmer look.

Landscape

Shoots with the focus on a distant subject.

Twilight Portrait

Shoots sharp images of people in a dark place without losing the nighttime atmosphere.

Twilight

Shoots night scenes without losing the nighttime atmosphere.

Beach

Shoots seaside or lakeside scenes with the blueness of the water captured more vividly.

Snow

Shoots snow scenes in white more clearly.

W/T Using the zoom

Press T to zoom, press W to undo zoom.

Flash (Selecting a flash mode for still images)

Press  on the control button repeatedly until the desired mode is selected.

(No indicator): Flash Auto

Strobes when there is insufficient light (default setting).

: Flash forced on

: Slow synchro (Flash forced on)

The shutter speed is slow in a dark place to clearly shoot the background that is out of flash light.

: Flash forced off

Macro (Shooting close-up)

Press  on the control button repeatedly until the desired mode is selected.

(No indicator): Macro Off

: Macro On (W side: Approx. 5 cm or farther (2 inches or farther), T side: Approx. 35 cm or farther (13 7/8 inches or farther) from the front of the lens)

CX60800に合わせて修正しております
(from the front of the lens を挿入) 。
ご確認ください。

機種名
 挿入致しました。ご確認ください

3:2を1項目削除させて頂きました。
 ご確認ください。

Using the self-timer

Press \blacktriangledown (Ⓢ) on the control button repeatedly until the desired mode is selected.

(No indicator): Not using the self-timer
 10 : Setting the 10-second delay self-timer
 2 : Setting the 2-second delay self-timer

When you press the shutter button, the self-timer lamp flashes and a beep sounds until the shutter operates.

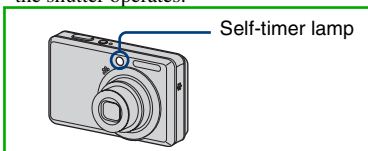

Self-timer lamp

DISP Changing the screen display

Press \blacktriangle (DISP) on the control button. Each time you press \blacktriangle (DISP), the display changes as follows:

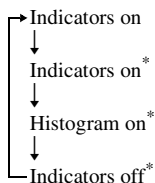

*The brightness of the LCD Backlight up

To change the still image size

Press Image Size (Image Size), then press $\blacktriangle/\blacktriangledown$ to select the size. To turn off the Image Size menu, press Image Size again.

Image size	Guidelines
8M : 8M (DSC-S780 only)	Up to A3/11x17" print
7M : 7M (DSC-S750 only)	Up to A3/11x17" print
3:2 : 3:2	Match 3:2 Aspect Ratio
5M : 5M	Up to A4/8x10" print
3M : 3M	Up to 13x18cm /5x7" print
VGA : VGA	For E-mail
16:9 : 16:9	Display On 16:9 HDTV

Viewing/deleting images

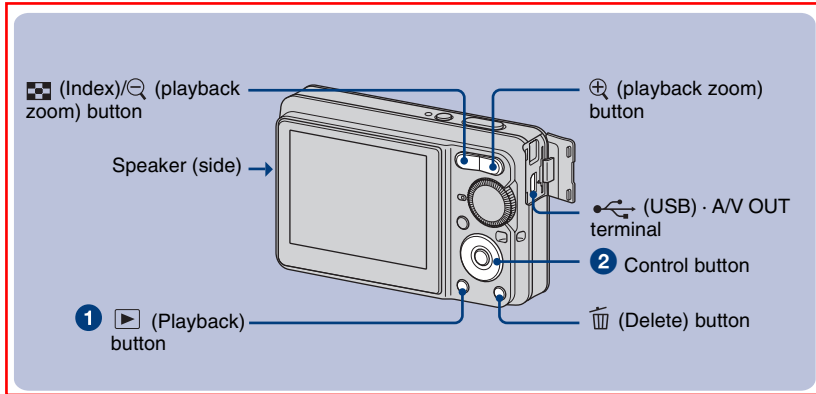

1 Press (Playback).

If you press when the camera is powered off, the camera is turned on automatically and set to playback mode. To switch to the shooting mode, press again.

2 Select an image with /▶ on the control button.

Movie:

Press to play back a movie. (Press again to stop playback.)

Press to fast forward, to rewind. (Press to return to normal playback.)

Press to display the volume control screen, then press /▶ to adjust the volume.

Handbook同様、Volumeの記載を変更致しました。ご確認ください。

To delete images

1 Display the image you want to delete and press (Delete).

2 Select [Delete] with , then press .

To view an enlarged image (playback zoom)

Press while displaying a still image.

To undo the zoom, press .

Adjust the position with /▼/◀/▶.









To cancel the playback zoom, press .

To view an index screen

Press (Index) and select an image with /▼/◀/▶. To display the next (previous) index screen, press .

To return to the single image screen, press .

To delete images in index mode

- 1 While an index screen is displayed, press  (Delete) and select [Select] with  on the control button, then press .
- 2 Select the image you want to delete with , then press  to display the  (Delete) indicator on the selected image.
- 3 Press  (Delete).
- 4 Select [OK] with , then press .

To view images on TV

Connect the camera to the TV with the dedicated A/V cable (supplied).

- Align the arrow mark on the dedicated A/V cable connector with the  mark beside the A/V OUT terminal and connect the cable to the camera.

CX60800と同様の文言を挿入致しました。ご確認ください。

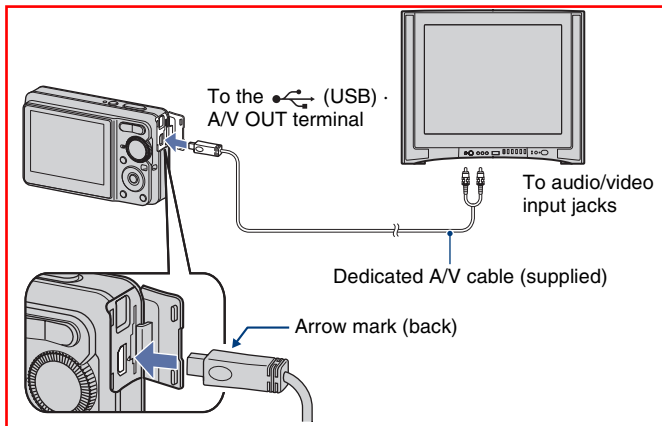

この箇所のみ、マークに変更しておりました。失礼致しました。

9/21のイラストチェックより、イラストと引き出し線を修正致しました。ご確認ください。

Indicators on the screen

Each time you press ▲ (DISP) on the control button, the display changes (page 15).

When shooting still images

顔検出マークを挿入致しました。(10/10現在、イラストチェック出し、ご確認中) ご確認ください。

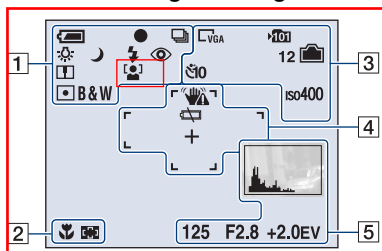

When shooting movies

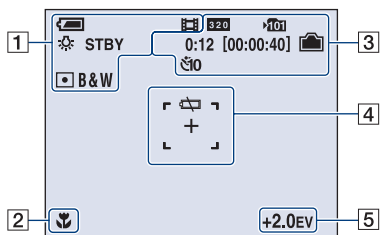

When playing back

VOLUMEアイコンの「上」を削除致しました。(10/10現在、イラストチェック出し、ご確認中) ご確認ください。

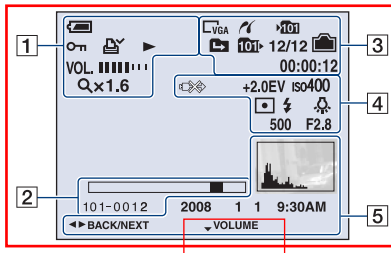

「1.6」に修正致しました。ご確認ください。

1		Battery remaining
		AE/AF lock
		Recording mode
		White balance
		Standby/Recording a movie
		Mode dial (Scene Selection)
		Mode dial (Program Auto)
		Camera mode
		Playback mode
		Flash mode
		Flash charging
		Zoom scaling
		Red-eye reduction
		Sharpness
		Face Detection
		Metering mode
		Color mode
		Protect
		Print order (DPOF) mark
		Zoom scaling
		Playback
		Volume

Handbook同様、再生ズームの値も「1.6」に修正致しました。ご確認ください。

顔検出の項目を挿入致しました。ご確認ください。

機種名
 挿入致しました。ご確認ください

	Macro
	AF range finder frame indicator
1.0m	Focus preset distance
101-0012	Folder-file number
	Playback bar

	PictBridge connecting
	Image size <ul style="list-style-type: none"> • 8M is displayed only for the DSC-S780. • 7M is displayed only for the DSC-S750.
	Recording folder
	Changing folder
	Playback folder
	Remaining internal memory capacity
	Remaining "Memory Stick" capacity
0:12 [00:00:40]	Recording time [maximum recordable time]
12	Remaining number of recordable images
	Self-timer
iso400	ISO number
12/12	Image number/Number of images recorded in selected folder
00:00:12	Counter

	Vibration warning
	Low battery warning
	PictBridge connecting
+2.0EV	Exposure Value
iso400	ISO number
	Metering mode
	Flash
	White balance
+	Spot metering cross hairs
	AF range finder frame
500	Shutter speed
F2.8	Aperture value

	Histogram
125	Shutter speed
F2.8	Aperture value
+2.0EV	Exposure Value
2008 1 1 9:30 AM	Recorded date/time of the playback image
	Selecting images
	Adjusting volume
	Menu

VOLUMEマーク
 画面イラストに合わせておりませ
 ん。
 VOLUMEアイコンが決まりましたら
 修正させていただきます。
 ご了承ください。

顔検出マークを挿入致しました。
 (10/10現在、イラストチェック出し、ご確認中)
 ご確認ください。