



YAMAGATA INTECH

DRAFT 1

SONY®

初校提出

- * 修正対応した箇所、ご確認頂きたい箇所、にコメントさせて頂いております。
- * 数値確認しましたら、ご連絡ください。

Cyber-shot

Digital Still Camera

Instruction Manual

GB

DSC-S650/S700

機種名ご確認下さい。

OK. ありがとうございました。



For details on the advanced operations, please access “Cyber-shot Handbook” contained on the supplied CD-ROM via a computer.

Operating Instructions

Before operating the unit, please read this manual thoroughly, and retain it for future reference.

「Owner's Record」を次ページへ移動させました。ご確認ください。

OK. ありがとうございました。

© 2007 Sony Corporation

2-897-955-12(1)

部番ご確認下さい。

OKです。





前頁より移動させました。ご確認ください。

OK。ありがとうございました。

Owner's Record

The model and serial numbers are located on the bottom. Record the serial number in the space provided below. Refer to these numbers whenever you call upon your Sony dealer regarding this product.

Model No. DSC-S650/S700

Serial No. _____

WARNING

To reduce fire or shock hazard, do not expose the unit to rain or moisture.

For Customers in the U.S.A.

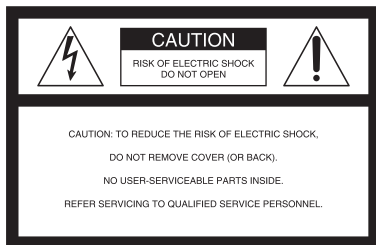

This symbol is intended to alert the user to the presence of uninsulated "dangerous voltage" within the product's enclosure that may be of sufficient magnitude to constitute a risk of electric shock to persons.



This symbol is intended to alert the user to the presence of important operating and maintenance (servicing) instructions in the literature accompanying the appliance.

IMPORTANT SAFEGUARDS

For your protection, please read these safety instructions completely before operating the appliance, and keep this manual for future reference.

Carefully observe all warnings, precautions and instructions on the appliance, or the one described in the operating instructions and adhere to them.

Use

Power Sources

This set should be operated only from the type of power source indicated on the marking label. If you are not sure of the type of electrical power supplied to your home, consult your dealer or local power company. For those sets designed to operate from battery power, or other sources, refer to the operating instructions.

Polarization

This set may be equipped with a polarized ac power cord plug (a plug having one blade wider than the other).

This plug will fit into the power outlet only one way. This is a safety feature. If you are unable to insert the plug fully into the outlet, try reversing the plug. If the plug should still fail to fit, contact your electrician to have a suitable outlet installed. Do not defeat the safety purpose of the polarized plug by forcing it in.

Overloading

Do not overload wall outlets, extension cords or convenience receptacles beyond their capacity, since this can result in fire or electric shock.

Object and Liquid Entry

Never push objects of any kind into the set through openings as they may touch dangerous voltage points or short out parts that could result in a fire or electric shock. Never spill liquid of any kind on the set.

Attachments

Do not use attachments not recommended by the manufacturer, as they may cause hazards.





Cleaning

Unplug the set from the wall outlet before cleaning or polishing it. Do not use liquid cleaners or aerosol cleaners. Use a cloth lightly dampened with water for cleaning the exterior of the set.

Installation

Water and Moisture

Do not use power-line operated sets near water – for example, near a bathtub, washbowl, kitchen sink, or laundry tub, in a wet basement, or near a swimming pool, etc.

Power-Cord Protection

Route the power cord so that it is not likely to be walked on or pinched by items placed upon or against them, paying particular attention to the plugs, receptacles, and the point where the cord exits from the appliance.

Accessories

Do not place the set on an unstable cart, stand, tripod, bracket, or table. The set may fall, causing serious injury to a child or an adult, and serious damage to the set. Use only a cart, stand, tripod, bracket, or table recommended by the manufacturer.

Ventilation

The slots and openings in the cabinet are provided for necessary ventilation. To ensure reliable operation of the set, and to protect it from overheating, these slots and openings must never be blocked or covered.

- Never cover the slots and openings with a cloth or other materials.
- Never block the slots and openings by placing the set on a bed, sofa, rug, or other similar surface.
- Never place the set in a confined space, such as a bookcase, or built-in cabinet, unless proper ventilation is provided.
- Do not place the set near or over a radiator or heat register, or where it is exposed to direct sunlight.

Lightning

For added protection for this set during a lightning storm, or when it is left unattended and unused for

long periods of time, unplug it from the wall outlet and disconnect the antenna or cable system. This will prevent damage to the set due to lightning and power-line surges.

Service

Damage Requiring Service

Unplug the set from the wall outlet and refer servicing to qualified service personnel under the following conditions:

- When the power cord or plug is damaged or frayed.
- If liquid has been spilled or objects have fallen into the set.
- If the set has been exposed to rain or water.
- If the set has been subject to excessive shock by being dropped, or the cabinet has been damaged.
- If the set does not operate normally when following the operating instructions. Adjust only those controls that are specified in the operating instructions. Improper adjustment of other controls may result in damage and will often require extensive work by a qualified technician to restore the set to normal operation.
- When the set exhibits a distinct change in performance – this indicates a need for service.

Servicing

Do not attempt to service the set yourself as opening or removing covers may expose you to dangerous voltage or other hazards. Refer all servicing to qualified service personnel.

Replacement parts

When replacement parts are required, be sure the service technician has used replacement parts specified by the manufacturer that have the same characteristics as the original parts. Unauthorized substitutions may result in fire, electric shock, or other hazards.

Safety Check

Upon completion of any service or repairs to the set, ask the service technician to perform routine safety checks (as specified by the manufacturer) to determine that the set is in safe operating condition.





Read this first

For Customers in the U.S.A.

This device complies with Part 15 of the FCC Rules. Operation is subject to the following two conditions: (1) This device may not cause harmful interference, and (2) this device must accept any interference received, including interference that may cause undesired operation.

CAUTION

You are cautioned that any changes or modifications not expressly approved in this manual could void your authority to operate this equipment.

Note:

This equipment has been tested and found to comply with the limits for a Class B digital device, pursuant to Part 15 of the FCC Rules.

These limits are designed to provide reasonable protection against harmful interference in a residential installation. This equipment generates, uses, and can radiate radio frequency energy and, if not installed and used in accordance with the instructions, may cause harmful interference to radio communications. However, there is no guarantee that interference will not occur in a particular installation. If this equipment does cause harmful interference to radio or television reception, which can be determined by turning the equipment off and on, the user is encouraged to try to correct the interference by one or more of the following measures:

- Reorient or relocate the receiving antenna.
- Increase the separation between the equipment and receiver.
- Connect the equipment into an outlet on a circuit different from that to which the receiver is connected.
- Consult the dealer or an experienced radio/TV technician for help.

The supplied interface cable must be used with the equipment in order to comply with the limits for a digital device pursuant to Subpart B of Part 15 of FCC Rules.

For the State of California, USA only

Perchlorate Material - special handling may apply. See www.dtsc.ca.gov/hazardouswaste/perchlorate

Perchlorate Material : Lithium battery contains perchlorate





For Customers in Europe

This product has been tested and found compliant with the limits set out in the EMC Directive for using connection cables shorter than 3 meters (9.8 feet).

Attention

The electromagnetic fields at the specific frequencies may influence the picture and sound of this unit.

Notice

If static electricity or electromagnetism causes data transfer to discontinue midway (fail), restart the application or disconnect and connect the communication cable (USB, etc.) again.

Disposal of Old Electrical & Electronic Equipment (Applicable in the European Union and other European countries with separate collection systems)



This symbol on the product or on its packaging indicates that this product shall not be treated as household waste. Instead it shall be handed over to the applicable collection point for the recycling of electrical and electronic equipment. By ensuring this product is disposed of correctly, you will help prevent potential negative consequences for the environment and human health, which could otherwise be caused by inappropriate waste handling of this product. The recycling of materials will help to conserve natural resources. For more detailed information about recycling of this product, please contact your local Civic Office, your household waste disposal service or the shop where you purchased the product.





Notes on using your camera

Internal memory and “Memory Stick Duo” back up

Do not turn off the camera or remove the batteries or “Memory Stick Duo” while the access lamp is lighted, as the internal memory data or “Memory Stick Duo” data may be destroyed. Always protect your data by making a back up copy.

Notes on recording/playback

- This camera is neither dust-proof, nor splash-proof, nor water-proof. Read “Precautions” (page 29) before operating the camera.
- Before you record one-time events, make a trial recording to make sure that the camera is working correctly.
- Be careful not to get the camera wet. Water entering the inside of the camera may cause malfunctions which in some cases may not be repairable.
- Do not aim the camera at the sun or other bright light. It may cause the malfunction of your camera.
- Do not use the camera near a location that generates strong radio waves or emits radiation. The camera may not be able to record or play back properly.
- Using the camera in sandy or dusty locations may cause malfunctions.
- If moisture condensation occurs, remove it before using the camera (page 29).
- Do not shake or strike the camera. In addition to malfunctions and an inability to record images, this may render the recording medium unusable, or cause image data breakdown, damage or loss.
- Clean the flash surface before use. The heat of flash emission may cause dirt on the flash surface to become discolored or to stick to the flash surface, resulting in insufficient light emission.

Notes on the LCD screen

- The LCD screen is manufactured using extremely high-precision technology so over 99.99% of the pixels are operational for effective use. However, there may be some tiny black points and/or bright points (white, red, blue or green in color) that constantly appear on the LCD screen. These points are normal in the manufacturing process and do not affect the recording in any way.

On image data compatibility

- This camera conforms with DCF (Design rule for Camera File system) universal standard established by JEITA (Japan Electronics and Information Technology Industries Association).
- Playback of images recorded with your camera on other equipment and playback of images recorded or edited with other equipment on your camera are not guaranteed.

Warning on copyright

Television programs, films, videotapes, and other materials may be copyrighted. Unauthorized recording of such materials may be contrary to the provisions of the copyright laws.

No compensation for contents of the recording

The contents of the recording cannot be compensated for if recording or playback is not possible due to a malfunction of your camera or recording media, etc.

On illustrations

Illustrations used in this manual are of the DSC-S650 unless noted otherwise.

「On illustrations」の項目を追加致しました。
ご確認ください。

OK, ありがとうございました。





Table of contents

IMPORTANT SAFEGUARDS	2
Read this first	4
Notes on using your camera	6
Getting started	8
Checking the accessories supplied	8
1 Inserting the batteries/a "Memory Stick Duo" (not supplied)	9
2 Turning the camera on/setting the clock	11
Shooting images easily	12
Viewing/deleting images	15
Indicators on the screen	17
Changing the settings – Menu/Setup	19
Menu items	20
Setup items	21
Enjoying your computer	22
Supported Operating Systems for USB connection and application software (supplied)	22
Viewing "Cyber-shot Handbook"	22
Battery life and memory capacity	23
Battery life and number of images that can be recorded/viewed	23
Number of still images and recording time of movies	25
Troubleshooting	27
Batteries and power	27
Shooting still images/movies	28
Viewing images	28
Precautions	29
Specifications	30

目次更新致しました。ご確認をお願いします。

OK。ありがとうございました。





Getting started

Checking the accessories supplied

- LR6 (size AA) alkaline batteries (2)
- Dedicated USB cable (1)

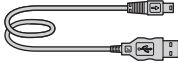

- Dedicated A/V cable (1)

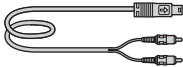

- Wrist strap (1)

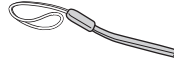

- CD-ROM (Cyber-shot application software/ "Cyber-shot Handbook") (1)
- Instruction Manual (this manual) (1)

Attach the strap to prevent the camera from damage by being dropped, etc.

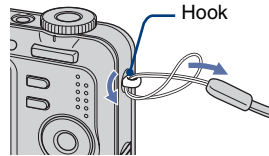



1 Inserting the batteries/a “Memory Stick Duo” (not supplied)

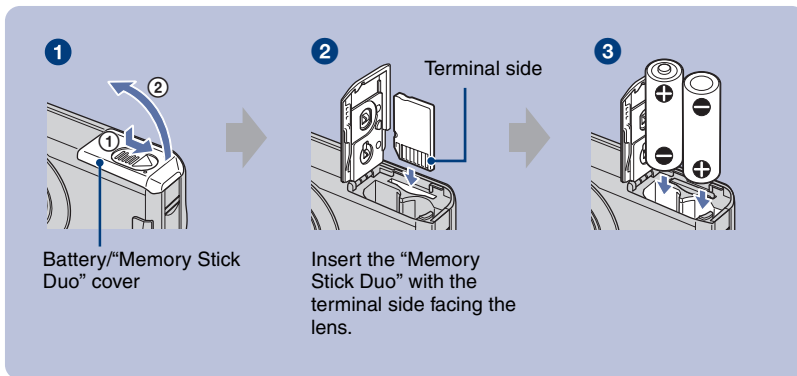

- 1** Open the battery/“Memory Stick Duo” cover.
- 2** Insert the “Memory Stick Duo” (not supplied) all the way in until it clicks.
- 3** Match +/- and insert.
- 4** Close the battery/“Memory Stick Duo” cover.

When there is no “Memory Stick Duo” inserted

The camera records/plays back images using the internal memory (approx. 24 MB).

Batteries you can and cannot use with your camera

Battery type	supplied	supported	rechargeable
LR6 (size AA) alkaline batteries	○	○	—
HR 15/51:HR6 (size AA) Nickel-Metal Hydride batteries ^{*1}	—	○	○
ZR6 (size AA) Oxy Nickel Primary Battery	—	○	—
Manganese batteries ^{*2}	—	—	—
Lithium batteries ^{*2}	—	—	—
Ni-Cd batteries ^{*2}	—	—	—

^{*1} NH-AA-2DB twin pack, etc.

^{*2} Operating performance cannot be ensured if voltage drops or other problems are caused by the nature of the battery.





WARNING

Battery may explode or leak if mistreated. Do not recharge, disassemble or dispose of in fire. Check the valid date (month-year) displayed on the batteries.

To check the remaining battery time

Press POWER to turn on and check the time on the LCD screen.

Battery remaining indicator				
Battery remaining guidelines	Sufficient power remaining	Battery half full	Battery low, recording/playback will stop soon.	Replace the batteries with new ones, or fully charged Nickel-Metal Hydride batteries. (The warning indicator flashes.)

- The displayed time remaining may not be correct under certain circumstances.
- When using alkaline batteries/Oxy Nickel Primary Battery, the battery remaining indicator may not display the correct information.
- When the AC Adaptor (not supplied) is used, the battery remaining indicator is not displayed.

To remove the batteries/"Memory Stick Duo"

Open the battery/"Memory Stick Duo" cover.

"Memory Stick Duo"

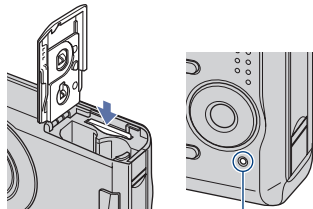

Access lamp

- Make sure that the **access lamp** is not lit, then push the "Memory Stick Duo" in once.

Batteries

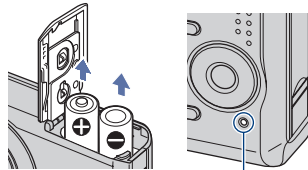

Access lamp

- Be sure not to drop the batteries.
- Do not open the battery cover or turn off the camera while the access lamp is lit, otherwise the data may be destroyed.





2 Turning the camera on/setting the clock

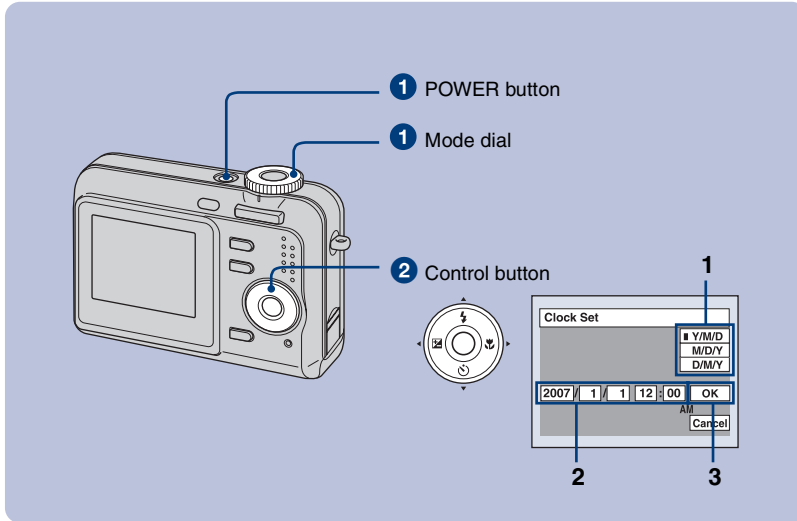

1 Select  with the mode dial, then press the POWER button.

2 Set the clock with the control button.

- 1 Select the date display format with ▲/▼, then press ●.
- 2 Select each item with ◀/▶ and set the numeric value with ▲/▼, then press ●.
- 3 Select [OK] with ▶, then press ●.

To change the date and time

Select [Clock Set] in the  (Setup) screen (page 19).

When you turn on the power

- Unless you set the clock, the Clock Set screen appears each time the camera is turned on.
- If the camera is running on battery power and you do not operate the camera for about three minutes, the camera turns off automatically to prevent wearing down the battery (Auto power-off function).





Shooting images easily

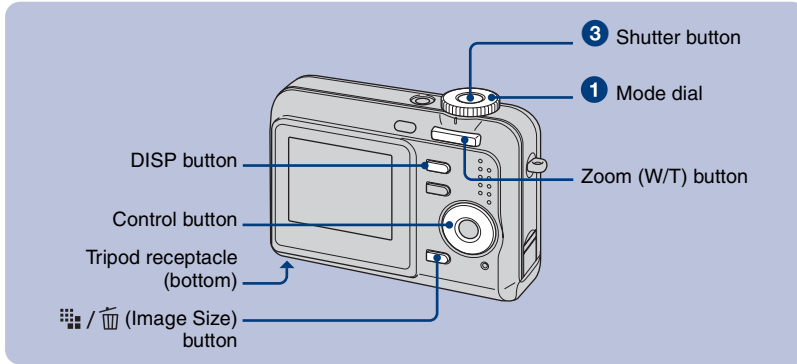

1 Select a mode with the mode dial.

Still image (auto adjustment mode): Select .
Movie: Select .

2 Hold the camera steady, keeping your arm at your side.



Position the subject in the center of the focus frame.

3 Shoot with the shutter button.

Still image:

- Press and hold the shutter button halfway down to focus.
The ● (AE/AF lock) indicator (green) flashes, a beep sounds, the indicator stops flashing and remains lit.
- Press the shutter button fully down.
The shutter sounds.

AE/AF lock indicator

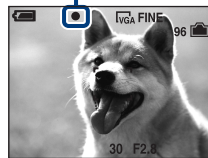

Movie:

Press the shutter button fully down.
To stop recording, press the shutter button fully down again.





Selecting the still image mode

Set the mode dial to the desired function.

	Auto Adjustment mode	Allows easy shooting with the settings adjusted automatically.
P	Program auto shooting mode	Allows you to shoot with the exposure adjusted automatically (both the shutter speed and the aperture value). Also you can select various settings using the menu.
	High Sensitivity	Shoot images without a flash even in low lighting.
	Soft Snap	Shoot a person's skin with a warmer look.
	Twilight Portrait	Shoot sharp images of people in a dark place without losing the nighttime atmosphere.
	Twilight	Shoot night scenes without losing the nighttime atmosphere.
	Landscape	Shoot with the focus on a distant subject.
	Beach	Shoot seaside or lakeside scenes with the blueness of the water captured more vividly.
	Snow	Shoot snow scenes in white more clearly.

Using the zoom

Press the zoom button.

- When the zoom scale exceeds 3x, the camera uses the Digital Zoom function.
- You cannot change the zoom scale while shooting a movie.

Flash (Selecting a flash mode for still images)

Press on the control button repeatedly until the desired mode is selected.

(No indicator): Flash Auto

Strobes when there is insufficient light (default setting).

: Flash forced on

: Slow synchro (Flash forced on)

The shutter speed is slow in a dark place to clearly shoot the background that is out of flash light.

: Flash forced off

Macro (Shooting close-up)

Press on the control button.

To cancel, press again.

(No indicator): Macro Off

: Macro On (W side: Approx. 5 cm or farther (2 inches or farther), T side: Approx. 35 cm or farther (13 7/8 inches or farther))





Using the self-timer

Press on the control button repeatedly until the desired mode is selected.

- (No indicator): Not using the self-timer
- : Setting the 10-second delay self-timer
- : Setting the 2-second delay self-timer

Press the shutter button, the self-timer lamp flashes, and a beep sounds until the shutter operates.

EV (Adjusting the exposure)

Press on the control button, then press / to adjust the exposure.

- Toward +: Brightens an image.
- Toward -: Darkens an image.

To turn off the EV adjustment bar, press the button again.

To change the still image size

Press the / (Image Size) button, then press / to select the size.

To turn off the Image Size menu, press the / button again.

Image size	Guidelines
: 7M	Up to A3/11×17" print
: 3:2	Match 3:2 Aspect Ratio
: 5M	Up to A4/8×10" print
: 3M	Up to 13×18cm /5×7" print
: 2M	Up to 10×15cm /4×6" print
: VGA	For E-mail
: 16:9	Display On 16:9 HDTV

On the recordable number of still images and recordable time of movies

Recordable number of still images vary depending on the selected image size.

Still images

Maximum number of recordable images



Movies

Maximum recordable time

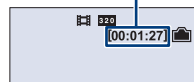

- The number of recordable images and time can differ according to shooting conditions.





Viewing/deleting images

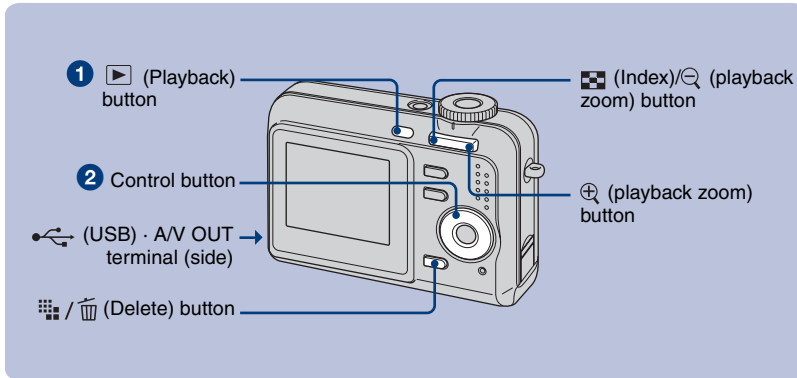

1 Press (Playback).

If you press (Playback) button when the camera is powered off, the camera is turned on in the playback mode. If you press again, switches to recording mode.

2 Select an image with / on the control button.

Movie:

Press to play back a movie. (Press again to stop playback.)

Press to fast forward, press to rewind. (Press to return to normal playback.)

- You cannot listen to the audio with this camera when a movie is played back. To listen to the audio, connect with external outputs such as a TV, a speaker, etc.

/ To delete images

1 Display the image you want to delete and press / (Delete).

2 Select [Delete] with , then press .

/ To view an enlarged image (playback zoom)

Press while displaying a still image.

To undo the zoom, press .

Adjust the portion: / / / .

Cancel playback zoom: .

Viewing an index screen

Press (Index) and select an image with / / / . To display the next (previous) index screen, press .

To return to the single-image screen, press .





To delete images in index mode

- 1 While an index screen is displayed, press / (Delete) and select [Select] with on the control button, then press .
- 2 Select the image you want to delete with , then press to display the (Delete) indicator on the selected image.
- 3 Press / (Delete).
- 4 Select [OK] with , then press .

To view images on TV screen

Connect the camera to the TV with the dedicated A/V cable (supplied).

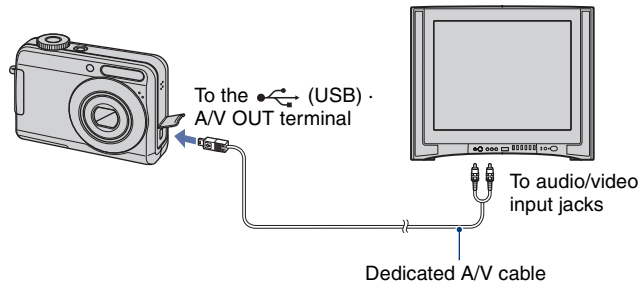



Indicators on the screen

Every time you press the DISP button, the display data and indicator is turned on and off.

When shooting still images

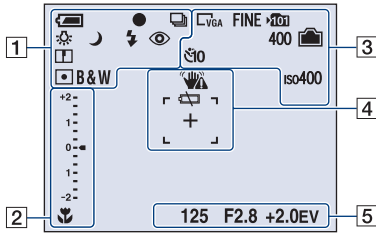

When shooting movies

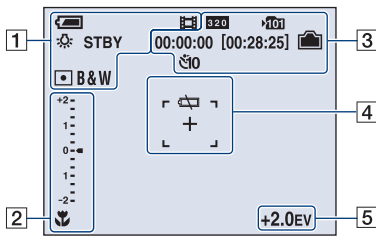

When playing back

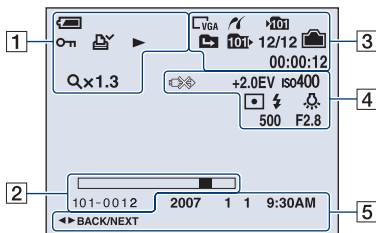

1

	Battery remaining
	AE/AF lock
	Recording mode
	White balance
STBY REC	Standby/Recording a movie
	Mode dial (Scene Selection)
P	Mode dial (Program Auto)
	Camera mode
	Playback mode
	Flash mode
	Flash charging
w r x1.3	Zoom scaling
	Red-eye reduction
	Sharpness
	Metering mode
RICH NATURAL SEPIA B&W	Color mode
	Protect
	Print order (DPOF) mark
Qx1.3	Zoom scaling
	Playback



2

	Macro
+2 1 0 -1 -2	EV adjustment bar
▼ Darker ▲ Brighter	Adjusting EV
101-0012	Folder-file number
	Playback bar

3

	PictBridge connecting
	Image size
FINE STD	Image quality
	Recording folder
	Change folder
	Playback folder
	Remaining internal memory capacity
	Remaining "Memory Stick" capacity
00:00:00 [00:28:25]	Recording time [maximum recordable time]
400	Remaining number of recordable images
	Self-timer
iso400	ISO number
12/12	Image number/Number of images recorded in selected folder
00:00:12	Counter

4

	Vibration warning
	Low battery warning
	PictBridge connecting
+2.0EV	Exposure Value
iso400	ISO number
	Metering mode
	Flash
	White balance
+	Spot metering cross hair
	AF range finder frame
500	Shutter speed
F2.8	Aperture value

5

125	Shutter speed
F2.8	Aperture value
+2.0EV	Exposure Value
2007 1 1 9:30 AM	Recorded date/time of the playback image
◀▶ BACK/ NEXT	Select images
	Menu





Changing the settings – Menu/Setup

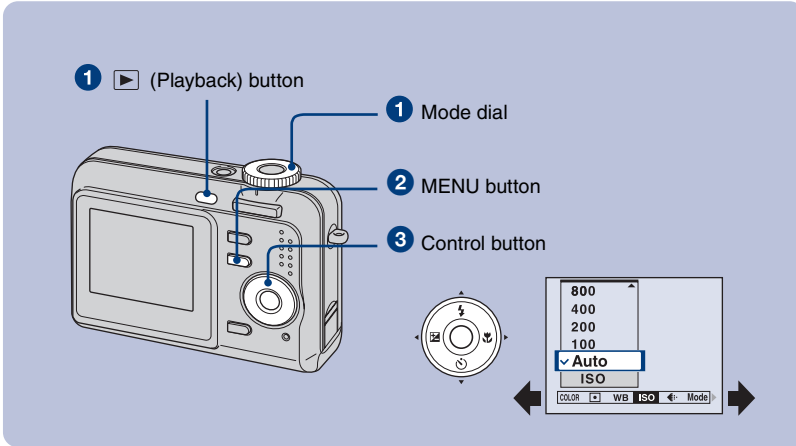

- 1 Recording:** Turn on the camera, then set the mode dial.
Playback: Press (Playback) button.

Different items are available depending on the position of the mode dial and Recording/Playback mode.

- 2 Press MENU to display the menu.**
- 3 Select the desired menu item with / on the control button.**

- If the desired item is invisible, keep pressing / until the item appears on the screen.
- Press after selecting an item in the Playback mode.

- 4 Select a setting with / .**

The setting you select is zoomed and set.

- 5 Press MENU to turn off the menu.**

To select a Setup item

Press and hold MENU, or select (Setup) in step 3 and then press . Select the item to set with / / / , then press .

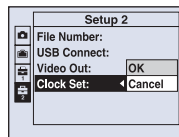









For details on the operation  page 19







Menu items

The available menu items vary depending on the mode dial position and settings. Only the available items are displayed on the screen.

Menu for shooting

 COLOR (Color Mode)	Changes the vividness of the image or adds special effects.
 (Metering Mode)	Selects the metering mode.
WB (White Bal)	Adjusts the color tones.
ISO	Selects a luminous sensitivity.
 (P. Quality)	Selects the still image quality.
Mode (REC Mode)	Selects the continuous shooting method.
 (Flash Level)	Adjusts the amount of flash light.
 (Sharpness)	Adjusts the sharpness of the image.
 (Setup)	Changes Setup items.

Menu for viewing

 (Folder)	Selects the folder for viewing images.
 (Protect)	Prevents accidental erasure.
DPOF	Adds a Print order mark.
 (Print)	Prints images using a PictBridge compliant printer.
 (Slide)	Plays back a series of images.
 (Resize)	Changes the image size of a recorded image.
 (Rotate)	Rotates a still image.
 (Setup)	Changes Setup items.





For details on the operation page 19

Setup items

Camera

Digital Zoom	Selects the digital zoom mode.
Function Guide	Displays the description of functions when you operate the camera.
Red Eye Reduction	Reduces the red-eye phenomenon when using the flash.
Auto Review	Displays the recorded image on the screen for approximately two seconds immediately after shooting a still image.

Internal Memory Tool

Format	Formats the internal memory.
--------	------------------------------

Memory Stick Tool

Format	Formats the "Memory Stick Duo".
Create REC. Folder	Creates a folder in a "Memory Stick Duo" for recording images.
Change REC. Folder	Changes the folder currently used for recording images.
Copy	Copies all images in the internal memory to a "Memory Stick Duo".

Setup 1

LCD Backlight	Selects the brightness of the LCD backlight when using the camera with battery pack.
Beep	Selects the sound produced when you operate the camera.
Language	Selects the language to be used to display the menu items, warnings, and messages.
Initialize	Initializes the setting to the default setting.

Setup 2

File Number	Selects the method used to assign file numbers to images.
USB Connect	Selects the USB mode to be used when connecting the camera to a computer or a PictBridge compliant printer using the dedicated USB cable.
Video Out	Sets the video signal output according to the TV color system of the connected video equipment.
Clock Set	Sets the date and time.





Enjoying your computer

You can display images shot with the camera on the computer. Also, you can use still images and movies from the camera more than ever by taking advantage of the software. For details, refer to “Cyber-shot Handbook.”

Supported Operating Systems for USB connection and application software (supplied)

	For Windows users	For Macintosh users
USB connection	Windows 2000 Professional, Windows XP Home Edition or Windows XP Professional	Mac OS 9.1/9.2/ Mac OS X(v10.1 to v10.4)
Application software “Picture Motion Browser”	Windows 2000 Professional, Windows XP Home Edition or Windows XP Professional	not compatible

- Must be installed with above OS at delivery.
- If your OS does not support USB connections, use a commercially available Memory Stick Reader/Writer.
- For further details on the operating environment of Cyber-shot application software, “Picture Motion Browser,” refer to “Cyber-shot Handbook.”

Viewing “Cyber-shot Handbook”

For Windows users

- 1 Turn on your computer, and insert the CD-ROM into the CD-ROM (supplied) drive. The screen below appears.



When you click the [Cyber-shot Handbook] button, the screen for copying “Cyber-shot Handbook” appears. Follow the on-screen instructions to copy.

- 2 After the installation is complete, double-click the shortcut created on the desktop.

For Macintosh users

- 1 Turn on your computer, and insert the CD-ROM (supplied) into the CD-ROM drive. Select the “Handbook” folder and copy “Handbook.pdf” stored in the “GB” folder to your computer.
- 2 After copying is complete, double-click “Handbook.pdf.”



Battery life and memory capacity

枠ですが、もし数値が同じでも
そのまますすめます。
(同じ数値を表内に追加する)

このページ、メールにて修正しない旨をお伝え致しましたが、
後ほど追加作成するよりも、作成しておいて削除がやりやすかったため挿入させて頂きました。ご確認ください。

Battery life and number of images that can be recorded/viewed

The tables show the approximate number of images that can be recorded/viewed and the battery life when you shoot images in [Normal] mode with batteries at full capacity and at an ambient temperature of 25°C (77°F). The numbers of images that can be recorded or viewed take into account changing the “Memory Stick Duo” as necessary.

Note that the actual numbers may be less than those indicated in the table depending on the conditions of use.

- The battery capacity decreases as the number of uses increases and also over time.
- The number of images that can be recorded/viewed and the battery life are decreased under the following conditions:
 - The surrounding temperature is low.
 - The flash is used frequently.
 - The camera has been turned on and off many times.
 - The zoom is used frequently.
 - The brightness of LCD Backlight is set to up.
 - The battery power is low.
- The values shown for alkaline battery are based on commercial norms, and do not apply to all alkaline batteries in all conditions. The values may vary, depending on the battery manufacturer/type, environmental conditions, product setting, etc.
- The supplied alkaline battery is for trial use only. You may need to purchase an additional battery for regular camera use.

When shooting still images

Battery	No. of images	Battery life (min.)
DSC-S650		
Alkaline	Approx. 100	Approx. 50
NH-AA-DB (Ni-MH)	Approx. 460	Approx. 230
DSC-S700		
Alkaline	Approx. XXX	Approx. XXX
NH-AA-DB (Ni-MH)	Approx. XXX	Approx. XXX

- Shooting in the following situations:
 - (P.Quality) is set to [Fine].
 - Shooting once every 30 seconds.
 - The zoom is switched alternately between the W and T ends.
 - The flash strobes once every two times.
 - The power turns on and off once every ten times.
- The measurement method is based on the CIPA standard.
(CIPA: Camera & Imaging Products Association)
- The number of images/battery life does not change, regardless of image size.

DSC-S600とDSC-S700のタイトルを追加して、表組みを作成致しました。ご確認ください。

OK. ありがとうございます。
ございました。

表を分けてしまうとわかりにくくなるため、
表を分けずに挿入するため、改コラム致しました。ご確認ください。

畏まりました。
ありがとうございました！





When viewing still images

Battery	No. of images	Battery life (min.)
DSC-S650		
Alkaline	Approx. 7000	Approx. 350
NH-AA-DB (Ni-MH)	Approx. 10600	Approx. 530
DSC-S700		
Alkaline	Approx. XXX	Approx. XXX
NH-AA-DB (Ni-MH)	Approx. XXX	Approx. XXX

- Viewing single images in order at about three second intervals

When shooting movies

Battery	Battery life (min.)
DSC-S-650	
Alkaline	Approx. 50
NH-AA-DB (Ni-MH)	Approx. 230
DSC-S700	
Alkaline	Approx. XXX
NH-AA-DB (Ni-MH)	Approx. XXX

表組みが増えた為、前頁より移動させました。
 DSC-S650,DSC-S700のタイトルの追加と表組みを作成しました。
 これにより、ページ数に変更になっております。
 併せてご確認ください。

畏まりました。
 修正ありがとうございました。





Number of still images and recording time of movies

The number of still images and the length of time for movies may vary depending on the shooting conditions and the recording mediums.

- For details on the image size, see page 14.

The approximate number of still images (The image quality is [Fine] on the upper line and [Standard] on the lower line.)

(Units: Images)

Capacity Size	Internal memory	"Memory Stick Duo" formatted with this camera						
	Approx. 24MB	64MB	128MB	256MB	512MB	1GB	2GB	4GB
7M	6	18	37	67	137	279	573	1132
	13	36	73	132	268	548	1125	2223
3:2	6	18	37	67	137	279	573	1132
	13	36	73	132	268	548	1125	2223
5M	9	25	51	92	188	384	789	1559
	17	48	96	174	354	723	1482	2928
3M	15	41	82	148	302	617	1266	2501
	27	74	149	264	537	1097	2250	4447
2M	24	66	133	238	484	988	2025	4002
	45	123	246	446	907	1852	3798	7504
VGA	146	394	790	1428	2904	5928	12154	24014
	241	637	1276	2400	4802	9762	19661	39334
16:9	24	66	133	238	484	988	2025	4002
	45	123	246	446	907	1852	3798	7504

- The number of images listed is for when [Mode] is set to [Normal].
- When the number of remaining shootable images is greater than 9,999, the ">9999" indicator appears.
- You can resize the images later ([Resize], page 20).

4万枚 のファイル記録/再生不可、の仕様について注記追加。
(本機では、ひとつの"メモリースティック デュオ"に記録できる
画像枚数は最大40000枚です。
記録画像が40000枚を超えると撮影ができません。また、40000
枚以上の画像は再生ができません。)

G B

A "Memory Stick Duo" can contain up to 40,000 images on this camera.
If the "Memory Stick Duo" has already 40,000 images stored,
>you can not shoot more images on this camera.
Also "Memory Stick Duo" will not be able to playback images
>when the number of stored images exceeds 40,000 on this
camera.

前頁追加のため、これより
ノンブルが変更になってお
ります。ご確認ください。

25

OK. ありがとうございます。



The approximate recording time of movies

(Units: hour : minute : second)

Capacity Size	Internal memory	"Memory Stick Duo" formatted with this camera						
	Approx. 24MB	64MB	128MB	256MB	512MB	1GB	2GB	4GB
320×240	0:01:00	0:02:50	0:05:50	0:10:40	0:21:40	0:44:20	1:31:00	3:00:00

- The aspect ratio of the movie frame is 320×240.
- Recordable movie file size is up to approx. 2 GB for each file. If the file size reaches approx. 2 GB, the camera stops recording automatically.
- When images recorded using earlier Sony models are played back on this camera, the display may differ from the actual image size.





Troubleshooting

If you experience trouble with your camera, try the following solutions.

1 Check the items below, and refer to “Cyber-shot Handbook” (PDF).

2 Remove the batteries, and insert the batteries again after about one minute, and turn on the power.

3 Initialize the settings (page 21).

4 Consult your Sony dealer or local authorized Sony service facility.

Please understand that you give your consent that the contents of the internal memory may be checked when you send your camera to be repaired.

Batteries and power

The battery remaining indicator is incorrect, or sufficient battery remaining indicator is displayed but the power runs out too quickly.

- This phenomenon occurs when you use the camera in an extremely hot or cold location.
- When using alkaline batteries/Oxy Nickel Primary Battery (not supplied), the displayed time remaining may not be correctly indicated.
- The batteries are discharged. Install new batteries or charged Nickel-Metal Hydride batteries (not supplied) (page 9).
- When using the Nickel-Metal Hydride batteries, the poles of batteries or the terminals of the battery cover are dirty so the batteries are not charged sufficiently. Clean them with a cotton swab, etc.
- When using the Nickel-Metal Hydride batteries, the displayed time remaining differs from the current one due to the memory effect, etc. Fully discharge and then charge the batteries to correct the display.
- The batteries are dead. Replace them with new ones.

The batteries run down too quickly.

- You are using the camera in an extremely cold location.
- The batteries are dead. Replace them with new ones.
- When using the Nickel-Metal Hydride batteries, charge them sufficiently.

Camera power is turned off automatically when you open the battery/“Memory Stick Duo” cover.

- This is not a malfunction. Turn off the camera before you open the battery/“Memory Stick Duo” cover.



Cannot turn on the camera.

- Install the batteries correctly (page 9).
- Properly connect the AC Adaptor (not supplied).
- The batteries are discharged. Install new batteries or charged Nickel-Metal Hydride batteries (page 9).
- The batteries are dead. Replace them with new ones.

The power turns off suddenly.

- If you do not operate the camera for about three minutes while the power is on, the camera turns off automatically to prevent wearing down the batteries. Turn on the camera again (page 11).
- The batteries are discharged. Install new batteries or charged Nickel-Metal Hydride batteries (page 9).

Shooting still images/movies

Your camera cannot record images.

- Check the free capacity of the internal memory or “Memory Stick Duo” (pages 25, 26). If it is full, do one of the following:
 - Delete unnecessary images (page 15).
 - Change the “Memory Stick Duo”.
- You are using the “Memory Stick Duo” with the write-protect switch, and the switch is set to the LOCK position. Set the switch to the recording position.
- You cannot record images while charging the flash.
- Set the mode dial to , P , , , , , , or when shooting still images.
- Set the mode dial to when shooting movies.

Cannot insert dates on images.

- This camera does not have a feature for superimposing dates on images. You can print or save images with the date inserted using “Picture Motion Browser”.

Viewing images

Your camera cannot play back images.

- Press (Playback) button (page 15).
- The folder/file name has been changed on your computer.
- When an image file has been processed by a computer or when the image file was recorded using a model other than that of your camera, playback on your camera is not guaranteed.
- The camera is in USB mode. Delete the USB connection.





Precautions

Do not use/store the camera in the following places

- In an extremely hot, cold or humid place
In places such as in a car parked in the sun, the camera body may become deformed and this may cause a malfunction.
- Under direct sunlight or near a heater
The camera body may become discolored or deformed, and this may cause a malfunction.
- In a location subject to rocking vibration
- Near strong magnetic place
- In sandy or dusty places
Be careful not to let sand or dust get into the camera. This may cause the camera to malfunction, and in some cases this malfunction cannot be repaired.

On carrying

Do not sit down in a chair or other place with the camera in the back pocket of your trousers or skirt, as this may cause malfunction or damage the camera.

On cleaning

Cleaning the LCD screen

Wipe the screen surface with an LCD cleaning kit (not supplied) to remove fingerprints, dust, etc.

Cleaning the lens

Wipe the lens with a soft cloth to remove fingerprints, dust, etc.

Cleaning the camera surface

Clean the camera surface with a soft cloth slightly moistened with water, then wipe the surface with a dry cloth. Do not use the following as they may damage the finish or the casing.

- Chemical products such as thinner, benzine, alcohol, disposable cloths, insect repellent, sunscreen or insecticide, etc.
- Do not touch the camera with the above on your hand.
- Do not leave the camera in contact with rubber or vinyl for a long time.

On operating temperatures

Your camera is designed for use under the temperatures between 0°C and 40°C (32°F and 104°F). Shooting in extremely cold or hot places that exceed this range is not recommended.

On moisture condensation

If the camera is brought directly from a cold to a warm location, moisture may condense inside or outside the camera. This moisture condensation may cause a malfunction of the camera.

If moisture condensation occurs

Turn off the camera and wait about an hour for the moisture to evaporate. Note that if you attempt to shoot with moisture remaining inside the lens, you will be unable to record clear images.

On the internal rechargeable backup battery

This camera has an internal rechargeable battery for maintaining the date and time and other settings regardless of whether the power is on or off.

This rechargeable battery is continually charged as long as you are using the camera. However, if you use the camera for only short periods, it discharges gradually, and if you do not use the camera at all for about one month it becomes completely discharged. In this case, be sure to charge this rechargeable battery before using the camera.

However, even if this rechargeable battery is not charged, you can still use the camera as long as you do not record the date and time.

Charging method of the internal rechargeable backup battery

Insert batteries with enough capacity in the camera, or connect the camera to a wall outlet (wall socket) using the AC Adaptor (not supplied), and leave the camera for 24 hours or more with the power off.

青でマーキングした箇所
数値未定です。
(12/11出し可能そうか12/7
に決定)

Specifications

タイトル別に枠を分けて作成致しました。外形寸法と併せてご確認下さい。

OK。ありがとうございます。

Camera

[System]

Image device: 7.20 mm (1/2.5 type) color CCD,

Primary color filter

Total pixel number of camera:

Approx. 7 410 000 pixels

Effective pixel number of camera:

Approx. 7 201 000 pixels

Lens: 3× zoom lens f = 5.8 – 17.4 mm (35 – 105 mm when converted to a 35 mm still camera) F2.8 ~ 4.8

Exposure control: Automatic exposure, Scene Selection (7 modes)

White balance: Automatic, Daylight, Cloudy,

Fluorescent, Incandescent, Flash

File format (DCF compliant):

Still images: Exif Ver. 2.21 JPEG compliant, DPOF compatible

Movies: AVI (Motion JPEG)

Recording media: Internal Memory (approx.

24 MB), "Memory Stick Duo"

Flash: Flash range (ISO sensitivity

(Recommended Exposure Index) set to Auto):

approx. 0.5 to 3.5 m (19 3/4 inches to 137 7/8

inches) (W)/approx. 0.5 to 2.0 m (19 3/4

inches to 78 3/4 inches) (T)

[Input and Output connectors]

Multi connector: Video, Audio (Monaural), USB communication

USB communication: Full-Speed USB (USB 2.0 compliant)

[LCD screen]

DSC-S650

LCD panel: 5.1 cm (2.0 type) TFT drive

Total number of dots: 115 200 (480×240) dots

DSC-S700

LCD panel: 6.0 cm (2.4 type) TFT drive

Total number of dots: xxx xxx (xxxxxxx) dots

[Power, general]

Power: LR6 (size AA) Alkaline batteries (2), 3 V

HR15/51:HR6 (size AA) Nickel-Metal

Hydride batteries (2) (not supplied), 2.4 V

ZR6 (size AA) Oxy Nickel Primary Battery

(2) (not supplied), 3 V

AC-LS5K AC Adaptor (not supplied), 4.2 V

Power consumption (during shooting):

DSC-S650

1.2W

DSC-S700

xxx W

Operating temperature: 0 to 40°C (32 to 104°F)

Storage temperature: -20 to +60°C (-4 to +140°F)

Dimensions:

DSC-S650

91.0×61.0×26.5 mm (3 5/8×2 1/2×1 1/16

inches) (W/H/D, excluding protrusions)

DSC-S700

xx.xxxx.xxxxxx mm (x.x/xxx x/xxx x/x

inches) (W/H/D, excluding protrusions)

Mass:

DSC-S650

Approx. 178 g (6.3 oz) (including two batteries and wrist strap, etc.)

DSC-S700

Approx. xxx g (xx oz) (including two batteries and wrist strap, etc.)

Microphone: Monaural

Buzzer

Exif Print: Compatible

PRINT Image Matching III: Compatible

PictBridge: Compatible

Design and specifications are subject to change without notice.

タイトル別に枠を分けて作成致しました。質量と併せてご確認下さい。

OK。ありがとうございます。

(USB)・A/V OUT terminal

[入出力端子]の内容を変更しました。ご確認下さい。

タイトル別に枠を分けて作成致しました。DSC-S700の数値と併せてご確認下さい。

112 320(480×234) dots
に修正願います。

Trademarks

- **Cyber-shot** is a trademark of Sony Corporation.
- "Memory Stick",  "Memory Stick PRO", **MEMORY STICK PRO**, "Memory Stick Duo", **MEMORY STICK DUO**, "Memory Stick PRO Duo", **MEMORY STICK PRO DUO**, "Memory Stick Micro", "MagicGate", and **MAGICGATE** are trademarks of Sony Corporation.
- Microsoft, Windows and DirectX are either registered trademarks or trademarks of Microsoft Corporation in the United States and/ or other countries.
- Macintosh, Mac OS, iMac, iBook, PowerBook, Power Mac and eMac are trademarks or registered trademarks of Apple Computer, Inc.
- Intel, MMX, and Pentium are trademarks or registered trademarks of Intel Corporation.
- Google is a registered trademark of Google Inc.
- In addition, system and product names used in this manual are, in general, trademarks or registered trademarks of their respective developers or manufacturers. However, the TM or © marks are not used in all cases in this manual.



32ページにて作成するため、白ページを1ページ挿入しました。
ご確認ください。

OK、ありがとうございます。





Additional information on this product and answers to frequently asked questions can be found at our Customer Support Website.

<http://www.sony.net/>

 Printed on 70% or more recycled paper using VOC (Volatile Organic Compound)-free vegetable oil based ink.

Printed in China

バーコード変更致しました。
ご確認下さい。

OK. ありがとうございます。

