



## Test Report

Product Name : Digital Still Camera  
Model No. : DSC-S650  
FCC ID : TVRDSCS650

Applicant : PREMIER IMAGE TECHNOLOGY CORPORATION  
Address : 5F, No.9, LI-SHIN RD. V, SCIENCE-BASED INDUSTRIAL  
PARK, HSINCHU, TAIWAN, R.O.C.

Date of Receipt : 2006/11/06  
Issued Date : 2006/11/15  
Report No. : 06BH040-IT-US-P01V02

The test results relate only to the samples tested.

The test results shown in the test report are traceable to the national/international standard through the calibration of the equipment and evaluated measurement uncertainty herein.

This report must not be used to claim product endorsement by CNLA, NVLAP, NIST or any agency of the Government.

The test report shall not be reproduced except in full without the written approval of QuieTek Corporation.

# Test Report Certification

Issued Date : 2006/11/15

Report No. : 06BH040-IT-US-P01V02



Product Name : Digital Still Camera  
 Applicant : PREMIER IMAGE TECHNOLOGY CORPORATION  
 Address : 5F, No.9, LI-SHIN RD. V, SCIENCE-BASED  
 INDUSTRIAL PARK, HSINCHU, TAIWAN, R.O.C.  
 Manufacturer : PREMIER IMAGE TECHNOLOGY CORPORATION  
 Model No. : DSC-S650  
 Rated Voltage : AC 120 V / 60 Hz  
 EUT Voltage : AC 120 V / 60 Hz  
 Trade Name : SONY  
 Applicable Standard : FCC CFR Title 47 Part 15 Subpart B: 2005 Class B,  
 CISPR 22: 2005  
 Test Result : Complied  
 Performed Location : Hsinchu EMC Laboratory  
 N0. 75-2, 3rd Lin, Wangye Keng, Yonghxing Tsuen,  
 Qionglin Shiang, Hsinchu County 307, Taiwan, R.O.C.  
 TEL:+886-3-592-8858 / FAX:+886-3-592-8859

Documented By : Carol Tsai  
 ( Carol Tsai )

Reviewed By : Gavin chen  
 ( Gavin Chen )

Approved By : Arthur Liu  
 ( Authur Liu )

## Laboratory Information

We , **Quietek Corporation**, are an independent EMC and safety consultancy that was established the whole facility in our laboratories. The test facility has been accredited by the following accreditation Bodies in compliance with ISO 17025, EN 45001 and Guide 25:

Taiwan R.O.C.	: BSMI, DGT, CNLA
Germany	: TÜV Rheinland
Norway	: Nemko, DNV
USA	: FCC, NVLAP
Japan	: VCCI

The related certificate for our laboratories about the test site and management system can be downloaded from Quietek Corporation's Web Site : <http://tw.quietek.com/modules/myalbum/>

The address and introduction of Quietek Corporation's laboratories can be founded in our Web site : <http://www.quietek.com/>

If you have any comments, Please don't hesitate to contact us. Our contact information is as below:

### HsinChu Testing Laboratory :

No.75-2, 3rd Lin, Wangye Keng, Yonghxing Tsuen, Qionglin Shiang, Hsinchu County 307, Taiwan, R.O.C.

TEL:+886-3-592-8858 / FAX:+886-3-592-8859

E-Mail : [service@quietek.com](mailto:service@quietek.com)



### LinKou Testing Laboratory :

No. 5, Ruei-Shu Valley, Ruei-Ping Tsuen, Lin-Kou Shiang, Taipei, Taiwan, R.O.C.

TEL : 886-2-8601-3788 / FAX : 886-2-8601-3789

E-Mail : [service@quietek.com](mailto:service@quietek.com)



## TABLE OF CONTENTS

Description	Page
1. General Information .....	5
1.1. EUT Description .....	5
1.2. Mode of Operation .....	6
1.3. Tested System Details.....	7
1.4. Configuration of Tested System .....	8
1.5. EUT Exercise Software .....	10
2. Technical Test.....	11
2.1. Summary of Test Result .....	11
2.2. List of Test Equipment.....	11
2.3. Measurement Uncertainty .....	12
2.4. Test Environment .....	12
3. Conducted Emission .....	13
3.1. Test Specification .....	13
3.2. Test Setup .....	13
3.3. Limit.....	13
3.4. Test Procedure .....	14
3.5. Test Result .....	15
3.6. Test Photograph .....	19
4. Radiated Emission .....	20
4.1. Test Specification .....	20
4.2. Test Setup .....	20
4.3. Limit.....	21
4.4. Test Procedure .....	22
4.5. Test Result .....	23
4.6. Test Photograph .....	39
5. Attachment.....	47
EUT Photograph.....	47

## 1. General Information

### 1.1. EUT Description

Product Name	Digital Still Camera
Trade Name	SONY
Model No.	DSC-S650
Max Resolution	7.2 Mega Pixels

Component	
USB Cable	Shielded, 1.5m, one ferrite core bonded.
AV Cable	Shielded, 1.5m, one ferrite core bonded.
Battery Cable	Shielded, 0.15m
Power Adapter	SONY, AC-LS5 Cable Out: Non-Shielded, 1.8m Power Cord: Non-Shielded, 1.8m

**Note:**

This EUT is a Digital Still Camera.

**1.2. Mode of Operation**

Quietek has verified the construction and function in typical operation. All the test modes were carried out with the EUT in normal operation, which was shown in this test report and defined as:

Pre-Test Mode		
Mode 1: Slide Show		
Mode 2: REC		
Mode 3: USB LCD on		
Mode 4: Preview		
Final Test Mode		
Emission	Conducted Emission	Mode 3: USB LCD on
	Radiated Emission	Mode 1: Slide Show Mode 2: REC Mode 3: USB LCD on Mode 4: Preview

### 1.3. Tested System Details

The types for all equipments, plus descriptions of all cables used in the tested system (including inserted cards) are:

Test Mode		Mode 1: Slide Show Mode 2: REC Mode 4: Preview				
Product		Manufacturer	Model No.	Serial No.	FCC ID	Power Cord
1	Monitor	SONY	PVM-14M2U	2013141	DoC	Non-Shielded, 1.8m

Test Mode		Mode 3: USB LCD on				
Product		Manufacturer	Model No.	Serial No.	FCC ID	Power Cord
1	Notebook PC	DELL	PP10L	3Y220	E2K24BNHM	Non-Shielded, 1.8m
2	Monitor	CHI MEI	A170E1-09	3UC120955S A1250	DoC	Non-Shielded, 1.8m
3	Digital 8 (D8)	SONY	DCR-TRV110	P35209	DoC	--
4	Microphone & Earphone	Ronald	MOE060	N/A	DoC	--
5	USB 2.0 Flash Memory	Ridata	PEN000-DP0 65-37	N/A	DoC	--
6	Modem	ACEEX	DM-1414	0102027546	DoC	Non-Shielded, 1.6m
7	TV	THOMSON	15LCDMO3B SN	15LCDMO3B SN FRD100085	DoC	Non-Shielded, 1.8m
8	Printer	HP	C2642A	MY75L1D2X N	DoC	Non-Shielded, 0.7m

**1.4. Configuration of Tested System**

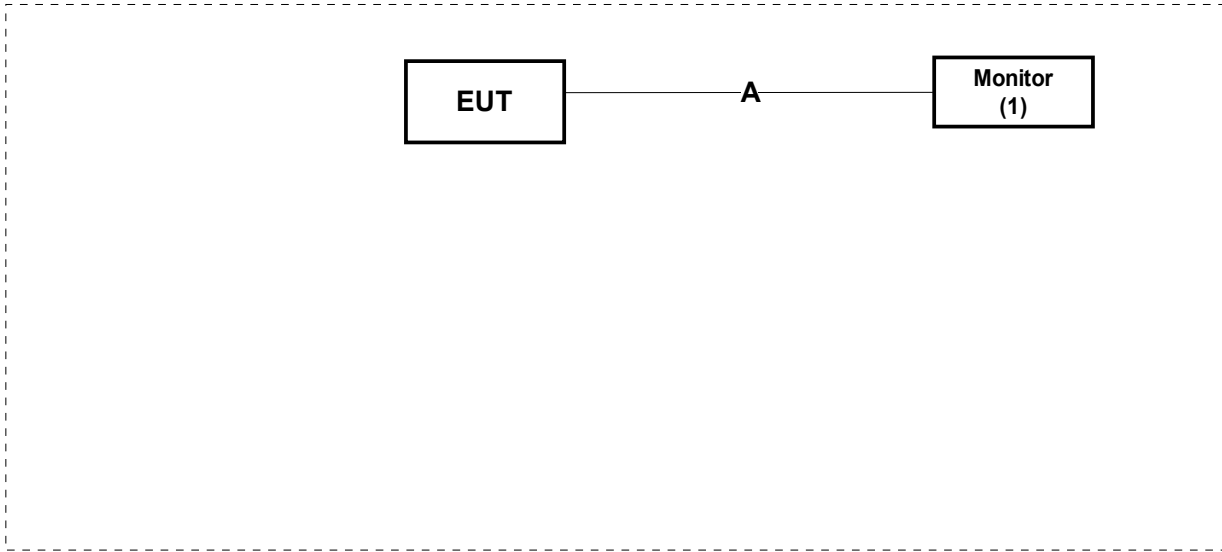
Test Mode	Mode 1: Slide Show Mode 2: REC Mode 4: Preview		
Connection Diagram			
 <pre> graph LR     EUT[EUT] --- A[A] --- Monitor["Monitor (1)"]             </pre>			
Signal Cable Type		Signal cable Description	Interface
A	AV Cable	Non-Shielded, 1.5m	AV Port



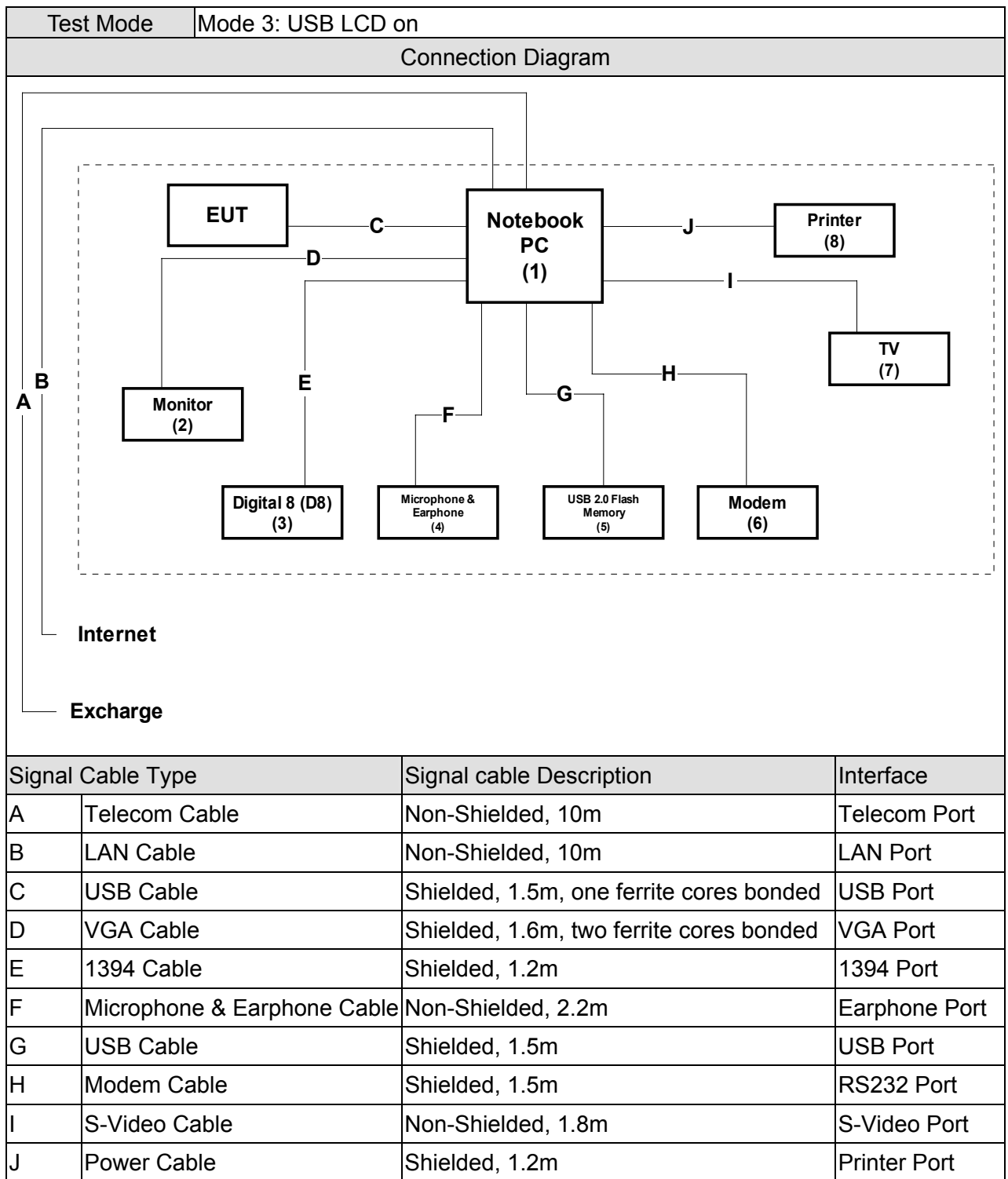

**1.5. EUT Exercise Software**

Test Mode	Mode 1: Slide Show
1	Setup EUT and PC as shown on 1.4.
2	Play REC file (black loop).
3	Turn on the power.
4	Select play key.
5	Press MENU.
6	Press left key to select play OK.
7	Select START OK.
8	Show word of slide show on LCD display.
9	Test.

Test Mode	Mode 2: REC
1	Setup EUT and PC as shown on 1.4.
2	The lens of EUT was covered with black tape.
3	Turn on the power of all equipment.
4	Press REC key.
5	Save black file.

Test Mode	Mode 3: USB LCD on
1	Setup EUT and PC as shown on 1.4.
2	Loop transmit REC file with USB cable.
3	Turn on the power.
4	Write DSC file to PC for example.

Test Mode	Mode 4: Preview
1	Setup EUT and PC as shown on 1.4.
2	The lens of EUT was covered with black tape.
3	Turn on the power of all equipment.
4	Select capture preview mode.
5	Test.

**2. Technical Test**

**2.1. Summary of Test Result**

- No deviations from the test standards
- Deviations from the test standards as below description:

Emission			
Performed Item	Normative References	Test Performed	Deviation
Conducted Emission	FCC CFR Title 47 Part 15 Subpart B: 2005 Class B, CISPR 22: 2005, ANSI C63.4: 2003	Yes	No
Radiated Emission	FCC CFR Title 47 Part 15 Subpart B: 2005 Class B, CISPR 22: 2005, ANSI C63.4: 2003	Yes	No

**2.2. List of Test Equipment**

Conducted Emission / SR2

Instrument	Manufacturer	Type No.	Serial No	Cal. Date
4-Wire ISN	R & S	ENY 41	837032/001	2006/02/25
Artificial Mains Network	R & S	ENV4200	848411/010	2006/02/18
Double 2-Wire ISN	R & S	ENY 22	835354/008	2006/02/25
LISN	R & S	ESH3-Z5	825562/002	2006/02/18
Pulse Limiter	R & S	ZSH3Z2	357.8810.52	2006/02/12
Test Receiver	R & S	ESCS 30	825442/018	2006/09/16

Radiated Emission / Site2

Instrument	Manufacturer	Type No.	Serial No	Cal. Date
Bilog Antenna	Schaffner Chase	CBL6112B	2708	2006/09/03
Horn Antenna	Schwarzbeck	BBHA 9120D	BBHA9120D312	2006/07/29
Pre-Amplifier	Quietek	QTK-AMP	AMP1	N/A
Pre-Amplifier	HP	8449B	3008A01123	2006/02/15
Spectrum Analyzer	Advantest	R3261C	81720471	2006/02/17
Spectrum Analyzer	R & S	FSP40	100005	2006/08/25
Test Receiver	R & S	ESCS 30	836858/023	2006/02/17

**2.3. Measurement Uncertainty**

Conducted Emission

The measurement uncertainty is evaluated as  $\pm 2.26$  dB.

Radiated Emission

The measurement uncertainty is evaluated as  $\pm 3.19$  dB.

**2.4. Test Environment**

Performed Item	Items	Required	Actual
Conducted Emission	Temperature (°C)	15-35	25
	Humidity (%RH)	25-75	50
	Barometric pressure (mbar)	860-1060	950-1000
Radiated Emission	Temperature (°C)	15-35	25
	Humidity (%RH)	25-75	65
	Barometric pressure (mbar)	860-1060	950-1000

### 3. Conducted Emission

#### 3.1. Test Specification

According to Standard: FCC Part 15 Subpart B, ANSI C63.4

#### 3.2. Test Setup

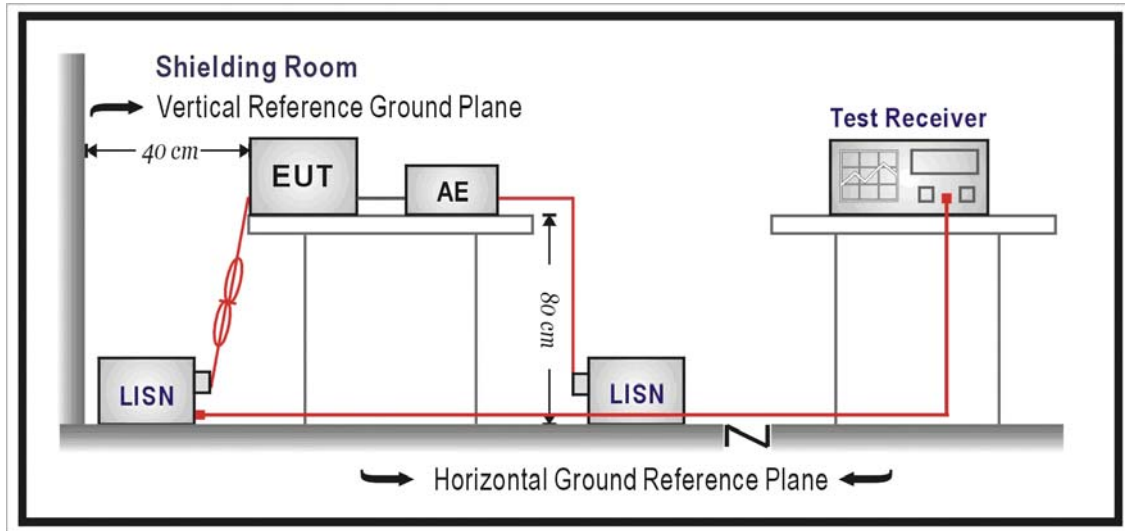

#### 3.3. Limit

Limits		
Frequency (MHz)	QP (dBuV)	AV (dBuV)
0.15 - 0.50	66 - 56	56 - 46
0.50-5.0	56	46
5.0 - 30	60	50

Remarks: In the above table, the tighter limit applies at the band edges.

### 3.4. Test Procedure

The EUT and simulators are connected to the main power through a line impedance stabilization network (L.I.S.N.). This provides a 50 ohm /50uH coupling impedance for the measuring equipment. The peripheral devices are also connected to the main power through a LISN that provides a 50ohm/50uH coupling impedance with 50ohm termination.

(Please refers to the block diagram of the test setup and photographs.)

Both sides of A.C. line are checked for maximum conducted interference. In order to find the maximum emission, the relative positions of equipment and all of the interface cables must be changed on conducted measurement.

Conducted emissions were invested over the frequency range from 0.15MHz to 30MHz using a receiver bandwidth of 9kHz.

3.5. Test Result

Site : Quietek Shielding Room 2	Time : 2006/11/14 - 15:23
Limit : CISPR_B_00M_QP	Margin : 0
EUT : Digital Still Camera	Probe : QTK-LISN-SR2 - Line1
Power : AC 120V/60Hz	Note : Mode 3: USB LCD on

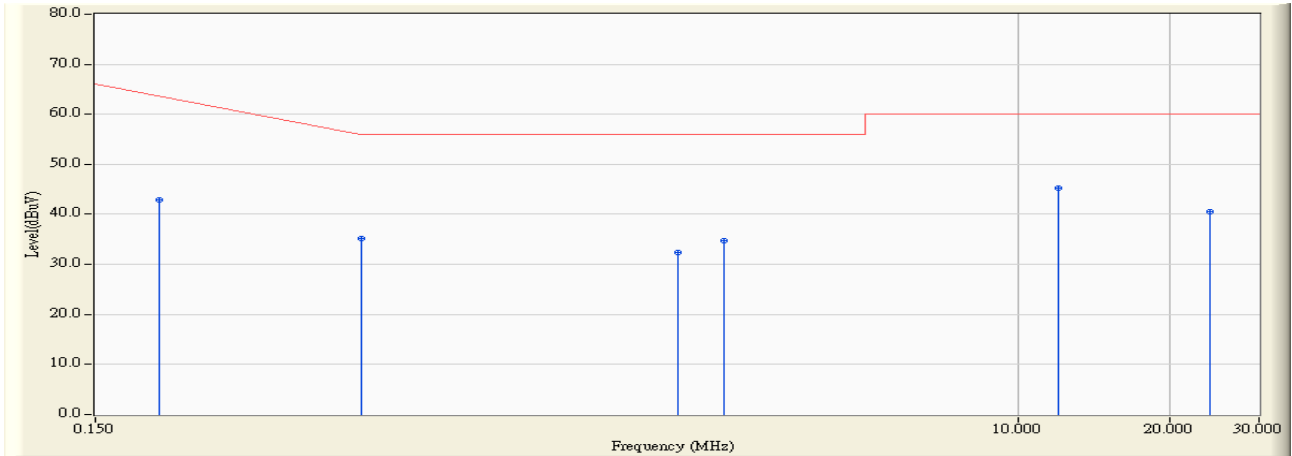

	Frequency (MHz)	Correct Factor (dB)	Reading Level (dBuV)	Measure Level (dBuV)	Margin (dB)	Limit (dBuV)	Detector Type
1	0.201	0.200	42.710	42.910	-21.633	64.543	QUASIPeAK
2	0.505	0.210	34.890	35.100	-20.900	56.000	QUASIPeAK
3	2.127	0.230	32.180	32.410	-23.590	56.000	QUASIPeAK
4	2.630	0.260	34.550	34.810	-21.190	56.000	QUASIPeAK
5	* 12.002	0.840	44.420	45.260	-14.740	60.000	QUASIPeAK
6	24.000	1.200	39.270	40.470	-19.530	60.000	QUASIPeAK

Note:

1. All Reading Levels are Quasi-Peak and average value.
2. " \* ", means this data is the worst emission level.
3. Measurement Level = Reading Level + Correct Factor.

Site : Quietek Shielding Room 2	Time : 2006/11/14 - 15:23
Limit : CISPR_B_00M_AV	Margin : 0
EUT : Digital Still Camera	Probe : QTK-LISN-SR2 - Line1
Power : AC 120V/60Hz	Note : Mode 3: USB LCD on

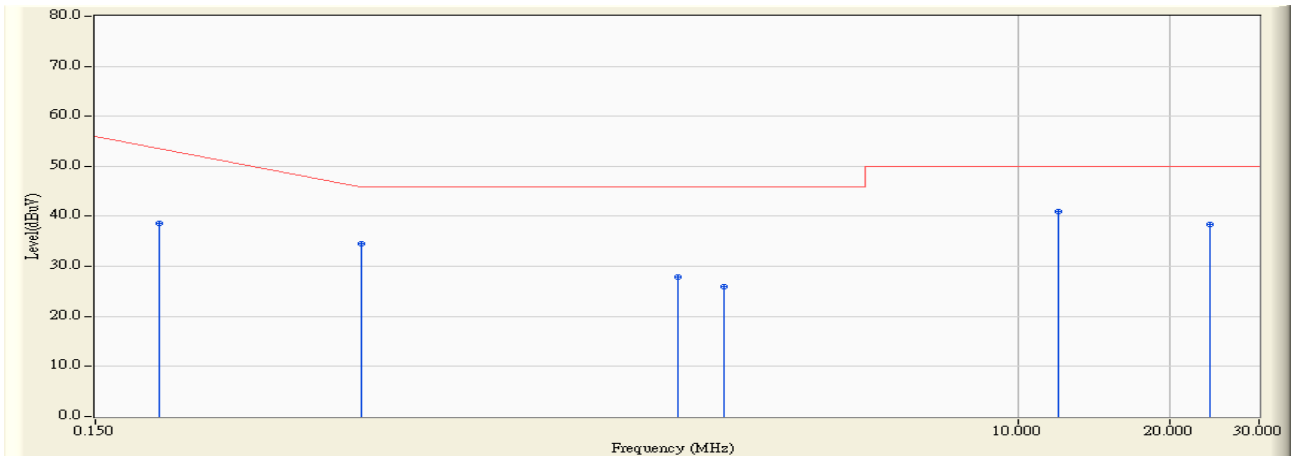

		Frequency (MHz)	Correct Factor (dB)	Reading Level (dBuV)	Measure Level (dBuV)	Margin (dB)	Limit (dBuV)	Detector Type
1		0.201	0.200	38.400	38.600	-15.943	54.543	AVERAGE
2		0.505	0.210	34.220	34.430	-11.570	46.000	AVERAGE
3		2.127	0.230	27.750	27.980	-18.020	46.000	AVERAGE
4		2.630	0.260	25.630	25.890	-20.110	46.000	AVERAGE
5	*	12.002	0.840	40.020	40.860	-9.140	50.000	AVERAGE
6		24.000	1.200	37.130	38.330	-11.670	50.000	AVERAGE

**Note:**

1. All Reading Levels are Quasi-Peak and average value.
2. " \* ", means this data is the worst emission level.
3. Measurement Level = Reading Level + Correct Factor.



Site : Quietek Shielding Room 2	Time : 2006/11/14 - 15:20
Limit : CISPR_B_00M_QP	Margin : 0
EUT : Digital Still Camera	Probe : QTK-LISN-SR2 - Line2
Power : AC 120V/60Hz	Note : Mode 3: USB LCD on

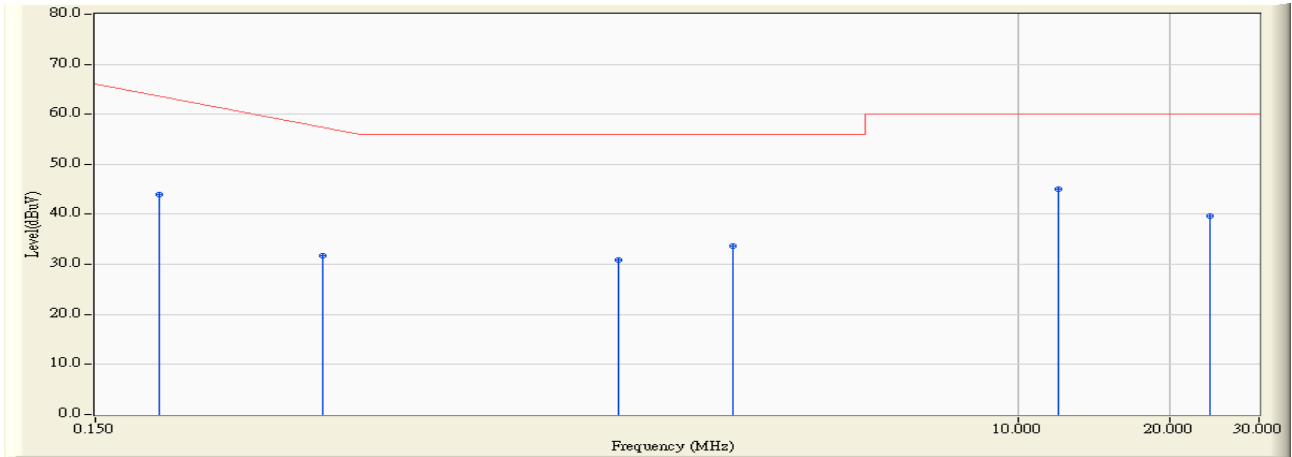

		Frequency (MHz)	Correct Factor (dB)	Reading Level (dBuV)	Measure Level (dBuV)	Margin (dB)	Limit (dBuV)	Detector Type
1		0.201	0.200	43.750	43.950	-20.593	64.543	QUASPEAK
2		0.423	0.200	31.450	31.650	-26.550	58.200	QUASPEAK
3		1.619	0.220	30.640	30.860	-25.140	56.000	QUASPEAK
4		2.733	0.230	33.480	33.710	-22.290	56.000	QUASPEAK
5	*	12.000	0.600	44.440	45.040	-14.960	60.000	QUASPEAK
6		24.002	0.900	38.790	39.690	-20.310	60.000	QUASPEAK

Note:

1. All Reading Levels are Quasi-Peak and average value.
2. " \* ", means this data is the worst emission level.
3. Measurement Level = Reading Level + Correct Factor.

Site : Quietek Shielding Room 2	Time : 2006/11/14 - 15:20
Limit : CISPR_B_00M_AV	Margin : 0
EUT : Digital Still Camera	Probe : QTK-LISN-SR2 - Line2
Power : AC 120V/60Hz	Note : Mode 3: USB LCD on

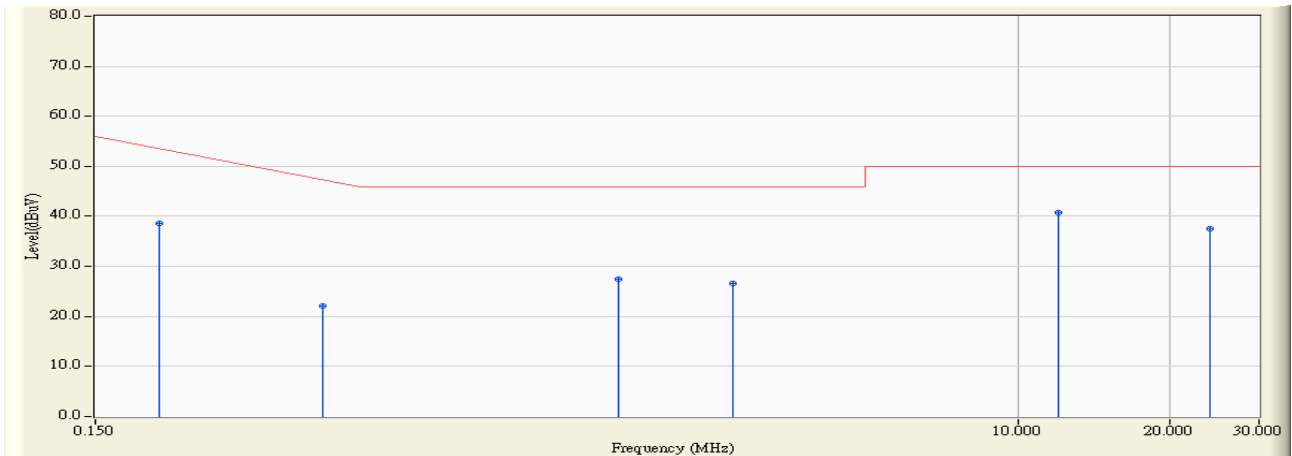

		Frequency (MHz)	Correct Factor (dB)	Reading Level (dBuV)	Measure Level (dBuV)	Margin (dB)	Limit (dBuV)	Detector Type
1		0.201	0.200	38.450	38.650	-15.893	54.543	AVERAGE
2		0.423	0.200	21.800	22.000	-26.200	48.200	AVERAGE
3		1.619	0.220	27.250	27.470	-18.530	46.000	AVERAGE
4		2.733	0.230	26.330	26.560	-19.440	46.000	AVERAGE
5	*	12.000	0.600	40.110	40.710	-9.290	50.000	AVERAGE
6		24.002	0.900	36.570	37.470	-12.530	50.000	AVERAGE

**Note:**

1. All Reading Levels are Quasi-Peak and average value.
2. " \* ", means this data is the worst emission level.
3. Measurement Level = Reading Level + Correct Factor.

#### 4. Radiated Emission

##### 4.1. Test Specification

According to EMC Standard: FCC Part 15 Subpart B, ANSI C63.4

##### 4.2. Test Setup

Under 1GHz Test Setup:

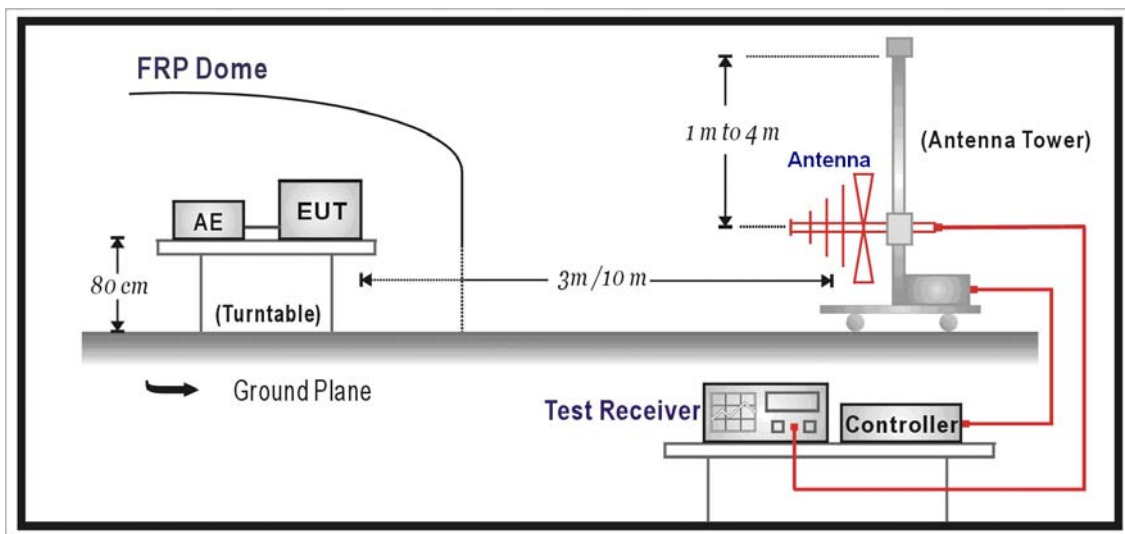

Above 1GHz Test Setup:

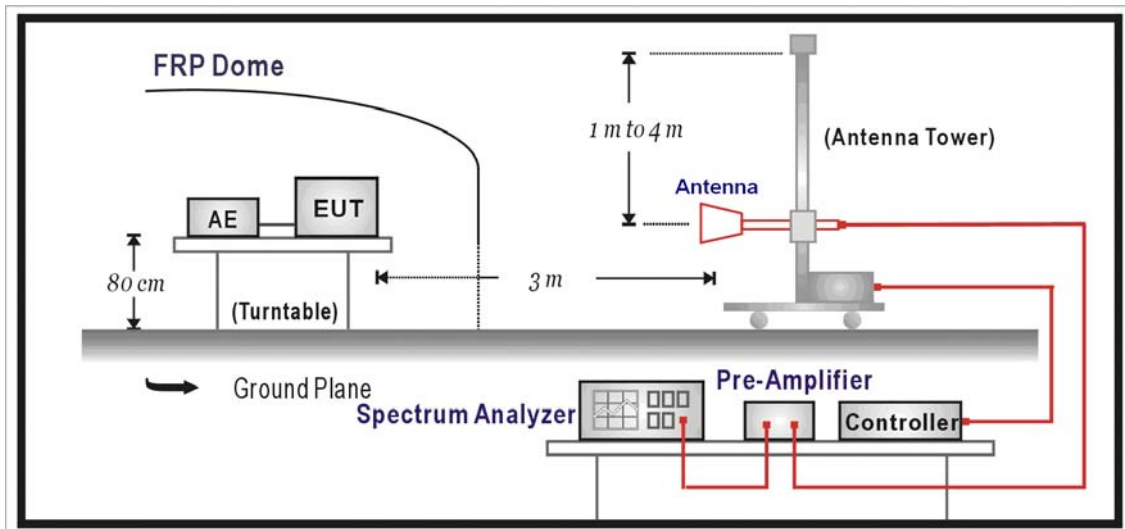

**4.3. Limit**

<b>FCC Part 15 Subpart B Paragraph 15.109 Limits (dBuV/m)</b>		
<b>Frequency (MHz)</b>	<b>Distance (m)</b>	<b>dBuV/m</b>
30-88	3	40
88-216	3	43.5
216-960	3	46
Above 960	3	54

Remark:

1. The tighter limit shall apply at the edge between two frequency bands.
2. Distance refers to the distance in meters between the measuring instrument antenna and the closed point of any part of the device or system.
3. RF Voltage (dBuV/m) = 20 log RF Voltage (uV/m)

**4.4. Test Procedure**

The EUT and its simulators are placed on a turn table which is 0.8 meter above ground.

The turn table can rotate 360 degrees to determine the position of the maximum emission level and the antenna can move up and down between 1 meter and 4 meters to find out the maximum emission level.

Both horizontal and vertical polarization of the antenna are set on measurement. In order to find the maximum emission, all of the interface cables must be manipulated on radiated measurement.

For an unintentional radiator, including a digital device, the spectrum shall be investigated from the lowest radio frequency signal generated or used in the device, without going below the lowest frequency for which a radiated emission limit is specified, up to the frequency shown in the following table:

Highest frequency generated or used in the device or on which the device operates or tunes (MHz)	Upper frequency of measurement range (MHz)
Below 1.705	30
1.705 – 108	1000
108 – 500	2000
500 – 1000	5000
Above 1000	5 <sup>th</sup> harmonic of the highest frequency or 40 GHz, whichever is lower

On any frequency or frequencies below or equal to 1000 MHz, the radiated limits shown are based on measuring equipment employing a quasi-peak detector function and above 1000 MHz, the radiated limits shown are based measuring equipment employing an average detector function.

When average radiated emission measurement are included emission measurement Above 1000 MHz, there also is a limit on the radio frequency emissions, as measured using instrumentation with a peak detector function, corresponding to 20 dB above the maximum permitted average limit.

For class A, the measurement distance between the EUT and antenna is 10 meters for under 1GHz and above 1GHz.

For class B, the measurement distance between the EUT and antenna is 3 meters for under 1GHz and 3 meters for above 1GHz.

The bandwidth below 1GHz setting on the field strength meter (R&S Test Receiver ESCS 30) is 120 kHz and above 1GHz is 1MHz.

4.5. Test Result

Site : Site 2	Time : 2006/11/08 - 11:29
Limit : FCC_CLASS_B_03M_QP	Margin : 6
EUT : Digital Still Camera	Probe : PRO 06-03-29 ST2 - HORIZONTAL
Power : AC 120V/60Hz	Note : Mode 1: Slide Show

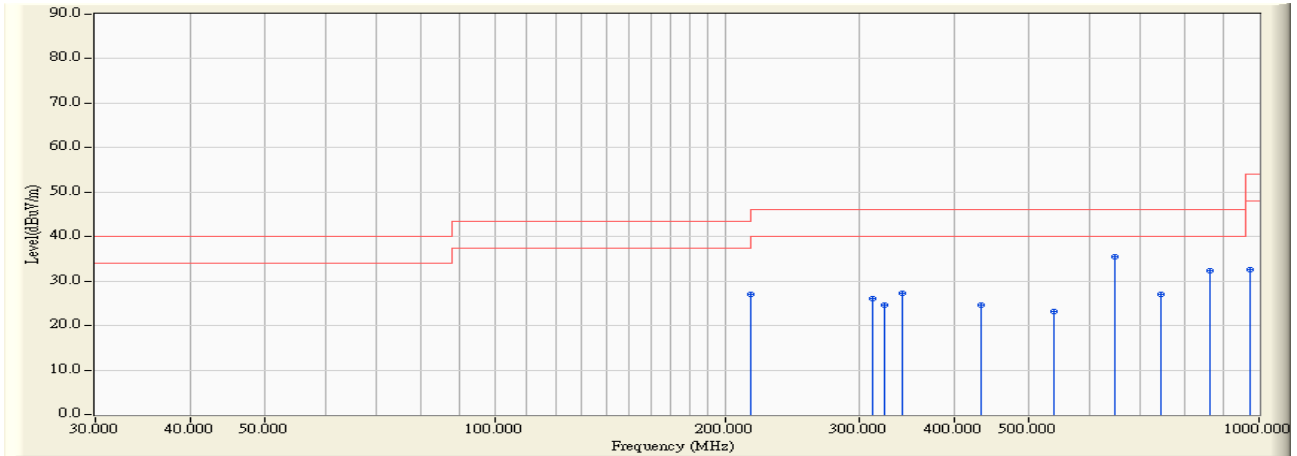

	Frequency (MHz)	Correct Factor (dB)	Reading Level (dBuV)	Measure Level (dBuV/m)	Margin (dB)	Limit (dBuV/m)	Detector Type	Ant Pos (cm)	Table Pos (deg)
1	216.000	11.315	15.680	26.995	-16.505	43.500	QUASIPeAK	147.000	106.000
2	311.925	14.706	11.470	26.176	-19.824	46.000	QUASIPeAK	100.000	-195.000
3	324.000	16.100	8.490	24.590	-21.410	46.000	QUASIPeAK	100.000	-195.000
4	341.650	15.671	11.690	27.361	-18.639	46.000	QUASIPeAK	100.000	92.000
5	432.000	17.935	6.730	24.665	-21.335	46.000	QUASIPeAK	100.000	-103.000
6	540.000	19.743	3.460	23.203	-22.797	46.000	QUASIPeAK	173.000	-200.000
7	* 648.000	23.202	12.280	35.482	-10.518	46.000	QUASIPeAK	136.000	171.000
8	742.700	22.874	4.030	26.904	-19.096	46.000	QUASIPeAK	100.000	150.000
9	864.000	23.652	8.690	32.342	-13.658	46.000	QUASIPeAK	100.000	-150.000
10	972.000	26.445	6.040	32.485	-21.515	54.000	QUASIPeAK	147.000	173.000

Note:

1. All Reading Levels are Quasi-Peak and average value.
2. " \* ", means this data is the worst emission level.
3. Measurement Level = Reading Level + Correct Factor.

Site : Site 2	Time : 2006/11/22 - 11:43
Limit : FCC_B_(Above_1G)_3M_PK	Margin : 6
EUT : Digital Still Camera	Probe : FCC_RF_1G-18G(2005-3) - HORIZONTAL
Power : AC 120 V/ 60Hz	Note : Mode 1: Slide Show

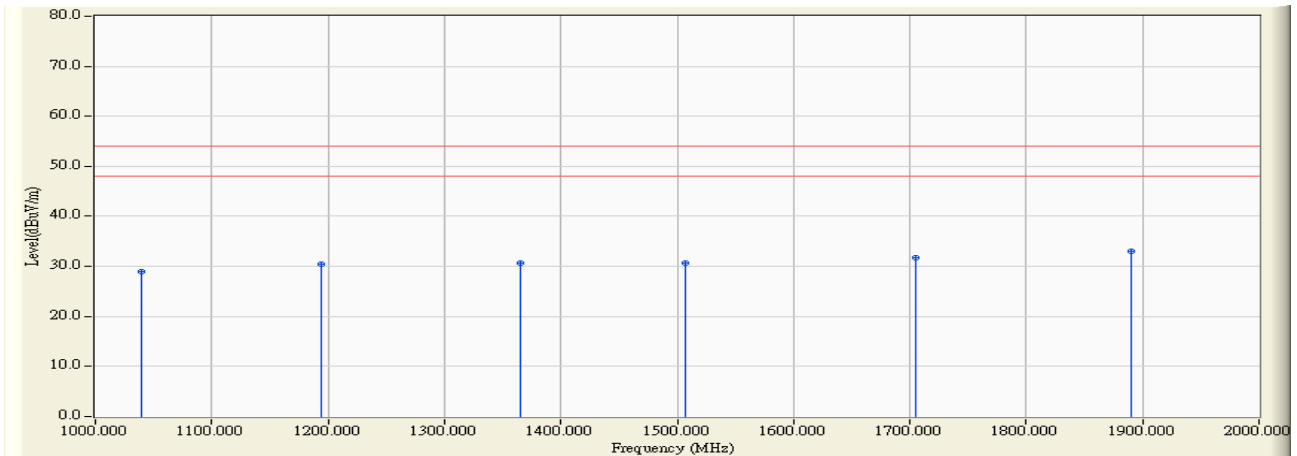

	Frequency (MHz)	Correct Factor (dB)	Reading Level (dBuV)	Measure Level (dBuV/m)	Margin (dB)	Limit (dBuV/m)	Detector Type	Ant Pos (cm)	Table Pos (deg)
1	1040.000	-9.890	38.800	28.909	-25.091	54.000	PEAK	0.000	0.000
2	1194.390	-9.110	39.510	30.400	-23.600	54.000	PEAK	0.000	0.000
3	1364.700	-8.620	39.350	30.731	-23.269	54.000	PEAK	0.000	0.000
4	1507.010	-8.065	38.830	30.765	-23.235	54.000	PEAK	0.000	0.000
5	1705.400	-7.259	39.070	31.811	-22.189	54.000	PEAK	0.000	0.000
6	* 1889.780	-5.831	38.930	33.099	-20.901	54.000	PEAK	0.000	0.000

**Note:**

1. All Readings below 1GHz are Quasi-Peak, above are performed with peak and/or average measurements as necessary.
2. “ \* ”, means this data is the worst emission level.
3. Measurement Level = Reading Level + Correct Factor.
4. The average measurement was not performed when the peak measured data under the limit of average detection. If the readings given are average, peak measurement should also be supplied.

Site : Site 2	Time : 2006/11/08 - 11:44
Limit : FCC_CLASS_B_03M_QP	Margin : 6
EUT : Digital Still Camera	Probe : PRO 06-03-29 ST2 - VERTICAL
Power : AC 120V/60Hz	Note : Mode 1: Slide Show

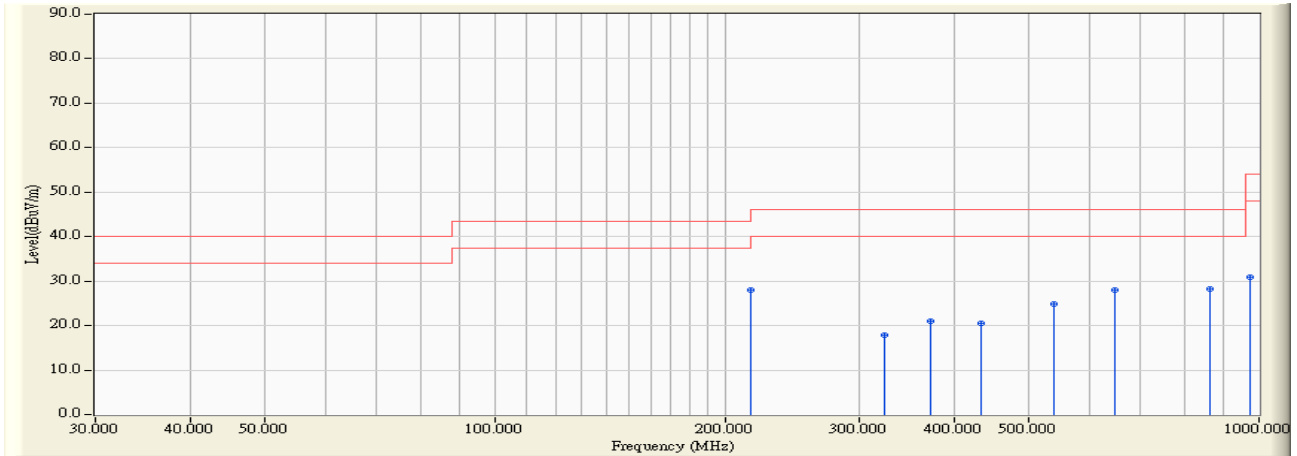

		Frequency (MHz)	Correct Factor (dB)	Reading Level (dBuV)	Measure Level (dBuV/m)	Margin (dB)	Limit (dBuV/m)	Detector Type	Ant Pos (cm)	Table Pos (deg)
1	*	216.000	11.221	16.690	27.911	-15.589	43.500	QUASIPeAK	100.000	-100.000
2		324.000	13.372	4.490	17.862	-28.138	46.000	QUASIPeAK	100.000	165.000
3		371.350	15.565	5.360	20.925	-25.075	46.000	QUASIPeAK	100.000	84.000
4		432.000	15.636	4.810	20.446	-25.554	46.000	QUASIPeAK	148.000	138.000
5		540.000	21.850	3.000	24.850	-21.150	46.000	QUASIPeAK	100.000	153.000
6		648.000	21.154	6.930	28.084	-17.916	46.000	QUASIPeAK	100.000	-70.000
7		864.000	24.115	4.220	28.335	-17.665	46.000	QUASIPeAK	126.000	-175.000
8		972.000	24.972	5.800	30.772	-23.228	54.000	QUASIPeAK	122.000	-139.000

**Note:**

1. All Reading Levels are Quasi-Peak and average value.
2. " \* ", means this data is the worst emission level.
3. Measurement Level = Reading Level + Correct Factor.



Site : Site 2	Time : 2006/11/22 - 11:43
Limit : FCC_B_(Above_1G)_3M_PK	Margin : 6
EUT : Digital Still Camera	Probe : FCC_RF_1G-18G(2005-3) - VERTICAL
Power : AC 120 V/ 60Hz	Note : Mode 1: Slide Show

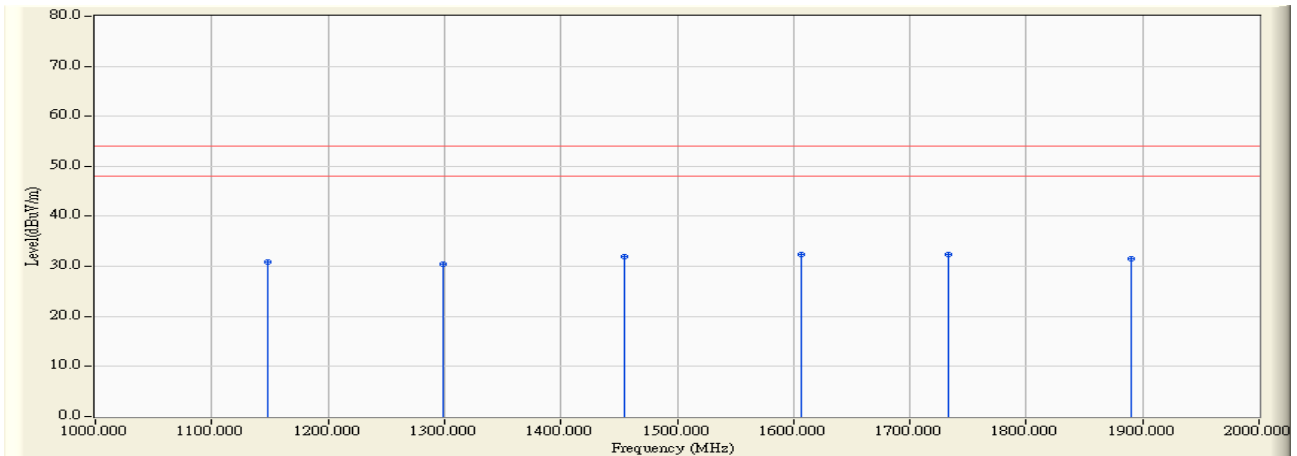

	Frequency (MHz)	Correct Factor (dB)	Reading Level (dBuV)	Measure Level (dBuV/m)	Margin (dB)	Limit (dBuV/m)	Detector Type	Ant Pos (cm)	Table Pos (deg)
1	1148.300	-8.503	39.350	30.847	-23.153	54.000	PEAK	0.000	0.000
2	1298.600	-8.055	38.610	30.556	-23.444	54.000	PEAK	0.000	0.000
3	1454.900	-7.492	39.370	31.878	-22.122	54.000	PEAK	0.000	0.000
4	* 1607.200	-7.045	39.460	32.415	-21.585	54.000	PEAK	0.000	0.000
5	1733.470	-6.179	38.560	32.381	-21.619	54.000	PEAK	0.000	0.000
6	1889.780	-6.092	37.600	31.508	-22.492	54.000	PEAK	0.000	0.000

**Note:**

1. All Readings below 1GHz are Quasi-Peak, above are performed with peak and/or average measurements as necessary.
2. “ \* ”, means this data is the worst emission level.
3. Measurement Level = Reading Level + Correct Factor.
4. The average measurement was not performed when the peak measured data under the limit of average detection. If the readings given are average, peak measurement should also be supplied.

Site : Site 2	Time : 2006/11/08 - 09:51
Limit : FCC_CLASS_B_03M_QP	Margin : 6
EUT : Digital Still Camera	Probe : PRO 06-03-29 ST2 - HORIZONTAL
Power : AC 120V/60Hz	Note : Mode 2: REC

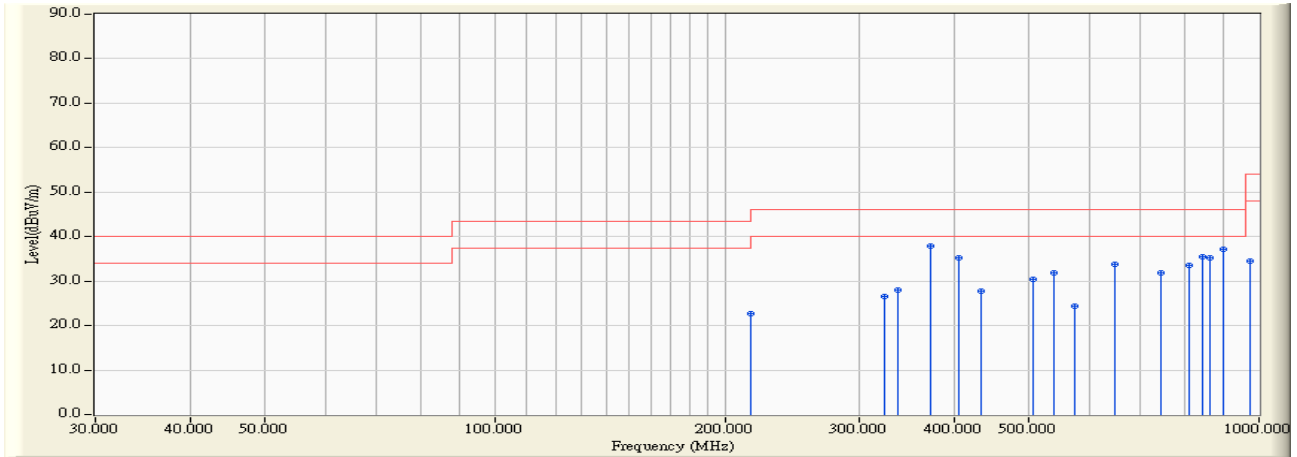

	Frequency (MHz)	Correct Factor (dB)	Reading Level (dBuV)	Measure Level (dBuV/m)	Margin (dB)	Limit (dBuV/m)	Detector Type	Ant Pos (cm)	Table Pos (deg)
1	216.000	11.315	11.260	22.575	-20.925	43.500	QUASIPeAK	127.000	129.000
2	324.000	16.100	10.430	26.530	-19.470	46.000	QUASIPeAK	100.000	-200.000
3	337.500	15.444	12.560	28.004	-17.996	46.000	QUASIPeAK	100.000	-58.000
4	* 371.250	16.774	21.170	37.944	-8.056	46.000	QUASIPeAK	100.000	-58.000
5	405.000	18.536	16.680	35.216	-10.784	46.000	QUASIPeAK	100.000	119.000
6	432.000	17.935	9.910	27.845	-18.155	46.000	QUASIPeAK	100.000	106.000
7	506.250	20.611	9.740	30.351	-15.649	46.000	QUASIPeAK	138.000	62.000
8	540.000	19.743	12.220	31.963	-14.037	46.000	QUASIPeAK	138.000	127.000
9	573.750	20.013	4.400	24.413	-21.587	46.000	QUASIPeAK	138.000	140.000
10	648.000	23.202	10.670	33.872	-12.128	46.000	QUASIPeAK	127.000	99.000
11	742.500	22.909	9.050	31.959	-14.041	46.000	QUASIPeAK	100.000	168.000
12	810.000	22.456	11.060	33.516	-12.484	46.000	QUASIPeAK	100.000	153.000
13	843.750	23.931	11.520	35.451	-10.549	46.000	QUASIPeAK	100.000	159.000
14	864.000	23.652	11.690	35.342	-10.658	46.000	QUASIPeAK	100.000	153.000
15	900.000	25.318	11.780	37.098	-8.902	46.000	QUASIPeAK	100.000	-77.000
16	972.025	26.448	7.940	34.388	-19.612	54.000	QUASIPeAK	100.000	51.000

**Note:**

1. All Reading Levels are Quasi-Peak and average value.
2. " \* ", means this data is the worst emission level.
3. Measurement Level = Reading Level + Correct Factor.

Site : Site 2	Time : 2006/11/22 - 11:43
Limit : FCC_B_(Above_1G)_3M_PK	Margin : 6
EUT : Digital Still Camera	Probe : FCC_RF_1G-18G(2005-3) - HORIZONTAL
Power : AC 120 V/ 60Hz	Note : Mode 2: REC

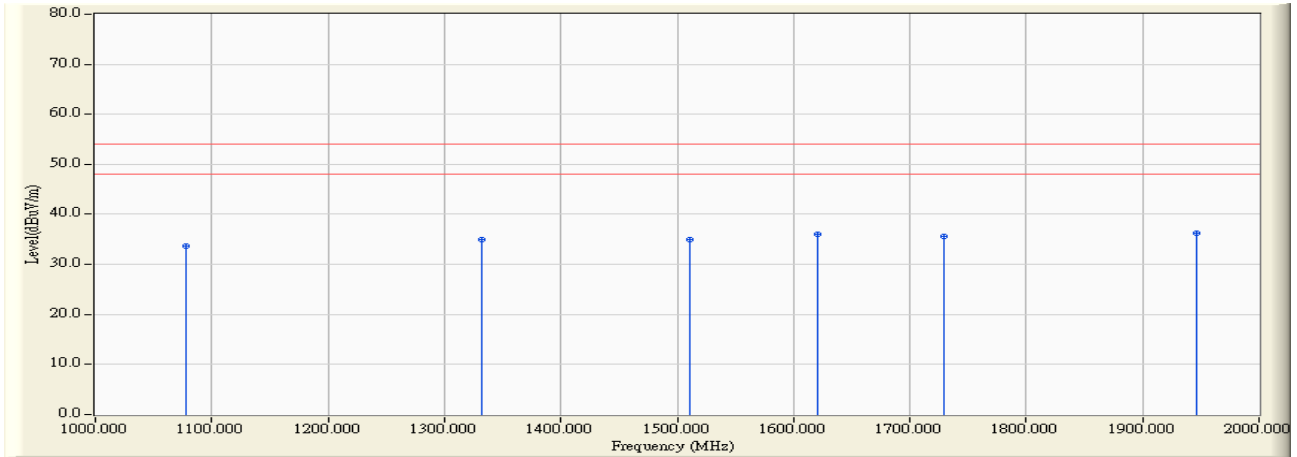

	Frequency (MHz)	Correct Factor (dB)	Reading Level (dBuV)	Measure Level (dBuV/m)	Margin (dB)	Limit (dBuV/m)	Detector Type	Ant Pos (cm)	Table Pos (deg)
1	1078.160	-9.664	43.420	33.756	-20.244	54.000	PEAK	0.000	0.000
2	1332.670	-8.705	43.640	34.936	-19.064	54.000	PEAK	0.000	0.000
3	1511.020	-8.032	43.010	34.977	-19.023	54.000	PEAK	0.000	0.000
4	1621.200	-7.766	43.850	36.084	-17.916	54.000	PEAK	0.000	0.000
5	1729.500	-7.011	42.610	35.599	-18.401	54.000	PEAK	0.000	0.000
6	* 1945.890	-4.817	41.140	36.323	-17.677	54.000	PEAK	0.000	0.000

**Note:**

1. All Readings below 1GHz are Quasi-Peak, above are performed with peak and/or average measurements as necessary.
2. “ \* ”, means this data is the worst emission level.
3. Measurement Level = Reading Level + Correct Factor.
4. The average measurement was not performed when the peak measured data under the limit of average detection. If the readings given are average, peak measurement should also be supplied.

Site : Site 2	Time : 2006/11/08 - 10:05
Limit : FCC_CLASS_B_03M_QP	Margin : 6
EUT : Digital Still Camera	Probe : PRO 06-03-29 ST2 - VERTICAL
Power : AC 120V/60Hz	Note : Mode 2: REC

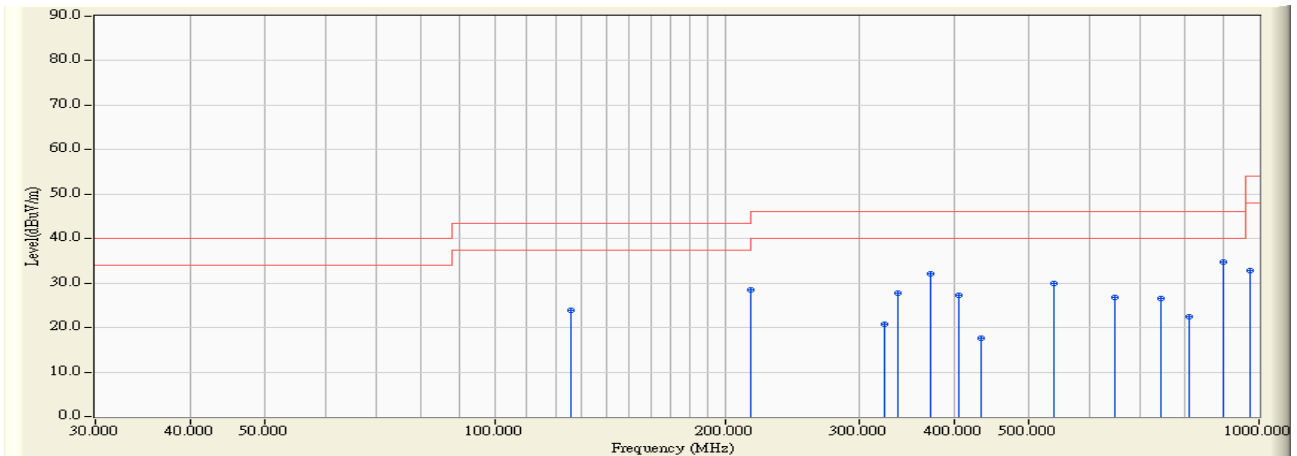

	Frequency (MHz)	Correct Factor (dB)	Reading Level (dBuV)	Measure Level (dBuV/m)	Margin (dB)	Limit (dBuV/m)	Detector Type	Ant Pos (cm)	Table Pos (deg)
1	125.500	13.803	10.090	23.893	-19.607	43.500	QUASIPeAK	100.000	202.000
2	216.000	11.221	17.370	28.591	-14.909	43.500	QUASIPeAK	100.000	184.000
3	324.000	13.372	7.410	20.782	-25.218	46.000	QUASIPeAK	100.000	-110.000
4	337.500	16.427	11.370	27.797	-18.203	46.000	QUASIPeAK	100.000	148.000
5	371.250	15.560	16.440	32.000	-14.000	46.000	QUASIPeAK	100.000	-34.000
6	405.000	16.356	10.910	27.266	-18.734	46.000	QUASIPeAK	100.000	-62.000
7	432.000	15.636	1.960	17.596	-28.404	46.000	QUASIPeAK	100.000	-4.000
8	540.000	21.850	8.190	30.040	-15.960	46.000	QUASIPeAK	100.000	-48.000
9	648.000	21.154	5.630	26.784	-19.216	46.000	QUASIPeAK	100.000	-67.000
10	742.500	21.643	4.840	26.483	-19.517	46.000	QUASIPeAK	100.000	50.000
11	810.000	18.336	4.020	22.356	-23.644	46.000	QUASIPeAK	100.000	50.000
12	* 900.000	24.116	10.590	34.706	-11.294	46.000	QUASIPeAK	100.000	142.000
13	972.000	24.972	7.860	32.832	-21.168	54.000	QUASIPeAK	100.000	-201.000

Note:

1. All Reading Levels are Quasi-Peak and average value.
2. " \* ", means this data is the worst emission level.
3. Measurement Level = Reading Level + Correct Factor.

Site : Site 2	Time : 2006/11/22 - 11:44
Limit : FCC_B_(Above_1G)_3M_PK	Margin : 6
EUT : Digital Still Camera	Probe : FCC_RF_1G-18G(2005-3) - VERTICAL
Power : AC 120 V/ 60Hz	Note : Mode 2: REC

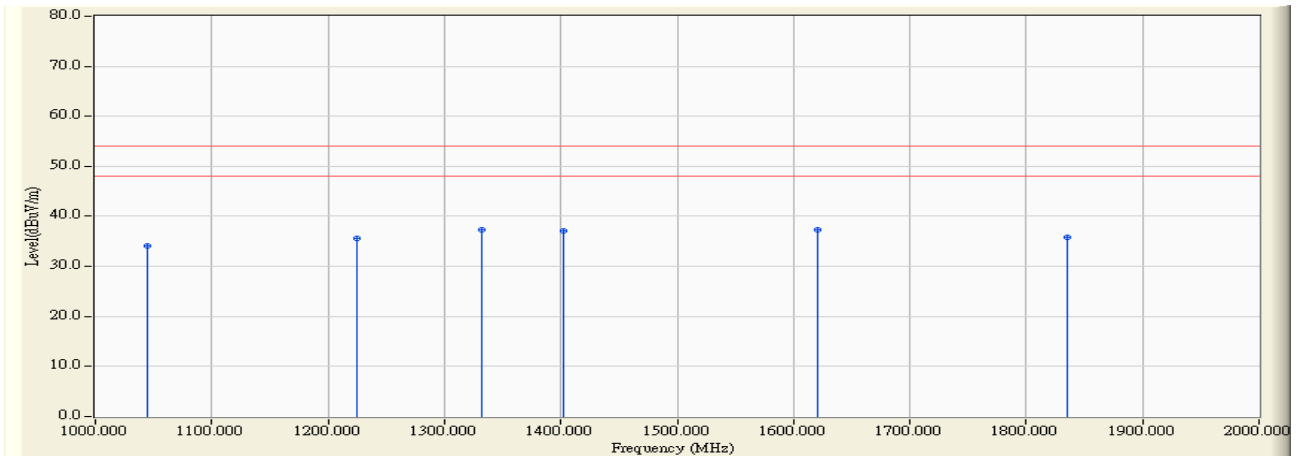

	Frequency (MHz)	Correct Factor (dB)	Reading Level (dBuV)	Measure Level (dBuV/m)	Margin (dB)	Limit (dBuV/m)	Detector Type	Ant Pos (cm)	Table Pos (deg)
1	1044.080	-8.980	42.980	34.000	-20.000	54.000	PEAK	0.000	0.000
2	1224.450	-8.593	44.290	35.697	-18.303	54.000	PEAK	0.000	0.000
3	1332.670	-7.905	45.180	37.276	-16.724	54.000	PEAK	0.000	0.000
4	1402.800	-7.689	44.810	37.121	-16.879	54.000	PEAK	0.000	0.000
5	* 1621.240	-6.966	44.350	37.384	-16.616	54.000	PEAK	0.000	0.000
6	1835.670	-6.236	42.153	35.918	-18.082	54.000	PEAK	0.000	0.000

**Note:**

1. All Readings below 1GHz are Quasi-Peak, above are performed with peak and/or average measurements as necessary.
2. “ \* ”, means this data is the worst emission level.
3. Measurement Level = Reading Level + Correct Factor.
4. The average measurement was not performed when the peak measured data under the limit of average detection. If the readings given are average, peak measurement should also be supplied.

Site : Site 2	Time : 2006/11/08 - 10:42
Limit : FCC_CLASS_B_03M_QP	Margin : 6
EUT : Digital Still Camera	Probe : PRO 06-03-29 ST2 - HORIZONTAL
Power : AC 120V/60Hz	Note : Mode 3: USB LCD on

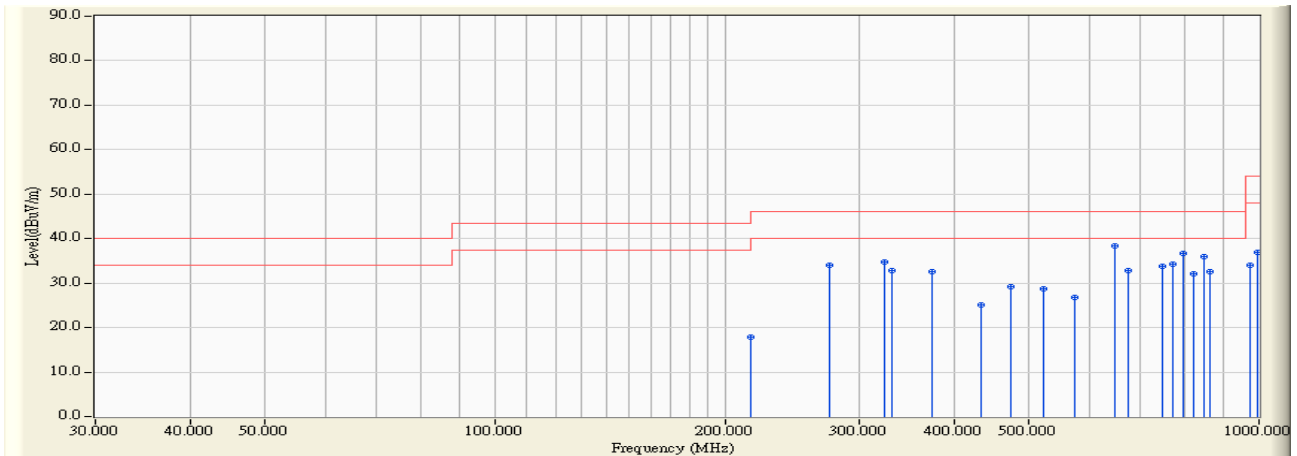

	Frequency (MHz)	Correct Factor (dB)	Reading Level (dBuV)	Measure Level (dBuV/m)	Margin (dB)	Limit (dBuV/m)	Detector Type	Ant Pos (cm)	Table Pos (deg)
1	216.000	11.315	6.520	17.835	-25.665	43.500	QUASIPeAK	100.000	202.000
2	274.150	13.913	20.180	34.093	-11.907	46.000	QUASIPeAK	100.000	139.000
3	324.000	16.100	18.680	34.780	-11.220	46.000	QUASIPeAK	100.000	124.000
4	330.250	15.068	17.760	32.828	-13.172	46.000	QUASIPeAK	100.000	136.000
5	373.850	17.083	15.580	32.663	-13.337	46.000	QUASIPeAK	100.000	68.000
6	432.000	17.935	7.150	25.085	-20.915	46.000	QUASIPeAK	100.000	-141.000
7	473.550	18.070	11.170	29.240	-16.760	46.000	QUASIPeAK	100.000	47.000
8	523.400	18.808	9.950	28.758	-17.242	46.000	QUASIPeAK	100.000	120.000
9	573.225	20.029	6.690	26.719	-19.281	46.000	QUASIPeAK	100.000	-70.000
10	* 648.000	23.202	15.210	38.412	-7.588	46.000	QUASIPeAK	129.000	142.000
11	672.925	22.921	9.850	32.771	-13.229	46.000	QUASIPeAK	129.000	142.000
12	747.700	22.018	11.770	33.788	-12.212	46.000	QUASIPeAK	100.000	141.000
13	772.625	22.637	11.690	34.327	-11.673	46.000	QUASIPeAK	100.000	136.000
14	797.550	21.869	14.870	36.739	-9.261	46.000	QUASIPeAK	100.000	202.000
15	822.475	21.442	10.730	32.172	-13.828	46.000	QUASIPeAK	100.000	202.000
16	847.400	24.294	11.760	36.054	-9.946	46.000	QUASIPeAK	100.000	202.000
17	864.000	23.652	8.970	32.622	-13.378	46.000	QUASIPeAK	100.000	-198.000
18	972.025	26.448	7.480	33.928	-20.072	54.000	QUASIPeAK	100.000	35.000
19	996.950	25.879	10.980	36.859	-17.141	54.000	QUASIPeAK	100.000	68.000

Note:

1. All Reading Levels are Quasi-Peak and average value.
2. " \* ", means this data is the worst emission level.
3. Measurement Level = Reading Level + Correct Factor.

Site : Site 2	Time : 2006/11/22 - 11:43
Limit : FCC_B_(Above_1G)_3M_PK	Margin : 6
EUT : Digital Still Camera	Probe : FCC_RF_1G-18G(2005-3) - HORIZONTAL
Power : AC 120 V/ 60Hz	Note : Mode 3: USB LCD on

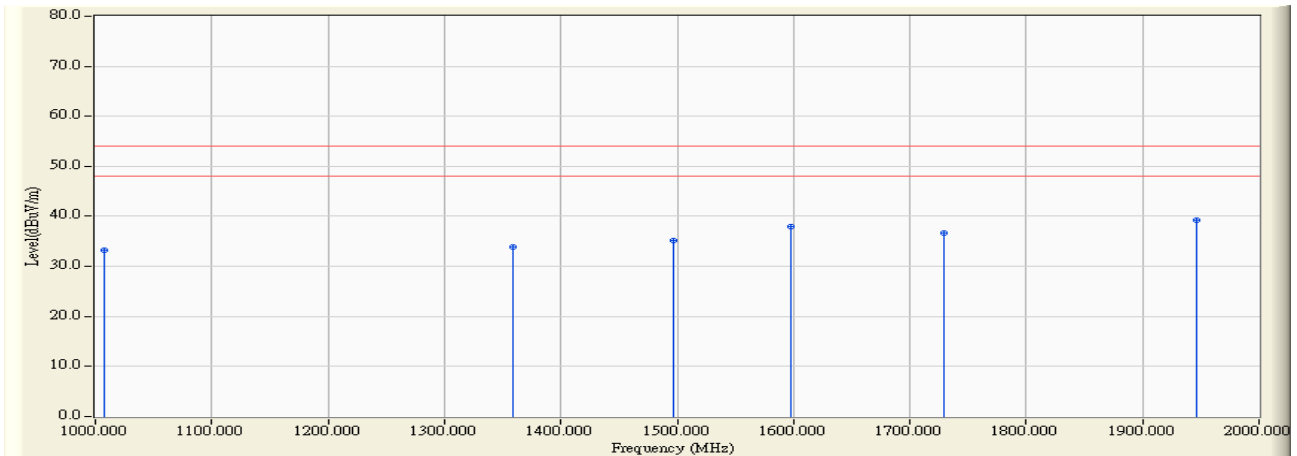

	Frequency (MHz)	Correct Factor (dB)	Reading Level (dBuV)	Measure Level (dBuV/m)	Margin (dB)	Limit (dBuV/m)	Detector Type	Ant Pos (cm)	Table Pos (deg)
1	1008.000	-11.828	45.010	33.182	-20.818	54.000	PEAK	0.000	0.000
2	1358.720	-8.612	42.550	33.938	-20.062	54.000	PEAK	0.000	0.000
3	1496.990	-8.147	43.320	35.173	-18.827	54.000	PEAK	0.000	0.000
4	1597.200	-7.899	45.760	37.862	-16.138	54.000	PEAK	0.000	0.000
5	1729.500	-7.011	43.700	36.689	-17.311	54.000	PEAK	0.000	0.000
6	* 1945.890	-4.817	44.030	39.213	-14.787	54.000	PEAK	0.000	0.000

**Note:**

1. All Readings below 1GHz are Quasi-Peak, above are performed with peak and/or average measurements as necessary.
2. “ \* ”, means this data is the worst emission level.
3. Measurement Level = Reading Level + Correct Factor.
4. The average measurement was not performed when the peak measured data under the limit of average detection. If the readings given are average, peak measurement should also be supplied.

Site : Site 2	Time : 2006/11/08 - 11:01
Limit : FCC_CLASS_B_03M_QP	Margin : 6
EUT : Digital Still Camera	Probe : PRO 06-03-29 ST2 - VERTICAL
Power : AC 120V/60Hz	Note : Mode 3: USB LCD on

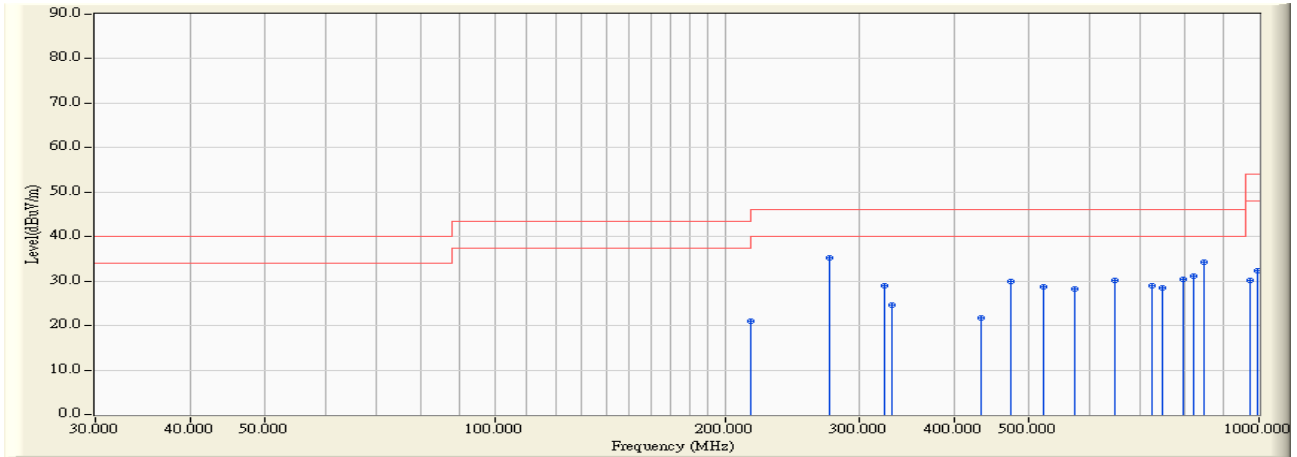

	Frequency (MHz)	Correct Factor (dB)	Reading Level (dBuV)	Measure Level (dBuV/m)	Margin (dB)	Limit (dBuV/m)	Detector Type	Ant Pos (cm)	Table Pos (deg)
1	216.000	11.221	9.780	21.001	-22.499	43.500	QUASIPeAK	100.000	-27.000
2	* 274.150	18.096	17.020	35.116	-10.884	46.000	QUASIPeAK	100.000	87.000
3	324.000	13.372	15.470	28.842	-17.158	46.000	QUASIPeAK	160.000	-164.000
4	330.250	14.215	10.470	24.685	-21.315	46.000	QUASIPeAK	160.000	171.000
5	432.000	15.636	6.130	21.766	-24.234	46.000	QUASIPeAK	143.000	134.000
6	473.550	18.910	10.930	29.840	-16.160	46.000	QUASIPeAK	143.000	134.000
7	523.400	19.561	9.080	28.641	-17.359	46.000	QUASIPeAK	161.000	-194.000
8	573.250	19.994	8.330	28.324	-17.676	46.000	QUASIPeAK	161.000	-159.000
9	648.000	21.154	9.000	30.154	-15.846	46.000	QUASIPeAK	161.000	191.000
10	722.775	21.024	7.920	28.944	-17.056	46.000	QUASIPeAK	100.000	-121.000
11	747.700	21.085	7.300	28.385	-17.615	46.000	QUASIPeAK	160.000	-134.000
12	797.550	19.374	11.070	30.444	-15.556	46.000	QUASIPeAK	160.000	-134.000
13	822.475	22.773	8.350	31.123	-14.877	46.000	QUASIPeAK	100.000	158.000
14	847.400	24.099	10.130	34.229	-11.771	46.000	QUASIPeAK	100.000	158.000
15	972.025	24.965	5.300	30.265	-23.735	54.000	QUASIPeAK	178.000	-189.000
16	996.950	23.271	9.030	32.301	-21.699	54.000	QUASIPeAK	100.000	198.000

**Note:**

1. All Reading Levels are Quasi-Peak and average value.
2. " \* ", means this data is the worst emission level.
3. Measurement Level = Reading Level + Correct Factor.



Site : Site 2	Time : 2006/11/22 - 11:40
Limit : FCC_B_(Above_1G)_3M_PK	Margin : 6
EUT : Digital Still Camera	Probe : FCC_RF_1G-18G(2005-3) - VERTICAL
Power : AC 120 V/ 60Hz	Note : Mode 3: USB LCD on

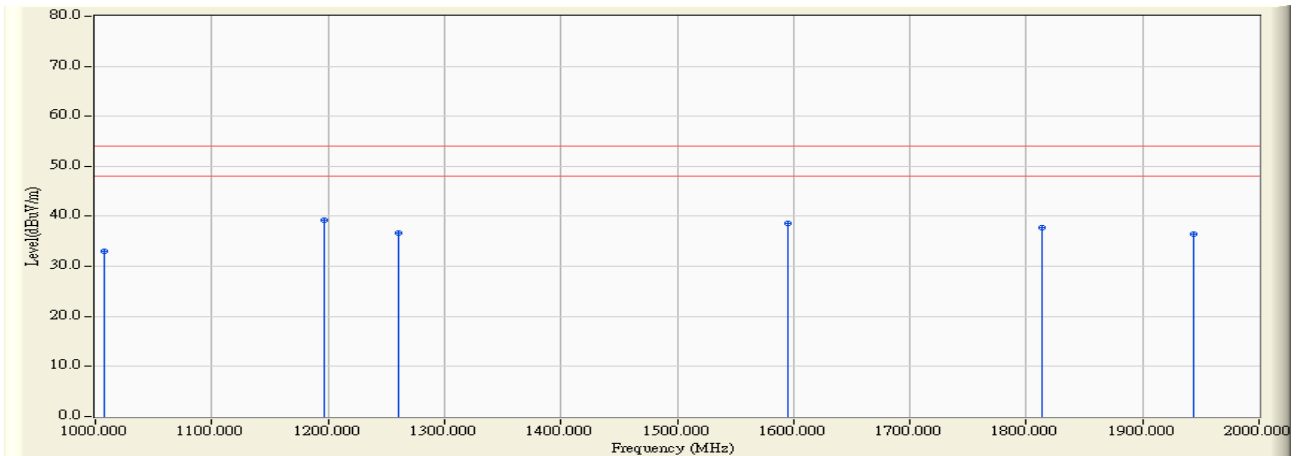

	Frequency (MHz)	Correct Factor (dB)	Reading Level (dBuV)	Measure Level (dBuV/m)	Margin (dB)	Limit (dBuV/m)	Detector Type	Ant Pos (cm)	Table Pos (deg)
1	1008.010	-11.458	44.390	32.932	-21.068	54.000	PEAK	0.000	0.000
2	* 1196.400	-8.319	47.640	39.321	-14.679	54.000	PEAK	0.000	0.000
3	1260.500	-8.169	44.810	36.641	-17.359	54.000	PEAK	0.000	0.000
4	1595.200	-7.109	45.770	38.661	-15.339	54.000	PEAK	0.000	0.000
5	1813.600	-6.031	43.810	37.779	-16.221	54.000	PEAK	0.000	0.000
6	1943.880	-5.752	42.220	36.468	-17.532	54.000	PEAK	0.000	0.000

**Note:**

1. All Readings below 1GHz are Quasi-Peak, above are performed with peak and/or average measurements as necessary.
2. “ \* ”, means this data is the worst emission level.
3. Measurement Level = Reading Level + Correct Factor.
4. The average measurement was not performed when the peak measured data under the limit of average detection. If the readings given are average, peak measurement should also be supplied.

Site : Site 2	Time : 2006/11/08 - 17:43
Limit : FCC_CLASS_B_03M_QP	Margin : 6
EUT : Digital Still Camera	Probe : PRO 06-03-29 ST2 - HORIZONTAL
Power : AC 120V/60Hz	Note : Mode 4: Preview

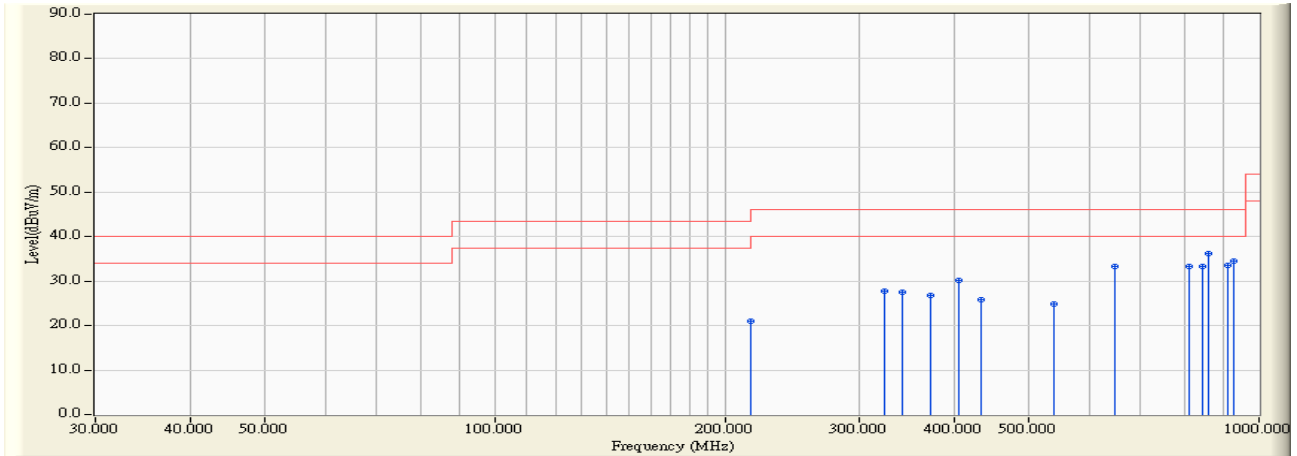

	Frequency (MHz)	Correct Factor (dB)	Reading Level (dBuV)	Measure Level (dBuV/m)	Margin (dB)	Limit (dBuV/m)	Detector Type	Ant Pos (cm)	Table Pos (deg)
1	216.000	11.315	9.740	21.055	-22.445	43.500	QUASIPeAK	135.000	19.000
2	324.000	16.100	11.760	27.860	-18.140	46.000	QUASIPeAK	100.000	-32.000
3	341.650	15.671	11.940	27.611	-18.389	46.000	QUASIPeAK	100.000	-195.000
4	371.250	16.774	10.100	26.874	-19.126	46.000	QUASIPeAK	100.000	-182.000
5	405.000	18.536	11.670	30.206	-15.794	46.000	QUASIPeAK	100.000	99.000
6	432.000	17.935	7.870	25.805	-20.195	46.000	QUASIPeAK	100.000	189.000
7	540.000	19.743	5.050	24.793	-21.207	46.000	QUASIPeAK	100.000	-199.000
8	648.000	23.202	10.010	33.212	-12.788	46.000	QUASIPeAK	133.000	118.000
9	810.000	22.456	10.800	33.256	-12.744	46.000	QUASIPeAK	100.000	-199.000
10	843.750	23.931	9.260	33.191	-12.809	46.000	QUASIPeAK	100.000	-199.000
11	* 860.625	23.697	12.530	36.227	-9.773	46.000	QUASIPeAK	100.000	-199.000
12	911.250	25.495	8.130	33.625	-12.375	46.000	QUASIPeAK	100.000	-187.000
13	928.125	26.009	8.440	34.449	-11.551	46.000	QUASIPeAK	100.000	137.000

Note:

1. All Reading Levels are Quasi-Peak and average value.
2. " \* ", means this data is the worst emission level.
3. Measurement Level = Reading Level + Correct Factor.

Site : Site 2	Time : 2006/11/22 - 11:43
Limit : FCC_B_(Above_1G)_3M_PK	Margin : 6
EUT : Digital Still Camera	Probe : FCC_RF_1G-18G(2005-3) - HORIZONTAL
Power : AC 120 V/ 60Hz	Note : Mode 4: Preview

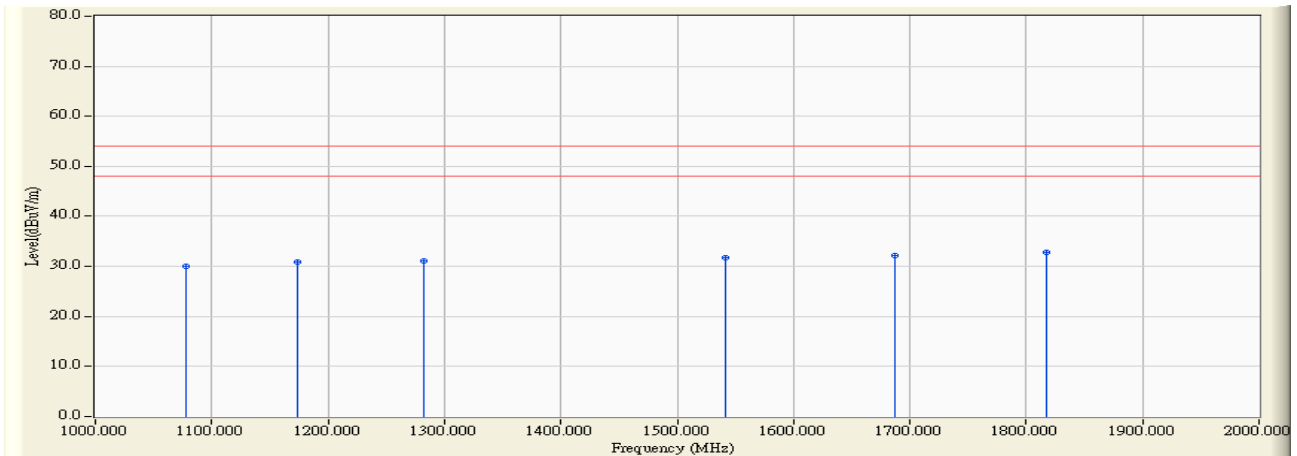

	Frequency (MHz)	Correct Factor (dB)	Reading Level (dBuV)	Measure Level (dBuV/m)	Margin (dB)	Limit (dBuV/m)	Detector Type	Ant Pos (cm)	Table Pos (deg)
1	1078.200	-9.664	39.620	29.956	-24.044	54.000	PEAK	0.000	0.000
2	1174.300	-9.237	40.040	30.803	-23.197	54.000	PEAK	0.000	0.000
3	1282.600	-8.932	40.050	31.118	-22.882	54.000	PEAK	0.000	0.000
4	1541.080	-8.176	39.920	31.743	-22.257	54.000	PEAK	0.000	0.000
5	1687.400	-7.360	39.600	32.241	-21.759	54.000	PEAK	0.000	0.000
6	* 1817.600	-6.649	39.440	32.791	-21.209	54.000	PEAK	0.000	0.000

**Note:**

1. All Readings below 1GHz are Quasi-Peak, above are performed with peak and/or average measurements as necessary.
2. “ \* ”, means this data is the worst emission level.
3. Measurement Level = Reading Level + Correct Factor.
4. The average measurement was not performed when the peak measured data under the limit of average detection. If the readings given are average, peak measurement should also be supplied.

Site : Site 2	Time : 2006/11/08 - 17:53
Limit : FCC_CLASS_B_03M_QP	Margin : 6
EUT : Digital Still Camera	Probe : PRO 06-03-29 ST2 - VERTICAL
Power : AC 120V/60Hz	Note : Mode 4: Preview

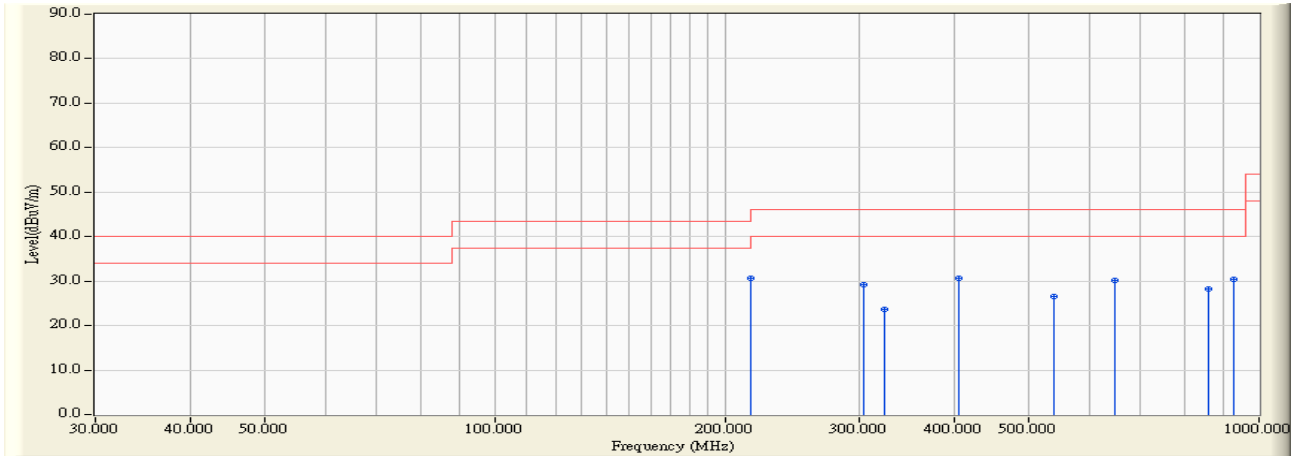

		Frequency (MHz)	Correct Factor (dB)	Reading Level (dBuV)	Measure Level (dBuV/m)	Margin (dB)	Limit (dBuV/m)	Detector Type	Ant Pos (cm)	Table Pos (deg)
1	*	216.000	11.221	19.420	30.641	-12.859	43.500	QUASIPeAK	100.000	-199.000
2		303.750	16.732	12.370	29.102	-16.898	46.000	QUASIPeAK	100.000	201.000
3		324.000	13.372	10.370	23.742	-22.258	46.000	QUASIPeAK	100.000	123.000
4		405.000	16.356	14.230	30.586	-15.414	46.000	QUASIPeAK	100.000	-61.000
5		540.000	21.850	4.590	26.440	-19.560	46.000	QUASIPeAK	100.000	121.000
6		648.000	21.154	9.000	30.154	-15.846	46.000	QUASIPeAK	100.000	-118.000
7		860.625	23.705	4.500	28.205	-17.795	46.000	QUASIPeAK	100.000	145.000
8		928.125	26.032	4.380	30.412	-15.588	46.000	QUASIPeAK	100.000	-45.000

**Note:**

1. All Reading Levels are Quasi-Peak and average value.
2. " \* ", means this data is the worst emission level.
3. Measurement Level = Reading Level + Correct Factor.

Site : Site 2	Time : 2006/11/22 - 11:43
Limit : FCC_B_(Above_1G)_3M_PK	Margin : 6
EUT : Digital Still Camera	Probe : FCC_RF_1G-18G(2005-3) - VERTICAL
Power : AC 120 V/ 60Hz	Note : Mode 4: Preview

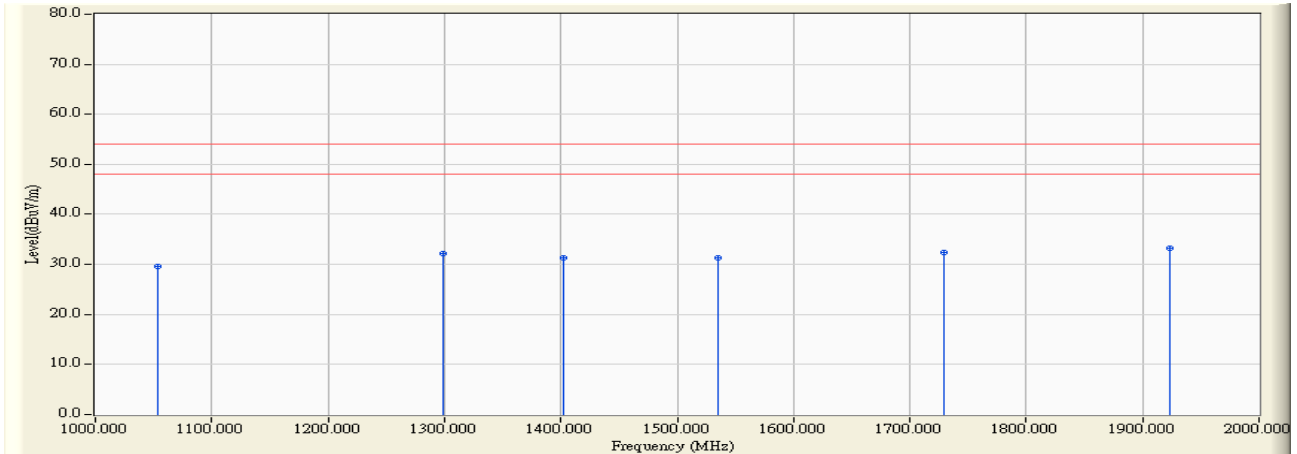

	Frequency (MHz)	Correct Factor (dB)	Reading Level (dBuV)	Measure Level (dBuV/m)	Margin (dB)	Limit (dBuV/m)	Detector Type	Ant Pos (cm)	Table Pos (deg)
1	1054.100	-8.981	38.530	29.548	-24.452	54.000	PEAK	0.000	0.000
2	1298.600	-8.055	40.160	32.106	-21.894	54.000	PEAK	0.000	0.000
3	1402.800	-7.689	39.000	31.311	-22.689	54.000	PEAK	0.000	0.000
4	1535.070	-7.268	38.670	31.403	-22.597	54.000	PEAK	0.000	0.000
5	1729.500	-6.211	38.540	32.329	-21.671	54.000	PEAK	0.000	0.000
6	* 1923.800	-5.664	38.890	33.226	-20.774	54.000	PEAK	0.000	0.000

**Note:**

1. All Readings below 1GHz are Quasi-Peak, above are performed with peak and/or average measurements as necessary.
2. “ \* ”, means this data is the worst emission level.
3. Measurement Level = Reading Level + Correct Factor.
4. The average measurement was not performed when the peak measured data under the limit of average detection. If the readings given are average, peak measurement should also be supplied.