



# Radio Test Report

**FCC ID: TVR-WD385UEST**

**Issued Date** : Oct. 19, 2011  
**Project No.** : R1108003  
**Equipment** : Data Projector  
**Model Name** : WD385U-EST

**Applicant** : Hon Hai Precision Ind. Co., Ltd.  
Nei-Hu Branch Office  
**Address** : No. 32, JI-HU ROAD, NEI-HU, TAIPEI,  
TAIWAN, R.O.C.

**Tested by:** Neutron Engineering Inc. EMC Laboratory  
**Date of Receipt:** Aug. 22, 2011  
**Date of Test:** Aug. 22, 2011 ~ Oct. 03, 2011

**Testing Engineer:** Rush Kao  
(Rush Kao)

**Technical Manager:** Jeff Yang  
(Jeff Yang)

**Authorized Signatory:** Andy Chiu  
(Andy Chiu)

## Neutron Engineering Inc.

B1, No. 37, Lane 365, YangGuang St.,  
NeiHu District 114, Taipei, Taiwan.

TEL: +886-2-2657-3299

FAX: +886-2-2657-3331





### **Declaration**

**Neutron** represents to the client that testing is done in accordance with standard procedures as applicable and that test instruments used has been calibrated with the standards traceable to National Measurement Laboratory (**NML**) of **R.O.C.**, or National Institute of Standards and Technology (**NIST**) of **U.S.A.**

**Neutron's** reports apply only to the specific samples tested under conditions. It is manufacture's responsibility to ensure that additional production units of this model are manufactured with the identical electrical and mechanical components. **Neutron** shall have no liability for any declarations, inferences or generalizations drawn by the client or others from **Neutron** issued reports.

**Neutron's** reports must not be used by the client to claim product endorsement by the authorities or any agency of the Government.

This report is the confidential property of the client. As a mutual protection to the clients, the public and **Neutron-self**, extracts from the test report shall not be reproduced except in full with **Neutron's** authorized written approval.

**Neutron's** laboratory quality assurance procedures are in compliance with the **ISO Guide 17025** requirements, and accredited by the conformity assessment authorities listed in this test report.

### **Limitation**

For the use of the authority's logo is limited unless the Test Standard(s)/Scope(s)/Item(s) mentioned in this test report is (are) included in the conformity assessment authorities acceptance respective.



<b>Table of Contents</b>	<b>Page</b>
<b>1 . CERTIFICATION</b>	<b>4</b>
<b>2 . SUMMARY OF TEST RESULTS</b>	<b>5</b>
2.1 TEST FACILITY	6
2.2 MEASUREMENT UNCERTAINTY	6
<b>3 . GENERAL INFORMATION</b>	<b>7</b>
3.1 GENERAL DESCRIPTION OF EUT	7
3.2 DESCRIPTION OF TEST MODES	9
3.3 BLOCK DIAGRAM SHOWING THE CONFIGURATION OF SYSTEM TESTED	10
3.4 DESCRIPTION OF SUPPORT UNITS	11
<b>4 . EMC EMISSION TEST</b>	<b>12</b>
4.1 CONDUCTED EMISSION MEASUREMENT	12
4.1.1 POWER LINE CONDUCTED EMISSION	12
4.1.2 MEASUREMENT INSTRUMENTS LIST	12
4.1.3 TEST PROCEDURE	13
4.1.4 DEVIATION FROM TEST STANDARD	13
4.1.5 TEST SETUP	13
4.1.6 EUT OPERATING CONDITIONS	14
4.1.7 TEST RESULTS	15
4.2 RADIATED EMISSION MEASUREMENT	17
4.3 RADIATED EMISSION MEASUREMENT	17
4.3.1 RADIATED EMISSION LIMITS	17
4.3.2 MEASUREMENT INSTRUMENTS LIST	18
4.3.3 TEST PROCEDURE	18
4.3.4 DEVIATION FROM TEST STANDARD	18
4.3.5 TEST SETUP	19
4.3.6 EUT OPERATING CONDITIONS	20
4.3.7 TEST RESULTS-BETWEEN 30MHZ AND 1000MHZ	21
4.3.8 TEST RESULTS- FUNDAMENTAL FREQUENCY & ABOVE 1000MHZ	23
<b>5 . ANTENNA CONDUCTED SPURIOUS EMISSION</b>	<b>35</b>
5.1 APPLIED PROCEDURES / LIMIT	35
5.1.1 MEASUREMENT INSTRUMENTS LIST	35
5.1.2 TEST PROCEDURE	35
5.1.3 DEVIATION FROM STANDARD	35
5.1.4 TEST SETUP	35
5.1.5 EUT OPERATION CONDITIONS	35
5.1.6 TEST RESULTS	36
<b>6 . EUT TEST PHOTO</b>	<b>38</b>



## 1. CERTIFICATION

Equipment : Data Projector  
Brand Name : MITSUBISHI ELECTRIC; MITSUBISHI  
Model Name : WD385U-EST  
Applicant : Hon Hai Precision Ind. Co., Ltd. Nei-Hu Branch Office  
Date of Test : Aug. 22, 2011 ~ Oct. 03, 2011  
Standards : FCC Part15, Subpart C(15.249) / ANCI C63.4: 2003

The above equipment has been tested and found compliance with the requirement of the relative standards by Neutron Engineering Inc. EMC Laboratory.

The test data, data evaluation, and equipment configuration contained in our test report (Ref No. NEI-FCCP-1-R1108003) were obtained utilizing the test procedures, test instruments, test sites that has been accredited by the Authority of NVLAP and TAF according to the ISO-17025 quality assessment standard and technical standard(s).



**2. SUMMARY OF TEST RESULTS**

Test procedures according to the technical standards:

FCC Part15, Subpart C			
Standard Section	Test Item	Judgment	Remark
FCC Part15, Subpart C			
15.207	Conducted Emission	PASS	
15.209	Radiated Emission	PASS	
15.249	Radiated Spurious Emission	PASS	

**NOTE:**

(1) " N/A" denotes test is not applicable in this Test Report.



**2.1 TEST FACILITY**

The test facilities used to collect the test data in this report:

- C01:** (VCCI RN: C-2918; T-1666; FCC RN: 95335; FCC DN: TW1010)  
No.132-1, Ln. 329, Sec. 2, Balian Rd., Xizhi Dist., New Taipei City 221, Taiwan (R.O.C.)
- C02:** (VCCI RN: C-3477; FCC RN: 614388; FCC DN: TW1054)  
1F., No. 61, Ln. 77, Sing-ai Rd., Neihu Dist., Taipei City 114, Taiwan (R.O.C.)
- CB08:** (VCCI RN: G-91; FCC RN: 614388; FCC DN: TW1054;  
IC Assigned Code: 4428C-1)  
1F., No. 61, Ln. 77, Sing-ai Rd., Neihu Dist., Taipei City 114, Taiwan (R.O.C.)

**2.2 MEASUREMENT UNCERTAINTY**

The reported uncertainty of measurement  $y \pm U$ , where expanded uncertainty  $U$  is based on a standard uncertainty multiplied by a coverage factor of  $k=2$ , providing a level of confidence of approximately 95%.

The measurement instrumentation uncertainty considerations contained in CISPR 16-4-2.

A. Conducted Measurement :

Test Site	Method	Measurement Frequency Range	U , (dB)	NOTE
C01	ANSI	150 kHz ~ 30 MHz	1.94	
C02	ANSI	150 kHz ~ 30 MHz	2.59	

B. Radiated Measurement :

Test Site	Item	Measurement Frequency Range	Uncertainty	NOTE	
CB08	Radiated Emission at 3m	Horizontal Polarization	30 - 200MHz	3.35 dB	
			200 - 1000MHz	3.11 dB	
			1 - 18GHz	3.97 dB	
			18 - 40GHz	4.01 dB	
		Vertical Polarization	30 - 200MHz	3.22 dB	
			200 - 1000MHz	3.24 dB	
			1 - 18GHz	4.05 dB	
			18 - 40GHz	4.04 dB	

Our calculated Measurement Instrumentation Uncertainty is shown in the tables above. These are our  $U_{lab}$  values in CISPR 16-4-2 terminology.

Since Table 1 of CISPR 16-4-2 has values of measurement instrumentation uncertainty, called  $U_{CISPR}$ , as follows:

- Conducted Disturbance (mains port) – 150 kHz – 30 MHz : 3.6 dB
- Radiated Disturbance (electric field strength on an open area test site or alternative test site) – 30 MHz – 1000 MHz : 5.2 dB

It can be seen that our  $U_{lab}$  values are smaller than  $U_{CISPR}$ .



**3. GENERAL INFORMATION**

**3.1 GENERAL DESCRIPTION OF EUT**

Equipment	Data Projector
Brand Name	MITSUBISHI ELECTRIC; MITSUBISHI
Model Name	WD385U-EST
OEM Brand/Model Name	N/A
Model Difference	N/A
Product Description	The EUT is a Data Projector.
	Operation Frequency: 2402~2479 MHz
	Modulation Type: GFSK
	Bit Rate of Transmitter: 500K
	Number Of Channel Please see Note 2.
	Antenna Designation: Please see Note 3.
	Antenna Gain(Peak) Please see Note 3.
	Max Output Power 85.20 dBuV/m
Based on the application, features, or specification exhibited in User's Manual, the EUT is considered as an ITE/Computing Device. More details of EUT technical specification, please refer to the User's Manual.	
Power Source	AC Mains. (Power Build-in)
Power Rating	I/P: AC 100-240V 50-60Hz
Connecting I/O Port(s)	Please refer to the User's Manual
Products Covered	1 * Remote Control
EUT Modification(s)	N/A

**Note:**

1. For a more detailed features description, please refer to the manufacturer's specifications or the User's Manual.



2.

Channel List					
Channel	Frequency (MHz)	Channel	Frequency (MHz)	Channel	Frequency (MHz)
01	2402	27	2428	53	2454
02	2403	28	2429	54	2455
03	2404	29	2430	55	2456
04	2405	30	2431	56	2457
05	2406	31	2432	57	2458
06	2407	32	2433	58	2459
07	2408	33	2434	59	2460
08	2409	34	2435	60	2461
09	2410	35	2436	61	2462
10	2411	36	2437	62	2463
11	2412	37	2438	63	2464
12	2413	38	2439	64	2465
13	2414	39	2440	65	2466
14	2415	40	2441	66	2467
15	2416	41	2442	67	2468
16	2417	42	2443	68	2469
17	2418	43	2444	69	2470
18	2419	44	2445	70	2471
19	2420	45	2446	71	2472
20	2421	46	2447	72	2473
21	2422	47	2448	73	2474
22	2423	48	2449	74	2475
23	2424	49	2450	75	2476
24	2425	50	2451	76	2477
25	2426	51	2452	77	2478
26	2427	52	2453	78	2479

3. Table for Filed Antenna

Ant.	Brand	Model Name	Antenna Type	Connector	Gain (dBi)
1	N/A	N/A	PCB Antenna	N/A	-1.51





**3.2 DESCRIPTION OF TEST MODES**

To investigate the maximum EMI emission characteristics generates from EUT, the test system was pre-scanning tested base on the consideration of following EUT operation mode or test configuration mode which possible have effect on EMI emission level. Each of these EUT operation mode(s) or test configuration mode(s) mentioned above was evaluated respectively.

Pretest Test Mode	Description
Mode 1	2402 MHz
Mode 2	2441 MHz
Mode 3	2479 MHz

<b>For Conducted Test</b>	
Final Test Mode	Description
Mode 1	TX

<b>For Radiated Test</b>	
Final Test Mode	Description
Mode 1	2402 MHz
Mode 2	2441 MHz
Mode 3	2479 MHz



**3.3 BLOCK DIAGRAM SHOWING THE CONFIGURATION OF SYSTEM TESTED**

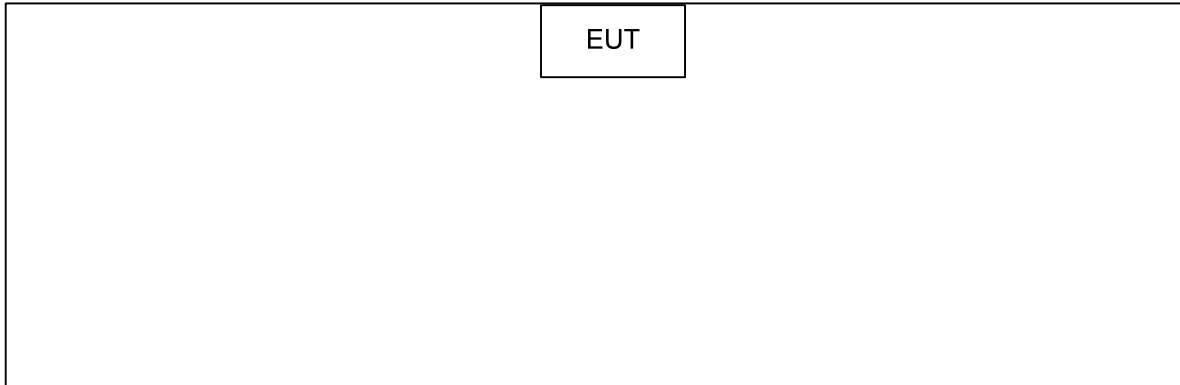



### 3.4 DESCRIPTION OF SUPPORT UNITS

The EUT has been tested as an independent unit together with other necessary accessories or support units. The following support units or accessories were used to form a representative test configuration during the tests.

Item	Equipment	Mfr/Brand	Model/Type No.	FCC ID	Series No.	Note
E-1	Data Projector	mitsubishi ELECTRIC; mitsubishi	WD385U-EST	TVR-WD385UEST	N/A	EUT

Item	Shielded Type	Ferrite Core	Length	Note
N/A	-	-	-	-

**Note:**

- (1) The support equipment was authorized by Declaration of Conformity.
- (2) For detachable type I/O cable should be specified the length in cm in 『Length』 column.



**4. EMC EMISSION TEST**

**4.1 CONDUCTED EMISSION MEASUREMENT**

**4.1.1 POWER LINE CONDUCTED EMISSION (FREQUENCY RANGE 150 KHZ-30MHZ)**

FREQUENCY ( MHz)	Class A (dBuV)		Class B (dBuV)	
	Quasi-peak	Average	Quasi-peak	Average
0.15 -0.5	79.00	66.00	66 - 56 *	56 - 46 *
0.50 -5.0	73.00	60.00	56.00	46.00
5.0 -30.0	73.00	60.00	60.00	50.00

Note:

- (1) The tighter limit applies at the band edges.
- (2) The limit of " \* " marked band means the limitation decreases linearly with the logarithm of the frequency in the range.
- (3) The test result calculated as following:  
 Measurement Value = Reading Level + Correct Factor  
 Correct Factor = Insertion Loss + Cable Loss + Attenuator Factor(if use)  
 Margin Level = Measurement Value – Limit Value

**4.1.2 MEASUREMENT INSTRUMENTS LIST**

Item	Kind of Equipment	Manufacturer	Type No.	Serial No.	Calibrated until
1	LISN	EMCO	3816/2	00042991	Feb. 16, 2012
2	Test Cable	TIMES	LMR-400	SR03_C_01& 02	Aug. 18, 2012
3	Pulse Limiter	Electro-Metrics	EM-7600	112647	Dec. 13, 2011
4	EMI Test Receiver	R&S	ESCI	100082	Mar. 15, 2012
5	50Ω BNC TYPE Terminator	N/A	N/A	01	Jun. 02, 2013
6	50Ω BNC TYPE Terminator	N/A	N/A	03	Jun. 02, 2013
7	LISN	EMCO	4825/2	00028234	Sep. 19, 2012

Remark: " N/A" denotes No Model Name , Serial No. or No Calibration specified.

#### 4.1.3 TEST PROCEDURE

- a. The EUT was placed 0.8 meters from the horizontal ground plane with EUT being connected to the power mains through a line impedance stabilization network (LISN). All other support equipments powered from additional LISN(s). The LISN provide 50 Ohm/ 50uH of coupling impedance for the measuring instrument.
- b. Interconnecting cables that hang closer than 40 cm to the ground plane shall be folded back and forth in the center forming a bundle 30 to 40 cm long.
- c. I/O cables that are not connected to a peripheral shall be bundled in the center. The end of the cable may be terminated, if required, using the correct terminating impedance. The overall length shall not exceed 1 m.
- d. LISN at least 80 cm from nearest part of EUT chassis.
- e. For the actual test configuration, please refer to the related Item –EUT Test Photos.

#### 4.1.4 DEVIATION FROM TEST STANDARD

No deviation

#### 4.1.5 TEST SETUP

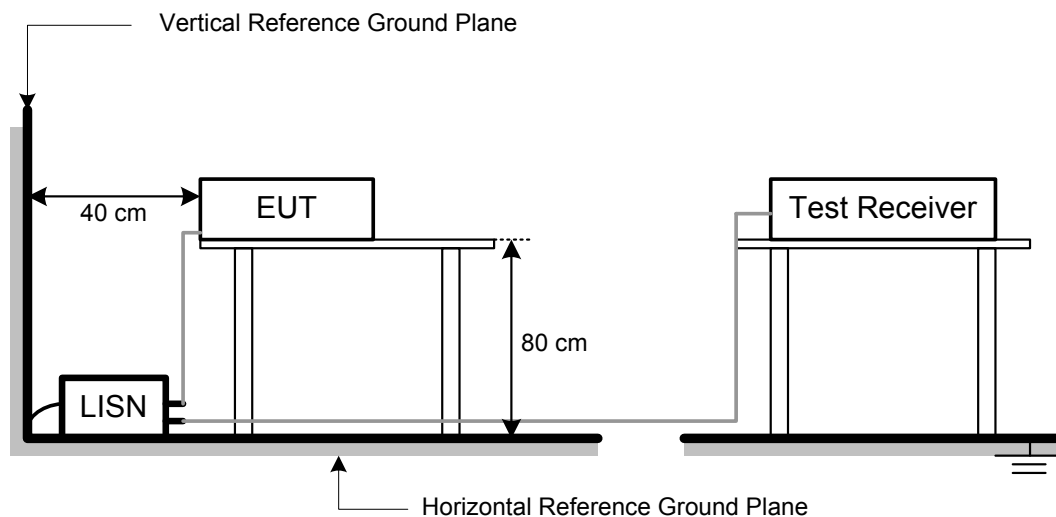



#### **4.1.6 EUT OPERATING CONDITIONS**

The EUT was configured for testing in a typical fashion (as a customer would normally use it). The EUT has been programmed to continuously transmit and receive during test. This operating condition was tested and used to collect the included data.



**4.1.7 TEST RESULTS**

E.U.T :	Data Projector	Model Name :	WD385U-EST
Temperature :	24 °C	Relative Humidity :	48%
Test Voltage :	AC 120V/60Hz		
Test Mode :	TX		

Freq. (MHz)	Terminal L/N	Reading Level(dBuV)		Correct Factor(dB)	Measurement(dBuV)		Limit(dBuV)		Margin (dB)	Note
		QP-Mode	AV-Mode		QP-Mode	AV-Mode	QP-Mode	AV-Mode		
0.1864	Line	39.82	*	10.00	49.82	*	64.20	54.20	-14.38	(QP)
0.2312	Line	35.26	*	9.92	45.18	*	62.41	52.41	-17.23	(QP)
0.3082	Line	34.95	*	9.79	44.74	*	60.02	50.02	-15.28	(QP)
7.0000	Line	47.69	31.80	9.11	56.80	40.91	60.00	50.00	-3.20	(QP)
11.1500	Line	39.59	23.50	9.32	48.91	32.82	60.00	50.00	-11.09	(QP)
18.1000	Line	41.72	31.80	9.45	51.17	41.25	60.00	50.00	-8.75	(AV)

**Remark:**

- (1) Reading in which marked as QP means measurements by using are Quasi-Peak Mode with Detector BW=9 kHz; SPA setting in RBW=10 kHz, VBW =10 kHz, Swp. Time = 0.2 sec./ MHz. Reading in which marked as AV means measurements by using are Average Mode with instrument setting in RBW=10 kHz, VBW=10 kHz, Swp. Time =0.2 sec./ MHz.
- (2) All readings are QP Mode value unless otherwise stated AVG in column of Note. If the QP Mode Measured value compliance with the QP Limits and lower than AVG Limits, the EUT shall be deemed to meet both QP & AVG Limits and then only QP Mode was measured, but AVG Mode didn't perform. In this case, a " \* " marked in AVG Mode column of Interference Voltage Measured.
- (3) In the "Note" column, QP means the margin value of QP is higher than Average and the "Margin" column shows the margin value of QP; AV means the margin value of Average is higher than QP and the "Margin" column shows the margin value of Average.

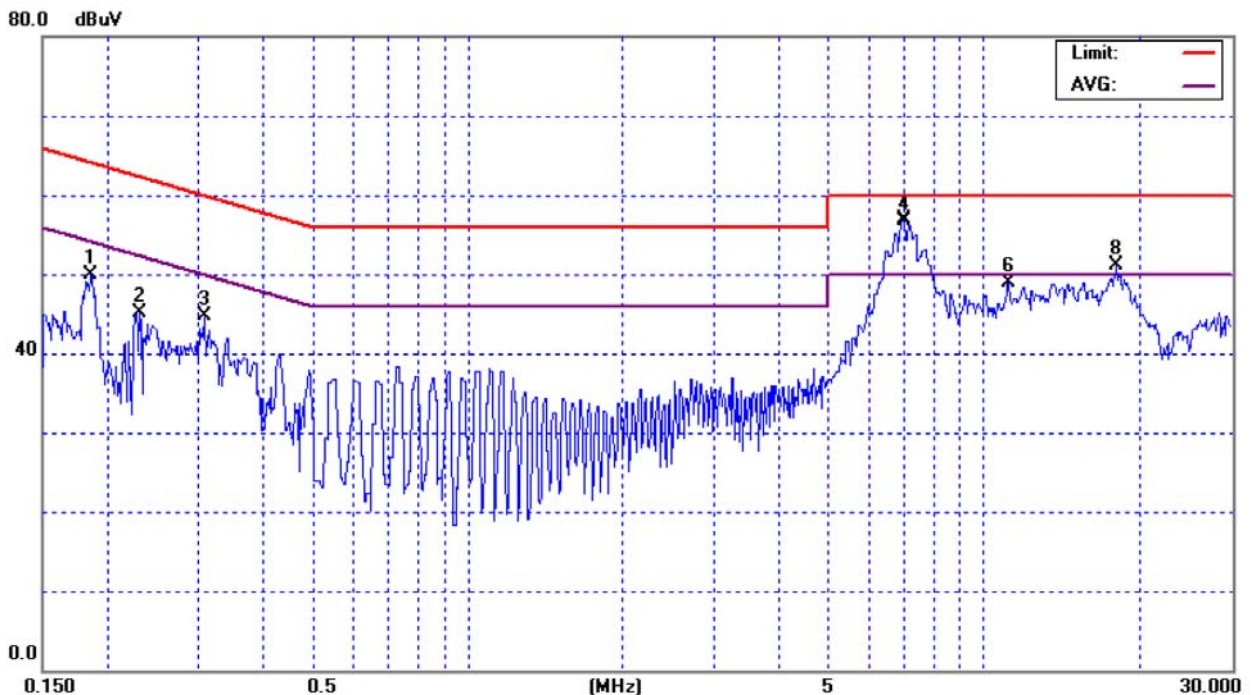



E.U.T :	Data Projector	Model Name :	WD385U-EST
Temperature :	24 °C	Relative Humidity :	48%
Test Voltage :	AC 120V/60Hz		
Test Mode :	TX		

Freq. (MHz)	Terminal L/N	Reading Level(dBuV)		Correct Factor(dB)	Measurement(dBuV)		Limit(dBuV)		Margin (dB)	Note
		QP-Mode	AV-Mode		QP-Mode	AV-Mode	QP-Mode	AV-Mode		
0.1857	Neutral	39.25	*	9.83	49.08	*	64.23	54.23	-15.15	(QP)
0.2375	Neutral	34.58	*	9.76	44.34	*	62.18	52.18	-17.84	(QP)
0.3082	Neutral	35.37	*	9.65	45.02	*	60.02	50.02	-15.00	(QP)
6.8000	Neutral	48.05	31.80	8.85	56.90	40.65	60.00	50.00	-3.10	(QP)
14.7000	Neutral	40.73	26.70	9.11	49.84	35.81	60.00	50.00	-10.16	(QP)
17.7500	Neutral	42.77	27.90	9.18	51.95	37.08	60.00	50.00	-8.05	(QP)

**Remark:**

- (1) Reading in which marked as QP means measurements by using are Quasi-Peak Mode with Detector BW=9 kHz; SPA setting in RBW=10 kHz, VBW =10 kHz, Swp. Time = 0.2 sec./ MHz. Reading in which marked as AV means measurements by using are Average Mode with instrument setting in RBW=10 kHz, VBW=10 kHz, Swp. Time =0.2 sec./ MHz.
- (2) All readings are QP Mode value unless otherwise stated AVG in column of Note. If the QP Mode Measured value compliance with the QP Limits and lower than AVG Limits, the EUT shall be deemed to meet both QP & AVG Limits and then only QP Mode was measured, but AVG Mode didn't perform. In this case, a " \* " marked in AVG Mode column of Interference Voltage Measured.
- (3) In the "Note" column, QP means the margin value of QP is higher than Average and the "Margin" column shows the margin value of QP; AV means the margin value of Average is higher than QP and the "Margin" column shows the margin value of Average.

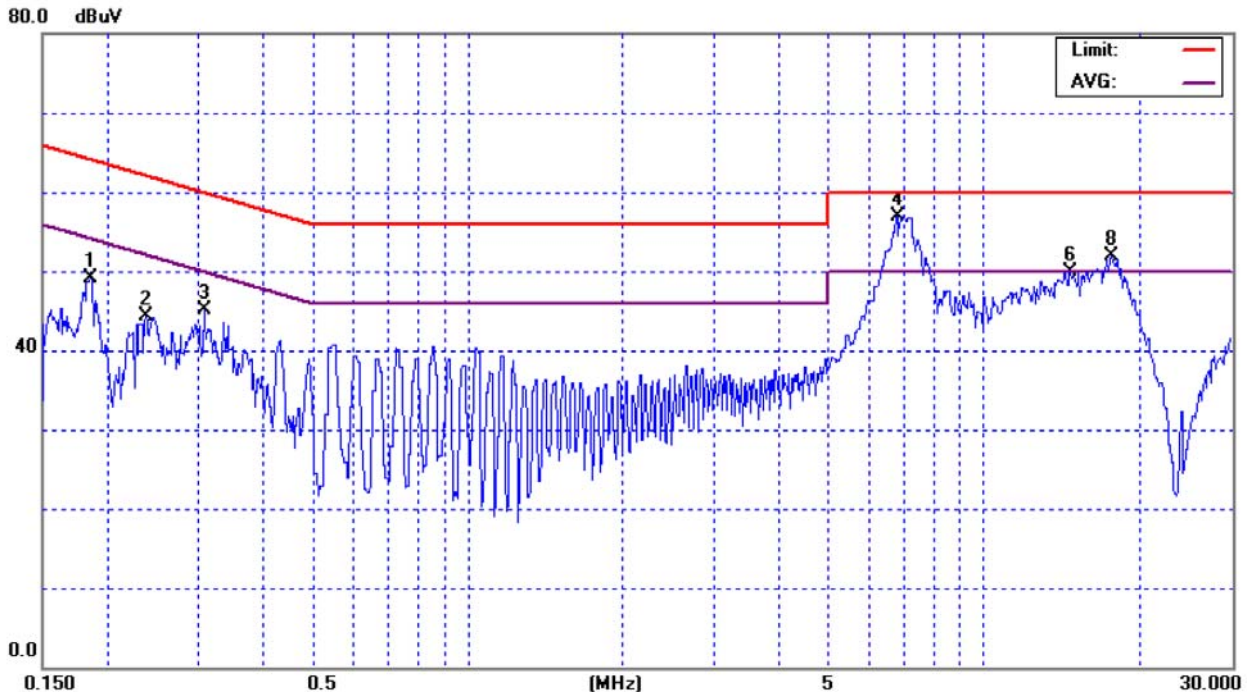





**4.2 RADIATED EMISSION MEASUREMENT**

**4.3 RADIATED EMISSION MEASUREMENT**

**4.3.1 RADIATED EMISSION LIMITS ( FCC 15.209 )**

Frequencies (MHz)	Field Strength (micorvolts/meter)	Measurement Distance (meters)
0.009~0.490	2400/F(KHz)	300
0.490~1.705	24000/F(KHz)	30
1.705~30.0	30	30
30~88	100	3
88~216	150	3
216~960	200	3
Above 960	500	3

Harmonic emissions limits comply with below 54 dBuV/m at 3m. Other emissions radiated outside of the specified frequency bands, except for harmonics, shall be attenuated by at least 50 dB below the level of the fundamental or comply with the radiated emissions limits specified in section 15.209(a) limit in the table below has to be followed.

Note:

- (1) The tighter limit applies at the band edges.
- (2) Emission level (dBuV/m)=20log Emission level (uV/m).

**LIMITS OF RADIATED EMISSION MEASUREMENT ( FCC 15.209 )**

FREQUENCY (MHz)	(dBuV/m) (at 3m)	
	PEAK	AVERAGE
Above 1000	74	54

Notes:

- (1) The limit for radiated test was performed according to FCC PART 15C.
- (2) The tighter limit applies at the band edges.
- (3) Emission level (dBuV/m)=20log Emission level (uV/m).

**LIMITS OF RADIATED EMISSION MEASUREMENT (FCC Part 15.249)**

FCC Part15 (15.249) , Subpart C	
Limit	Frequency Range (MHz)
Field strength of fundamental 50000 μV/m (94 dBμV/m) @ 3 m	2400-2483.5
Field strength of harmonics 500 μV/m (54 dBμV/m) @ 3 m	Above 2483.5



#### 4.3.2 MEASUREMENT INSTRUMENTS LIST

Item	Kind of Equipment	Manufacturer	Type No.	Serial No.	Calibrated until
1	Spectrum Analyzer	R&S	FSP-40	100129	Aug. 30, 2012
2	Horn Antenna	Schwarzbeck	BBHA 9120	D-325	Dec. 08, 2011
3	Microwave Pre_amplifier	Agilent	8449B	3008A01714	Apr. 18, 2012
4	Microflex Cable	N/A	N/A	1m	May. 18, 2012
5	Microflex Cable	AISI	S104-SMAP-1	10m	Aug. 21, 2012
6	Microflex Cable	N/A	N/A	3m	Aug. 21, 2012
7	Test Cable	N/A	LMR-400	966_12m	Jun. 16, 2012
8	Test Cable	N/A	LMR-400	966_3m	Jun. 16, 2012
9	Pre-Amplifier	EMC	EMC-330	980001	Jun. 02, 2012
10	Log-Bicon Antenna	Schwarzbeck	VULB9168-352	9168-352	Jun. 20, 2012

Remark: " N/A" denotes No Model Name / Serial No. and No Calibration specified.

#### 4.3.3 TEST PROCEDURE

- The measuring distance of at 3 m shall be used for measurements at frequency up to 1GHz. For frequencies above 1GHz, any suitable measuring distance may be used.
- The EUT was placed on the top of a rotating table 0.8 meters above the ground at a 3m or 10 meter open area test site. The table was rotated 360 degrees to determine the position of the highest radiation.
- The height of the equipment or of the substitution antenna shall be 0.8 m; the height of the test antenna shall vary between 1 m to 4 m. Both horizontal and vertical polarizations of the antenna are set to make the measurement.
- The initial step in collecting radiated emission data is a spectrum analyzer peak detector mode pre-scanning the measurement frequency range. Significant peaks are then marked and then Quasi Peak detector mode re-measured.
- If the Peak Mode measured value compliance with and lower than Quasi Peak Mode Limit, the EUT shall be deemed to meet QP Limits and then no additional QP Mode measurement performed.
- For the actual test configuration, please refer to the related Item –EUT Test Photos.

#### 4.3.4 DEVIATION FROM TEST STANDARD

No deviation

**4.3.5 TEST SETUP**

(A) Radiated Emission Test Set-Up, Frequency Below 1000MHz

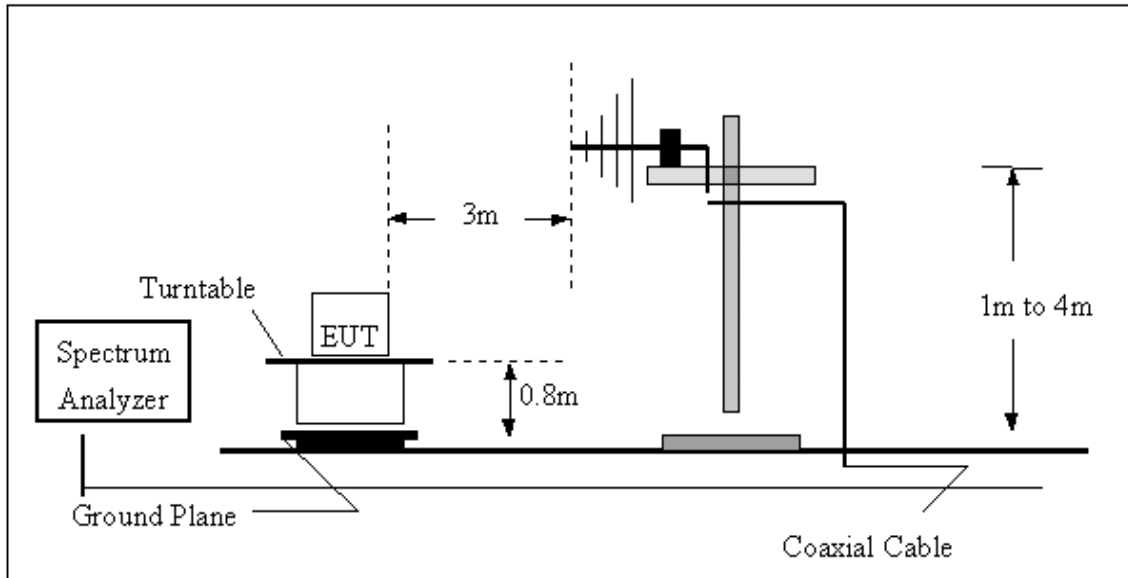

(B) Radiated Emission Test Set-Up Frequency Above 1 GHz

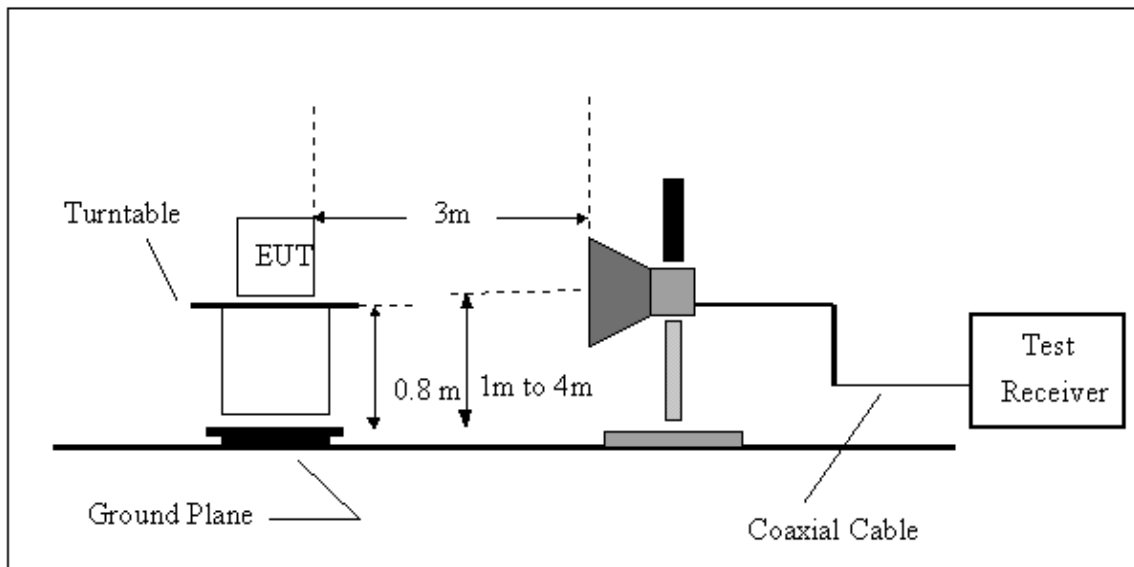



#### **4.3.6 EUT OPERATING CONDITIONS**

The EUT was configured for testing in a typical fashion (as a customer would normally use it). The EUT has been programmed to continuously transmit and receive during test. This operating condition was tested and used to collect the included data.



**4.3.7 TEST RESULTS-BETWEEN 30MHZ AND 1000MHZ**

E.U.T :	Data Projector	Model Name :	WD385U-EST
Temperature :	26 °C	Relative Humidity :	60%
Test Voltage :	AC 120V/60Hz		
Test Mode :	2441 MHz		

Freq. (MHz)	Polarization H/V	Reading Level (dBuV)	Correct Factor(dB)	Measurement (dBuV/m)	Limit(Quasi-Peak) (dBuV/m)	Margin (dB)	Note
33.8800	V	42.38	-13.01	29.37	40.00	- 10.63	
136.6999	V	35.09	-13.68	21.41	43.50	- 22.09	
646.9199	V	42.75	-5.17	37.58	46.00	- 8.42	
730.3400	V	38.92	-3.88	35.04	46.00	- 10.96	
738.0999	V	38.64	-3.71	34.93	46.00	- 11.07	
972.8400	V	35.02	-1.60	33.42	54.00	- 20.58	

Remark :

- (1) Reading in which marked as QP or Peak means measurements by using are Quasi-Peak Mode or Peak Mode with Detector BW=120 kHz; SPA setting in RBW=120 kHz, VBW =120 kHz, Swp. Time = 0.3 sec./ MHz.
- (2) All readings are Peak unless otherwise stated QP in column of Note. Peak denotes that the Peak reading compliance with the QP Limits and then QP Mode measurement didn't perform.
- (3) Measuring frequency range from 30 MHz to 1000 MHz.
- (4) If the peak scan value is under the limit for more than 20dB, the signal will not show in table.

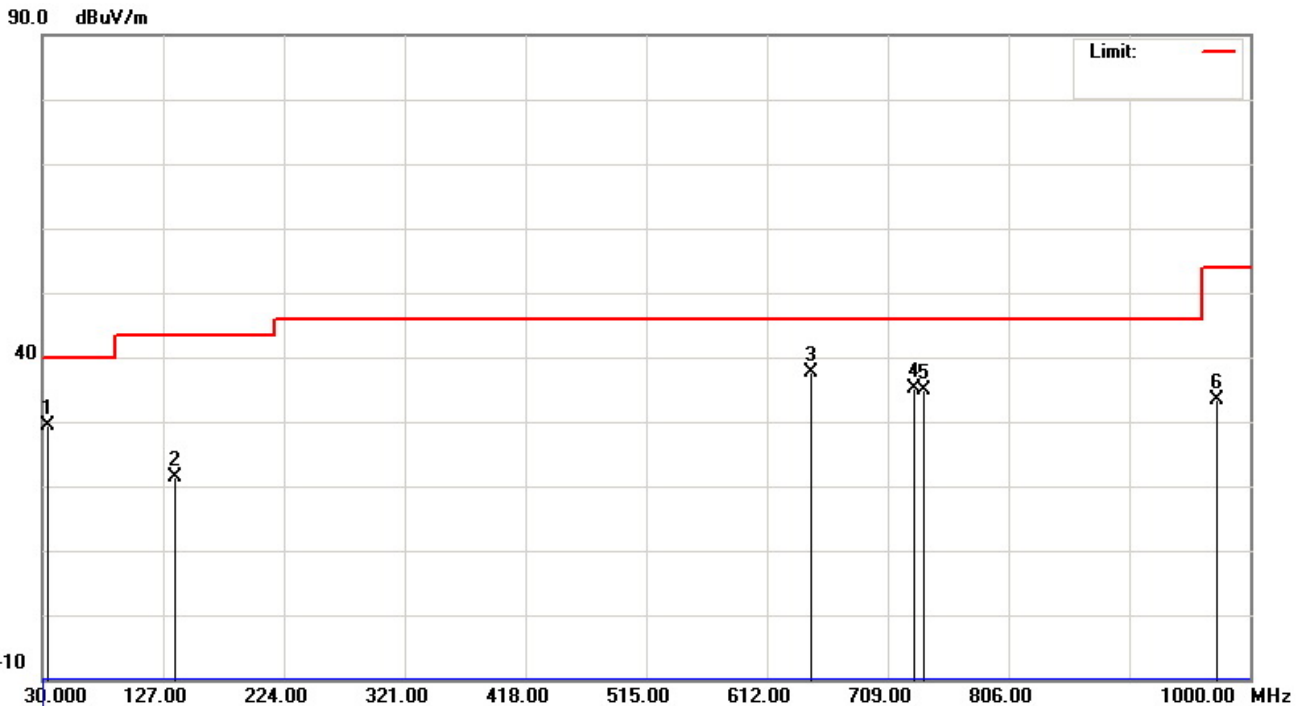



E.U.T :	Data Projector	Model Name :	WD385U-EST
Temperature :	26 °C	Relative Humidity :	60%
Test Voltage :	AC 120V/60Hz		
Test Mode :	2441 MHz		

Freq. (MHz)	Polarization H/V	Reading Level (dBuV)	Correct Factor(dB)	Measurement (dBuV/m)	Limit(Quasi-Peak) (dBuV/m)	Margin (dB)	Note
225.9400	H	50.02	-15.19	34.83	46.00	- 11.17	
251.1600	H	47.51	-14.09	33.42	46.00	- 12.58	
720.6400	H	43.79	-4.10	39.69	46.00	- 6.31	
730.3400	H	44.97	-3.88	41.09	46.00	- 4.91	
738.1000	H	44.65	-3.71	40.94	46.00	- 5.06	
745.8600	H	41.39	-3.54	37.85	46.00	- 8.15	

Remark :

- (1) Reading in which marked as QP or Peak means measurements by using are Quasi-Peak Mode or Peak Mode with Detector BW=120 kHz; SPA setting in RBW=120 kHz, VBW =120 kHz, Swp. Time = 0.3 sec./ MHz.
- (2) All readings are Peak unless otherwise stated QP in column of Note. Peak denotes that the Peak reading compliance with the QP Limits and then QP Mode measurement didn't perform.
- (3) Measuring frequency range from 30 MHz to 1000 MHz.
- (4) If the peak scan value is under the limit for more than 20dB, the signal will not show in table.

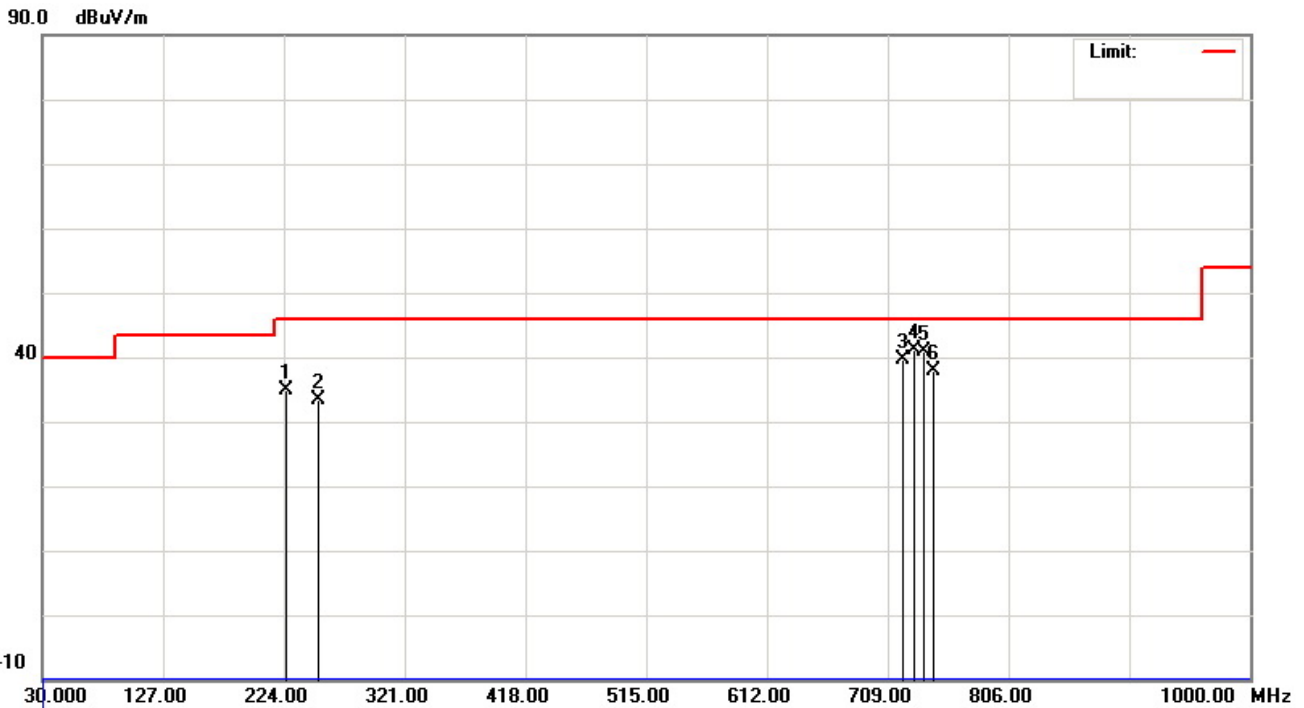



**4.3.8 TEST RESULTS- FUNDAMENTAL FREQUENCY & ABOVE 1000MHZ**

E.U.T :	Data Projector	Model Name :	WD385U-EST
Temperature :	26 °C	Relative Humidity :	60%
Test Voltage :	AC 120V/60Hz	EUT Orthogonal Axis:	X
Test Mode :	2402 MHz		

Freq. (MHz)	Polarization H/V	Reading Level(dBuV)		Correct Factor(dB)	Measurement(dBuV/m)		Limit(dBuV/m)		Margin (dB)	Note
		Peak	AV		Peak	AV	Peak	AV		
2390.000	V	20.20	11.18	32.15	52.35	43.33	74.00	54.00	-10.67	AV/E
2400.000	V	28.43	20.32	32.19	60.62	52.51	74.00	54.00	-1.49	AV/E
2402.020	V	52.43	37.87	32.20	84.63	70.07	-	-	-	F
4804.060	V	48.17	37.82	2.90	51.07	40.72	74.00	54.00	-13.28	AV/H

**Remark :**

- (1) All readings are Peak unless otherwise stated QP in column of 『Note』 . Peak denotes that the Peak reading compliance with the QP Limits and then QP Mode measurement didn't perform ◦
- (2) Measuring frequency range from 30MHz to 1000MHz or the 10th harmonic of highest fundamental frequency ◦ “F” denotes fundamental frequency; “H” denotes spurious frequency. “E” denotes band edge frequency. (This judgment method includes the Band Edge Requirement.)
- (3) Radiated emissions measured in frequency range above 1000MHz were made with an instrument using Peak detector mode and AV detector mode of the emission ◦
- (4) Data of measurement within this frequency range shown “ \* ” in the table above means the reading of emissions are attenuated more than 20dB below the permissible limits or the field strength is too small to be measured.
- (5) A preamp and high pass filter were used for this test in order to provide sufficient measurement sensitivity.
- (6) EUT Orthogonal Axis :  
“X” - denotes Laid on Table ; “Y” - denotes Vertical Stand ; “Z” - denotes Side Stand
- (7) During the measurements above 1 GHz it is taken care of that the EUT is always within the 3 dB cone of radiation BW of the used antenna



Orthogonal Axis : X  
2402 MHz (Vertical)

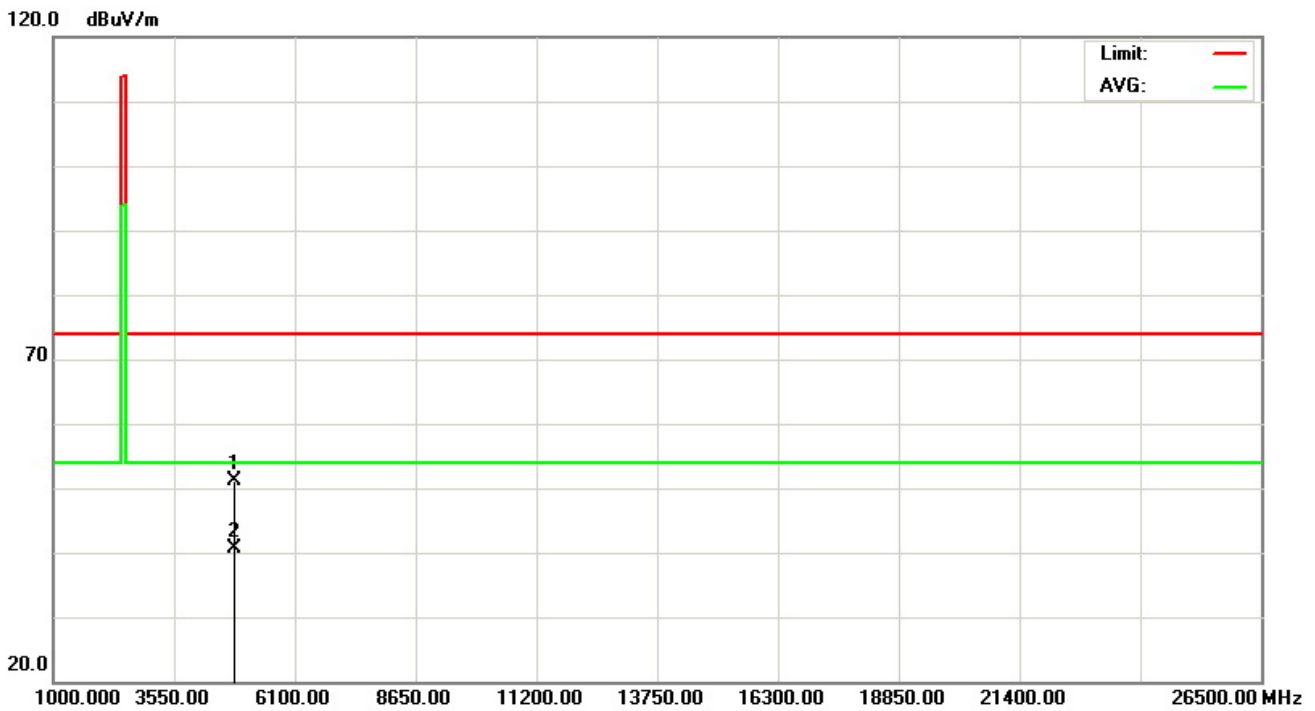
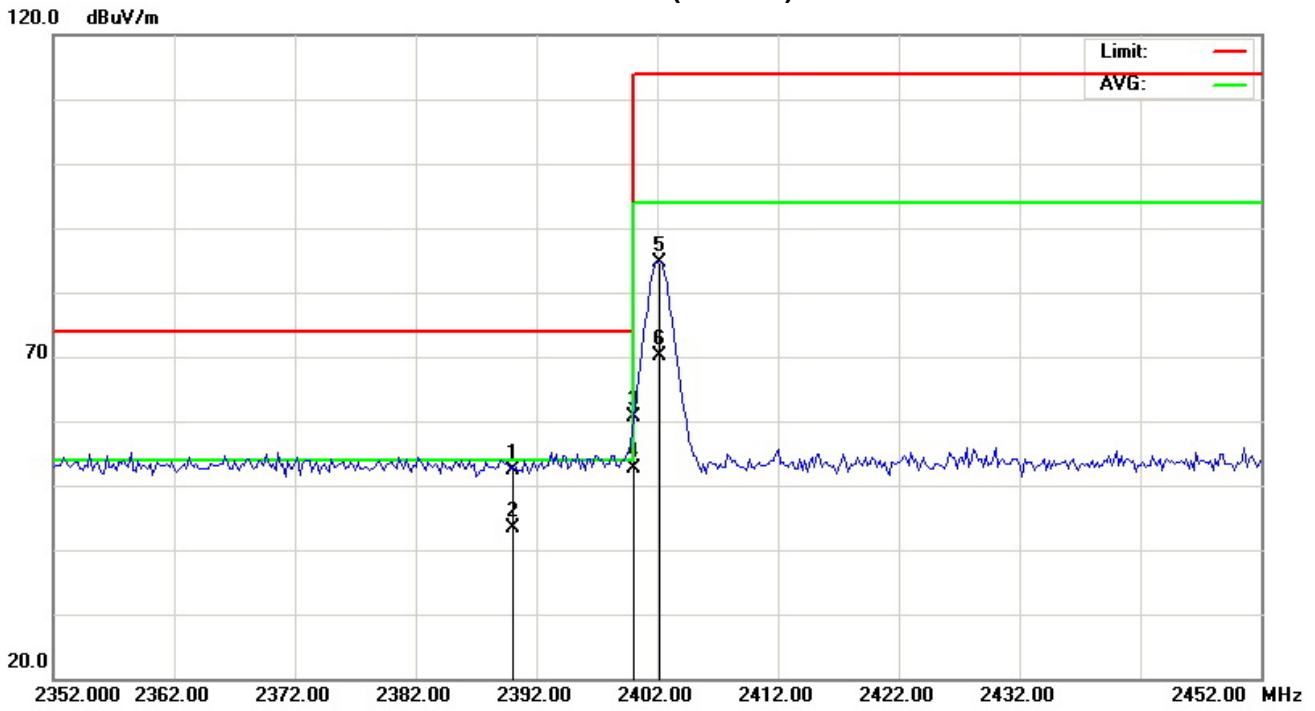





E.U.T :	Data Projector	Model Name :	WD385U-EST
Temperature :	26 °C	Relative Humidity :	60%
Test Voltage :	AC 120V/60Hz	EUT Orthogonal Axis:	X
Test Mode :	2402 MHz		

Freq. (MHz)	Polarization H/V	Reading Level(dBuV)		Correct Factor(dB)	Measurement(dBuV/m)		Limit(dBuV/m)		Margin (dB)	Note
		Peak	AV		Peak	AV	Peak	AV		
2390.000	H	22.29	11.17	32.15	54.44	43.32	74.00	54.00	-10.68	AV/E
2400.000	H	26.15	18.71	32.19	58.34	50.90	74.00	54.00	-3.10	AV/E
2402.000	H	50.43	36.82	32.20	82.63	69.02	-	-	-	F
4804.020	H	47.77	38.16	2.90	50.67	41.06	74.00	54.00	-12.94	AV/H

**Remark :**

- (1) All readings are Peak unless otherwise stated QP in column of 『 Note 』 . Peak denotes that the Peak reading compliance with the QP Limits and then QP Mode measurement didn't perform ◦
- (2) Measuring frequency range from 30MHz to 1000MHz or the 10th harmonic of highest fundamental frequency ◦ “F” denotes fundamental frequency; “H” denotes spurious frequency. “E” denotes band edge frequency. (This judgment method includes the Band Edge Requirement.)
- (3) Radiated emissions measured in frequency range above 1000MHz were made with an instrument using Peak detector mode and AV detector mode of the emission ◦
- (4) Data of measurement within this frequency range shown “ \* ” in the table above means the reading of emissions are attenuated more than 20dB below the permissible limits or the field strength is too small to be measured.
- (5) A preamp and high pass filter were used for this test in order to provide sufficient measurement sensitivity.
- (6) EUT Orthogonal Axis :  
“X” - denotes Laid on Table ; “Y” - denotes Vertical Stand ; “Z” - denotes Side Stand
- (7) During the measurements above 1 GHz it is taken care of that the EUT is always within the 3 dB cone of radiation BW of the used antenna



Orthogonal Axis : X  
2402 MHz (Horizontal)

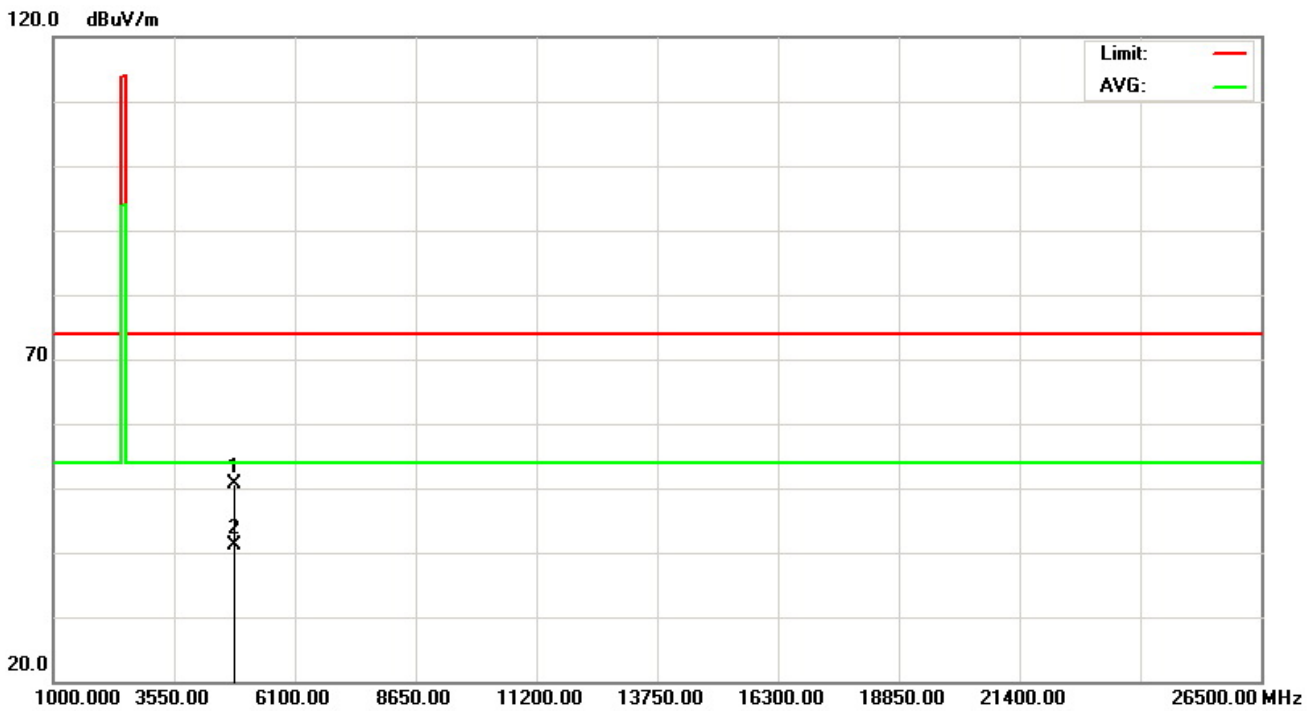
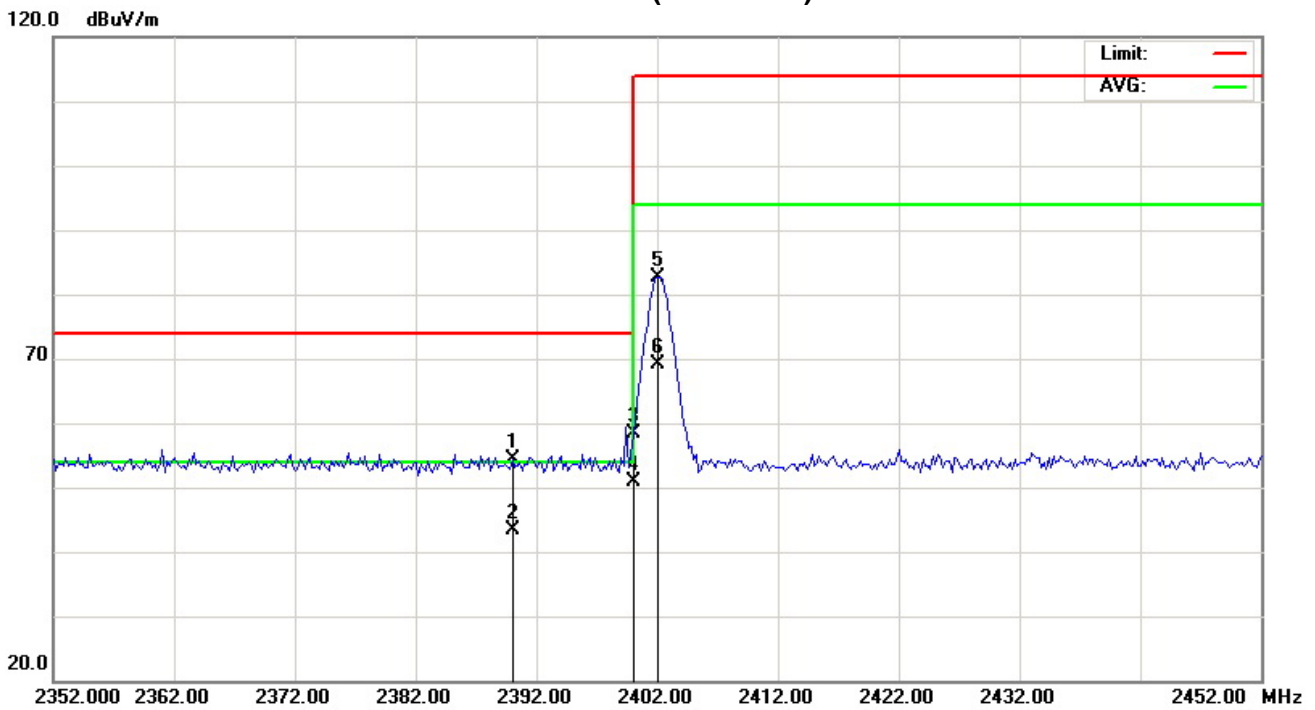



E.U.T :	Data Projector	Model Name :	WD385U-EST
Temperature :	26 °C	Relative Humidity :	60%
Test Voltage :	AC 120V/60Hz	EUT Orthogonal Axis:	X
Test Mode :	2441 MHz		

Freq. (MHz)	Polarization H/V	Reading Level(dBuV)		Correct Factor(dB)	Measurement(dBuV/m)		Limit(dBuV/m)		Margin (dB)	Note
		Peak	AV		Peak	AV	Peak	AV		
2441.000	V	52.09	35.66	32.39	84.48	68.05	-	-	-	F
4882.000	V	50.53	38.79	3.08	53.61	41.87	74.00	54.00	-12.13	AV/H

Remark :

- (1) All readings are Peak unless otherwise stated QP in column of 『Note』 . Peak denotes that the Peak reading compliance with the QP Limits and then QP Mode measurement didn't perform ◦
- (2) Measuring frequency range from 30MHz to 1000MHz or the 10th harmonic of highest fundamental frequency ◦ "F" denotes fundamental frequency; "H" denotes spurious frequency. "E" denotes band edge frequency. (This judgment method includes the Band Edge Requirement.)
- (3) Radiated emissions measured in frequency range above 1000MHz were made with an instrument using Peak detector mode and AV detector mode of the emission ◦
- (4) Data of measurement within this frequency range shown " \* " in the table above means the reading of emissions are attenuated more than 20dB below the permissible limits or the field strength is too small to be measured.
- (5) A preamp and high pass filter were used for this test in order to provide sufficient measurement sensitivity.
- (6) EUT Orthogonal Axis :  
"X" - denotes Laid on Table ; "Y" - denotes Vertical Stand ; "Z" - denotes Side Stand
- (7) During the measurements above 1 GHz it is taken care of that the EUT is always within the 3 dB cone of radiation BW of the used antenna



Orthogonal Axis : X  
2441 MHz (Vertical)

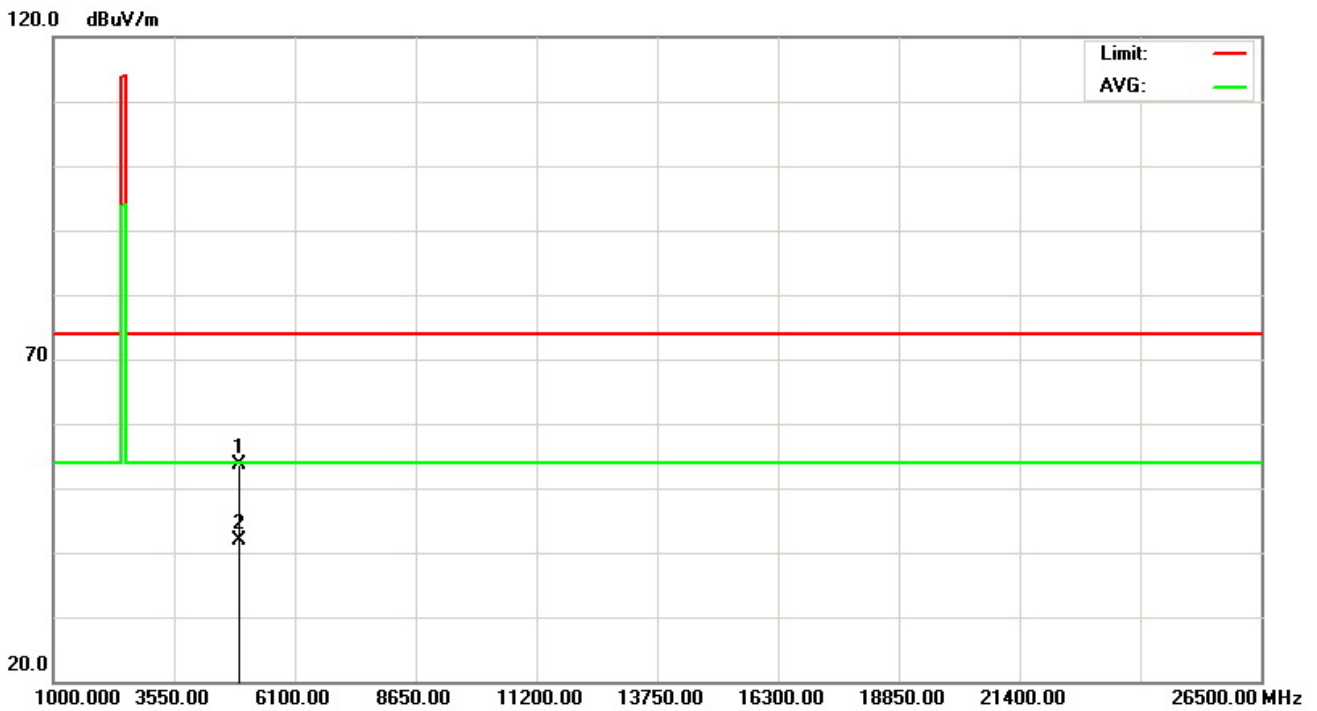
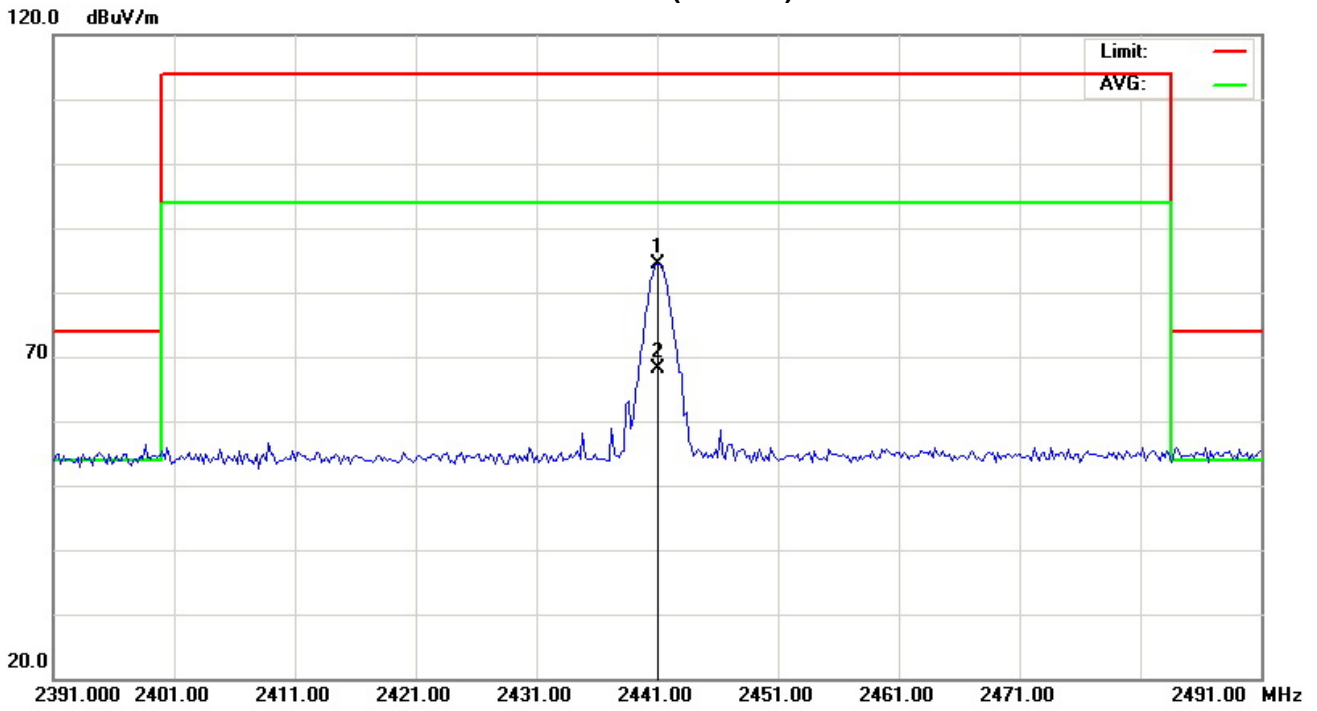



E.U.T :	Data Projector	Model Name :	WD385U-EST
Temperature :	26 °C	Relative Humidity :	60%
Test Voltage :	AC 120V/60Hz	EUT Orthogonal Axis:	X
Test Mode :	2441 MHz		

Freq. (MHz)	Polarization H/V	Reading Level(dBuV)		Correct Factor(dB)	Measurement(dBuV/m)		Limit(dBuV/m)		Margin (dB)	Note
		Peak	AV		Peak	AV	Peak	AV		
2441.200	H	50.77	36.66	32.39	83.16	69.05	-	-	-	F
4881.280	H	47.24	36.98	3.08	50.32	40.06	74.00	54.00	-13.94	AV/H

Remark :

- (1) All readings are Peak unless otherwise stated QP in column of 『Note』 . Peak denotes that the Peak reading compliance with the QP Limits and then QP Mode measurement didn't perform ◦
- (2) Measuring frequency range from 30MHz to 1000MHz or the 10th harmonic of highest fundamental frequency ◦ "F" denotes fundamental frequency; "H" denotes spurious frequency. "E" denotes band edge frequency. (This judgment method includes the Band Edge Requirement.)
- (3) Radiated emissions measured in frequency range above 1000MHz were made with an instrument using Peak detector mode and AV detector mode of the emission ◦
- (4) Data of measurement within this frequency range shown " \* " in the table above means the reading of emissions are attenuated more than 20dB below the permissible limits or the field strength is too small to be measured.
- (5) A preamp and high pass filter were used for this test in order to provide sufficient measurement sensitivity.
- (6) EUT Orthogonal Axis :  
"X" - denotes Laid on Table ; "Y" - denotes Vertical Stand ; "Z" - denotes Side Stand
- (7) During the measurements above 1 GHz it is taken care of that the EUT is always within the 3 dB cone of radiation BW of the used antenna



Orthogonal Axis : X  
2441 MHz (Horizontal)

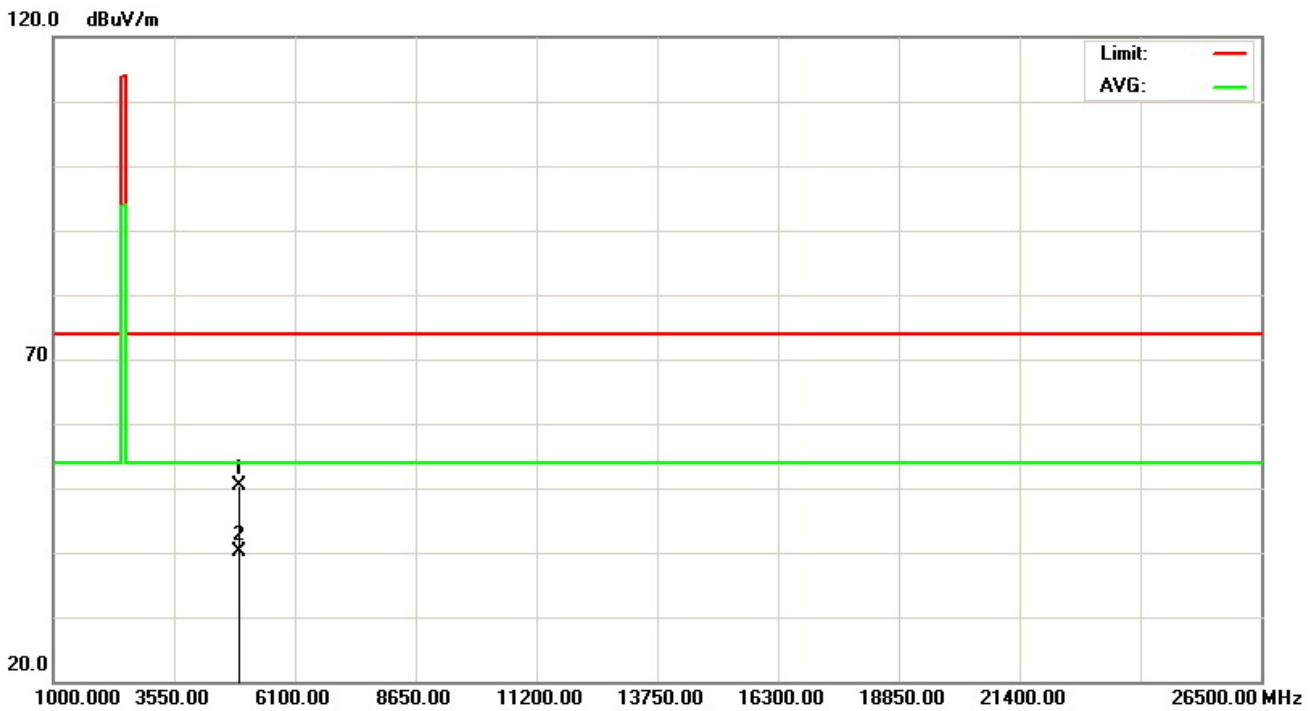
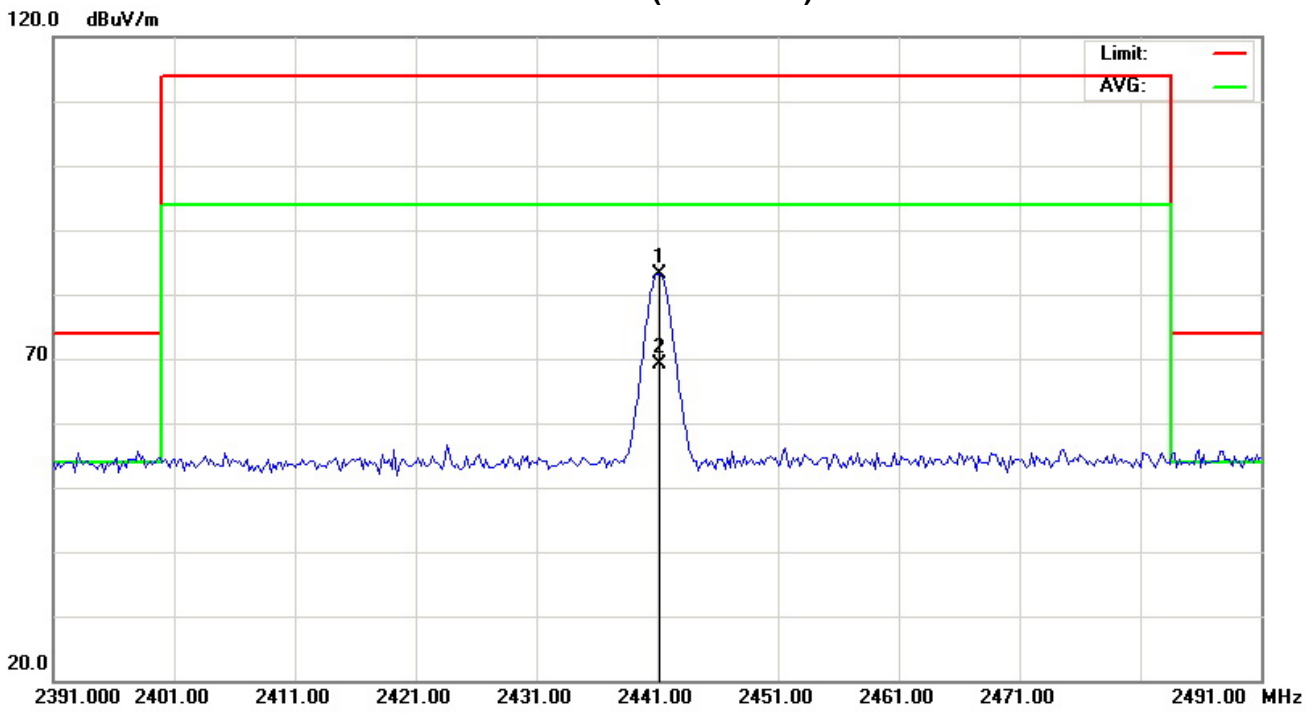



E.U.T :	Data Projector	Model Name :	WD385U-EST
Temperature :	26 °C	Relative Humidity :	60%
Test Voltage :	AC 120V/60Hz	EUT Orthogonal Axis:	X
Test Mode :	2479 MHz		

Freq. (MHz)	Polarization H/V	Reading Level(dBuV)		Correct Factor(dB)	Measurement(dBuV/m)		Limit(dBuV/m)		Margin (dB)	Note
		Peak	AV		Peak	AV	Peak	AV		
2479.200	V	52.63	36.45	32.57	85.20	69.02	-	-	-	F
2483.500	V	21.45	11.54	32.59	54.04	44.13	74.00	54.00	-9.87	AV/E
4957.970	V	48.84	38.39	3.25	52.09	41.64	74.00	54.00	-12.36	AV/H

**Remark :**

- (1) All readings are Peak unless otherwise stated QP in column of 『Note』 . Peak denotes that the Peak reading compliance with the QP Limits and then QP Mode measurement didn't perform ◦
- (2) Measuring frequency range from 30MHz to 1000MHz or the 10th harmonic of highest fundamental frequency ◦ “F” denotes fundamental frequency; “H” denotes spurious frequency. “E” denotes band edge frequency. (This judgment method includes the Band Edge Requirement.)
- (3) Radiated emissions measured in frequency range above 1000MHz were made with an instrument using Peak detector mode and AV detector mode of the emission ◦
- (4) Data of measurement within this frequency range shown “ \* ” in the table above means the reading of emissions are attenuated more than 20dB below the permissible limits or the field strength is too small to be measured.
- (5) A preamp and high pass filter were used for this test in order to provide sufficient measurement sensitivity.
- (6) EUT Orthogonal Axis :  
“X” - denotes Laid on Table ; “Y” - denotes Vertical Stand ; “Z” - denotes Side Stand
- (7) During the measurements above 1 GHz it is taken care of that the EUT is always within the 3 dB cone of radiation BW of the used antenna



Orthogonal Axis : X  
2479 MHz (Vertical)

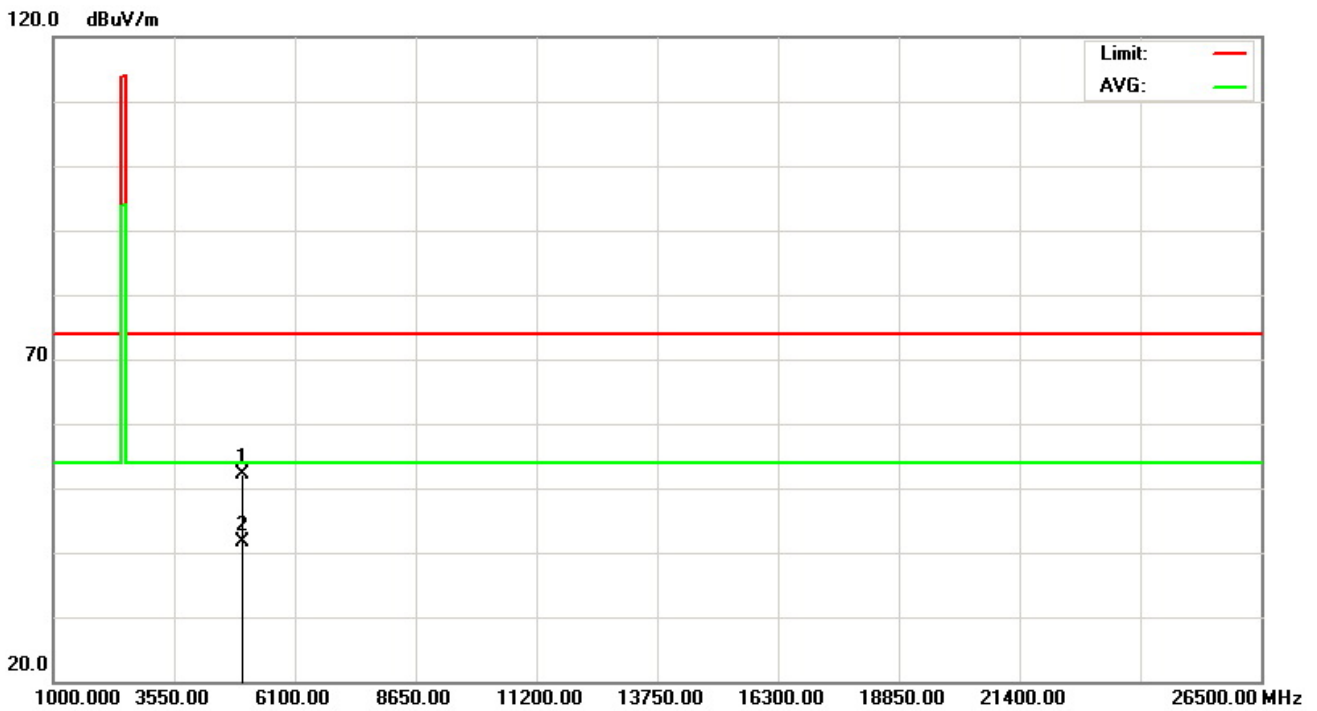
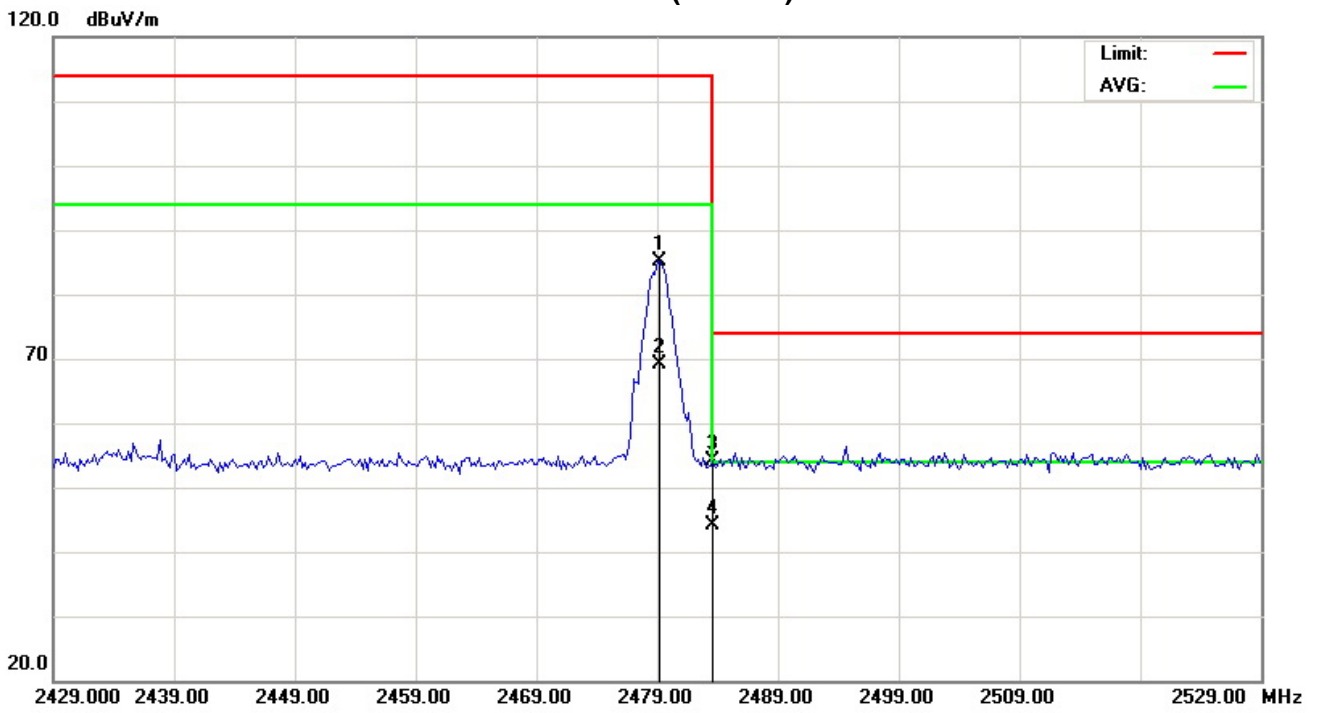





E.U.T :	Data Projector	Model Name :	WD385U-EST
Temperature :	26 °C	Relative Humidity :	60%
Test Voltage :	AC 120V/60Hz	EUT Orthogonal Axis:	X
Test Mode :	2479 MHz		

Freq. (MHz)	Polarization H/V	Reading Level(dBuV)		Correct Factor(dB)	Measurement(dBuV/m)		Limit(dBuV/m)		Margin (dB)	Note
		Peak	AV		Peak	AV	Peak	AV		
2479.200	H	50.02	34.62	32.57	82.59	67.19	-	-	-	F
2483.500	H	20.87	11.41	32.59	53.46	44.00	74.00	54.00	-10.00	AV/E
4958.240	H	50.43	39.70	3.25	53.68	42.95	74.00	54.00	-11.05	AV/H

Remark :

- (1) All readings are Peak unless otherwise stated QP in column of 『Note』 . Peak denotes that the Peak reading compliance with the QP Limits and then QP Mode measurement didn't perform ◦
- (2) Measuring frequency range from 30MHz to 1000MHz or the 10th harmonic of highest fundamental frequency ◦ “F” denotes fundamental frequency; “H” denotes spurious frequency. “E” denotes band edge frequency. (This judgment method includes the Band Edge Requirement.)
- (3) Radiated emissions measured in frequency range above 1000MHz were made with an instrument using Peak detector mode and AV detector mode of the emission ◦
- (4) Data of measurement within this frequency range shown “ \* ” in the table above means the reading of emissions are attenuated more than 20dB below the permissible limits or the field strength is too small to be measured.
- (5) A preamp and high pass filter were used for this test in order to provide sufficient measurement sensitivity.
- (6) EUT Orthogonal Axis :  
“X” - denotes Laid on Table ; “Y” - denotes Vertical Stand ; “Z” - denotes Side Stand
- (7) During the measurements above 1 GHz it is taken care of that the EUT is always within the 3 dB cone of radiation BW of the used antenna



Orthogonal Axis : X  
2479 MHz (Horizontal)

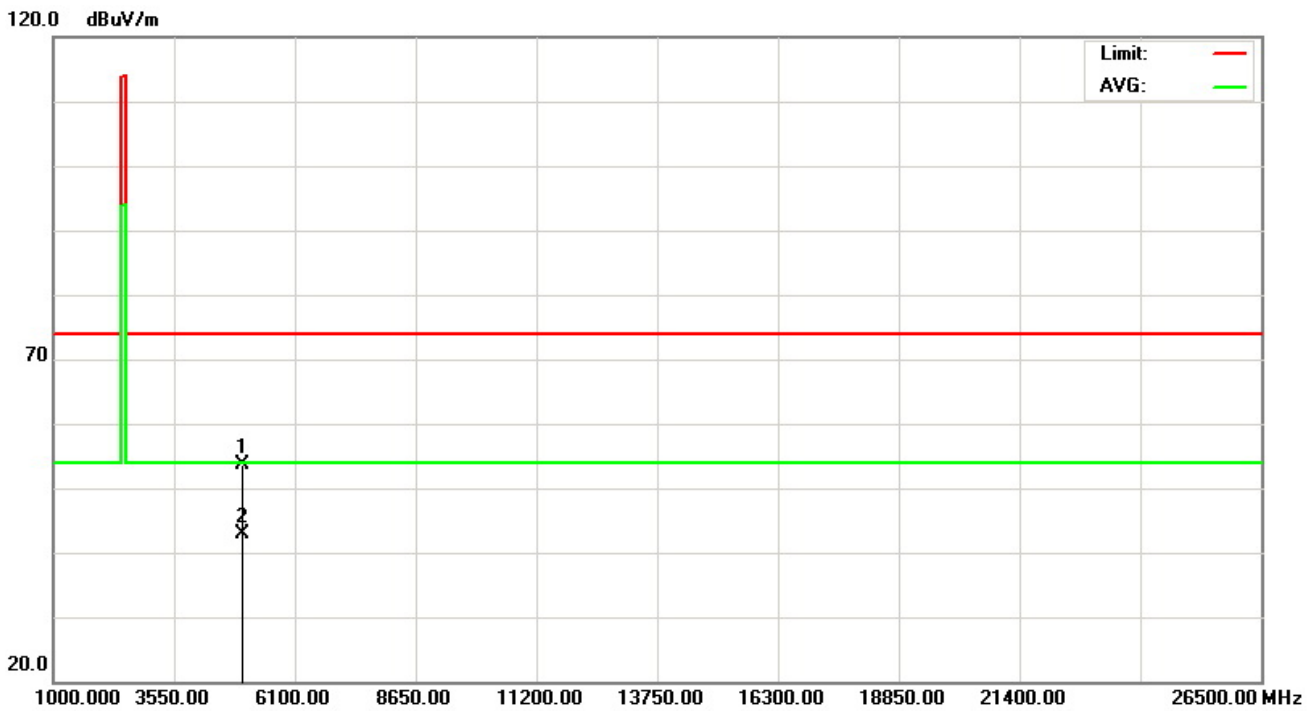
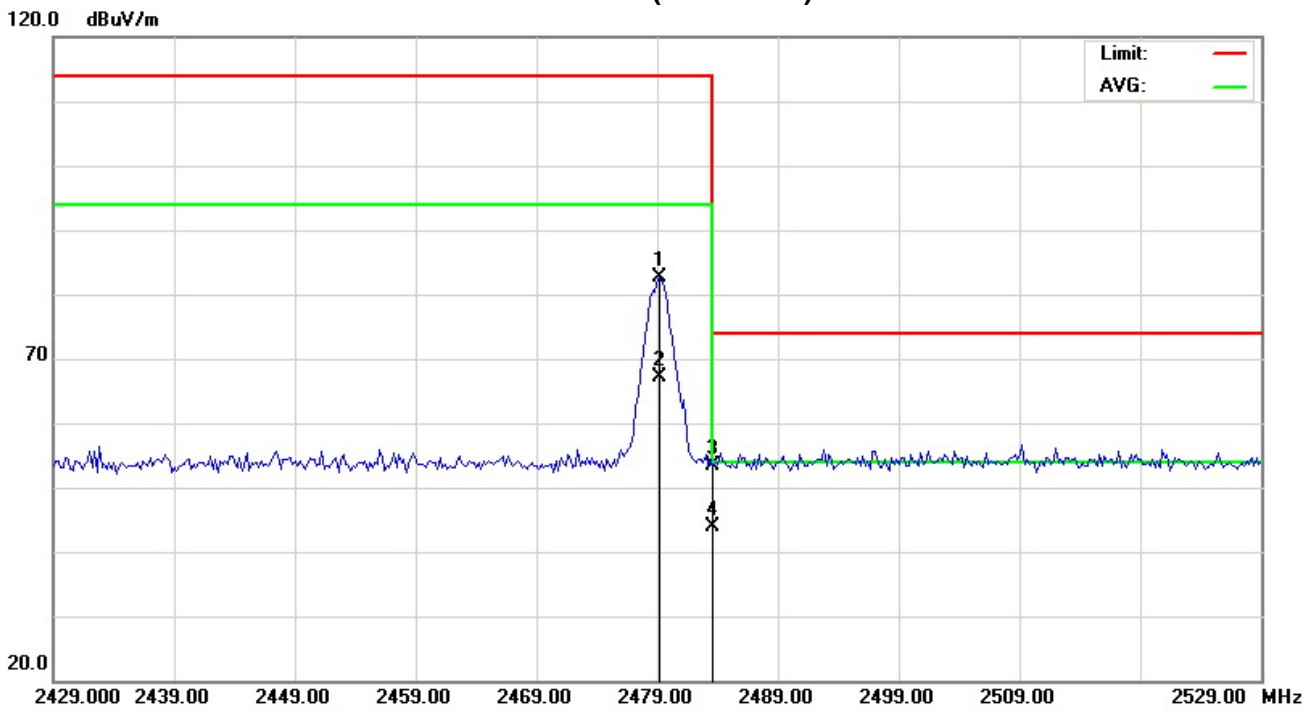



**5. ANTENNA CONDUCTED SPURIOUS EMISSION**

**5.1 APPLIED PROCEDURES / LIMIT**

20dBc in any 100 kHz bandwidth outside the operating frequency band. In case the emission fall within the restricted band specified on 15.205(a), then the 15.209(a) limit in the table below has to be followed.

<b>Frequencies (MHz)</b>	<b>Field Strength (micorvolts/meter)</b>	<b>Measurement Distance (meters)</b>
0.009~0.490	2400/F(KHz)	300
0.490~1.705	24000/F(KHz)	30
1.705~30.0	30	30
30~88	100	3
88~216	150	3
216~960	200	3
Above 960	500	3

**5.1.1 MEASUREMENT INSTRUMENTS LIST**

Item	Kind of Equipment	Manufacturer	Type No.	Serial No.	Calibrated until
1	Spectrum Analyzer	R&S	FSP-40	100129	Aug. 30, 2012

Remark: " N/A" denotes No Model Name. , Serial No. or No Calibration specified.

**5.1.2 TEST PROCEDURE**

- a. The EUT was directly connected to the spectrum analyzer and antenna output port as show in the block diagram below,
- b. Spectrum Setting : RBW= 100KHz, VBW=100KHz, Sweep time = 200 ms.

**5.1.3 DEVIATION FROM STANDARD**

No deviation.

**5.1.4 TEST SETUP**

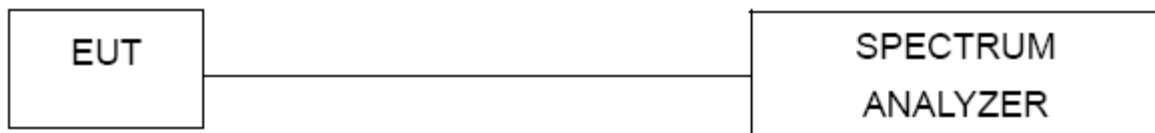

**5.1.5 EUT OPERATION CONDITIONS**

The EUT tested system was configured as the statements of 4.1.6 Unless otherwise a special operating condition is specified in the follows during the testing.



**5.1.6 TEST RESULTS**

EUT :	Data Projector	Model Name. :	WD385U-EST
Temperature :	26 °C	Relative Humidity :	60%
Pressure :	AC 120V/60Hz	Test Power :	X
Test Mode :	2402MHz / 2479 MHz		

Channel of Worst Data			
The max. radio frequency power in any 100kHz bandwidth outside the frequency band		The max. radio frequency power in any 100 kHz bandwidth within the frequency band.	
FREQUENCY(MHz)	POWER(dBm)	FREQUENCY(MHz)	POWER(dBm)
2389.00	-66.80	2495.60	-63.28
Result			
In any 100kHz bandwidth outside the frequency band, the radio frequency power is at least 50dB below that in the 100kHz bandwidth within the band that contains the highest level of the desired power.			



### TX CH 01

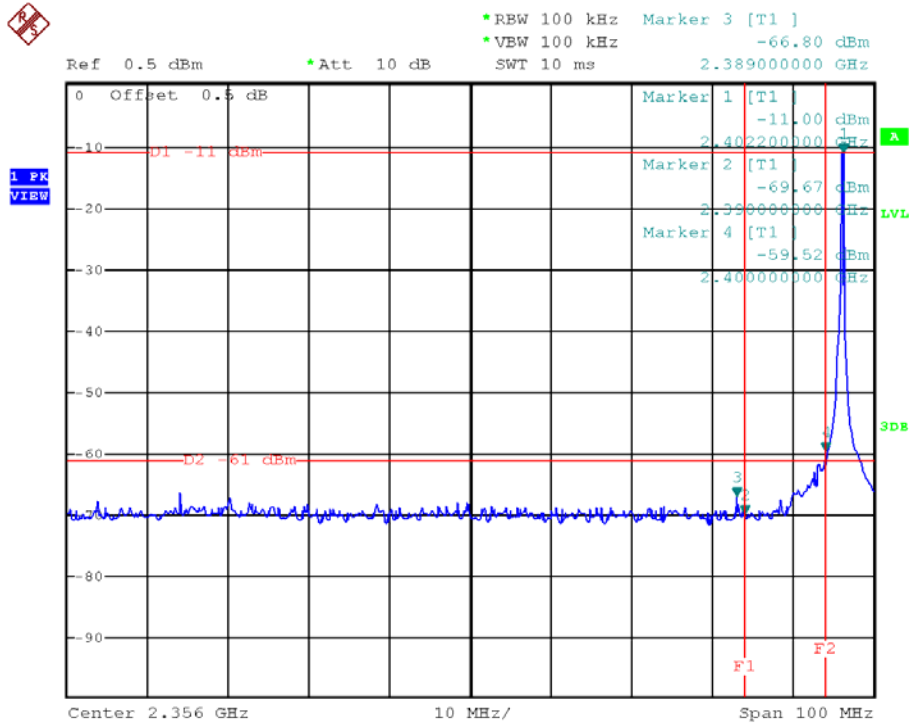

### TX CH 78

