

Utilización de los Manuales

El Manual de funcionamiento y el Manual de funcionamiento del controlador de la impresora están preparados en el Portable Document Format (PDF) en este CD-ROM. Se requiere Adobe Acrobat Reader para abrir el Manual de funcionamiento.















Instalación del Adobe Acrobat Reader (Versión en español)

1. Cargue el CD-ROM en la unidad de CD-ROM.
2. Abra el CD-ROM "PROJECTOR."
3. Abra la carpeta "ACROBAT_READER" dentro del CD-ROM.
4. Abra la carpeta "ESPAÑOL".
5. Haga doble clic en el icono para instalación.

Cómo abrir el Manual de funcionamiento

1. Cargue el CD-ROM en la unidad de CD-ROM.
 2. Abra el CD-ROM "PROJECTOR."
 3. Haga doble clic en "MANUAL.HTML" dentro del CD-ROM. Se visualizará una lista de selección de idioma para el Manual de funcionamiento.
 4. Mueva el puntero del ratón al idioma deseado y haga clic. Esto iniciará Adobe Acrobat Reader y el Manual de funcionamiento se abrirá.
- Adobe y Acrobat Reader son marcas registradas de Adobe Systems Incorporated de los Estados Unidos y/u otros países.

Solución de problemas

Problema	Solución																				
No se puede conectar la alimentación eléctrica.	<ul style="list-style-type: none"> • Compruebe si los indicadores están encendidos o apagados y cómo se iluminan. <table border="1"> <thead> <tr> <th>POWER</th> <th>STATUS</th> <th>Solucion</th> </tr> </thead> <tbody> <tr> <td> <ul style="list-style-type: none"> ○ Off </td> <td> <ul style="list-style-type: none"> ○ Off </td> <td> <ul style="list-style-type: none"> • Conecte el cable de alimentación al proyector. • Enchufe el cable de alimentación en la toma de corriente de la pared. </td> </tr> <tr> <td rowspan="4">  Se mantiene encendido en rojo </td> <td> <ul style="list-style-type: none"> ○ Off </td> <td> <ul style="list-style-type: none"> • Si algún objeto bloquea la rejilla de entrada o de salida de aire, quítelo y haga lo siguiente. <ol style="list-style-type: none"> 1. Desconecte el cable de alimentación de la toma de corriente de la pared. 2. Asegúrese de que el proyector se ha enfriado. 3. Enchufe el cable de alimentación en la toma de corriente de la pared. 4. Pulse el botón POWER. </td> </tr> <tr> <td>  Parpadea en naranja </td> <td> <ul style="list-style-type: none"> • Si algún objeto bloquea la rejilla de entrada o de salida de aire, quítelo. • No exponga las rejillas de salida del aire al aire caliente emitido por un aparato de calefacción. </td> </tr> <tr> <td>  Parpadea en verde </td> <td> <ul style="list-style-type: none"> • Cuando el indicador STATUS deje de parpadear, pulse el botón POWER. <ul style="list-style-type: none"> • Si desconecta el cable de alimentación mientras el ventilador está funcionando, es posible que no se encienda la lámpara durante un minuto la próxima vez que conecte el cable. • La lámpara no puede encenderse de nuevo durante un minuto después de apagarse. • Pulse el botón POWER varias veces. </td> </tr> <tr> <td>  mantiene encendido en rojo </td> <td> <ul style="list-style-type: none"> • Sustituya la lámpara (ha terminado la vida de la lámpara). </td> </tr> <tr> <td rowspan="2">  Parpadea en rojo / verde </td> <td> <ul style="list-style-type: none"> ○ Off </td> <td> <ul style="list-style-type: none"> • Sujetar la parte de arriba de la cubierta del faro. </td> </tr> <tr> <td> <ul style="list-style-type: none"> Se mantiene encendido o parpadea </td> <td> <ul style="list-style-type: none"> • Desconecte el cable de alimentación de la toma de corriente de la pared y póngase en contacto con su distribuidor. </td> </tr> </tbody> </table>	POWER	STATUS	Solucion	<ul style="list-style-type: none"> ○ Off 	<ul style="list-style-type: none"> ○ Off 	<ul style="list-style-type: none"> • Conecte el cable de alimentación al proyector. • Enchufe el cable de alimentación en la toma de corriente de la pared. 	 Se mantiene encendido en rojo	<ul style="list-style-type: none"> ○ Off 	<ul style="list-style-type: none"> • Si algún objeto bloquea la rejilla de entrada o de salida de aire, quítelo y haga lo siguiente. <ol style="list-style-type: none"> 1. Desconecte el cable de alimentación de la toma de corriente de la pared. 2. Asegúrese de que el proyector se ha enfriado. 3. Enchufe el cable de alimentación en la toma de corriente de la pared. 4. Pulse el botón POWER. 	 Parpadea en naranja	<ul style="list-style-type: none"> • Si algún objeto bloquea la rejilla de entrada o de salida de aire, quítelo. • No exponga las rejillas de salida del aire al aire caliente emitido por un aparato de calefacción. 	 Parpadea en verde	<ul style="list-style-type: none"> • Cuando el indicador STATUS deje de parpadear, pulse el botón POWER. <ul style="list-style-type: none"> • Si desconecta el cable de alimentación mientras el ventilador está funcionando, es posible que no se encienda la lámpara durante un minuto la próxima vez que conecte el cable. • La lámpara no puede encenderse de nuevo durante un minuto después de apagarse. • Pulse el botón POWER varias veces. 	 mantiene encendido en rojo	<ul style="list-style-type: none"> • Sustituya la lámpara (ha terminado la vida de la lámpara). 	 Parpadea en rojo / verde	<ul style="list-style-type: none"> ○ Off 	<ul style="list-style-type: none"> • Sujetar la parte de arriba de la cubierta del faro. 	<ul style="list-style-type: none"> Se mantiene encendido o parpadea 	<ul style="list-style-type: none"> • Desconecte el cable de alimentación de la toma de corriente de la pared y póngase en contacto con su distribuidor.
	POWER	STATUS	Solucion																		
	<ul style="list-style-type: none"> ○ Off 	<ul style="list-style-type: none"> ○ Off 	<ul style="list-style-type: none"> • Conecte el cable de alimentación al proyector. • Enchufe el cable de alimentación en la toma de corriente de la pared. 																		
	 Se mantiene encendido en rojo	<ul style="list-style-type: none"> ○ Off 	<ul style="list-style-type: none"> • Si algún objeto bloquea la rejilla de entrada o de salida de aire, quítelo y haga lo siguiente. <ol style="list-style-type: none"> 1. Desconecte el cable de alimentación de la toma de corriente de la pared. 2. Asegúrese de que el proyector se ha enfriado. 3. Enchufe el cable de alimentación en la toma de corriente de la pared. 4. Pulse el botón POWER. 																		
		 Parpadea en naranja	<ul style="list-style-type: none"> • Si algún objeto bloquea la rejilla de entrada o de salida de aire, quítelo. • No exponga las rejillas de salida del aire al aire caliente emitido por un aparato de calefacción. 																		
		 Parpadea en verde	<ul style="list-style-type: none"> • Cuando el indicador STATUS deje de parpadear, pulse el botón POWER. <ul style="list-style-type: none"> • Si desconecta el cable de alimentación mientras el ventilador está funcionando, es posible que no se encienda la lámpara durante un minuto la próxima vez que conecte el cable. • La lámpara no puede encenderse de nuevo durante un minuto después de apagarse. • Pulse el botón POWER varias veces. 																		
 mantiene encendido en rojo		<ul style="list-style-type: none"> • Sustituya la lámpara (ha terminado la vida de la lámpara). 																			
 Parpadea en rojo / verde	<ul style="list-style-type: none"> ○ Off 	<ul style="list-style-type: none"> • Sujetar la parte de arriba de la cubierta del faro. 																			
	<ul style="list-style-type: none"> Se mantiene encendido o parpadea 	<ul style="list-style-type: none"> • Desconecte el cable de alimentación de la toma de corriente de la pared y póngase en contacto con su distribuidor. 																			
No aparece ninguna imagen en pantalla.	<ul style="list-style-type: none"> • Cancele modo de silencio AV pulsando el botón AV MUTE. • Compruebe que ha quitado la tapa del objetivo. • La lámpara puede tardar 1 minuto aprox. en encenderse. • En muy pocas ocasiones, la lámpara no se enciende. En tal caso, espere unos minutos y vuelva a encenderla. • Si ha apagado el proyector antes de que la lámpara se haya enfriado suficientemente, el ventilador puede empezar a girar y el botón POWER no funcionará después de encender el interruptor principal. Pulse el botón POWER para que se vuelva a encender el indicador POWER. • Compruebe que el ventilador de admisión está limpio. • Compruebe que la cubierta de la lámpara está cerrada. • Compruebe que los cables conectados a dispositivos externos no están rotos. • Si utiliza un alargador, cámbielo por el cable suministrado para comprobar su funcionamiento. Si las imágenes aparecen correctamente, añada un amplificador de señal RGB al alargador. 																				



ESPAÑOL

PROYECTOR DLP™
 MODELO XD365U-EST/WD385U-EST

Inicio rápido

Qué se incluye en la caja

<p>Cable de alimentación CA</p>	<p>Cable para el ordenador</p>	<p>Cable USB</p>	<p>Mando a distancia</p>
<p>* Se suministra el cable de alimentación adecuado para EE.UU., Europa, Reino Unido, Australia, o Corea.</p>			<ul style="list-style-type: none"> • Manual de seguridad/ Inicio rápido • CD-ROM • Pila (2) • Tapa de objetivo • Accesorio de sustitución de lámpara • Kit de lápiz interactivo (RC-380P1)

1

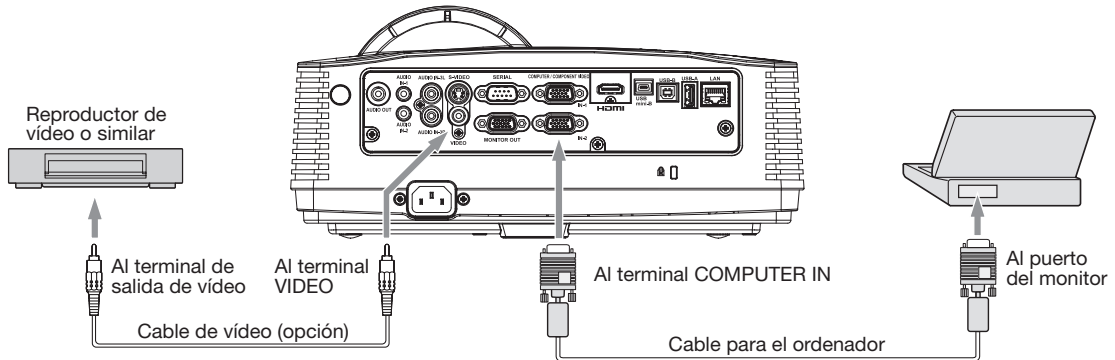

2

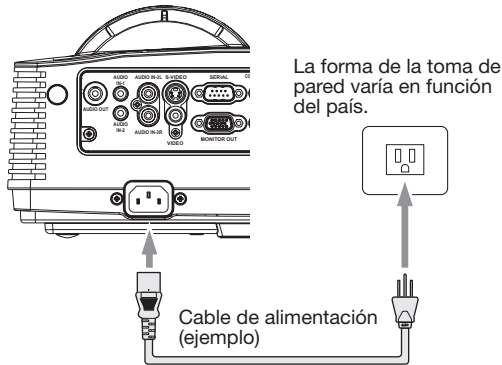

5

Cuando no se proyecta la imagen suministrada del ordenador portátil:

Pulse la tecla **[Fn]** y cualquiera de las teclas **[F1]** a **[F12]** (dependiendo del tipo de ordenador portátil) al mismo tiempo.



3

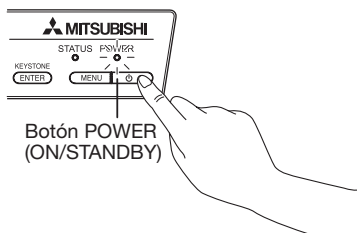

4

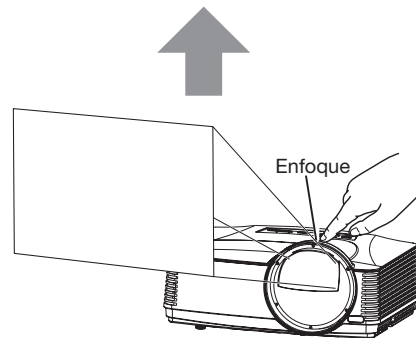

Utilizzazione dei manuali

Il manuale operativo e il manuale operativo per il driver della stampante sono preparati nel Formato di Documento Portabile (PDF) in questo CD-ROM. Adobe Acrobat Reader è richiesto per aprire il Manuale Operativo.

Installazione dell'Adobe Acrobat Reader (Versione Italiano)

1. Inserite il CD-ROM nel drive del CD-ROM.
2. Aprite il CD-ROM "PROJECTOR."
3. Aprite la cartella "ACROBAT_READER" con il CD-ROM.
4. Aprite la cartella "ITALIANO".
5. Cliccate doppiamente l'icona per installazione.

Apertura del manuale operativo

1. Caricate il CD-ROM nel drive del CD-ROM.
2. Aprite il CD-ROM "PROJECTOR."
3. Cliccate doppiamente su "MANUAL.HTML" nell'ambitodel CD-ROM. Apparirà una lista di selezione della lingua per il manuale operativo.
4. Muovete il puntatore del mouse fino al linguaggio desiderato e cliccate. Lancerete così Adobe Acrobat Reader e il manuale operativo si aprirà.

- Adobe e Acrobat Reader sono marchi registrati di Adobe Systems Incorporated negli Stati Uniti e/o in altri paesi.

Ricerca ed eliminazione guasti

Problema	Soluzione																				
L'alimentazione non può essere accesa.	<ul style="list-style-type: none"> • Controllare se gli indicatori sono accesi o spenti e come lampeggiano. <table border="1"> <thead> <tr> <th>POWER</th> <th>STATUS</th> <th>Soluzione</th> </tr> </thead> <tbody> <tr> <td>  Off </td> <td>  Off </td> <td> <ul style="list-style-type: none"> • Collegare il cavo dell'alimentazione al proiettore. • Collegare il cavo dell'alimentazione alla presa murale. </td> </tr> <tr> <td rowspan="4">  Luce rossa fissa </td> <td>  Off </td> <td> <ul style="list-style-type: none"> • Se un oggetto blocca la fessura d'ingresso o di uscita dell'aria, rimuoverlo ed eseguire quanto segue. <ol style="list-style-type: none"> 1. Scollegare il cavo dell'alimentazione dalla presa murale. 2. Verificare che il proiettore si è raffreddato. 3. Collegare il cavo dell'alimentazione alla presa murale. 4. Premere il tasto POWER. </td> </tr> <tr> <td>  Luce arancione lampeggiante </td> <td> <ul style="list-style-type: none"> • Se un oggetto blocca la fessura d'ingresso o di uscita dell'aria, rimuoverlo. • Non esporre le fessure per la fuoriuscita dell'aria calda emessa da un apparecchio per il riscaldamento. </td> </tr> <tr> <td>  Luce verde lampeggiante </td> <td> <ul style="list-style-type: none"> • Dopo che l'indicatore STATUS smette di lampeggiare, premere il tasto POWER. <ul style="list-style-type: none"> • Se il cavo di alimentazione viene scollegato mentre la ventola ruota, la lampada non può accendersi per circa un minuto quando il cavo di alimentazione verrà collegato la volta successiva. • La lampada non può accendersi per circa un minuto dopo che si spegne. • Premere il tasto POWER più volte. </td> </tr> <tr> <td>  Luce rossa fissa </td> <td> <ul style="list-style-type: none"> • Sostituire la lampada. (La vita utile della lampada sta per esaurirsi). </td> </tr> <tr> <td rowspan="2">  Rosso/verde sbiadito </td> <td>  Off </td> <td> <ul style="list-style-type: none"> • Attaccare sopra il coperchio della lampada. </td> </tr> <tr> <td>  Fisso o lampeggiante </td> <td> <ul style="list-style-type: none"> • Scollegare il cavo dell'alimentazione dalla presa murale e contattare il proprio rivenditore. </td> </tr> </tbody> </table>	POWER	STATUS	Soluzione	 Off	 Off	<ul style="list-style-type: none"> • Collegare il cavo dell'alimentazione al proiettore. • Collegare il cavo dell'alimentazione alla presa murale. 	 Luce rossa fissa	 Off	<ul style="list-style-type: none"> • Se un oggetto blocca la fessura d'ingresso o di uscita dell'aria, rimuoverlo ed eseguire quanto segue. <ol style="list-style-type: none"> 1. Scollegare il cavo dell'alimentazione dalla presa murale. 2. Verificare che il proiettore si è raffreddato. 3. Collegare il cavo dell'alimentazione alla presa murale. 4. Premere il tasto POWER. 	 Luce arancione lampeggiante	<ul style="list-style-type: none"> • Se un oggetto blocca la fessura d'ingresso o di uscita dell'aria, rimuoverlo. • Non esporre le fessure per la fuoriuscita dell'aria calda emessa da un apparecchio per il riscaldamento. 	 Luce verde lampeggiante	<ul style="list-style-type: none"> • Dopo che l'indicatore STATUS smette di lampeggiare, premere il tasto POWER. <ul style="list-style-type: none"> • Se il cavo di alimentazione viene scollegato mentre la ventola ruota, la lampada non può accendersi per circa un minuto quando il cavo di alimentazione verrà collegato la volta successiva. • La lampada non può accendersi per circa un minuto dopo che si spegne. • Premere il tasto POWER più volte. 	 Luce rossa fissa	<ul style="list-style-type: none"> • Sostituire la lampada. (La vita utile della lampada sta per esaurirsi). 	 Rosso/verde sbiadito	 Off	<ul style="list-style-type: none"> • Attaccare sopra il coperchio della lampada. 	 Fisso o lampeggiante	<ul style="list-style-type: none"> • Scollegare il cavo dell'alimentazione dalla presa murale e contattare il proprio rivenditore.
POWER	STATUS	Soluzione																			
 Off	 Off	<ul style="list-style-type: none"> • Collegare il cavo dell'alimentazione al proiettore. • Collegare il cavo dell'alimentazione alla presa murale. 																			
 Luce rossa fissa	 Off	<ul style="list-style-type: none"> • Se un oggetto blocca la fessura d'ingresso o di uscita dell'aria, rimuoverlo ed eseguire quanto segue. <ol style="list-style-type: none"> 1. Scollegare il cavo dell'alimentazione dalla presa murale. 2. Verificare che il proiettore si è raffreddato. 3. Collegare il cavo dell'alimentazione alla presa murale. 4. Premere il tasto POWER. 																			
	 Luce arancione lampeggiante	<ul style="list-style-type: none"> • Se un oggetto blocca la fessura d'ingresso o di uscita dell'aria, rimuoverlo. • Non esporre le fessure per la fuoriuscita dell'aria calda emessa da un apparecchio per il riscaldamento. 																			
	 Luce verde lampeggiante	<ul style="list-style-type: none"> • Dopo che l'indicatore STATUS smette di lampeggiare, premere il tasto POWER. <ul style="list-style-type: none"> • Se il cavo di alimentazione viene scollegato mentre la ventola ruota, la lampada non può accendersi per circa un minuto quando il cavo di alimentazione verrà collegato la volta successiva. • La lampada non può accendersi per circa un minuto dopo che si spegne. • Premere il tasto POWER più volte. 																			
	 Luce rossa fissa	<ul style="list-style-type: none"> • Sostituire la lampada. (La vita utile della lampada sta per esaurirsi). 																			
 Rosso/verde sbiadito	 Off	<ul style="list-style-type: none"> • Attaccare sopra il coperchio della lampada. 																			
	 Fisso o lampeggiante	<ul style="list-style-type: none"> • Scollegare il cavo dell'alimentazione dalla presa murale e contattare il proprio rivenditore. 																			
Le immagini non compaiono sullo schermo.	<ul style="list-style-type: none"> • Annullare modo de silenzio AV premendo il tasto AV MUTE. • Controllare che sia stato rimosso il coperchio della lente. • La lampada può impiegare circa un minuto per accendersi. • La lampada non si accende in rare occasioni. In questo caso, attendere qualche minuto e riprovare. • Se il proiettore era spento prima che la lampada si raffreddasse completamente, le ventole possono iniziare a ruotare e il tasto POWER potrebbe non funzionare se il cavo dell'alimentazione viene inserito nella presa murale la volta successiva. Premere il tasto POWER per accendere la lampada di nuovo. • Controllare che la presa di aerazione sia pulita. • Controllare che il coperchio della lampada sia chiuso. • Controllare che i cavi collegati agli apparecchi esterni non siano danneggiati. • Quando è utilizzata una prolunga, sostituirla con il cavo in dotazione per una verifica. Quando le immagini sono visualizzate correttamente, aggiungere un amplificatore di segnale RGB alla prolunga. 																				



ITALIANO

PROIETTORE DLP™
MODELLO XD365U-EST/WD385U-EST

Avvio veloce

Accessori contenuti nella scatola

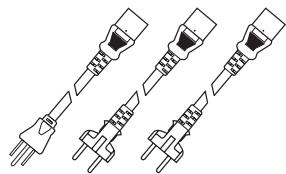

Cavo di alimentazione AC

* In dotazione viene fornito un cavo di alimentazione adatto agli U.S.A., all'Europa, al Regno Unito, all'Australia, o alla Corea, a seconda della destinazione.



Mini D-SUB 15-pin

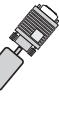

Mini D-SUB 15-pin

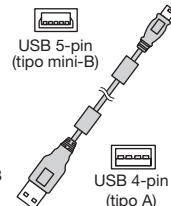

USB 5-pin (tipo mini-B)

USB 4-pin (tipo A)

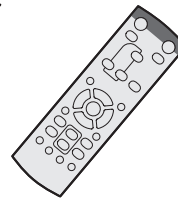

Telecomando

- Manuale di protezione/Avvio veloce
- CD-ROM
- Batterie (2)
- Coprilente
- Portalamпада di sostituzione
- Kit puntatore interattivo (RC-380P1)

1

Video riproduttore o apparecchio simile



Al terminale d'uscita video

Cavo Video (opzionale)

Al terminale VIDEO

Al terminale COMPUTER IN

Cavo computer



Alla porta per il monitor

2

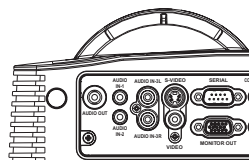

Cavo di alimentazione (esempio)

La forma della presa a parete varia a seconda della nazione.



5

Quando l'immagine ricevuta dal computer laptop non viene proiettata:

Premete il tasto **[Fn]** e uno dei tasti **[F1]** o **[F12]** (a seconda del computer laptop) allo stesso tempo.



3

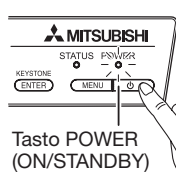

Tasto POWER (ON/STANDBY)

4

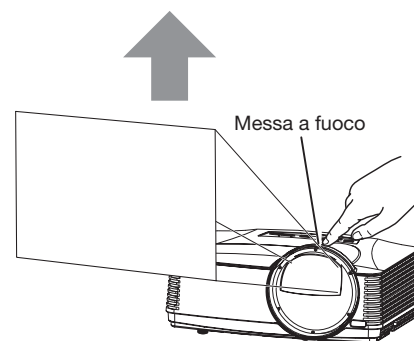

Messa a fuoco

Verwendung der Anleitungen

Die Bedienungsanleitung und die Bedienungsanleitung des Druckertreibers sind auf dieser CD-ROM im Portable Document Format (PDF) verfügbar. Zum Öffnen der Bedienungsanleitung ist Adobe Acrobat Reader erforderlich.

Installation von Adobe Acrobat Reader (Deutsch Version)







1. Legen Sie die CD-ROM in das CD-ROM-Laufwerk ein.
2. Öffnen Sie auf der CD-ROM "PROJECTOR."
3. Öffnen Sie den "ACROBAT_READER"-Ordner auf der CD-ROM.
4. Öffnen Sie den "DEUTSCH"-Ordner.
5. Doppelklicken Sie auf das Symbol für Installation.

Öffnen der Bedienungsanleitung

1. Legen Sie die CD-ROM in das CD-ROM-Laufwerk ein.
2. Öffnen Sie auf der CD-ROM "PROJECTOR."
3. Doppelklicken Sie auf "MANUAL.HTML" auf der CD-ROM. Eine Sprachauswahlliste für die Bedienungsanleitung wird angezeigt.
4. Bewegen Sie den Mauszeiger auf die gewünschte Sprache und klicken Sie diese an. Dadurch werden der Adobe Acrobat Reader, und die Bedienungsanleitung geöffnet.

- Adobe und Acrobat Reader sind eingetragene Marken von Adobe Systems Incorporated in den USA und/oder in anderen Ländern.

Fehlerbehebung

Problem	Lösung																				
Power kann nicht eingeschaltet werden.	<ul style="list-style-type: none"> • Überprüfen Sie, ob die Betriebsanzeigen ein oder aus sind und wie diese leuchten. <table border="1" data-bbox="445 801 1398 1563"> <thead> <tr> <th>POWER</th> <th>STATUS</th> <th>Lösung</th> </tr> </thead> <tbody> <tr> <td>○ Aus</td> <td>○ Aus</td> <td> <ul style="list-style-type: none"> • Schließen Sie das Netzkabel am Projektor an. • Stecken Sie das Netzkabel in eine Steckdose. </td> </tr> <tr> <td rowspan="4">  Rotes Dauerlicht </td> <td>○ Aus</td> <td> <ul style="list-style-type: none"> • Wenn das Luftein- oder Luftauslassgitter blockiert ist, entfernen Sie die Blockierung und führen folgendes aus. <ol style="list-style-type: none"> 1. Ziehen Sie das Netzkabel aus der Steckdose. 2. Stellen Sie sicher, dass der Projektor abgekühlt ist. 3. Stecken Sie das Netzkabel in die Steckdose. 4. Drücken Sie die POWER-Taste. </td> </tr> <tr> <td>○ → ☀ Orange Blinken</td> <td> <ul style="list-style-type: none"> • Wenn das Luftein- oder Luftauslassgitter blockiert ist, beseitigen Sie die blockierenden Objekte. • Achten Sie darauf, dass die Luftauslassgitter nicht heißer Luft aus Heizgeräten ausgesetzt sind. </td> </tr> <tr> <td>○ → ☀ Grünes Blinken</td> <td> <ul style="list-style-type: none"> • Wenn die STATUS-Anzeige aufgehört hat zu blinken, drücken Sie die POWER-Taste. • Wenn Sie das Netzkabel ausstecken, während der Lüfter noch läuft, kann es sein, dass die Lampe beim nächsten Einstecken des Netzkabels erst nach ca. 1 Minute leuchtet. • Die Lampe kann nur in Abständen von mindestens 1 Minute ein- und ausgeschaltet werden. • Drücken Sie mehrmals die POWER-Taste. </td> </tr> <tr> <td>☀ Rotes Dauerlicht</td> <td> <ul style="list-style-type: none"> • Ersetzen Sie die Lampe. (Die Lampe hat die maximale Betriebszeit erreicht.) </td> </tr> <tr> <td rowspan="2">  Rot/grünes Blinken </td> <td>○ Aus</td> <td> <ul style="list-style-type: none"> • Bringen Sie die Lampenabdeckung an der Oberseite an. </td> </tr> <tr> <td> ☀ Dauerlicht oder ○ → ☀ Blinken </td> <td> <ul style="list-style-type: none"> • Ziehen Sie das Netzkabel aus der Steckdose und wenden Sie sich an Ihren Händler. </td> </tr> </tbody> </table> 	POWER	STATUS	Lösung	○ Aus	○ Aus	<ul style="list-style-type: none"> • Schließen Sie das Netzkabel am Projektor an. • Stecken Sie das Netzkabel in eine Steckdose. 	 Rotes Dauerlicht	○ Aus	<ul style="list-style-type: none"> • Wenn das Luftein- oder Luftauslassgitter blockiert ist, entfernen Sie die Blockierung und führen folgendes aus. <ol style="list-style-type: none"> 1. Ziehen Sie das Netzkabel aus der Steckdose. 2. Stellen Sie sicher, dass der Projektor abgekühlt ist. 3. Stecken Sie das Netzkabel in die Steckdose. 4. Drücken Sie die POWER-Taste. 	○ → ☀ Orange Blinken	<ul style="list-style-type: none"> • Wenn das Luftein- oder Luftauslassgitter blockiert ist, beseitigen Sie die blockierenden Objekte. • Achten Sie darauf, dass die Luftauslassgitter nicht heißer Luft aus Heizgeräten ausgesetzt sind. 	○ → ☀ Grünes Blinken	<ul style="list-style-type: none"> • Wenn die STATUS-Anzeige aufgehört hat zu blinken, drücken Sie die POWER-Taste. • Wenn Sie das Netzkabel ausstecken, während der Lüfter noch läuft, kann es sein, dass die Lampe beim nächsten Einstecken des Netzkabels erst nach ca. 1 Minute leuchtet. • Die Lampe kann nur in Abständen von mindestens 1 Minute ein- und ausgeschaltet werden. • Drücken Sie mehrmals die POWER-Taste. 	☀ Rotes Dauerlicht	<ul style="list-style-type: none"> • Ersetzen Sie die Lampe. (Die Lampe hat die maximale Betriebszeit erreicht.) 	 Rot/grünes Blinken	○ Aus	<ul style="list-style-type: none"> • Bringen Sie die Lampenabdeckung an der Oberseite an. 	☀ Dauerlicht oder ○ → ☀ Blinken	<ul style="list-style-type: none"> • Ziehen Sie das Netzkabel aus der Steckdose und wenden Sie sich an Ihren Händler.
POWER	STATUS	Lösung																			
○ Aus	○ Aus	<ul style="list-style-type: none"> • Schließen Sie das Netzkabel am Projektor an. • Stecken Sie das Netzkabel in eine Steckdose. 																			
 Rotes Dauerlicht	○ Aus	<ul style="list-style-type: none"> • Wenn das Luftein- oder Luftauslassgitter blockiert ist, entfernen Sie die Blockierung und führen folgendes aus. <ol style="list-style-type: none"> 1. Ziehen Sie das Netzkabel aus der Steckdose. 2. Stellen Sie sicher, dass der Projektor abgekühlt ist. 3. Stecken Sie das Netzkabel in die Steckdose. 4. Drücken Sie die POWER-Taste. 																			
	○ → ☀ Orange Blinken	<ul style="list-style-type: none"> • Wenn das Luftein- oder Luftauslassgitter blockiert ist, beseitigen Sie die blockierenden Objekte. • Achten Sie darauf, dass die Luftauslassgitter nicht heißer Luft aus Heizgeräten ausgesetzt sind. 																			
	○ → ☀ Grünes Blinken	<ul style="list-style-type: none"> • Wenn die STATUS-Anzeige aufgehört hat zu blinken, drücken Sie die POWER-Taste. • Wenn Sie das Netzkabel ausstecken, während der Lüfter noch läuft, kann es sein, dass die Lampe beim nächsten Einstecken des Netzkabels erst nach ca. 1 Minute leuchtet. • Die Lampe kann nur in Abständen von mindestens 1 Minute ein- und ausgeschaltet werden. • Drücken Sie mehrmals die POWER-Taste. 																			
	☀ Rotes Dauerlicht	<ul style="list-style-type: none"> • Ersetzen Sie die Lampe. (Die Lampe hat die maximale Betriebszeit erreicht.) 																			
 Rot/grünes Blinken	○ Aus	<ul style="list-style-type: none"> • Bringen Sie die Lampenabdeckung an der Oberseite an. 																			
	☀ Dauerlicht oder ○ → ☀ Blinken	<ul style="list-style-type: none"> • Ziehen Sie das Netzkabel aus der Steckdose und wenden Sie sich an Ihren Händler. 																			
Kein Bild erscheint auf dem Schirm.	<ul style="list-style-type: none"> • Deaktivieren Sie AV-Mute durch Drücken der AV MUTE-Taste. • Nehmen Sie den Objektivdeckel ab. • Es kann ungefähr 1 Minute dauern bis die Lampe leuchtet. • In einigen Fällen kann es passieren, dass die Lampe nicht leuchtet. Bitte warten Sie einige Minuten und versuchen Sie es dann noch einmal. • Wenn der Projektor ausgeschaltet worden ist, bevor die Lampe ganz abgekühlt ist, kann es sein, dass beim nächsten Einstecken des Netzkabels die Ventilatoren starten und die POWER-Taste nicht funktioniert. Drücken Sie dann die POWER-Taste, um die Lampe wieder einzuschalten. • Prüfen Sie, ob die Lufteinlassöffnung sauber ist. • Prüfen Sie, ob die Lampenabdeckung geschlossen ist. • Prüfen Sie, ob die Kabel, die an die externen Geräten angeschlossen wurden, keinen Bruch haben. • Wenn ein Datenkabel zur Verlängerung benutzt wird, ersetzen Sie es zur Überprüfung mit dem original gelieferten Datenkabel. Wenn die Bilder dann korrekt angezeigt werden, benutzen Sie bitte einen RGB-Signalverstärker zwischen dem Datenverlängerungskabel. 																				



DLP™ PROJEKTOR
 MODELL XD365U-EST/WD385U-EST

Schnellstart

DEUTSCH

Lieferumfang

Netz Kabel

* Eines der Netz Kabel für USA, Europa, UK, Australien, und Korea wird entsprechend mitgeliefert.

Computer Kabel

USB-Kabel

Fernbedienung

- Sicherheits-Anleitung/ Schnellstart
- CD-ROM
- Batterie (2)
- Objektivdeckel
- Lampenwechselhalterung
- Interaktiver Stift-Set (RC-380P1)

1

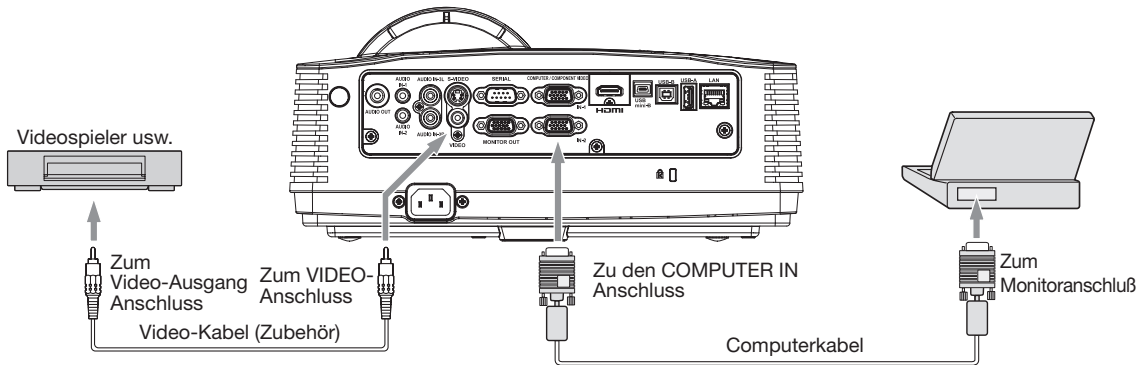

2

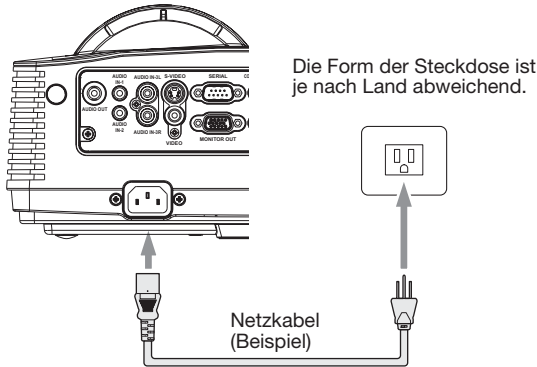

5

Wenn das vom Laptop einzugebende Bild nicht projiziert wird:
 Drücken Sie die **[Fn]** -Taste und eine beliebige der **[F1]** - bis **[F12]** -Tasten gleichzeitig (je nach Art des Laptops).



3

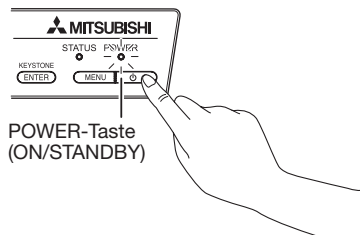

4

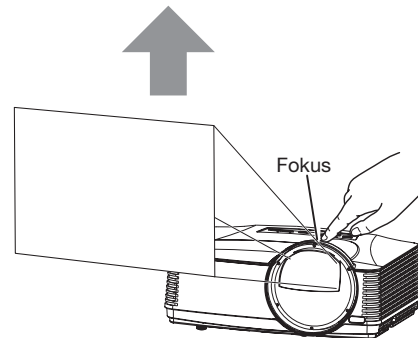

Utilisation des modes d'emploi

Le mode d'emploi et le mode d'emploi du pilote de l'imprimante sont disponibles en format PDF sur ce CD-ROM. Le logiciel Adobe Acrobat Reader est nécessaire pour ouvrir ce mode d'emploi.

Installation d'Adobe Acrobat Reader (Version français)

1. Charger le CD-ROM dans le lecteur de CD-ROM.
2. Ouvrir le CD-ROM "PROJECTOR."
3. A l'intérieur du CD-ROM, ouvrir le dossier "ACROBAT_READER".
4. Ouvrir le dossier "FRANCAIS".
5. Double-cliquer sur l'icône pour installation.

Ouverture du mode d'emploi

1. Charger le CD-ROM dans le lecteur de CD-ROM.
 2. Ouvrir le CD-ROM "PROJECTOR."
 3. Double-cliquer sur "MANUAL.HTML" à l'intérieur du CD-ROM. Une liste de choix de langue pour le mode d'emploi d'affichera.
 4. Déplacer le pointeur de la souris sur la langue désirée et cliquer. Ceci lancera Adobe Acrobat Reader et le mode d'emploi s'ouvrira.
- Adobe et Acrobat Reader sont deux marques de fabrique déposées de Adobe Systems Incorporated aux Etats-Unis et/ou autres pays.

Dépannage

Problème	Solution																				
Mise sous tension impossible.	<ul style="list-style-type: none"> • Vérifiez si les voyants sont éteints ou allumés (dans ce cas, vérifiez également leur couleur et s'ils clignotent ou non). <table border="1"> <thead> <tr> <th>POWER</th> <th>STATUS</th> <th>Solution</th> </tr> </thead> <tbody> <tr> <td> Arrêt</td> <td> Arrêt</td> <td> <ul style="list-style-type: none"> • Branchez le cordon d'alimentation sur le projecteur. • Branchez le cordon d'alimentation sur une prise secteur. </td> </tr> <tr> <td rowspan="4"> Rouge fixe</td> <td> Arrêt</td> <td> <ul style="list-style-type: none"> • Si des objets bloquent l'entrée d'air ou la grille de sortie, retirez-les et effectuez les opérations suivantes : <ol style="list-style-type: none"> 1. Débranchez le cordon d'alimentation de la prise secteur. 2. Attendez que le projecteur ait refroidi. 3. Branchez le cordon d'alimentation sur la prise secteur. 4. Appuyez sur la touche POWER. </td> </tr> <tr> <td> Orange clignotant</td> <td> <ul style="list-style-type: none"> • Si des objets bloquent l'entrée d'air ou la grille de sortie, retirez-les. • N'exposez pas les grilles de sortie d'air à un courant d'air chaud émis par un appareil de chauffage. </td> </tr> <tr> <td> Vert clignotant</td> <td> <ul style="list-style-type: none"> • Lorsque le voyant STATUS arrête de clignoter, appuyez sur la touche POWER. <ul style="list-style-type: none"> • Si vous débranchez le cordon d'alimentation alors que le ventilateur tourne encore, la lampe risque de ne pas s'allumer avant environ une minute, la prochaine fois que vous rebranchez le cordon d'alimentation. • Après s'être éteinte, la lampe ne peut plus se rallumer pendant environ une minute. • Appuyez plusieurs fois sur la touche POWER. </td> </tr> <tr> <td> Rouge fixe</td> <td> <ul style="list-style-type: none"> • Remplacez la lampe. (La lampe a atteint la fin de sa durée de vie.) </td> </tr> <tr> <td rowspan="2"> Rouge/vert clignotant</td> <td> Arrêt</td> <td> <ul style="list-style-type: none"> • Fixez le capot du logement de la lampe sur le dessus. </td> </tr> <tr> <td> Fixe ou clignotant</td> <td> <ul style="list-style-type: none"> • Débranchez le cordon d'alimentation de la prise secteur et contactez votre revendeur. </td> </tr> </tbody> </table>	POWER	STATUS	Solution	 Arrêt	 Arrêt	<ul style="list-style-type: none"> • Branchez le cordon d'alimentation sur le projecteur. • Branchez le cordon d'alimentation sur une prise secteur. 	 Rouge fixe	 Arrêt	<ul style="list-style-type: none"> • Si des objets bloquent l'entrée d'air ou la grille de sortie, retirez-les et effectuez les opérations suivantes : <ol style="list-style-type: none"> 1. Débranchez le cordon d'alimentation de la prise secteur. 2. Attendez que le projecteur ait refroidi. 3. Branchez le cordon d'alimentation sur la prise secteur. 4. Appuyez sur la touche POWER. 	 Orange clignotant	<ul style="list-style-type: none"> • Si des objets bloquent l'entrée d'air ou la grille de sortie, retirez-les. • N'exposez pas les grilles de sortie d'air à un courant d'air chaud émis par un appareil de chauffage. 	 Vert clignotant	<ul style="list-style-type: none"> • Lorsque le voyant STATUS arrête de clignoter, appuyez sur la touche POWER. <ul style="list-style-type: none"> • Si vous débranchez le cordon d'alimentation alors que le ventilateur tourne encore, la lampe risque de ne pas s'allumer avant environ une minute, la prochaine fois que vous rebranchez le cordon d'alimentation. • Après s'être éteinte, la lampe ne peut plus se rallumer pendant environ une minute. • Appuyez plusieurs fois sur la touche POWER. 	 Rouge fixe	<ul style="list-style-type: none"> • Remplacez la lampe. (La lampe a atteint la fin de sa durée de vie.) 	 Rouge/vert clignotant	 Arrêt	<ul style="list-style-type: none"> • Fixez le capot du logement de la lampe sur le dessus. 	 Fixe ou clignotant	<ul style="list-style-type: none"> • Débranchez le cordon d'alimentation de la prise secteur et contactez votre revendeur.
POWER	STATUS	Solution																			
 Arrêt	 Arrêt	<ul style="list-style-type: none"> • Branchez le cordon d'alimentation sur le projecteur. • Branchez le cordon d'alimentation sur une prise secteur. 																			
 Rouge fixe	 Arrêt	<ul style="list-style-type: none"> • Si des objets bloquent l'entrée d'air ou la grille de sortie, retirez-les et effectuez les opérations suivantes : <ol style="list-style-type: none"> 1. Débranchez le cordon d'alimentation de la prise secteur. 2. Attendez que le projecteur ait refroidi. 3. Branchez le cordon d'alimentation sur la prise secteur. 4. Appuyez sur la touche POWER. 																			
	 Orange clignotant	<ul style="list-style-type: none"> • Si des objets bloquent l'entrée d'air ou la grille de sortie, retirez-les. • N'exposez pas les grilles de sortie d'air à un courant d'air chaud émis par un appareil de chauffage. 																			
	 Vert clignotant	<ul style="list-style-type: none"> • Lorsque le voyant STATUS arrête de clignoter, appuyez sur la touche POWER. <ul style="list-style-type: none"> • Si vous débranchez le cordon d'alimentation alors que le ventilateur tourne encore, la lampe risque de ne pas s'allumer avant environ une minute, la prochaine fois que vous rebranchez le cordon d'alimentation. • Après s'être éteinte, la lampe ne peut plus se rallumer pendant environ une minute. • Appuyez plusieurs fois sur la touche POWER. 																			
	 Rouge fixe	<ul style="list-style-type: none"> • Remplacez la lampe. (La lampe a atteint la fin de sa durée de vie.) 																			
 Rouge/vert clignotant	 Arrêt	<ul style="list-style-type: none"> • Fixez le capot du logement de la lampe sur le dessus. 																			
	 Fixe ou clignotant	<ul style="list-style-type: none"> • Débranchez le cordon d'alimentation de la prise secteur et contactez votre revendeur. 																			
Aucune image ne s'affiche à l'écran.	<ul style="list-style-type: none"> • Annulez la mise en sourdine du signal audio/vidéo en appuyant sur la bouton AV MUTE. • Vérifiez que le cache de l'objectif a été enlevé. • L'allumage de la lampe peut prendre environ 1 minute. • Dans des cas très rares, elle peut ne pas s'allumer. Le cas échéant, attendez quelques minutes puis recommencez. • Si le projecteur a été mis hors tension avant le refroidissement suffisant de la lampe, le ventilateur peut se mettre en marche et le bouton POWER risque de ne pas fonctionner après la mise sous tension. Appuyez sur le bouton POWER pour que le voyant POWER s'allume fixe de nouveau. • Vérifiez que la grille d'entrée d'air est propre. • Vérifiez que le capot de la lampe est fermé. • Vérifiez que les câbles raccordés aux périphériques extérieurs ne sont pas coupés. • Si vous utilisez un prolongateur, remplacez-le par le câble fourni avec l'équipement pour vérification. Si les images sont affichées correctement, ajoutez un amplificateur de signal RVB au prolongateur. 																				



FRANÇAIS

PROJECTEUR DLP™
 MODELE XD365U-EST/WD385U-EST

Démarrage rapide

Fourni avec l'appareil

<p>Cable d'alimentation CA</p>	<p>Mini D-SUB 15 broches</p>	<p>USB 5 broches (type mini-B)</p>	<p>Télécommande</p>
<p>* Le câble d'alimentation approprié pour les États-unis, l'Europe, le Royaume-Uni, l'Australie, ou la Corée est fourni, selon le cas.</p>	<p>Mini D-SUB 15 broches</p>	<p>USB 4 broches (type A)</p>	<ul style="list-style-type: none"> • Manuel de sûreté/ Démarrage rapide • CD-ROM • Batterie (2) • Bouchon d'objectif • Fixation de recharge de lampe • Kit de stylet interactif (RC-380P1)

1

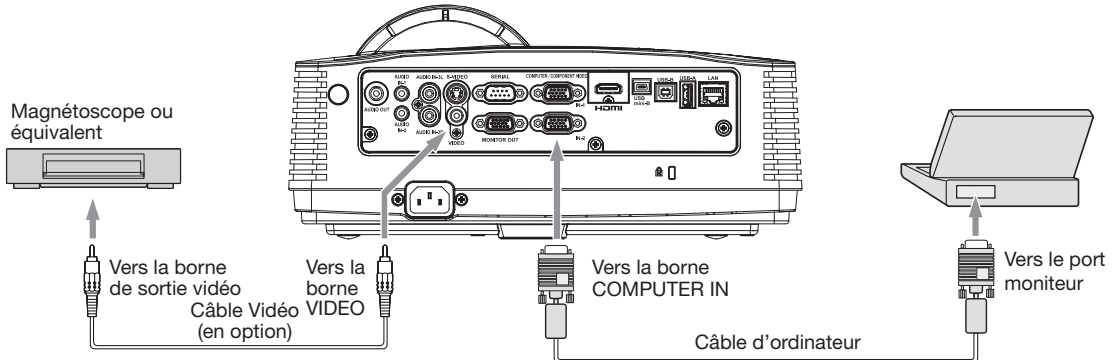

2

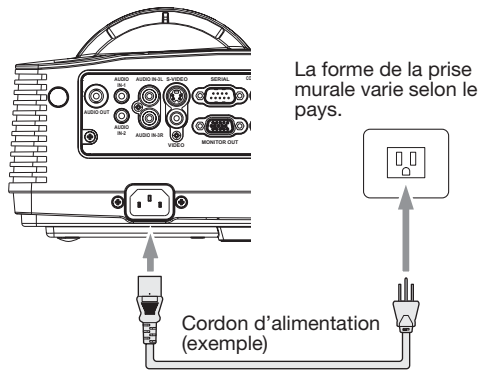

5

Lorsque l'image fournie par un ordinateur portable n'est pas projetée:
 Appuyer en même temps sur la bouton **[Fn]** et sur une des boutons **[F1]** à **[F12]** (en fonction du type d'ordinateur portable).



3

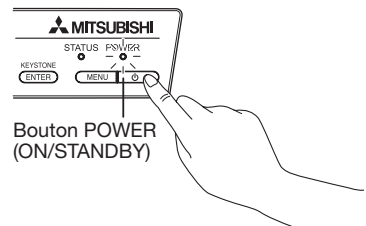

4

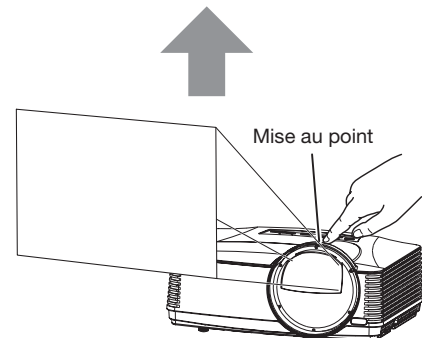

Using the User Manual

The User Manual is prepared in the Portable Document Format (PDF) in the CD-ROM. Adobe Acrobat Reader is required to open the User Manual.

































Adobe Acrobat Reader (English Version) installation

1. Load the CD-ROM into the CD-ROM drive.
2. Open CD-ROM "PROJECTOR".
3. Open the "ACROBAT_READER" folder within the CD-ROM.
4. Open the "ENGLISH" folder.
5. Double-click on the icon for installation.

Opening the Operation Manuals

1. Load the CD-ROM into the CD-ROM drive.
 2. Open CD-ROM "PROJECTOR".
 3. Double-click on "MANUAL.HTML" within the CD-ROM. A language selection list for the User Manual will be displayed.
 4. Move the mouse pointer to the desired language and click. This will launch Adobe Acrobat Reader and the User Manual will open.
- Adobe and Acrobat Reader are either registered trademarks of Adobe Systems Incorporated in the United States and/or other countries.

Troubleshooting

Problem	Solution																				
Power can not be turned on.	<ul style="list-style-type: none"> • Check whether the indicators are on or off and how they are lightning. <table border="1"> <thead> <tr> <th>POWER</th> <th>STATUS</th> <th>Solution</th> </tr> </thead> <tbody> <tr> <td>  Off </td> <td>  Off </td> <td> <ul style="list-style-type: none"> • Connect the power cord to the projector. • Plug the power cord into a wall outlet. </td> </tr> <tr> <td rowspan="4">  Steady red </td> <td>  Off </td> <td> <ul style="list-style-type: none"> • If any objects are blocking the air inlet or outlet grille, remove them and carry out the following. <ol style="list-style-type: none"> 1. Unplug the power cord from the wall outlet. 2. Make sure that the projector has cooled off. 3. Plug the power cord into the wall outlet. 4. Press the POWER button. </td> </tr> <tr> <td>  Blinking orange </td> <td> <ul style="list-style-type: none"> • If any objects are blocking the air inlet or outlet grille, remove them. • Don't expose the air outlet grilles to hot air emitted from a heating appliance. </td> </tr> <tr> <td>  Blinking green </td> <td> <ul style="list-style-type: none"> • After the STATUS indicator stops blinking, press the POWER button. <ul style="list-style-type: none"> • If you unplug the power cord while the fan is rotating, the lamp may not turn on about 1 minute when you plug the power cord next time. • The lamp can't turn on again for 1 minute after it goes out. • Press the POWER button several times. </td> </tr> <tr> <td>  Steady red </td> <td> <ul style="list-style-type: none"> • Replace the lamp. (The lamp is at the end of its life.) </td> </tr> <tr> <td rowspan="2">  Blinking red/green </td> <td>  Off </td> <td> <ul style="list-style-type: none"> • Attach the lamp cover on the top. </td> </tr> <tr> <td>  Steady or  Blinking </td> <td> <ul style="list-style-type: none"> • Unplug the power cord from the wall outlet and contact your dealer. </td> </tr> </tbody> </table> 	POWER	STATUS	Solution	 Off	 Off	<ul style="list-style-type: none"> • Connect the power cord to the projector. • Plug the power cord into a wall outlet. 	 Steady red	 Off	<ul style="list-style-type: none"> • If any objects are blocking the air inlet or outlet grille, remove them and carry out the following. <ol style="list-style-type: none"> 1. Unplug the power cord from the wall outlet. 2. Make sure that the projector has cooled off. 3. Plug the power cord into the wall outlet. 4. Press the POWER button. 	 Blinking orange	<ul style="list-style-type: none"> • If any objects are blocking the air inlet or outlet grille, remove them. • Don't expose the air outlet grilles to hot air emitted from a heating appliance. 	 Blinking green	<ul style="list-style-type: none"> • After the STATUS indicator stops blinking, press the POWER button. <ul style="list-style-type: none"> • If you unplug the power cord while the fan is rotating, the lamp may not turn on about 1 minute when you plug the power cord next time. • The lamp can't turn on again for 1 minute after it goes out. • Press the POWER button several times. 	 Steady red	<ul style="list-style-type: none"> • Replace the lamp. (The lamp is at the end of its life.) 	 Blinking red/green	 Off	<ul style="list-style-type: none"> • Attach the lamp cover on the top. 	 Steady or  Blinking	<ul style="list-style-type: none"> • Unplug the power cord from the wall outlet and contact your dealer.
POWER	STATUS	Solution																			
 Off	 Off	<ul style="list-style-type: none"> • Connect the power cord to the projector. • Plug the power cord into a wall outlet. 																			
 Steady red	 Off	<ul style="list-style-type: none"> • If any objects are blocking the air inlet or outlet grille, remove them and carry out the following. <ol style="list-style-type: none"> 1. Unplug the power cord from the wall outlet. 2. Make sure that the projector has cooled off. 3. Plug the power cord into the wall outlet. 4. Press the POWER button. 																			
	 Blinking orange	<ul style="list-style-type: none"> • If any objects are blocking the air inlet or outlet grille, remove them. • Don't expose the air outlet grilles to hot air emitted from a heating appliance. 																			
	 Blinking green	<ul style="list-style-type: none"> • After the STATUS indicator stops blinking, press the POWER button. <ul style="list-style-type: none"> • If you unplug the power cord while the fan is rotating, the lamp may not turn on about 1 minute when you plug the power cord next time. • The lamp can't turn on again for 1 minute after it goes out. • Press the POWER button several times. 																			
	 Steady red	<ul style="list-style-type: none"> • Replace the lamp. (The lamp is at the end of its life.) 																			
 Blinking red/green	 Off	<ul style="list-style-type: none"> • Attach the lamp cover on the top. 																			
	 Steady or  Blinking	<ul style="list-style-type: none"> • Unplug the power cord from the wall outlet and contact your dealer. 																			
No image appears on the screen.	<ul style="list-style-type: none"> • Cancel the AV mute by pressing the AV MUTE button. • Check that the lens cap is removed. • It may take about 1 minute for the lamp to light up. • The lamp fails to light up on rare occasions. In such a case, wait for a few minutes and then try again. • If the projector was turned off before the lamp was cooled down sufficiently last time, the fan may start rotating and the POWER button may not work after the power cord is plugged. Press the POWER button to turn back on the POWER indicator. • Check that the intake vent is clean. • Check that the lamp cover is closed. • Check that the cables connected to the external devices are not broken. • When an extension cable is being used, replace it with the supplied cable for check. When images are displayed correctly, add an RGB signal amplifier to the extension cable. 																				



ENGLISH

DLP™ PROJECTOR
MODEL XD365U-EST/WD385U-EST

Quick Start up

What's included in the box

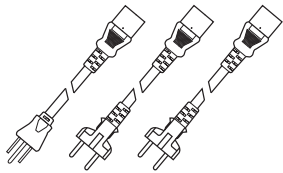

AC power cord

* One of power cords for the U.S., Europe, U.K., Australia, and Korea is provided appropriately.

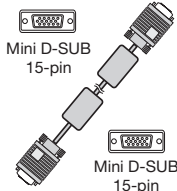

Mini D-SUB 15-pin

Computer cable

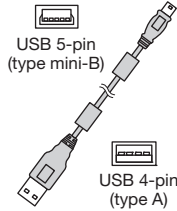

USB 5-pin (type mini-B)

USB 4-pin (type A)

USB cable

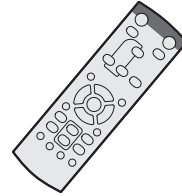

Remote control

- Safety Manual/ Quick Start up
- CD-ROM
- Battery (2)
- Lens cap
- Lamp replacement attachment
- Interactive pen kit (RC-380P1)

1

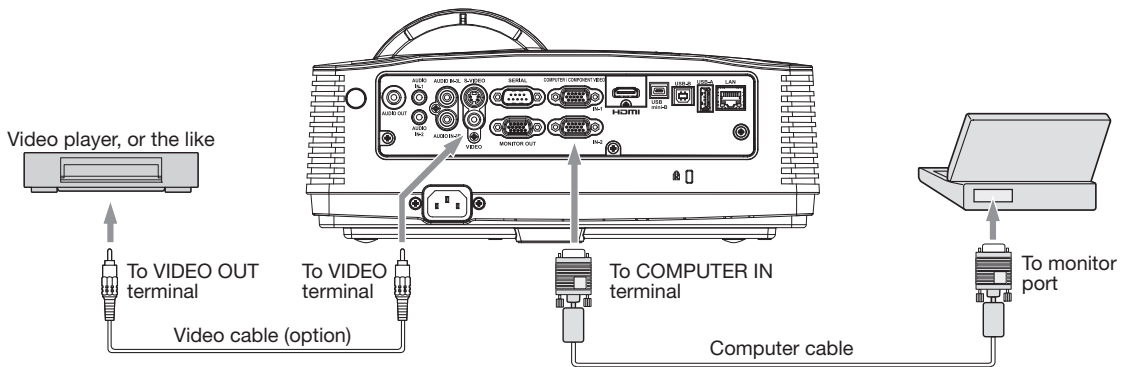

2

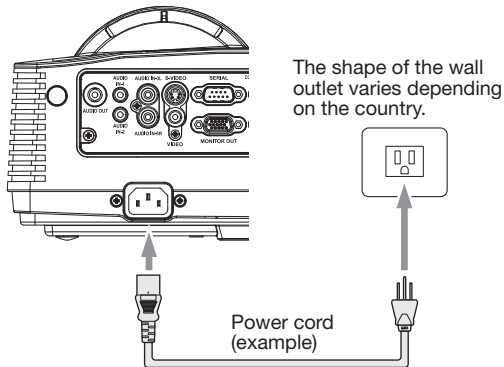

5

When the image supplied from the laptop computer isn't projected:
Press the **[Fn]** key and any of the **[F1]** to **[F12]** key (depending on the type of the laptop computer) at the same time.



3

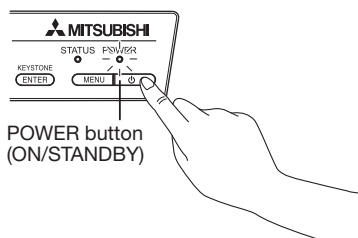

4

