



TEST REPORT

Applicant Name : Fortinet, Inc.
 Address : FCC: 899 Kifer Road Sunnyvale, CA 94086 United States
 IC:899 Kifer Road Sunnyvale CA 94086 United States Of America (Excluding The States Of Alaska)
 Report Number : SZNS221012-46650E-RFB
 FCC ID: TVE-FON480B
 IC: 7280B-FON480B

Test Standard (s)

FCC PART 15.247; RSS-GEN ISSUE 5, FEBRUARY 2021 AMENDMENT 2; RSS-247, ISSUE 2, FEBRUARY 2017

Sample Description

Product Type: IP Phone
 Model No.: FON-480B
 Multiple Model(s) No.: FCC: FON-480Bxxxxxxxxxx, FortiFone 480Bxxxxxxxxxx, FORTIFONE-480Bxxxxxxxxxx (where "x" can be "0-9" , or "A-Z" , or "- " , or blank for marketing purposes or software changes only)
 Trade Mark: FORTINET, 
 Date Received: 2022/10/12
 Report Date: 2022/11/18

Test Result:	Pass*
--------------	-------

* In the configuration tested, the EUT complied with the standards above.

Prepared and Checked By:

Roger Ling

Roger Ling
 EMC Engineer

Approved By:

Candy Li

Candy Li
 EMC Engineer

Note: This report may contain data that are not covered by the A2LA accreditation and are marked with an asterisk "*" .

Shenzhen Accurate Technology Co., Ltd. is not responsible for the authenticity of any test data provided by the applicant. Data included from the applicant that may affect test results are marked with an asterisk "**". Customer model name, addresses, names, trademarks etc. are not considered data.

This report cannot be reproduced except in full, without prior written approval of the Company. Unless otherwise stated the results shown in this test report refer only to the sample(s) tested. This report is valid only with a valid digital signature. The digital signature may be available only under the Adobe software above version 7.0.

Shenzhen Accurate Technology Co., Ltd.

1/F., Building A, Changyuan New Material Port, Science & Industry Park, Nanshan District, Shenzhen, Guangdong, P.R. China
 Tel: +86 755-26503290 Fax: +86 755-26503396 Web: www.atc-lab.com

TABLE OF CONTENTS

GENERAL INFORMATION.....	4
PRODUCT DESCRIPTION FOR EQUIPMENT UNDER TEST (EUT).....	4
OBJECTIVE	4
TEST METHODOLOGY	4
MEASUREMENT UNCERTAINTY	5
TEST FACILITY	5
SYSTEM TEST CONFIGURATION.....	6
DESCRIPTION OF TEST CONFIGURATION	6
EUT EXERCISE SOFTWARE	6
EQUIPMENT MODIFICATIONS	6
DUTY CYCLE	6
SUPPORT EQUIPMENT LIST AND DETAILS	7
EXTERNAL I/O CABLE.....	7
BLOCK DIAGRAM OF TEST SETUP	7
SUMMARY OF TEST RESULTS.....	10
TEST EQUIPMENT LIST	11
FCC §1.1307(B) & 2.1091 - MPE-BASED EXEMPTION.....	12
APPLICABLE STANDARD	12
RESULT	12
RSS-102 § 2.5.2 –EXEMPTION LIMITS FOR ROUTINE EVALUATION-RF EXPOSURE EVALUATION	13
APPLICABLE STANDARD	13
CALCULATED DATA:.....	13
FCC §15.203 & RSS-GEN §6.8 – ANTENNA REQUIREMENT.....	14
APPLICABLE STANDARD	14
ANTENNA CONNECTOR CONSTRUCTION	14
FCC §15.207 (A), RSS-GEN §8.8 - AC POWER LINE CONDUCTED EMISSIONS.....	15
APPLICABLE STANDARD	15
EUT SETUP.....	15
EMI TEST RECEIVER SETUP.....	15
TEST PROCEDURE	16
TEST RESULTS SUMMARY	16
TRANSD FACTOR & MARGIN CALCULATION.....	16
TEST DATA	16
FCC §15.209, §15.205 & §15.247(D), RSS-GEN § 8.10 & RSS-247 § 5.5 – UNWANTED EMISSION FREQUENCIES AND RESTRICTED BANDS.....	21
APPLICABLE STANDARD	21
EUT SETUP	21
EMI TEST RECEIVER & SPECTRUM ANALYZER SETUP	22
TEST PROCEDURE	22
FACTOR & MARGIN CALCULATION	22
TEST RESULTS SUMMARY	22
TEST DATA	23

FCC §15.247(A) (2), RSS-GEN § 6.7 & RSS-247 § 5.2 (A) – 99% OCCUPIED BANDWIDTH & 6 DB EMISSION BANDWIDTH32

- STANDARD APPLICABLE32
- TEST PROCEDURE33
- TEST DATA33

FCC §15.247(E), RSS-247 §5.2 (B) – POWER SPECTRAL DENSITY34

- APPLICABLE STANDARD34
- TEST PROCEDURE34
- TEST DATA35

FCC §15.247(B) (3), RSS-247 §5.4 (D) - PEAK OUTPUT POWER MEASUREMENT36

- APPLICABLE STANDARD36
- TEST PROCEDURE36
- TEST DATA36

APPENDIX37

- APPENDIX A: DTS BANDWIDTH37
- APPENDIX B: OCCUPIED CHANNEL BANDWIDTH40
- APPENDIX C: MAXIMUM CONDUCTED OUTPUT POWER43
- APPENDIX D: MAXIMUM POWER SPECTRAL DENSITY46
- APPENDIX E: BAND EDGE MEASUREMENTS49
- APPENDIX F: DUTY CYCLE51

GENERAL INFORMATION

Product Description for Equipment under Test (EUT)

Product	IP Phone
Tested Model	FON-480B
Multiple Models	FCC: FON-480Bxxxxxxxx, FortiFone 480Bxxxxxxxx, FORTIFONE-480Bxxxxxxxx (where “x” can be “0-9” , or “A-Z” , or “- “, or blank for marketing purposes or software changes only) (model difference see product declaration letter of similarity)
HVIN	FON-480B
FVIN	V3.0.15
Frequency Range	BLE: 2402-2480MHz
Maximum Conducted Peak Output Power	1.30dBm
Modulation Technique	BLE: GFSK
Data Rate	1Mbps/2Mbps
Antenna Specification*	2.9dBi (provided by the applicant)
Voltage Range	DC 5V from Adapter or DC 48V from PoE
Sample serial number	1M30 for RF Conducted Test 1M31 for Conducted and Radiated Emissions Test (Assigned by ATC)
Sample/EUT Status	Good condition
Adapter Information	Model: GQ12-050200-AU Input: AC 100-240V, 50/60Hz, 0.4A Max Output: DC 5.0V, 2.0A

Objective

This report is in accordance with FCC Part 15, Subpart C, and section 15.203, 15.205, 15.207, 15.209, 15.247 rules and RSS-GEN Issue 5, February 2021 Amendment 2 and RSS-247, Issue 2, February 2017 of the Innovation, Science and Economic Development Canada rules.

Test Methodology

All tests and measurements indicated in this document were performed in accordance ANSI C63.10-2013, RSS-GEN Issue 5, February 2021 Amendment 2 and RSS-247, Issue 2, February 2017.

And KDB 558074 D01 15.247 Meas Guidance v05r02.

All emissions measurement was performed at Shenzhen Accurate Technology Co., Ltd. The radiated testing was performed at an antenna-to-EUT distance of 3 meters.

Measurement Uncertainty

Parameter		Uncertainty
Occupied Channel Bandwidth		5%
RF Frequency		0.082×10^{-7}
RF output power, conducted		0.73dB
Unwanted Emission, conducted		1.6dB
AC Power Lines Conducted Emissions		2.72dB
Emissions, Radiated	9kHz - 30MHz	2.66dB
	30MHz - 1GHz	4.28dB
	1GHz - 18GHz	4.98dB
	18GHz - 26.5GHz	5.06dB
	26.5GHz - 40GHz	4.72dB
Temperature		1°C
Humidity		6%
Supply voltages		0.4%

Note: The extended uncertainty given in this report is obtained by combining the standard uncertainty times the coverage factor K with the 95% confidence interval. Otherwise required by the applicant or Product Regulations, Decision Rule in this report did not consider the uncertainty.

Test Facility

The test site used by Shenzhen Accurate Technology Co., Ltd. to collect test data is located on the 1/F., Building A, Changyuan New Material Port, Science & Industry Park, Nanshan District, Shenzhen, Guangdong, P.R. China.

The test site has been approved by the FCC under the KDB 974614 D01 and is listed in the FCC Public Access Link (PAL) database, FCC Registration No.: 708358, the FCC Designation No.: CN1189.

The lab has been recognized by Innovation, Science and Economic Development Canada to test to Canadian radio equipment requirements, the CAB identifier: CN0016.

SYSTEM TEST CONFIGURATION

Description of Test Configuration

For BLE mode, 40 channels are provided to testing:

Channel	Frequency (MHz)	Channel	Frequency (MHz)
0	2402	20	2442
1	2404	21	2444
2	2406	22	2446
3	2408	23	2448
4	2410	24	2450
5	2412	25	2452
6	2414	26	2454
7	2416	27	2456
8	2418	28	2458
9	2420	29	2460
10	2422	30	2462
11	2424	31	2464
12	2426	32	2466
13	2428	33	2468
14	2430	34	2470
15	2432	35	2472
16	2434	36	2474
17	2436	37	2476
18	2438	38	2478
19	2440	39	2480

EUT was tested with Channel 0, 19 and 39.

EUT Exercise Software

“Tera Term”* exercise software was made to the EUT tested and the power level is 31*. The software and power level was provided by the applicant.

Equipment Modifications

No modification was made to the EUT tested.

Duty cycle

Test Result: Compliant. Please refer to the Appendix

Support Equipment List and Details

Manufacturer	Description	Model	Serial Number
DELL	NoteBook	Latitude E4710	PC201911252059
HUAWEI	Router	WS5100	A4933FEF1D01
Xilang	Headset	Unknown	Unknown
Sandisk	USB flash disk	Unknown	Unknown
GOSPELL	PoE Adapter	G0720-480-050	212701319

External I/O Cable

Cable Description	Length (m)	From Port	To
Un-shielding detachable RJ45 Cable	8.0	EUT	Notebook
Unshielded detachable AC cable	1.0	LISN	PoE
Un-shielded detachable RJ45 Cable	8.0	EUT	Router
Un-shielded detachable RJ11 Cable	1.2	EUT	Headset
Unshielded Un-detachable DC cable	1.0	EUT	Adapter
Un-shielded detachable RJ45 Cable	8.0	Router	PoE
Un-shielded detachable RJ45 Cable	0.8	EUT	PoE

Block Diagram of Test Setup

For conducted emission (Adapter power supply):

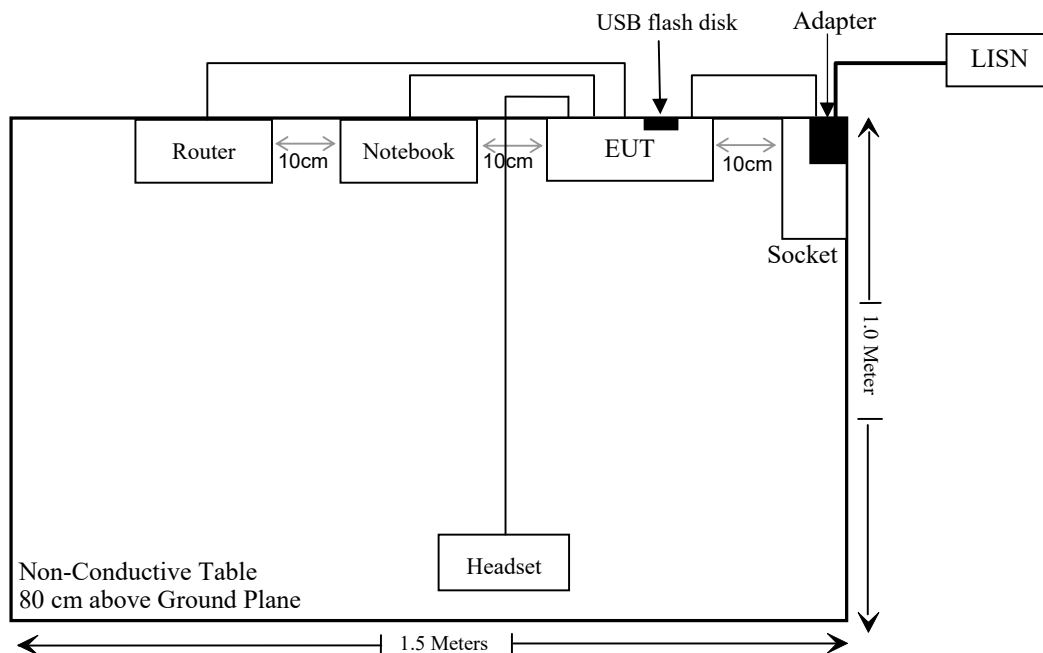

For conducted emission (PoE power supply):

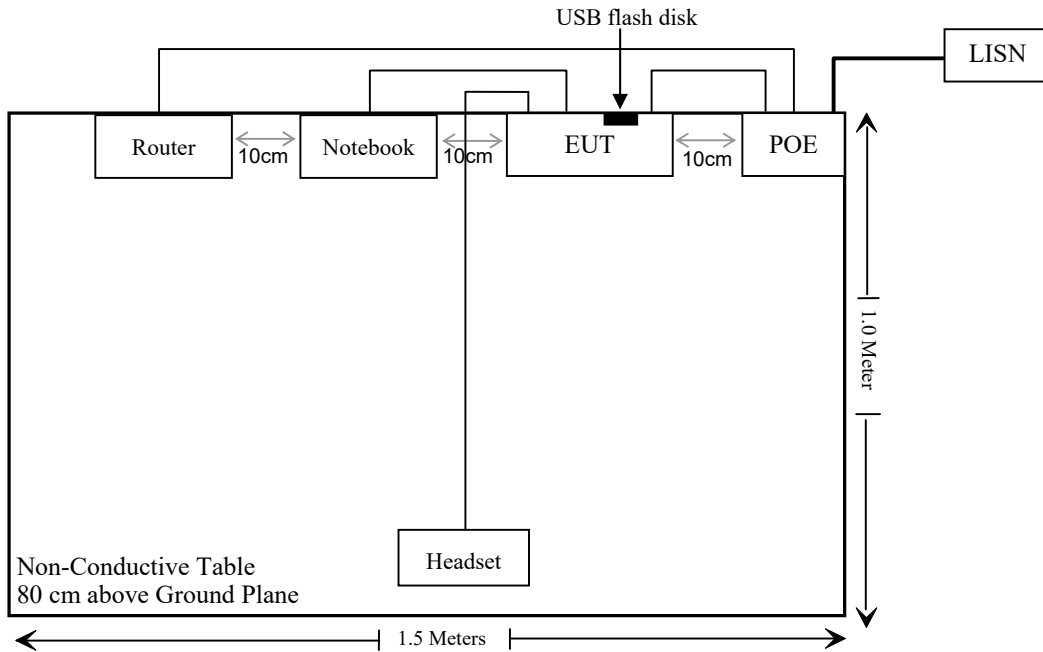

For radiated emissions (Adapter power supply)

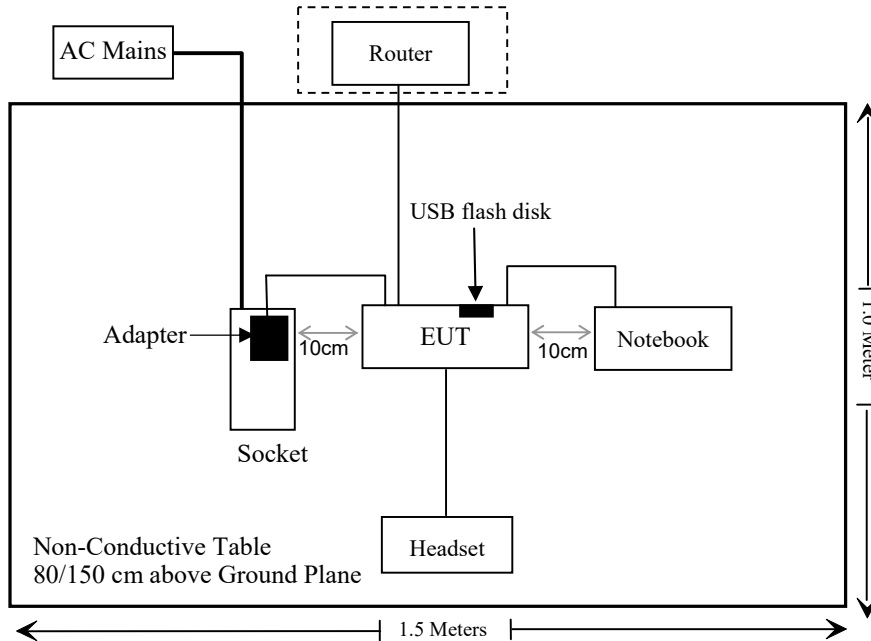

For radiated emissions (PoE power supply)

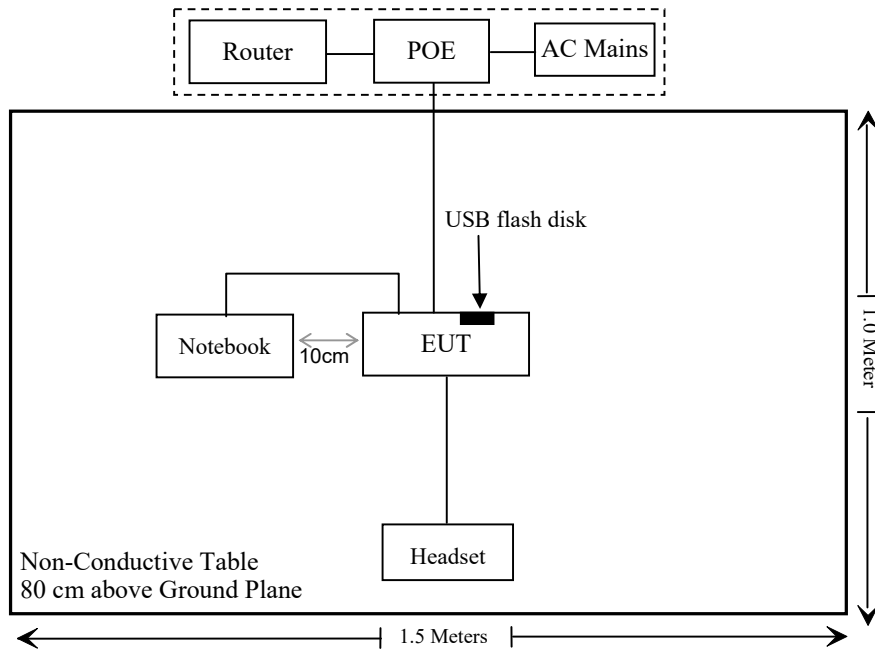

SUMMARY OF TEST RESULTS

FCC Rules	RSS Rules	Description of Test	Result
§15.247 (i), §2.1091	RSS-102 § 2.52	MPE-Based Exemption & Exemption Limits For Routine Evaluation-RF Exposure Evaluation	Compliant
§15.203	RSS-Gen §6.8	Antenna Requirement	Compliant
§15.207 (a)	RSS-Gen §8.8	AC Line Conducted Emissions	Compliant
§15.205, §15.209, §15.247(d)	RSS-GEN § 8.10 & RSS-247 § 5.5	Spurious Emissions	Compliant
§15.247 (a)(2)	RSS- Gen§6.7 RSS-247 § 5.2 (a)	99% Occupied Bandwidth & 6 dB Emission Bandwidth	Compliant
§15.247(b)(3)	RSS-247 § 5.4(d)	Maximum Conducted Output Power	Compliant
§15.247(d)	RSS-247 § 5.5	100 kHz Bandwidth of Frequency Band Edge	Compliant
§15.247(e)	RSS-247 § 5.2 (b)	Power Spectral Density	Compliant

TEST EQUIPMENT LIST

Manufacturer	Description	Model	Serial Number	Calibration Date	Calibration Due Date
Conducted Emissions Test					
Rohde& Schwarz	EMI Test Receiver	ESCI	100784	2021/12/13	2022/12/12
Rohde & Schwarz	L.I.S.N.	ENV216	101314	2021/12/13	2022/12/12
Anritsu Corp	50 Coaxial Switch	MP59B	6100237248	2021/12/13	2022/12/12
Unknown	RF Coaxial Cable	No.17	N0350	2021/12/14	2022/12/13
Conducted Emission Test Software: e3 19821b (V9)					
Radiated Emissions Test					
Rohde& Schwarz	Test Receiver	ESR	102725	2021/12/13	2022/12/12
Rohde&Schwarz	Spectrum Analyzer	FSV40	101949	2021/12/13	2022/12/12
SONOMA INSTRUMENT	Amplifier	310 N	186131	2021/11/09	2022/11/08
SONOMA INSTRUMENT	Amplifier	310 N	186131	2022/11/08	2023/11/07
A.H. Systems, inc.	Preamplifier	PAM-0118P	135	2021/11/09	2022/11/08
A.H. Systems, inc.	Preamplifier	PAM-0118P	135	2022/11/08	2023/11/07
Quinstar	Amplifier	QLW-18405536-J0	15964001002	2021/11/11	2022/11/10
Quinstar	Amplifier	QLW-18405536-J0	15964001002	2022/11/08	2023/11/07
Schwarzbeck	Bilog Antenna	VULB9163	9163-323	2021/07/06	2024/07/05
Schwarzbeck	Horn Antenna	BBHA9120D	9120D-1067	2020/01/05	2023/01/04
Schwarzbeck	HORN ANTENNA	BBHA9170	9170-359	2020/01/05	2023/01/04
Radiated Emission Test Software: e3 19821b (V9)					
Unknown	RF Coaxial Cable	No.10	N050	2021/12/14	2022/12/13
Unknown	RF Coaxial Cable	No.11	N1000	2021/12/14	2022/12/13
Unknown	RF Coaxial Cable	No.12	N040	2021/12/14	2022/12/13
Unknown	RF Coaxial Cable	No.13	N300	2021/12/14	2022/12/13
Unknown	RF Coaxial Cable	No.14	N800	2021/12/14	2022/12/13
Unknown	RF Coaxial Cable	No.15	N600	2021/12/14	2022/12/13
Unknown	RF Coaxial Cable	No.16	N650	2021/12/14	2022/12/13
Wainwright	High Pass Filter	WHKX3.6/18 G-10SS	5	2021/12/14	2022/12/13
RF conducted test					
Rohde&Schwarz	Spectrum Analyzer	FSV-40	101590	2022/01/19	2023/01/18
Tonscend	RF Control Unit	JS0806-2	19G8060182	2021/10/26	2022/10/25
WEINSCHHEL	10dB Attenuator	5324	AU 3842	2021/12/14	2022/12/13
Unknown	RF Coaxial Cable	No.31	RF-01	Each time	

* **Statement of Traceability:** Shenzhen Accurate Technology Co., Ltd. attests that all calibrations have been performed in accordance to requirements that traceable to National Primary Standards and International System of Units (SI).

FCC §1.1307(b) & 2.1091 - MPE-Based Exemption

Applicable Standard

According to KDB 447498 D04 Interim General RF Exposure Guidance

MPE-Based Exemption:

An alternative to the SAR-based exemption is provided in § 1.1307(b)(3)(i)(C), for a much wider frequency range, from 300 kHz to 100 GHz, applicable for separation distances greater or equal to $\lambda/2\pi$, where λ is the free-space operating wavelength in meters. The MPE-based test exemption condition is in terms of ERP, defined as the product of the maximum antenna gain and the delivered maximum time-averaged power. For this case, a RF exempt device if its ERP (watts) is no more than a frequency-dependent value, as detailed tabular form in Appendix B. These limits have been derived based on the basic specifications on Maximum Permissible Exposure (MPE) considered for the FCC rules in § 1.1310(e)(1).

Table 1 to § 1.1307(b)(3)(i)(C) - Single RF Sources Subject to Routine Environmental Evaluation

RF Source frequency (MHz)	Threshold ERP (watts)
0.3-1.34	$1,920 R^2$.
1.34-30	$3,450 R^2/f^2$.
30-300	$3.83 R^2$.
300-1,500	$0.0128 R^2f$.
1,500-100,000	$19.2R^2$.

f = frequency in MHz;

R = minimum separation distance from the body of a nearby person (appropriate units, e.g., m);

Result

For worst case:

Mode	Frequency (MHz)	Tune up conducted power	Antenna Gain		ERP		Evaluation Distance (m)	ERP Limit (mW)
		(dBm)	(dBi)	(dBd)	(dBm)	(mW)		
BT	2402-2480	1.5	2.9	0.75	2.25	1.679	0.2	768

Note 1: The tune-up power and antenna gain was declared by the applicant.

Note 2: 0dBd=2.15dBi.

Result: Compliant.

RSS-102 § 2.5.2 –EXEMPTION LIMITS FOR ROUTINE EVALUATION-RF EXPOSURE EVALUATION

Applicable Standard

According to RSS-102 § (2.5.2):

2.5.2 Exemption Limits for Routine Evaluation — RF Exposure Evaluation

RF exposure evaluation is required if the separation distance between the user and/or bystander and the device's radiating element is greater than 20 cm, except when the device operates as follows:

- below 20 MHz⁵ and the source-based, time-averaged maximum e.i.r.p. of the device is equal to or less than 1 W (adjusted for tune-up tolerance);
- at or above 20 MHz and below 48 MHz and the source-based, time-averaged maximum e.i.r.p. of the device is equal to or less than $22.48/f^{0.5}$ W (adjusted for tune-up tolerance), where f is in MHz;
- at or above 48 MHz and below 300 MHz and the source-based, time-averaged maximum e.i.r.p. of the device is equal to or less than 0.6 W (adjusted for tune-up tolerance);
- at or above 300 MHz and below 6 GHz and the source-based, time-averaged maximum e.i.r.p. of the device is equal to or less than $1.31 \times 10^{-2} f^{0.6834}$ W (adjusted for tune-up tolerance), where f is in MHz;
- at or above 6 GHz and the source-based, time-averaged maximum e.i.r.p. of the device is equal to or less than 5 W (adjusted for tune-up tolerance).

In these cases, the information contained in the RF exposure technical brief may be limited to information that demonstrates how the e.i.r.p. was derived.

Calculated Data:

The maximum tune-up conducted output power is 1.5dBm.

And the maximum antenna gain is 2.9dBi.

So the maximum tune-up EIRP is 4.4dBm=0.003W<2.68W.

$f = 2402$ MHz:

The limit is $1.31 \times 10^{-2} \times 2402^{0.6834} = 2.68$ W

So the RF Exposure evaluation can be exempted.

FCC §15.203 & RSS-GEN §6.8 – ANTENNA REQUIREMENT

Applicable Standard

According to FCC § 15.203, an intentional radiator shall be designed to ensure that no antenna other than that furnished by the responsible party shall be used with the device. The use of a permanently attached antenna or of an antenna that uses a unique coupling to the intentional radiator shall be considered sufficient to comply with the provisions of this Section. The manufacturer may design the unit so that a broken antenna can be replaced by the user, but the use of a standard antenna jack or electrical connector is prohibited.

According to FCC § 15.203, the applicant for equipment certification shall provide a list of all antenna types that may be used with the transmitter, where applicable (i.e. for transmitters with detachable antenna), indicating the maximum permissible antenna gain (in dBi) and the required impedance for each antenna. The test report shall demonstrate the compliance of the transmitter with the limit for maximum equivalent isotropically radiated power (e.i.r.p.) specified in the applicable RSS, when the transmitter is equipped with any antenna type, selected from this list.

For expediting the testing, measurements may be performed using only the antenna with highest gain of each combination of transmitter and antenna type, with the transmitter output power set at the maximum level. However, the transmitter shall comply with the applicable requirements under all operational conditions and when in combination with any type of antenna from the list provided in the test report (and in the notice to be included in the user manual, provided below).

When measurements at the antenna port are used to determine the RF output power, the effective gain of the device's antenna shall be stated, based on a measurement or on data from the antenna's manufacturer.

The test report shall state the RF power, output power setting and spurious emission measurements with each antenna type that is used with the transmitter being tested.

For licence-exempt equipment with detachable antennas, the user manual shall also contain the following notice in a conspicuous location:

This radio transmitter [enter the device's ISED certification number] has been approved by Innovation, Science and Economic Development Canada to operate with the antenna types listed below, with the maximum permissible gain indicated. Antenna types not included in this list that have a gain greater than the maximum gain indicated for any type listed are strictly prohibited for use with this device.

Immediately following the above notice, the manufacturer shall provide a list of all antenna types which can be used with the transmitter, indicating the maximum permissible antenna gain (in dBi) and the required impedance for each antenna type.

Antenna Connector Construction

The EUT has one internal antenna arrangement which was permanently attached and the maximum antenna gain is 2.9dBi, fulfill the requirement of this section. Please refer to the EUT photos.

Antenna Type	Antenna Gain	Impedance	Frequency Range
FPC	2.9dBi	50 Ω	2.4~2.5GHz

Result: Compliance

FCC §15.207 (A), RSS-GEN §8.8 - AC POWER LINE CONDUCTED EMISSIONS

Applicable Standard

FCC§15.207(a). RSS-Gen§8.8.

EUT Setup

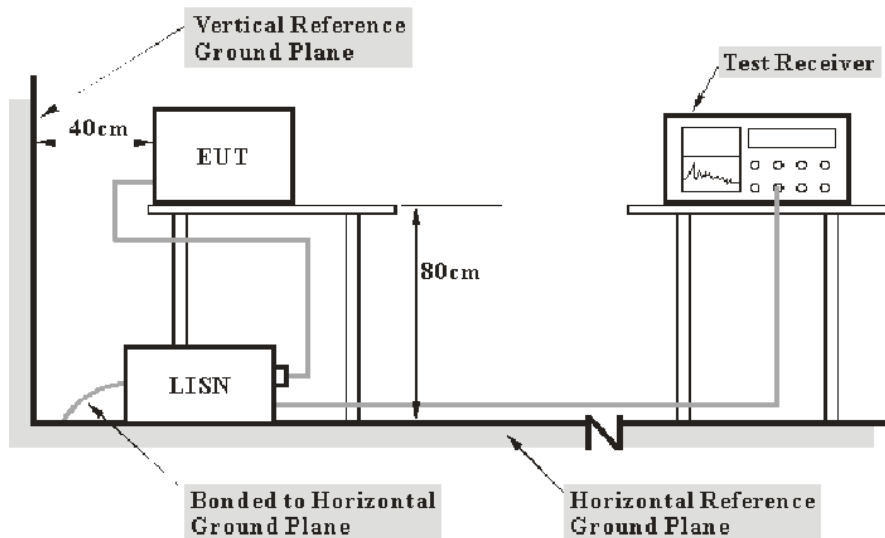

- Note: 1. Support units were connected to second LISN.
 2. Both of LISNs (AMN) 80 cm from EUT and at the least 80 cm from other units and other metal planes support units.

The setup of EUT is according with per ANSI C63.10-2013 measurement procedure. The specification used was with the FCC Part 15.207 limits and RSS-Gen limits.

The external I/O cables were draped along the test table and formed a bundle 30 to 40 cm long in the middle.

EMI Test Receiver Setup

The EMI test receiver was set to investigate the spectrum from 150 kHz to 30 MHz.

During the conducted emission test, the EMI test receiver was set with the following configurations:

Frequency Range	IF B/W
150 kHz – 30 MHz	9 kHz

Test Procedure

Maximizing procedure was performed on the six (6) highest emissions of the EUT.

All final data was recorded in the Quasi-peak and average detection mode.

Test Results Summary

According to the EUT complied with the FCC 15.207/RSS-Gen.

Transd Factor & Margin Calculation

The Transd factor is calculated by adding LISN VDF (Voltage Division Factor) and Cable Loss. The basic equation is as follows:

$$\text{Factor} = \text{LISN VDF} + \text{Cable Loss}$$

The “**Over limit**” column of the following data tables indicates the degree of compliance with the applicable limit. For example, an Over limit of -7 dB means the emission is 7 dB below the limit. The equation for calculation is as follows:

$$\begin{aligned}\text{Over Limit} &= \text{Level} - \text{Limit} \\ \text{Level} &= \text{Read Level} + \text{Factor}\end{aligned}$$

Test Data

Environmental Conditions

Temperature:	23 °C
Relative Humidity:	42 %
ATM Pressure:	101.0 kPa

The testing was performed by Jason Liu on 2022-10-27 and Lipa on 2022-11-16.

EUT operation mode: Transmitting (worst case is BLE 1M, Lowchannel)

For POE Power Supply:

AC 120V/60 Hz, Line

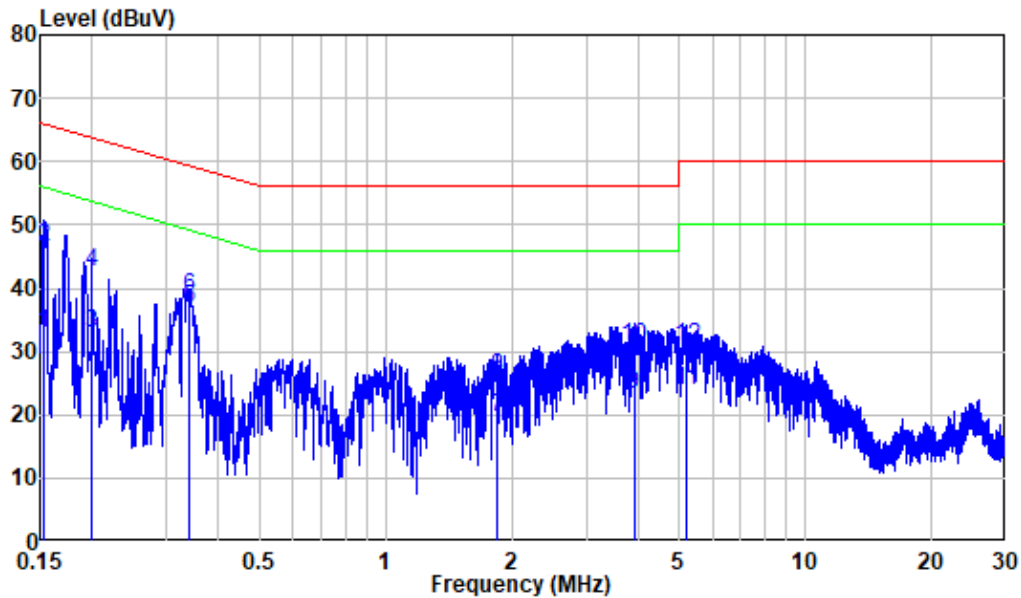

Site : Shielding Room
 Condition: Line
 Job No. : SZNS221012-46650E-RF
 Mode : BLE Transmitting
 Power : AC 120V 60Hz POE

	Freq	Factor	Read Level	Level	Limit Line	Over Limit	Remark
	MHz	dB	dBuV	dBuV	dBuV	dB	
1	0.154	9.80	23.00	32.80	55.81	-23.01	Average
2	0.154	9.80	36.62	46.42	65.81	-19.39	QP
3	0.200	9.80	23.18	32.98	53.61	-20.63	Average
4	0.200	9.80	32.69	42.49	63.61	-21.12	QP
5	0.341	9.80	27.02	36.82	49.17	-12.35	Average
6	0.341	9.80	28.98	38.78	59.17	-20.39	QP
7	1.845	9.82	9.73	19.55	46.00	-26.45	Average
8	1.845	9.82	16.11	25.93	56.00	-30.07	QP
9	3.899	9.84	13.39	23.23	46.00	-22.77	Average
10	3.899	9.84	21.04	30.88	56.00	-25.12	QP
11	5.187	9.85	13.95	23.80	50.00	-26.20	Average
12	5.187	9.85	20.85	30.70	60.00	-29.30	QP

AC 120V/60 Hz, Neutral

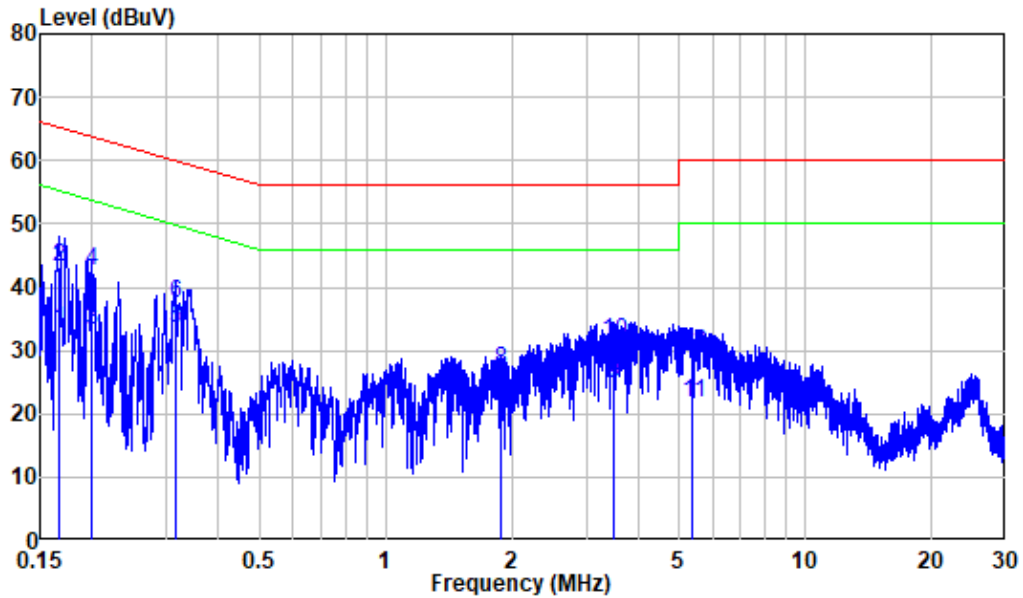

Site : Shielding Room
 Condition: Neutral
 Job No. : SZNS221012-46650E-RF
 Mode : BLE Transmitting
 Power : AC 120V 60Hz POE

	Freq	Factor	Read Level	Limit Level	Limit Line	Over Limit	Remark
	MHz	dB	dBuV	dBuV	dBuV	dB	
1	0.167	9.80	23.36	33.16	55.13	-21.97	Average
2	0.167	9.80	33.48	43.28	65.13	-21.85	QP
3	0.200	9.80	23.32	33.12	53.62	-20.50	Average
4	0.200	9.80	32.87	42.67	63.62	-20.95	QP
5	0.315	9.80	23.70	33.50	49.84	-16.34	Average
6	0.315	9.80	27.65	37.45	59.84	-22.39	QP
7	1.888	9.82	12.82	22.64	46.00	-23.36	Average
8	1.888	9.82	17.00	26.82	56.00	-29.18	QP
9	3.505	9.83	14.81	24.64	46.00	-21.36	Average
10	3.505	9.83	21.55	31.38	56.00	-24.62	QP
11	5.390	9.90	11.87	21.77	50.00	-28.23	Average
12	5.390	9.90	19.66	29.56	60.00	-30.44	QP

For Adapter Power Supply:

AC 120V/60 Hz, Line

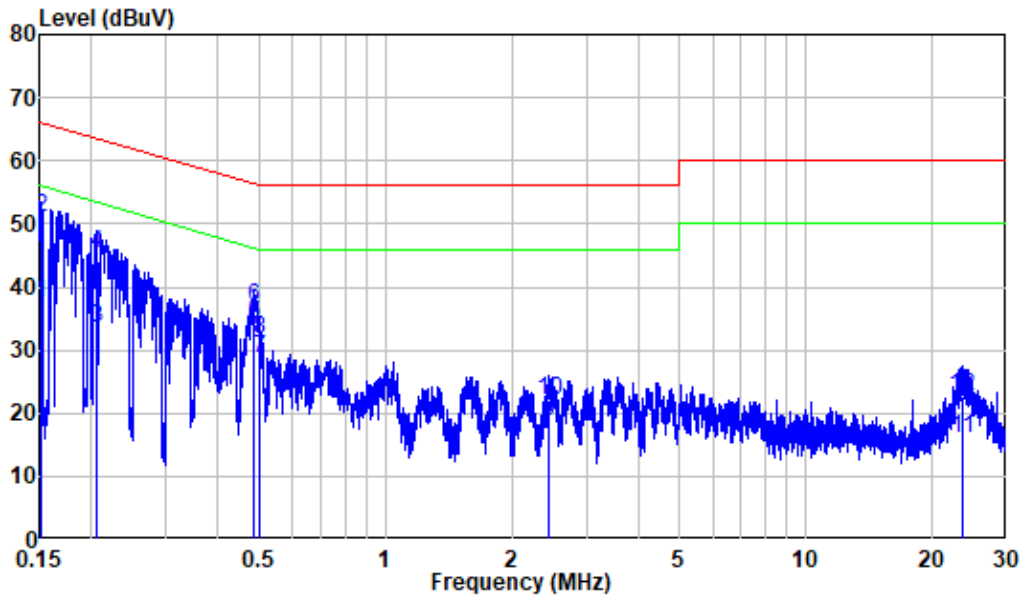

Site : Shielding Room
 Condition: Line
 Job No. : SZNS221012-46650E-RF
 Mode : BLE Transmitting
 Power : AC 120V 60Hz adapter

	Freq	Factor	Read Level	Level	Limit Line	Over Limit	Remark
	MHz	dB	dBuV	dBuV	dBuV	dB	
1	0.152	9.80	27.53	37.33	55.91	-18.58	Average
2	0.152	9.80	41.27	51.07	65.91	-14.84	QP
3	0.205	9.80	23.69	33.49	53.41	-19.92	Average
4	0.205	9.80	35.60	45.40	63.41	-18.01	QP
5	0.487	9.80	24.29	34.09	46.22	-12.13	Average
6	0.487	9.80	27.12	36.92	56.22	-19.30	QP
7	0.500	9.80	19.00	28.80	46.00	-17.20	Average
8	0.500	9.80	22.02	31.82	56.00	-24.18	QP
9	2.452	9.82	8.79	18.61	46.00	-27.39	Average
10	2.452	9.82	12.37	22.19	56.00	-33.81	QP
11	23.464	10.03	5.98	16.01	50.00	-33.99	Average
12	23.464	10.03	12.59	22.62	60.00	-37.38	QP

AC 120V/60 Hz, Neutral

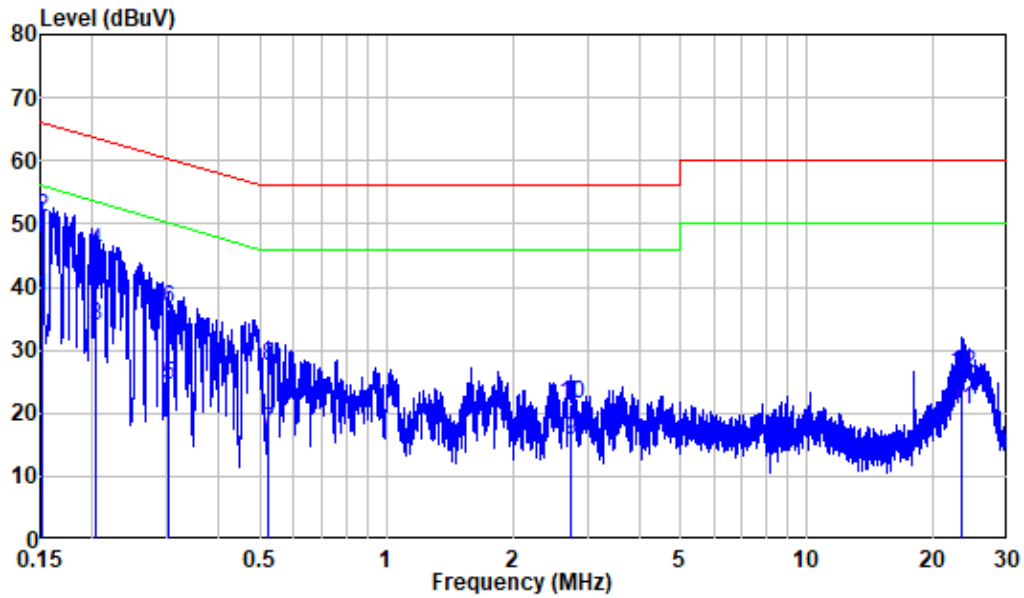

Site : Shielding Room
 Condition: Neutral
 Job No. : SZNS221012-46650E-RF
 Mode : BLE Transmitting
 Power : AC 120V 60Hz adapter

	Freq	Factor	Read Level	Level	Limit Line	Over Limit	Remark
	MHz	dB	dBuV	dBuV	dBuV	dB	
1	0.152	9.80	28.40	38.20	55.89	-17.69	Average
2	0.152	9.80	41.18	50.98	65.89	-14.91	QP
3	0.203	9.80	24.01	33.81	53.48	-19.67	Average
4	0.203	9.80	35.81	45.61	63.48	-17.87	QP
5	0.303	9.80	14.74	24.54	50.15	-25.61	Average
6	0.303	9.80	26.73	36.53	60.15	-23.62	QP
7	0.525	9.81	7.37	17.18	46.00	-28.82	Average
8	0.525	9.81	17.65	27.46	56.00	-28.54	QP
9	2.737	9.83	5.95	15.78	46.00	-30.22	Average
10	2.737	9.83	11.66	21.49	56.00	-34.51	QP
11	23.356	10.13	10.51	20.64	50.00	-29.36	Average
12	23.356	10.13	16.26	26.39	60.00	-33.61	QP

FCC §15.209, §15.205 & §15.247(D), RSS-GEN § 8.10 & RSS-247 § 5.5 – UNWANTED EMISSION FREQUENCIES AND RESTRICTED BANDS

Applicable Standard

FCC §15.247 (d); §15.209; §15.205; RSS-247 §5.5, RSS-GEN §8.10.

EUT Setup

Below 1 GHz:

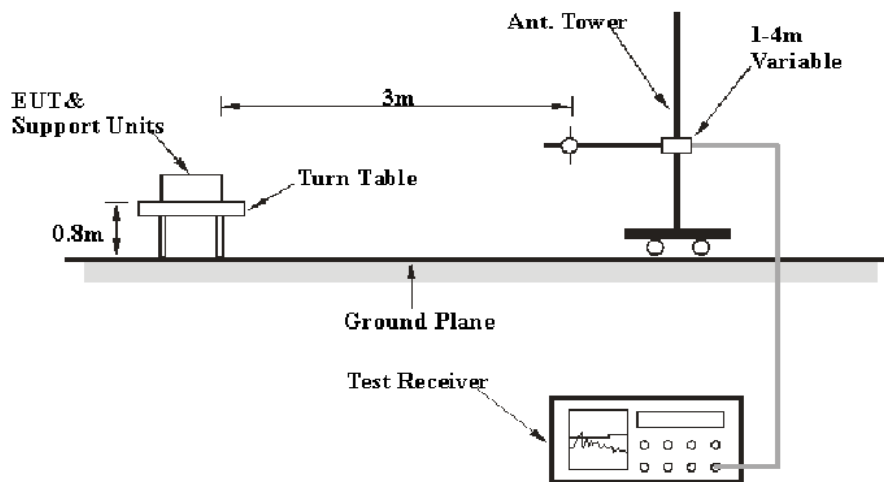

Above 1GHz:

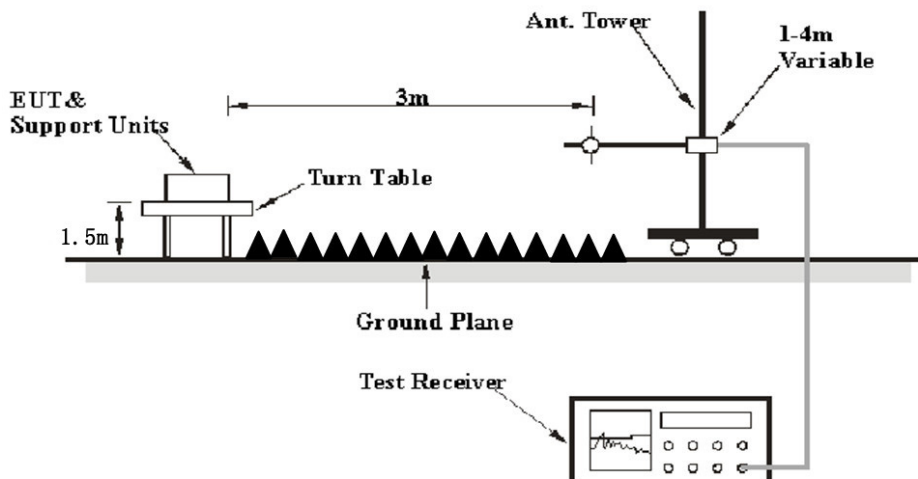

The radiated emission tests were performed in the 3meters test site, using the setup accordance with the ANSI C63.10-2013. The specification used was the FCC 15.205, FCC 15.209, FCC 15.247, RSS-Gen and RSS-247 limits.

The external I/O cables were draped along the test table and formed a bundle 30 to 40 cm long in the middle.

EMI Test Receiver & Spectrum Analyzer Setup

The system was investigated from 30 MHz to 25 GHz.

During the radiated emission test, the EMI test receiver & Spectrum Analyzer Setup were set with the following configurations:

Frequency Range	RBW	Video B/W	IF B/W	Measurement
30MHz – 1000 MHz	100 kHz	300 kHz	120kHz	QP
Above 1 GHz	1MHz	3 MHz	/	PK
	1MHz	10 Hz ^{Note 1}	/	Average
	1MHz	> 1/T ^{Note 2}	/	Average

Note 1: when duty cycle is no less than 98%

Note 2: when duty cycle is less than 98%

Test Procedure

Maximizing procedure was performed on the highest emissions to ensure that the EUT complied with all installation combinations.

Check the calibration of the measuring instrument using either an internal calibrator or a known signal from an external generator.

Measure the highest amplitude appearing on spectral display and set it as a reference level. Plot the graph with marking the highest point and edge frequency.

Repeat above procedures until all measured frequencies were complete.

Factor & Margin Calculation

The Factor is calculated by adding the Antenna Factor and Cable Loss, and subtracting the Amplifier Gain. The basic equation is as follows:

$$\text{Factor} = \text{Antenna Factor} + \text{Cable Loss} - \text{Amplifier Gain}$$

The “**Over Limit/Margin**” column of the following data tables indicates the degree of compliance with the applicable limit. For example, an Over Limit/margin of -7dB means the emission is 7dB below the limit. The equation for calculation is as follows:

$$\begin{aligned} \text{Over Limit/Margin} &= \text{Level} / \text{Corrected Amplitude} - \text{Limit} \\ \text{Level} / \text{Corrected Amplitude} &= \text{Read Level} + \text{Factor} \end{aligned}$$

Test Results Summary

According to the data in the following table, the EUT complied with the FCC 15.205, FCC 15.209, FCC 15.247, RSS-Gen and RSS-247.

Test Data**Environmental Conditions**

Temperature:	24~25 °C
Relative Humidity:	58~59 %
ATM Pressure:	101.0~101.2 kPa

The testing was performed by Level Li on 2022-10-31 and 2022-11-16.

EUT operation mode: Transmitting(Pre-scan in the X,Y and Z axes of orientation, the worst case X-axis of orientation was recorded)

30MHz-1GHz: (worst case is BLE IM, Lowchannel)

Note: When the test result of peak was less than the limit of QP more than 6dB, just peak value were recorded.

For POE Power Supply:

Horizontal

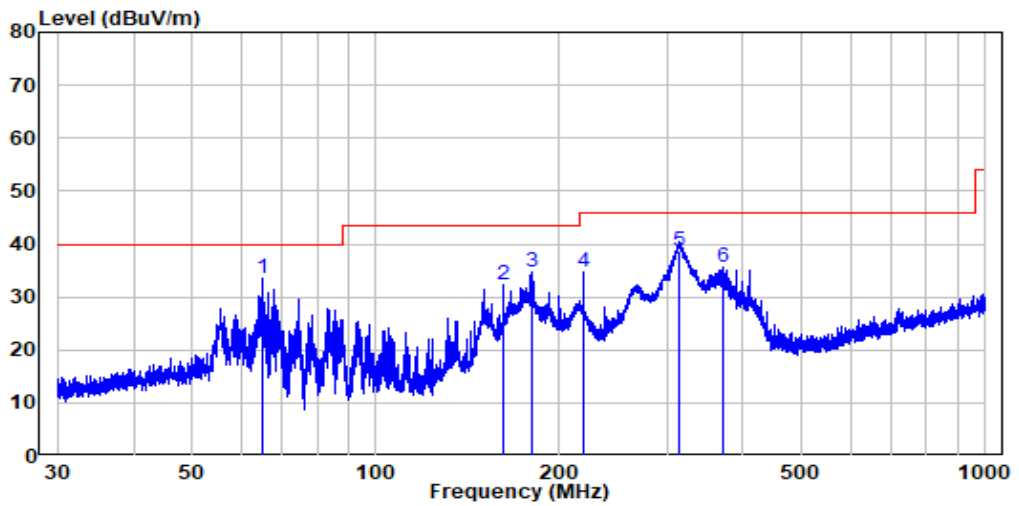

Site : chamber
 Condition: 3m HORIZONTAL
 Job No. : SZNS221012-46650E-RF
 Test Mode: BLE Transmitting(POE)

	Freq	Factor	Read Level	Limit Level	Limit Line	Over Limit	Remark
	MHz	dB/m	dBuV	dBuV/m	dBuV/m	dB	
1	65.029	-12.52	45.97	33.45	40.00	-6.55	Peak
2	161.758	-14.28	46.69	32.41	43.50	-11.09	Peak
3	180.728	-12.69	47.52	34.83	43.50	-8.67	Peak
4	218.788	-11.48	46.34	34.86	46.00	-11.14	Peak
5	313.413	-8.77	47.50	38.73	46.00	-7.27	QP
6	371.027	-7.30	42.89	35.59	46.00	-10.41	Peak

Vertical

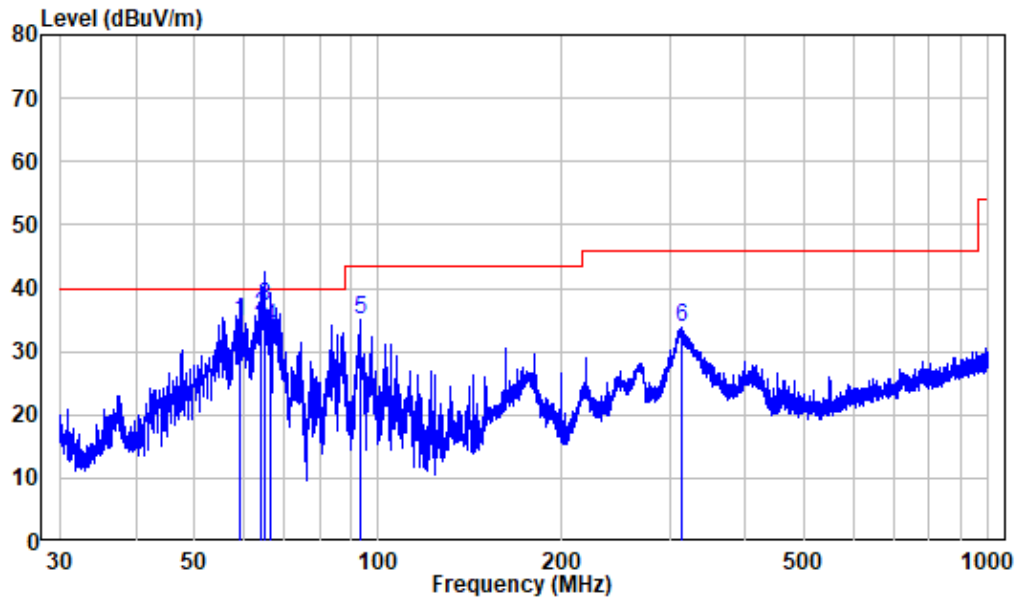

Site : chamber
 Condition: 3m VERTICAL
 Job No. : SZNS221012-46650E-RF
 Test Mode: BLE Transmitting(POE)

	Freq	Factor	Read Level	Limit Level	Limit Line	Over Limit	Remark
	MHz	dB/m	dBuV	dBuV/m	dBuV/m	dB	
1	59.388	-10.40	45.20	34.80	40.00	-5.20	QP
2	64.348	-12.27	47.89	35.62	40.00	-4.38	QP
3	64.972	-12.50	49.50	37.00	40.00	-3.00	QP
4	66.586	-13.16	47.10	33.94	40.00	-6.06	QP
5	93.522	-12.83	47.72	34.89	43.50	-8.61	Peak
6	313.826	-8.76	42.54	33.78	46.00	-12.22	Peak

For Adapter Power Supply:

Horizontal

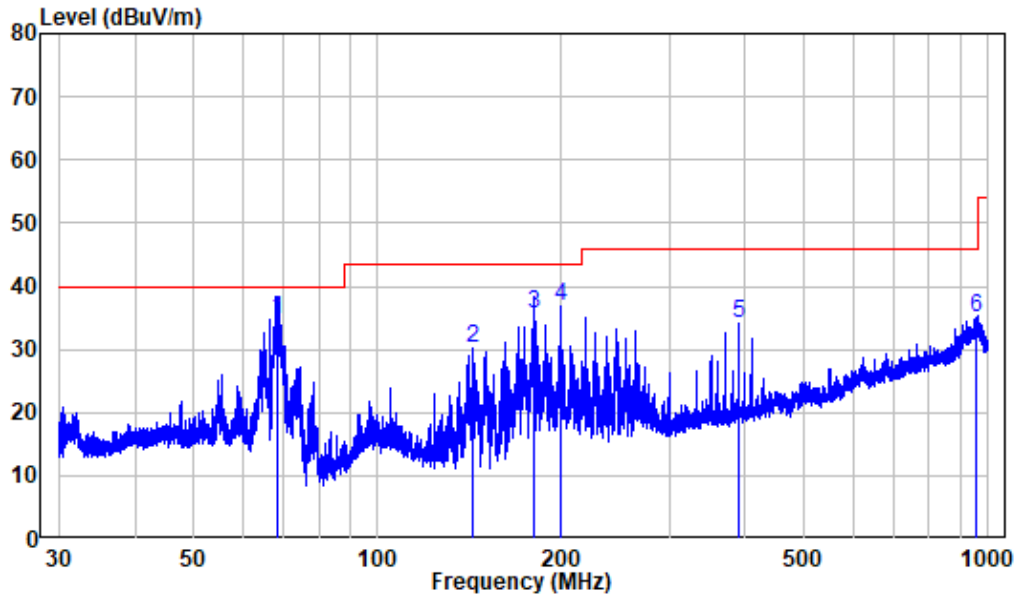

Site : chamber
 Condition: 3m HORIZONTAL
 Job No. : SZNS221012-46650E-RF
 Test Mode: BLE Transmitting

	Read	Limit	Over				
Freq	Factor	Level	Level	Line			
MHz	dB/m	dBuV	dBuV/m	dBuV/m			
1	68.421	-14.03	48.70	34.67	40.00	-5.33	QP
2	142.699	-15.52	45.64	30.12	43.50	-13.38	Peak
3	180.807	-12.68	48.21	35.53	43.50	-7.97	QP
4	199.810	-11.41	48.24	36.83	43.50	-6.67	Peak
5	390.209	-6.89	41.14	34.25	46.00	-11.75	Peak
6	955.438	2.13	32.84	34.97	46.00	-11.03	Peak

Vertical

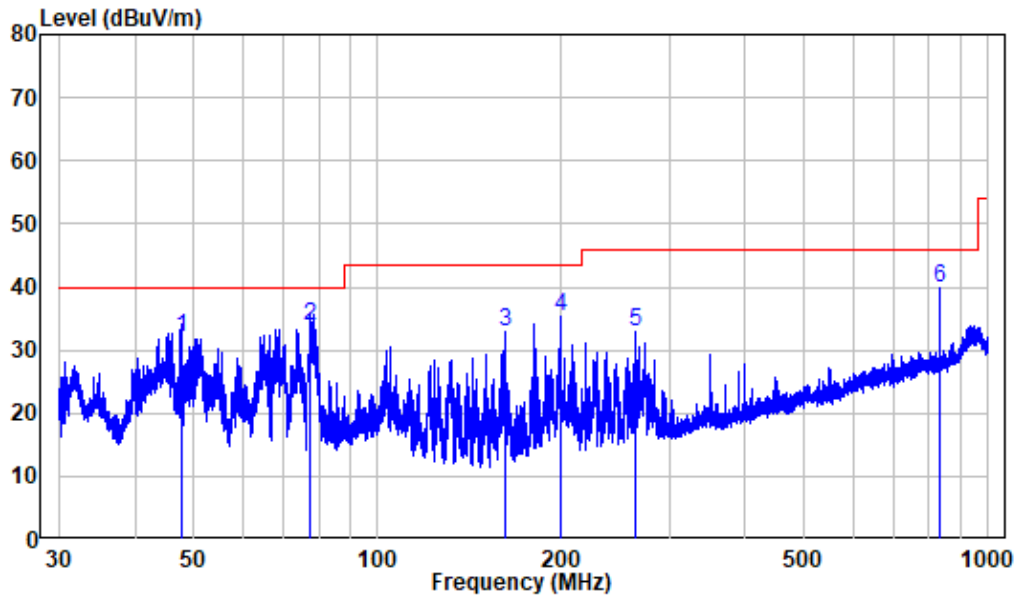

Site : chamber
 Condition: 3m VERTICAL
 Job No. : SZNS221012-46650E-RF
 Test Mode: BLE Transmitting

	Freq	Factor	Read Level	Limit Level	Over Limit	Remark
	MHz	dB/m	dBuV	dBuV/m	dBuV/m	dB
1	47.596	-10.00	42.10	32.10	40.00	-7.90 QP
2	77.695	-16.58	50.40	33.82	40.00	-6.18 QP
3	161.758	-14.28	47.26	32.98	43.50	-10.52 Peak
4	199.810	-11.41	46.85	35.44	43.50	-8.06 Peak
5	264.166	-10.48	43.25	32.77	46.00	-13.23 Peak
6	833.317	0.14	39.79	39.93	46.00	-6.07 Peak

Above 1 GHz: (worst case is Adapter Power Supply):

BLE 1M

Frequency (MHz)	Receiver		Turntable Angle Degree	Rx Antenna		Factor (dB/m)	Corrected Amplitude (dBμV/m)	Limit (dBμV/m)	Margin (dB)
	Reading (dBμV)	PK/Ave		Height (m)	Polar (H/V)				
Low Channel(2402MHz)									
2310	60.82	PK	243	2	H	-7.24	53.58	74	-20.42
2310	48.80	AV	243	2	H	-7.24	41.56	54	-12.44
2310	60.65	PK	201	2.5	V	-7.24	53.41	74	-20.59
2310	48.61	AV	201	2.5	V	-7.24	41.37	54	-12.63
2390	62.06	PK	71	1.6	H	-7.22	54.84	74	-19.16
2390	49.95	AV	71	1.6	H	-7.22	42.73	54	-11.27
2390	62.08	PK	121	1.8	V	-7.22	54.86	74	-19.14
2390	50.27	AV	121	1.8	V	-7.22	43.05	54	-10.95
4804	60.24	PK	87	2.4	H	-3.51	56.73	74	-17.27
4804	51.44	AV	87	2.4	H	-3.51	47.93	54	-6.07
4804	57.21	PK	34	1.8	V	-3.51	53.7	74	-20.30
Middle Channel(2440MHz)									
4880	58.11	PK	260	1.5	H	-3.38	54.73	74	-19.27
4880	48.73	AV	260	1.5	H	-3.38	45.35	54	-8.65
4880	55.12	PK	357	2	V	-3.38	51.74	74	-22.26
High Channel(2480 MHz)									
2483.5	62.37	PK	205	2	H	-7.20	55.17	74	-18.83
2483.5	50.75	AV	205	2	H	-7.20	43.55	54	-10.45
2483.5	62.91	PK	285	2	V	-7.20	55.71	74	-18.29
2483.5	50.54	AV	285	2	V	-7.20	43.34	54	-10.66
2500	61.04	PK	212	1.4	H	-7.18	53.86	74	-20.14
2500	49.12	AV	212	1.4	H	-7.18	41.94	54	-12.06
2500	61.61	PK	333	1.9	V	-7.18	54.43	74	-19.57
2500	49.95	AV	333	1.9	V	-7.18	42.77	54	-11.23
4960	57.82	PK	100	1.8	H	-3.01	54.81	74	-19.19
4960	48.21	AV	100	1.8	H	-3.01	45.20	54	-8.80
4960	54.87	PK	220	1.1	V	-3.01	51.86	74	-22.14

BLE 2M

Frequency (MHz)	Receiver		Turntable Angle Degree	Rx Antenna		Factor (dB/m)	Corrected Amplitude (dBμV/m)	Limit (dBμV/m)	Margin (dB)
	Reading (dBμV)	PK/Ave		Height (m)	Polar (H/V)				
Low Channel(2402MHz)									
2310	60.87	PK	322	2.4	H	-7.24	53.63	74	-20.37
2310	48.66	AV	322	2.4	H	-7.24	41.42	54	-12.58
2310	60.81	PK	76	1.1	V	-7.24	53.57	74	-20.43
2310	49.18	AV	76	1.1	V	-7.24	41.94	54	-12.06
2390	62.00	PK	92	1.9	H	-7.22	54.78	74	-19.22
2390	50.53	AV	92	1.9	H	-7.22	43.31	54	-10.69
2390	62.32	PK	221	1.6	V	-7.22	55.10	74	-18.90
2390	50.48	AV	221	1.6	V	-7.22	43.26	54	-10.74
4804	59.93	PK	305	2.3	H	-3.51	56.42	74	-17.58
4804	48.18	AV	305	2.3	H	-3.51	44.67	54	-9.33
4804	56.01	PK	52	2	V	-3.51	52.50	74	-21.50
Middle Channel(2440MHz)									
4880	59.30	PK	350	1.7	H	-3.38	55.92	74	-18.08
4880	47.29	AV	350	1.7	H	-3.38	43.91	54	-10.09
4880	55.97	PK	271	1.5	V	-3.38	52.59	74	-21.41
High Channel(2480 MHz)									
2483.5	62.70	PK	112	2.1	H	-7.20	55.5	74	-18.50
2483.5	50.17	AV	112	2.1	H	-7.20	42.97	54	-11.03
2483.5	62.48	PK	225	1.7	V	-7.20	55.28	74	-18.72
2483.5	50.75	AV	225	1.7	V	-7.20	43.55	54	-10.45
2500	61.22	PK	100	2.3	H	-7.18	54.04	74	-19.96
2500	49.56	AV	100	2.3	H	-7.18	42.38	54	-11.62
2500	61.63	PK	95	2.3	V	-7.18	54.45	74	-19.55
2500	49.89	AV	95	2.3	V	-7.18	42.71	54	-11.29
4960	59.34	PK	231	1	H	-3.01	56.33	74	-17.67
4960	47.21	AV	231	1	H	-3.01	44.20	54	-9.80
4960	55.65	PK	105	1.6	V	-3.01	52.64	74	-21.36

Note:

Corrected Factor = Antenna factor (RX) + Cable Loss – Amplifier Factor

Corrected. Amplitude = Corrected Factor + Reading

Margin = Absolute Level - Limit

The other spurious emission which is in the noise floor level was not recorded.

When the test result of Peak was below the limit of average, just the Peak value was recorded.

1-18 GHz:

Pre-scan for BLE 1M, Low Channel

Horizontal

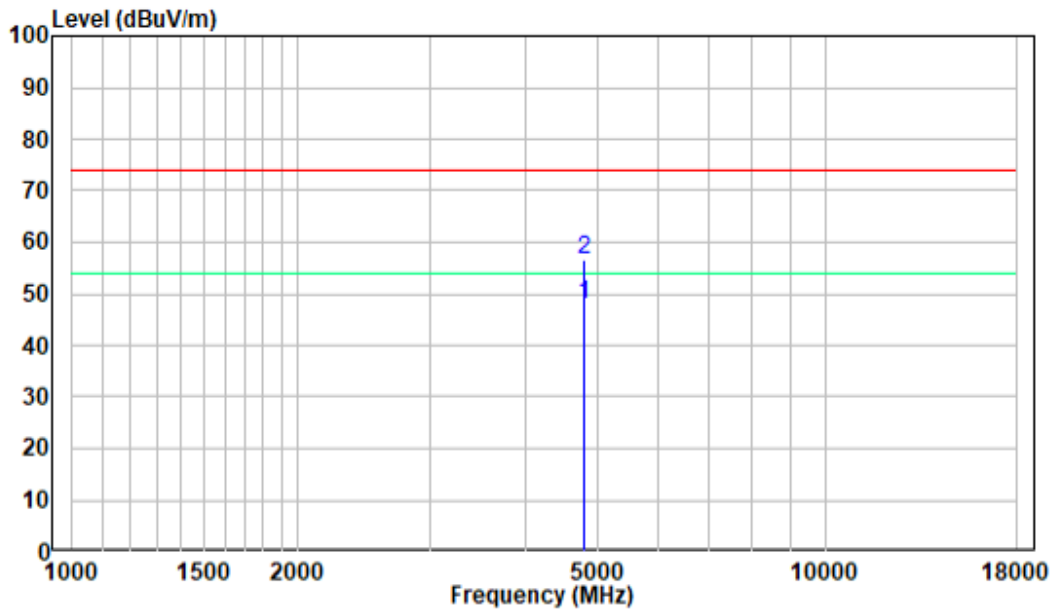

Vertical

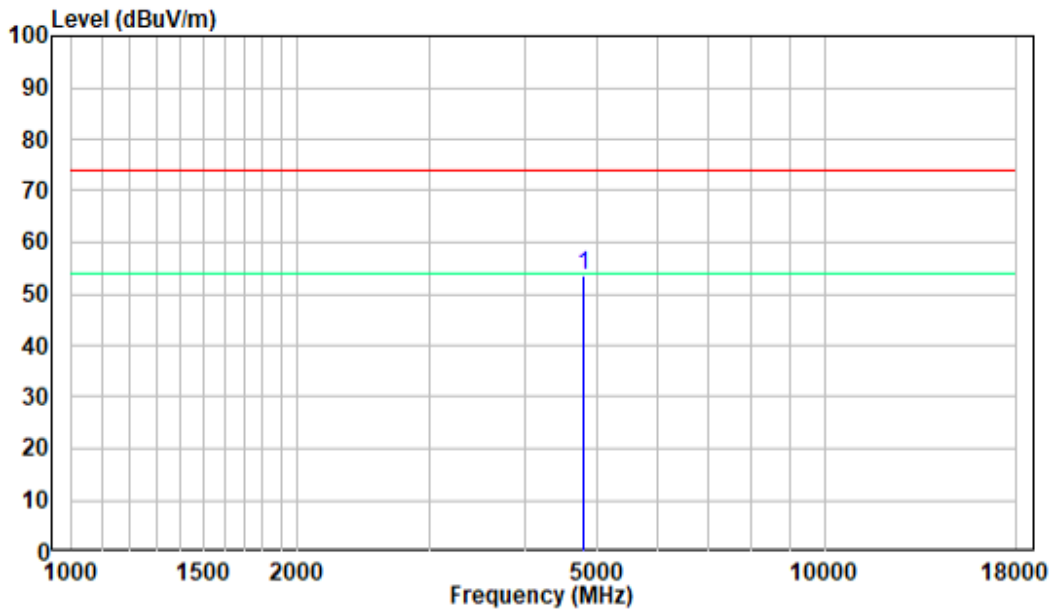

18 -25GHz:

Pre-scan for BLE, Low Channel

Horizontal

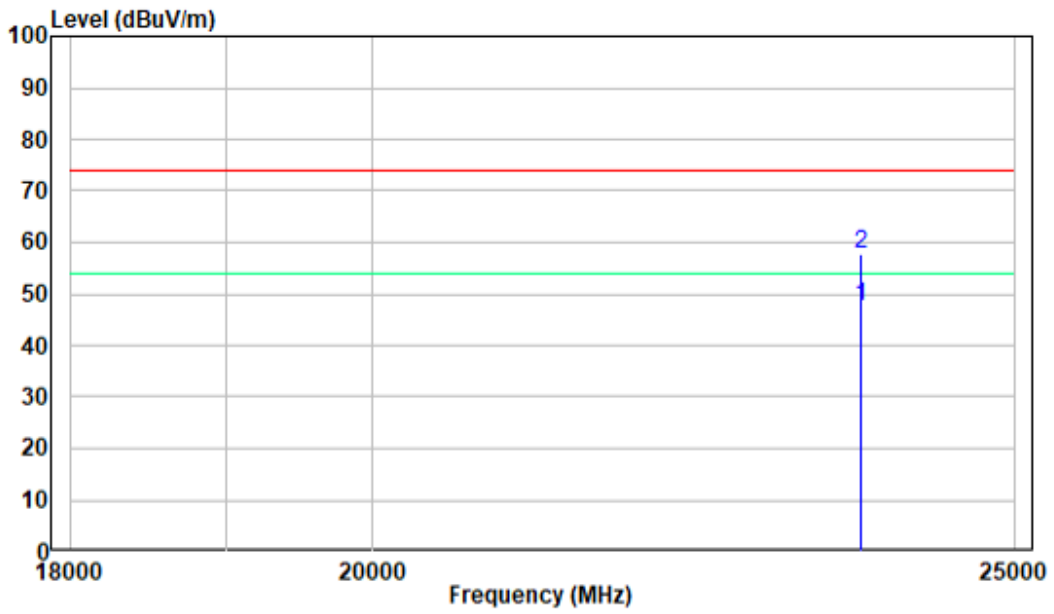

Vertical

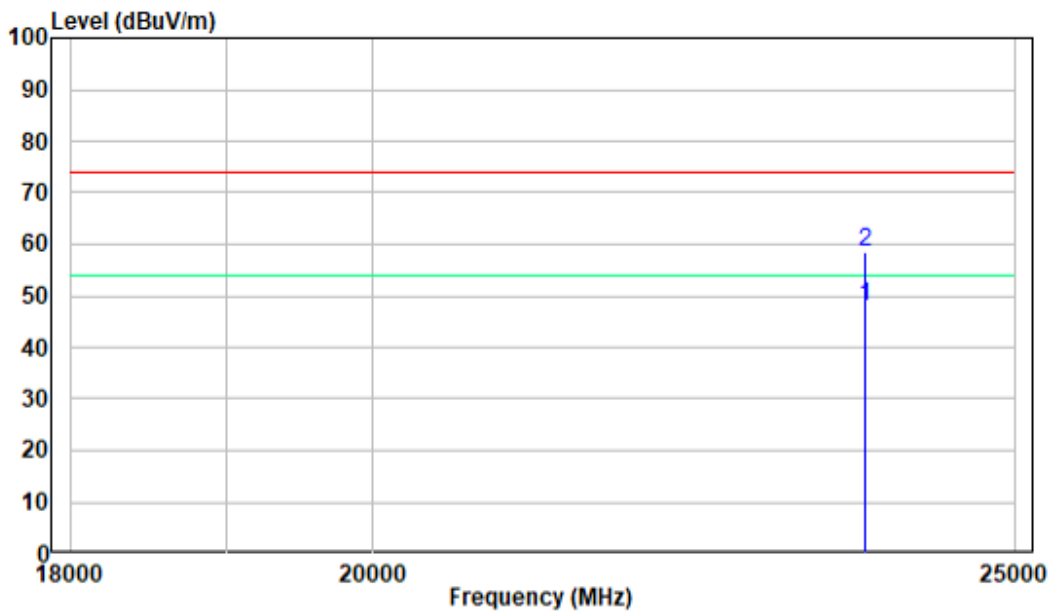

FCC §15.247(a) (2), RSS-GEN § 6.7 & RSS-247 § 5.2 (a) – 99% OCCUPIED BANDWIDTH & 6 dB EMISSION BANDWIDTH

Standard Applicable

According to FCC §15.247(a) (2)

Systems using digital modulation techniques may operate in the 902–928 MHz, 2400–2483.5 MHz, and 5725–5850 MHz bands. The minimum 6 dB bandwidth shall be at least 500 kHz.

According to RSS-247 §5.2 a)

The minimum 6 dB bandwidth shall be 500 kHz.

According to RSS-Gen §6.7

The occupied bandwidth or the “99% emission bandwidth” is defined as the frequency range between two points, one above and the other below the carrier frequency, within which 99% of the total transmitted power of the fundamental transmitted emission is contained. The occupied bandwidth shall be reported for all equipment in addition to the specified bandwidth required in the applicable RSSs.

In some cases, the “x dB bandwidth” is required, which is defined as the frequency range between two points, one at the lowest frequency below and one at the highest frequency above the carrier frequency, at which the maximum power level of the transmitted emission is attenuated x dB below the maximum in-band power level of the modulated signal, where the two points are on the outskirts of the in-band emission.

The following conditions shall be observed for measuring the occupied bandwidth and x dB bandwidth:

- The transmitter shall be operated at its maximum carrier power measured under normal test conditions.
- The span of the spectrum analyzer shall be set large enough to capture all products of the modulation process, including the emission skirts, around the carrier frequency, but small enough to avoid having other emissions (e.g. on adjacent channels) within the span.
- The detector of the spectrum analyzer shall be set to “Sample”. However, a peak, or peak hold, may be used in place of the sampling detector since this usually produces a wider bandwidth than the actual bandwidth (worst-case measurement). Use of a peak hold (or “Max Hold”) may be necessary to determine the occupied / x dB bandwidth if the device is not transmitting continuously.
- The resolution bandwidth (RBW) shall be in the range of 1% to 5% of the actual occupied / x dB bandwidth and the video bandwidth (VBW) shall not be smaller than three times the RBW value. Video averaging is not permitted.

Note: It may be necessary to repeat the measurement a few times until the RBW and VBW are in compliance with the above requirement.

For the 99% emission bandwidth, the trace data points are recovered and directly summed in linear power level terms. The recovered amplitude data points, beginning at the lowest frequency, are placed in a running sum until 0.5% of the total is reached, and that frequency recorded. The process is repeated for the highest frequency data points (starting at the highest frequency, at the right side of the span, and going down in frequency). This frequency is then recorded. The difference between the two recorded frequencies is the occupied bandwidth (or the 99% emission bandwidth).

Test Procedure

1. Check the calibration of the measuring instrument using either an internal calibrator or a known signal from an external generator.
2. Position the EUT without connection to measurement instrument. Turn on the EUT and connect it to measurement instrument. Then set it to any one convenient frequency within its operating range. Set a reference level on the measuring instrument equal to the highest peak value.
3. Measure the frequency difference of two frequencies that were attenuated 6 dB from the reference level. Record the frequency difference as the emission bandwidth.
4. Repeat above procedures until all frequencies measured were complete.

99% Occupied bandwidth test:

Use Occupied bandwidth test function, measure the 99% Occupied bandwidth.

Repeat above procedures until all frequencies measured were complete.

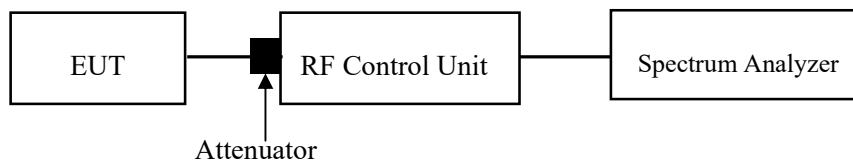

Test Data

Environmental Conditions

Temperature:	25 °C
Relative Humidity:	50 %
ATM Pressure:	101.0 kPa

The testing was performed by Roger Ling on 2022-10-21.

Test Mode: Transmitting

Test Result: Pass.

Please refer to the Appendix.

FCC §15.247(e), RSS-247 §5.2 (b) – POWER SPECTRAL DENSITY

Applicable Standard

According to FCC §15.247(e):

For digitally modulated systems, the power spectral density conducted from the intentional radiator to the antenna shall not be greater than 8 dBm in any 3 kHz band during any time interval of continuous transmission. This power spectral density shall be determined in accordance with the provisions of paragraph (b) of this section. The same method of determining the conducted output power shall be used to determine the power spectral density.

According to RSS-247 §5.2 b):

- b) The transmitter power spectral density conducted from the transmitter to the antenna shall not be greater than 8 dBm in any 3 kHz band during any time interval of continuous transmission. This power spectral density shall be determined in accordance with the provisions of section 5.4(d), (i.e. the power spectral density shall be determined using the same method as is used to determine the conducted output power).

Test Procedure

1. Use this procedure when the maximum peak conducted output power in the fundamental emission is used to demonstrate compliance.
2. Set the RBW to: $3\text{kHz} \leq \text{RBW} \leq 100\text{ kHz}$.
3. Set the VBW $\geq 3 \times \text{RBW}$.
4. Set the span to 1.5 times the DTS bandwidth.
5. Detector = peak.
6. Sweep time = auto couple.
7. Trace mode = max hold.
8. Allow trace to fully stabilize.
9. Use the peak marker function to determine the maximum amplitude level within the RBW.
10. If measured value exceeds limit, reduce RBW (no less than 3 kHz) and repeat.

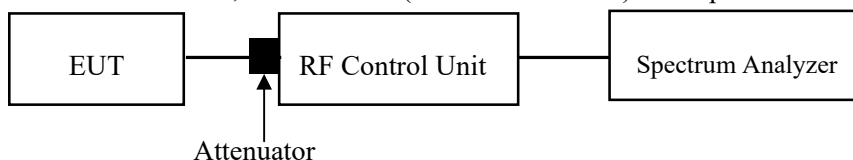

Test Data

Environmental Conditions

Temperature:	25 °C
Relative Humidity:	50 %
ATM Pressure:	101.0 kPa

The testing was performed by Roger Ling on 2022-10-21.

Test Mode: Transmitting

Test Result: Pass

Please refer to the Appendix.

FCC §15.247(b) (3), RSS-247 §5.4 (d) - PEAK OUTPUT POWER MEASUREMENT

Applicable Standard

According to FCC §15.247(b) (3), for systems using digital modulation in the 902-928 MHz, 2400-2483.5 MHz, and 5725-5850 MHz bands: 1 Watt. As an alternative to a peak power measurement, compliance with the one Watt limit can be based on a measurement of the maximum conducted output power. Maximum Conducted Output Power is defined as the total transmit power delivered to all antennas and antenna elements averaged across all symbols in the signaling alphabet when the transmitter is operating at its maximum power control level. Power must be summed across all antennas and antenna elements. The average must not include any time intervals during which the transmitter is off or is transmitting at a reduced power level. If multiple modes of operation are possible (e.g., alternative modulation methods), the maximum conducted output power is the highest total transmit power occurring in any mode.

According to RSS-247§5.4 d) For DTSs employing digital modulation techniques operating in the bands 902-928 MHz and 2400-2483.5 MHz, the maximum peak conducted output power shall not exceed 1W. Except as provided in Section 5.4(e), the e.i.r.p. shall not exceed 4 W.

As an alternative to a peak power measurement, compliance can be based on a measurement of the maximum conducted output power. The maximum conducted output power is the total transmit power delivered to all antennas and antenna elements, averaged across all symbols in the signaling alphabet when the transmitter is operating at its maximum power control level. Power must be summed across all antennas and antenna elements. The average must not include any time intervals during which the transmitter is off or transmitting at a reduced power level. If multiple modes of operation are implemented, the maximum conducted output power is the highest total transmit power occurring in any mode.

Test Procedure

1. Place the EUT on a bench and set it in transmitting mode.
2. Remove the antenna from the EUT and then connect a low loss RF cable from the antenna port to one test equipment.
3. Add a correction factor to the display.

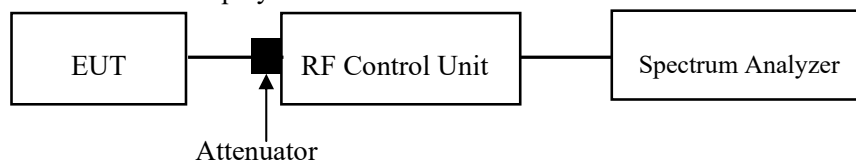

Test Data

Environmental Conditions

Temperature:	25 °C
Relative Humidity:	50 %
ATM Pressure:	101.0 kPa

The testing was performed by Roger Ling on 2022-10-21.

Test Result: Compliant

EUT operation mode: Transmitting

Please refer to the Appendix.

APPENDIX

Appendix A: DTS Bandwidth Test Result

Test Mode	Antenna	Channel	DTS BW [MHz]	Limit[MHz]	Verdict
BLE_1M	Ant1	2402	0.66	0.5	PASS
		2440	0.66	0.5	PASS
		2480	0.66	0.5	PASS
BLE_2M	Ant1	2402	1.13	0.5	PASS
		2440	1.13	0.5	PASS
		2480	1.13	0.5	PASS

Test Graphs

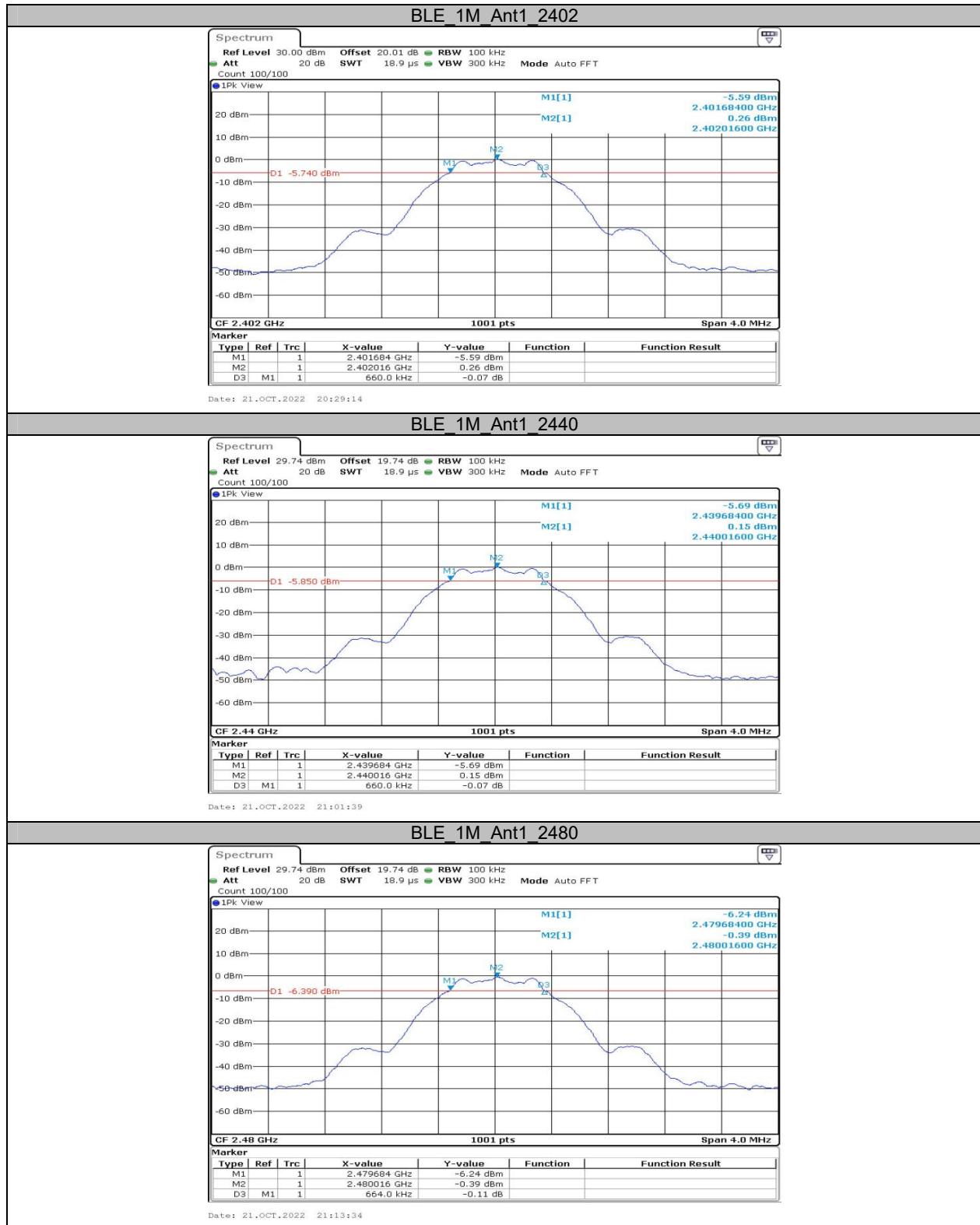

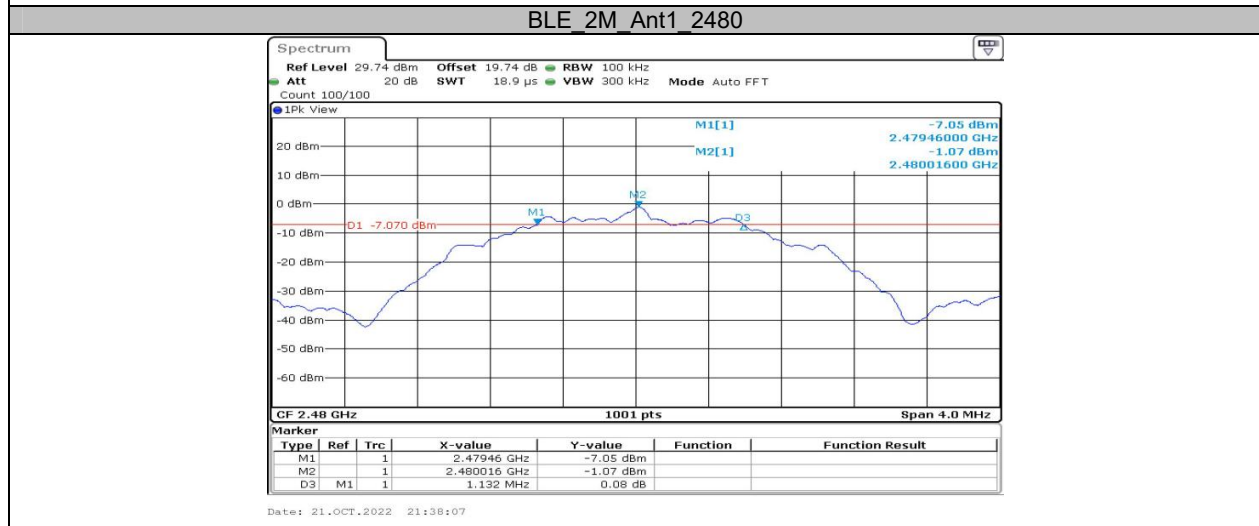
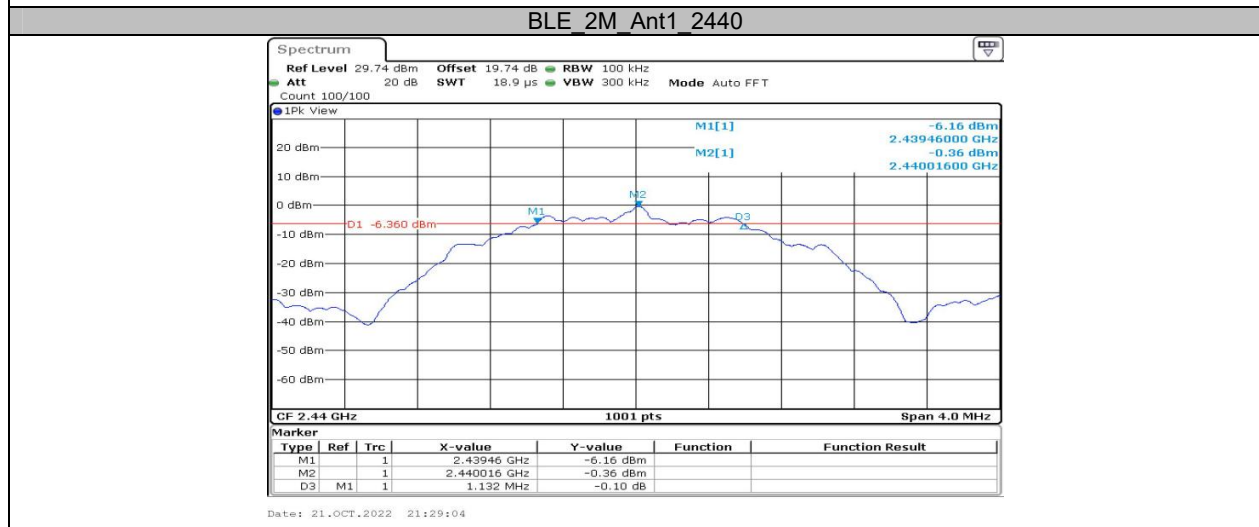
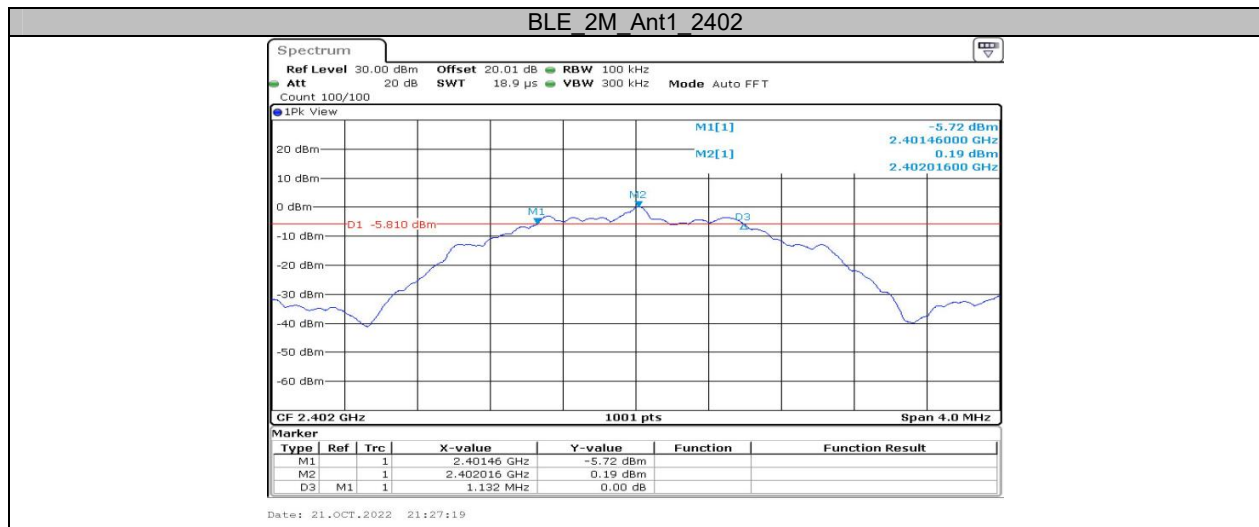

**Appendix B: Occupied Channel Bandwidth
Test Result**

Test Mode	Antenna	Channel	OCB [MHz]	FL[MHz]	FH[MHz]	Limit[MHz]	Verdict
BLE_1M	Ant1	2402	1.027	2401.512	2402.539	---	---
		2440	1.027	2439.512	2440.539	---	---
		2480	1.027	2479.512	2480.539	---	---
BLE_2M	Ant1	2402	2.042	2401.025	2403.067	---	---
		2440	2.046	2439.021	2441.067	---	---
		2480	2.050	2479.021	2481.071	---	---

Test Graphs

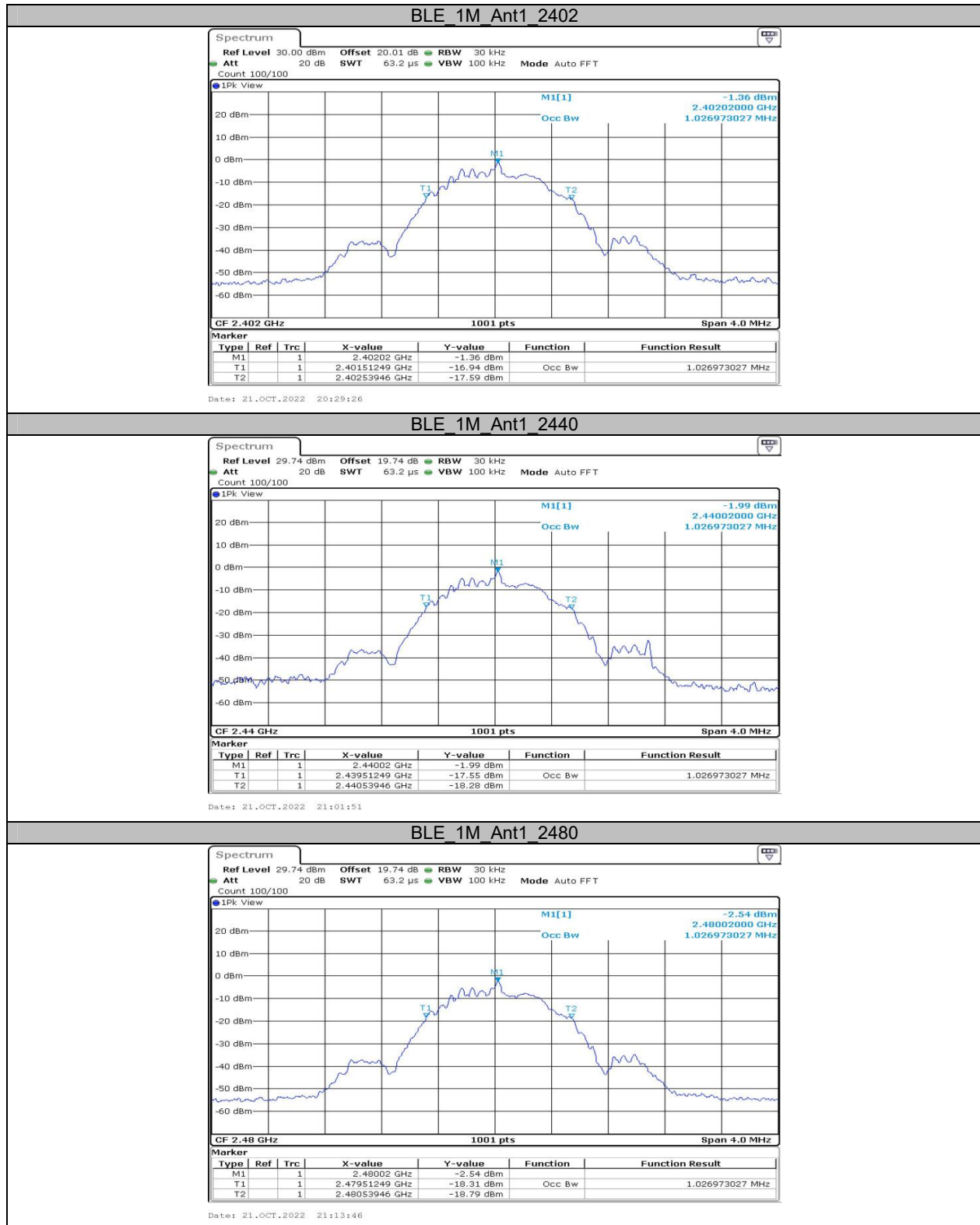

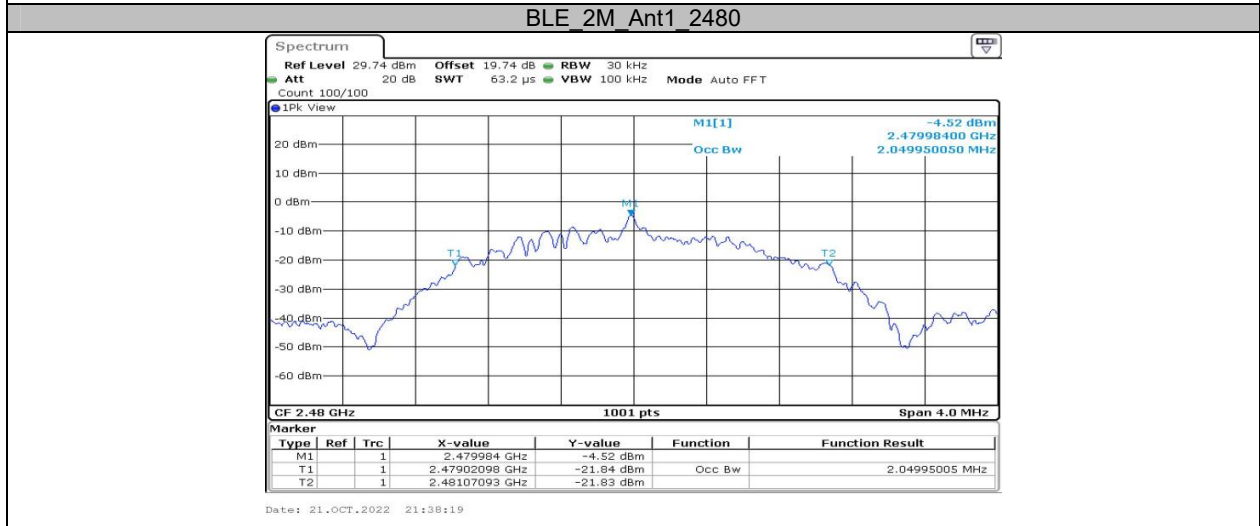
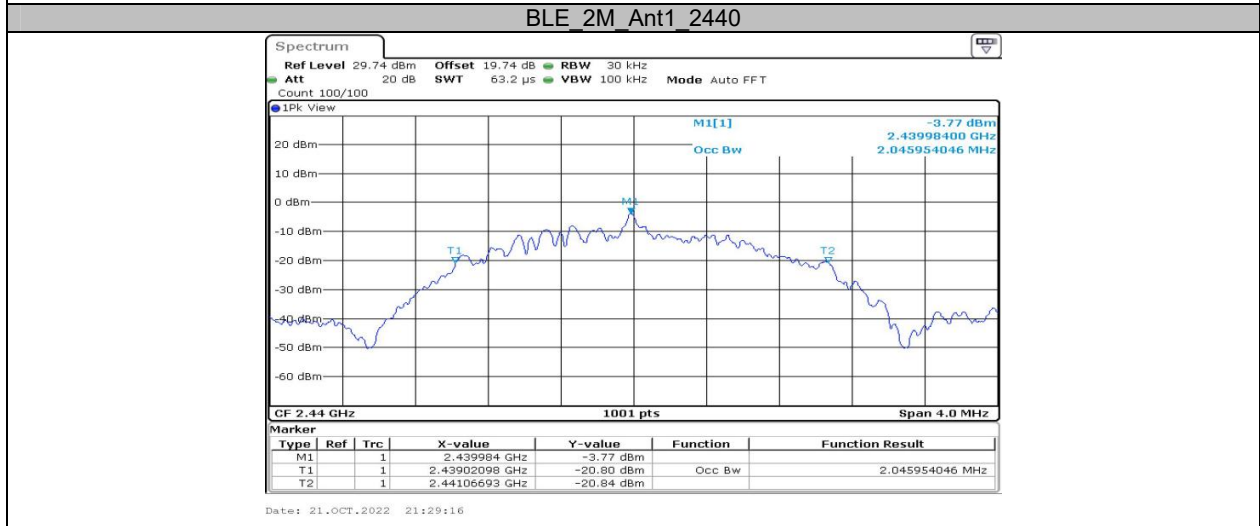
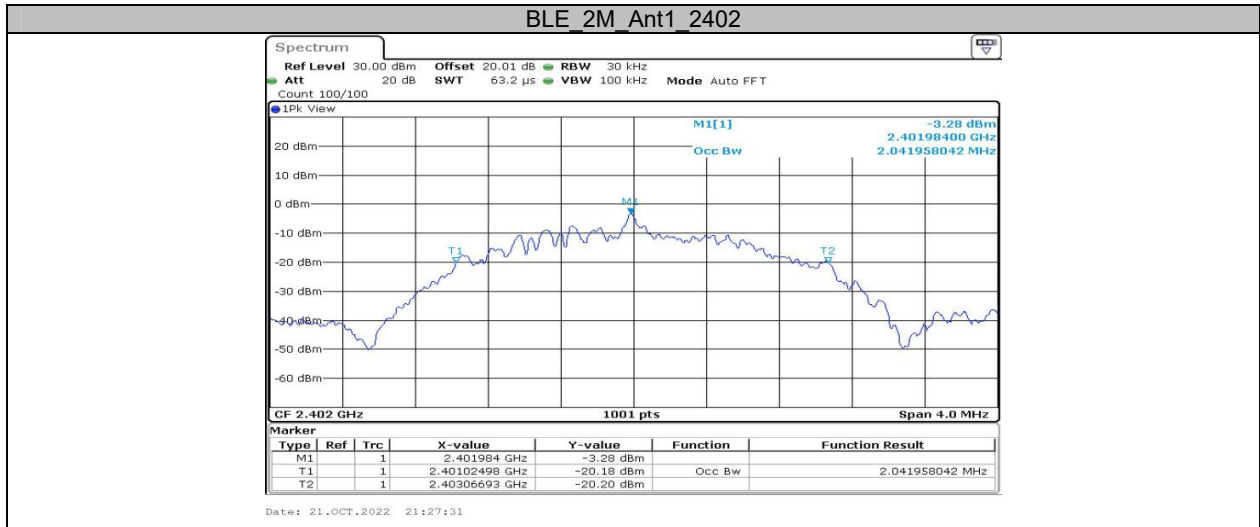

**Appendix C: Maximum conducted output power
Test Result**

Test Mode	Antenna	Channel	Result[dBm]	Limit[dBm]	Verdict
BLE_1M	Ant1	2402	1.30	≤30	PASS
		2440	1.15	≤30	PASS
		2480	0.44	≤30	PASS
BLE_2M	Ant1	2402	0.80	≤30	PASS
		2440	0.69	≤30	PASS
		2480	-0.10	≤30	PASS

Note: the antenna gain is 2.9dBi, the maximum EIRP=1.30 dBm+2.9dBi= 4.2dBm<36dBm, so it can meet the limit of ISEDC

Test Graphs

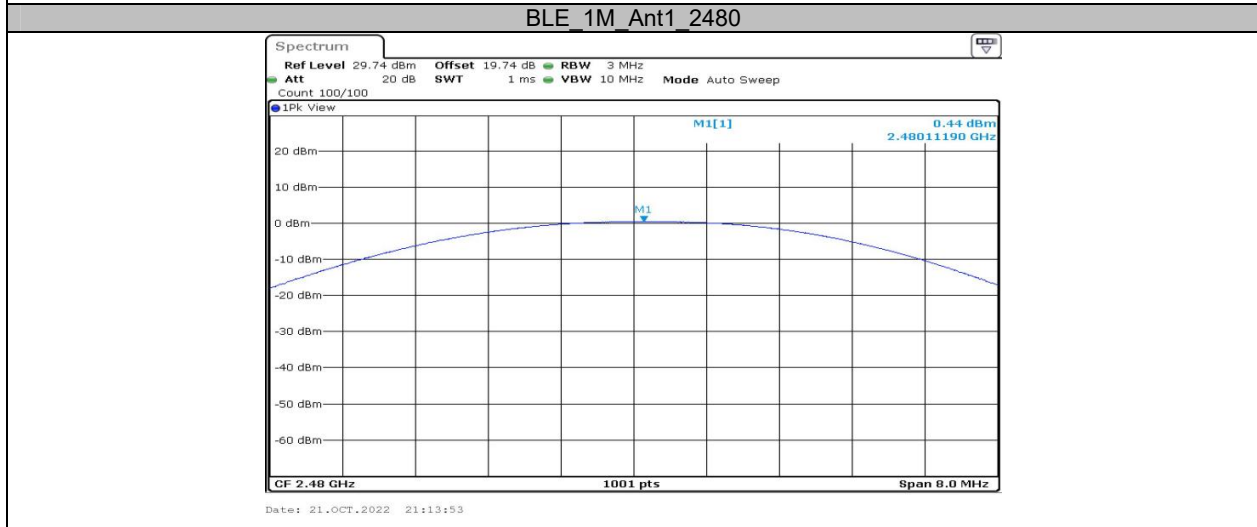
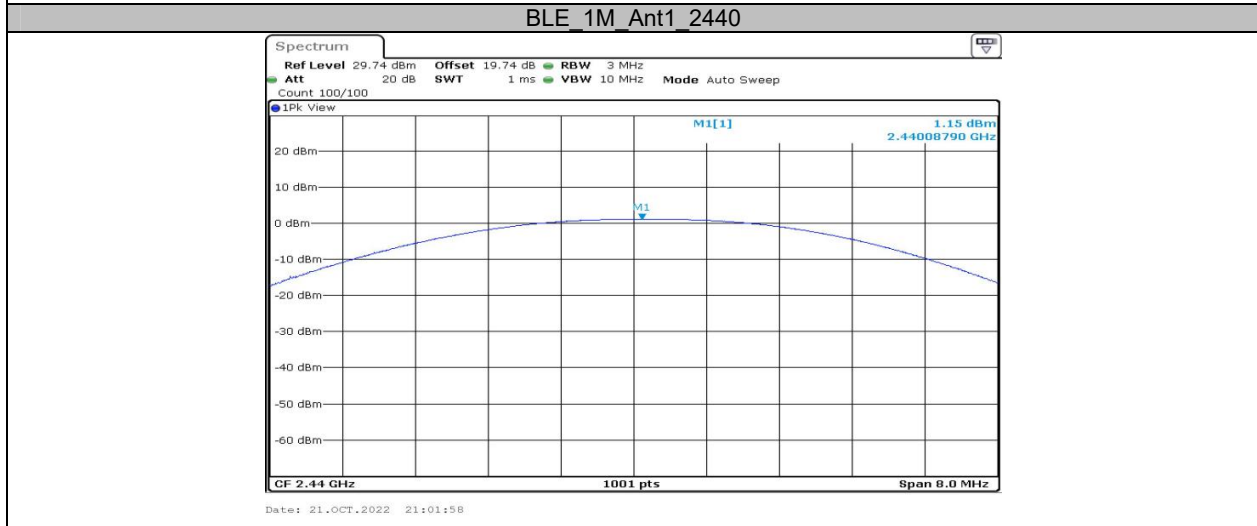

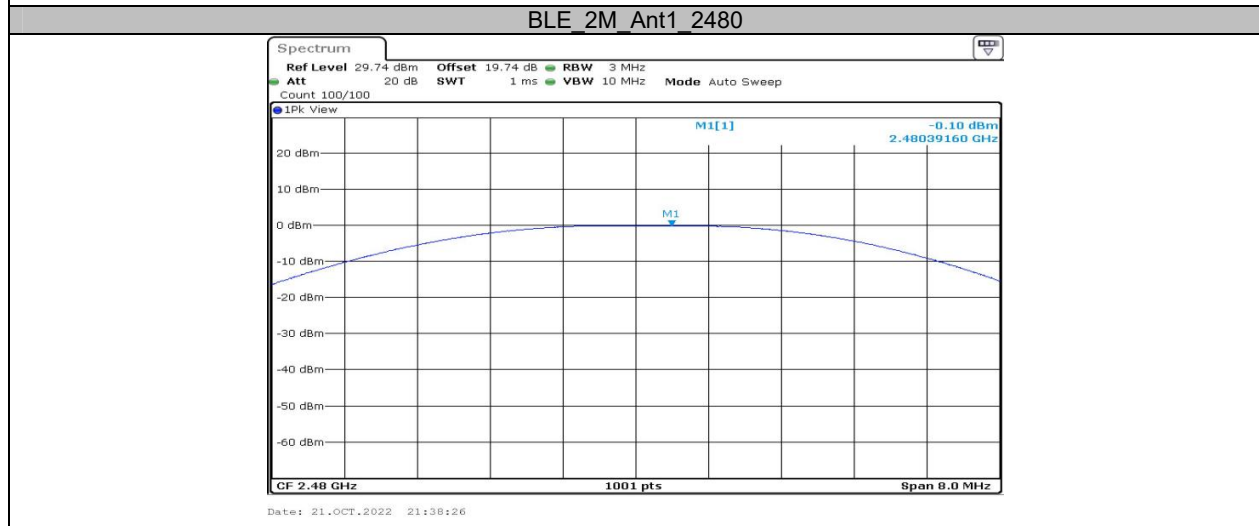
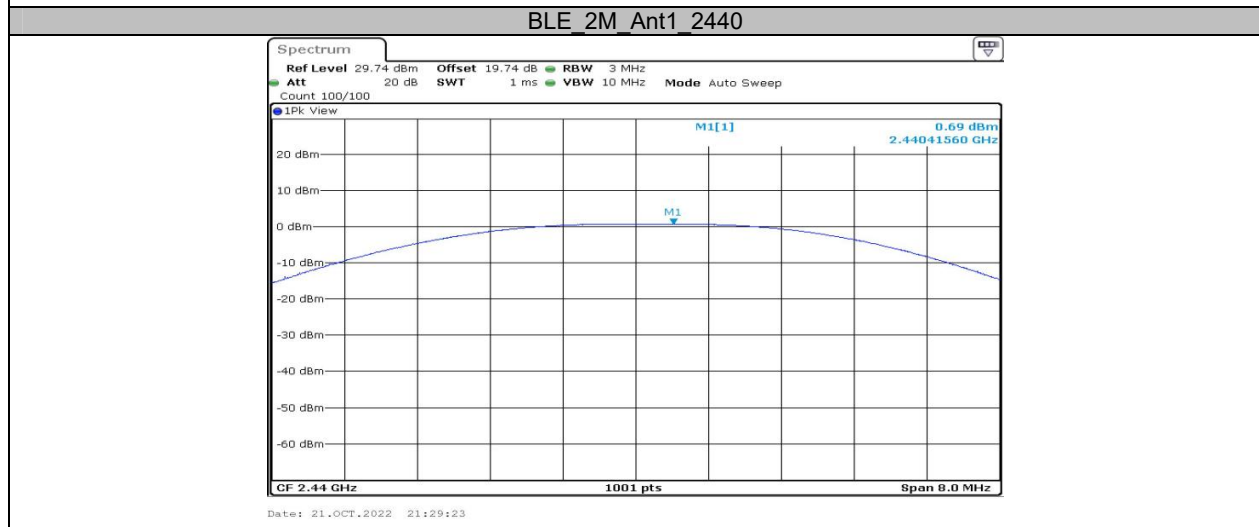

**Appendix D: Maximum power spectral density
Test Result**

Test Mode	Antenna	Channel	Result[dBm/3kHz]	Limit[dBm/3kHz]	Verdict
BLE_1M	Ant1	2402	-14.72	≤8.00	PASS
		2440	-14.88	≤8.00	PASS
		2480	-15.54	≤8.00	PASS
BLE_2M	Ant1	2402	-16.27	≤8.00	PASS
		2440	-16.36	≤8.00	PASS
		2480	-17.10	≤8.00	PASS

Test Graphs

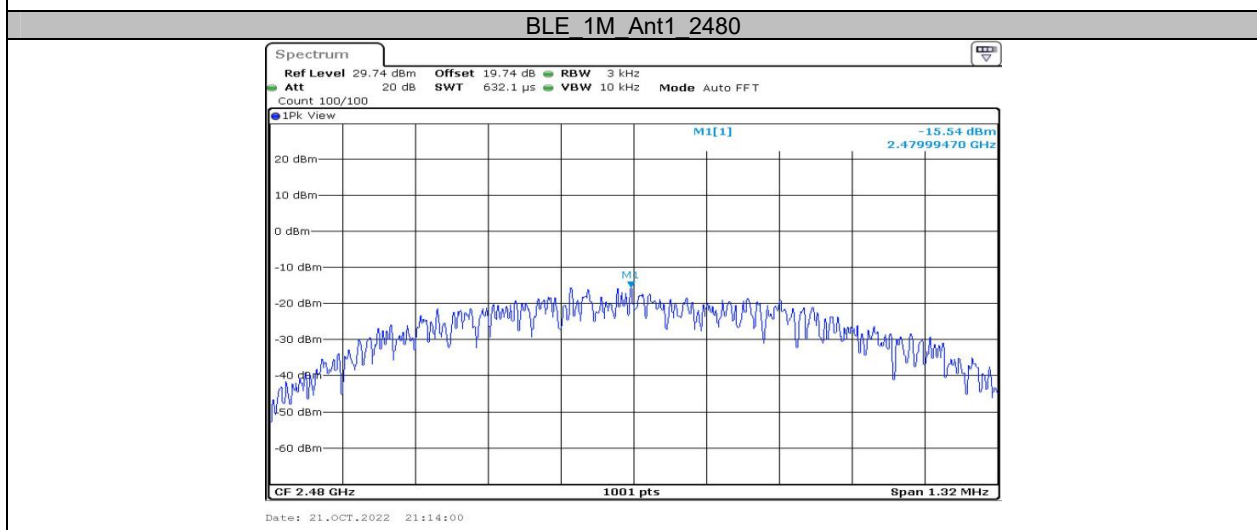
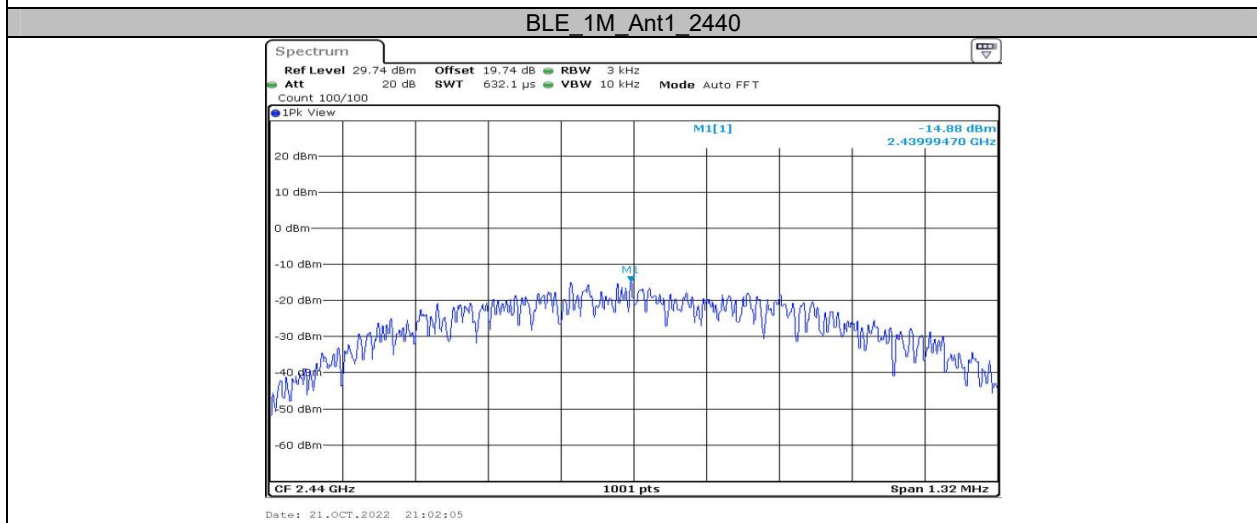
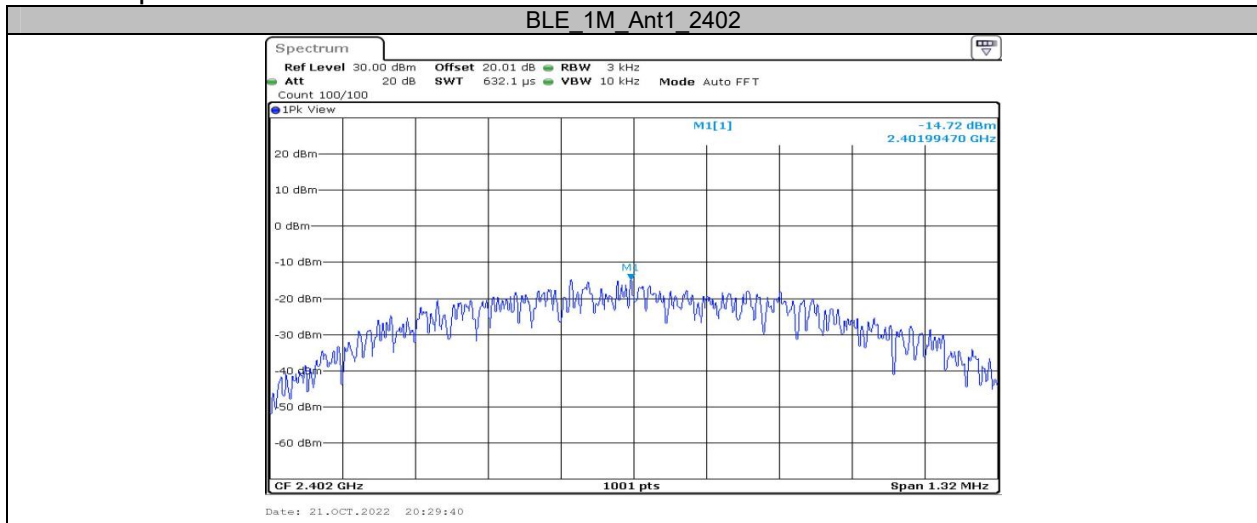

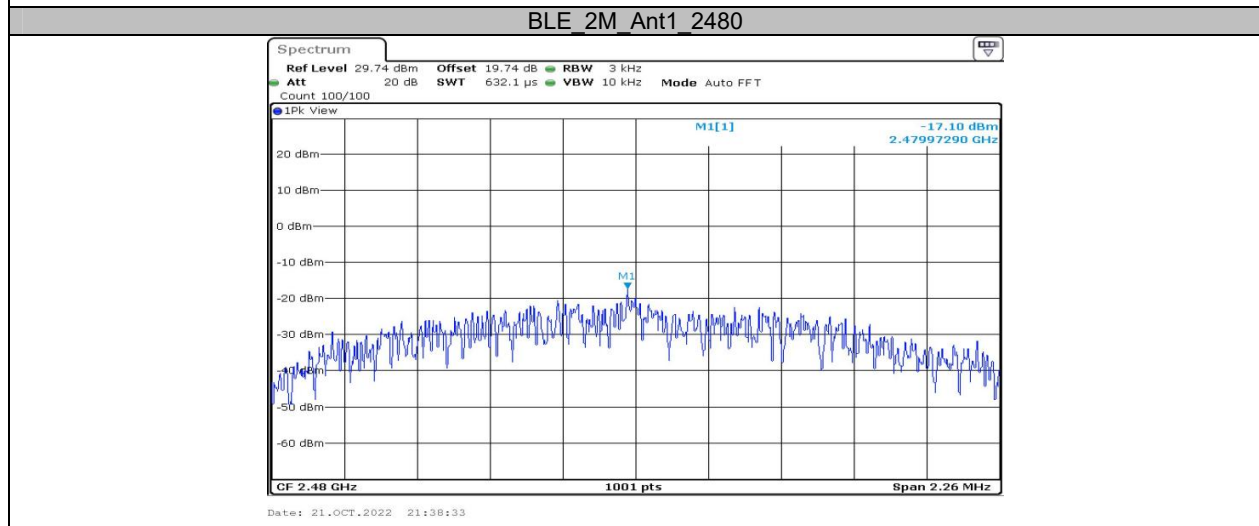
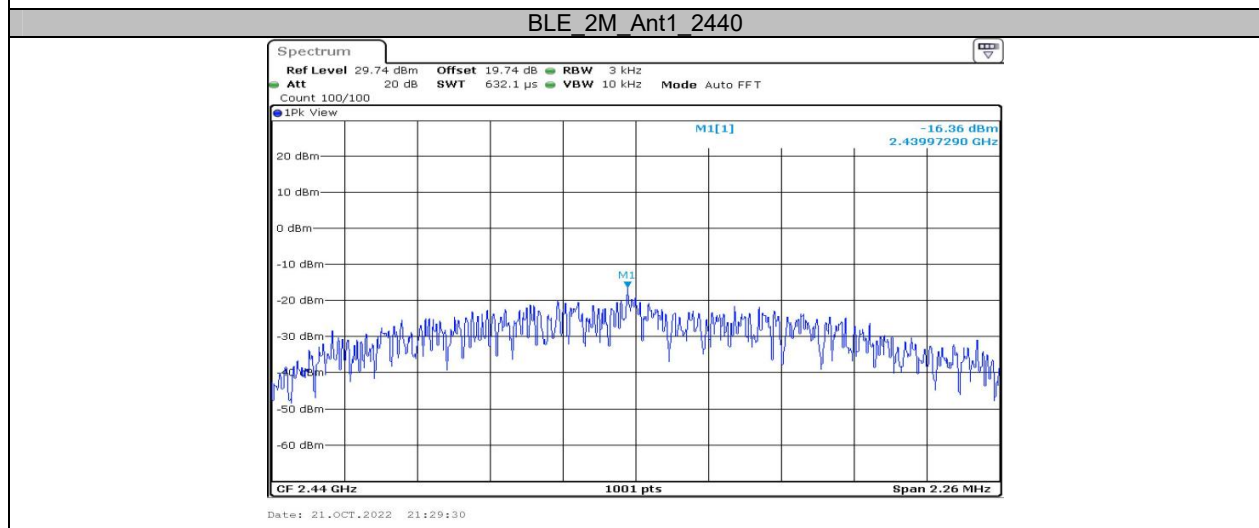
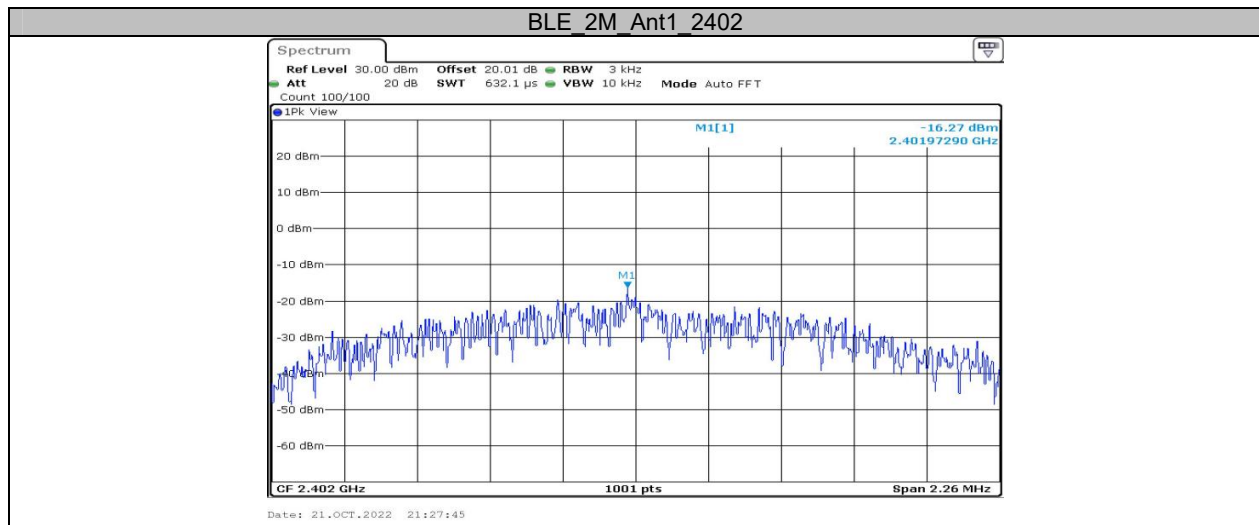

Appendix E: Band edge measurements Test Graphs



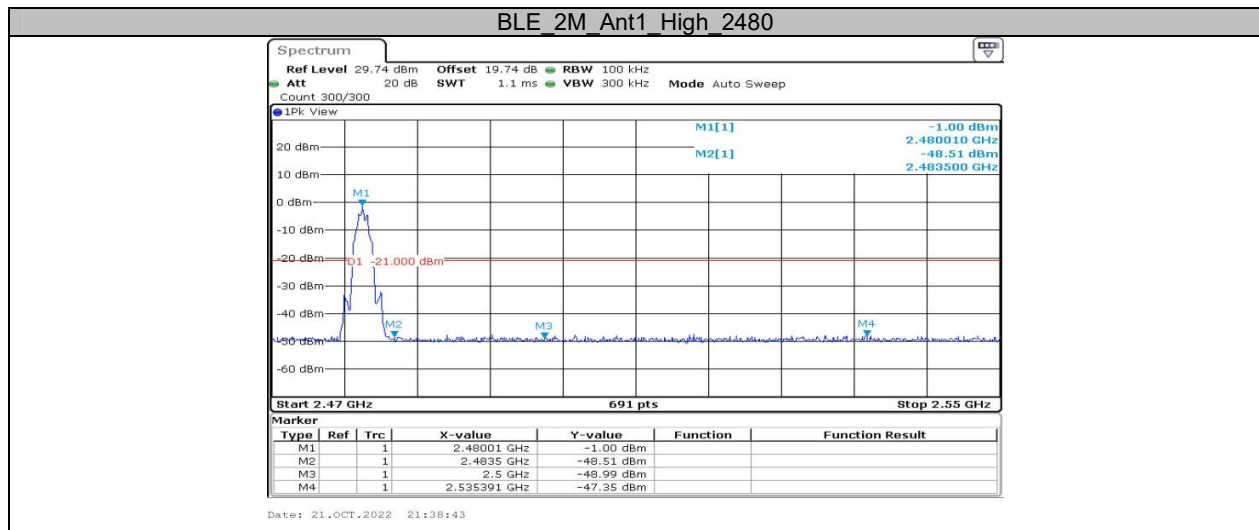

Appendix F: Duty Cycle Test Result

Test Mode	Antenna	Channel	Transmission Duration [ms]	Transmission Period [ms]	Duty Cycle [%]
BLE_1M	Ant1	2440	0.39	0.63	61.90
BLE_2M	Ant1	2440	0.20	0.62	32.26

Test Graphs

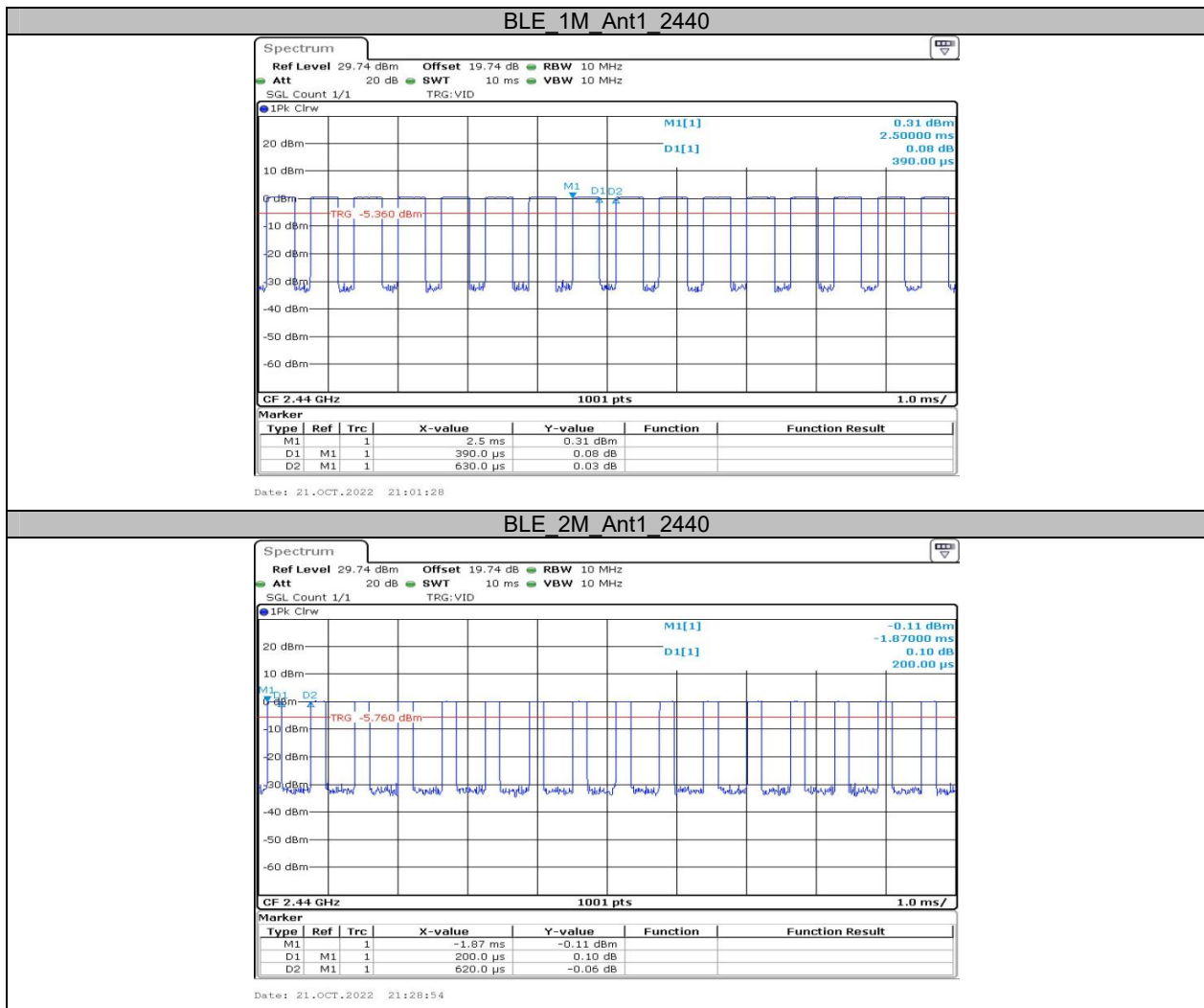

***** END OF REPORT *****