

DATA SHEET

Fortinet Antenna Portfolio

Indoor and Outdoor Antennas

Fortinet offers many different antenna options that can be used with our FortiAP line of products. These antennas can help to optimize coverage and overall wireless performance in a range of installation settings. Antennas come in a variety of patterns and with various numbers of antenna elements to help installers find the best match for their equipment.



Available Models

SKU	PATTERN	GAIN	LEADS	APPLICATION
FANT-04ABGN-2504-O-R	Omni	2.5 dBi (2.4 GHz) / 4 dBi (5 GHz)	4 RPSMA	Indoor / Outdoor
FANT-04ABGN-0606-O-R	Omni	6 dBi	4 RPSMA	Indoor / Outdoor
FANT-04ABGN-0606-O-N	Omni	6 dBi	4 N-Type	Indoor / Outdoor
FANT-06ABGN-0606-O-R	Omni	6 dBi	6 RPSMA	Indoor / Outdoor
FANT-06ABGN-2504-O-R	Omni	2.5 dBi (2.4 GHz) / 4 dBi (5 GHz)	6 RPSMA	Indoor Plenum
FANT-04ABGN-0606-P-R	Patch	6 dBi	4 RPSMA	Indoor / Outdoor
FANT-04ABGN-1414-P-N	Patch	14 dBi	4 N-Type	Indoor / Outdoor
FANT-04ABGN-8065-P-N	Patch	8 dBi (2.4 GHz) / 6.5 dBi (5 GHz)	4 N-Type	Indoor / Outdoor
FANT-08ABGN-1213-D-R	Directional	12 dBi (2.4 GHz) / 13 dBi (5 GHz)	8 RPSMA	Indoor / Outdoor
FANT-06ACAX-8509-D-N	Directional	2.4-2.5 GHz @ 6 × 8.5 dBi 5.15-5.875 GHz @ 6 × 9 dBi	6 N-Type	Indoor / Outdoor
FANT-10ACAX-1213-D-N	Directional	12dBi / 13dBi	10 N-Type	Indoor / Outdoor
FANT-02ACAX-0505-D-N	Directional	5dBi	2 N-Type	Indoor
FANT-02ACAX-0505-D-R	Directional	5dBi	2 RPSMA	Indoor
FANT-04ACAX-0505-D-R	Directional	2.4/5GHz 5dBi(2.4GHz)/5dBi(5GHz)	4 RPSMA	Outdoor
FANT-04ACAX-0606-D-R	Directional	6dBi	4 RPSMA	Outdoor

HIGHLIGHTS

FANT-04ABGN-2504-O-R

This aesthetically pleasing micro omni antenna is optimized for small form factor, aesthetically sensitive, or mobile Wi-Fi applications. This antenna includes four dual band pigtailed and RPSMA connectors. This antenna is perfect for wireless installations where low profile and looks are a major consideration. Alternatively, this antenna can be used in vehicles for communication, presence detection, and fleet management.



SPECIFICATIONS		
Frequency Range	2400-2500 MHz	4900-5850 MHz
Bandwidth	100 MHz	950 MHz
Gain	2.5 dBi	4 dBi
Horizontal Beamwidth	360°	360°
VSWR	≤2	
Nominal Impedance	50 ohms	
Polarization	Vertical	
Max Power	50 Watts	
Connectors	4 x RPSMA Male	
Pigtail length	36 in. with Connector / 91.44 cm with Connector	
Dimensions	3.54 in. x 1.57 in. (9.0 cm x 4.0 cm)	
Weight	0.27 lbs (124.7 g)	
Environment	Indoor / Outdoor	
Operating Temperature	-40°F to +158°F (-40°C to +70°C)	
Mounting Method	Surface Mount	

Port 1: 2450MHz

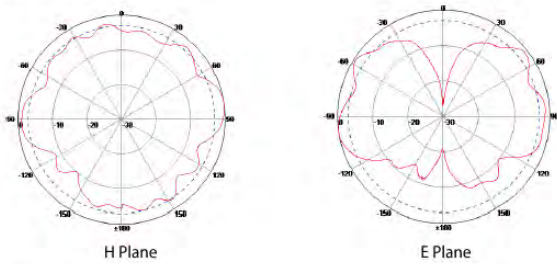

Port 1: 5500MHz

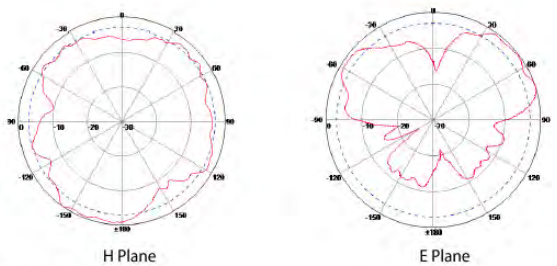

Port 2: 2450MHz

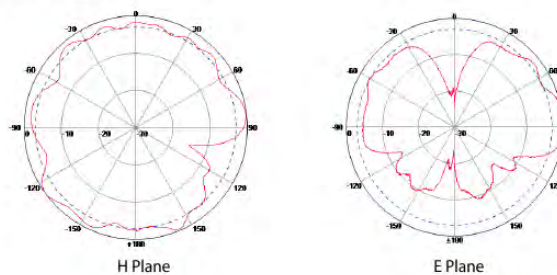

Port 2: 5500MHz

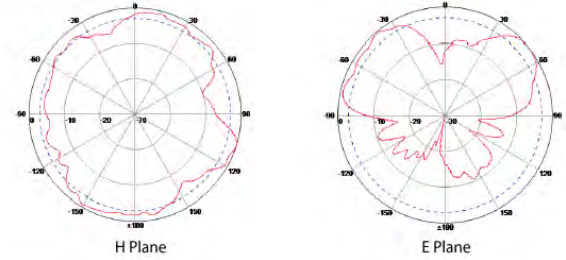

Port 3: 2450MHz

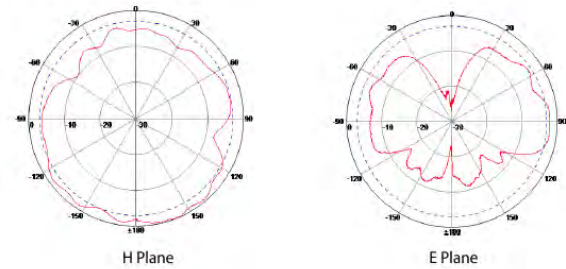

Port 3: 5500MHz

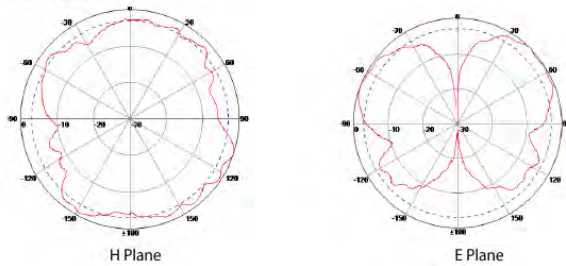

Port 4: 2450MHz

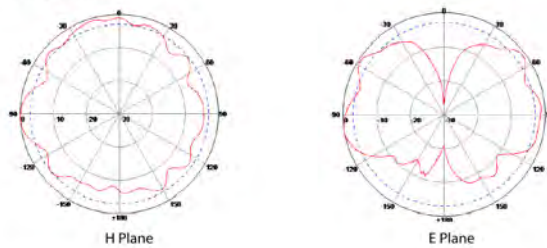

Port 4: 5500MHz

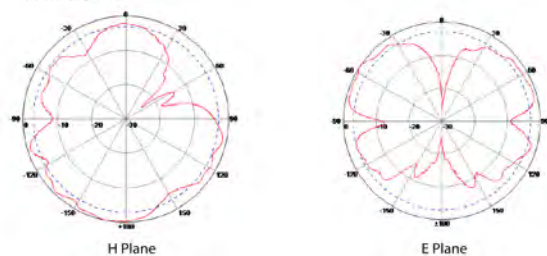

HIGHLIGHTS

FANT-04ABGN-0606-O-R / FANT-04ABGN-0606-O-N

This ruggedized 6 dBi omnidirectional antenna is perfectly suited for use outdoors, in warehouses, or in manufacturing environments where it must withstand exposure to moisture and dust. This antenna includes four dual band pigtailed. Includes an L-Bracket for mast and/or wall mounting.

The FANT-08ABGN-0606-O-R version of this antenna (pictured) features RPSMA connectors while the FANT-04ABGN-0606-O-N version of this antenna features N-Type connectors.



SPECIFICATIONS		
Frequency Range	2400-2500 MHz	5150-5850 MHz
Bandwidth	100 MHz	700 MHz
Gain	6 dBi	6 dBi
Vertical Beamwidth	45°	20°
Horizontal Beamwidth	360°	360°
VSWR	≤2.0	≤2.2
Nominal Impedance	50 ohms	
Polarization	Vertical	
Isolation	≤-15dB	
Max Power	10 Watts	
Lightning Protection	Not DC Grounded	
Connectors	4 x RPSMA Male or 4 x N-Type Male	
Dimensions	5.9 in. x 7 in. (14.99 cm x 17.78 cm)	
Pigtail Length	36 in. with Connector / 91.44 cm with Connector	
Weight	2.64 lbs. (1.2 kg)	
Environment	Indoor / Outdoor	
Mast Mount Diameter	1.37 in. - 1.97 in. (3.48 cm x 5.0 cm)	
Operating Temperature	-40°F to +158°F (-40°C to +70°C)	
Wind Load	134 mph (216 km/h)	
Mounting Method	Mast and/or Wall Mounting	

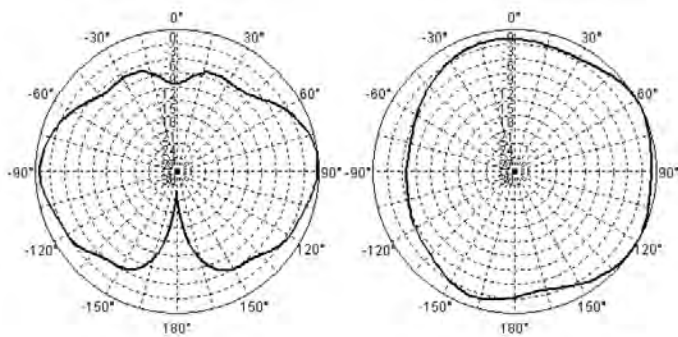

E-Plane Pattern H-Plane Pattern
2.4 GHz

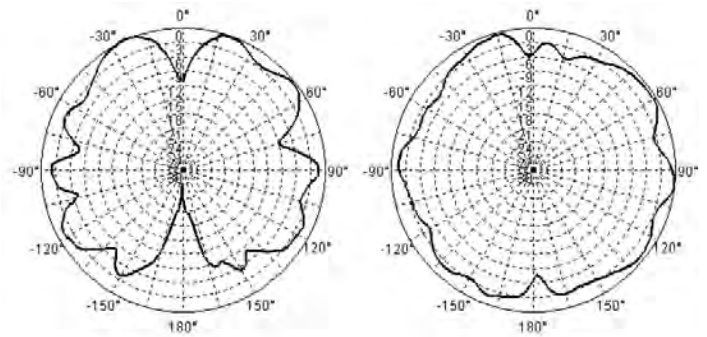

E-Plane Pattern H-Plane Pattern
5 GHz



HIGHLIGHTS

FANT-06ABGN-0606-O-R

This ruggedized 6 dBi omnidirectional antenna is perfectly suited for use outdoors, in warehouses, or in manufacturing environments where it must withstand exposure to moisture and dust. This antenna includes six dual band pigtails and RPSMA connectors. Includes an L-Bracket for mast and or wall mounting.

SPECIFICATIONS		
Frequency Range	2400-2500 MHz	5150-5850 MHz
Bandwidth	100 MHz	100 MHz
Gain	6 dBi	6 dBi
Vertical Beamwidth	35°	25°
Horizontal Beamwidth	360°	360°
VSWR	Typical $\leq 1.5 - 2.0$	
Nominal Impedance	50 ohms	
Polarization	Vertical	
Isolation	≤ -15 dB	
Max Power	10 Watts	
Lightning Protection	Not DC Grounded	
Connectors	6 x RPSMA Male	
Pigtail Length	36 in. with Connector / 91.44 cm with Connector	
Dimensions	5.9 in. x 7 in. (14.99 cm x 17.78 cm)	
Weight	3.15 lbs. (1.43 kg)	
Environment	Indoor / Outdoor	
Mast Mount Diameter	1.37 in. - 1.97 in. (3.48 cm x 5.0 cm)	
Operating Temperature	-40°F to $+158^{\circ}\text{F}$ (-40°C to $+70^{\circ}\text{C}$)	
Wind Load	134 mph (216 km/h)	
Mounting Method	Mast and/or Wall Mounting	

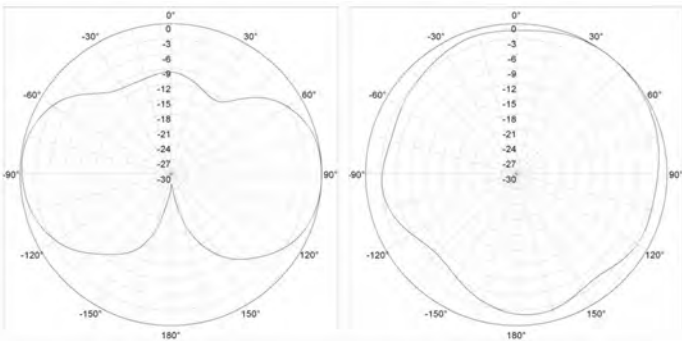
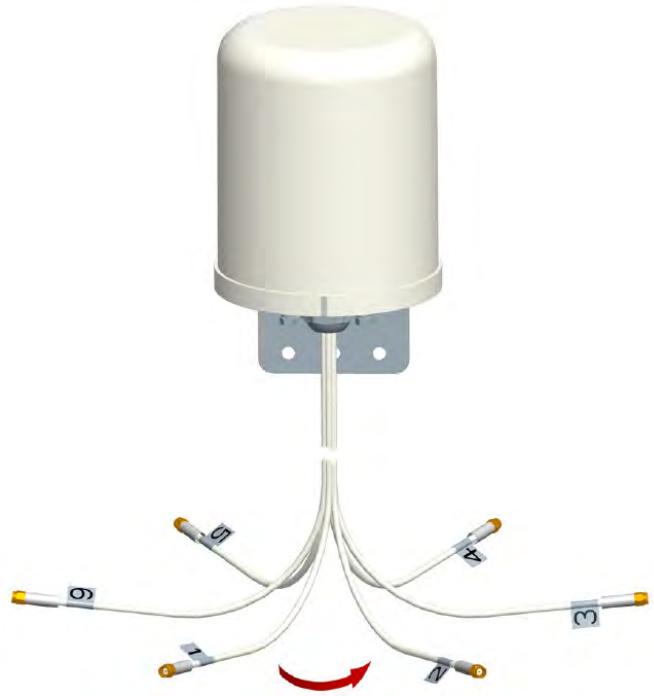

E-Plane Pattern H-Plane Pattern
2.4 GHz

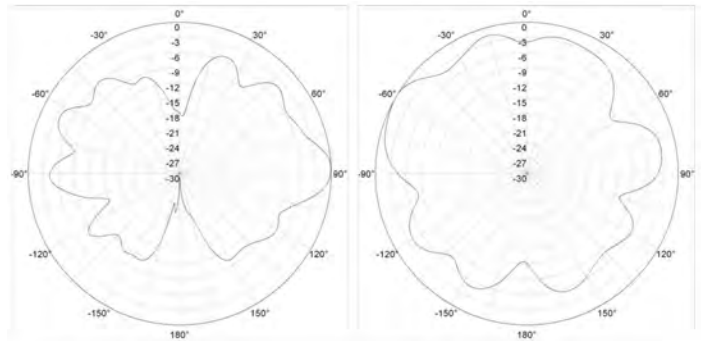

E-Plane Pattern H-Plane Pattern
5 GHz

HIGHLIGHTS

FANT-06ABGN-2504-O-R

This ceiling mount 2.5 dBi (2.4GHz) / 4 dBi (5GHz) omnidirectional antenna is well suited to ceiling installations where looks matter. This antenna includes six dual band pigtailed and RPSMA connectors.



SPECIFICATIONS		
Frequency Range	2400-2483 MHz	5150-5850 MHz
Bandwidth	83 MHz	700 MHz
Gain	2.5 dBi	4 dBi
Vertical Beamwidth	55°	60°
Horizontal Beamwidth	360°	360°
VSWR	≤2.0	≤2.5
Nominal Impedance	50 ohms	
Polarization	Vertical	
Max Power	50 Watts	
Connectors	6 x RPSMA Male	
Pigtail Length	36 in. with Connector / 91.44 cm with Connector	
Dimensions	7.1 in. x 5.1 in. x 1.9 in. (18.03 cm x 12.95 cm x 4.83 cm)	
Weight	0.68 lbs. (0.31 kg)	
Environment	Indoor - Plenum rated	
Operating Temperature	-40°F to +158°F (-40°C to +70°C)	
Mounting Method	Ceiling	

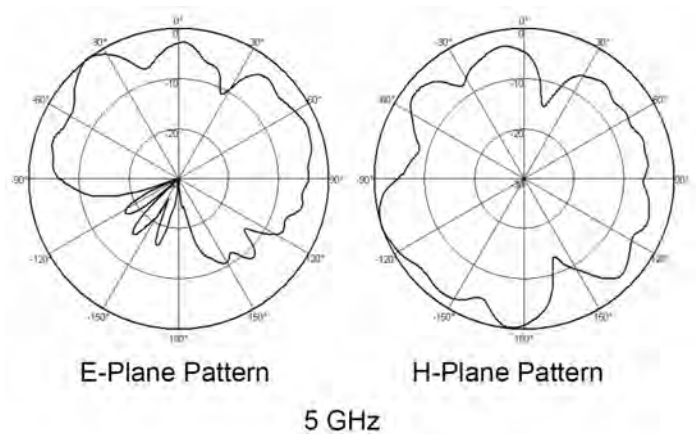
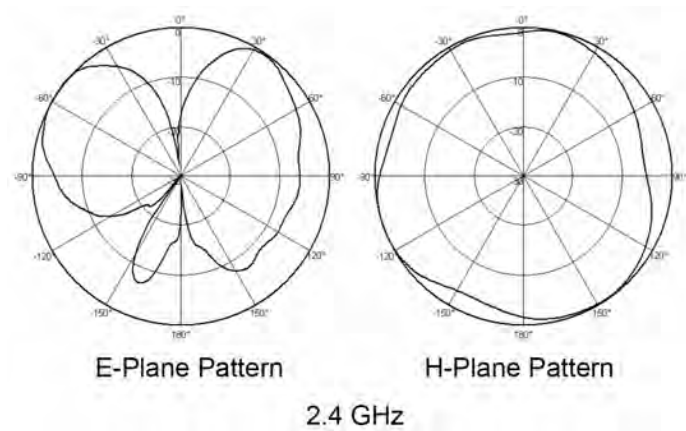

HIGHLIGHTS

FANT-04ABGN-0606-P-R

This 6 dBi patch antenna is well suited for use outdoors, in warehouses, or in manufacturing environments where it must withstand exposure to moisture and dust. This antenna includes four dual band pigtailed and RPSMA connectors. An articulating mount is included with the antenna.



SPECIFICATIONS		
Frequency Range	2400-2500 MHz	5150-5850 MHz
Gain	6 dBi	6 dBi
Vertical Beamwidth	80±20° / 45±20°	80±20° / 45±20°
Horizontal Beamwidth	80±20° / 45±20°	80±20° / 45±20°
VSWR	≤2.0	≤2.5
Front-to-back ratio	≤18	
Nominal Impedance	50 ohms	
Polarization	Vertical	
Max Power	100 Watts	
Connectors	4 x RPSMA Male	
Pigtail Length	36 in. with Connector / 91.44 cm with Connector	
Dimensions	9.2 in. x 9.0 in. x 1.1 in. (23.37 cm x 22.86 cm x 2.79 cm)	
Weight	2.65 lbs. (1.2 kg)	
Environment	Indoor / Outdoor	
Operating Temperature	-40°F to +140°F (-40°C to +60°C)	
Mounting Style	Wall or Mast/Pole	

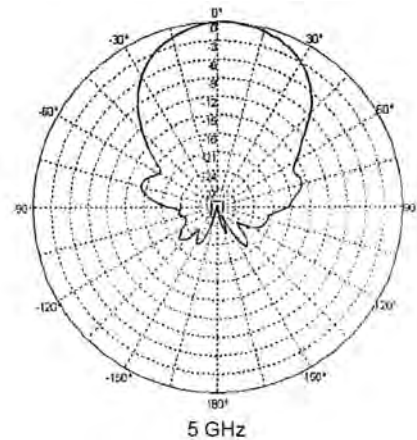
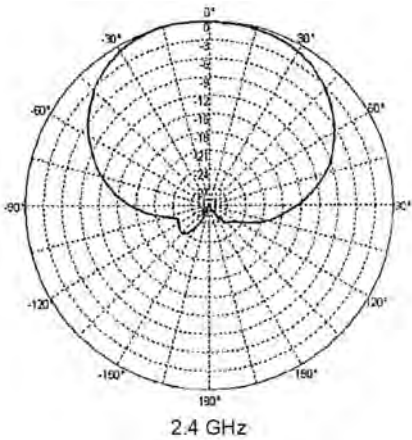

HIGHLIGHTS

FANT-04ABGN-1414-P-N

This high density 14 dBi patch antenna is well suited for use outdoors, in warehouses, or in manufacturing environments where it must withstand exposure to moisture and dust. The antenna features a 35-degree beamwidth at both the 2.4GHz and 5GHz bands which helps to minimize co-channel interference. This antenna features four dual band N-Type jacks on the back of the antenna.

SPECIFICATIONS		
Frequency Range	2400-2500 MHz	5150-5850 MHz
Bandwidth	100 MHz	700 MHz
Gain	14 dBi	14 dBi
Vertical Beamwidth	35°	35°
Horizontal Beamwidth	35°	35°
VSWR	≤2	
Nominal Impedance	50 ohms	
Polarization	Vertical / Linear	
Isolation	≤28dB	
Max Power	50 Watts	
Connectors	N-Type Male	
Pigtail Length	Need to order separately	
Mounting Method	Mast Mounting	
Dimensions	14.96 in. x 14.96 in. x 1.3 in. (38 cm x 38 cm x 3.3 cm)	
Weight	7.5 lbs. (3.4 kg)	
Pole Diameter	1.97 in. - 4.7 in. (5 cm to 11.94 cm)	
Environment	Indoor / Outdoor	
Operating Temperature	-22°F to +158°F (-30°C to +70°C)	

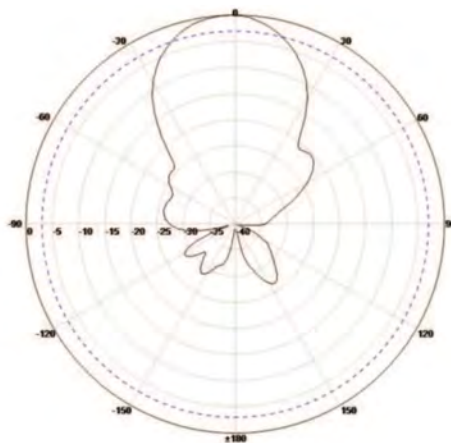

H Plane

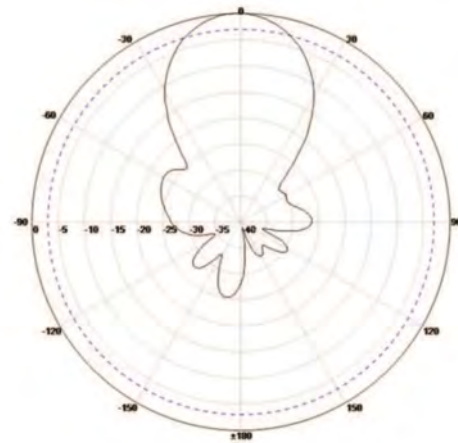

E Plane



HIGHLIGHTS

FANT-04ABGN-8065-P-N

This 8 dBi (2.4 GHz) / 6.5 dBi (5GHz) patch antenna is well suited for use outdoors, in warehouses, or in manufacturing environments where it must withstand exposure to moisture and dust. The antenna pattern and beamwidth facilitate specific coverage planning. This antenna features four dual band pigtailed and N-Type connectors.

SPECIFICATIONS		
Frequency Range	2.4-2.5 GHz	5.1-5.9 GHz
Gain	8 dBi	6.5 dBi
Vertical Beamwidths	65°	70°
Horizontal Beamwidths	60°	65°
Nominal Impedance	50 ohms	50 ohms
VSWR	<2	
Front-to-Back Ratio (dB)	>13	>15
Port-to-Port Isolation (dB)	>25	>30
Connectors	4 x N-Type Male	
Cable Length	24 in. (60.96 cm)	
Dimensions	7.5 in. x 7.5 in. x 1.5 in. (19.05 × 19.05 × 3.81 cm)	
Weight	2.5 lb. (1.134 kg)	
Environment	Indoor / Outdoor	
Ingress Protection	IP-66 Compliant	
Operating Temperature	-40°F to +140°F (-40°C to +60°C)	

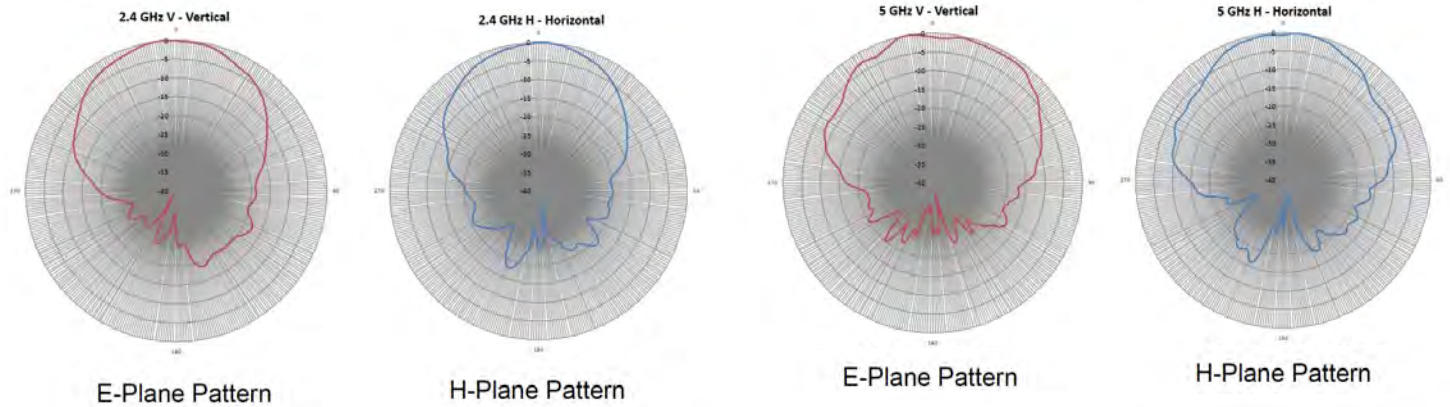

HIGHLIGHTS

FANT-08ABGN-1213-D-R

This high gain directional antenna is well suited for use outdoors, in warehouses, or in manufacturing environments where it must withstand exposure to moisture and dust. The antenna features narrow beamwidth to help minimize co-channel interference in dense deployments and facilitate highly specific coverage planning. This antenna features eight dual band pigtailed and RPSMA connectors. An articulating mount is included with the antenna.



SPECIFICATIONS		
Frequency Range	2400-2500 MHz	5150-5850 MHz
Bandwidth	100 MHz	700 MHz
Gain	12 dBi	13 dBi
VSWR	≤2.25	
Nominal Impedance	50 ohms	
Polarization	4x Horizontal / 4x Vertical	
Vertical Beamwidth	45° / 28° (Ports 1-4); 50° / 40° (Ports 5-8)	
Horizontal Beamwidth	50° / 40° (Ports 1-4); 45° / 28° (Ports 5-8)	
Front-to-Back Ratio (dB)	≤19	
Port-to-Port Isolation	≤18	≤25
Max Power	50 Watts	
Connectors	8 x RPSMA Male	
Pigtail length	36 in. with Connector / 91.44 cm with Connector	
Dimensions (LxWxH)	12 in. x 12 in. x 1.5 in. (30.48 cm x 30.48 cm x 3.81 cm)	
Weight	2.1 lbs. (0.95 kg)	
Environment	Indoor / Outdoor	
Ingress Protection	IP-54 Compliant	
Wind Load	100 mph (160 km/h)	
Operating Temperature	-40° to 140° F (-40° to 60° C)	

2.4GHz Horizontal Polarization

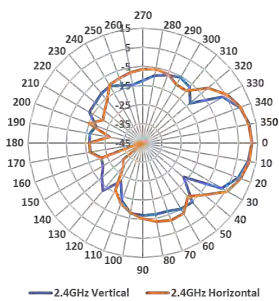

5.0GHz Horizontal Polarization

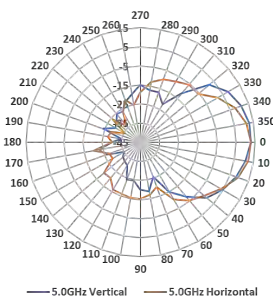

2.4GHz Vertical Polarization

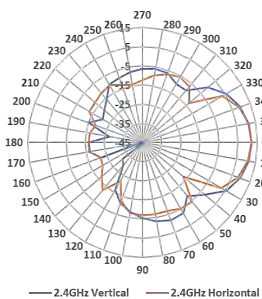

5.0GHz Vertical Polarization

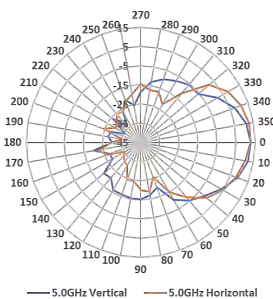

HIGHLIGHTS

FANT-06ACAX-8509-D-N

This 8.5 dBi (2.4 GHz) / 9 dBi (5GHz) vertically polarized antenna is well suited for use outdoors, in warehouses, or in manufacturing environments where it must withstand exposure to moisture and dust. This antenna features six dual band pigtailed and N-Type connectors.



SPECIFICATIONS		
Frequency Range	2.4-2.5 GHz	5.15-5.875 GHz
Gain	8.5 dBi	9 dBi
Vertical Beamwidths	65°	70°
Horizontal Beamwidths	60°	65°
Nominal Impedance	50 ohm	50 ohm
VSWR	2.0: 1 max	
Front-to-Back Ratio (dB)	-20 dB	-20 dB
Port-to-Port Isolation (dB)	20	30
Connectors	6x N-Type Male	
Cable Length	47.2 in. (120 cm)	
Dimensions	11.8 in. x 11.8 in. x 1.77 in. (300 x 300 x 45 mm)	
Weight	TBD	
Environment	Indoor / Outdoor	
Ingress Protection	IP-65 Compliant	
Operating Temperature	-40°F to +149°F (-40°C to +65°C)	

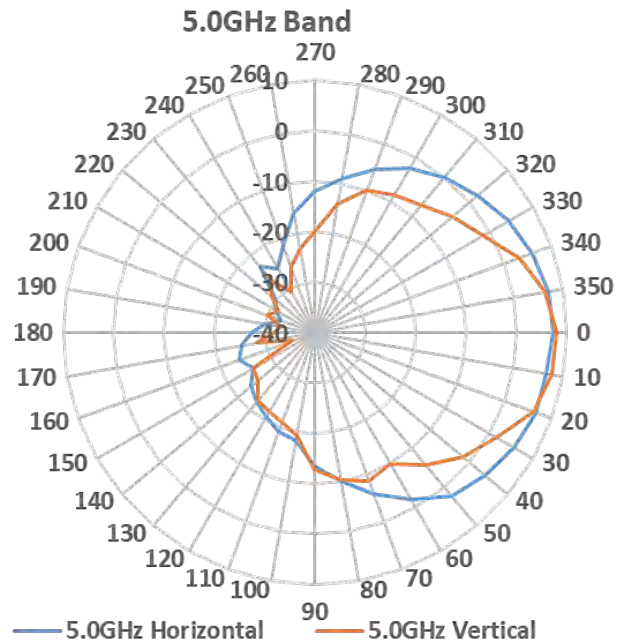
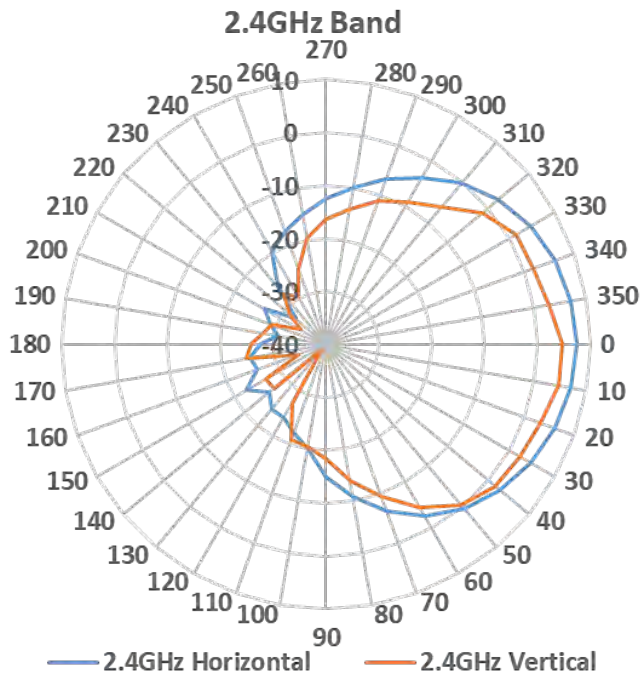

HIGHLIGHTS

FANT-10ACAX-1213-D-N

This high gain directional antenna is well suited for use outdoors, in warehouses, or in manufacturing environments where it must withstand exposure to moisture and dust. The narrow beam widths of this dual-polarized antenna are ideal for high-density environments including large public venues. This antenna features ten dual band pigtails and Type N connectors. An articulating mount is included with the antenna.



SPECIFICATIONS		
Frequency Range	2.4-2.5 GHz	5.1-5.9 GHz
Gain	12 dBi	13 dBi
Vertical Beamwidths	65°	70°
Horizontal Beamwidths	60°	65°
Nominal Impedance	50 ohms	50 ohms
VSWR	≤2.0	
Front-to-Back Ratio (dB)	≤18	≤25
Port-to-Port Isolation (dB)	≤28	
Connectors	10 x N-Male	
Cable Length	36 in. RG58 (91.4 cm)	
Dimensions	14.6 in. x 14.6 in. x 1.5 in. (371 x 371 x 3.81 cm)	
Weight	2.6 lb. (1.18 kg)	
Environment	Indoor / Outdoor	
Ingress Protection	IP-54 Compliant	
Operating Temperature	-40°F to +140°F (-40°C to +60°C)	

2.4GHz Band Horizontal Polarization

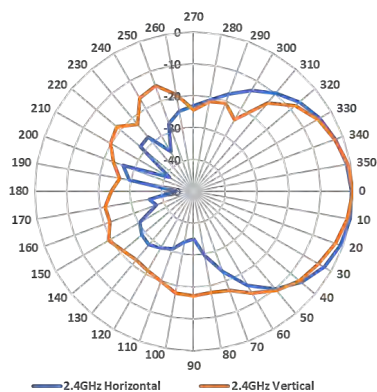

5.0GHz Band Horizontal Polarization

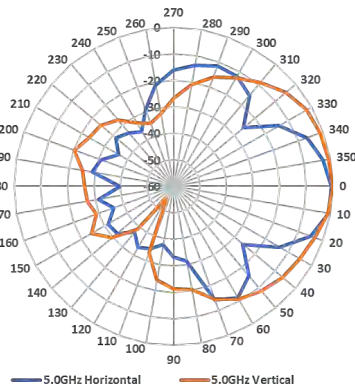

2.4GHz Band Vertical Polarization

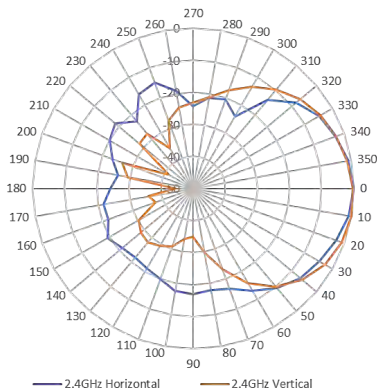

5.0GHz Band Vertical Polarization

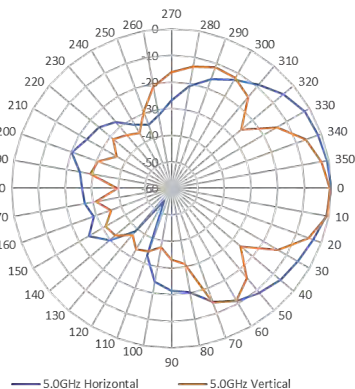

HIGHLIGHTS

FANT-02ACAX-0505-D-N FANT-02ACAX-0505-D-R

FANT-02ACAX-0505-D-N and FANT-02ACAX-0505-D-R are dual-band two-element 120° sector antennas for use in 2x2 MIMO applications. The antennas offer RPSMA and N-Type connectors respectively. The antennas provide coverage of 2.4–2.5 GHz and 4.9–5.9 GHz in a single antenna radome. The lightweight and durable construction and UV-protected radome made of plastic allow indoor and outdoor installation. This antenna is suitable for coverage of large rectangular areas like shopping centers, courtyards, and hallways.

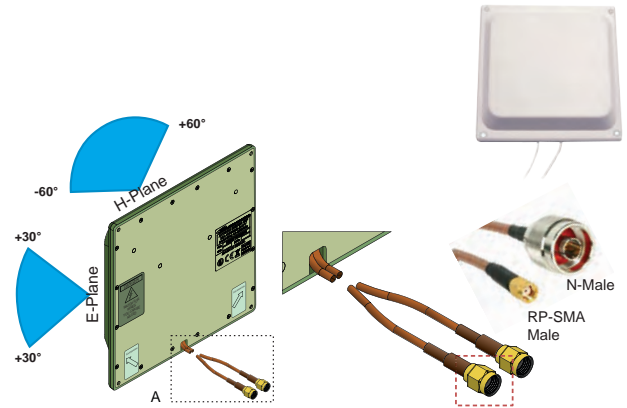

E-Plane Pattern

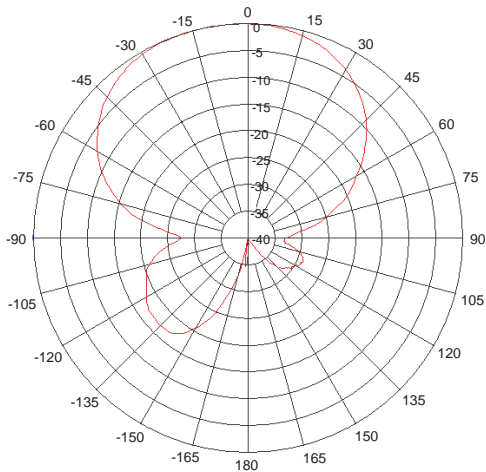

Frequency
2500 MHz

H-Plane Pattern

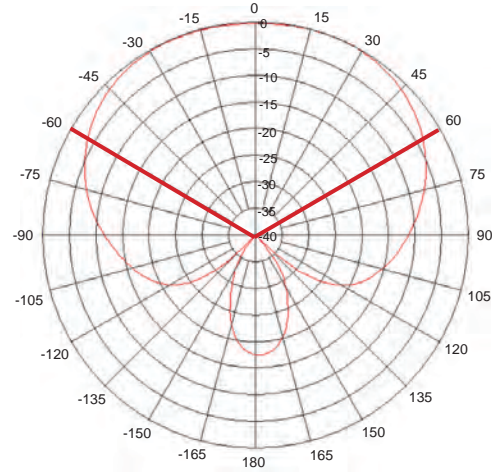

E-Plane Pattern

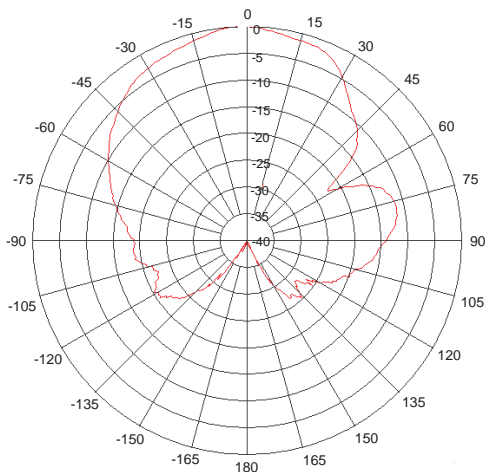

Frequency
5500 MHz

H-Plane Pattern

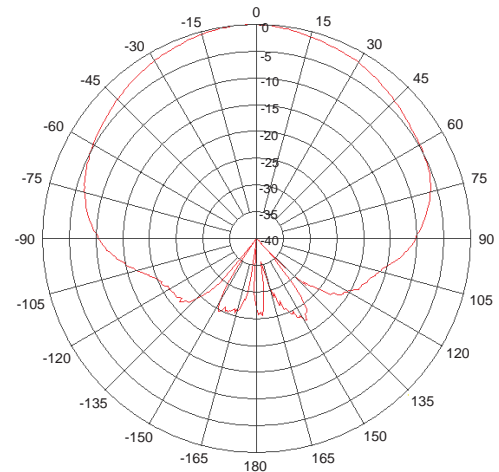

HIGHLIGHTS

FANT-04ACAX-0505-D-R

FANT-04ACAX-0505-D-R is a sector 120° 5 dBi wall mount indoor 4×4 MIMO sector panel antenna that provides coverage of 2.3–2.7 GHz and 4.9–6.1 GHz in a single antenna radome. This antenna has four RP-SMA connectors attached to 1.2 meter cables.



E-Plane Pattern

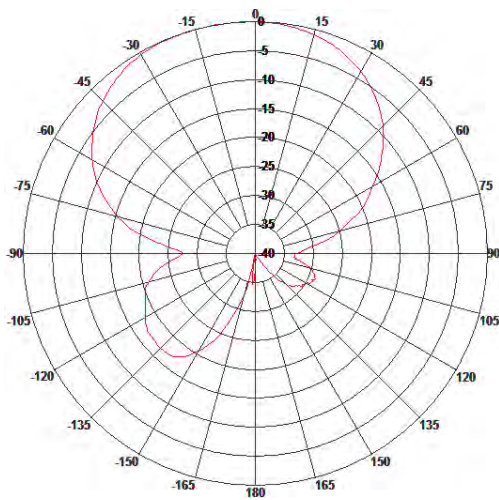

Frequency
2500 MHz

H-Plane Pattern

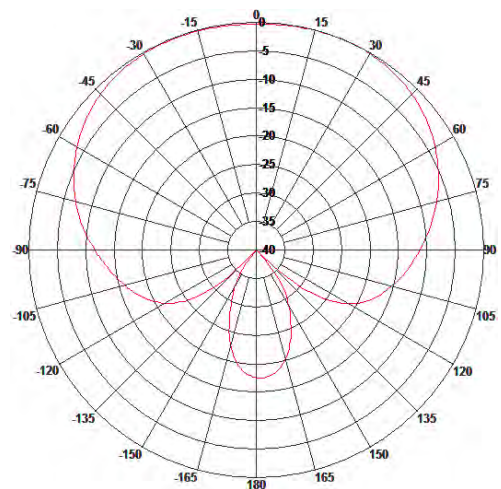

E-Plane Pattern

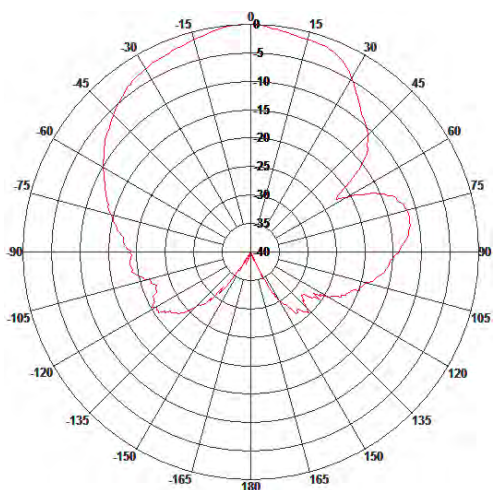

Frequency
5500 MHz

H-Plane Pattern

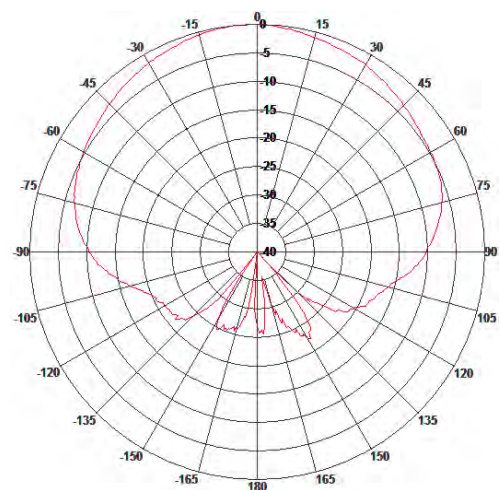

HIGHLIGHTS

FANT-04ACAX-0606-D-R

FANT-04ACAX-0606-D-R is a 60° 6 dBi dual-band 4x4 MIMO sector panel antenna with four connectors that provide coverage of 2.4–2.5 GHz and 5.15–5.875 GHz in a single antenna radome. This antenna has four RP-SMA connectors attached to 75 cm cables.

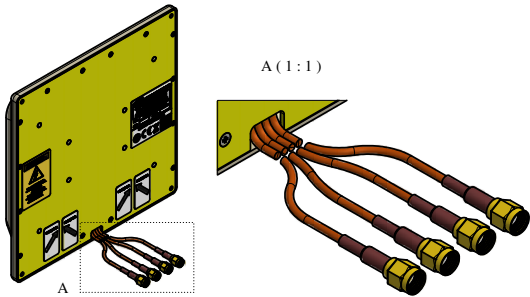

E-Plane Pattern

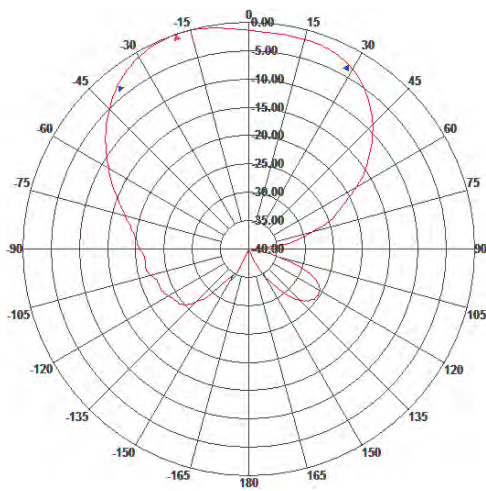

H-Plane Pattern

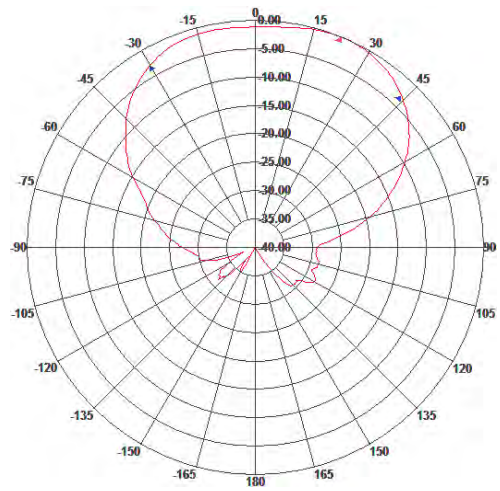

Frequency
2450 MHz

E-Plane Pattern

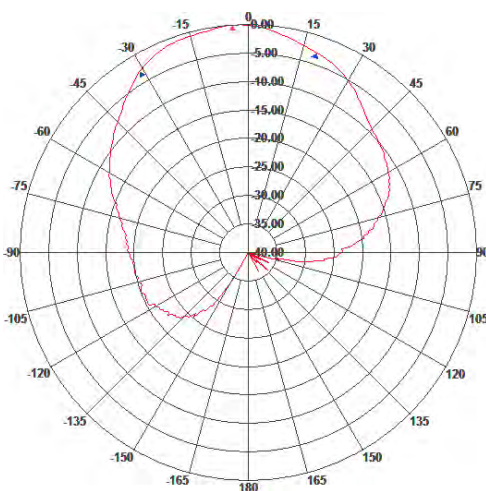

H-Plane Pattern

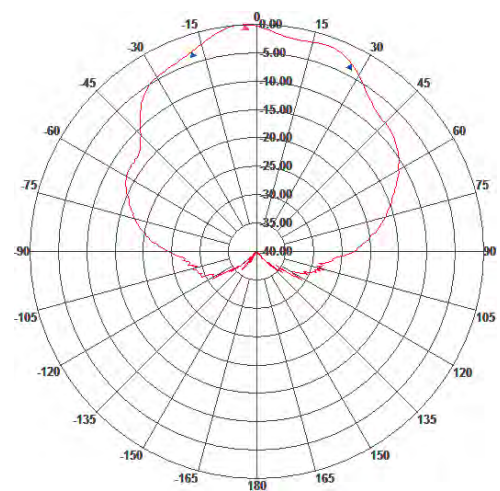

Frequency
5300 MHz



MOUNTING HARDWARE

SKU	MOUNTING HARDWARE INCLUDED	MOUNTING BRACKET BOLT PATTERN	MOUNT STAND OFF ANTENNA DISTANCE
FANT-04ABGN-2504-O-R	Nut (Ceiling Mount)	N/A	N/A
FANT-04ABGN-0606-O-R	L-Bracket	1.97 in. x 2.36 in.	1.5 in.
FANT-04ABGN-0606-O-N	L-Bracket	1.97 in. x 2.36 in.	1.5 in.
FANT-06ABGN-0606-O-R	L-Bracket	1.97 in. x 2.36 in.	1.5 in.
FANT-06ABGN-2504-O-R	Nut (Ceiling Mount)	N/A	N/A
FANT-04ABGN-0606-P-R	Universal Articulating Mount	2 in. x 2 in.	3.3 in.
FANT-04ABGN-1414-P-N	Industrial Articulating Mount	Multiple (incl. 2 in. x 2 in.)	5.91 in.
FANT-04ABGN-8065-P-N	Universal Articulating Mount	2 in. x 2 in.	3.3 in.
FANT-08ABGN-1213-D-R	10 in. Strong Arm Mount	2 in. x 2 in.	10 in.



L-Bracket

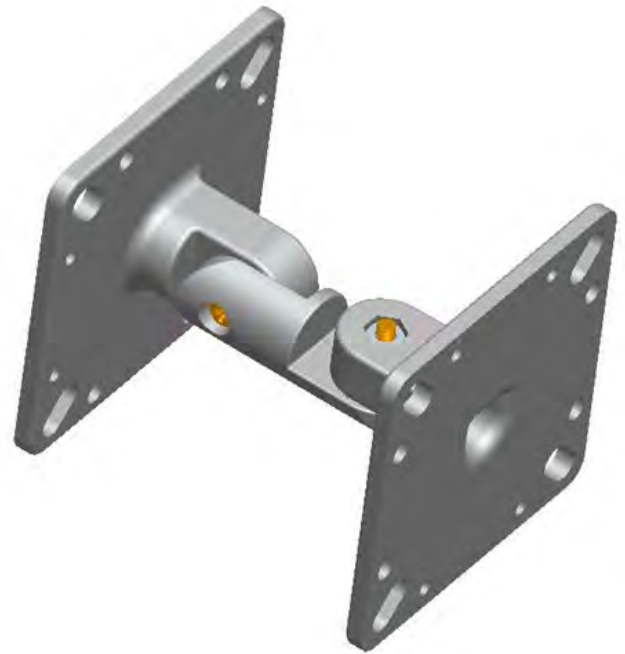

Universal Articulating Mount

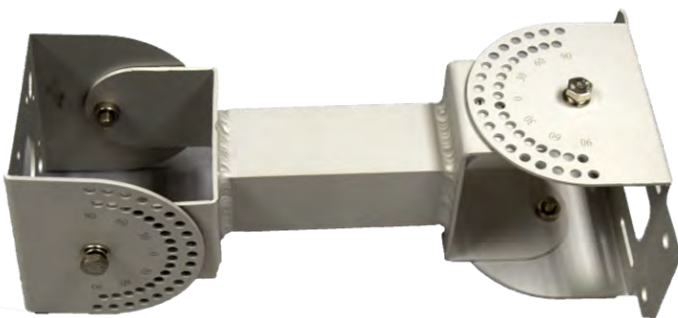

Strong Arm Mount



Industrial Articulating Mount



SKU COMPARISON

SKU	FANT-04ABGN-2504-O-R	FANT-04ABGN-0606-O-R / FANT-04ABGN-0606-O-N	FANT-06ABGN-0606-O-R	FANT-06ABGN-2504-O-R	FANT-04ABGN-0606-P-R	FANT-04ABGN-1414-P-N	FANT-04ABGN-8065-P-N	FANT-06ABGN-1213-D-R
Frequency	2400-2500 MHz 4900-5850 MHz	2400-2500 MHz 5150-5850 MHz	2400-2500 MHz 5150-5850 MHz	2400-2483 MHz 5150-5850 MHz	2400-2500 MHz 5150-5850 MHz	2400-2500 MHz 5150-5850 MHz	2400-2500 GHz 5100-5900 GHz	2400-2500 MHz 5150-5850 MHz
Bandwidth	100 MHz & 950 MHz	100 MHz & 700 MHz	100 MHz	83 MHz & 700 MHz	--	100 MHz & 700 MHz	--	100 MHz & 700 MHz
Gain	2.5 dBi / 4 dBi	6 dBi	6 dBi	2.5 dBi / 4 dBi	6 dBi	14 dBi	8 dBi / 6.5 dBi	12 dBi / 13 dBi
Vertical Beamwidth	--	45° / 20°	35° / 25°	55° / 60°	80±20° / 45±20°	35°	65° / 70°	45° / 28° (Ports 1-4) 50° / 40° (Ports 5-8)
Horizontal Beamwidth	360°	360°	360°	360°	80±20° / 45±20°	35°	60° / 65°	50° / 40° (Ports 1-4) 45° / 28° (Ports 5-8)
VSWR	≤2	≤2.2	Typical ≤1.5 - 2.0	≤2.0 / ≤2.5	≤2.0 / ≤2.5	≤2	<2	≤2.25
Front-to-back ratio	--	--	--	--	≤18	--	>13 dB / >15 dB	≤19 dB
Port to Port Isolation	--	--	--	--	--	--	>25 dB / >30 dB	≤18 dB / ≤ 25 dB
Nominal Impedance	50 ohms	50 ohms	50 ohms	50 ohms	50 ohms	50 ohms	50 ohms	50 ohms
Polarization	Vertical	Vertical	Vertical	Vertical	Vertical	Vertical / Linear	--	4x Horizontal / 4x Vertical
Isolation	--	≤-15dB	≤-15dB	--	--	≤28dB	--	--
Max Power	50 Watts	10 Watts	10 Watts	50 Watts	100 Watts	50 Watts	--	50 Watts
Lightning Protection	--	Not DC Grounded	Not DC Grounded	--	--	--	--	--
Connectors	4 x RPSMA Male	4 x RPSMA Male or 4 x N-Type Male	6 x RPSMA Male	6 x RPSMA Male	4 x RPSMA Male	N-Type Male	4 x N-Type Male	8 x RPSMA Male
Cable Length	4X CABLE RPSMA PLUG D12MM- HOLE	4X 36INCH-CABLE RPSMA-PLUG 4X 36INCH-CABLE N-PLUG	6X 36INCH-CABLE RPSMA PLUG	6X 36INCH-CABLE RPSMA PLUG	4X 36INCH-CABLE RPSMA PLUG	--	4X 24INCH-CABLE N-PLUG	8X 36INCH-CABLE RPSMA PLUG
Digital Length	36 in. with Connector 91.44 cm with Connector	36 in. with Connector 91.44 cm with Connector	36 in. with Connector 91.44 cm with Connector	36 in. with Connector 91.44 cm with Connector	36 in. with Connector 91.44 cm with Connector	Need to order separately	--	36 in. with Connector 91.44 cm with Connector
Environment	Indoor / Outdoor	Indoor / Outdoor	Indoor / Outdoor	Indoor - Plenum rated	Indoor / Outdoor	Indoor / Outdoor	Indoor / Outdoor	Indoor / Outdoor
Ingress Protection	--	--	--	--	--	--	IP-66 Compliant	IP-54 Compliant
Operating Temperature	-40°F to +158°F -40°C to +70°C	-40°F to +158°F -40°C to +70°C	-40°F to +158°F -40°C to +70°C	-40°F to +158°F -40°C to +70°C	-40°F to +140°F -40°C to +60°C	-22°F to +158°F -30°C to +70°C	-40°F to +140°F -40°C to +60°C	-40° to 140° F -40° to 60° C
Wind Load	--	134 mph 216 km/h	134 mph 216 km/h	--	--	--	--	100 mph 160 km/h
Mounting Method	Surface	Mast or Wall	Mast or Wall	Ceiling	Wall or Mast/Pole	Mast	--	--



ORDER INFORMATION

PRODUCT	SKU	DESCRIPTION
Fortinet Antennas	FANT-04ABGN-2504-O-R	2.4/5GHz 2.5/4dBi Wi-Fi Omni Micro Antenna with 4 RPSMA Connectors
	FANT-04ABGN-0606-O-R	2.4/5GHz 6dBi Wi-Fi Omni Antenna with 4 RPSMA Connectors
	FANT-04ABGN-0606-O-N	2.4/5GHz 6dBi Wi-Fi Omni Antenna with 4 N-Style Connectors
	FANT-06ABGN-0606-O-R	2.4/5GHz 6dBi Wi-Fi Omni Antenna with 6 RPSMA Connectors
	FANT-06ABGN-2504-O-R	2.4/5GHz 2.5/4 dBi Wi-Fi Omni Antenna with 6 RPSMA Connectors (Ceiling Mount)
	FANT-04ABGN-0606-P-R	2.4/5GHz 6dBi Wi-Fi Patch (H:80/45/V:45/80) Antenna with 4 RPSMA Connectors
	FANT-04ABGN-1414-P-N	2.4/5GHz 14dBi Wi-Fi Patch (H:35/V:35) Antenna with 4 N-Style Connectors
	FANT-04ABGN-8065-P-N	2.4/5GHz 8/6.5dBi Wi-Fi Patch (H:60/65/V:65/70) Antenna with 4 N-Style Connectors
	FANT-08ABGN-1213-D-R	2.4/5 GHz 12/13 dBi Wi-Fi Directional Antenna (H:50/40/V:45/28) with 8 RPSMA Connectors
	FANT-06ACAX-8509-D-N	2.4/5 GHz 8.5/9 dBi Wi-Fi Directional Antenna with 6 N-Type Male Connectors
	FANT-10ACAX-1213-D-N	2.4/5 GHz 12/13 dBi Wi-Fi Directional Antenna with 10 N-Male Connector
	FANT-02ACAX-0505-D-N	2.4/5GHz 5dBi/5dBi Wi-Fi directional Sector Antenna with 2 N-Style Connectors
	FANT-02ACAX-0505-D-R	2.4/5GHz 5dBi/5dBi Wi-Fi directional Sector Antenna with 2 RPSMA Connectors
	FANT-04ACAX-0505-D-R	2.4/5GHz 5dBi/5dBi Wi-Fi directional Sector Antenna with 4 RPSMA Connectors
	FANT-04ACAX-0606-D-R	2.4/5GHz 6dBi/6dBi Wi-Fi directional High gain Narrow Beam width Sector Antenna with 4 RPSMA Connectors



www.fortinet.com

Copyright © 2021 Fortinet, Inc. All rights reserved. Fortinet®, FortiGate®, FortiCare® and FortiGuard®, and certain other marks are registered trademarks of Fortinet, Inc., and other Fortinet names herein may also be registered and/or common law trademarks of Fortinet. All other product or company names may be trademarks of their respective owners. Performance and other metrics contained herein were attained in internal lab tests under ideal conditions, and actual performance and other results may vary. Network variables, different network environments and other conditions may affect performance results. Nothing herein represents any binding commitment by Fortinet, and Fortinet disclaims all warranties, whether express or implied, except to the extent Fortinet enters a binding written contract, signed by Fortinet's General Counsel, with a purchaser that expressly warrants that the identified product will perform according to certain expressly-identified performance metrics and, in such event, only the specific performance metrics expressly identified in such binding written contract shall be binding on Fortinet. For absolute clarity, any such warranty will be limited to performance in the same ideal conditions as in Fortinet's internal lab tests. Fortinet disclaims in full any covenants, representations, and guarantees pursuant hereto, whether express or implied. Fortinet reserves the right to change, modify, transfer, or otherwise revise this publication without notice, and the most current version of the publication shall be applicable.