



FCC Radio Test Report

FCC ID : TVE-4111BBE0671
Equipment : Secured Wireless Access Point
Brand Name : FORTINET
Model Name : FortiAP U432Fxxxxxx, FAP-U432Fxxxxxx,
FORTIAP-U432Fxxxxxx
(where “x” can be “A-Z”, or “0-9”, or “-“, or blank for software purposes or marketing purposes only)
Applicant : Fortinet, Inc.
899 Kifer Road, Sunnyvale, CA 94086, USA
Manufacturer : Fortinet, Inc.
899 Kifer Road, Sunnyvale, CA 94086, USA
Standard : 47 CFR FCC Part 15.407

The product was received on Feb. 09, 2022, and testing was started from May 26, 2022 and completed on Aug. 25, 2022. We, SPORTON INTERNATIONAL INC. Hsinhua Laboratory, would like to declare that the tested sample has been evaluated in accordance with the procedures given in ANSI C63.10-2013 and shown compliance with the applicable technical standards.

The test results in this variant report apply exclusively to the tested model / sample. Without written approval of SPORTON INTERNATIONAL INC. Hsinhua Laboratory, the test report shall not be reproduced except in full.

Approved by: Jackson Tsai

SPORTON INTERNATIONAL INC. Hsinhua Laboratory

No.52, Huaya 1st Rd., Guishan Dist., Taoyuan City 333411, Taiwan (R.O.C.)



Table of Contents

HISTORY OF THIS TEST REPORT3

SUMMARY OF TEST RESULT4

1 GENERAL DESCRIPTION5

1.1 Information.....5

1.2 Testing Applied Standards16

1.3 Testing Location Information16

1.4 Measurement Uncertainty16

2 TEST CONFIGURATION OF EUT.....17

2.1 Test Channel Mode17

2.2 The Worst Case Measurement Configuration.....30

2.3 Accessories32

2.4 Support Equipment.....32

2.5 Test Setup Diagram33

3 TRANSMITTER TEST RESULT36

3.1 AC Power-line Conducted Emissions36

3.2 Emission Bandwidth38

3.3 Maximum Conducted Output Power39

3.4 Peak Power Spectral Density.....41

3.5 Unwanted Emissions.....43

4 TEST EQUIPMENT AND CALIBRATION DATA.....47

APPENDIX A. TEST RESULTS OF AC POWER-LINE CONDUCTED EMISSIONS

APPENDIX B. TEST RESULTS OF EMISSION BANDWIDTH

APPENDIX C. TEST RESULTS OF MAXIMUM CONDUCTED OUTPUT POWER AND MAX. E.I.R.P. AT ANY ELEVATION ANGLE ABOVE 30 DEGREES RESULT

APPENDIX D. TEST RESULTS OF PEAK POWER SPECTRAL DENSITY

APPENDIX E. TEST RESULTS OF UNWANTED EMISSIONS

APPENDIX F. TEST RESULTS OF RADIATED EMISSION CO-LOCATION

APPENDIX G. TEST PHOTOS

PHOTOGRAPHS OF EUT V01



History of this test report

Report No.	Version	Description	Issued Date
FR0D01422-02BN	01	Initial issue of report	Nov. 18, 2022



Summary of Test Result

Report Clause	Ref. Std. Clause	Test Items	Result (PASS/FAIL)	Remark
1.1.2	15.203	Antenna Requirement	PASS	-
3.1	15.207	AC Power-line Conducted Emissions	PASS	-
3.2	15.407(a)	Emission Bandwidth	PASS	-
3.3	15.407(a)	Maximum Conducted Output Power	PASS	-
3.4	15.407(a)	Peak Power Spectral Density	PASS	-
3.5	15.407(b)	Unwanted Emissions	PASS	-

Declaration of Conformity:
The test results with all measurement uncertainty excluded are presented in accordance with the regulation limits or requirements declared by manufacturers.
Comments and explanations:
None

Reviewed by: Barry Hsiao

Report Producer: Debby Hung



1 General Description

1.1 Information

1.1.1 RF General Information

Frequency Range (MHz)	IEEE Std. 802.11	Ch. Frequency (MHz)	Channel Number
5150-5250	a, n (HT20), ac (VHT20) ax (HEW20)	5180-5240	36-48 [4]
5250-5350		5260-5320	52-64 [4]
5470-5725		5500-5700	100-140 [11]
Straddle 5720		5720	144 [1]
5725-5850		5745-5825	149-165 [5]
5150-5250	n (HT40), ac (VHT40) ax (HEW40)	5190-5230	38-46 [2]
5250-5350		5270-5310	54-62 [2]
5470-5725		5510-5670	102-134 [5]
Straddle 5710		5710	142 [1]
5725-5850		5755-5795	151-159 [2]
5150-5250	ac (VHT80) , ax (HEW80)	5210	42 [1]
5250-5350		5290	58 [1]
5470-5725		5530-5610	106-122 [2]
Straddle 5690		5690	138 [1]
5725-5850		5775	155 [1]
5150-5350	ac (VHT160)	5250	50 [1]
5470-5725		5570	114 [1]

Non-Beamforming_Radio 1

Band	Mode	BWch (MHz)	Nant
5.47-5.725GHz	802.11a	20	4TX
5.725-5.85GHz	802.11a	20	4TX
5.47-5.725GHz	802.11n HT20	20	4TX
5.725-5.85GHz	802.11n HT20	20	4TX
5.47-5.725GHz	802.11n HT40	40	4TX
5.725-5.85GHz	802.11n HT40	40	4TX
5.47-5.725GHz	802.11ac VHT20	20	4TX
5.725-5.85GHz	802.11ac VHT20	20	4TX
5.47-5.725GHz	802.11ac VHT40	40	4TX
5.725-5.85GHz	802.11ac VHT40	40	4TX
5.47-5.725GHz	802.11ac VHT80	80	4TX



Band	Mode	BWch (MHz)	Nant
5.725-5.85GHz	802.11ac VHT80	80	4TX
5.47-5.725GHz	802.11ac VHT160	160	4TX
5.47-5.725GHz	802.11ax HEW20	20	4TX
5.725-5.85GHz	802.11ax HEW20	20	4TX
5.47-5.725GHz	802.11ax HEW40	40	4TX
5.725-5.85GHz	802.11ax HEW40	40	4TX
5.47-5.725GHz	802.11ax HEW80	80	4TX
5.725-5.85GHz	802.11ax HEW80	80	4TX
5.47-5.725GHz	802.11ax HEW160	160	4TX

Non-Beamforming_Radio 2

Band	Mode	BWch (MHz)	Nant
5.15-5.25GHz	802.11a	20	4TX
5.25-5.35GHz	802.11a	20	4TX
5.47-5.725GHz	802.11a	20	4TX
5.725-5.85GHz	802.11a	20	4TX
5.15-5.25GHz	802.11n HT20	20	4TX
5.25-5.35GHz	802.11n HT20	20	4TX
5.47-5.725GHz	802.11n HT20	20	4TX
5.725-5.85GHz	802.11n HT20	20	4TX
5.15-5.25GHz	802.11n HT40	40	4TX
5.25-5.35GHz	802.11n HT40	40	4TX
5.47-5.725GHz	802.11n HT40	40	4TX
5.725-5.85GHz	802.11n HT40	40	4TX
5.15-5.25GHz	802.11ac VHT20	20	4TX
5.25-5.35GHz	802.11ac VHT20	20	4TX
5.47-5.725GHz	802.11ac VHT20	20	4TX
5.725-5.85GHz	802.11ac VHT20	20	4TX
5.15-5.25GHz	802.11ac VHT40	40	4TX
5.25-5.35GHz	802.11ac VHT40	40	4TX
5.47-5.725GHz	802.11ac VHT40	40	4TX
5.725-5.85GHz	802.11ac VHT40	40	4TX
5.15-5.25GHz	802.11ac VHT80	80	4TX
5.25-5.35GHz	802.11ac VHT80	80	4TX
5.47-5.725GHz	802.11ac VHT80	80	4TX
5.725-5.85GHz	802.11ac VHT80	80	4TX



Band	Mode	BWch (MHz)	Nant
5.15-5.25GHz	802.11ac VHT160	160	4TX
5.25-5.35GHz	802.11ac VHT160	160	4TX
5.47-5.725GHz	802.11ac VHT160	160	4TX
5.15-5.25GHz	802.11ax HEW20	20	4TX
5.25-5.35GHz	802.11ax HEW20	20	4TX
5.47-5.725GHz	802.11ax HEW20	20	4TX
5.725-5.85GHz	802.11ax HEW20	20	4TX
5.15-5.25GHz	802.11ax HEW40	40	4TX
5.25-5.35GHz	802.11ax HEW40	40	4TX
5.47-5.725GHz	802.11ax HEW40	40	4TX
5.725-5.85GHz	802.11ax HEW40	40	4TX
5.15-5.25GHz	802.11ax HEW80	80	4TX
5.25-5.35GHz	802.11ax HEW80	80	4TX
5.47-5.725GHz	802.11ax HEW80	80	4TX
5.725-5.85GHz	802.11ax HEW80	80	4TX
5.15-5.25GHz	802.11ax HEW160	160	4TX
5.25-5.35GHz	802.11ax HEW160	160	4TX
5.47-5.725GHz	802.11ax HEW160	160	4TX

Non-Beamforming_Radio 3

Band	Mode	BWch (MHz)	Nant
5.15-5.25GHz	802.11a	20	2TX
5.25-5.35GHz	802.11a	20	2TX
5.47-5.725GHz	802.11a	20	2TX
5.725-5.85GHz	802.11a	20	2TX
5.15-5.25GHz	802.11n HT20	20	2TX
5.25-5.35GHz	802.11n HT20	20	2TX
5.47-5.725GHz	802.11n HT20	20	2TX
5.725-5.85GHz	802.11n HT20	20	2TX
5.15-5.25GHz	802.11n HT40	40	2TX
5.25-5.35GHz	802.11n HT40	40	2TX
5.47-5.725GHz	802.11n HT40	40	2TX
5.725-5.85GHz	802.11n HT40	40	2TX
5.15-5.25GHz	802.11ac VHT20	20	2TX
5.25-5.35GHz	802.11ac VHT20	20	2TX
5.47-5.725GHz	802.11ac VHT20	20	2TX



Band	Mode	BWch (MHz)	Nant
5.725-5.85GHz	802.11ac VHT20	20	2TX
5.15-5.25GHz	802.11ac VHT40	40	2TX
5.25-5.35GHz	802.11ac VHT40	40	2TX
5.47-5.725GHz	802.11ac VHT40	40	2TX
5.725-5.85GHz	802.11ac VHT40	40	2TX
5.15-5.25GHz	802.11ac VHT80	80	2TX
5.25-5.35GHz	802.11ac VHT80	80	2TX
5.47-5.725GHz	802.11ac VHT80	80	2TX
5.725-5.85GHz	802.11ac VHT80	80	2TX
5.15-5.25GHz	802.11ax HEW20	20	2TX
5.25-5.35GHz	802.11ax HEW20	20	2TX
5.47-5.725GHz	802.11ax HEW20	20	2TX
5.725-5.85GHz	802.11ax HEW20	20	2TX
5.15-5.25GHz	802.11ax HEW40	40	2TX
5.25-5.35GHz	802.11ax HEW40	40	2TX
5.47-5.725GHz	802.11ax HEW40	40	2TX
5.725-5.85GHz	802.11ax HEW40	40	2TX
5.15-5.25GHz	802.11ax HEW80	80	2TX
5.25-5.35GHz	802.11ax HEW80	80	2TX
5.47-5.725GHz	802.11ax HEW80	80	2TX
5.725-5.85GHz	802.11ax HEW80	80	2TX

Beamforming_Radio 1

Band	Mode	BWch (MHz)	Nant
5.47-5.725GHz	802.11ax HEW20-BF	20	4TX
5.725-5.85GHz	802.11ax HEW20-BF	20	4TX
5.47-5.725GHz	802.11ax HEW40-BF	40	4TX
5.725-5.85GHz	802.11ax HEW40-BF	40	4TX
5.47-5.725GHz	802.11ax HEW80-BF	80	4TX
5.725-5.85GHz	802.11ax HEW80-BF	80	4TX
5.47-5.725GHz	802.11ax HEW160-BF	160	4TX



Beamforming_Radio 2

Band	Mode	BWch (MHz)	Nant
5.15-5.25GHz	802.11ax HEW20-BF	20	4TX
5.25-5.35GHz	802.11ax HEW20-BF	20	4TX
5.47-5.725GHz	802.11ax HEW20-BF	20	4TX
5.725-5.85GHz	802.11ax HEW20-BF	20	4TX
5.15-5.25GHz	802.11ax HEW40-BF	40	4TX
5.25-5.35GHz	802.11ax HEW40-BF	40	4TX
5.47-5.725GHz	802.11ax HEW40-BF	40	4TX
5.725-5.85GHz	802.11ax HEW40-BF	40	4TX
5.15-5.25GHz	802.11ax HEW80-BF	80	4TX
5.25-5.35GHz	802.11ax HEW80-BF	80	4TX
5.47-5.725GHz	802.11ax HEW80-BF	80	4TX
5.725-5.85GHz	802.11ax HEW80-BF	80	4TX
5.15-5.25GHz	802.11ax HEW160-BF	160	4TX
5.25-5.35GHz	802.11ax HEW160-BF	160	4TX
5.47-5.725GHz	802.11ax HEW160-BF	160	4TX

Beamforming_Radio 3

Band	Mode	BWch (MHz)	Nant
5.15-5.25GHz	802.11ax HEW20-BF	20	2TX
5.25-5.35GHz	802.11ax HEW20-BF	20	2TX
5.47-5.725GHz	802.11ax HEW20-BF	20	2TX
5.725-5.85GHz	802.11ax HEW20-BF	20	2TX
5.15-5.25GHz	802.11ax HEW40-BF	40	2TX
5.25-5.35GHz	802.11ax HEW40-BF	40	2TX
5.47-5.725GHz	802.11ax HEW40-BF	40	2TX
5.725-5.85GHz	802.11ax HEW40-BF	40	2TX
5.15-5.25GHz	802.11ax HEW80-BF	80	2TX
5.25-5.35GHz	802.11ax HEW80-BF	80	2TX
5.47-5.725GHz	802.11ax HEW80-BF	80	2TX
5.725-5.85GHz	802.11ax HEW80-BF	80	2TX

Note:

- ♦ 11a, HT20 and HT40 use a combination of OFDM-BPSK, QPSK, 16QAM, 64QAM modulation.
- ♦ VHT20, VHT40, VHT80, VHT160 use a combination of OFDM-BPSK, QPSK, 16QAM, 64QAM, 256QAM modulation.
- ♦ HEW20, HEW40, HEW80, HEW160 use a combination of OFDMA-BPSK, QPSK, 16QAM, 64QAM, 256QAM, 1024QAM modulation.
- ♦ BWch is the nominal channel bandwidth.



1.1.2 Antenna Information

Ant.	Brand	Model Name	Antenna Type	Connector
1	SENAO	5718A0619300	Dipole	N-type
2	SENAO	5718A0619300	Dipole	N-type
3	SENAO	5718A0619300	Dipole	N-type
4	SENAO	5718A0619300	Dipole	N-type
5	SENAO	5718A0620300	Dipole	N-type
6	SENAO	5718A0620300	Dipole	N-type
7	SENAO	5718A0620300	Dipole	N-type
8	SENAO	5718A0620300	Dipole	N-type
9	SENAO	5718A0619300	Dipole	N-type
10	SENAO	5718A0619300	Dipole	N-type
11	SENAO	5718A0618300	Dipole	N-type
12	Fortinet	FANT-10ACAX-1213-D-N	Directional	N-type



Radio	Ant.	Port	Antenna Gain (dBi)				Cable Loss Gain (dBi)			
			2.4G	5G	BT	Zigbee	2.4G	5G	BT	Zigbee
1	1	1	5.5	7.2	-	-	0.6	1	-	-
	2	2	5.5	7.2	-	-	0.6	1	-	-
	3	3	5.5	7.2	-	-	0.5	0.8	-	-
	4	4	5.5	7.2	-	-	0.4	0.7	-	-
2	5	1	-	6.3	-	-	-	1	-	-
	6	2	-	6.3	-	-	-	1.1	-	-
	7	3	-	6.3	-	-	-	0.9	-	-
	8	4	-	6.3	-	-	-	0.9	-	-
3	9	1	5.5	7.2	-	-	0.6	1	-	-
	10	2	5.5	7.2	-	-	0.6	1	-	-
BT+Zigbee	11	1	-	-	4.5	4.5	-	-	0.5	0.5
1	12	1	12	13	-	-	0.6	1	-	-
1	12	2	12	13	-	-	0.6	1	-	-
1	12	3	12	13	-	-	0.5	0.8	-	-
1	12	4	12	13	-	-	0.4	0.7	-	-
2	12	1	12	13	-	-	-	1	-	-
2	12	2	12	13	-	-	-	1.1	-	-
2	12	3	12	13	-	-	-	0.9	-	-
2	12	4	12	13	-	-	-	0.9	-	-
3	12	1	12	13	-	-	0.6	1	-	-
3	12	2	12	13	-	-	0.6	1	-	-

Note 1: The EUT has twelve antennas.

For 2.4GHz function:

Radio 1

For IEEE 802.11 b/g/n/VHT/ax mode (4TX/4RX)

Ant. 1 (port 1), Ant. 2 (port 2), Ant. 3 (port 3) and Ant. 4 (port 4) could transmit/receive simultaneously.

Ant. 12 could transmit/receive simultaneously.

Radio 3

For IEEE 802.11 b/g/n/VHT/ax mode (2TX/2RX)

Ant. 9 (port 1) and Ant. 10 (port 2) could transmit/receive simultaneously.

Ant. 12 could transmit/receive simultaneously.

For 5GHz function:

Radio 1

For IEEE 802.11 a/n/ac/ax mode (4TX/4RX)

Ant. 1 (port 1), Ant. 2 (port 2), Ant. 3 (port 3) and Ant. 4 (port 4) could transmit/receive simultaneously.

Ant. 12 could transmit/receive simultaneously.



Radio 2

For IEEE 802.11 a/n/ac/ax mode (4TX/4RX)

Ant. 5 (port 1), Ant. 6 (port 2), Ant. 7 (port 3) and Ant. 8 (port 4) could transmit/receive simultaneously.

Ant. 12 could transmit/receive simultaneously.

Radio 3

For IEEE 802.11 a/n/ac/ax mode (2TX/2RX)

Ant. 9 (port 1) and Ant. 10 (port 2) could transmit/receive simultaneously.

Ant. 12 could transmit/receive simultaneously.

For Bluetooth function:

For IEEE 802.15.1 Bluetooth mode (1TX/1RX)

Only Ant. 11 (port 1) could transmit/receive.

For Zigbee function:

For Zigbee mode (1TX/1RX)

Only Ant. 11 (port 1) could transmit/receive.

1.1.3 EUT Information

Operational Condition			
EUT Power Type	From PoE		
EUT Function	<input checked="" type="checkbox"/>	Outdoor AP	<input type="checkbox"/> Indoor AP
	<input type="checkbox"/>	Fixed P2P AP	<input type="checkbox"/> Client
Beamforming Function	<input checked="" type="checkbox"/>	With beamforming	<input type="checkbox"/> Without beamforming
TPC Function	<input checked="" type="checkbox"/>	With TPC Function	<input type="checkbox"/> Without TPC Function
Weather Band	<input checked="" type="checkbox"/>	With 5600~5650MHz	<input type="checkbox"/> Without 5600~5650MHz
Resource Unit(802.11ax)	<input checked="" type="checkbox"/>	Full RU	<input type="checkbox"/> Partial RU
Type of EUT			
<input checked="" type="checkbox"/>	Stand-alone		
<input type="checkbox"/>	Combined (EUT where the radio part is fully integrated within another device)		
	Combined Equipment - Brand Name / Model No.: ...		
<input type="checkbox"/>	Plug-in radio (EUT intended for a variety of host systems)		
	Host System - Brand Name / Model No.:		
<input type="checkbox"/>	Other:		



1.1.4 Mode Test Duty Cycle

Non-Beamforming_Radio 1

Mode	DC	DCF(dB)	T(s)	VBW(Hz) ≥ 1/T
802.11a_Nss1,(6Mbps)_4TX	0.957	0.19	2.064m	1k
802.11n HT20_Nss1,(MCS0)_4TX	0.95	0.22	1.92m	1k
802.11n HT40_Nss1,(MCS0)_4TX	0.911	0.4	944.375u	3k
802.11ac VHT20_Nss1,(MCS0)_4TX	0.985	0.07	n/a (DC>=0.98)	n/a (DC>=0.98)
802.11ac VHT40_Nss1,(MCS0)_4TX	0.971	0.13	952.5u	3k
802.11ac VHT80_Nss1,(MCS0)_4TX	0.942	0.26	460.625u	3k
802.11ac VHT160_Nss1,(MCS0)_4TX	0.897	0.47	252.5u	10k
802.11ax HEW20_Nss1,(MCS0)_4TX	0.978	0.1	1.488m	1k
802.11ax HEW40_Nss1,(MCS0)_4TX	0.96	0.18	772.5u	3k
802.11ax HEW80_Nss1,(MCS0)_4TX	0.926	0.33	401.25u	3k
802.11ax HEW160_Nss1,(MCS0)_4TX	0.884	0.54	232.5u	10k

Note. If DC < 0.98, the DCF was added while measuring Output power and PSD.

Non-Beamforming_Radio 2

Mode	DC	DCF(dB)	T(s)	VBW(Hz) ≥ 1/T
802.11a_Nss1,(6Mbps)_4TX	0.957	0.19	2.064m	1k
802.11n HT20_Nss1,(MCS0)_4TX	0.95	0.22	1.921m	1k
802.11n HT40_Nss1,(MCS0)_4TX	0.901	0.45	944.375u	3k
802.11ac VHT20_Nss1,(MCS0)_4TX	0.985	0.07	n/a (DC>=0.98)	n/a (DC>=0.98)
802.11ac VHT40_Nss1,(MCS0)_4TX	0.971	0.13	952.5u	3k
802.11ac VHT80_Nss1,(MCS0)_4TX	0.939	0.27	460.625u	3k
802.11ac VHT160_Nss1,(MCS0)_4TX	0.897	0.47	252.5u	10k
802.11ax HEW20_Nss1,(MCS0)_4TX	0.978	0.1	1.488m	1k
802.11ax HEW40_Nss1,(MCS0)_4TX	0.963	0.16	772.5u	3k
802.11ax HEW80_Nss1,(MCS0)_4TX	0.926	0.33	401.25u	3k
802.11ax HEW160_Nss1,(MCS0)_4TX	0.884	0.54	232.5u	10k

Note. If DC < 0.98, the DCF was added while measuring Output power and PSD.



Non-Beamforming_Radio 3

Mode	DC	DCF(dB)	T(s)	VBW(Hz) ≥ 1/T
802.11a_Nss1,(6Mbps)_2TX	0.957	0.19	2.064m	1k
802.11n HT20_Nss1,(MCS0)_2TX	0.95	0.22	1.92m	1k
802.11n HT40_Nss1,(MCS0)_2TX	0.901	0.45	944.375u	3k
802.11ac VHT20_Nss1,(MCS0)_2TX	0.985	0.07	n/a (DC>=0.98)	n/a (DC>=0.98)
802.11ac VHT40_Nss1,(MCS0)_2TX	0.971	0.13	952.5u	3k
802.11ac VHT80_Nss1,(MCS0)_2TX	0.942	0.26	460.313u	3k
802.11ax HEW20_Nss1,(MCS0)_2TX	0.978	0.1	1.488m	1k
802.11ax HEW40_Nss1,(MCS0)_2TX	0.963	0.16	772.5u	3k
802.11ax HEW80_Nss1,(MCS0)_2TX	0.927	0.33	401.25u	3k

Note. If DC < 0.98, the DCF was added while measuring Output power and PSD.

Beamforming_Radio 1

Mode	DC	DCF(dB)	T(s)	VBW(Hz) ≥ 1/T
802.11ax HEW20-BF_Nss1,(MCS0)_4TX	0.945	0.25	2.931m	1k
802.11ax HEW40-BF_Nss1,(MCS0)_4TX	0.95	0.22	4.367m	300
802.11ax HEW80-BF_Nss1,(MCS0)_4TX	0.953	0.21	4.149m	300
802.11ax HEW160-BF_Nss1,(MCS0)_4TX	0.943	0.25	2.808m	1k

Note. If DC < 0.98, the DCF was added while measuring Output power and PSD.

Beamforming_Radio 2

Mode	DC	DCF(dB)	T(s)	VBW(Hz) ≥ 1/T
802.11ax HEW20-BF_Nss1,(MCS0)_4TX	0.946	0.24	2.931m	1k
802.11ax HEW40-BF_Nss1,(MCS0)_4TX	0.966	0.15	3.375m	300
802.11ax HEW80-BF_Nss1,(MCS0)_4TX	0.945	0.25	4.149m	300
802.11ax HEW160-BF_Nss1,(MCS0)_4TX	0.954	0.2	4.829m	300

Note. If DC < 0.98, the DCF was added while measuring Output power and PSD.

Beamforming_Radio 3

Mode	DC	DCF(dB)	T(s)	VBW(Hz) ≥ 1/T
802.11ax HEW20-BF_Nss1,(MCS0)_2TX	0.956	0.2	2.073m	1k
802.11ax HEW40-BF_Nss1,(MCS0)_2TX	0.954	0.2	5.101m	300
802.11ax HEW80-BF_Nss1,(MCS0)_2TX	0.955	0.2	4.149m	300

Note. If DC < 0.98, the DCF was added while measuring Output power and PSD.



1.1.5 Table for Multiple Listing

The brand/model names in the following table are all refer to the identical product.

Brand Name	Model Name	Description
FORTINET	FortiAP U432Fxxxxxx	All the models are identical, the difference model for served as marketing strategy.
	FAP-U432Fxxxxxx	
	FORTIAP-U432Fxxxxxx	

1.1.6 Table for Permissive Change

This product is an extension of original one reported under Sporton project number: FR0D1422BN and FR0D1422-01BN. Below is the table for the change of the product with respect to the original one.

Modifications	Performance Checking
Antenna 12 was added	All



1.2 Testing Applied Standards

According to the specifications of the manufacturer, the EUT must comply with the requirements of the following standards:

- ◆ 47 CFR FCC Part 15
- ◆ ANSI C63.10-2013
- ◆ KDB 789033 D02 v02r01

The following reference test guidance is not within the scope of accreditation of TAF:

- ◆ KDB 662911 D01 v02r01
- ◆ KDB 414788 D01 v01r01

1.3 Testing Location Information

Test Lab. : Sporton International Inc. Hsinhua Laboratory				
<input checked="" type="checkbox"/>	Hsinhua (TAF: 3785)	ADD: No.52, Huaya 1st Rd., Guishan Dist., Taoyuan City 333411, Taiwan (R.O.C.)		
		TEL: 886-3-327-3456	FAX: 886-3-327-0973	
Test site Designation No. TW3785 with FCC.				
Test Condition	Test Site No.	Test Engineer	Test Environment	Test Date
AC Conduction	CO04-HY	Ivan Chung	18.2~19.2°C / 50~54%	23/Jun/2022
RF Conducted	TH01-HY	Luby hsu	22.1~25.6°C / 51~57%	14/Jun/2022~10/Aug/2022
Radiated	03CH03-HY	Bart Chen	23.5~24.4°C / 55.4~57.5%	26/May/2022~25/Aug/2022
<input type="checkbox"/>	Wen 33rd.St. (TAF: 3785)	ADD: No.14-1, Ln. 19, Wen 33rd St., Guishan Dist., Taoyuan City 333010, Taiwan (R.O.C.)		
		TEL: 886-3-318-0787	FAX: 886-3-318-0287	
Test site Designation No. TW0008 with FCC.				

1.4 Measurement Uncertainty

ISO/IEC 17025 requires that an estimate of the measurement uncertainties associated with the emissions test results be included in the report. The measurement uncertainties given below are based on a 95% confidence level (based on a coverage factor (k=2))

Test Items	Uncertainty	Remark
AC Power-line Conducted Emissions	4.53 dB	Confidence levels of 95%
Emission Bandwidth	3 MHz	Confidence levels of 95%
Maximum Conducted Output Power	2 dB	Confidence levels of 95%
Power Spectral Density	2 dB	Confidence levels of 95%
Unwanted Emissions	4.8 dB	Confidence levels of 95%
Receiver Radiated Unwanted Emissions	4.8 dB	Confidence levels of 95%
Temperature	0.41 °C	Confidence levels of 95%
Humidity	3.4 %	Confidence levels of 95%



2 Test Configuration of EUT

2.1 Test Channel Mode

Test Software Version	accessMTool_REL_3_1_0_1
-----------------------	-------------------------

Non-Beamforming_Radio 1

Mode	Power Setting
802.11a_Nss1,(6Mbps)_4TX	-
5500MHz	33
5580MHz	22
5700MHz	25
5720MHz Straddle 5.47-5.725GHz	26
5720MHz Straddle 5.725-5.85GHz	26
5745MHz	72
5785MHz	73
5825MHz	73
802.11n HT20_Nss1,(MCS0)_4TX	-
5500MHz	27
5580MHz	23
5700MHz	26
5720MHz Straddle 5.47-5.725GHz	27
5720MHz Straddle 5.725-5.85GHz	27
5745MHz	71
5785MHz	72
5825MHz	72
802.11n HT40_Nss1,(MCS0)_4TX	-
5510MHz	39
5550MHz	36
5670MHz	37
5710MHz Straddle 5.47-5.725GHz	37
5710MHz Straddle 5.725-5.85GHz	37
5755MHz	72
5795MHz	73
802.11ac VHT20_Nss1,(MCS0)_4TX	-
5500MHz	27
5580MHz	23



Mode	Power Setting
5700MHz	26
5720MHz Straddle 5.47-5.725GHz	27
5720MHz Straddle 5.725-5.85GHz	27
5745MHz	71
5785MHz	72
5825MHz	72
802.11ac VHT40_Nss1,(MCS0)_4TX	-
5510MHz	39
5550MHz	36
5670MHz	37
5710MHz Straddle 5.47-5.725GHz	37
5710MHz Straddle 5.725-5.85GHz	37
5755MHz	72
5795MHz	73
802.11ac VHT80_Nss1,(MCS0)_4TX	-
5530MHz	44
5610MHz	45
5690MHz Straddle 5.47-5.725GHz	45
5690MHz Straddle 5.725-5.85GHz	45
5775MHz	73
802.11ac VHT160_Nss1,(MCS0)_4TX	-
5570MHz	47
802.11ax HEW20_Nss1,(MCS0)_4TX	-
5500MHz	27
5580MHz	23
5700MHz	26
5720MHz Straddle 5.47-5.725GHz	27
5720MHz Straddle 5.725-5.85GHz	27
5745MHz	71
5785MHz	72
5825MHz	72
802.11ax HEW40_Nss1,(MCS0)_4TX	-
5510MHz	39
5550MHz	36
5670MHz	37
5710MHz Straddle 5.47-5.725GHz	37



Mode	Power Setting
5710MHz Straddle 5.725-5.85GHz	37
5755MHz	72
5795MHz	73
802.11ax HEW80_Nss1,(MCS0)_4TX	-
5530MHz	44
5610MHz	45
5690MHz Straddle 5.47-5.725GHz	45
5690MHz Straddle 5.725-5.85GHz	45
5775MHz	73
802.11ax HEW160_Nss1,(MCS0)_4TX	-
5570MHz	47

Non-Beamforming_Radio 2

Mode	Power Setting
802.11a_Nss1,(6Mbps)_4TX	-
5180MHz	45
5200MHz	45
5240MHz	45
5260MHz	24
5300MHz	24
5320MHz	23
5500MHz	23
5580MHz	23
5700MHz	24
5720MHz Straddle 5.47-5.725GHz	25
5720MHz Straddle 5.725-5.85GHz	25
5745MHz	70
5785MHz	70
5825MHz	72
802.11n HT20_Nss1,(MCS0)_4TX	-
5180MHz	46
5200MHz	46
5240MHz	46
5260MHz	23
5300MHz	25
5320MHz	23



Mode	Power Setting
5500MHz	25
5580MHz	25
5700MHz	23
5720MHz Straddle 5.47-5.725GHz	23
5720MHz Straddle 5.725-5.85GHz	23
5745MHz	70
5785MHz	70
5825MHz	70
802.11n HT40_Nss1,(MCS0)_4TX	-
5190MHz	51
5230MHz	58
5270MHz	33
5310MHz	36
5510MHz	35
5550MHz	37
5670MHz	36
5710MHz Straddle 5.47-5.725GHz	37
5710MHz Straddle 5.725-5.85GHz	37
5755MHz	71
5795MHz	71
802.11ac VHT20_Nss1,(MCS0)_4TX	-
5180MHz	46
5200MHz	46
5240MHz	46
5260MHz	23
5300MHz	25
5320MHz	23
5500MHz	25
5580MHz	25
5700MHz	23
5720MHz Straddle 5.47-5.725GHz	23
5720MHz Straddle 5.725-5.85GHz	23
5745MHz	70
5785MHz	70
5825MHz	70
802.11ac VHT40_Nss1,(MCS0)_4TX	-



Mode	Power Setting
5190MHz	51
5230MHz	58
5270MHz	33
5310MHz	36
5510MHz	35
5550MHz	37
5670MHz	36
5710MHz Straddle 5.47-5.725GHz	37
5710MHz Straddle 5.725-5.85GHz	37
5755MHz	71
5795MHz	71
802.11ac VHT80_Nss1,(MCS0)_4TX	-
5210MHz	53
5290MHz	46
5530MHz	45
5610MHz	45
5690MHz Straddle 5.47-5.725GHz	45
5690MHz Straddle 5.725-5.85GHz	45
5775MHz	72
802.11ac VHT160_Nss1,(MCS0)_4TX	-
5250MHz Straddle 5.15-5.25GHz	47
5250MHz Straddle 5.25-5.35GHz	47
5570MHz	44
802.11ax HEW20_Nss1,(MCS0)_4TX	-
5180MHz	46
5200MHz	46
5240MHz	46
5260MHz	23
5300MHz	25
5320MHz	23
5500MHz	25
5580MHz	25
5700MHz	23
5720MHz Straddle 5.47-5.725GHz	23
5720MHz Straddle 5.725-5.85GHz	23
5745MHz	70



Mode	Power Setting
5785MHz	70
5825MHz	70
802.11ax HEW40_Nss1,(MCS0)_4TX	-
5190MHz	51
5230MHz	58
5270MHz	33
5310MHz	36
5510MHz	35
5550MHz	37
5670MHz	36
5710MHz Straddle 5.47-5.725GHz	37
5710MHz Straddle 5.725-5.85GHz	37
5755MHz	71
5795MHz	71
802.11ax HEW80_Nss1,(MCS0)_4TX	-
5210MHz	53
5290MHz	46
5530MHz	45
5610MHz	45
5690MHz Straddle 5.47-5.725GHz	45
5690MHz Straddle 5.725-5.85GHz	45
5775MHz	72
802.11ax HEW160_Nss1,(MCS0)_4TX	-
5250MHz Straddle 5.15-5.25GHz	47
5250MHz Straddle 5.25-5.35GHz	47
5570MHz	44



Non-Beamforming_Radio 3

Mode	Power Setting
802.11a_Nss1,(6Mbps)_2TX	-
5180MHz	65
5200MHz	66
5240MHz	66
5260MHz	45
5300MHz	45
5320MHz	45
5500MHz	45
5580MHz	45
5700MHz	47
5720MHz Straddle 5.47-5.725GHz	47
5720MHz Straddle 5.725-5.85GHz	47
5745MHz	82
5785MHz	82
5825MHz	82
802.11n HT20_Nss1,(MCS0)_2TX	-
5180MHz	63
5200MHz	67
5240MHz	67
5260MHz	46
5300MHz	45
5320MHz	45
5500MHz	45
5580MHz	45
5700MHz	47
5720MHz Straddle 5.47-5.725GHz	48
5720MHz Straddle 5.725-5.85GHz	48
5745MHz	80
5785MHz	80
5825MHz	80
802.11n HT40_Nss1,(MCS0)_2TX	-
5190MHz	53
5230MHz	68
5270MHz	54



Mode	Power Setting
5310MHz	52
5510MHz	55
5550MHz	56
5670MHz	57
5710MHz Straddle 5.47-5.725GHz	58
5710MHz Straddle 5.725-5.85GHz	58
5755MHz	83
5795MHz	83
802.11ac VHT20_Nss1,(MCS0)_2TX	-
5180MHz	63
5200MHz	67
5240MHz	67
5260MHz	46
5300MHz	45
5320MHz	45
5500MHz	45
5580MHz	45
5700MHz	47
5720MHz Straddle 5.47-5.725GHz	48
5720MHz Straddle 5.725-5.85GHz	48
5745MHz	80
5785MHz	80
5825MHz	80
802.11ac VHT40_Nss1,(MCS0)_2TX	-
5190MHz	53
5230MHz	68
5270MHz	54
5310MHz	52
5510MHz	55
5550MHz	56
5670MHz	57
5710MHz Straddle 5.47-5.725GHz	58
5710MHz Straddle 5.725-5.85GHz	58
5755MHz	83
5795MHz	83
802.11ac VHT80_Nss1,(MCS0)_2TX	-



Mode	Power Setting
5210MHz	60
5290MHz	51
5530MHz	57
5610MHz	58
5690MHz Straddle 5.47-5.725GHz	59
5690MHz Straddle 5.725-5.85GHz	59
5775MHz	68
802.11ax HEW20_Nss1,(MCS0)_2TX	-
5180MHz	63
5200MHz	67
5240MHz	67
5260MHz	46
5300MHz	45
5320MHz	45
5500MHz	45
5580MHz	45
5700MHz	47
5720MHz Straddle 5.47-5.725GHz	48
5720MHz Straddle 5.725-5.85GHz	48
5745MHz	80
5785MHz	80
5825MHz	80
802.11ax HEW40_Nss1,(MCS0)_2TX	-
5190MHz	53
5230MHz	68
5270MHz	54
5310MHz	52
5510MHz	55
5550MHz	56
5670MHz	57
5710MHz Straddle 5.47-5.725GHz	58
5710MHz Straddle 5.725-5.85GHz	58
5755MHz	83
5795MHz	83
802.11ax HEW80_Nss1,(MCS0)_2TX	-
5210MHz	60



Mode	Power Setting
5290MHz	51
5530MHz	57
5610MHz	58
5690MHz Straddle 5.47-5.725GHz	59
5690MHz Straddle 5.725-5.85GHz	59
5775MHz	68

Test Software Version	Dos 6.1
-----------------------	---------

Beamforming_Radio 1

Mode	Power Setting
802.11ax HEW20-BF_Nss1,(MCS0)_4TX	-
5500MHz	25
5580MHz	21
5700MHz	24
5720MHz Straddle 5.47-5.725GHz	23
5720MHz Straddle 5.725-5.85GHz	23
5745MHz	43
5785MHz	44
5825MHz	45
802.11ax HEW40-BF_Nss1,(MCS0)_4TX	-
5510MHz	23
5550MHz	23
5670MHz	23
5710MHz Straddle 5.47-5.725GHz	24
5710MHz Straddle 5.725-5.85GHz	24
5755MHz	43
5795MHz	44
802.11ax HEW80-BF_Nss1,(MCS0)_4TX	-
5530MHz	23
5610MHz	23
5690MHz Straddle 5.47-5.725GHz	22
5690MHz Straddle 5.725-5.85GHz	22
5775MHz	42
802.11ax HEW160-BF_Nss1,(MCS0)_4TX	-
5570MHz	23



Beamforming_Radio 2

Mode	Power Setting
802.11ax HEW20-BF_Nss1,(MCS0)_4TX	-
5180MHz	47
5200MHz	47
5240MHz	46
5260MHz	24
5300MHz	24
5320MHz	23
5500MHz	25
5580MHz	25
5700MHz	25
5720MHz Straddle 5.47-5.725GHz	25
5720MHz Straddle 5.725-5.85GHz	25
5745MHz	46
5785MHz	46
5825MHz	46
802.11ax HEW40-BF_Nss1,(MCS0)_4TX	-
5190MHz	47
5230MHz	46
5270MHz	23
5310MHz	25
5510MHz	25
5550MHz	24
5670MHz	24
5710MHz Straddle 5.47-5.725GHz	28
5710MHz Straddle 5.725-5.85GHz	28
5755MHz	46
5795MHz	46
802.11ax HEW80-BF_Nss1,(MCS0)_4TX	-
5210MHz	48
5290MHz	24
5530MHz	23
5610MHz	23
5690MHz Straddle 5.47-5.725GHz	28
5690MHz Straddle 5.725-5.85GHz	28
5775MHz	46



Mode	Power Setting
802.11ax HEW160-BF_Nss1,(MCS0)_4TX	-
5250MHz Straddle 5.15-5.25GHz	41
5250MHz Straddle 5.25-5.35GHz	41
5570MHz	22

Beamforming_Radio 3

Mode	Power Setting
802.11ax HEW20-BF_Nss1,(MCS0)_2TX	-
5180MHz	65
5200MHz	68
5240MHz	68
5260MHz	45
5300MHz	46
5320MHz	45
5500MHz	45
5580MHz	45
5700MHz	46
5720MHz Straddle 5.47-5.725GHz	48
5720MHz Straddle 5.725-5.85GHz	48
5745MHz	68
5785MHz	68
5825MHz	68
802.11ax HEW40-BF_Nss1,(MCS0)_2TX	-
5190MHz	61
5230MHz	69
5270MHz	47
5310MHz	46
5510MHz	46
5550MHz	46
5670MHz	46
5710MHz Straddle 5.47-5.725GHz	54
5710MHz Straddle 5.725-5.85GHz	54
5755MHz	70
5795MHz	70
802.11ax HEW80-BF_Nss1,(MCS0)_2TX	-
5210MHz	62



Mode	Power Setting
5290MHz	46
5530MHz	45
5610MHz	45
5690MHz Straddle 5.47-5.725GHz	52
5690MHz Straddle 5.725-5.85GHz	52
5775MHz	70

2.2 The Worst Case Measurement Configuration

The Worst Case Mode for Following Conformance Tests	
Tests Item	AC power-line conducted emissions
Condition	AC power-line conducted measurement for line and neutral Test Voltage: 120Vac / 60Hz
Operating Mode	CTX
1	PoE mode

The Worst Case Mode for Following Conformance Tests	
Tests Item	Emission Bandwidth Maximum Conducted Output Power Peak Power Spectral Density
Test Condition	Conducted measurement at transmit chains

The Worst Case Mode for Following Conformance Tests	
Tests Item	Unwanted Emissions
Test Condition	Radiated measurement If EUT consist of multiple antenna assembly (multiple antenna are used in EUT regardless of spatial multiplexing MIMO configuration), the radiated test should be performed with highest antenna gain of each antenna type.
Operating Mode < 1GHz	CTX
1	PoE mode
Operating Mode > 1GHz	CTX
Orthogonal Planes of EUT	Y Plane
	
Worst Planes of EUT	V



The Worst Case Mode for Following Conformance Tests	
Tests Item	Simultaneous Transmission Analysis
Test Condition	Radiated measurement
Operating Mode	CTX
1	Radio 1(2.4G)+ Radio 2(5G)+ Radio 3(2.4G)+ Bluetooth
2	Radio 1(5G)+ Radio 2(5G)+ Radio 3(2.4G)+ Bluetooth
3	Radio 1(5G)+ Radio 2(5G)+ Radio 3(5G)+ Bluetooth
4	Radio 1(2.4G)+ Radio 2(5G)+ Radio 3(5G)+ Bluetooth
5	Radio 1(2.4G)+ Radio 2(5G)+ Radio 3(2.4G)+Zigbee
6	Radio 1(5G)+ Radio 2(5G)+ Radio 3(2.4G)+Zigbee
7	Radio 1(5G)+ Radio 2(5G)+ Radio 3(5G)+Zigbee
8	Radio 1(2.4G)+ Radio 2(5G)+ Radio 3(5G)+Zigbee

Refer to Sporton Test Report No.: FA0D1422-02 for Co-location RF Exposure Evaluation and Appendix F for Radiated Emission Co-location.



2.3 Accessories

Accessories				
PoE Adapter	Brand Name	Senao Inc.	Model Name	PIN060-54PR
	Power Rating	I/P: 100-240Vac, 1.5A, 50-60Hz, O/P: 54Vdc, 1.11A		
AC CORD	Brand Name	I-SHENG	Model Name	AC CORD 600mm
	Signal Line	0.5 meter, shielded cable, w/o ferrite core		
Ground Wire	Brand Name	BO YAO	Model Name	WIRE GEN AWG10 180cm
	Signal Line	1.8 meter, shielded cable, w/o ferrite core		
Bracket wall mount	Brand Name	XIERTEK	Model Name	BRACKET WALL MOUNT
Bracket pole mount	Brand Name	CUN SHENG	Model Name	BRACKET WALL MOUNT

Reminder: Regarding to more detail and other information, please refer to user manual.

2.4 Support Equipment

Support Equipment – AC Conduction					
No.	Equipment	Brand Name	Model Name	FCC ID	Remark
1	RJ45 Cable	Power Sync	CAT-6E-01	-	-

Support Equipment – Conducted					
No.	Equipment	Brand Name	Model Name	FCC ID	Remark
1	Notebook	DELL	E5410	-	-
2	Adapter for NB	DELL	HA65NM130	-	-

Support Equipment – Radiated					
No.	Equipment	Brand Name	Model Name	FCC ID	Remark
1	RJ45 Cable	Power Sync	CAT-6E-01	-	-
2	RJ45 Cable	Power Sync	CAT-6E-10	-	-
3	Client for BF	Fortinet	FAP-U432F	-	-
4	Notebook	HP	5220M	-	Remote

2.5 Test Setup Diagram

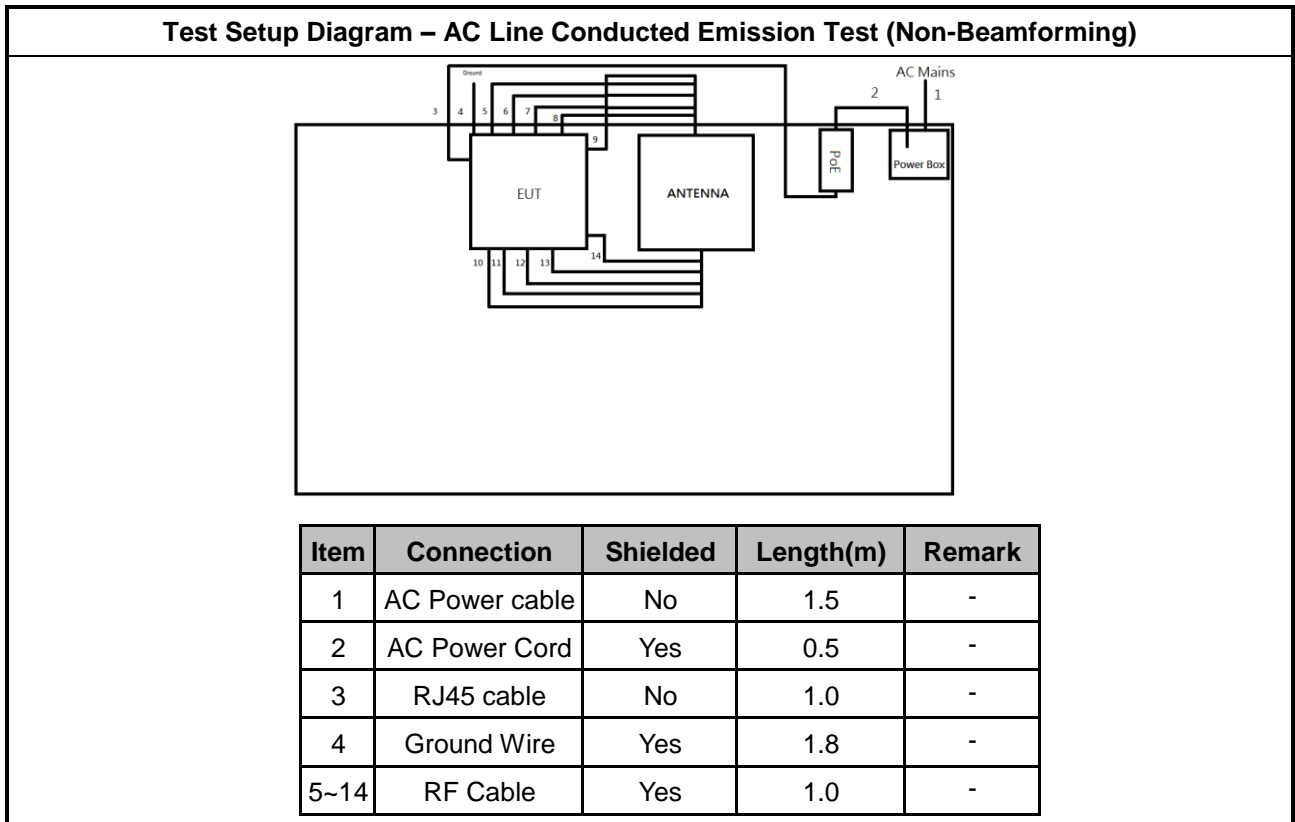

Test Setup Diagram - Radiated Test (Non-Beamforming)

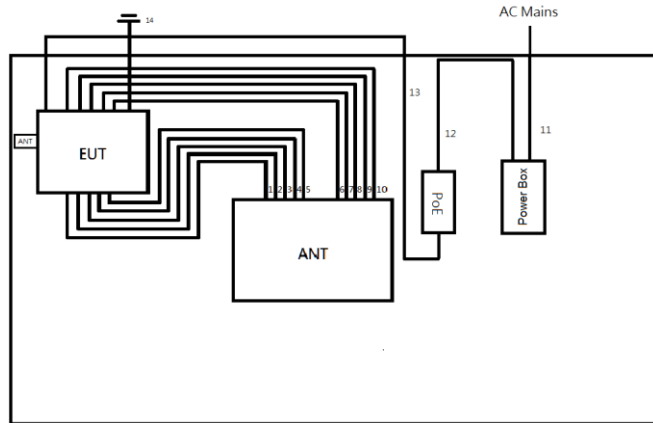

Item	Connection	Shielded	Length(m)	Remark
1	Antenna cable	No	1.0	-
2	Antenna cable	No	1.0	-
3	Antenna cable	No	1.0	-
4	Antenna cable	No	1.0	-
5	Antenna cable	No	1.0	-
6	Antenna cable	No	1.0	-
7	Antenna cable	No	1.0	-
8	Antenna cable	No	1.0	-
9	Antenna cable	No	1.0	-
10	Antenna cable	No	1.0	-
11	AC Power cable	No	1.5	-
12	AC CORD	Yes	0.5	-
13	RJ45 cable	No	1.0	-
14	Ground Wire	Yes	1.8	-

Test Setup Diagram - Radiated Test (Beamforming)

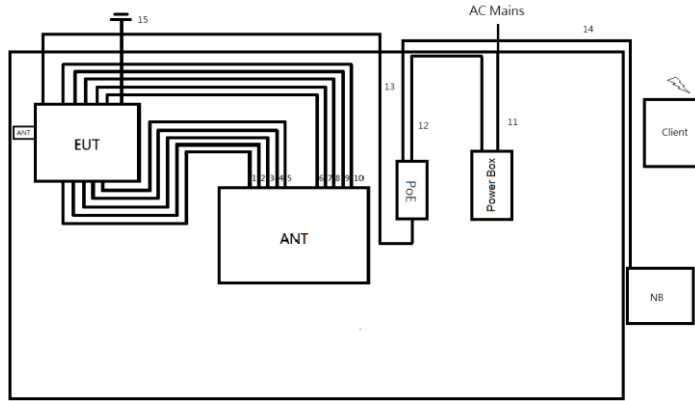

Item	Connection	Shielded	Length(m)	Remark
1	Antenna cable	No	1.0	-
2	Antenna cable	No	1.0	-
3	Antenna cable	No	1.0	-
4	Antenna cable	No	1.0	-
5	Antenna cable	No	1.0	-
6	Antenna cable	No	1.0	-
7	Antenna cable	No	1.0	-
8	Antenna cable	No	1.0	-
9	Antenna cable	No	1.0	-
10	Antenna cable	No	1.0	-
11	AC Power cable	No	1.5	-
12	AC CORD	Yes	0.5	-
13	RJ45 cable	No	1.0	-
14	RJ45 Cable	No	10.0	-
15	Ground Wire	Yes	1.8	-



3 Transmitter Test Result

3.1 AC Power-line Conducted Emissions

3.1.1 AC Power-line Conducted Emissions Limit

AC Power-line Conducted Emissions Limit		
Frequency Emission (MHz)	Quasi-Peak	Average
0.15-0.5	66 - 56 *	56 - 46 *
0.5-5	56	46
5-30	60	50

Note 1: * Decreases with the logarithm of the frequency.

3.1.2 Measuring Instruments

Refer a test equipment and calibration data table in this test report.

3.1.3 Test Procedures

Test Method
<input checked="" type="checkbox"/> Refer as ANSI C63.10-2013, clause 6.2 for AC power-line conducted emissions.

3.1.4 Measurement Results Calculation

The measured Level is calculated using:

Corrected Reading: Raw(Read Level) + LISN(LISN Factor) + CL(Cable Loss) + AT(Attenuator).

3.1.5 Test Setup

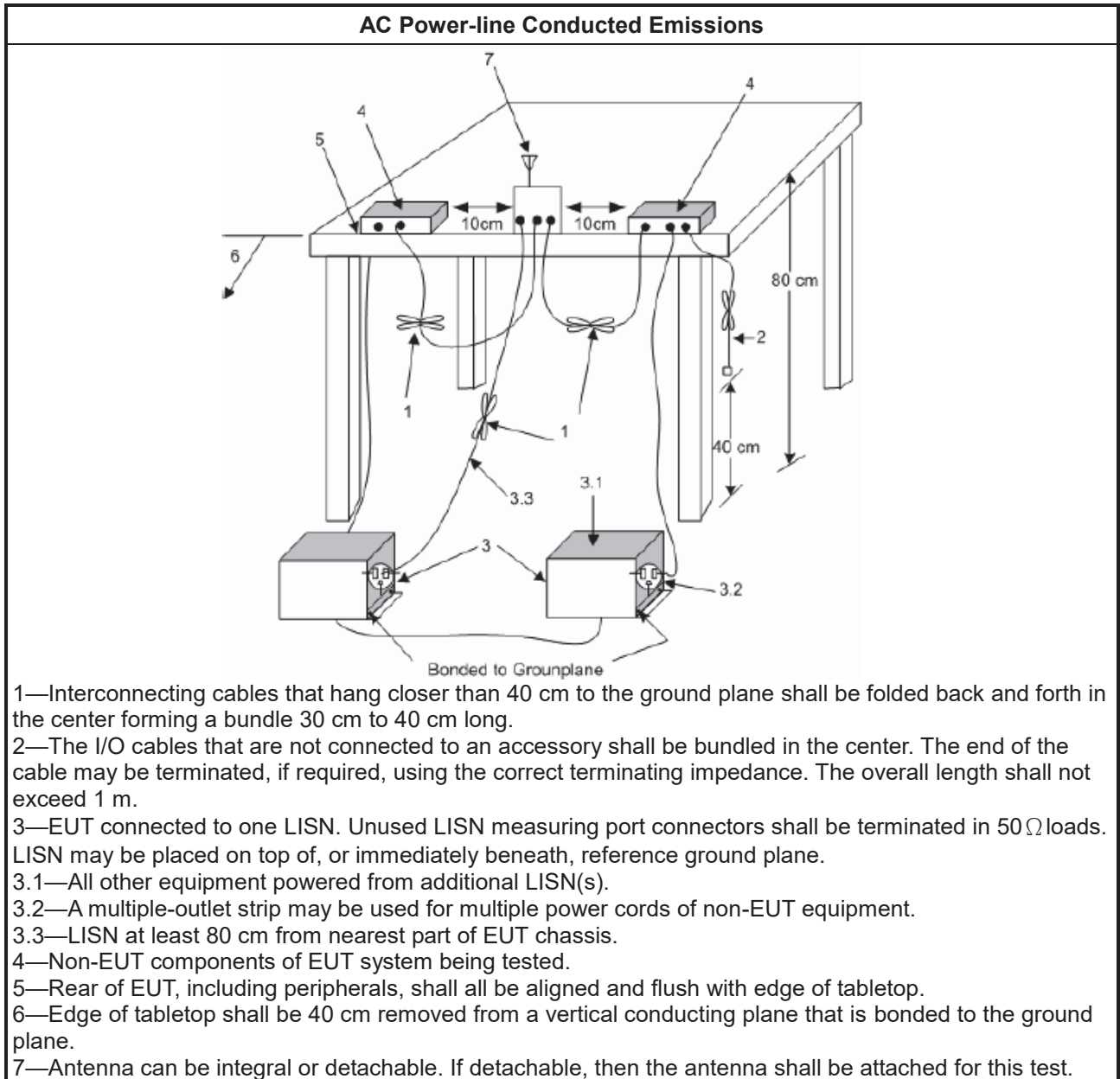

3.1.6 Test Result of AC Power-line Conducted Emissions

Refer as Appendix A

3.2 Emission Bandwidth

3.2.1 Emission Bandwidth Limit

Emission Bandwidth Limit	
UNII Devices	
<input checked="" type="checkbox"/>	For the 5.15-5.25 GHz band, N/A
<input checked="" type="checkbox"/>	For the 5.25-5.35 GHz band, N/A
<input checked="" type="checkbox"/>	For the 5.47-5.725 GHz band, N/A
<input checked="" type="checkbox"/>	For the 5.725-5.85 GHz band, 6 dB emission bandwidth \geq 500kHz.

3.2.2 Measuring Instruments

Refer a test equipment and calibration data table in this test report.

3.2.3 Test Procedures

Test Method	
<ul style="list-style-type: none"> ▪ For the emission bandwidth shall be measured using one of the options below: 	
<input checked="" type="checkbox"/>	Refer as KDB 789033, clause C for EBW and clause D for OBW measurement.
<input type="checkbox"/>	Refer as ANSI C63.10, clause 6.9.3 for occupied bandwidth testing.
<input type="checkbox"/>	Refer as IC RSS-Gen, clause 6.7 for bandwidth testing.

3.2.4 Test Setup

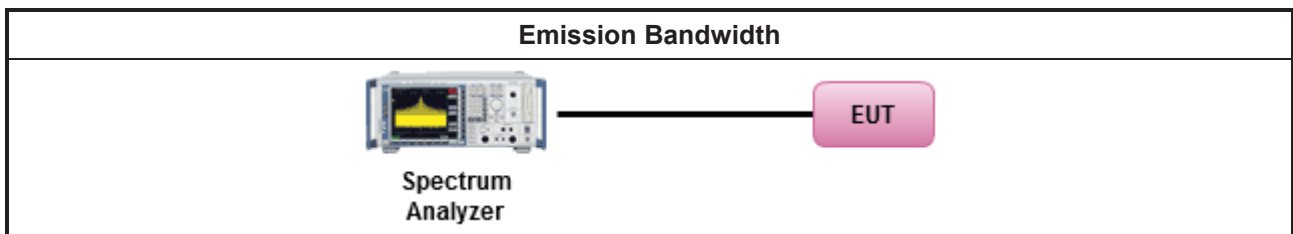

3.2.5 Test Result of Emission Bandwidth

Refer as Appendix B



3.3 Maximum Conducted Output Power

3.3.1 Maximum Conducted Output Power Limit

Maximum Conducted Output Power Limit	
UNII Devices	
<input checked="" type="checkbox"/> For the 5.15-5.25 GHz band:	
	<ul style="list-style-type: none"> ▪ Outdoor AP: the maximum conducted output power (P_{Out}) shall not exceed the lesser of 1 W. If $G_{TX} > 6$ dBi, then $P_{Out} = 30 - (G_{TX} - 6)$. e.i.r.p. at any elevation angle above 30 degrees $\leq 125mW$ [21dBm]
	<ul style="list-style-type: none"> ▪ Indoor AP: the maximum conducted output power (P_{Out}) shall not exceed the lesser of 1 W. If $G_{TX} > 6$ dBi, then $P_{Out} = 30 - (G_{TX} - 6)$
	<ul style="list-style-type: none"> ▪ Point-to-point AP: the maximum conducted output power (P_{Out}) shall not exceed the lesser of 1 W. If $G_{TX} > 23$ dBi, then $P_{Out} = 30 - (G_{TX} - 23)$.
	<ul style="list-style-type: none"> ▪ Mobile or Portable Client: the maximum conducted output power (P_{Out}) shall not exceed the lesser of 250 mW. If $G_{TX} > 6$ dBi, then $P_{Out} = 24 - (G_{TX} - 6)$.
<input checked="" type="checkbox"/> For the 5.25-5.35 GHz band, the maximum conducted output power (P_{Out}) shall not exceed the lesser of 250 mW or $11 \text{ dBm} + 10 \log B$, where B is the 26 dB emission bandwidth in MHz. If $G_{TX} > 6$ dBi, then $P_{Out} = 24 - (G_{TX} - 6)$.	
<input checked="" type="checkbox"/> For the 5.47-5.725 GHz band, the maximum conducted output power (P_{Out}) shall not exceed the lesser of 250 mW or $11 \text{ dBm} + 10 \log B$, where B is the 26 dB emission bandwidth in MHz. If $G_{TX} > 6$ dBi, then $P_{Out} = 24 - (G_{TX} - 6)$.	
<input checked="" type="checkbox"/> For the 5.725-5.85 GHz band:	
	<ul style="list-style-type: none"> ▪ Point-to-multipoint systems (P2M): the maximum conducted output power (P_{Out}) shall not exceed the lesser of 1 W. If $G_{TX} > 6$ dBi, then $P_{Out} = 30 - (G_{TX} - 6)$.
	<ul style="list-style-type: none"> ▪ Point-to-point systems (P2P): the maximum conducted output power (P_{Out}) shall not exceed the lesser of 1 W.
P_{Out} = maximum conducted output power in dBm, G_{TX} = the maximum transmitting antenna directional gain in dBi.	

3.3.2 Measuring Instruments

Refer a test equipment and calibration data table in this test report.

3.3.3 Test Procedures

Test Method	
<ul style="list-style-type: none"> Maximum Conducted Output Power 	
	Duty cycle $\geq 98\%$
<input checked="" type="checkbox"/>	Refer as KDB 789033, clause E Method SA-2 (spectral trace averaging).
	Duty cycle $< 98\%$
<input checked="" type="checkbox"/>	Refer as KDB 789033, clause E Method SA-2 Alt. (RMS detection with slow sweep speed)
Wideband RF power meter and average over on/off periods with duty factor	
<input checked="" type="checkbox"/>	Refer as KDB 789033, clause E Method PM (using an RF average power meter).
<ul style="list-style-type: none"> For conducted measurement. 	
	<ul style="list-style-type: none"> If the EUT supports multiple transmit chains using options given below: Refer as KDB 662911, In-band power measurements. Using the measure-and-sum approach, measured all transmit ports individually. Sum the power (in linear power units e.g., mW) of all ports for each individual sample and save them.
	<ul style="list-style-type: none"> If multiple transmit chains, EIRP calculation could be following as methods: $P_{total} = P_1 + P_2 + \dots + P_n$ (calculated in linear unit [mW] and transfer to log unit [dBm]) $EIRP_{total} = P_{total} + DG$

3.3.4 Test Setup

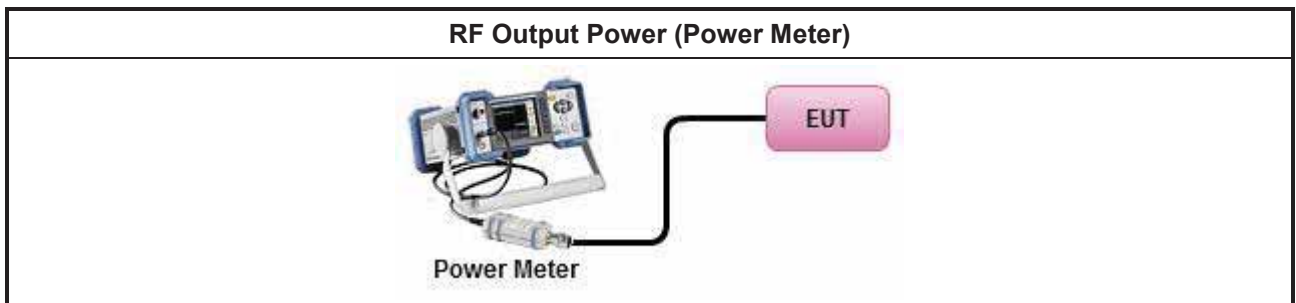
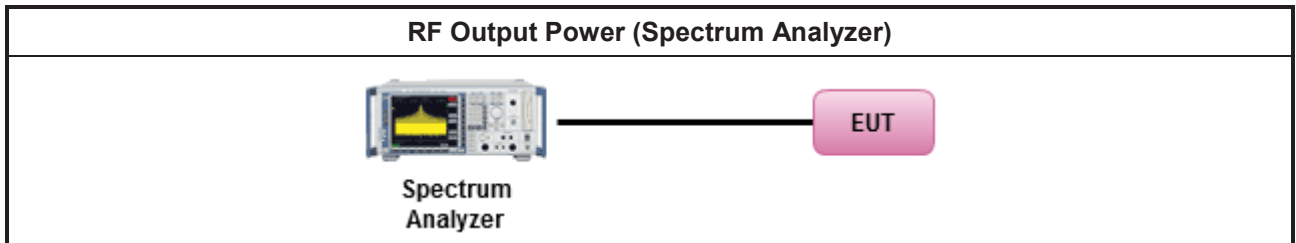

3.3.5 Test Result of Maximum Conducted Output Power

Refer as Appendix C

3.4 Peak Power Spectral Density

3.4.1 Peak Power Spectral Density Limit

Peak Power Spectral Density Limit	
UNII Devices	
<input checked="" type="checkbox"/> For the 5.15-5.25 GHz band:	
	<ul style="list-style-type: none"> ▪ Outdoor AP: the peak power spectral density (PPSD) shall not exceed the lesser of 17dBm/MHz. If $G_{TX} > 6$ dBi, then $P_{Out} = 17 - (G_{TX} - 6)$. ▪ Indoor AP: the peak power spectral density (PPSD) shall not exceed the lesser of 17dBm/MHz. If $G_{TX} > 6$ dBi, then $P_{Out} = 17 - (G_{TX} - 6)$. ▪ Point-to-point AP: the peak power spectral density (PPSD) shall not exceed the lesser of 17dBm/MHz. If $G_{TX} > 23$ dBi, then $P_{Out} = 17 - (G_{TX} - 23)$. ▪ Mobile or Portable Client: the peak power spectral density (PPSD) ≤ 11 dBm/MHz. If $G_{TX} > 6$ dBi, then $PPSD = 11 - (G_{TX} - 6)$.
<input checked="" type="checkbox"/> For the 5.25-5.35 GHz band, the peak power spectral density (PPSD) ≤ 11 dBm/MHz. If $G_{TX} > 6$ dBi, then $PPSD = 11 - (G_{TX} - 6)$.	
<input checked="" type="checkbox"/> For the 5.47-5.725 GHz band, the peak power spectral density (PPSD) ≤ 11 dBm/MHz. If $G_{TX} > 6$ dBi, then $PPSD = 11 - (G_{TX} - 6)$.	
<input checked="" type="checkbox"/> For the 5.725-5.85 GHz band:	
	<ul style="list-style-type: none"> ▪ Point-to-multipoint systems (P2M): the peak power spectral density (PPSD) ≤ 30 dBm/500kHz. If $G_{TX} > 6$ dBi, then $PPSD = 30 - (G_{TX} - 6)$. ▪ Point-to-point systems (P2P): the peak power spectral density (PPSD) ≤ 30 dBm/500kHz.
<p>PPSD = peak power spectral density that he same method as used to determine the conducted output power shall be used to determine the power spectral density. And power spectral density in dBm/MHz G_{TX} = the maximum transmitting antenna directional gain in dBi.</p>	

3.4.2 Measuring Instruments

Refer a test equipment and calibration data table in this test report.

3.4.3 Test Procedures

Test Method	
<ul style="list-style-type: none"> ▪ Peak power spectral density procedures that the same method as used to determine the conducted output power shall be used to determine the peak power spectral density and use the peak search function on the spectrum analyzer to find the peak of the spectrum. For the peak power spectral density shall be measured using below options: 	
<input type="checkbox"/>	Refer as KDB 789033, F)5) power spectral density can be measured using resolution bandwidths < 1 MHz provided that the results are integrated over 1 MHz bandwidth
Duty cycle ≥ 98%	
<input checked="" type="checkbox"/>	Refer as KDB 789033, clause E Method SA-2 (spectral trace averaging).
Duty cycle < 98%	
<input checked="" type="checkbox"/>	Refer as KDB 789033, clause E Method SA-2 Alt. (RMS detection with slow sweep speed)
<ul style="list-style-type: none"> ▪ For conducted measurement. 	
<ul style="list-style-type: none"> ▪ If the EUT supports multiple transmit chains using options given below: <ul style="list-style-type: none"> ▪ Measure and sum the spectra across the outputs. Refer as KDB 662911, In-band power spectral density (PSD). Sample all transmit ports simultaneously using a spectrum analyzer for each transmit port. Where the trace bin-by-bin of each transmit port summing can be performed. (i.e., in the first spectral bin of output 1 is summed with that in the first spectral bin of output 2 and that from the first spectral bin of output 3, and so on up to the NTX output to obtain the value for the first frequency bin of the summed spectrum.). Add up the amplitude (power) values for the different transmit chains and use this as the new data trace. 	
<ul style="list-style-type: none"> ▪ If multiple transmit chains, EIRP PPSD calculation could be following as methods: $PPSD_{total} = PPSD_1 + PPSD_2 + \dots + PPSD_n$ (calculated in linear unit [mW] and transfer to log unit [dBm]) $EIRP_{total} = PPSD_{total} + DG$ 	

3.4.4 Test Setup

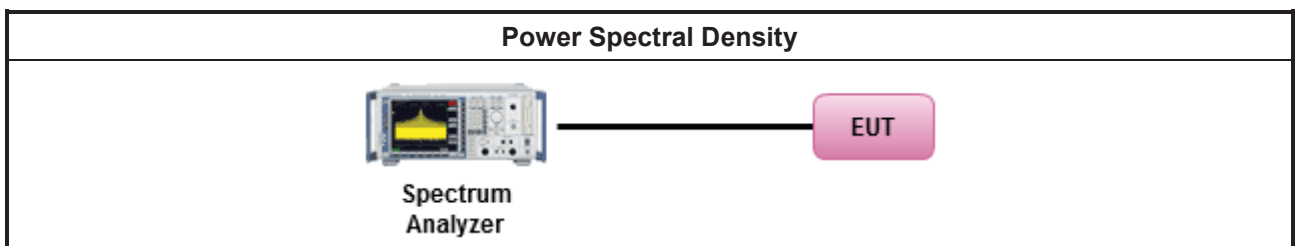

3.4.5 Test Result of Peak Power Spectral Density

Refer as Appendix D

3.5 Unwanted Emissions

3.5.1 Transmitter Radiated Unwanted Emissions Limit

Unwanted emissions below 1 GHz and restricted band emissions above 1GHz limit			
Frequency Range (MHz)	Field Strength (uV/m)	Field Strength (dBuV/m)	Measure Distance (m)
0.009~0.490	2400/F(kHz)	48.5 - 13.8	300
0.490~1.705	24000/F(kHz)	33.8 - 23	30
1.705~30.0	30	29	30
30~88	100	40	3
88~216	150	43.5	3
216~960	200	46	3
Above 960	500	54	3

Note 1: Test distance for frequencies at or above 30 MHz, measurements may be performed at a distance other than the limit distance provided they are not performed in the near field and the emissions to be measured can be detected by the measurement equipment. When performing measurements at a distance other than that specified, the results shall be extrapolated to the specified distance using an extrapolation factor of 20 dB/decade (inverse of linear distance for field-strength measurements, inverse of linear distance-squared for power-density measurements).

Note 2: Test distance for frequencies at below 30 MHz, measurements may be performed at a distance closer than the EUT limit distance; however, an attempt should be made to avoid making measurements in the near field. When performing measurements below 30 MHz at a closer distance than the limit distance, the results shall be extrapolated to the specified distance by either making measurements at a minimum of two or more distances on at least one radial to determine the proper extrapolation factor or by using the square of an inverse linear distance extrapolation factor (40 dB/decade). The test report shall specify the extrapolation method used to determine compliance of the EUT.

Note 3: Using the distance of 1m during the test for above 18 GHz, and the test value to correct for the distance factor at 3m.

Un-restricted band emissions above 1GHz Limit	
Operating Band	Limit
5.15 - 5.25 GHz	e.i.r.p. -27 dBm [68.2 dBuV/m@3m]
5.25 - 5.35 GHz	e.i.r.p. -27 dBm [68.2 dBuV/m@3m]
5.47 - 5.725 GHz	e.i.r.p. -27 dBm [68.2 dBuV/m@3m]
5.725 - 5.85 GHz	5.650-5700 GHz: e.i.r.p. -27 ~ 10 dBm [68.2 ~ 105.2 dBuV/m@3m] 5.700-5720 GHz: e.i.r.p. 10 ~ 15.6 dBm [105.2 ~ 110.8 dBuV/m@3m] 5.720-5725 GHz: e.i.r.p. 15.6 ~ 27 dBm [110.8 ~ 122.2 dBuV/m@3m] 5.850-5.855 GHz: e.i.r.p. 27 ~ 15.6 dBm [122.2 ~ 110.8 dBuV/m@3m] 5.855-5.875 GHz: e.i.r.p. 15.6 ~ 10 dBm [110.8 ~ 105.2 dBuV/m@3m] 5.875-5.925 GHz: e.i.r.p. 10 ~ -27 dBm [105.2 ~ 68.2dBuV/m@3m] Other un-restricted band: e.i.r.p. -27 dBm [68.2 dBuV/m@3m]

Note 1: Measurements may be performed at a distance other than the limit distance provided they are not performed in the near field and the emissions to be measured can be detected by the measurement equipment. When performing measurements at a distance other than that specified, the results shall be extrapolated to the specified distance using an extrapolation factor of 20 dB/decade (inverse of linear distance for field-strength measurements, inverse of linear distance-squared for power-density measurements).

3.5.2 Measuring Instruments

Refer a test equipment and calibration data table in this test report.

3.5.3 Test Procedures

Test Method	
<ul style="list-style-type: none"> Measurements may be performed at a distance other than the limit distance provided they are not performed in the near field and the emissions to be measured can be detected by the measurement equipment. Measurements shall not be performed at a distance greater than 30 m for frequencies above 30 MHz, unless it can be further demonstrated that measurements at a distance of 30 m or less are impractical. When performing measurements at a distance other than that specified, the results shall be extrapolated to the specified distance using an extrapolation factor of 20 dB/decade (inverse of linear distance for field-strength measurements, inverse of linear distance-squared for power-density measurements). 	
<ul style="list-style-type: none"> The average emission levels shall be measured in [duty cycle \geq 98 or duty factor]. 	
<ul style="list-style-type: none"> For the transmitter unwanted emissions shall be measured using following options below: <ul style="list-style-type: none"> Refer as KDB 789033, clause G)2) for unwanted emissions into non-restricted bands. Refer as KDB 789033, clause G)1) for unwanted emissions into restricted bands. <input checked="" type="checkbox"/> Refer as KDB 789033, G)6) Method VB (ANSI C63.10, clause 4.1.4.2.3), Reduced VBW. <input checked="" type="checkbox"/> Refer as KDB 789033, clause G)5) (ANSI C63.10, clause 4.1.4.2.2), measurement procedure peak limit. 	
<ul style="list-style-type: none"> For radiated measurement. <ul style="list-style-type: none"> Refer as ANSI C63.10, clause 6.4 for radiated emissions below 30 MHz and test distance is 3m. Refer as ANSI C63.10, clause 6.5 for radiated emissions 30 MHz to 1 GHz and test distance is 3m. Refer as ANSI C63.10, clause 6.6 for radiated emissions above 1GHz. 	
<ul style="list-style-type: none"> The any unwanted emissions level shall not exceed the fundamental emission level. 	
<ul style="list-style-type: none"> All amplitude of spurious emissions that are attenuated by more than 20 dB below the permissible value has no need to be reported. 	
<ul style="list-style-type: none"> Use the following spectrum analyzer settings: <ul style="list-style-type: none"> Set RBW=100 kHz for $f < 1$ GHz; VBW=3 * RBW; Sweep = auto; Detector function = peak; Trace = max hold. Set RBW = 1 MHz, VBW= 3MHz for $f \geq 1$ GHz for peak measurement. For average measurement, refer as 1.1.4. 	
<ul style="list-style-type: none"> KDB 414788 Open-Field Test Sites and Chamber Correlation Justification. <ul style="list-style-type: none"> Based on FCC 15.31(f)(2): measurements may be performed at a distance closer than that specified in regulations; however, an attempt should be made to avoid making measurements in the near field. Open-field site and chamber correlation testing had been performed and chamber measured test result is the worst case test result. 	

3.5.4 Measurement Results Calculation

The measured Level is calculated using:

Corrected Reading: Raw(Read Level) + AF(Antenna Factor) + CL(Cable Loss) - PA(Preamp Factor)

3.5.5 Test Setup

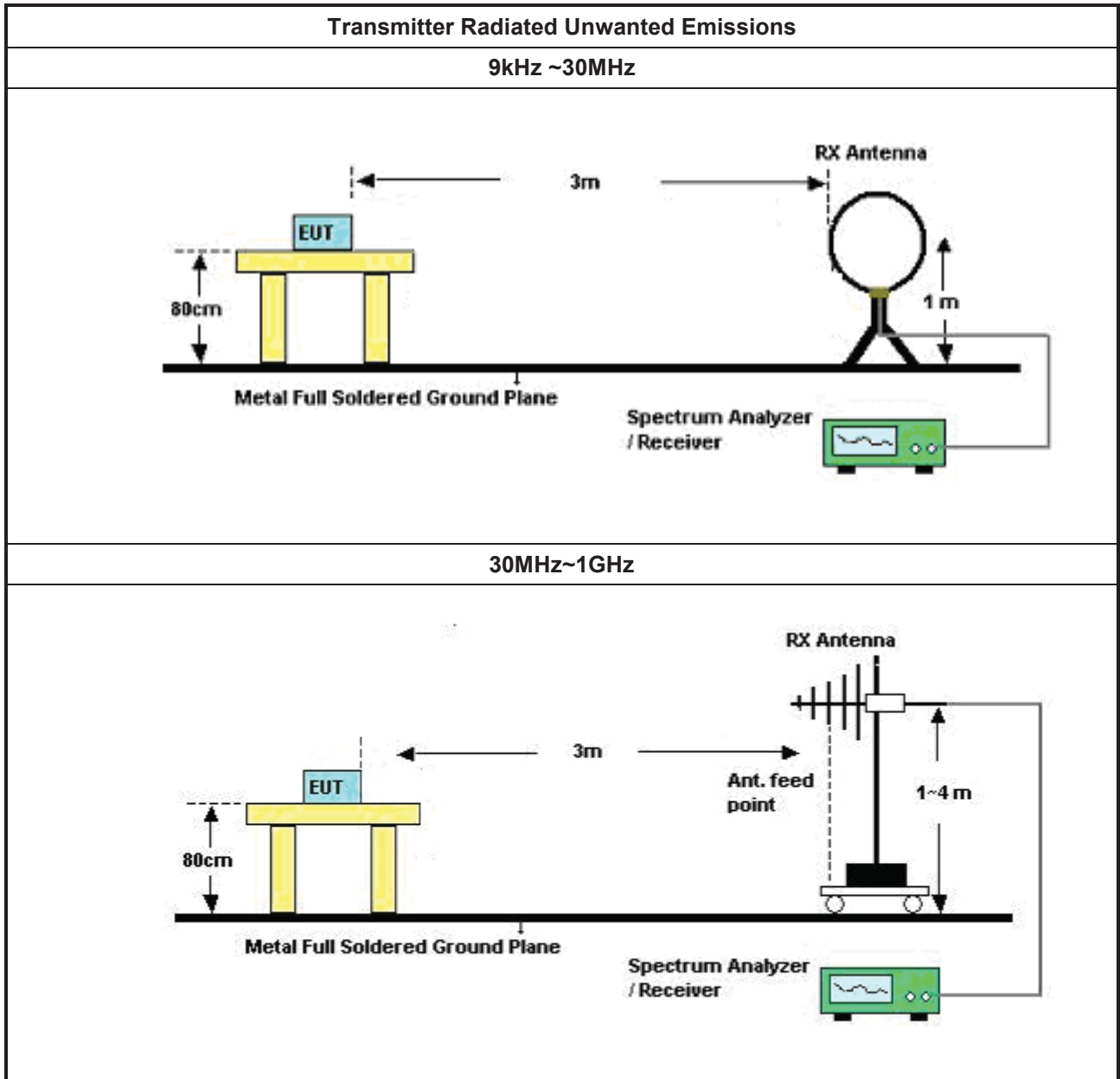

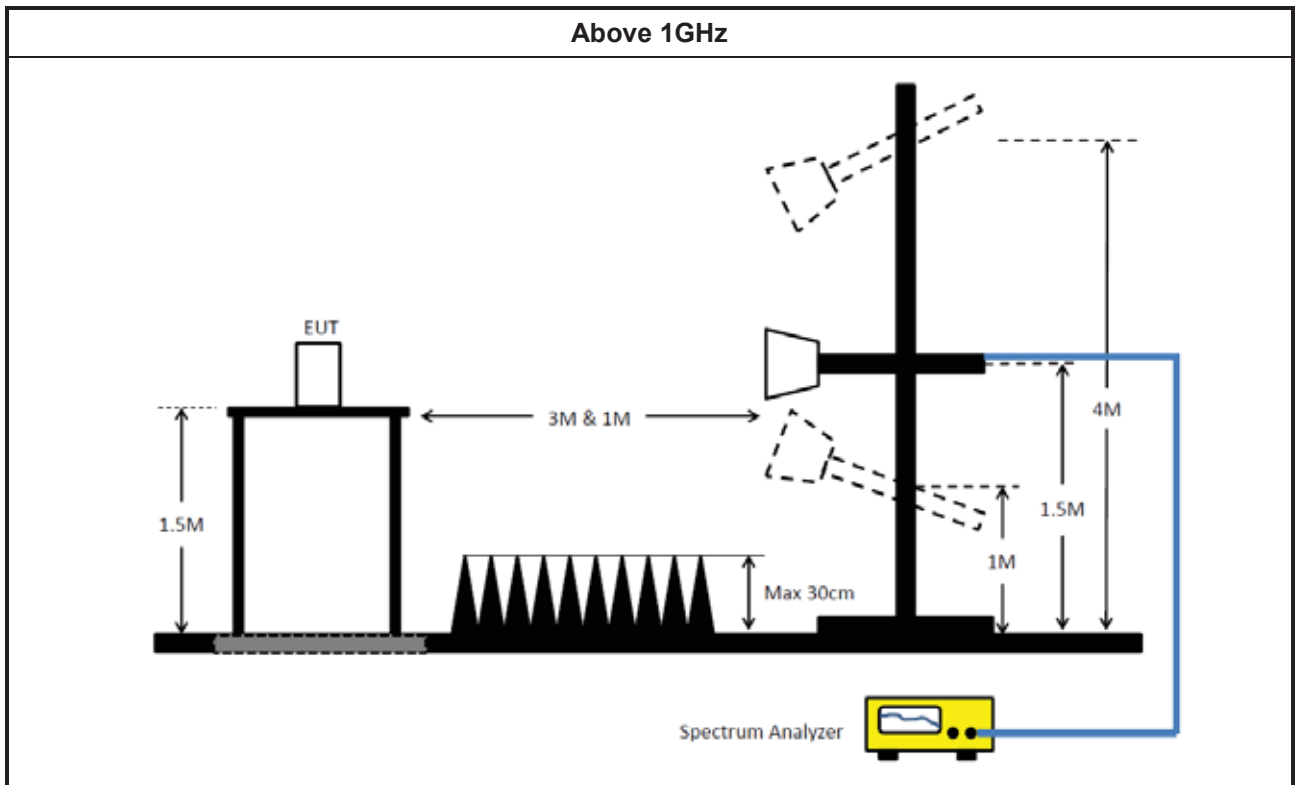

3.5.6 Transmitter Unwanted Emissions (Below 30MHz)

The amplitude of spurious emissions which are attenuated by more than 20dB below the permissible value has no need to be reported.

3.5.7 Test Result of Transmitter Unwanted Emissions

Refer as Appendix E



4 Test Equipment and Calibration Data

Instrument for AC Conduction

Instrument	Manufacturer /Brand	Model No.	Serial No.	Spec.	Calibration Date	Calibration Due Date
EMI Test Receiver	R&S	ESR	102051	9kHz ~ 3.6GHz	13/May/2022	12/May/2023
Two-Line V-Network	R&S	ENV 216	100003	9kHz ~ 30MHz	18/Feb/2022	17/Feb/2023
RF Cable 5m	TITAN	TITAN	CO04-cable-01	9 kHz~200MHz	01/Mar/2022	28/Feb/2023
Impuls Begrenzer Pulse Limiter	SCHWARZBECK	VTSD 9561-F	9561-F041	9kHz ~ 30MHz	26/Oct/2021	25/Oct/2022
Software	Sporton	SENSE-EMI	V5.10.14	-	NCR	NCR

NCR: No Calibration Required

Instrument for Conducted Test

Instrument	Manufacturer /Brand	Model No.	Serial No.	Spec.	Calibration Date	Calibration Due Date
Signal Analyzer	R&S	FSV 40	101013	10Hz~40GHz	01/Apr/2022	31/Mar/2023
SMB100A Signal Generator	R&S	SMB100A	181147	100kHz~40GHz	21/Oct/2021	20/Oct/2022
Signal Generator	R&S	SMR 40	100116	10 MHz ~10GHz	11/Jan/2022	10/Jan/2023
Pulse Sensor	Anritsu	MA2411B	0917017	300MHz~40GHz	21/Feb/2022	20/Feb/2023
Power Meter	Anritsu	ML2495A	0949003	300MHz~40GHz	21/Feb/2022	20/Feb/2023
SENSE-15407_NII	Sporton	5.10.8.2	N/A	N/A	N/A	N/A



Instrument for Radiated Test

Instrument	Manufacturer /Brand	Model No.	Serial No.	Spec.	Calibration Date	Calibration Due Date
3m Semi Anechoic Chamber	SIDT FRANKONIA	SAC-3M	03CH03-HY	30MHz~1GHz 3m	03/Aug/2021	02/Aug/2022
3m Semi Anechoic Chamber	SIDT FRANKONIA	SAC-3M	03CH03-HY	1GHz~18GHz 3m	01/Aug/2021	31/Jul/2022
Signal Analyzer	R&S	FSV40	101500	10Hz~40GHz	12/Oct/2021	11/Oct/2022
Amplifier	HP	8447D	2944A08033	10kHz~1.3GHz	08/Apr/2022	07/Apr/2023
Double Ridged Guide Horn Antenna	SCHWARZBECK	BBHA 9120 D	02267	1GHz ~18GHz	14/Sep/2021	13/Sep/2022
Bilog Antenna & 6dB Attenuator	SCHAFFNER / EMCI	CBL6112B / N-6-05	22237 / AT-N-0603	30MHz~1GHz	17/Oct/2021	16/Oct/2022
RF Cable-R03m	Jye Bao	RG142	CB021	9kHz~30MHz	16/Jun/2021	15/Jun/2022
RF Cable-R03m	Jye Bao	RG142	CB021	9kHz~30MHz	13/Jun/2022	12/Jun/2023
RF Cable-R03m	Jye Bao	RG142	MY37335/4+CB021-1+CB021-2	30MHz~1GHz	22/Mar/2022	21/Mar/2023
RF CABLE 5+6m	HUBER+SUHNER	SUOFLEX 104	MY38596/4+SN804300/4	1GHz~40GHz	28/Jul/2021	27/Jul/2022
Broadband Horn Antenna	SCHWARZBECK	BBHA 9170	BBHA 9170221	15GHz~40GHz	18/Mar/2022	17/Mar/2023
Microwave Prempplier	EMC INSTRUMENTS	EM18G40G	060604	18GHz ~ 40GHz	08/Mar/2022	07/Mar/2023
Loop Antenna	Teseq	HLA 6120	24155	9kHz~30MHz	14/May/2022	13/May/2023
Loop Antenna	TESEQ	HLA 6120	31244	9kHz~30MHz	18/Mar/2022	17/Mar/2023
EMI Test Receiver	R&S	ESR3	102052	9kHz~3.6GHz	13/May/2022	12/May/2023
Microwave Preampplier	Agilent	8449B	3008A02326	1GHz~26.5GHz	15/Jul/2021	14/Jul/2022
SENSE-15407_NII	Sporton	V5.10.7.20	N/A	N/A	N/A	N/A

Instrument for Radiated Emission Co-location Test

Instrument	Manufacturer /Brand	Model No.	Serial No.	Spec.	Calibration Date	Calibration Due Date
3m Semi Anechoic Chamber	SIDT FRANKONIA	SAC-3M	03CH03-HY	1GHz~18GHz 3m	02/Aug/2022	01/Aug/2023
Signal Analyzer	R&S	FSV40	101500	10Hz~40GHz	12/Oct/2021	11/Oct/2022
Microwave Preampplier	Agilent	8449B	3008A02326	1GHz~26.5GHz	14/Jul/2022	13/Jul/2023
Double Ridged Guide Horn Antenna	SCHWARZBECK	BBHA 9120 D	02267	1GHz ~18GHz	14/Sep/2021	13/Sep/2022
RF CABLE 5+6m	HUBER+SUHNER	SUOFLEX 104	03CH03-cable-01	1GHz~40GHz	27/Jul/2022	26/Jul/2023
Broadband Horn Antenna	SCHWARZBECK	BBHA 9170	BBHA 9170221	15GHz~40GHz	18/Mar/2022	17/Mar/2023
Microwave Prempplier	EMC INSTRUMENTS	EM18G40G	060604	18GHz ~ 40GHz	08/Mar/2022	07/Mar/2023
SENSE-EMI	Sporton	v5.10.8.6	NA	NA	NA	NA



Conducted Emissions at Powerline_Non-Beamforming_Radio 1 Appendix A.1

Summary

Mode	Result	Type	Freq (Hz)	Level (dBuV)	Limit (dBuV)	Margin (dB)	Condition
Mode 1	Pass	QP	442.514k	27.18	57.01	-29.83	Line



Conducted Emissions at Powerline_Non-Beamforming_Radio 1 Appendix A.1

Result

Mode	Result	Type	Freq (Hz)	Level (dBuV)	Limit (dBuV)	Margin (dB)	Condition	Comments
Mode 1	Pass	QP	177.381k	31.70	64.60	-32.90	Line	-
Mode 1	Pass	AV	177.381k	15.48	54.60	-39.12	Line	-
Mode 1	Pass	QP	442.514k	27.18	57.01	-29.83	Line	-
Mode 1	Pass	AV	442.514k	13.11	47.01	-33.90	Line	-
Mode 1	Pass	QP	1.249M	17.72	56.00	-38.28	Line	-
Mode 1	Pass	AV	1.249M	12.59	46.00	-33.41	Line	-
Mode 1	Pass	QP	2.765M	20.87	56.00	-35.13	Line	-
Mode 1	Pass	AV	2.765M	14.13	46.00	-31.87	Line	-
Mode 1	Pass	QP	3.701M	17.23	56.00	-38.77	Line	-
Mode 1	Pass	AV	3.701M	14.45	46.00	-31.55	Line	-
Mode 1	Pass	QP	22.129M	24.68	60.00	-35.32	Line	-
Mode 1	Pass	AV	22.129M	19.80	50.00	-30.20	Line	-
Mode 1	Pass	QP	258.152k	19.61	61.49	-41.88	Neutral	-
Mode 1	Pass	AV	258.152k	13.59	51.49	-37.90	Neutral	-
Mode 1	Pass	QP	631.288k	19.04	56.00	-36.96	Neutral	-
Mode 1	Pass	AV	631.288k	12.75	46.00	-33.25	Neutral	-
Mode 1	Pass	QP	897.004k	17.33	56.00	-38.67	Neutral	-
Mode 1	Pass	AV	897.004k	12.54	46.00	-33.46	Neutral	-
Mode 1	Pass	QP	1.639M	23.71	56.00	-32.29	Neutral	-
Mode 1	Pass	AV	1.639M	13.06	46.00	-32.94	Neutral	-
Mode 1	Pass	QP	2.678M	21.99	56.00	-34.01	Neutral	-
Mode 1	Pass	AV	2.678M	13.83	46.00	-32.17	Neutral	-
Mode 1	Pass	QP	22.756M	21.98	60.00	-38.02	Neutral	-
Mode 1	Pass	AV	22.756M	18.31	50.00	-31.69	Neutral	-



Conducted Emissions at Powerline_Mode 1

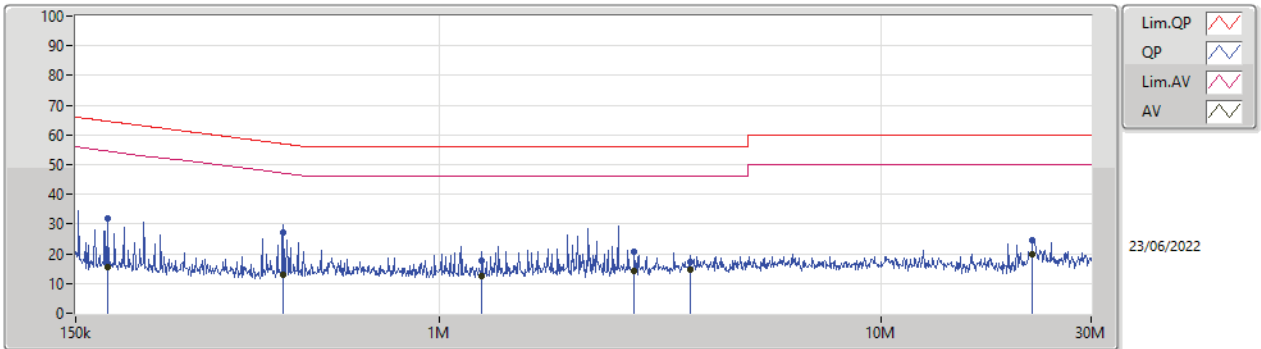

Type	Freq (Hz)	Level (dBuV)	Limit (dBuV)	Margin (dB)	Factor (dB)	Condition	Comment	Raw (dBuV)	LISN (dB)	CL (dB)	AT (dB)
QP	177.381k	31.70	64.60	-32.90	19.63	Line	-	12.07	9.69	0.03	9.91
AV	177.381k	15.48	54.60	-39.12	19.63	Line	-	-4.15	9.69	0.03	9.91
QP	442.514k	27.18	57.01	-29.83	19.63	Line	-	7.55	9.68	0.04	9.91
AV	442.514k	13.11	47.01	-33.90	19.63	Line	-	-6.52	9.68	0.04	9.91
QP	1.249M	17.72	56.00	-38.28	19.67	Line	-	-1.95	9.69	0.06	9.92
AV	1.249M	12.59	46.00	-33.41	19.67	Line	-	-7.08	9.69	0.06	9.92
QP	2.765M	20.87	56.00	-35.13	19.72	Line	-	1.15	9.70	0.10	9.92
AV	2.765M	14.13	46.00	-31.87	19.72	Line	-	-5.59	9.70	0.10	9.92
QP	3.701M	17.23	56.00	-38.77	19.75	Line	-	-2.52	9.71	0.12	9.92
AV	3.701M	14.45	46.00	-31.55	19.75	Line	-	-5.30	9.71	0.12	9.92
QP	22.129M	24.68	60.00	-35.32	20.01	Line	-	4.67	9.79	0.29	9.93
AV	22.129M	19.80	50.00	-30.20	20.01	Line	-	-0.21	9.79	0.29	9.93

Conducted Emissions at Powerline_Mode 1

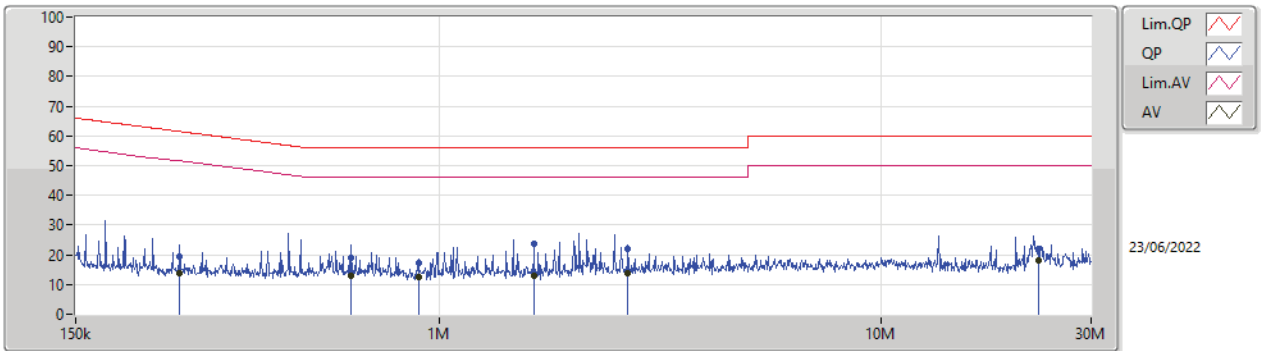

Type	Freq (Hz)	Level (dBuV)	Limit (dBuV)	Margin (dB)	Factor (dB)	Condition	Comment	Raw (dBuV)	LISN (dB)	CL (dB)	AT (dB)
QP	258.152k	19.61	61.49	-41.88	19.66	Neutral	-	-0.05	9.72	0.03	9.91
AV	258.152k	13.59	51.49	-37.90	19.66	Neutral	-	-6.07	9.72	0.03	9.91
QP	631.288k	19.04	56.00	-36.96	19.67	Neutral	-	-0.63	9.72	0.04	9.91
AV	631.288k	12.75	46.00	-33.25	19.67	Neutral	-	-6.92	9.72	0.04	9.91
QP	897.004k	17.33	56.00	-38.67	19.70	Neutral	-	-2.37	9.73	0.05	9.92
AV	897.004k	12.54	46.00	-33.46	19.70	Neutral	-	-7.16	9.73	0.05	9.92
QP	1.639M	23.71	56.00	-32.29	19.73	Neutral	-	3.98	9.74	0.07	9.92
AV	1.639M	13.06	46.00	-32.94	19.73	Neutral	-	-6.67	9.74	0.07	9.92
QP	2.678M	21.99	56.00	-34.01	19.77	Neutral	-	2.22	9.75	0.10	9.92
AV	2.678M	13.83	46.00	-32.17	19.77	Neutral	-	-5.94	9.75	0.10	9.92
QP	22.756M	21.98	60.00	-38.02	20.26	Neutral	-	1.72	10.04	0.29	9.93
AV	22.756M	18.31	50.00	-31.69	20.26	Neutral	-	-1.95	10.04	0.29	9.93



Conducted Emissions at Powerline_Non-Beamforming_Radio 2 Appendix A.2

Summary

Mode	Result	Type	Freq (Hz)	Level (dBuV)	Limit (dBuV)	Margin (dB)	Condition
Mode 1	Pass	QP	2.31M	28.24	56.00	-27.76	Neutral



Conducted Emissions at Powerline_Non-Beamforming_Radio 2 Appendix A.2

Result

Mode	Result	Type	Freq (Hz)	Level (dBuV)	Limit (dBuV)	Margin (dB)	Condition	Comments
Mode 1	Pass	QP	184.605k	32.38	64.28	-31.90	Line	-
Mode 1	Pass	AV	184.605k	15.43	54.28	-38.85	Line	-
Mode 1	Pass	QP	458.702k	28.10	56.71	-28.61	Line	-
Mode 1	Pass	AV	458.702k	13.30	46.71	-33.41	Line	-
Mode 1	Pass	QP	1.442M	20.52	56.00	-35.48	Line	-
Mode 1	Pass	AV	1.442M	12.69	46.00	-33.31	Line	-
Mode 1	Pass	QP	2.194M	26.99	56.00	-29.01	Line	-
Mode 1	Pass	AV	2.194M	15.09	46.00	-30.91	Line	-
Mode 1	Pass	QP	4.238M	16.44	56.00	-39.56	Line	-
Mode 1	Pass	AV	4.238M	14.36	46.00	-31.64	Line	-
Mode 1	Pass	QP	22.218M	25.84	60.00	-34.16	Line	-
Mode 1	Pass	AV	22.218M	20.52	50.00	-29.48	Line	-
Mode 1	Pass	QP	183.137k	26.22	64.34	-38.12	Neutral	-
Mode 1	Pass	AV	183.137k	14.95	54.34	-39.39	Neutral	-
Mode 1	Pass	QP	425.197k	21.57	57.34	-35.77	Neutral	-
Mode 1	Pass	AV	425.197k	12.88	47.34	-34.46	Neutral	-
Mode 1	Pass	QP	496.827k	17.46	56.06	-38.60	Neutral	-
Mode 1	Pass	AV	496.827k	12.51	46.06	-33.55	Neutral	-
Mode 1	Pass	QP	1.87M	25.06	56.00	-30.94	Neutral	-
Mode 1	Pass	AV	1.87M	13.60	46.00	-32.40	Neutral	-
Mode 1	Pass	QP	2.31M	28.24	56.00	-27.76	Neutral	-
Mode 1	Pass	AV	2.31M	14.15	46.00	-31.85	Neutral	-
Mode 1	Pass	QP	21.866M	24.56	60.00	-35.44	Neutral	-
Mode 1	Pass	AV	21.866M	19.57	50.00	-30.43	Neutral	-



Conducted Emissions at Powerline_Mode 1

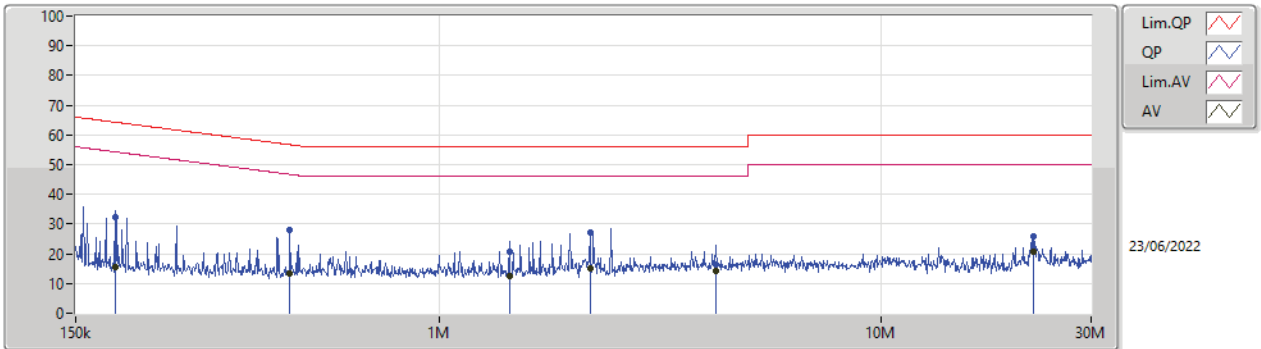

Type	Freq (Hz)	Level (dBuV)	Limit (dBuV)	Margin (dB)	Factor (dB)	Condition	Comment	Raw (dBuV)	LISN (dB)	CL (dB)	AT (dB)
QP	184.605k	32.38	64.28	-31.90	19.63	Line	-	12.75	9.69	0.03	9.91
AV	184.605k	15.43	54.28	-38.85	19.63	Line	-	-4.20	9.69	0.03	9.91
QP	458.702k	28.10	56.71	-28.61	19.63	Line	-	8.47	9.68	0.04	9.91
AV	458.702k	13.30	46.71	-33.41	19.63	Line	-	-6.33	9.68	0.04	9.91
QP	1.442M	20.52	56.00	-35.48	19.68	Line	-	0.84	9.69	0.07	9.92
AV	1.442M	12.69	46.00	-33.31	19.68	Line	-	-6.99	9.69	0.07	9.92
QP	2.194M	26.99	56.00	-29.01	19.71	Line	-	7.28	9.70	0.09	9.92
AV	2.194M	15.09	46.00	-30.91	19.71	Line	-	-4.62	9.70	0.09	9.92
QP	4.238M	16.44	56.00	-39.56	19.77	Line	-	-3.33	9.72	0.13	9.92
AV	4.238M	14.36	46.00	-31.64	19.77	Line	-	-5.41	9.72	0.13	9.92
QP	22.218M	25.84	60.00	-34.16	20.02	Line	-	5.82	9.80	0.29	9.93
AV	22.218M	20.52	50.00	-29.48	20.02	Line	-	0.50	9.80	0.29	9.93

Conducted Emissions at Powerline_Mode 1

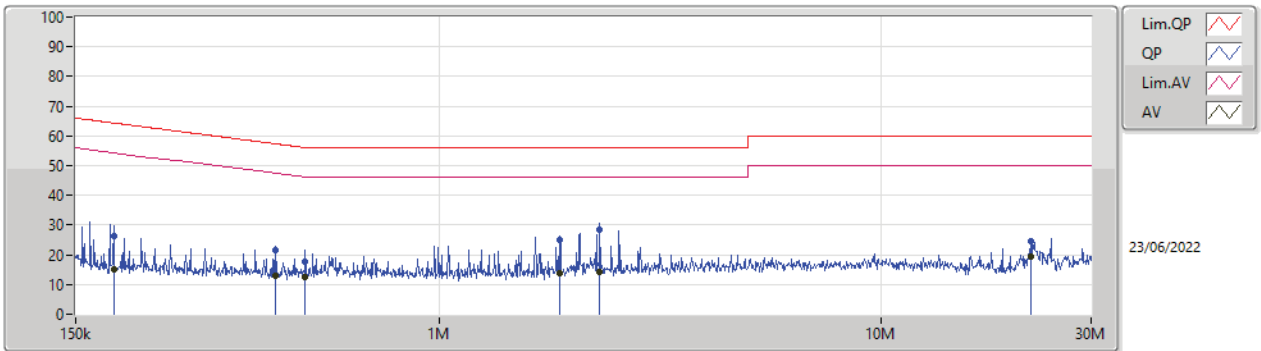

Type	Freq (Hz)	Level (dBuV)	Limit (dBuV)	Margin (dB)	Factor (dB)	Condition	Comment	Raw (dBuV)	LISN (dB)	CL (dB)	AT (dB)
QP	183.137k	26.22	64.34	-38.12	19.66	Neutral	-	6.56	9.72	0.03	9.91
AV	183.137k	14.95	54.34	-39.39	19.66	Neutral	-	-4.71	9.72	0.03	9.91
QP	425.197k	21.57	57.34	-35.77	19.67	Neutral	-	1.90	9.72	0.04	9.91
AV	425.197k	12.88	47.34	-34.46	19.67	Neutral	-	-6.79	9.72	0.04	9.91
QP	496.827k	17.46	56.06	-38.60	19.67	Neutral	-	-2.21	9.72	0.04	9.91
AV	496.827k	12.51	46.06	-33.55	19.67	Neutral	-	-7.16	9.72	0.04	9.91
QP	1.87M	25.06	56.00	-30.94	19.74	Neutral	-	5.32	9.74	0.08	9.92
AV	1.87M	13.60	46.00	-32.40	19.74	Neutral	-	-6.14	9.74	0.08	9.92
QP	2.31M	28.24	56.00	-27.76	19.75	Neutral	-	8.49	9.74	0.09	9.92
AV	2.31M	14.15	46.00	-31.85	19.75	Neutral	-	-5.60	9.74	0.09	9.92
QP	21.866M	24.56	60.00	-35.44	20.24	Neutral	-	4.32	10.02	0.29	9.93
AV	21.866M	19.57	50.00	-30.43	20.24	Neutral	-	-0.67	10.02	0.29	9.93



Conducted Emissions at Powerlin_Non-Beamforminge_Radio 3 Appendix A.3

Summary

Mode	Result	Type	Freq (Hz)	Level (dBuV)	Limit (dBuV)	Margin (dB)	Condition
Mode 1	Pass	QP	2.366M	27.10	56.00	-28.90	Line



Conducted Emissions at Powerlin_Non-Beamforming_Radio 3 Appendix A.3

Result

Mode	Result	Type	Freq (Hz)	Level (dBuV)	Limit (dBuV)	Margin (dB)	Condition	Comments
Mode 1	Pass	QP	174.571k	29.51	64.74	-35.23	Line	-
Mode 1	Pass	AV	174.571k	15.53	54.74	-39.21	Line	-
Mode 1	Pass	QP	228.103k	28.46	62.52	-34.06	Line	-
Mode 1	Pass	AV	228.103k	14.45	52.52	-38.07	Line	-
Mode 1	Pass	QP	453.242k	27.13	56.82	-29.69	Line	-
Mode 1	Pass	AV	453.242k	13.11	46.82	-33.71	Line	-
Mode 1	Pass	QP	1.74M	22.94	56.00	-33.06	Line	-
Mode 1	Pass	AV	1.74M	13.40	46.00	-32.60	Line	-
Mode 1	Pass	QP	2.366M	27.10	56.00	-28.90	Line	-
Mode 1	Pass	AV	2.366M	14.20	46.00	-31.80	Line	-
Mode 1	Pass	QP	22.485M	20.93	60.00	-39.07	Line	-
Mode 1	Pass	AV	22.485M	15.10	50.00	-34.90	Line	-
Mode 1	Pass	QP	204.796k	25.35	63.42	-38.07	Neutral	-
Mode 1	Pass	AV	204.796k	14.47	53.42	-38.95	Neutral	-
Mode 1	Pass	QP	467.95k	23.79	56.55	-32.76	Neutral	-
Mode 1	Pass	AV	467.95k	12.78	46.55	-33.77	Neutral	-
Mode 1	Pass	QP	929.818k	17.92	56.00	-38.08	Neutral	-
Mode 1	Pass	AV	929.818k	12.47	46.00	-33.53	Neutral	-
Mode 1	Pass	QP	2.176M	26.49	56.00	-29.51	Neutral	-
Mode 1	Pass	AV	2.176M	14.04	46.00	-31.96	Neutral	-
Mode 1	Pass	QP	3.627M	17.71	56.00	-38.29	Neutral	-
Mode 1	Pass	AV	3.627M	14.21	46.00	-31.79	Neutral	-
Mode 1	Pass	QP	21.605M	23.20	60.00	-36.80	Neutral	-
Mode 1	Pass	AV	21.605M	16.97	50.00	-33.03	Neutral	-



Conducted Emissions at Powerline_Mode 1

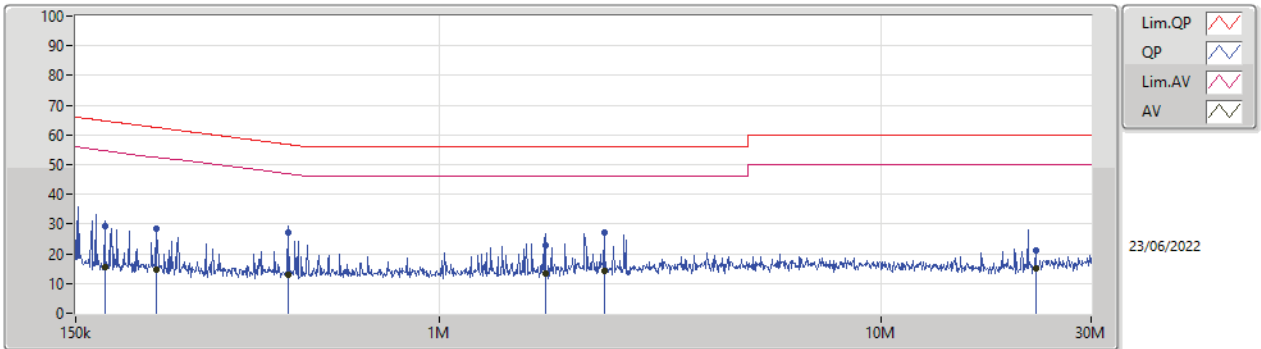

Type	Freq (Hz)	Level (dBuV)	Limit (dBuV)	Margin (dB)	Factor (dB)	Condition	Comment	Raw (dBuV)	LISN (dB)	CL (dB)	AT (dB)
QP	174.571k	29.51	64.74	-35.23	19.63	Line	-	9.88	9.69	0.03	9.91
AV	174.571k	15.53	54.74	-39.21	19.63	Line	-	-4.10	9.69	0.03	9.91
QP	228.103k	28.46	62.52	-34.06	19.63	Line	-	8.83	9.69	0.03	9.91
AV	228.103k	14.45	52.52	-38.07	19.63	Line	-	-5.18	9.69	0.03	9.91
QP	453.242k	27.13	56.82	-29.69	19.63	Line	-	7.50	9.68	0.04	9.91
AV	453.242k	13.11	46.82	-33.71	19.63	Line	-	-6.52	9.68	0.04	9.91
QP	1.74M	22.94	56.00	-33.06	19.69	Line	-	3.25	9.70	0.07	9.92
AV	1.74M	13.40	46.00	-32.60	19.69	Line	-	-6.29	9.70	0.07	9.92
QP	2.366M	27.10	56.00	-28.90	19.71	Line	-	7.39	9.70	0.09	9.92
AV	2.366M	14.20	46.00	-31.80	19.71	Line	-	-5.51	9.70	0.09	9.92
QP	22.485M	20.93	60.00	-39.07	20.02	Line	-	0.91	9.80	0.29	9.93
AV	22.485M	15.10	50.00	-34.90	20.02	Line	-	-4.92	9.80	0.29	9.93

Conducted Emissions at Powerline_Mode 1

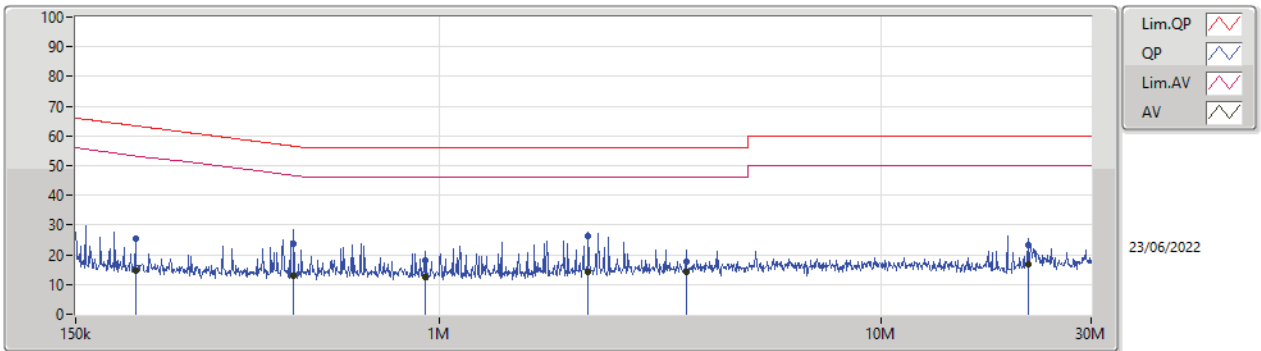

Type	Freq (Hz)	Level (dBuV)	Limit (dBuV)	Margin (dB)	Factor (dB)	Condition	Comment	Raw (dBuV)	LISN (dB)	CL (dB)	AT (dB)
QP	204.796k	25.35	63.42	-38.07	19.66	Neutral	-	5.69	9.72	0.03	9.91
AV	204.796k	14.47	53.42	-38.95	19.66	Neutral	-	-5.19	9.72	0.03	9.91
QP	467.95k	23.79	56.55	-32.76	19.67	Neutral	-	4.12	9.72	0.04	9.91
AV	467.95k	12.78	46.55	-33.77	19.67	Neutral	-	-6.89	9.72	0.04	9.91
QP	929.818k	17.92	56.00	-38.08	19.70	Neutral	-	-1.78	9.73	0.05	9.92
AV	929.818k	12.47	46.00	-33.53	19.70	Neutral	-	-7.23	9.73	0.05	9.92
QP	2.176M	26.49	56.00	-29.51	19.75	Neutral	-	6.74	9.74	0.09	9.92
AV	2.176M	14.04	46.00	-31.96	19.75	Neutral	-	-5.71	9.74	0.09	9.92
QP	3.627M	17.71	56.00	-38.29	19.80	Neutral	-	-2.09	9.76	0.12	9.92
AV	3.627M	14.21	46.00	-31.79	19.80	Neutral	-	-5.59	9.76	0.12	9.92
QP	21.605M	23.20	60.00	-36.80	20.23	Neutral	-	2.97	10.02	0.28	9.93
AV	21.605M	16.97	50.00	-33.03	20.23	Neutral	-	-3.26	10.02	0.28	9.93



Summary

Mode	Max-N dB (Hz)	Max-OBW (Hz)	ITU-Code	Min-N dB (Hz)	Min-OBW (Hz)
5.47-5.725GHz	-	-	-	-	-
802.11a_Nss1,(6Mbps)_4TX	21.72M	17.211M	17M3D1D	15.585M	13.508M
802.11n HT20_Nss1,(MCS0)_4TX	21.81M	18.171M	18M2D1D	15.72M	14.003M
802.11n HT40_Nss1,(MCS0)_4TX	40.26M	36.762M	36M8D1D	34.825M	33.163M
802.11ac VHT20_Nss1,(MCS0)_4TX	21.78M	18.111M	18M2D1D	15.765M	14.033M
802.11ac VHT40_Nss1,(MCS0)_4TX	40.26M	36.762M	36M8D1D	34.895M	33.163M
802.11ac VHT80_Nss1,(MCS0)_4TX	81.96M	76.162M	76M2D1D	75.525M	72.489M
802.11ac VHT160_Nss1,(MCS0)_4TX	164.4M	154.243M	154MD1D	162.96M	153.763M
802.11ax HEW20_Nss1,(MCS0)_4TX	21.78M	19.19M	19M2D1D	15.645M	14.498M
802.11ax HEW40_Nss1,(MCS0)_4TX	40.14M	37.661M	37M7D1D	34.895M	33.618M
802.11ax HEW80_Nss1,(MCS0)_4TX	82.32M	77.601M	77M7D1D	75.675M	73.313M
802.11ax HEW160_Nss1,(MCS0)_4TX	164.4M	154.723M	155MD1D	163.92M	154.723M
5.725-5.85GHz	-	-	-	-	-
802.11a_Nss1,(6Mbps)_4TX	16.35M	17.301M	17M4D1D	3.12M	4.278M
802.11n HT20_Nss1,(MCS0)_4TX	17.61M	18.171M	18M2D1D	3.74M	4.458M
802.11n HT40_Nss1,(MCS0)_4TX	36.36M	36.822M	36M9D1D	3.12M	3.598M
802.11ac VHT20_Nss1,(MCS0)_4TX	17.73M	18.111M	18M2D1D	3.76M	4.398M
802.11ac VHT40_Nss1,(MCS0)_4TX	36.36M	36.822M	36M9D1D	3.12M	3.678M
802.11ac VHT80_Nss1,(MCS0)_4TX	76.32M	76.402M	76M5D1D	3.1M	3.758M
802.11ax HEW20_Nss1,(MCS0)_4TX	19.05M	19.19M	19M2D1D	4.44M	4.658M
802.11ax HEW40_Nss1,(MCS0)_4TX	37.62M	37.721M	37M8D1D	3.72M	4.058M
802.11ax HEW80_Nss1,(MCS0)_4TX	77.4M	77.721M	77M8D1D	3.72M	4.118M

Max-N dB = Maximum 6dB down bandwidth for 5.725-5.85GHz band / Maximum 26dB down bandwidth for other band;
 Max-OBW = Maximum 99% occupied bandwidth;
 Min-N dB = Minimum 6dB down bandwidth for 5.725-5.85GHz band / Maximum 26dB down bandwidth for other band;
 Min-OBW = Minimum 99% occupied bandwidth



Result

Mode	Result	Limit (Hz)	Port 1-N dB (Hz)	Port 1-OBW (Hz)	Port 2-N dB (Hz)	Port 2-OBW (Hz)	Port 3-N dB (Hz)	Port 3-OBW (Hz)	Port 4-N dB (Hz)	Port 4-OBW (Hz)
802.11a_Nss1,(6Mbps)_4TX	-	-	-	-	-	-	-	-	-	-
5500MHz	Pass	Inf	21.42M	17.091M	21.63M	17.211M	21.72M	17.061M	21.57M	16.942M
5580MHz	Pass	Inf	21.42M	17.061M	21.57M	17.151M	21.72M	17.061M	21.51M	16.942M
5700MHz	Pass	Inf	21.48M	17.061M	21.66M	17.211M	21.66M	17.031M	21.48M	16.942M
5720MHz Straddle 5.47-5.725GHz	Pass	Inf	15.585M	13.508M	15.795M	13.643M	15.705M	13.628M	15.66M	13.508M
5720MHz Straddle 5.725-5.85GHz	Pass	500k	3.14M	4.358M	3.2M	4.418M	3.12M	4.318M	3.12M	4.278M
5745MHz	Pass	500k	16.35M	17.061M	16.35M	17.241M	16.35M	17.061M	16.35M	16.912M
5785MHz	Pass	500k	16.35M	17.151M	16.35M	17.301M	16.32M	17.091M	16.35M	16.972M
5825MHz	Pass	500k	16.35M	17.031M	16.35M	17.211M	16.35M	17.031M	16.35M	16.912M
802.11n HT20_Nss1,(MCS0)_4TX	-	-	-	-	-	-	-	-	-	-
5500MHz	Pass	Inf	21.69M	18.171M	21.51M	17.901M	21.51M	17.931M	21.48M	17.931M
5580MHz	Pass	Inf	21.81M	18.171M	21.6M	17.901M	21.51M	17.901M	21.57M	17.871M
5700MHz	Pass	Inf	21.69M	18.141M	21.54M	17.901M	21.66M	17.931M	21.48M	17.931M
5720MHz Straddle 5.47-5.725GHz	Pass	Inf	15.81M	14.183M	15.78M	14.003M	15.75M	14.003M	15.72M	14.003M
5720MHz Straddle 5.725-5.85GHz	Pass	500k	3.74M	4.498M	3.76M	4.498M	3.76M	4.458M	3.76M	4.458M
5745MHz	Pass	500k	17.61M	18.141M	17.61M	17.871M	17.58M	17.931M	17.61M	17.901M
5785MHz	Pass	500k	17.61M	18.171M	17.61M	17.931M	17.58M	17.931M	17.61M	17.931M
5825MHz	Pass	500k	17.55M	18.111M	17.58M	17.901M	17.61M	17.931M	17.61M	17.931M
802.11n HT40_Nss1,(MCS0)_4TX	-	-	-	-	-	-	-	-	-	-
5510MHz	Pass	Inf	40.14M	36.762M	39.6M	36.462M	39.96M	36.702M	39.66M	36.642M
5550MHz	Pass	Inf	40.26M	36.702M	39.48M	36.462M	39.66M	36.642M	39.72M	36.642M
5670MHz	Pass	Inf	40.14M	36.762M	39.54M	36.462M	39.96M	36.642M	39.72M	36.642M
5710MHz Straddle 5.47-5.725GHz	Pass	Inf	35.07M	33.198M	34.825M	33.163M	35.035M	33.268M	34.86M	33.233M
5710MHz Straddle 5.725-5.85GHz	Pass	500k	3.12M	3.718M	3.14M	3.638M	3.12M	3.638M	3.12M	3.598M
5755MHz	Pass	500k	36.3M	36.702M	36.36M	36.582M	36.3M	36.642M	36.24M	36.642M
5795MHz	Pass	500k	36.3M	36.822M	36.3M	36.522M	36.36M	36.642M	36.3M	36.642M
802.11ac VHT20_Nss1,(MCS0)_4TX	-	-	-	-	-	-	-	-	-	-
5500MHz	Pass	Inf	21.75M	18.111M	21.57M	17.931M	21.45M	17.961M	21.75M	18.051M
5580MHz	Pass	Inf	21.78M	18.111M	21.6M	17.961M	21.51M	17.931M	21.78M	18.051M
5700MHz	Pass	Inf	21.78M	18.081M	21.6M	17.961M	21.54M	17.931M	21.63M	18.081M
5720MHz Straddle 5.47-5.725GHz	Pass	Inf	15.795M	14.078M	15.765M	14.033M	15.765M	14.033M	15.81M	14.048M
5720MHz Straddle 5.725-5.85GHz	Pass	500k	3.76M	4.518M	3.76M	4.558M	3.76M	4.398M	3.76M	4.518M
5745MHz	Pass	500k	17.55M	18.081M	17.58M	17.961M	17.58M	17.901M	17.61M	18.021M
5785MHz	Pass	500k	17.58M	18.111M	17.73M	17.991M	17.61M	17.931M	17.58M	18.081M
5825MHz	Pass	500k	17.55M	18.051M	17.67M	17.961M	17.61M	17.901M	17.61M	18.051M
802.11ac VHT40_Nss1,(MCS0)_4TX	-	-	-	-	-	-	-	-	-	-
5510MHz	Pass	Inf	40.26M	36.702M	39.96M	36.642M	40.26M	36.702M	39.9M	36.762M
5550MHz	Pass	Inf	40.08M	36.702M	39.78M	36.582M	40.02M	36.702M	39.84M	36.702M
5670MHz	Pass	Inf	40.26M	36.762M	39.84M	36.582M	40.08M	36.702M	39.84M	36.762M
5710MHz Straddle 5.47-5.725GHz	Pass	Inf	35.105M	33.198M	34.93M	33.163M	35.07M	33.233M	34.895M	33.268M
5710MHz Straddle 5.725-5.85GHz	Pass	500k	3.12M	3.678M	3.12M	3.778M	3.12M	3.698M	3.12M	3.698M
5755MHz	Pass	500k	36.36M	36.702M	36.36M	36.582M	36.36M	36.702M	36.24M	36.702M
5795MHz	Pass	500k	36.3M	36.822M	36.36M	36.582M	36.3M	36.702M	36.36M	36.762M
802.11ac VHT80_Nss1,(MCS0)_4TX	-	-	-	-	-	-	-	-	-	-
5530MHz	Pass	Inf	81.72M	75.922M	81.36M	75.802M	81.36M	75.922M	81.84M	76.162M
5610MHz	Pass	Inf	81.96M	76.042M	81.6M	76.042M	81.48M	75.922M	81.84M	75.922M
5690MHz Straddle 5.47-5.725GHz	Pass	Inf	75.75M	72.564M	75.525M	72.489M	75.525M	72.714M	76.05M	72.864M
5690MHz Straddle 5.725-5.85GHz	Pass	500k	3.1M	3.838M	3.1M	3.758M	3.12M	3.818M	3.1M	3.878M
5775MHz	Pass	500k	76.32M	76.402M	75.84M	76.162M	75.72M	76.042M	75.72M	76.282M
802.11ac VHT160_Nss1,(MCS0)_4TX	-	-	-	-	-	-	-	-	-	-
5570MHz	Pass	Inf	162.96M	153.763M	164.4M	154.243M	164.16M	154.243M	163.44M	154.243M
802.11ax HEW20_Nss1,(MCS0)_4TX	-	-	-	-	-	-	-	-	-	-
5500MHz	Pass	Inf	21.75M	19.04M	21.51M	19.13M	21.72M	19.16M	21.72M	19.16M
5580MHz	Pass	Inf	21.78M	19.04M	21.54M	19.13M	21.66M	19.13M	21.51M	19.19M
5700MHz	Pass	Inf	21.39M	19.07M	21.45M	19.1M	21.72M	19.1M	21.66M	19.16M



Mode	Result	Limit (Hz)	Port 1-N dB (Hz)	Port 1-OBW (Hz)	Port 2-N dB (Hz)	Port 2-OBW (Hz)	Port 3-N dB (Hz)	Port 3-OBW (Hz)	Port 4-N dB (Hz)	Port 4-OBW (Hz)
5720MHz Straddle 5.47-5.725GHz	Pass	Inf	15.765M	14.543M	15.735M	14.498M	15.765M	14.573M	15.645M	14.543M
5720MHz Straddle 5.725-5.85GHz	Pass	500k	4.44M	4.658M	4.44M	4.738M	4.44M	4.718M	4.54M	4.778M
5745MHz	Pass	500k	18.99M	19.07M	18.93M	19.1M	18.9M	19.13M	19.05M	19.16M
5785MHz	Pass	500k	19.02M	19.07M	18.96M	19.1M	18.96M	19.19M	18.96M	19.19M
5825MHz	Pass	500k	18.99M	19.07M	19.05M	19.13M	18.93M	19.07M	18.99M	19.19M
802.11ax HEW40_Nss1,(MCS0)_4TX	-	-	-	-	-	-	-	-	-	-
5510MHz	Pass	Inf	40.02M	37.601M	39.84M	37.601M	40.14M	37.661M	40.08M	37.661M
5550MHz	Pass	Inf	39.96M	37.601M	39.9M	37.601M	40.08M	37.661M	40.08M	37.601M
5670MHz	Pass	Inf	40.02M	37.601M	39.9M	37.661M	39.96M	37.661M	40.14M	37.661M
5710MHz Straddle 5.47-5.725GHz	Pass	Inf	34.895M	33.618M	34.965M	33.688M	34.965M	33.688M	34.965M	33.688M
5710MHz Straddle 5.725-5.85GHz	Pass	500k	3.72M	4.058M	3.86M	4.098M	3.78M	4.078M	3.82M	4.098M
5755MHz	Pass	500k	37.26M	37.601M	37.5M	37.661M	37.56M	37.661M	37.44M	37.601M
5795MHz	Pass	500k	37.56M	37.721M	37.62M	37.721M	37.5M	37.661M	37.62M	37.661M
802.11ax HEW80_Nss1,(MCS0)_4TX	-	-	-	-	-	-	-	-	-	-
5530MHz	Pass	Inf	81.96M	77.361M	81.72M	77.361M	81.84M	77.361M	81.72M	77.361M
5610MHz	Pass	Inf	82.32M	77.481M	82.32M	77.601M	81.72M	77.481M	81.84M	77.361M
5690MHz Straddle 5.47-5.725GHz	Pass	Inf	75.675M	73.313M	75.825M	73.313M	76.125M	73.388M	75.975M	73.613M
5690MHz Straddle 5.725-5.85GHz	Pass	500k	3.82M	4.258M	3.86M	4.178M	3.72M	4.118M	3.74M	4.138M
5775MHz	Pass	500k	77.4M	77.721M	76.32M	77.601M	76.56M	77.481M	76.32M	77.481M
802.11ax HEW160_Nss1,(MCS0)_4TX	-	-	-	-	-	-	-	-	-	-
5570MHz	Pass	Inf	164.4M	154.723M	164.4M	154.723M	164.4M	154.723M	163.92M	154.723M

Port X-N dB = Port X 6dB down bandwidth for 5.725-5.85GHz band / 26dB down bandwidth for other band
 Port X-OBW = Port X 99% occupied bandwidth

802.11a_Nss1,(6Mbps)_4TX

EBW

5500MHz

15/06/2022

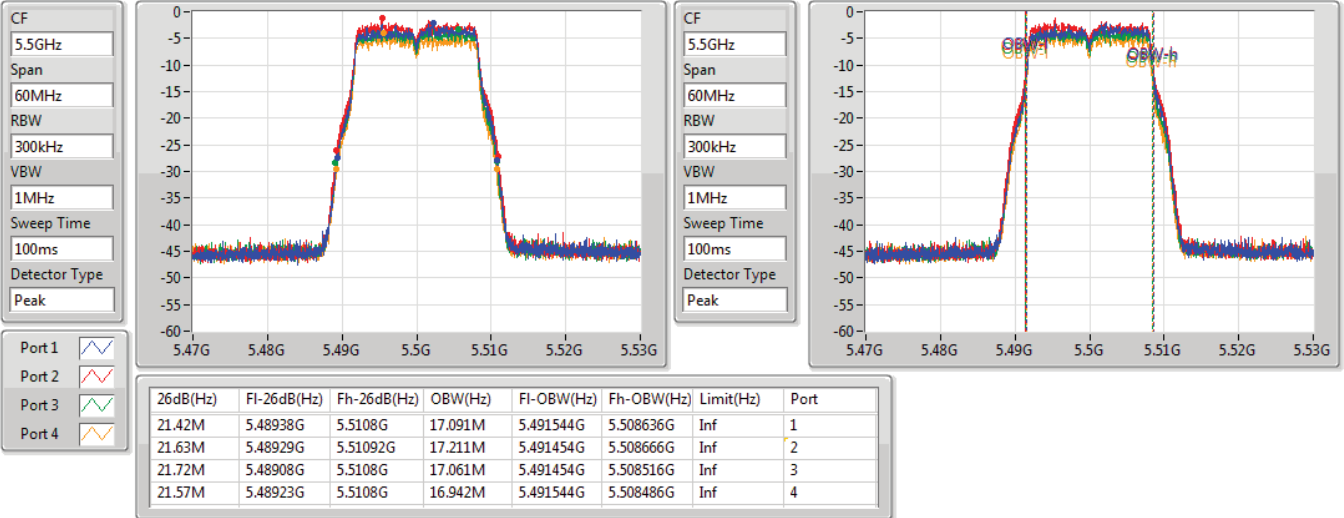

802.11a_Nss1,(6Mbps)_4TX

EBW

5580MHz

16/06/2022

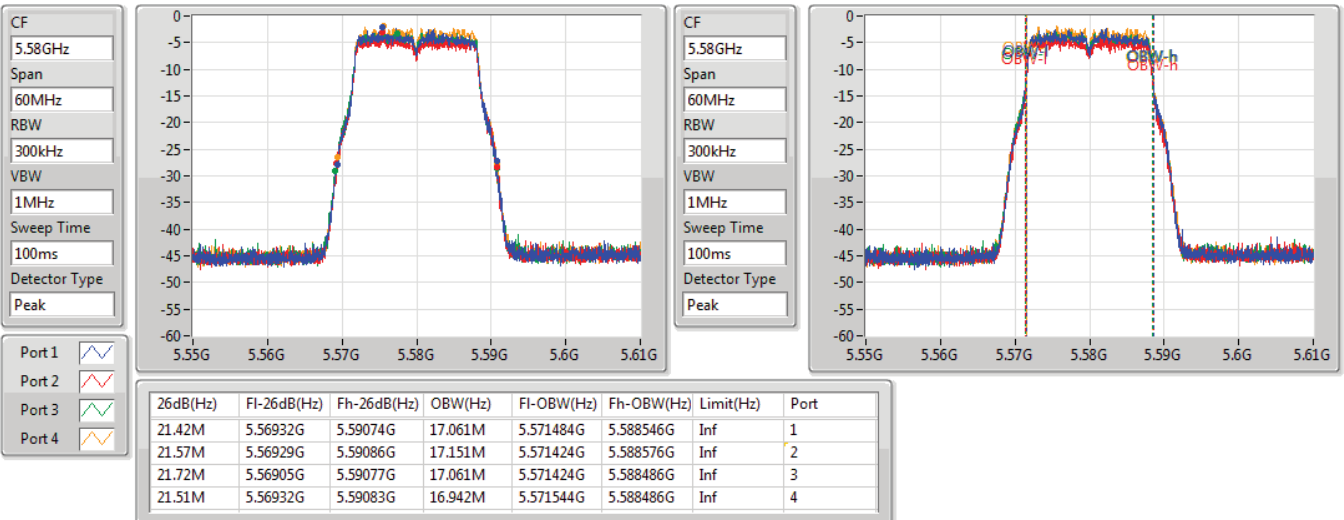

802.11a_Nss1,(6Mbps)_4TX

EBW

5700MHz

16/06/2022

CF
5.7GHz
Span
60MHz
RBW
300kHz
VBW
1MHz
Sweep Time
100ms
Detector Type
Peak

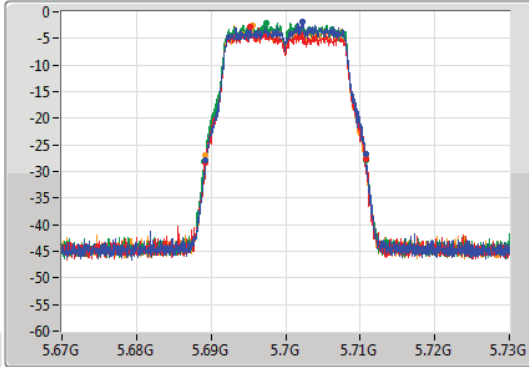

CF
5.7GHz
Span
60MHz
RBW
300kHz
VBW
1MHz
Sweep Time
100ms
Detector Type
Peak

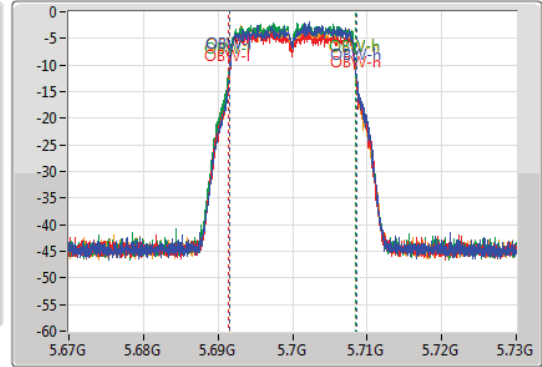

Port 1
Port 2
Port 3
Port 4

26dB(Hz)	Fl-26dB(Hz)	Fh-26dB(Hz)	OBW(Hz)	Fl-OBW(Hz)	Fh-OBW(Hz)	Limit(Hz)	Port
21.48M	5.68929G	5.71077G	17.061M	5.691544G	5.708606G	Inf	1
21.66M	5.6892G	5.71086G	17.211M	5.691424G	5.708636G	Inf	2
21.66M	5.68911G	5.71077G	17.031M	5.691454G	5.708486G	Inf	3
21.48M	5.68929G	5.71077G	16.942M	5.691544G	5.708486G	Inf	4

802.11a_Nss1,(6Mbps)_4TX

EBW

5720MHz Straddle 5.47-5.725GHz

16/06/2022

CF
5.71GHz
Span
30MHz
RBW
200kHz
VBW
1MHz
Sweep Time
100ms
Detector Type
Peak

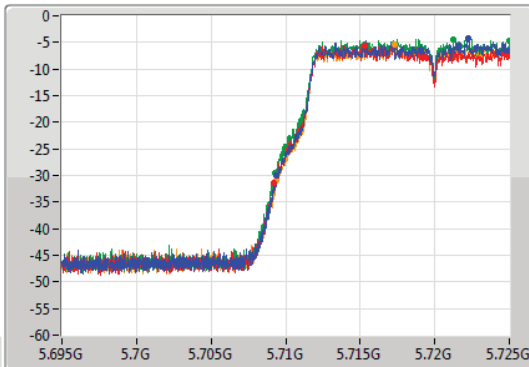

CF
5.71GHz
Span
30MHz
RBW
300kHz
VBW
1MHz
Sweep Time
100ms
Detector Type
Peak

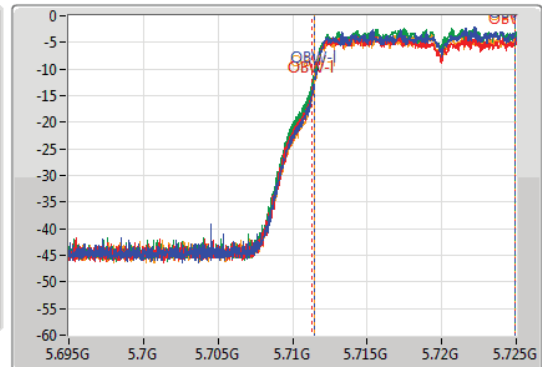

Port 1
Port 2
Port 3
Port 4

26dB(Hz)	Fl-26dB(Hz)	Fh-26dB(Hz)	OBW(Hz)	Fl-OBW(Hz)	Fh-OBW(Hz)	Limit(Hz)	Port
15.585M	5.709415G	5.725G	13.508M	5.711424G	5.724933G	Inf	1
15.795M	5.709205G	5.725G	13.643M	5.711289G	5.724933G	Inf	2
15.705M	5.709295G	5.725G	13.628M	5.711304G	5.724933G	Inf	3
15.66M	5.70934G	5.725G	13.508M	5.711439G	5.724948G	Inf	4

802.11a_Nss1,(6Mbps)_4TX

EBW

5720MHz Straddle 5.725-5.85GHz

16/06/2022

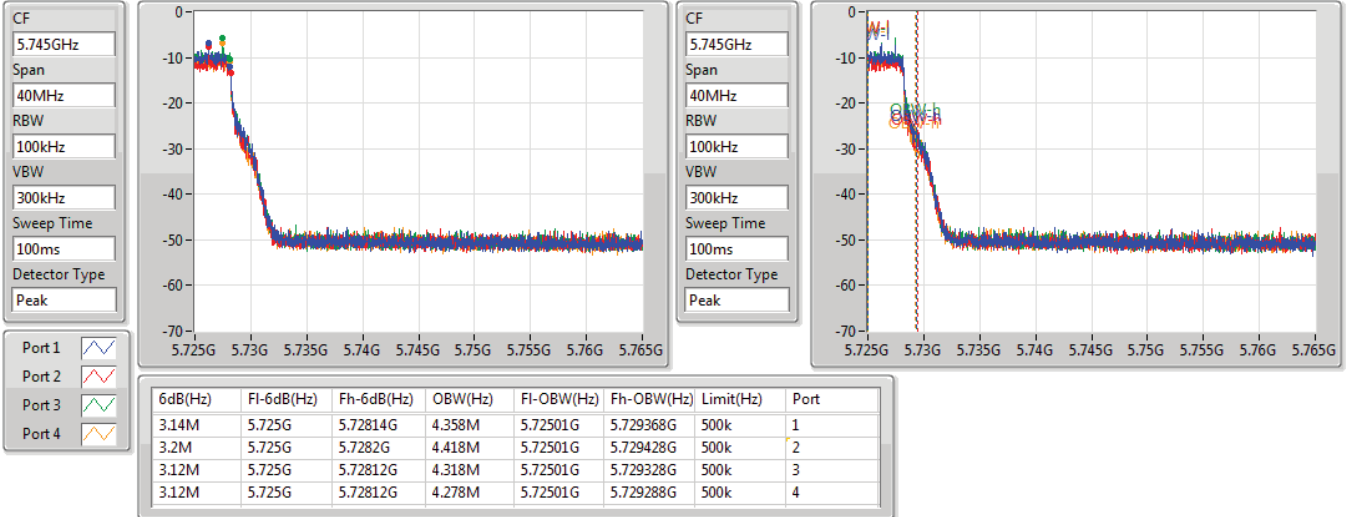

802.11a_Nss1,(6Mbps)_4TX

EBW

5745MHz

16/06/2022

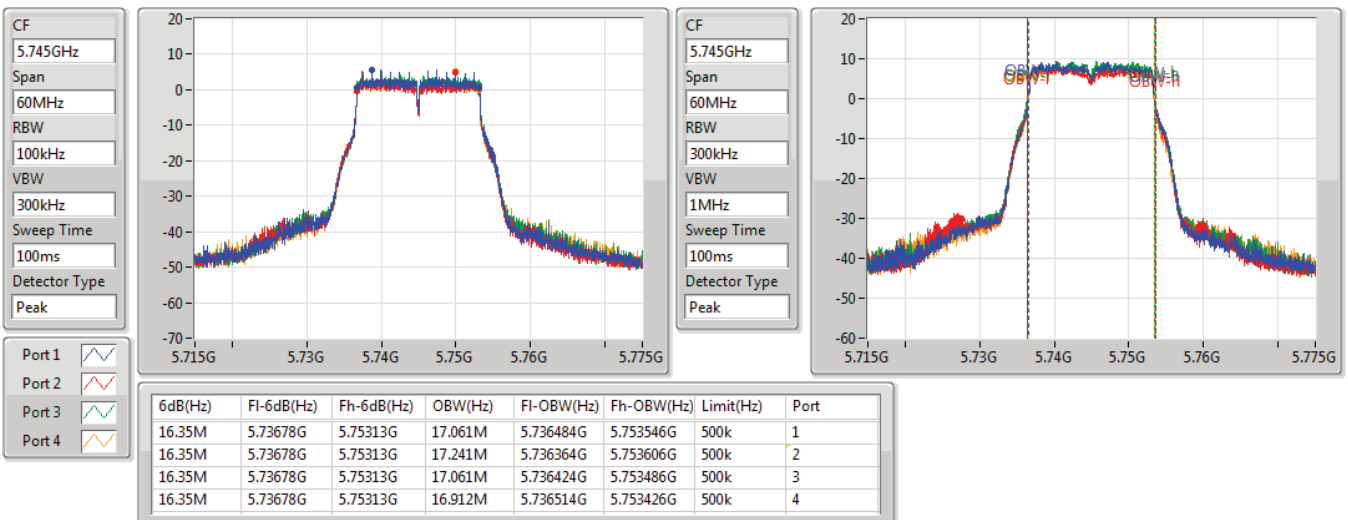

802.11a_Nss1,(6Mbps)_4TX

EBW

5785MHz

16/06/2022

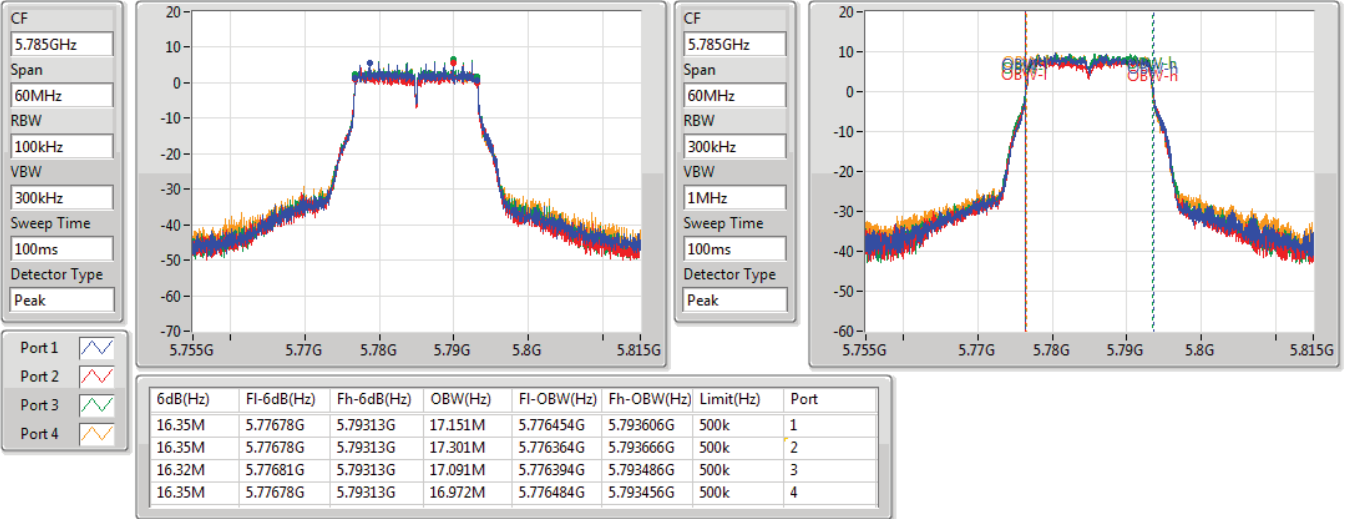

802.11a_Nss1,(6Mbps)_4TX

EBW

5825MHz

16/06/2022

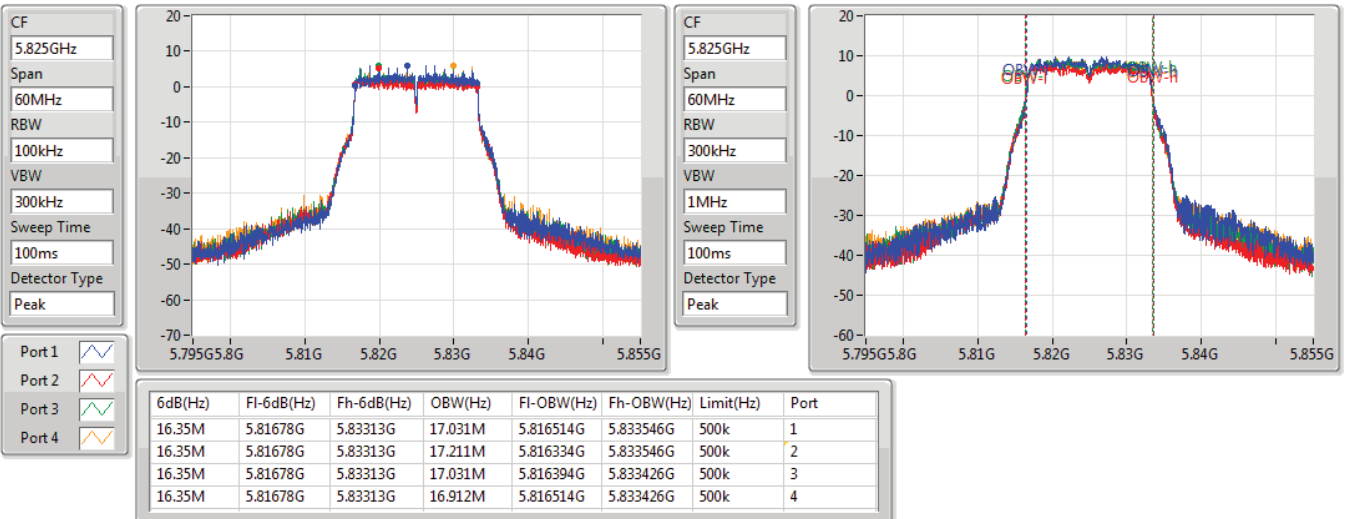



802.11n HT20_Nss1,(MCS0)_4TX

EBW

5500MHz

16/06/2022

CF
5.5GHz
Span
60MHz
RBW
300kHz
VBW
1MHz
Sweep Time
100ms
Detector Type
Peak

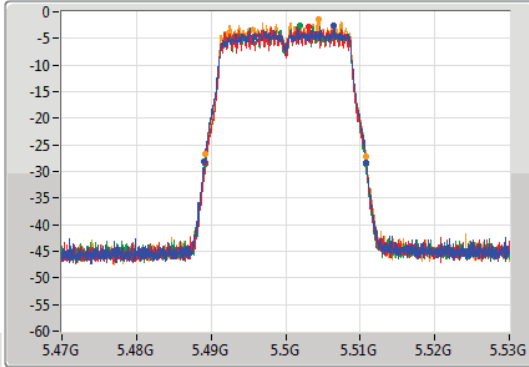

CF
5.5GHz
Span
60MHz
RBW
300kHz
VBW
1MHz
Sweep Time
100ms
Detector Type
Peak

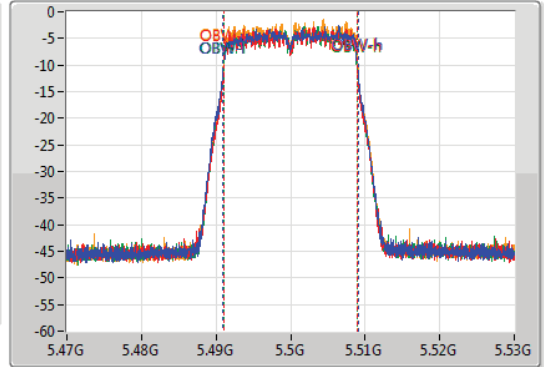

Port 1
Port 2
Port 3
Port 4

26dB(Hz)	Fl-26dB(Hz)	Fh-26dB(Hz)	OBW(Hz)	Fl-OBW(Hz)	Fh-OBW(Hz)	Limit(Hz)	Port
21.69M	5.48911G	5.5108G	18.171M	5.490885G	5.509055G	Inf	1
21.51M	5.48923G	5.51074G	17.901M	5.491064G	5.508966G	Inf	2
21.51M	5.48923G	5.51074G	17.931M	5.491034G	5.508966G	Inf	3
21.48M	5.48929G	5.51077G	17.931M	5.491034G	5.508966G	Inf	4

802.11n HT20_Nss1,(MCS0)_4TX

EBW

5580MHz

16/06/2022

CF
5.58GHz
Span
60MHz
RBW
300kHz
VBW
1MHz
Sweep Time
100ms
Detector Type
Peak

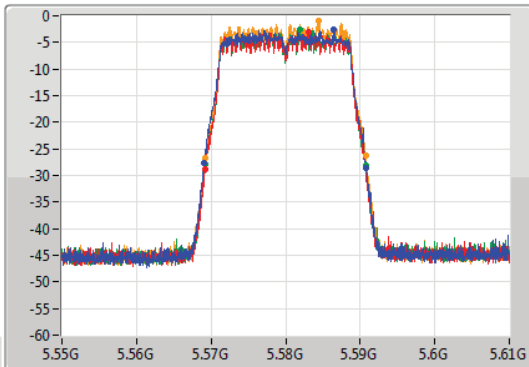

CF
5.58GHz
Span
60MHz
RBW
300kHz
VBW
1MHz
Sweep Time
100ms
Detector Type
Peak

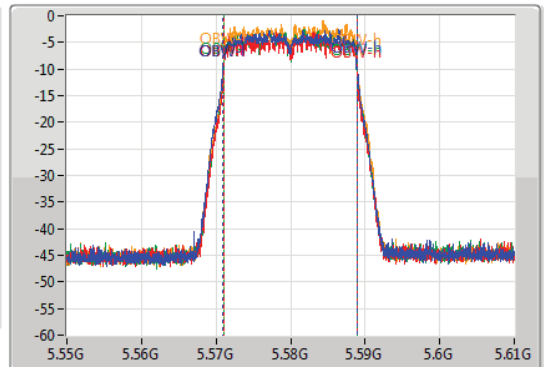

Port 1
Port 2
Port 3
Port 4

26dB(Hz)	Fl-26dB(Hz)	Fh-26dB(Hz)	OBW(Hz)	Fl-OBW(Hz)	Fh-OBW(Hz)	Limit(Hz)	Port
21.81M	5.56902G	5.59083G	18.171M	5.570825G	5.588996G	Inf	1
21.6M	5.56914G	5.59074G	17.901M	5.571004G	5.588906G	Inf	2
21.51M	5.56926G	5.59077G	17.901M	5.571034G	5.588936G	Inf	3
21.57M	5.56923G	5.5908G	17.871M	5.571064G	5.588936G	Inf	4

802.11n HT20_Nss1,(MCS0)_4TX

EBW

5700MHz

18/06/2022

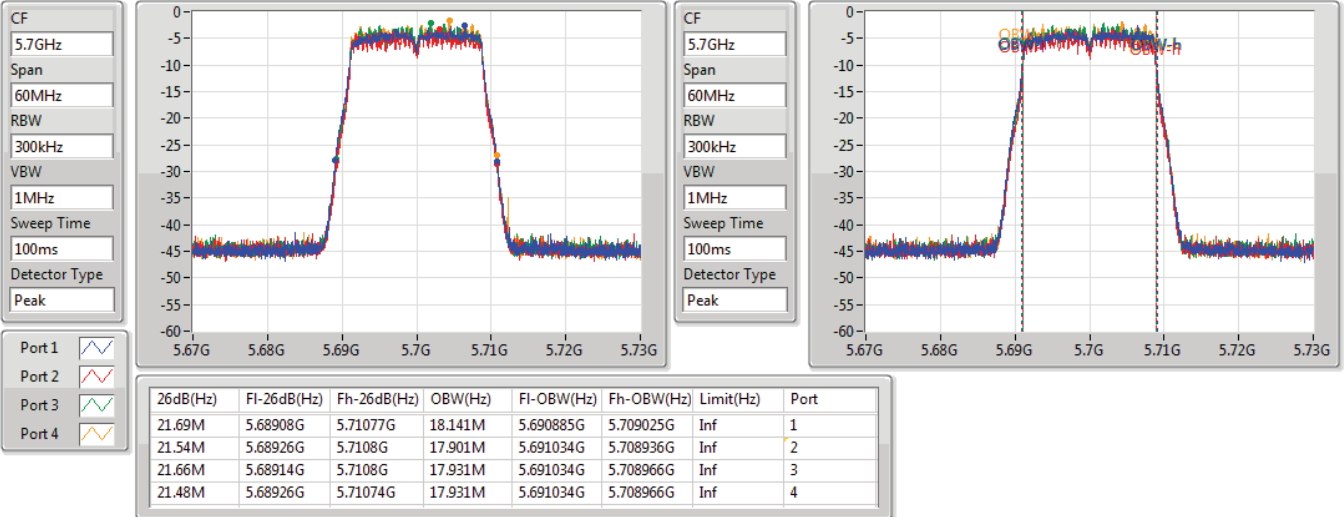

802.11n HT20_Nss1,(MCS0)_4TX

EBW

5720MHz Straddle 5.47-5.725GHz

16/06/2022

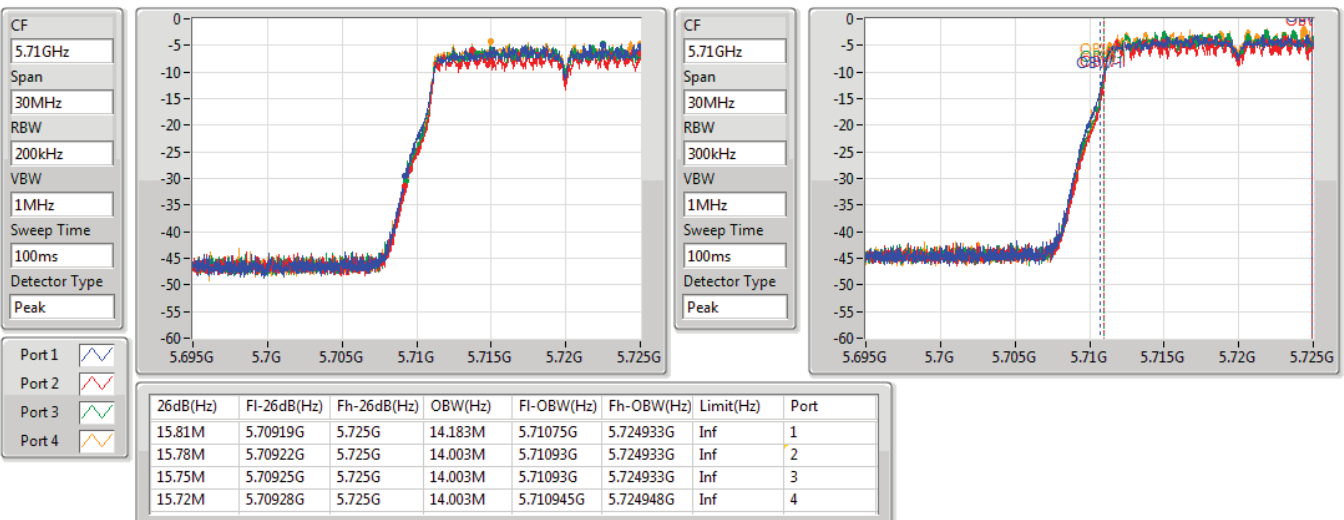

802.11n HT20_Nss1,(MCS0)_4TX

EBW

5720MHz Straddle 5.725-5.85GHz

16/06/2022



802.11n HT20_Nss1,(MCS0)_4TX

EBW

5745MHz

16/06/2022

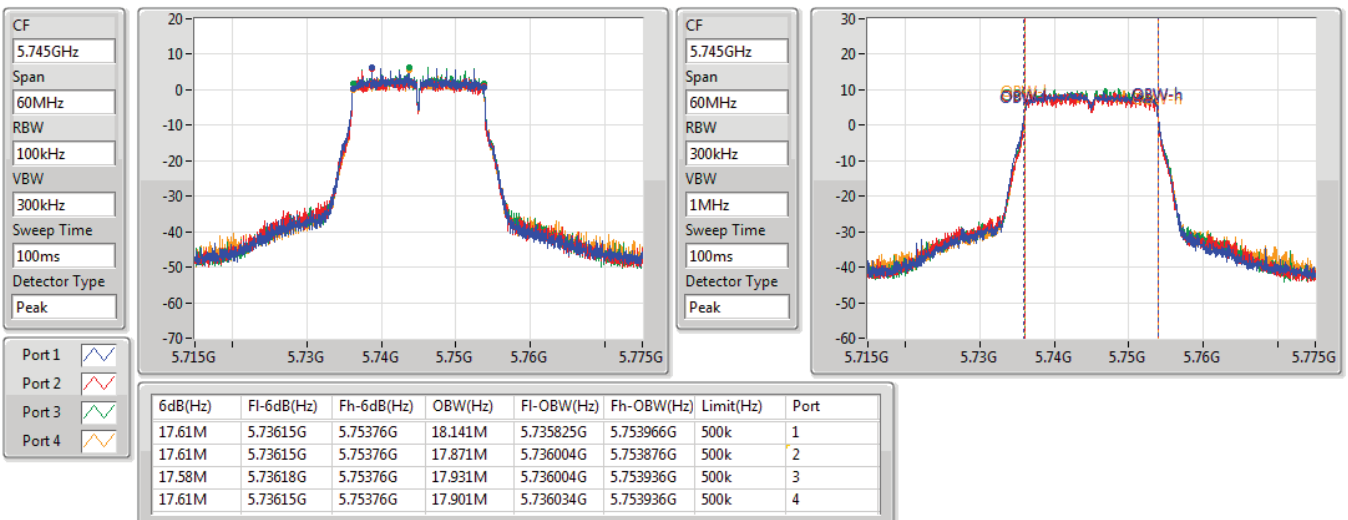

802.11n HT20_Nss1,(MCS0)_4TX

EBW

5785MHz

16/06/2022

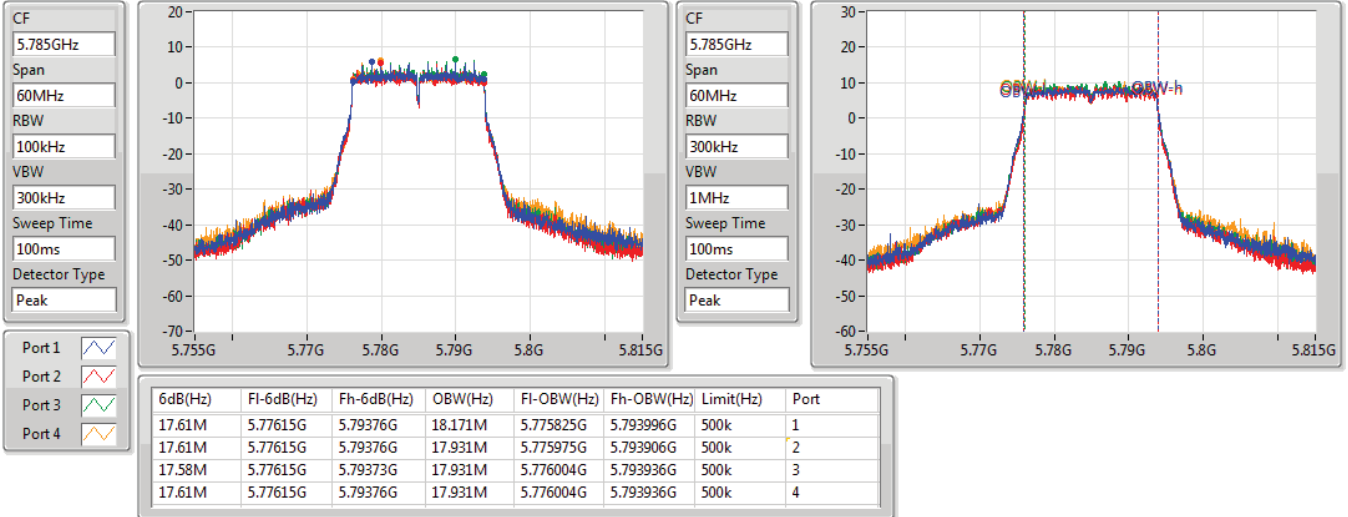

802.11n HT20_Nss1,(MCS0)_4TX

EBW

5825MHz

16/06/2022

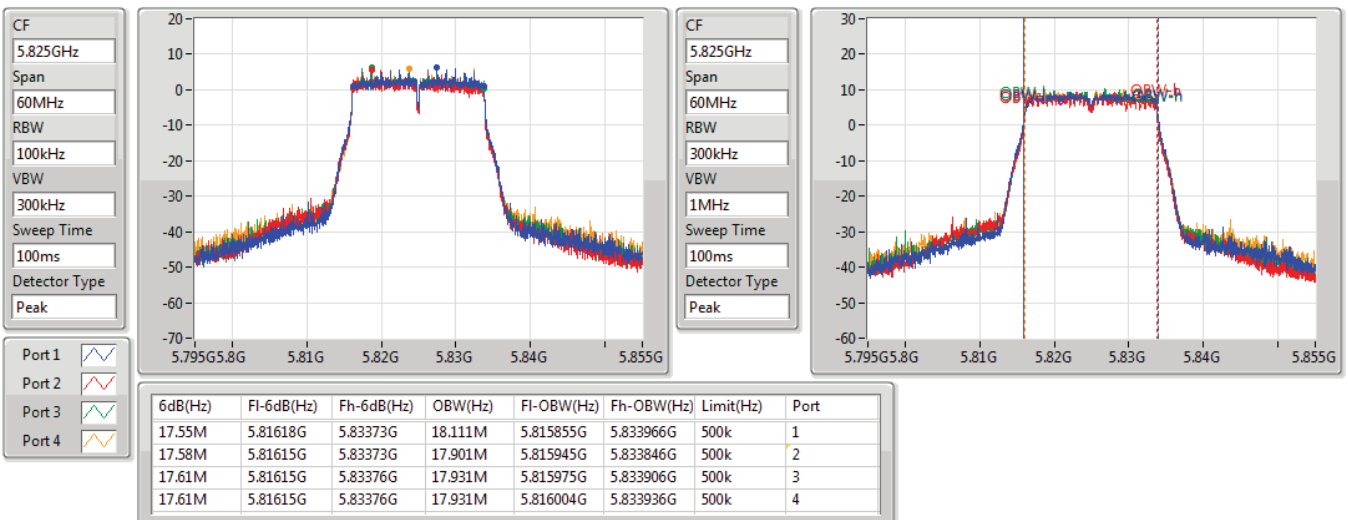

802.11n HT40_Nss1,(MCS0)_4TX

EBW

5510MHz

16/06/2022

CF
5.51GHz
Span
120MHz
RBW
500kHz
VBW
2MHz
Sweep Time
100ms
Detector Type
Peak

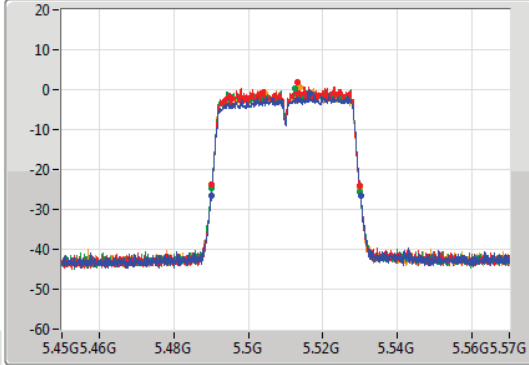

CF
5.51GHz
Span
120MHz
RBW
1MHz
VBW
3MHz
Sweep Time
100ms
Detector Type
Peak

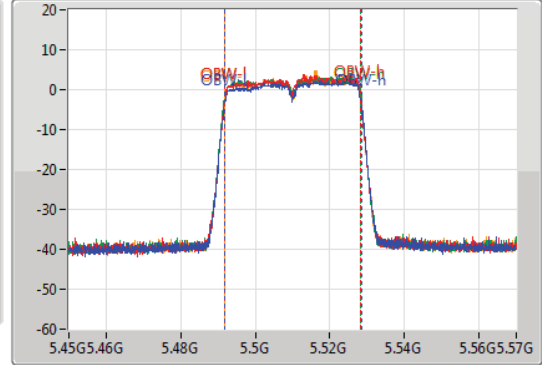

Port 1
Port 2
Port 3
Port 4

26dB(Hz)	Fl-26dB(Hz)	Fh-26dB(Hz)	OBW(Hz)	Fl-OBW(Hz)	Fh-OBW(Hz)	Limit(Hz)	Port
40.14M	5.49002G	5.53016G	36.762M	5.491709G	5.528471G	Inf	1
39.6M	5.4902G	5.5298G	36.462M	5.491829G	5.528291G	Inf	2
39.96M	5.49002G	5.52998G	36.702M	5.491649G	5.528351G	Inf	3
39.66M	5.4902G	5.52986G	36.642M	5.491649G	5.528291G	Inf	4

802.11n HT40_Nss1,(MCS0)_4TX

EBW

5550MHz

16/06/2022

CF
5.55GHz
Span
120MHz
RBW
500kHz
VBW
2MHz
Sweep Time
100ms
Detector Type
Peak

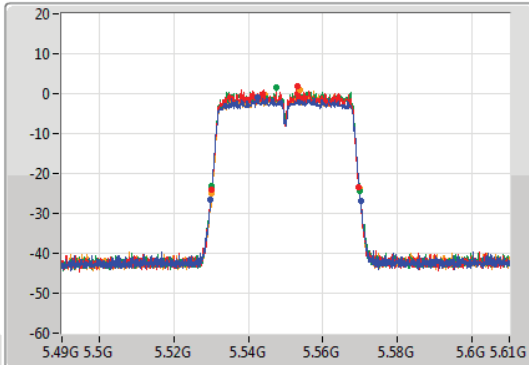

CF
5.55GHz
Span
120MHz
RBW
1MHz
VBW
3MHz
Sweep Time
100ms
Detector Type
Peak

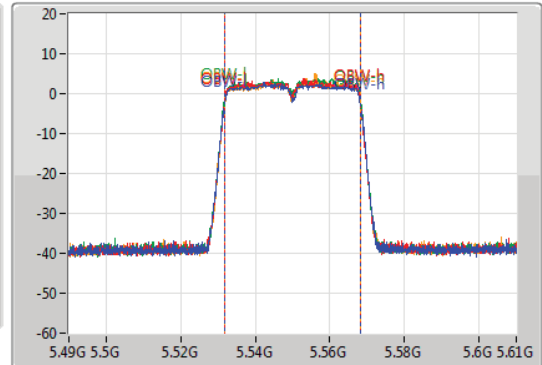

Port 1
Port 2
Port 3
Port 4

26dB(Hz)	Fl-26dB(Hz)	Fh-26dB(Hz)	OBW(Hz)	Fl-OBW(Hz)	Fh-OBW(Hz)	Limit(Hz)	Port
40.26M	5.52984G	5.5701G	36.702M	5.531649G	5.568351G	Inf	1
39.48M	5.5302G	5.56968G	36.462M	5.531709G	5.568171G	Inf	2
39.66M	5.5302G	5.56986G	36.642M	5.531649G	5.568291G	Inf	3
39.72M	5.53008G	5.5698G	36.642M	5.531649G	5.568291G	Inf	4

802.11n HT40_Nss1,(MCS0)_4TX

EBW

5670MHz

16/06/2022

CF
5.67GHz
Span
120MHz
RBW
500kHz
VBW
2MHz
Sweep Time
100ms
Detector Type
Peak

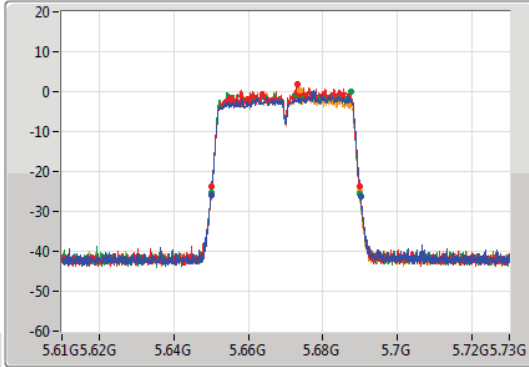

CF
5.67GHz
Span
120MHz
RBW
1MHz
VBW
3MHz
Sweep Time
100ms
Detector Type
Peak

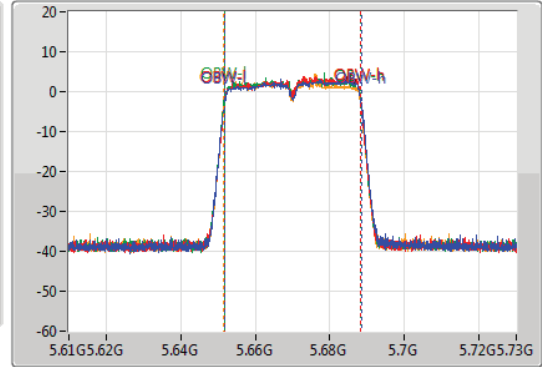

Port 1
Port 2
Port 3
Port 4

26dB(Hz)	Fl-26dB(Hz)	Fh-26dB(Hz)	OBW(Hz)	Fl-OBW(Hz)	Fh-OBW(Hz)	Limit(Hz)	Port
40.14M	5.64996G	5.6901G	36.762M	5.651709G	5.688471G	Inf	1
39.54M	5.65026G	5.6898G	36.462M	5.651829G	5.688291G	Inf	2
39.96M	5.65002G	5.68998G	36.642M	5.651649G	5.688291G	Inf	3
39.72M	5.65008G	5.6898G	36.642M	5.651589G	5.688231G	Inf	4

802.11n HT40_Nss1,(MCS0)_4TX

EBW

5710MHz Straddle 5.47-5.725GHz

16/06/2022

CF
5.69GHz
Span
70MHz
RBW
500kHz
VBW
2MHz
Sweep Time
100ms
Detector Type
Peak

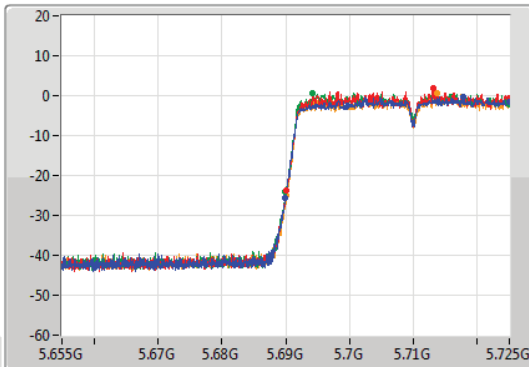

CF
5.69GHz
Span
70MHz
RBW
1MHz
VBW
3MHz
Sweep Time
100ms
Detector Type
Peak

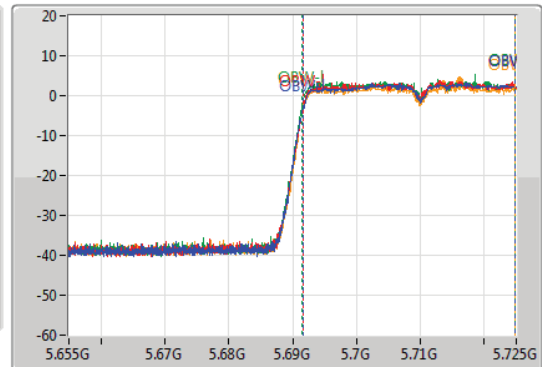

Port 1
Port 2
Port 3
Port 4

26dB(Hz)	Fl-26dB(Hz)	Fh-26dB(Hz)	OBW(Hz)	Fl-OBW(Hz)	Fh-OBW(Hz)	Limit(Hz)	Port
35.07M	5.68993G	5.725G	33.198M	5.691644G	5.724843G	Inf	1
34.825M	5.690175G	5.725G	33.163M	5.691679G	5.724843G	Inf	2
35.035M	5.689965G	5.725G	33.268M	5.691539G	5.724808G	Inf	3
34.86M	5.69014G	5.725G	33.233M	5.691609G	5.724843G	Inf	4

802.11n HT40_Nss1,(MCS0)_4TX

EBW

5710MHz Straddle 5.725-5.85GHz

16/06/2022

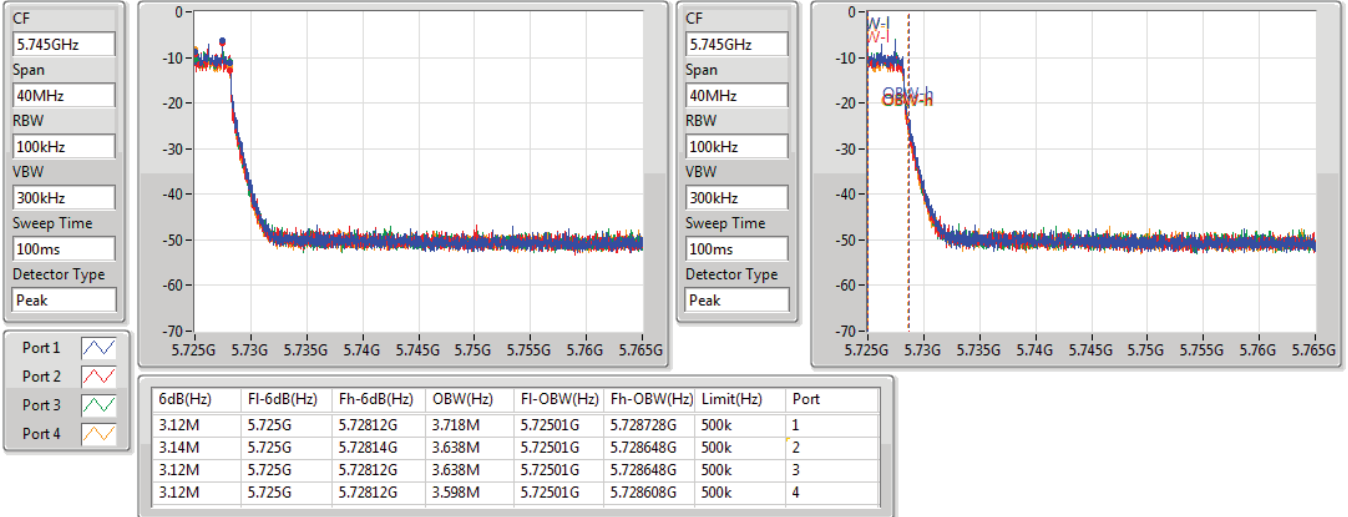

802.11n HT40_Nss1,(MCS0)_4TX

EBW

5755MHz

16/06/2022

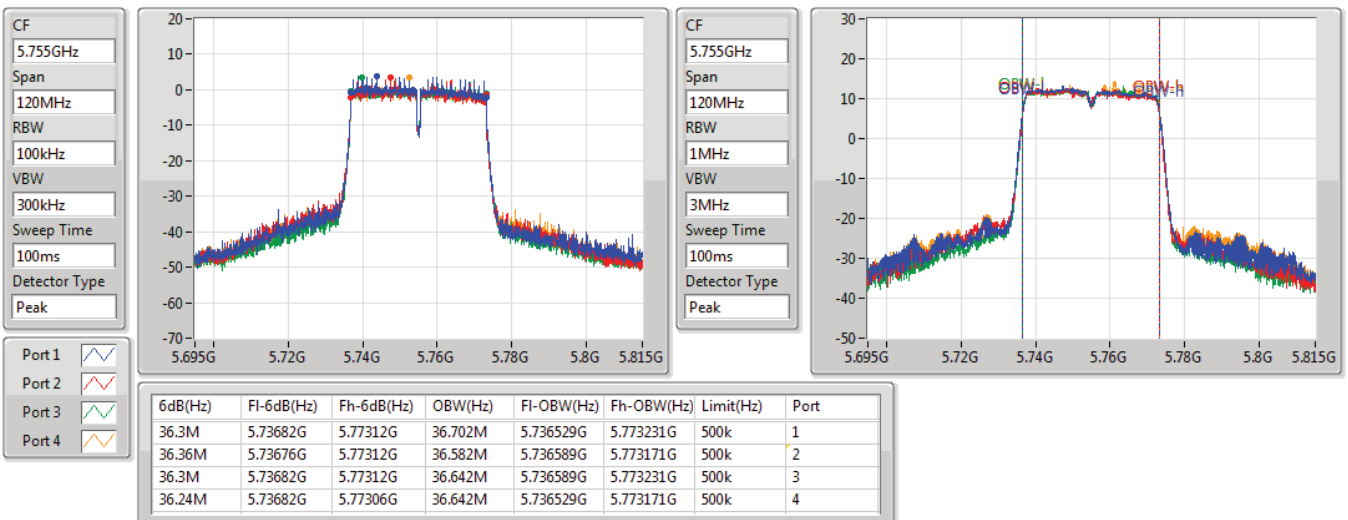

802.11n HT40_Nss1,(MCS0)_4TX

EBW

5795MHz

16/06/2022

CF
5.795GHz
Span
120MHz
RBW
100kHz
VBW
300kHz
Sweep Time
100ms
Detector Type
Peak

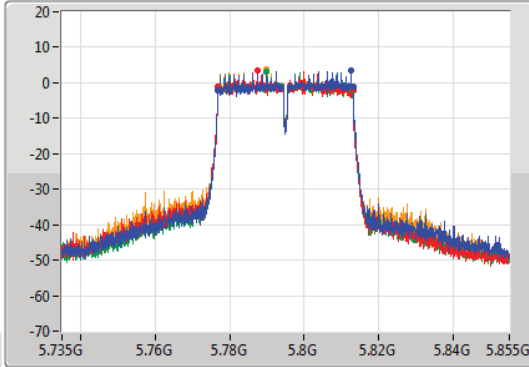

CF
5.795GHz
Span
120MHz
RBW
1MHz
VBW
3MHz
Sweep Time
100ms
Detector Type
Peak

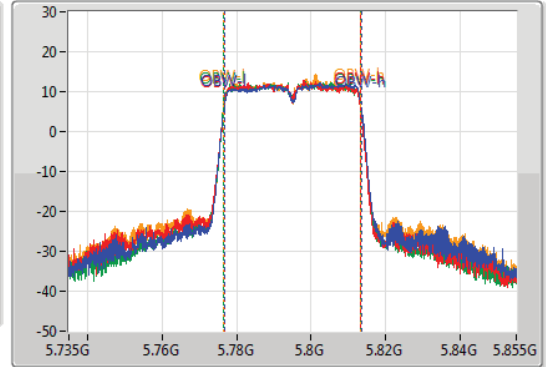

Port 1
Port 2
Port 3
Port 4

6dB(Hz)	Fl-6dB(Hz)	Fh-6dB(Hz)	OBW(Hz)	Fl-OBW(Hz)	Fh-OBW(Hz)	Limit(Hz)	Port
36.3M	5.77682G	5.81312G	36.822M	5.776649G	5.813471G	500k	1
36.3M	5.77682G	5.81312G	36.522M	5.776649G	5.813171G	500k	2
36.36M	5.77676G	5.81312G	36.642M	5.776589G	5.813231G	500k	3
36.3M	5.77682G	5.81312G	36.642M	5.776589G	5.813231G	500k	4

802.11ac VHT20_Nss1,(MCS0)_4TX

EBW

5500MHz

16/06/2022

CF
5.5GHz
Span
60MHz
RBW
300kHz
VBW
1MHz
Sweep Time
100ms
Detector Type
Peak

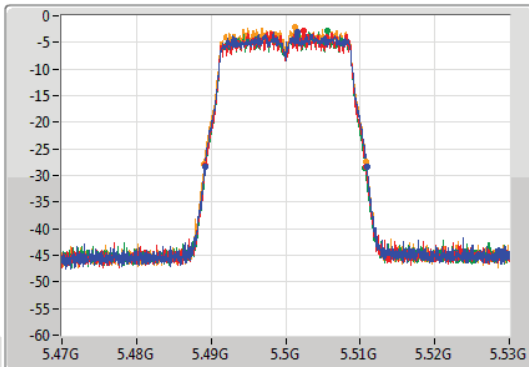

CF
5.5GHz
Span
60MHz
RBW
300kHz
VBW
1MHz
Sweep Time
100ms
Detector Type
Peak

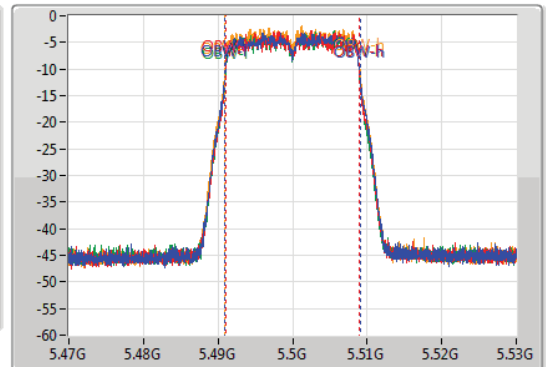

Port 1
Port 2
Port 3
Port 4

26dB(Hz)	Fl-26dB(Hz)	Fh-26dB(Hz)	OBW(Hz)	Fl-OBW(Hz)	Fh-OBW(Hz)	Limit(Hz)	Port
21.75M	5.48917G	5.51092G	18.111M	5.490975G	5.509085G	Inf	1
21.57M	5.48923G	5.5108G	17.931M	5.491034G	5.508966G	Inf	2
21.45M	5.48923G	5.51068G	17.961M	5.491004G	5.508966G	Inf	3
21.75M	5.48908G	5.51083G	18.051M	5.490975G	5.509025G	Inf	4

802.11ac VHT20_Nss1,(MCS0)_4TX

EBW

5580MHz

16/06/2022

CF
5.58GHz
Span
60MHz
RBW
300kHz
VBW
1MHz
Sweep Time
100ms
Detector Type
Peak

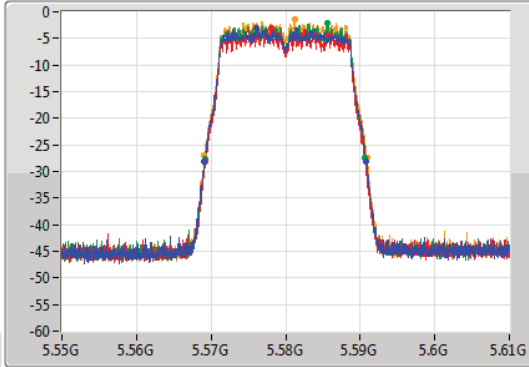

CF
5.58GHz
Span
60MHz
RBW
300kHz
VBW
1MHz
Sweep Time
100ms
Detector Type
Peak

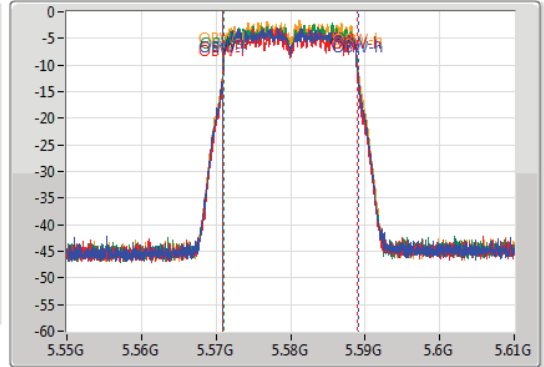

Port 1
Port 2
Port 3
Port 4

26dB(Hz)	Fl-26dB(Hz)	Fh-26dB(Hz)	OBW(Hz)	Fl-OBW(Hz)	Fh-OBW(Hz)	Limit(Hz)	Port
21.78M	5.56908G	5.59086G	18.111M	5.570915G	5.589025G	Inf	1
21.6M	5.56914G	5.59074G	17.961M	5.570975G	5.588936G	Inf	2
21.51M	5.56917G	5.59068G	17.931M	5.571004G	5.588936G	Inf	3
21.78M	5.56911G	5.59089G	18.051M	5.570975G	5.589025G	Inf	4

802.11ac VHT20_Nss1,(MCS0)_4TX

EBW

5700MHz

16/06/2022

CF
5.7GHz
Span
60MHz
RBW
300kHz
VBW
1MHz
Sweep Time
100ms
Detector Type
Peak

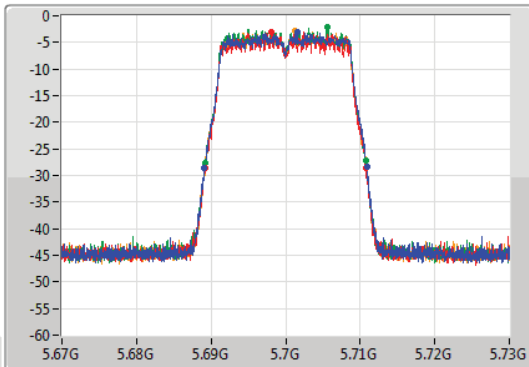

CF
5.7GHz
Span
60MHz
RBW
300kHz
VBW
1MHz
Sweep Time
100ms
Detector Type
Peak

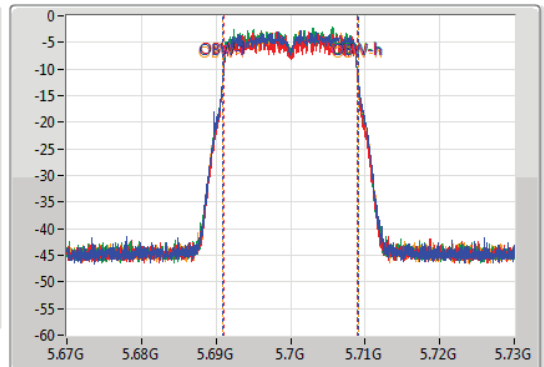

Port 1
Port 2
Port 3
Port 4

26dB(Hz)	Fl-26dB(Hz)	Fh-26dB(Hz)	OBW(Hz)	Fl-OBW(Hz)	Fh-OBW(Hz)	Limit(Hz)	Port
21.78M	5.68911G	5.71089G	18.081M	5.690975G	5.709055G	Inf	1
21.6M	5.6892G	5.7108G	17.961M	5.691004G	5.708966G	Inf	2
21.54M	5.68917G	5.71071G	17.931M	5.691004G	5.708936G	Inf	3
21.63M	5.6892G	5.71083G	18.081M	5.690975G	5.709055G	Inf	4

802.11ac VHT20_Nss1,(MCS0)_4TX

EBW

5720MHz Straddle 5.47-5.725GHz

16/06/2022

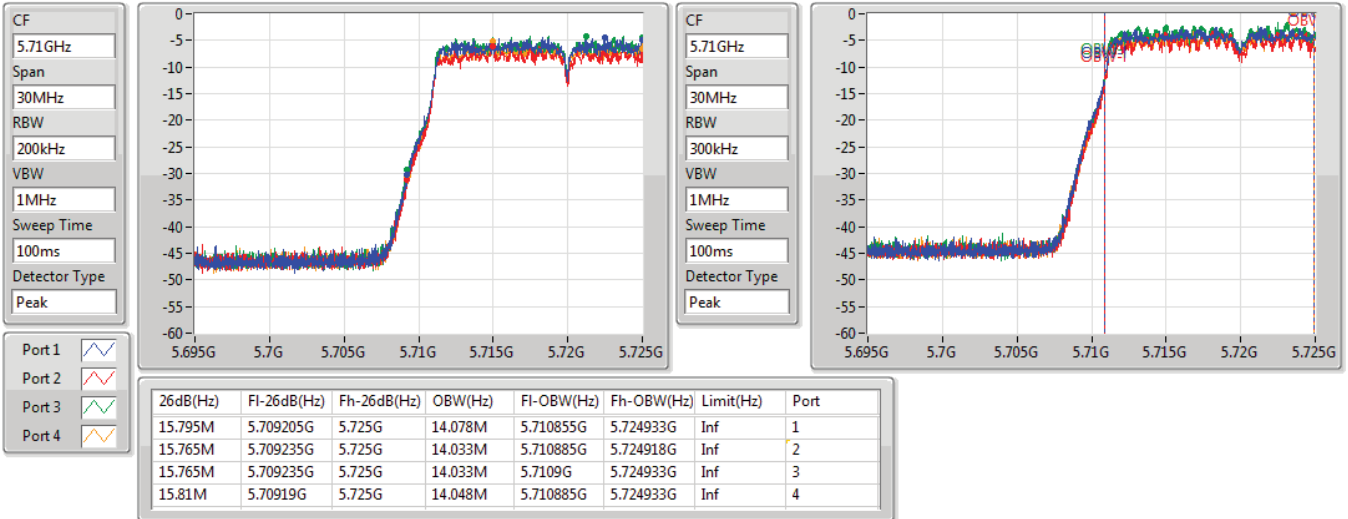

802.11ac VHT20_Nss1,(MCS0)_4TX

EBW

5720MHz Straddle 5.725-5.85GHz

16/06/2022

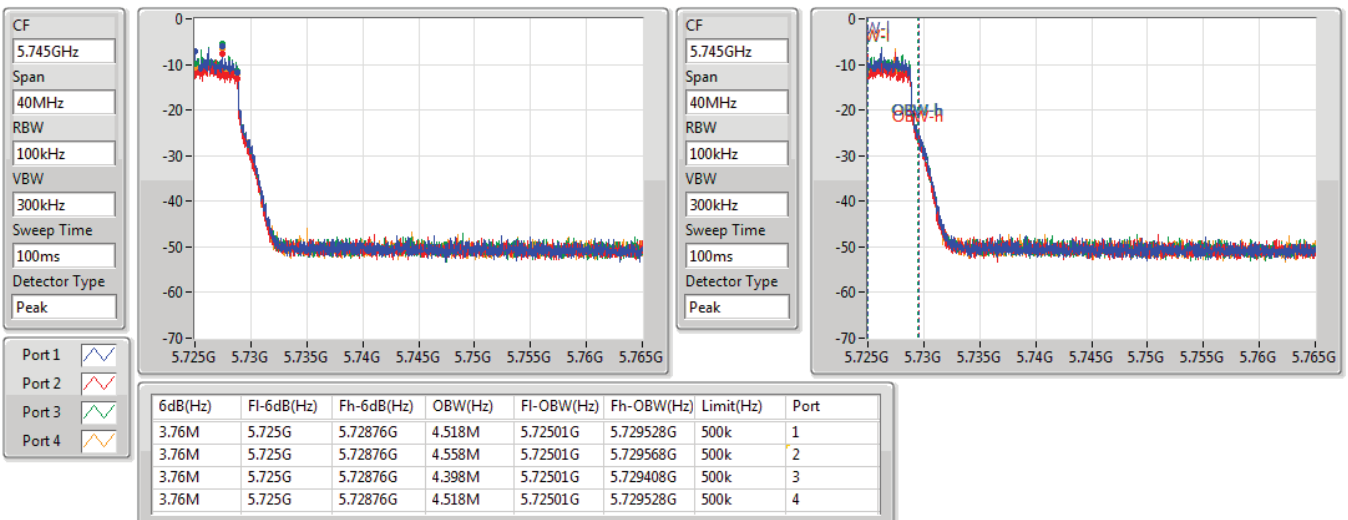

802.11ac VHT20_Nss1,(MCS0)_4TX

EBW

5745MHz

16/06/2022

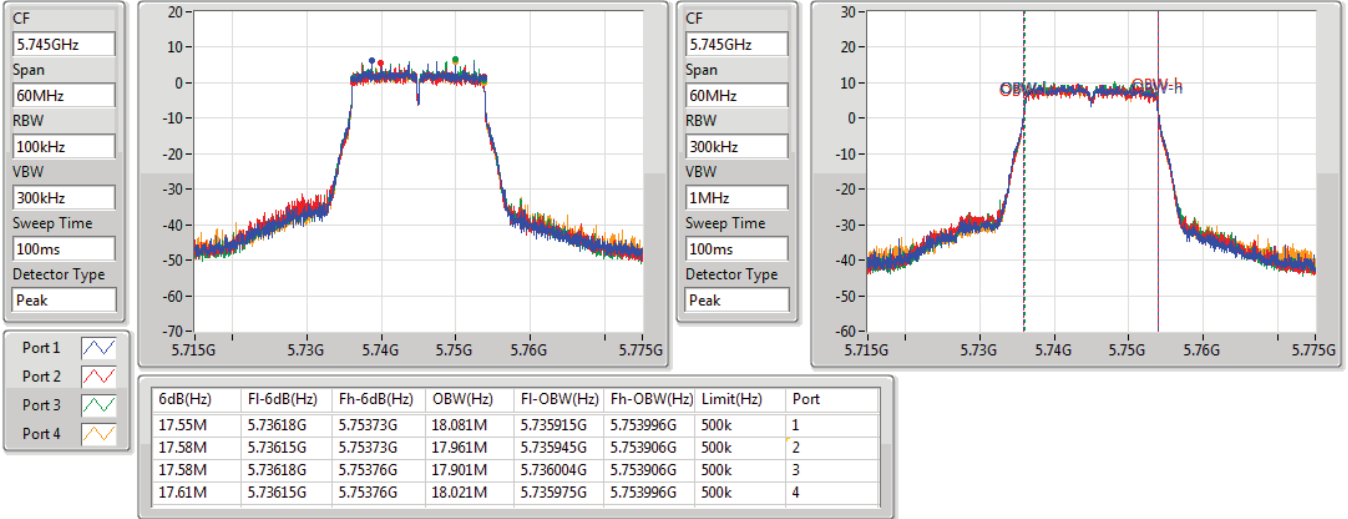

802.11ac VHT20_Nss1,(MCS0)_4TX

EBW

5785MHz

16/06/2022

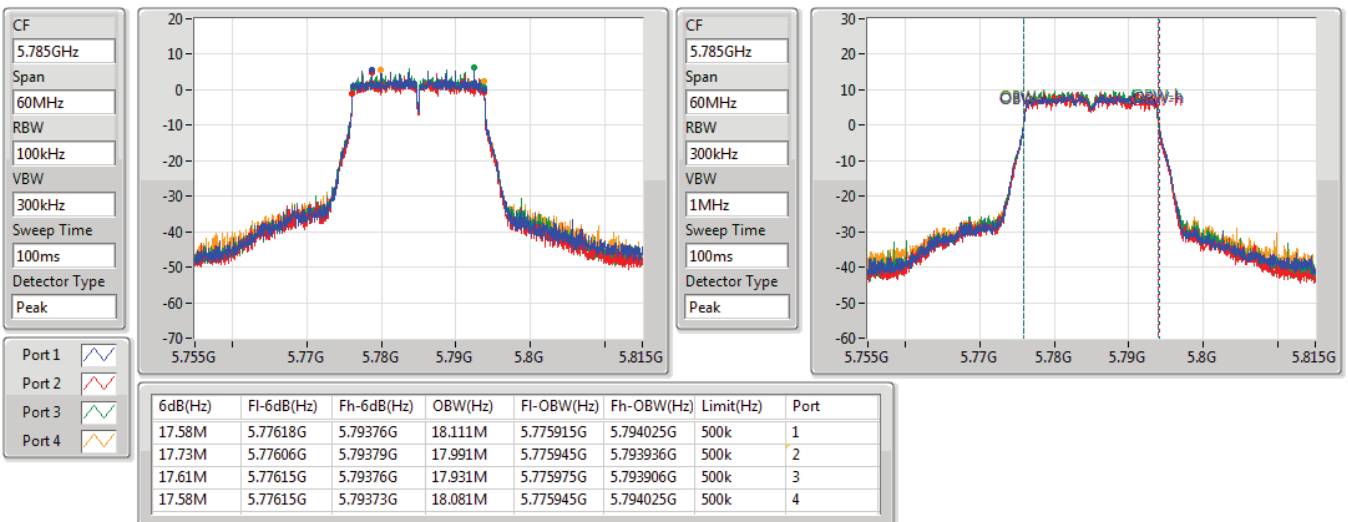

802.11ac VHT20_Nss1,(MCS0)_4TX

EBW

5825MHz

16/06/2022

CF
5.825GHz
Span
60MHz
RBW
100kHz
VBW
300kHz
Sweep Time
100ms
Detector Type
Peak

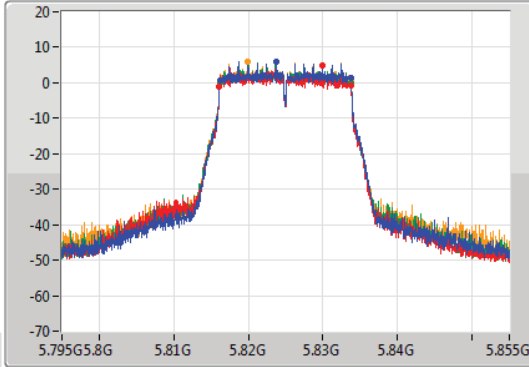

CF
5.825GHz
Span
60MHz
RBW
300kHz
VBW
1MHz
Sweep Time
100ms
Detector Type
Peak

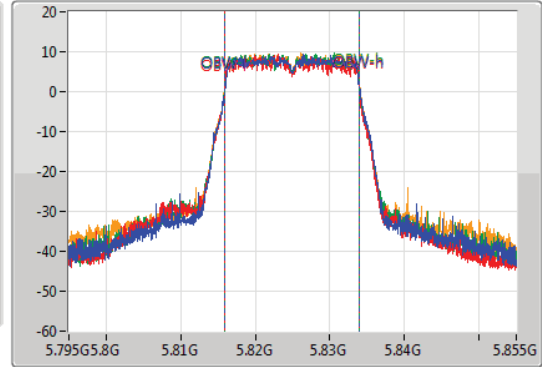

Port 1
Port 2
Port 3
Port 4

6dB(Hz)	FI-6dB(Hz)	Fh-6dB(Hz)	OBW(Hz)	FI-OBW(Hz)	Fh-OBW(Hz)	Limit(Hz)	Port
17.55M	5.81618G	5.83373G	18.051M	5.815945G	5.833996G	500k	1
17.67M	5.81609G	5.83376G	17.961M	5.815915G	5.833876G	500k	2
17.61M	5.81615G	5.83376G	17.901M	5.815975G	5.833876G	500k	3
17.61M	5.81615G	5.83376G	18.051M	5.815945G	5.833996G	500k	4

802.11ac VHT40_Nss1,(MCS0)_4TX

EBW

5510MHz

16/06/2022

CF
5.51GHz
Span
120MHz
RBW
500kHz
VBW
2MHz
Sweep Time
100ms
Detector Type
Peak

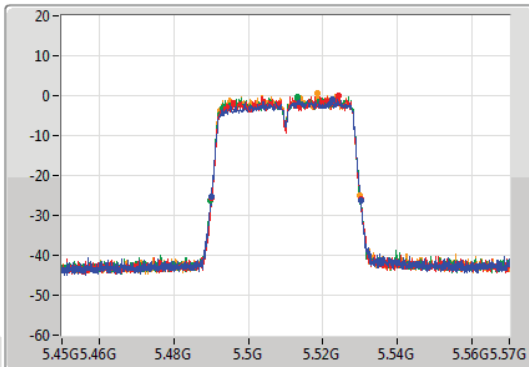

CF
5.51GHz
Span
120MHz
RBW
1MHz
VBW
3MHz
Sweep Time
100ms
Detector Type
Peak

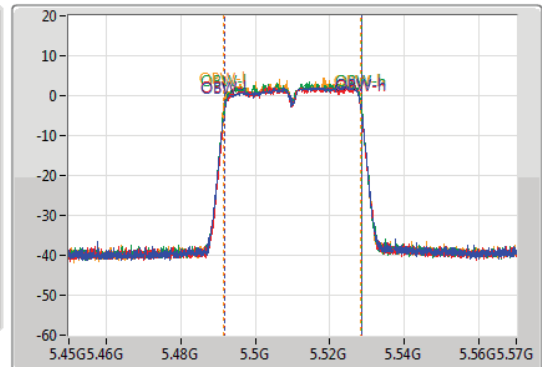

Port 1
Port 2
Port 3
Port 4

26dB(Hz)	FI-26dB(Hz)	Fh-26dB(Hz)	OBW(Hz)	FI-OBW(Hz)	Fh-OBW(Hz)	Limit(Hz)	Port
40.26M	5.49002G	5.53028G	36.702M	5.491769G	5.528471G	Inf	1
39.96M	5.4902G	5.53016G	36.642M	5.491769G	5.528411G	Inf	2
40.26M	5.4899G	5.53016G	36.702M	5.491709G	5.528411G	Inf	3
39.9M	5.49014G	5.53004G	36.762M	5.491589G	5.528351G	Inf	4



802.11ac VHT40_Nss1,(MCS0)_4TX

EBW

5550MHz

16/06/2022

CF
5.55GHz
Span
120MHz
RBW
500kHz
VBW
2MHz
Sweep Time
100ms
Detector Type
Peak

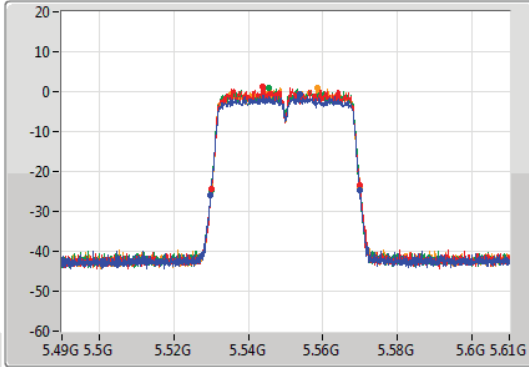

CF
5.55GHz
Span
120MHz
RBW
1MHz
VBW
3MHz
Sweep Time
100ms
Detector Type
Peak

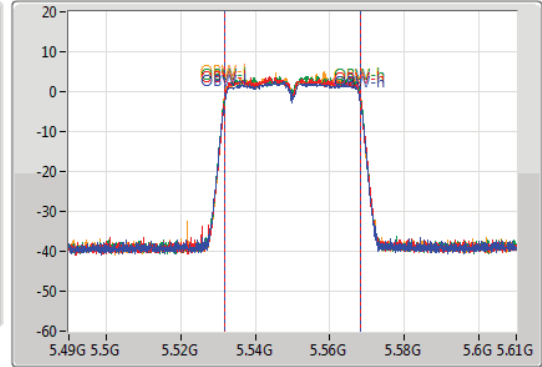

Port 1
Port 2
Port 3
Port 4

26dB(Hz)	Fl-26dB(Hz)	Fh-26dB(Hz)	OBW(Hz)	Fl-OBW(Hz)	Fh-OBW(Hz)	Limit(Hz)	Port
40.08M	5.52984G	5.56992G	36.702M	5.531649G	5.568351G	Inf	1
39.78M	5.53014G	5.56992G	36.582M	5.531709G	5.568291G	Inf	2
40.02M	5.53002G	5.57004G	36.702M	5.531649G	5.568351G	Inf	3
39.84M	5.53014G	5.56998G	36.702M	5.531649G	5.568351G	Inf	4

802.11ac VHT40_Nss1,(MCS0)_4TX

EBW

5670MHz

16/06/2022

CF
5.67GHz
Span
120MHz
RBW
500kHz
VBW
2MHz
Sweep Time
100ms
Detector Type
Peak

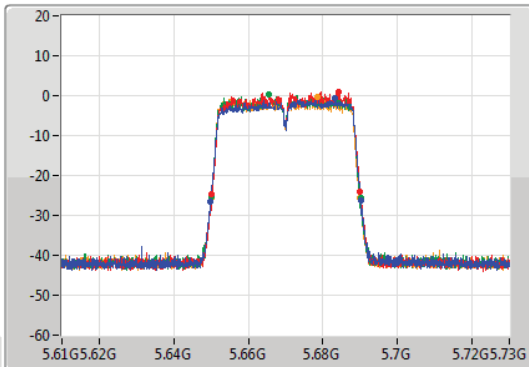

CF
5.67GHz
Span
120MHz
RBW
1MHz
VBW
3MHz
Sweep Time
100ms
Detector Type
Peak

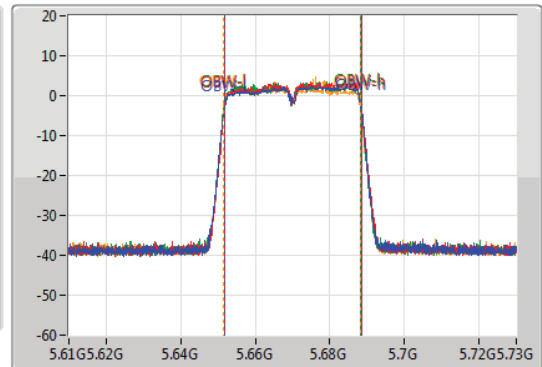

Port 1
Port 2
Port 3
Port 4

26dB(Hz)	Fl-26dB(Hz)	Fh-26dB(Hz)	OBW(Hz)	Fl-OBW(Hz)	Fh-OBW(Hz)	Limit(Hz)	Port
40.26M	5.6499G	5.69016G	36.762M	5.651709G	5.688471G	Inf	1
39.84M	5.6502G	5.69004G	36.582M	5.651829G	5.688411G	Inf	2
40.08M	5.65002G	5.6901G	36.702M	5.651649G	5.688351G	Inf	3
39.84M	5.65008G	5.68992G	36.762M	5.651529G	5.688291G	Inf	4

802.11ac VHT40_Nss1,(MCS0)_4TX

EBW

5710MHz Straddle 5.47-5.725GHz

16/06/2022

CF
5.69GHz
Span
70MHz
RBW
500kHz
VBW
2MHz
Sweep Time
100ms
Detector Type
Peak

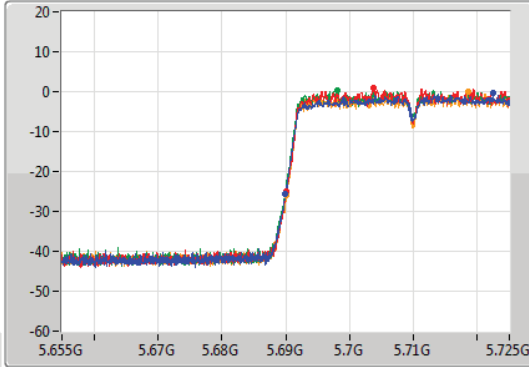

CF
5.69GHz
Span
70MHz
RBW
1MHz
VBW
3MHz
Sweep Time
100ms
Detector Type
Peak

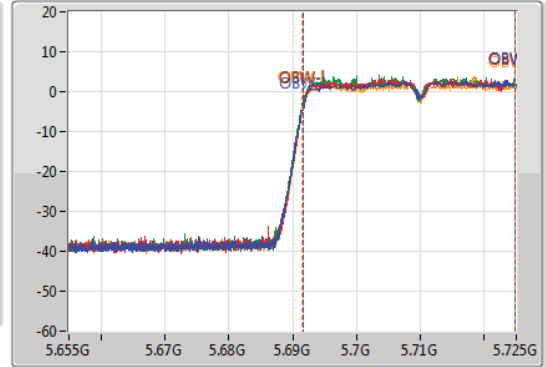

26dB(Hz)	Fl-26dB(Hz)	Fh-26dB(Hz)	OBW(Hz)	Fl-OBW(Hz)	Fh-OBW(Hz)	Limit(Hz)	Port
35.105M	5.689895G	5.725G	33.198M	5.691644G	5.724843G	Inf	1
34.93M	5.69007G	5.725G	33.163M	5.691679G	5.724843G	Inf	2
35.07M	5.68993G	5.725G	33.233M	5.691574G	5.724808G	Inf	3
34.895M	5.690105G	5.725G	33.268M	5.691539G	5.724808G	Inf	4

802.11ac VHT40_Nss1,(MCS0)_4TX

EBW

5710MHz Straddle 5.725-5.85GHz

16/06/2022

CF
5.745GHz
Span
40MHz
RBW
100kHz
VBW
300kHz
Sweep Time
100ms
Detector Type
Peak

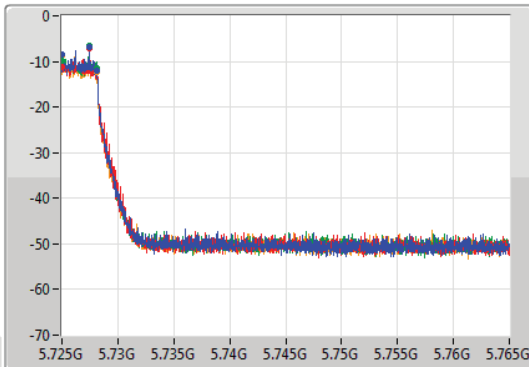

CF
5.745GHz
Span
40MHz
RBW
100kHz
VBW
300kHz
Sweep Time
100ms
Detector Type
Peak

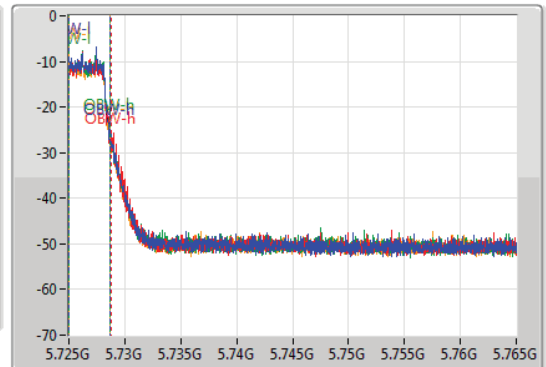

6dB(Hz)	Fl-6dB(Hz)	Fh-6dB(Hz)	OBW(Hz)	Fl-OBW(Hz)	Fh-OBW(Hz)	Limit(Hz)	Port
3.12M	5.725G	5.72812G	3.678M	5.72501G	5.728688G	500k	1
3.12M	5.725G	5.72812G	3.778M	5.72501G	5.728788G	500k	2
3.12M	5.725G	5.72812G	3.698M	5.72501G	5.728708G	500k	3
3.12M	5.725G	5.72812G	3.698M	5.72501G	5.728708G	500k	4

802.11ac VHT40_Nss1,(MCS0)_4TX

EBW

5755MHz

16/06/2022

CF
5.755GHz
Span
120MHz
RBW
100kHz
VBW
300kHz
Sweep Time
100ms
Detector Type
Peak

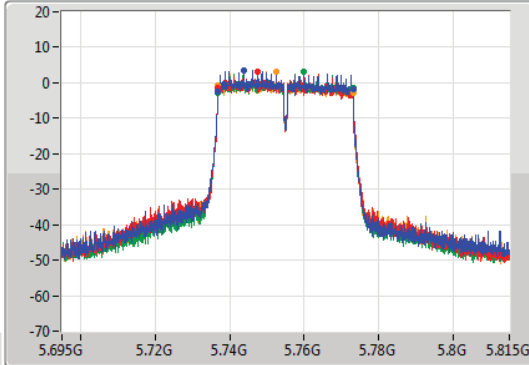

CF
5.755GHz
Span
120MHz
RBW
1MHz
VBW
3MHz
Sweep Time
100ms
Detector Type
Peak

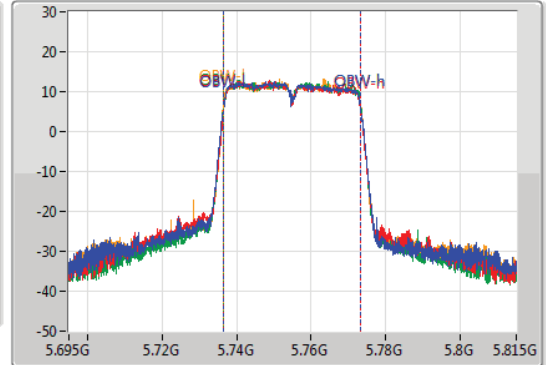

Port 1
Port 2
Port 3
Port 4

6dB(Hz)	Fl-6dB(Hz)	Fh-6dB(Hz)	OBW(Hz)	Fl-OBW(Hz)	Fh-OBW(Hz)	Limit(Hz)	Port
36.36M	5.73676G	5.77312G	36.702M	5.736529G	5.773231G	500k	1
36.36M	5.73676G	5.77312G	36.582M	5.736589G	5.773171G	500k	2
36.36M	5.73676G	5.77312G	36.702M	5.736589G	5.773291G	500k	3
36.24M	5.73682G	5.77306G	36.702M	5.736529G	5.773231G	500k	4

802.11ac VHT40_Nss1,(MCS0)_4TX

EBW

5795MHz

16/06/2022

CF
5.795GHz
Span
120MHz
RBW
100kHz
VBW
300kHz
Sweep Time
100ms
Detector Type
Peak

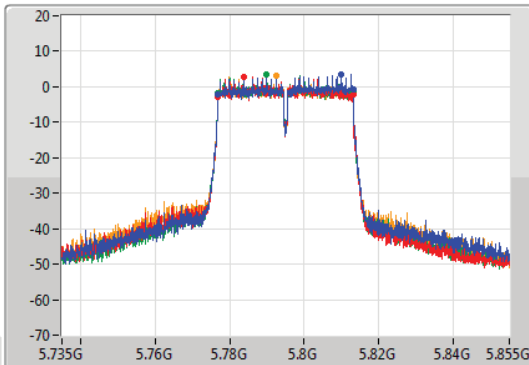

CF
5.795GHz
Span
120MHz
RBW
1MHz
VBW
3MHz
Sweep Time
100ms
Detector Type
Peak

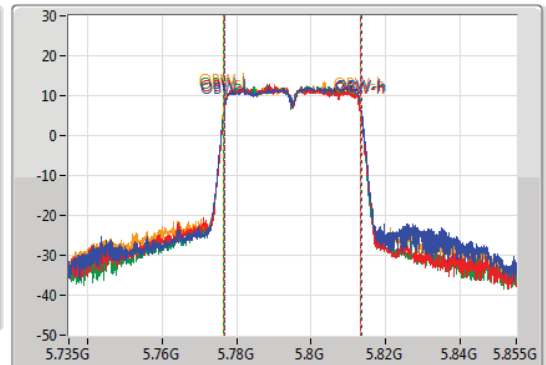

Port 1
Port 2
Port 3
Port 4

6dB(Hz)	Fl-6dB(Hz)	Fh-6dB(Hz)	OBW(Hz)	Fl-OBW(Hz)	Fh-OBW(Hz)	Limit(Hz)	Port
36.3M	5.77682G	5.81312G	36.822M	5.776649G	5.813471G	500k	1
36.36M	5.77676G	5.81312G	36.582M	5.776649G	5.813231G	500k	2
36.3M	5.77682G	5.81312G	36.702M	5.776589G	5.813291G	500k	3
36.36M	5.77676G	5.81312G	36.762M	5.776529G	5.813291G	500k	4

802.11ac VHT80_Nss1,(MCS0)_4TX

EBW

5530MHz

16/06/2022

CF
5.53GHz
Span
240MHz
RBW
1MHz
VBW
3MHz
Sweep Time
100ms
Detector Type
Peak

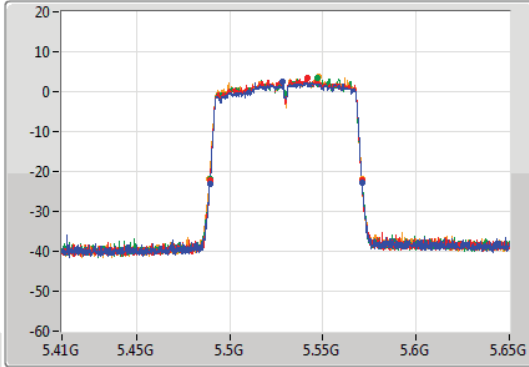

CF
5.53GHz
Span
240MHz
RBW
2MHz
VBW
10MHz
Sweep Time
100ms
Detector Type
Peak

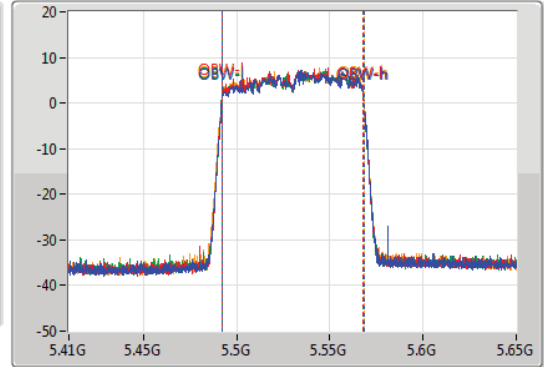

Port 1
Port 2
Port 3
Port 4

26dB(Hz)	Fl-26dB(Hz)	Fh-26dB(Hz)	OBW(Hz)	Fl-OBW(Hz)	Fh-OBW(Hz)	Limit(Hz)	Port
81.72M	5.48932G	5.57104G	75.922M	5.492219G	5.568141G	Inf	1
81.36M	5.48944G	5.5708G	75.802M	5.492219G	5.568021G	Inf	2
81.36M	5.48956G	5.57092G	75.922M	5.492099G	5.568021G	Inf	3
81.84M	5.48908G	5.57092G	76.162M	5.491979G	5.568141G	Inf	4

802.11ac VHT80_Nss1,(MCS0)_4TX

EBW

5610MHz

16/06/2022

CF
5.61GHz
Span
240MHz
RBW
1MHz
VBW
3MHz
Sweep Time
100ms
Detector Type
Peak

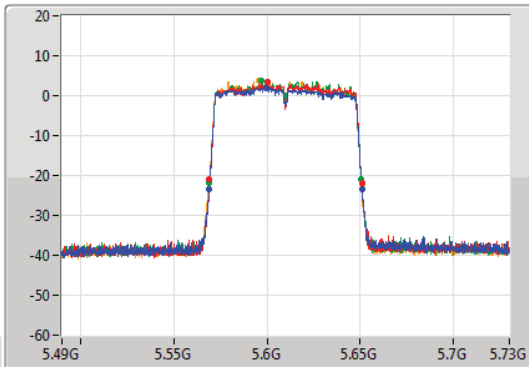

CF
5.61GHz
Span
240MHz
RBW
2MHz
VBW
10MHz
Sweep Time
100ms
Detector Type
Peak

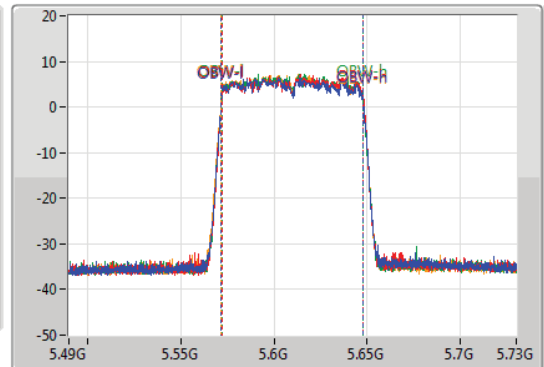

Port 1
Port 2
Port 3
Port 4

26dB(Hz)	Fl-26dB(Hz)	Fh-26dB(Hz)	OBW(Hz)	Fl-OBW(Hz)	Fh-OBW(Hz)	Limit(Hz)	Port
81.96M	5.56896G	5.65092G	76.042M	5.571859G	5.647901G	Inf	1
81.6M	5.5692G	5.6508G	76.042M	5.571979G	5.648021G	Inf	2
81.48M	5.5692G	5.65068G	75.922M	5.571979G	5.647901G	Inf	3
81.84M	5.56896G	5.6508G	75.922M	5.571859G	5.647781G	Inf	4

802.11ac VHT80_Nss1,(MCS0)_4TX

EBW

5690MHz Straddle 5.47-5.725GHz

16/06/2022

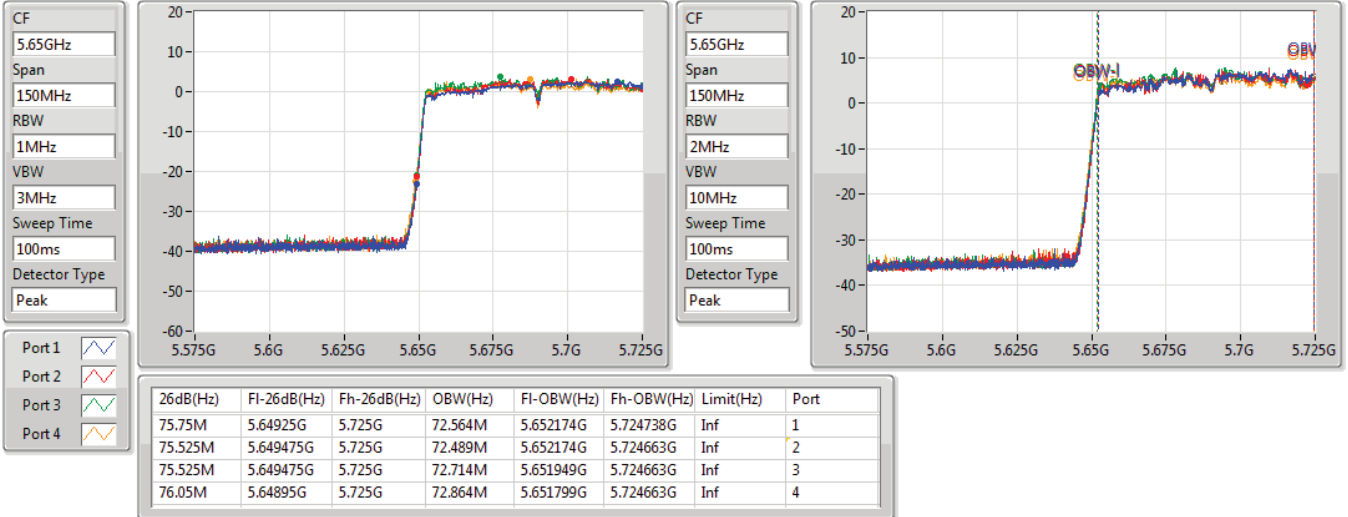

802.11ac VHT80_Nss1,(MCS0)_4TX

EBW

5690MHz Straddle 5.725-5.85GHz

16/06/2022

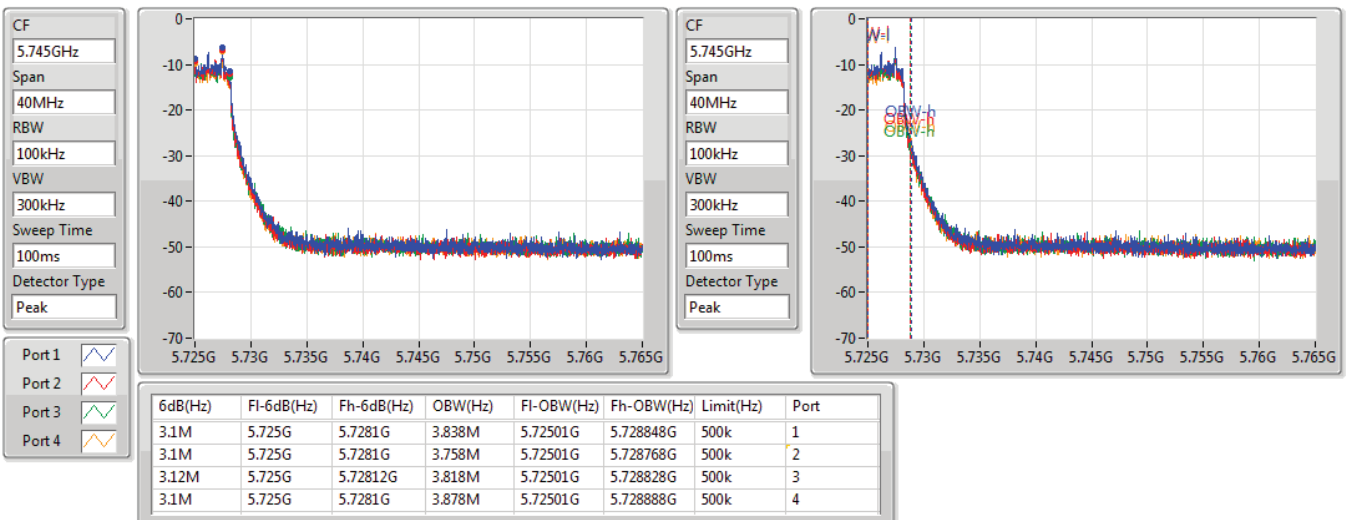

802.11ac VHT80_Nss1,(MCS0)_4TX

EBW

5775MHz

16/06/2022

CF
5.775GHz
Span
240MHz
RBW
100kHz
VBW
300kHz
Sweep Time
100ms
Detector Type
Peak

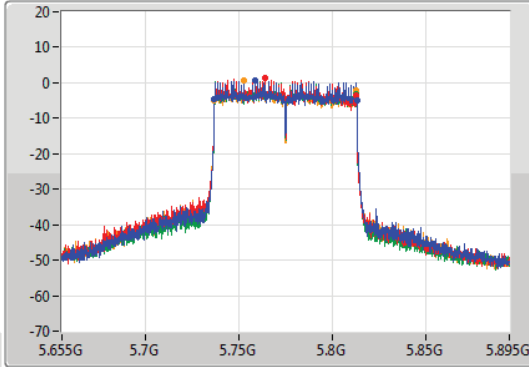

CF
5.775GHz
Span
240MHz
RBW
2MHz
VBW
10MHz
Sweep Time
100ms
Detector Type
Peak

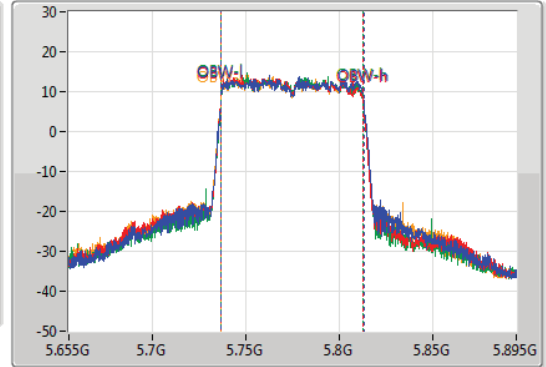

Port 1
Port 2
Port 3
Port 4

6dB(Hz)	Fl-6dB(Hz)	Fh-6dB(Hz)	OBW(Hz)	Fl-OBW(Hz)	Fh-OBW(Hz)	Limit(Hz)	Port
76.32M	5.73684G	5.81316G	76.402M	5.736739G	5.813141G	500k	1
75.84M	5.73672G	5.81256G	76.162M	5.736619G	5.812781G	500k	2
75.72M	5.73684G	5.81256G	76.042M	5.736739G	5.812781G	500k	3
75.72M	5.73684G	5.81256G	76.282M	5.736619G	5.812901G	500k	4

802.11ac VHT160_Nss1,(MCS0)_4TX

EBW

5570MHz

16/06/2022

CF
5.57GHz
Span
480MHz
RBW
2MHz
VBW
10MHz
Sweep Time
100ms
Detector Type
Peak

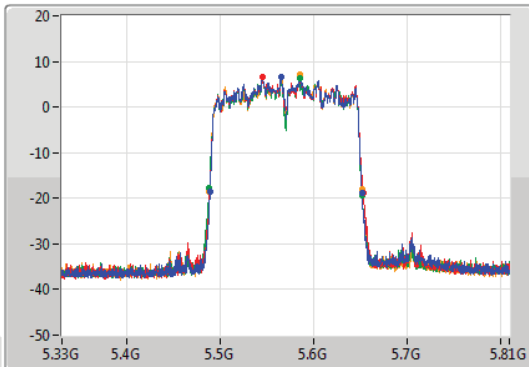

CF
5.57GHz
Span
480MHz
RBW
3MHz
VBW
10MHz
Sweep Time
100ms
Detector Type
Peak

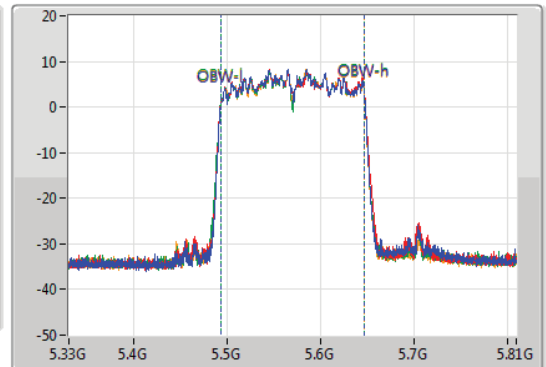

Port 1
Port 2
Port 3
Port 4

26dB(Hz)	Fl-26dB(Hz)	Fh-26dB(Hz)	OBW(Hz)	Fl-OBW(Hz)	Fh-OBW(Hz)	Limit(Hz)	Port
162.96M	5.48888G	5.65184G	153.763M	5.493478G	5.647241G	Inf	1
164.4M	5.48864G	5.65304G	154.243M	5.493238G	5.647481G	Inf	2
164.16M	5.48792G	5.65208G	154.243M	5.492999G	5.647241G	Inf	3
163.44M	5.48816G	5.6516G	154.243M	5.492999G	5.647241G	Inf	4

802.11ax HEW20_Nss1,(MCS0)_4TX

EBW

5500MHz

16/06/2022

CF
5.5GHz
Span
60MHz
RBW
300kHz
VBW
1MHz
Sweep Time
100ms
Detector Type
Peak

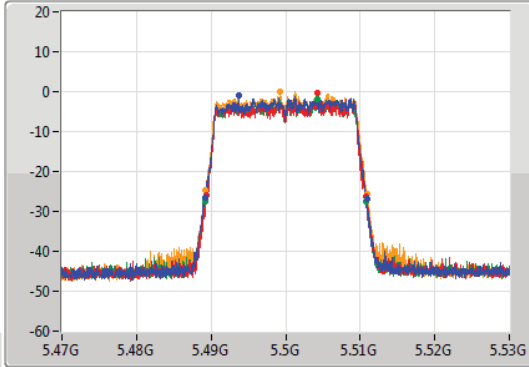

CF
5.5GHz
Span
60MHz
RBW
300kHz
VBW
1MHz
Sweep Time
100ms
Detector Type
Peak

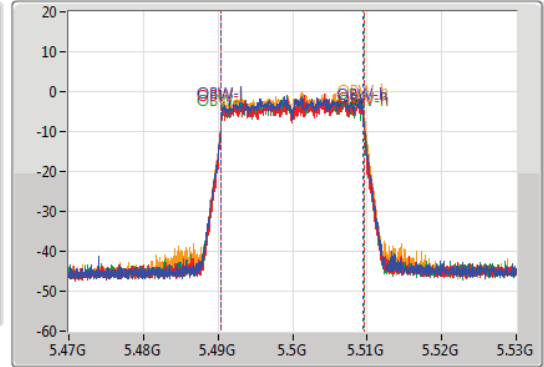

Port 1
Port 2
Port 3
Port 4

26dB(Hz)	Fl-26dB(Hz)	Fh-26dB(Hz)	OBW(Hz)	Fl-OBW(Hz)	Fh-OBW(Hz)	Limit(Hz)	Port
21.75M	5.48914G	5.51089G	19.04M	5.490465G	5.509505G	Inf	1
21.51M	5.48935G	5.51086G	19.13M	5.490465G	5.509595G	Inf	2
21.72M	5.48914G	5.51086G	19.16M	5.490435G	5.509595G	Inf	3
21.72M	5.48923G	5.51095G	19.16M	5.490435G	5.509595G	Inf	4

802.11ax HEW20_Nss1,(MCS0)_4TX

EBW

5580MHz

16/06/2022

CF
5.58GHz
Span
60MHz
RBW
300kHz
VBW
1MHz
Sweep Time
100ms
Detector Type
Peak

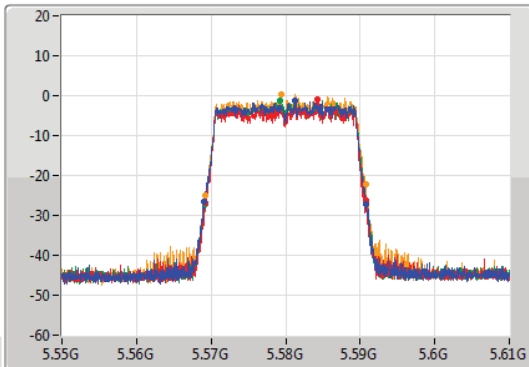

CF
5.58GHz
Span
60MHz
RBW
300kHz
VBW
1MHz
Sweep Time
100ms
Detector Type
Peak

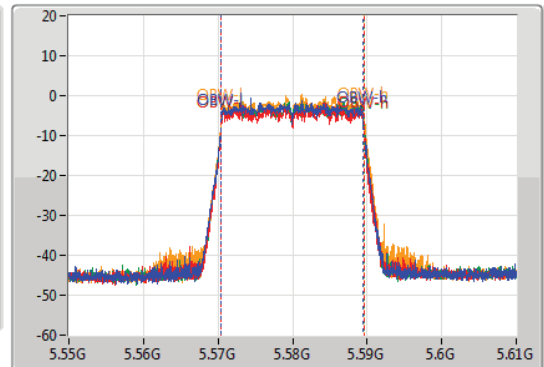

Port 1
Port 2
Port 3
Port 4

26dB(Hz)	Fl-26dB(Hz)	Fh-26dB(Hz)	OBW(Hz)	Fl-OBW(Hz)	Fh-OBW(Hz)	Limit(Hz)	Port
21.78M	5.56902G	5.5908G	19.04M	5.570435G	5.589475G	Inf	1
21.54M	5.56926G	5.5908G	19.13M	5.570435G	5.589565G	Inf	2
21.66M	5.56914G	5.5908G	19.13M	5.570435G	5.589565G	Inf	3
21.51M	5.5692G	5.59071G	19.19M	5.570435G	5.589625G	Inf	4

802.11ax HEW20_Nss1,(MCS0)_4TX

EBW

5700MHz

16/06/2022

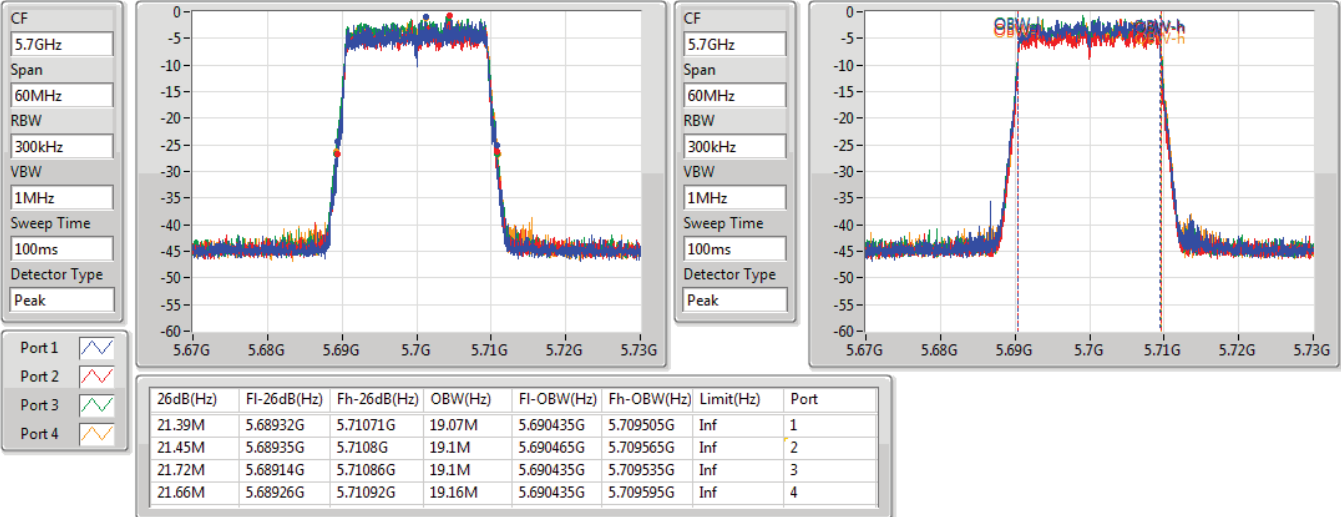

802.11ax HEW20_Nss1,(MCS0)_4TX

EBW

5720MHz Straddle 5.47-5.725GHz

16/06/2022

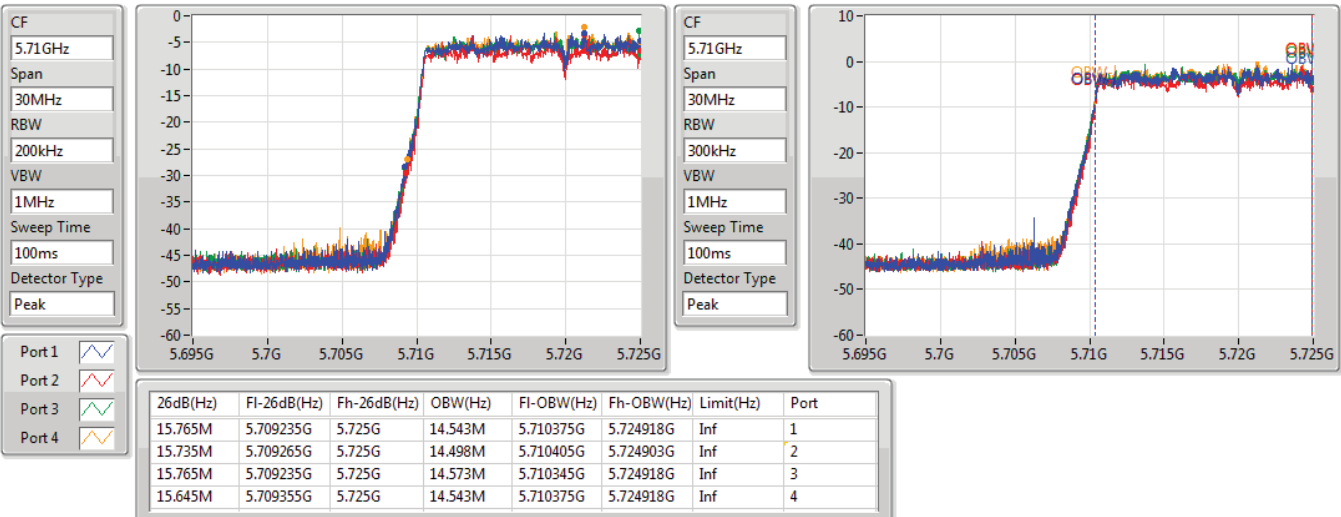

802.11ax HEW20_Nss1,(MCS0)_4TX

EBW

5720MHz Straddle 5.725-5.85GHz

16/06/2022

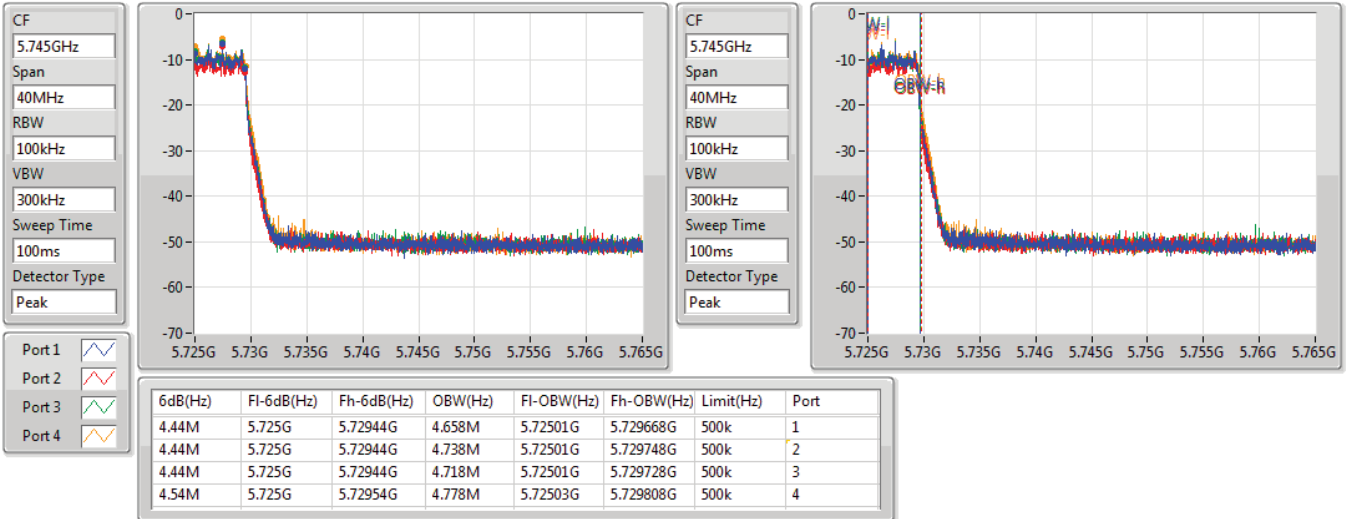

802.11ax HEW20_Nss1,(MCS0)_4TX

EBW

5745MHz

16/06/2022

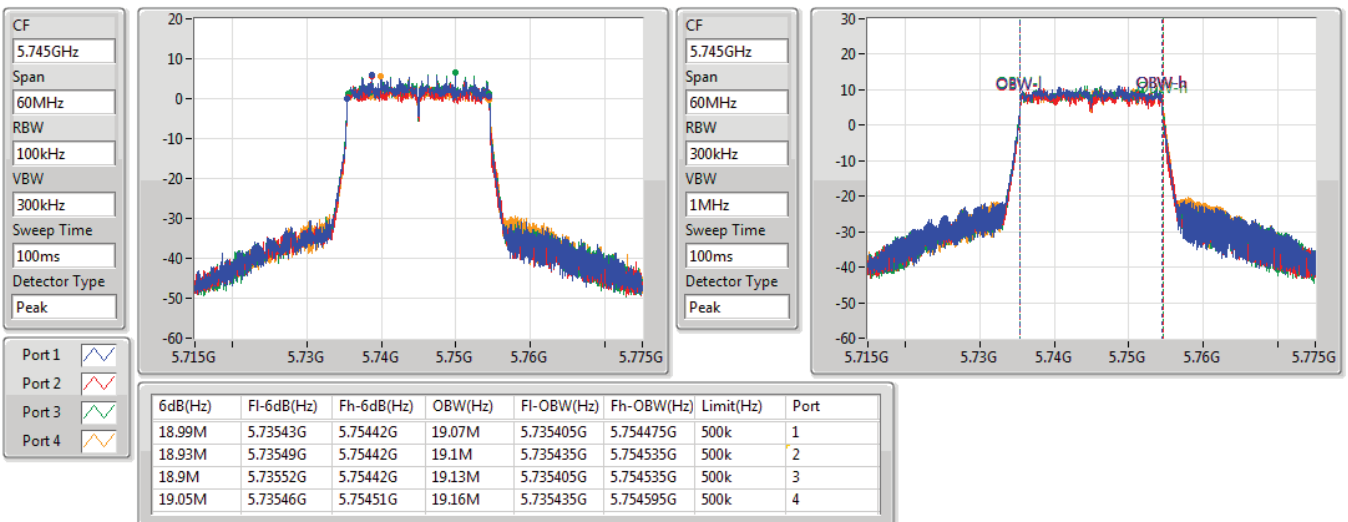

802.11ax HEW20_Nss1,(MCS0)_4TX

EBW

5785MHz

16/06/2022

CF
5.785GHz
Span
60MHz
RBW
100kHz
VBW
300kHz
Sweep Time
100ms
Detector Type
Peak

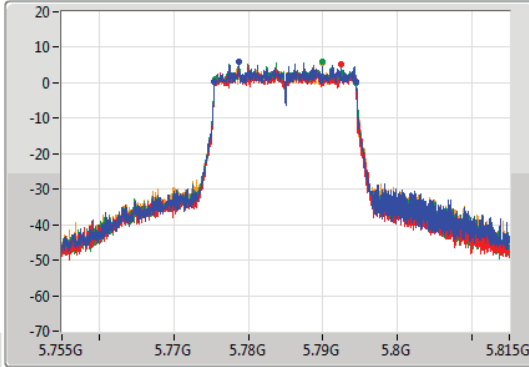

CF
5.785GHz
Span
60MHz
RBW
300kHz
VBW
1MHz
Sweep Time
100ms
Detector Type
Peak

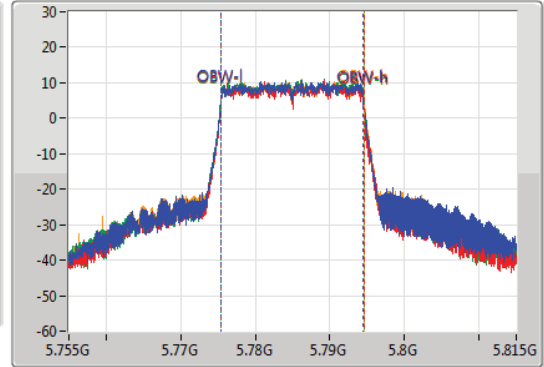

Port 1
Port 2
Port 3
Port 4

6dB(Hz)	Fl-6dB(Hz)	Fh-6dB(Hz)	OBW(Hz)	Fl-OBW(Hz)	Fh-OBW(Hz)	Limit(Hz)	Port
19.02M	5.77546G	5.79448G	19.07M	5.775435G	5.794505G	500k	1
18.96M	5.77549G	5.79445G	19.1M	5.775435G	5.794535G	500k	2
18.96M	5.77549G	5.79445G	19.19M	5.775375G	5.794565G	500k	3
18.96M	5.77549G	5.79445G	19.19M	5.775405G	5.794595G	500k	4

802.11ax HEW20_Nss1,(MCS0)_4TX

EBW

5825MHz

16/06/2022

CF
5.825GHz
Span
60MHz
RBW
100kHz
VBW
300kHz
Sweep Time
100ms
Detector Type
Peak

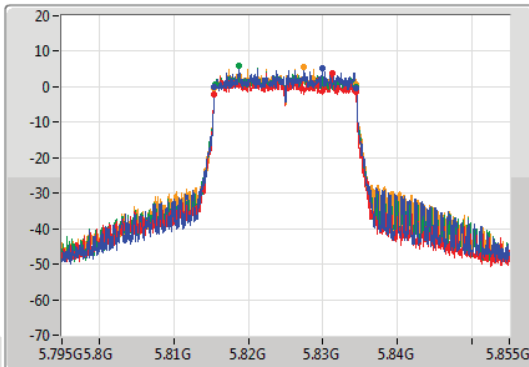

CF
5.825GHz
Span
60MHz
RBW
300kHz
VBW
1MHz
Sweep Time
100ms
Detector Type
Peak

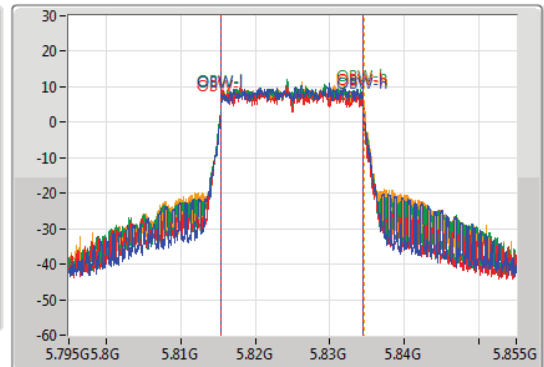

Port 1
Port 2
Port 3
Port 4

6dB(Hz)	Fl-6dB(Hz)	Fh-6dB(Hz)	OBW(Hz)	Fl-OBW(Hz)	Fh-OBW(Hz)	Limit(Hz)	Port
18.99M	5.81546G	5.83445G	19.07M	5.815435G	5.834505G	500k	1
19.05M	5.81543G	5.83448G	19.13M	5.815375G	5.834505G	500k	2
18.93M	5.81552G	5.83445G	19.07M	5.815405G	5.834475G	500k	3
18.99M	5.81546G	5.83445G	19.19M	5.815405G	5.834595G	500k	4

802.11ax HEW40_Nss1,(MCS0)_4TX

EBW

5510MHz

16/06/2022

CF
5.51GHz
Span
120MHz
RBW
500kHz
VBW
2MHz
Sweep Time
100ms
Detector Type
Peak

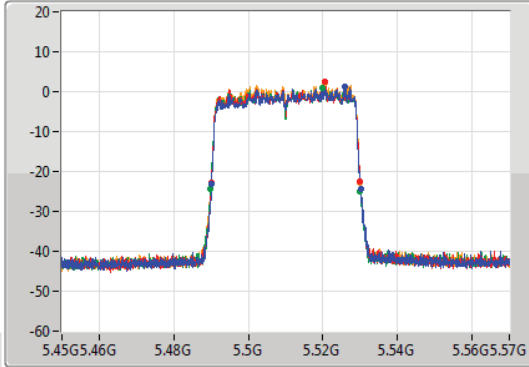

CF
5.51GHz
Span
120MHz
RBW
1MHz
VBW
3MHz
Sweep Time
100ms
Detector Type
Peak

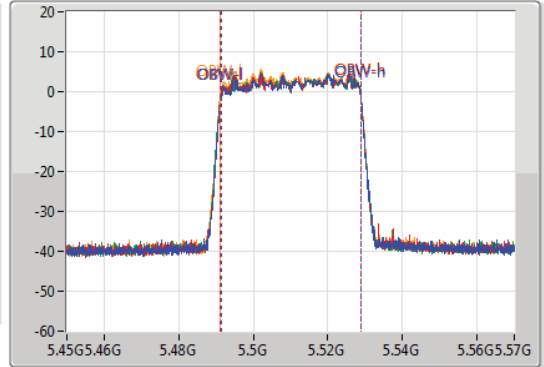

Port 1
Port 2
Port 3
Port 4

26dB(Hz)	Fl-26dB(Hz)	Fh-26dB(Hz)	OBW(Hz)	Fl-OBW(Hz)	Fh-OBW(Hz)	Limit(Hz)	Port
40.02M	5.49014G	5.53016G	37.601M	5.491289G	5.528891G	Inf	1
39.84M	5.49014G	5.52998G	37.601M	5.491229G	5.528831G	Inf	2
40.14M	5.4899G	5.53004G	37.661M	5.491169G	5.528831G	Inf	3
40.08M	5.48996G	5.53004G	37.661M	5.491169G	5.528831G	Inf	4

802.11ax HEW40_Nss1,(MCS0)_4TX

EBW

5550MHz

16/06/2022

CF
5.55GHz
Span
120MHz
RBW
500kHz
VBW
2MHz
Sweep Time
100ms
Detector Type
Peak

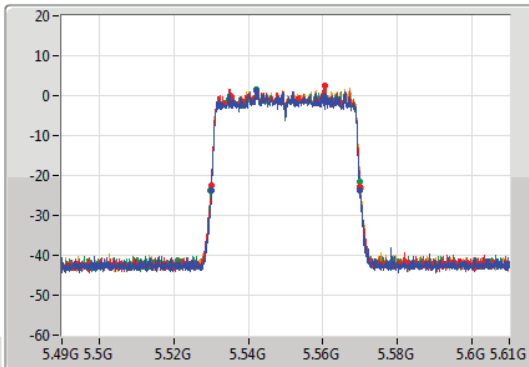

CF
5.55GHz
Span
120MHz
RBW
1MHz
VBW
3MHz
Sweep Time
100ms
Detector Type
Peak

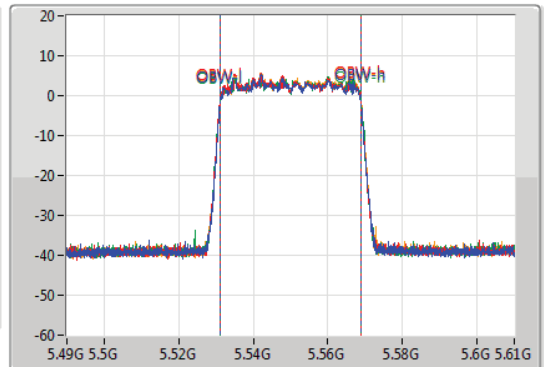

Port 1
Port 2
Port 3
Port 4

26dB(Hz)	Fl-26dB(Hz)	Fh-26dB(Hz)	OBW(Hz)	Fl-OBW(Hz)	Fh-OBW(Hz)	Limit(Hz)	Port
39.96M	5.53008G	5.57004G	37.601M	5.531169G	5.568771G	Inf	1
39.9M	5.53008G	5.56998G	37.601M	5.531169G	5.568771G	Inf	2
40.08M	5.5299G	5.56998G	37.661M	5.531169G	5.568831G	Inf	3
40.08M	5.53002G	5.5701G	37.601M	5.531229G	5.568831G	Inf	4

802.11ax HEW40_Nss1,(MCS0)_4TX

EBW

5670MHz

16/06/2022

CF
5.67GHz
Span
120MHz
RBW
500kHz
VBW
2MHz
Sweep Time
100ms
Detector Type
Peak

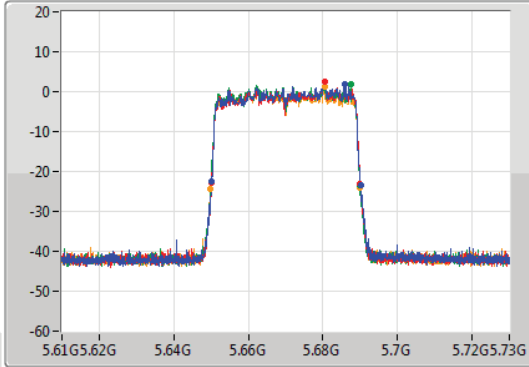

CF
5.67GHz
Span
120MHz
RBW
1MHz
VBW
3MHz
Sweep Time
100ms
Detector Type
Peak

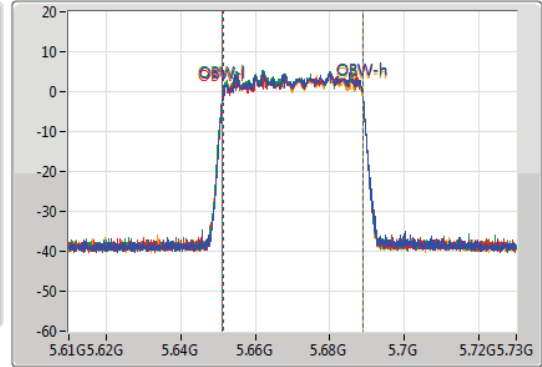

Port 1
Port 2
Port 3
Port 4

26dB(Hz)	Fl-26dB(Hz)	Fh-26dB(Hz)	OBW(Hz)	Fl-OBW(Hz)	Fh-OBW(Hz)	Limit(Hz)	Port
40.02M	5.65014G	5.69016G	37.601M	5.651289G	5.688891G	Inf	1
39.9M	5.65014G	5.69004G	37.661M	5.651229G	5.688891G	Inf	2
39.96M	5.64996G	5.68992G	37.661M	5.651169G	5.688831G	Inf	3
40.14M	5.6499G	5.69004G	37.661M	5.651169G	5.688831G	Inf	4

802.11ax HEW40_Nss1,(MCS0)_4TX

EBW

5710MHz Straddle 5.47-5.725GHz

16/06/2022

CF
5.69GHz
Span
70MHz
RBW
500kHz
VBW
2MHz
Sweep Time
100ms
Detector Type
Peak

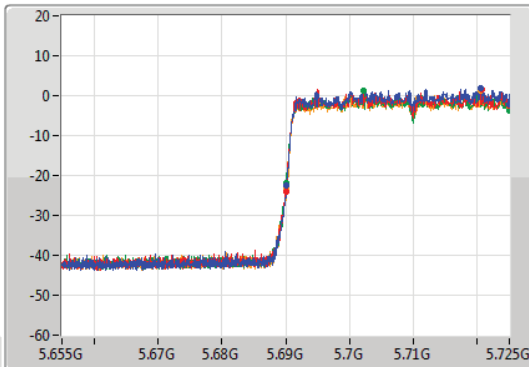

CF
5.69GHz
Span
70MHz
RBW
1MHz
VBW
3MHz
Sweep Time
100ms
Detector Type
Peak

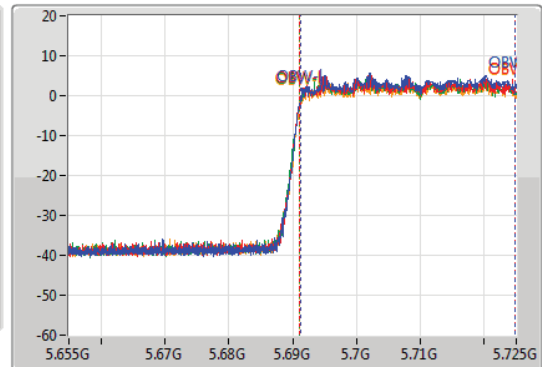

Port 1
Port 2
Port 3
Port 4

26dB(Hz)	Fl-26dB(Hz)	Fh-26dB(Hz)	OBW(Hz)	Fl-OBW(Hz)	Fh-OBW(Hz)	Limit(Hz)	Port
34.895M	5.690105G	5.725G	33.618M	5.691189G	5.724808G	Inf	1
34.965M	5.690035G	5.725G	33.688M	5.691084G	5.724773G	Inf	2
34.965M	5.690035G	5.725G	33.688M	5.691084G	5.724773G	Inf	3
34.965M	5.690035G	5.725G	33.688M	5.691084G	5.724773G	Inf	4

802.11ax HEW40_Nss1,(MCS0)_4TX

EBW

5710MHz Straddle 5.725-5.85GHz

16/06/2022

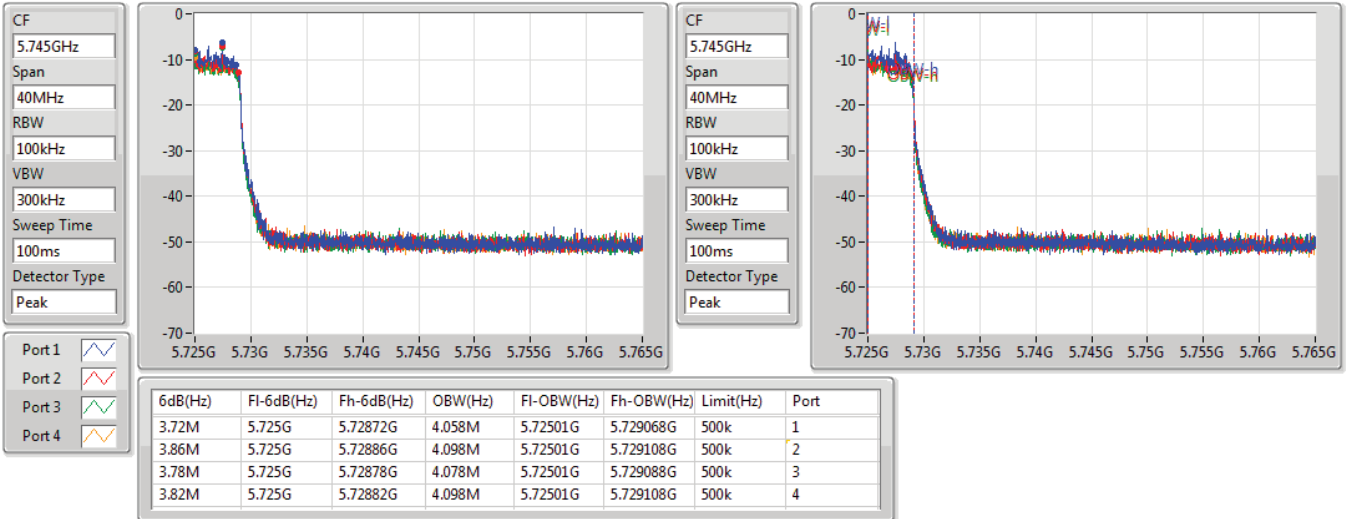

802.11ax HEW40_Nss1,(MCS0)_4TX

EBW

5755MHz

16/06/2022

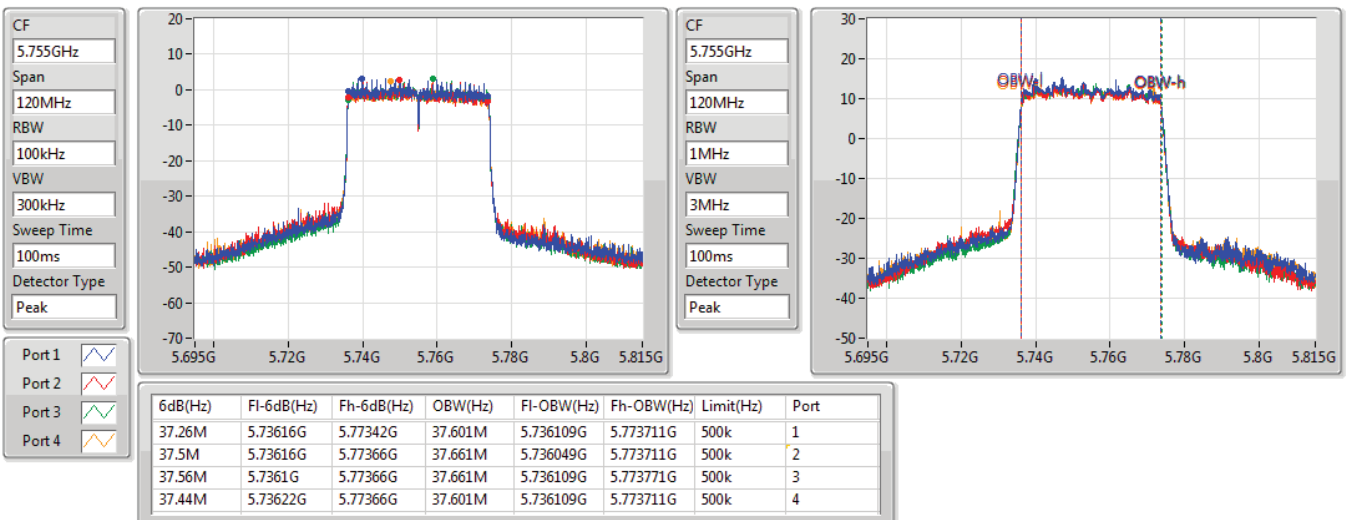

802.11ax HEW40_Nss1,(MCS0)_4TX

EBW

5795MHz

16/06/2022

CF
5.795GHz
Span
120MHz
RBW
100kHz
VBW
300kHz
Sweep Time
100ms
Detector Type
Peak

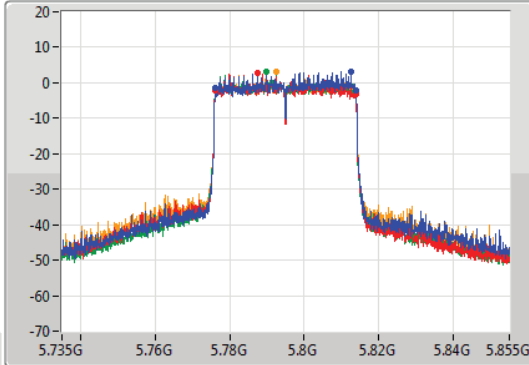

CF
5.795GHz
Span
120MHz
RBW
1MHz
VBW
3MHz
Sweep Time
100ms
Detector Type
Peak

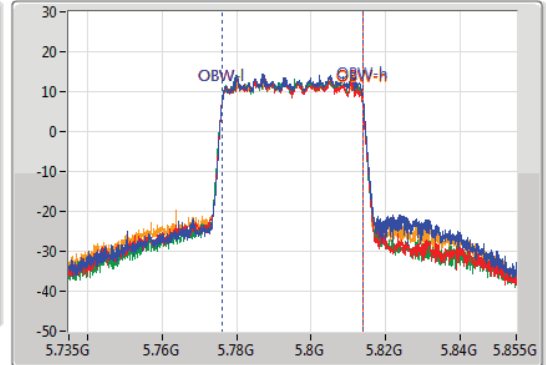

Port 1
Port 2
Port 3
Port 4

6dB(Hz)	Fl-6dB(Hz)	Fh-6dB(Hz)	OBW(Hz)	Fl-OBW(Hz)	Fh-OBW(Hz)	Limit(Hz)	Port
37.56M	5.77616G	5.81372G	37.721M	5.776169G	5.813891G	500k	1
37.62M	5.77616G	5.81378G	37.721M	5.776049G	5.813771G	500k	2
37.5M	5.77616G	5.81366G	37.661M	5.776109G	5.813771G	500k	3
37.62M	5.77616G	5.81378G	37.661M	5.776109G	5.813771G	500k	4

802.11ax HEW80_Nss1,(MCS0)_4TX

EBW

5530MHz

16/06/2022

CF
5.53GHz
Span
240MHz
RBW
1MHz
VBW
3MHz
Sweep Time
100ms
Detector Type
Peak

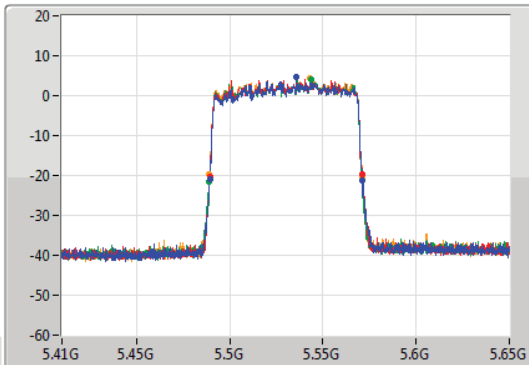

CF
5.53GHz
Span
240MHz
RBW
2MHz
VBW
10MHz
Sweep Time
100ms
Detector Type
Peak

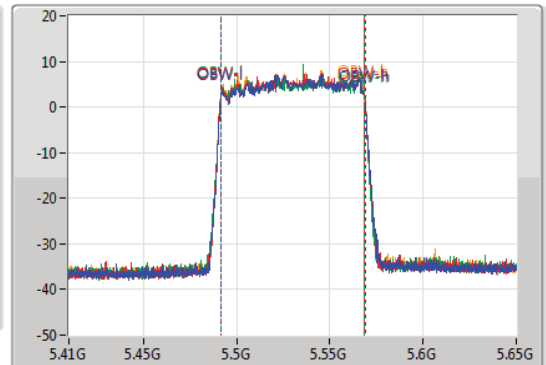

Port 1
Port 2
Port 3
Port 4

26dB(Hz)	Fl-26dB(Hz)	Fh-26dB(Hz)	OBW(Hz)	Fl-OBW(Hz)	Fh-OBW(Hz)	Limit(Hz)	Port
81.96M	5.48932G	5.57128G	77.361M	5.491499G	5.568861G	Inf	1
81.72M	5.48932G	5.57104G	77.361M	5.491379G	5.568741G	Inf	2
81.84M	5.48896G	5.5708G	77.361M	5.491379G	5.568741G	Inf	3
81.72M	5.4892G	5.57092G	77.361M	5.491379G	5.568741G	Inf	4

802.11ax HEW80_Nss1,(MCS0)_4TX

EBW

5610MHz

16/06/2022

CF
5.61GHz
Span
240MHz
RBW
1MHz
VBW
3MHz
Sweep Time
100ms
Detector Type
Peak

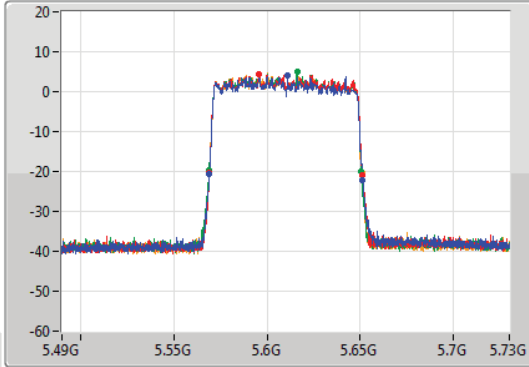

CF
5.61GHz
Span
240MHz
RBW
2MHz
VBW
10MHz
Sweep Time
100ms
Detector Type
Peak

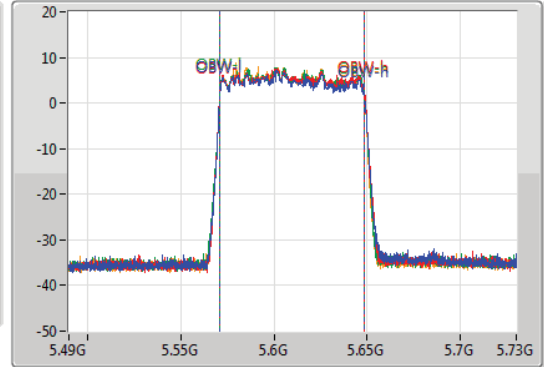

Port 1
Port 2
Port 3
Port 4

26dB(Hz)	Fl-26dB(Hz)	Fh-26dB(Hz)	OBW(Hz)	Fl-OBW(Hz)	Fh-OBW(Hz)	Limit(Hz)	Port
82.32M	5.56908G	5.6514G	77.481M	5.571139G	5.648621G	Inf	1
82.32M	5.56908G	5.6514G	77.601M	5.571139G	5.648741G	Inf	2
81.72M	5.56896G	5.65068G	77.481M	5.571139G	5.648621G	Inf	3
81.84M	5.56908G	5.65092G	77.361M	5.571139G	5.648501G	Inf	4

802.11ax HEW80_Nss1,(MCS0)_4TX

EBW

5690MHz Straddle 5.47-5.725GHz

16/06/2022

CF
5.65GHz
Span
150MHz
RBW
1MHz
VBW
3MHz
Sweep Time
100ms
Detector Type
Peak

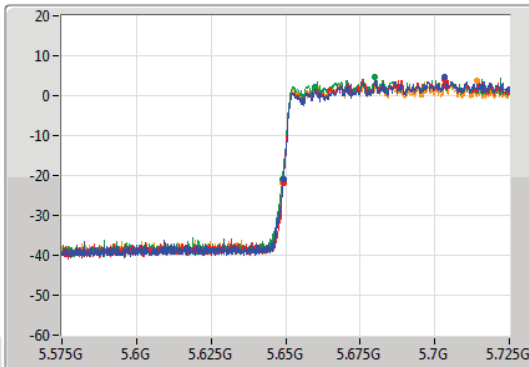

CF
5.65GHz
Span
150MHz
RBW
2MHz
VBW
10MHz
Sweep Time
100ms
Detector Type
Peak

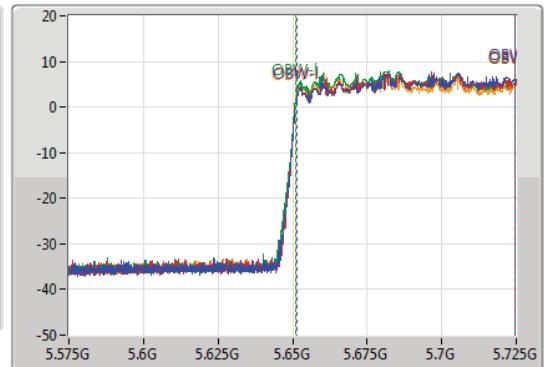

Port 1
Port 2
Port 3
Port 4

26dB(Hz)	Fl-26dB(Hz)	Fh-26dB(Hz)	OBW(Hz)	Fl-OBW(Hz)	Fh-OBW(Hz)	Limit(Hz)	Port
75.675M	5.649325G	5.725G	73.313M	5.651424G	5.724738G	Inf	1
75.825M	5.649175G	5.725G	73.313M	5.651349G	5.724663G	Inf	2
76.125M	5.648875G	5.725G	73.388M	5.651199G	5.724588G	Inf	3
75.975M	5.649025G	5.725G	73.613M	5.651124G	5.724738G	Inf	4

802.11ax HEW80_Nss1,(MCS0)_4TX

EBW

5690MHz Straddle 5.725-5.85GHz

16/06/2022

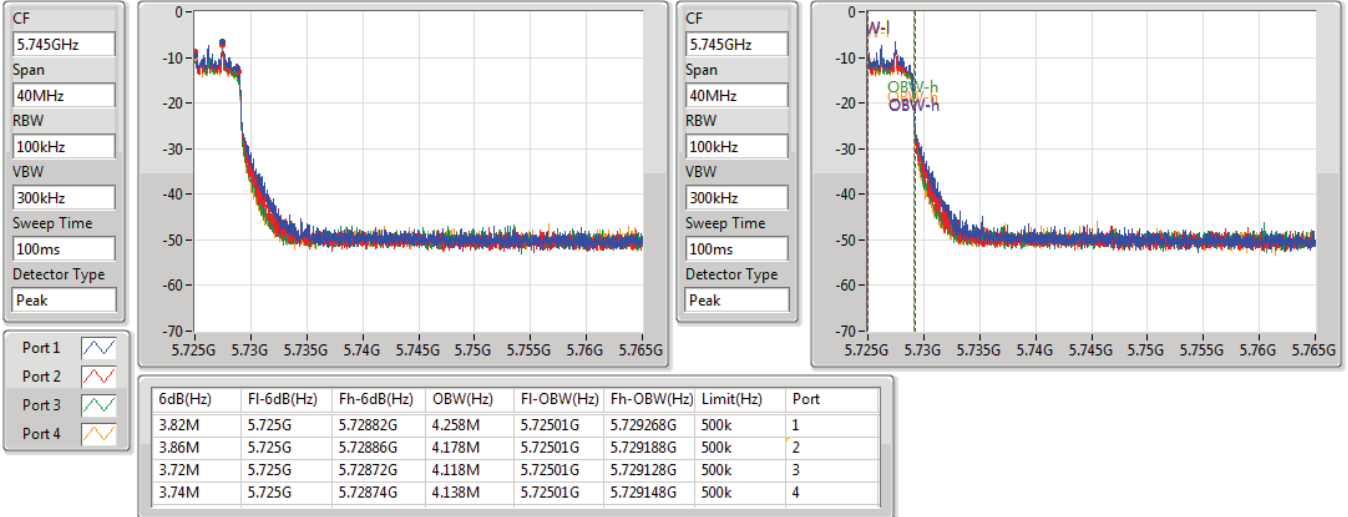

802.11ax HEW80_Nss1,(MCS0)_4TX

EBW

5775MHz

16/06/2022

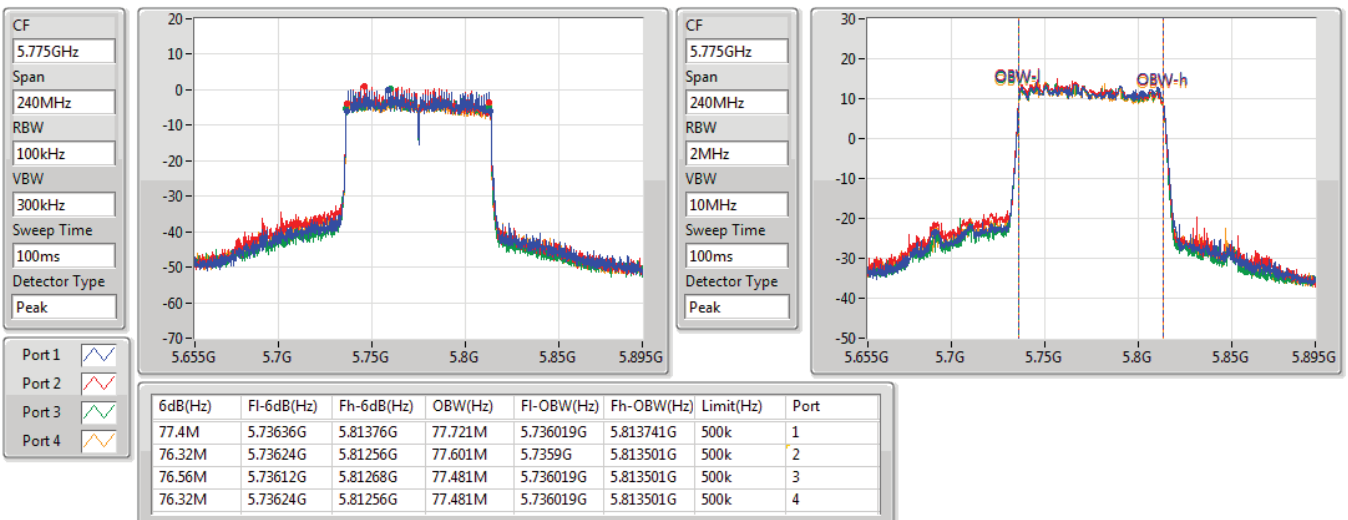

802.11ax HEW160_Nss1,(MCS0)_4TX

EBW

5570MHz

16/06/2022

CF
5.57GHz
Span
480MHz
RBW
2MHz
VBW
10MHz
Sweep Time
100ms
Detector Type
Peak

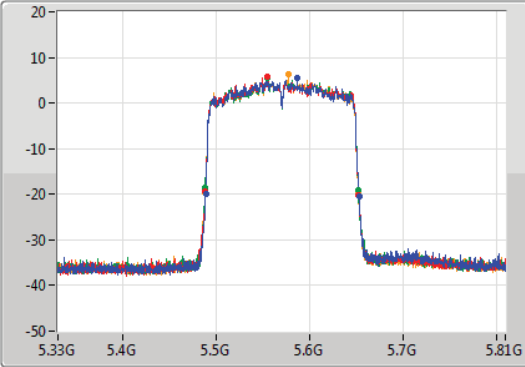

CF
5.57GHz
Span
480MHz
RBW
3MHz
VBW
10MHz
Sweep Time
100ms
Detector Type
Peak

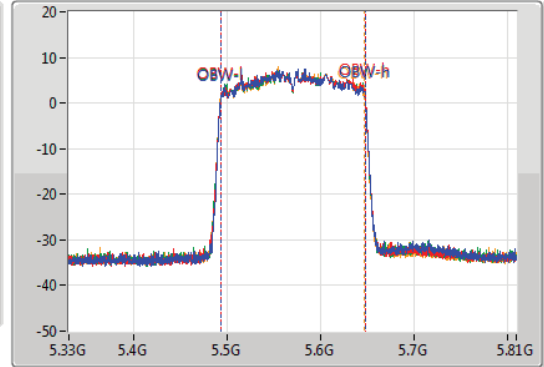

Port 1
Port 2
Port 3
Port 4

26dB(Hz)	Fl-26dB(Hz)	Fh-26dB(Hz)	OBW(Hz)	Fl-OBW(Hz)	Fh-OBW(Hz)	Limit(Hz)	Port
164.4M	5.48864G	5.65304G	154.723M	5.492999G	5.647721G	Inf	1
164.4M	5.4884G	5.6528G	154.723M	5.492999G	5.647721G	Inf	2
164.4M	5.48792G	5.65232G	154.723M	5.492999G	5.647721G	Inf	3
163.92M	5.48816G	5.65208G	154.723M	5.492759G	5.647481G	Inf	4



Summary

Mode	Max-N dB (Hz)	Max-OBW (Hz)	ITU-Code	Min-N dB (Hz)	Min-OBW (Hz)
5.15-5.25GHz	-	-	-	-	-
802.11a_Nss1,(6Mbps)_4TX	21.69M	17.121M	17M2D1D	21.36M	16.912M
802.11n HT20_Nss1,(MCS0)_4TX	21.81M	18.141M	18M2D1D	21.33M	17.871M
802.11n HT40_Nss1,(MCS0)_4TX	40.2M	36.702M	36M8D1D	39.48M	36.522M
802.11ac VHT20_Nss1,(MCS0)_4TX	21.81M	18.081M	18M1D1D	21.36M	17.901M
802.11ac VHT40_Nss1,(MCS0)_4TX	40.38M	36.762M	36M8D1D	39.66M	36.582M
802.11ac VHT80_Nss1,(MCS0)_4TX	81.84M	76.042M	76M0D1D	81.24M	75.922M
802.11ac VHT160_Nss1,(MCS0)_4TX	82.8M	77.561M	77M6D1D	81.92M	77.081M
802.11ax HEW20_Nss1,(MCS0)_4TX	21.75M	19.19M	19M2D1D	21.45M	17.901M
802.11ax HEW40_Nss1,(MCS0)_4TX	40.14M	37.661M	37M7D1D	39.84M	37.601M
802.11ax HEW80_Nss1,(MCS0)_4TX	82.32M	77.481M	77M5D1D	81.84M	77.361M
802.11ax HEW160_Nss1,(MCS0)_4TX	82.48M	77.881M	77M9D1D	82.16M	77.801M
5.25-5.35GHz	-	-	-	-	-
802.11a_Nss1,(6Mbps)_4TX	21.66M	17.151M	17M2D1D	21.45M	16.912M
802.11n HT20_Nss1,(MCS0)_4TX	21.84M	18.171M	18M2D1D	21.36M	17.871M
802.11n HT40_Nss1,(MCS0)_4TX	40.2M	36.762M	36M8D1D	39.6M	36.522M
802.11ac VHT20_Nss1,(MCS0)_4TX	21.78M	18.111M	18M2D1D	21.45M	17.901M
802.11ac VHT40_Nss1,(MCS0)_4TX	40.32M	36.762M	36M8D1D	39.72M	36.582M
802.11ac VHT80_Nss1,(MCS0)_4TX	81.96M	76.162M	76M2D1D	81.36M	75.922M
802.11ac VHT160_Nss1,(MCS0)_4TX	83.52M	77.881M	77M9D1D	82M	77.001M
802.11ax HEW20_Nss1,(MCS0)_4TX	21.75M	19.16M	19M2D1D	21.36M	19.04M
802.11ax HEW40_Nss1,(MCS0)_4TX	40.2M	37.661M	37M7D1D	39.84M	37.601M
802.11ax HEW80_Nss1,(MCS0)_4TX	82.2M	77.481M	77M5D1D	81.96M	77.361M
802.11ax HEW160_Nss1,(MCS0)_4TX	82.88M	78.121M	78M2D1D	82.48M	77.961M
5.47-5.725GHz	-	-	-	-	-
802.11a_Nss1,(6Mbps)_4TX	21.72M	17.151M	17M2D1D	15.63M	13.508M
802.11n HT20_Nss1,(MCS0)_4TX	21.87M	18.171M	18M2D1D	15.69M	13.973M
802.11n HT40_Nss1,(MCS0)_4TX	40.32M	36.762M	36M8D1D	34.825M	33.198M
802.11ac VHT20_Nss1,(MCS0)_4TX	21.87M	18.081M	18M1D1D	15.72M	14.018M
802.11ac VHT40_Nss1,(MCS0)_4TX	40.26M	36.822M	36M9D1D	34.825M	33.198M
802.11ac VHT80_Nss1,(MCS0)_4TX	81.96M	76.162M	76M2D1D	75.6M	72.714M
802.11ac VHT160_Nss1,(MCS0)_4TX	165.12M	154.963M	155MD1D	164.16M	154.723M
802.11ax HEW20_Nss1,(MCS0)_4TX	21.84M	19.19M	19M2D1D	15.69M	14.543M
802.11ax HEW40_Nss1,(MCS0)_4TX	40.14M	37.661M	37M7D1D	34.93M	33.618M
802.11ax HEW80_Nss1,(MCS0)_4TX	82.68M	77.601M	77M7D1D	75.825M	73.313M
802.11ax HEW160_Nss1,(MCS0)_4TX	164.88M	155.442M	155MD1D	164.4M	155.202M
5.725-5.85GHz	-	-	-	-	-
802.11a_Nss1,(6Mbps)_4TX	16.5M	17.181M	17M2D1D	3.14M	4.258M
802.11n HT20_Nss1,(MCS0)_4TX	17.61M	18.171M	18M2D1D	3.74M	4.458M
802.11n HT40_Nss1,(MCS0)_4TX	36.36M	36.762M	36M8D1D	3.1M	3.598M
802.11ac VHT20_Nss1,(MCS0)_4TX	17.61M	18.111M	18M2D1D	3.74M	4.378M
802.11ac VHT40_Nss1,(MCS0)_4TX	36.36M	36.822M	36M9D1D	3.12M	3.678M
802.11ac VHT80_Nss1,(MCS0)_4TX	76.32M	76.282M	76M3D1D	3.1M	3.778M
802.11ax HEW20_Nss1,(MCS0)_4TX	19.05M	19.19M	19M2D1D	4.44M	4.618M
802.11ax HEW40_Nss1,(MCS0)_4TX	37.62M	37.661M	37M7D1D	3.72M	4.038M
802.11ax HEW80_Nss1,(MCS0)_4TX	77.28M	77.481M	77M5D1D	3.48M	4.158M

Max-N dB = Maximum 6dB down bandwidth for 5.725-5.85GHz band / Maximum 26dB down bandwidth for other band;
 Max-OBW = Maximum 99% occupied bandwidth;
 Min-N dB = Minimum 6dB down bandwidth for 5.725-5.85GHz band / Maximum 26dB down bandwidth for other band;
 Min-OBW = Minimum 99% occupied bandwidth



Result

Mode	Result	Limit (Hz)	Port 1-N dB (Hz)	Port 1-OBW (Hz)	Port 2-N dB (Hz)	Port 2-OBW (Hz)	Port 3-N dB (Hz)	Port 3-OBW (Hz)	Port 4-N dB (Hz)	Port 4-OBW (Hz)
802.11a_Nss1,(6Mbps)_4TX	-	-	-	-	-	-	-	-	-	-
5180MHz	Pass	Inf	21.57M	16.912M	21.6M	17.031M	21.6M	17.121M	21.36M	17.061M
5200MHz	Pass	Inf	21.45M	16.942M	21.69M	17.031M	21.57M	17.091M	21.42M	17.031M
5240MHz	Pass	Inf	21.42M	16.942M	21.6M	17.031M	21.66M	17.121M	21.45M	17.031M
5260MHz	Pass	Inf	21.48M	16.912M	21.66M	17.091M	21.48M	17.151M	21.48M	17.061M
5300MHz	Pass	Inf	21.48M	16.942M	21.63M	17.061M	21.48M	17.121M	21.45M	17.061M
5320MHz	Pass	Inf	21.63M	16.942M	21.45M	17.091M	21.57M	17.151M	21.51M	17.061M
5500MHz	Pass	Inf	21.57M	16.942M	21.69M	17.091M	21.69M	17.121M	21.39M	17.091M
5580MHz	Pass	Inf	21.54M	16.912M	21.72M	17.061M	21.66M	17.121M	21.45M	17.031M
5700MHz	Pass	Inf	21.6M	16.882M	21.63M	17.061M	21.63M	17.151M	21.54M	17.091M
5720MHz Straddle 5.47-5.725GHz	Pass	Inf	15.66M	13.508M	15.75M	13.658M	15.69M	13.613M	15.63M	13.553M
5720MHz Straddle 5.725-5.85GHz	Pass	500k	3.14M	4.258M	3.2M	4.278M	3.2M	4.498M	3.2M	4.338M
5745MHz	Pass	500k	16.35M	16.882M	16.38M	17.061M	16.35M	17.121M	16.41M	17.091M
5785MHz	Pass	500k	16.41M	16.912M	16.38M	17.091M	16.35M	17.121M	16.5M	17.061M
5825MHz	Pass	500k	16.35M	16.942M	16.35M	17.061M	16.35M	17.181M	16.35M	17.121M
802.11n HT20_Nss1,(MCS0)_4TX	-	-	-	-	-	-	-	-	-	-
5180MHz	Pass	Inf	21.48M	17.901M	21.33M	17.901M	21.36M	17.871M	21.75M	18.141M
5200MHz	Pass	Inf	21.51M	17.901M	21.45M	17.901M	21.45M	17.871M	21.81M	18.141M
5240MHz	Pass	Inf	21.48M	17.901M	21.48M	17.901M	21.57M	17.871M	21.81M	18.111M
5260MHz	Pass	Inf	21.54M	17.931M	21.57M	17.901M	21.57M	17.901M	21.84M	18.171M
5300MHz	Pass	Inf	21.51M	17.901M	21.36M	17.931M	21.63M	17.871M	21.84M	18.141M
5320MHz	Pass	Inf	21.51M	17.871M	21.45M	17.931M	21.57M	17.871M	21.81M	18.141M
5500MHz	Pass	Inf	21.6M	17.901M	21.54M	17.931M	21.51M	17.871M	21.78M	18.141M
5580MHz	Pass	Inf	21.51M	17.931M	21.57M	17.931M	21.57M	17.871M	21.87M	18.141M
5700MHz	Pass	Inf	21.63M	17.931M	21.51M	17.901M	21.57M	17.901M	21.75M	18.171M
5720MHz Straddle 5.47-5.725GHz	Pass	Inf	15.69M	13.973M	15.735M	14.003M	15.735M	14.003M	15.87M	14.198M
5720MHz Straddle 5.725-5.85GHz	Pass	500k	3.74M	4.478M	3.74M	4.478M	3.76M	4.498M	3.74M	4.458M
5745MHz	Pass	500k	17.61M	17.871M	17.61M	17.901M	17.61M	17.871M	17.55M	18.171M
5785MHz	Pass	500k	17.61M	17.901M	17.61M	17.931M	17.61M	17.871M	17.61M	18.141M
5825MHz	Pass	500k	17.61M	17.901M	17.58M	17.931M	17.61M	17.871M	17.58M	18.141M
802.11n HT40_Nss1,(MCS0)_4TX	-	-	-	-	-	-	-	-	-	-
5190MHz	Pass	Inf	39.66M	36.642M	39.96M	36.582M	39.6M	36.522M	40.08M	36.702M
5230MHz	Pass	Inf	39.6M	36.582M	39.96M	36.642M	39.48M	36.522M	40.2M	36.702M
5270MHz	Pass	Inf	39.78M	36.582M	39.9M	36.642M	39.6M	36.522M	40.14M	36.762M
5310MHz	Pass	Inf	39.9M	36.642M	39.84M	36.702M	39.6M	36.522M	40.2M	36.762M
5510MHz	Pass	Inf	39.78M	36.582M	40.02M	36.642M	39.6M	36.522M	40.2M	36.762M
5550MHz	Pass	Inf	39.72M	36.702M	39.72M	36.702M	39.48M	36.582M	40.26M	36.702M
5670MHz	Pass	Inf	39.78M	36.642M	40.02M	36.642M	39.6M	36.582M	40.32M	36.762M
5710MHz Straddle 5.47-5.725GHz	Pass	Inf	34.825M	33.268M	34.965M	33.268M	34.86M	33.198M	35.14M	33.268M
5710MHz Straddle 5.725-5.85GHz	Pass	500k	3.1M	3.598M	3.1M	3.638M	3.1M	3.678M	3.1M	3.718M
5755MHz	Pass	500k	36.3M	36.642M	36.36M	36.582M	36.3M	36.522M	36.36M	36.762M
5795MHz	Pass	500k	36.36M	36.642M	36.3M	36.702M	36.36M	36.522M	36.36M	36.762M
802.11ac VHT20_Nss1,(MCS0)_4TX	-	-	-	-	-	-	-	-	-	-
5180MHz	Pass	Inf	21.75M	18.051M	21.36M	17.901M	21.66M	17.901M	21.66M	18.051M
5200MHz	Pass	Inf	21.63M	18.051M	21.6M	17.901M	21.54M	17.931M	21.81M	18.081M
5240MHz	Pass	Inf	21.69M	18.051M	21.54M	17.901M	21.54M	17.931M	21.75M	18.081M
5260MHz	Pass	Inf	21.72M	18.051M	21.45M	17.901M	21.63M	17.961M	21.78M	18.081M
5300MHz	Pass	Inf	21.78M	18.051M	21.48M	17.901M	21.54M	17.931M	21.78M	18.081M
5320MHz	Pass	Inf	21.78M	18.051M	21.51M	17.931M	21.63M	17.931M	21.72M	18.111M
5500MHz	Pass	Inf	21.78M	18.051M	21.51M	17.931M	21.54M	17.931M	21.78M	18.051M
5580MHz	Pass	Inf	21.72M	18.051M	21.48M	17.931M	21.63M	17.931M	21.87M	18.051M
5700MHz	Pass	Inf	21.72M	18.051M	21.51M	17.931M	21.57M	17.931M	21.81M	18.081M
5720MHz Straddle 5.47-5.725GHz	Pass	Inf	15.84M	14.048M	15.72M	14.033M	15.765M	14.018M	15.81M	14.093M
5720MHz Straddle 5.725-5.85GHz	Pass	500k	3.74M	4.478M	3.76M	4.378M	3.74M	4.498M	3.74M	4.498M
5745MHz	Pass	500k	17.61M	18.021M	17.58M	17.901M	17.61M	17.901M	17.58M	18.081M



EBW_Non-Beamforming_Radio 2

Appendix B.2

Mode	Result	Limit (Hz)	Port 1-N dB (Hz)	Port 1-OBW (Hz)	Port 2-N dB (Hz)	Port 2-OBW (Hz)	Port 3-N dB (Hz)	Port 3-OBW (Hz)	Port 4-N dB (Hz)	Port 4-OBW (Hz)
5785MHz	Pass	500k	17.58M	18.051M	17.58M	17.901M	17.61M	17.931M	17.58M	18.111M
5825MHz	Pass	500k	17.55M	18.051M	17.58M	17.931M	17.61M	17.901M	17.58M	18.081M
802.11ac VHT40_Nss1,(MCS0)_4TX	-	-	-	-	-	-	-	-	-	-
5190MHz	Pass	Inf	40.02M	36.762M	40.02M	36.702M	39.9M	36.582M	40.38M	36.702M
5230MHz	Pass	Inf	39.9M	36.762M	40.08M	36.702M	39.66M	36.582M	40.26M	36.702M
5270MHz	Pass	Inf	39.96M	36.762M	40.08M	36.762M	39.72M	36.642M	40.32M	36.702M
5310MHz	Pass	Inf	39.84M	36.762M	40.02M	36.702M	39.9M	36.582M	40.2M	36.702M
5510MHz	Pass	Inf	39.9M	36.702M	40.26M	36.702M	39.78M	36.642M	40.14M	36.762M
5550MHz	Pass	Inf	39.9M	36.822M	39.9M	36.702M	40.02M	36.642M	40.26M	36.702M
5670MHz	Pass	Inf	40.02M	36.822M	40.2M	36.702M	39.96M	36.582M	40.14M	36.702M
5710MHz Straddle 5.47-5.725GHz	Pass	Inf	34.93M	33.303M	35.035M	33.233M	34.825M	33.198M	35.21M	33.268M
5710MHz Straddle 5.725-5.85GHz	Pass	500k	3.12M	3.678M	3.12M	3.678M	3.12M	3.818M	3.14M	3.678M
5755MHz	Pass	500k	36.3M	36.822M	36.36M	36.702M	36.3M	36.642M	36.3M	36.702M
5795MHz	Pass	500k	36.3M	36.822M	36.3M	36.702M	36.36M	36.642M	36.3M	36.762M
802.11ac VHT80_Nss1,(MCS0)_4TX	-	-	-	-	-	-	-	-	-	-
5210MHz	Pass	Inf	81.84M	76.042M	81.36M	75.922M	81.24M	75.922M	81.72M	76.042M
5290MHz	Pass	Inf	81.96M	76.042M	81.36M	75.922M	81.48M	76.162M	81.72M	76.162M
5530MHz	Pass	Inf	81.84M	76.042M	81.6M	75.922M	81.36M	76.042M	81.96M	76.162M
5610MHz	Pass	Inf	81.84M	76.162M	81.48M	75.922M	81.6M	76.162M	81.84M	76.162M
5690MHz Straddle 5.47-5.725GHz	Pass	Inf	75.9M	72.864M	75.6M	72.714M	75.675M	72.789M	75.675M	72.714M
5690MHz Straddle 5.725-5.85GHz	Pass	500k	3.1M	3.778M	3.1M	3.798M	3.12M	3.858M	3.12M	3.898M
5775MHz	Pass	500k	75.12M	76.282M	75.96M	76.042M	76.32M	76.162M	75.6M	76.042M
802.11ac VHT160_Nss1,(MCS0)_4TX	-	-	-	-	-	-	-	-	-	-
5250MHz Straddle 5.15-5.25GHz	Pass	Inf	82.4M	77.241M	82.8M	77.081M	81.92M	77.561M	82.32M	77.401M
5250MHz Straddle 5.25-5.35GHz	Pass	Inf	82M	77.001M	82.16M	77.161M	83.52M	77.881M	82.24M	77.321M
5570MHz	Pass	Inf	164.4M	154.963M	164.88M	154.723M	165.12M	154.963M	164.16M	154.723M
802.11ax HEW20_Nss1,(MCS0)_4TX	-	-	-	-	-	-	-	-	-	-
5180MHz	Pass	Inf	21.66M	18.051M	21.45M	17.901M	21.6M	17.901M	21.75M	18.051M
5200MHz	Pass	Inf	21.6M	19.16M	21.75M	19.13M	21.45M	19.1M	21.63M	19.04M
5240MHz	Pass	Inf	21.54M	19.19M	21.63M	19.13M	21.6M	19.1M	21.54M	19.07M
5260MHz	Pass	Inf	21.6M	19.16M	21.75M	19.13M	21.48M	19.1M	21.63M	19.04M
5300MHz	Pass	Inf	21.69M	19.16M	21.69M	19.13M	21.6M	19.1M	21.69M	19.04M
5320MHz	Pass	Inf	21.72M	19.16M	21.6M	19.07M	21.36M	19.13M	21.57M	19.1M
5500MHz	Pass	Inf	21.69M	19.19M	21.57M	19.16M	21.57M	19.1M	21.78M	19.04M
5580MHz	Pass	Inf	21.81M	19.16M	21.72M	19.16M	21.45M	19.1M	21.54M	19.04M
5700MHz	Pass	Inf	21.84M	19.16M	21.75M	19.13M	21.72M	19.1M	21.72M	19.07M
5720MHz Straddle 5.47-5.725GHz	Pass	Inf	15.705M	14.558M	15.765M	14.558M	15.69M	14.543M	15.81M	14.558M
5720MHz Straddle 5.725-5.85GHz	Pass	500k	4.52M	4.758M	4.54M	4.718M	4.44M	4.718M	4.44M	4.618M
5745MHz	Pass	500k	18.96M	19.16M	18.93M	19.16M	18.96M	19.13M	19.05M	19.07M
5785MHz	Pass	500k	18.99M	19.16M	18.96M	19.13M	18.99M	19.1M	19.02M	19.07M
5825MHz	Pass	500k	19.02M	19.13M	18.96M	19.19M	18.96M	19.13M	18.99M	19.04M
802.11ax HEW40_Nss1,(MCS0)_4TX	-	-	-	-	-	-	-	-	-	-
5190MHz	Pass	Inf	40.14M	37.601M	40.02M	37.601M	39.9M	37.661M	40.08M	37.601M
5230MHz	Pass	Inf	40.08M	37.601M	40.08M	37.601M	39.84M	37.601M	40.14M	37.601M
5270MHz	Pass	Inf	40.2M	37.601M	40.02M	37.661M	39.9M	37.661M	40.08M	37.661M
5310MHz	Pass	Inf	40.2M	37.601M	40.2M	37.661M	39.84M	37.601M	40.14M	37.601M
5510MHz	Pass	Inf	40.08M	37.601M	40.08M	37.661M	39.9M	37.661M	40.08M	37.601M
5550MHz	Pass	Inf	40.14M	37.661M	40.08M	37.661M	39.78M	37.661M	40.02M	37.601M
5670MHz	Pass	Inf	40.08M	37.601M	39.96M	37.661M	39.84M	37.601M	40.08M	37.601M
5710MHz Straddle 5.47-5.725GHz	Pass	Inf	35.105M	33.618M	35.175M	33.688M	34.93M	33.723M	35M	33.653M
5710MHz Straddle 5.725-5.85GHz	Pass	500k	3.78M	4.058M	3.78M	4.058M	3.8M	4.058M	3.72M	4.038M
5755MHz	Pass	500k	37.56M	37.661M	37.5M	37.661M	37.08M	37.661M	36.96M	37.601M
5795MHz	Pass	500k	37.5M	37.601M	37.62M	37.661M	37.62M	37.601M	37.56M	37.661M
802.11ax HEW80_Nss1,(MCS0)_4TX	-	-	-	-	-	-	-	-	-	-
5210MHz	Pass	Inf	81.84M	77.361M	82.32M	77.361M	82.08M	77.481M	82.08M	77.361M
5290MHz	Pass	Inf	81.96M	77.361M	82.2M	77.481M	81.96M	77.481M	82.08M	77.481M



Mode	Result	Limit (Hz)	Port 1-N dB (Hz)	Port 1-OBW (Hz)	Port 2-N dB (Hz)	Port 2-OBW (Hz)	Port 3-N dB (Hz)	Port 3-OBW (Hz)	Port 4-N dB (Hz)	Port 4-OBW (Hz)
5530MHz	Pass	Inf	82.08M	77.361M	82.44M	77.481M	82.08M	77.481M	81.96M	77.481M
5610MHz	Pass	Inf	81.96M	77.361M	82.68M	77.481M	82.32M	77.601M	82.32M	77.481M
5690MHz Straddle 5.47-5.725GHz	Pass	Inf	75.9M	73.538M	76.2M	73.463M	75.9M	73.463M	75.825M	73.313M
5690MHz Straddle 5.725-5.85GHz	Pass	500k	3.48M	4.158M	3.8M	4.158M	3.66M	4.298M	3.8M	4.258M
5775MHz	Pass	500k	76.56M	77.481M	77.28M	77.481M	76.32M	77.481M	77.04M	77.481M
802.11ax HEW160_Nss1,(MCS0)_4TX	-	-	-	-	-	-	-	-	-	-
5250MHz Straddle 5.15-5.25GHz	Pass	Inf	82.4M	77.881M	82.48M	77.801M	82.16M	77.881M	82.48M	77.881M
5250MHz Straddle 5.25-5.35GHz	Pass	Inf	82.48M	77.961M	82.64M	77.961M	82.56M	78.121M	82.88M	78.041M
5570MHz	Pass	Inf	164.88M	155.202M	164.64M	155.202M	164.4M	155.442M	164.64M	155.442M

Port X-N dB = Port X 6dB down bandwidth for 5.725-5.85GHz band / 26dB down bandwidth for other band
 Port X-OBW = Port X 99% occupied bandwidth

802.11a_Nss1,(6Mbps)_4TX

EBW

5180MHz

16/06/2022

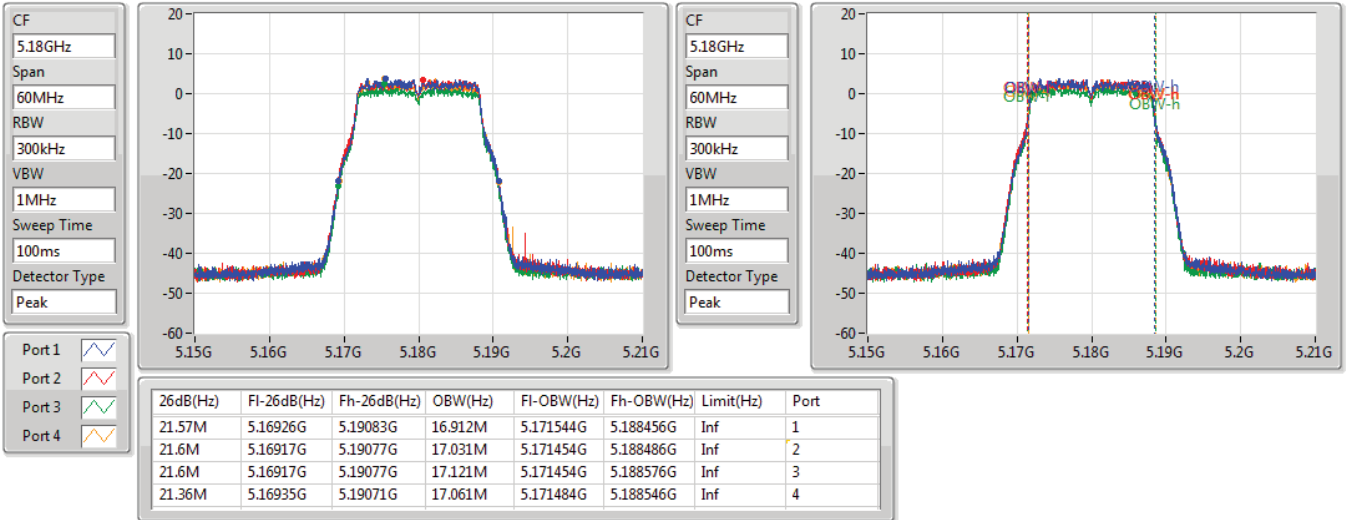

802.11a_Nss1,(6Mbps)_4TX

EBW

5200MHz

16/06/2022

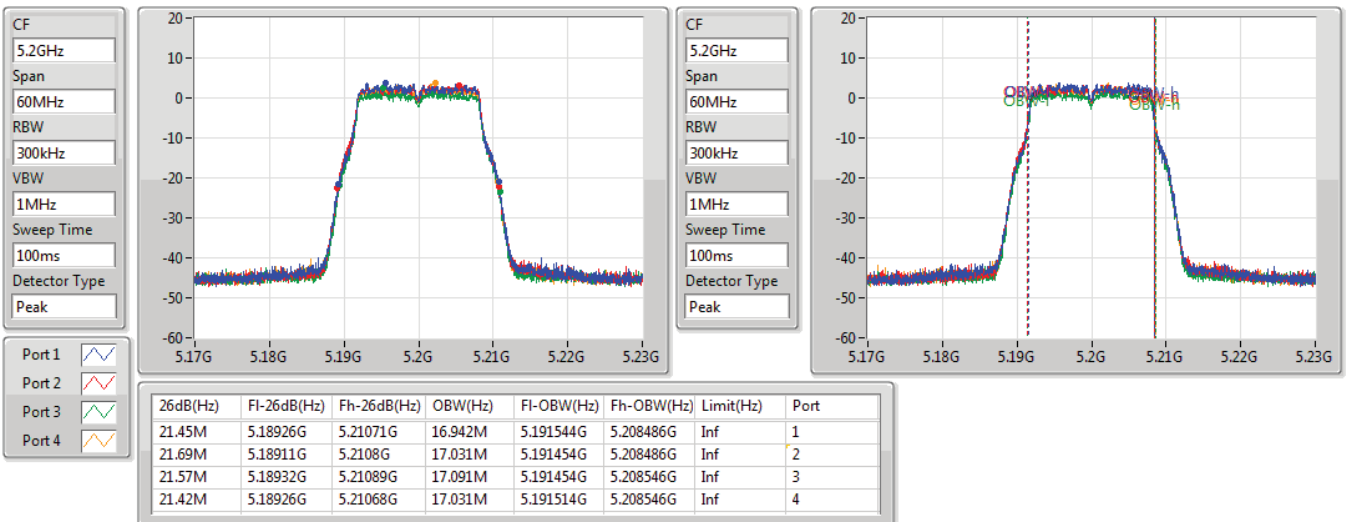

802.11a_Nss1,(6Mbps)_4TX

EBW

5240MHz

16/06/2022

CF
5.24GHz
Span
60MHz
RBW
300kHz
VBW
1MHz
Sweep Time
100ms
Detector Type
Peak

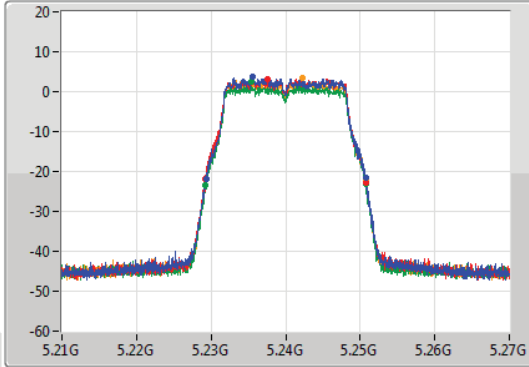

CF
5.24GHz
Span
60MHz
RBW
300kHz
VBW
1MHz
Sweep Time
100ms
Detector Type
Peak

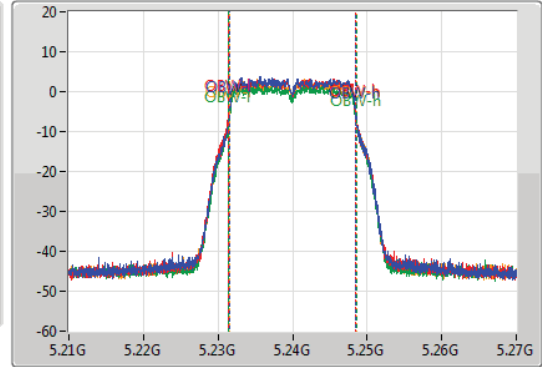

Port 1
Port 2
Port 3
Port 4

26dB(Hz)	Fl-26dB(Hz)	Fh-26dB(Hz)	OBW(Hz)	Fl-OBW(Hz)	Fh-OBW(Hz)	Limit(Hz)	Port
21.42M	5.22935G	5.25077G	16.942M	5.231544G	5.248486G	Inf	1
21.6M	5.22917G	5.25077G	17.031M	5.231454G	5.248486G	Inf	2
21.66M	5.2292G	5.25086G	17.121M	5.231454G	5.248576G	Inf	3
21.45M	5.22932G	5.25077G	17.031M	5.231514G	5.248546G	Inf	4

802.11a_Nss1,(6Mbps)_4TX

EBW

5260MHz

16/06/2022

CF
5.26GHz
Span
60MHz
RBW
300kHz
VBW
1MHz
Sweep Time
100ms
Detector Type
Peak

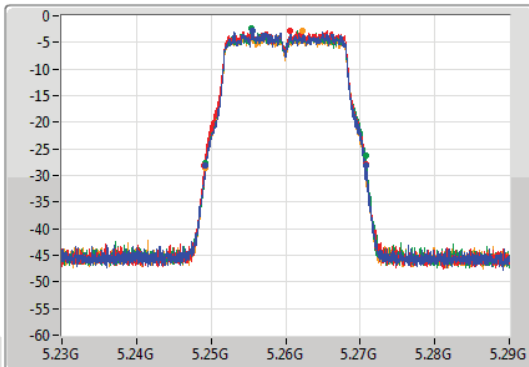

CF
5.26GHz
Span
60MHz
RBW
300kHz
VBW
1MHz
Sweep Time
100ms
Detector Type
Peak

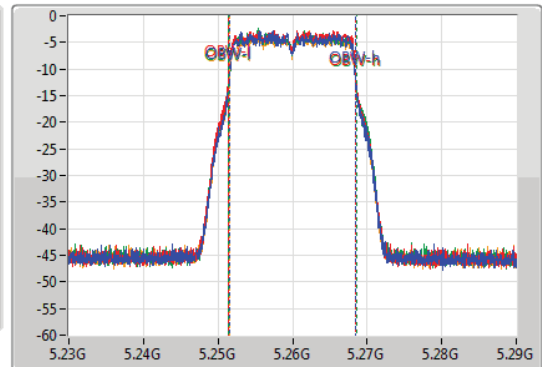

Port 1
Port 2
Port 3
Port 4

26dB(Hz)	Fl-26dB(Hz)	Fh-26dB(Hz)	OBW(Hz)	Fl-OBW(Hz)	Fh-OBW(Hz)	Limit(Hz)	Port
21.48M	5.24929G	5.27077G	16.912M	5.251514G	5.268426G	Inf	1
21.66M	5.24911G	5.27077G	17.091M	5.251394G	5.268486G	Inf	2
21.48M	5.24923G	5.27071G	17.151M	5.251424G	5.268576G	Inf	3
21.48M	5.24926G	5.27074G	17.061M	5.251484G	5.268546G	Inf	4



802.11a_Nss1,(6Mbps)_4TX

EBW

5300MHz

17/06/2022

CF
5.3GHz
Span
60MHz
RBW
300kHz
VBW
1MHz
Sweep Time
100ms
Detector Type
Peak

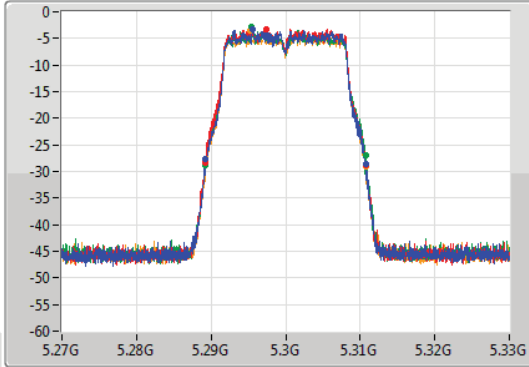

CF
5.3GHz
Span
60MHz
RBW
300kHz
VBW
1MHz
Sweep Time
100ms
Detector Type
Peak

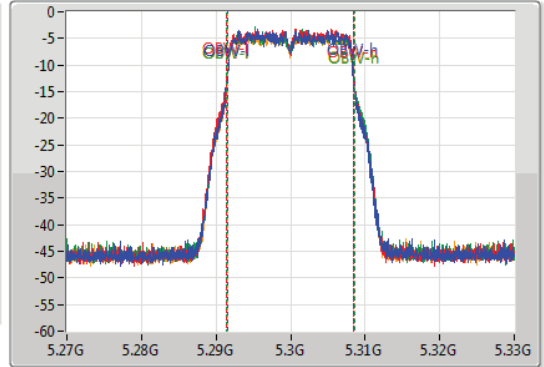

Port 1
Port 2
Port 3
Port 4

26dB(Hz)	Fl-26dB(Hz)	Fh-26dB(Hz)	OBW(Hz)	Fl-OBW(Hz)	Fh-OBW(Hz)	Limit(Hz)	Port
21.48M	5.28929G	5.31077G	16.942M	5.291514G	5.308456G	Inf	1
21.63M	5.28914G	5.31077G	17.061M	5.291424G	5.308486G	Inf	2
21.48M	5.28923G	5.31071G	17.121M	5.291454G	5.308576G	Inf	3
21.45M	5.28926G	5.31071G	17.061M	5.291484G	5.308546G	Inf	4

802.11a_Nss1,(6Mbps)_4TX

EBW

5320MHz

17/06/2022

CF
5.32GHz
Span
60MHz
RBW
300kHz
VBW
1MHz
Sweep Time
100ms
Detector Type
Peak

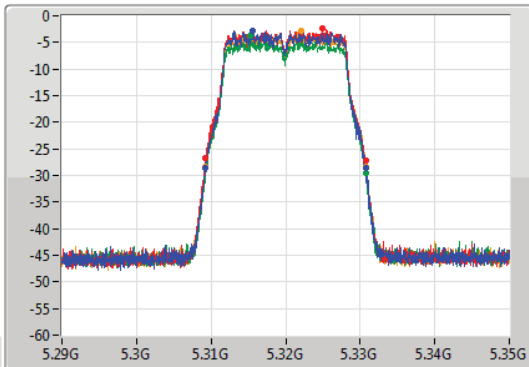

CF
5.32GHz
Span
60MHz
RBW
300kHz
VBW
1MHz
Sweep Time
100ms
Detector Type
Peak

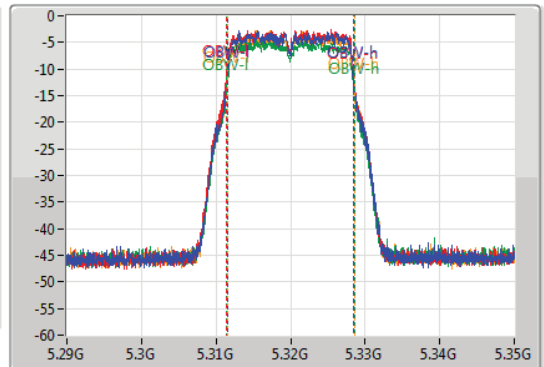

Port 1
Port 2
Port 3
Port 4

26dB(Hz)	Fl-26dB(Hz)	Fh-26dB(Hz)	OBW(Hz)	Fl-OBW(Hz)	Fh-OBW(Hz)	Limit(Hz)	Port
21.63M	5.30923G	5.33086G	16.942M	5.311514G	5.328456G	Inf	1
21.45M	5.30926G	5.33071G	17.091M	5.311394G	5.328486G	Inf	2
21.57M	5.30929G	5.33086G	17.151M	5.311424G	5.328576G	Inf	3
21.51M	5.30926G	5.33077G	17.061M	5.311484G	5.328546G	Inf	4

802.11a_Nss1,(6Mbps)_4TX

EBW

5500MHz

16/06/2022

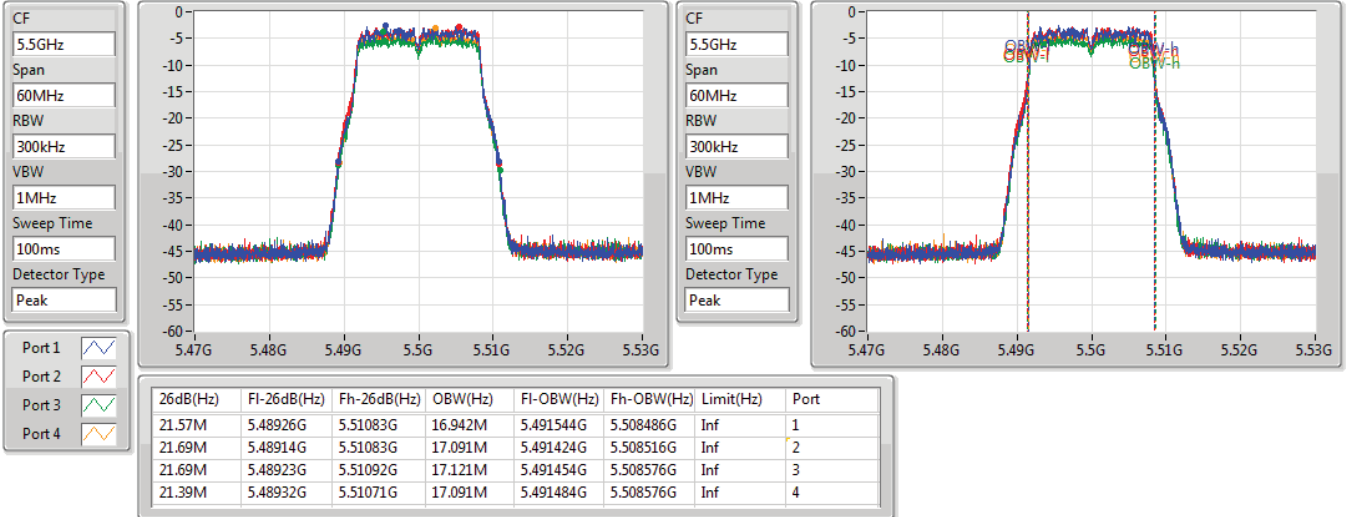

802.11a_Nss1,(6Mbps)_4TX

EBW

5580MHz

17/06/2022

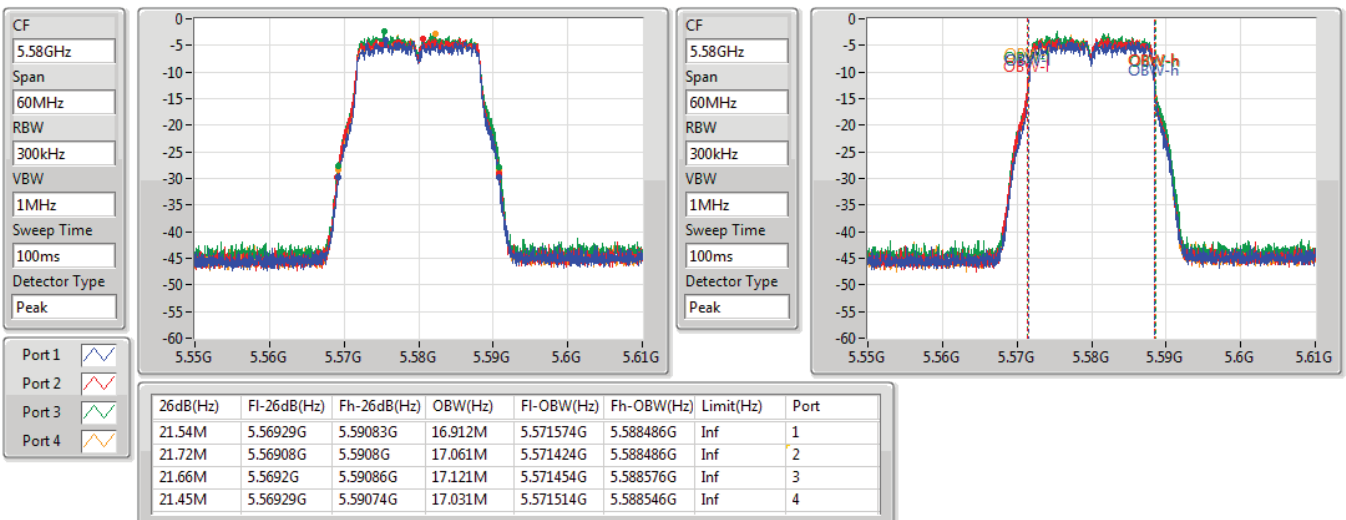

802.11a_Nss1,(6Mbps)_4TX

EBW

5700MHz

17/06/2022

CF
5.7GHz
Span
60MHz
RBW
300kHz
VBW
1MHz
Sweep Time
100ms
Detector Type
Peak

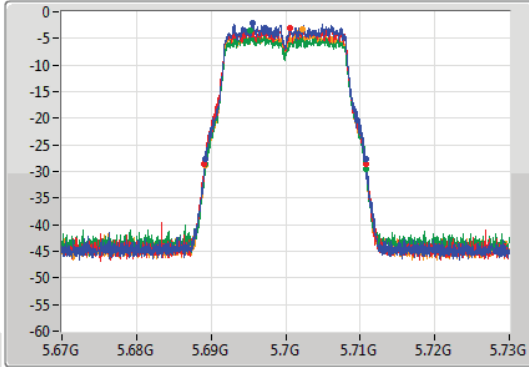

CF
5.7GHz
Span
60MHz
RBW
300kHz
VBW
1MHz
Sweep Time
100ms
Detector Type
Peak

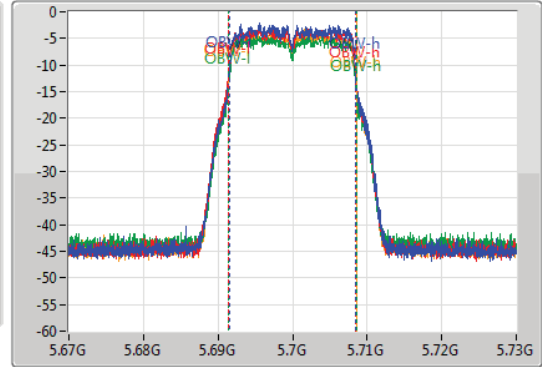

Port 1
Port 2
Port 3
Port 4

26dB(Hz)	Fl-26dB(Hz)	Fh-26dB(Hz)	OBW(Hz)	Fl-OBW(Hz)	Fh-OBW(Hz)	Limit(Hz)	Port
21.6M	5.6892G	5.7108G	16.882M	5.691544G	5.708426G	Inf	1
21.63M	5.68911G	5.71074G	17.061M	5.691394G	5.708456G	Inf	2
21.63M	5.68923G	5.71086G	17.151M	5.691424G	5.708576G	Inf	3
21.54M	5.68923G	5.71077G	17.091M	5.691454G	5.708546G	Inf	4

802.11a_Nss1,(6Mbps)_4TX

EBW

5720MHz Straddle 5.47-5.725GHz

17/06/2022

CF
5.71GHz
Span
30MHz
RBW
200kHz
VBW
1MHz
Sweep Time
100ms
Detector Type
Peak

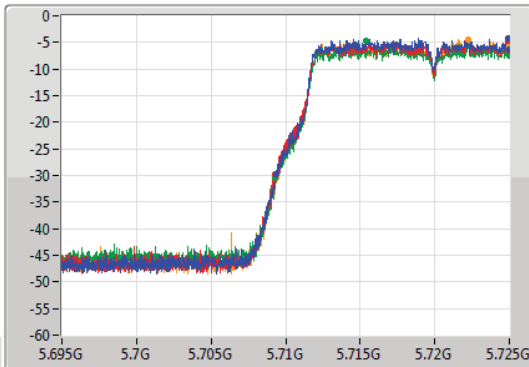

CF
5.71GHz
Span
30MHz
RBW
300kHz
VBW
1MHz
Sweep Time
100ms
Detector Type
Peak

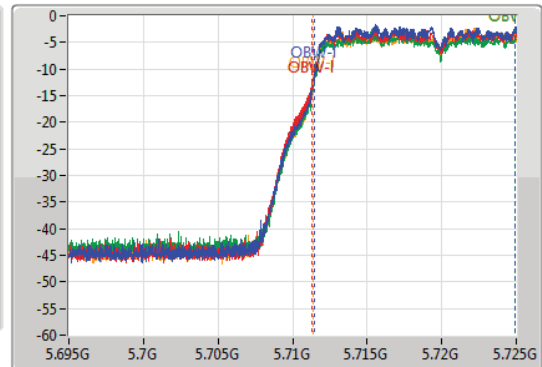

Port 1
Port 2
Port 3
Port 4

26dB(Hz)	Fl-26dB(Hz)	Fh-26dB(Hz)	OBW(Hz)	Fl-OBW(Hz)	Fh-OBW(Hz)	Limit(Hz)	Port
15.66M	5.70934G	5.725G	13.508M	5.711439G	5.724948G	Inf	1
15.75M	5.70925G	5.725G	13.658M	5.711274G	5.724933G	Inf	2
15.69M	5.70931G	5.725G	13.613M	5.711319G	5.724933G	Inf	3
15.63M	5.70937G	5.725G	13.553M	5.711379G	5.724933G	Inf	4

802.11a_Nss1,(6Mbps)_4TX

EBW

5720MHz Straddle 5.725-5.85GHz

17/06/2022

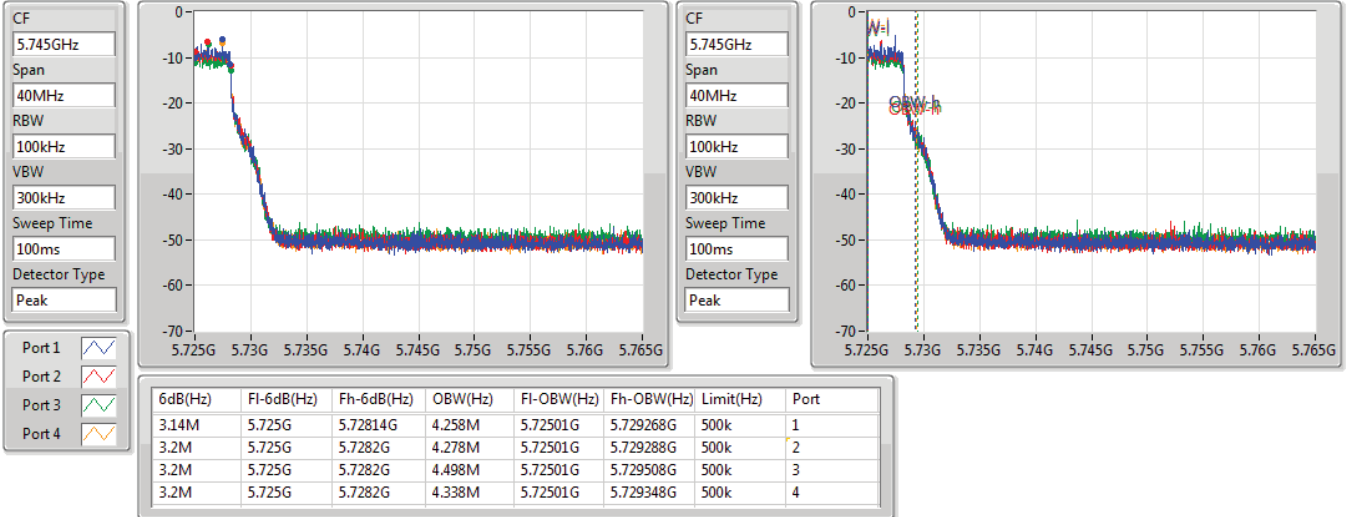

802.11a_Nss1,(6Mbps)_4TX

EBW

5745MHz

16/06/2022

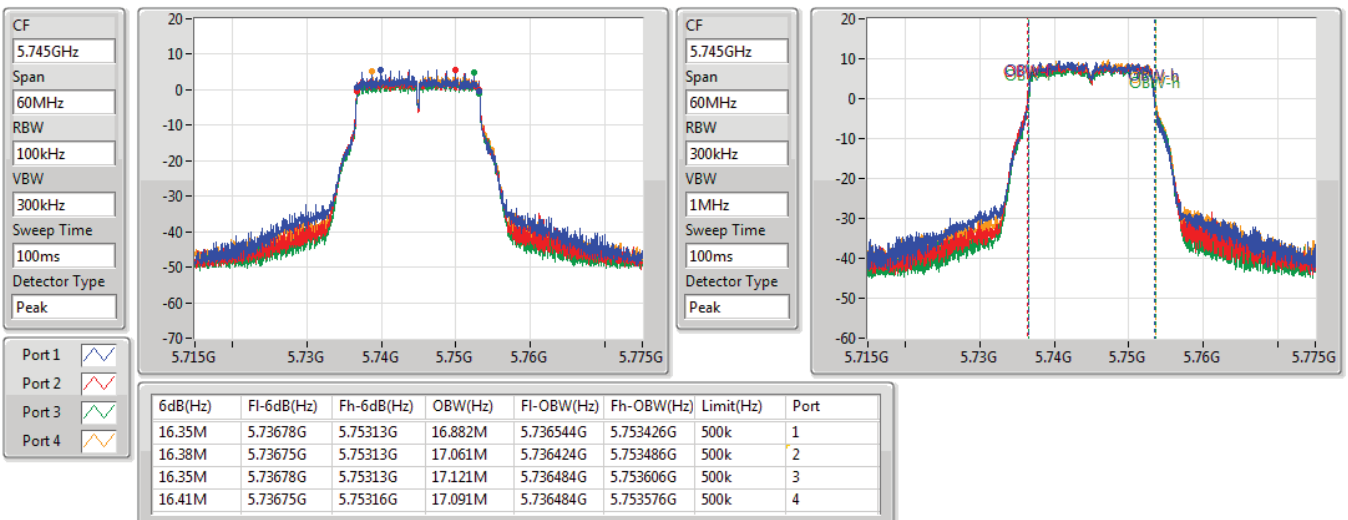

802.11a_Nss1,(6Mbps)_4TX

EBW

5785MHz

16/06/2022

CF
5.785GHz
Span
60MHz
RBW
100kHz
VBW
300kHz
Sweep Time
100ms
Detector Type
Peak

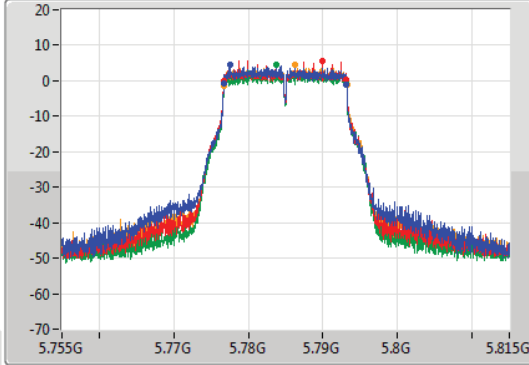

CF
5.785GHz
Span
60MHz
RBW
300kHz
VBW
1MHz
Sweep Time
100ms
Detector Type
Peak

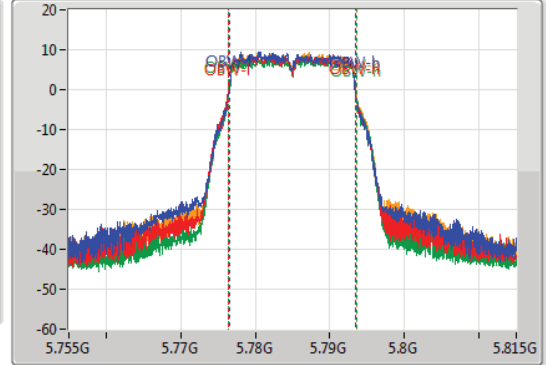

Port 1
Port 2
Port 3
Port 4

6dB(Hz)	Fl-6dB(Hz)	Fh-6dB(Hz)	OBW(Hz)	Fl-OBW(Hz)	Fh-OBW(Hz)	Limit(Hz)	Port
16.41M	5.77675G	5.79316G	16.912M	5.776514G	5.793426G	500k	1
16.38M	5.77675G	5.79313G	17.091M	5.776394G	5.793486G	500k	2
16.35M	5.77678G	5.79313G	17.121M	5.776454G	5.793576G	500k	3
16.5M	5.77669G	5.79319G	17.061M	5.776484G	5.793546G	500k	4

802.11a_Nss1,(6Mbps)_4TX

EBW

5825MHz

16/06/2022

CF
5.825GHz
Span
60MHz
RBW
100kHz
VBW
300kHz
Sweep Time
100ms
Detector Type
Peak

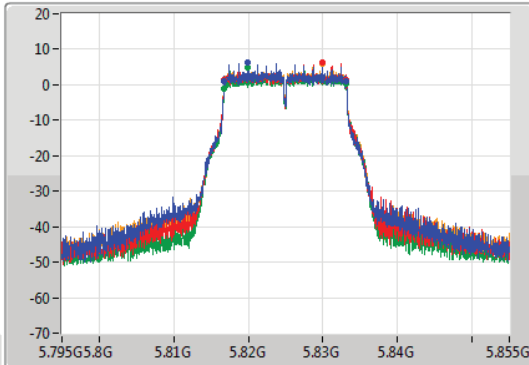

CF
5.825GHz
Span
60MHz
RBW
300kHz
VBW
1MHz
Sweep Time
100ms
Detector Type
Peak

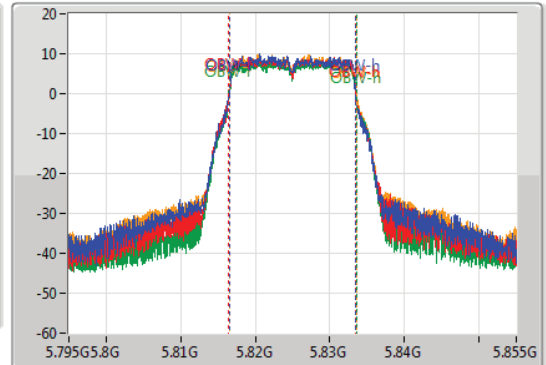

Port 1
Port 2
Port 3
Port 4

6dB(Hz)	Fl-6dB(Hz)	Fh-6dB(Hz)	OBW(Hz)	Fl-OBW(Hz)	Fh-OBW(Hz)	Limit(Hz)	Port
16.35M	5.81678G	5.83313G	16.942M	5.816514G	5.833456G	500k	1
16.35M	5.81678G	5.83313G	17.061M	5.816454G	5.833516G	500k	2
16.35M	5.81678G	5.83313G	17.181M	5.816454G	5.833636G	500k	3
16.35M	5.81678G	5.83313G	17.121M	5.816484G	5.833606G	500k	4

802.11n HT20_Nss1,(MCS0)_4TX

EBW

5180MHz

17/06/2022

CF
5.18GHz
Span
60MHz
RBW
300kHz
VBW
1MHz
Sweep Time
100ms
Detector Type
Peak

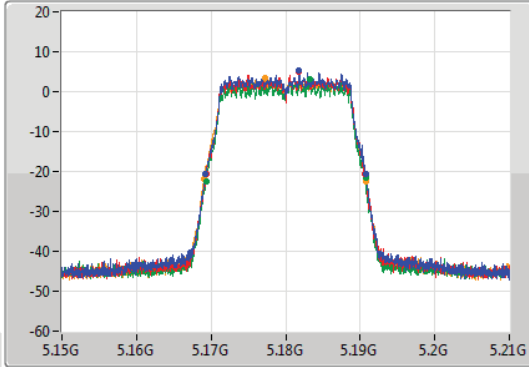

CF
5.18GHz
Span
60MHz
RBW
300kHz
VBW
1MHz
Sweep Time
100ms
Detector Type
Peak

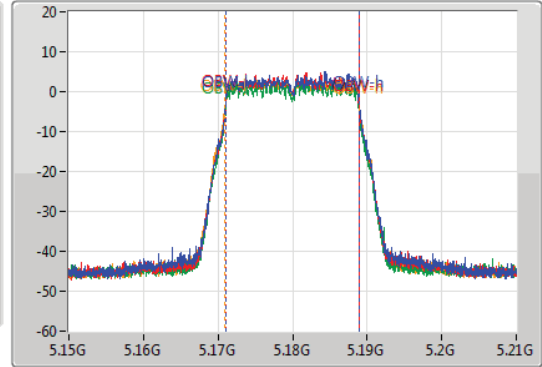

Port 1
Port 2
Port 3
Port 4

26dB(Hz)	Fl-26dB(Hz)	Fh-26dB(Hz)	OBW(Hz)	Fl-OBW(Hz)	Fh-OBW(Hz)	Limit(Hz)	Port
21.48M	5.16929G	5.19077G	17.901M	5.171064G	5.188966G	Inf	1
21.33M	5.16932G	5.19065G	17.901M	5.171034G	5.188936G	Inf	2
21.36M	5.16935G	5.19071G	17.871M	5.171034G	5.188906G	Inf	3
21.75M	5.16902G	5.19077G	18.141M	5.170855G	5.188996G	Inf	4

802.11n HT20_Nss1,(MCS0)_4TX

EBW

5200MHz

17/06/2022

CF
5.2GHz
Span
60MHz
RBW
300kHz
VBW
1MHz
Sweep Time
100ms
Detector Type
Peak

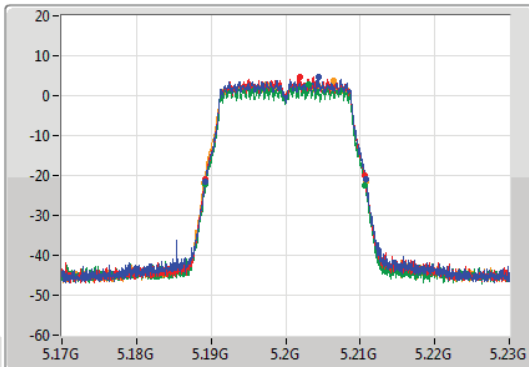

CF
5.2GHz
Span
60MHz
RBW
300kHz
VBW
1MHz
Sweep Time
100ms
Detector Type
Peak

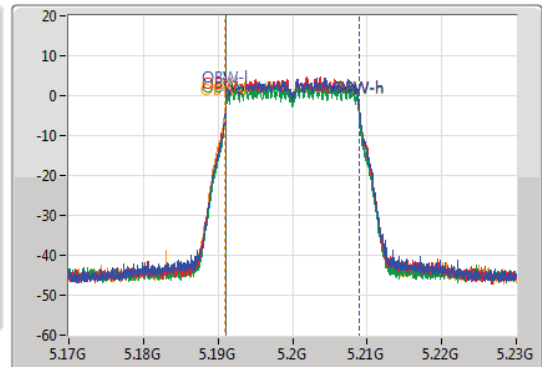

Port 1
Port 2
Port 3
Port 4

26dB(Hz)	Fl-26dB(Hz)	Fh-26dB(Hz)	OBW(Hz)	Fl-OBW(Hz)	Fh-OBW(Hz)	Limit(Hz)	Port
21.51M	5.18923G	5.21074G	17.901M	5.191064G	5.208966G	Inf	1
21.45M	5.18923G	5.21068G	17.901M	5.191034G	5.208936G	Inf	2
21.45M	5.18923G	5.21068G	17.871M	5.191034G	5.208906G	Inf	3
21.81M	5.18899G	5.2108G	18.141M	5.190855G	5.208996G	Inf	4

802.11n HT20_Nss1,(MCS0)_4TX

EBW

5240MHz

17/06/2022

CF
5.24GHz
Span
60MHz
RBW
300kHz
VBW
1MHz
Sweep Time
100ms
Detector Type
Peak

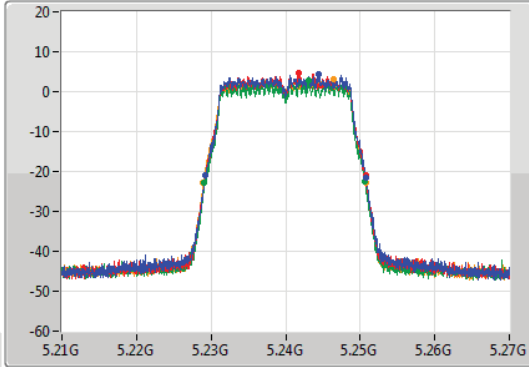

CF
5.24GHz
Span
60MHz
RBW
300kHz
VBW
1MHz
Sweep Time
100ms
Detector Type
Peak

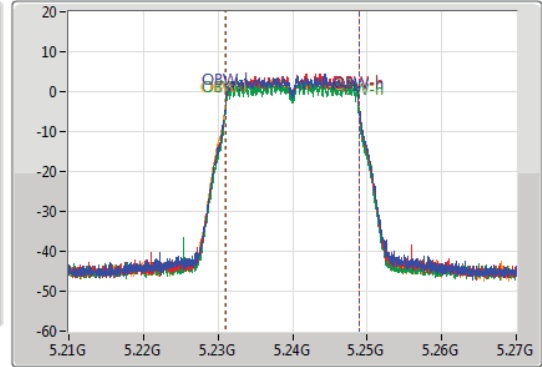

Port 1
Port 2
Port 3
Port 4

26dB(Hz)	Fl-26dB(Hz)	Fh-26dB(Hz)	OBW(Hz)	Fl-OBW(Hz)	Fh-OBW(Hz)	Limit(Hz)	Port
21.48M	5.22929G	5.25077G	17.901M	5.231034G	5.248936G	Inf	1
21.48M	5.22926G	5.25074G	17.901M	5.231034G	5.248936G	Inf	2
21.57M	5.22911G	5.25068G	17.871M	5.231004G	5.248876G	Inf	3
21.81M	5.22896G	5.25077G	18.111M	5.230855G	5.248966G	Inf	4

802.11n HT20_Nss1,(MCS0)_4TX

EBW

5260MHz

17/06/2022

CF
5.26GHz
Span
60MHz
RBW
300kHz
VBW
1MHz
Sweep Time
100ms
Detector Type
Peak

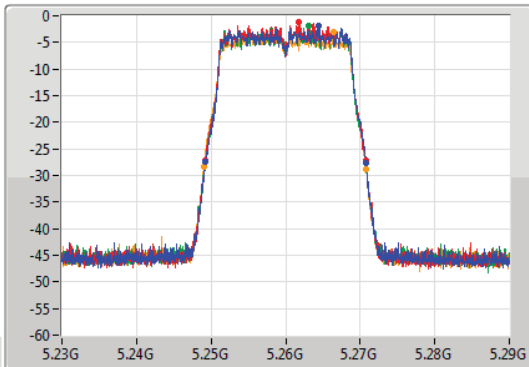

CF
5.26GHz
Span
60MHz
RBW
300kHz
VBW
1MHz
Sweep Time
100ms
Detector Type
Peak

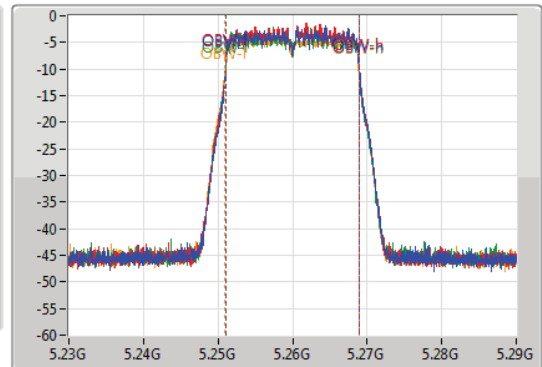

Port 1
Port 2
Port 3
Port 4

26dB(Hz)	Fl-26dB(Hz)	Fh-26dB(Hz)	OBW(Hz)	Fl-OBW(Hz)	Fh-OBW(Hz)	Limit(Hz)	Port
21.54M	5.24923G	5.27077G	17.931M	5.251034G	5.268966G	Inf	1
21.57M	5.2492G	5.27077G	17.901M	5.251034G	5.268936G	Inf	2
21.57M	5.24914G	5.27071G	17.901M	5.251004G	5.268906G	Inf	3
21.84M	5.24902G	5.27086G	18.171M	5.250825G	5.268996G	Inf	4

802.11n HT20_Nss1,(MCS0)_4TX

EBW

5300MHz

17/06/2022

CF
5.3GHz
Span
60MHz
RBW
300kHz
VBW
1MHz
Sweep Time
100ms
Detector Type
Peak

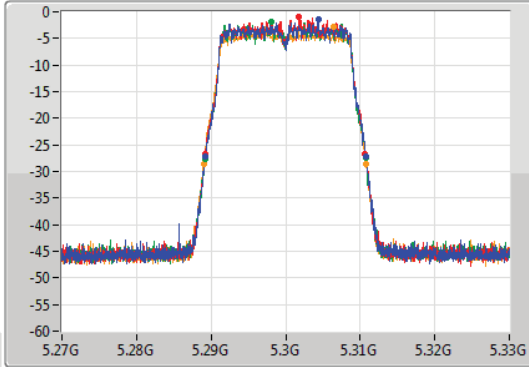

CF
5.3GHz
Span
60MHz
RBW
300kHz
VBW
1MHz
Sweep Time
100ms
Detector Type
Peak

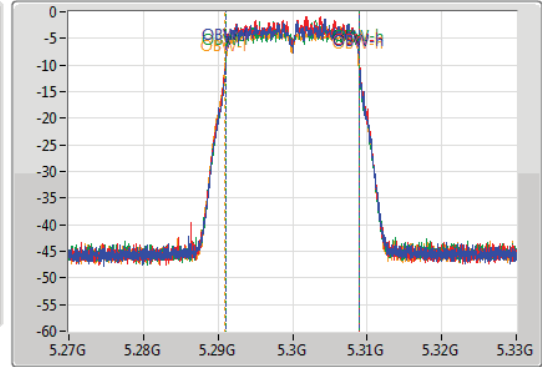

Port 1
Port 2
Port 3
Port 4

26dB(Hz)	Fl-26dB(Hz)	Fh-26dB(Hz)	OBW(Hz)	Fl-OBW(Hz)	Fh-OBW(Hz)	Limit(Hz)	Port
21.51M	5.28926G	5.31077G	17.901M	5.291064G	5.308966G	Inf	1
21.36M	5.28926G	5.31062G	17.931M	5.291034G	5.308966G	Inf	2
21.63M	5.28914G	5.31077G	17.871M	5.291034G	5.308906G	Inf	3
21.84M	5.28899G	5.31083G	18.141M	5.290855G	5.308996G	Inf	4

802.11n HT20_Nss1,(MCS0)_4TX

EBW

5320MHz

17/06/2022

CF
5.32GHz
Span
60MHz
RBW
300kHz
VBW
1MHz
Sweep Time
100ms
Detector Type
Peak

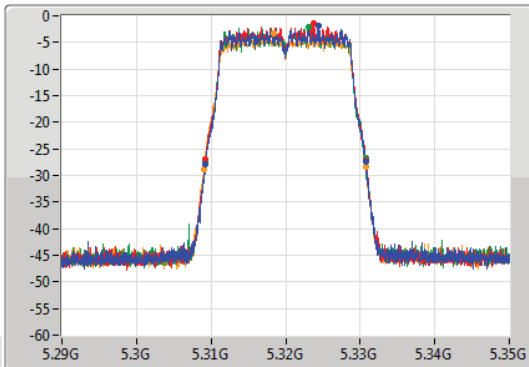

CF
5.32GHz
Span
60MHz
RBW
300kHz
VBW
1MHz
Sweep Time
100ms
Detector Type
Peak

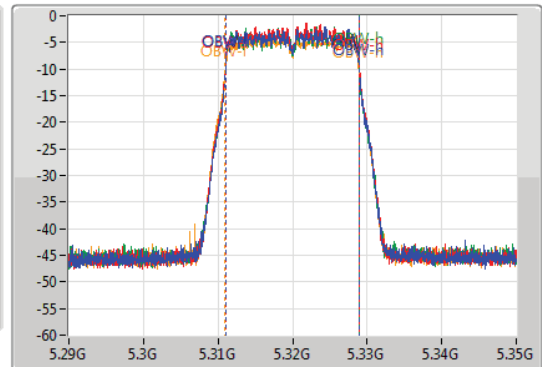

Port 1
Port 2
Port 3
Port 4

26dB(Hz)	Fl-26dB(Hz)	Fh-26dB(Hz)	OBW(Hz)	Fl-OBW(Hz)	Fh-OBW(Hz)	Limit(Hz)	Port
21.51M	5.30923G	5.33074G	17.871M	5.311064G	5.328936G	Inf	1
21.45M	5.30926G	5.33071G	17.931M	5.311034G	5.328966G	Inf	2
21.57M	5.3092G	5.33077G	17.871M	5.311034G	5.328906G	Inf	3
21.81M	5.30902G	5.33083G	18.141M	5.310855G	5.328996G	Inf	4



802.11n HT20_Nss1,(MCS0)_4TX

EBW

5500MHz

17/06/2022

CF
5.5GHz
Span
60MHz
RBW
300kHz
VBW
1MHz
Sweep Time
100ms
Detector Type
Peak

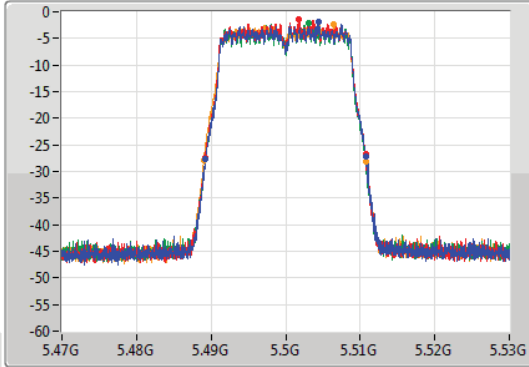

CF
5.5GHz
Span
60MHz
RBW
300kHz
VBW
1MHz
Sweep Time
100ms
Detector Type
Peak

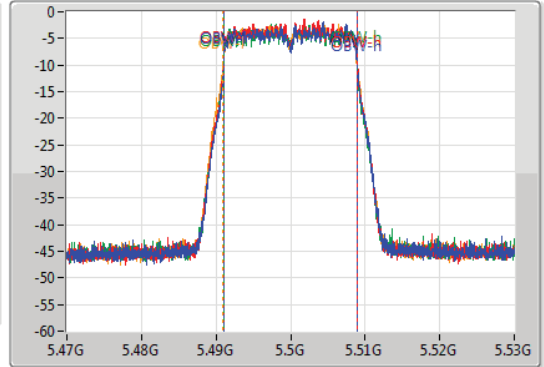

Port 1
Port 2
Port 3
Port 4

26dB(Hz)	Fl-26dB(Hz)	Fh-26dB(Hz)	OBW(Hz)	Fl-OBW(Hz)	Fh-OBW(Hz)	Limit(Hz)	Port
21.6M	5.48917G	5.51077G	17.901M	5.491064G	5.508966G	Inf	1
21.54M	5.4892G	5.51074G	17.931M	5.491034G	5.508966G	Inf	2
21.51M	5.4892G	5.51071G	17.871M	5.491034G	5.508906G	Inf	3
21.78M	5.48899G	5.51077G	18.141M	5.490855G	5.508996G	Inf	4

802.11n HT20_Nss1,(MCS0)_4TX

EBW

5580MHz

17/06/2022

CF
5.58GHz
Span
60MHz
RBW
300kHz
VBW
1MHz
Sweep Time
100ms
Detector Type
Peak

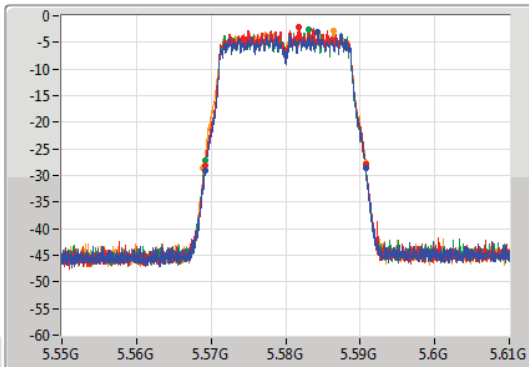

CF
5.58GHz
Span
60MHz
RBW
300kHz
VBW
1MHz
Sweep Time
100ms
Detector Type
Peak

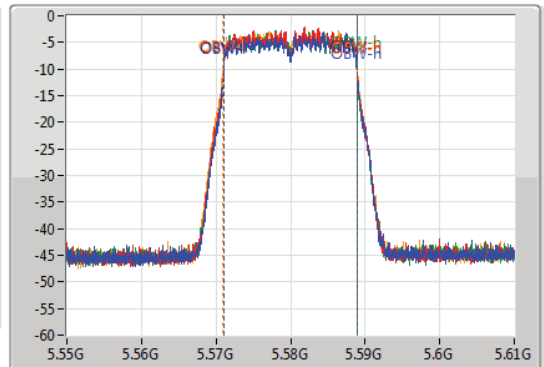

Port 1
Port 2
Port 3
Port 4

26dB(Hz)	Fl-26dB(Hz)	Fh-26dB(Hz)	OBW(Hz)	Fl-OBW(Hz)	Fh-OBW(Hz)	Limit(Hz)	Port
21.51M	5.56926G	5.59077G	17.931M	5.571034G	5.588966G	Inf	1
21.57M	5.5692G	5.59077G	17.931M	5.571004G	5.588936G	Inf	2
21.57M	5.56923G	5.5908G	17.871M	5.571004G	5.588876G	Inf	3
21.87M	5.56896G	5.59083G	18.141M	5.570855G	5.588996G	Inf	4

802.11n HT20_Nss1,(MCS0)_4TX

EBW

5700MHz

17/06/2022

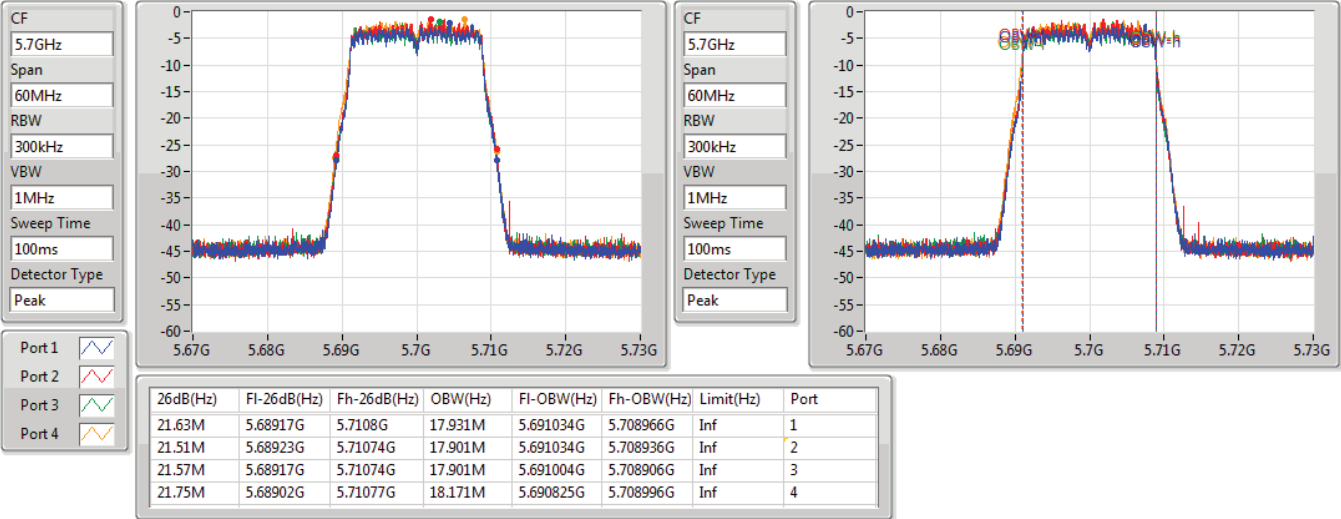

802.11n HT20_Nss1,(MCS0)_4TX

EBW

5720MHz Straddle 5.47-5.725GHz

17/06/2022

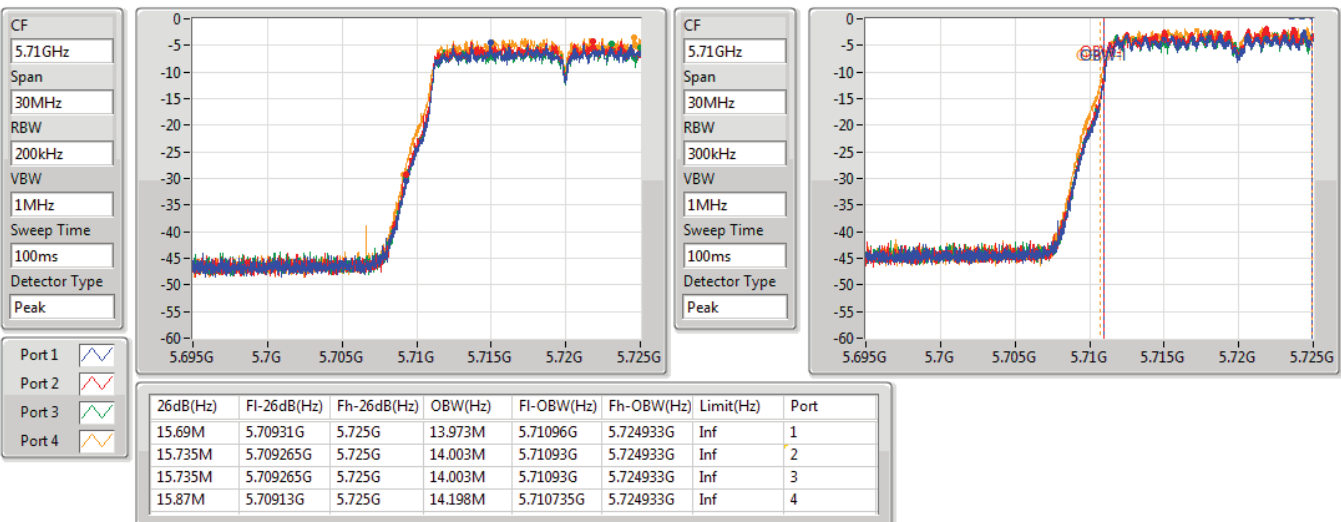

802.11n HT20_Nss1,(MCS0)_4TX

EBW

5720MHz Straddle 5.725-5.85GHz

17/06/2022

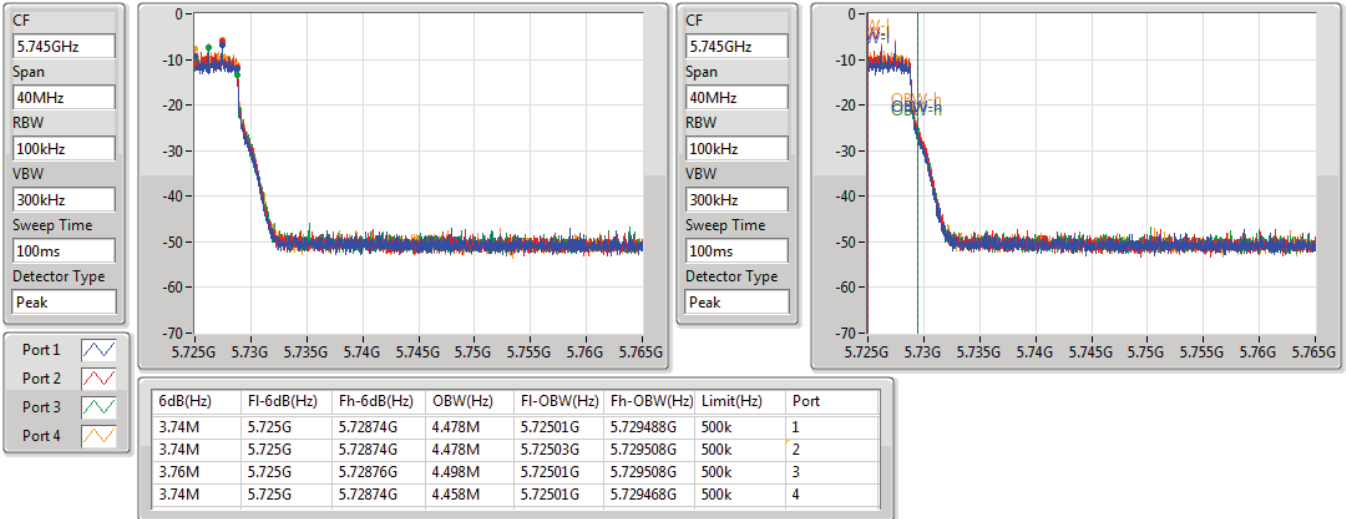

802.11n HT20_Nss1,(MCS0)_4TX

EBW

5745MHz

17/06/2022

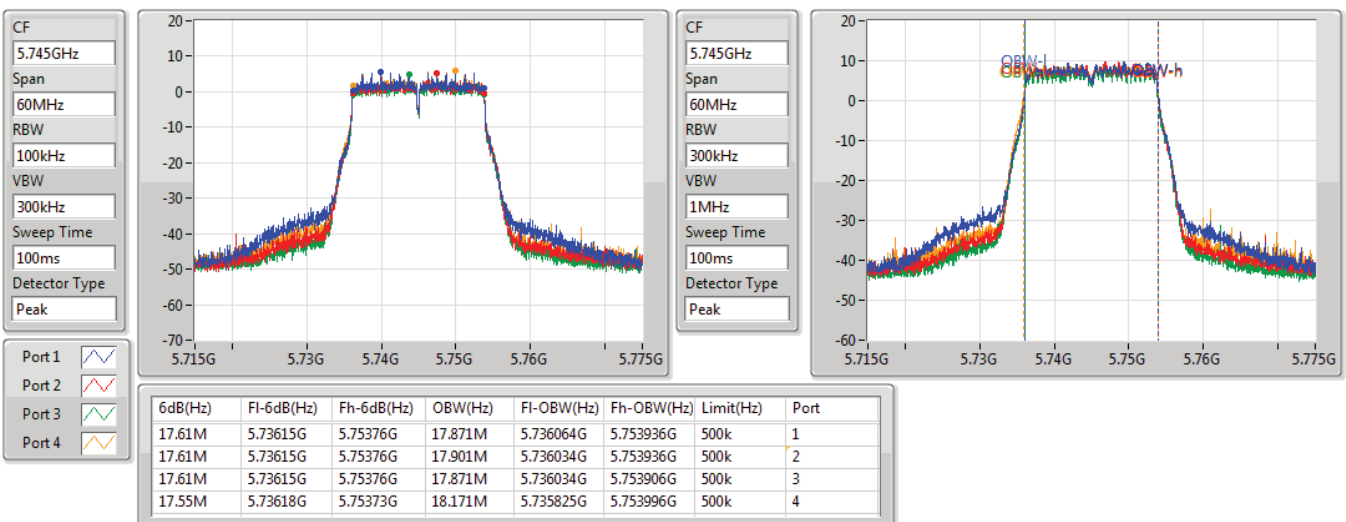

802.11n HT20_Nss1,(MCS0)_4TX

EBW

5785MHz

17/06/2022

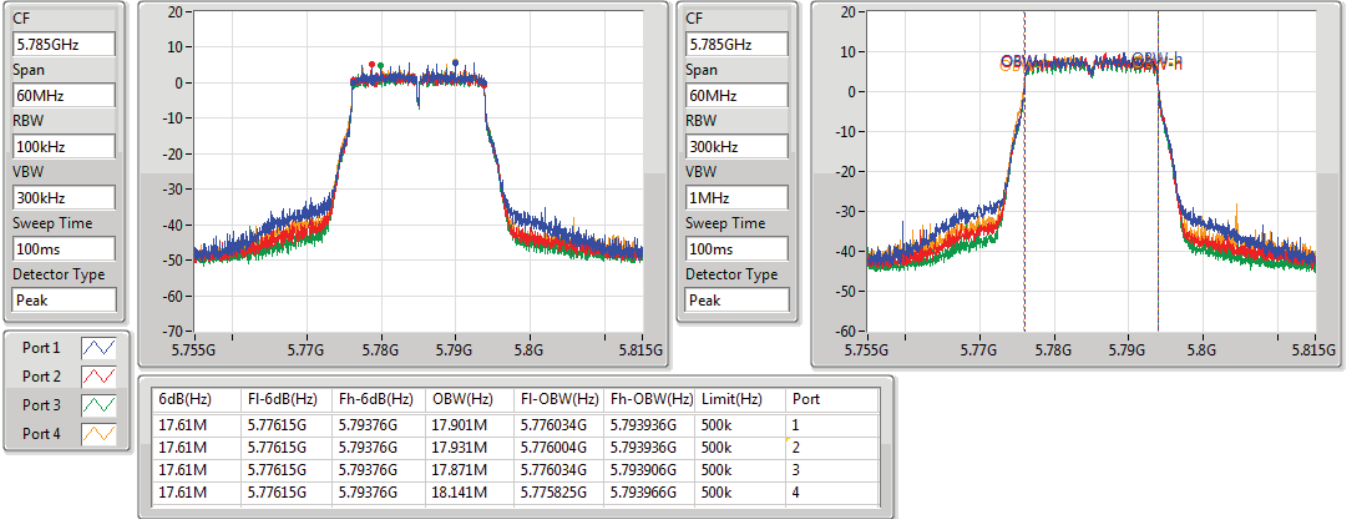

802.11n HT20_Nss1,(MCS0)_4TX

EBW

5825MHz

17/06/2022

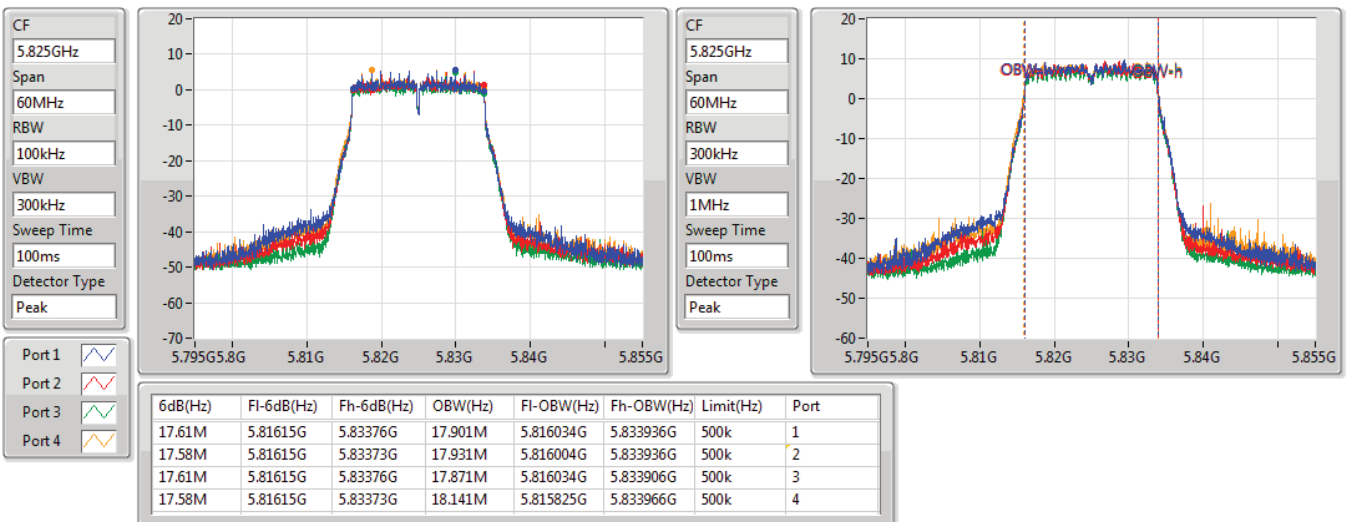

802.11n HT40_Nss1,(MCS0)_4TX

EBW

5190MHz

17/06/2022

CF
5.19GHz
Span
120MHz
RBW
500kHz
VBW
2MHz
Sweep Time
100ms
Detector Type
Peak

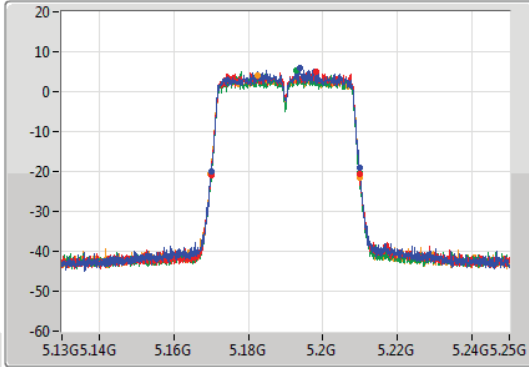

CF
5.19GHz
Span
120MHz
RBW
1MHz
VBW
3MHz
Sweep Time
100ms
Detector Type
Peak

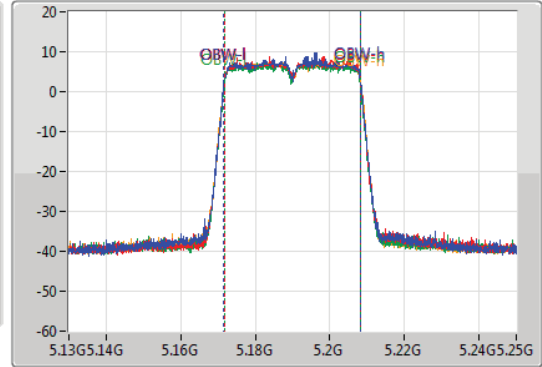

Port 1
Port 2
Port 3
Port 4

26dB(Hz)	Fl-26dB(Hz)	Fh-26dB(Hz)	OBW(Hz)	Fl-OBW(Hz)	Fh-OBW(Hz)	Limit(Hz)	Port
39.66M	5.17008G	5.20974G	36.642M	5.171589G	5.208231G	Inf	1
39.96M	5.16996G	5.20992G	36.582M	5.171649G	5.208231G	Inf	2
39.6M	5.17014G	5.20974G	36.522M	5.171709G	5.208231G	Inf	3
40.08M	5.1699G	5.20998G	36.702M	5.171589G	5.208291G	Inf	4

802.11n HT40_Nss1,(MCS0)_4TX

EBW

5230MHz

17/06/2022

CF
5.23GHz
Span
120MHz
RBW
500kHz
VBW
2MHz
Sweep Time
100ms
Detector Type
Peak

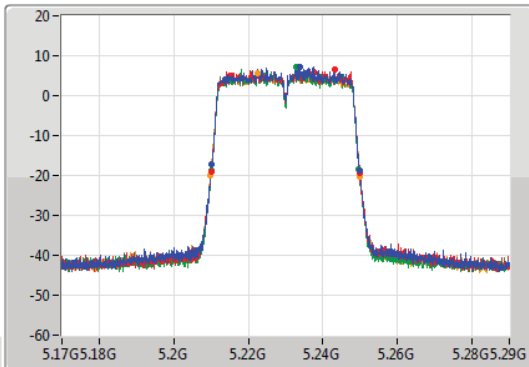

CF
5.23GHz
Span
120MHz
RBW
1MHz
VBW
3MHz
Sweep Time
100ms
Detector Type
Peak

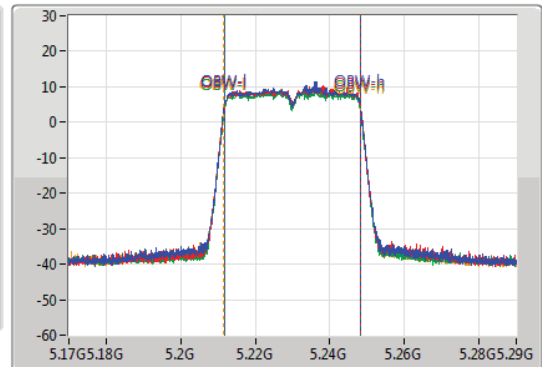

Port 1
Port 2
Port 3
Port 4

26dB(Hz)	Fl-26dB(Hz)	Fh-26dB(Hz)	OBW(Hz)	Fl-OBW(Hz)	Fh-OBW(Hz)	Limit(Hz)	Port
39.6M	5.2102G	5.2498G	36.582M	5.211649G	5.248231G	Inf	1
39.96M	5.20996G	5.24992G	36.642M	5.211649G	5.248291G	Inf	2
39.48M	5.21014G	5.24962G	36.522M	5.211709G	5.248231G	Inf	3
40.2M	5.20984G	5.25004G	36.702M	5.211589G	5.248291G	Inf	4

802.11n HT40_Nss1,(MCS0)_4TX

EBW

5270MHz

17/06/2022

CF
5.27GHz
Span
120MHz
RBW
500kHz
VBW
2MHz
Sweep Time
100ms
Detector Type
Peak

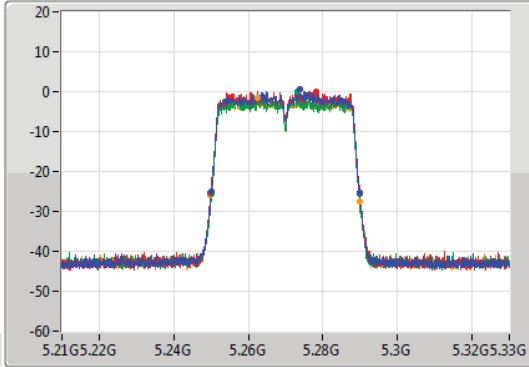

CF
5.27GHz
Span
120MHz
RBW
1MHz
VBW
3MHz
Sweep Time
100ms
Detector Type
Peak

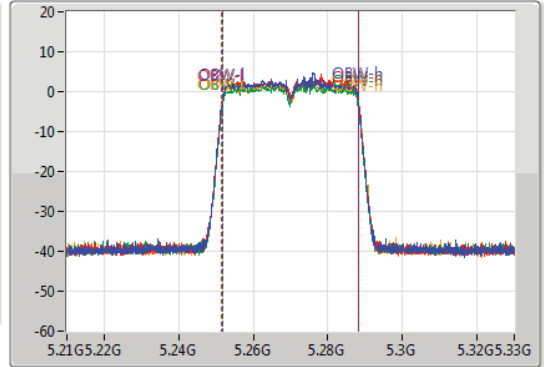

Port 1
Port 2
Port 3
Port 4

26dB(Hz)	Fl-26dB(Hz)	Fh-26dB(Hz)	OBW(Hz)	Fl-OBW(Hz)	Fh-OBW(Hz)	Limit(Hz)	Port
39.78M	5.25008G	5.28986G	36.582M	5.251649G	5.288231G	Inf	1
39.9M	5.2499G	5.2898G	36.642M	5.251589G	5.288231G	Inf	2
39.6M	5.25014G	5.28974G	36.522M	5.251649G	5.288171G	Inf	3
40.14M	5.2499G	5.29004G	36.762M	5.251589G	5.288351G	Inf	4

802.11n HT40_Nss1,(MCS0)_4TX

EBW

5310MHz

17/06/2022

CF
5.31GHz
Span
120MHz
RBW
500kHz
VBW
2MHz
Sweep Time
100ms
Detector Type
Peak

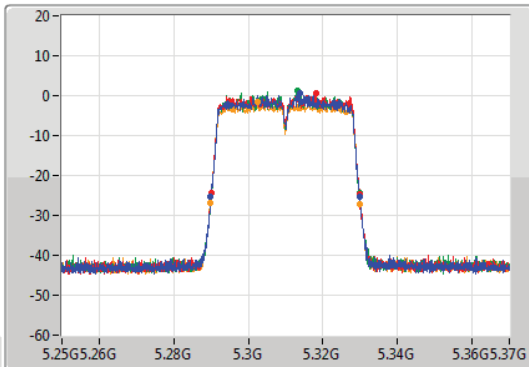

CF
5.31GHz
Span
120MHz
RBW
1MHz
VBW
3MHz
Sweep Time
100ms
Detector Type
Peak

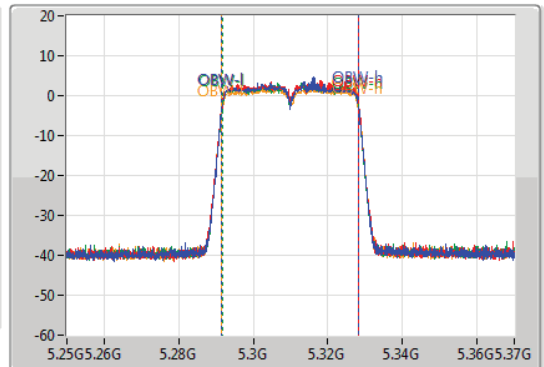

Port 1
Port 2
Port 3
Port 4

26dB(Hz)	Fl-26dB(Hz)	Fh-26dB(Hz)	OBW(Hz)	Fl-OBW(Hz)	Fh-OBW(Hz)	Limit(Hz)	Port
39.9M	5.2899G	5.3298G	36.642M	5.291589G	5.328231G	Inf	1
39.84M	5.29002G	5.32986G	36.702M	5.291589G	5.328291G	Inf	2
39.6M	5.29014G	5.32974G	36.522M	5.291709G	5.328231G	Inf	3
40.2M	5.28984G	5.33004G	36.762M	5.291589G	5.328351G	Inf	4

802.11n HT40_Nss1,(MCS0)_4TX

EBW

5510MHz

17/06/2022

CF
5.51GHz
Span
120MHz
RBW
500kHz
VBW
2MHz
Sweep Time
100ms
Detector Type
Peak

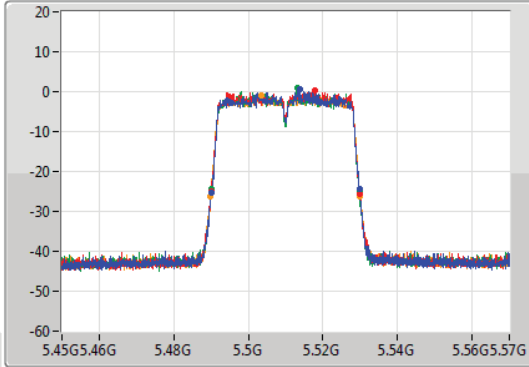

CF
5.51GHz
Span
120MHz
RBW
1MHz
VBW
3MHz
Sweep Time
100ms
Detector Type
Peak

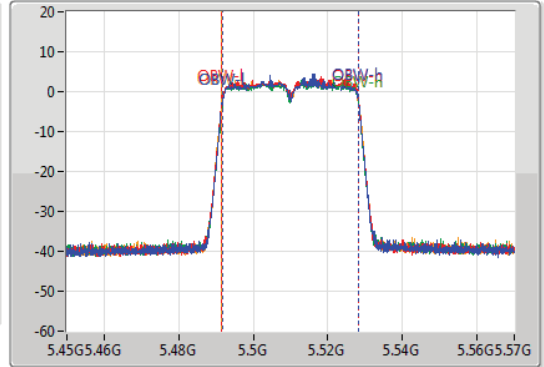

Port 1
Port 2
Port 3
Port 4

26dB(Hz)	Fl-26dB(Hz)	Fh-26dB(Hz)	OBW(Hz)	Fl-OBW(Hz)	Fh-OBW(Hz)	Limit(Hz)	Port
39.78M	5.49008G	5.52986G	36.582M	5.491649G	5.528231G	Inf	1
40.02M	5.49002G	5.53004G	36.642M	5.491589G	5.528231G	Inf	2
39.6M	5.49014G	5.52974G	36.522M	5.491709G	5.528231G	Inf	3
40.2M	5.48984G	5.53004G	36.762M	5.491589G	5.528351G	Inf	4

802.11n HT40_Nss1,(MCS0)_4TX

EBW

5550MHz

17/06/2022

CF
5.55GHz
Span
120MHz
RBW
500kHz
VBW
2MHz
Sweep Time
100ms
Detector Type
Peak

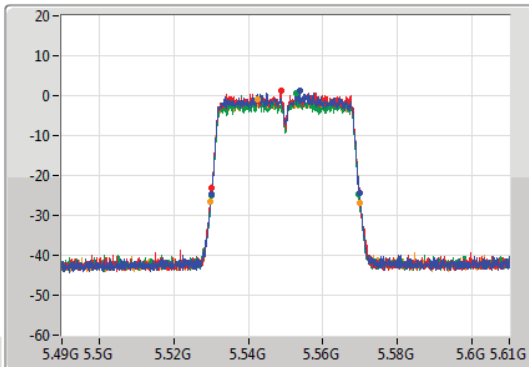

CF
5.55GHz
Span
120MHz
RBW
1MHz
VBW
3MHz
Sweep Time
100ms
Detector Type
Peak

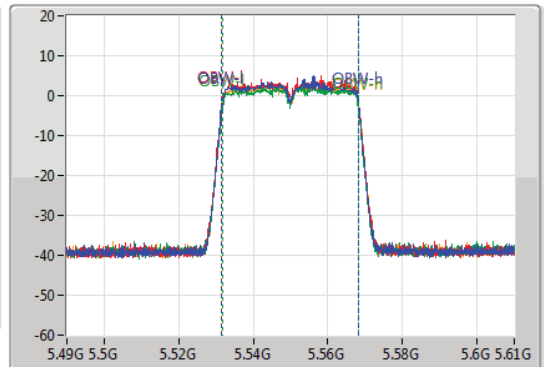

Port 1
Port 2
Port 3
Port 4

26dB(Hz)	Fl-26dB(Hz)	Fh-26dB(Hz)	OBW(Hz)	Fl-OBW(Hz)	Fh-OBW(Hz)	Limit(Hz)	Port
39.72M	5.53008G	5.5698G	36.702M	5.531589G	5.568291G	Inf	1
39.72M	5.53014G	5.56986G	36.702M	5.531589G	5.568291G	Inf	2
39.48M	5.53014G	5.56962G	36.582M	5.531649G	5.568231G	Inf	3
40.26M	5.52978G	5.57004G	36.702M	5.531649G	5.568351G	Inf	4

802.11n HT40_Nss1,(MCS0)_4TX

EBW

5670MHz

17/06/2022

CF
5.67GHz
Span
120MHz
RBW
500kHz
VBW
2MHz
Sweep Time
100ms
Detector Type
Peak

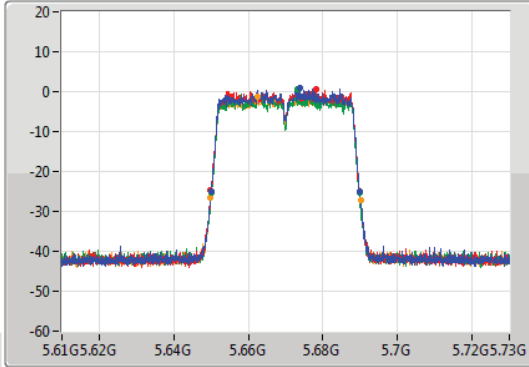

CF
5.67GHz
Span
120MHz
RBW
1MHz
VBW
3MHz
Sweep Time
100ms
Detector Type
Peak

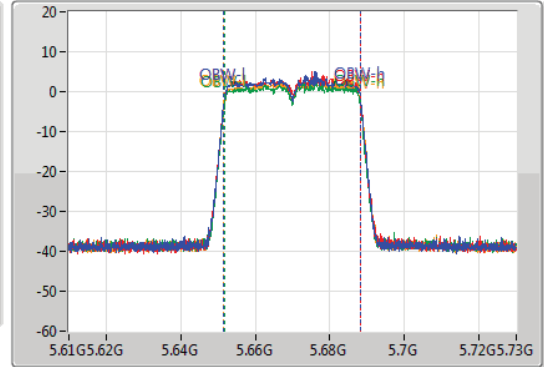

Port 1
Port 2
Port 3
Port 4

26dB(Hz)	Fl-26dB(Hz)	Fh-26dB(Hz)	OBW(Hz)	Fl-OBW(Hz)	Fh-OBW(Hz)	Limit(Hz)	Port
39.78M	5.65008G	5.68986G	36.642M	5.651589G	5.688231G	Inf	1
40.02M	5.64984G	5.68986G	36.642M	5.651589G	5.688231G	Inf	2
39.6M	5.65014G	5.68974G	36.582M	5.651649G	5.688231G	Inf	3
40.32M	5.64984G	5.69016G	36.762M	5.651589G	5.688351G	Inf	4

802.11n HT40_Nss1,(MCS0)_4TX

EBW

5710MHz Straddle 5.47-5.725GHz

17/06/2022

CF
5.69GHz
Span
70MHz
RBW
500kHz
VBW
2MHz
Sweep Time
100ms
Detector Type
Peak

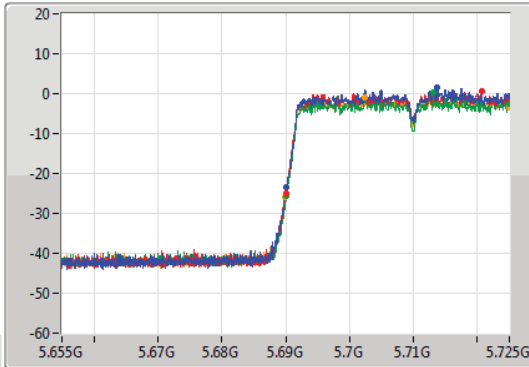

CF
5.69GHz
Span
70MHz
RBW
1MHz
VBW
3MHz
Sweep Time
100ms
Detector Type
Peak

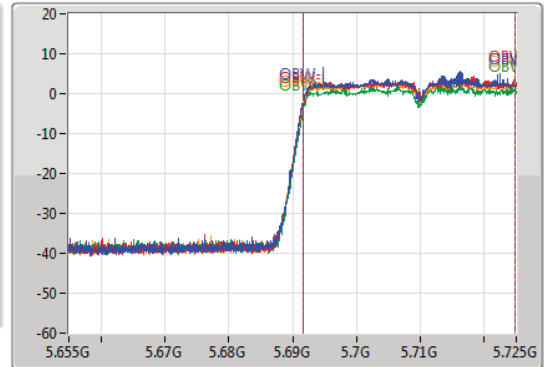

Port 1
Port 2
Port 3
Port 4

26dB(Hz)	Fl-26dB(Hz)	Fh-26dB(Hz)	OBW(Hz)	Fl-OBW(Hz)	Fh-OBW(Hz)	Limit(Hz)	Port
34.825M	5.690175G	5.725G	33.268M	5.691574G	5.724843G	Inf	1
34.965M	5.690035G	5.725G	33.268M	5.691574G	5.724843G	Inf	2
34.86M	5.69014G	5.725G	33.198M	5.691644G	5.724843G	Inf	3
35.14M	5.68986G	5.725G	33.268M	5.691574G	5.724843G	Inf	4

802.11n HT40_Nss1,(MCS0)_4TX

EBW

5710MHz Straddle 5.725-5.85GHz

17/06/2022

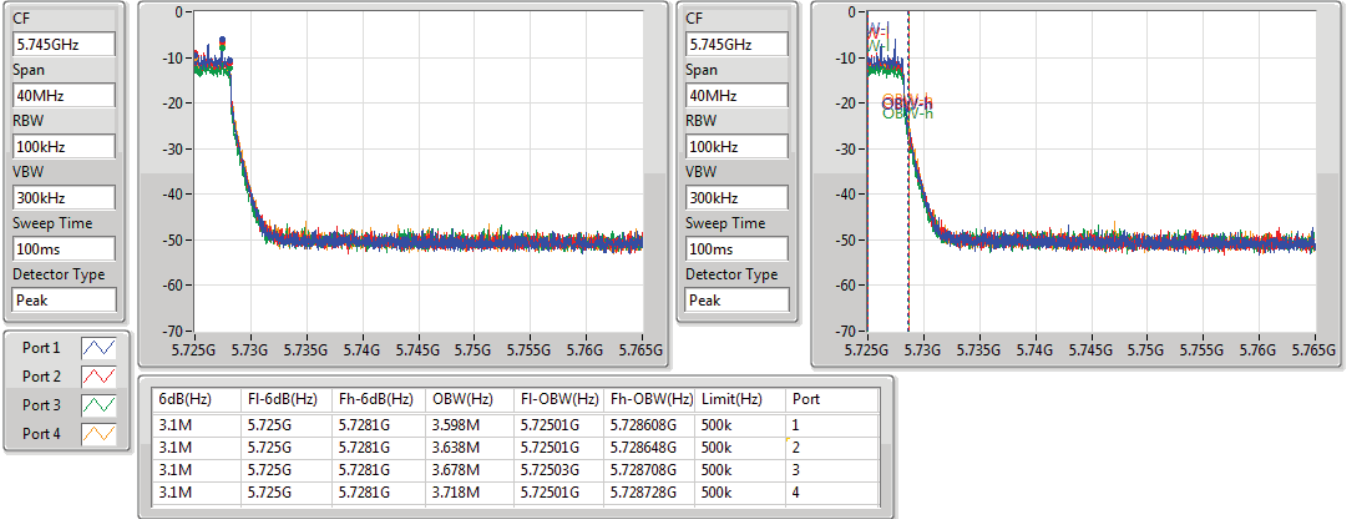

802.11n HT40_Nss1,(MCS0)_4TX

EBW

5755MHz

17/06/2022

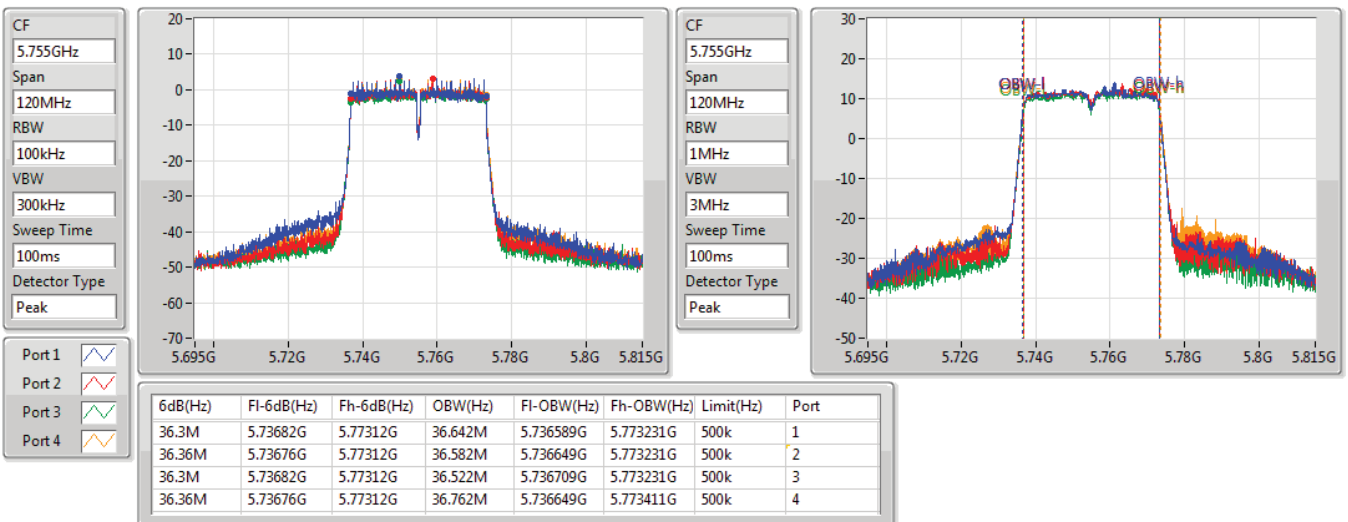



802.11n HT40_Nss1,(MCS0)_4TX

EBW

5795MHz

17/06/2022

CF
5.795GHz
Span
120MHz
RBW
100kHz
VBW
300kHz
Sweep Time
100ms
Detector Type
Peak

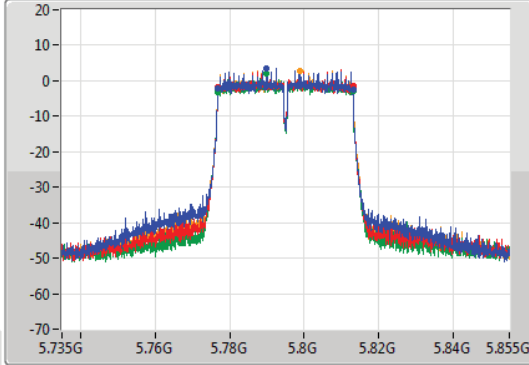

CF
5.795GHz
Span
120MHz
RBW
1MHz
VBW
3MHz
Sweep Time
100ms
Detector Type
Peak

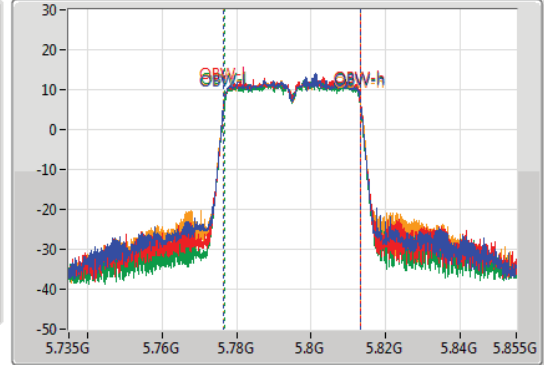

6dB(Hz)	Fl-6dB(Hz)	Fh-6dB(Hz)	OBW(Hz)	Fl-OBW(Hz)	Fh-OBW(Hz)	Limit(Hz)	Port
36.36M	5.77676G	5.81312G	36.642M	5.776589G	5.813231G	500k	1
36.3M	5.77682G	5.81312G	36.702M	5.776589G	5.813291G	500k	2
36.36M	5.77676G	5.81312G	36.522M	5.776709G	5.813231G	500k	3
36.36M	5.77676G	5.81312G	36.762M	5.776589G	5.813351G	500k	4

802.11ac VHT20_Nss1,(MCS0)_4TX

EBW

5180MHz

17/06/2022

CF
5.18GHz
Span
60MHz
RBW
300kHz
VBW
1MHz
Sweep Time
100ms
Detector Type
Peak

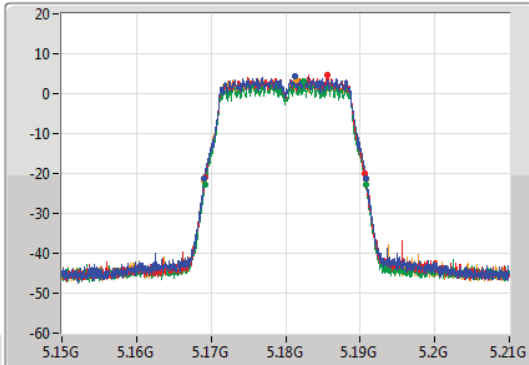

CF
5.18GHz
Span
60MHz
RBW
300kHz
VBW
1MHz
Sweep Time
100ms
Detector Type
Peak

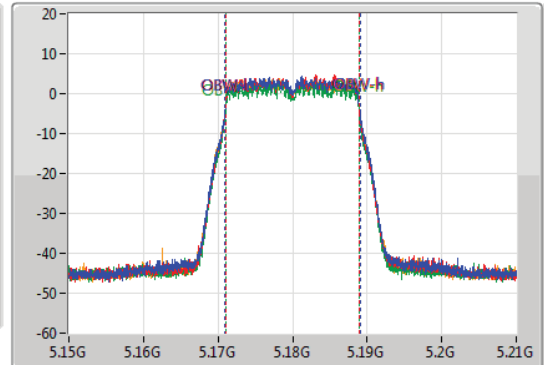

26dB(Hz)	Fl-26dB(Hz)	Fh-26dB(Hz)	OBW(Hz)	Fl-OBW(Hz)	Fh-OBW(Hz)	Limit(Hz)	Port
21.75M	5.16908G	5.19083G	18.051M	5.170975G	5.189025G	Inf	1
21.36M	5.16923G	5.19059G	17.901M	5.171004G	5.188906G	Inf	2
21.66M	5.16914G	5.1908G	17.901M	5.171004G	5.188906G	Inf	3
21.66M	5.16911G	5.19077G	18.051M	5.170945G	5.188996G	Inf	4

802.11ac VHT20_Nss1,(MCS0)_4TX

EBW

5200MHz

17/06/2022

CF
5.2GHz
Span
60MHz
RBW
300kHz
VBW
1MHz
Sweep Time
100ms
Detector Type
Peak

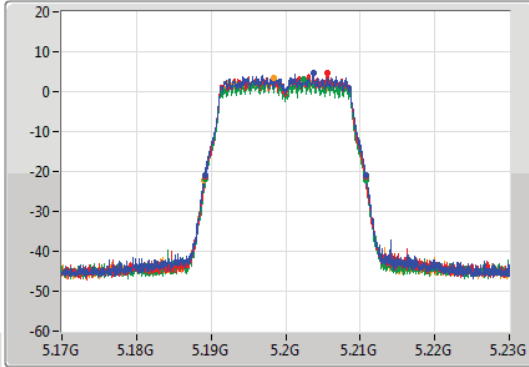

CF
5.2GHz
Span
60MHz
RBW
300kHz
VBW
1MHz
Sweep Time
100ms
Detector Type
Peak

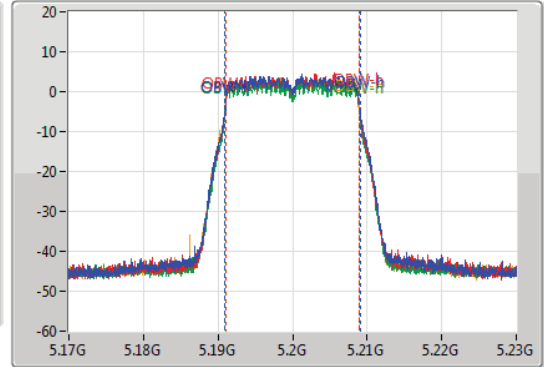

Port 1
Port 2
Port 3
Port 4

26dB(Hz)	Fl-26dB(Hz)	Fh-26dB(Hz)	OBW(Hz)	Fl-OBW(Hz)	Fh-OBW(Hz)	Limit(Hz)	Port
21.63M	5.18917G	5.2108G	18.051M	5.190975G	5.209025G	Inf	1
21.6M	5.1892G	5.2108G	17.901M	5.191004G	5.208906G	Inf	2
21.54M	5.18923G	5.21077G	17.931M	5.190975G	5.208906G	Inf	3
21.81M	5.18905G	5.21086G	18.081M	5.190915G	5.208996G	Inf	4

802.11ac VHT20_Nss1,(MCS0)_4TX

EBW

5240MHz

17/06/2022

CF
5.24GHz
Span
60MHz
RBW
300kHz
VBW
1MHz
Sweep Time
100ms
Detector Type
Peak

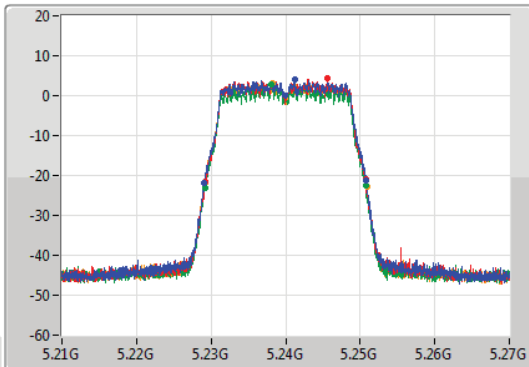

CF
5.24GHz
Span
60MHz
RBW
300kHz
VBW
1MHz
Sweep Time
100ms
Detector Type
Peak

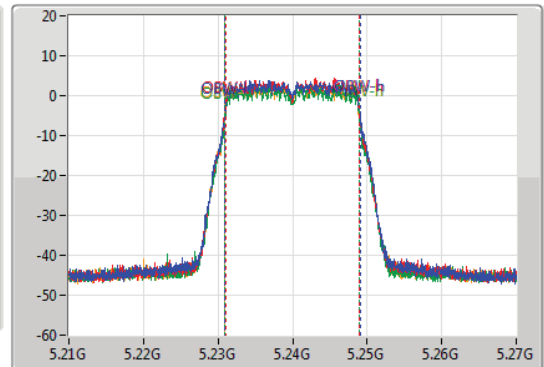

Port 1
Port 2
Port 3
Port 4

26dB(Hz)	Fl-26dB(Hz)	Fh-26dB(Hz)	OBW(Hz)	Fl-OBW(Hz)	Fh-OBW(Hz)	Limit(Hz)	Port
21.69M	5.22911G	5.2508G	18.051M	5.230975G	5.249025G	Inf	1
21.54M	5.22926G	5.2508G	17.901M	5.231004G	5.248906G	Inf	2
21.54M	5.22923G	5.25077G	17.931M	5.230975G	5.248906G	Inf	3
21.75M	5.22914G	5.25089G	18.081M	5.230915G	5.248996G	Inf	4

802.11ac VHT20_Nss1,(MCS0)_4TX

EBW

5260MHz

17/06/2022

CF
5.26GHz
Span
60MHz
RBW
300kHz
VBW
1MHz
Sweep Time
100ms
Detector Type
Peak

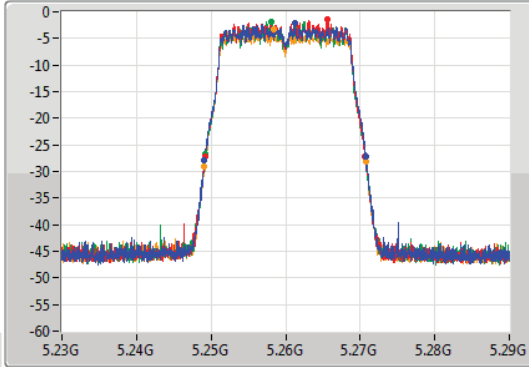

CF
5.26GHz
Span
60MHz
RBW
300kHz
VBW
1MHz
Sweep Time
100ms
Detector Type
Peak

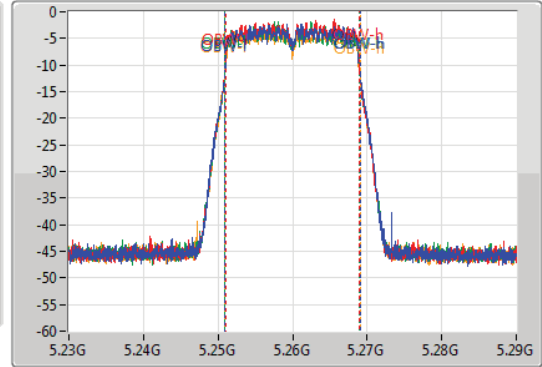

Port 1
Port 2
Port 3
Port 4

26dB(Hz)	Fl-26dB(Hz)	Fh-26dB(Hz)	OBW(Hz)	Fl-OBW(Hz)	Fh-OBW(Hz)	Limit(Hz)	Port
21.72M	5.24908G	5.2708G	18.051M	5.250975G	5.269025G	Inf	1
21.45M	5.2492G	5.27065G	17.901M	5.251004G	5.268906G	Inf	2
21.63M	5.24914G	5.27077G	17.961M	5.250975G	5.268936G	Inf	3
21.78M	5.24902G	5.2708G	18.081M	5.250945G	5.269025G	Inf	4

802.11ac VHT20_Nss1,(MCS0)_4TX

EBW

5300MHz

17/06/2022

CF
5.3GHz
Span
60MHz
RBW
300kHz
VBW
1MHz
Sweep Time
100ms
Detector Type
Peak

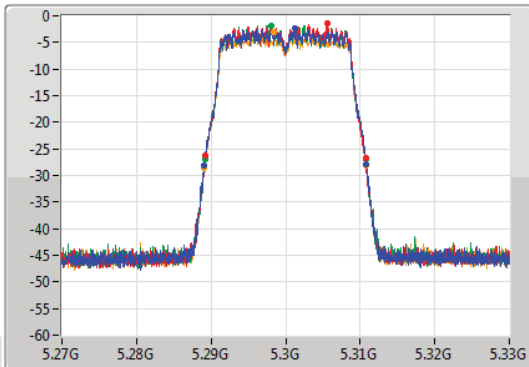

CF
5.3GHz
Span
60MHz
RBW
300kHz
VBW
1MHz
Sweep Time
100ms
Detector Type
Peak

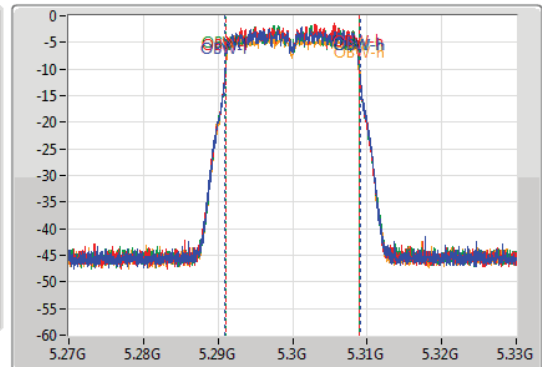

Port 1
Port 2
Port 3
Port 4

26dB(Hz)	Fl-26dB(Hz)	Fh-26dB(Hz)	OBW(Hz)	Fl-OBW(Hz)	Fh-OBW(Hz)	Limit(Hz)	Port
21.78M	5.28908G	5.31086G	18.051M	5.290975G	5.309025G	Inf	1
21.48M	5.28923G	5.31071G	17.901M	5.291004G	5.308906G	Inf	2
21.54M	5.2892G	5.31074G	17.931M	5.291004G	5.308936G	Inf	3
21.78M	5.28905G	5.31083G	18.081M	5.290945G	5.309025G	Inf	4

802.11ac VHT20_Nss1,(MCS0)_4TX

EBW

5320MHz

17/06/2022

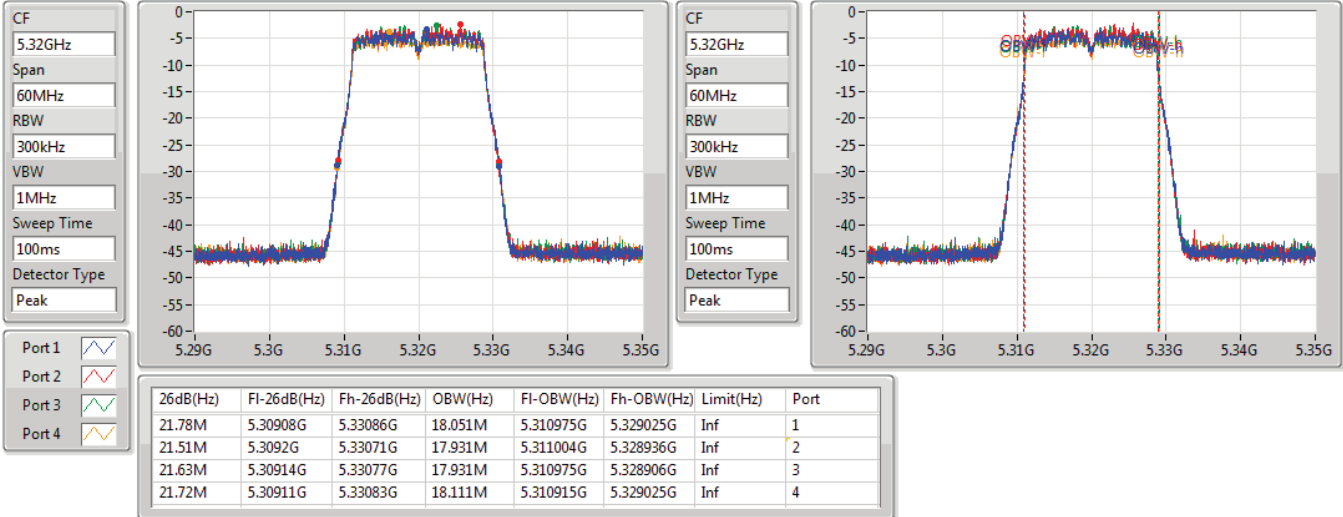

802.11ac VHT20_Nss1,(MCS0)_4TX

EBW

5500MHz

17/06/2022

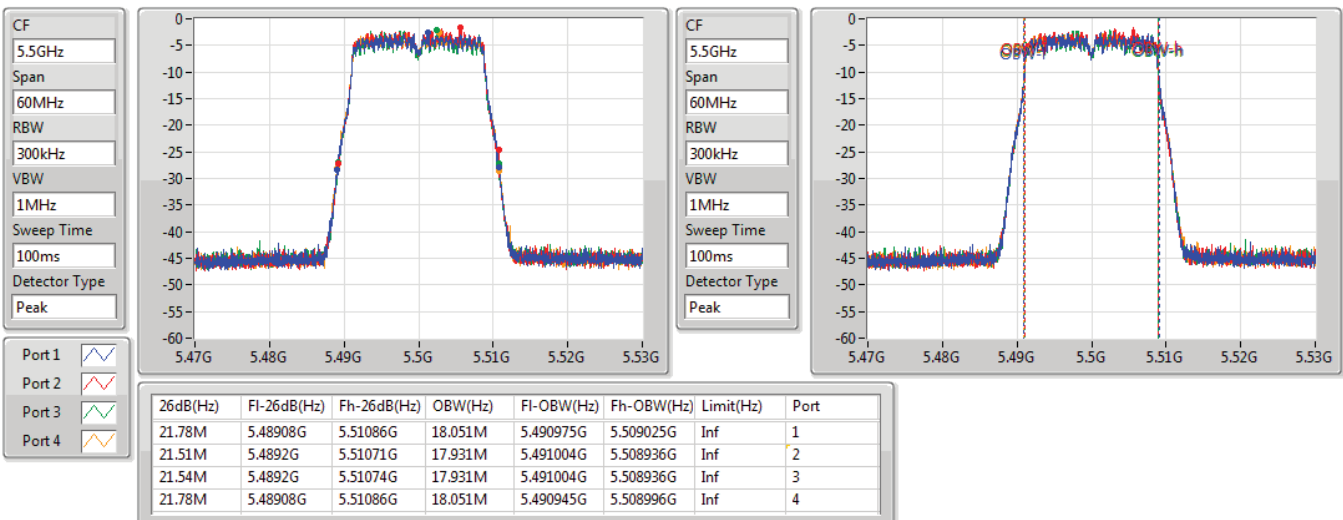

802.11ac VHT20_Nss1,(MCS0)_4TX

EBW

5580MHz

17/06/2022

CF
5.58GHz
Span
60MHz
RBW
300kHz
VBW
1MHz
Sweep Time
100ms
Detector Type
Peak

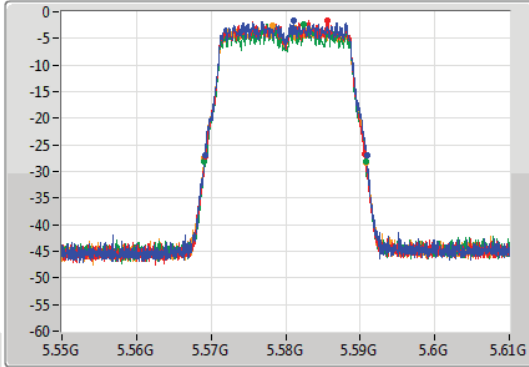

CF
5.58GHz
Span
60MHz
RBW
300kHz
VBW
1MHz
Sweep Time
100ms
Detector Type
Peak

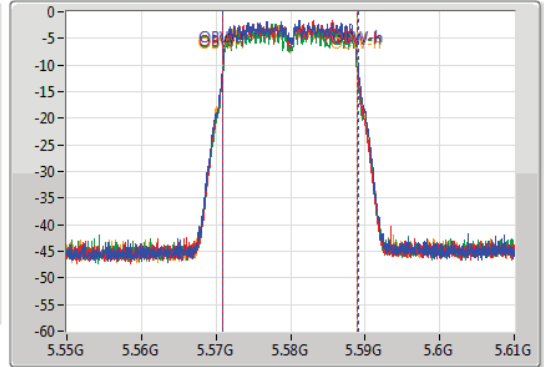

Port 1
Port 2
Port 3
Port 4

26dB(Hz)	Fl-26dB(Hz)	Fh-26dB(Hz)	OBW(Hz)	Fl-OBW(Hz)	Fh-OBW(Hz)	Limit(Hz)	Port
21.72M	5.56917G	5.59089G	18.051M	5.570975G	5.589025G	Inf	1
21.48M	5.5692G	5.59068G	17.931M	5.570975G	5.588906G	Inf	2
21.63M	5.56911G	5.59074G	17.931M	5.570975G	5.588906G	Inf	3
21.87M	5.56899G	5.59086G	18.051M	5.570945G	5.588996G	Inf	4

802.11ac VHT20_Nss1,(MCS0)_4TX

EBW

5700MHz

17/06/2022

CF
5.7GHz
Span
60MHz
RBW
300kHz
VBW
1MHz
Sweep Time
100ms
Detector Type
Peak

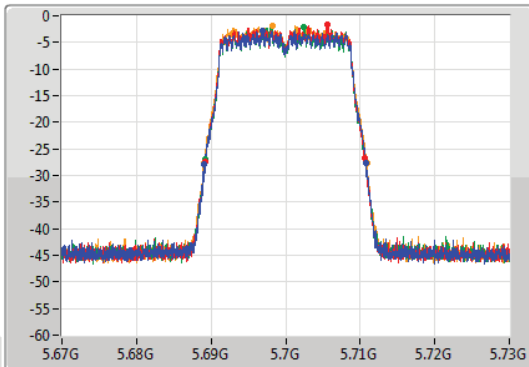

CF
5.7GHz
Span
60MHz
RBW
300kHz
VBW
1MHz
Sweep Time
100ms
Detector Type
Peak

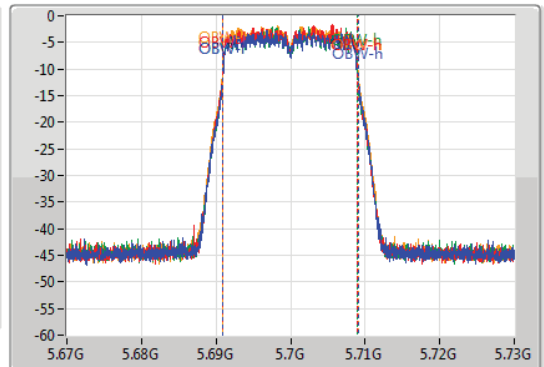

Port 1
Port 2
Port 3
Port 4

26dB(Hz)	Fl-26dB(Hz)	Fh-26dB(Hz)	OBW(Hz)	Fl-OBW(Hz)	Fh-OBW(Hz)	Limit(Hz)	Port
21.72M	5.68908G	5.7108G	18.051M	5.690975G	5.709025G	Inf	1
21.51M	5.68917G	5.71068G	17.931M	5.690975G	5.708906G	Inf	2
21.57M	5.68923G	5.7108G	17.931M	5.690975G	5.708906G	Inf	3
21.81M	5.68908G	5.71089G	18.081M	5.690945G	5.709025G	Inf	4

802.11ac VHT20_Nss1,(MCS0)_4TX

EBW

5720MHz Straddle 5.47-5.725GHz

17/06/2022

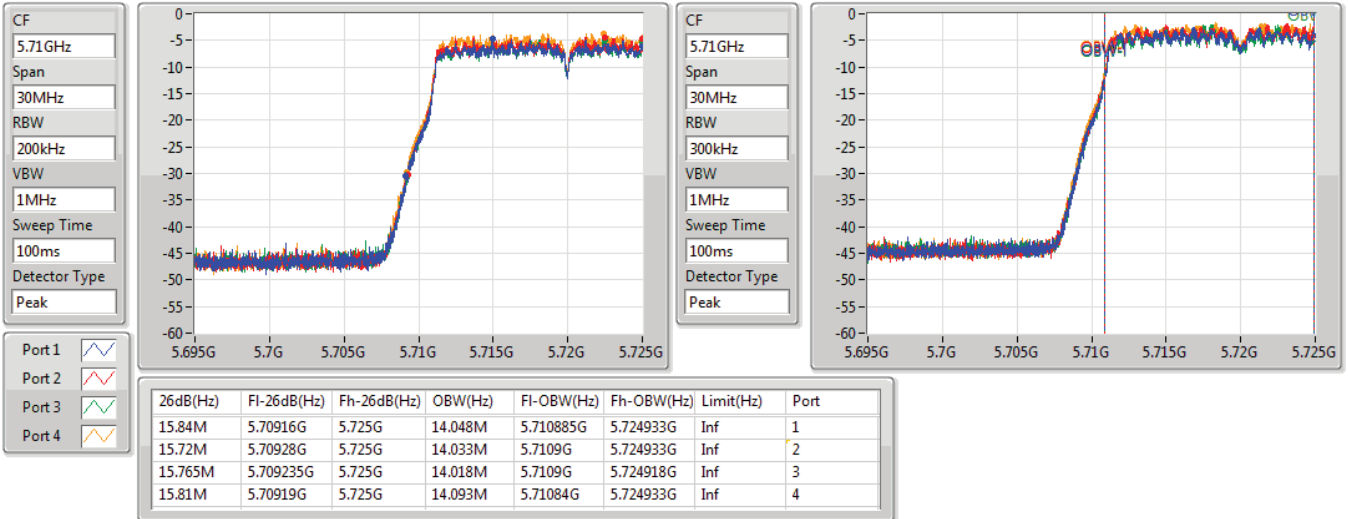

802.11ac VHT20_Nss1,(MCS0)_4TX

EBW

5720MHz Straddle 5.725-5.85GHz

17/06/2022

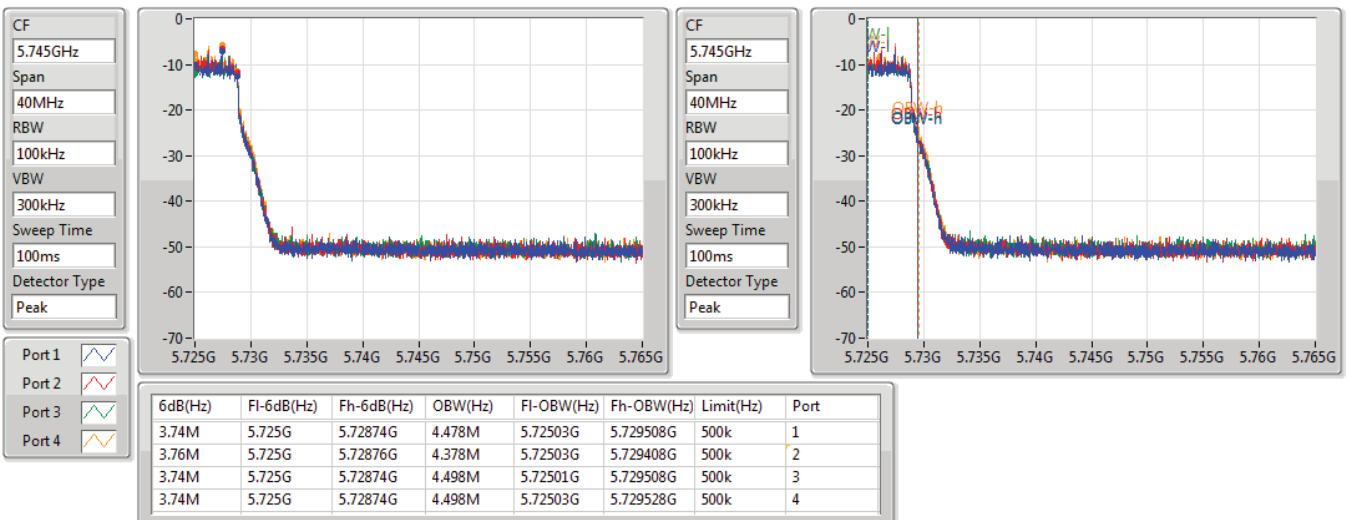

802.11ac VHT20_Nss1,(MCS0)_4TX

EBW

5745MHz

17/06/2022

CF
5.745GHz
Span
60MHz
RBW
100kHz
VBW
300kHz
Sweep Time
100ms
Detector Type
Peak

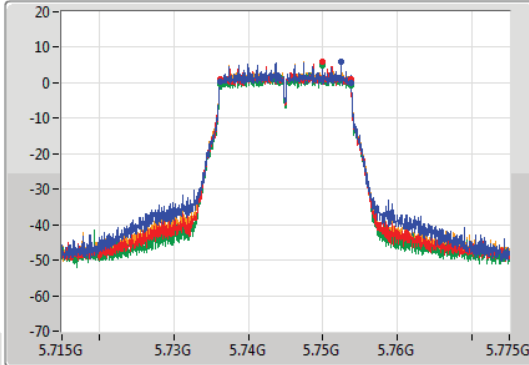

CF
5.745GHz
Span
60MHz
RBW
300kHz
VBW
1MHz
Sweep Time
100ms
Detector Type
Peak

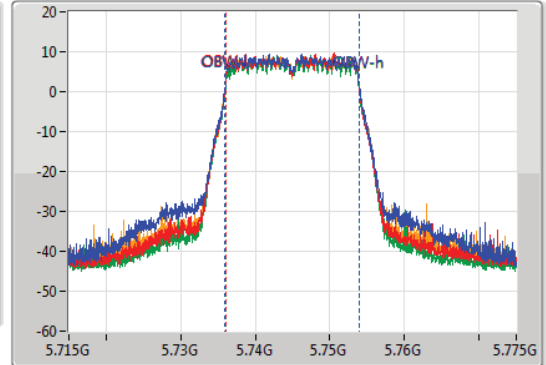

Port 1
Port 2
Port 3
Port 4

6dB(Hz)	Fl-6dB(Hz)	Fh-6dB(Hz)	OBW(Hz)	Fl-OBW(Hz)	Fh-OBW(Hz)	Limit(Hz)	Port
17.61M	5.73615G	5.75376G	18.021M	5.735975G	5.753996G	500k	1
17.58M	5.73615G	5.75373G	17.901M	5.736004G	5.753906G	500k	2
17.61M	5.73615G	5.75376G	17.901M	5.736004G	5.753906G	500k	3
17.58M	5.73615G	5.75373G	18.081M	5.735915G	5.753996G	500k	4

802.11ac VHT20_Nss1,(MCS0)_4TX

EBW

5785MHz

17/06/2022

CF
5.785GHz
Span
60MHz
RBW
100kHz
VBW
300kHz
Sweep Time
100ms
Detector Type
Peak

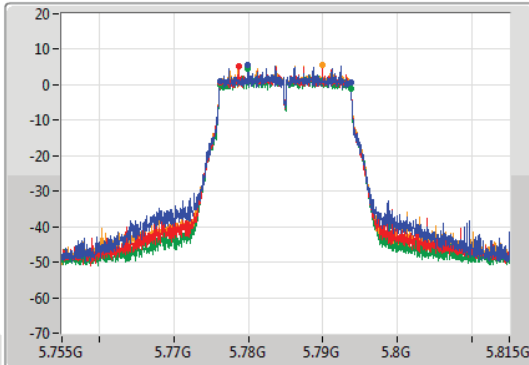

CF
5.785GHz
Span
60MHz
RBW
300kHz
VBW
1MHz
Sweep Time
100ms
Detector Type
Peak

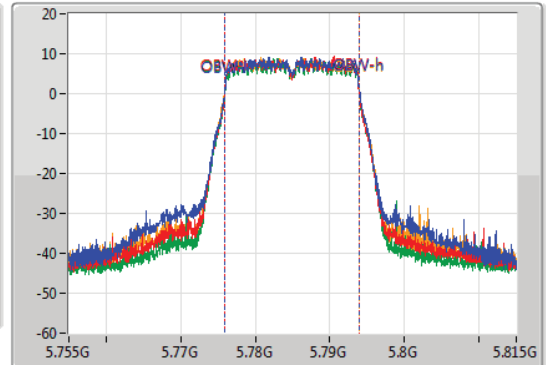

Port 1
Port 2
Port 3
Port 4

6dB(Hz)	Fl-6dB(Hz)	Fh-6dB(Hz)	OBW(Hz)	Fl-OBW(Hz)	Fh-OBW(Hz)	Limit(Hz)	Port
17.58M	5.77615G	5.79373G	18.051M	5.775945G	5.793996G	500k	1
17.58M	5.77615G	5.79373G	17.901M	5.775975G	5.793876G	500k	2
17.61M	5.77615G	5.79376G	17.931M	5.775975G	5.793906G	500k	3
17.58M	5.77615G	5.79373G	18.111M	5.775885G	5.793996G	500k	4

802.11ac VHT20_Nss1,(MCS0)_4TX

EBW

5825MHz

17/06/2022

CF
5.825GHz
Span
60MHz
RBW
100kHz
VBW
300kHz
Sweep Time
100ms
Detector Type
Peak

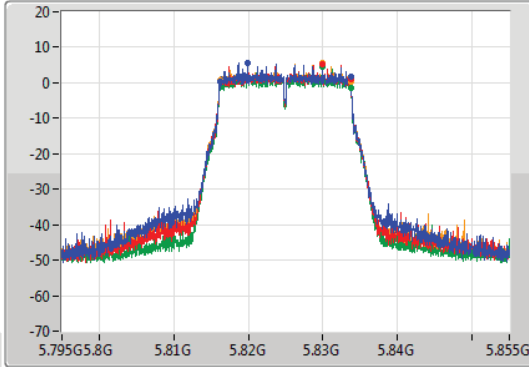

CF
5.825GHz
Span
60MHz
RBW
300kHz
VBW
1MHz
Sweep Time
100ms
Detector Type
Peak

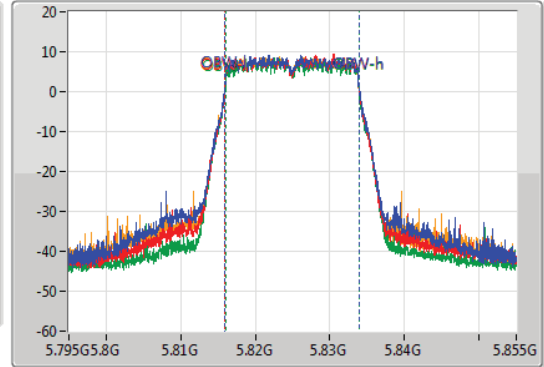

Port 1
Port 2
Port 3
Port 4

6dB(Hz)	Fl-6dB(Hz)	Fh-6dB(Hz)	OBW(Hz)	Fl-OBW(Hz)	Fh-OBW(Hz)	Limit(Hz)	Port
17.55M	5.81615G	5.8337G	18.051M	5.815945G	5.833996G	500k	1
17.58M	5.81615G	5.83373G	17.931M	5.815975G	5.833906G	500k	2
17.61M	5.81615G	5.83376G	17.901M	5.816004G	5.833906G	500k	3
17.58M	5.81615G	5.83373G	18.081M	5.815915G	5.833996G	500k	4

802.11ac VHT40_Nss1,(MCS0)_4TX

EBW

5190MHz

17/06/2022

CF
5.19GHz
Span
120MHz
RBW
500kHz
VBW
2MHz
Sweep Time
100ms
Detector Type
Peak

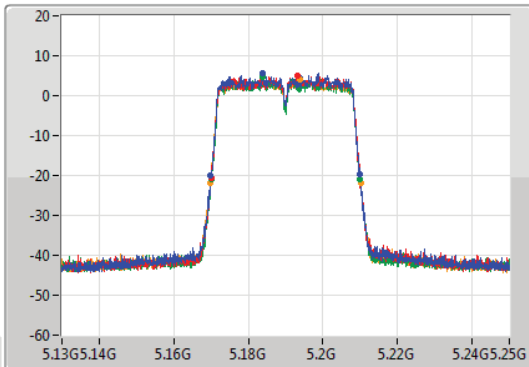

CF
5.19GHz
Span
120MHz
RBW
1MHz
VBW
3MHz
Sweep Time
100ms
Detector Type
Peak

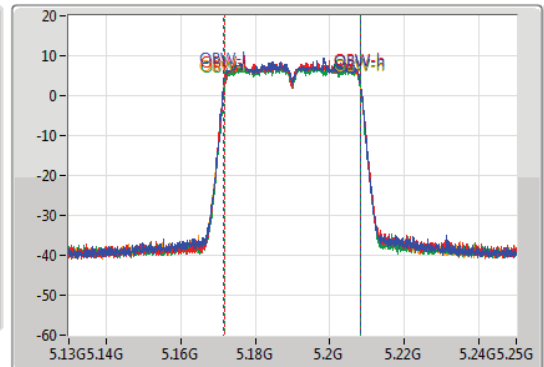

Port 1
Port 2
Port 3
Port 4

26dB(Hz)	Fl-26dB(Hz)	Fh-26dB(Hz)	OBW(Hz)	Fl-OBW(Hz)	Fh-OBW(Hz)	Limit(Hz)	Port
40.02M	5.1699G	5.20992G	36.762M	5.171529G	5.208291G	Inf	1
40.02M	5.16996G	5.20998G	36.702M	5.171649G	5.208351G	Inf	2
39.9M	5.17008G	5.20998G	36.582M	5.171709G	5.208291G	Inf	3
40.38M	5.16978G	5.21016G	36.702M	5.171589G	5.208291G	Inf	4

802.11ac VHT40_Nss1,(MCS0)_4TX

EBW

5230MHz

17/06/2022

CF
5.23GHz
Span
120MHz
RBW
500kHz
VBW
2MHz
Sweep Time
100ms
Detector Type
Peak

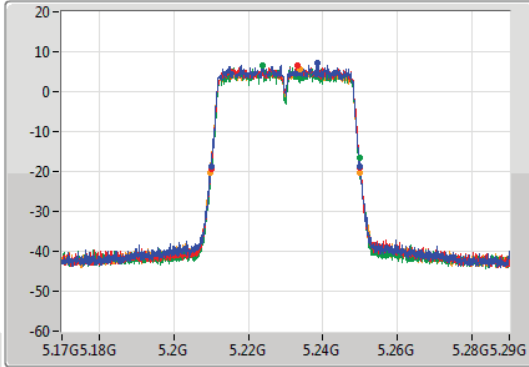

CF
5.23GHz
Span
120MHz
RBW
1MHz
VBW
3MHz
Sweep Time
100ms
Detector Type
Peak

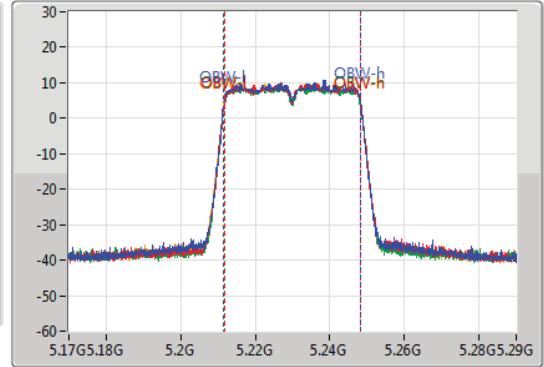

Port 1
Port 2
Port 3
Port 4

26dB(Hz)	Fl-26dB(Hz)	Fh-26dB(Hz)	OBW(Hz)	Fl-OBW(Hz)	Fh-OBW(Hz)	Limit(Hz)	Port
39.9M	5.21008G	5.24998G	36.762M	5.211529G	5.248291G	Inf	1
40.08M	5.20996G	5.25004G	36.702M	5.211649G	5.248351G	Inf	2
39.66M	5.21008G	5.24974G	36.582M	5.211709G	5.248291G	Inf	3
40.26M	5.20978G	5.25004G	36.702M	5.211589G	5.248291G	Inf	4

802.11ac VHT40_Nss1,(MCS0)_4TX

EBW

5270MHz

17/06/2022

CF
5.27GHz
Span
120MHz
RBW
500kHz
VBW
2MHz
Sweep Time
100ms
Detector Type
Peak

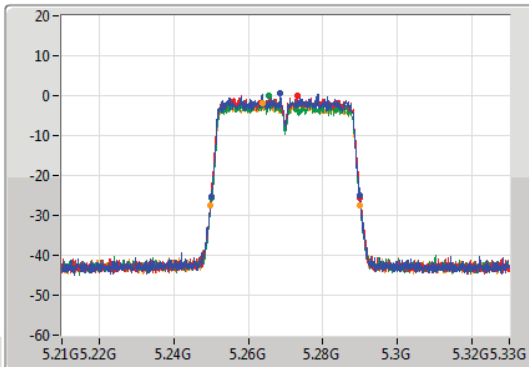

CF
5.27GHz
Span
120MHz
RBW
1MHz
VBW
3MHz
Sweep Time
100ms
Detector Type
Peak

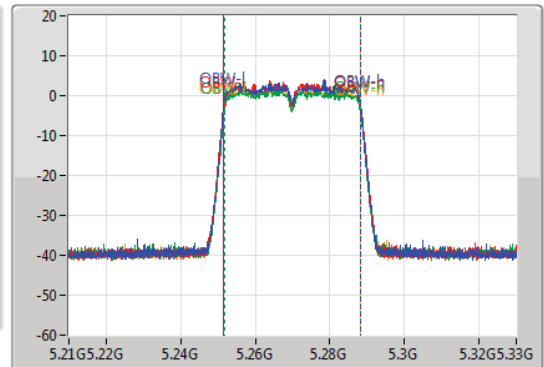

Port 1
Port 2
Port 3
Port 4

26dB(Hz)	Fl-26dB(Hz)	Fh-26dB(Hz)	OBW(Hz)	Fl-OBW(Hz)	Fh-OBW(Hz)	Limit(Hz)	Port
39.96M	5.25002G	5.28998G	36.762M	5.251589G	5.288351G	Inf	1
40.08M	5.24996G	5.29004G	36.762M	5.251589G	5.288351G	Inf	2
39.72M	5.25014G	5.28986G	36.642M	5.251649G	5.288291G	Inf	3
40.32M	5.24972G	5.29004G	36.702M	5.251589G	5.288291G	Inf	4

802.11ac VHT40_Nss1,(MCS0)_4TX

EBW

5310MHz

17/06/2022

CF
5.31GHz
Span
120MHz
RBW
500kHz
VBW
2MHz
Sweep Time
100ms
Detector Type
Peak

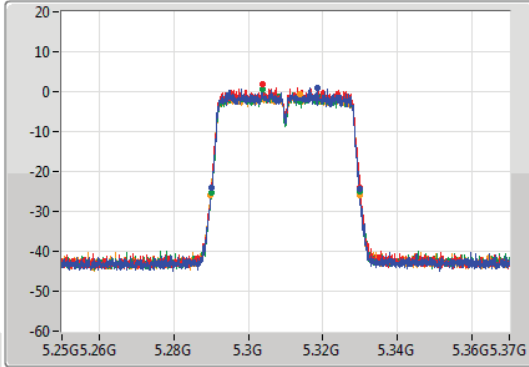

CF
5.31GHz
Span
120MHz
RBW
1MHz
VBW
3MHz
Sweep Time
100ms
Detector Type
Peak

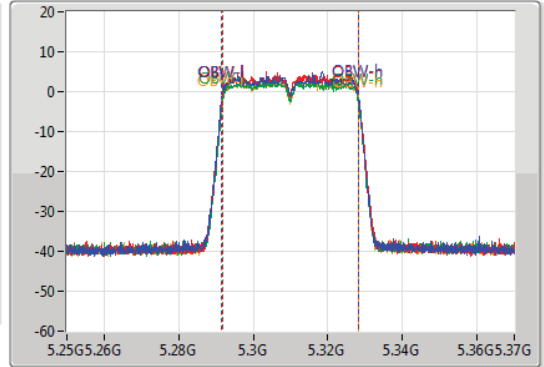

Port 1
Port 2
Port 3
Port 4

26dB(Hz)	Fl-26dB(Hz)	Fh-26dB(Hz)	OBW(Hz)	Fl-OBW(Hz)	Fh-OBW(Hz)	Limit(Hz)	Port
39.84M	5.29014G	5.32998G	36.762M	5.291529G	5.328291G	Inf	1
40.02M	5.28996G	5.32998G	36.702M	5.291649G	5.328351G	Inf	2
39.9M	5.29002G	5.32992G	36.582M	5.291709G	5.328291G	Inf	3
40.2M	5.28984G	5.33004G	36.702M	5.291589G	5.328291G	Inf	4

802.11ac VHT40_Nss1,(MCS0)_4TX

EBW

5510MHz

17/06/2022

CF
5.51GHz
Span
120MHz
RBW
500kHz
VBW
2MHz
Sweep Time
100ms
Detector Type
Peak

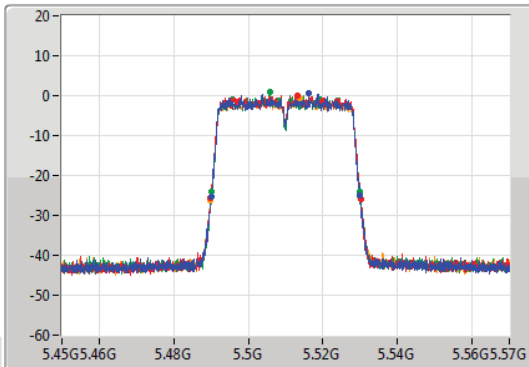

CF
5.51GHz
Span
120MHz
RBW
1MHz
VBW
3MHz
Sweep Time
100ms
Detector Type
Peak

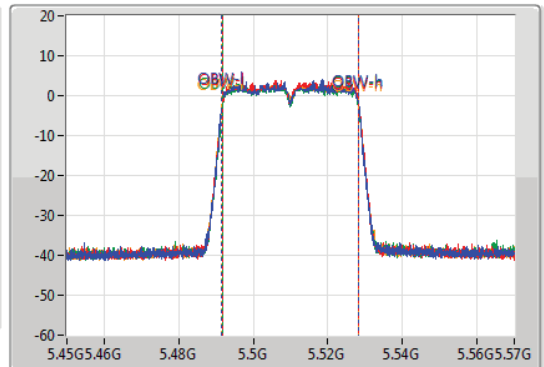

Port 1
Port 2
Port 3
Port 4

26dB(Hz)	Fl-26dB(Hz)	Fh-26dB(Hz)	OBW(Hz)	Fl-OBW(Hz)	Fh-OBW(Hz)	Limit(Hz)	Port
39.9M	5.49014G	5.53004G	36.702M	5.491589G	5.528291G	Inf	1
40.26M	5.4899G	5.53016G	36.702M	5.491649G	5.528351G	Inf	2
39.78M	5.4902G	5.52998G	36.642M	5.491709G	5.528351G	Inf	3
40.14M	5.48984G	5.52998G	36.762M	5.491589G	5.528351G	Inf	4

802.11ac VHT40_Nss1,(MCS0)_4TX

EBW

5550MHz

17/06/2022

CF
5.55GHz
Span
120MHz
RBW
500kHz
VBW
2MHz
Sweep Time
100ms
Detector Type
Peak

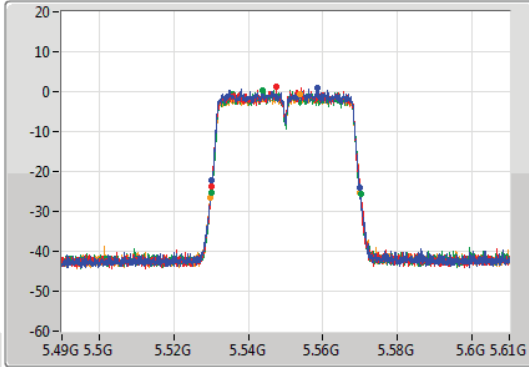

CF
5.55GHz
Span
120MHz
RBW
1MHz
VBW
3MHz
Sweep Time
100ms
Detector Type
Peak

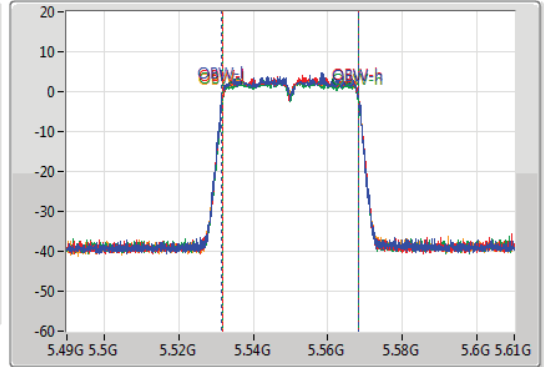

Port 1
Port 2
Port 3
Port 4

26dB(Hz)	Fl-26dB(Hz)	Fh-26dB(Hz)	OBW(Hz)	Fl-OBW(Hz)	Fh-OBW(Hz)	Limit(Hz)	Port
39.9M	5.53002G	5.56992G	36.822M	5.531529G	5.568351G	Inf	1
39.9M	5.53008G	5.56998G	36.702M	5.531649G	5.568351G	Inf	2
40.02M	5.53008G	5.5701G	36.642M	5.531709G	5.568351G	Inf	3
40.26M	5.52978G	5.57004G	36.702M	5.531649G	5.568351G	Inf	4

802.11ac VHT40_Nss1,(MCS0)_4TX

EBW

5670MHz

17/06/2022

CF
5.67GHz
Span
120MHz
RBW
500kHz
VBW
2MHz
Sweep Time
100ms
Detector Type
Peak

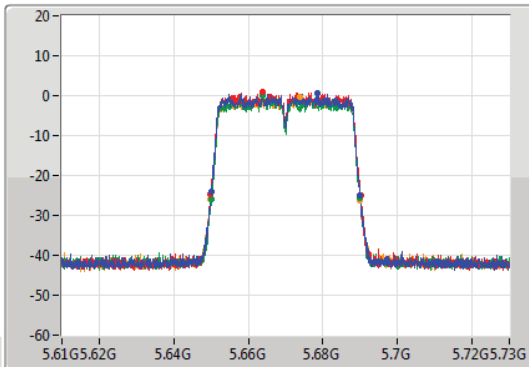

CF
5.67GHz
Span
120MHz
RBW
1MHz
VBW
3MHz
Sweep Time
100ms
Detector Type
Peak

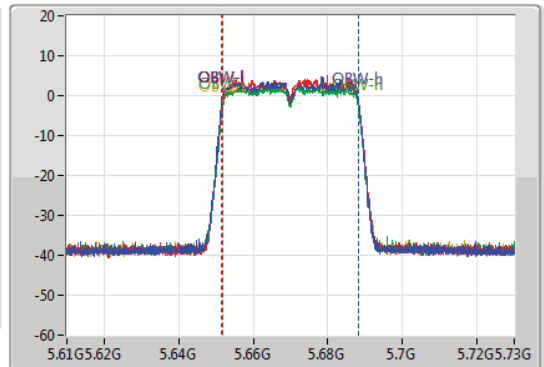

Port 1
Port 2
Port 3
Port 4

26dB(Hz)	Fl-26dB(Hz)	Fh-26dB(Hz)	OBW(Hz)	Fl-OBW(Hz)	Fh-OBW(Hz)	Limit(Hz)	Port
40.02M	5.65002G	5.69004G	36.822M	5.651529G	5.688351G	Inf	1
40.2M	5.6499G	5.6901G	36.702M	5.651649G	5.688351G	Inf	2
39.96M	5.65008G	5.69004G	36.582M	5.651709G	5.688291G	Inf	3
40.14M	5.6499G	5.69004G	36.702M	5.651649G	5.688351G	Inf	4

802.11ac VHT40_Nss1,(MCS0)_4TX

EBW

5710MHz Straddle 5.47-5.725GHz

17/06/2022

CF
5.69GHz
Span
70MHz
RBW
500kHz
VBW
2MHz
Sweep Time
100ms
Detector Type
Peak

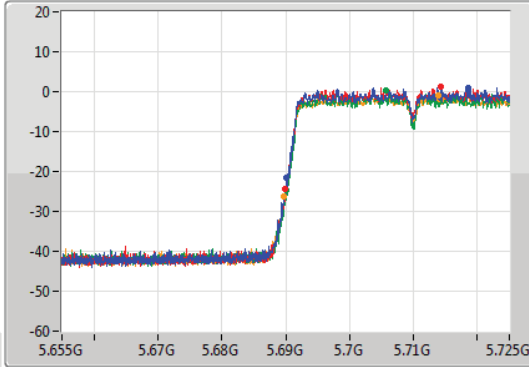

CF
5.69GHz
Span
70MHz
RBW
1MHz
VBW
3MHz
Sweep Time
100ms
Detector Type
Peak

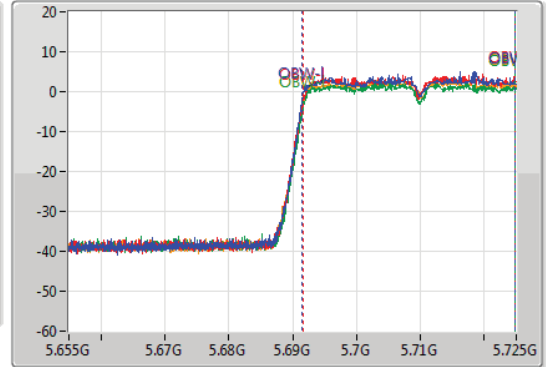

Port 1
Port 2
Port 3
Port 4

26dB(Hz)	Fl-26dB(Hz)	Fh-26dB(Hz)	OBW(Hz)	Fl-OBW(Hz)	Fh-OBW(Hz)	Limit(Hz)	Port
34.93M	5.69007G	5.725G	33.303M	5.691504G	5.724808G	Inf	1
35.035M	5.689965G	5.725G	33.233M	5.691609G	5.724843G	Inf	2
34.825M	5.690175G	5.725G	33.198M	5.691644G	5.724843G	Inf	3
35.21M	5.68979G	5.725G	33.268M	5.691574G	5.724843G	Inf	4

802.11ac VHT40_Nss1,(MCS0)_4TX

EBW

5710MHz Straddle 5.725-5.85GHz

17/06/2022

CF
5.745GHz
Span
40MHz
RBW
100kHz
VBW
300kHz
Sweep Time
100ms
Detector Type
Peak

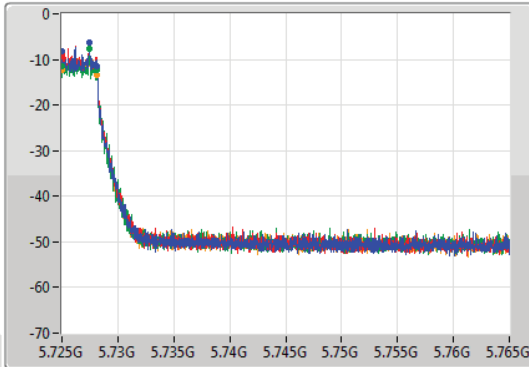

CF
5.745GHz
Span
40MHz
RBW
100kHz
VBW
300kHz
Sweep Time
100ms
Detector Type
Peak

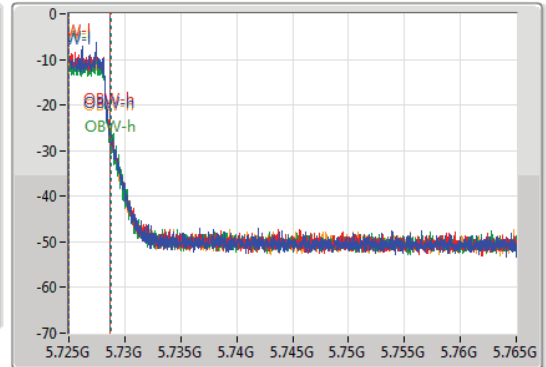

Port 1
Port 2
Port 3
Port 4

6dB(Hz)	Fl-6dB(Hz)	Fh-6dB(Hz)	OBW(Hz)	Fl-OBW(Hz)	Fh-OBW(Hz)	Limit(Hz)	Port
3.12M	5.725G	5.72812G	3.678M	5.72501G	5.728688G	500k	1
3.12M	5.725G	5.72812G	3.678M	5.72501G	5.728688G	500k	2
3.12M	5.725G	5.72812G	3.818M	5.72501G	5.728828G	500k	3
3.14M	5.725G	5.72814G	3.678M	5.72501G	5.728688G	500k	4

802.11ac VHT40_Nss1,(MCS0)_4TX

EBW

5755MHz

17/06/2022

CF
5.755GHz
Span
120MHz
RBW
100kHz
VBW
300kHz
Sweep Time
100ms
Detector Type
Peak

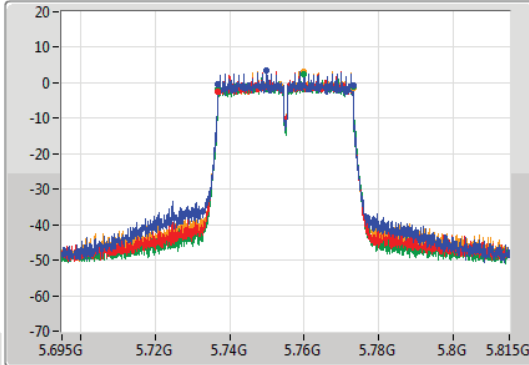

CF
5.755GHz
Span
120MHz
RBW
1MHz
VBW
3MHz
Sweep Time
100ms
Detector Type
Peak

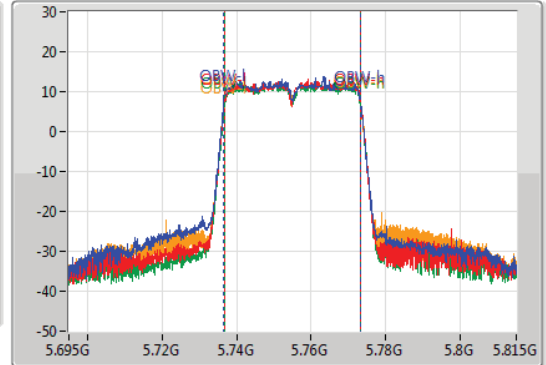

Port 1
Port 2
Port 3
Port 4

6dB(Hz)	Fl-6dB(Hz)	Fh-6dB(Hz)	OBW(Hz)	Fl-OBW(Hz)	Fh-OBW(Hz)	Limit(Hz)	Port
36.3M	5.73682G	5.77312G	36.822M	5.736529G	5.773351G	500k	1
36.36M	5.73676G	5.77312G	36.702M	5.736649G	5.773351G	500k	2
36.3M	5.73682G	5.77312G	36.642M	5.736709G	5.773351G	500k	3
36.3M	5.73682G	5.77312G	36.702M	5.736649G	5.773351G	500k	4

802.11ac VHT40_Nss1,(MCS0)_4TX

EBW

5795MHz

17/06/2022

CF
5.795GHz
Span
120MHz
RBW
100kHz
VBW
300kHz
Sweep Time
100ms
Detector Type
Peak

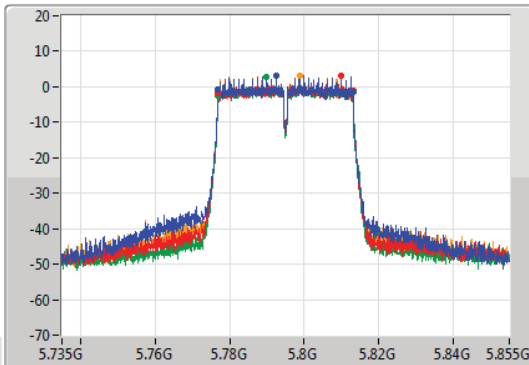

CF
5.795GHz
Span
120MHz
RBW
1MHz
VBW
3MHz
Sweep Time
100ms
Detector Type
Peak

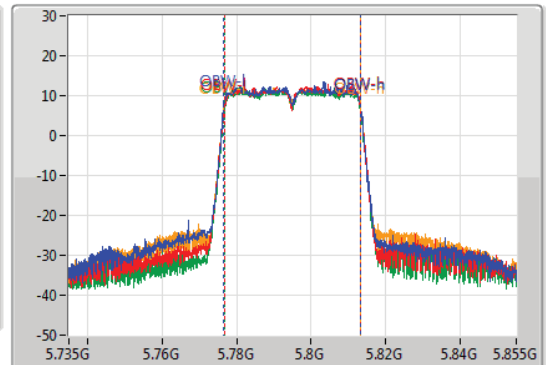

Port 1
Port 2
Port 3
Port 4

6dB(Hz)	Fl-6dB(Hz)	Fh-6dB(Hz)	OBW(Hz)	Fl-OBW(Hz)	Fh-OBW(Hz)	Limit(Hz)	Port
36.3M	5.77682G	5.81312G	36.822M	5.776529G	5.813351G	500k	1
36.3M	5.77682G	5.81312G	36.702M	5.776649G	5.813351G	500k	2
36.36M	5.77676G	5.81312G	36.642M	5.776709G	5.813351G	500k	3
36.3M	5.77682G	5.81312G	36.762M	5.776589G	5.813351G	500k	4

802.11ac VHT80_Nss1,(MCS0)_4TX

EBW

5210MHz

17/06/2022

CF
5.21GHz
Span
240MHz
RBW
1MHz
VBW
3MHz
Sweep Time
100ms
Detector Type
Peak

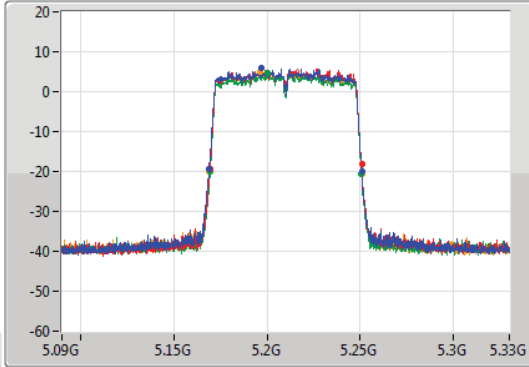

CF
5.21GHz
Span
240MHz
RBW
2MHz
VBW
10MHz
Sweep Time
100ms
Detector Type
Peak

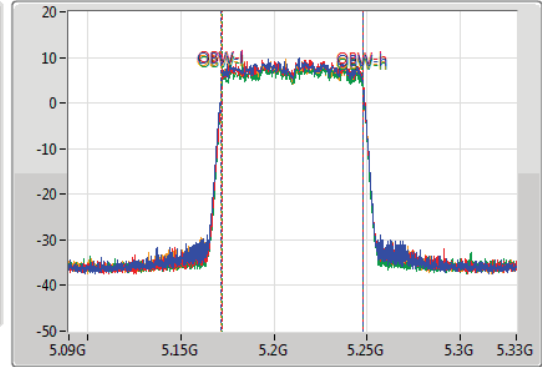

26dB(Hz)	Fl-26dB(Hz)	Fh-26dB(Hz)	OBW(Hz)	Fl-OBW(Hz)	Fh-OBW(Hz)	Limit(Hz)	Port
81.84M	5.16896G	5.2508G	76.042M	5.171859G	5.247901G	Inf	1
81.36M	5.16944G	5.2508G	75.922M	5.171979G	5.247901G	Inf	2
81.24M	5.16944G	5.25068G	75.922M	5.171979G	5.247901G	Inf	3
81.72M	5.16908G	5.2508G	76.042M	5.171859G	5.247901G	Inf	4

802.11ac VHT80_Nss1,(MCS0)_4TX

EBW

5290MHz

17/06/2022

CF
5.29GHz
Span
240MHz
RBW
1MHz
VBW
3MHz
Sweep Time
100ms
Detector Type
Peak

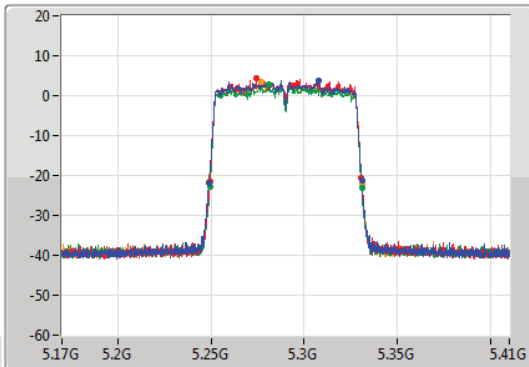

CF
5.29GHz
Span
240MHz
RBW
2MHz
VBW
10MHz
Sweep Time
100ms
Detector Type
Peak

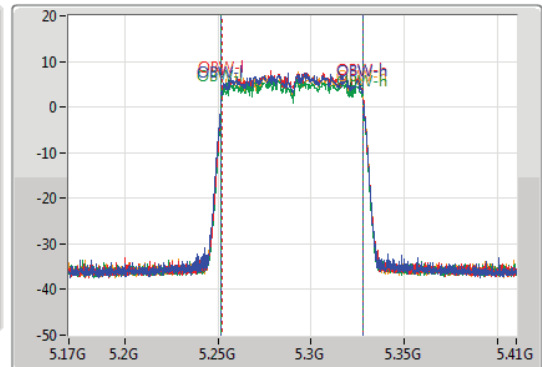

26dB(Hz)	Fl-26dB(Hz)	Fh-26dB(Hz)	OBW(Hz)	Fl-OBW(Hz)	Fh-OBW(Hz)	Limit(Hz)	Port
81.96M	5.24884G	5.3308G	76.042M	5.251859G	5.327901G	Inf	1
81.36M	5.24932G	5.33068G	75.922M	5.251979G	5.327901G	Inf	2
81.48M	5.24932G	5.3308G	76.162M	5.251859G	5.328021G	Inf	3
81.72M	5.24908G	5.3308G	76.162M	5.251859G	5.328021G	Inf	4

802.11ac VHT80_Nss1,(MCS0)_4TX

EBW

5530MHz

17/06/2022

CF
5.53GHz
Span
240MHz
RBW
1MHz
VBW
3MHz
Sweep Time
100ms
Detector Type
Peak

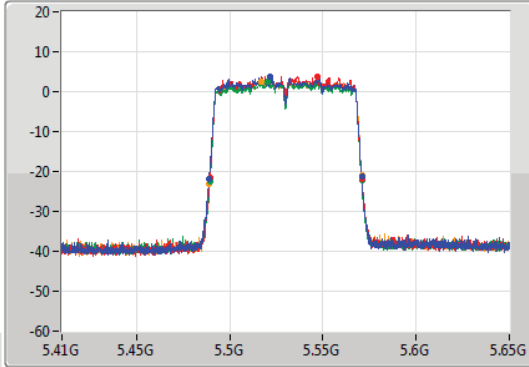

CF
5.53GHz
Span
240MHz
RBW
2MHz
VBW
10MHz
Sweep Time
100ms
Detector Type
Peak

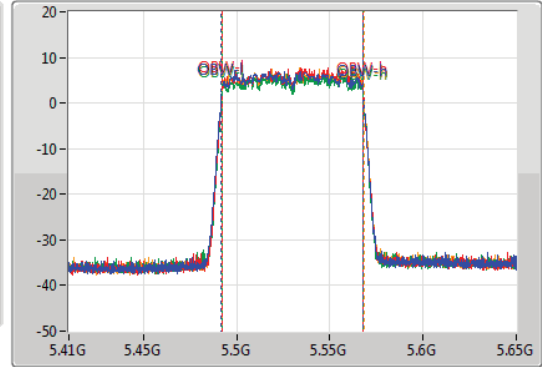

Port 1
Port 2
Port 3
Port 4

26dB(Hz)	Fl-26dB(Hz)	Fh-26dB(Hz)	OBW(Hz)	Fl-OBW(Hz)	Fh-OBW(Hz)	Limit(Hz)	Port
81.84M	5.48896G	5.5708G	76.042M	5.491859G	5.567901G	Inf	1
81.6M	5.48932G	5.57092G	75.922M	5.491979G	5.567901G	Inf	2
81.36M	5.48944G	5.5708G	76.042M	5.491979G	5.568021G	Inf	3
81.96M	5.48896G	5.57092G	76.162M	5.491979G	5.568141G	Inf	4

802.11ac VHT80_Nss1,(MCS0)_4TX

EBW

5610MHz

17/06/2022

CF
5.61GHz
Span
240MHz
RBW
1MHz
VBW
3MHz
Sweep Time
100ms
Detector Type
Peak

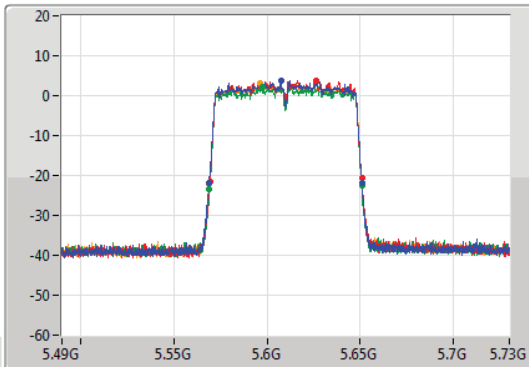

CF
5.61GHz
Span
240MHz
RBW
2MHz
VBW
10MHz
Sweep Time
100ms
Detector Type
Peak

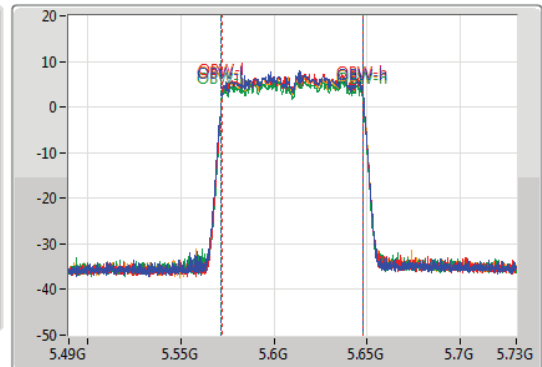

Port 1
Port 2
Port 3
Port 4

26dB(Hz)	Fl-26dB(Hz)	Fh-26dB(Hz)	OBW(Hz)	Fl-OBW(Hz)	Fh-OBW(Hz)	Limit(Hz)	Port
81.84M	5.56896G	5.6508G	76.162M	5.571859G	5.648021G	Inf	1
81.48M	5.56932G	5.6508G	75.922M	5.571979G	5.647901G	Inf	2
81.6M	5.5692G	5.6508G	76.162M	5.571859G	5.648021G	Inf	3
81.84M	5.56908G	5.65092G	76.162M	5.571859G	5.648021G	Inf	4

802.11ac VHT80_Nss1,(MCS0)_4TX

EBW

5690MHz Straddle 5.47-5.725GHz

17/06/2022

CF
5.65GHz
Span
150MHz
RBW
1MHz
VBW
3MHz
Sweep Time
100ms
Detector Type
Peak

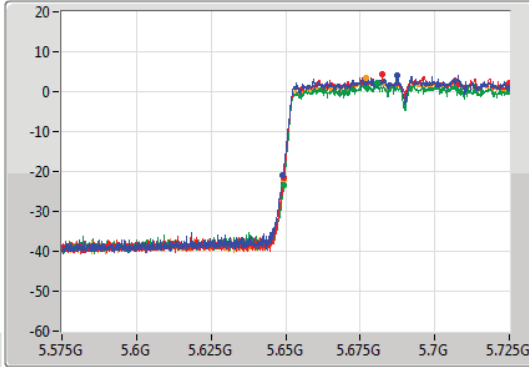

CF
5.65GHz
Span
150MHz
RBW
2MHz
VBW
10MHz
Sweep Time
100ms
Detector Type
Peak



Port 1
Port 2
Port 3
Port 4

26dB(Hz)	Fl-26dB(Hz)	Fh-26dB(Hz)	OBW(Hz)	Fl-OBW(Hz)	Fh-OBW(Hz)	Limit(Hz)	Port
75.9M	5.6491G	5.725G	72.864M	5.651799G	5.724663G	Inf	1
75.6M	5.6494G	5.725G	72.714M	5.651949G	5.724663G	Inf	2
75.675M	5.649325G	5.725G	72.789M	5.651874G	5.724663G	Inf	3
75.675M	5.649325G	5.725G	72.714M	5.651949G	5.724663G	Inf	4

802.11ac VHT80_Nss1,(MCS0)_4TX

EBW

5690MHz Straddle 5.725-5.85GHz

17/06/2022

CF
5.745GHz
Span
40MHz
RBW
100kHz
VBW
300kHz
Sweep Time
100ms
Detector Type
Peak

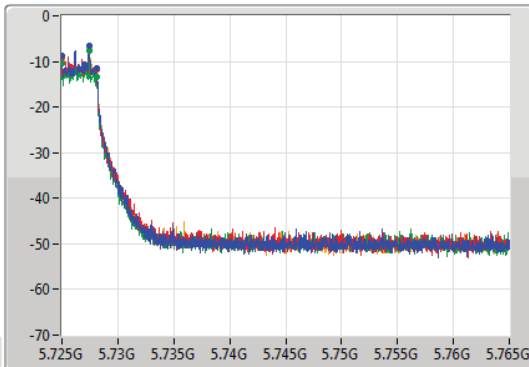

CF
5.745GHz
Span
40MHz
RBW
100kHz
VBW
300kHz
Sweep Time
100ms
Detector Type
Peak

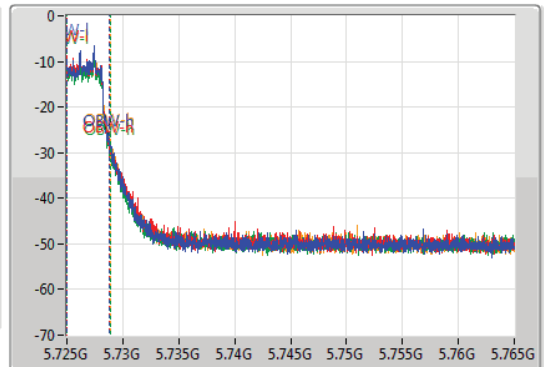

Port 1
Port 2
Port 3
Port 4

6dB(Hz)	Fl-6dB(Hz)	Fh-6dB(Hz)	OBW(Hz)	Fl-OBW(Hz)	Fh-OBW(Hz)	Limit(Hz)	Port
3.1M	5.725G	5.7281G	3.778M	5.72501G	5.728788G	500k	1
3.1M	5.725G	5.7281G	3.798M	5.72501G	5.728808G	500k	2
3.12M	5.725G	5.72812G	3.858M	5.72501G	5.728868G	500k	3
3.12M	5.725G	5.72812G	3.898M	5.72501G	5.728908G	500k	4

802.11ac VHT80_Nss1,(MCS0)_4TX

EBW

5775MHz

17/06/2022

CF
5.775GHz
Span
240MHz
RBW
100kHz
VBW
300kHz
Sweep Time
100ms
Detector Type
Peak

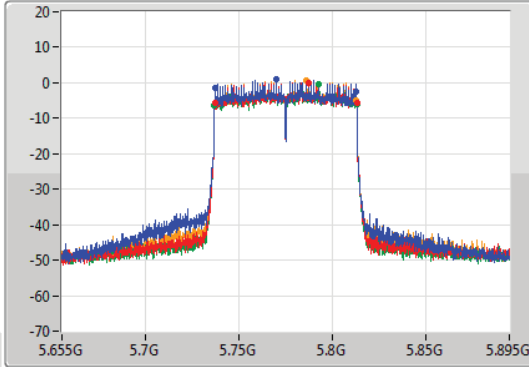

CF
5.775GHz
Span
240MHz
RBW
2MHz
VBW
10MHz
Sweep Time
100ms
Detector Type
Peak

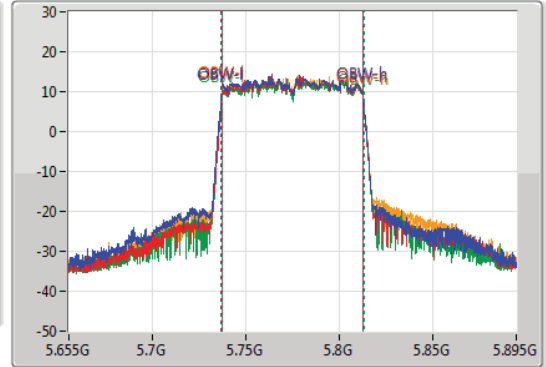

Port 1
Port 2
Port 3
Port 4

6dB(Hz)	Fl-6dB(Hz)	Fh-6dB(Hz)	OBW(Hz)	Fl-OBW(Hz)	Fh-OBW(Hz)	Limit(Hz)	Port
75.12M	5.73744G	5.81256G	76.282M	5.736739G	5.813021G	500k	1
75.96M	5.7372G	5.81316G	76.042M	5.736979G	5.813021G	500k	2
76.32M	5.73684G	5.81316G	76.162M	5.736979G	5.813141G	500k	3
75.6M	5.73744G	5.81304G	76.042M	5.736979G	5.813021G	500k	4

802.11ac VHT160_Nss1,(MCS0)_4TX

EBW

5250MHz Straddle 5.15-5.25GHz

17/06/2022

CF
5.17GHz
Span
160MHz
RBW
2MHz
VBW
10MHz
Sweep Time
100ms
Detector Type
Peak

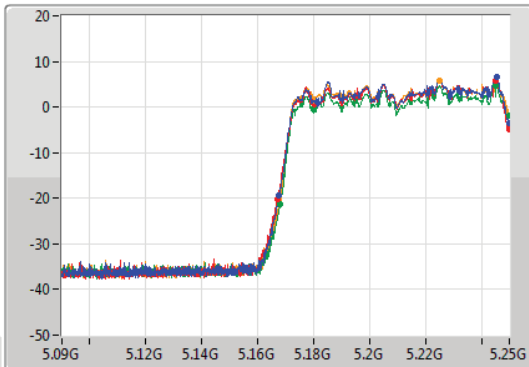

CF
5.17GHz
Span
160MHz
RBW
3MHz
VBW
10MHz
Sweep Time
100ms
Detector Type
Peak

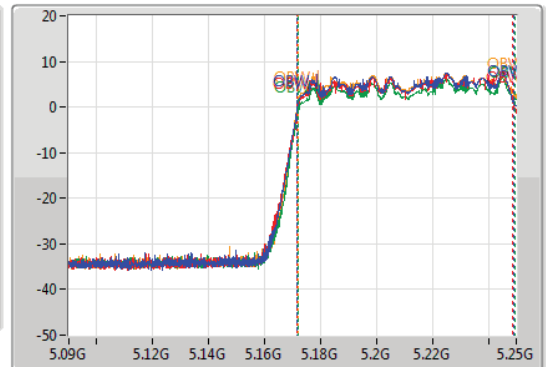

Port 1
Port 2
Port 3
Port 4

26dB(Hz)	Fl-26dB(Hz)	Fh-26dB(Hz)	OBW(Hz)	Fl-OBW(Hz)	Fh-OBW(Hz)	Limit(Hz)	Port
82.4M	5.1676G	5.25G	77.241M	5.171759G	5.249G	Inf	1
82.8M	5.1672G	5.25G	77.081M	5.171759G	5.248841G	Inf	2
81.92M	5.16808G	5.25G	77.561M	5.171839G	5.2494G	Inf	3
82.32M	5.16768G	5.25G	77.401M	5.171839G	5.24924G	Inf	4

802.11ac VHT160_Nss1,(MCS0)_4TX

EBW

5250MHz Straddle 5.25-5.35GHz

17/06/2022

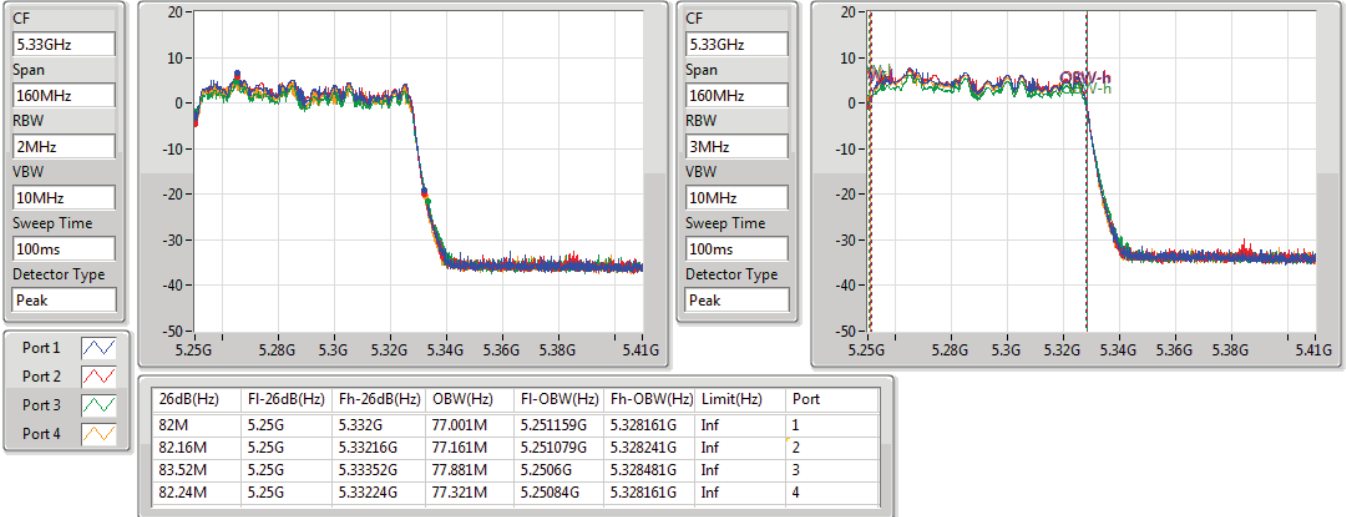

802.11ac VHT160_Nss1,(MCS0)_4TX

EBW

5570MHz

17/06/2022

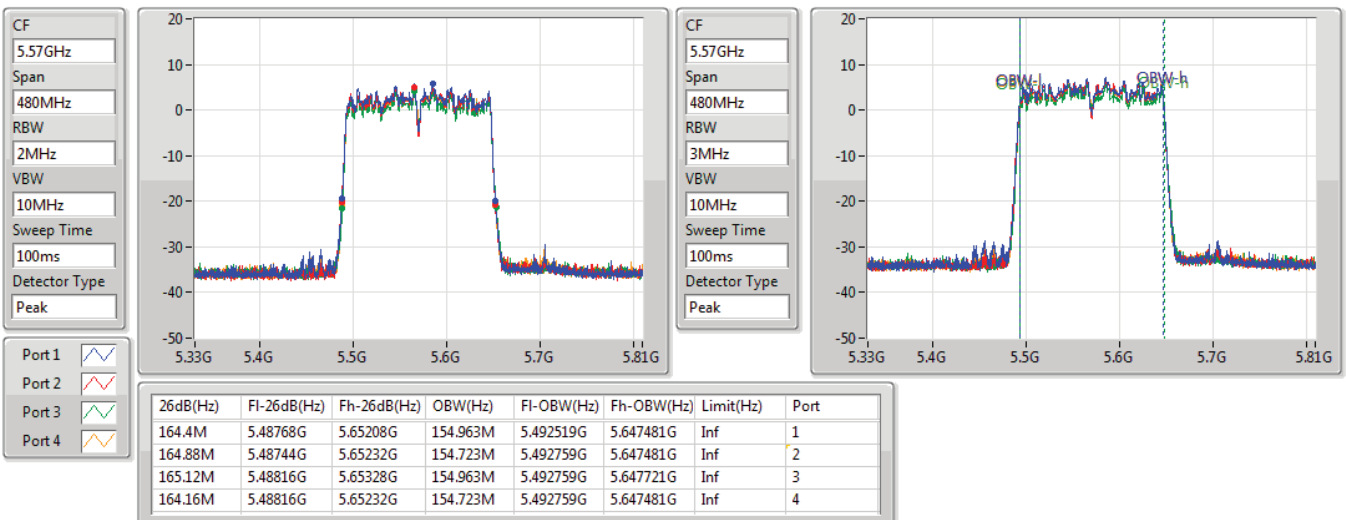



802.11ax HEW20_Nss1,(MCS0)_4TX

EBW

5180MHz

17/06/2022

CF
5.18GHz
Span
60MHz
RBW
300kHz
VBW
1MHz
Sweep Time
100ms
Detector Type
Peak

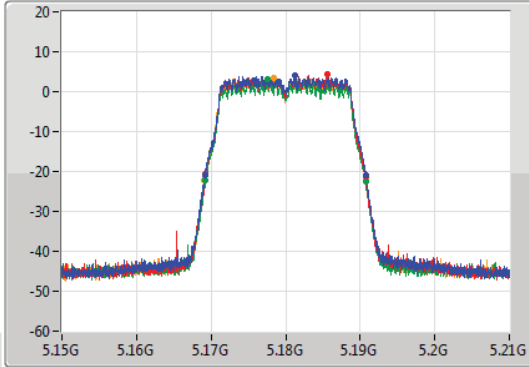

CF
5.18GHz
Span
60MHz
RBW
300kHz
VBW
1MHz
Sweep Time
100ms
Detector Type
Peak

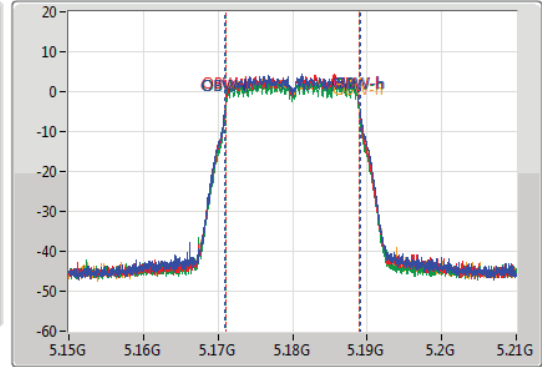

Port 1
Port 2
Port 3
Port 4

26dB(Hz)	Fl-26dB(Hz)	Fh-26dB(Hz)	OBW(Hz)	Fl-OBW(Hz)	Fh-OBW(Hz)	Limit(Hz)	Port
21.66M	5.16914G	5.1908G	18.051M	5.170975G	5.189025G	Inf	1
21.45M	5.16926G	5.19071G	17.901M	5.171004G	5.188906G	Inf	2
21.6M	5.16917G	5.19077G	17.901M	5.171004G	5.188906G	Inf	3
21.75M	5.16908G	5.19083G	18.051M	5.170945G	5.188996G	Inf	4

802.11ax HEW20_Nss1,(MCS0)_4TX

EBW

5200MHz

17/06/2022

CF
5.2GHz
Span
60MHz
RBW
300kHz
VBW
1MHz
Sweep Time
100ms
Detector Type
Peak

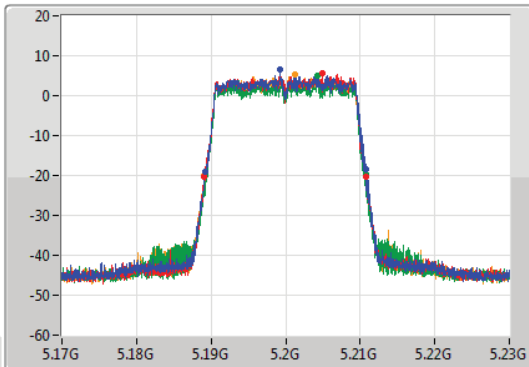

CF
5.2GHz
Span
60MHz
RBW
300kHz
VBW
1MHz
Sweep Time
100ms
Detector Type
Peak

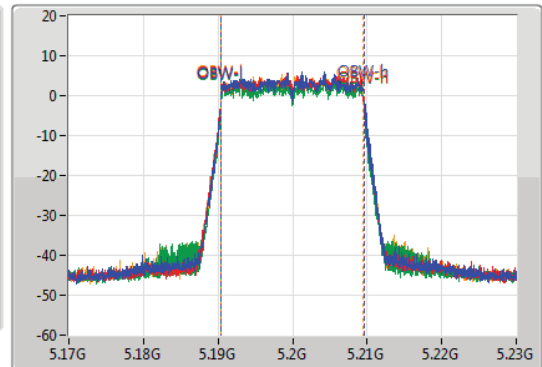

Port 1
Port 2
Port 3
Port 4

26dB(Hz)	Fl-26dB(Hz)	Fh-26dB(Hz)	OBW(Hz)	Fl-OBW(Hz)	Fh-OBW(Hz)	Limit(Hz)	Port
21.6M	5.18923G	5.21083G	19.16M	5.190435G	5.209595G	Inf	1
21.75M	5.18911G	5.21086G	19.13M	5.190435G	5.209565G	Inf	2
21.45M	5.18929G	5.21074G	19.1M	5.190465G	5.209565G	Inf	3
21.63M	5.18911G	5.21074G	19.04M	5.190435G	5.209475G	Inf	4

802.11ax HEW20_Nss1,(MCS0)_4TX

EBW

5240MHz

17/06/2022

CF
5.24GHz
Span
60MHz
RBW
300kHz
VBW
1MHz
Sweep Time
100ms
Detector Type
Peak

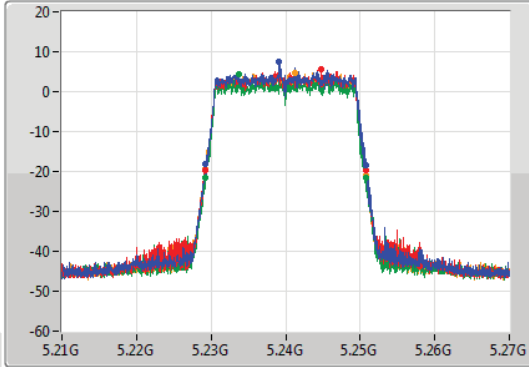

CF
5.24GHz
Span
60MHz
RBW
300kHz
VBW
1MHz
Sweep Time
100ms
Detector Type
Peak

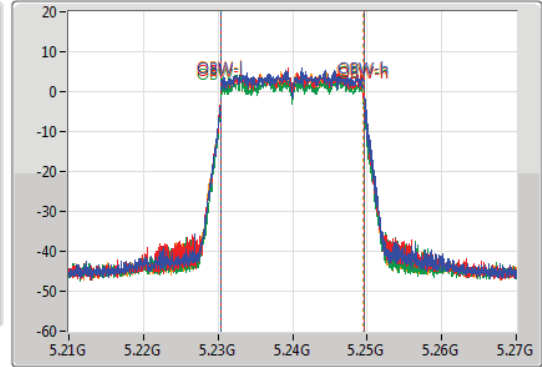

Port 1
Port 2
Port 3
Port 4

26dB(Hz)	Fl-26dB(Hz)	Fh-26dB(Hz)	OBW(Hz)	Fl-OBW(Hz)	Fh-OBW(Hz)	Limit(Hz)	Port
21.54M	5.22929G	5.25083G	19.19M	5.230435G	5.249625G	Inf	1
21.63M	5.22917G	5.2508G	19.13M	5.230405G	5.249535G	Inf	2
21.6M	5.22923G	5.25083G	19.1M	5.230435G	5.249535G	Inf	3
21.54M	5.22917G	5.25071G	19.07M	5.230405G	5.249475G	Inf	4

802.11ax HEW20_Nss1,(MCS0)_4TX

EBW

5260MHz

17/06/2022

CF
5.26GHz
Span
60MHz
RBW
300kHz
VBW
1MHz
Sweep Time
100ms
Detector Type
Peak

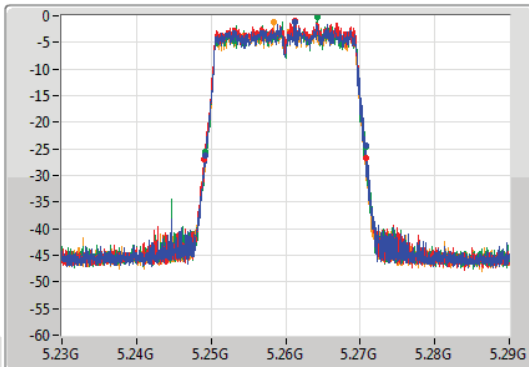

CF
5.26GHz
Span
60MHz
RBW
300kHz
VBW
1MHz
Sweep Time
100ms
Detector Type
Peak

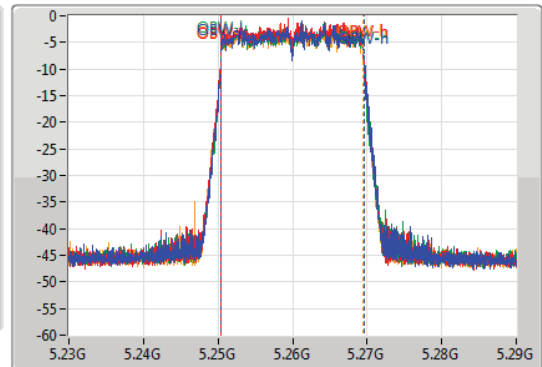

Port 1
Port 2
Port 3
Port 4

26dB(Hz)	Fl-26dB(Hz)	Fh-26dB(Hz)	OBW(Hz)	Fl-OBW(Hz)	Fh-OBW(Hz)	Limit(Hz)	Port
21.6M	5.24917G	5.27077G	19.16M	5.250435G	5.269595G	Inf	1
21.75M	5.24908G	5.27083G	19.13M	5.250405G	5.269535G	Inf	2
21.48M	5.24926G	5.27074G	19.1M	5.250435G	5.269535G	Inf	3
21.63M	5.24911G	5.27074G	19.04M	5.250435G	5.269475G	Inf	4

802.11ax HEW20_Nss1,(MCS0)_4TX

EBW

5300MHz

17/06/2022

CF
5.3GHz
Span
60MHz
RBW
300kHz
VBW
1MHz
Sweep Time
100ms
Detector Type
Peak

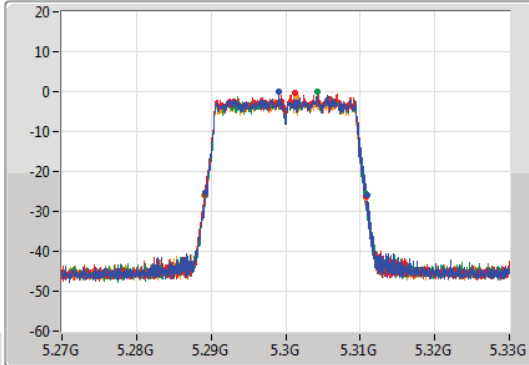

CF
5.3GHz
Span
60MHz
RBW
300kHz
VBW
1MHz
Sweep Time
100ms
Detector Type
Peak

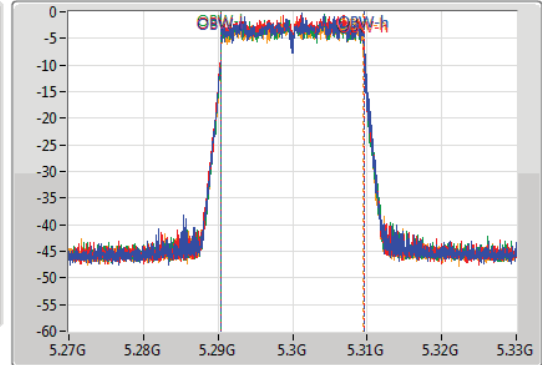

Port 1
Port 2
Port 3
Port 4

26dB(Hz)	Fl-26dB(Hz)	Fh-26dB(Hz)	OBW(Hz)	Fl-OBW(Hz)	Fh-OBW(Hz)	Limit(Hz)	Port
21.69M	5.2892G	5.31089G	19.16M	5.290435G	5.309595G	Inf	1
21.69M	5.28914G	5.31083G	19.13M	5.290405G	5.309535G	Inf	2
21.6M	5.28923G	5.31083G	19.1M	5.290435G	5.309535G	Inf	3
21.69M	5.28908G	5.31077G	19.04M	5.290435G	5.309475G	Inf	4

802.11ax HEW20_Nss1,(MCS0)_4TX

EBW

5320MHz

17/06/2022

CF
5.32GHz
Span
60MHz
RBW
300kHz
VBW
1MHz
Sweep Time
100ms
Detector Type
Peak

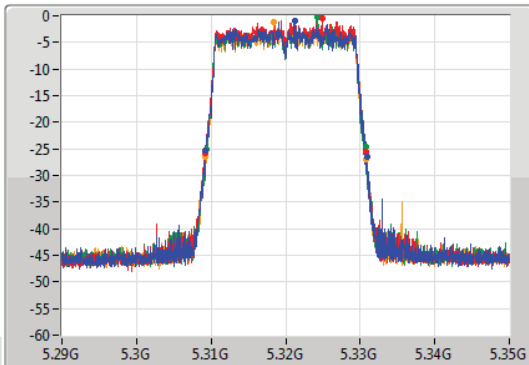

CF
5.32GHz
Span
60MHz
RBW
300kHz
VBW
1MHz
Sweep Time
100ms
Detector Type
Peak

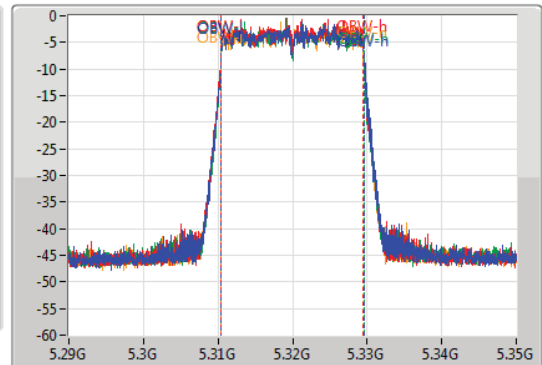

Port 1
Port 2
Port 3
Port 4

26dB(Hz)	Fl-26dB(Hz)	Fh-26dB(Hz)	OBW(Hz)	Fl-OBW(Hz)	Fh-OBW(Hz)	Limit(Hz)	Port
21.72M	5.3092G	5.33092G	19.16M	5.310435G	5.329595G	Inf	1
21.6M	5.30917G	5.33077G	19.07M	5.310435G	5.329505G	Inf	2
21.36M	5.30935G	5.33071G	19.13M	5.310435G	5.329565G	Inf	3
21.57M	5.30917G	5.33074G	19.1M	5.310405G	5.329505G	Inf	4

802.11ax HEW20_Nss1,(MCS0)_4TX

EBW

5500MHz

17/06/2022

CF
5.5GHz
Span
60MHz
RBW
300kHz
VBW
1MHz
Sweep Time
100ms
Detector Type
Peak

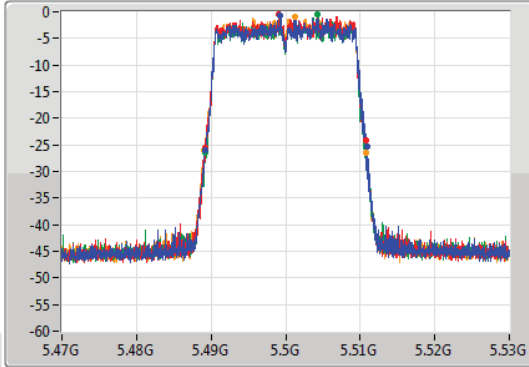

CF
5.5GHz
Span
60MHz
RBW
300kHz
VBW
1MHz
Sweep Time
100ms
Detector Type
Peak

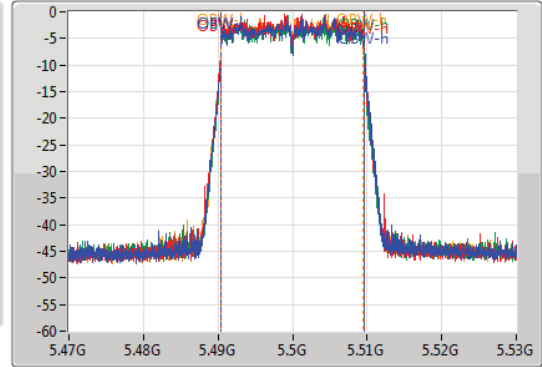

Port 1
Port 2
Port 3
Port 4

26dB(Hz)	Fl-26dB(Hz)	Fh-26dB(Hz)	OBW(Hz)	Fl-OBW(Hz)	Fh-OBW(Hz)	Limit(Hz)	Port
21.69M	5.4892G	5.51089G	19.19M	5.490435G	5.509625G	Inf	1
21.57M	5.48917G	5.51074G	19.16M	5.490405G	5.509565G	Inf	2
21.57M	5.48923G	5.5108G	19.1M	5.490435G	5.509535G	Inf	3
21.78M	5.48902G	5.5108G	19.04M	5.490435G	5.509475G	Inf	4

802.11ax HEW20_Nss1,(MCS0)_4TX

EBW

5580MHz

17/06/2022

CF
5.58GHz
Span
60MHz
RBW
300kHz
VBW
1MHz
Sweep Time
100ms
Detector Type
Peak

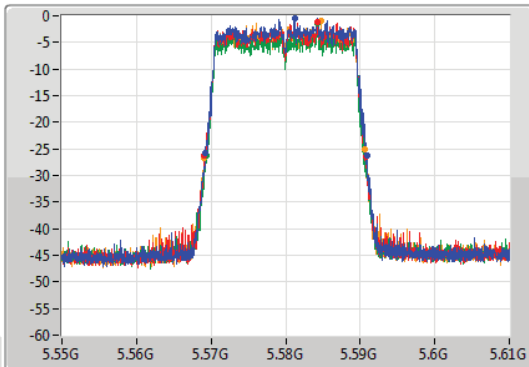

CF
5.58GHz
Span
60MHz
RBW
300kHz
VBW
1MHz
Sweep Time
100ms
Detector Type
Peak

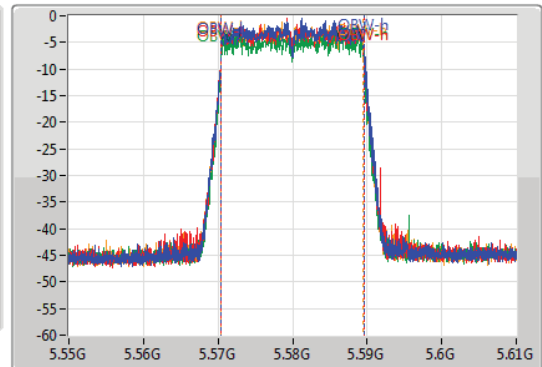

Port 1
Port 2
Port 3
Port 4

26dB(Hz)	Fl-26dB(Hz)	Fh-26dB(Hz)	OBW(Hz)	Fl-OBW(Hz)	Fh-OBW(Hz)	Limit(Hz)	Port
21.81M	5.56917G	5.59098G	19.16M	5.570435G	5.589595G	Inf	1
21.72M	5.56911G	5.59083G	19.16M	5.570405G	5.589565G	Inf	2
21.45M	5.56932G	5.59077G	19.1M	5.570435G	5.589535G	Inf	3
21.54M	5.56911G	5.59065G	19.04M	5.570435G	5.589475G	Inf	4

802.11ax HEW20_Nss1,(MCS0)_4TX

EBW

5700MHz

17/06/2022

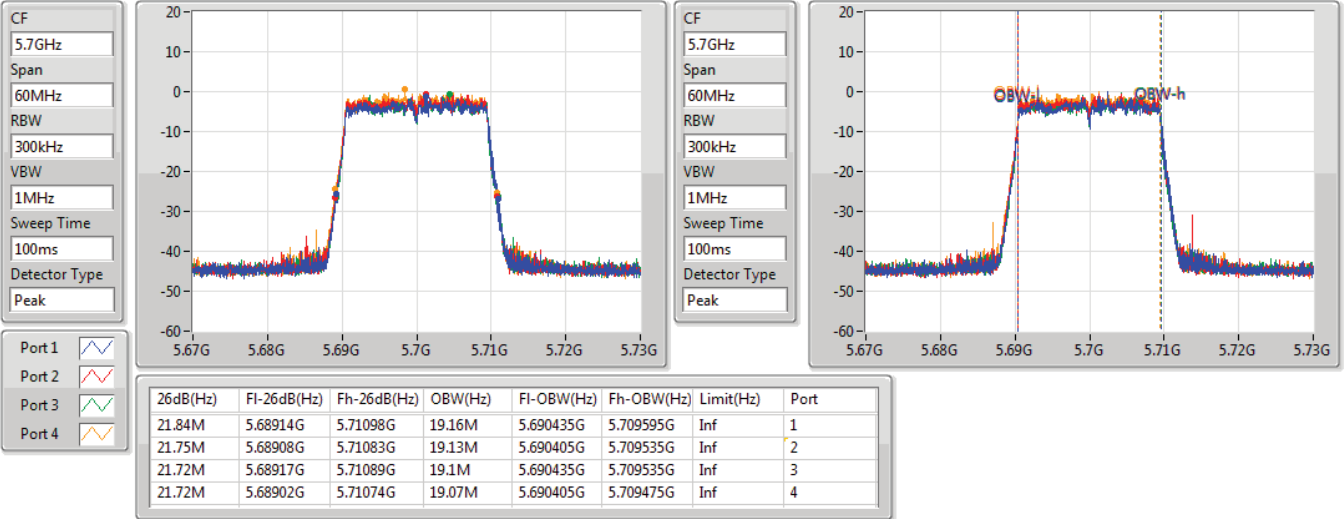

802.11ax HEW20_Nss1,(MCS0)_4TX

EBW

5720MHz Straddle 5.47-5.725GHz

17/06/2022

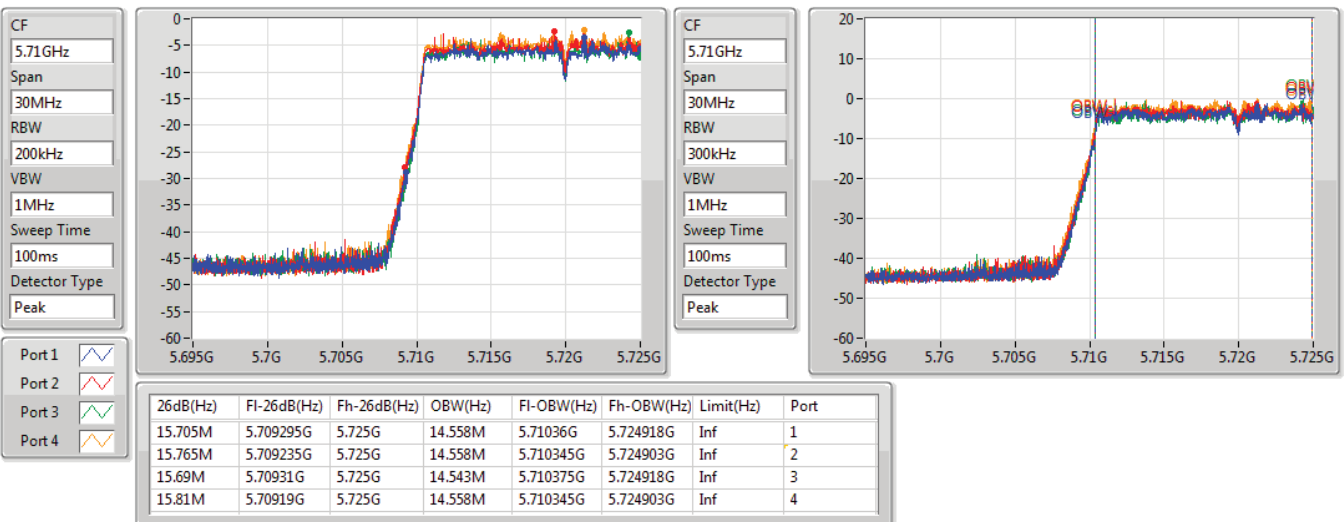

802.11ax HEW20_Nss1,(MCS0)_4TX

EBW

5720MHz Straddle 5.725-5.85GHz

17/06/2022

CF
5.745GHz
Span
40MHz
RBW
100kHz
VBW
300kHz
Sweep Time
100ms
Detector Type
Peak

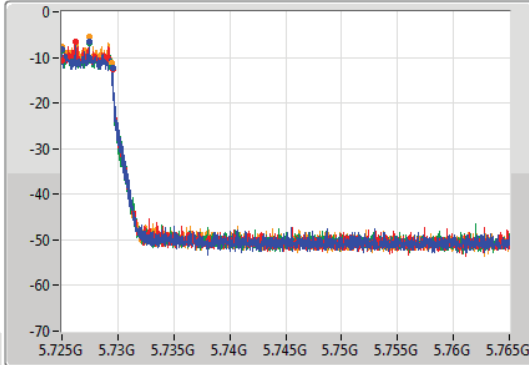

CF
5.745GHz
Span
40MHz
RBW
100kHz
VBW
300kHz
Sweep Time
100ms
Detector Type
Peak

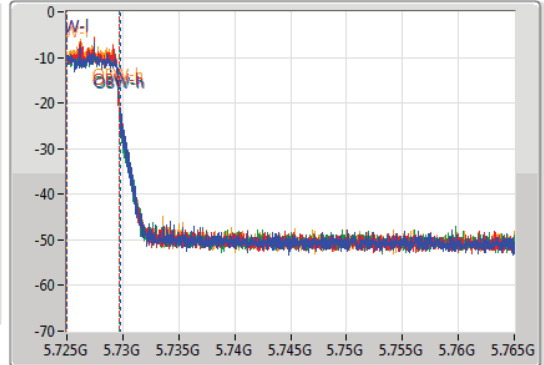

Port 1
Port 2
Port 3
Port 4

6dB(Hz)	Fl-6dB(Hz)	Fh-6dB(Hz)	OBW(Hz)	Fl-OBW(Hz)	Fh-OBW(Hz)	Limit(Hz)	Port
4.52M	5.725G	5.72952G	4.758M	5.72501G	5.729768G	500k	1
4.54M	5.725G	5.72954G	4.718M	5.72501G	5.729728G	500k	2
4.44M	5.725G	5.72944G	4.718M	5.72501G	5.729728G	500k	3
4.44M	5.725G	5.72944G	4.618M	5.72503G	5.729648G	500k	4

802.11ax HEW20_Nss1,(MCS0)_4TX

EBW

5745MHz

17/06/2022

CF
5.745GHz
Span
60MHz
RBW
100kHz
VBW
300kHz
Sweep Time
100ms
Detector Type
Peak

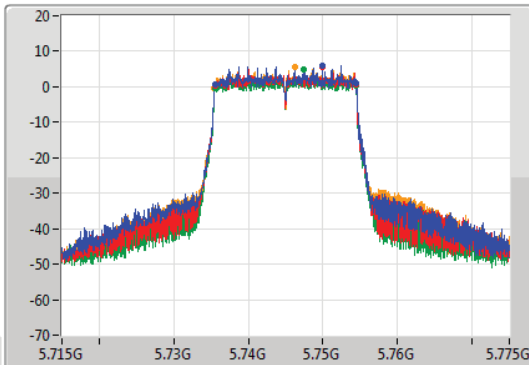

CF
5.745GHz
Span
60MHz
RBW
300kHz
VBW
1MHz
Sweep Time
100ms
Detector Type
Peak

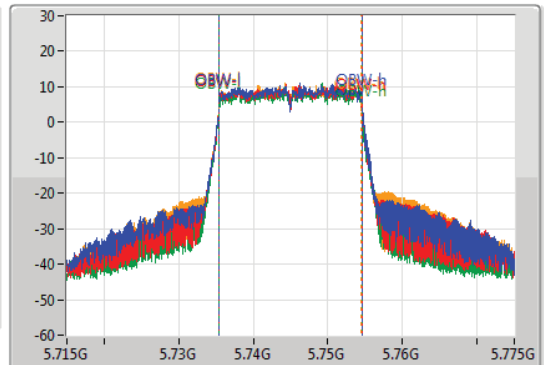

Port 1
Port 2
Port 3
Port 4

6dB(Hz)	Fl-6dB(Hz)	Fh-6dB(Hz)	OBW(Hz)	Fl-OBW(Hz)	Fh-OBW(Hz)	Limit(Hz)	Port
18.96M	5.73549G	5.75445G	19.16M	5.735435G	5.754595G	500k	1
18.93M	5.73549G	5.75442G	19.16M	5.735405G	5.754565G	500k	2
18.96M	5.73549G	5.75445G	19.13M	5.735435G	5.754565G	500k	3
19.05M	5.73543G	5.75448G	19.07M	5.735435G	5.754505G	500k	4

802.11ax HEW20_Nss1,(MCS0)_4TX

EBW

5785MHz

17/06/2022

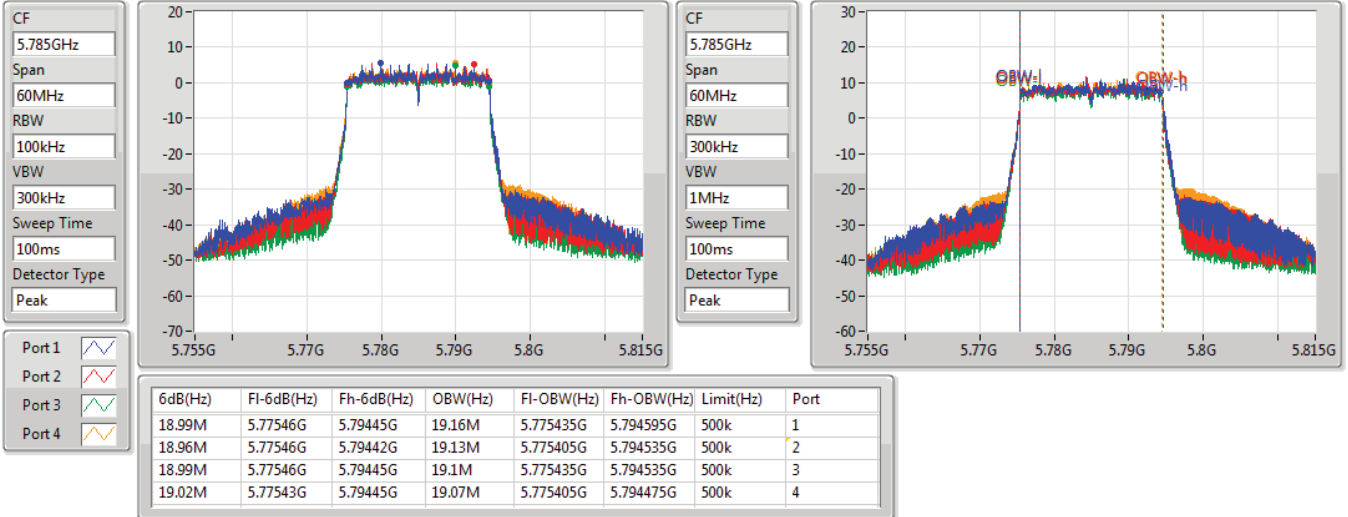

802.11ax HEW20_Nss1,(MCS0)_4TX

EBW

5825MHz

17/06/2022

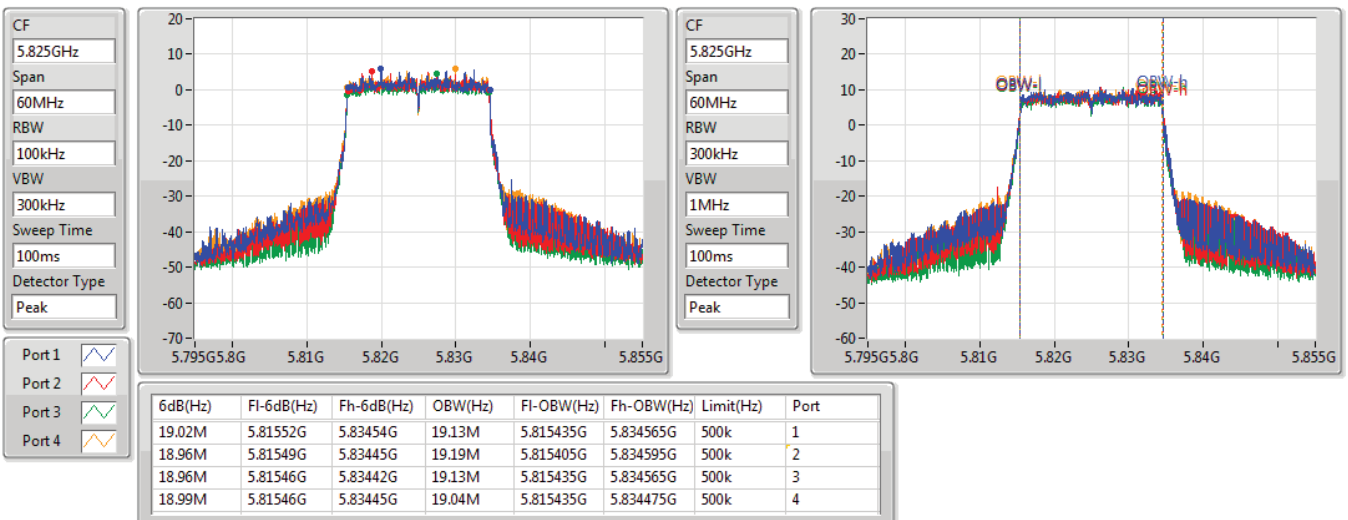

802.11ax HEW40_Nss1,(MCS0)_4TX

EBW

5190MHz

17/06/2022

CF
5.19GHz
Span
120MHz
RBW
500kHz
VBW
2MHz
Sweep Time
100ms
Detector Type
Peak

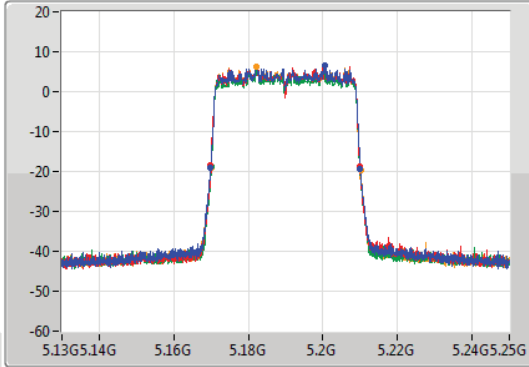

CF
5.19GHz
Span
120MHz
RBW
1MHz
VBW
3MHz
Sweep Time
100ms
Detector Type
Peak

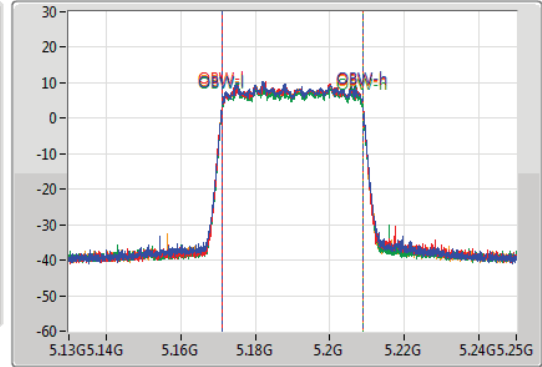

Port 1
Port 2
Port 3
Port 4

26dB(Hz)	Fl-26dB(Hz)	Fh-26dB(Hz)	OBW(Hz)	Fl-OBW(Hz)	Fh-OBW(Hz)	Limit(Hz)	Port
40.14M	5.1699G	5.21004G	37.601M	5.171169G	5.208771G	Inf	1
40.02M	5.1699G	5.20992G	37.601M	5.171169G	5.208771G	Inf	2
39.9M	5.17008G	5.20998G	37.661M	5.171109G	5.208771G	Inf	3
40.08M	5.17002G	5.2101G	37.601M	5.171169G	5.208771G	Inf	4

802.11ax HEW40_Nss1,(MCS0)_4TX

EBW

5230MHz

17/06/2022

CF
5.23GHz
Span
120MHz
RBW
500kHz
VBW
2MHz
Sweep Time
100ms
Detector Type
Peak

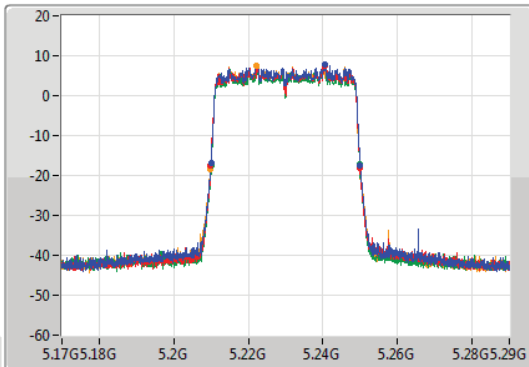

CF
5.23GHz
Span
120MHz
RBW
1MHz
VBW
3MHz
Sweep Time
100ms
Detector Type
Peak

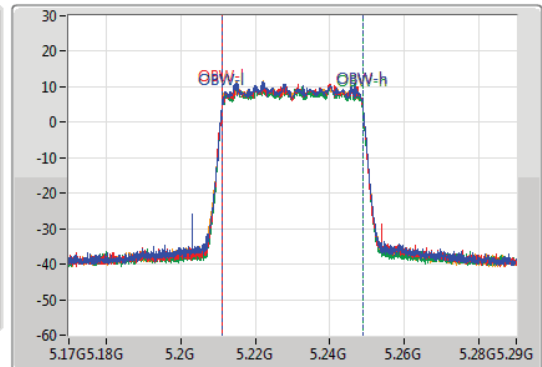

Port 1
Port 2
Port 3
Port 4

26dB(Hz)	Fl-26dB(Hz)	Fh-26dB(Hz)	OBW(Hz)	Fl-OBW(Hz)	Fh-OBW(Hz)	Limit(Hz)	Port
40.08M	5.20996G	5.25004G	37.601M	5.211169G	5.248771G	Inf	1
40.08M	5.2099G	5.24998G	37.601M	5.211169G	5.248771G	Inf	2
39.84M	5.21008G	5.24992G	37.601M	5.211169G	5.248771G	Inf	3
40.14M	5.20984G	5.24998G	37.601M	5.211169G	5.248771G	Inf	4

802.11ax HEW40_Nss1,(MCS0)_4TX

EBW

5270MHz

17/06/2022

CF
5.27GHz
Span
120MHz
RBW
500kHz
VBW
2MHz
Sweep Time
100ms
Detector Type
Peak

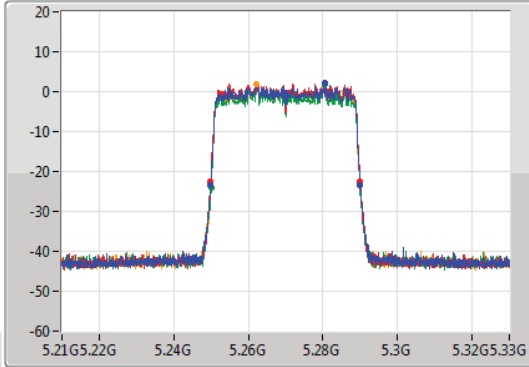

CF
5.27GHz
Span
120MHz
RBW
1MHz
VBW
3MHz
Sweep Time
100ms
Detector Type
Peak

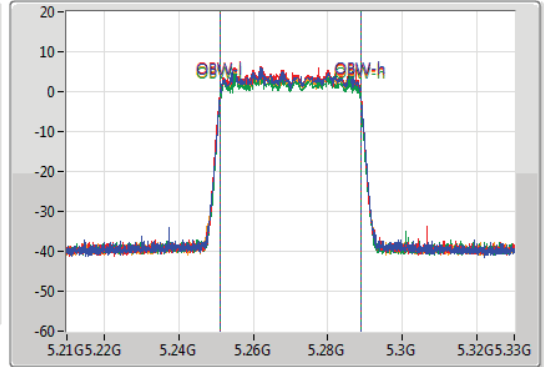

Port 1
Port 2
Port 3
Port 4

26dB(Hz)	Fl-26dB(Hz)	Fh-26dB(Hz)	OBW(Hz)	Fl-OBW(Hz)	Fh-OBW(Hz)	Limit(Hz)	Port
40.2M	5.24984G	5.29004G	37.601M	5.251169G	5.288771G	Inf	1
40.02M	5.2499G	5.28992G	37.661M	5.251109G	5.288771G	Inf	2
39.9M	5.25002G	5.28992G	37.661M	5.251109G	5.288771G	Inf	3
40.08M	5.2499G	5.28998G	37.661M	5.251109G	5.288771G	Inf	4

802.11ax HEW40_Nss1,(MCS0)_4TX

EBW

5310MHz

17/06/2022

CF
5.31GHz
Span
120MHz
RBW
500kHz
VBW
2MHz
Sweep Time
100ms
Detector Type
Peak

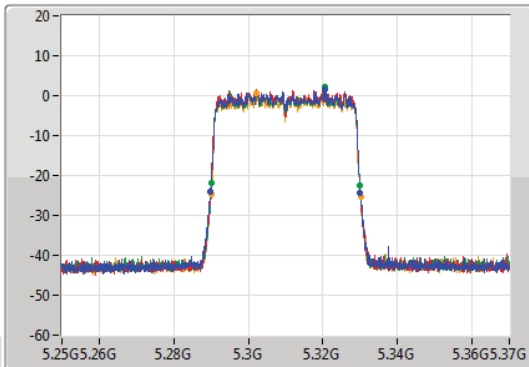

CF
5.31GHz
Span
120MHz
RBW
1MHz
VBW
3MHz
Sweep Time
100ms
Detector Type
Peak

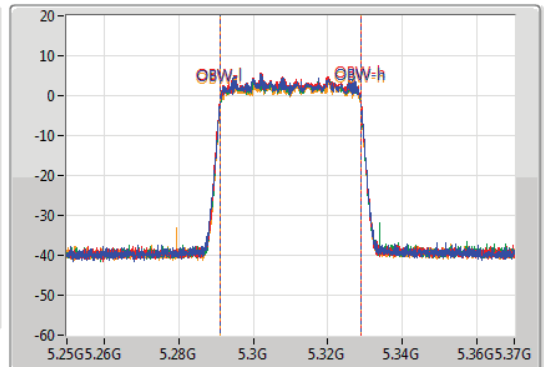

Port 1
Port 2
Port 3
Port 4

26dB(Hz)	Fl-26dB(Hz)	Fh-26dB(Hz)	OBW(Hz)	Fl-OBW(Hz)	Fh-OBW(Hz)	Limit(Hz)	Port
40.2M	5.28984G	5.33004G	37.601M	5.291169G	5.328771G	Inf	1
40.2M	5.28984G	5.33004G	37.661M	5.291109G	5.328771G	Inf	2
39.84M	5.29008G	5.32992G	37.601M	5.291169G	5.328771G	Inf	3
40.14M	5.29002G	5.33016G	37.601M	5.291169G	5.328771G	Inf	4

802.11ax HEW40_Nss1,(MCS0)_4TX

EBW

5510MHz

17/06/2022

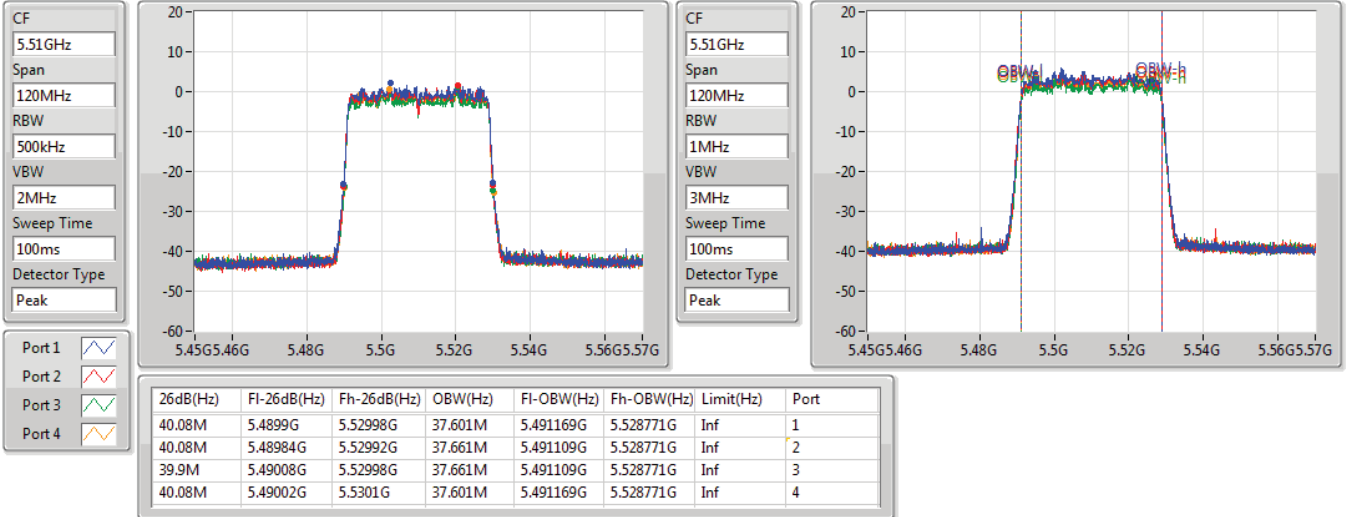

802.11ax HEW40_Nss1,(MCS0)_4TX

EBW

5550MHz

17/06/2022

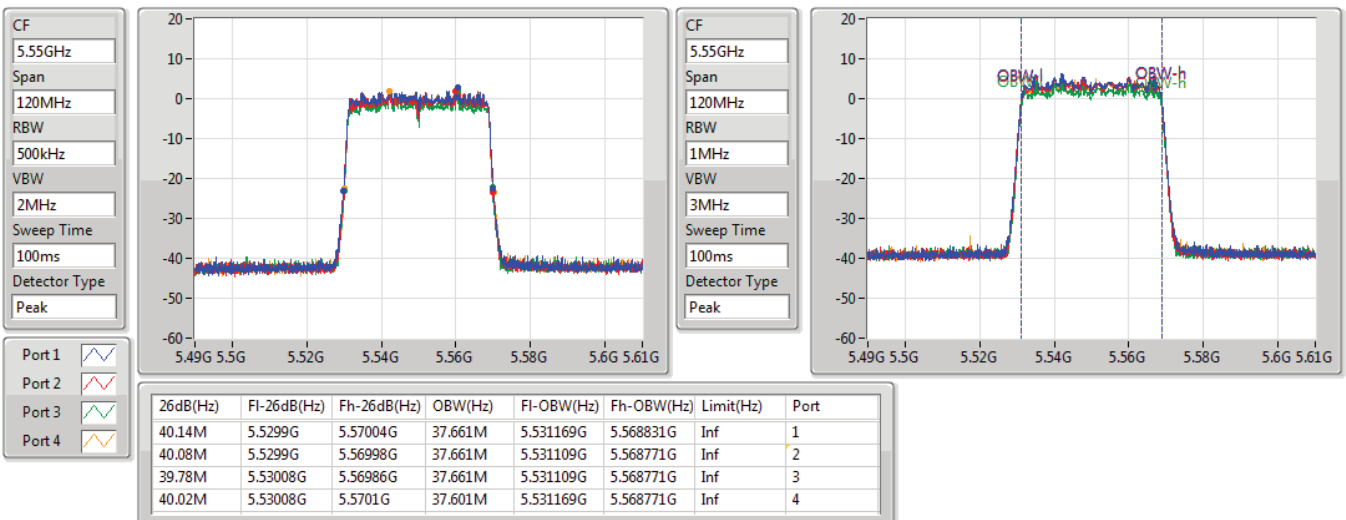

802.11ax HEW40_Nss1,(MCS0)_4TX

EBW

5670MHz

17/06/2022

CF
5.67GHz
Span
120MHz
RBW
500kHz
VBW
2MHz
Sweep Time
100ms
Detector Type
Peak

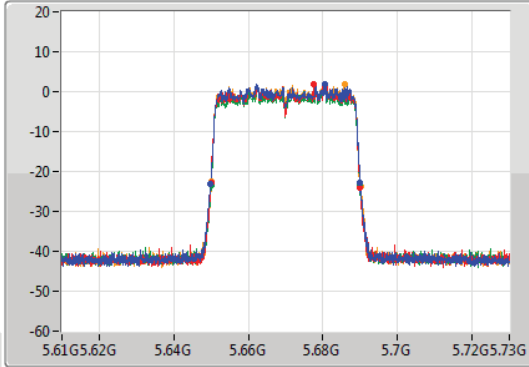

CF
5.67GHz
Span
120MHz
RBW
1MHz
VBW
3MHz
Sweep Time
100ms
Detector Type
Peak

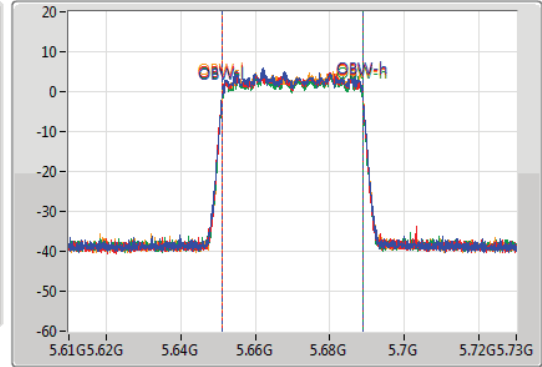

Port 1
Port 2
Port 3
Port 4

26dB(Hz)	Fl-26dB(Hz)	Fh-26dB(Hz)	OBW(Hz)	Fl-OBW(Hz)	Fh-OBW(Hz)	Limit(Hz)	Port
40.08M	5.6499G	5.68998G	37.601M	5.651169G	5.688771G	Inf	1
39.96M	5.64996G	5.68992G	37.661M	5.651109G	5.688771G	Inf	2
39.84M	5.65008G	5.68992G	37.601M	5.651169G	5.688771G	Inf	3
40.08M	5.65008G	5.69016G	37.601M	5.651169G	5.688771G	Inf	4

802.11ax HEW40_Nss1,(MCS0)_4TX

EBW

5710MHz Straddle 5.47-5.725GHz

17/06/2022

CF
5.69GHz
Span
70MHz
RBW
500kHz
VBW
2MHz
Sweep Time
100ms
Detector Type
Peak

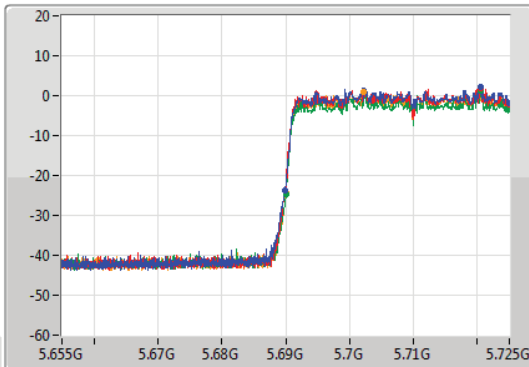

CF
5.69GHz
Span
70MHz
RBW
1MHz
VBW
3MHz
Sweep Time
100ms
Detector Type
Peak

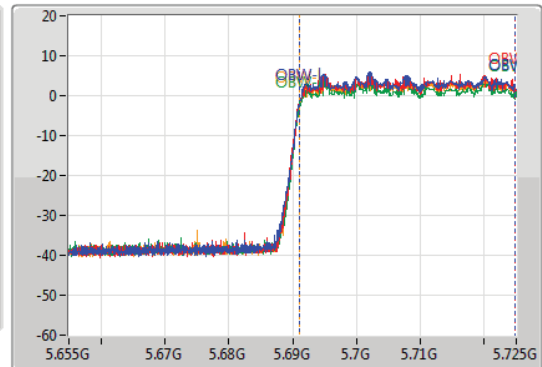

Port 1
Port 2
Port 3
Port 4

26dB(Hz)	Fl-26dB(Hz)	Fh-26dB(Hz)	OBW(Hz)	Fl-OBW(Hz)	Fh-OBW(Hz)	Limit(Hz)	Port
35.105M	5.689895G	5.725G	33.618M	5.691119G	5.724738G	Inf	1
35.175M	5.689825G	5.725G	33.688M	5.691084G	5.724773G	Inf	2
34.93M	5.69007G	5.725G	33.723M	5.691084G	5.724808G	Inf	3
35M	5.69G	5.725G	33.653M	5.691119G	5.724773G	Inf	4

802.11ax HEW40_Nss1,(MCS0)_4TX

EBW

5710MHz Straddle 5.725-5.85GHz

17/06/2022

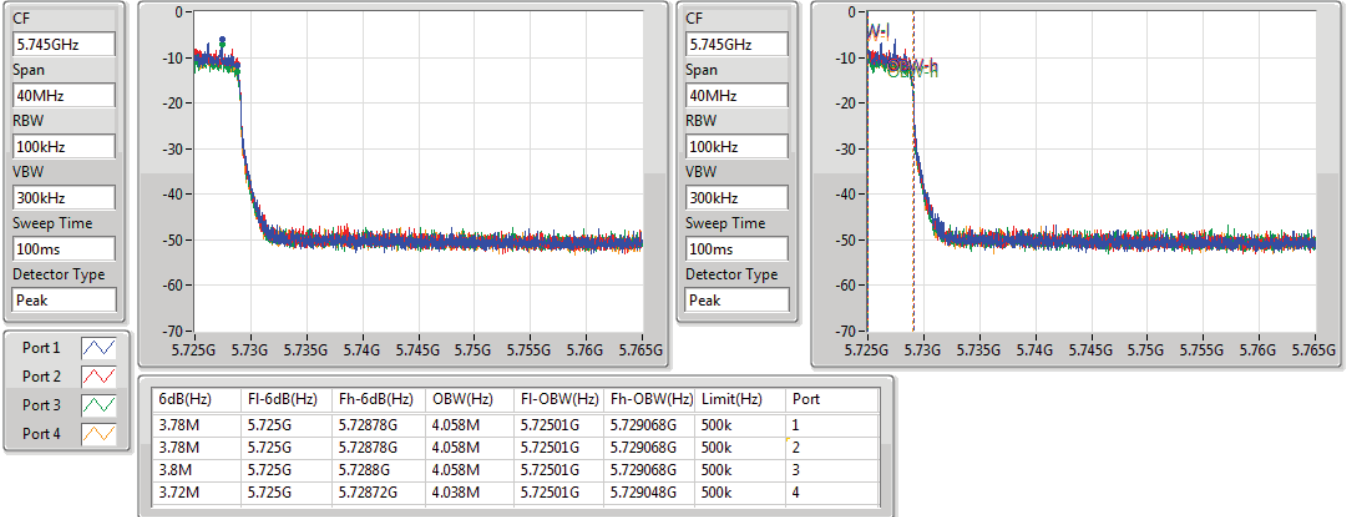

802.11ax HEW40_Nss1,(MCS0)_4TX

EBW

5755MHz

17/06/2022

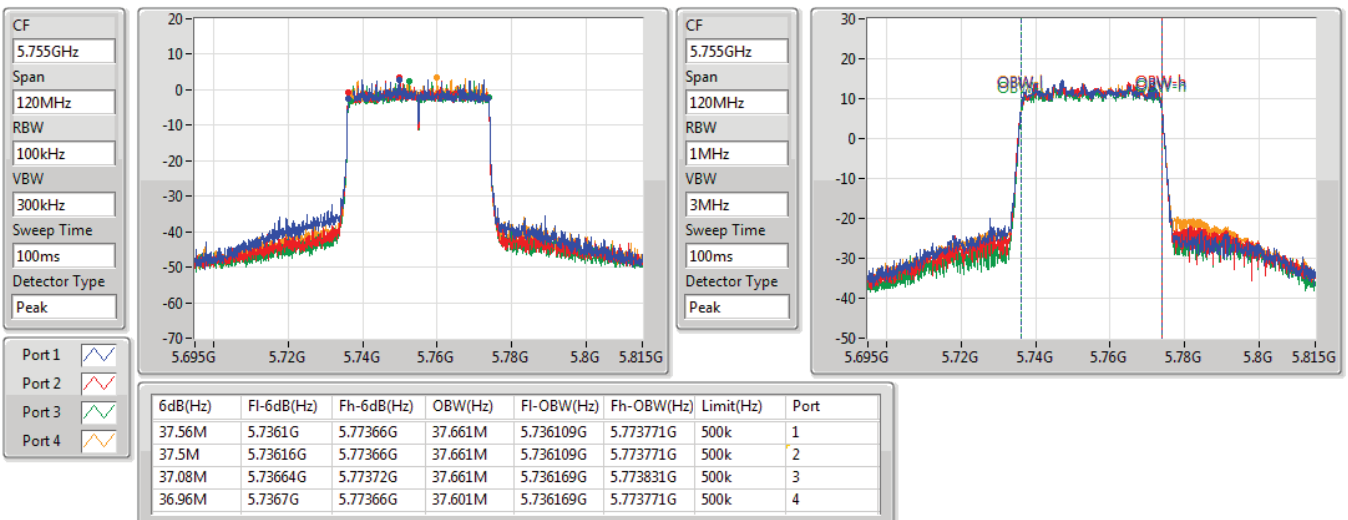

802.11ax HEW40_Nss1,(MCS0)_4TX

EBW

5795MHz

17/06/2022

CF
5.795GHz
Span
120MHz
RBW
100kHz
VBW
300kHz
Sweep Time
100ms
Detector Type
Peak

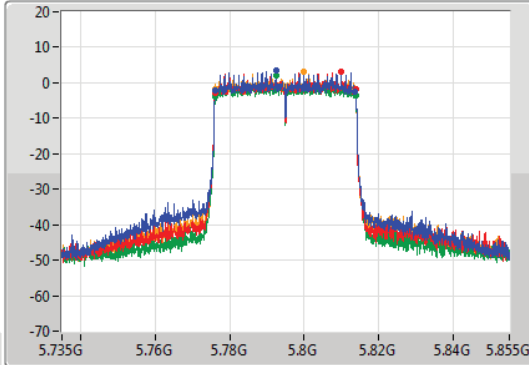

CF
5.795GHz
Span
120MHz
RBW
1MHz
VBW
3MHz
Sweep Time
100ms
Detector Type
Peak

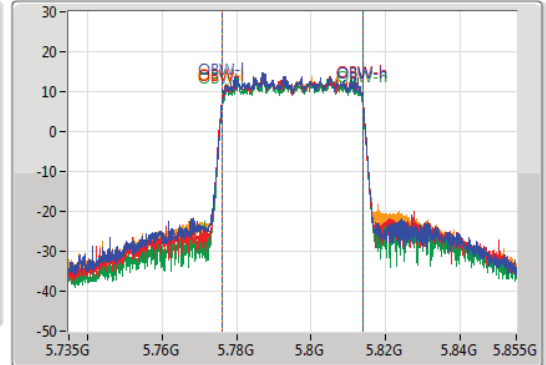

Port 1
Port 2
Port 3
Port 4

6dB(Hz)	Fl-6dB(Hz)	Fh-6dB(Hz)	OBW(Hz)	Fl-OBW(Hz)	Fh-OBW(Hz)	Limit(Hz)	Port
37.5M	5.77616G	5.81366G	37.601M	5.776169G	5.813771G	500k	1
37.62M	5.7761G	5.81372G	37.661M	5.776109G	5.813771G	500k	2
37.62M	5.77622G	5.81384G	37.601M	5.776169G	5.813771G	500k	3
37.56M	5.7761G	5.81366G	37.661M	5.776109G	5.813771G	500k	4

802.11ax HEW80_Nss1,(MCS0)_4TX

EBW

5210MHz

17/06/2022

CF
5.21GHz
Span
240MHz
RBW
1MHz
VBW
3MHz
Sweep Time
100ms
Detector Type
Peak

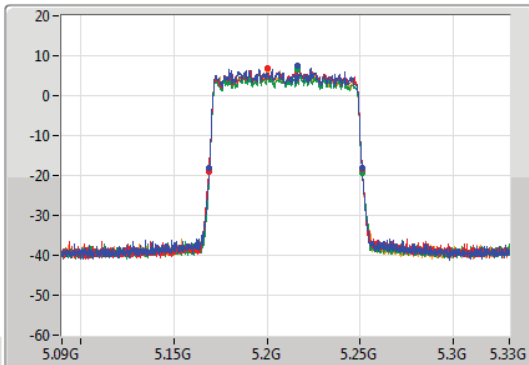

CF
5.21GHz
Span
240MHz
RBW
2MHz
VBW
10MHz
Sweep Time
100ms
Detector Type
Peak

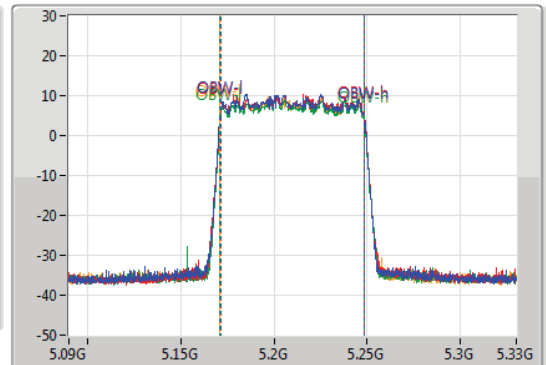

Port 1
Port 2
Port 3
Port 4

26dB(Hz)	Fl-26dB(Hz)	Fh-26dB(Hz)	OBW(Hz)	Fl-OBW(Hz)	Fh-OBW(Hz)	Limit(Hz)	Port
81.84M	5.1692G	5.25104G	77.361M	5.171259G	5.248621G	Inf	1
82.32M	5.16872G	5.25104G	77.361M	5.171259G	5.248621G	Inf	2
82.08M	5.16908G	5.25116G	77.481M	5.171139G	5.248621G	Inf	3
82.08M	5.16908G	5.25116G	77.361M	5.171139G	5.248501G	Inf	4

802.11ax HEW80_Nss1,(MCS0)_4TX

EBW

5290MHz

17/06/2022

CF
5.29GHz
Span
240MHz
RBW
1MHz
VBW
3MHz
Sweep Time
100ms
Detector Type
Peak

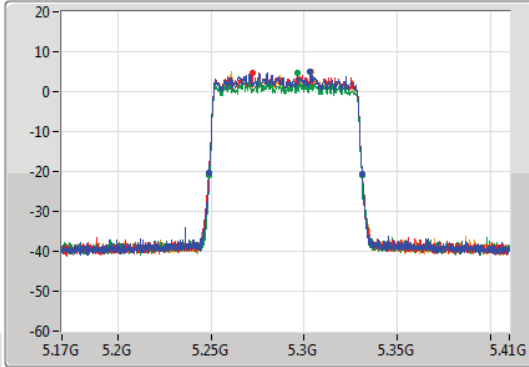

CF
5.29GHz
Span
240MHz
RBW
2MHz
VBW
10MHz
Sweep Time
100ms
Detector Type
Peak

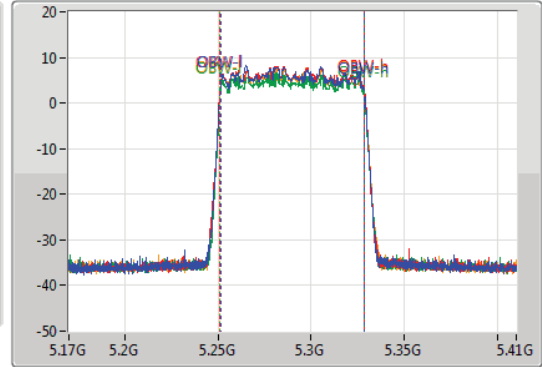

Port 1
Port 2
Port 3
Port 4

26dB(Hz)	Fl-26dB(Hz)	Fh-26dB(Hz)	OBW(Hz)	Fl-OBW(Hz)	Fh-OBW(Hz)	Limit(Hz)	Port
81.96M	5.24908G	5.33104G	77.361M	5.251259G	5.328621G	Inf	1
82.2M	5.24884G	5.33104G	77.481M	5.251139G	5.328621G	Inf	2
81.96M	5.24908G	5.33104G	77.481M	5.251139G	5.328621G	Inf	3
82.08M	5.24908G	5.33116G	77.481M	5.251139G	5.328621G	Inf	4

802.11ax HEW80_Nss1,(MCS0)_4TX

EBW

5530MHz

17/06/2022

CF
5.53GHz
Span
240MHz
RBW
1MHz
VBW
3MHz
Sweep Time
100ms
Detector Type
Peak

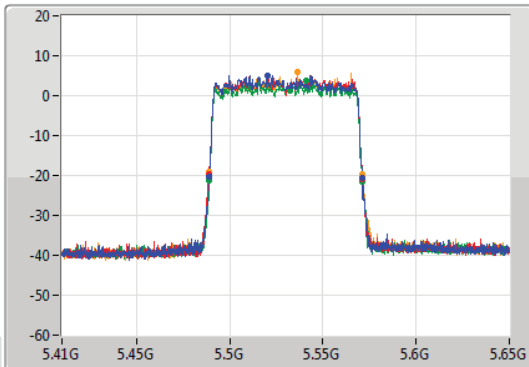

CF
5.53GHz
Span
240MHz
RBW
2MHz
VBW
10MHz
Sweep Time
100ms
Detector Type
Peak

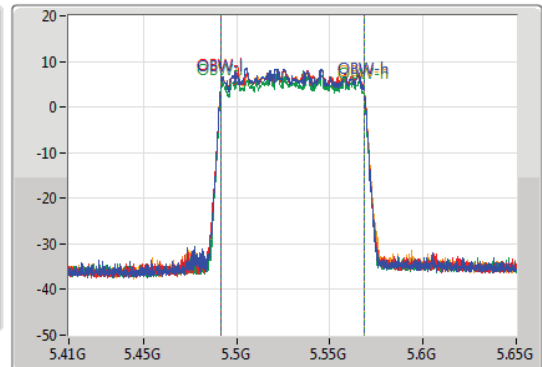

Port 1
Port 2
Port 3
Port 4

26dB(Hz)	Fl-26dB(Hz)	Fh-26dB(Hz)	OBW(Hz)	Fl-OBW(Hz)	Fh-OBW(Hz)	Limit(Hz)	Port
82.08M	5.48908G	5.57116G	77.361M	5.491259G	5.568621G	Inf	1
82.44M	5.48884G	5.57128G	77.481M	5.491259G	5.568741G	Inf	2
82.08M	5.48908G	5.57116G	77.481M	5.491259G	5.568741G	Inf	3
81.96M	5.4892G	5.57116G	77.481M	5.491259G	5.568741G	Inf	4

802.11ax HEW80_Nss1,(MCS0)_4TX

EBW

5610MHz

17/06/2022

CF
5.61GHz
Span
240MHz
RBW
1MHz
VBW
3MHz
Sweep Time
100ms
Detector Type
Peak

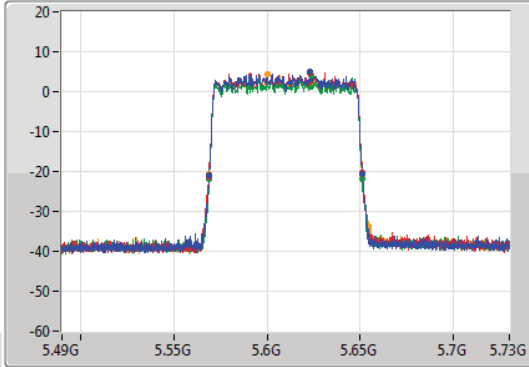

CF
5.61GHz
Span
240MHz
RBW
2MHz
VBW
10MHz
Sweep Time
100ms
Detector Type
Peak

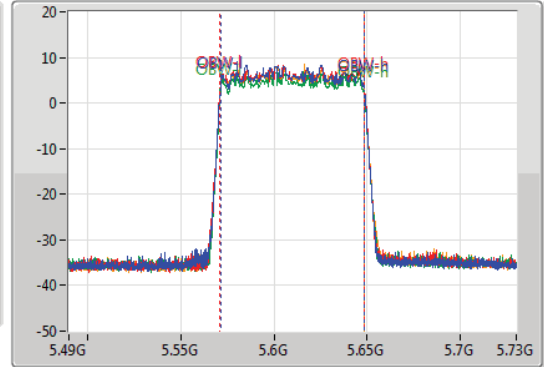

Port 1
Port 2
Port 3
Port 4

26dB(Hz)	Fl-26dB(Hz)	Fh-26dB(Hz)	OBW(Hz)	Fl-OBW(Hz)	Fh-OBW(Hz)	Limit(Hz)	Port
81.96M	5.56908G	5.65104G	77.361M	5.571259G	5.648621G	Inf	1
82.68M	5.5686G	5.65128G	77.481M	5.571139G	5.648621G	Inf	2
82.32M	5.56908G	5.6514G	77.601M	5.571139G	5.648741G	Inf	3
82.32M	5.56908G	5.6514G	77.481M	5.571259G	5.648741G	Inf	4

802.11ax HEW80_Nss1,(MCS0)_4TX

EBW

5690MHz Straddle 5.47-5.725GHz

17/06/2022

CF
5.65GHz
Span
150MHz
RBW
1MHz
VBW
3MHz
Sweep Time
100ms
Detector Type
Peak

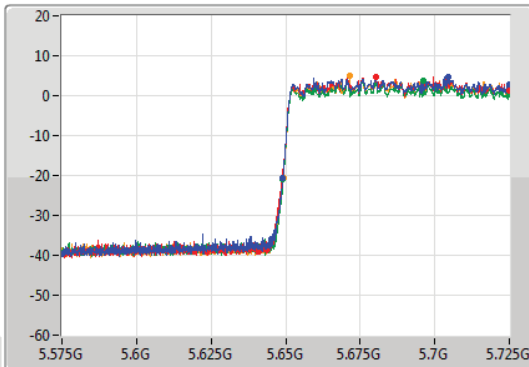

CF
5.65GHz
Span
150MHz
RBW
2MHz
VBW
10MHz
Sweep Time
100ms
Detector Type
Peak

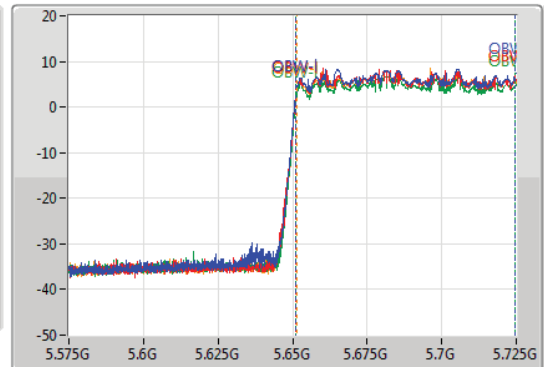

Port 1
Port 2
Port 3
Port 4

26dB(Hz)	Fl-26dB(Hz)	Fh-26dB(Hz)	OBW(Hz)	Fl-OBW(Hz)	Fh-OBW(Hz)	Limit(Hz)	Port
75.9M	5.6491G	5.725G	73.538M	5.651199G	5.724738G	Inf	1
76.2M	5.6488G	5.725G	73.463M	5.651199G	5.724663G	Inf	2
75.9M	5.6491G	5.725G	73.463M	5.651199G	5.724663G	Inf	3
75.825M	5.649175G	5.725G	73.313M	5.651274G	5.724588G	Inf	4

802.11ax HEW80_Nss1,(MCS0)_4TX

EBW

5690MHz Straddle 5.725-5.85GHz

17/06/2022

CF
5.745GHz
Span
40MHz
RBW
100kHz
VBW
300kHz
Sweep Time
100ms
Detector Type
Peak

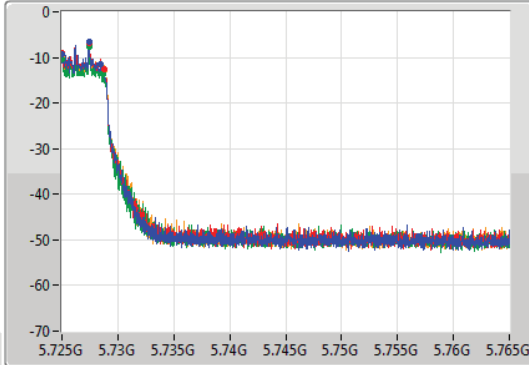

CF
5.745GHz
Span
40MHz
RBW
100kHz
VBW
300kHz
Sweep Time
100ms
Detector Type
Peak

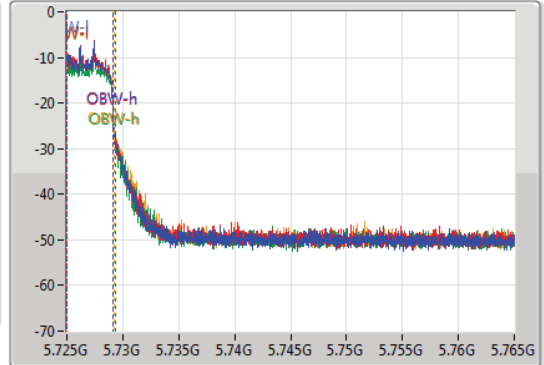

Port 1
Port 2
Port 3
Port 4

6dB(Hz)	Fl-6dB(Hz)	Fh-6dB(Hz)	OBW(Hz)	Fl-OBW(Hz)	Fh-OBW(Hz)	Limit(Hz)	Port
3.48M	5.725G	5.72848G	4.158M	5.72501G	5.729168G	500k	1
3.8M	5.725G	5.7288G	4.158M	5.72501G	5.729168G	500k	2
3.66M	5.725G	5.72866G	4.298M	5.72501G	5.729308G	500k	3
3.8M	5.725G	5.7288G	4.258M	5.72501G	5.729268G	500k	4

802.11ax HEW80_Nss1,(MCS0)_4TX

EBW

5775MHz

17/06/2022

CF
5.775GHz
Span
240MHz
RBW
100kHz
VBW
300kHz
Sweep Time
100ms
Detector Type
Peak

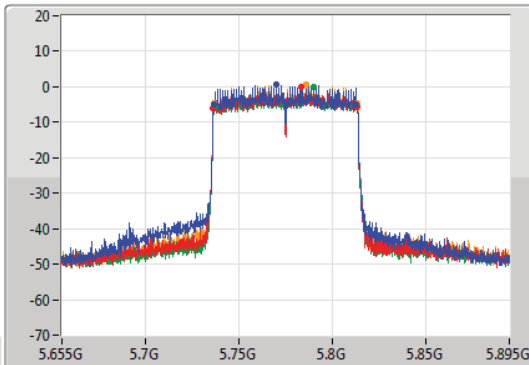

CF
5.775GHz
Span
240MHz
RBW
2MHz
VBW
10MHz
Sweep Time
100ms
Detector Type
Peak

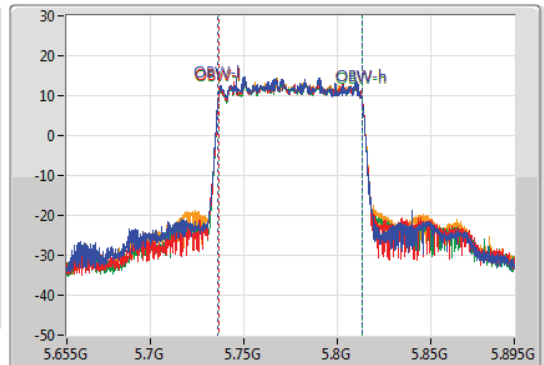

Port 1
Port 2
Port 3
Port 4

6dB(Hz)	Fl-6dB(Hz)	Fh-6dB(Hz)	OBW(Hz)	Fl-OBW(Hz)	Fh-OBW(Hz)	Limit(Hz)	Port
76.56M	5.73624G	5.8128G	77.481M	5.736139G	5.813621G	500k	1
77.28M	5.73612G	5.8134G	77.481M	5.736259G	5.813741G	500k	2
76.32M	5.7372G	5.81352G	77.481M	5.736259G	5.813741G	500k	3
77.04M	5.73648G	5.81352G	77.481M	5.736259G	5.813741G	500k	4

802.11ax HEW160_Nss1,(MCS0)_4TX

EBW

5250MHz Straddle 5.15-5.25GHz

17/06/2022

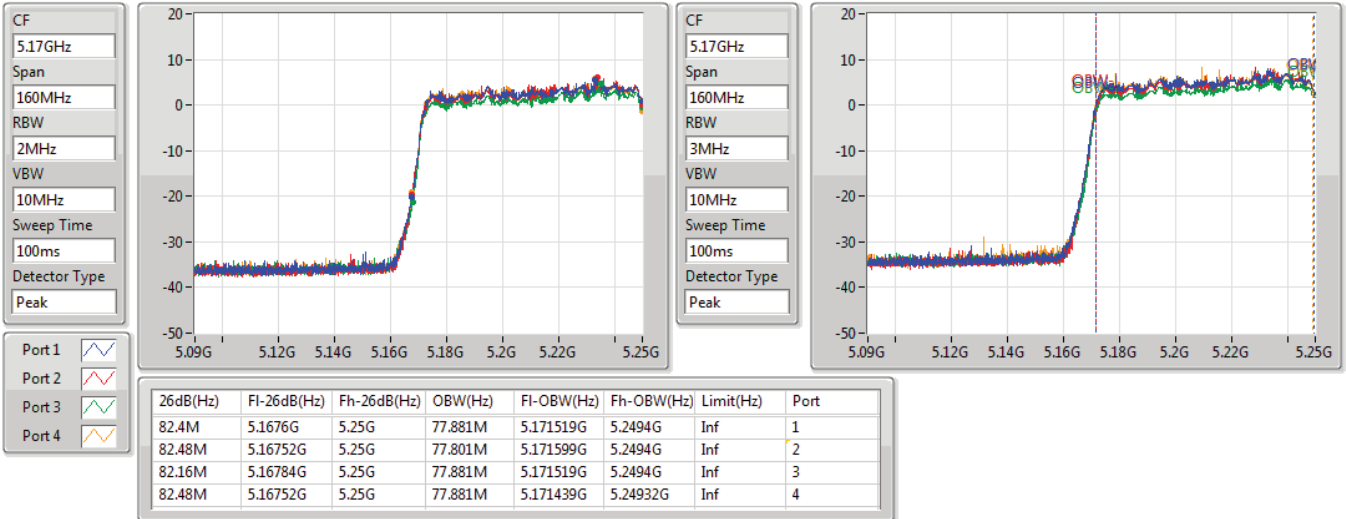

802.11ax HEW160_Nss1,(MCS0)_4TX

EBW

5250MHz Straddle 5.25-5.35GHz

17/06/2022

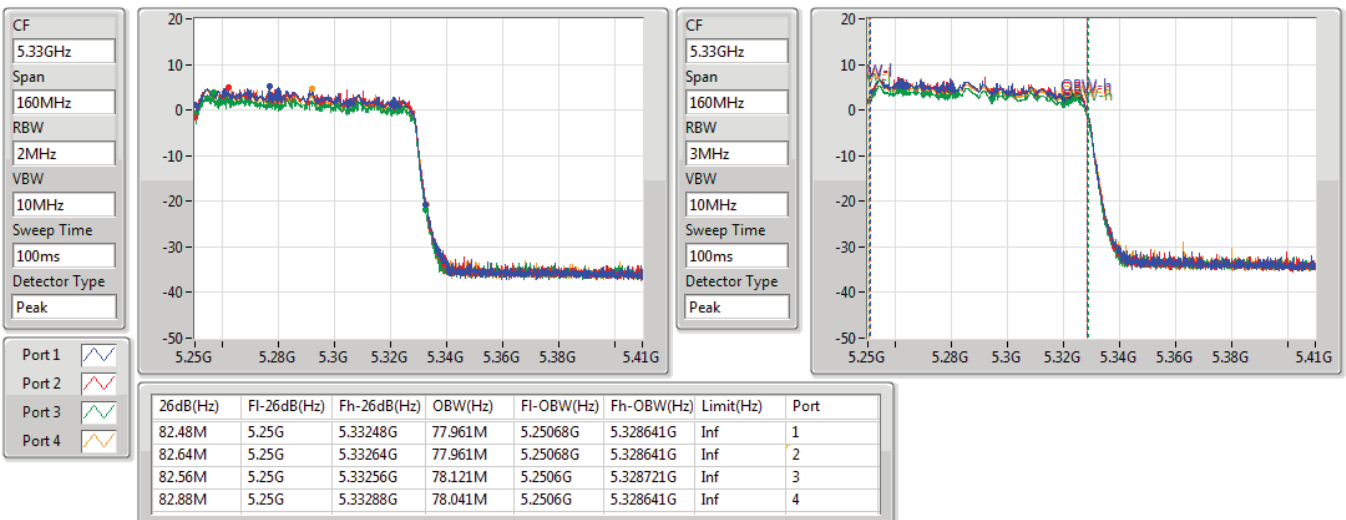

802.11ax HEW160_Nss1,(MCS0)_4TX

EBW

5570MHz

17/06/2022

CF
5.57GHz
Span
480MHz
RBW
2MHz
VBW
10MHz
Sweep Time
100ms
Detector Type
Peak

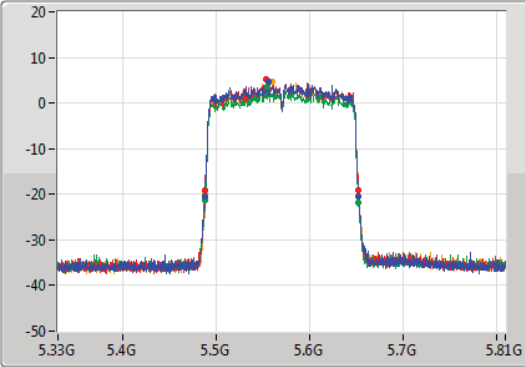

CF
5.57GHz
Span
480MHz
RBW
3MHz
VBW
10MHz
Sweep Time
100ms
Detector Type
Peak

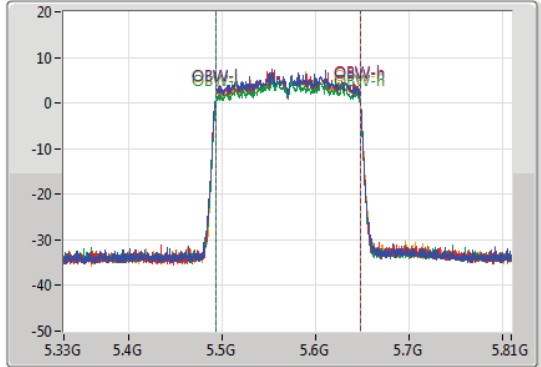

Port 1

Port 2

Port 3

Port 4

26dB(Hz)	Fl-26dB(Hz)	Fh-26dB(Hz)	OBW(Hz)	Fl-OBW(Hz)	Fh-OBW(Hz)	Limit(Hz)	Port
164.88M	5.48768G	5.65256G	155.202M	5.492519G	5.647721G	Inf	1
164.64M	5.48768G	5.65232G	155.202M	5.492519G	5.647721G	Inf	2
164.4M	5.48816G	5.65256G	155.442M	5.492519G	5.647961G	Inf	3
164.64M	5.48816G	5.6528G	155.442M	5.492519G	5.647961G	Inf	4



Summary

Mode	Max-N dB (Hz)	Max-OBW (Hz)	ITU-Code	Min-N dB (Hz)	Min-OBW (Hz)
5.15-5.25GHz	-	-	-	-	-
802.11a_Nss1,(6Mbps)_2TX	21.57M	17.061M	17M1D1D	21.42M	16.852M
802.11n HT20_Nss1,(MCS0)_2TX	21.78M	18.171M	18M2D1D	21.36M	17.871M
802.11n HT40_Nss1,(MCS0)_2TX	40.26M	36.762M	36M8D1D	39.54M	36.462M
802.11ac VHT20_Nss1,(MCS0)_2TX	21.78M	18.081M	18M1D1D	21.42M	17.931M
802.11ac VHT40_Nss1,(MCS0)_2TX	40.32M	36.762M	36M8D1D	39.9M	36.582M
802.11ac VHT80_Nss1,(MCS0)_2TX	82.32M	76.162M	76M2D1D	81.24M	76.042M
802.11ax HEW20_Nss1,(MCS0)_2TX	21.72M	19.13M	19M2D1D	21.51M	19.07M
802.11ax HEW40_Nss1,(MCS0)_2TX	40.14M	37.661M	37M7D1D	39.84M	37.601M
802.11ax HEW80_Nss1,(MCS0)_2TX	82.08M	77.481M	77M5D1D	81.84M	77.361M
5.25-5.35GHz	-	-	-	-	-
802.11a_Nss1,(6Mbps)_2TX	21.54M	17.061M	17M1D1D	21.3M	16.822M
802.11n HT20_Nss1,(MCS0)_2TX	21.69M	18.141M	18M2D1D	21.48M	17.841M
802.11n HT40_Nss1,(MCS0)_2TX	40.56M	36.762M	36M8D1D	39.48M	36.522M
802.11ac VHT20_Nss1,(MCS0)_2TX	21.84M	18.081M	18M1D1D	21.54M	17.901M
802.11ac VHT40_Nss1,(MCS0)_2TX	40.26M	36.762M	36M8D1D	39.9M	36.582M
802.11ac VHT80_Nss1,(MCS0)_2TX	81.96M	76.162M	76M2D1D	81.6M	76.042M
802.11ax HEW20_Nss1,(MCS0)_2TX	21.6M	19.1M	19M1D1D	21.42M	19.04M
802.11ax HEW40_Nss1,(MCS0)_2TX	40.02M	37.661M	37M7D1D	39.9M	37.601M
802.11ax HEW80_Nss1,(MCS0)_2TX	82.2M	77.601M	77M7D1D	82.08M	77.481M
5.47-5.725GHz	-	-	-	-	-
802.11a_Nss1,(6Mbps)_2TX	21.45M	17.061M	17M1D1D	15.525M	13.448M
802.11n HT20_Nss1,(MCS0)_2TX	21.75M	18.141M	18M2D1D	15.675M	13.943M
802.11n HT40_Nss1,(MCS0)_2TX	40.2M	36.702M	36M8D1D	34.685M	33.058M
802.11ac VHT20_Nss1,(MCS0)_2TX	21.69M	18.081M	18M1D1D	15.705M	13.973M
802.11ac VHT40_Nss1,(MCS0)_2TX	40.26M	36.762M	36M8D1D	34.72M	33.093M
802.11ac VHT80_Nss1,(MCS0)_2TX	82.2M	76.042M	76MOD1D	75.375M	72.639M
802.11ax HEW20_Nss1,(MCS0)_2TX	21.84M	19.1M	19M1D1D	15.63M	14.498M
802.11ax HEW40_Nss1,(MCS0)_2TX	40.02M	37.601M	37M7D1D	34.86M	33.583M
802.11ax HEW80_Nss1,(MCS0)_2TX	82.2M	77.601M	77M7D1D	75.675M	73.388M
5.725-5.85GHz	-	-	-	-	-
802.11a_Nss1,(6Mbps)_2TX	16.44M	17.811M	17M9D1D	3.18M	4.098M
802.11n HT20_Nss1,(MCS0)_2TX	17.61M	18.351M	18M4D1D	3.78M	4.418M
802.11n HT40_Nss1,(MCS0)_2TX	36.36M	37.121M	37M2D1D	3.16M	3.678M
802.11ac VHT20_Nss1,(MCS0)_2TX	17.58M	18.291M	18M3D1D	3.78M	4.458M
802.11ac VHT40_Nss1,(MCS0)_2TX	36.36M	37.181M	37M2D1D	3.16M	3.698M
802.11ac VHT80_Nss1,(MCS0)_2TX	76.32M	76.282M	76M3D1D	3.14M	3.838M
802.11ax HEW20_Nss1,(MCS0)_2TX	18.99M	19.34M	19M4D1D	4.48M	4.638M
802.11ax HEW40_Nss1,(MCS0)_2TX	37.68M	38.021M	38MOD1D	3.82M	4.078M
802.11ax HEW80_Nss1,(MCS0)_2TX	76.56M	77.721M	77M8D1D	3.74M	4.178M

Max-N dB = Maximum 6dB down bandwidth for 5.725-5.85GHz band / Maximum 26dB down bandwidth for other band;
 Max-OBW = Maximum 99% occupied bandwidth;
 Min-N dB = Minimum 6dB down bandwidth for 5.725-5.85GHz band / Maximum 26dB down bandwidth for other band;
 Min-OBW = Minimum 99% occupied bandwidth



Result

Mode	Result	Limit (Hz)	Port 1-N dB (Hz)	Port 1-OBW (Hz)	Port 2-N dB (Hz)	Port 2-OBW (Hz)
802.11a_Nss1,(6Mbps)_2TX	-	-	-	-	-	-
5180MHz	Pass	Inf	21.57M	17.061M	21.48M	16.852M
5200MHz	Pass	Inf	21.48M	17.061M	21.45M	16.852M
5240MHz	Pass	Inf	21.57M	17.061M	21.42M	16.852M
5260MHz	Pass	Inf	21.45M	17.031M	21.3M	16.852M
5300MHz	Pass	Inf	21.54M	17.031M	21.33M	16.822M
5320MHz	Pass	Inf	21.51M	17.061M	21.33M	16.822M
5500MHz	Pass	Inf	21.42M	17.061M	21.39M	16.852M
5580MHz	Pass	Inf	21.42M	17.031M	21.36M	16.822M
5700MHz	Pass	Inf	21.45M	17.061M	21.33M	16.852M
5720MHz Straddle 5.47-5.725GHz	Pass	Inf	15.6M	13.508M	15.525M	13.448M
5720MHz Straddle 5.725-5.85GHz	Pass	500k	3.18M	4.278M	3.18M	4.098M
5745MHz	Pass	500k	16.35M	17.481M	16.32M	17.811M
5785MHz	Pass	500k	16.32M	17.391M	16.32M	17.421M
5825MHz	Pass	500k	16.35M	17.391M	16.44M	17.361M
802.11n HT20_Nss1,(MCS0)_2TX	-	-	-	-	-	-
5180MHz	Pass	Inf	21.69M	18.141M	21.36M	17.871M
5200MHz	Pass	Inf	21.72M	18.171M	21.6M	17.871M
5240MHz	Pass	Inf	21.78M	18.141M	21.6M	17.871M
5260MHz	Pass	Inf	21.69M	18.111M	21.48M	17.841M
5300MHz	Pass	Inf	21.66M	18.141M	21.51M	17.871M
5320MHz	Pass	Inf	21.63M	18.141M	21.54M	17.841M
5500MHz	Pass	Inf	21.72M	18.141M	21.51M	17.871M
5580MHz	Pass	Inf	21.69M	18.141M	21.45M	17.871M
5700MHz	Pass	Inf	21.75M	18.141M	21.48M	17.841M
5720MHz Straddle 5.47-5.725GHz	Pass	Inf	15.855M	14.168M	15.675M	13.943M
5720MHz Straddle 5.725-5.85GHz	Pass	500k	3.78M	4.438M	3.8M	4.418M
5745MHz	Pass	500k	17.58M	18.351M	17.61M	18.171M
5785MHz	Pass	500k	17.58M	18.321M	17.58M	18.111M
5825MHz	Pass	500k	17.58M	18.291M	17.58M	18.141M
802.11n HT40_Nss1,(MCS0)_2TX	-	-	-	-	-	-
5190MHz	Pass	Inf	40.08M	36.702M	39.54M	36.462M
5230MHz	Pass	Inf	40.26M	36.762M	39.54M	36.582M
5270MHz	Pass	Inf	40.56M	36.762M	39.6M	36.522M
5310MHz	Pass	Inf	40.2M	36.762M	39.48M	36.522M
5510MHz	Pass	Inf	40.2M	36.702M	39.48M	36.462M
5550MHz	Pass	Inf	40.2M	36.702M	39.48M	36.522M
5670MHz	Pass	Inf	40.2M	36.702M	39.48M	36.522M
5710MHz Straddle 5.47-5.725GHz	Pass	Inf	35.105M	33.268M	34.685M	33.058M
5710MHz Straddle 5.725-5.85GHz	Pass	500k	3.16M	3.718M	3.16M	3.678M
5755MHz	Pass	500k	36.3M	37.121M	36.3M	36.942M
5795MHz	Pass	500k	36.3M	37.121M	36.36M	36.882M
802.11ac VHT20_Nss1,(MCS0)_2TX	-	-	-	-	-	-
5180MHz	Pass	Inf	21.78M	18.081M	21.72M	17.931M
5200MHz	Pass	Inf	21.63M	18.081M	21.6M	17.931M
5240MHz	Pass	Inf	21.63M	18.051M	21.42M	17.931M
5260MHz	Pass	Inf	21.84M	18.051M	21.54M	17.931M
5300MHz	Pass	Inf	21.78M	18.081M	21.57M	17.901M
5320MHz	Pass	Inf	21.78M	18.081M	21.63M	17.901M
5500MHz	Pass	Inf	21.66M	18.081M	21.69M	17.901M
5580MHz	Pass	Inf	21.69M	18.081M	21.48M	17.901M
5700MHz	Pass	Inf	21.69M	18.081M	21.57M	17.901M
5720MHz Straddle 5.47-5.725GHz	Pass	Inf	15.795M	14.063M	15.705M	13.973M
5720MHz Straddle 5.725-5.85GHz	Pass	500k	3.78M	4.458M	3.78M	4.478M
5745MHz	Pass	500k	17.58M	18.291M	17.58M	18.261M



EBW_Non-Beamforming_Radio 3

Appendix B.3

Mode	Result	Limit (Hz)	Port 1-N dB (Hz)	Port 1-OBW (Hz)	Port 2-N dB (Hz)	Port 2-OBW (Hz)
5785MHz	Pass	500k	17.58M	18.291M	17.58M	18.171M
5825MHz	Pass	500k	17.58M	18.291M	17.58M	18.141M
802.11ac VHT40_Nss1,(MCS0)_2TX	-	-	-	-	-	-
5190MHz	Pass	Inf	40.26M	36.702M	39.9M	36.582M
5230MHz	Pass	Inf	40.32M	36.762M	39.9M	36.642M
5270MHz	Pass	Inf	40.26M	36.762M	39.9M	36.582M
5310MHz	Pass	Inf	40.2M	36.642M	39.96M	36.582M
5510MHz	Pass	Inf	40.2M	36.762M	39.96M	36.582M
5550MHz	Pass	Inf	40.26M	36.702M	39.78M	36.582M
5670MHz	Pass	Inf	40.26M	36.702M	39.84M	36.582M
5710MHz Straddle 5.47-5.725GHz	Pass	Inf	35.21M	33.233M	34.72M	33.093M
5710MHz Straddle 5.725-5.85GHz	Pass	500k	3.16M	3.698M	3.16M	3.778M
5755MHz	Pass	500k	36.3M	37.181M	36.36M	37.121M
5795MHz	Pass	500k	36.36M	37.121M	36.36M	37.061M
802.11ac VHT80_Nss1,(MCS0)_2TX	-	-	-	-	-	-
5210MHz	Pass	Inf	82.32M	76.162M	81.24M	76.042M
5290MHz	Pass	Inf	81.96M	76.042M	81.6M	76.162M
5530MHz	Pass	Inf	82.2M	76.042M	81.24M	76.042M
5610MHz	Pass	Inf	82.2M	76.042M	81.48M	75.922M
5690MHz Straddle 5.47-5.725GHz	Pass	Inf	75.975M	72.714M	75.375M	72.639M
5690MHz Straddle 5.725-5.85GHz	Pass	500k	3.14M	3.918M	3.14M	3.838M
5775MHz	Pass	500k	75.36M	76.282M	76.32M	76.282M
802.11ax HEW20_Nss1,(MCS0)_2TX	-	-	-	-	-	-
5180MHz	Pass	Inf	21.6M	19.07M	21.51M	19.1M
5200MHz	Pass	Inf	21.72M	19.07M	21.57M	19.13M
5240MHz	Pass	Inf	21.57M	19.07M	21.63M	19.13M
5260MHz	Pass	Inf	21.6M	19.04M	21.54M	19.1M
5300MHz	Pass	Inf	21.51M	19.07M	21.42M	19.1M
5320MHz	Pass	Inf	21.57M	19.04M	21.45M	19.1M
5500MHz	Pass	Inf	21.66M	19.07M	21.6M	19.1M
5580MHz	Pass	Inf	21.78M	19.04M	21.6M	19.1M
5700MHz	Pass	Inf	21.84M	19.04M	21.51M	19.07M
5720MHz Straddle 5.47-5.725GHz	Pass	Inf	15.72M	14.528M	15.63M	14.498M
5720MHz Straddle 5.725-5.85GHz	Pass	500k	4.48M	4.638M	4.48M	4.738M
5745MHz	Pass	500k	18.96M	19.22M	18.93M	19.34M
5785MHz	Pass	500k	18.9M	19.19M	18.9M	19.25M
5825MHz	Pass	500k	18.99M	19.22M	18.75M	19.25M
802.11ax HEW40_Nss1,(MCS0)_2TX	-	-	-	-	-	-
5190MHz	Pass	Inf	40.14M	37.601M	39.84M	37.601M
5230MHz	Pass	Inf	40.02M	37.601M	39.84M	37.661M
5270MHz	Pass	Inf	40.02M	37.601M	39.9M	37.661M
5310MHz	Pass	Inf	40.02M	37.661M	39.9M	37.601M
5510MHz	Pass	Inf	39.96M	37.601M	39.84M	37.601M
5550MHz	Pass	Inf	40.02M	37.601M	40.02M	37.601M
5670MHz	Pass	Inf	39.96M	37.601M	39.9M	37.601M
5710MHz Straddle 5.47-5.725GHz	Pass	Inf	34.93M	33.653M	34.86M	33.583M
5710MHz Straddle 5.725-5.85GHz	Pass	500k	3.82M	4.078M	3.84M	4.098M
5755MHz	Pass	500k	37.26M	37.901M	37.02M	38.021M
5795MHz	Pass	500k	37.32M	37.901M	37.68M	38.021M
802.11ax HEW80_Nss1,(MCS0)_2TX	-	-	-	-	-	-
5210MHz	Pass	Inf	82.08M	77.481M	81.84M	77.361M
5290MHz	Pass	Inf	82.2M	77.601M	82.08M	77.481M
5530MHz	Pass	Inf	81.96M	77.481M	81.6M	77.361M
5610MHz	Pass	Inf	82.2M	77.601M	81.72M	77.361M
5690MHz Straddle 5.47-5.725GHz	Pass	Inf	75.675M	73.388M	75.825M	73.388M
5690MHz Straddle 5.725-5.85GHz	Pass	500k	3.82M	4.318M	3.74M	4.178M



Mode	Result	Limit (Hz)	Port 1-N dB (Hz)	Port 1-OBW (Hz)	Port 2-N dB (Hz)	Port 2-OBW (Hz)
5775MHz	Pass	500k	76.32M	77.601M	76.56M	77.721M

Port X-N dB = Port X 6dB down bandwidth for 5.725-5.85GHz band / 26dB down bandwidth for other band
Port X-OBW = Port X 99% occupied bandwidth

802.11a_Nss1,(6Mbps)_2TX

EBW

5180MHz

18/06/2022

CF
5.18GHz
Span
60MHz
RBW
300kHz
VBW
1MHz
Sweep Time
100ms
Detector Type
Peak

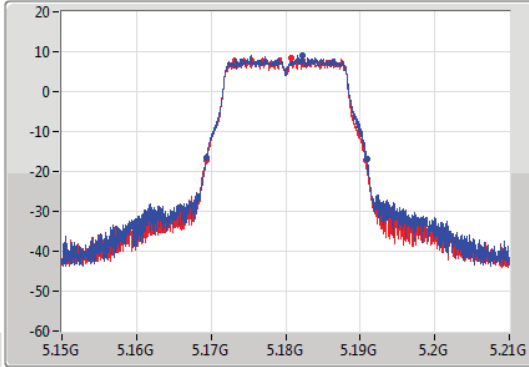

CF
5.18GHz
Span
60MHz
RBW
300kHz
VBW
1MHz
Sweep Time
100ms
Detector Type
Peak

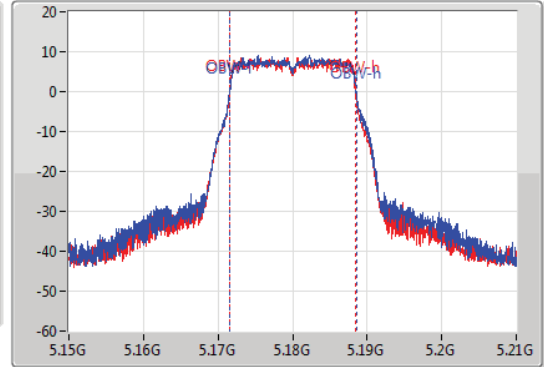

Port 1
Port 2

802.11a_Nss1,(6Mbps)_2TX

EBW

5200MHz

18/06/2022

CF
5.2GHz
Span
60MHz
RBW
300kHz
VBW
1MHz
Sweep Time
100ms
Detector Type
Peak

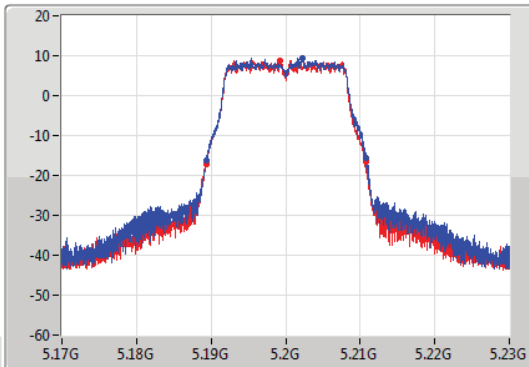

CF
5.2GHz
Span
60MHz
RBW
300kHz
VBW
1MHz
Sweep Time
100ms
Detector Type
Peak

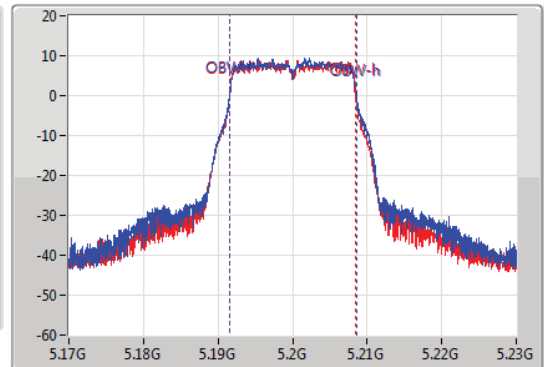

Port 1
Port 2

802.11a_Nss1,(6Mbps)_2TX

EBW

5240MHz

18/06/2022

CF
5.24GHz
Span
60MHz
RBW
300kHz
VBW
1MHz
Sweep Time
100ms
Detector Type
Peak

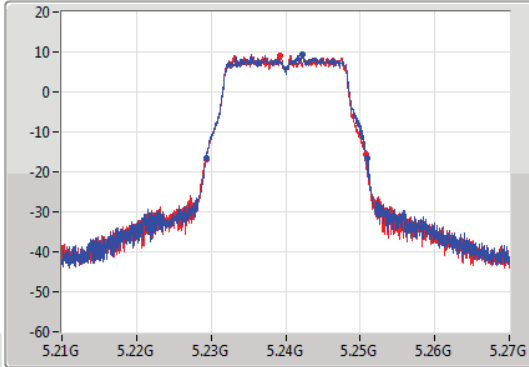

CF
5.24GHz
Span
60MHz
RBW
300kHz
VBW
1MHz
Sweep Time
100ms
Detector Type
Peak

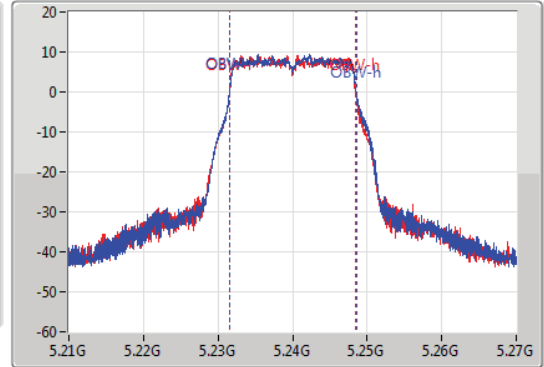

26dB(Hz)	Fl-26dB(Hz)	Fh-26dB(Hz)	OBW(Hz)	Fl-OBW(Hz)	Fh-OBW(Hz)	Limit(Hz)	Port
21.57M	5.22938G	5.25095G	17.061M	5.231574G	5.248636G	Inf	1
21.42M	5.22932G	5.25074G	16.852M	5.231574G	5.248426G	Inf	2

802.11a_Nss1,(6Mbps)_2TX

EBW

5260MHz

18/06/2022

CF
5.26GHz
Span
60MHz
RBW
300kHz
VBW
1MHz
Sweep Time
100ms
Detector Type
Peak

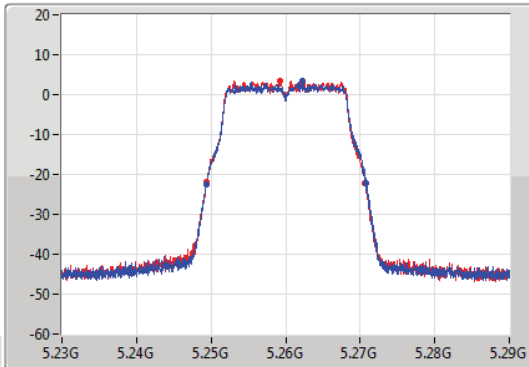

CF
5.26GHz
Span
60MHz
RBW
300kHz
VBW
1MHz
Sweep Time
100ms
Detector Type
Peak

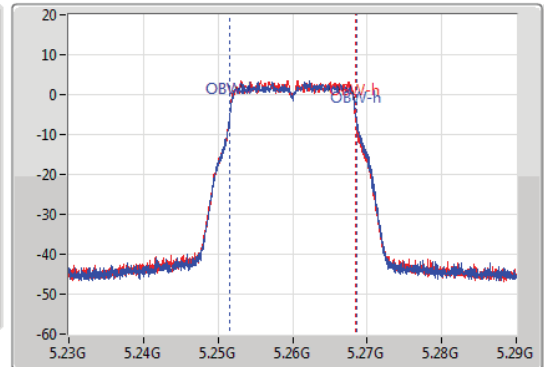

26dB(Hz)	Fl-26dB(Hz)	Fh-26dB(Hz)	OBW(Hz)	Fl-OBW(Hz)	Fh-OBW(Hz)	Limit(Hz)	Port
21.45M	5.24932G	5.27077G	17.031M	5.251574G	5.268606G	Inf	1
21.3M	5.24938G	5.27068G	16.852M	5.251574G	5.268426G	Inf	2

802.11a_Nss1,(6Mbps)_2TX

EBW

5300MHz

18/06/2022

CF
5.3GHz
Span
60MHz
RBW
300kHz
VBW
1MHz
Sweep Time
100ms
Detector Type
Peak

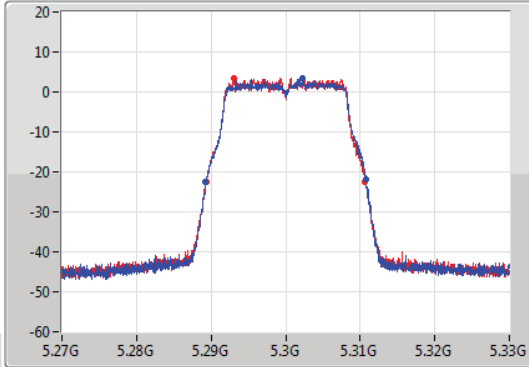

CF
5.3GHz
Span
60MHz
RBW
300kHz
VBW
1MHz
Sweep Time
100ms
Detector Type
Peak

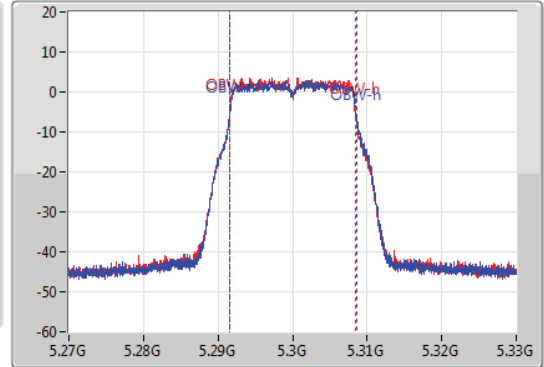

26dB(Hz)	Fl-26dB(Hz)	Fh-26dB(Hz)	OBW(Hz)	Fl-OBW(Hz)	Fh-OBW(Hz)	Limit(Hz)	Port
21.54M	5.28929G	5.31083G	17.031M	5.291574G	5.308606G	Inf	1
21.33M	5.28935G	5.31068G	16.822M	5.291604G	5.308426G	Inf	2

802.11a_Nss1,(6Mbps)_2TX

EBW

5320MHz

18/06/2022

CF
5.32GHz
Span
60MHz
RBW
300kHz
VBW
1MHz
Sweep Time
100ms
Detector Type
Peak

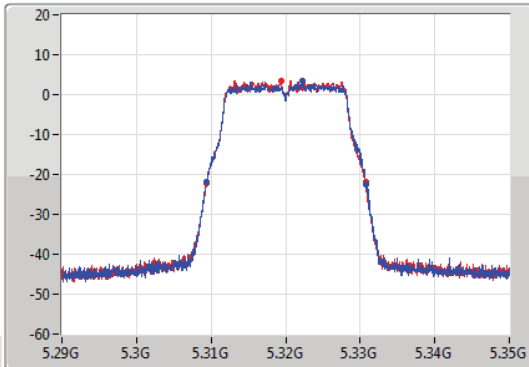

CF
5.32GHz
Span
60MHz
RBW
300kHz
VBW
1MHz
Sweep Time
100ms
Detector Type
Peak

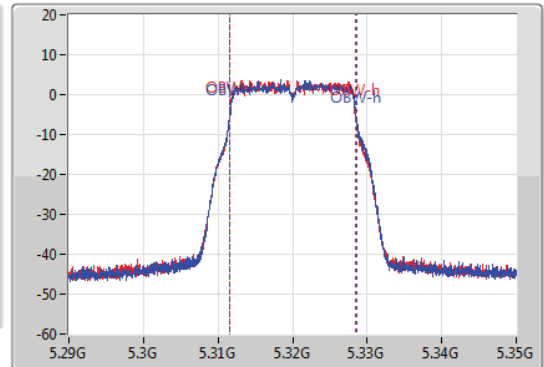

26dB(Hz)	Fl-26dB(Hz)	Fh-26dB(Hz)	OBW(Hz)	Fl-OBW(Hz)	Fh-OBW(Hz)	Limit(Hz)	Port
21.51M	5.30935G	5.33086G	17.061M	5.311544G	5.328606G	Inf	1
21.33M	5.30938G	5.33071G	16.822M	5.311604G	5.328426G	Inf	2

802.11a_Nss1,(6Mbps)_2TX

EBW

5500MHz

18/06/2022

CF
5.5GHz
Span
60MHz
RBW
300kHz
VBW
1MHz
Sweep Time
100ms
Detector Type
Peak

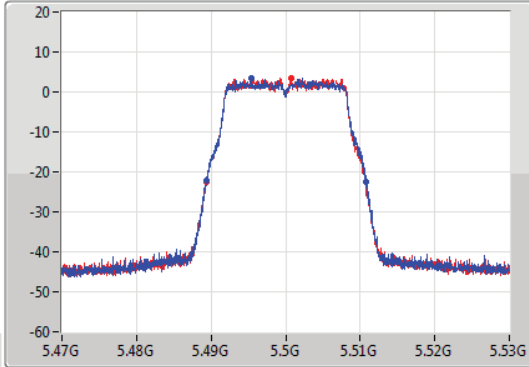

CF
5.5GHz
Span
60MHz
RBW
300kHz
VBW
1MHz
Sweep Time
100ms
Detector Type
Peak

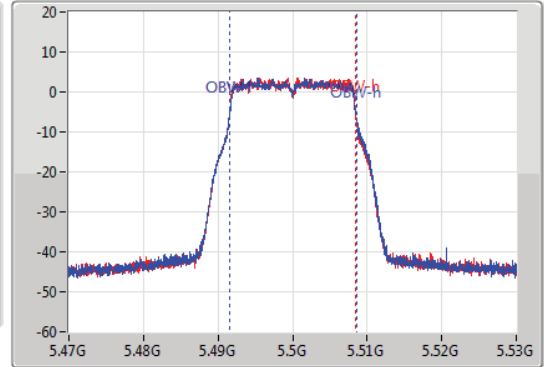

26dB(Hz)	Fl-26dB(Hz)	Fh-26dB(Hz)	OBW(Hz)	Fl-OBW(Hz)	Fh-OBW(Hz)	Limit(Hz)	Port
21.42M	5.48935G	5.51077G	17.061M	5.491544G	5.508606G	Inf	1
21.39M	5.48932G	5.51071G	16.852M	5.491574G	5.508426G	Inf	2

802.11a_Nss1,(6Mbps)_2TX

EBW

5580MHz

18/06/2022

CF
5.58GHz
Span
60MHz
RBW
300kHz
VBW
1MHz
Sweep Time
100ms
Detector Type
Peak

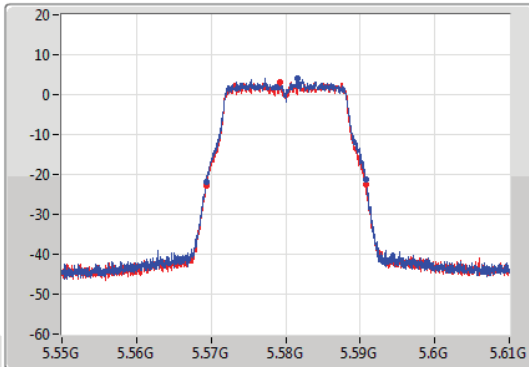

CF
5.58GHz
Span
60MHz
RBW
300kHz
VBW
1MHz
Sweep Time
100ms
Detector Type
Peak

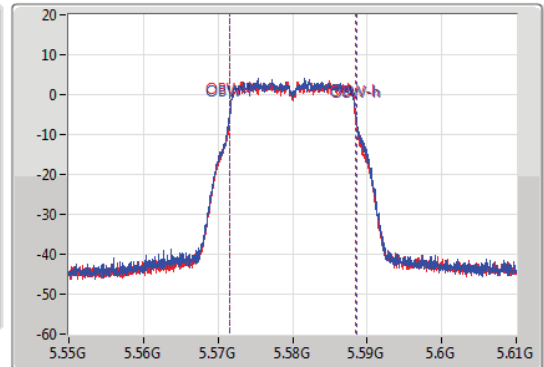

26dB(Hz)	Fl-26dB(Hz)	Fh-26dB(Hz)	OBW(Hz)	Fl-OBW(Hz)	Fh-OBW(Hz)	Limit(Hz)	Port
21.42M	5.56932G	5.59074G	17.031M	5.571544G	5.588576G	Inf	1
21.36M	5.56938G	5.59074G	16.822M	5.571604G	5.588426G	Inf	2

802.11a_Nss1,(6Mbps)_2TX

EBW

5700MHz

18/06/2022

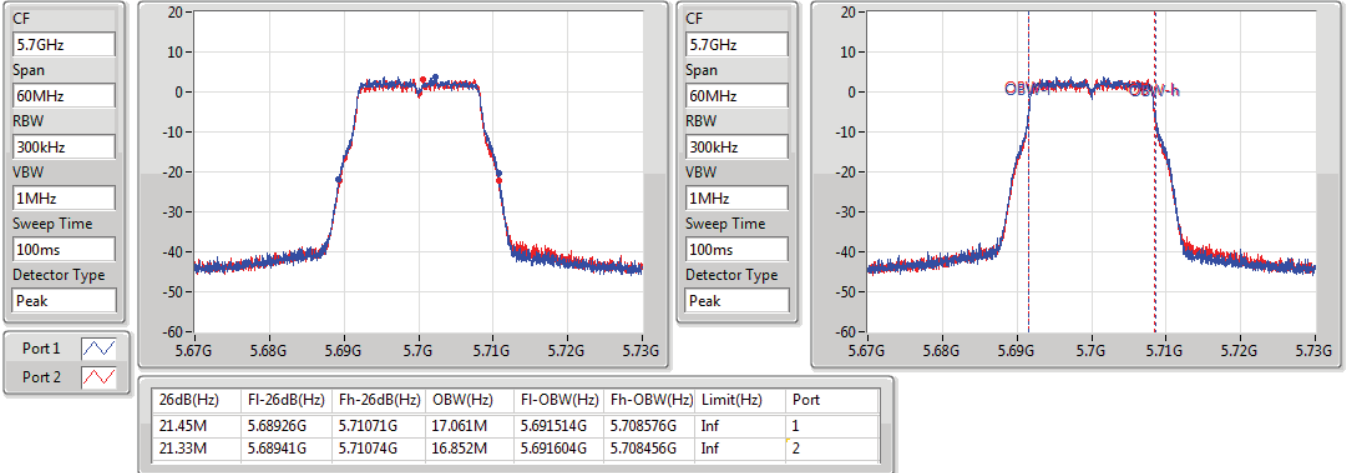

802.11a_Nss1,(6Mbps)_2TX

EBW

5720MHz Straddle 5.47-5.725GHz

18/06/2022

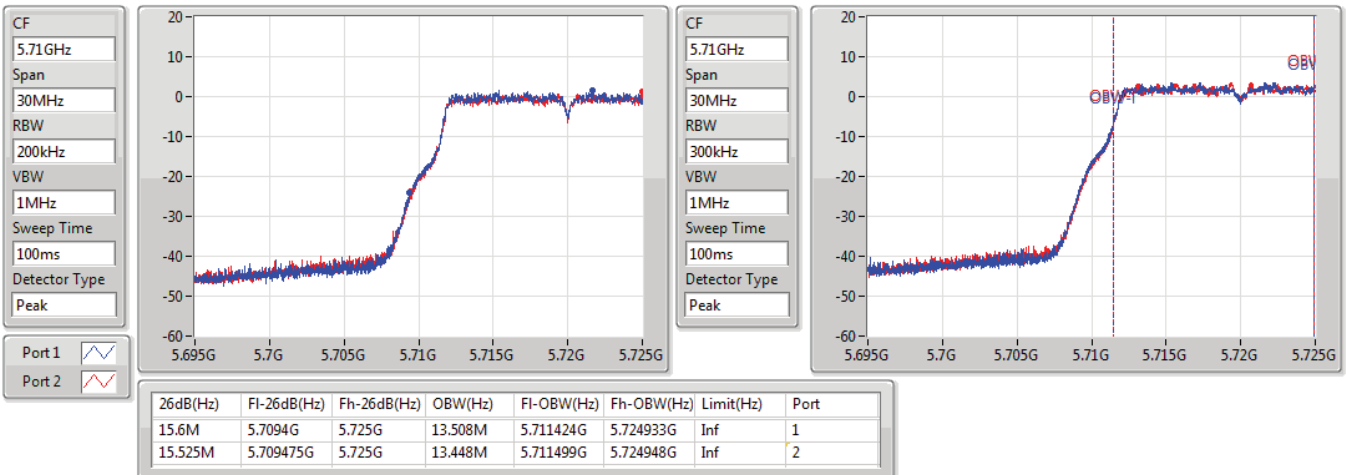

802.11a_Nss1,(6Mbps)_2TX

EBW

5720MHz Straddle 5.725-5.85GHz

18/06/2022

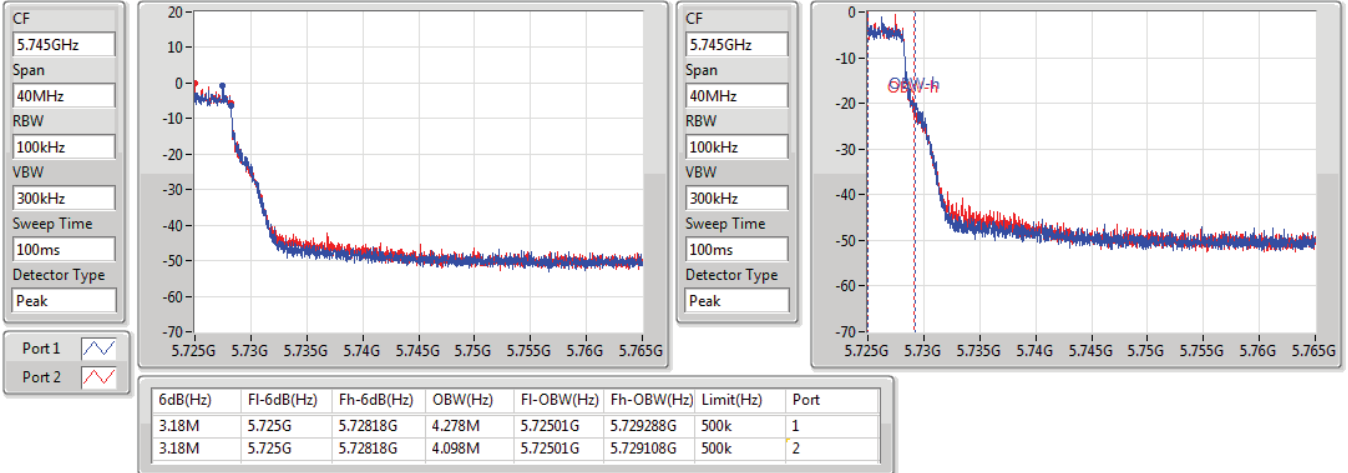

802.11a_Nss1,(6Mbps)_2TX

EBW

5745MHz

18/06/2022

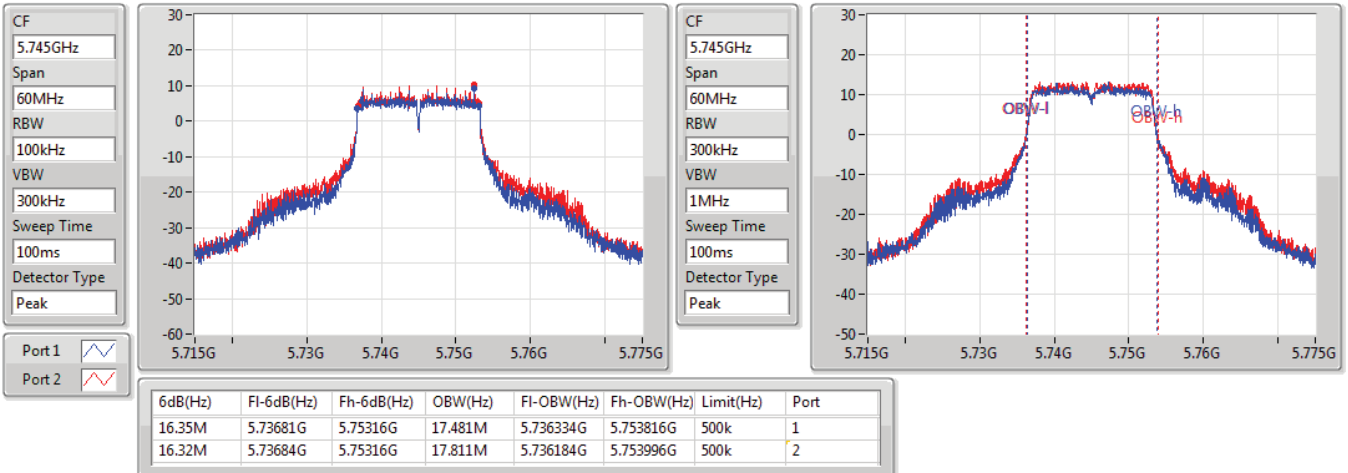

802.11a_Nss1,(6Mbps)_2TX

EBW

5785MHz

18/06/2022

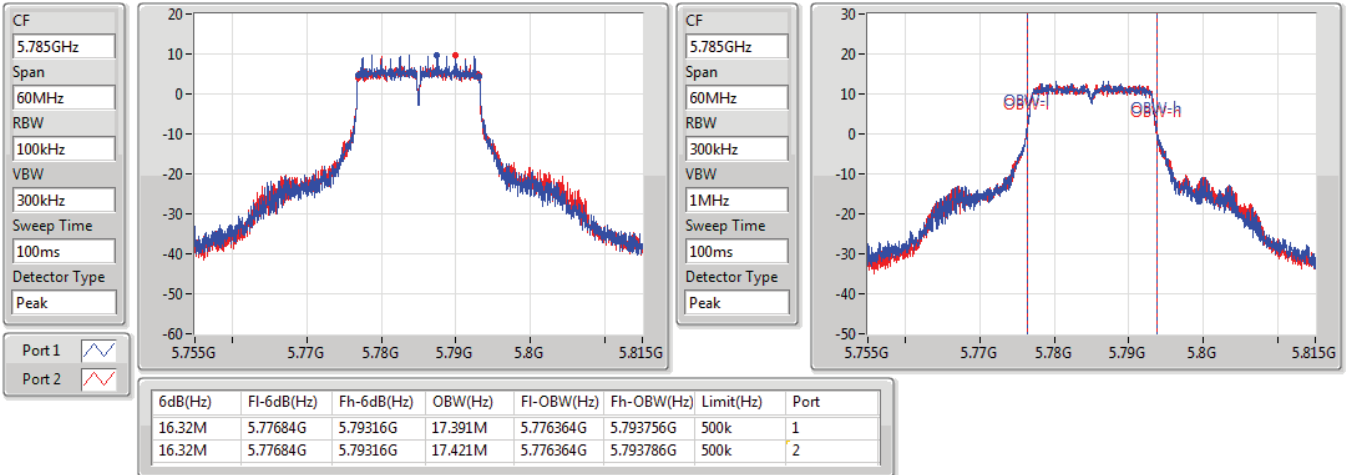

802.11a_Nss1,(6Mbps)_2TX

EBW

5825MHz

18/06/2022

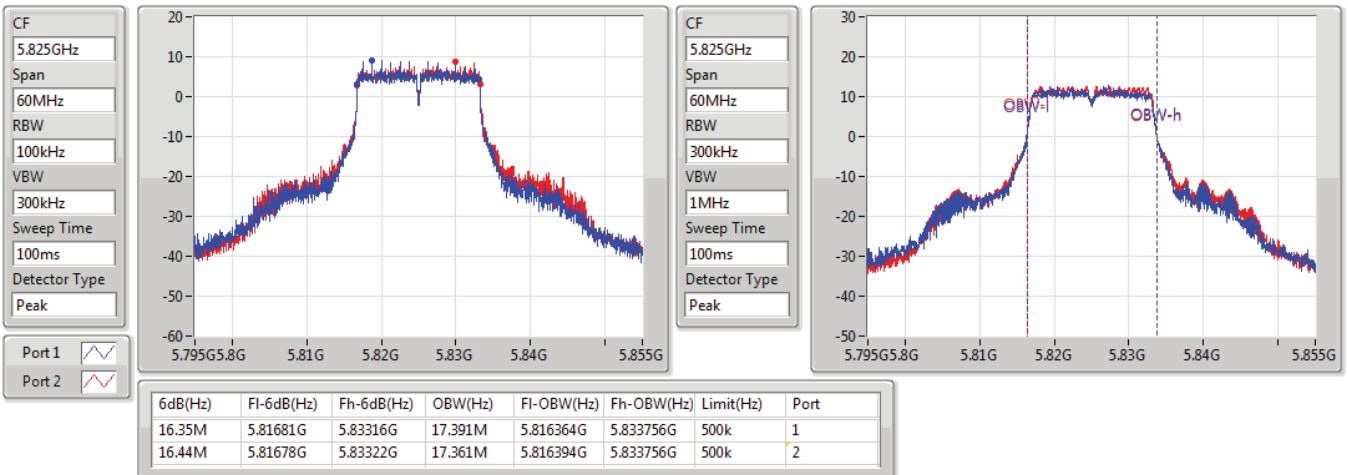

802.11n HT20_Nss1,(MCS0)_2TX

EBW

5180MHz

18/06/2022

CF
5.18GHz
Span
60MHz
RBW
300kHz
VBW
1MHz
Sweep Time
100ms
Detector Type
Peak

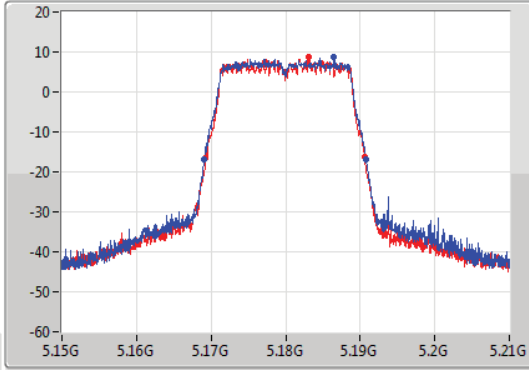

CF
5.18GHz
Span
60MHz
RBW
300kHz
VBW
1MHz
Sweep Time
100ms
Detector Type
Peak

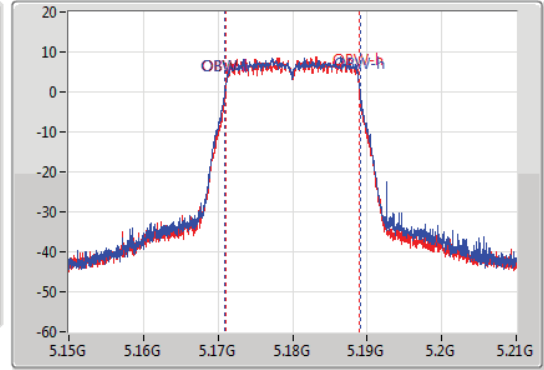

26dB(Hz)	Fl-26dB(Hz)	Fh-26dB(Hz)	OBW(Hz)	Fl-OBW(Hz)	Fh-OBW(Hz)	Limit(Hz)	Port
21.69M	5.16908G	5.19077G	18.141M	5.170885G	5.189025G	Inf	1
21.36M	5.16929G	5.19065G	17.871M	5.171064G	5.188936G	Inf	2

802.11n HT20_Nss1,(MCS0)_2TX

EBW

5200MHz

18/06/2022

CF
5.2GHz
Span
60MHz
RBW
300kHz
VBW
1MHz
Sweep Time
100ms
Detector Type
Peak

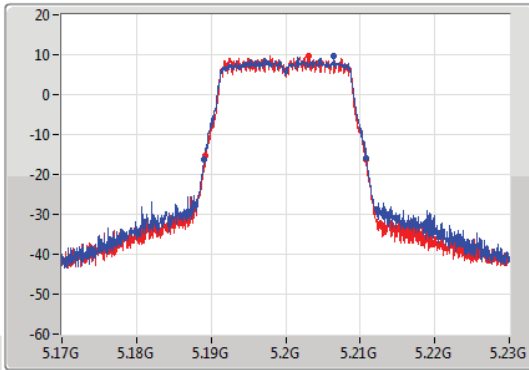

CF
5.2GHz
Span
60MHz
RBW
300kHz
VBW
1MHz
Sweep Time
100ms
Detector Type
Peak

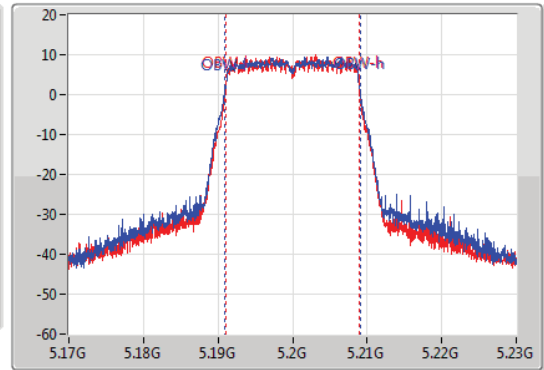

26dB(Hz)	Fl-26dB(Hz)	Fh-26dB(Hz)	OBW(Hz)	Fl-OBW(Hz)	Fh-OBW(Hz)	Limit(Hz)	Port
21.72M	5.18908G	5.2108G	18.171M	5.190885G	5.209055G	Inf	1
21.6M	5.1892G	5.2108G	17.871M	5.191064G	5.208936G	Inf	2

802.11n HT20_Nss1,(MCS0)_2TX

EBW

5240MHz

18/06/2022

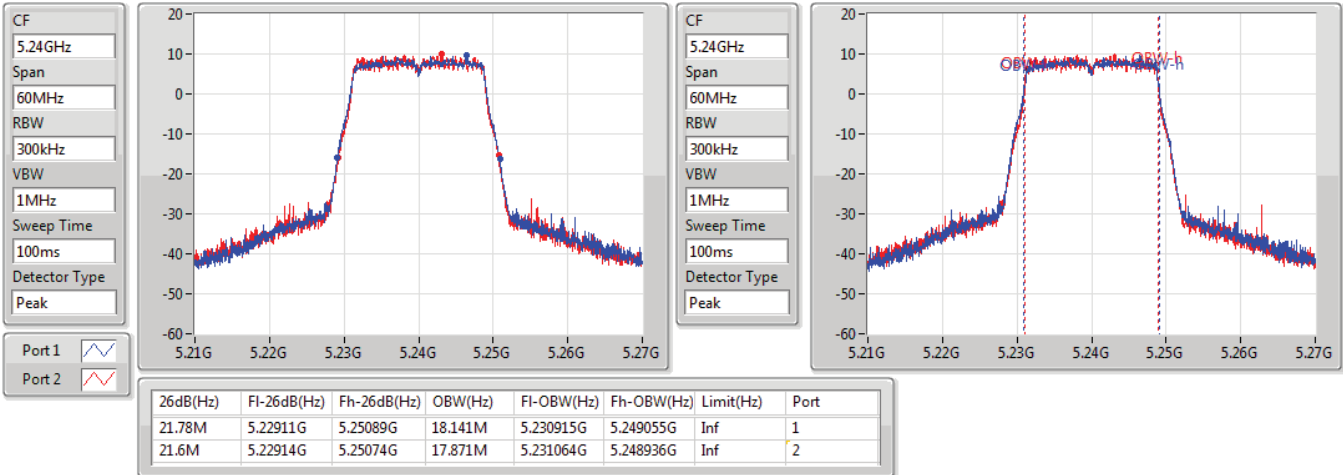

802.11n HT20_Nss1,(MCS0)_2TX

EBW

5260MHz

18/06/2022

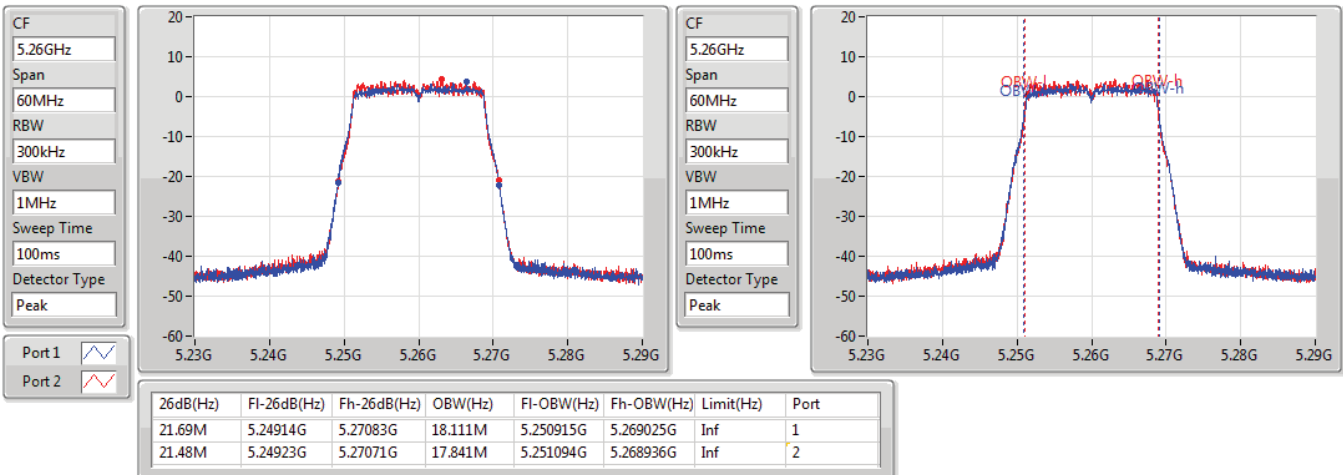

802.11n HT20_Nss1,(MCS0)_2TX

EBW

5300MHz

18/06/2022

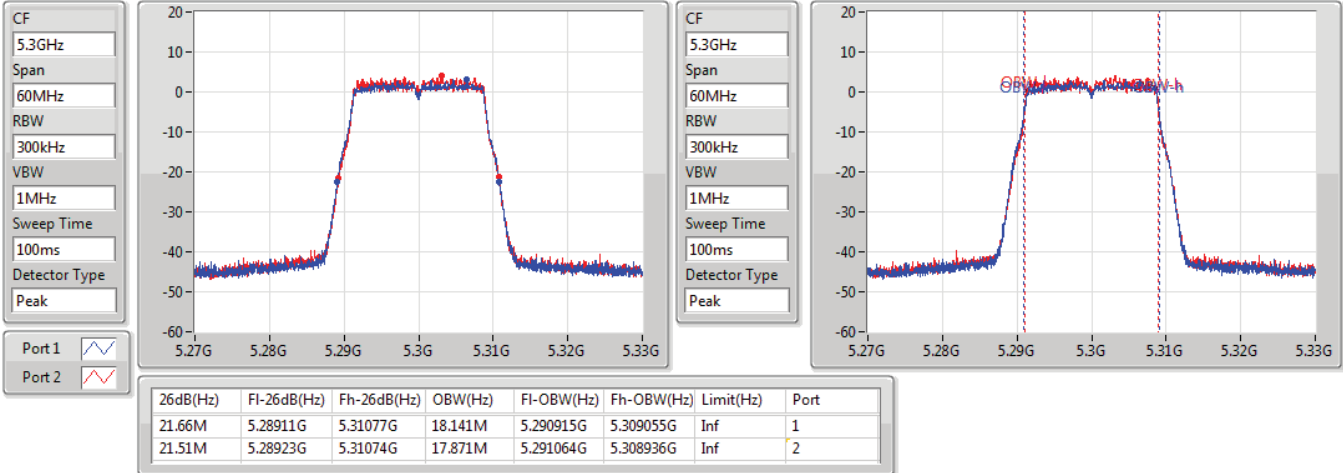

802.11n HT20_Nss1,(MCS0)_2TX

EBW

5320MHz

18/06/2022

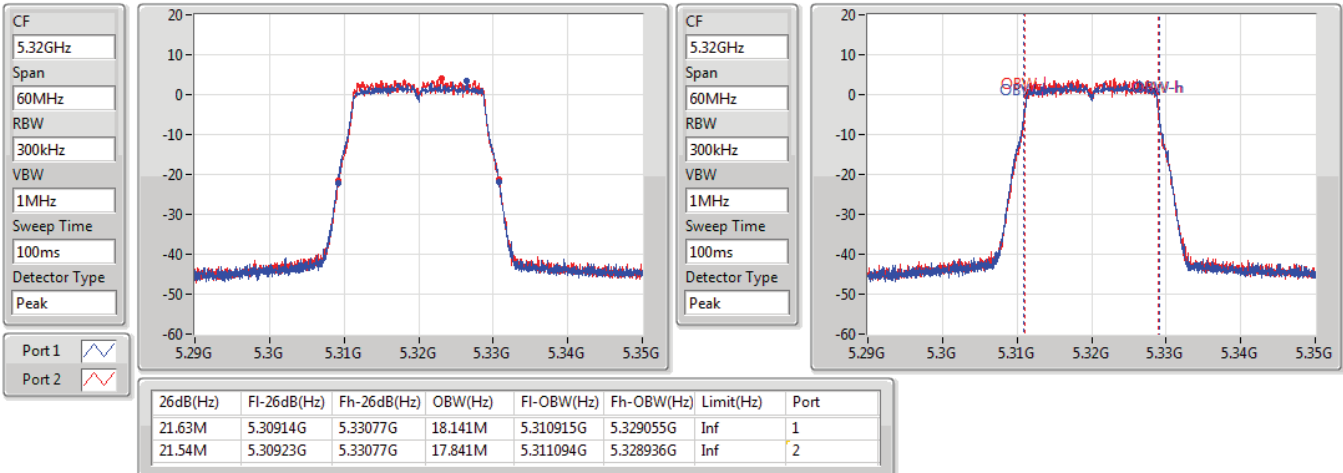

802.11n HT20_Nss1,(MCS0)_2TX

EBW

5500MHz

18/06/2022

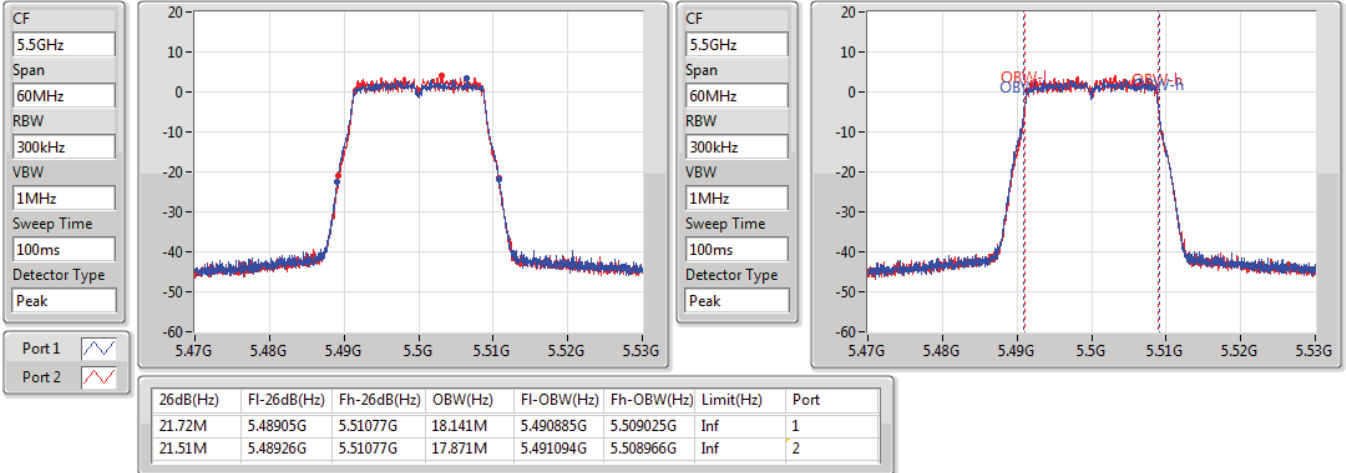

802.11n HT20_Nss1,(MCS0)_2TX

EBW

5580MHz

18/06/2022

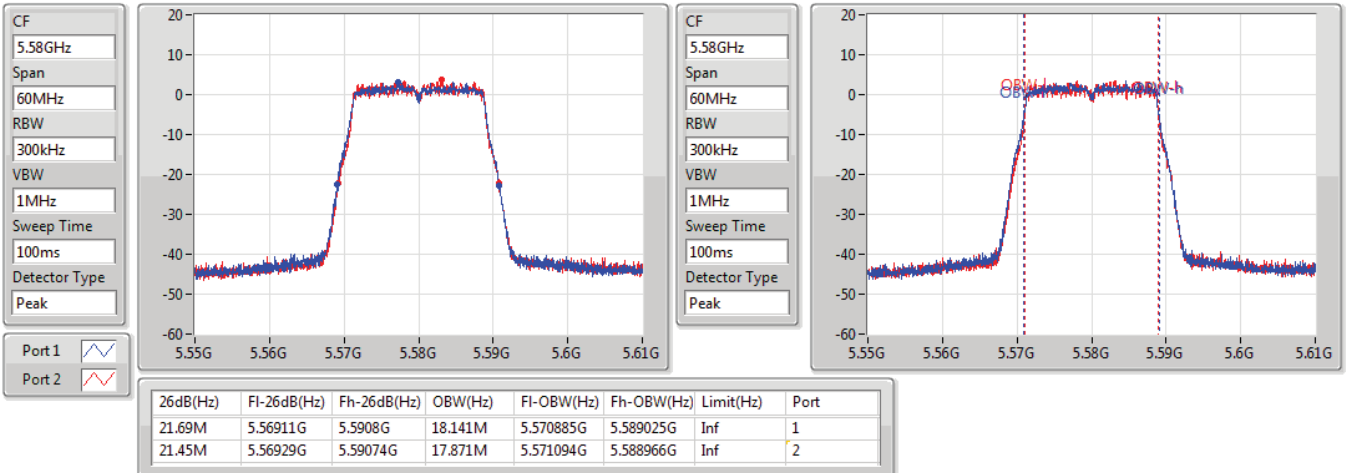

802.11n HT20_Nss1,(MCS0)_2TX

EBW

5700MHz

18/06/2022

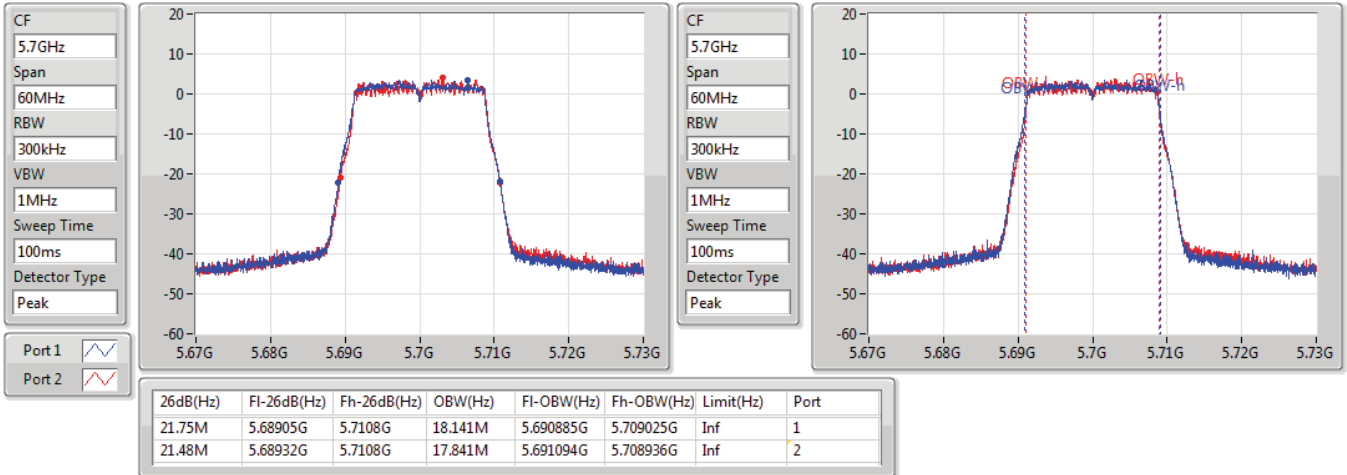

802.11n HT20_Nss1,(MCS0)_2TX

EBW

5720MHz Straddle 5.47-5.725GHz

18/06/2022

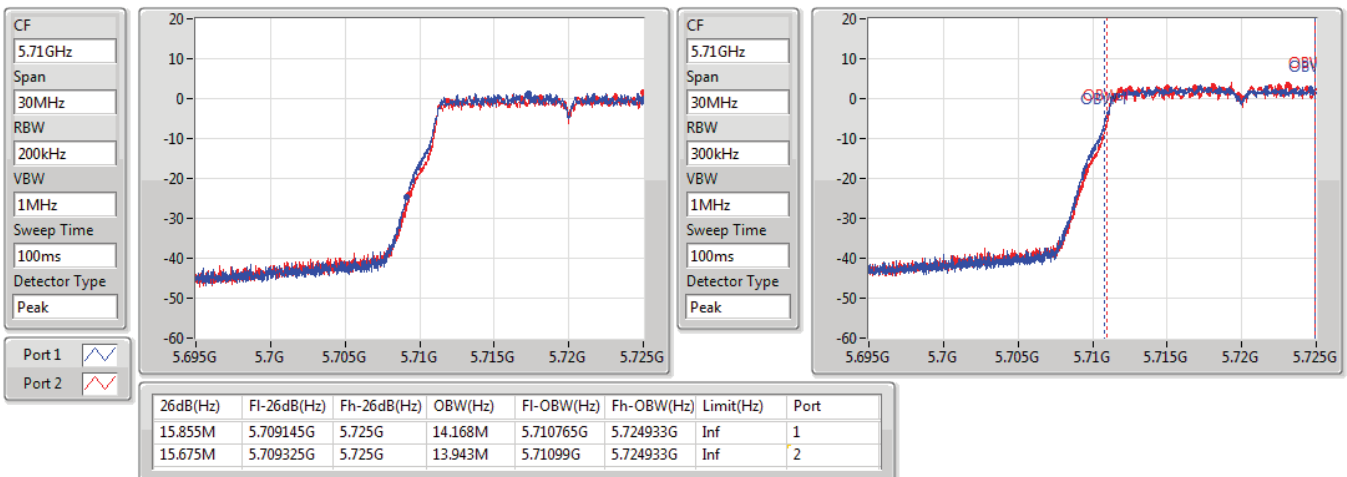

802.11n HT20_Nss1,(MCS0)_2TX

EBW

5720MHz Straddle 5.725-5.85GHz

18/06/2022

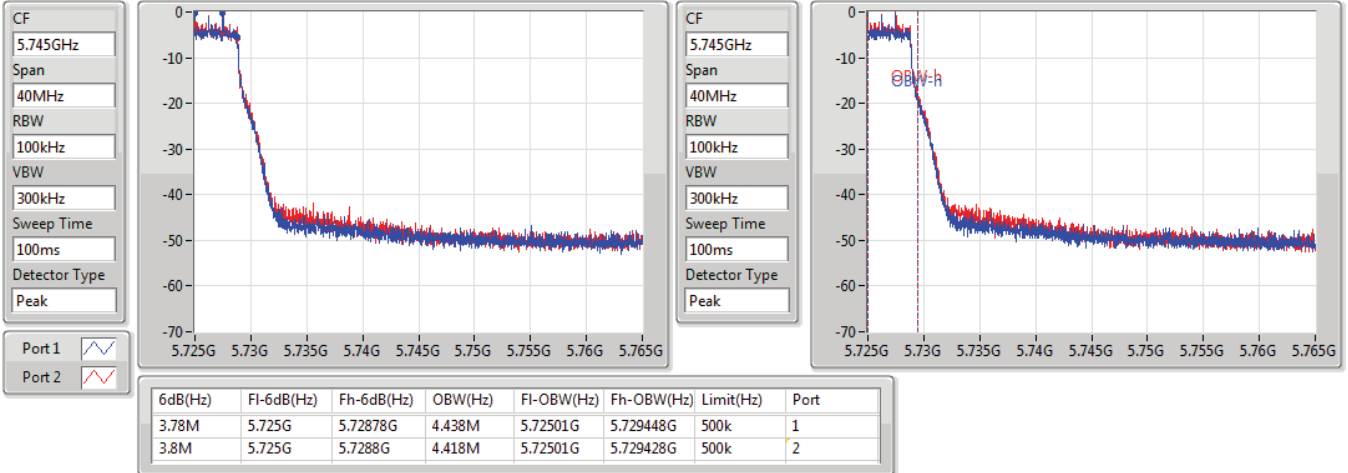

802.11n HT20_Nss1,(MCS0)_2TX

EBW

5745MHz

18/06/2022

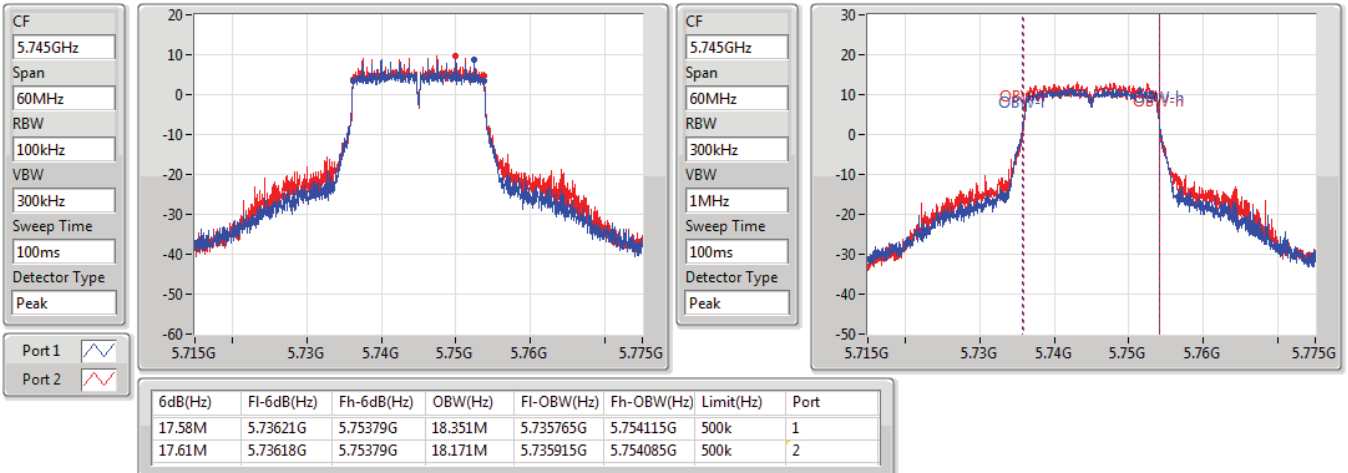

802.11n HT20_Nss1,(MCS0)_2TX

EBW

5785MHz

18/06/2022

CF
5.785GHz
Span
60MHz
RBW
100kHz
VBW
300kHz
Sweep Time
100ms
Detector Type
Peak

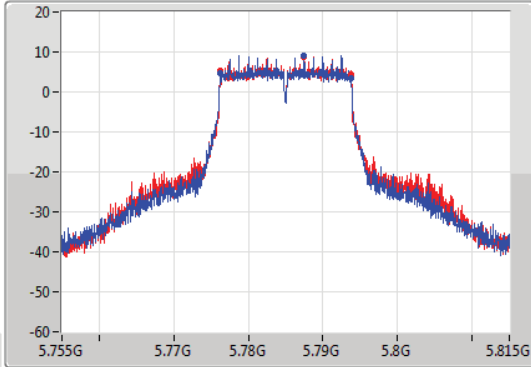

CF
5.785GHz
Span
60MHz
RBW
300kHz
VBW
1MHz
Sweep Time
100ms
Detector Type
Peak

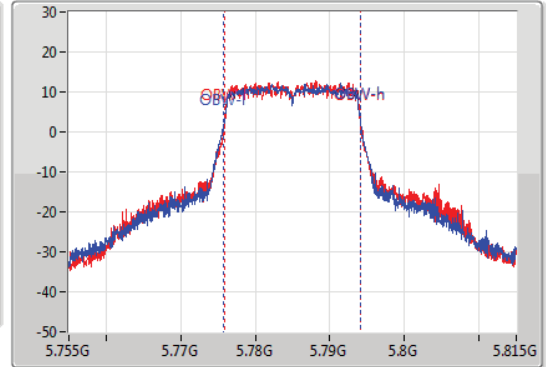

6dB(Hz)	Fl-6dB(Hz)	Fh-6dB(Hz)	OBW(Hz)	Fl-OBW(Hz)	Fh-OBW(Hz)	Limit(Hz)	Port
17.58M	5.77621G	5.79379G	18.321M	5.775795G	5.794115G	500k	1
17.58M	5.77621G	5.79379G	18.111M	5.775945G	5.794055G	500k	2

802.11n HT20_Nss1,(MCS0)_2TX

EBW

5825MHz

18/06/2022

CF
5.825GHz
Span
60MHz
RBW
100kHz
VBW
300kHz
Sweep Time
100ms
Detector Type
Peak

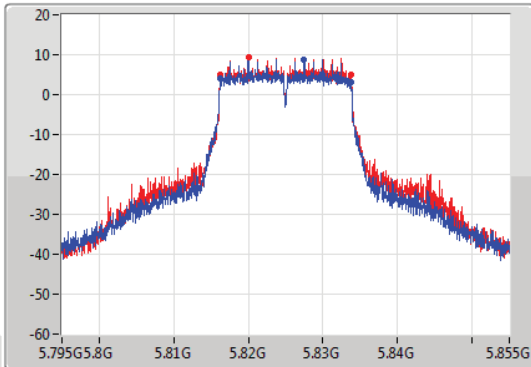

CF
5.825GHz
Span
60MHz
RBW
300kHz
VBW
1MHz
Sweep Time
100ms
Detector Type
Peak

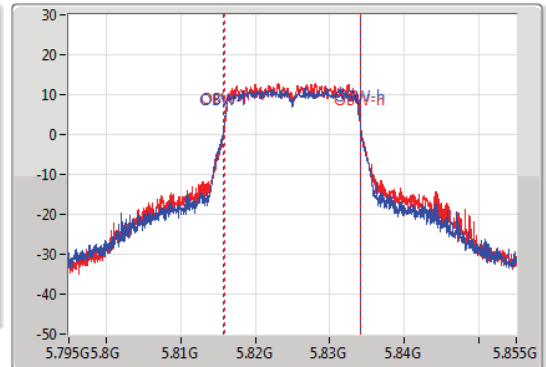

6dB(Hz)	Fl-6dB(Hz)	Fh-6dB(Hz)	OBW(Hz)	Fl-OBW(Hz)	Fh-OBW(Hz)	Limit(Hz)	Port
17.58M	5.81621G	5.83379G	18.291M	5.815795G	5.834085G	500k	1
17.58M	5.81621G	5.83379G	18.141M	5.815945G	5.834085G	500k	2



802.11n HT40_Nss1,(MCS0)_2TX

EBW

5190MHz

20/06/2022

CF
5.19GHz
Span
120MHz
RBW
500kHz
VBW
2MHz
Sweep Time
100ms
Detector Type
Peak

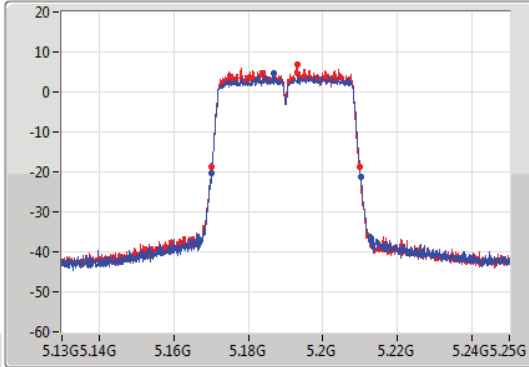

CF
5.19GHz
Span
120MHz
RBW
1MHz
VBW
3MHz
Sweep Time
100ms
Detector Type
Peak

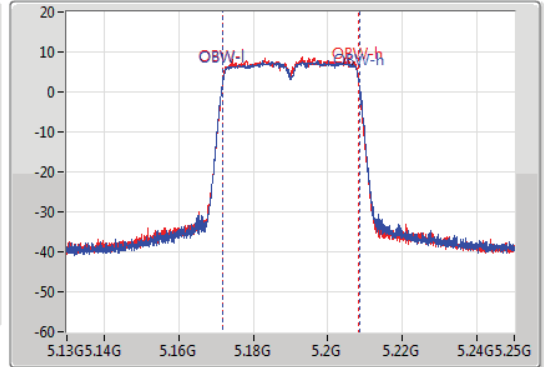

26dB(Hz)	Fl-26dB(Hz)	Fh-26dB(Hz)	OBW(Hz)	Fl-OBW(Hz)	Fh-OBW(Hz)	Limit(Hz)	Port
40.08M	5.17002G	5.2101G	36.702M	5.171709G	5.208411G	Inf	1
39.54M	5.1702G	5.20974G	36.462M	5.171769G	5.208231G	Inf	2

802.11n HT40_Nss1,(MCS0)_2TX

EBW

5230MHz

20/06/2022

CF
5.23GHz
Span
120MHz
RBW
500kHz
VBW
2MHz
Sweep Time
100ms
Detector Type
Peak

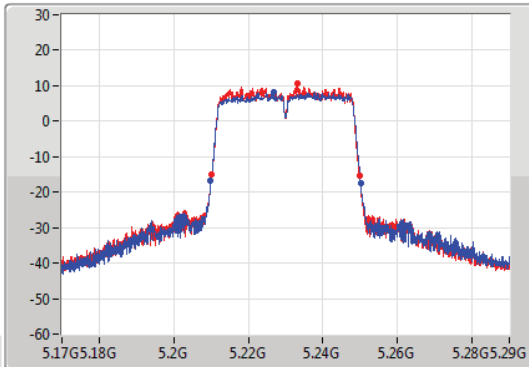

CF
5.23GHz
Span
120MHz
RBW
1MHz
VBW
3MHz
Sweep Time
100ms
Detector Type
Peak

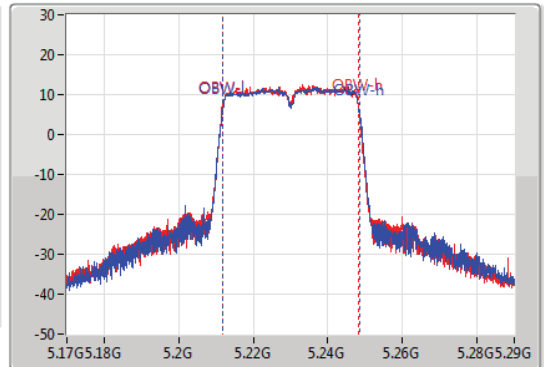

26dB(Hz)	Fl-26dB(Hz)	Fh-26dB(Hz)	OBW(Hz)	Fl-OBW(Hz)	Fh-OBW(Hz)	Limit(Hz)	Port
40.26M	5.2099G	5.25016G	36.762M	5.211709G	5.248471G	Inf	1
39.54M	5.2102G	5.24974G	36.582M	5.211709G	5.248291G	Inf	2

802.11n HT40_Nss1,(MCS0)_2TX

EBW

5270MHz

20/06/2022

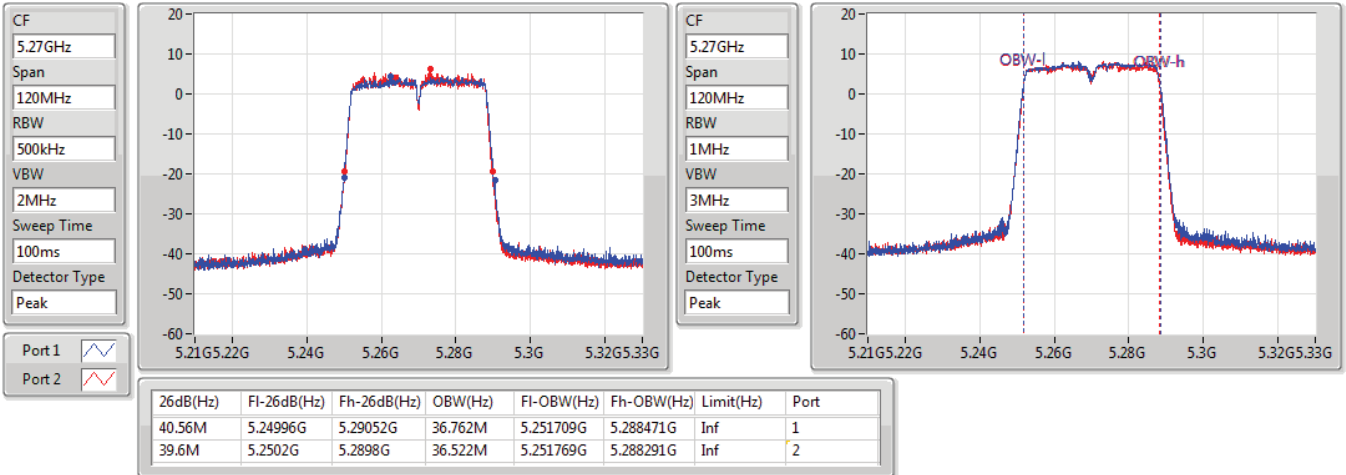

802.11n HT40_Nss1,(MCS0)_2TX

EBW

5310MHz

20/06/2022

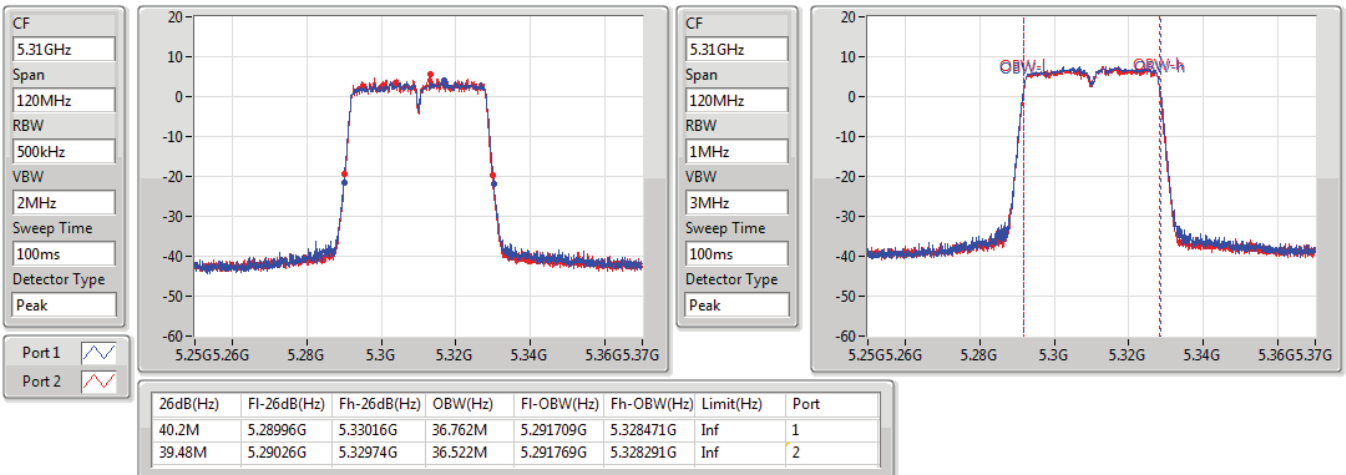

802.11n HT40_Nss1,(MCS0)_2TX

EBW

5510MHz

20/06/2022

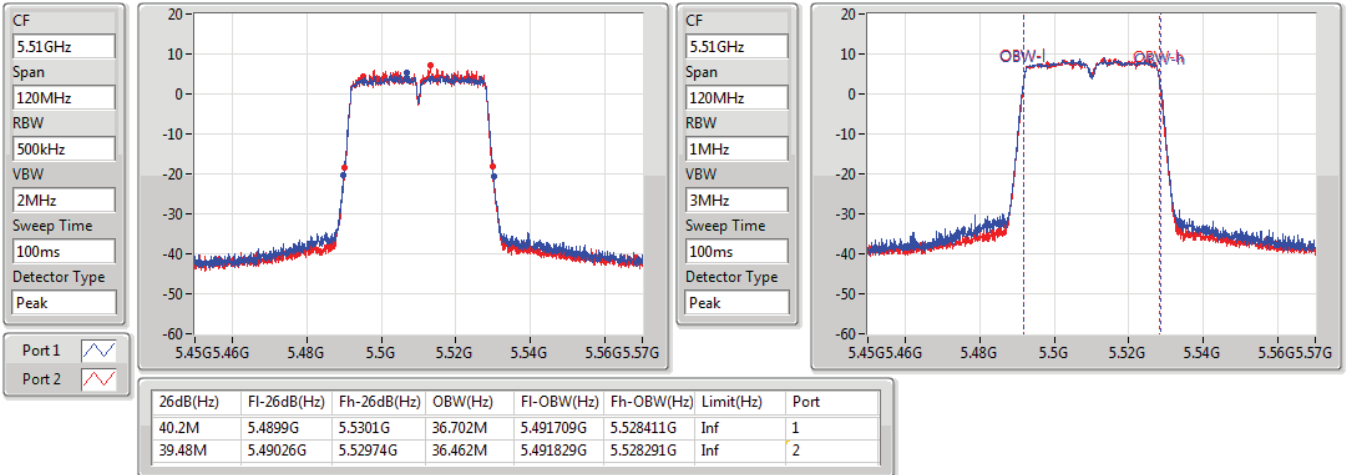

802.11n HT40_Nss1,(MCS0)_2TX

EBW

5550MHz

20/06/2022

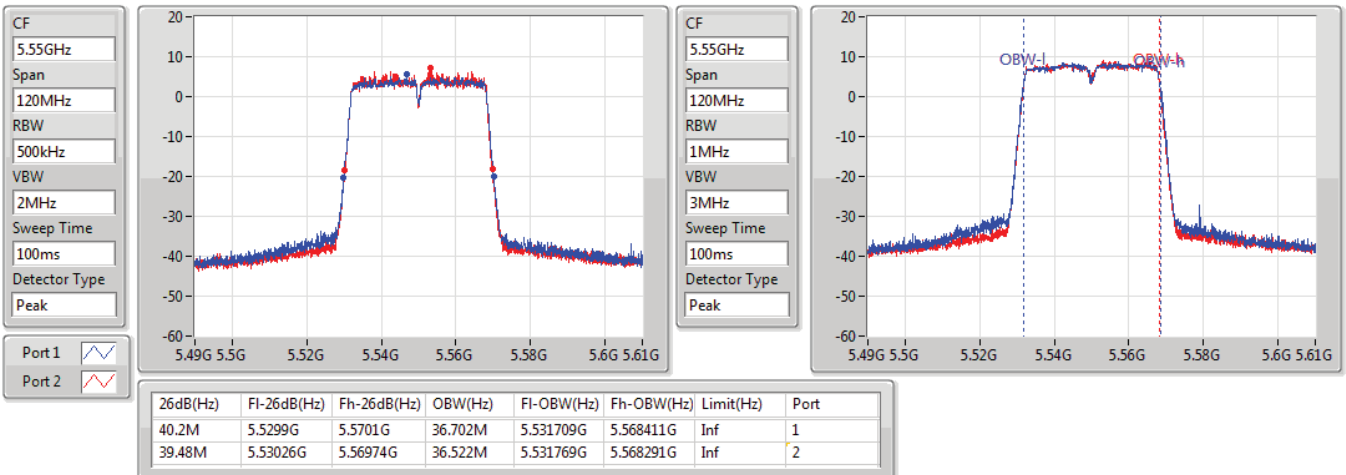

802.11n HT40_Nss1,(MCS0)_2TX

EBW

5670MHz

20/06/2022

CF
5.67GHz
Span
120MHz
RBW
500kHz
VBW
2MHz
Sweep Time
100ms
Detector Type
Peak

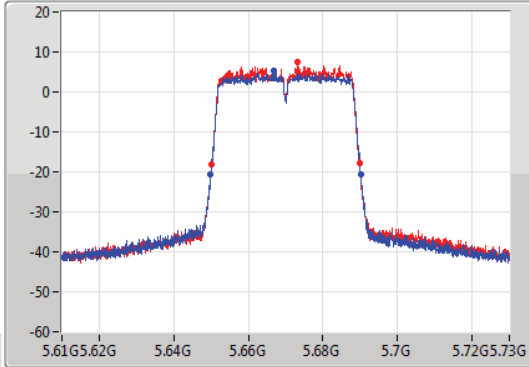

CF
5.67GHz
Span
120MHz
RBW
1MHz
VBW
3MHz
Sweep Time
100ms
Detector Type
Peak

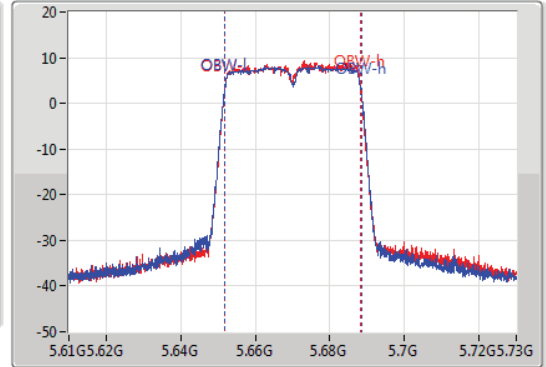

26dB(Hz)	Fl-26dB(Hz)	Fh-26dB(Hz)	OBW(Hz)	Fl-OBW(Hz)	Fh-OBW(Hz)	Limit(Hz)	Port
40.2M	5.6499G	5.6901G	36.702M	5.651709G	5.688411G	Inf	1
39.48M	5.65026G	5.68974G	36.522M	5.651769G	5.688291G	Inf	2

802.11n HT40_Nss1,(MCS0)_2TX

EBW

5710MHz Straddle 5.47-5.725GHz

20/06/2022

CF
5.69GHz
Span
70MHz
RBW
500kHz
VBW
2MHz
Sweep Time
100ms
Detector Type
Peak

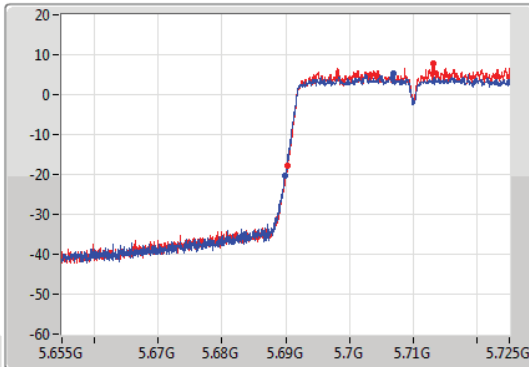

CF
5.69GHz
Span
70MHz
RBW
1MHz
VBW
3MHz
Sweep Time
100ms
Detector Type
Peak

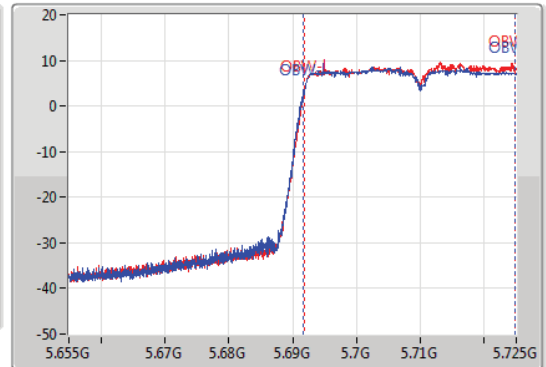

26dB(Hz)	Fl-26dB(Hz)	Fh-26dB(Hz)	OBW(Hz)	Fl-OBW(Hz)	Fh-OBW(Hz)	Limit(Hz)	Port
35.105M	5.689895G	5.725G	33.268M	5.691574G	5.724843G	Inf	1
34.685M	5.690315G	5.725G	33.058M	5.691784G	5.724843G	Inf	2

802.11n HT40_Nss1,(MCS0)_2TX

EBW

5710MHz Straddle 5.725-5.85GHz

20/06/2022

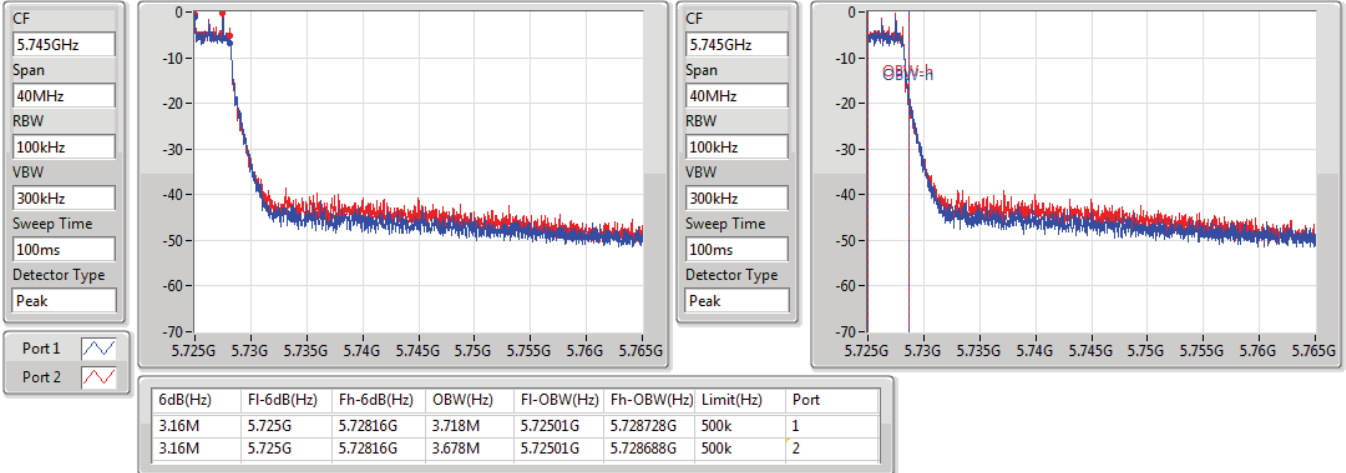

802.11n HT40_Nss1,(MCS0)_2TX

EBW

5755MHz

20/06/2022

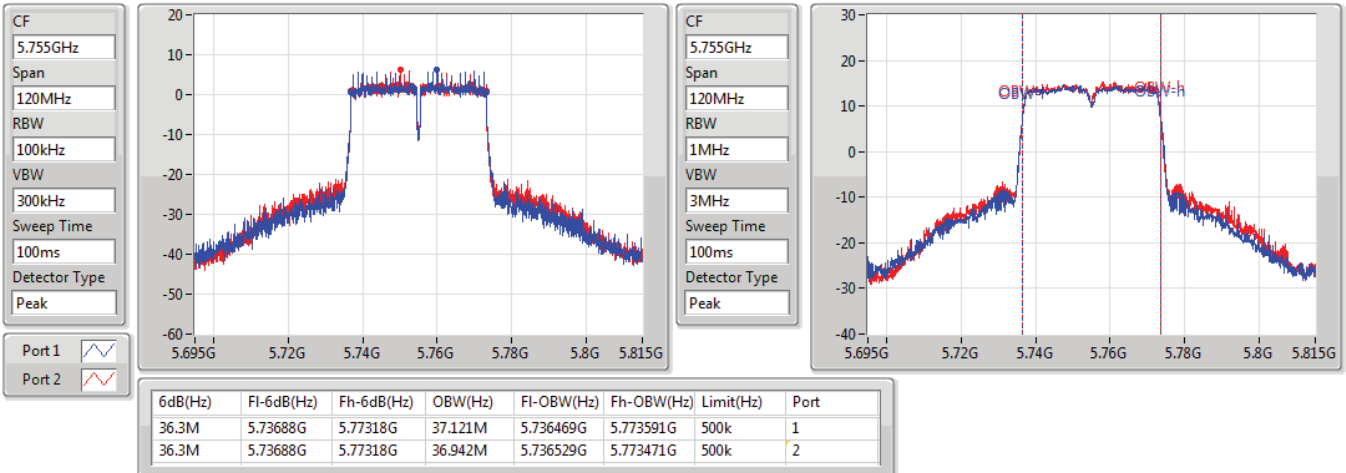

802.11n HT40_Nss1,(MCS0)_2TX

EBW

5795MHz

20/06/2022

CF
5.795GHz
Span
120MHz
RBW
100kHz
VBW
300kHz
Sweep Time
100ms
Detector Type
Peak

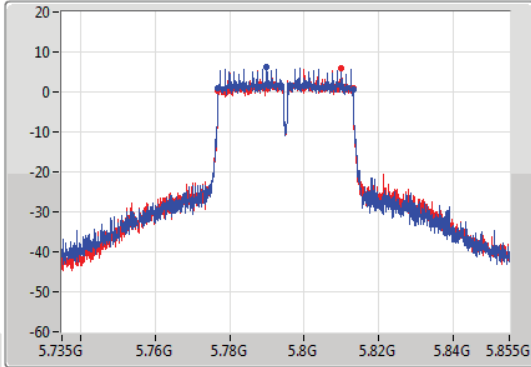

CF
5.795GHz
Span
120MHz
RBW
1MHz
VBW
3MHz
Sweep Time
100ms
Detector Type
Peak

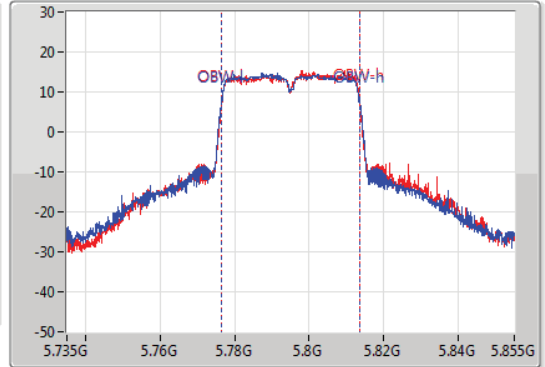

6dB(Hz)	Fl-6dB(Hz)	Fh-6dB(Hz)	OBW(Hz)	Fl-OBW(Hz)	Fh-OBW(Hz)	Limit(Hz)	Port
36.3M	5.77688G	5.81318G	37.121M	5.776469G	5.813591G	500k	1
36.36M	5.77682G	5.81318G	36.882M	5.776589G	5.813471G	500k	2

802.11ac VHT20_Nss1,(MCS0)_2TX

EBW

5180MHz

18/06/2022

CF
5.18GHz
Span
60MHz
RBW
300kHz
VBW
1MHz
Sweep Time
100ms
Detector Type
Peak

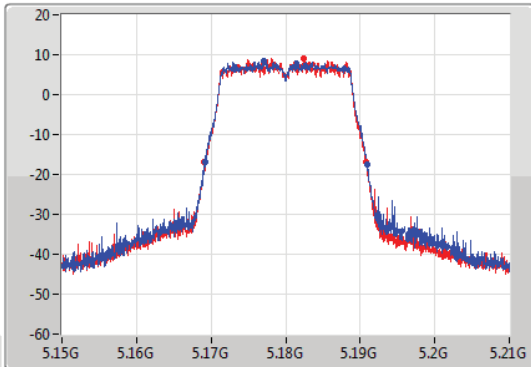

CF
5.18GHz
Span
60MHz
RBW
300kHz
VBW
1MHz
Sweep Time
100ms
Detector Type
Peak

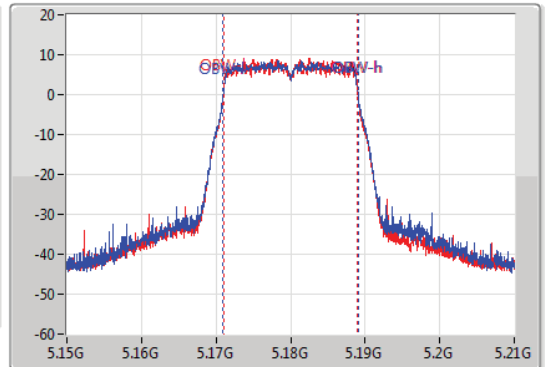

26dB(Hz)	Fl-26dB(Hz)	Fh-26dB(Hz)	OBW(Hz)	Fl-OBW(Hz)	Fh-OBW(Hz)	Limit(Hz)	Port
21.78M	5.16914G	5.19092G	18.081M	5.170975G	5.189055G	Inf	1
21.72M	5.16911G	5.19083G	17.931M	5.171034G	5.188966G	Inf	2

802.11ac VHT20_Nss1,(MCS0)_2TX

EBW

5200MHz

18/06/2022

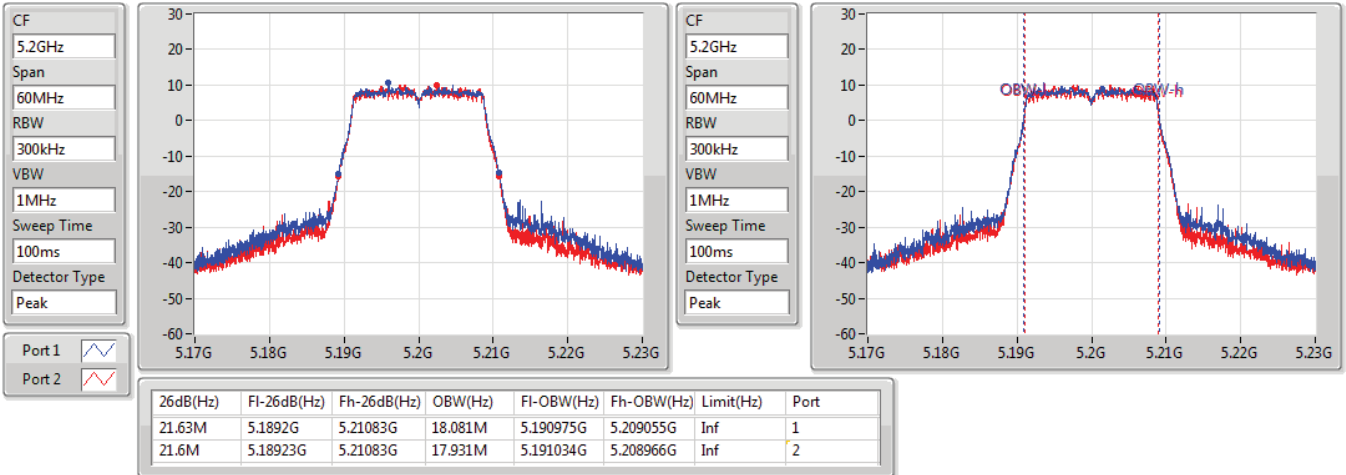

802.11ac VHT20_Nss1,(MCS0)_2TX

EBW

5240MHz

18/06/2022

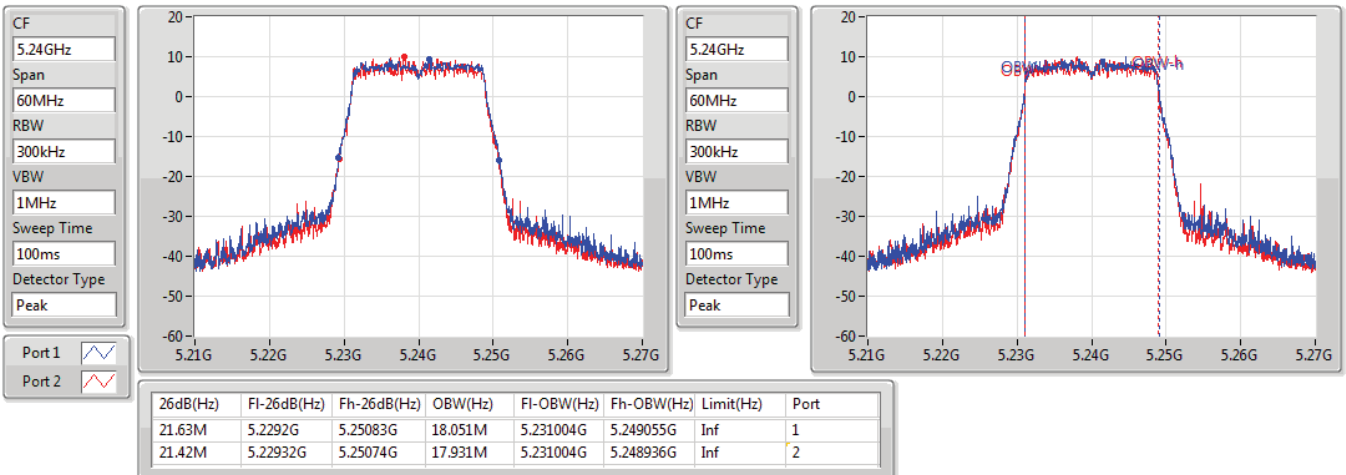

802.11ac VHT20_Nss1,(MCS0)_2TX

EBW

5260MHz

18/06/2022

CF
5.26GHz
Span
60MHz
RBW
300kHz
VBW
1MHz
Sweep Time
100ms
Detector Type
Peak

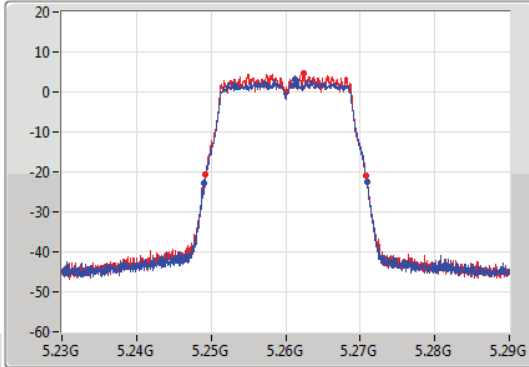

CF
5.26GHz
Span
60MHz
RBW
300kHz
VBW
1MHz
Sweep Time
100ms
Detector Type
Peak

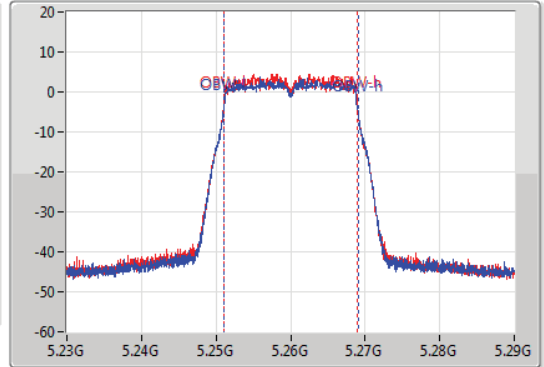

26dB(Hz)	Fl-26dB(Hz)	Fh-26dB(Hz)	OBW(Hz)	Fl-OBW(Hz)	Fh-OBW(Hz)	Limit(Hz)	Port
21.84M	5.24911G	5.27095G	18.051M	5.251004G	5.269055G	Inf	1
21.54M	5.24926G	5.2708G	17.931M	5.251034G	5.268966G	Inf	2

802.11ac VHT20_Nss1,(MCS0)_2TX

EBW

5300MHz

18/06/2022

CF
5.3GHz
Span
60MHz
RBW
300kHz
VBW
1MHz
Sweep Time
100ms
Detector Type
Peak

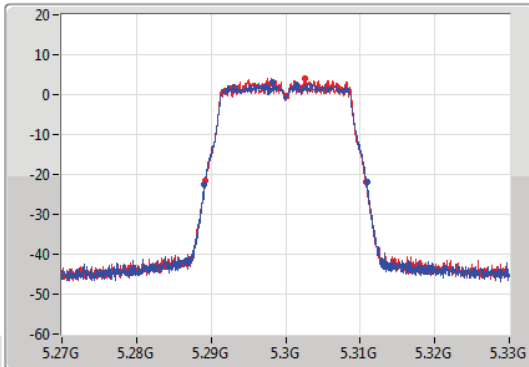

CF
5.3GHz
Span
60MHz
RBW
300kHz
VBW
1MHz
Sweep Time
100ms
Detector Type
Peak

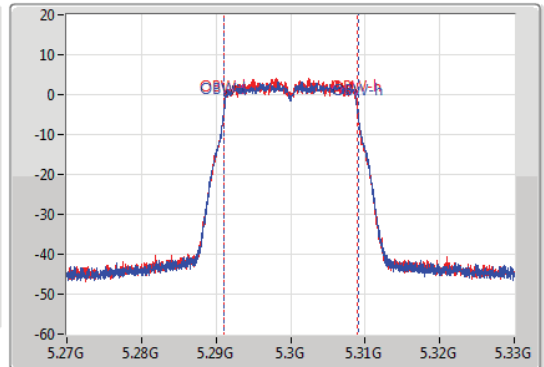

26dB(Hz)	Fl-26dB(Hz)	Fh-26dB(Hz)	OBW(Hz)	Fl-OBW(Hz)	Fh-OBW(Hz)	Limit(Hz)	Port
21.78M	5.28911G	5.31089G	18.081M	5.291004G	5.309085G	Inf	1
21.57M	5.28926G	5.31083G	17.901M	5.291064G	5.308966G	Inf	2

802.11ac VHT20_Nss1,(MCS0)_2TX

EBW

5320MHz

18/06/2022

CF
5.32GHz
Span
60MHz
RBW
300kHz
VBW
1MHz
Sweep Time
100ms
Detector Type
Peak

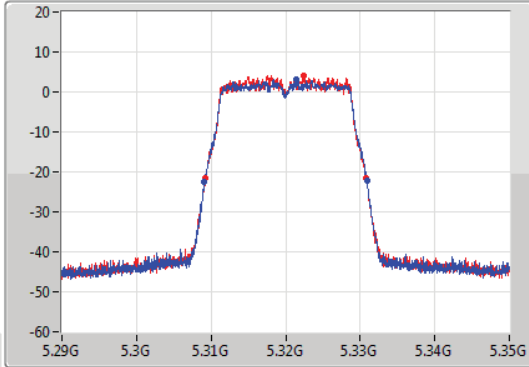

CF
5.32GHz
Span
60MHz
RBW
300kHz
VBW
1MHz
Sweep Time
100ms
Detector Type
Peak

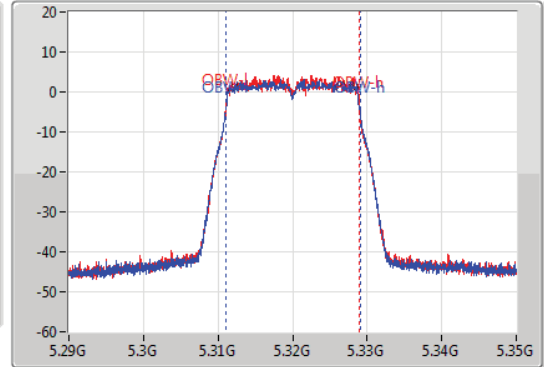

26dB(Hz)	Fl-26dB(Hz)	Fh-26dB(Hz)	OBW(Hz)	Fl-OBW(Hz)	Fh-OBW(Hz)	Limit(Hz)	Port
21.78M	5.30911G	5.33089G	18.081M	5.311004G	5.329085G	Inf	1
21.63M	5.30923G	5.33086G	17.901M	5.311064G	5.328966G	Inf	2

802.11ac VHT20_Nss1,(MCS0)_2TX

EBW

5500MHz

18/06/2022

CF
5.5GHz
Span
60MHz
RBW
300kHz
VBW
1MHz
Sweep Time
100ms
Detector Type
Peak

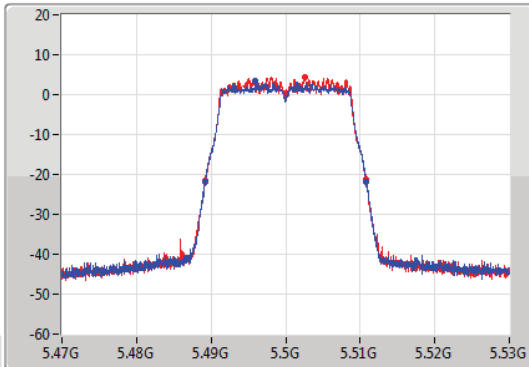

CF
5.5GHz
Span
60MHz
RBW
300kHz
VBW
1MHz
Sweep Time
100ms
Detector Type
Peak

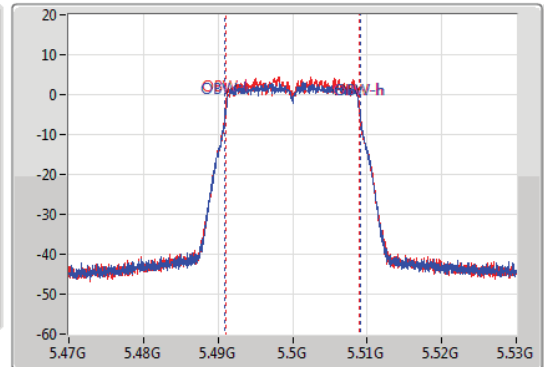

26dB(Hz)	Fl-26dB(Hz)	Fh-26dB(Hz)	OBW(Hz)	Fl-OBW(Hz)	Fh-OBW(Hz)	Limit(Hz)	Port
21.66M	5.48917G	5.51083G	18.081M	5.490975G	5.509055G	Inf	1
21.69M	5.48917G	5.51086G	17.901M	5.491064G	5.508966G	Inf	2

802.11ac VHT20_Nss1,(MCS0)_2TX

EBW

5580MHz

18/06/2022

CF
5.58GHz
Span
60MHz
RBW
300kHz
VBW
1MHz
Sweep Time
100ms
Detector Type
Peak

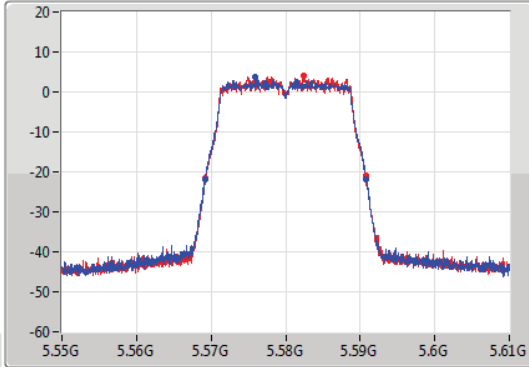

CF
5.58GHz
Span
60MHz
RBW
300kHz
VBW
1MHz
Sweep Time
100ms
Detector Type
Peak

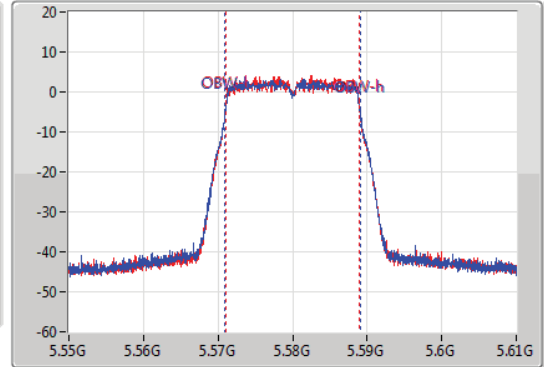

26dB(Hz)	Fl-26dB(Hz)	Fh-26dB(Hz)	OBW(Hz)	Fl-OBW(Hz)	Fh-OBW(Hz)	Limit(Hz)	Port
21.69M	5.56917G	5.59086G	18.081M	5.570975G	5.589055G	Inf	1
21.48M	5.56929G	5.59077G	17.901M	5.571064G	5.588966G	Inf	2

802.11ac VHT20_Nss1,(MCS0)_2TX

EBW

5700MHz

18/06/2022

CF
5.7GHz
Span
60MHz
RBW
300kHz
VBW
1MHz
Sweep Time
100ms
Detector Type
Peak

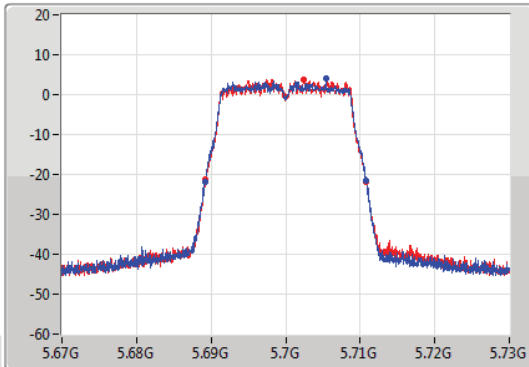

CF
5.7GHz
Span
60MHz
RBW
300kHz
VBW
1MHz
Sweep Time
100ms
Detector Type
Peak

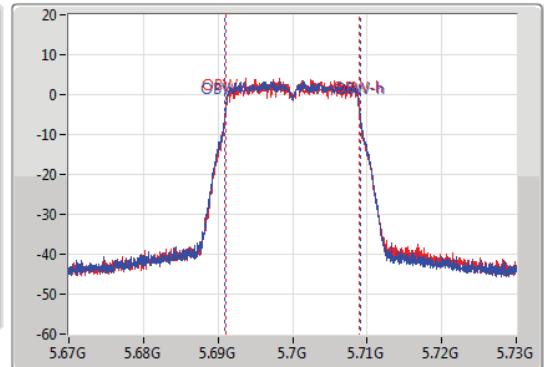

26dB(Hz)	Fl-26dB(Hz)	Fh-26dB(Hz)	OBW(Hz)	Fl-OBW(Hz)	Fh-OBW(Hz)	Limit(Hz)	Port
21.69M	5.68917G	5.71086G	18.081M	5.690975G	5.709055G	Inf	1
21.57M	5.68929G	5.71086G	17.901M	5.691064G	5.708966G	Inf	2

802.11ac VHT20_Nss1,(MCS0)_2TX

EBW

5720MHz Straddle 5.47-5.725GHz

18/06/2022

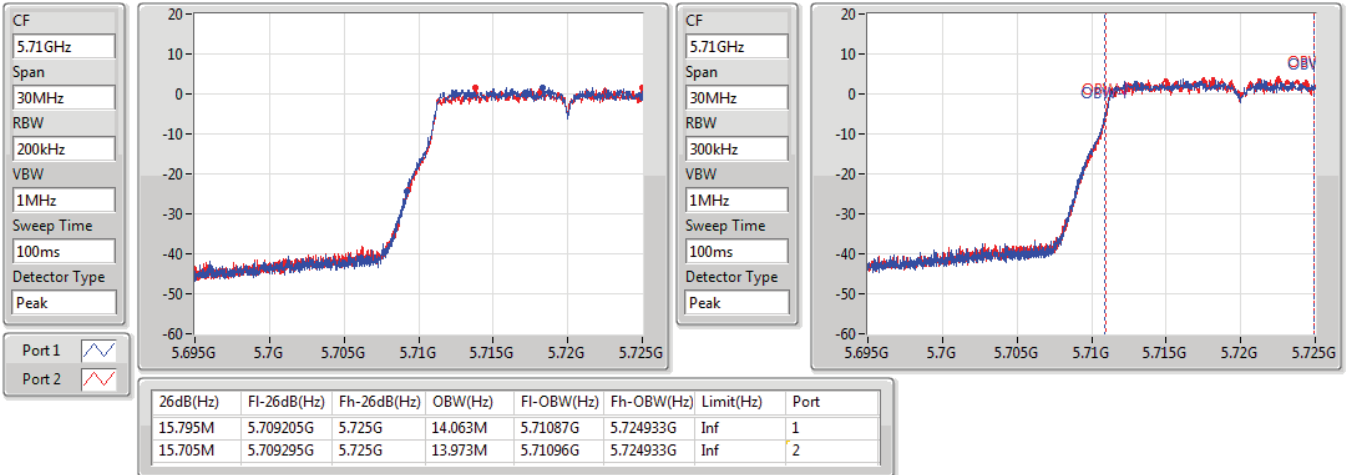

802.11ac VHT20_Nss1,(MCS0)_2TX

EBW

5720MHz Straddle 5.725-5.85GHz

18/06/2022

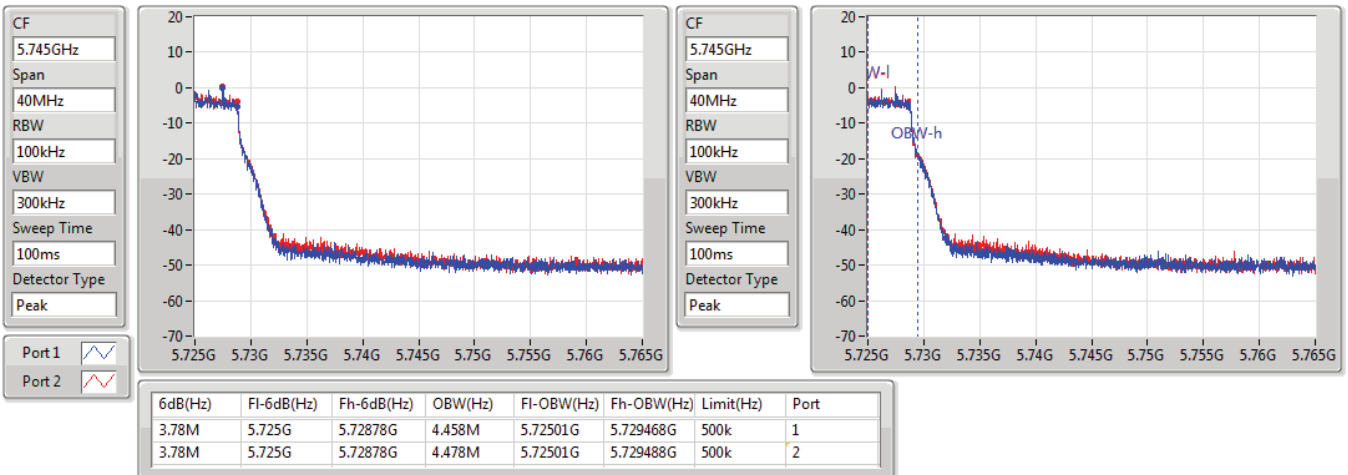

802.11ac VHT20_Nss1,(MCS0)_2TX

EBW

5745MHz

18/06/2022

CF
5.745GHz
Span
60MHz
RBW
100kHz
VBW
300kHz
Sweep Time
100ms
Detector Type
Peak

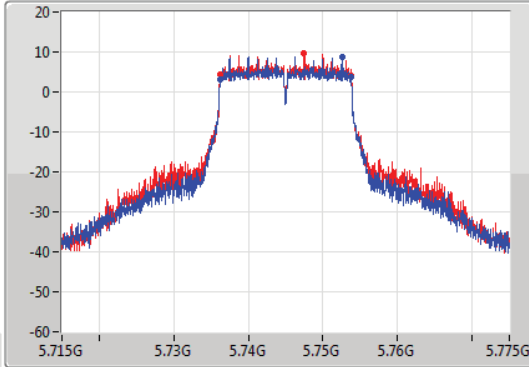

CF
5.745GHz
Span
60MHz
RBW
300kHz
VBW
1MHz
Sweep Time
100ms
Detector Type
Peak

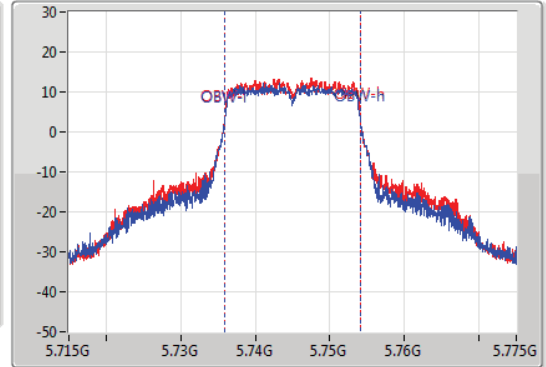

6dB(Hz)	Fl-6dB(Hz)	Fh-6dB(Hz)	OBW(Hz)	Fl-OBW(Hz)	Fh-OBW(Hz)	Limit(Hz)	Port
17.58M	5.73621G	5.75379G	18.291M	5.735855G	5.754145G	500k	1
17.58M	5.73621G	5.75379G	18.261M	5.735855G	5.754115G	500k	2

802.11ac VHT20_Nss1,(MCS0)_2TX

EBW

5785MHz

18/06/2022

CF
5.785GHz
Span
60MHz
RBW
100kHz
VBW
300kHz
Sweep Time
100ms
Detector Type
Peak

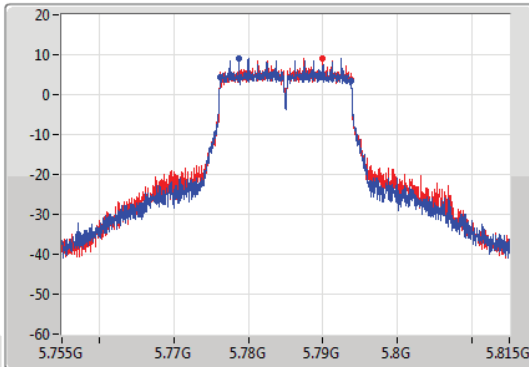

CF
5.785GHz
Span
60MHz
RBW
300kHz
VBW
1MHz
Sweep Time
100ms
Detector Type
Peak

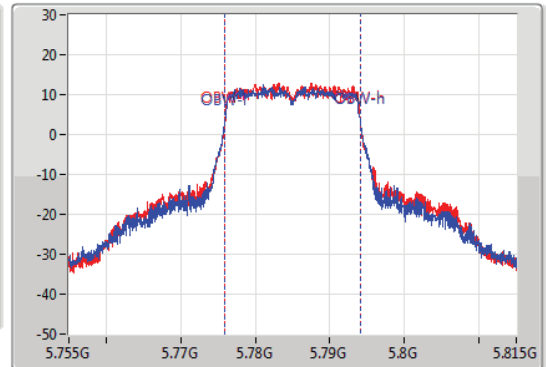

6dB(Hz)	Fl-6dB(Hz)	Fh-6dB(Hz)	OBW(Hz)	Fl-OBW(Hz)	Fh-OBW(Hz)	Limit(Hz)	Port
17.58M	5.77621G	5.79379G	18.291M	5.775855G	5.794145G	500k	1
17.58M	5.77621G	5.79379G	18.171M	5.775915G	5.794085G	500k	2