



FCC Radio Test Report

FCC ID : TVE-4111BBE0671
Equipment : Secured Wireless Access Point
Brand Name : FORTINET
Model Name : FortiAP U432Fxxxxxx, FAP-U432Fxxxxxx, FORTIAP-U432Fxxxxxx
(where “x” can be “A-Z”, or “0-9”, or “-“, or blank for software purposes or marketing purposes only)
Applicant : Fortinet, Inc.
899 Kifer Road, Sunnyvale, CA 94086, USA
Manufacturer : Fortinet, Inc.
899 Kifer Road, Sunnyvale, CA 94086, USA
Standard : 47 CFR FCC Part 15.407

The product was received on Dec. 16, 2020, and testing was started from Dec. 24, 2020 and completed on Apr. 15, 2021. We, SPORTON INTERNATIONAL INC. Hsinhua Laboratory, would like to declare that the tested sample has been evaluated in accordance with the procedures given in ANSI C63.10-2013 and shown compliance with the applicable technical standards.

The test results in this report apply exclusively to the tested model / sample. Without written approval of SPORTON INTERNATIONAL INC. Hsinhua Laboratory, the test report shall not be reproduced except in full.

Approved by: Allen Lin

SPORTON INTERNATIONAL INC. Hsinhua Laboratory

No.52, Huaya 1st Rd., Guishan Dist., Taoyuan City 333411, Taiwan (R.O.C.)



Table of Contents

HISTORY OF THIS TEST REPORT3

SUMMARY OF TEST RESULT4

1 GENERAL DESCRIPTION5

1.1 Information.....5

1.2 Testing Applied Standards12

1.3 Testing Location Information12

1.4 Measurement Uncertainty12

2 TEST CONFIGURATION OF EUT.....13

2.1 Test Channel Mode13

2.2 The Worst Case Measurement Configuration18

2.3 Accessories19

2.4 Support Equipment.....19

2.5 Test Setup Diagram20

3 TRANSMITTER TEST RESULT22

3.1 AC Power-line Conducted Emissions22

3.2 Emission Bandwidth24

3.3 Maximum Conducted Output Power25

3.4 Peak Power Spectral Density27

3.5 Unwanted Emissions29

4 TEST EQUIPMENT AND CALIBRATION DATA.....33

APPENDIX A. TEST RESULTS OF AC POWER-LINE CONDUCTED EMISSIONS

APPENDIX B. TEST RESULTS OF EMISSION BANDWIDTH

APPENDIX C. TEST RESULTS OF MAXIMUM CONDUCTED OUTPUT POWER

APPENDIX D. TEST RESULTS OF PEAK POWER SPECTRAL DENSITY

APPENDIX E. TEST RESULTS OF UNWANTED EMISSIONS

APPENDIX F. TEST PHOTOS

PHOTOGRAPHS OF EUT V01



Summary of Test Result

Report Clause	Ref. Std. Clause	Test Items	Result (PASS/FAIL)	Remark
1.1.2	15.203	Antenna Requirement	PASS	-
3.1	15.207	AC Power-line Conducted Emissions	PASS	-
3.2	15.407(a)	Emission Bandwidth	PASS	-
3.3	15.407(a)	Maximum Conducted Output Power	PASS	-
3.4	15.407(a)	Peak Power Spectral Density	PASS	-
3.5	15.407(b)	Unwanted Emissions	PASS	-

Declaration of Conformity:
The test results with all measurement uncertainty excluded are presented in accordance with the regulation limits or requirements declared by manufacturers.
Comments and explanations:
None

Reviewed by: Sam Tsai
Report Producer: Ann Hou



1 General Description

1.1 Information

1.1.1 RF General Information

Frequency Range (MHz)	IEEE Std. 802.11	Ch. Frequency (MHz)	Channel Number
5150-5250	a, n (HT20), ac (VHT20),	5180-5240	36-48 [4]
5725-5850	ax (HEW20)	5745-5825	149-165 [5]
5150-5250	n (HT40), ac (VHT40),	5190-5230	38-46 [2]
5725-5850	ax (HEW40)	5755-5795	151-159 [2]
5150-5250	ac (VHT80), ax (HEW80)	5210	42 [1]
5725-5850		5775	155 [1]

Non-Beamforming_Radio 1

Band	Mode	BWch (MHz)	Nant
5.725-5.85GHz	802.11a	20	4TX
5.725-5.85GHz	802.11n HT20	20	4TX
5.725-5.85GHz	802.11n HT40	40	4TX
5.725-5.85GHz	802.11ac VHT20	20	4TX
5.725-5.85GHz	802.11ac VHT40	40	4TX
5.725-5.85GHz	802.11ac VHT80	80	4TX
5.725-5.85GHz	802.11ax HEW20	20	4TX
5.725-5.85GHz	802.11ax HEW40	40	4TX
5.725-5.85GHz	802.11ax HEW80	80	4TX

Non-Beamforming_Radio 2

Band	Mode	BWch (MHz)	Nant
5.15-5.25GHz	802.11a	20	4TX
5.725-5.85GHz	802.11a	20	4TX
5.15-5.25GHz	802.11n HT20	20	4TX
5.725-5.85GHz	802.11n HT20	20	4TX
5.15-5.25GHz	802.11n HT40	40	4TX
5.725-5.85GHz	802.11n HT40	40	4TX
5.15-5.25GHz	802.11ac VHT20	20	4TX
5.725-5.85GHz	802.11ac VHT20	20	4TX
5.15-5.25GHz	802.11ac VHT40	40	4TX
5.725-5.85GHz	802.11ac VHT40	40	4TX



Band	Mode	BWch (MHz)	Nant
5.15-5.25GHz	802.11ac VHT80	80	4TX
5.725-5.85GHz	802.11ac VHT80	80	4TX
5.15-5.25GHz	802.11ax HEW20	20	4TX
5.725-5.85GHz	802.11ax HEW20	20	4TX
5.15-5.25GHz	802.11ax HEW40	40	4TX
5.725-5.85GHz	802.11ax HEW40	40	4TX
5.15-5.25GHz	802.11ax HEW80	80	4TX
5.725-5.85GHz	802.11ax HEW80	80	4TX

Non-Beamforming_Radio 3

Band	Mode	BWch (MHz)	Nant
5.15-5.25GHz	802.11a	20	2TX
5.725-5.85GHz	802.11a	20	2TX
5.15-5.25GHz	802.11n HT20	20	2TX
5.725-5.85GHz	802.11n HT20	20	2TX
5.15-5.25GHz	802.11n HT40	40	2TX
5.725-5.85GHz	802.11n HT40	40	2TX
5.15-5.25GHz	802.11ac VHT20	20	2TX
5.725-5.85GHz	802.11ac VHT20	20	2TX
5.15-5.25GHz	802.11ac VHT40	40	2TX
5.725-5.85GHz	802.11ac VHT40	40	2TX
5.15-5.25GHz	802.11ac VHT80	80	2TX
5.725-5.85GHz	802.11ac VHT80	80	2TX
5.15-5.25GHz	802.11ax HEW20	20	2TX
5.725-5.85GHz	802.11ax HEW20	20	2TX
5.15-5.25GHz	802.11ax HEW40	40	2TX
5.725-5.85GHz	802.11ax HEW40	40	2TX
5.15-5.25GHz	802.11ax HEW80	80	2TX
5.725-5.85GHz	802.11ax HEW80	80	2TX

Beamforming_Radio 1

Band	Mode	BWch (MHz)	Nant
5.725-5.85GHz	802.11ax HEW20-BF	20	4TX
5.725-5.85GHz	802.11ax HEW40-BF	40	4TX
5.725-5.85GHz	802.11ax HEW80-BF	80	4TX



Beamforming_Radio 2

Band	Mode	BWch (MHz)	Nant
5.15-5.25GHz	802.11ax HEW20-BF	20	4TX
5.725-5.85GHz	802.11ax HEW20-BF	20	4TX
5.15-5.25GHz	802.11ax HEW40-BF	40	4TX
5.725-5.85GHz	802.11ax HEW40-BF	40	4TX
5.15-5.25GHz	802.11ax HEW80-BF	80	4TX
5.725-5.85GHz	802.11ax HEW80-BF	80	4TX

Beamforming_Radio 3

Band	Mode	BWch (MHz)	Nant
5.15-5.25GHz	802.11ax HEW20-BF	20	2TX
5.725-5.85GHz	802.11ax HEW20-BF	20	2TX
5.15-5.25GHz	802.11ax HEW40-BF	40	2TX
5.725-5.85GHz	802.11ax HEW40-BF	40	2TX
5.15-5.25GHz	802.11ax HEW80-BF	80	2TX
5.725-5.85GHz	802.11ax HEW80-BF	80	2TX

Note:

- 11a, HT20 and HT40 use a combination of OFDM-BPSK, QPSK, 16QAM, 64QAM modulation.
- VHT20, VHT40, VHT80 use a combination of OFDM-BPSK, QPSK, 16QAM, 64QAM, 256QAM modulation.
- HEW20, HEW40, HEW80 use a combination of OFDMA-BPSK, QPSK, 16QAM, 64QAM, 256QAM, 1024QAM modulation.
- BWch is the nominal channel bandwidth.

1.1.2 Antenna Information

Ant.	Brand	Model Name	Antenna Type	Connector
1	SENAO	5718A0619300	Dipole	N-type
2	SENAO	5718A0619300	Dipole	N-type
3	SENAO	5718A0619300	Dipole	N-type
4	SENAO	5718A0619300	Dipole	N-type
5	SENAO	5718A0620300	Dipole	N-type
6	SENAO	5718A0620300	Dipole	N-type
7	SENAO	5718A0620300	Dipole	N-type
8	SENAO	5718A0620300	Dipole	N-type
9	SENAO	5718A0619300	Dipole	N-type
10	SENAO	5718A0619300	Dipole	N-type
11	SENAO	5718A0618300	Dipole	N-type



Radio	Ant.	Port	Antenna Gain (dBi)				Cable Loss Gain (dBi)			
			2.4G	5G	BT	Zigbee	2.4G	5G	BT	Zigbee
1	1	1	5.5	7.2	-	-	0.6	1	-	-
	2	2	5.5	7.2	-	-	0.6	1	-	-
	3	3	5.5	7.2	-	-	0.5	0.8	-	-
	4	4	5.5	7.2	-	-	0.4	0.7	-	-
2	5	1	-	6.3	-	-	-	1	-	-
	6	2	-	6.3	-	-	-	1.1	-	-
	7	3	-	6.3	-	-	-	0.9	-	-
	8	4	-	6.3	-	-	-	0.9	-	-
3	9	1	5.5	7.2	-	-	0.6	1	-	-
	10	2	5.5	7.2	-	-	0.6	1	-	-
BT+Zigbee	11	1	-	-	4.5	4.5	-	-	0.5	0.5

Note 1: The EUT has eleven antennas.

For 2.4GHz function:

Radio 1

For IEEE 802.11 b/g/n/VHT/ax mode (4TX/4RX)

Ant. 1 (port 1), Ant. 2 (port 2), Ant. 3 (port 3) and Ant. 4 (port 4) could transmit/receive simultaneously.

Radio 3

For IEEE 802.11 b/g/n/VHT/ax mode (2TX/2RX)

Ant. 9 (port 1) and Ant. 10 (port 2) could transmit/receive simultaneously.

For 5GHz function:

Radio 1

For IEEE 802.11 a/n/ac/ax mode (4TX/4RX)

Ant. 1 (port 1), Ant. 2 (port 2), Ant. 3 (port 3) and Ant. 4 (port 4) could transmit/receive simultaneously.

Radio 2

For IEEE 802.11 a/n/ac/ax mode (4TX/4RX)

Ant. 5 (port 1), Ant. 6 (port 2), Ant. 7 (port 3) and Ant. 8 (port 4) could transmit/receive simultaneously.

Radio 3

For IEEE 802.11 a/n/ac/ax mode (2TX/2RX)

Ant. 9 (port 1) and Ant. 10 (port 2) could transmit/receive simultaneously.

For Bluetooth function:

For IEEE 802.15.1 Bluetooth mode (1TX/1RX)

Only Ant. 11 (port 1) could transmit/receive.

For Zigbee function:

For Zigbee mode (1TX/1RX)

Only Ant. 11 (port 1) could transmit/receive.



1.1.3 EUT Information

Operational Condition			
EUT Power Type	From PoE		
EUT Function	<input type="checkbox"/> Outdoor AP	<input checked="" type="checkbox"/> Indoor AP	
	<input type="checkbox"/> Fixed P2P AP	<input type="checkbox"/> Indoor Client	
Beamforming Function	<input checked="" type="checkbox"/> With beamforming	<input type="checkbox"/> Without beamforming	
Type of EUT			
<input checked="" type="checkbox"/>	Stand-alone		
<input type="checkbox"/>	Combined (EUT where the radio part is fully integrated within another device)		
	Combined Equipment - Brand Name / Model No.: ...		
<input type="checkbox"/>	Plug-in radio (EUT intended for a variety of host systems)		
	Host System - Brand Name / Model No.:		
<input type="checkbox"/>	Other:		



1.1.4 Mode Test Duty Cycle

Non-Beamforming_Radio 1

Mode	DC	DCF(dB)	T(s)	VBW(Hz) ≥ 1/T
802.11a_Nss1,(6Mbps)_4TX	0.952	0.21	2.065m	1k
802.11n HT20_Nss1,(MCS0)_4TX	0.95	0.22	1.921m	1k
802.11n HT40_Nss1,(MCS0)_4TX	0.906	0.43	945u	3k
802.11ac VHT20_Nss1,(MCS0)_4TX	0.985	0.07	1.929m	10
802.11ac VHT40_Nss1,(MCS0)_4TX	0.97	0.13	953.125u	3k
802.11ac VHT80_Nss1,(MCS0)_4TX	0.941	0.26	461.25u	3k
802.11ax HEW20_Nss1,(MCS0)_4TX	0.98	0.09	1.488m	1k
802.11ax HEW40_Nss1,(MCS0)_4TX	0.962	0.17	773.125u	3k
802.11ax HEW80_Nss1,(MCS0)_4TX	0.927	0.33	401.875u	3k

Note. If DC < 0.98, the DCF was added while measuring Output power and PSD.

Non-Beamforming_Radio 2

Mode	DC	DCF(dB)	T(s)	VBW(Hz) ≥ 1/T
802.11a_Nss1,(6Mbps)_4TX	0.541	2.67	128.437u	10k
802.11n HT20_Nss1,(MCS0)_4TX	0.95	0.22	1.921m	1k
802.11n HT40_Nss1,(MCS0)_4TX	0.901	0.45	944.375u	3k
802.11ac VHT20_Nss1,(MCS0)_4TX	0.985	0.07	1.928m	10
802.11ac VHT40_Nss1,(MCS0)_4TX	0.971	0.13	952.5u	3k
802.11ac VHT80_Nss1,(MCS0)_4TX	0.939	0.27	460.625u	3k
802.11ax HEW20_Nss1,(MCS0)_4TX	0.914	0.39	318.125u	10k
802.11ax HEW40_Nss1,(MCS0)_4TX	0.903	0.44	304.375u	10k
802.11ax HEW80_Nss1,(MCS0)_4TX	0.927	0.33	401.25u	3k

Note. If DC < 0.98, the DCF was added while measuring Output power and PSD.

Non-Beamforming_Radio 3

Mode	DC	DCF(dB)	T(s)	VBW(Hz) ≥ 1/T
802.11a_Nss1,(6Mbps)_2TX	0.95	0.22	2.066m	1k
802.11n HT20_Nss1,(MCS0)_2TX	0.951	0.22	1.922m	1k
802.11n HT40_Nss1,(MCS0)_2TX	0.905	0.43	946u	3k
802.11ac VHT20_Nss1,(MCS0)_2TX	0.986	0.06	1.93m	10
802.11ac VHT40_Nss1,(MCS0)_2TX	0.971	0.13	953u	3k
802.11ac VHT80_Nss1,(MCS0)_2TX	0.943	0.25	462u	3k
802.11ax HEW20_Nss1,(MCS0)_2TX	0.98	0.09	1.489m	1k
802.11ax HEW40_Nss1,(MCS0)_2TX	0.963	0.16	774u	3k
802.11ax HEW80_Nss1,(MCS0)_2TX	0.928	0.32	402u	3k

Note. If DC < 0.98, the DCF was added while measuring Output power and PSD.



Beamforming_Radio 1

Mode	DC	DCF(dB)	T(s)	VBW(Hz) ≥ 1/T
802.11ax HEW20-BF_Nss1,(MCS0)_4TX	0.929	0.32	2.932m	1k
802.11ax HEW40-BF_Nss1,(MCS0)_4TX	0.943	0.25	4.368m	300
802.11ax HEW80-BF_Nss1,(MCS0)_4TX	0.933	0.3	4.15m	300

Note. If DC < 0.98, the DCF was added while measuring Output power and PSD.

Beamforming_Radio 2

Mode	DC	DCF(dB)	T(s)	VBW(Hz) ≥ 1/T
802.11ax HEW20-BF_Nss1,(MCS0)_4TX	0.888	0.52	2.932m	1k
802.11ax HEW40-BF_Nss1,(MCS0)_4TX	0.922	0.35	4.368m	300
802.11ax HEW80-BF_Nss1,(MCS0)_4TX	0.939	0.27	4.15m	300

Note. If DC < 0.98, the DCF was added while measuring Output power and PSD.

Beamforming_Radio 3

Mode	DC	DCF(dB)	T(s)	VBW(Hz) ≥ 1/T
802.11ax HEW20-BF_Nss1,(MCS0)_2TX	0.953	0.21	2.932m	1k
802.11ax HEW40-BF_Nss1,(MCS0)_2TX	0.951	0.22	4.368m	300
802.11ax HEW80-BF_Nss1,(MCS0)_2TX	0.955	0.2	4.15m	300

Note. If DC < 0.98, the DCF was added while measuring Output power and PSD.

1.1.5 Table for Multiple Listing

The brand/model names in the following table are all refer to the identical product.

Brand Name	Model Name	Description
FORTINET	FortiAP U432Fxxxxxx	All the models are identical, the difference model for served as marketing strategy.
	FAP-U432Fxxxxxx	
	FORTIAP-U432Fxxxxxx	

1.2 Testing Applied Standards

According to the specifications of the manufacturer, the EUT must comply with the requirements of the following standards:

- ◆ 47 CFR FCC Part 15
- ◆ ANSI C63.10-2013
- ◆ KDB 789033 D02 v02r01

The following reference test guidance is not within the scope of accreditation of TAF:

- ◆ KDB 662911 D01 v02r01
- ◆ KDB 414788 D01 v01r01

1.3 Testing Location Information

Test Lab. : Sporton International Inc. Hsinhua Laboratory				
<input checked="" type="checkbox"/> Hsinhua (TAF: 3785)	ADD: No.52, Huaya 1st Rd., Guishan Dist., Taoyuan City 333411, Taiwan (R.O.C.)			
	TEL: 886-3-327-3456		FAX: 886-3-327-0973	
Test site Designation No. TW3785 with FCC.				
Test Condition	Test Site No.	Test Engineer	Test Environment	Test Date
AC Conduction	CO04-HY	Edward	18.2~19.2°C / 42~48%	31/Dec/2020
RF Conducted	TH06-HY	Alan	20.1~26.9°C / 50~60%	25/Dec/2020~14/Feb/2021
Radiated	03CH02-HY	Frank	19.7~26.5°C / 50~60%	24/Dec/2020~15/Apr/2021
<input type="checkbox"/> Wen 33rd.St. (TAF: 3785)	ADD: No.14-1, Ln. 19, Wen 33rd St., Guishan Dist., Taoyuan City 333010, Taiwan (R.O.C.)			
	TEL: 886-3-318-0787		FAX: 886-3-318-0287	
Test site Designation No. TW0008 with FCC.				

1.4 Measurement Uncertainty

ISO/IEC 17025 requires that an estimate of the measurement uncertainties associated with the emissions test results be included in the report. The measurement uncertainties given below are based on a 95% confidence level (based on a coverage factor (k=2))

Test Items	Uncertainty	Remark
Conducted Emission (150kHz ~ 30MHz)	0.9 dB	Confidence levels of 95%
Radiated Emission (9kHz ~ 30MHz)	2.4 dB	Confidence levels of 95%
Radiated Emission (30MHz ~ 1,000MHz)	3.7 dB	Confidence levels of 95%
Radiated Emission (1GHz ~ 18GHz)	3.6 dB	Confidence levels of 95%
Radiated Emission (18GHz ~ 40GHz)	3.5 dB	Confidence levels of 95%
Conducted Emission	1.0 dB	Confidence levels of 95%
Temperature	0.41 °C	Confidence levels of 95%
Humidity	3.4 %	Confidence levels of 95%



2 Test Configuration of EUT

2.1 Test Channel Mode

Test Software Version	accessMTool_REL_3_1_0_1
-----------------------	-------------------------

Non-Beamforming_Radio 1

Mode	Power Setting
802.11a_Nss1,(6Mbps)_4TX	-
5745MHz	87
5785MHz	88
5825MHz	87
802.11n HT20_Nss1,(MCS0)_4TX	-
5745MHz	86
5785MHz	84
5825MHz	86
802.11n HT40_Nss1,(MCS0)_4TX	-
5755MHz	86
5795MHz	87
802.11ac VHT20_Nss1,(MCS0)_4TX	-
5745MHz	86
5785MHz	84
5825MHz	86
802.11ac VHT40_Nss1,(MCS0)_4TX	-
5755MHz	86
5795MHz	87
802.11ac VHT80_Nss1,(MCS0)_4TX	-
5775MHz	72
802.11ax HEW20_Nss1,(MCS0)_4TX	-
5745MHz	86
5785MHz	84
5825MHz	86
802.11ax HEW40_Nss1,(MCS0)_4TX	-
5755MHz	86
5795MHz	87
802.11ax HEW80_Nss1,(MCS0)_4TX	-
5775MHz	72



Non-Beamforming_Radio 2

Mode	Power Setting
802.11a_Nss1,(6Mbps)_4TX	-
5180MHz	72
5200MHz	79
5240MHz	78
5745MHz	89
5785MHz	90
5825MHz	91
802.11n HT20_Nss1,(MCS0)_4TX	-
5180MHz	63
5200MHz	75
5240MHz	75
5745MHz	91
5785MHz	91
5825MHz	91
802.11n HT40_Nss1,(MCS0)_4TX	-
5190MHz	51
5230MHz	74
5755MHz	86
5795MHz	89
802.11ac VHT20_Nss1,(MCS0)_4TX	-
5180MHz	63
5200MHz	75
5240MHz	75
5745MHz	91
5785MHz	91
5825MHz	91
802.11ac VHT40_Nss1,(MCS0)_4TX	-
5190MHz	51
5230MHz	74
5755MHz	86
5795MHz	89
802.11ac VHT80_Nss1,(MCS0)_4TX	-
5210MHz	54
5775MHz	74
802.11ax HEW20_Nss1,(MCS0)_4TX	-
5180MHz	63
5200MHz	75



Mode	Power Setting
5240MHz	75
5745MHz	91
5785MHz	91
5825MHz	91
802.11ax HEW40_Nss1,(MCS0)_4TX	-
5190MHz	51
5230MHz	74
5755MHz	86
5795MHz	89
802.11ax HEW80_Nss1,(MCS0)_4TX	-
5210MHz	54
5775MHz	74

Non-Beamforming_Radio 3

Mode	Power Setting
802.11a_Nss1,(6Mbps)_2TX	-
5180MHz	66
5200MHz	77
5240MHz	76
5745MHz	84
5785MHz	96
5825MHz	87
802.11n HT20_Nss1,(MCS0)_2TX	-
5180MHz	67
5200MHz	76
5240MHz	77
5745MHz	86
5785MHz	96
5825MHz	86
802.11n HT40_Nss1,(MCS0)_2TX	-
5190MHz	57
5230MHz	76
5755MHz	85
5795MHz	96
802.11ac VHT20_Nss1,(MCS0)_2TX	-
5180MHz	67
5200MHz	76
5240MHz	77



Mode	Power Setting
5745MHz	86
5785MHz	96
5825MHz	86
802.11ac VHT40_Nss1,(MCS0)_2TX	-
5190MHz	57
5230MHz	76
5755MHz	85
5795MHz	96
802.11ac VHT80_Nss1,(MCS0)_2TX	-
5210MHz	60
5775MHz	67
802.11ax HEW20_Nss1,(MCS0)_2TX	-
5180MHz	67
5200MHz	76
5240MHz	77
5745MHz	86
5785MHz	96
5825MHz	86
802.11ax HEW40_Nss1,(MCS0)_2TX	-
5190MHz	57
5230MHz	76
5755MHz	85
5795MHz	96
802.11ax HEW80_Nss1,(MCS0)_2TX	-
5210MHz	60
5775MHz	67

Beamforming_Radio 1

Mode	Power Setting
802.11ax HEW20-BF_Nss1,(MCS0)_4TX	-
5745MHz	69
5785MHz	70
5825MHz	73
802.11ax HEW40-BF_Nss1,(MCS0)_4TX	-
5755MHz	70
5795MHz	72
802.11ax HEW80-BF_Nss1,(MCS0)_4TX	-
5775MHz	70



Beamforming_Radio 2

Mode	Power Setting
802.11ax HEW20-BF_Nss1,(MCS0)_4TX	-
5180MHz	66
5200MHz	75
5240MHz	75
5745MHz	79
5785MHz	79
5825MHz	79
802.11ax HEW40-BF_Nss1,(MCS0)_4TX	-
5190MHz	59
5230MHz	75
5755MHz	77
5795MHz	78
802.11ax HEW80-BF_Nss1,(MCS0)_4TX	-
5210MHz	62
5775MHz	78

Beamforming_Radio 3

Mode	Power Setting
802.11ax HEW20-BF_Nss1,(MCS0)_2TX	-
5180MHz	69
5200MHz	90
5240MHz	74
5745MHz	96
5785MHz	96
5825MHz	96
802.11ax HEW40-BF_Nss1,(MCS0)_2TX	-
5190MHz	64
5230MHz	86
5755MHz	84
5795MHz	96
802.11ax HEW80-BF_Nss1,(MCS0)_2TX	-
5210MHz	64
5775MHz	68

2.2 The Worst Case Measurement Configuration

The Worst Case Mode for Following Conformance Tests	
Tests Item	AC power-line conducted emissions
Condition	AC power-line conducted measurement for line and neutral Test Voltage: 120Vac / 60Hz
Operating Mode	CTX
1	PoE mode

The Worst Case Mode for Following Conformance Tests	
Tests Item	Emission Bandwidth Maximum Conducted Output Power Peak Power Spectral Density
Test Condition	Conducted measurement at transmit chains

The Worst Case Mode for Following Conformance Tests	
Tests Item	Unwanted Emissions
Test Condition	Radiated measurement If EUT consist of multiple antenna assembly (multiple antenna are used in EUT regardless of spatial multiplexing MIMO configuration), the radiated test should be performed with highest antenna gain of each antenna type.
Operating Mode < 1GHz	CTX
1	PoE mode
Operating Mode > 1GHz	CTX
Orthogonal Planes of EUT	Y Plane
	

The Worst Case Mode for Following Conformance Tests	
Tests Item	Simultaneous Transmission Analysis
Operating Mode	CTX
1	Radio 1(2.4G)+ Radio 2(5G)+ Radio 3(2.4G)+ Bluetooth
2	Radio 1(5G)+ Radio 2(5G)+ Radio 3(2.4G)+ Bluetooth
3	Radio 1(5G)+ Radio 2(5G)+ Radio 3(5G)+ Bluetooth
4	Radio 1(2.4G)+ Radio 2(5G)+ Radio 3(5G)+ Bluetooth
5	Radio 1(2.4G)+ Radio 2(5G)+ Radio 3(2.4G)+Zigbee
6	Radio 1(5G)+ Radio 2(5G)+ Radio 3(2.4G)+Zigbee
7	Radio 1(5G)+ Radio 2(5G)+ Radio 3(5G)+Zigbee
8	Radio 1(2.4G)+ Radio 2(5G)+ Radio 3(5G)+Zigbee
Refer to Sporton Test Report No.: FA0D1422 for Co-location RF Exposure Evaluation.	



2.3 Accessories

Accessories				
PoE Adapter	Brand Name	Senao Inc.	Model Name	PIN060-54PR
	Power Rating	I/P: 100-240Vac, 1.5A, 50-60Hz, O/P: 54Vdc, 1.11A		
AC CORD	Brand Name	I-SHENG	Model Name	AC CORD 600mm
	Signal Line	0.5 meter, shielded cable, w/o ferrite core		
Ground Wire	Brand Name	BO YAO	Model Name	WIRE GEN AWG10 180cm
	Signal Line	1.8 meter, shielded cable, w/o ferrite core		
Bracket wall mount	Brand Name	XIERTEK	Model Name	BRACKET WALL MOUNT
Bracket pole mount	Brand Name	CUN SHENG	Model Name	BRACKET POLE MOUN

Reminder: Regarding to more detail and other information, please refer to user manual.

2.4 Support Equipment

Support Equipment – AC Conduction					
No.	Equipment	Brand Name	Model Name	FCC ID	Remark
1	RJ45 Cable	Power Sync	CAT-6E-01	-	-
2	AC Power Cable	I-SHENG	AC CORD 600mm	-	Customer provide /Remote
3	Notebook	DELL	PP13S	-	Remote
4	RJ45 Cable	Power Sync	CAT-6E-01	-	Remote
5	RJ45 Cable	Power Sync	CAT-6E-10	-	Remote
6	Client	SENAO	FAP-U432F	-	Customer provide /Remote

Support Equipment – Conducted					
No.	Equipment	Brand Name	Model Name	FCC ID	Remark
1	Notebook	DELL	E5410	-	-
2	AC Adapter for NB	DELL	HA65NM130	-	-

Support Equipment – Radiated					
No.	Equipment	Brand Name	Model Name	FCC ID	Remark
1	RJ45 Cable	Power Sync	CAT-6E-01	-	-
2	RJ45 Cable	Power Sync	CAT-6E-10	-	-
3	Notebook	HP	5220M	-	Remote
4	AC Adapter for NB	HP	PPP012L-E	-	Remote
5	RJ45 Cable	Power Sync	CAT-6E-01	-	Remote
6	RJ45 Cable	Power Sync	CAT-6E-10	-	Remote
7	Client	SENAO	FAP-U432F	-	Customer provide /Remote

2.5 Test Setup Diagram

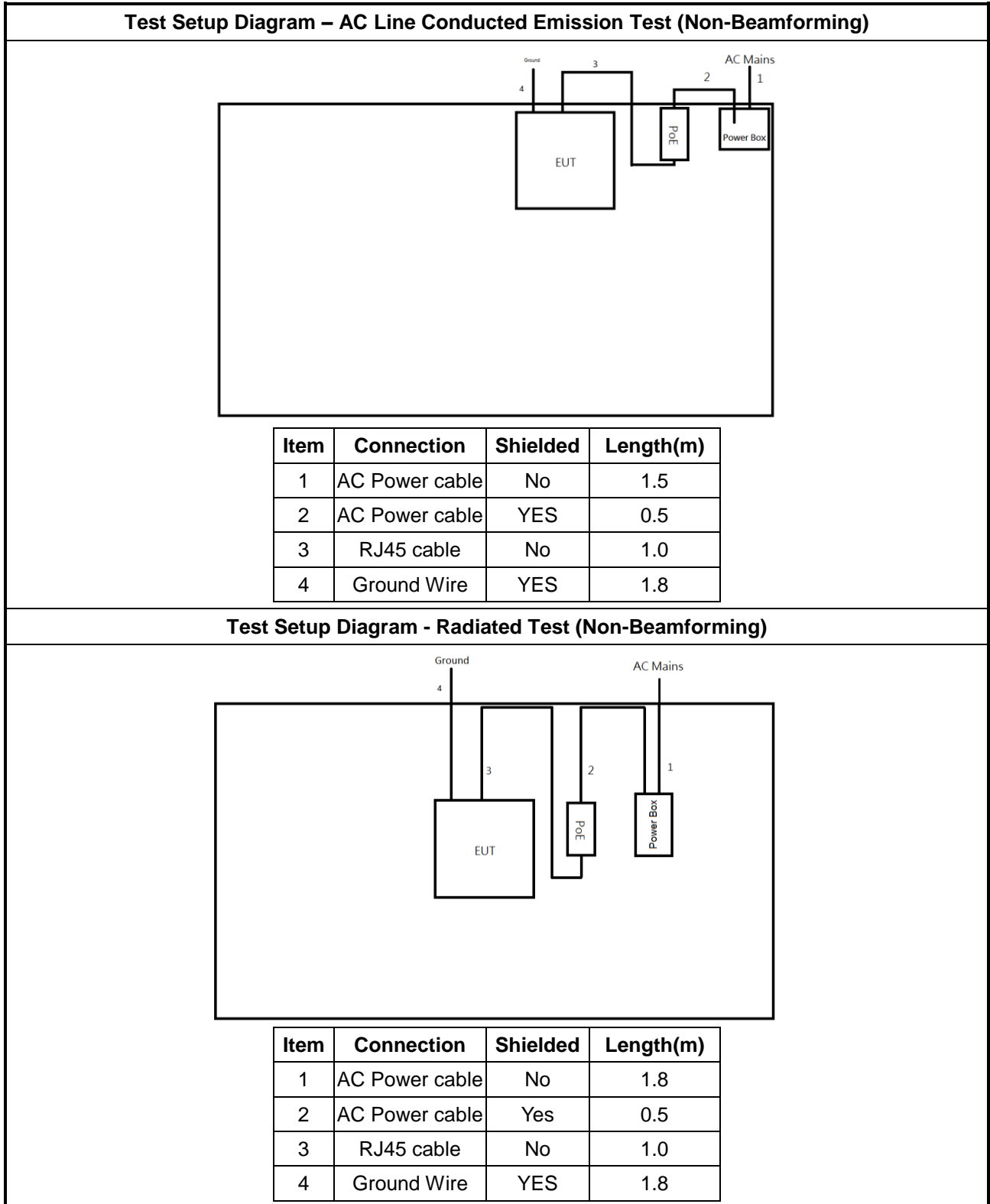

Test Setup Diagram – AC Line Conducted Emission Test (Beamforming)

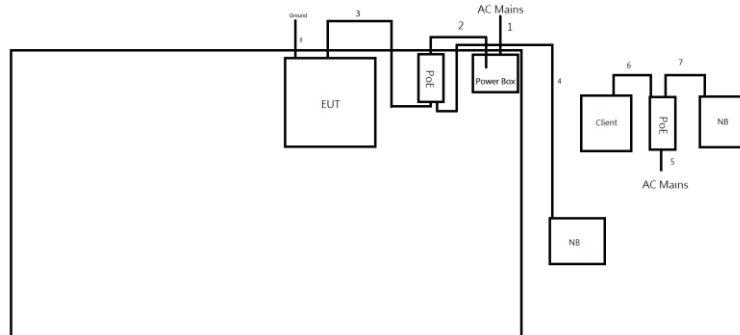

Item	Connection	Shielded	Length(m)
1	AC Power cable	No	1.5
2	AC Power cable	YES	0.5
3	RJ45 cable	No	1.0
4	RJ45 Cable	No	10.0
5	AC Power cable	YES	0.5
6	RJ45 Cable	No	1.0
7	RJ45 Cable	No	1.0
8	Ground Wire	YES	1.8

Test Setup Diagram - Radiated Test (Beamforming)

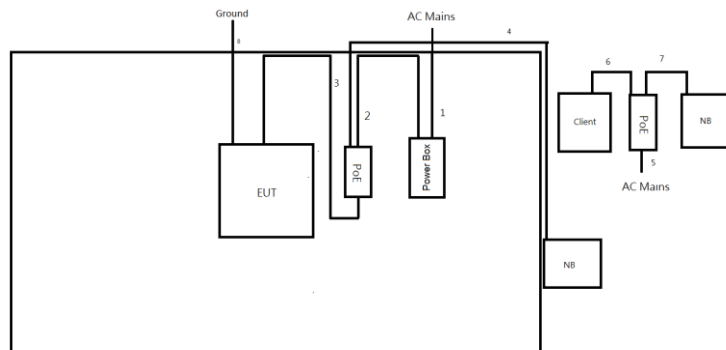

Item	Connection	Shielded	Length(m)
1	AC Power cable	No	1.5
2	AC Power cable	YES	0.5
3	RJ45 cable	No	1.0
4	RJ45 Cable	No	10.0
5	AC Power cable	YES	0.5
6	RJ45 Cable	No	1.0
7	RJ45 Cable	No	1.0
8	Ground Wire	YES	1.8



3 Transmitter Test Result

3.1 AC Power-line Conducted Emissions

3.1.1 AC Power-line Conducted Emissions Limit

AC Power-line Conducted Emissions Limit		
Frequency Emission (MHz)	Quasi-Peak	Average
0.15-0.5	66 - 56 *	56 - 46 *
0.5-5	56	46
5-30	60	50

Note 1: * Decreases with the logarithm of the frequency.

3.1.2 Measuring Instruments

Refer a test equipment and calibration data table in this test report.

3.1.3 Test Procedures

Test Method
<input checked="" type="checkbox"/> Refer as ANSI C63.10-2013, clause 6.2 for AC power-line conducted emissions.

3.1.4 Measurement Results Calculation

The measured Level is calculated using:

Corrected Reading: Raw(Read Level) +LISN(LISN Factor) + CL(Cable Loss) + AT(Attenuator).

3.1.5 Test Setup

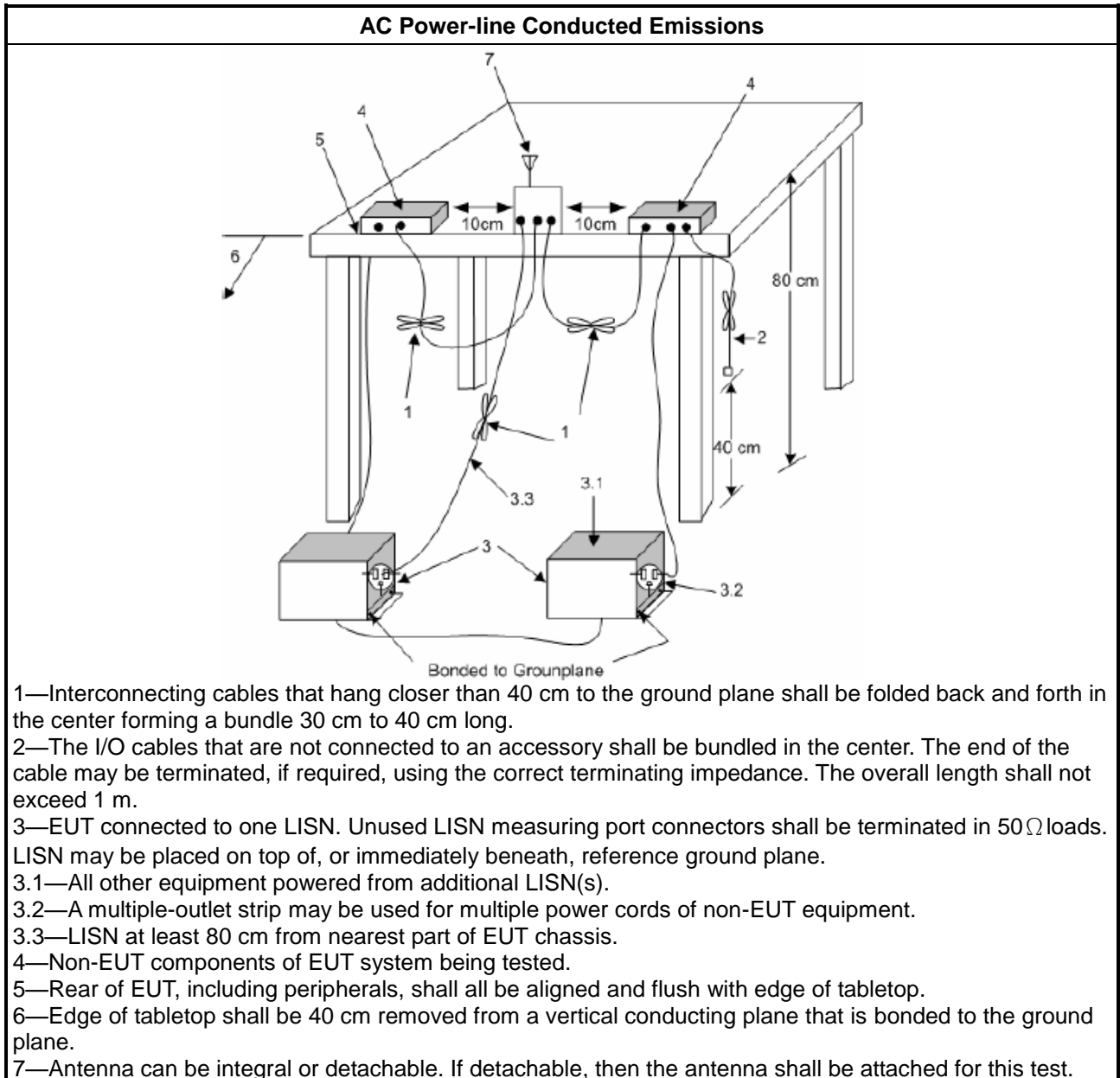

3.1.6 Test Result of AC Power-line Conducted Emissions

Refer as Appendix A

3.2 Emission Bandwidth

3.2.1 Emission Bandwidth Limit

Emission Bandwidth Limit	
UNII Devices	
<input checked="" type="checkbox"/>	For the 5.15-5.25 GHz band, N/A
<input type="checkbox"/>	For the 5.25-5.35 GHz band, N/A
<input type="checkbox"/>	For the 5.47-5.725 GHz band, N/A
<input checked="" type="checkbox"/>	For the 5.725-5.85 GHz band, 6 dB emission bandwidth \geq 500kHz.

3.2.2 Measuring Instruments

Refer a test equipment and calibration data table in this test report.

3.2.3 Test Procedures

Test Method	
<ul style="list-style-type: none"> ▪ For the emission bandwidth shall be measured using one of the options below: 	
<input checked="" type="checkbox"/>	Refer as KDB 789033, clause C for EBW and clause D for OBW measurement.
<input type="checkbox"/>	Refer as ANSI C63.10, clause 6.9.3 for occupied bandwidth testing.
<input type="checkbox"/>	Refer as IC RSS-Gen, clause 6.7 for bandwidth testing.

3.2.4 Test Setup

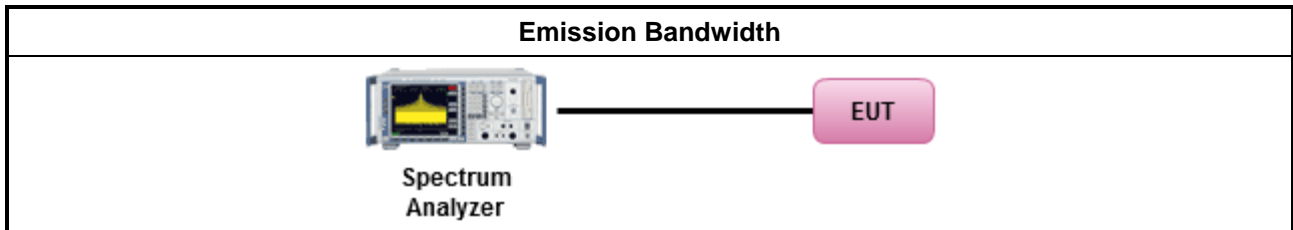

3.2.5 Test Result of Emission Bandwidth

Refer as Appendix B

3.3 Maximum Conducted Output Power

3.3.1 Maximum Conducted Output Power Limit

Maximum Conducted Output Power Limit	
UNII Devices	
<input checked="" type="checkbox"/> For the 5.15-5.25 GHz band:	
	<ul style="list-style-type: none"> ▪ Outdoor AP: the maximum conducted output power (P_{Out}) shall not exceed the lesser of 1 W. If $G_{TX} > 6$ dBi, then $P_{Out} = 30 - (G_{TX} - 6)$. e.i.r.p. at any elevation angle above 30 degrees $\leq 125mW$ [21dBm] ▪ Indoor AP: the maximum conducted output power (P_{Out}) shall not exceed the lesser of 1 W. If $G_{TX} > 6$ dBi, then $P_{Out} = 30 - (G_{TX} - 6)$ ▪ Point-to-point AP: the maximum conducted output power (P_{Out}) shall not exceed the lesser of 1 W. If $G_{TX} > 23$ dBi, then $P_{Out} = 30 - (G_{TX} - 23)$. ▪ Mobile or Portable Client: the maximum conducted output power (P_{Out}) shall not exceed the lesser of 250 mW. If $G_{TX} > 6$ dBi, then $P_{Out} = 24 - (G_{TX} - 6)$.
<input type="checkbox"/> For the 5.25-5.35 GHz band, the maximum conducted output power (P_{Out}) shall not exceed the lesser of 250 mW or 11 dBm + 10 log B, where B is the 26 dB emission bandwidth in MHz. If $G_{TX} > 6$ dBi, then $P_{Out} = 24 - (G_{TX} - 6)$.	
<input type="checkbox"/> For the 5.47-5.725 GHz band, the maximum conducted output power (P_{Out}) shall not exceed the lesser of 250 mW or 11 dBm + 10 log B, where B is the 26 dB emission bandwidth in MHz. If $G_{TX} > 6$ dBi, then $P_{Out} = 24 - (G_{TX} - 6)$.	
<input checked="" type="checkbox"/> For the 5.725-5.85 GHz band:	
	<ul style="list-style-type: none"> ▪ Point-to-multipoint systems (P2M): the maximum conducted output power (P_{Out}) shall not exceed the lesser of 1 W. If $G_{TX} > 6$ dBi, then $P_{Out} = 30 - (G_{TX} - 6)$. ▪ Point-to-point systems (P2P): the maximum conducted output power (P_{Out}) shall not exceed the lesser of 1 W.
P_{Out} = maximum conducted output power in dBm, G_{TX} = the maximum transmitting antenna directional gain in dBi.	

3.3.2 Measuring Instruments

Refer a test equipment and calibration data table in this test report.

3.3.3 Test Procedures

Test Method	
<ul style="list-style-type: none"> ▪ Maximum Conducted Output Power 	
	Duty cycle ≥ 98%
<input type="checkbox"/>	Refer as KDB 789033, clause E Method SA-2 (spectral trace averaging).
	Duty cycle < 98%
<input type="checkbox"/>	Refer as KDB 789033, clause E Method SA-2 Alt. (RMS detection with slow sweep speed)
	Wideband RF power meter and average over on/off periods with duty factor
<input checked="" type="checkbox"/>	Refer as KDB 789033, clause E Method PM (using an RF average power meter).
<ul style="list-style-type: none"> ▪ For conducted measurement. 	
	<ul style="list-style-type: none"> ▪ If the EUT supports multiple transmit chains using options given below: Refer as KDB 662911, In-band power measurements. Using the measure-and-sum approach, measured all transmit ports individually. Sum the power (in linear power units e.g., mW) of all ports for each individual sample and save them.
	<ul style="list-style-type: none"> ▪ If multiple transmit chains, EIRP calculation could be following as methods: $P_{total} = P_1 + P_2 + \dots + P_n$ (calculated in linear unit [mW] and transfer to log unit [dBm]) $EIRP_{total} = P_{total} + DG$

3.3.4 Test Setup

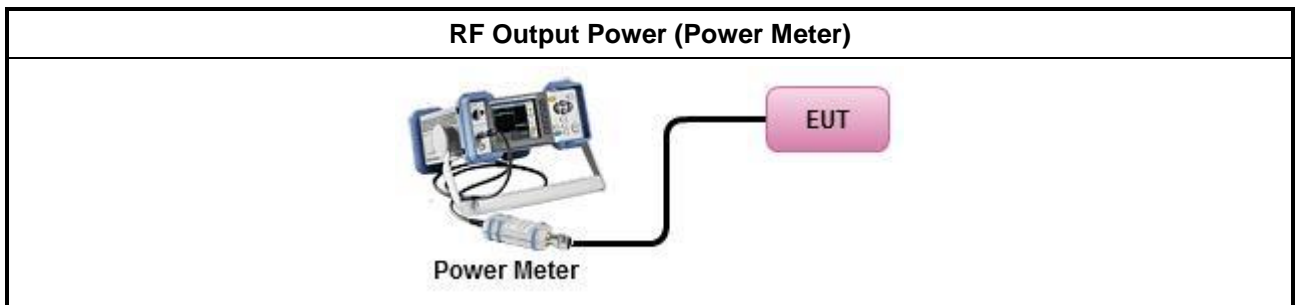

3.3.5 Test Result of Maximum Conducted Output Power

Refer as Appendix C

3.4 Peak Power Spectral Density

3.4.1 Peak Power Spectral Density Limit

Peak Power Spectral Density Limit	
UNII Devices	
<input checked="" type="checkbox"/> For the 5.15-5.25 GHz band:	
<input type="checkbox"/>	<ul style="list-style-type: none"> ▪ Outdoor AP: the peak power spectral density (PPSD) shall not exceed the lesser of 17dBm/MHz. If $G_{TX} > 6$ dBi, then $P_{Out} = 17 - (G_{TX} - 6)$. ▪ Indoor AP: the peak power spectral density (PPSD) shall not exceed the lesser of 17dBm/MHz. If $G_{TX} > 6$ dBi, then $P_{Out} = 17 - (G_{TX} - 6)$. ▪ Point-to-point AP: the peak power spectral density (PPSD) shall not exceed the lesser of 17dBm/MHz. If $G_{TX} > 23$ dBi, then $P_{Out} = 17 - (G_{TX} - 23)$. ▪ Mobile or Portable Client: the peak power spectral density (PPSD) ≤ 11 dBm/MHz. If $G_{TX} > 6$ dBi, then $PPSD = 11 - (G_{TX} - 6)$.
<input type="checkbox"/> For the 5.25-5.35 GHz band, the peak power spectral density (PPSD) ≤ 11 dBm/MHz. If $G_{TX} > 6$ dBi, then $PPSD = 11 - (G_{TX} - 6)$.	
<input type="checkbox"/> For the 5.47-5.725 GHz band, the peak power spectral density (PPSD) ≤ 11 dBm/MHz. If $G_{TX} > 6$ dBi, then $PPSD = 11 - (G_{TX} - 6)$.	
<input checked="" type="checkbox"/> For the 5.725-5.85 GHz band:	
<input type="checkbox"/>	<ul style="list-style-type: none"> ▪ Point-to-multipoint systems (P2M): the peak power spectral density (PPSD) ≤ 30 dBm/500kHz. If $G_{TX} > 6$ dBi, then $PPSD = 30 - (G_{TX} - 6)$. ▪ Point-to-point systems (P2P): the peak power spectral density (PPSD) ≤ 30 dBm/500kHz.
<p>PPSD = peak power spectral density that he same method as used to determine the conducted output power shall be used to determine the power spectral density. And power spectral density in dBm/MHz</p> <p>G_{TX} = the maximum transmitting antenna directional gain in dBi.</p>	

3.4.2 Measuring Instruments

Refer a test equipment and calibration data table in this test report.

3.4.3 Test Procedures

Test Method	
<ul style="list-style-type: none"> ▪ Peak power spectral density procedures that the same method as used to determine the conducted output power shall be used to determine the peak power spectral density and use the peak search function on the spectrum analyzer to find the peak of the spectrum. For the peak power spectral density shall be measured using below options: 	
<input type="checkbox"/>	Refer as KDB 789033, F)5) power spectral density can be measured using resolution bandwidths < 1 MHz provided that the results are integrated over 1 MHz bandwidth
Duty cycle ≥ 98%	
<input checked="" type="checkbox"/>	Refer as KDB 789033, clause E Method SA-2 (spectral trace averaging).
Duty cycle < 98%	
<input checked="" type="checkbox"/>	Refer as KDB 789033, clause E Method SA-2 Alt. (RMS detection with slow sweep speed)
<ul style="list-style-type: none"> ▪ For conducted measurement. 	
<ul style="list-style-type: none"> ▪ If the EUT supports multiple transmit chains using options given below: <ul style="list-style-type: none"> ▪ Measure and sum the spectra across the outputs. Refer as KDB 662911, In-band power spectral density (PSD). Sample all transmit ports simultaneously using a spectrum analyzer for each transmit port. Where the trace bin-by-bin of each transmit port summing can be performed. (i.e., in the first spectral bin of output 1 is summed with that in the first spectral bin of output 2 and that from the first spectral bin of output 3, and so on up to the NTX output to obtain the value for the first frequency bin of the summed spectrum.). Add up the amplitude (power) values for the different transmit chains and use this as the new data trace. ▪ If multiple transmit chains, EIRP PPSD calculation could be following as methods: $PPSD_{total} = PPSD_1 + PPSD_2 + \dots + PPSD_n$ (calculated in linear unit [mW] and transfer to log unit [dBm]) $EIRP_{total} = PPSD_{total} + DG$ 	

3.4.4 Test Setup

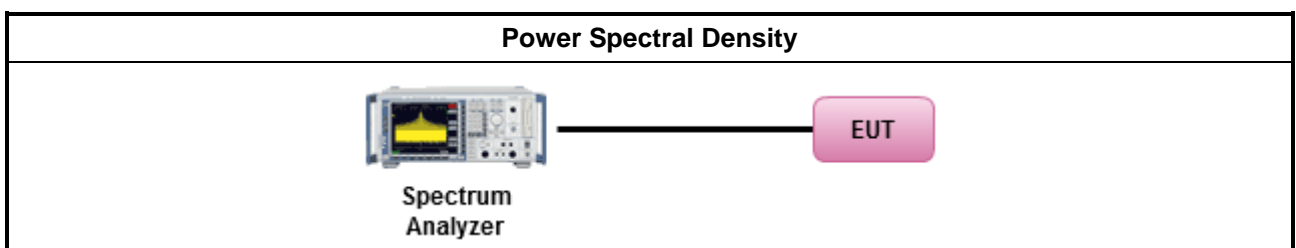

3.4.5 Test Result of Peak Power Spectral Density

Refer as Appendix D

3.5 Unwanted Emissions

3.5.1 Transmitter Radiated Unwanted Emissions Limit

Unwanted emissions below 1 GHz and restricted band emissions above 1GHz limit			
Frequency Range (MHz)	Field Strength (uV/m)	Field Strength (dBuV/m)	Measure Distance (m)
0.009~0.490	2400/F(kHz)	48.5 - 13.8	300
0.490~1.705	24000/F(kHz)	33.8 - 23	30
1.705~30.0	30	29	30
30~88	100	40	3
88~216	150	43.5	3
216~960	200	46	3
Above 960	500	54	3

Note 1: Test distance for frequencies at or above 30 MHz, measurements may be performed at a distance other than the limit distance provided they are not performed in the near field and the emissions to be measured can be detected by the measurement equipment. When performing measurements at a distance other than that specified, the results shall be extrapolated to the specified distance using an extrapolation factor of 20 dB/decade (inverse of linear distance for field-strength measurements, inverse of linear distance-squared for power-density measurements).

Note 2: Test distance for frequencies at below 30 MHz, measurements may be performed at a distance closer than the EUT limit distance; however, an attempt should be made to avoid making measurements in the near field. When performing measurements below 30 MHz at a closer distance than the limit distance, the results shall be extrapolated to the specified distance by either making measurements at a minimum of two or more distances on at least one radial to determine the proper extrapolation factor or by using the square of an inverse linear distance extrapolation factor (40 dB/decade). The test report shall specify the extrapolation method used to determine compliance of the EUT.

Note 3: Using the distance of 1m during the test for above 18 GHz, and the test value to correct for the distance factor at 3m.

Un-restricted band emissions above 1GHz Limit	
Operating Band	Limit
5.15 - 5.25 GHz	e.i.r.p. -27 dBm [68.2 dBuV/m@3m]
5.25 - 5.35 GHz	e.i.r.p. -27 dBm [68.2 dBuV/m@3m]
5.47 - 5.725 GHz	e.i.r.p. -27 dBm [68.2 dBuV/m@3m]
5.725 - 5.85 GHz	5.650-5700 GHz: e.i.r.p. -27 ~ 10 dBm [68.2 ~ 105.2 dBuV/m@3m] 5.700-5720 GHz: e.i.r.p. 10 ~ 15.6 dBm [105.2 ~ 110.8 dBuV/m@3m] 5.720-5725 GHz: e.i.r.p. 15.6 ~ 27 dBm [110.8 ~ 122.2 dBuV/m@3m] 5.850-5.855 GHz: e.i.r.p. 27 ~ 15.6 dBm [122.2 ~ 110.8 dBuV/m@3m] 5.855-5.875 GHz: e.i.r.p. 15.6 ~ 10 dBm [110.8 ~ 105.2 dBuV/m@3m] 5.875-5.925 GHz: e.i.r.p. 10 ~ -27 dBm [105.2 ~ 68.2dBuV/m@3m] Other un-restricted band: e.i.r.p. -27 dBm [68.2 dBuV/m@3m]

Note 1: Measurements may be performed at a distance other than the limit distance provided they are not performed in the near field and the emissions to be measured can be detected by the measurement equipment. When performing measurements at a distance other than that specified, the results shall be extrapolated to the specified distance using an extrapolation factor of 20 dB/decade (inverse of linear distance for field-strength measurements, inverse of linear distance-squared for power-density measurements).

3.5.2 Measuring Instruments

Refer a test equipment and calibration data table in this test report.

3.5.3 Test Procedures

Test Method	
<ul style="list-style-type: none"> ▪ Measurements may be performed at a distance other than the limit distance provided they are not performed in the near field and the emissions to be measured can be detected by the measurement equipment. Measurements shall not be performed at a distance greater than 30 m for frequencies above 30 MHz, unless it can be further demonstrated that measurements at a distance of 30 m or less are impractical. When performing measurements at a distance other than that specified, the results shall be extrapolated to the specified distance using an extrapolation factor of 20 dB/decade (inverse of linear distance for field-strength measurements, inverse of linear distance-squared for power-density measurements). 	
<ul style="list-style-type: none"> ▪ The average emission levels shall be measured in [duty cycle \geq 98 or duty factor]. 	
<ul style="list-style-type: none"> ▪ For the transmitter unwanted emissions shall be measured using following options below: 	
	<ul style="list-style-type: none"> ▪ Refer as KDB 789033, clause G)2) for unwanted emissions into non-restricted bands.
	<ul style="list-style-type: none"> ▪ Refer as KDB 789033, clause G)1) for unwanted emissions into restricted bands.
<input checked="" type="checkbox"/>	Refer as KDB 789033, G)6) Method VB (ANSI C63.10, clause 4.1.4.2.3), Reduced VBW.
<input checked="" type="checkbox"/>	Refer as KDB 789033, clause G)5) (ANSI C63.10, clause 4.1.4.2.2), measurement procedure peak limit.
<ul style="list-style-type: none"> ▪ For radiated measurement. 	
	<ul style="list-style-type: none"> ▪ Refer as ANSI C63.10, clause 6.4 for radiated emissions below 30 MHz and test distance is 3m.
	<ul style="list-style-type: none"> ▪ Refer as ANSI C63.10, clause 6.5 for radiated emissions 30 MHz to 1 GHz and test distance is 3m.
	<ul style="list-style-type: none"> ▪ Refer as ANSI C63.10, clause 6.6 for radiated emissions above 1GHz.
<ul style="list-style-type: none"> ▪ The any unwanted emissions level shall not exceed the fundamental emission level. 	
<ul style="list-style-type: none"> ▪ All amplitude of spurious emissions that are attenuated by more than 20 dB below the permissible value has no need to be reported. 	
<ul style="list-style-type: none"> ▪ Use the following spectrum analyzer settings: 	
	<ul style="list-style-type: none"> ▪ Set RBW=100 kHz for $f < 1$ GHz; VBW=3 * RBW; Sweep = auto; Detector function = peak; Trace = max hold.
	<ul style="list-style-type: none"> ▪ Set RBW = 1 MHz, VBW= 3MHz for $f \geq 1$ GHz for peak measurement. For average measurement, refer as 1.1.4.
<ul style="list-style-type: none"> ▪ KDB 414788 Open-Field Test Sites and Chamber Correlation Justification. 	
	<ul style="list-style-type: none"> ▪ Based on FCC 15.31(f)(2): measurements may be performed at a distance closer than that specified in regulations; however, an attempt should be made to avoid making measurements in the near field.
	<ul style="list-style-type: none"> ▪ Open-field site and chamber correlation testing had been performed and chamber measured test result is the worst case test result.

3.5.4 Measurement Results Calculation

The measured Level is calculated using:

Corrected Reading: Raw(Read Level) + AF(Antenna Factor) + CL(Cable Loss) - PA(Preamplifier Factor)

3.5.5 Test Setup

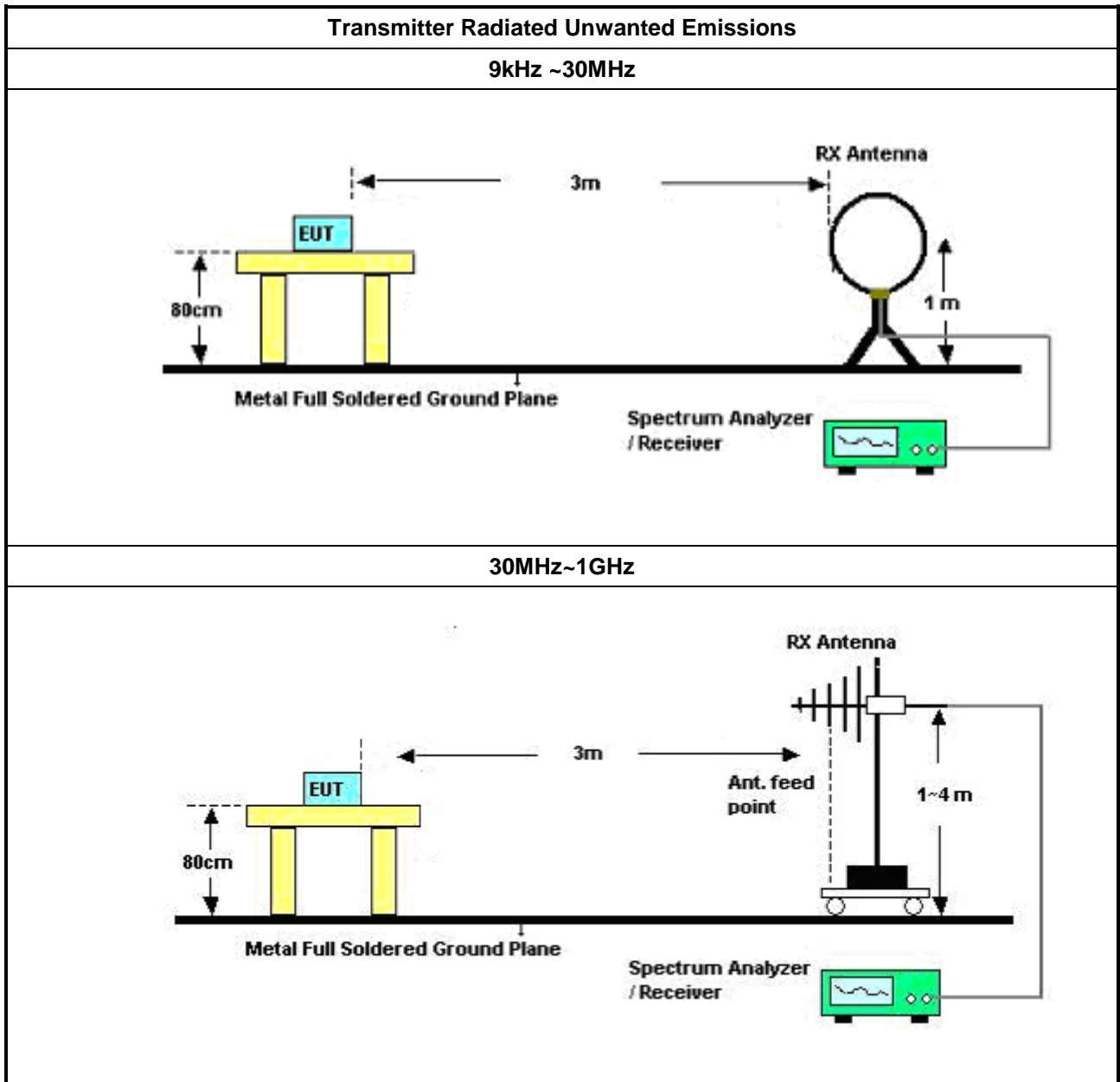

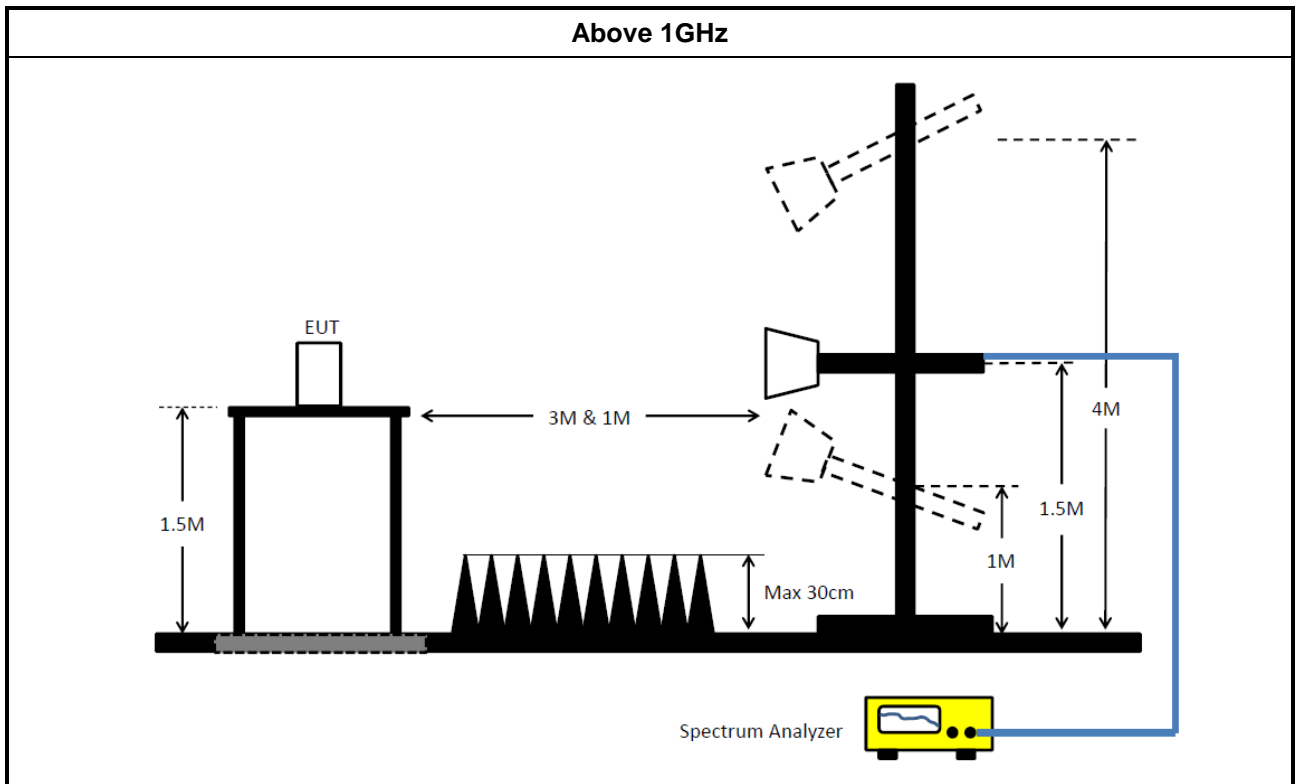

3.5.6 Transmitter Unwanted Emissions (Below 30MHz)

The amplitude of spurious emissions which are attenuated by more than 20dB below the permissible value has no need to be reported.

3.5.7 Test Result of Transmitter Unwanted Emissions

Refer as Appendix E

4 Test Equipment and Calibration Data

Instrument for AC Conduction

Instrument	Manufacturer /Brand	Model No.	Serial No.	Spec.	Calibration Date	Calibration Due Date
EMI Test Receiver	R&S	ESR3	102051	9kHz ~ 3.6GHz	29/May/2020	28/May/2021
LISN	R&S	ENV216	101295	9kHz ~ 30MHz	11/Nov/2020	10/Nov/2021
RF Cable-CON	MTJ	RG142	CB002-CO	9kHz ~ 200MHz	31/Aug/2020	30/Aug/2021
Impuls Begrenzer Pulse Limiter	SCHWARZBECK	VTSD 9561-F	9561-F041	9kHz ~ 30MHz	21/Sep/2020	20/Sep/2021

Instrument for Conducted Test

Instrument	Manufacturer /Brand	Model No.	Serial No.	Spec.	Calibration Date	Calibration Due Date
Signal Analyzer	R&S	FSV 40	101029	10Hz~40GHz	19/Oct/2020	18/Oct/2021
SMB100A Signal Generator	R&S	SMB100A03	181147	100kHz~40GHz	20/Oct/2020	19/Oct/2021
Pulse Sensor	Anritsu	MA2411B	1339407	300MHz~40GHz	27/Nov/2020	26/Nov/2021
Power Meter	Anritsu	ML2495A	1517010	300MHz~40GHz	27/Nov/2020	26/Nov/2021

Instrument for Radiated Test

Instrument	Manufacturer /Brand	Model No.	Serial No.	Spec.	Calibration Date	Calibration Due Date
3m Semi Anechoic Chamber	SIDT FRANKONIA	SAC-3M	03CH02-HY	30MHz~1GHz 3m	04/Aug/2020	03/Aug/2021
3m Semi Anechoic Chamber	SIDT FRANKONIA	SAC-3M	03CH02-HY	1GHz~18GHz 3m	02/Aug/2020	01/Aug/2021
Signal Analyzer	R&S	FSV40	101500	10Hz~40GHz	19/Aug/2020	18/Aug/2021
Amplifier	Agilent	8447D	2944A11149	100kHz~1.3GHz	30/Jun/2020	29/Jun/2021
Microwave Preamp	Agilent	8449B	3008A02373	1GHz~18GHz	23/Oct/2020	22/Oct/2021
Bilog Antenna & 5dB Attenuator	SCHAFFNER / MTJ	CBL 6112B / MTJ6102-05	2723 / 2	30MHz~1GHz	06/Sep/2020	05/Sep/2021
Double Ridged Guide Horn Antenna	SCHWARZBEC	BBHA 9120 D	BBHA 9120 D 01543	1GHz~18GHz	09/Jun/2020	08/Jun/2021
RF Cable-R03m	Jye Bao	RG142	CB017	9kHz~30MHz	20/Jun/2020	19/Jun/2021
RF Cable-R03m	Jye Bao	RG142	CB017	30MHz~1GHz	25/Mar/2020	24/Mar/2021
RF Cable-R03m	Jye Bao	RG142	CB017	30MHz~1GHz	23/Mar/2021	22/Mar/2022
RF Cable-R03m	HUBER+SUHNER	SUCOFLEX104	805193/4+805192/4	1GHz~40GHz	08/Apr/2020	07/Apr/2021
RF Cable-R03m	HUBER+SUHNER	SUCOFLEX104	805193/4+805192/4	1GHz~40GHz	06/Apr/2021	05/Apr/2022
Broadband Horn Antenna	SCHWARZBECK	BBHA 9170	BBHA 9170221	18GHz~40GHz	13/Mar/2020	12/Mar/2021
Broadband Horn Antenna	SCHWARZBECK	BBHA 9170	BBHA 9170221	18GHz~40GHz	11/Mar/2021	10/Mar/2022
Preamp	MITEQ	TTA1840-35-HG	1864481	18GHz~40GHz	10/Mar/2020	09/Mar/2021



Instrument	Manufacturer /Brand	Model No.	Serial No.	Spec.	Calibration Date	Calibration Due Date
Microwave Premplifier	EMC INSTRUMENTS	EM18G40G	060604	18GHz~40GHz	09/Mar/2021	08/Mar/2022
Loop Antenna	Teseq	HLA 6120	24155	9kHz~30MHz	13/Apr/2020	12/Apr/2021
Loop Antenna	TESEQ	HLA 6120	31244	9kHz~30MHz	16/Mar/2021	15/Mar/2022
EMI Test Receiver	R&S	ESR3	102051	9kHz~3.6GHz	29/May/2020	28/May/2021



Conducted Emissions at Powerline_Non-Beamforming_Radio 1 Appendix A.1

Summary

Mode	Result	Type	Freq (Hz)	Level (dBuV)	Limit (dBuV)	Margin (dB)	Condition
Mode 1	Pass	QP	447.846k	30.44	56.92	-26.48	Line

Mode Configure

Mode	Result	Type	Freq (Hz)	Level (dBuV)	Limit (dBuV)	Margin (dB)	Condition	Comments
Mode 1	Pass	QP	154.251k	37.49	65.77	-28.28	Line	-
Mode 1	Pass	AV	154.251k	17.96	55.77	-37.81	Line	-
Mode 1	Pass	QP	198.359k	32.24	63.69	-31.45	Line	-
Mode 1	Pass	AV	198.359k	17.72	53.69	-35.97	Line	-
Mode 1	Pass	QP	233.633k	30.98	62.31	-31.33	Line	-
Mode 1	Pass	AV	233.633k	19.07	52.31	-33.24	Line	-
Mode 1	Pass	QP	447.846k	30.44	56.92	-26.48	Line	"Worst"
Mode 1	Pass	AV	447.846k	13.54	46.92	-33.38	Line	-
Mode 1	Pass	QP	2.522M	26.95	56.00	-29.05	Line	-
Mode 1	Pass	AV	2.522M	13.73	46.00	-32.27	Line	-
Mode 1	Pass	QP	2.81M	20.84	56.00	-35.16	Line	-
Mode 1	Pass	AV	2.81M	13.71	46.00	-32.29	Line	-
Mode 1	Pass	QP	171.806k	32.04	64.87	-32.83	Neutral	-
Mode 1	Pass	AV	171.806k	17.20	54.87	-37.67	Neutral	-
Mode 1	Pass	QP	209.76k	28.77	63.21	-34.44	Neutral	-
Mode 1	Pass	AV	209.76k	17.59	53.21	-35.62	Neutral	-
Mode 1	Pass	QP	358.13k	21.03	58.77	-37.74	Neutral	-
Mode 1	Pass	AV	358.13k	12.93	48.77	-35.84	Neutral	-
Mode 1	Pass	QP	460.537k	23.62	56.69	-33.07	Neutral	-
Mode 1	Pass	AV	460.537k	12.78	46.69	-33.91	Neutral	-
Mode 1	Pass	QP	2.463M	21.87	56.00	-34.13	Neutral	-
Mode 1	Pass	AV	2.463M	13.63	46.00	-32.37	Neutral	"Worst"
Mode 1	Pass	QP	2.667M	22.48	56.00	-33.52	Neutral	-
Mode 1	Pass	AV	2.667M	13.46	46.00	-32.54	Neutral	-



Conducted Emissions at Powerline_Mode 1

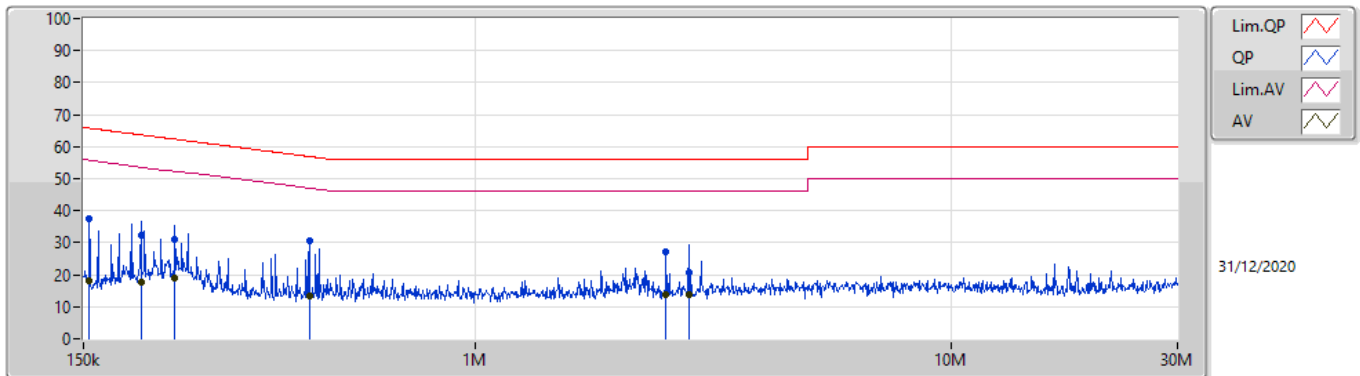

Type	Freq (Hz)	Level (dBuV)	Limit (dBuV)	Margin (dB)	Factor (dB)	Condition	Comment	Raw (dBuV)	LISN (dB)	CL (dB)	AT (dB)
QP	154.251k	37.49	65.77	-28.28	19.60	Line	-	17.89	9.69	0.01	9.90
AV	154.251k	17.96	55.77	-37.81	19.60	Line	-	-1.64	9.69	0.01	9.90
QP	198.359k	32.24	63.69	-31.45	19.59	Line	-	12.65	9.68	0.01	9.90
AV	198.359k	17.72	53.69	-35.97	19.59	Line	-	-1.87	9.68	0.01	9.90
QP	233.633k	30.98	62.31	-31.33	19.59	Line	-	11.39	9.68	0.01	9.90
AV	233.633k	19.07	52.31	-33.24	19.59	Line	-	-0.52	9.68	0.01	9.90
QP	447.846k	30.44	56.92	-26.48	19.58	Line	"Worst"	10.86	9.67	0.02	9.89
AV	447.846k	13.54	46.92	-33.38	19.58	Line	-	-6.04	9.67	0.02	9.89
QP	2.522M	26.95	56.00	-29.05	19.60	Line	-	7.35	9.68	0.09	9.83
AV	2.522M	13.73	46.00	-32.27	19.60	Line	-	-5.87	9.68	0.09	9.83
QP	2.81M	20.84	56.00	-35.16	19.63	Line	-	1.21	9.68	0.10	9.85
AV	2.81M	13.71	46.00	-32.29	19.63	Line	-	-5.92	9.68	0.10	9.85

Conducted Emissions at Powerline_Mode 1

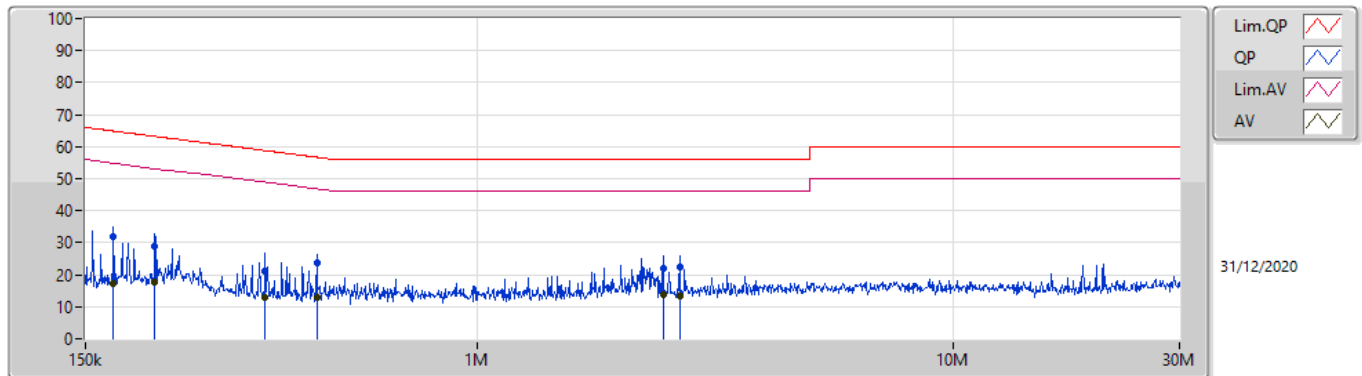

Type	Freq (Hz)	Level (dBuV)	Limit (dBuV)	Margin (dB)	Factor (dB)	Condition	Comment	Raw (dBuV)	LISN (dB)	CL (dB)	AT (dB)
QP	171.806k	32.04	64.87	-32.83	19.60	Neutral	-	12.44	9.69	0.01	9.90
AV	171.806k	17.20	54.87	-37.67	19.60	Neutral	-	-2.40	9.69	0.01	9.90
QP	209.76k	28.77	63.21	-34.44	19.59	Neutral	-	9.18	9.68	0.01	9.90
AV	209.76k	17.59	53.21	-35.62	19.59	Neutral	-	-2.00	9.68	0.01	9.90
QP	358.13k	21.03	58.77	-37.74	19.59	Neutral	-	1.44	9.67	0.02	9.90
AV	358.13k	12.93	48.77	-35.84	19.59	Neutral	-	-6.66	9.67	0.02	9.90
QP	460.537k	23.62	56.69	-33.07	19.57	Neutral	-	4.05	9.67	0.02	9.88
AV	460.537k	12.78	46.69	-33.91	19.57	Neutral	-	-6.79	9.67	0.02	9.88
QP	2.463M	21.87	56.00	-34.13	19.60	Neutral	-	2.27	9.68	0.09	9.83
AV	2.463M	13.63	46.00	-32.37	19.60	Neutral	"Worst"	-5.97	9.68	0.09	9.83
QP	2.667M	22.48	56.00	-33.52	19.62	Neutral	-	2.86	9.68	0.10	9.84
AV	2.667M	13.46	46.00	-32.54	19.62	Neutral	-	-6.16	9.68	0.10	9.84



Conducted Emissions at Powerline_Non-Beamforming_Radio 2 Appendix A.2

Summary

Mode	Result	Type	Freq (Hz)	Level (dBuV)	Limit (dBuV)	Margin (dB)	Condition
Mode 1	Pass	QP	435.504k	29.42	57.15	-27.73	Line

Mode Configure

Mode	Result	Type	Freq (Hz)	Level (dBuV)	Limit (dBuV)	Margin (dB)	Condition	Comments
Mode 1	Pass	QP	186.83k	34.75	64.18	-29.43	Line	-
Mode 1	Pass	AV	186.83k	17.73	54.18	-36.45	Line	-
Mode 1	Pass	QP	248.05k	30.28	61.81	-31.53	Line	-
Mode 1	Pass	AV	248.05k	17.21	51.81	-34.60	Line	-
Mode 1	Pass	QP	435.504k	29.42	57.15	-27.73	Line	"Worst"
Mode 1	Pass	AV	435.504k	13.36	47.15	-33.79	Line	-
Mode 1	Pass	QP	2.211M	26.24	56.00	-29.76	Line	-
Mode 1	Pass	AV	2.211M	17.86	46.00	-28.14	Line	-
Mode 1	Pass	QP	2.646M	25.51	56.00	-30.49	Line	-
Mode 1	Pass	AV	2.646M	13.86	46.00	-32.14	Line	-
Mode 1	Pass	QP	20.269M	23.43	60.00	-36.57	Line	-
Mode 1	Pass	AV	20.269M	14.44	50.00	-35.56	Line	-
Mode 1	Pass	QP	182.408k	32.33	64.37	-32.04	Neutral	-
Mode 1	Pass	AV	182.408k	17.71	54.37	-36.66	Neutral	-
Mode 1	Pass	QP	222.704k	25.84	62.71	-36.87	Neutral	-
Mode 1	Pass	AV	222.704k	17.21	52.71	-35.50	Neutral	-
Mode 1	Pass	QP	418.461k	25.46	57.47	-32.01	Neutral	"Worst"
Mode 1	Pass	AV	418.461k	13.02	47.47	-34.45	Neutral	-
Mode 1	Pass	QP	1.719M	19.64	56.00	-36.36	Neutral	-
Mode 1	Pass	AV	1.719M	12.69	46.00	-33.31	Neutral	-
Mode 1	Pass	QP	2.433M	23.05	56.00	-32.95	Neutral	-
Mode 1	Pass	AV	2.433M	13.43	46.00	-32.57	Neutral	-
Mode 1	Pass	QP	19.321M	23.17	60.00	-36.83	Neutral	-
Mode 1	Pass	AV	19.321M	14.13	50.00	-35.87	Neutral	-

Conducted Emissions at Powerline_Mode 1

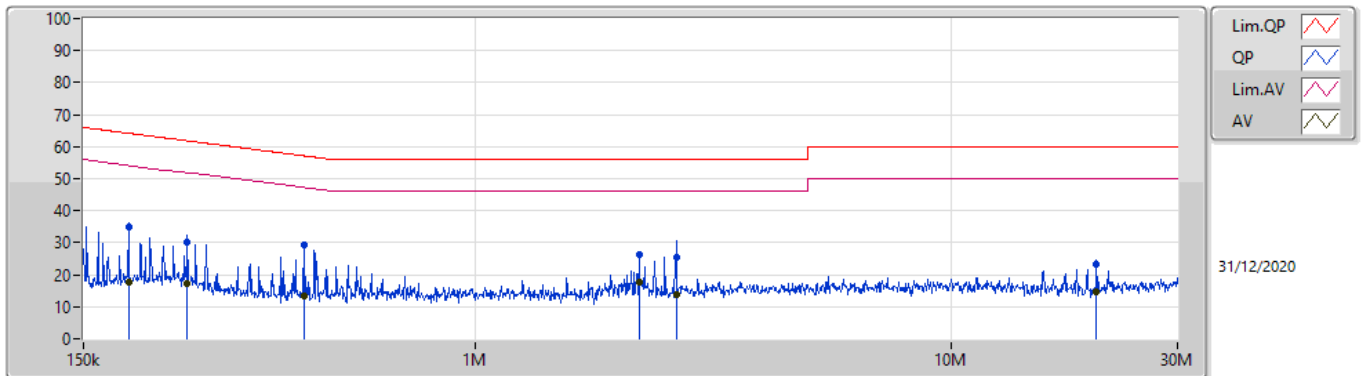

Type	Freq (Hz)	Level (dBuV)	Limit (dBuV)	Margin (dB)	Factor (dB)	Condition	Comment	Raw (dBuV)	LISN (dB)	CL (dB)	AT (dB)			
QP	186.83k	34.75	64.18	-29.43	19.59	Line	-	15.16	9.68	0.01	9.90			
AV	186.83k	17.73	54.18	-36.45	19.59	Line	-	-1.86	9.68	0.01	9.90			
QP	248.05k	30.28	61.81	-31.53	19.59	Line	-	10.69	9.68	0.01	9.90			
AV	248.05k	17.21	51.81	-34.60	19.59	Line	-	-2.38	9.68	0.01	9.90			
QP	435.504k	29.42	57.15	-27.73	19.58	Line	"Worst"	9.84	9.67	0.02	9.89			
AV	435.504k	13.36	47.15	-33.79	19.58	Line	-	-6.22	9.67	0.02	9.89			
QP	2.211M	26.24	56.00	-29.76	19.58	Line	-	6.66	9.68	0.09	9.81			
AV	2.211M	17.86	46.00	-28.14	19.58	Line	-	-1.72	9.68	0.09	9.81			
QP	2.646M	25.51	56.00	-30.49	19.62	Line	-	5.89	9.68	0.10	9.84			
AV	2.646M	13.86	46.00	-32.14	19.62	Line	-	-5.76	9.68	0.10	9.84			
QP	20.269M	23.43	60.00	-36.57	19.86	Line	-	3.57	9.67	0.29	9.90			
AV	20.269M	14.44	50.00	-35.56	19.86	Line	-	-5.42	9.67	0.29	9.90			

Conducted Emissions at Powerline_Mode 1

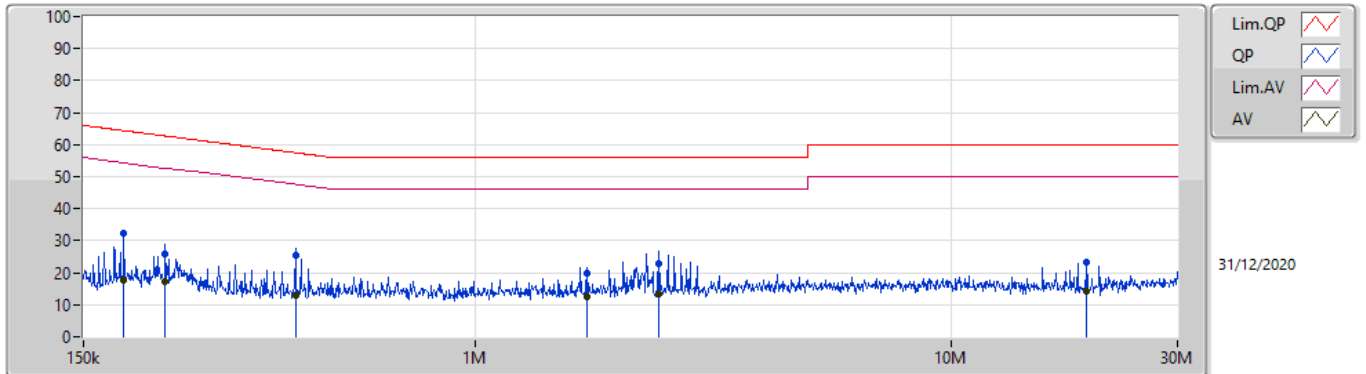

Type	Freq (Hz)	Level (dBuV)	Limit (dBuV)	Margin (dB)	Factor (dB)	Condition	Comment	Raw (dBuV)	LISN (dB)	CL (dB)	AT (dB)			
QP	182.408k	32.33	64.37	-32.04	19.59	Neutral	-	12.74	9.68	0.01	9.90			
AV	182.408k	17.71	54.37	-36.66	19.59	Neutral	-	-1.88	9.68	0.01	9.90			
QP	222.704k	25.84	62.71	-36.87	19.59	Neutral	-	6.25	9.68	0.01	9.90			
AV	222.704k	17.21	52.71	-35.50	19.59	Neutral	-	-2.38	9.68	0.01	9.90			
QP	418.461k	25.46	57.47	-32.01	19.58	Neutral	"Worst"	5.88	9.67	0.02	9.89			
AV	418.461k	13.02	47.47	-34.45	19.58	Neutral	-	-6.56	9.67	0.02	9.89			
QP	1.719M	19.64	56.00	-36.36	19.55	Neutral	-	0.09	9.68	0.07	9.80			
AV	1.719M	12.69	46.00	-33.31	19.55	Neutral	-	-6.86	9.68	0.07	9.80			
QP	2.433M	23.05	56.00	-32.95	19.60	Neutral	-	3.45	9.68	0.09	9.83			
AV	2.433M	13.43	46.00	-32.57	19.60	Neutral	-	-6.17	9.68	0.09	9.83			
QP	19.321M	23.17	60.00	-36.83	19.94	Neutral	-	3.23	9.75	0.29	9.90			
AV	19.321M	14.13	50.00	-35.87	19.94	Neutral	-	-5.81	9.75	0.29	9.90			



Conducted Emissions at Powerlin_Non-Beamforming_Radio 3 Appendix A.3

Summary

Mode	Result	Type	Freq (Hz)	Level (dBuV)	Limit (dBuV)	Margin (dB)	Condition
Mode 1	Pass	QP	442.514k	31.37	57.01	-25.64	Line

Mode Configure

Mode	Result	Type	Freq (Hz)	Level (dBuV)	Limit (dBuV)	Margin (dB)	Condition	Comments
Mode 1	Pass	QP	150.6k	35.92	65.96	-30.04	Line	-
Mode 1	Pass	AV	150.6k	18.61	55.96	-37.35	Line	-
Mode 1	Pass	QP	442.514k	31.37	57.01	-25.64	Line	"Worst"
Mode 1	Pass	AV	442.514k	13.62	47.01	-33.39	Line	-
Mode 1	Pass	QP	675.618k	16.34	56.00	-39.66	Line	-
Mode 1	Pass	AV	675.618k	12.36	46.00	-33.64	Line	-
Mode 1	Pass	QP	1.797M	18.46	56.00	-37.54	Line	-
Mode 1	Pass	AV	1.797M	13.50	46.00	-32.50	Line	-
Mode 1	Pass	QP	2.667M	25.71	56.00	-30.29	Line	-
Mode 1	Pass	AV	2.667M	13.74	46.00	-32.26	Line	-
Mode 1	Pass	QP	20.107M	21.71	60.00	-38.29	Line	-
Mode 1	Pass	AV	20.107M	14.24	50.00	-35.76	Line	-
Mode 1	Pass	QP	154.251k	33.66	65.77	-32.11	Neutral	-
Mode 1	Pass	AV	154.251k	17.29	55.77	-38.48	Neutral	-
Mode 1	Pass	QP	202.358k	29.07	63.51	-34.44	Neutral	-
Mode 1	Pass	AV	202.358k	17.17	53.51	-36.34	Neutral	-
Mode 1	Pass	QP	442.514k	27.22	57.01	-29.79	Neutral	"Worst"
Mode 1	Pass	AV	442.514k	13.15	47.01	-33.86	Neutral	-
Mode 1	Pass	QP	1.962M	20.11	56.00	-35.89	Neutral	-
Mode 1	Pass	AV	1.962M	13.53	46.00	-32.47	Neutral	-
Mode 1	Pass	QP	2.732M	20.91	56.00	-35.09	Neutral	-
Mode 1	Pass	AV	2.732M	13.62	46.00	-32.38	Neutral	-
Mode 1	Pass	QP	17.004M	18.41	60.00	-41.59	Neutral	-
Mode 1	Pass	AV	17.004M	14.01	50.00	-35.99	Neutral	-

Conducted Emissions at Powerline_Mode 1

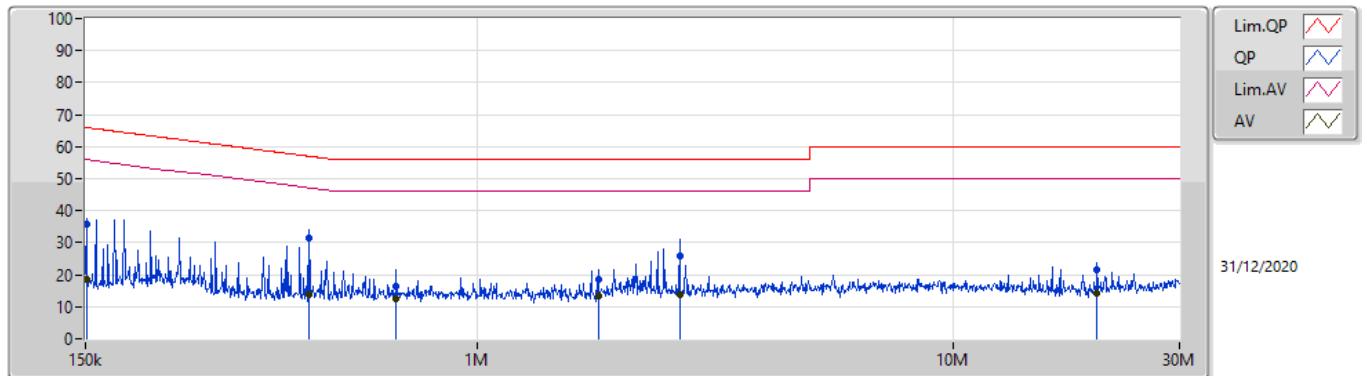

Type	Freq (Hz)	Level (dBuV)	Limit (dBuV)	Margin (dB)	Factor (dB)	Condition	Comment	Raw (dBuV)	LISN (dB)	CL (dB)	AT (dB)
QP	150.6k	35.92	65.96	-30.04	19.60	Line	-	16.32	9.69	0.01	9.90
AV	150.6k	18.61	55.96	-37.35	19.60	Line	-	-0.99	9.69	0.01	9.90
QP	442.514k	31.37	57.01	-25.64	19.58	Line	"Worst"	11.79	9.67	0.02	9.89
AV	442.514k	13.62	47.01	-33.39	19.58	Line	-	-5.96	9.67	0.02	9.89
QP	675.618k	16.34	56.00	-39.66	19.55	Line	-	-3.21	9.67	0.04	9.84
AV	675.618k	12.36	46.00	-33.64	19.55	Line	-	-7.19	9.67	0.04	9.84
QP	1.797M	18.46	56.00	-37.54	19.56	Line	-	-1.10	9.68	0.08	9.80
AV	1.797M	13.50	46.00	-32.50	19.56	Line	-	-6.06	9.68	0.08	9.80
QP	2.667M	25.71	56.00	-30.29	19.62	Line	-	6.09	9.68	0.10	9.84
AV	2.667M	13.74	46.00	-32.26	19.62	Line	-	-5.88	9.68	0.10	9.84
QP	20.107M	21.71	60.00	-38.29	19.86	Line	-	1.85	9.67	0.29	9.90
AV	20.107M	14.24	50.00	-35.76	19.86	Line	-	-5.62	9.67	0.29	9.90

Conducted Emissions at Powerline_Mode 1

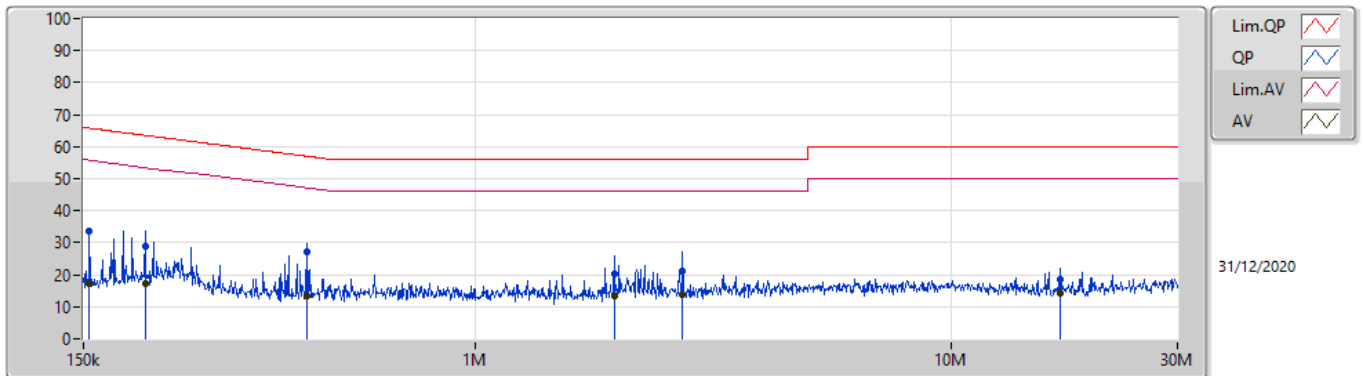

Type	Freq (Hz)	Level (dBuV)	Limit (dBuV)	Margin (dB)	Factor (dB)	Condition	Comment	Raw (dBuV)	LISN (dB)	CL (dB)	AT (dB)			
QP	154.251k	33.66	65.77	-32.11	19.60	Neutral	-	14.06	9.69	0.01	9.90			
AV	154.251k	17.29	55.77	-38.48	19.60	Neutral	-	-2.31	9.69	0.01	9.90			
QP	202.358k	29.07	63.51	-34.44	19.59	Neutral	-	9.48	9.68	0.01	9.90			
AV	202.358k	17.17	53.51	-36.34	19.59	Neutral	-	-2.42	9.68	0.01	9.90			
QP	442.514k	27.22	57.01	-29.79	19.58	Neutral	"Worst"	7.64	9.67	0.02	9.89			
AV	442.514k	13.15	47.01	-33.86	19.58	Neutral	-	-6.43	9.67	0.02	9.89			
QP	1.962M	20.11	56.00	-35.89	19.56	Neutral	-	0.55	9.68	0.08	9.80			
AV	1.962M	13.53	46.00	-32.47	19.56	Neutral	-	-6.03	9.68	0.08	9.80			
QP	2.732M	20.91	56.00	-35.09	19.62	Neutral	-	1.29	9.68	0.10	9.84			
AV	2.732M	13.62	46.00	-32.38	19.62	Neutral	-	-6.00	9.68	0.10	9.84			
QP	17.004M	18.41	60.00	-41.59	19.92	Neutral	-	-1.51	9.75	0.27	9.90			
AV	17.004M	14.01	50.00	-35.99	19.92	Neutral	-	-5.91	9.75	0.27	9.90			



Summary

Mode	Result	Type	Freq (Hz)	Level (dBuV)	Limit (dBuV)	Margin (dB)	Condition
Mode 1	Pass	QP	435.504k	30.25	57.15	-26.90	Line

Mode Configure

Mode	Result	Type	Freq (Hz)	Level (dBuV)	Limit (dBuV)	Margin (dB)	Condition	Comments
Mode 1	Pass	QP	151.807k	33.64	65.90	-32.26	Line	-
Mode 1	Pass	AV	151.807k	18.09	55.90	-37.81	Line	-
Mode 1	Pass	QP	208.092k	33.75	63.28	-29.53	Line	-
Mode 1	Pass	AV	208.092k	17.83	53.28	-35.45	Line	-
Mode 1	Pass	QP	435.504k	30.25	57.15	-26.90	Line	"Worst"
Mode 1	Pass	AV	435.504k	13.55	47.15	-33.60	Line	-
Mode 1	Pass	QP	2.133M	22.64	56.00	-33.36	Line	-
Mode 1	Pass	AV	2.133M	15.56	46.00	-30.44	Line	-
Mode 1	Pass	QP	2.947M	21.91	56.00	-34.09	Line	-
Mode 1	Pass	AV	2.947M	13.79	46.00	-32.21	Line	-
Mode 1	Pass	QP	19.475M	21.73	60.00	-38.27	Line	-
Mode 1	Pass	AV	19.475M	14.11	50.00	-35.89	Line	-
Mode 1	Pass	QP	199.152k	28.48	63.65	-35.17	Neutral	-
Mode 1	Pass	AV	199.152k	17.34	53.65	-36.31	Neutral	-
Mode 1	Pass	QP	231.775k	27.14	62.39	-35.25	Neutral	-
Mode 1	Pass	AV	231.775k	17.71	52.39	-34.68	Neutral	-
Mode 1	Pass	QP	423.503k	25.18	57.38	-32.20	Neutral	-
Mode 1	Pass	AV	423.503k	12.98	47.38	-34.40	Neutral	-
Mode 1	Pass	QP	2.083M	22.80	56.00	-33.20	Neutral	-
Mode 1	Pass	AV	2.083M	13.96	46.00	-32.04	Neutral	-
Mode 1	Pass	QP	2.573M	25.27	56.00	-30.73	Neutral	"Worst"
Mode 1	Pass	AV	2.573M	13.48	46.00	-32.52	Neutral	-
Mode 1	Pass	QP	20.269M	21.89	60.00	-38.11	Neutral	-
Mode 1	Pass	AV	20.269M	14.37	50.00	-35.63	Neutral	-

Conducted Emissions at Powerline_Mode 1

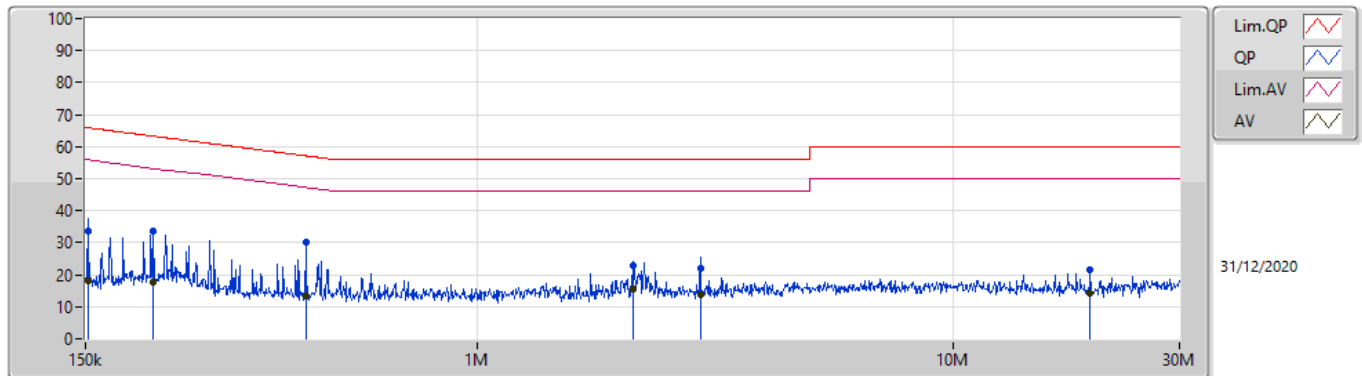

Type	Freq (Hz)	Level (dBuV)	Limit (dBuV)	Margin (dB)	Factor (dB)	Condition	Comment	Raw (dBuV)	LISN (dB)	CL (dB)	AT (dB)
QP	151.807k	33.64	65.90	-32.26	19.60	Line	-	14.04	9.69	0.01	9.90
AV	151.807k	18.09	55.90	-37.81	19.60	Line	-	-1.51	9.69	0.01	9.90
QP	208.092k	33.75	63.28	-29.53	19.59	Line	-	14.16	9.68	0.01	9.90
AV	208.092k	17.83	53.28	-35.45	19.59	Line	-	-1.76	9.68	0.01	9.90
QP	435.504k	30.25	57.15	-26.90	19.58	Line	"Worst"	10.67	9.67	0.02	9.89
AV	435.504k	13.55	47.15	-33.60	19.58	Line	-	-6.03	9.67	0.02	9.89
QP	2.133M	22.64	56.00	-33.36	19.57	Line	-	3.07	9.68	0.08	9.81
AV	2.133M	15.56	46.00	-30.44	19.57	Line	-	-4.01	9.68	0.08	9.81
QP	2.947M	21.91	56.00	-34.09	19.65	Line	-	2.26	9.69	0.10	9.86
AV	2.947M	13.79	46.00	-32.21	19.65	Line	-	-5.86	9.69	0.10	9.86
QP	19.475M	21.73	60.00	-38.27	19.86	Line	-	1.87	9.67	0.29	9.90
AV	19.475M	14.11	50.00	-35.89	19.86	Line	-	-5.75	9.67	0.29	9.90

Conducted Emissions at Powerline_Mode 1

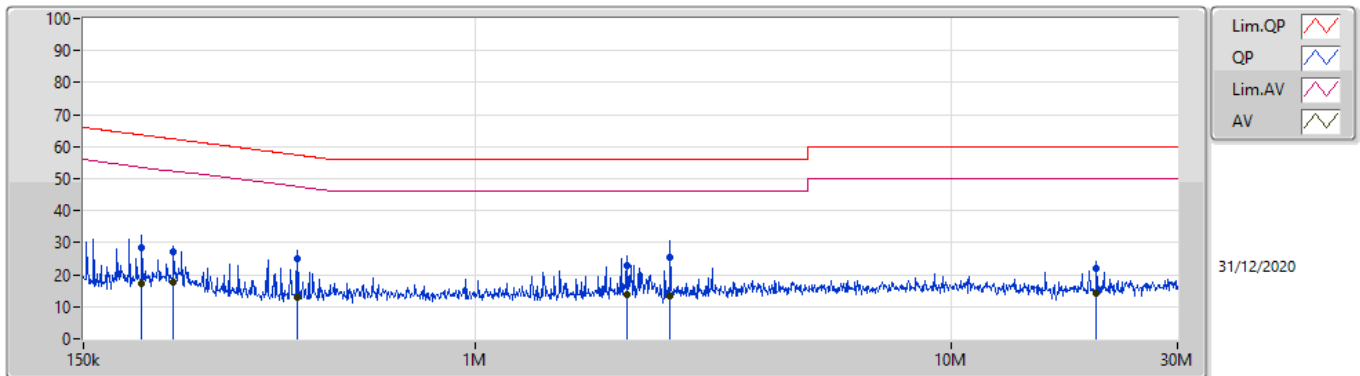

Type	Freq (Hz)	Level (dBuV)	Limit (dBuV)	Margin (dB)	Factor (dB)	Condition	Comment	Raw (dBuV)	LISN (dB)	CL (dB)	AT (dB)
QP	199.152k	28.48	63.65	-35.17	19.59	Neutral	-	8.89	9.68	0.01	9.90
AV	199.152k	17.34	53.65	-36.31	19.59	Neutral	-	-2.25	9.68	0.01	9.90
QP	231.775k	27.14	62.39	-35.25	19.59	Neutral	-	7.55	9.68	0.01	9.90
AV	231.775k	17.71	52.39	-34.68	19.59	Neutral	-	-1.88	9.68	0.01	9.90
QP	423.503k	25.18	57.38	-32.20	19.58	Neutral	-	5.60	9.67	0.02	9.89
AV	423.503k	12.98	47.38	-34.40	19.58	Neutral	-	-6.60	9.67	0.02	9.89
QP	2.083M	22.80	56.00	-33.20	19.57	Neutral	-	3.23	9.68	0.08	9.81
AV	2.083M	13.96	46.00	-32.04	19.57	Neutral	-	-5.61	9.68	0.08	9.81
QP	2.573M	25.27	56.00	-30.73	19.61	Neutral	"Worst"	5.66	9.68	0.09	9.84
AV	2.573M	13.48	46.00	-32.52	19.61	Neutral	-	-6.13	9.68	0.09	9.84
QP	20.269M	21.89	60.00	-38.11	19.94	Neutral	-	1.95	9.75	0.29	9.90
AV	20.269M	14.37	50.00	-35.63	19.94	Neutral	-	-5.57	9.75	0.29	9.90



Summary

Mode	Result	Type	Freq (Hz)	Level (dBuV)	Limit (dBuV)	Margin (dB)	Condition
Mode 1	Pass	QP	188.327k	34.06	64.11	-30.05	Line

Mode Configure

Mode	Result	Type	Freq (Hz)	Level (dBuV)	Limit (dBuV)	Margin (dB)	Condition	Comments
Mode 1	Pass	QP	188.327k	34.06	64.11	-30.05	Line	"Worst"
Mode 1	Pass	AV	188.327k	18.26	54.11	-35.85	Line	-
Mode 1	Pass	QP	255.079k	29.43	61.58	-32.15	Line	-
Mode 1	Pass	AV	255.079k	17.89	51.58	-33.69	Line	-
Mode 1	Pass	QP	389.447k	22.46	58.08	-35.62	Line	-
Mode 1	Pass	AV	389.447k	12.90	48.08	-35.18	Line	-
Mode 1	Pass	QP	2.443M	23.20	56.00	-32.80	Line	-
Mode 1	Pass	AV	2.443M	13.35	46.00	-32.65	Line	-
Mode 1	Pass	QP	3.57M	16.01	56.00	-39.99	Line	-
Mode 1	Pass	AV	3.57M	13.72	46.00	-32.28	Line	-
Mode 1	Pass	QP	20.188M	21.99	60.00	-38.01	Line	-
Mode 1	Pass	AV	20.188M	14.42	50.00	-35.58	Line	-
Mode 1	Pass	QP	165.743k	30.28	65.18	-34.90	Neutral	-
Mode 1	Pass	AV	165.743k	16.58	55.18	-38.60	Neutral	-
Mode 1	Pass	QP	210.599k	28.82	63.19	-34.37	Neutral	-
Mode 1	Pass	AV	210.599k	17.14	53.19	-36.05	Neutral	-
Mode 1	Pass	QP	356.703k	22.14	58.81	-36.67	Neutral	-
Mode 1	Pass	AV	356.703k	12.90	48.81	-35.91	Neutral	-
Mode 1	Pass	QP	1.848M	20.78	56.00	-35.22	Neutral	-
Mode 1	Pass	AV	1.848M	13.07	46.00	-32.93	Neutral	-
Mode 1	Pass	QP	2.522M	23.78	56.00	-32.22	Neutral	"Worst"
Mode 1	Pass	AV	2.522M	13.62	46.00	-32.38	Neutral	-
Mode 1	Pass	QP	18.863M	21.53	60.00	-38.47	Neutral	-
Mode 1	Pass	AV	18.863M	14.13	50.00	-35.87	Neutral	-

Conducted Emissions at Powerline_Mode 1

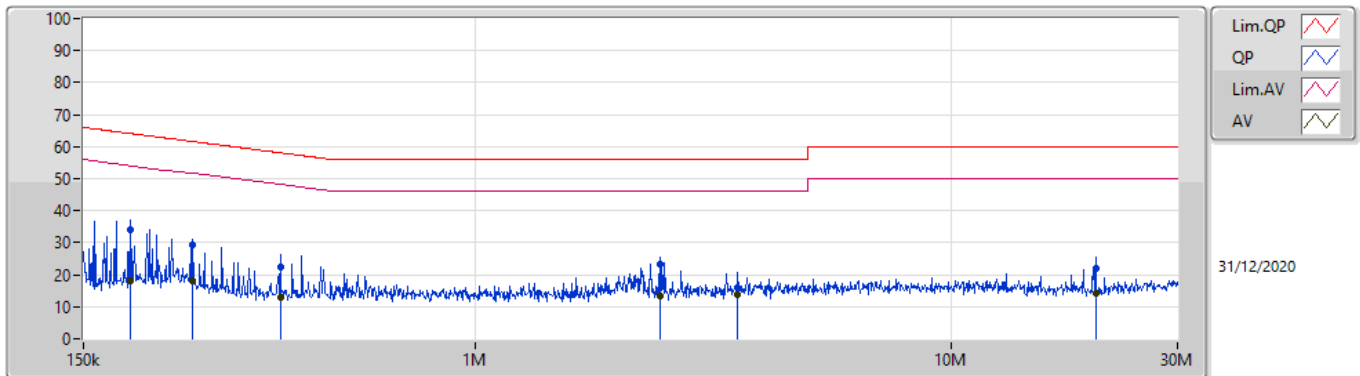

Type	Freq (Hz)	Level (dBuV)	Limit (dBuV)	Margin (dB)	Factor (dB)	Condition	Comment	Raw (dBuV)	LISN (dB)	CL (dB)	AT (dB)			
QP	188.327k	34.06	64.11	-30.05	19.59	Line	"Worst"	14.47	9.68	0.01	9.90			
AV	188.327k	18.26	54.11	-35.85	19.59	Line	-	-1.33	9.68	0.01	9.90			
QP	255.079k	29.43	61.58	-32.15	19.59	Line	-	9.84	9.68	0.01	9.90			
AV	255.079k	17.89	51.58	-33.69	19.59	Line	-	-1.70	9.68	0.01	9.90			
QP	389.447k	22.46	58.08	-35.62	19.59	Line	-	2.87	9.67	0.02	9.90			
AV	389.447k	12.90	48.08	-35.18	19.59	Line	-	-6.69	9.67	0.02	9.90			
QP	2.443M	23.20	56.00	-32.80	19.60	Line	-	3.60	9.68	0.09	9.83			
AV	2.443M	13.35	46.00	-32.65	19.60	Line	-	-6.25	9.68	0.09	9.83			
QP	3.57M	16.01	56.00	-39.99	19.68	Line	-	-3.67	9.69	0.11	9.88			
AV	3.57M	13.72	46.00	-32.28	19.68	Line	-	-5.96	9.69	0.11	9.88			
QP	20.188M	21.99	60.00	-38.01	19.86	Line	-	2.13	9.67	0.29	9.90			
AV	20.188M	14.42	50.00	-35.58	19.86	Line	-	-5.44	9.67	0.29	9.90			

Conducted Emissions at Powerline_Mode 1

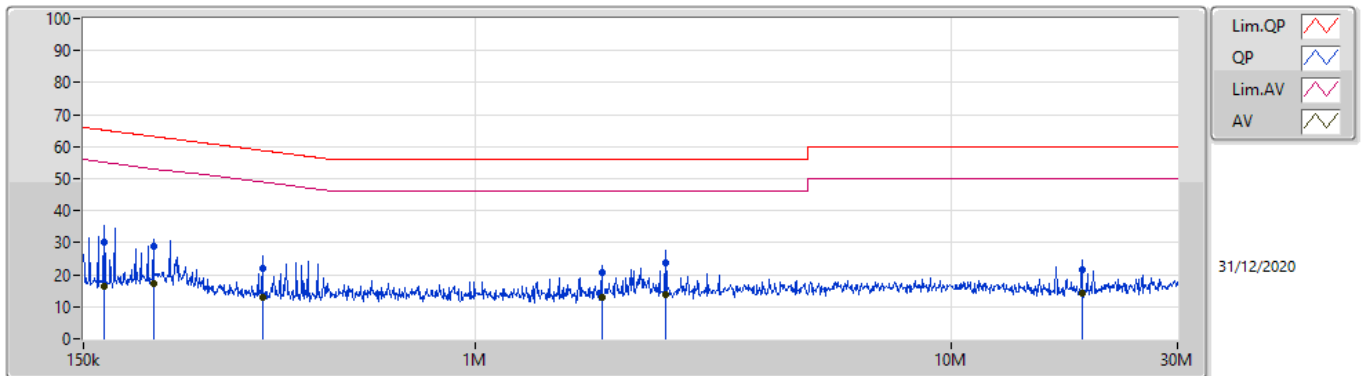

Type	Freq (Hz)	Level (dBuV)	Limit (dBuV)	Margin (dB)	Factor (dB)	Condition	Comment	Raw (dBuV)	LISN (dB)	CL (dB)	AT (dB)			
QP	165.743k	30.28	65.18	-34.90	19.60	Neutral	-	10.68	9.69	0.01	9.90			
AV	165.743k	16.58	55.18	-38.60	19.60	Neutral	-	-3.02	9.69	0.01	9.90			
QP	210.599k	28.82	63.19	-34.37	19.59	Neutral	-	9.23	9.68	0.01	9.90			
AV	210.599k	17.14	53.19	-36.05	19.59	Neutral	-	-2.45	9.68	0.01	9.90			
QP	356.703k	22.14	58.81	-36.67	19.59	Neutral	-	2.55	9.67	0.02	9.90			
AV	356.703k	12.90	48.81	-35.91	19.59	Neutral	-	-6.69	9.67	0.02	9.90			
QP	1.848M	20.78	56.00	-35.22	19.56	Neutral	-	1.22	9.68	0.08	9.80			
AV	1.848M	13.07	46.00	-32.93	19.56	Neutral	-	-6.49	9.68	0.08	9.80			
QP	2.522M	23.78	56.00	-32.22	19.60	Neutral	"Worst"	4.18	9.68	0.09	9.83			
AV	2.522M	13.62	46.00	-32.38	19.60	Neutral	-	-5.98	9.68	0.09	9.83			
QP	18.863M	21.53	60.00	-38.47	19.93	Neutral	-	1.60	9.75	0.28	9.90			
AV	18.863M	14.13	50.00	-35.87	19.93	Neutral	-	-5.80	9.75	0.28	9.90			



Summary

Mode	Result	Type	Freq (Hz)	Level (dBuV)	Limit (dBuV)	Margin (dB)	Condition
Mode 1	Pass	QP	435.504k	29.07	57.15	-28.08	Line

Mode Configure

Mode	Result	Type	Freq (Hz)	Level (dBuV)	Limit (dBuV)	Margin (dB)	Condition	Comments
Mode 1	Pass	QP	157.361k	35.72	65.60	-29.88	Line	-
Mode 1	Pass	AV	157.361k	17.12	55.60	-38.48	Line	-
Mode 1	Pass	QP	214.845k	30.49	63.02	-32.53	Line	-
Mode 1	Pass	AV	214.845k	17.91	53.02	-35.11	Line	-
Mode 1	Pass	QP	435.504k	29.07	57.15	-28.08	Line	"Worst"
Mode 1	Pass	AV	435.504k	13.34	47.15	-33.81	Line	-
Mode 1	Pass	QP	1.713M	17.37	56.00	-38.63	Line	-
Mode 1	Pass	AV	1.713M	12.48	46.00	-33.52	Line	-
Mode 1	Pass	QP	2.099M	20.97	56.00	-35.03	Line	-
Mode 1	Pass	AV	2.099M	13.62	46.00	-32.38	Line	-
Mode 1	Pass	QP	2.636M	24.00	56.00	-32.00	Line	-
Mode 1	Pass	AV	2.636M	13.64	46.00	-32.36	Line	-
Mode 1	Pass	QP	162.467k	32.88	65.33	-32.45	Neutral	-
Mode 1	Pass	AV	162.467k	16.49	55.33	-38.84	Neutral	-
Mode 1	Pass	QP	195.216k	25.80	63.80	-38.00	Neutral	-
Mode 1	Pass	AV	195.216k	16.97	53.80	-36.83	Neutral	-
Mode 1	Pass	QP	440.751k	28.52	57.05	-28.53	Neutral	"Worst"
Mode 1	Pass	AV	440.751k	13.23	47.05	-33.82	Neutral	-
Mode 1	Pass	QP	1.855M	20.97	56.00	-35.03	Neutral	-
Mode 1	Pass	AV	1.855M	13.18	46.00	-32.82	Neutral	-
Mode 1	Pass	QP	2.512M	25.20	56.00	-30.80	Neutral	-
Mode 1	Pass	AV	2.512M	13.73	46.00	-32.27	Neutral	-
Mode 1	Pass	QP	20.027M	21.75	60.00	-38.25	Neutral	-
Mode 1	Pass	AV	20.027M	14.33	50.00	-35.67	Neutral	-

Conducted Emissions at Powerline_Mode 1

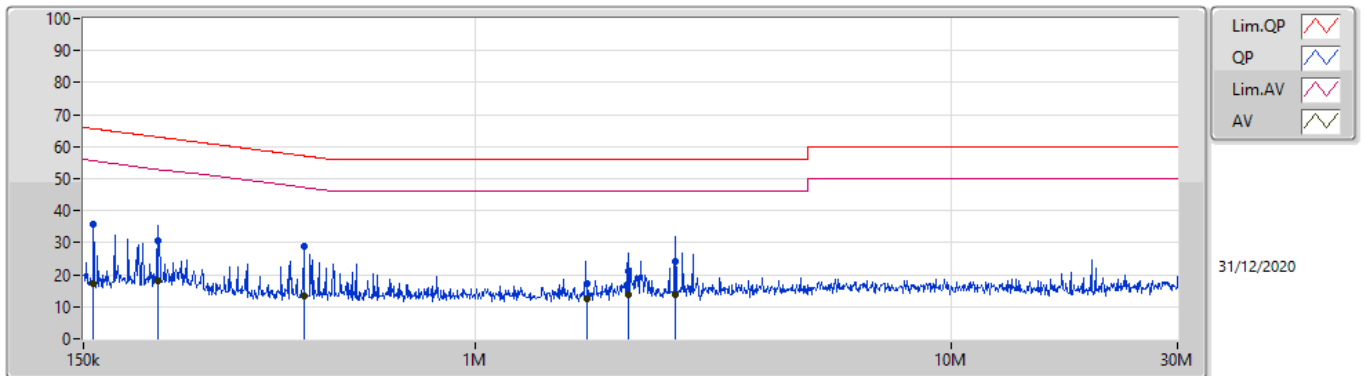

Type	Freq (Hz)	Level (dBuV)	Limit (dBuV)	Margin (dB)	Factor (dB)	Condition	Comment	Raw (dBuV)	LISN (dB)	CL (dB)	AT (dB)
QP	157.361k	35.72	65.60	-29.88	19.60	Line	-	16.12	9.69	0.01	9.90
AV	157.361k	17.12	55.60	-38.48	19.60	Line	-	-2.48	9.69	0.01	9.90
QP	214.845k	30.49	63.02	-32.53	19.59	Line	-	10.90	9.68	0.01	9.90
AV	214.845k	17.91	53.02	-35.11	19.59	Line	-	-1.68	9.68	0.01	9.90
QP	435.504k	29.07	57.15	-28.08	19.58	Line	"Worst"	9.49	9.67	0.02	9.89
AV	435.504k	13.34	47.15	-33.81	19.58	Line	-	-6.24	9.67	0.02	9.89
QP	1.713M	17.37	56.00	-38.63	19.55	Line	-	-2.18	9.68	0.07	9.80
AV	1.713M	12.48	46.00	-33.52	19.55	Line	-	-7.07	9.68	0.07	9.80
QP	2.099M	20.97	56.00	-35.03	19.57	Line	-	1.40	9.68	0.08	9.81
AV	2.099M	13.62	46.00	-32.38	19.57	Line	-	-5.95	9.68	0.08	9.81
QP	2.636M	24.00	56.00	-32.00	19.62	Line	-	4.38	9.68	0.10	9.84
AV	2.636M	13.64	46.00	-32.36	19.62	Line	-	-5.98	9.68	0.10	9.84

Conducted Emissions at Powerline_Mode 1

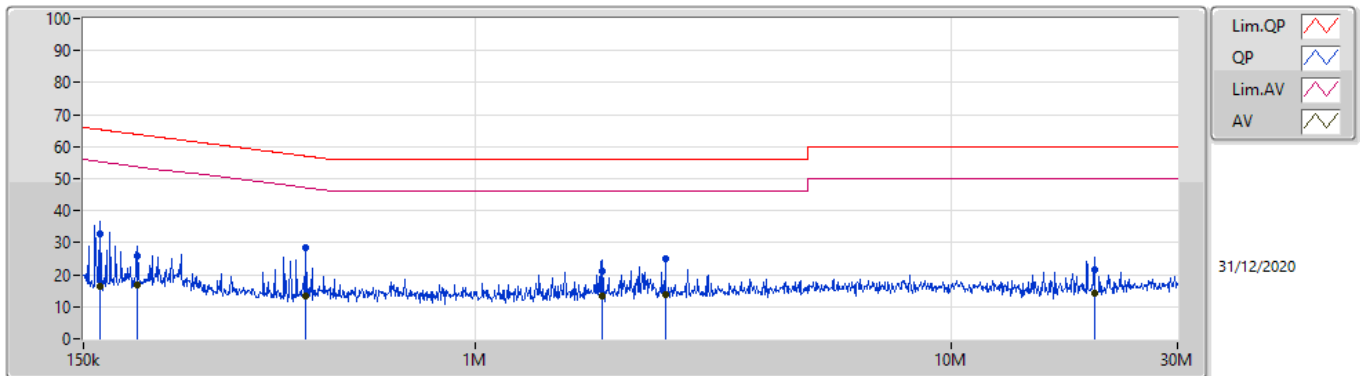

Type	Freq (Hz)	Level (dBuV)	Limit (dBuV)	Margin (dB)	Factor (dB)	Condition	Comment	Raw (dBuV)	LISN (dB)	CL (dB)	AT (dB)
QP	162.467k	32.88	65.33	-32.45	19.60	Neutral	-	13.28	9.69	0.01	9.90
AV	162.467k	16.49	55.33	-38.84	19.60	Neutral	-	-3.11	9.69	0.01	9.90
QP	195.216k	25.80	63.80	-38.00	19.59	Neutral	-	6.21	9.68	0.01	9.90
AV	195.216k	16.97	53.80	-36.83	19.59	Neutral	-	-2.62	9.68	0.01	9.90
QP	440.751k	28.52	57.05	-28.53	19.58	Neutral	"Worst"	8.94	9.67	0.02	9.89
AV	440.751k	13.23	47.05	-33.82	19.58	Neutral	-	-6.35	9.67	0.02	9.89
QP	1.855M	20.97	56.00	-35.03	19.56	Neutral	-	1.41	9.68	0.08	9.80
AV	1.855M	13.18	46.00	-32.82	19.56	Neutral	-	-6.38	9.68	0.08	9.80
QP	2.512M	25.20	56.00	-30.80	19.60	Neutral	-	5.60	9.68	0.09	9.83
AV	2.512M	13.73	46.00	-32.27	19.60	Neutral	-	-5.87	9.68	0.09	9.83
QP	20.027M	21.75	60.00	-38.25	19.94	Neutral	-	1.81	9.75	0.29	9.90
AV	20.027M	14.33	50.00	-35.67	19.94	Neutral	-	-5.61	9.75	0.29	9.90



Summary

Mode	Max-N dB (Hz)	Max-OBW (Hz)	ITU-Code	Min-N dB (Hz)	Min-OBW (Hz)
5.725-5.85GHz	-	-	-	-	-
802.11a_Nss1,(6Mbps)_4TX	16.38M	17.001M	17M0D1D	16.32M	16.792M
802.11n HT20_Nss1,(MCS0)_4TX	17.61M	17.991M	18M0D1D	17.55M	17.811M
802.11n HT40_Nss1,(MCS0)_4TX	36.36M	36.642M	36M6D1D	35.7M	36.402M
802.11ac VHT20_Nss1,(MCS0)_4TX	17.61M	18.021M	18M0D1D	17.55M	17.901M
802.11ac VHT40_Nss1,(MCS0)_4TX	36.36M	36.702M	36M7D1D	36.12M	36.462M
802.11ac VHT80_Nss1,(MCS0)_4TX	75.96M	76.282M	76M3D1D	75.6M	76.042M
802.11ax HEW20_Nss1,(MCS0)_4TX	19.02M	19.13M	19M1D1D	18.93M	18.981M
802.11ax HEW40_Nss1,(MCS0)_4TX	37.62M	38.081M	38M1D1D	36.66M	37.781M
802.11ax HEW80_Nss1,(MCS0)_4TX	77.04M	77.721M	77M7D1D	76.32M	77.361M

Max-N dB = Maximum 6dB down bandwidth for 5.725-5.85GHz band / Maximum 26dB down bandwidth for other band;
 Max-OBW = Maximum 99% occupied bandwidth;
 Min-N dB = Minimum 6dB down bandwidth for 5.725-5.85GHz band / Maximum 26dB down bandwidth for other band;
 Min-OBW = Minimum 99% occupied bandwidth



Result

Mode	Result	Limit (Hz)	Port 1-N dB (Hz)	Port 1-OBW (Hz)	Port 2-N dB (Hz)	Port 2-OBW (Hz)	Port 3-N dB (Hz)	Port 3-OBW (Hz)	Port 4-N dB (Hz)	Port 4-OBW (Hz)
802.11a_Nss1,(6Mbps)_4TX	-	-	-	-	-	-	-	-	-	-
5745MHz	Pass	500k	16.32M	16.852M	16.35M	16.882M	16.35M	16.882M	16.32M	16.912M
5785MHz	Pass	500k	16.38M	16.972M	16.32M	16.942M	16.35M	16.822M	16.35M	17.001M
5825MHz	Pass	500k	16.32M	16.912M	16.35M	16.822M	16.32M	16.792M	16.35M	16.972M
802.11n HT20_Nss1,(MCS0)_4TX	-	-	-	-	-	-	-	-	-	-
5745MHz	Pass	500k	17.58M	17.931M	17.61M	17.901M	17.55M	17.931M	17.58M	17.901M
5785MHz	Pass	500k	17.58M	17.901M	17.58M	17.841M	17.58M	17.901M	17.58M	17.871M
5825MHz	Pass	500k	17.55M	17.901M	17.61M	17.811M	17.58M	17.871M	17.58M	17.991M
802.11n HT40_Nss1,(MCS0)_4TX	-	-	-	-	-	-	-	-	-	-
5755MHz	Pass	500k	36.3M	36.462M	36.36M	36.402M	36.24M	36.402M	35.94M	36.462M
5795MHz	Pass	500k	36.3M	36.642M	36.3M	36.462M	35.7M	36.462M	36.36M	36.462M
802.11ac VHT20_Nss1,(MCS0)_4TX	-	-	-	-	-	-	-	-	-	-
5745MHz	Pass	500k	17.58M	18.021M	17.61M	17.931M	17.58M	17.961M	17.58M	17.931M
5785MHz	Pass	500k	17.61M	17.961M	17.58M	18.021M	17.58M	17.931M	17.58M	17.901M
5825MHz	Pass	500k	17.55M	17.961M	17.61M	17.931M	17.58M	17.961M	17.58M	17.991M
802.11ac VHT40_Nss1,(MCS0)_4TX	-	-	-	-	-	-	-	-	-	-
5755MHz	Pass	500k	36.36M	36.582M	36.36M	36.462M	36.36M	36.462M	36.36M	36.582M
5795MHz	Pass	500k	36.3M	36.702M	36.3M	36.582M	36.36M	36.522M	36.12M	36.522M
802.11ac VHT80_Nss1,(MCS0)_4TX	-	-	-	-	-	-	-	-	-	-
5775MHz	Pass	500k	75.96M	76.282M	75.72M	76.162M	75.6M	76.162M	75.72M	76.042M
802.11ax HEW20_Nss1,(MCS0)_4TX	-	-	-	-	-	-	-	-	-	-
5745MHz	Pass	500k	18.96M	19.07M	18.96M	18.981M	18.96M	19.1M	18.99M	19.07M
5785MHz	Pass	500k	18.99M	19.01M	19.02M	19.01M	18.93M	19.04M	18.96M	19.04M
5825MHz	Pass	500k	18.99M	19.1M	18.99M	19.01M	18.99M	19.01M	18.93M	19.13M
802.11ax HEW40_Nss1,(MCS0)_4TX	-	-	-	-	-	-	-	-	-	-
5755MHz	Pass	500k	37.62M	37.841M	37.62M	37.841M	37.26M	37.781M	36.66M	37.781M
5795MHz	Pass	500k	37.56M	38.081M	37.5M	37.901M	37.5M	37.841M	37.2M	37.901M
802.11ax HEW80_Nss1,(MCS0)_4TX	-	-	-	-	-	-	-	-	-	-
5775MHz	Pass	500k	77.04M	77.721M	76.44M	77.361M	76.44M	77.361M	76.32M	77.481M

Port X-N dB = Port X 6dB down bandwidth for 5.725-5.85GHz band / 26dB down bandwidth for other band
 Port X-OBW = Port X 99% occupied bandwidth

802.11a_Nss1,(6Mbps)_4TX

EBW

5745MHz

29/12/2020

CF
5.745GHz
Span
60MHz
RBW
100kHz
VBW
300kHz
Sweep Time
100ms
Detector Type
Peak

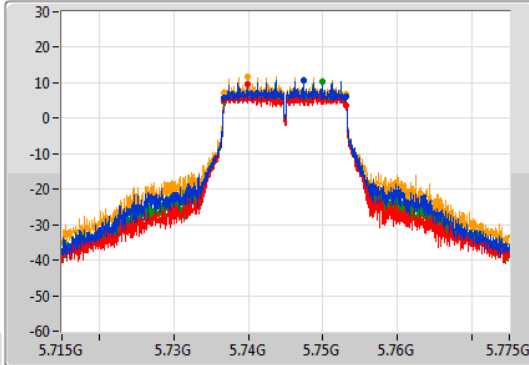

CF
5.745GHz
Span
60MHz
RBW
300kHz
VBW
1MHz
Sweep Time
100ms
Detector Type
Sample

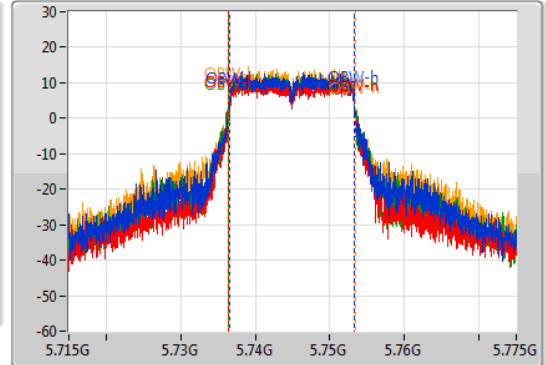

Port 1
Port 2
Port 3
Port 4

6dB(Hz)	Fl-6dB(Hz)	Fh-6dB(Hz)	OBW(Hz)	Fl-OBW(Hz)	Fh-OBW(Hz)	Limit(Hz)	Port
16.32M	5.73678G	5.7531G	16.852M	5.736484G	5.753336G	500k	1
16.35M	5.73678G	5.75313G	16.882M	5.736454G	5.753336G	500k	2
16.35M	5.73675G	5.7531G	16.882M	5.736454G	5.753336G	500k	3
16.32M	5.73678G	5.7531G	16.912M	5.736454G	5.753366G	500k	4

802.11a_Nss1,(6Mbps)_4TX

EBW

5785MHz

29/12/2020

CF
5.785GHz
Span
60MHz
RBW
100kHz
VBW
300kHz
Sweep Time
100ms
Detector Type
Peak

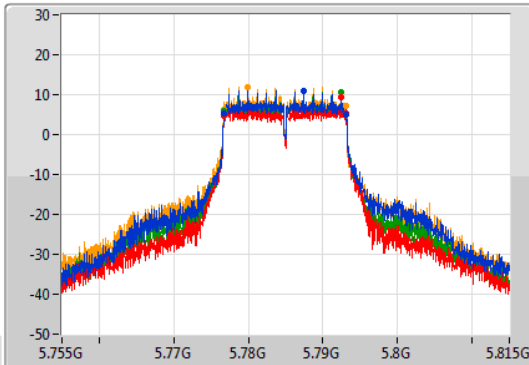

CF
5.785GHz
Span
60MHz
RBW
300kHz
VBW
1MHz
Sweep Time
100ms
Detector Type
Sample

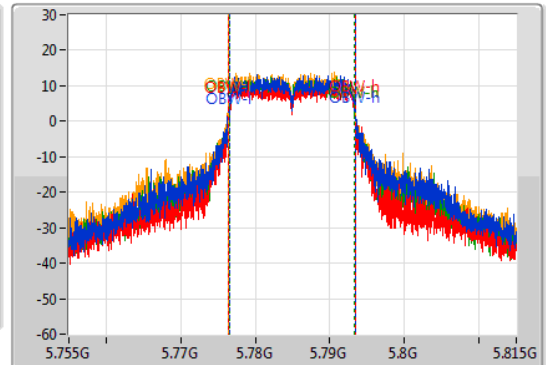

Port 1
Port 2
Port 3
Port 4

6dB(Hz)	Fl-6dB(Hz)	Fh-6dB(Hz)	OBW(Hz)	Fl-OBW(Hz)	Fh-OBW(Hz)	Limit(Hz)	Port
16.38M	5.77675G	5.79313G	16.972M	5.776484G	5.793456G	500k	1
16.32M	5.77678G	5.7931G	16.942M	5.776454G	5.793396G	500k	2
16.35M	5.77678G	5.79313G	16.822M	5.776514G	5.793336G	500k	3
16.35M	5.77675G	5.7931G	17.001M	5.776424G	5.793426G	500k	4

802.11a_Nss1,(6Mbps)_4TX

EBW

5825MHz

29/12/2020

CF: 5.825GHz
 Span: 60MHz
 RBW: 100kHz
 VBW: 300kHz
 Sweep Time: 100ms
 Detector Type: Peak

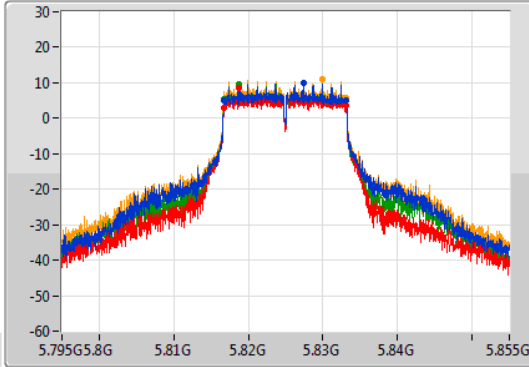

CF: 5.825GHz
 Span: 60MHz
 RBW: 300kHz
 VBW: 1MHz
 Sweep Time: 100ms
 Detector Type: Sample

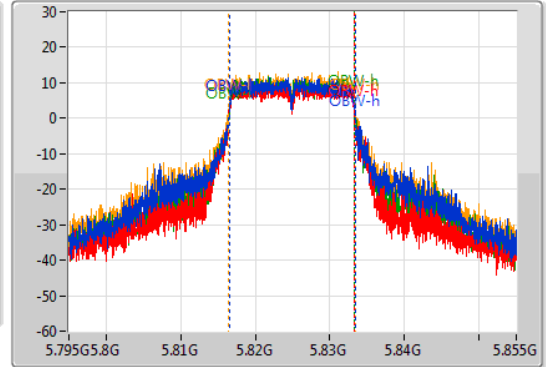

6dB(Hz)	Fl-6dB(Hz)	Fh-6dB(Hz)	OBW(Hz)	Fl-OBW(Hz)	Fh-OBW(Hz)	Limit(Hz)	Port
16.32M	5.81678G	5.8331G	16.912M	5.816484G	5.833396G	500k	1
16.35M	5.81675G	5.8331G	16.822M	5.816484G	5.833306G	500k	2
16.32M	5.81678G	5.8331G	16.792M	5.816514G	5.833306G	500k	3
16.35M	5.81675G	5.8331G	16.972M	5.816394G	5.833366G	500k	4

802.11n HT20_Nss1,(MCS0)_4TX

EBW

5745MHz

29/12/2020

CF: 5.745GHz
 Span: 60MHz
 RBW: 100kHz
 VBW: 300kHz
 Sweep Time: 100ms
 Detector Type: Peak

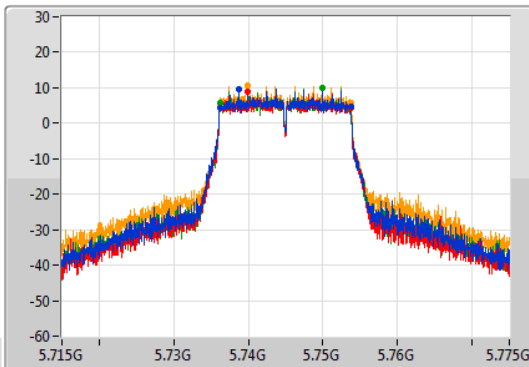

CF: 5.745GHz
 Span: 60MHz
 RBW: 300kHz
 VBW: 1MHz
 Sweep Time: 100ms
 Detector Type: Sample

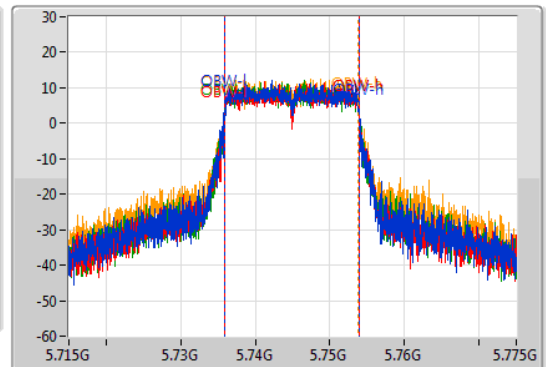

6dB(Hz)	Fl-6dB(Hz)	Fh-6dB(Hz)	OBW(Hz)	Fl-OBW(Hz)	Fh-OBW(Hz)	Limit(Hz)	Port
17.58M	5.73615G	5.75373G	17.931M	5.735945G	5.753876G	500k	1
17.61M	5.73615G	5.75376G	17.901M	5.735975G	5.753876G	500k	2
17.55M	5.73618G	5.75373G	17.931M	5.735945G	5.753876G	500k	3
17.58M	5.73615G	5.75373G	17.901M	5.735945G	5.753846G	500k	4

802.11n HT20_Nss1,(MCS0)_4TX

EBW

5785MHz

29/12/2020

CF
5.785GHz
Span
60MHz
RBW
100kHz
VBW
300kHz
Sweep Time
100ms
Detector Type
Peak

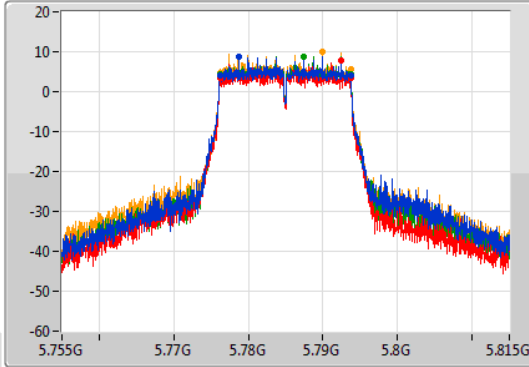

CF
5.785GHz
Span
60MHz
RBW
300kHz
VBW
1MHz
Sweep Time
100ms
Detector Type
Sample

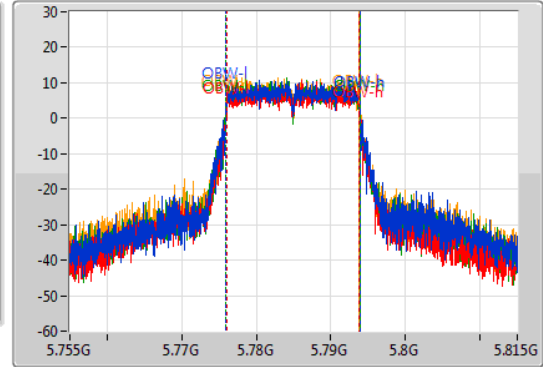

Port 1
Port 2
Port 3
Port 4

6dB(Hz)	Fl-6dB(Hz)	Fh-6dB(Hz)	OBW(Hz)	Fl-OBW(Hz)	Fh-OBW(Hz)	Limit(Hz)	Port
17.58M	5.77615G	5.79373G	17.901M	5.775975G	5.793876G	500k	1
17.58M	5.77615G	5.79373G	17.841M	5.776004G	5.793846G	500k	2
17.58M	5.77615G	5.79373G	17.901M	5.775975G	5.793876G	500k	3
17.58M	5.77615G	5.79373G	17.871M	5.775975G	5.793846G	500k	4

802.11n HT20_Nss1,(MCS0)_4TX

EBW

5825MHz

29/12/2020

CF
5.825GHz
Span
60MHz
RBW
100kHz
VBW
300kHz
Sweep Time
100ms
Detector Type
Peak

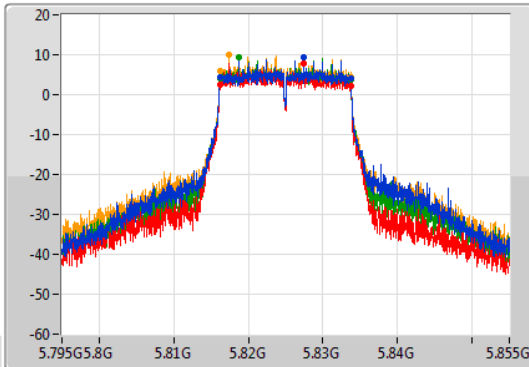

CF
5.825GHz
Span
60MHz
RBW
300kHz
VBW
1MHz
Sweep Time
100ms
Detector Type
Sample

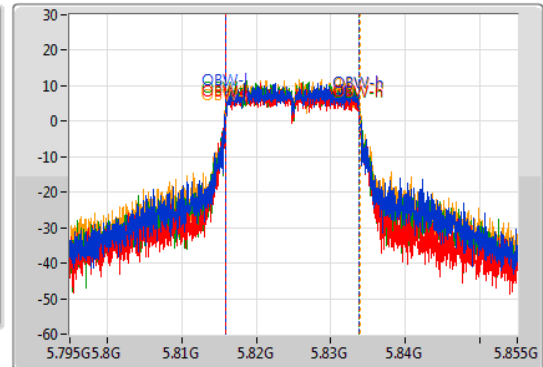

Port 1
Port 2
Port 3
Port 4

6dB(Hz)	Fl-6dB(Hz)	Fh-6dB(Hz)	OBW(Hz)	Fl-OBW(Hz)	Fh-OBW(Hz)	Limit(Hz)	Port
17.55M	5.81618G	5.83373G	17.901M	5.815945G	5.833846G	500k	1
17.61M	5.81615G	5.83376G	17.811M	5.815975G	5.833786G	500k	2
17.58M	5.81615G	5.83373G	17.871M	5.815975G	5.833846G	500k	3
17.58M	5.81615G	5.83373G	17.991M	5.815915G	5.833906G	500k	4

802.11n HT40_Nss1,(MCS0)_4TX

EBW

5755MHz

29/12/2020

CF
5.755GHz
Span
120MHz
RBW
100kHz
VBW
300kHz
Sweep Time
100ms
Detector Type
Peak

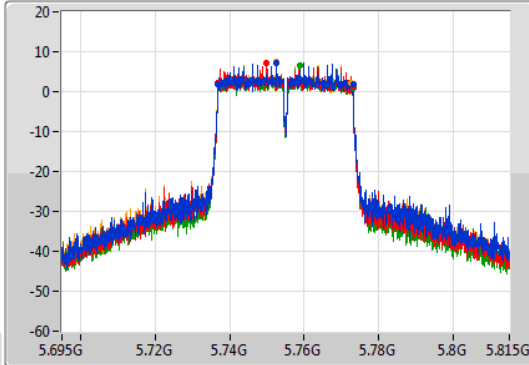

CF
5.755GHz
Span
120MHz
RBW
1MHz
VBW
3MHz
Sweep Time
100ms
Detector Type
Sample

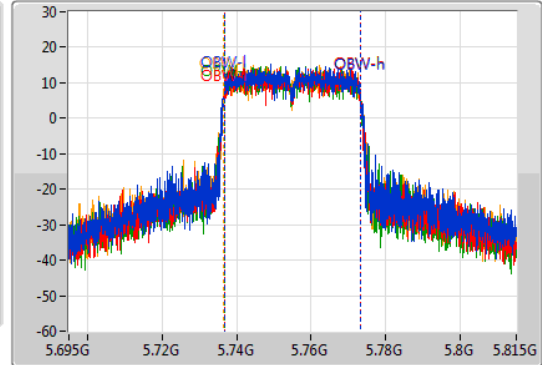

Port 1
Port 2
Port 3
Port 4

6dB(Hz)	Fl-6dB(Hz)	Fh-6dB(Hz)	OBW(Hz)	Fl-OBW(Hz)	Fh-OBW(Hz)	Limit(Hz)	Port
36.3M	5.73676G	5.77306G	36.462M	5.736649G	5.773111G	500k	1
36.36M	5.73676G	5.77312G	36.402M	5.736709G	5.773111G	500k	2
36.24M	5.73682G	5.77306G	36.402M	5.736649G	5.773051G	500k	3
35.94M	5.73676G	5.7727G	36.462M	5.736589G	5.773051G	500k	4

802.11n HT40_Nss1,(MCS0)_4TX

EBW

5795MHz

29/12/2020

CF
5.795GHz
Span
120MHz
RBW
100kHz
VBW
300kHz
Sweep Time
100ms
Detector Type
Peak

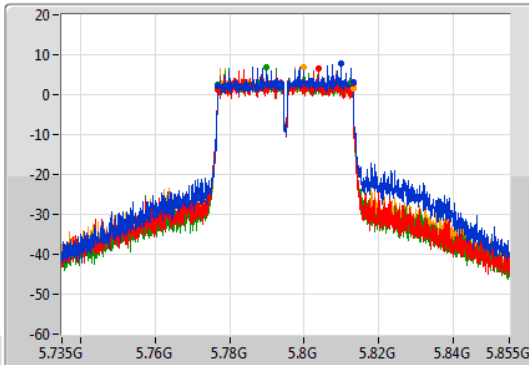

CF
5.795GHz
Span
120MHz
RBW
1MHz
VBW
3MHz
Sweep Time
100ms
Detector Type
Sample

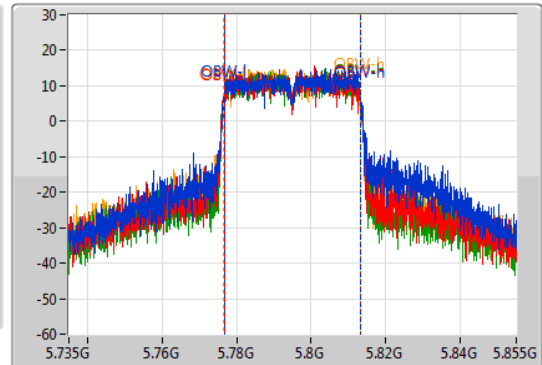

Port 1
Port 2
Port 3
Port 4

6dB(Hz)	Fl-6dB(Hz)	Fh-6dB(Hz)	OBW(Hz)	Fl-OBW(Hz)	Fh-OBW(Hz)	Limit(Hz)	Port
36.3M	5.77682G	5.81312G	36.642M	5.776649G	5.813291G	500k	1
36.3M	5.77682G	5.81312G	36.462M	5.776649G	5.813111G	500k	2
35.7M	5.77682G	5.81252G	36.462M	5.776649G	5.813111G	500k	3
36.36M	5.77676G	5.81312G	36.462M	5.776589G	5.813051G	500k	4

802.11ac VHT20_Nss1,(MCS0)_4TX

EBW

5745MHz

29/12/2020

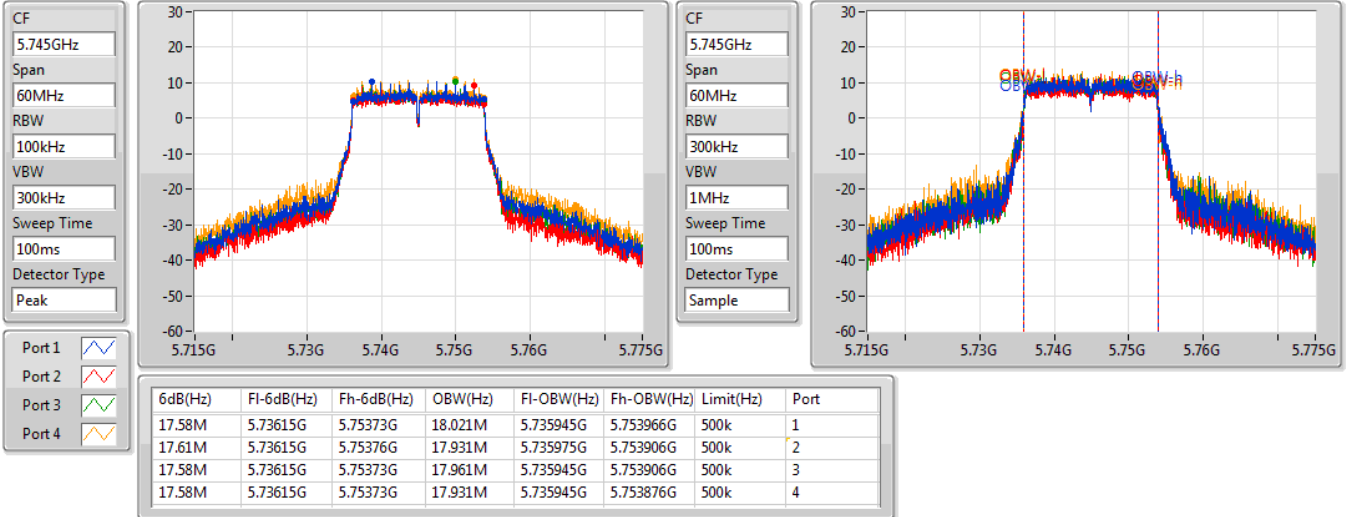

802.11ac VHT20_Nss1,(MCS0)_4TX

EBW

5785MHz

29/12/2020

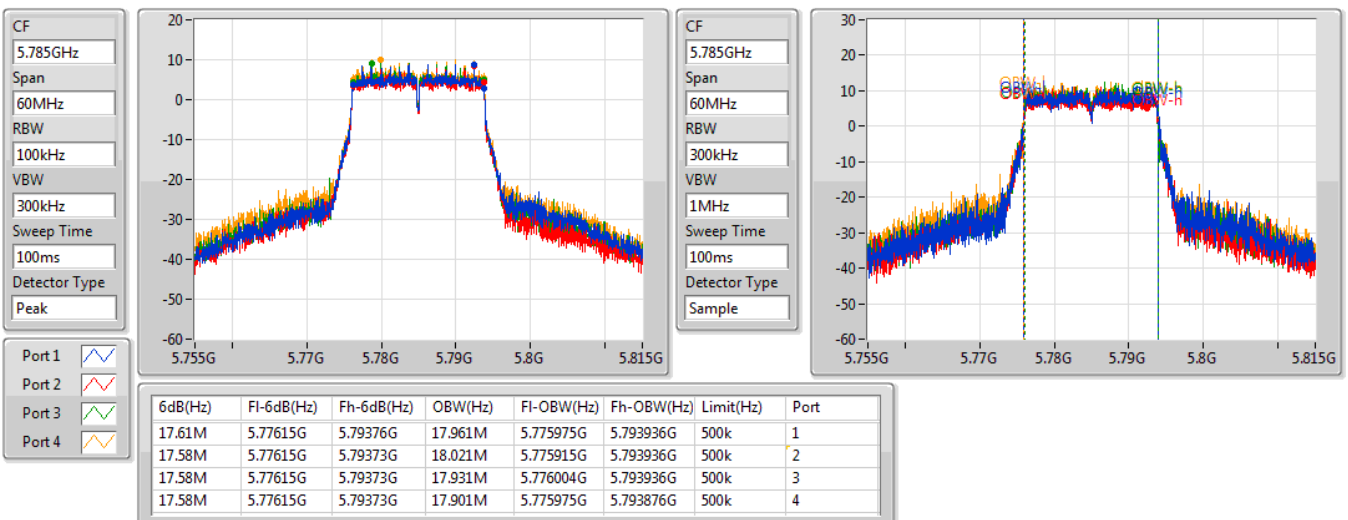

802.11ac VHT20_Nss1,(MCS0)_4TX

EBW

5825MHz

29/12/2020

CF
5.825GHz
Span
60MHz
RBW
100kHz
VBW
300kHz
Sweep Time
100ms
Detector Type
Peak

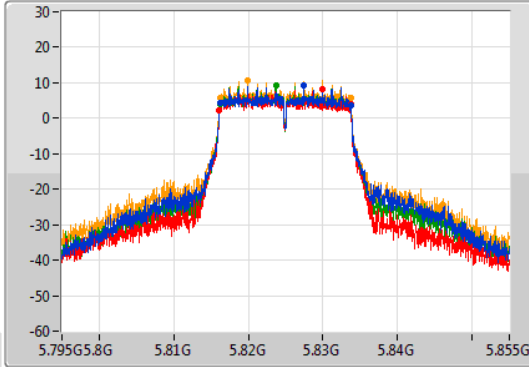

CF
5.825GHz
Span
60MHz
RBW
300kHz
VBW
1MHz
Sweep Time
100ms
Detector Type
Sample

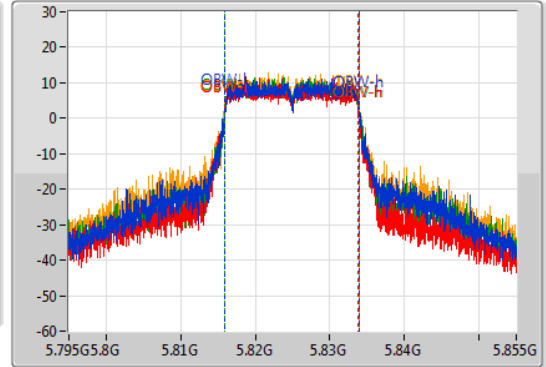

Port 1
Port 2
Port 3
Port 4

6dB(Hz)	Fl-6dB(Hz)	Fh-6dB(Hz)	OBW(Hz)	Fl-OBW(Hz)	Fh-OBW(Hz)	Limit(Hz)	Port
17.55M	5.81618G	5.83373G	17.961M	5.815945G	5.833906G	500k	1
17.61M	5.81612G	5.83373G	17.931M	5.815915G	5.833846G	500k	2
17.58M	5.81615G	5.83373G	17.961M	5.815945G	5.833906G	500k	3
17.58M	5.81615G	5.83373G	17.991M	5.815885G	5.833876G	500k	4

802.11ac VHT40_Nss1,(MCS0)_4TX

EBW

5755MHz

29/12/2020

CF
5.755GHz
Span
120MHz
RBW
100kHz
VBW
300kHz
Sweep Time
100ms
Detector Type
Peak

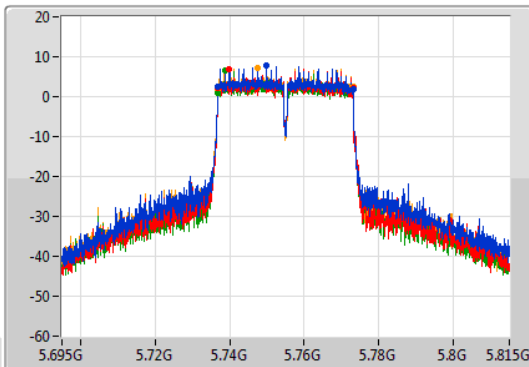

CF
5.755GHz
Span
120MHz
RBW
1MHz
VBW
3MHz
Sweep Time
100ms
Detector Type
Sample

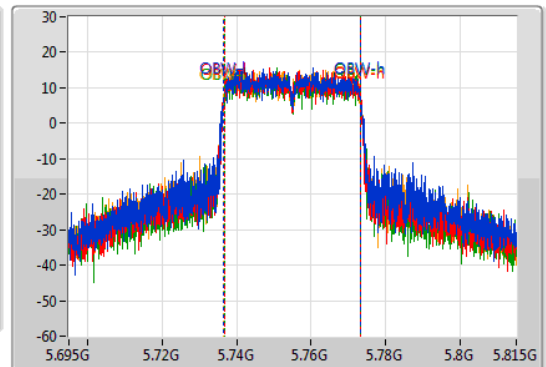

Port 1
Port 2
Port 3
Port 4

6dB(Hz)	Fl-6dB(Hz)	Fh-6dB(Hz)	OBW(Hz)	Fl-OBW(Hz)	Fh-OBW(Hz)	Limit(Hz)	Port
36.36M	5.73676G	5.77312G	36.582M	5.736589G	5.773171G	500k	1
36.36M	5.73676G	5.77312G	36.462M	5.736649G	5.773111G	500k	2
36.36M	5.73676G	5.77312G	36.462M	5.736709G	5.773171G	500k	3
36.36M	5.73676G	5.77312G	36.582M	5.736589G	5.773171G	500k	4

802.11ac VHT40_Nss1,(MCS0)_4TX

EBW

5795MHz

29/12/2020

CF
5.795GHz
Span
120MHz
RBW
100kHz
VBW
300kHz
Sweep Time
100ms
Detector Type
Peak

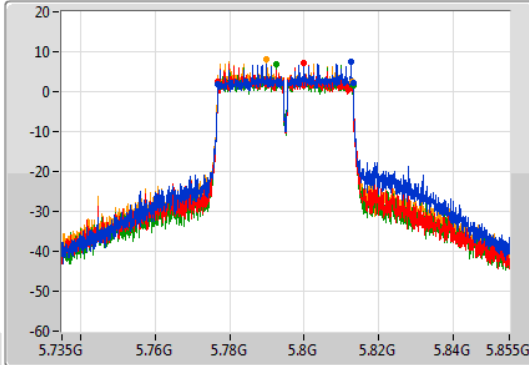

CF
5.795GHz
Span
120MHz
RBW
1MHz
VBW
3MHz
Sweep Time
100ms
Detector Type
Sample

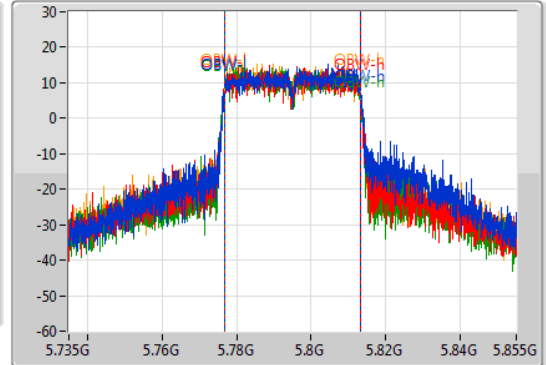

Port 1
Port 2
Port 3
Port 4

6dB(Hz)	Fl-6dB(Hz)	Fh-6dB(Hz)	OBW(Hz)	Fl-OBW(Hz)	Fh-OBW(Hz)	Limit(Hz)	Port
36.3M	5.77682G	5.81312G	36.702M	5.776649G	5.813351G	500k	1
36.3M	5.77682G	5.81312G	36.582M	5.776649G	5.813231G	500k	2
36.36M	5.77676G	5.81312G	36.522M	5.776649G	5.813171G	500k	3
36.12M	5.77676G	5.81288G	36.522M	5.776649G	5.813171G	500k	4

802.11ac VHT80_Nss1,(MCS0)_4TX

EBW

5775MHz

29/12/2020

CF
5.775GHz
Span
240MHz
RBW
100kHz
VBW
300kHz
Sweep Time
100ms
Detector Type
Peak

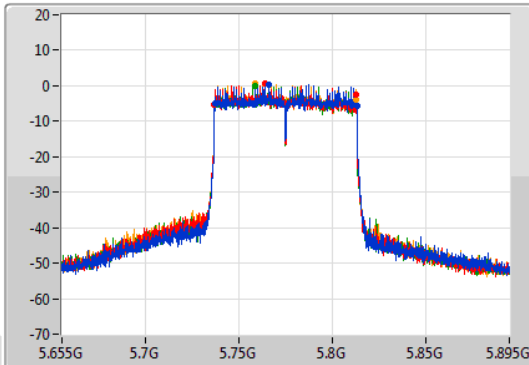

CF
5.775GHz
Span
240MHz
RBW
2MHz
VBW
10MHz
Sweep Time
100ms
Detector Type
Sample

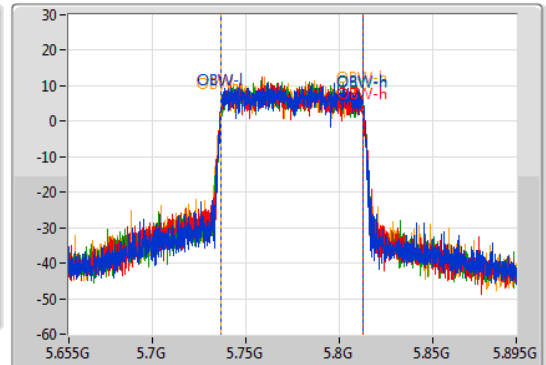

Port 1
Port 2
Port 3
Port 4

6dB(Hz)	Fl-6dB(Hz)	Fh-6dB(Hz)	OBW(Hz)	Fl-OBW(Hz)	Fh-OBW(Hz)	Limit(Hz)	Port
75.96M	5.7372G	5.81316G	76.282M	5.736739G	5.813021G	500k	1
75.72M	5.73672G	5.81244G	76.162M	5.736619G	5.812781G	500k	2
75.6M	5.73684G	5.81244G	76.162M	5.736619G	5.812781G	500k	3
75.72M	5.73684G	5.81256G	76.042M	5.736739G	5.812781G	500k	4

802.11ax HEW20_Nss1,(MCS0)_4TX

EBW

5745MHz

29/12/2020

CF
5.745GHz
Span
60MHz
RBW
100kHz
VBW
300kHz
Sweep Time
100ms
Detector Type
Peak

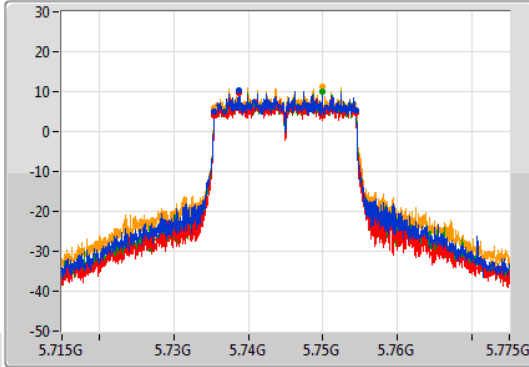

CF
5.745GHz
Span
60MHz
RBW
300kHz
VBW
1MHz
Sweep Time
100ms
Detector Type
Sample

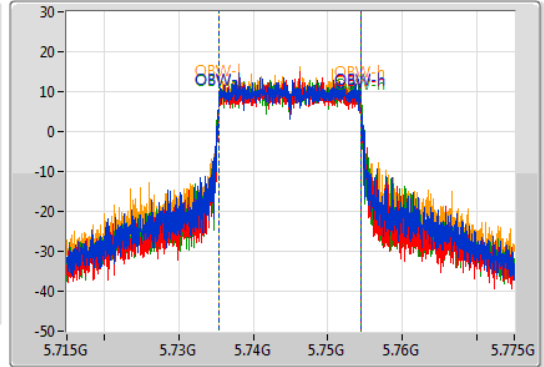

6dB(Hz)	Fl-6dB(Hz)	Fh-6dB(Hz)	OBW(Hz)	Fl-OBW(Hz)	Fh-OBW(Hz)	Limit(Hz)	Port
18.96M	5.73546G	5.75442G	19.07M	5.735375G	5.754445G	500k	1
18.96M	5.73546G	5.75442G	18.981M	5.735435G	5.754415G	500k	2
18.96M	5.73546G	5.75442G	19.1M	5.735375G	5.754475G	500k	3
18.99M	5.73546G	5.75445G	19.07M	5.735405G	5.754475G	500k	4

802.11ax HEW20_Nss1,(MCS0)_4TX

EBW

5785MHz

29/12/2020

CF
5.785GHz
Span
60MHz
RBW
100kHz
VBW
300kHz
Sweep Time
100ms
Detector Type
Peak

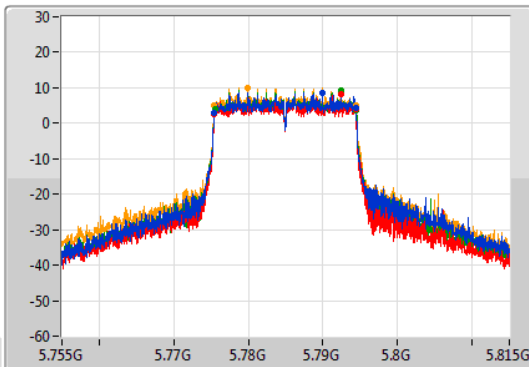

CF
5.785GHz
Span
60MHz
RBW
300kHz
VBW
1MHz
Sweep Time
100ms
Detector Type
Sample

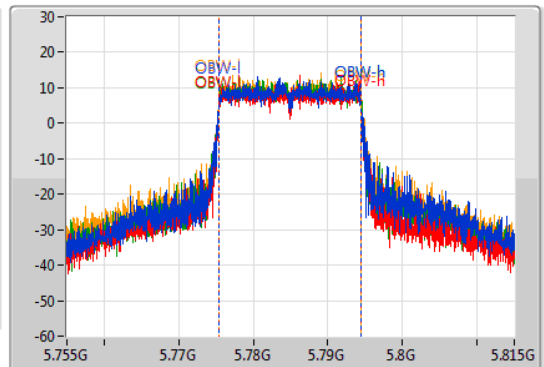

6dB(Hz)	Fl-6dB(Hz)	Fh-6dB(Hz)	OBW(Hz)	Fl-OBW(Hz)	Fh-OBW(Hz)	Limit(Hz)	Port
18.99M	5.77543G	5.79442G	19.01M	5.775435G	5.794445G	500k	1
19.02M	5.77537G	5.79439G	19.01M	5.775405G	5.794415G	500k	2
18.93M	5.77549G	5.79442G	19.04M	5.775405G	5.794445G	500k	3
18.96M	5.77546G	5.79442G	19.04M	5.775405G	5.794445G	500k	4

802.11ax HEW20_Nss1,(MCS0)_4TX

EBW

5825MHz

29/12/2020

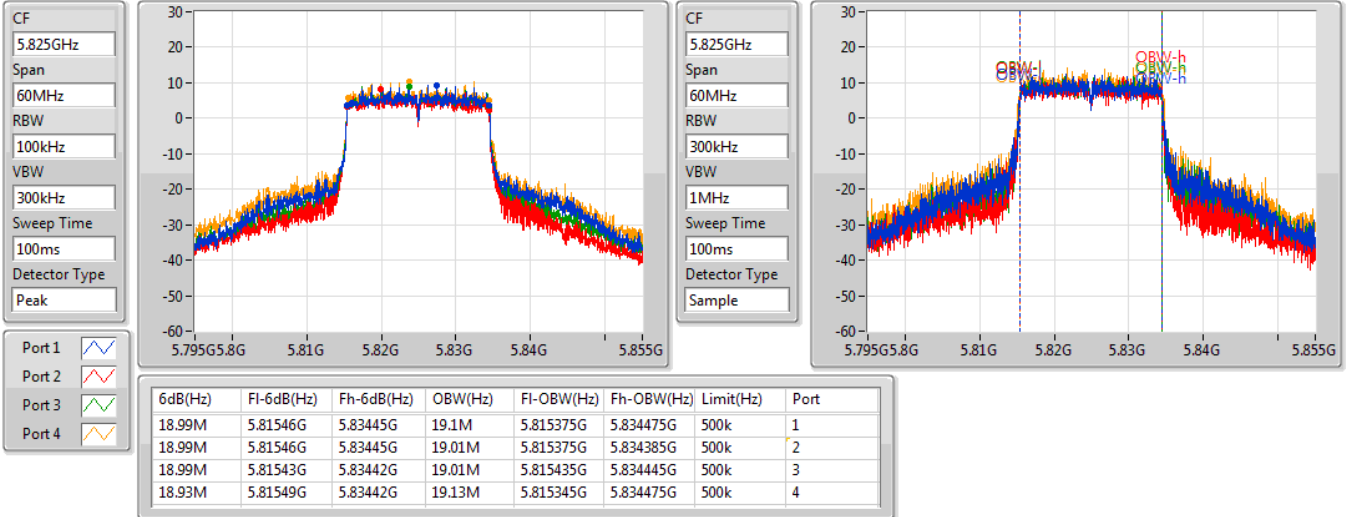

802.11ax HEW40_Nss1,(MCS0)_4TX

EBW

5755MHz

29/12/2020

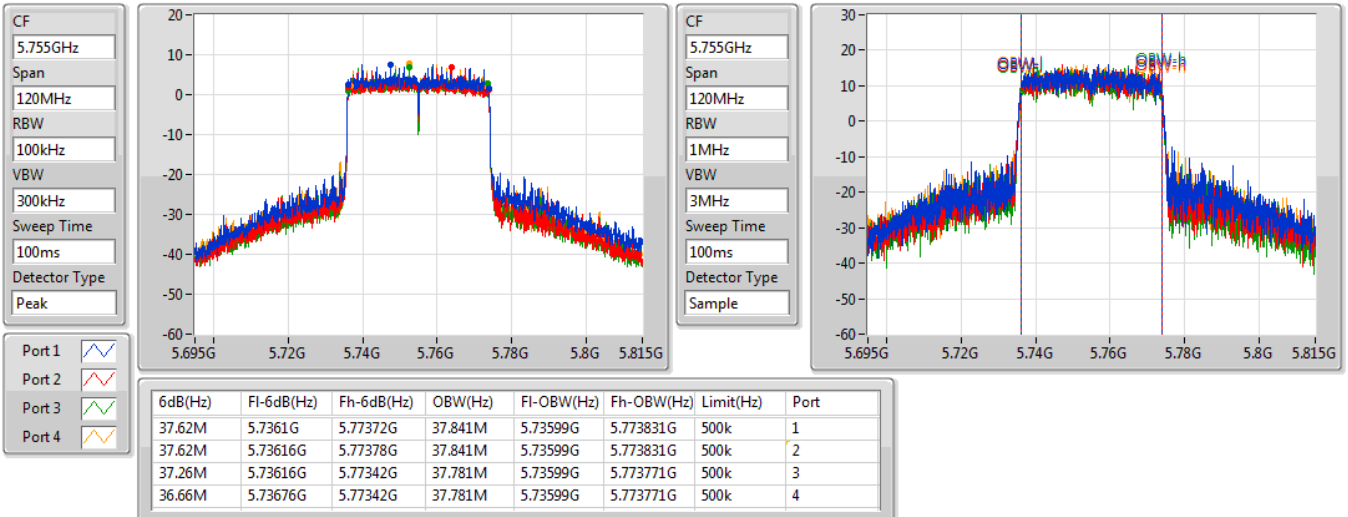

802.11ax HEW40_Nss1,(MCS0)_4TX

EBW

5795MHz

29/12/2020

CF
5.795GHz
Span
120MHz
RBW
100kHz
VBW
300kHz
Sweep Time
100ms
Detector Type
Peak

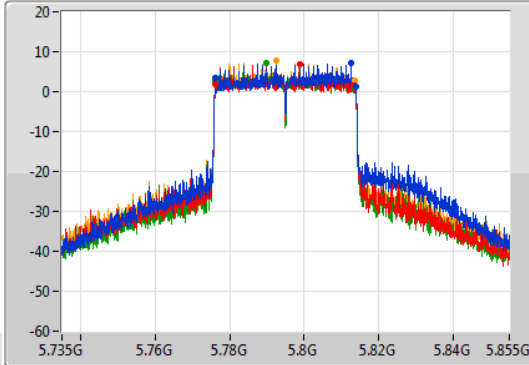

CF
5.795GHz
Span
120MHz
RBW
1MHz
VBW
3MHz
Sweep Time
100ms
Detector Type
Sample

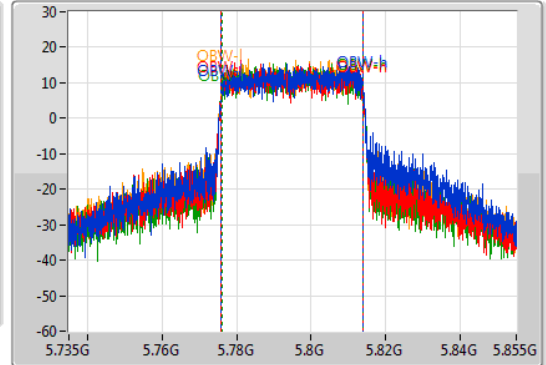

Port 1
Port 2
Port 3
Port 4

6dB(Hz)	Fl-6dB(Hz)	Fh-6dB(Hz)	OBW(Hz)	Fl-OBW(Hz)	Fh-OBW(Hz)	Limit(Hz)	Port
37.56M	5.77616G	5.81372G	38.081M	5.77593G	5.81401G	500k	1
37.5M	5.77616G	5.81366G	37.901M	5.77593G	5.813831G	500k	2
37.5M	5.77616G	5.81366G	37.841M	5.77599G	5.813831G	500k	3
37.2M	5.77622G	5.81342G	37.901M	5.77593G	5.813831G	500k	4

802.11ax HEW80_Nss1,(MCS0)_4TX

EBW

5775MHz

29/12/2020

CF
5.775GHz
Span
240MHz
RBW
100kHz
VBW
300kHz
Sweep Time
100ms
Detector Type
Peak

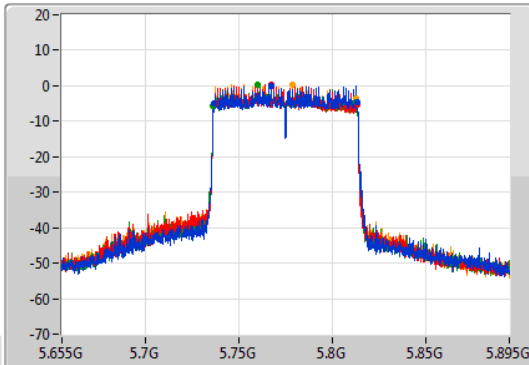

CF
5.775GHz
Span
240MHz
RBW
2MHz
VBW
10MHz
Sweep Time
100ms
Detector Type
Sample

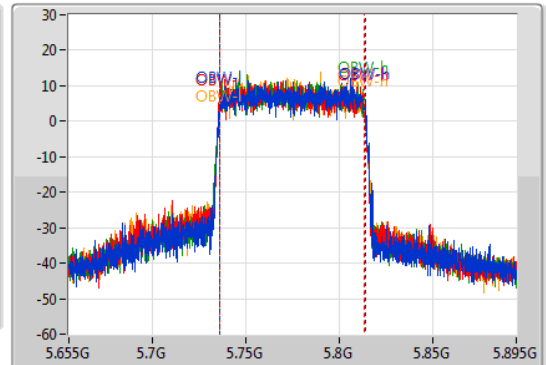

Port 1
Port 2
Port 3
Port 4

6dB(Hz)	Fl-6dB(Hz)	Fh-6dB(Hz)	OBW(Hz)	Fl-OBW(Hz)	Fh-OBW(Hz)	Limit(Hz)	Port
77.04M	5.73648G	5.81352G	77.721M	5.736139G	5.813861G	500k	1
76.44M	5.73708G	5.81352G	77.361M	5.7359G	5.813261G	500k	2
76.44M	5.73612G	5.81256G	77.361M	5.736139G	5.813501G	500k	3
76.32M	5.73624G	5.81256G	77.481M	5.736019G	5.813501G	500k	4



Summary

Mode	Max-N dB (Hz)	Max-OBW (Hz)	ITU-Code	Min-N dB (Hz)	Min-OBW (Hz)
5.15-5.25GHz	-	-	-	-	-
802.11a_Nss1,(6Mbps)_4TX	22.29M	16.822M	16M8D1D	21.18M	16.642M
802.11n HT20_Nss1,(MCS0)_4TX	21.78M	17.871M	17M9D1D	21.27M	17.781M
802.11n HT40_Nss1,(MCS0)_4TX	40.08M	36.462M	36M5D1D	39.48M	36.402M
802.11ac VHT20_Nss1,(MCS0)_4TX	21.75M	17.931M	17M9D1D	21.45M	17.781M
802.11ac VHT40_Nss1,(MCS0)_4TX	40.2M	36.582M	36M6D1D	39.72M	36.342M
802.11ac VHT80_Nss1,(MCS0)_4TX	81.84M	76.042M	76M0D1D	81.24M	75.922M
802.11ax HEW20_Nss1,(MCS0)_4TX	21.9M	19.04M	19M0D1D	21.48M	18.951M
802.11ax HEW40_Nss1,(MCS0)_4TX	40.26M	37.781M	37M8D1D	39.78M	37.661M
802.11ax HEW80_Nss1,(MCS0)_4TX	82.2M	77.481M	77M5D1D	82.08M	77.241M
5.725-5.85GHz	-	-	-	-	-
802.11a_Nss1,(6Mbps)_4TX	16.32M	19.46M	19M5D1D	16.02M	16.972M
802.11n HT20_Nss1,(MCS0)_4TX	17.61M	18.951M	19M0D1D	17.55M	17.991M
802.11n HT40_Nss1,(MCS0)_4TX	36.36M	36.822M	36M8D1D	36.06M	36.402M
802.11ac VHT20_Nss1,(MCS0)_4TX	17.58M	18.861M	18M9D1D	17.55M	18.021M
802.11ac VHT40_Nss1,(MCS0)_4TX	36.36M	36.942M	36M9D1D	36.3M	36.582M
802.11ac VHT80_Nss1,(MCS0)_4TX	76.2M	76.402M	76M4D1D	75.6M	75.922M
802.11ax HEW20_Nss1,(MCS0)_4TX	18.84M	20.06M	20M1D1D	18.6M	19.31M
802.11ax HEW40_Nss1,(MCS0)_4TX	37.56M	38.261M	38M3D1D	36.78M	37.841M
802.11ax HEW80_Nss1,(MCS0)_4TX	77.28M	77.721M	77M7D1D	76.44M	77.481M

Max-N dB = Maximum 6dB down bandwidth for 5.725-5.85GHz band / Maximum 26dB down bandwidth for other band;
 Max-OBW = Maximum 99% occupied bandwidth;
 Min-N dB = Minimum 6dB down bandwidth for 5.725-5.85GHz band / Maximum 26dB down bandwidth for other band;
 Min-OBW = Minimum 99% occupied bandwidth



Result

Mode	Result	Limit (Hz)	Port 1-N dB (Hz)	Port 1-OBW (Hz)	Port 2-N dB (Hz)	Port 2-OBW (Hz)	Port 3-N dB (Hz)	Port 3-OBW (Hz)	Port 4-N dB (Hz)	Port 4-OBW (Hz)
802.11a_Nss1,(6Mbps)_4TX	-	-	-	-	-	-	-	-	-	-
5180MHz	Pass	Inf	21.33M	16.822M	21.57M	16.642M	21.27M	16.642M	21.42M	16.672M
5200MHz	Pass	Inf	21.33M	16.732M	21.18M	16.642M	22.29M	16.672M	21.51M	16.702M
5240MHz	Pass	Inf	21.24M	16.792M	21.18M	16.672M	21.48M	16.702M	21.3M	16.642M
5745MHz	Pass	500k	16.05M	17.421M	16.29M	17.181M	16.29M	17.151M	16.32M	16.972M
5785MHz	Pass	500k	16.11M	18.351M	16.32M	17.481M	16.32M	17.481M	16.32M	17.121M
5825MHz	Pass	500k	16.02M	19.46M	16.02M	19.1M	16.29M	18.651M	16.32M	17.781M
802.11n HT20_Nss1,(MCS0)_4TX	-	-	-	-	-	-	-	-	-	-
5180MHz	Pass	Inf	21.69M	17.841M	21.27M	17.781M	21.6M	17.841M	21.78M	17.811M
5200MHz	Pass	Inf	21.75M	17.841M	21.54M	17.781M	21.63M	17.811M	21.54M	17.811M
5240MHz	Pass	Inf	21.6M	17.871M	21.51M	17.811M	21.45M	17.841M	21.6M	17.841M
5745MHz	Pass	500k	17.58M	18.081M	17.61M	18.441M	17.55M	18.441M	17.58M	18.051M
5785MHz	Pass	500k	17.58M	18.141M	17.61M	18.951M	17.58M	18.801M	17.58M	17.991M
5825MHz	Pass	500k	17.61M	18.261M	17.58M	18.651M	17.58M	18.681M	17.61M	18.201M
802.11n HT40_Nss1,(MCS0)_4TX	-	-	-	-	-	-	-	-	-	-
5190MHz	Pass	Inf	40.08M	36.402M	39.48M	36.462M	39.72M	36.462M	39.54M	36.462M
5230MHz	Pass	Inf	40.08M	36.462M	39.54M	36.462M	39.78M	36.462M	39.66M	36.402M
5755MHz	Pass	500k	36.3M	36.582M	36.36M	36.582M	36.3M	36.402M	36.36M	36.462M
5795MHz	Pass	500k	36.3M	36.822M	36.06M	36.762M	36.36M	36.762M	36.36M	36.582M
802.11ac VHT20_Nss1,(MCS0)_4TX	-	-	-	-	-	-	-	-	-	-
5180MHz	Pass	Inf	21.66M	17.811M	21.57M	17.871M	21.45M	17.871M	21.66M	17.901M
5200MHz	Pass	Inf	21.75M	17.841M	21.6M	17.781M	21.45M	17.841M	21.66M	17.931M
5240MHz	Pass	Inf	21.69M	17.931M	21.54M	17.781M	21.75M	17.811M	21.54M	17.931M
5745MHz	Pass	500k	17.58M	18.201M	17.55M	18.621M	17.55M	18.771M	17.58M	18.021M
5785MHz	Pass	500k	17.58M	18.321M	17.58M	18.711M	17.58M	18.801M	17.58M	18.171M
5825MHz	Pass	500k	17.55M	18.141M	17.58M	18.681M	17.55M	18.861M	17.58M	18.201M
802.11ac VHT40_Nss1,(MCS0)_4TX	-	-	-	-	-	-	-	-	-	-
5190MHz	Pass	Inf	40.2M	36.582M	39.72M	36.522M	40.02M	36.462M	39.84M	36.342M
5230MHz	Pass	Inf	40.14M	36.522M	39.72M	36.402M	40.08M	36.462M	40.02M	36.582M
5755MHz	Pass	500k	36.36M	36.642M	36.36M	36.762M	36.36M	36.582M	36.36M	36.582M
5795MHz	Pass	500k	36.3M	36.942M	36.36M	36.882M	36.36M	36.762M	36.36M	36.642M
802.11ac VHT80_Nss1,(MCS0)_4TX	-	-	-	-	-	-	-	-	-	-
5210MHz	Pass	Inf	81.48M	76.042M	81.36M	76.042M	81.24M	75.922M	81.84M	76.042M
5775MHz	Pass	500k	75.6M	75.922M	76.2M	76.162M	76.08M	76.402M	75.96M	76.162M
802.11ax HEW20_Nss1,(MCS0)_4TX	-	-	-	-	-	-	-	-	-	-
5180MHz	Pass	Inf	21.78M	19.01M	21.48M	19.01M	21.66M	18.951M	21.69M	18.951M
5200MHz	Pass	Inf	21.9M	19.01M	21.57M	19.04M	21.6M	18.981M	21.48M	18.951M
5240MHz	Pass	Inf	21.66M	18.981M	21.6M	19.01M	21.57M	18.951M	21.57M	19.01M
5745MHz	Pass	500k	18.84M	19.49M	18.63M	19.4M	18.63M	19.55M	18.72M	19.4M
5785MHz	Pass	500k	18.72M	19.46M	18.66M	19.31M	18.6M	19.43M	18.75M	19.37M
5825MHz	Pass	500k	18.78M	20.06M	18.81M	19.7M	18.81M	19.67M	18.66M	19.43M
802.11ax HEW40_Nss1,(MCS0)_4TX	-	-	-	-	-	-	-	-	-	-
5190MHz	Pass	Inf	40.14M	37.721M	39.84M	37.781M	40.2M	37.781M	39.84M	37.781M
5230MHz	Pass	Inf	40.14M	37.721M	39.78M	37.721M	40.26M	37.781M	40.02M	37.661M
5755MHz	Pass	500k	37.56M	37.901M	37.08M	37.901M	37.32M	37.841M	37.56M	37.841M
5795MHz	Pass	500k	37.56M	38.261M	36.78M	38.261M	37.5M	38.141M	37.32M	37.841M
802.11ax HEW80_Nss1,(MCS0)_4TX	-	-	-	-	-	-	-	-	-	-
5210MHz	Pass	Inf	82.2M	77.481M	82.2M	77.361M	82.08M	77.361M	82.2M	77.241M
5775MHz	Pass	500k	77.28M	77.481M	76.44M	77.601M	76.92M	77.601M	76.56M	77.721M

Port X-N dB = Port X 6dB down bandwidth for 5.725-5.85GHz band / 26dB down bandwidth for other band
 Port X-OBW = Port X 99% occupied bandwidth

802.11a_Nss1,(6Mbps)_4TX

EBW

5180MHz

30/12/2020

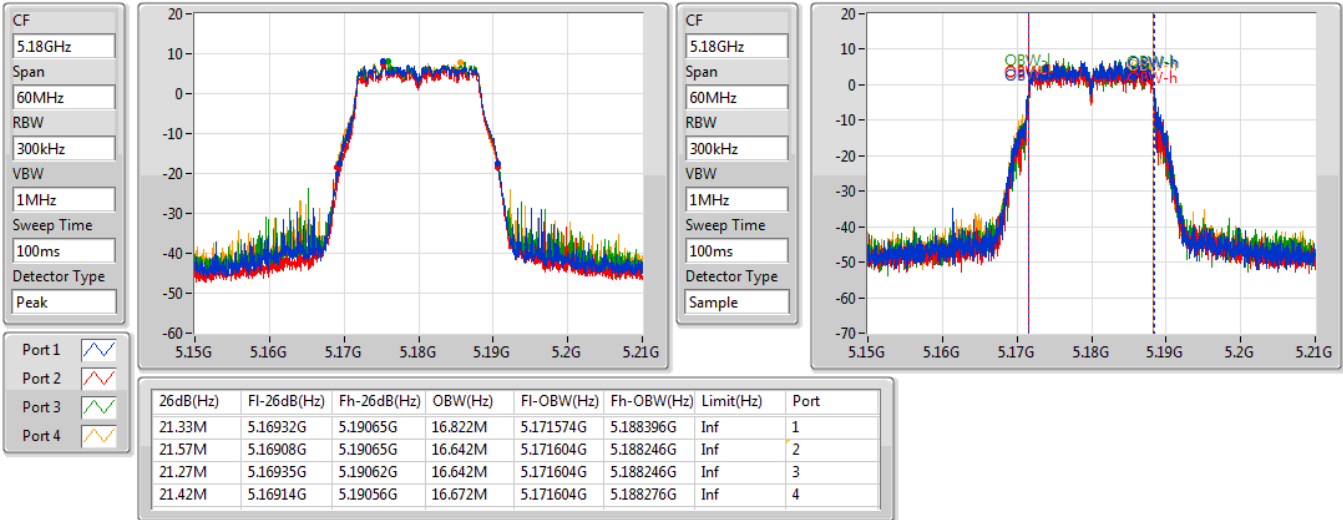

802.11a_Nss1,(6Mbps)_4TX

EBW

5200MHz

30/12/2020

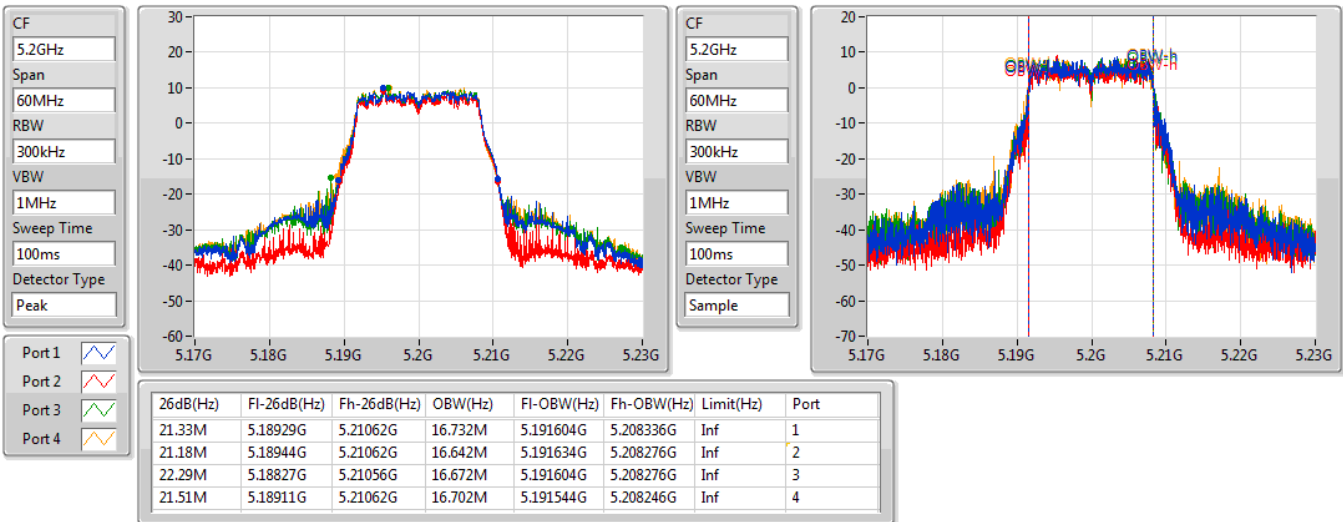

802.11a_Nss1,(6Mbps)_4TX

EBW

5240MHz

30/12/2020

CF: 5.24GHz
 Span: 60MHz
 RBW: 300kHz
 VBW: 1MHz
 Sweep Time: 100ms
 Detector Type: Peak

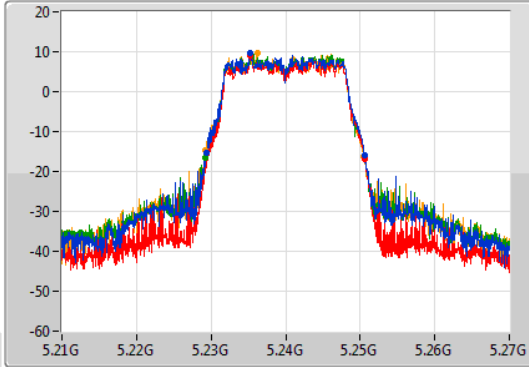

CF: 5.24GHz
 Span: 60MHz
 RBW: 300kHz
 VBW: 1MHz
 Sweep Time: 100ms
 Detector Type: Sample

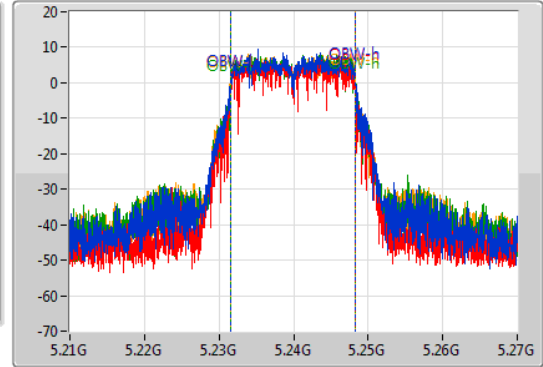

Port 1
 Port 2
 Port 3
 Port 4

26dB(Hz)	Fl-26dB(Hz)	Fh-26dB(Hz)	OBW(Hz)	Fl-OBW(Hz)	Fh-OBW(Hz)	Limit(Hz)	Port
21.24M	5.22938G	5.25062G	16.792M	5.231544G	5.248336G	Inf	1
21.18M	5.22944G	5.25062G	16.672M	5.231634G	5.248306G	Inf	2
21.48M	5.22914G	5.25062G	16.702M	5.231574G	5.248276G	Inf	3
21.3M	5.2292G	5.2505G	16.642M	5.231604G	5.248246G	Inf	4

802.11a_Nss1,(6Mbps)_4TX

EBW

5745MHz

30/12/2020

CF: 5.745GHz
 Span: 60MHz
 RBW: 100kHz
 VBW: 300kHz
 Sweep Time: 100ms
 Detector Type: Peak

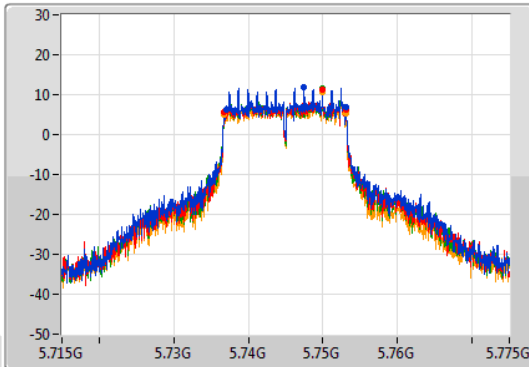

CF: 5.745GHz
 Span: 60MHz
 RBW: 300kHz
 VBW: 1MHz
 Sweep Time: 100ms
 Detector Type: Sample

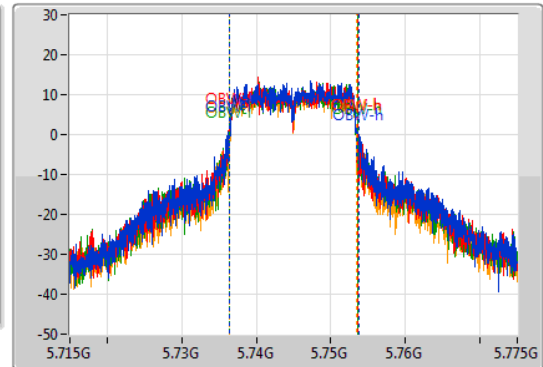

Port 1
 Port 2
 Port 3
 Port 4

6dB(Hz)	Fl-6dB(Hz)	Fh-6dB(Hz)	OBW(Hz)	Fl-OBW(Hz)	Fh-OBW(Hz)	Limit(Hz)	Port
16.05M	5.73705G	5.7531G	17.421M	5.736334G	5.753756G	500k	1
16.29M	5.73681G	5.7531G	17.181M	5.736424G	5.753606G	500k	2
16.29M	5.73681G	5.7531G	17.151M	5.736424G	5.753576G	500k	3
16.32M	5.73678G	5.7531G	16.972M	5.736454G	5.753426G	500k	4

802.11a_Nss1,(6Mbps)_4TX

EBW

5785MHz

30/12/2020

CF
5.785GHz
Span
60MHz
RBW
100kHz
VBW
300kHz
Sweep Time
100ms
Detector Type
Peak

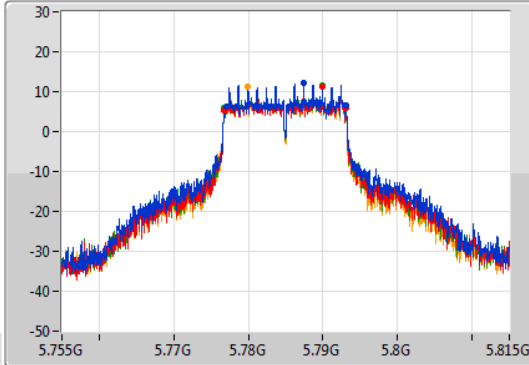

CF
5.785GHz
Span
60MHz
RBW
300kHz
VBW
1MHz
Sweep Time
100ms
Detector Type
Sample

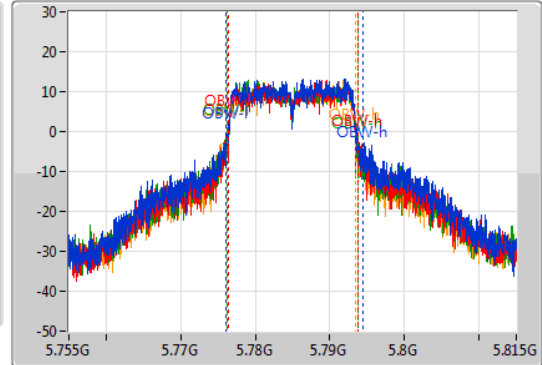

Port 1
Port 2
Port 3
Port 4

6dB(Hz)	Fl-6dB(Hz)	Fh-6dB(Hz)	OBW(Hz)	Fl-OBW(Hz)	Fh-OBW(Hz)	Limit(Hz)	Port
16.11M	5.77699G	5.7931G	18.351M	5.776124G	5.794475G	500k	1
16.32M	5.77678G	5.7931G	17.481M	5.776334G	5.793816G	500k	2
16.32M	5.77678G	5.7931G	17.481M	5.776244G	5.793726G	500k	3
16.32M	5.77678G	5.7931G	17.121M	5.776274G	5.793396G	500k	4

802.11a_Nss1,(6Mbps)_4TX

EBW

5825MHz

30/12/2020

CF
5.825GHz
Span
60MHz
RBW
100kHz
VBW
300kHz
Sweep Time
100ms
Detector Type
Peak

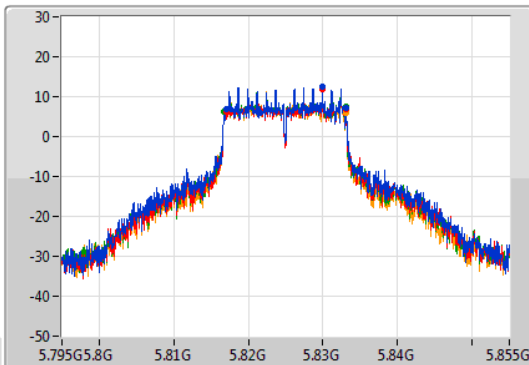

CF
5.825GHz
Span
60MHz
RBW
300kHz
VBW
1MHz
Sweep Time
100ms
Detector Type
Sample

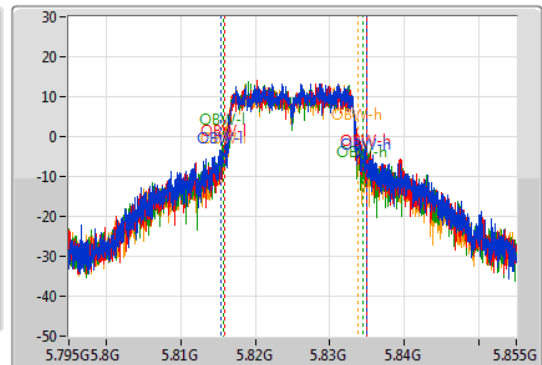

Port 1
Port 2
Port 3
Port 4

6dB(Hz)	Fl-6dB(Hz)	Fh-6dB(Hz)	OBW(Hz)	Fl-OBW(Hz)	Fh-OBW(Hz)	Limit(Hz)	Port
16.02M	5.81705G	5.83307G	19.46M	5.815435G	5.834895G	500k	1
16.02M	5.81705G	5.83307G	19.1M	5.815855G	5.834955G	500k	2
16.29M	5.81678G	5.83307G	18.651M	5.815735G	5.834385G	500k	3
16.32M	5.81678G	5.8331G	17.781M	5.815975G	5.833756G	500k	4

802.11n HT20_Nss1,(MCS0)_4TX

EBW

5180MHz

30/12/2020

CF
5.18GHz
Span
60MHz
RBW
300kHz
VBW
1MHz
Sweep Time
100ms
Detector Type
Peak

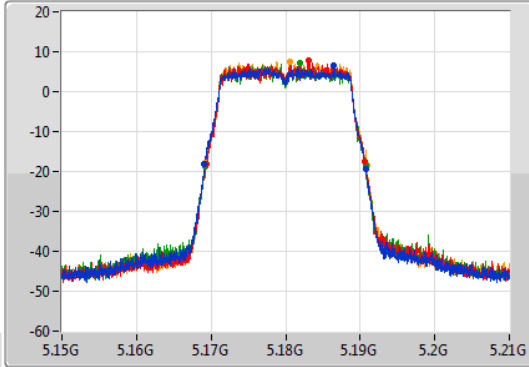

CF
5.18GHz
Span
60MHz
RBW
300kHz
VBW
1MHz
Sweep Time
100ms
Detector Type
Sample

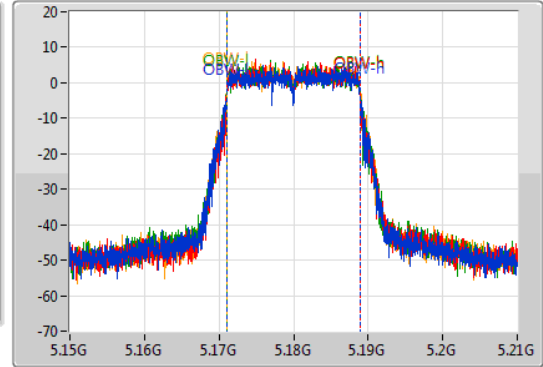

Port 1
Port 2
Port 3
Port 4

26dB(Hz)	Fl-26dB(Hz)	Fh-26dB(Hz)	OBW(Hz)	Fl-OBW(Hz)	Fh-OBW(Hz)	Limit(Hz)	Port
21.69M	5.16908G	5.19077G	17.841M	5.171034G	5.188876G	Inf	1
21.27M	5.16935G	5.19062G	17.781M	5.171094G	5.188876G	Inf	2
21.6M	5.1692G	5.1908G	17.841M	5.171034G	5.188876G	Inf	3
21.78M	5.16914G	5.19092G	17.811M	5.171094G	5.188906G	Inf	4

802.11n HT20_Nss1,(MCS0)_4TX

EBW

5200MHz

30/12/2020

CF
5.2GHz
Span
60MHz
RBW
300kHz
VBW
1MHz
Sweep Time
100ms
Detector Type
Peak

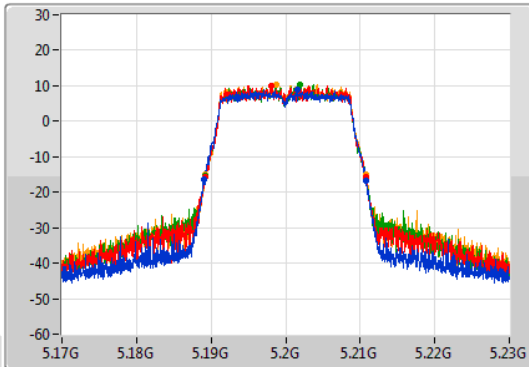

CF
5.2GHz
Span
60MHz
RBW
300kHz
VBW
1MHz
Sweep Time
100ms
Detector Type
Sample

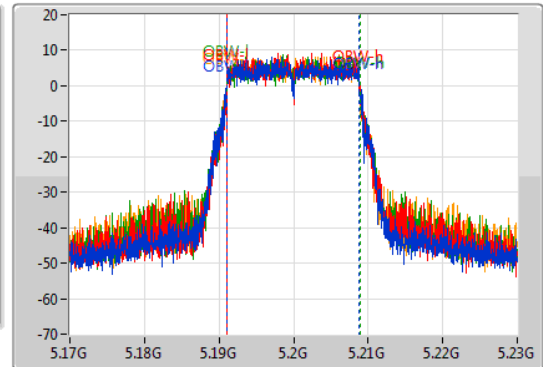

Port 1
Port 2
Port 3
Port 4

26dB(Hz)	Fl-26dB(Hz)	Fh-26dB(Hz)	OBW(Hz)	Fl-OBW(Hz)	Fh-OBW(Hz)	Limit(Hz)	Port
21.75M	5.18902G	5.21077G	17.841M	5.191004G	5.208846G	Inf	1
21.54M	5.18917G	5.21071G	17.781M	5.191034G	5.208816G	Inf	2
21.63M	5.18923G	5.21086G	17.811M	5.191064G	5.208876G	Inf	3
21.54M	5.1892G	5.21074G	17.811M	5.191034G	5.208846G	Inf	4

802.11n HT20_Nss1,(MCS0)_4TX

EBW

5240MHz

30/12/2020

CF
5.24GHz
Span
60MHz
RBW
300kHz
VBW
1MHz
Sweep Time
100ms
Detector Type
Peak

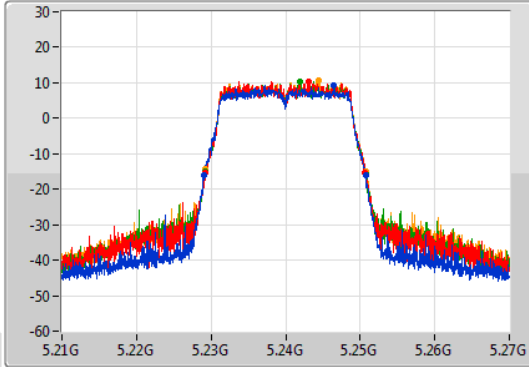

CF
5.24GHz
Span
60MHz
RBW
300kHz
VBW
1MHz
Sweep Time
100ms
Detector Type
Sample

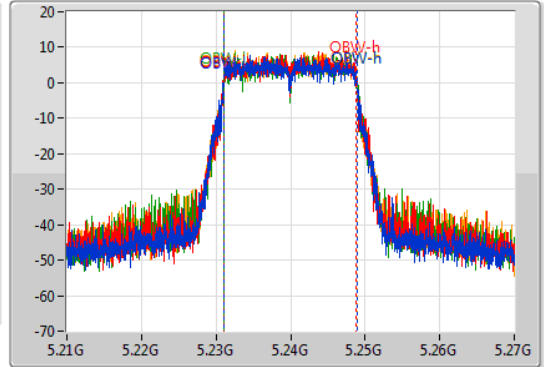

Port 1
Port 2
Port 3
Port 4

26dB(Hz)	Fl-26dB(Hz)	Fh-26dB(Hz)	OBW(Hz)	Fl-OBW(Hz)	Fh-OBW(Hz)	Limit(Hz)	Port
21.6M	5.22911G	5.25071G	17.871M	5.231004G	5.248876G	Inf	1
21.51M	5.22917G	5.25068G	17.811M	5.231034G	5.248846G	Inf	2
21.45M	5.22926G	5.25071G	17.841M	5.231034G	5.248876G	Inf	3
21.6M	5.22914G	5.25074G	17.841M	5.231034G	5.248876G	Inf	4

802.11n HT20_Nss1,(MCS0)_4TX

EBW

5745MHz

30/12/2020

CF
5.745GHz
Span
60MHz
RBW
100kHz
VBW
300kHz
Sweep Time
100ms
Detector Type
Peak

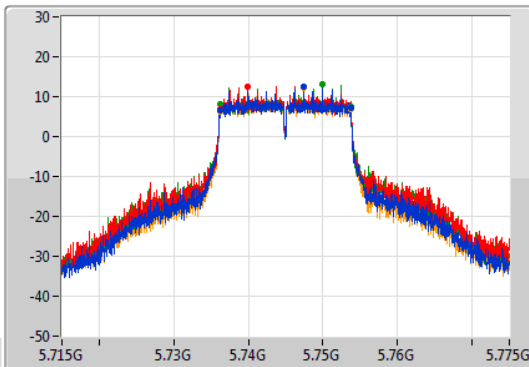

CF
5.745GHz
Span
60MHz
RBW
300kHz
VBW
1MHz
Sweep Time
100ms
Detector Type
Sample

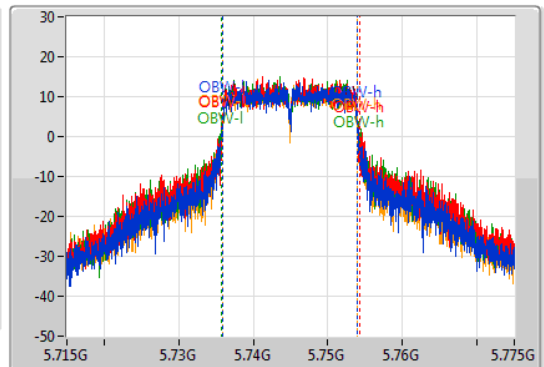

Port 1
Port 2
Port 3
Port 4

6dB(Hz)	Fl-6dB(Hz)	Fh-6dB(Hz)	OBW(Hz)	Fl-OBW(Hz)	Fh-OBW(Hz)	Limit(Hz)	Port
17.58M	5.73615G	5.75373G	18.081M	5.735855G	5.753936G	500k	1
17.61M	5.73615G	5.75376G	18.441M	5.735825G	5.754265G	500k	2
17.55M	5.73618G	5.75373G	18.441M	5.735765G	5.754205G	500k	3
17.58M	5.73615G	5.75373G	18.051M	5.735915G	5.753966G	500k	4

802.11n HT20_Nss1,(MCS0)_4TX

EBW

5785MHz

30/12/2020

CF
5.785GHz
Span
60MHz
RBW
100kHz
VBW
300kHz
Sweep Time
100ms
Detector Type
Peak

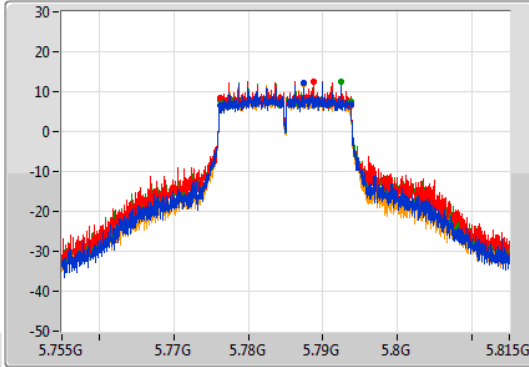

CF
5.785GHz
Span
60MHz
RBW
300kHz
VBW
1MHz
Sweep Time
100ms
Detector Type
Sample

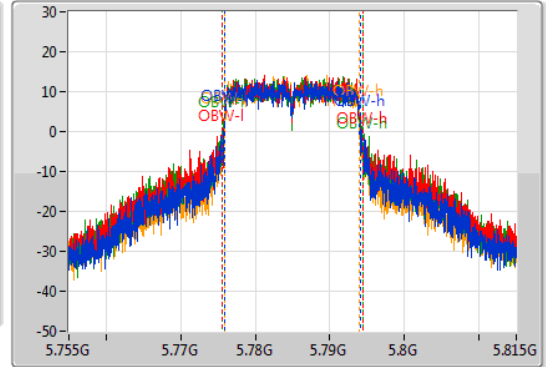

Port 1
Port 2
Port 3
Port 4

6dB(Hz)	Fl-6dB(Hz)	Fh-6dB(Hz)	OBW(Hz)	Fl-OBW(Hz)	Fh-OBW(Hz)	Limit(Hz)	Port
17.58M	5.77615G	5.79373G	18.141M	5.775915G	5.794055G	500k	1
17.61M	5.77615G	5.79376G	18.951M	5.775555G	5.794505G	500k	2
17.58M	5.77615G	5.79373G	18.801M	5.775615G	5.794415G	500k	3
17.58M	5.77615G	5.79373G	17.991M	5.775915G	5.793906G	500k	4

802.11n HT20_Nss1,(MCS0)_4TX

EBW

5825MHz

30/12/2020

CF
5.825GHz
Span
60MHz
RBW
100kHz
VBW
300kHz
Sweep Time
100ms
Detector Type
Peak

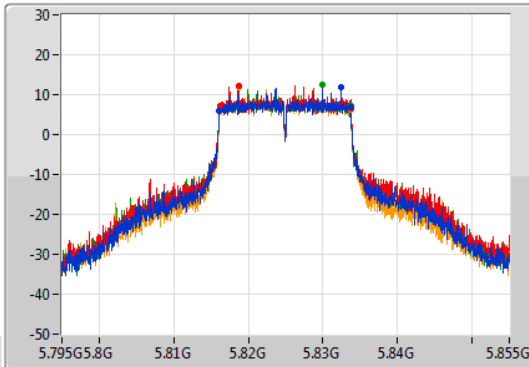

CF
5.825GHz
Span
60MHz
RBW
300kHz
VBW
1MHz
Sweep Time
100ms
Detector Type
Sample

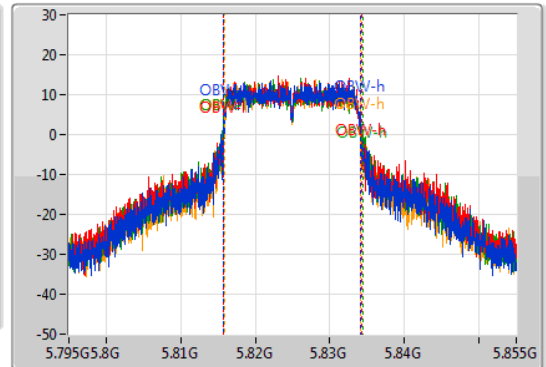

Port 1
Port 2
Port 3
Port 4

6dB(Hz)	Fl-6dB(Hz)	Fh-6dB(Hz)	OBW(Hz)	Fl-OBW(Hz)	Fh-OBW(Hz)	Limit(Hz)	Port
17.61M	5.81612G	5.83373G	18.261M	5.815795G	5.834055G	500k	1
17.58M	5.81615G	5.83373G	18.651M	5.815705G	5.834355G	500k	2
17.58M	5.81615G	5.83373G	18.681M	5.815705G	5.834385G	500k	3
17.61M	5.81612G	5.83373G	18.201M	5.815825G	5.834025G	500k	4

802.11n HT40_Nss1,(MCS0)_4TX

EBW

5190MHz

30/12/2020

CF: 5.19GHz
 Span: 120MHz
 RBW: 500kHz
 VBW: 2MHz
 Sweep Time: 100ms
 Detector Type: Peak

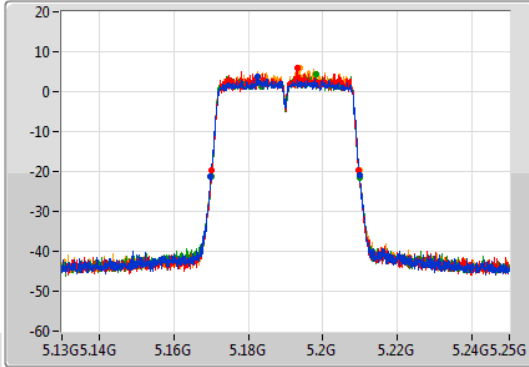

CF: 5.19GHz
 Span: 120MHz
 RBW: 1MHz
 VBW: 3MHz
 Sweep Time: 100ms
 Detector Type: Sample

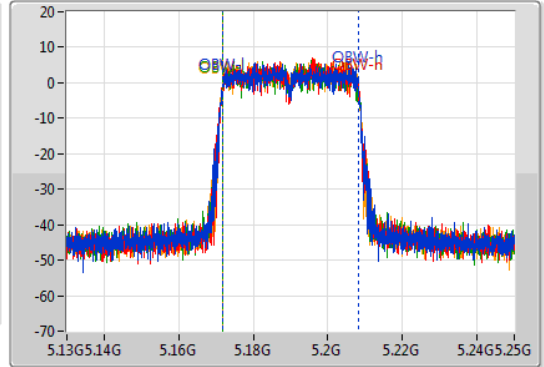

Port 1: [Waveform icon]
 Port 2: [Waveform icon]
 Port 3: [Waveform icon]
 Port 4: [Waveform icon]

26dB(Hz)	Fl-26dB(Hz)	Fh-26dB(Hz)	OBW(Hz)	Fl-OBW(Hz)	Fh-OBW(Hz)	Limit(Hz)	Port
40.08M	5.1699G	5.20998G	36.402M	5.171709G	5.208111G	Inf	1
39.48M	5.1702G	5.20968G	36.462M	5.171709G	5.208171G	Inf	2
39.72M	5.17014G	5.20986G	36.462M	5.171709G	5.208171G	Inf	3
39.54M	5.1702G	5.20974G	36.462M	5.171709G	5.208171G	Inf	4

802.11n HT40_Nss1,(MCS0)_4TX

EBW

5230MHz

30/12/2020

CF: 5.23GHz
 Span: 120MHz
 RBW: 500kHz
 VBW: 2MHz
 Sweep Time: 100ms
 Detector Type: Peak

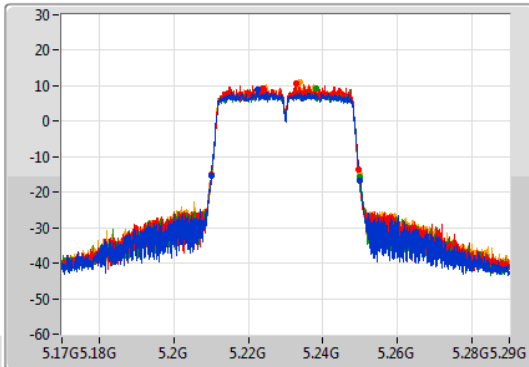

CF: 5.23GHz
 Span: 120MHz
 RBW: 1MHz
 VBW: 3MHz
 Sweep Time: 100ms
 Detector Type: Sample

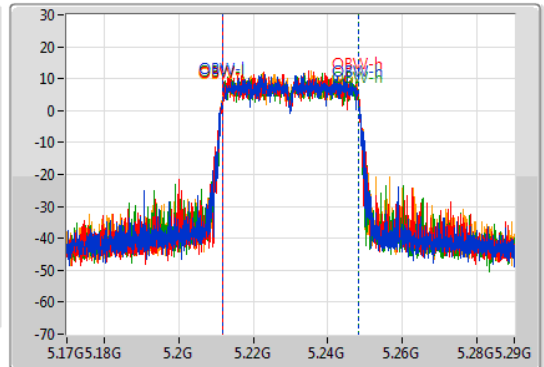

Port 1: [Waveform icon]
 Port 2: [Waveform icon]
 Port 3: [Waveform icon]
 Port 4: [Waveform icon]

26dB(Hz)	Fl-26dB(Hz)	Fh-26dB(Hz)	OBW(Hz)	Fl-OBW(Hz)	Fh-OBW(Hz)	Limit(Hz)	Port
40.08M	5.20996G	5.25004G	36.462M	5.211709G	5.248171G	Inf	1
39.54M	5.21014G	5.24968G	36.462M	5.211709G	5.248171G	Inf	2
39.78M	5.21008G	5.24986G	36.462M	5.211709G	5.248171G	Inf	3
39.66M	5.21014G	5.2498G	36.402M	5.211709G	5.248111G	Inf	4

802.11n HT40_Nss1,(MCS0)_4TX

EBW

5755MHz

30/12/2020

CF
5.755GHz
Span
120MHz
RBW
100kHz
VBW
300kHz
Sweep Time
100ms
Detector Type
Peak

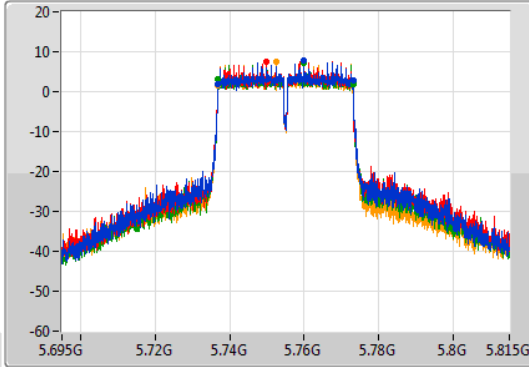

CF
5.755GHz
Span
120MHz
RBW
1MHz
VBW
3MHz
Sweep Time
100ms
Detector Type
Sample

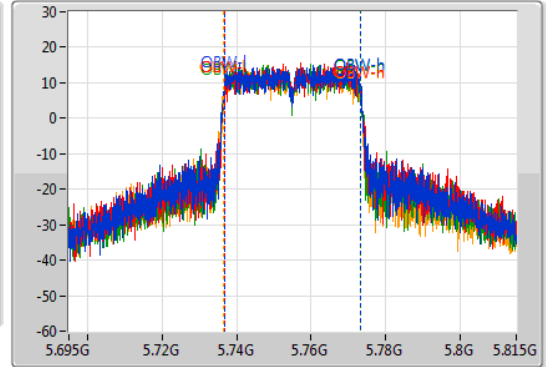

6dB(Hz)	Fl-6dB(Hz)	Fh-6dB(Hz)	OBW(Hz)	Fl-OBW(Hz)	Fh-OBW(Hz)	Limit(Hz)	Port
36.3M	5.73682G	5.77312G	36.582M	5.736649G	5.773231G	500k	1
36.36M	5.73676G	5.77312G	36.582M	5.736649G	5.773231G	500k	2
36.3M	5.73682G	5.77312G	36.402M	5.736709G	5.773111G	500k	3
36.36M	5.73676G	5.77312G	36.462M	5.736589G	5.773051G	500k	4

802.11n HT40_Nss1,(MCS0)_4TX

EBW

5795MHz

30/12/2020

CF
5.795GHz
Span
120MHz
RBW
100kHz
VBW
300kHz
Sweep Time
100ms
Detector Type
Peak

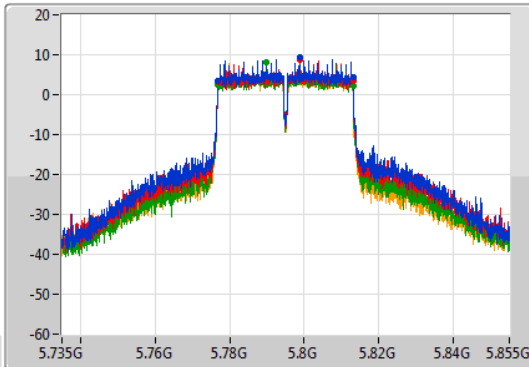

CF
5.795GHz
Span
120MHz
RBW
1MHz
VBW
3MHz
Sweep Time
100ms
Detector Type
Sample

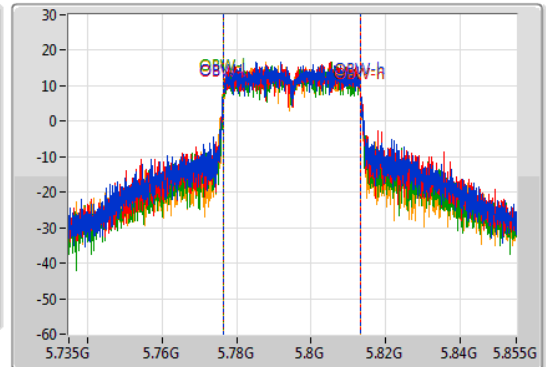

6dB(Hz)	Fl-6dB(Hz)	Fh-6dB(Hz)	OBW(Hz)	Fl-OBW(Hz)	Fh-OBW(Hz)	Limit(Hz)	Port
36.3M	5.77682G	5.81312G	36.822M	5.776529G	5.813351G	500k	1
36.06M	5.77706G	5.81312G	36.762M	5.776589G	5.813351G	500k	2
36.36M	5.77676G	5.81312G	36.762M	5.776529G	5.813291G	500k	3
36.36M	5.77676G	5.81312G	36.582M	5.776589G	5.813171G	500k	4

802.11ac VHT20_Nss1,(MCS0)_4TX

EBW

5180MHz

30/12/2020

CF
5.18GHz
Span
60MHz
RBW
300kHz
VBW
1MHz
Sweep Time
100ms
Detector Type
Peak

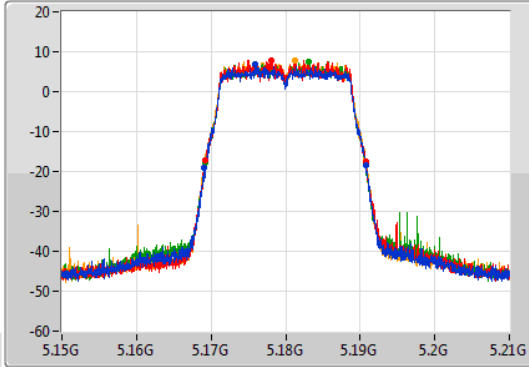

CF
5.18GHz
Span
60MHz
RBW
300kHz
VBW
1MHz
Sweep Time
100ms
Detector Type
Sample

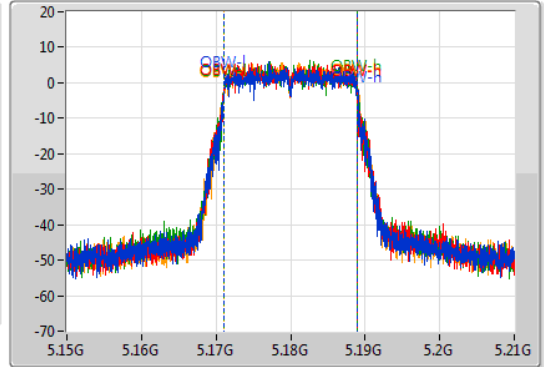

Port 1
Port 2
Port 3
Port 4

26dB(Hz)	Fl-26dB(Hz)	Fh-26dB(Hz)	OBW(Hz)	Fl-OBW(Hz)	Fh-OBW(Hz)	Limit(Hz)	Port
21.66M	5.16911G	5.19077G	17.811M	5.171094G	5.188906G	Inf	1
21.57M	5.16923G	5.1908G	17.871M	5.171034G	5.188906G	Inf	2
21.45M	5.16926G	5.19071G	17.871M	5.171004G	5.188876G	Inf	3
21.66M	5.1692G	5.19086G	17.901M	5.171034G	5.188936G	Inf	4

802.11ac VHT20_Nss1,(MCS0)_4TX

EBW

5200MHz

30/12/2020

CF
5.2GHz
Span
60MHz
RBW
300kHz
VBW
1MHz
Sweep Time
100ms
Detector Type
Peak

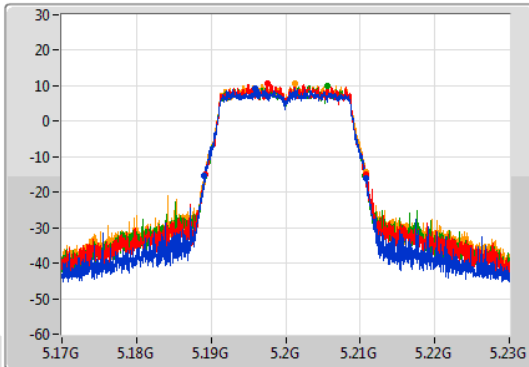

CF
5.2GHz
Span
60MHz
RBW
300kHz
VBW
1MHz
Sweep Time
100ms
Detector Type
Sample

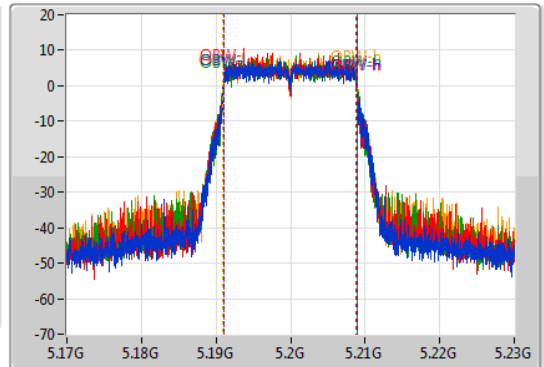

Port 1
Port 2
Port 3
Port 4

26dB(Hz)	Fl-26dB(Hz)	Fh-26dB(Hz)	OBW(Hz)	Fl-OBW(Hz)	Fh-OBW(Hz)	Limit(Hz)	Port
21.75M	5.18908G	5.21083G	17.841M	5.191034G	5.208876G	Inf	1
21.6M	5.18923G	5.21083G	17.781M	5.191064G	5.208846G	Inf	2
21.45M	5.1892G	5.21065G	17.841M	5.191034G	5.208876G	Inf	3
21.66M	5.18911G	5.21077G	17.931M	5.190945G	5.208876G	Inf	4

802.11ac VHT20_Nss1,(MCS0)_4TX

EBW

5240MHz

30/12/2020

CF
5.24GHz
Span
60MHz
RBW
300kHz
VBW
1MHz
Sweep Time
100ms
Detector Type
Peak

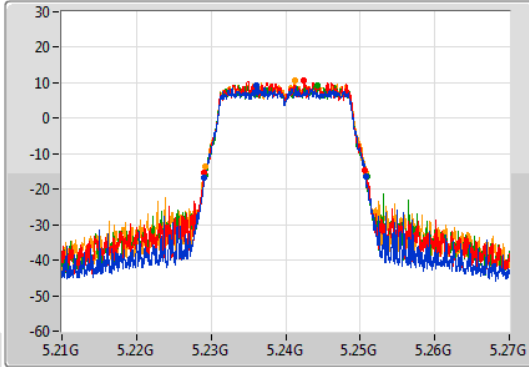

CF
5.24GHz
Span
60MHz
RBW
300kHz
VBW
1MHz
Sweep Time
100ms
Detector Type
Sample

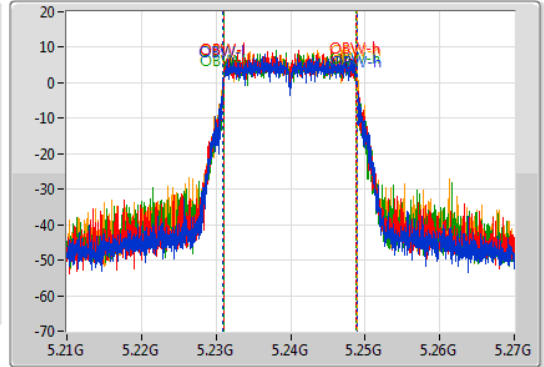

Port 1
Port 2
Port 3
Port 4

26dB(Hz)	Fl-26dB(Hz)	Fh-26dB(Hz)	OBW(Hz)	Fl-OBW(Hz)	Fh-OBW(Hz)	Limit(Hz)	Port
21.69M	5.22908G	5.25077G	17.931M	5.230975G	5.248906G	Inf	1
21.54M	5.22908G	5.25062G	17.781M	5.231064G	5.248846G	Inf	2
21.75M	5.22914G	5.25089G	17.811M	5.231034G	5.248846G	Inf	3
21.54M	5.22929G	5.25083G	17.931M	5.231004G	5.248936G	Inf	4

802.11ac VHT20_Nss1,(MCS0)_4TX

EBW

5745MHz

30/12/2020

CF
5.745GHz
Span
60MHz
RBW
100kHz
VBW
300kHz
Sweep Time
100ms
Detector Type
Peak

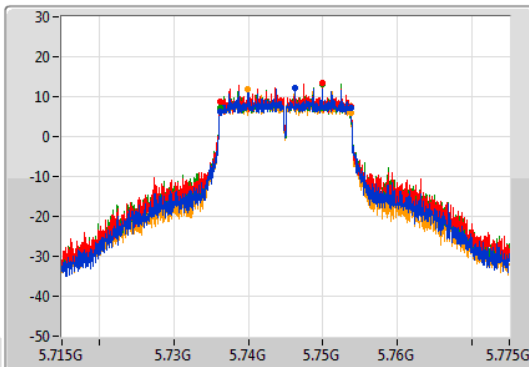

CF
5.745GHz
Span
60MHz
RBW
300kHz
VBW
1MHz
Sweep Time
100ms
Detector Type
Sample

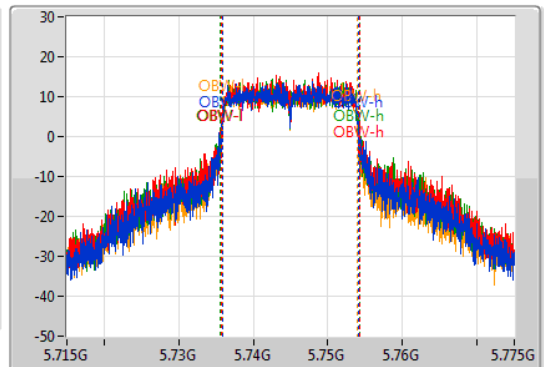

Port 1
Port 2
Port 3
Port 4

6dB(Hz)	Fl-6dB(Hz)	Fh-6dB(Hz)	OBW(Hz)	Fl-OBW(Hz)	Fh-OBW(Hz)	Limit(Hz)	Port
17.58M	5.73615G	5.75373G	18.201M	5.735885G	5.754085G	500k	1
17.55M	5.73618G	5.75373G	18.621M	5.735705G	5.754325G	500k	2
17.55M	5.73618G	5.75373G	18.771M	5.735585G	5.754355G	500k	3
17.58M	5.73615G	5.75373G	18.021M	5.735915G	5.753936G	500k	4

802.11ac VHT20_Nss1,(MCS0)_4TX

EBW

5785MHz

30/12/2020

CF
5.785GHz
Span
60MHz
RBW
100kHz
VBW
300kHz
Sweep Time
100ms
Detector Type
Peak

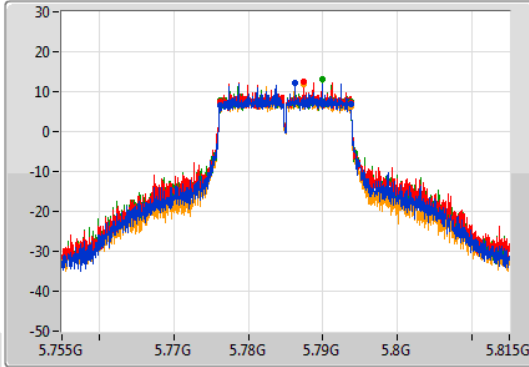

CF
5.785GHz
Span
60MHz
RBW
300kHz
VBW
1MHz
Sweep Time
100ms
Detector Type
Sample

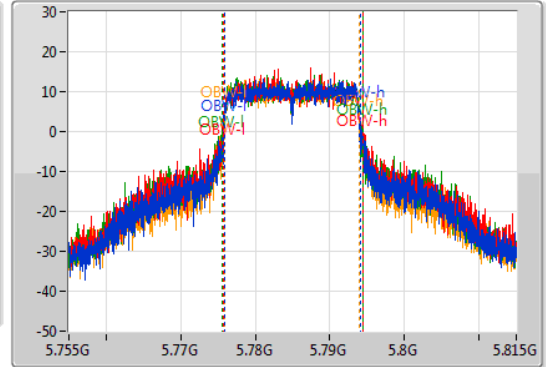

Port 1
Port 2
Port 3
Port 4

6dB(Hz)	Fl-6dB(Hz)	Fh-6dB(Hz)	OBW(Hz)	Fl-OBW(Hz)	Fh-OBW(Hz)	Limit(Hz)	Port
17.58M	5.77615G	5.79373G	18.321M	5.775825G	5.794145G	500k	1
17.58M	5.77615G	5.79373G	18.711M	5.775675G	5.794385G	500k	2
17.58M	5.77615G	5.79373G	18.801M	5.775585G	5.794385G	500k	3
17.58M	5.77615G	5.79373G	18.171M	5.775825G	5.793996G	500k	4

802.11ac VHT20_Nss1,(MCS0)_4TX

EBW

5825MHz

30/12/2020

CF
5.825GHz
Span
60MHz
RBW
100kHz
VBW
300kHz
Sweep Time
100ms
Detector Type
Peak

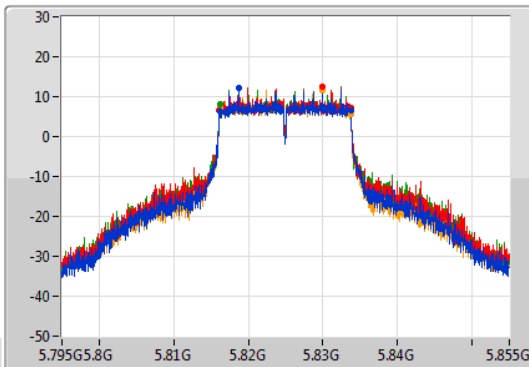

CF
5.825GHz
Span
60MHz
RBW
300kHz
VBW
1MHz
Sweep Time
100ms
Detector Type
Sample

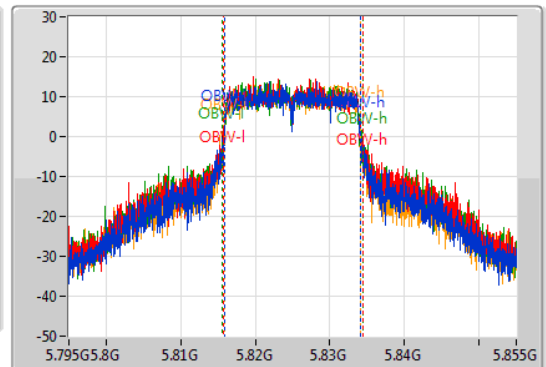

Port 1
Port 2
Port 3
Port 4

6dB(Hz)	Fl-6dB(Hz)	Fh-6dB(Hz)	OBW(Hz)	Fl-OBW(Hz)	Fh-OBW(Hz)	Limit(Hz)	Port
17.55M	5.81615G	5.8337G	18.141M	5.815885G	5.834025G	500k	1
17.58M	5.81612G	5.8337G	18.681M	5.815735G	5.834415G	500k	2
17.55M	5.81618G	5.83373G	18.861M	5.815615G	5.834475G	500k	3
17.58M	5.81615G	5.83373G	18.201M	5.815825G	5.834025G	500k	4

802.11ac VHT40_Nss1,(MCS0)_4TX

EBW

5190MHz

30/12/2020

CF
5.19GHz
Span
120MHz
RBW
500kHz
VBW
2MHz
Sweep Time
100ms
Detector Type
Peak

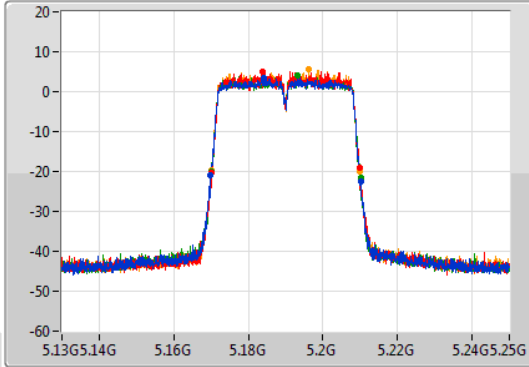

CF
5.19GHz
Span
120MHz
RBW
1MHz
VBW
3MHz
Sweep Time
100ms
Detector Type
Sample

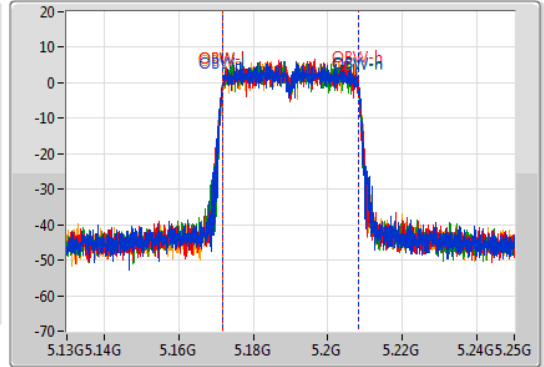

Port 1
Port 2
Port 3
Port 4

26dB(Hz)	Fl-26dB(Hz)	Fh-26dB(Hz)	OBW(Hz)	Fl-OBW(Hz)	Fh-OBW(Hz)	Limit(Hz)	Port
40.2M	5.1699G	5.2101G	36.582M	5.171709G	5.208291G	Inf	1
39.72M	5.17014G	5.20986G	36.522M	5.171649G	5.208171G	Inf	2
40.02M	5.17008G	5.2101G	36.462M	5.171709G	5.208171G	Inf	3
39.84M	5.17008G	5.20992G	36.342M	5.171769G	5.208111G	Inf	4

802.11ac VHT40_Nss1,(MCS0)_4TX

EBW

5230MHz

30/12/2020

CF
5.23GHz
Span
120MHz
RBW
500kHz
VBW
2MHz
Sweep Time
100ms
Detector Type
Peak

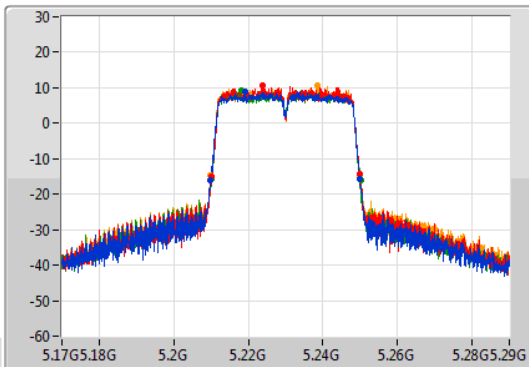

CF
5.23GHz
Span
120MHz
RBW
1MHz
VBW
3MHz
Sweep Time
100ms
Detector Type
Sample

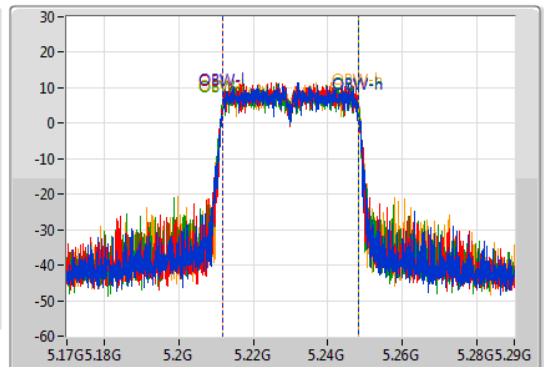

Port 1
Port 2
Port 3
Port 4

26dB(Hz)	Fl-26dB(Hz)	Fh-26dB(Hz)	OBW(Hz)	Fl-OBW(Hz)	Fh-OBW(Hz)	Limit(Hz)	Port
40.14M	5.20984G	5.24998G	36.522M	5.211709G	5.248231G	Inf	1
39.72M	5.2102G	5.24992G	36.402M	5.211709G	5.248111G	Inf	2
40.08M	5.21002G	5.2501G	36.462M	5.211709G	5.248171G	Inf	3
40.02M	5.2099G	5.24992G	36.582M	5.211649G	5.248231G	Inf	4

802.11ac VHT40_Nss1,(MCS0)_4TX

EBW

5755MHz

30/12/2020

CF
5.755GHz
Span
120MHz
RBW
100kHz
VBW
300kHz
Sweep Time
100ms
Detector Type
Peak

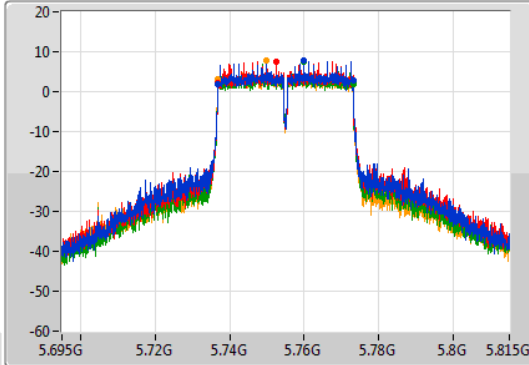

CF
5.755GHz
Span
120MHz
RBW
1MHz
VBW
3MHz
Sweep Time
100ms
Detector Type
Sample

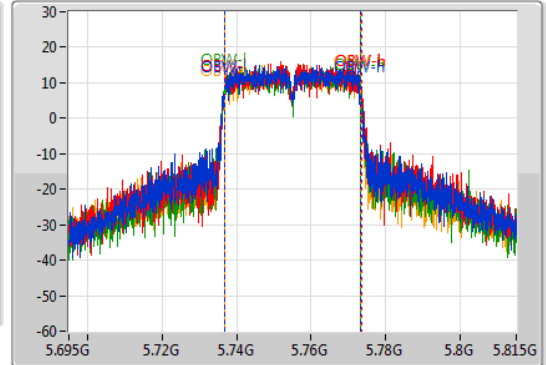

Port 1
Port 2
Port 3
Port 4

6dB(Hz)	Fl-6dB(Hz)	Fh-6dB(Hz)	OBW(Hz)	Fl-OBW(Hz)	Fh-OBW(Hz)	Limit(Hz)	Port
36.36M	5.73676G	5.77312G	36.642M	5.736649G	5.773291G	500k	1
36.36M	5.73676G	5.77312G	36.762M	5.736709G	5.773471G	500k	2
36.36M	5.73676G	5.77312G	36.582M	5.736649G	5.773231G	500k	3
36.36M	5.73676G	5.77312G	36.582M	5.736649G	5.773231G	500k	4

802.11ac VHT40_Nss1,(MCS0)_4TX

EBW

5795MHz

30/12/2020

CF
5.795GHz
Span
120MHz
RBW
100kHz
VBW
300kHz
Sweep Time
100ms
Detector Type
Peak

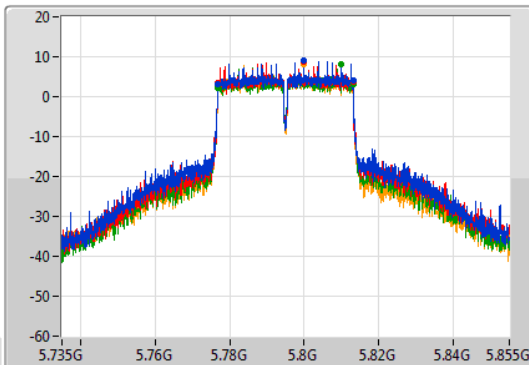

CF
5.795GHz
Span
120MHz
RBW
1MHz
VBW
3MHz
Sweep Time
100ms
Detector Type
Sample

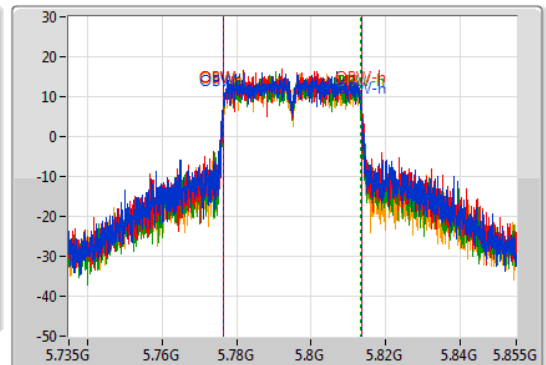

Port 1
Port 2
Port 3
Port 4

6dB(Hz)	Fl-6dB(Hz)	Fh-6dB(Hz)	OBW(Hz)	Fl-OBW(Hz)	Fh-OBW(Hz)	Limit(Hz)	Port
36.3M	5.77682G	5.81312G	36.942M	5.776469G	5.813411G	500k	1
36.36M	5.77676G	5.81312G	36.882M	5.776589G	5.813471G	500k	2
36.36M	5.77676G	5.81312G	36.762M	5.776529G	5.813291G	500k	3
36.36M	5.77676G	5.81312G	36.642M	5.776589G	5.813231G	500k	4

802.11ac VHT80_Nss1,(MCS0)_4TX

EBW

5210MHz

30/12/2020

CF
5.21GHz
Span
240MHz
RBW
1MHz
VBW
3MHz
Sweep Time
100ms
Detector Type
Peak

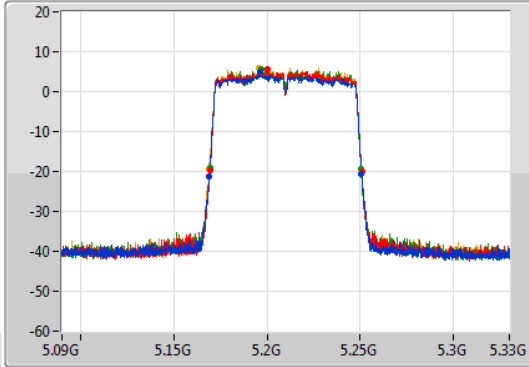

CF
5.21GHz
Span
240MHz
RBW
2MHz
VBW
10MHz
Sweep Time
100ms
Detector Type
Sample

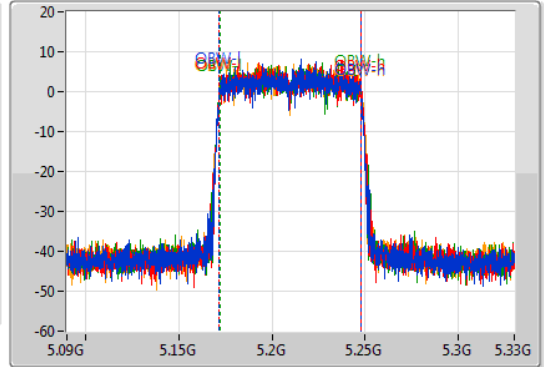

Port 1
Port 2
Port 3
Port 4

26dB(Hz)	Fl-26dB(Hz)	Fh-26dB(Hz)	OBW(Hz)	Fl-OBW(Hz)	Fh-OBW(Hz)	Limit(Hz)	Port
81.48M	5.1692G	5.25068G	76.042M	5.171739G	5.247781G	Inf	1
81.36M	5.16944G	5.2508G	76.042M	5.171859G	5.247901G	Inf	2
81.24M	5.16944G	5.25068G	75.922M	5.171979G	5.247901G	Inf	3
81.84M	5.16896G	5.2508G	76.042M	5.171859G	5.247901G	Inf	4

802.11ac VHT80_Nss1,(MCS0)_4TX

EBW

5775MHz

30/12/2020

CF
5.775GHz
Span
240MHz
RBW
100kHz
VBW
300kHz
Sweep Time
100ms
Detector Type
Peak

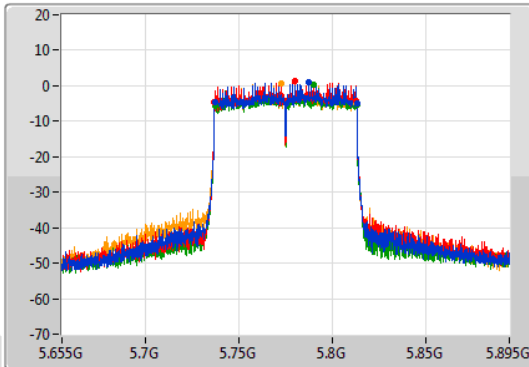

CF
5.775GHz
Span
240MHz
RBW
2MHz
VBW
10MHz
Sweep Time
100ms
Detector Type
Sample

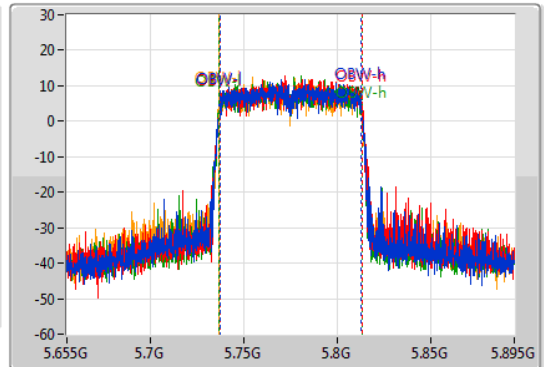

Port 1
Port 2
Port 3
Port 4

6dB(Hz)	Fl-6dB(Hz)	Fh-6dB(Hz)	OBW(Hz)	Fl-OBW(Hz)	Fh-OBW(Hz)	Limit(Hz)	Port
75.6M	5.73756G	5.81316G	75.922M	5.736979G	5.812901G	500k	1
76.2M	5.73684G	5.81304G	76.162M	5.736979G	5.813141G	500k	2
76.08M	5.73708G	5.81316G	76.402M	5.736739G	5.813141G	500k	3
75.96M	5.73708G	5.81304G	76.162M	5.736739G	5.812901G	500k	4

802.11ax HEW20_Nss1,(MCS0)_4TX

EBW

5180MHz

30/12/2020

CF: 5.18GHz
 Span: 60MHz
 RBW: 300kHz
 VBW: 1MHz
 Sweep Time: 100ms
 Detector Type: Peak

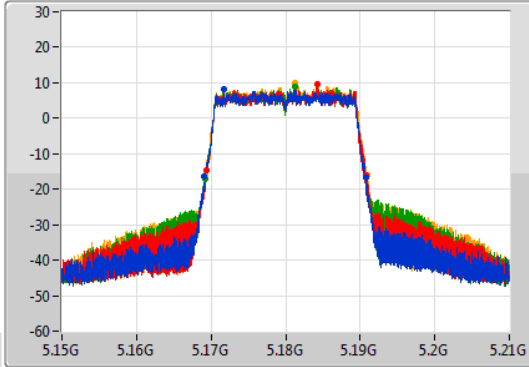

CF: 5.18GHz
 Span: 60MHz
 RBW: 300kHz
 VBW: 1MHz
 Sweep Time: 100ms
 Detector Type: Sample

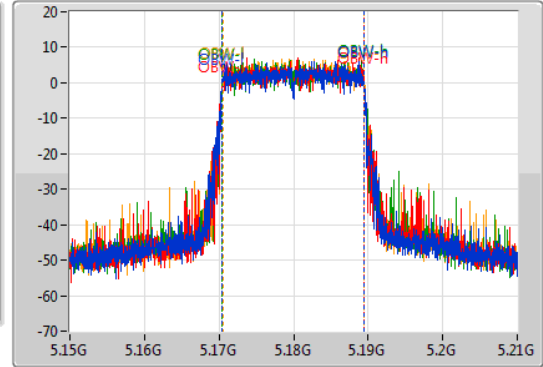

Port 1
 Port 2
 Port 3
 Port 4

26dB(Hz)	Fl-26dB(Hz)	Fh-26dB(Hz)	OBW(Hz)	Fl-OBW(Hz)	Fh-OBW(Hz)	Limit(Hz)	Port
21.78M	5.16905G	5.19083G	19.01M	5.170435G	5.189445G	Inf	1
21.48M	5.16935G	5.19083G	19.01M	5.170435G	5.189445G	Inf	2
21.66M	5.16917G	5.19083G	18.951M	5.170465G	5.189415G	Inf	3
21.69M	5.1692G	5.19089G	18.951M	5.170495G	5.189445G	Inf	4

802.11ax HEW20_Nss1,(MCS0)_4TX

EBW

5200MHz

30/12/2020

CF: 5.2GHz
 Span: 60MHz
 RBW: 300kHz
 VBW: 1MHz
 Sweep Time: 100ms
 Detector Type: Peak

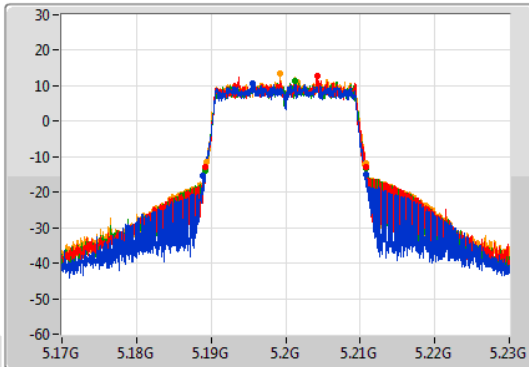

CF: 5.2GHz
 Span: 60MHz
 RBW: 300kHz
 VBW: 1MHz
 Sweep Time: 100ms
 Detector Type: Sample

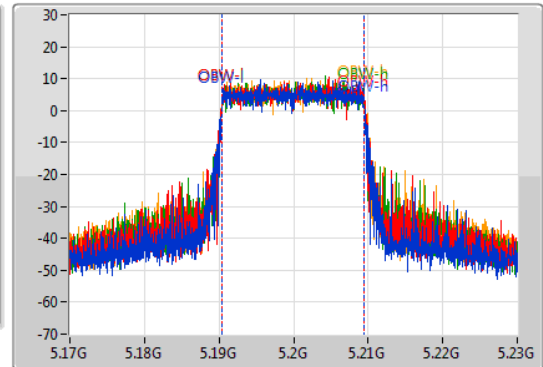

Port 1
 Port 2
 Port 3
 Port 4

26dB(Hz)	Fl-26dB(Hz)	Fh-26dB(Hz)	OBW(Hz)	Fl-OBW(Hz)	Fh-OBW(Hz)	Limit(Hz)	Port
21.9M	5.1889G	5.2108G	19.01M	5.190435G	5.209445G	Inf	1
21.57M	5.18926G	5.21083G	19.04M	5.190435G	5.209475G	Inf	2
21.6M	5.18914G	5.21074G	18.981M	5.190435G	5.209415G	Inf	3
21.48M	5.18932G	5.2108G	18.951M	5.190465G	5.209415G	Inf	4

802.11ax HEW20_Nss1,(MCS0)_4TX

EBW

5240MHz

30/12/2020

CF
5.24GHz
Span
60MHz
RBW
300kHz
VBW
1MHz
Sweep Time
100ms
Detector Type
Peak

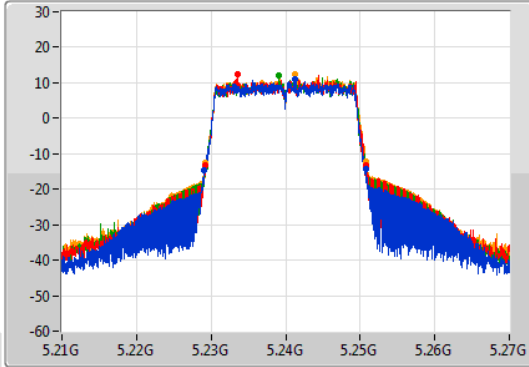

CF
5.24GHz
Span
60MHz
RBW
300kHz
VBW
1MHz
Sweep Time
100ms
Detector Type
Sample

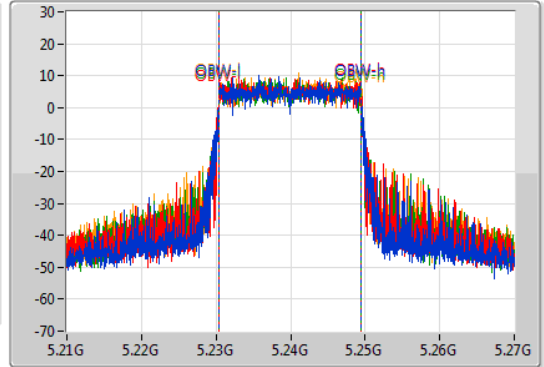

Port 1
Port 2
Port 3
Port 4

26dB(Hz)	Fl-26dB(Hz)	Fh-26dB(Hz)	OBW(Hz)	Fl-OBW(Hz)	Fh-OBW(Hz)	Limit(Hz)	Port
21.66M	5.22911G	5.25077G	18.981M	5.230435G	5.249415G	Inf	1
21.6M	5.22926G	5.25086G	19.01M	5.230435G	5.249445G	Inf	2
21.57M	5.22917G	5.25074G	18.951M	5.230435G	5.249385G	Inf	3
21.57M	5.22923G	5.2508G	19.01M	5.230435G	5.249445G	Inf	4

802.11ax HEW20_Nss1,(MCS0)_4TX

EBW

5745MHz

30/12/2020

CF
5.745GHz
Span
60MHz
RBW
100kHz
VBW
300kHz
Sweep Time
100ms
Detector Type
Peak

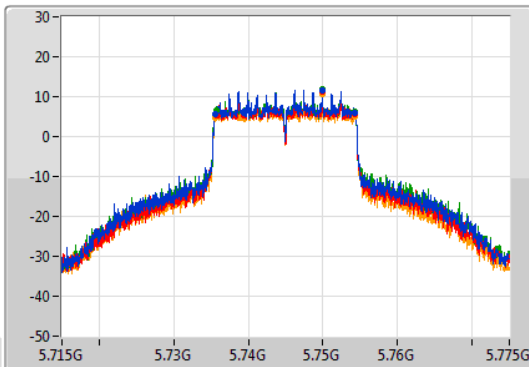

CF
5.745GHz
Span
60MHz
RBW
300kHz
VBW
1MHz
Sweep Time
100ms
Detector Type
Sample

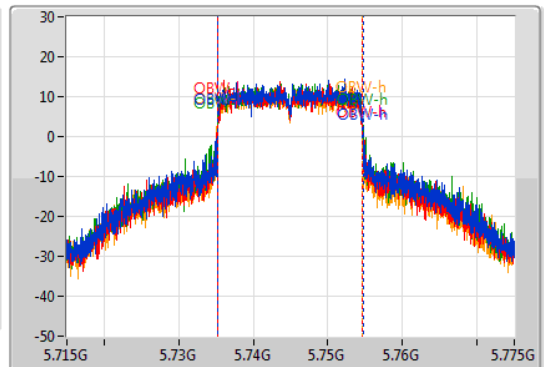

Port 1
Port 2
Port 3
Port 4

6dB(Hz)	Fl-6dB(Hz)	Fh-6dB(Hz)	OBW(Hz)	Fl-OBW(Hz)	Fh-OBW(Hz)	Limit(Hz)	Port
18.84M	5.73549G	5.75433G	19.49M	5.735255G	5.754745G	500k	1
18.63M	5.7357G	5.75433G	19.4M	5.735225G	5.754625G	500k	2
18.63M	5.73567G	5.7543G	19.55M	5.735225G	5.754775G	500k	3
18.72M	5.73558G	5.7543G	19.4M	5.735225G	5.754625G	500k	4

802.11ax HEW20_Nss1,(MCS0)_4TX

EBW

5785MHz

30/12/2020

CF
5.785GHz
Span
60MHz
RBW
100kHz
VBW
300kHz
Sweep Time
100ms
Detector Type
Peak

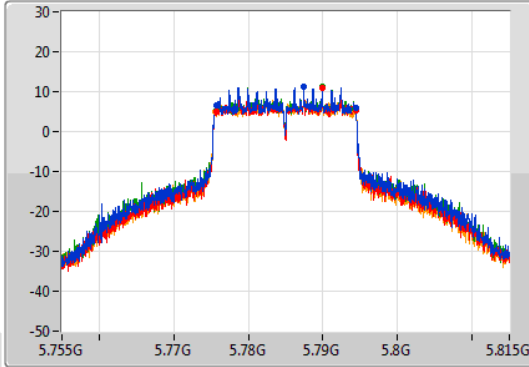

CF
5.785GHz
Span
60MHz
RBW
300kHz
VBW
1MHz
Sweep Time
100ms
Detector Type
Sample

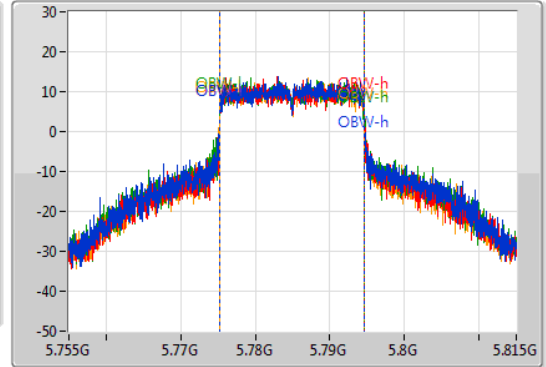

Port 1
Port 2
Port 3
Port 4

6dB(Hz)	FI-6dB(Hz)	Fh-6dB(Hz)	OBW(Hz)	FI-OBW(Hz)	Fh-OBW(Hz)	Limit(Hz)	Port
18.72M	5.77567G	5.79439G	19.46M	5.775225G	5.794685G	500k	1
18.66M	5.7757G	5.79436G	19.31M	5.775285G	5.794595G	500k	2
18.6M	5.77573G	5.79433G	19.43M	5.775225G	5.794655G	500k	3
18.75M	5.77558G	5.79433G	19.37M	5.775285G	5.794655G	500k	4

802.11ax HEW20_Nss1,(MCS0)_4TX

EBW

5825MHz

30/12/2020

CF
5.825GHz
Span
60MHz
RBW
100kHz
VBW
300kHz
Sweep Time
100ms
Detector Type
Peak

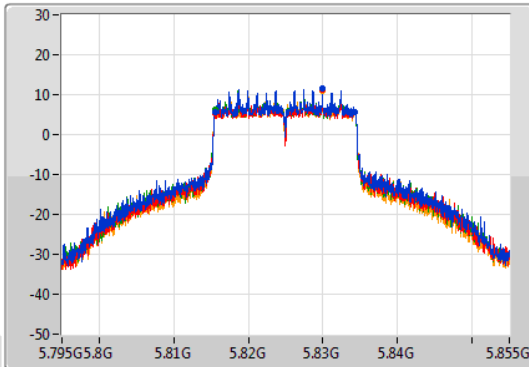

CF
5.825GHz
Span
60MHz
RBW
300kHz
VBW
1MHz
Sweep Time
100ms
Detector Type
Sample

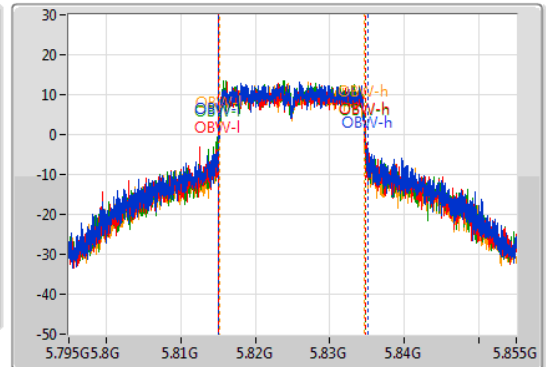

Port 1
Port 2
Port 3
Port 4

6dB(Hz)	FI-6dB(Hz)	Fh-6dB(Hz)	OBW(Hz)	FI-OBW(Hz)	Fh-OBW(Hz)	Limit(Hz)	Port
18.78M	5.81555G	5.83433G	20.06M	5.814985G	5.835045G	500k	1
18.81M	5.81552G	5.83433G	19.7M	5.815105G	5.834805G	500k	2
18.81M	5.81549G	5.8343G	19.67M	5.815045G	5.834715G	500k	3
18.66M	5.81564G	5.8343G	19.43M	5.815225G	5.834655G	500k	4

802.11ax HEW40_Nss1,(MCS0)_4TX

EBW

5190MHz

30/12/2020

CF
5.19GHz
Span
120MHz
RBW
500kHz
VBW
2MHz
Sweep Time
100ms
Detector Type
Peak

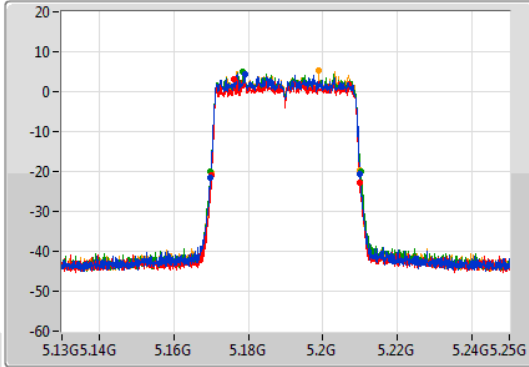

CF
5.19GHz
Span
120MHz
RBW
1MHz
VBW
3MHz
Sweep Time
100ms
Detector Type
Sample

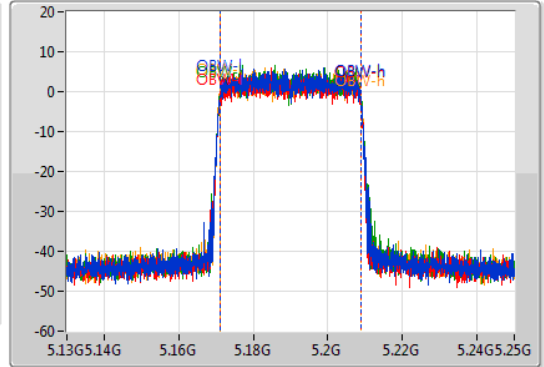

Port 1
Port 2
Port 3
Port 4

26dB(Hz)	Fl-26dB(Hz)	Fh-26dB(Hz)	OBW(Hz)	Fl-OBW(Hz)	Fh-OBW(Hz)	Limit(Hz)	Port
40.14M	5.16978G	5.20992G	37.721M	5.171049G	5.208771G	Inf	1
39.84M	5.17008G	5.20992G	37.781M	5.171049G	5.208831G	Inf	2
40.2M	5.1699G	5.2101G	37.781M	5.171049G	5.208831G	Inf	3
39.84M	5.17002G	5.20986G	37.781M	5.171049G	5.208831G	Inf	4

802.11ax HEW40_Nss1,(MCS0)_4TX

EBW

5230MHz

30/12/2020

CF
5.23GHz
Span
120MHz
RBW
500kHz
VBW
2MHz
Sweep Time
100ms
Detector Type
Peak

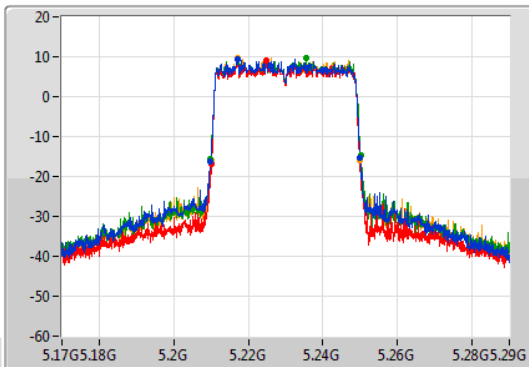

CF
5.23GHz
Span
120MHz
RBW
1MHz
VBW
3MHz
Sweep Time
100ms
Detector Type
Sample

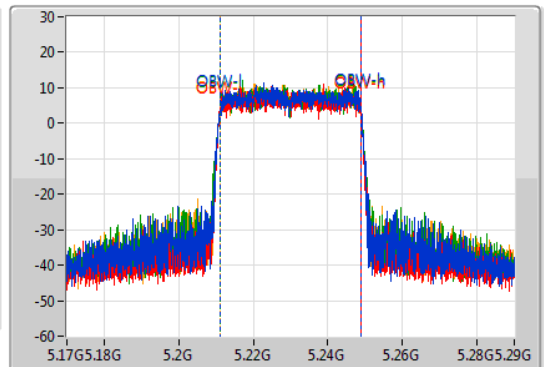

Port 1
Port 2
Port 3
Port 4

26dB(Hz)	Fl-26dB(Hz)	Fh-26dB(Hz)	OBW(Hz)	Fl-OBW(Hz)	Fh-OBW(Hz)	Limit(Hz)	Port
40.14M	5.2099G	5.25004G	37.721M	5.211049G	5.248771G	Inf	1
39.78M	5.21008G	5.24986G	37.721M	5.211049G	5.248771G	Inf	2
40.26M	5.2099G	5.25016G	37.781M	5.211049G	5.248831G	Inf	3
40.02M	5.20996G	5.24998G	37.661M	5.21109G	5.248771G	Inf	4

802.11ax HEW40_Nss1,(MCS0)_4TX

EBW

5755MHz

30/12/2020

CF
5.755GHz
Span
120MHz
RBW
100kHz
VBW
300kHz
Sweep Time
100ms
Detector Type
Peak

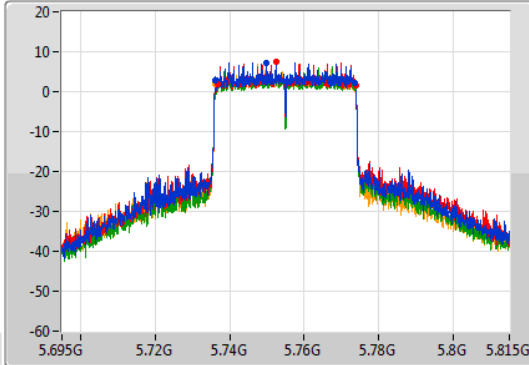

CF
5.755GHz
Span
120MHz
RBW
1MHz
VBW
3MHz
Sweep Time
100ms
Detector Type
Sample

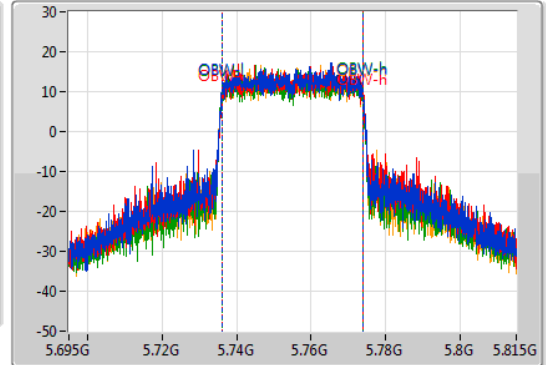

Port 1
Port 2
Port 3
Port 4

6dB(Hz)	Fl-6dB(Hz)	Fh-6dB(Hz)	OBW(Hz)	Fl-OBW(Hz)	Fh-OBW(Hz)	Limit(Hz)	Port
37.56M	5.7361G	5.77366G	37.901M	5.73599G	5.773891G	500k	1
37.08M	5.73664G	5.77372G	37.901M	5.736049G	5.773951G	500k	2
37.32M	5.7361G	5.77348G	37.841M	5.73599G	5.773831G	500k	3
37.56M	5.7361G	5.77366G	37.841M	5.73599G	5.773831G	500k	4

802.11ax HEW40_Nss1,(MCS0)_4TX

EBW

5795MHz

30/12/2020

CF
5.795GHz
Span
120MHz
RBW
100kHz
VBW
300kHz
Sweep Time
100ms
Detector Type
Peak

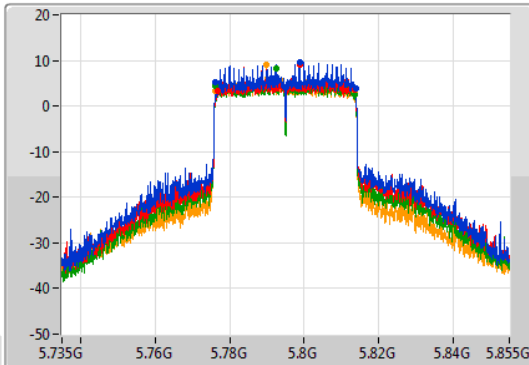

CF
5.795GHz
Span
120MHz
RBW
1MHz
VBW
3MHz
Sweep Time
100ms
Detector Type
Sample

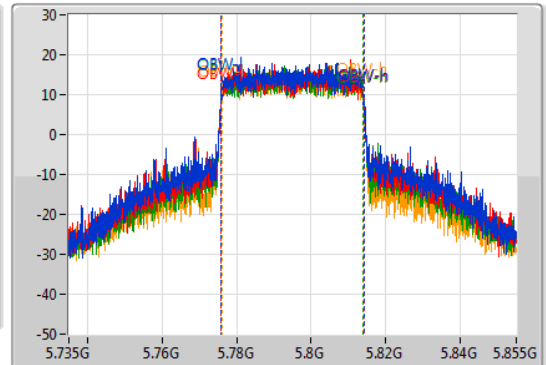

Port 1
Port 2
Port 3
Port 4

6dB(Hz)	Fl-6dB(Hz)	Fh-6dB(Hz)	OBW(Hz)	Fl-OBW(Hz)	Fh-OBW(Hz)	Limit(Hz)	Port
37.56M	5.77616G	5.81372G	38.261M	5.77587G	5.81413G	500k	1
36.78M	5.7767G	5.81348G	38.261M	5.77587G	5.81413G	500k	2
37.5M	5.77616G	5.81366G	38.141M	5.77587G	5.81401G	500k	3
37.32M	5.77616G	5.81348G	37.841M	5.77599G	5.813831G	500k	4

802.11ax HEW80_Nss1,(MCS0)_4TX

EBW

5210MHz

30/12/2020

CF
5.21GHz
Span
240MHz
RBW
1MHz
VBW
3MHz
Sweep Time
100ms
Detector Type
Peak

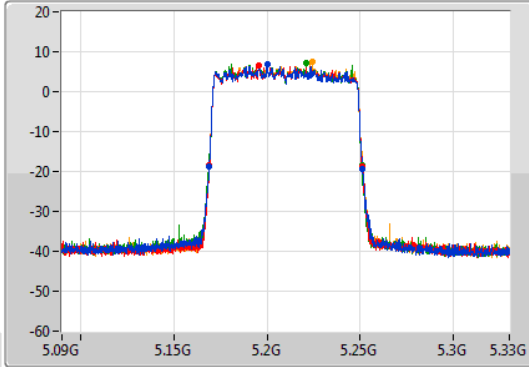

CF
5.21GHz
Span
240MHz
RBW
2MHz
VBW
10MHz
Sweep Time
100ms
Detector Type
Sample

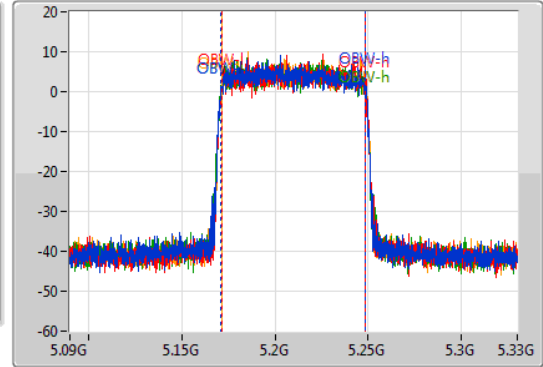

Port 1
Port 2
Port 3
Port 4

26dB(Hz)	Fl-26dB(Hz)	Fh-26dB(Hz)	OBW(Hz)	Fl-OBW(Hz)	Fh-OBW(Hz)	Limit(Hz)	Port
82.2M	5.16908G	5.25128G	77.481M	5.171139G	5.248621G	Inf	1
82.2M	5.16908G	5.25128G	77.361M	5.171259G	5.248621G	Inf	2
82.08M	5.16884G	5.25092G	77.361M	5.171139G	5.248501G	Inf	3
82.2M	5.16908G	5.25128G	77.241M	5.171259G	5.248501G	Inf	4

802.11ax HEW80_Nss1,(MCS0)_4TX

EBW

5775MHz

30/12/2020

CF
5.775GHz
Span
240MHz
RBW
100kHz
VBW
300kHz
Sweep Time
100ms
Detector Type
Peak

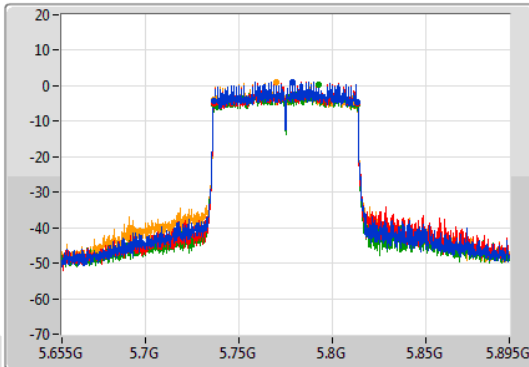

CF
5.775GHz
Span
240MHz
RBW
2MHz
VBW
10MHz
Sweep Time
100ms
Detector Type
Sample

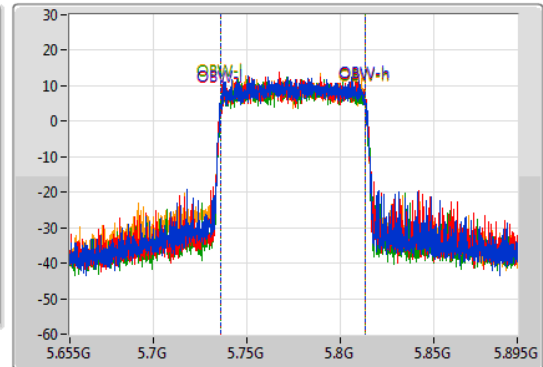

Port 1
Port 2
Port 3
Port 4

6dB(Hz)	Fl-6dB(Hz)	Fh-6dB(Hz)	OBW(Hz)	Fl-OBW(Hz)	Fh-OBW(Hz)	Limit(Hz)	Port
77.28M	5.73648G	5.81376G	77.481M	5.736139G	5.813621G	500k	1
76.44M	5.73684G	5.81328G	77.601M	5.736139G	5.813741G	500k	2
76.92M	5.73684G	5.81376G	77.601M	5.736139G	5.813741G	500k	3
76.56M	5.73624G	5.8128G	77.721M	5.736019G	5.813741G	500k	4



Summary

Mode	Max-N dB (Hz)	Max-OBW (Hz)	ITU-Code	Min-N dB (Hz)	Min-OBW (Hz)
5.15-5.25GHz	-	-	-	-	-
802.11a_Nss1,(6Mbps)_2TX	22.14M	16.834M	16M8D1D	21.36M	16.755M
802.11n HT20_Nss1,(MCS0)_2TX	21.9M	17.945M	17M9D1D	21.57M	17.864M
802.11n HT40_Nss1,(MCS0)_2TX	40.2M	36.483M	36M5D1D	39.48M	36.391M
802.11ac VHT20_Nss1,(MCS0)_2TX	21.93M	17.948M	17M9D1D	21.57M	17.896M
802.11ac VHT40_Nss1,(MCS0)_2TX	40.26M	36.593M	36M6D1D	39.78M	36.466M
802.11ac VHT80_Nss1,(MCS0)_2TX	81.48M	76.168M	76M2D1D	81.24M	76.061M
802.11ax HEW20_Nss1,(MCS0)_2TX	22.95M	19.058M	19M1D1D	21.42M	18.974M
802.11ax HEW40_Nss1,(MCS0)_2TX	40.26M	37.862M	37M9D1D	39.78M	37.667M
802.11ax HEW80_Nss1,(MCS0)_2TX	81.84M	77.566M	77M6D1D	81.36M	77.404M
5.725-5.85GHz	-	-	-	-	-
802.11a_Nss1,(6Mbps)_2TX	16.5M	21.997M	22M0D1D	16.29M	16.876M
802.11n HT20_Nss1,(MCS0)_2TX	17.55M	22.976M	23M0D1D	17.55M	18.121M
802.11n HT40_Nss1,(MCS0)_2TX	36.36M	49.448M	49M4D1D	36.3M	36.655M
802.11ac VHT20_Nss1,(MCS0)_2TX	17.58M	23.615M	23M6D1D	17.55M	17.965M
802.11ac VHT40_Nss1,(MCS0)_2TX	36.36M	51.36M	51M4D1D	36M	36.77M
802.11ac VHT80_Nss1,(MCS0)_2TX	75.84M	76.116M	76M1D1D	75.24M	76.072M
802.11ax HEW20_Nss1,(MCS0)_2TX	18.96M	24.01M	24M0D1D	18.78M	19.144M
802.11ax HEW40_Nss1,(MCS0)_2TX	37.56M	51.527M	51M5D1D	37.2M	37.95M
802.11ax HEW80_Nss1,(MCS0)_2TX	76.56M	77.593M	77M6D1D	75.72M	77.44M

Max-N dB = Maximum 6dB down bandwidth for 5.725-5.85GHz band / Maximum 26dB down bandwidth for other band;
 Max-OBW = Maximum 99% occupied bandwidth;
 Min-N dB = Minimum 6dB down bandwidth for 5.725-5.85GHz band / Maximum 26dB down bandwidth for other band;
 Min-OBW = Minimum 99% occupied bandwidth



Result

Mode	Result	Limit (Hz)	Port 1-N dB (Hz)	Port 1-OBW (Hz)	Port 2-N dB (Hz)	Port 2-OBW (Hz)
802.11a_Nss1,(6Mbps)_2TX	-	-	-	-	-	-
5180MHz	Pass	Inf	21.51M	16.766M	21.57M	16.755M
5200MHz	Pass	Inf	21.36M	16.806M	22.14M	16.791M
5240MHz	Pass	Inf	21.48M	16.78M	22.05M	16.834M
5745MHz	Pass	500k	16.32M	16.886M	16.32M	17.152M
5785MHz	Pass	500k	16.5M	17.776M	16.32M	21.997M
5825MHz	Pass	500k	16.29M	16.876M	16.35M	17.465M
802.11n HT20_Nss1,(MCS0)_2TX	-	-	-	-	-	-
5180MHz	Pass	Inf	21.66M	17.912M	21.63M	17.872M
5200MHz	Pass	Inf	21.9M	17.908M	21.84M	17.865M
5240MHz	Pass	Inf	21.75M	17.945M	21.57M	17.864M
5745MHz	Pass	500k	17.55M	18.122M	17.55M	18.334M
5785MHz	Pass	500k	17.55M	18.835M	17.55M	22.976M
5825MHz	Pass	500k	17.55M	18.121M	17.55M	18.19M
802.11n HT40_Nss1,(MCS0)_2TX	-	-	-	-	-	-
5190MHz	Pass	Inf	40.08M	36.469M	39.48M	36.391M
5230MHz	Pass	Inf	40.2M	36.469M	39.54M	36.483M
5755MHz	Pass	500k	36.36M	36.655M	36.3M	36.978M
5795MHz	Pass	500k	36.3M	37.921M	36.36M	49.448M
802.11ac VHT20_Nss1,(MCS0)_2TX	-	-	-	-	-	-
5180MHz	Pass	Inf	21.78M	17.931M	21.57M	17.896M
5200MHz	Pass	Inf	21.72M	17.926M	21.93M	17.906M
5240MHz	Pass	Inf	21.72M	17.948M	21.9M	17.909M
5745MHz	Pass	500k	17.55M	18.031M	17.58M	18.403M
5785MHz	Pass	500k	17.55M	18.882M	17.55M	23.615M
5825MHz	Pass	500k	17.55M	17.965M	17.55M	18.291M
802.11ac VHT40_Nss1,(MCS0)_2TX	-	-	-	-	-	-
5190MHz	Pass	Inf	40.2M	36.512M	39.78M	36.49M
5230MHz	Pass	Inf	40.26M	36.593M	39.78M	36.466M
5755MHz	Pass	500k	36.36M	36.77M	36.3M	37.1M
5795MHz	Pass	500k	36M	38.869M	36.36M	51.36M
802.11ac VHT80_Nss1,(MCS0)_2TX	-	-	-	-	-	-
5210MHz	Pass	Inf	81.48M	76.168M	81.24M	76.061M
5775MHz	Pass	500k	75.24M	76.116M	75.84M	76.072M
802.11ax HEW20_Nss1,(MCS0)_2TX	-	-	-	-	-	-
5180MHz	Pass	Inf	21.57M	19.058M	21.69M	19.003M
5200MHz	Pass	Inf	22.62M	19.015M	21.42M	19.056M
5240MHz	Pass	Inf	22.95M	19.05M	21.84M	18.974M
5745MHz	Pass	500k	18.96M	19.145M	18.87M	19.325M
5785MHz	Pass	500k	18.84M	19.586M	18.78M	24.01M
5825MHz	Pass	500k	18.84M	19.144M	18.78M	19.245M
802.11ax HEW40_Nss1,(MCS0)_2TX	-	-	-	-	-	-
5190MHz	Pass	Inf	40.26M	37.667M	39.84M	37.689M
5230MHz	Pass	Inf	40.02M	37.862M	39.78M	37.826M
5755MHz	Pass	500k	37.5M	37.95M	37.2M	38.374M
5795MHz	Pass	500k	37.2M	39.305M	37.56M	51.527M
802.11ax HEW80_Nss1,(MCS0)_2TX	-	-	-	-	-	-
5210MHz	Pass	Inf	81.84M	77.566M	81.36M	77.404M
5775MHz	Pass	500k	76.56M	77.44M	75.72M	77.593M

Port X-N dB = Port X 6dB down bandwidth for 5.725-5.85GHz band / 26dB down bandwidth for other band
 Port X-OBW = Port X 99% occupied bandwidth

802.11a_Nss1,(6Mbps)_2TX

EBW

5180MHz

04/01/2021

CF: 5.18GHz
 Span: 60MHz
 RBW: 300kHz
 VBW: 1MHz
 Sweep Time: 100ms
 Detector Type: Peak

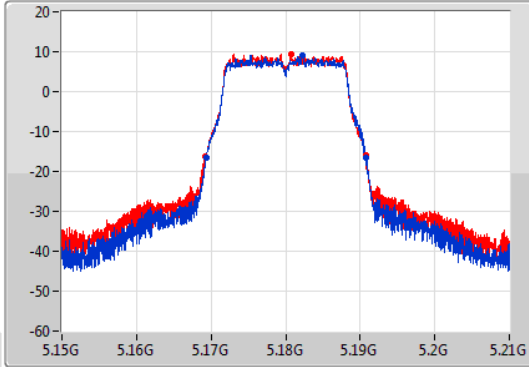

CF: 5.18GHz
 Span: 60MHz
 RBW: 300kHz
 VBW: 1MHz
 Sweep Time: 100ms
 Detector Type: Sample

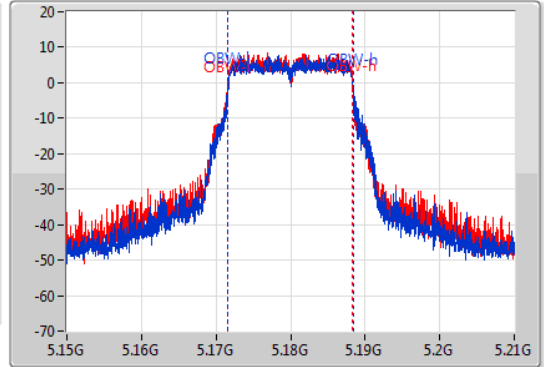

26dB(Hz)	Fl-26dB(Hz)	Fh-26dB(Hz)	OBW(Hz)	Fl-OBW(Hz)	Fh-OBW(Hz)	Limit(Hz)	Port
21.51M	5.16935G	5.19086G	16.766M	5.171619G	5.188385G	Inf	1
21.57M	5.16926G	5.19083G	16.755M	5.17156G	5.188315G	Inf	2

802.11a_Nss1,(6Mbps)_2TX

EBW

5200MHz

04/01/2021

CF: 5.2GHz
 Span: 60MHz
 RBW: 300kHz
 VBW: 1MHz
 Sweep Time: 100ms
 Detector Type: Peak

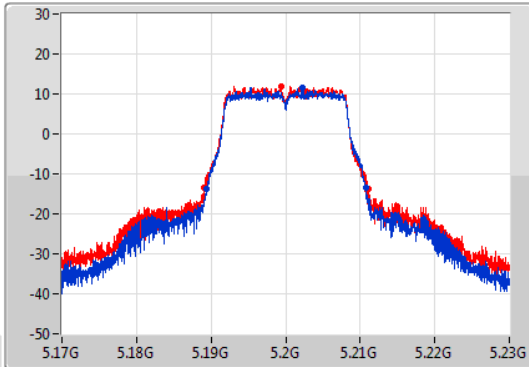

CF: 5.2GHz
 Span: 60MHz
 RBW: 300kHz
 VBW: 1MHz
 Sweep Time: 100ms
 Detector Type: Sample

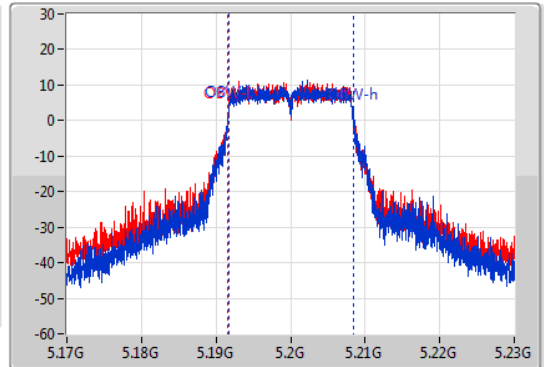

26dB(Hz)	Fl-26dB(Hz)	Fh-26dB(Hz)	OBW(Hz)	Fl-OBW(Hz)	Fh-OBW(Hz)	Limit(Hz)	Port
21.36M	5.18935G	5.21071G	16.806M	5.191648G	5.208455G	Inf	1
22.14M	5.18899G	5.21113G	16.791M	5.191591G	5.208382G	Inf	2

802.11a_Nss1,(6Mbps)_2TX

EBW

5240MHz

04/01/2021

CF
5.24GHz
Span
60MHz
RBW
300kHz
VBW
1MHz
Sweep Time
100ms
Detector Type
Peak

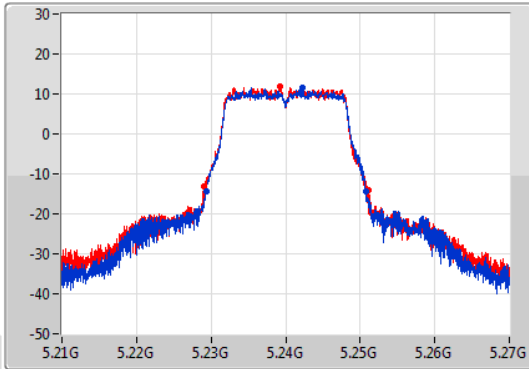

CF
5.24GHz
Span
60MHz
RBW
300kHz
VBW
1MHz
Sweep Time
100ms
Detector Type
Sample

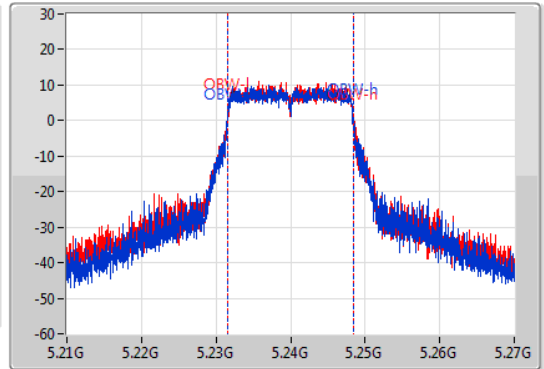

6dB(Hz)	Fl-26dB(Hz)	Fh-26dB(Hz)	OBW(Hz)	Fl-OBW(Hz)	Fh-OBW(Hz)	Limit(Hz)	Port
21.48M	5.22932G	5.2508G	16.78M	5.231587G	5.248366G	Inf	1
22.05M	5.22905G	5.2511G	16.834M	5.231536G	5.24837G	Inf	2

802.11a_Nss1,(6Mbps)_2TX

EBW

5745MHz

04/01/2021

CF
5.745GHz
Span
60MHz
RBW
100kHz
VBW
300kHz
Sweep Time
100ms
Detector Type
Peak

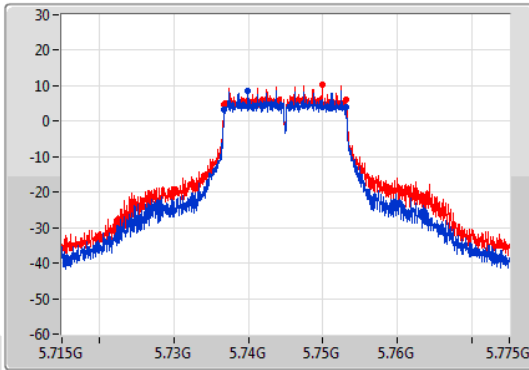

CF
5.745GHz
Span
60MHz
RBW
300kHz
VBW
1MHz
Sweep Time
100ms
Detector Type
Sample

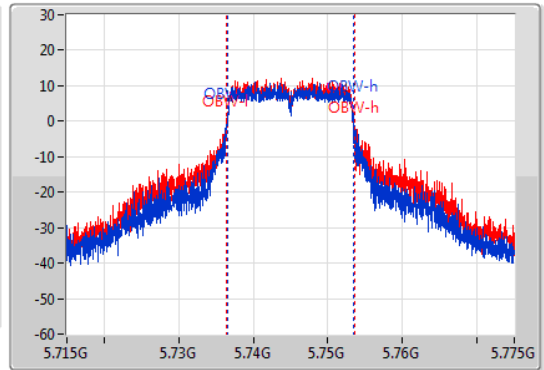

6dB(Hz)	Fl-6dB(Hz)	Fh-6dB(Hz)	OBW(Hz)	Fl-OBW(Hz)	Fh-OBW(Hz)	Limit(Hz)	Port
16.32M	5.73678G	5.7531G	16.886M	5.736506G	5.753392G	500k	1
16.32M	5.73678G	5.7531G	17.152M	5.736432G	5.753584G	500k	2

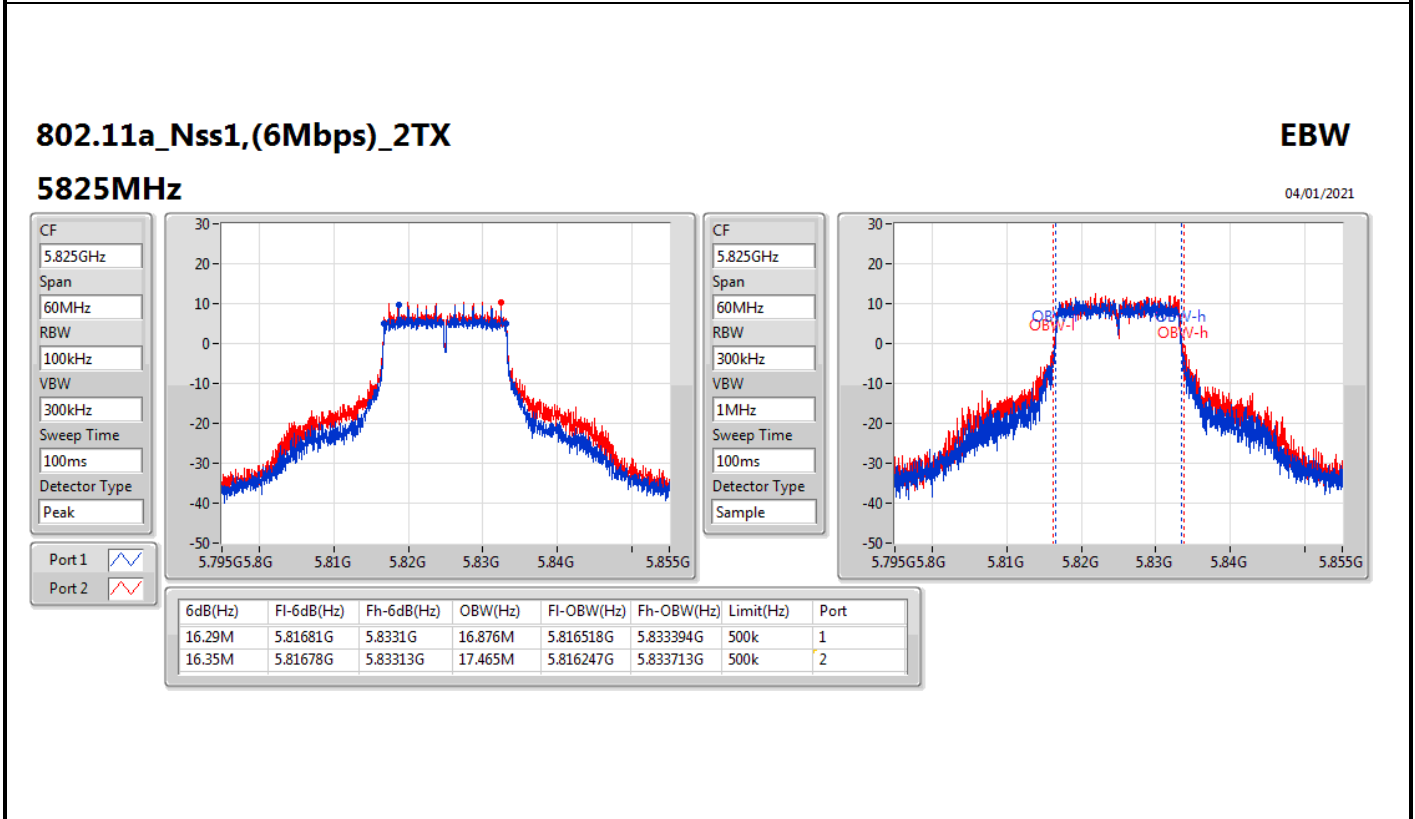
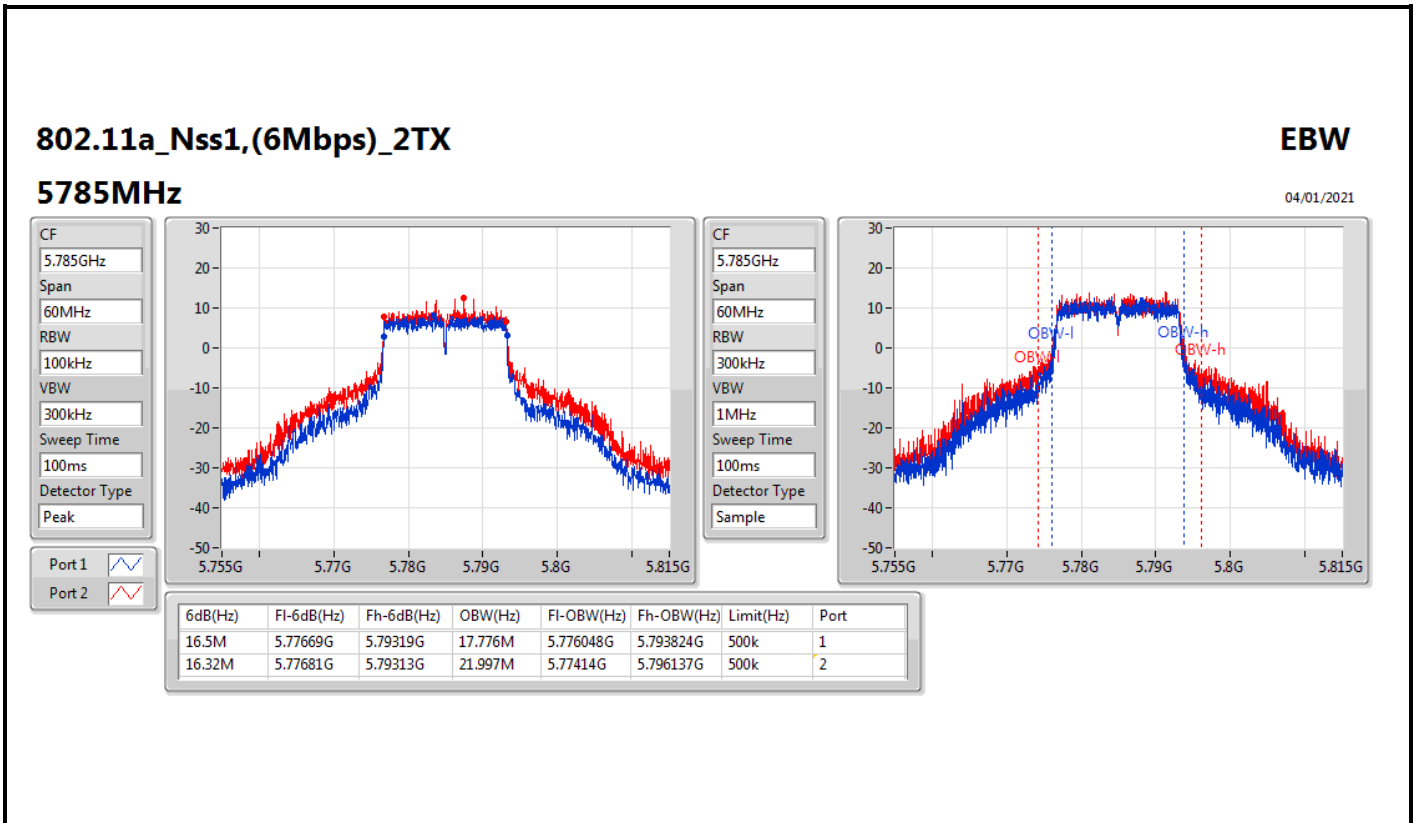

802.11n HT20_Nss1,(MCS0)_2TX

EBW

5180MHz

04/01/2021

CF: 5.18GHz
 Span: 60MHz
 RBW: 300kHz
 VBW: 1MHz
 Sweep Time: 100ms
 Detector Type: Peak

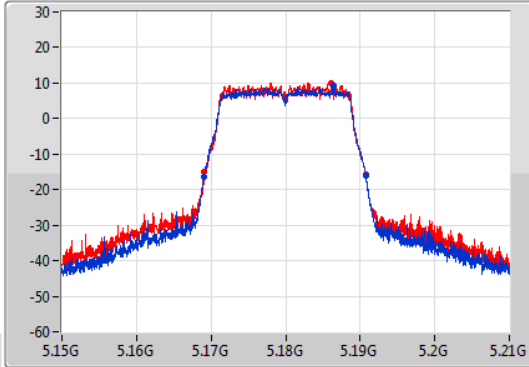

CF: 5.18GHz
 Span: 60MHz
 RBW: 300kHz
 VBW: 1MHz
 Sweep Time: 100ms
 Detector Type: Sample

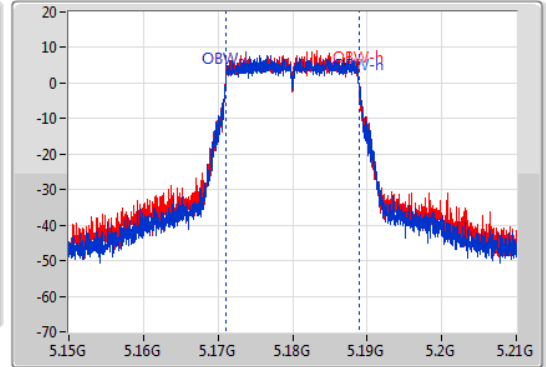

26dB(Hz)	Fl-26dB(Hz)	Fh-26dB(Hz)	OBW(Hz)	Fl-OBW(Hz)	Fh-OBW(Hz)	Limit(Hz)	Port
21.66M	5.16908G	5.19074G	17.912M	5.171005G	5.188917G	Inf	1
21.63M	5.16911G	5.19074G	17.872M	5.171005G	5.188877G	Inf	2

802.11n HT20_Nss1,(MCS0)_2TX

EBW

5200MHz

04/01/2021

CF: 5.2GHz
 Span: 60MHz
 RBW: 300kHz
 VBW: 1MHz
 Sweep Time: 100ms
 Detector Type: Peak

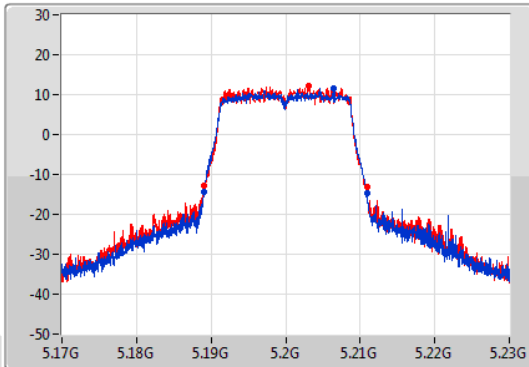

CF: 5.2GHz
 Span: 60MHz
 RBW: 300kHz
 VBW: 1MHz
 Sweep Time: 100ms
 Detector Type: Sample

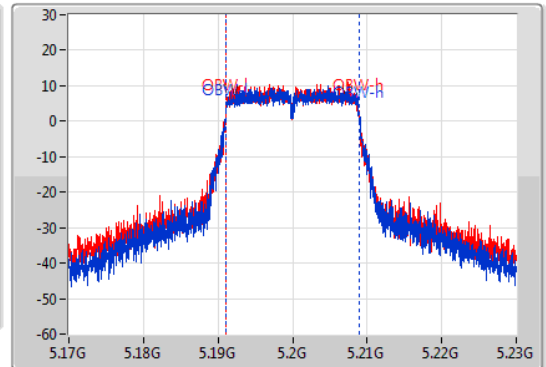

26dB(Hz)	Fl-26dB(Hz)	Fh-26dB(Hz)	OBW(Hz)	Fl-OBW(Hz)	Fh-OBW(Hz)	Limit(Hz)	Port
21.9M	5.18902G	5.21092G	17.908M	5.191025G	5.208934G	Inf	1
21.84M	5.18908G	5.21092G	17.865M	5.19103G	5.208895G	Inf	2

802.11n HT20_Nss1,(MCS0)_2TX

EBW

5240MHz

04/01/2021

CF
5.24GHz
Span
60MHz
RBW
300kHz
VBW
1MHz
Sweep Time
100ms
Detector Type
Peak

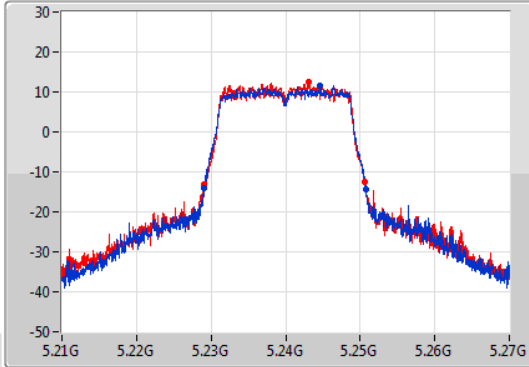

CF
5.24GHz
Span
60MHz
RBW
300kHz
VBW
1MHz
Sweep Time
100ms
Detector Type
Sample

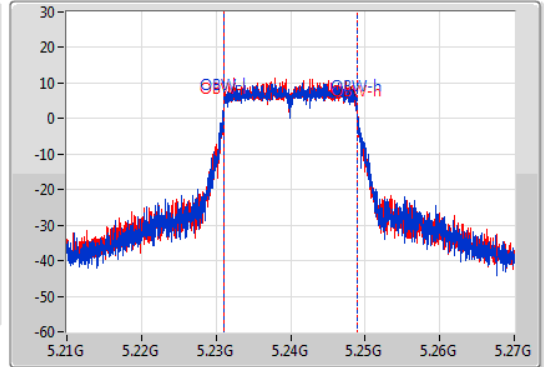

26dB(Hz)	Fl-26dB(Hz)	Fh-26dB(Hz)	OBW(Hz)	Fl-OBW(Hz)	Fh-OBW(Hz)	Limit(Hz)	Port
21.75M	5.22905G	5.2508G	17.945M	5.23098G	5.248926G	Inf	1
21.57M	5.22908G	5.25065G	17.864M	5.231038G	5.248902G	Inf	2

802.11n HT20_Nss1,(MCS0)_2TX

EBW

5745MHz

04/01/2021

CF
5.745GHz
Span
60MHz
RBW
100kHz
VBW
300kHz
Sweep Time
100ms
Detector Type
Peak

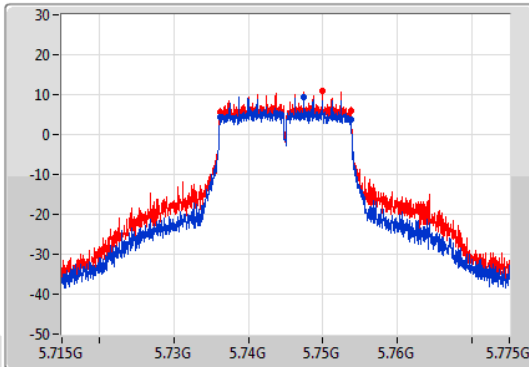

CF
5.745GHz
Span
60MHz
RBW
300kHz
VBW
1MHz
Sweep Time
100ms
Detector Type
Sample

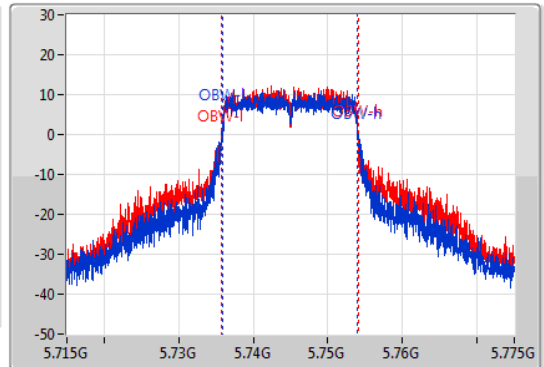

6dB(Hz)	Fl-6dB(Hz)	Fh-6dB(Hz)	OBW(Hz)	Fl-OBW(Hz)	Fh-OBW(Hz)	Limit(Hz)	Port
17.55M	5.73618G	5.75373G	18.122M	5.735844G	5.753966G	500k	1
17.55M	5.73618G	5.75373G	18.334M	5.735739G	5.754073G	500k	2

802.11n HT20_Nss1,(MCS0)_2TX

EBW

5785MHz

04/01/2021

CF
5.785GHz
Span
60MHz
RBW
100kHz
VBW
300kHz
Sweep Time
100ms
Detector Type
Peak

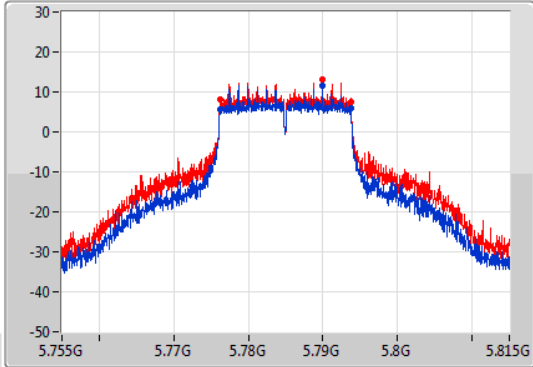

CF
5.785GHz
Span
60MHz
RBW
300kHz
VBW
1MHz
Sweep Time
100ms
Detector Type
Sample

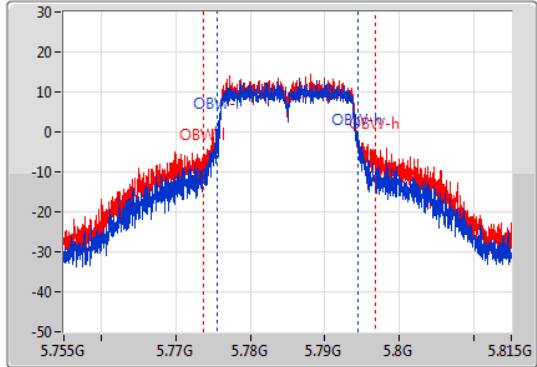

6dB(Hz)	Fl-6dB(Hz)	Fh-6dB(Hz)	OBW(Hz)	Fl-OBW(Hz)	Fh-OBW(Hz)	Limit(Hz)	Port
17.55M	5.77618G	5.79373G	18.835M	5.775538G	5.794373G	500k	1
17.55M	5.77618G	5.79373G	22.976M	5.773776G	5.796752G	500k	2

802.11n HT20_Nss1,(MCS0)_2TX

EBW

5825MHz

04/01/2021

CF
5.825GHz
Span
60MHz
RBW
100kHz
VBW
300kHz
Sweep Time
100ms
Detector Type
Peak

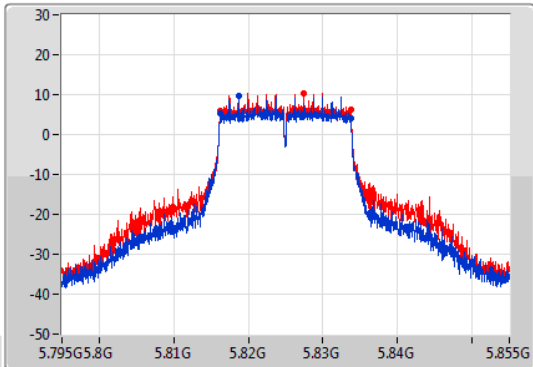

CF
5.825GHz
Span
60MHz
RBW
300kHz
VBW
1MHz
Sweep Time
100ms
Detector Type
Sample

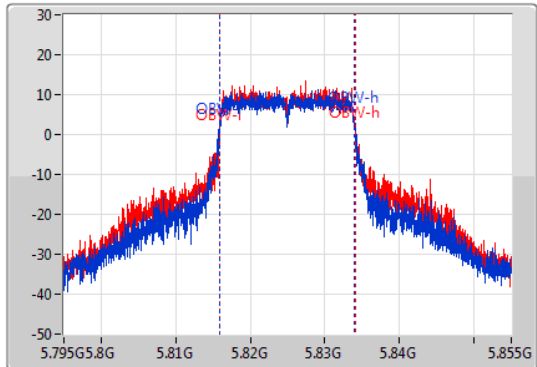

6dB(Hz)	Fl-6dB(Hz)	Fh-6dB(Hz)	OBW(Hz)	Fl-OBW(Hz)	Fh-OBW(Hz)	Limit(Hz)	Port
17.55M	5.81618G	5.83373G	18.121M	5.815898G	5.834019G	500k	1
17.55M	5.81618G	5.83373G	18.19M	5.815893G	5.834084G	500k	2

802.11n HT40_Nss1,(MCS0)_2TX

EBW

5190MHz

04/01/2021

CF
5.19GHz
Span
120MHz
RBW
500kHz
VBW
2MHz
Sweep Time
100ms
Detector Type
Peak

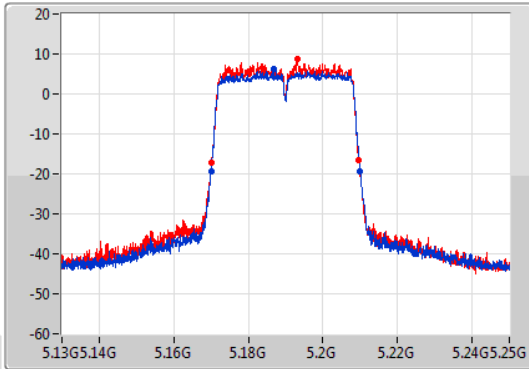

CF
5.19GHz
Span
120MHz
RBW
1MHz
VBW
3MHz
Sweep Time
100ms
Detector Type
Sample

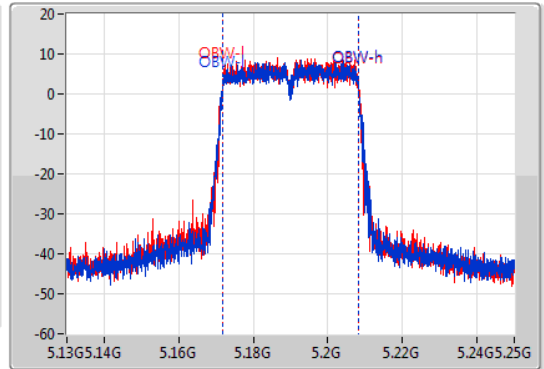

26dB(Hz)	Fl-26dB(Hz)	Fh-26dB(Hz)	OBW(Hz)	Fl-OBW(Hz)	Fh-OBW(Hz)	Limit(Hz)	Port
40.08M	5.16996G	5.21004G	36.469M	5.17172G	5.208189G	Inf	1
39.48M	5.1702G	5.20968G	36.391M	5.171798G	5.20819G	Inf	2

802.11n HT40_Nss1,(MCS0)_2TX

EBW

5230MHz

04/01/2021

CF
5.23GHz
Span
120MHz
RBW
500kHz
VBW
2MHz
Sweep Time
100ms
Detector Type
Peak

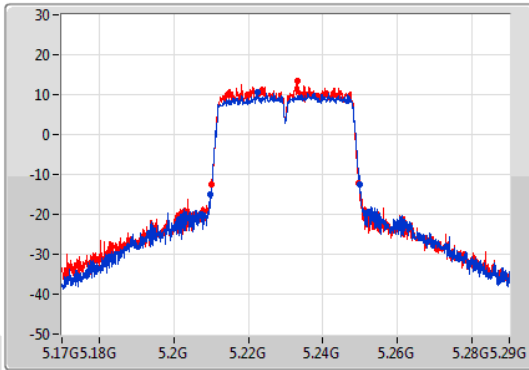

CF
5.23GHz
Span
120MHz
RBW
1MHz
VBW
3MHz
Sweep Time
100ms
Detector Type
Sample

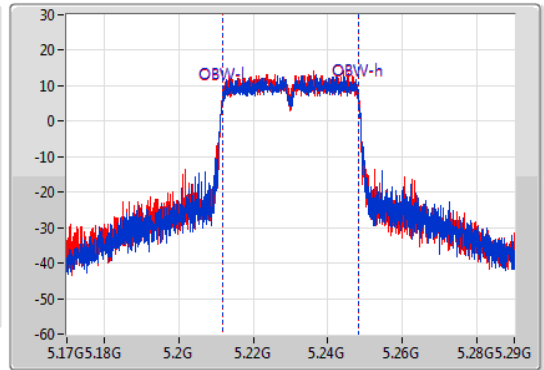

26dB(Hz)	Fl-26dB(Hz)	Fh-26dB(Hz)	OBW(Hz)	Fl-OBW(Hz)	Fh-OBW(Hz)	Limit(Hz)	Port
40.2M	5.20984G	5.25004G	36.469M	5.211732G	5.248201G	Inf	1
39.54M	5.21014G	5.24968G	36.483M	5.211727G	5.24821G	Inf	2

802.11n HT40_Nss1,(MCS0)_2TX

EBW

5755MHz

04/01/2021

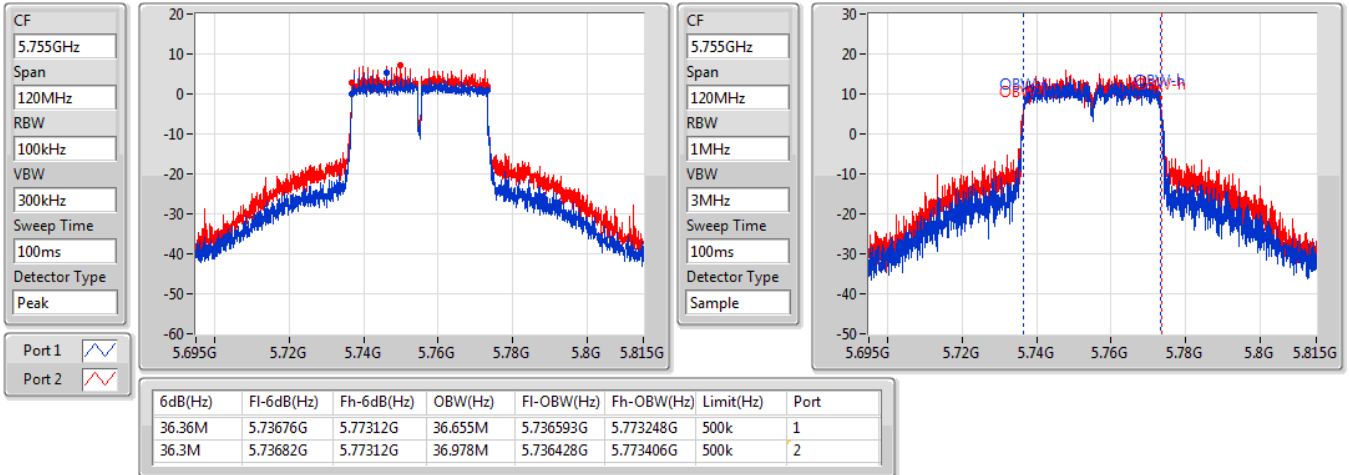

802.11n HT40_Nss1,(MCS0)_2TX

EBW

5795MHz

04/01/2021

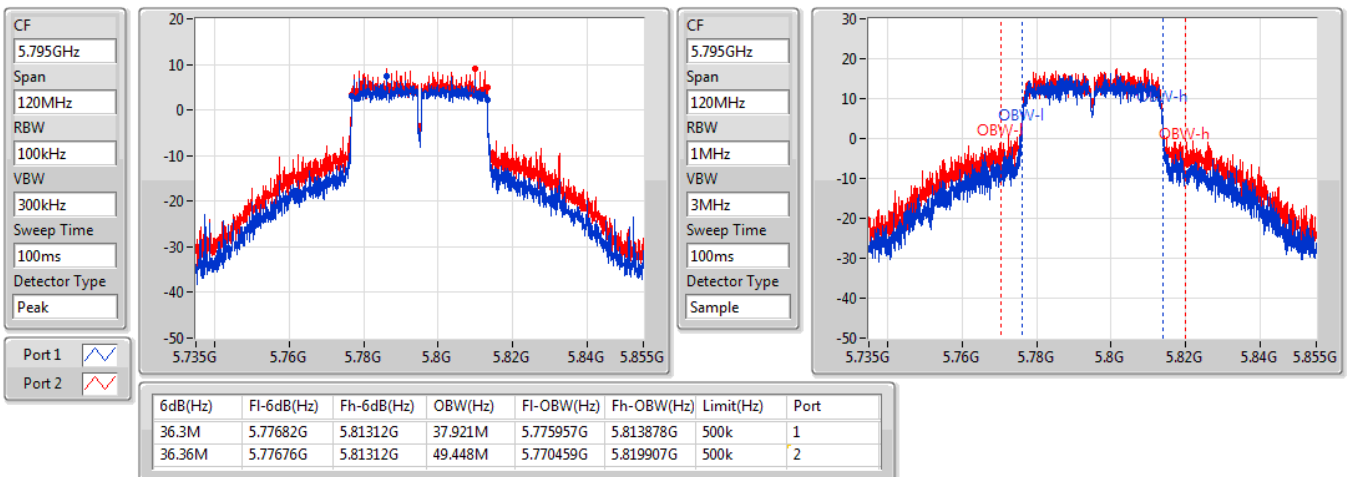

802.11ac VHT20_Nss1,(MCS0)_2TX

EBW

5180MHz

04/01/2021

CF
5.18GHz
Span
60MHz
RBW
300kHz
VBW
1MHz
Sweep Time
100ms
Detector Type
Peak

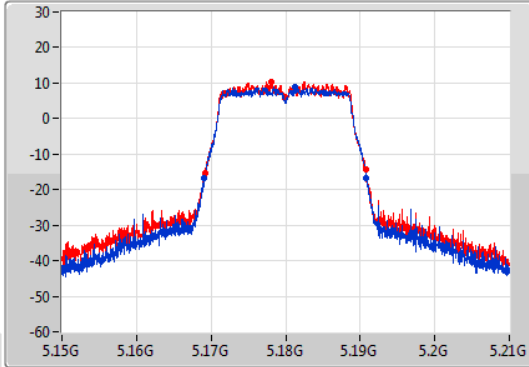

CF
5.18GHz
Span
60MHz
RBW
300kHz
VBW
1MHz
Sweep Time
100ms
Detector Type
Sample

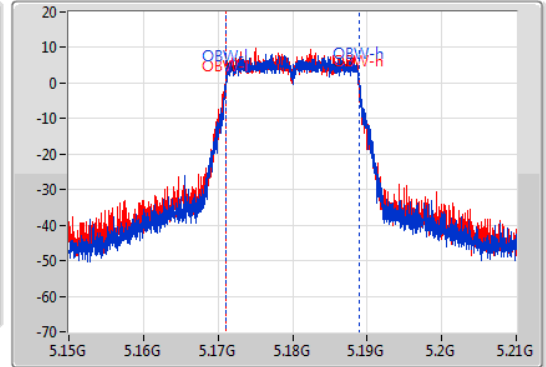

26dB(Hz)	Fl-26dB(Hz)	Fh-26dB(Hz)	OBW(Hz)	Fl-OBW(Hz)	Fh-OBW(Hz)	Limit(Hz)	Port
21.78M	5.16908G	5.19086G	17.931M	5.171041G	5.188972G	Inf	1
21.57M	5.16917G	5.19074G	17.896M	5.170995G	5.18889G	Inf	2

802.11ac VHT20_Nss1,(MCS0)_2TX

EBW

5200MHz

04/01/2021

CF
5.2GHz
Span
60MHz
RBW
300kHz
VBW
1MHz
Sweep Time
100ms
Detector Type
Peak

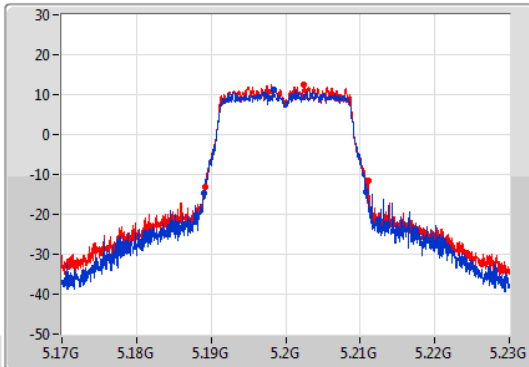

CF
5.2GHz
Span
60MHz
RBW
300kHz
VBW
1MHz
Sweep Time
100ms
Detector Type
Sample

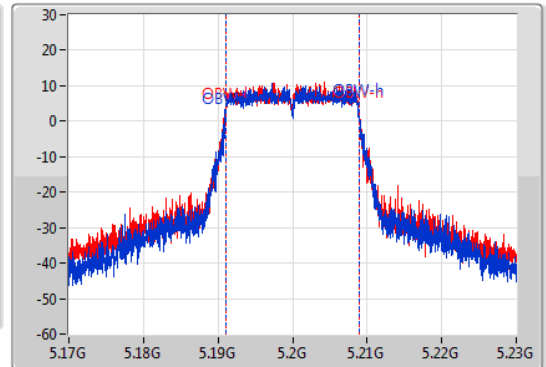

26dB(Hz)	Fl-26dB(Hz)	Fh-26dB(Hz)	OBW(Hz)	Fl-OBW(Hz)	Fh-OBW(Hz)	Limit(Hz)	Port
21.72M	5.18908G	5.2108G	17.926M	5.191008G	5.208934G	Inf	1
21.93M	5.18917G	5.2111G	17.906M	5.19099G	5.208897G	Inf	2

802.11ac VHT20_Nss1,(MCS0)_2TX

EBW

5240MHz

04/01/2021

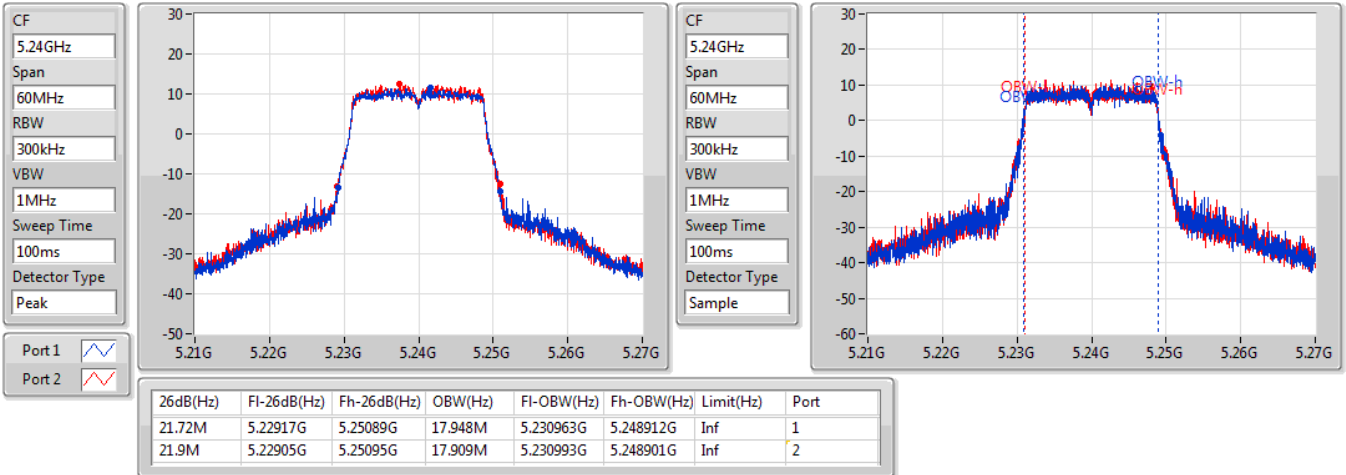

802.11ac VHT20_Nss1,(MCS0)_2TX

EBW

5745MHz

04/01/2021

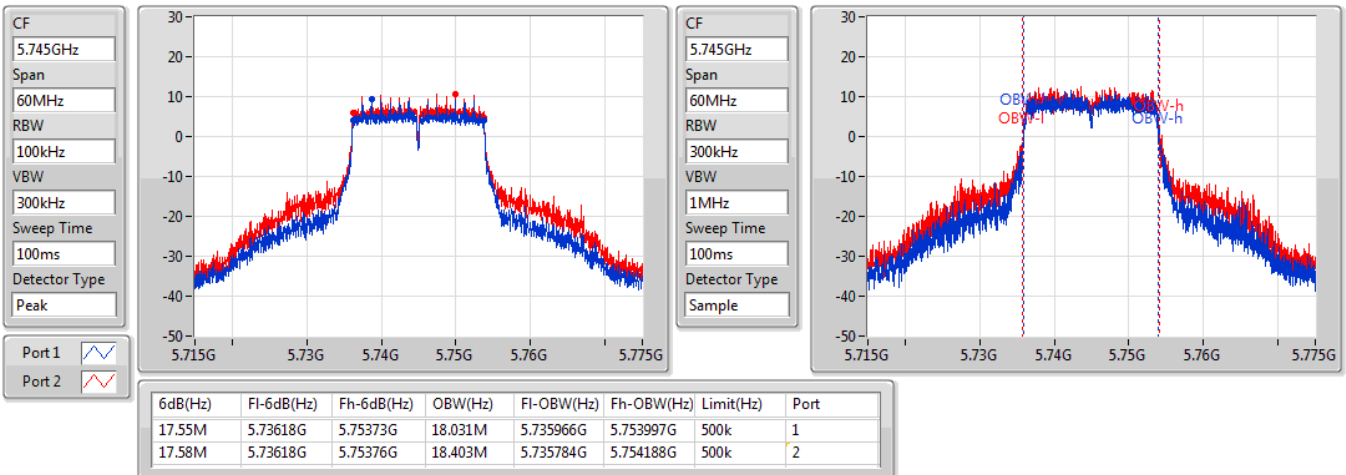

802.11ac VHT20_Nss1,(MCS0)_2TX

EBW

5785MHz

04/01/2021

CF
5.785GHz
Span
60MHz
RBW
100kHz
VBW
300kHz
Sweep Time
100ms
Detector Type
Peak

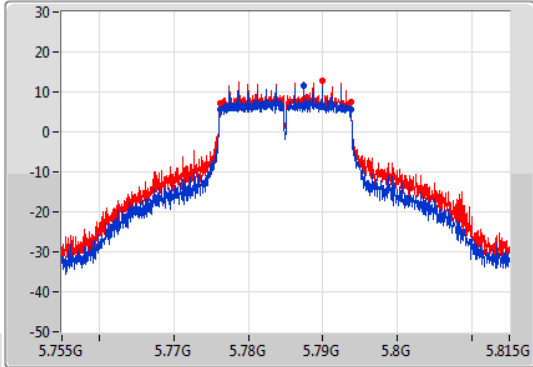

CF
5.785GHz
Span
60MHz
RBW
300kHz
VBW
1MHz
Sweep Time
100ms
Detector Type
Sample

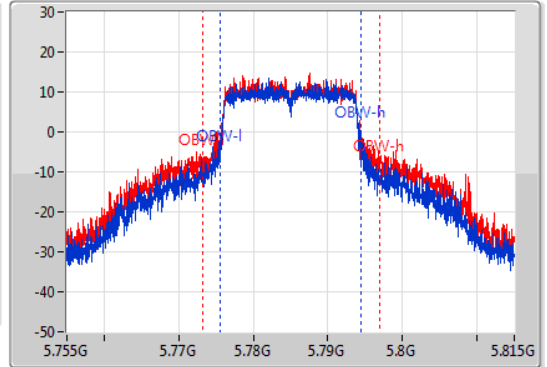

6dB(Hz)	Fl-6dB(Hz)	Fh-6dB(Hz)	OBW(Hz)	Fl-OBW(Hz)	Fh-OBW(Hz)	Limit(Hz)	Port
17.55M	5.77618G	5.79373G	18.882M	5.775545G	5.794427G	500k	1
17.55M	5.77618G	5.79373G	23.615M	5.773292G	5.796908G	500k	2

802.11ac VHT20_Nss1,(MCS0)_2TX

EBW

5825MHz

04/01/2021

CF
5.825GHz
Span
60MHz
RBW
100kHz
VBW
300kHz
Sweep Time
100ms
Detector Type
Peak

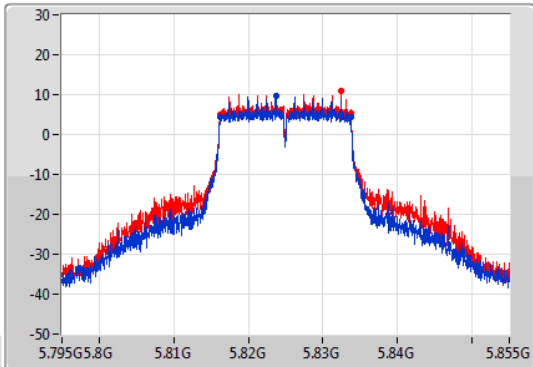

CF
5.825GHz
Span
60MHz
RBW
300kHz
VBW
1MHz
Sweep Time
100ms
Detector Type
Sample

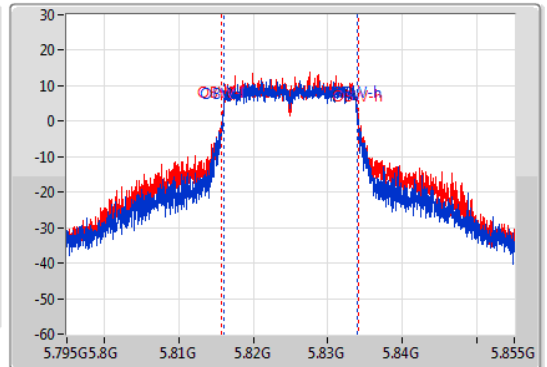

6dB(Hz)	Fl-6dB(Hz)	Fh-6dB(Hz)	OBW(Hz)	Fl-OBW(Hz)	Fh-OBW(Hz)	Limit(Hz)	Port
17.55M	5.81618G	5.83373G	17.965M	5.815979G	5.833943G	500k	1
17.55M	5.81618G	5.83373G	18.291M	5.815805G	5.834097G	500k	2

802.11ac VHT40_Nss1,(MCS0)_2TX

EBW

5190MHz

04/01/2021

CF
5.19GHz
Span
120MHz
RBW
500kHz
VBW
2MHz
Sweep Time
100ms
Detector Type
Peak

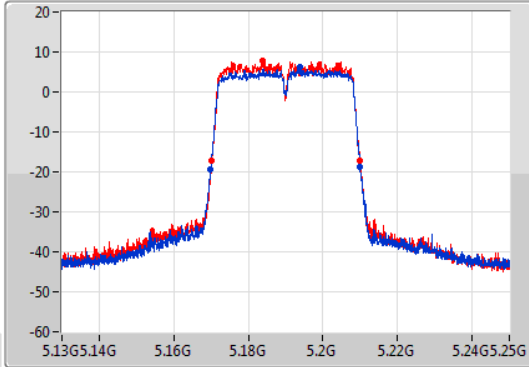

CF
5.19GHz
Span
120MHz
RBW
1MHz
VBW
3MHz
Sweep Time
100ms
Detector Type
Sample

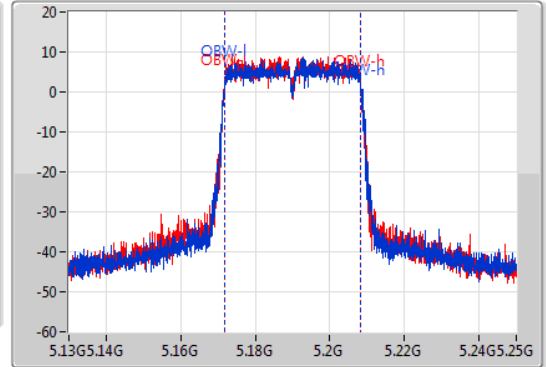

26dB(Hz)	Fl-26dB(Hz)	Fh-26dB(Hz)	OBW(Hz)	Fl-OBW(Hz)	Fh-OBW(Hz)	Limit(Hz)	Port
40.2M	5.16984G	5.21004G	36.512M	5.171802G	5.208314G	Inf	1
39.78M	5.1702G	5.20998G	36.49M	5.171765G	5.208256G	Inf	2

802.11ac VHT40_Nss1,(MCS0)_2TX

EBW

5230MHz

04/01/2021

CF
5.23GHz
Span
120MHz
RBW
500kHz
VBW
2MHz
Sweep Time
100ms
Detector Type
Peak

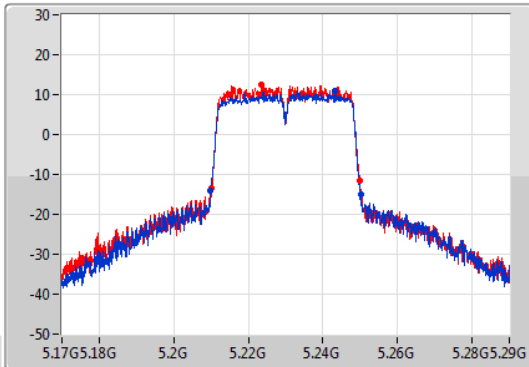

CF
5.23GHz
Span
120MHz
RBW
1MHz
VBW
3MHz
Sweep Time
100ms
Detector Type
Sample

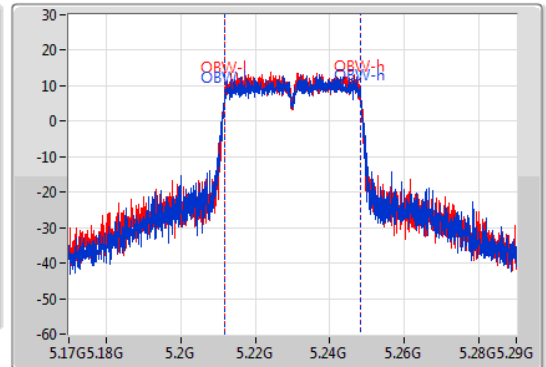

26dB(Hz)	Fl-26dB(Hz)	Fh-26dB(Hz)	OBW(Hz)	Fl-OBW(Hz)	Fh-OBW(Hz)	Limit(Hz)	Port
40.26M	5.20984G	5.2501G	36.593M	5.211691G	5.248284G	Inf	1
39.78M	5.21008G	5.24986G	36.466M	5.211793G	5.248259G	Inf	2

802.11ac VHT40_Nss1,(MCS0)_2TX

EBW

5755MHz

04/01/2021

CF
5.755GHz
Span
120MHz
RBW
100kHz
VBW
300kHz
Sweep Time
100ms
Detector Type
Peak

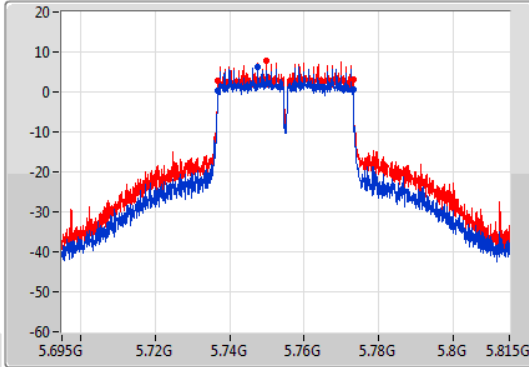

CF
5.755GHz
Span
120MHz
RBW
1MHz
VBW
3MHz
Sweep Time
100ms
Detector Type
Sample

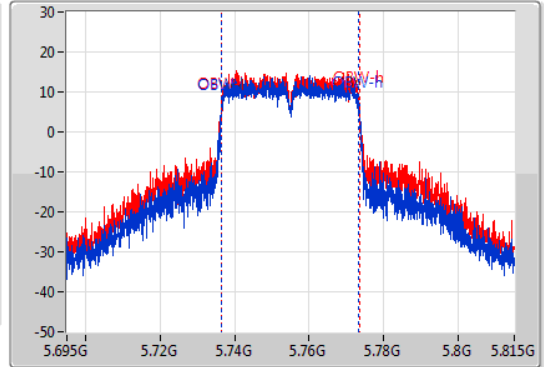

6dB(Hz)	Fl-6dB(Hz)	Fh-6dB(Hz)	OBW(Hz)	Fl-OBW(Hz)	Fh-OBW(Hz)	Limit(Hz)	Port
36.36M	5.73676G	5.77312G	36.77M	5.73655G	5.77332G	500k	1
36.3M	5.73682G	5.77312G	37.1M	5.736407G	5.773507G	500k	2

802.11ac VHT40_Nss1,(MCS0)_2TX

EBW

5795MHz

04/01/2021

CF
5.795GHz
Span
120MHz
RBW
100kHz
VBW
300kHz
Sweep Time
100ms
Detector Type
Peak

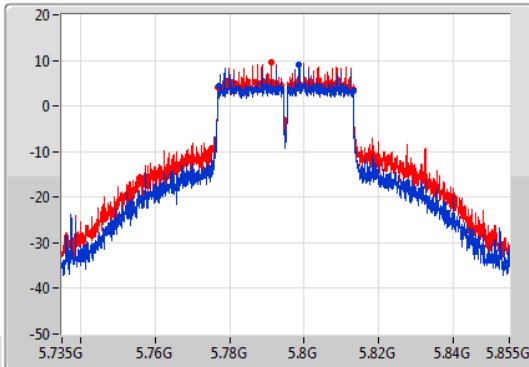

CF
5.795GHz
Span
120MHz
RBW
1MHz
VBW
3MHz
Sweep Time
100ms
Detector Type
Sample

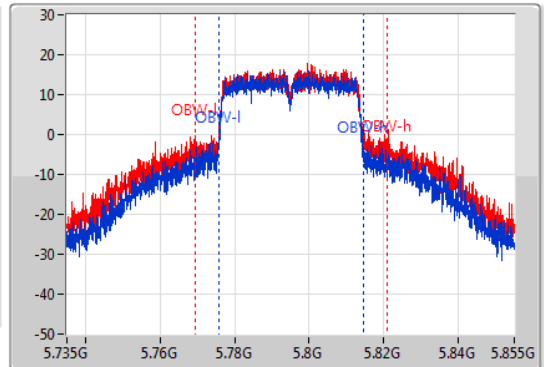

6dB(Hz)	Fl-6dB(Hz)	Fh-6dB(Hz)	OBW(Hz)	Fl-OBW(Hz)	Fh-OBW(Hz)	Limit(Hz)	Port
36M	5.77706G	5.81306G	38.869M	5.775623G	5.814491G	500k	1
36.36M	5.77676G	5.81312G	51.36M	5.76942G	5.82078G	500k	2

802.11ac VHT80_Nss1,(MCS0)_2TX

EBW

5210MHz

04/01/2021

CF
5.21GHz
Span
240MHz
RBW
1MHz
VBW
3MHz
Sweep Time
100ms
Detector Type
Peak

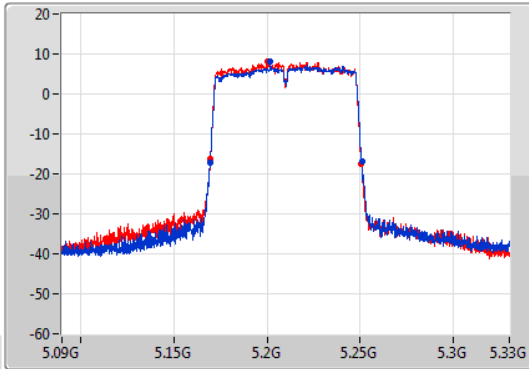

CF
5.21GHz
Span
240MHz
RBW
2MHz
VBW
8MHz
Sweep Time
100ms
Detector Type
Sample

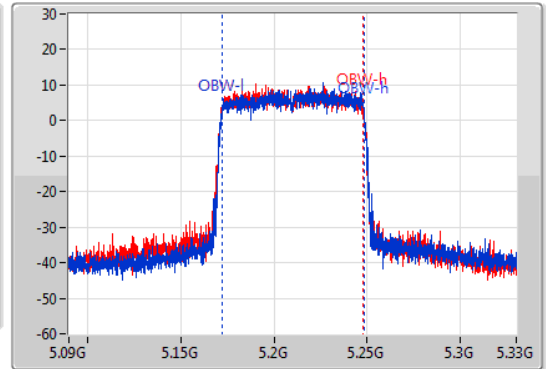

26dB(Hz)	Fl-26dB(Hz)	Fh-26dB(Hz)	OBW(Hz)	Fl-OBW(Hz)	Fh-OBW(Hz)	Limit(Hz)	Port
81.48M	5.16944G	5.25092G	76.168M	5.172014G	5.248182G	Inf	1
81.24M	5.16944G	5.25068G	76.061M	5.171934G	5.247995G	Inf	2

802.11ac VHT80_Nss1,(MCS0)_2TX

EBW

5775MHz

04/01/2021

CF
5.775GHz
Span
240MHz
RBW
100kHz
VBW
300kHz
Sweep Time
100ms
Detector Type
Peak

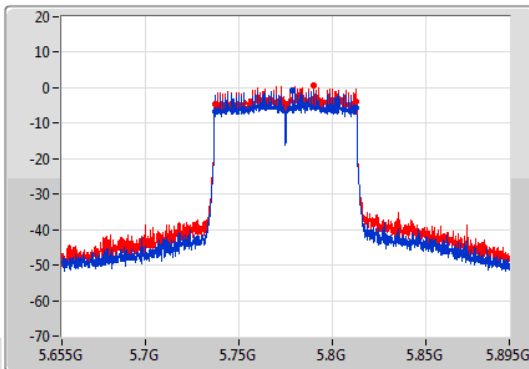

CF
5.775GHz
Span
240MHz
RBW
2MHz
VBW
8MHz
Sweep Time
100ms
Detector Type
Sample

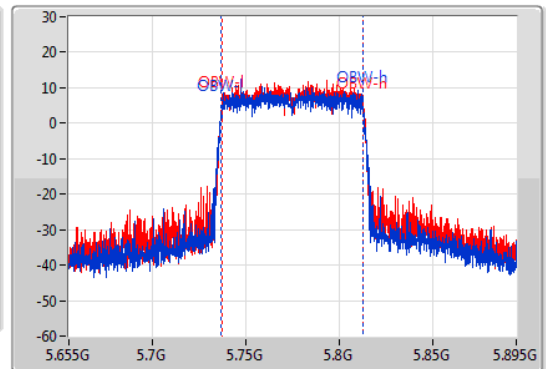

6dB(Hz)	Fl-6dB(Hz)	Fh-6dB(Hz)	OBW(Hz)	Fl-OBW(Hz)	Fh-OBW(Hz)	Limit(Hz)	Port
75.24M	5.73732G	5.81256G	76.116M	5.736827G	5.812943G	500k	1
75.84M	5.7372G	5.81304G	76.072M	5.736954G	5.813026G	500k	2

802.11ax HEW20_Nss1,(MCS0)_2TX

EBW

5180MHz

04/01/2021

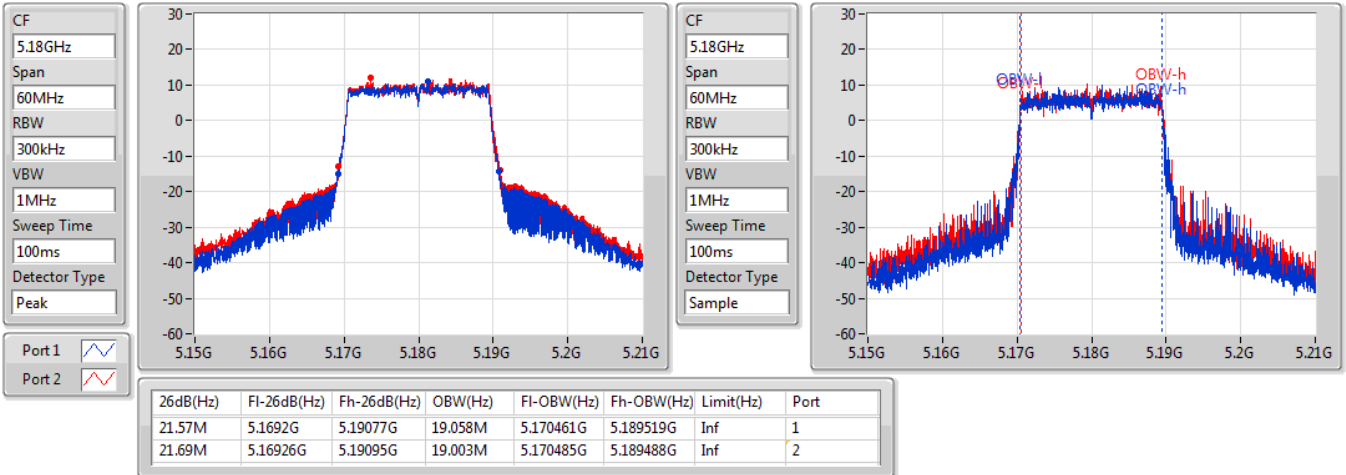

802.11ax HEW20_Nss1,(MCS0)_2TX

EBW

5200MHz

04/01/2021

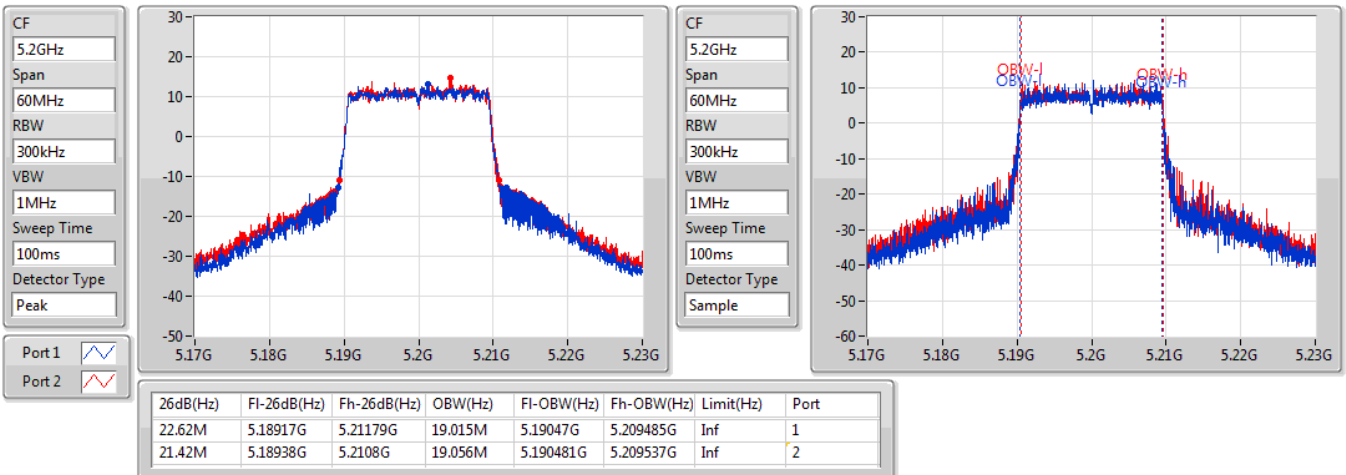

802.11ax HEW20_Nss1,(MCS0)_2TX

EBW

5240MHz

04/01/2021

CF
5.24GHz
Span
60MHz
RBW
300kHz
VBW
1MHz
Sweep Time
100ms
Detector Type
Peak

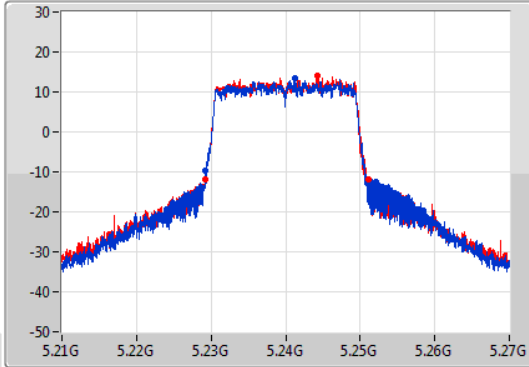

CF
5.24GHz
Span
60MHz
RBW
300kHz
VBW
1MHz
Sweep Time
100ms
Detector Type
Sample

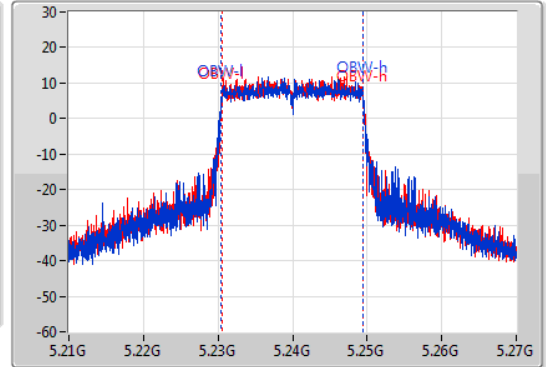

26dB(Hz)	Fl-26dB(Hz)	Fh-26dB(Hz)	OBW(Hz)	Fl-OBW(Hz)	Fh-OBW(Hz)	Limit(Hz)	Port
22.95M	5.22917G	5.25212G	19.05M	5.230439G	5.249489G	Inf	1
21.84M	5.22926G	5.2511G	18.974M	5.230489G	5.249463G	Inf	2

802.11ax HEW20_Nss1,(MCS0)_2TX

EBW

5745MHz

04/01/2021

CF
5.745GHz
Span
60MHz
RBW
100kHz
VBW
300kHz
Sweep Time
100ms
Detector Type
Peak

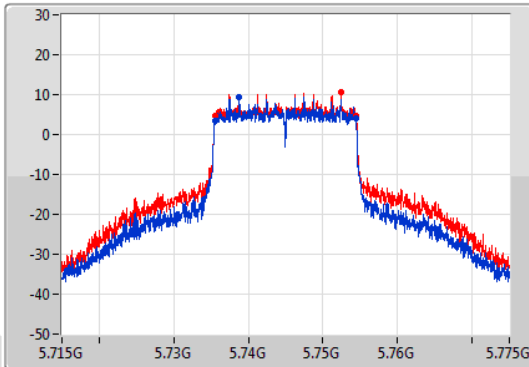

CF
5.745GHz
Span
60MHz
RBW
300kHz
VBW
1MHz
Sweep Time
100ms
Detector Type
Sample

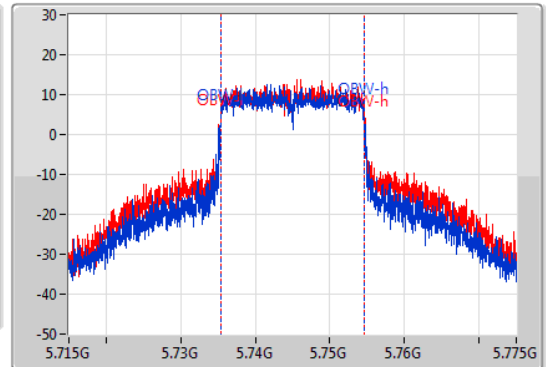

6dB(Hz)	Fl-6dB(Hz)	Fh-6dB(Hz)	OBW(Hz)	Fl-OBW(Hz)	Fh-OBW(Hz)	Limit(Hz)	Port
18.96M	5.73549G	5.75445G	19.145M	5.735383G	5.754527G	500k	1
18.87M	5.73552G	5.75439G	19.325M	5.735311G	5.754636G	500k	2

802.11ax HEW20_Nss1,(MCS0)_2TX

EBW

5785MHz

04/01/2021

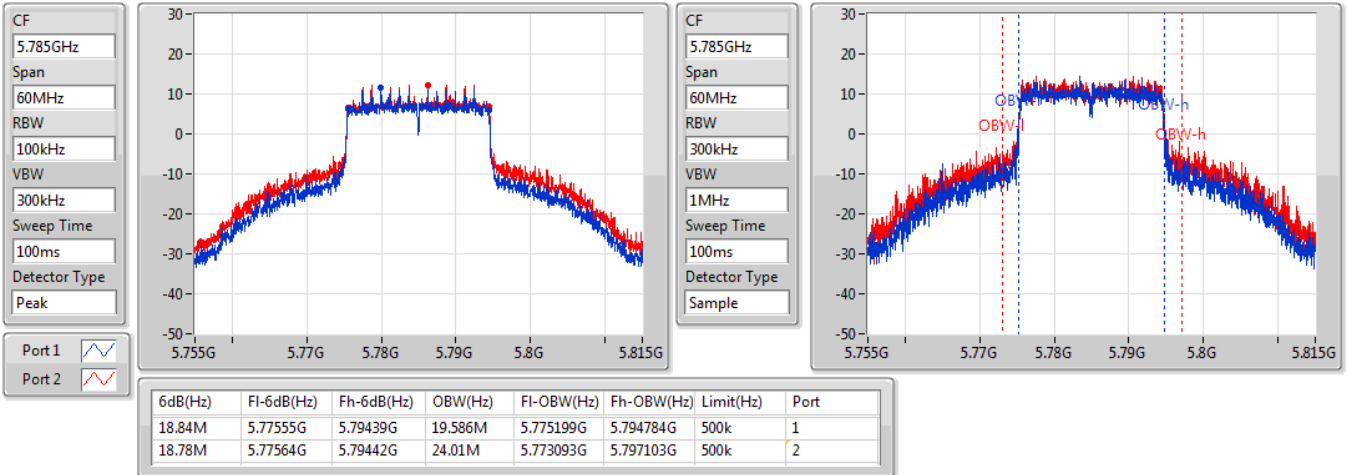

802.11ax HEW20_Nss1,(MCS0)_2TX

EBW

5825MHz

04/01/2021

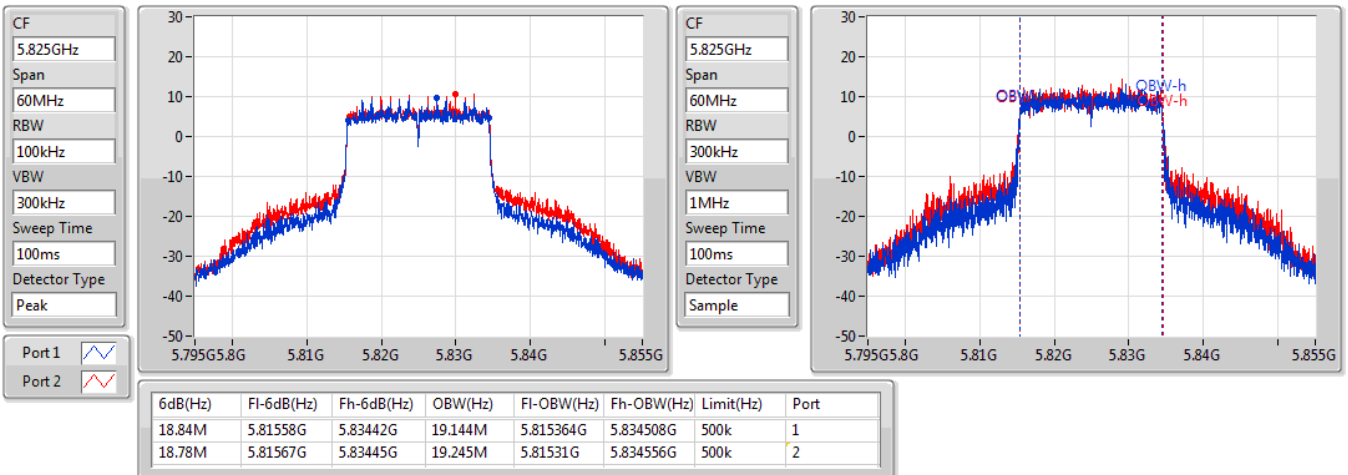

802.11ax HEW40_Nss1,(MCS0)_2TX

EBW

5190MHz

04/01/2021

CF
5.19GHz
Span
120MHz
RBW
500kHz
VBW
2MHz
Sweep Time
100ms
Detector Type
Peak

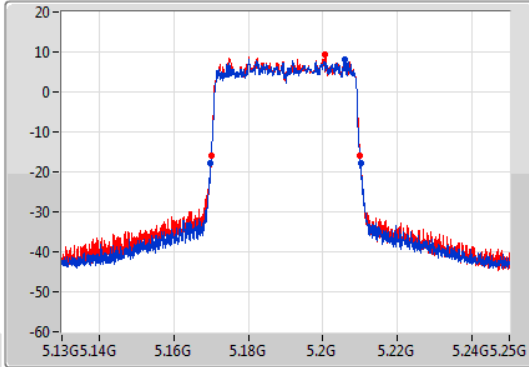

CF
5.19GHz
Span
120MHz
RBW
1MHz
VBW
3MHz
Sweep Time
100ms
Detector Type
Sample

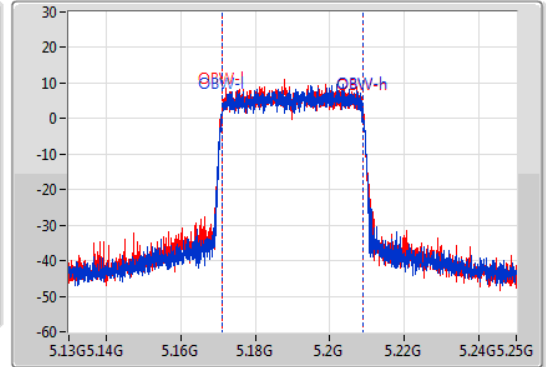

26dB(Hz)	Fl-26dB(Hz)	Fh-26dB(Hz)	OBW(Hz)	Fl-OBW(Hz)	Fh-OBW(Hz)	Limit(Hz)	Port
40.26M	5.16984G	5.2101G	37.667M	5.171133G	5.2088G	Inf	1
39.84M	5.17008G	5.20992G	37.689M	5.171103G	5.208791G	Inf	2

802.11ax HEW40_Nss1,(MCS0)_2TX

EBW

5230MHz

04/01/2021

CF
5.23GHz
Span
120MHz
RBW
500kHz
VBW
2MHz
Sweep Time
100ms
Detector Type
Peak

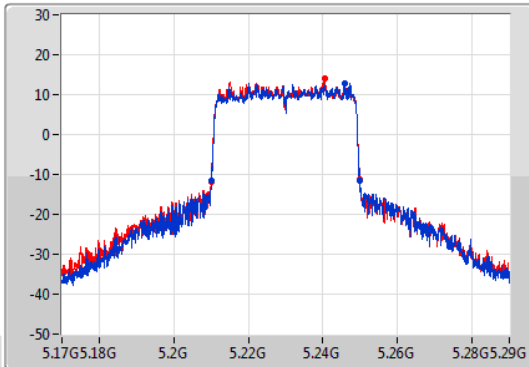

CF
5.23GHz
Span
120MHz
RBW
1MHz
VBW
3MHz
Sweep Time
100ms
Detector Type
Sample

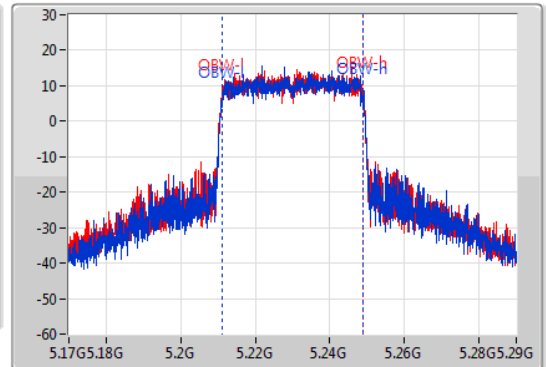

26dB(Hz)	Fl-26dB(Hz)	Fh-26dB(Hz)	OBW(Hz)	Fl-OBW(Hz)	Fh-OBW(Hz)	Limit(Hz)	Port
40.02M	5.20996G	5.24998G	37.862M	5.211106G	5.248967G	Inf	1
39.78M	5.21008G	5.24986G	37.826M	5.21104G	5.248866G	Inf	2

802.11ax HEW40_Nss1,(MCS0)_2TX

EBW

5755MHz

04/01/2021

CF
5.755GHz
Span
120MHz
RBW
100kHz
VBW
300kHz
Sweep Time
100ms
Detector Type
Peak

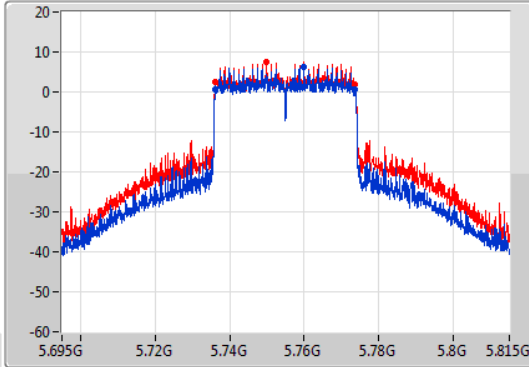

CF
5.755GHz
Span
120MHz
RBW
1MHz
VBW
3MHz
Sweep Time
100ms
Detector Type
Sample

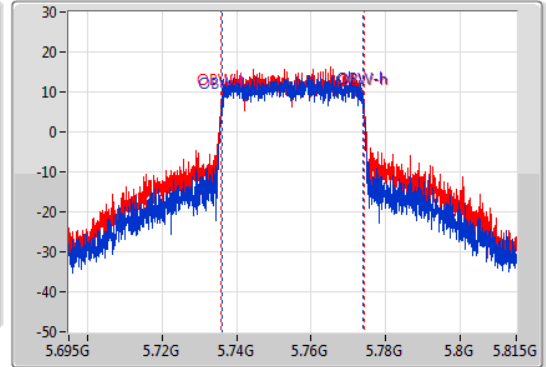

6dB(Hz)	Fl-6dB(Hz)	Fh-6dB(Hz)	OBW(Hz)	Fl-OBW(Hz)	Fh-OBW(Hz)	Limit(Hz)	Port
37.5M	5.7361G	5.7736G	37.95M	5.736004G	5.773954G	500k	1
37.2M	5.73622G	5.77342G	38.374M	5.735817G	5.774191G	500k	2

802.11ax HEW40_Nss1,(MCS0)_2TX

EBW

5795MHz

04/01/2021

CF
5.795GHz
Span
120MHz
RBW
100kHz
VBW
300kHz
Sweep Time
100ms
Detector Type
Peak

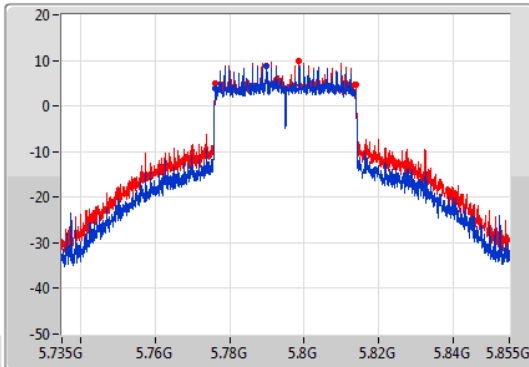

CF
5.795GHz
Span
120MHz
RBW
1MHz
VBW
3MHz
Sweep Time
100ms
Detector Type
Sample

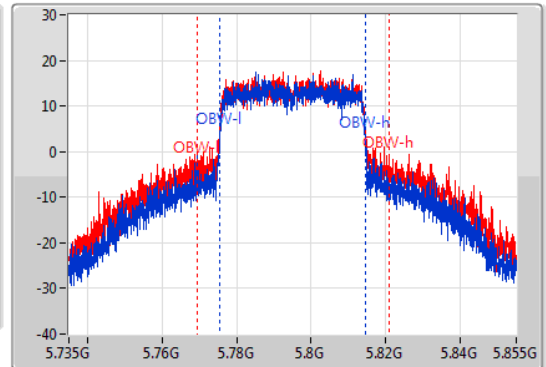

6dB(Hz)	Fl-6dB(Hz)	Fh-6dB(Hz)	OBW(Hz)	Fl-OBW(Hz)	Fh-OBW(Hz)	Limit(Hz)	Port
37.2M	5.77616G	5.81336G	39.305M	5.775411G	5.814715G	500k	1
37.56M	5.77616G	5.81372G	51.527M	5.769398G	5.820925G	500k	2

802.11ax HEW80_Nss1,(MCS0)_2TX

EBW

5210MHz

04/01/2021

CF
5.21GHz
Span
240MHz
RBW
1MHz
VBW
3MHz
Sweep Time
100ms
Detector Type
Peak

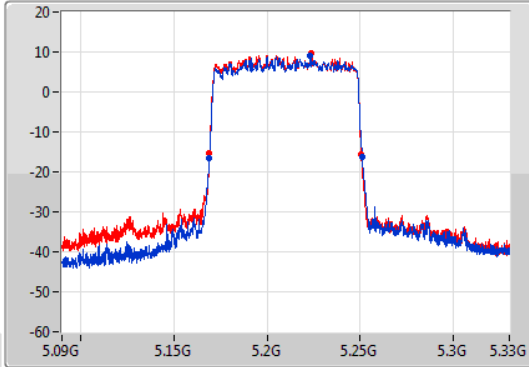

CF
5.21GHz
Span
240MHz
RBW
2MHz
VBW
8MHz
Sweep Time
100ms
Detector Type
Sample

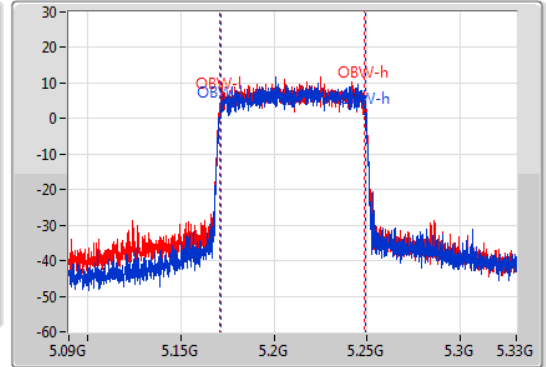

6dB(Hz)	Fl-26dB(Hz)	Fh-26dB(Hz)	OBW(Hz)	Fl-OBW(Hz)	Fh-OBW(Hz)	Limit(Hz)	Port
81.84M	5.1692G	5.25104G	77.566M	5.171335G	5.248901G	Inf	1
81.36M	5.1692G	5.25056G	77.404M	5.171165G	5.248569G	Inf	2

802.11ax HEW80_Nss1,(MCS0)_2TX

EBW

5775MHz

04/01/2021

CF
5.775GHz
Span
240MHz
RBW
100kHz
VBW
300kHz
Sweep Time
100ms
Detector Type
Peak

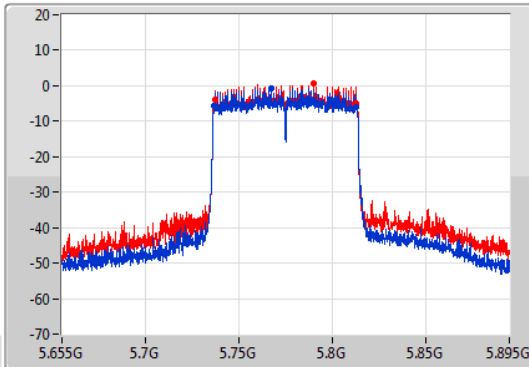

CF
5.775GHz
Span
240MHz
RBW
2MHz
VBW
8MHz
Sweep Time
100ms
Detector Type
Sample

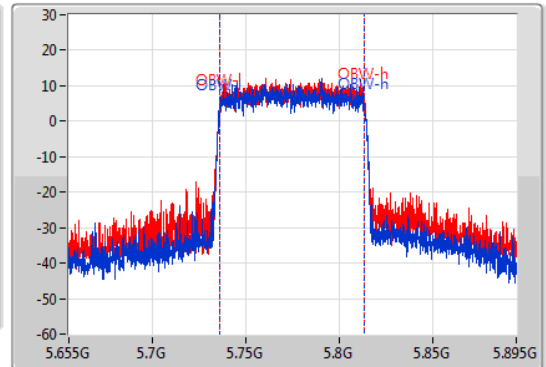

6dB(Hz)	Fl-6dB(Hz)	Fh-6dB(Hz)	OBW(Hz)	Fl-OBW(Hz)	Fh-OBW(Hz)	Limit(Hz)	Port
76.56M	5.73648G	5.81304G	77.44M	5.736135G	5.813575G	500k	1
75.72M	5.73732G	5.81304G	77.593M	5.736095G	5.813688G	500k	2



Summary

Mode	Max-N dB (Hz)	Max-OBW (Hz)	ITU-Code	Min-N dB (Hz)	Min-OBW (Hz)
5.725-5.85GHz	-	-	-	-	-
802.11ax HEW20-BF_Nss1,(MCS0)_4TX	19.08M	19.087M	19M1D1D	18.81M	18.9M
802.11ax HEW40-BF_Nss1,(MCS0)_4TX	37.8M	38.12M	38M1D1D	37.2M	37.529M
802.11ax HEW80-BF_Nss1,(MCS0)_4TX	77.4M	78.188M	78M2D1D	76.2M	77.094M

Max-N dB = Maximum 6dB down bandwidth for 5.725-5.85GHz band / Maximum 26dB down bandwidth for other band;
Max-OBW = Maximum 99% occupied bandwidth;
Min-N dB = Minimum 6dB down bandwidth for 5.725-5.85GHz band / Maximum 26dB down bandwidth for other band;
Min-OBW = Minimum 99% occupied bandwidth



Result

Mode	Result	Limit (Hz)	Port 1-N dB (Hz)	Port 1-OBW (Hz)	Port 2-N dB (Hz)	Port 2-OBW (Hz)	Port 3-N dB (Hz)	Port 3-OBW (Hz)	Port 4-N dB (Hz)	Port 4-OBW (Hz)
802.11ax HEW20-BF_Nss1,(MCS0)_4TX	-	-	-	-	-	-	-	-	-	-
5745MHz	Pass	500k	19.02M	18.9M	19.02M	18.979M	18.93M	19.061M	19.08M	19.087M
5785MHz	Pass	500k	19.08M	18.999M	18.84M	18.994M	18.93M	19.009M	18.81M	18.961M
5825MHz	Pass	500k	18.96M	18.991M	18.81M	18.974M	18.99M	19.005M	18.87M	19.015M
802.11ax HEW40-BF_Nss1,(MCS0)_4TX	-	-	-	-	-	-	-	-	-	-
5755MHz	Pass	500k	37.68M	37.529M	37.26M	37.707M	37.74M	37.974M	37.5M	37.819M
5795MHz	Pass	500k	37.2M	38.12M	37.74M	37.815M	37.38M	37.71M	37.8M	37.833M
802.11ax HEW80-BF_Nss1,(MCS0)_4TX	-	-	-	-	-	-	-	-	-	-
5775MHz	Pass	500k	77.4M	78.188M	76.68M	77.094M	76.44M	77.268M	76.2M	77.826M

Port X-N dB = Port X 6dB down bandwidth for 5.725-5.85GHz band / 26dB down bandwidth for other band
 Port X-OBW = Port X 99% occupied bandwidth

802.11ax HEW20-BF_Nss1,(MCS0)_4TX

EBW

5745MHz

06/01/2021

CF
5.745GHz
Span
60MHz
RBW
100kHz
VBW
300kHz
Sweep Time
100ms
Detector Type
Peak

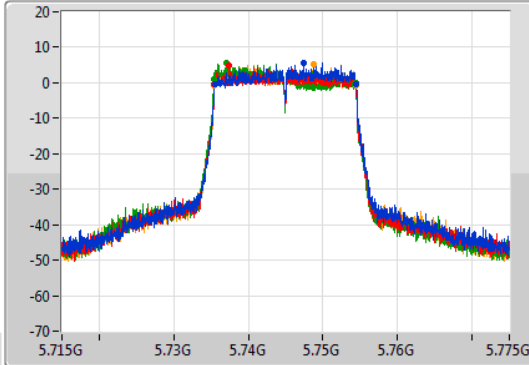

CF
5.745GHz
Span
60MHz
RBW
300kHz
VBW
1MHz
Sweep Time
100ms
Detector Type
Sample

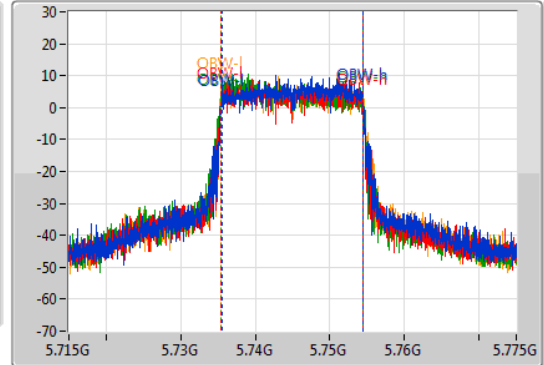

Port 1
Port 2
Port 3
Port 4

6dB(Hz)	Fl-6dB(Hz)	Fh-6dB(Hz)	OBW(Hz)	Fl-OBW(Hz)	Fh-OBW(Hz)	Limit(Hz)	Port
19.02M	5.73549G	5.75451G	18.9M	5.735532G	5.754432G	500k	1
19.02M	5.7354G	5.75442G	18.979M	5.73543G	5.75441G	500k	2
18.93M	5.73543G	5.75436G	19.061M	5.735371G	5.754432G	500k	3
19.08M	5.73537G	5.75445G	19.087M	5.735399G	5.754486G	500k	4

802.11ax HEW20-BF_Nss1,(MCS0)_4TX

EBW

5785MHz

06/01/2021

CF
5.785GHz
Span
60MHz
RBW
100kHz
VBW
300kHz
Sweep Time
100ms
Detector Type
Peak

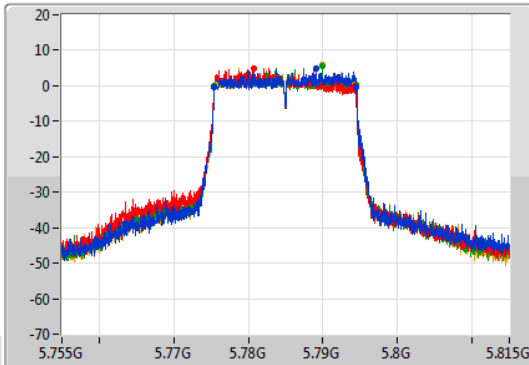

CF
5.785GHz
Span
60MHz
RBW
300kHz
VBW
1MHz
Sweep Time
100ms
Detector Type
Sample

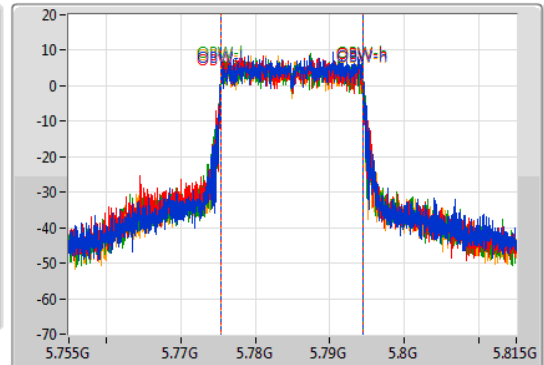

Port 1
Port 2
Port 3
Port 4

6dB(Hz)	Fl-6dB(Hz)	Fh-6dB(Hz)	OBW(Hz)	Fl-OBW(Hz)	Fh-OBW(Hz)	Limit(Hz)	Port
19.08M	5.77543G	5.79451G	18.999M	5.775452G	5.794451G	500k	1
18.84M	5.77543G	5.79427G	18.994M	5.77542G	5.794414G	500k	2
18.93M	5.77546G	5.79439G	19.009M	5.775423G	5.794432G	500k	3
18.81M	5.77549G	5.7943G	18.961M	5.775436G	5.794396G	500k	4

802.11ax HEW20-BF_Nss1,(MCS0)_4TX

EBW

5825MHz

06/01/2021

CF
5.825GHz
Span
60MHz
RBW
100kHz
VBW
300kHz
Sweep Time
100ms
Detector Type
Peak

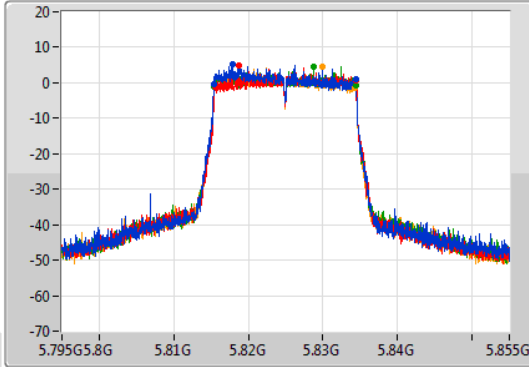

CF
5.825GHz
Span
60MHz
RBW
300kHz
VBW
1MHz
Sweep Time
100ms
Detector Type
Sample

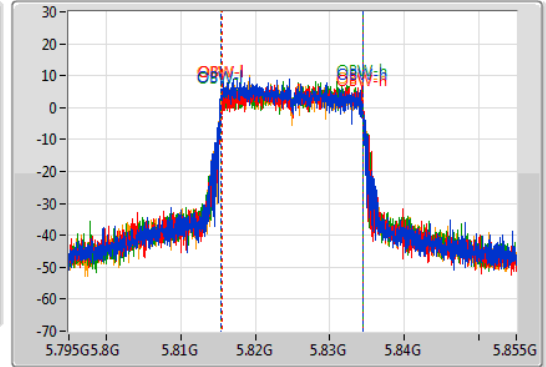

Port 1
Port 2
Port 3
Port 4

6dB(Hz)	Fl-6dB(Hz)	Fh-6dB(Hz)	OBW(Hz)	Fl-OBW(Hz)	Fh-OBW(Hz)	Limit(Hz)	Port
18.96M	5.8154G	5.83436G	18.991M	5.81538G	5.834372G	500k	1
18.81M	5.81558G	5.83439G	18.974M	5.815481G	5.834456G	500k	2
18.99M	5.81543G	5.83442G	19.005M	5.815436G	5.834441G	500k	3
18.87M	5.81543G	5.8343G	19.015M	5.81539G	5.834405G	500k	4

802.11ax HEW40-BF_Nss1,(MCS0)_4TX

EBW

5755MHz

06/01/2021

CF
5.755GHz
Span
120MHz
RBW
100kHz
VBW
300kHz
Sweep Time
100ms
Detector Type
Peak

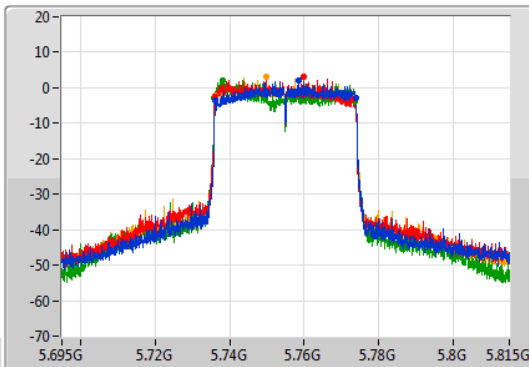

CF
5.755GHz
Span
120MHz
RBW
1MHz
VBW
3MHz
Sweep Time
100ms
Detector Type
Sample

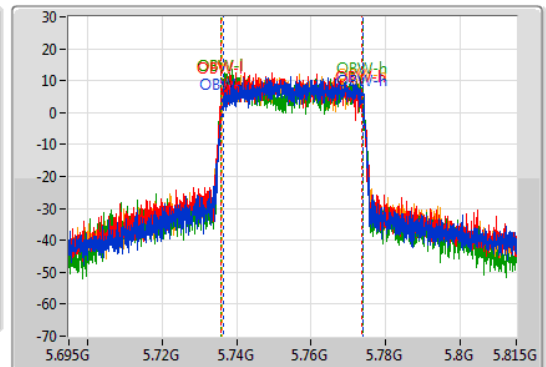

Port 1
Port 2
Port 3
Port 4

6dB(Hz)	Fl-6dB(Hz)	Fh-6dB(Hz)	OBW(Hz)	Fl-OBW(Hz)	Fh-OBW(Hz)	Limit(Hz)	Port
37.68M	5.73616G	5.77384G	37.529M	5.736341G	5.77387G	500k	1
37.26M	5.73598G	5.77324G	37.707M	5.735892G	5.773599G	500k	2
37.74M	5.73592G	5.77366G	37.974M	5.735843G	5.773817G	500k	3
37.5M	5.73598G	5.77348G	37.819M	5.736031G	5.77385G	500k	4

802.11ax HEW40-BF_Nss1,(MCS0)_4TX

EBW

5795MHz

07/01/2021

CF: 5.795GHz
 Span: 120MHz
 RBW: 100kHz
 VBW: 300kHz
 Sweep Time: 100ms
 Detector Type: Peak

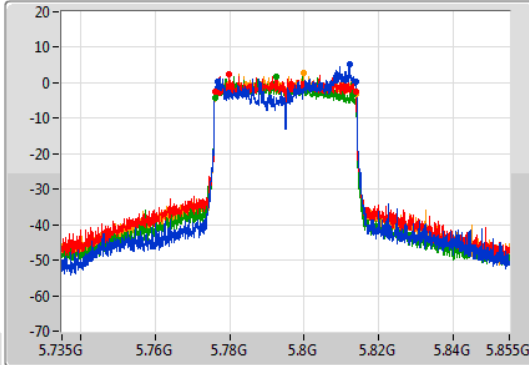

CF: 5.795GHz
 Span: 120MHz
 RBW: 1MHz
 VBW: 3MHz
 Sweep Time: 100ms
 Detector Type: Sample

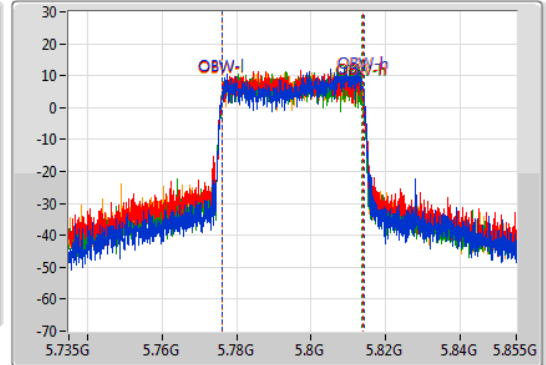

Port 1
 Port 2
 Port 3
 Port 4

6dB(Hz)	Fl-6dB(Hz)	Fh-6dB(Hz)	OBW(Hz)	Fl-OBW(Hz)	Fh-OBW(Hz)	Limit(Hz)	Port
37.2M	5.77664G	5.81384G	38.12M	5.776023G	5.814143G	500k	1
37.74M	5.77598G	5.81372G	37.815M	5.776068G	5.813883G	500k	2
37.38M	5.77598G	5.81336G	37.71M	5.775987G	5.813696G	500k	3
37.8M	5.77598G	5.81378G	37.833M	5.776018G	5.81385G	500k	4

802.11ax HEW80-BF_Nss1,(MCS0)_4TX

EBW

5775MHz

07/01/2021

CF: 5.775GHz
 Span: 240MHz
 RBW: 100kHz
 VBW: 300kHz
 Sweep Time: 100ms
 Detector Type: Peak

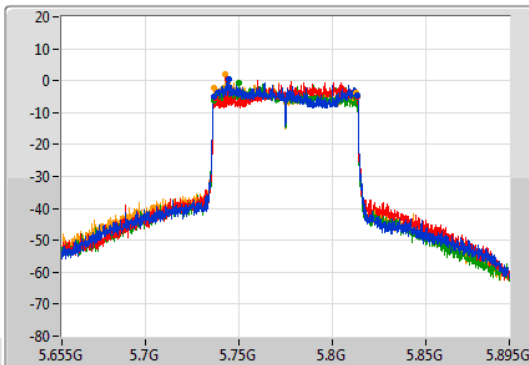

CF: 5.775GHz
 Span: 240MHz
 RBW: 2MHz
 VBW: 8MHz
 Sweep Time: 100ms
 Detector Type: Sample

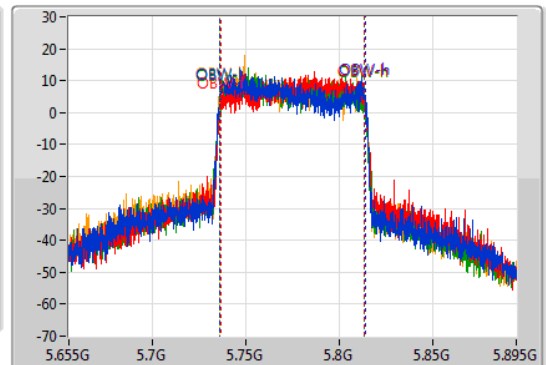

Port 1
 Port 2
 Port 3
 Port 4

6dB(Hz)	Fl-6dB(Hz)	Fh-6dB(Hz)	OBW(Hz)	Fl-OBW(Hz)	Fh-OBW(Hz)	Limit(Hz)	Port
77.4M	5.73636G	5.81376G	78.188M	5.735838G	5.814026G	500k	1
76.68M	5.73696G	5.81364G	77.094M	5.736613G	5.813707G	500k	2
76.44M	5.73648G	5.81292G	77.268M	5.736168G	5.813436G	500k	3
76.2M	5.73648G	5.81268G	77.826M	5.735745G	5.813571G	500k	4



Summary

Mode	Max-N dB (Hz)	Max-OBW (Hz)	ITU-Code	Min-N dB (Hz)	Min-OBW (Hz)
5.15-5.25GHz	-	-	-	-	-
802.11ax HEW20-BF_Nss1,(MCS0)_4TX	21.78M	19.027M	19M0D1D	21.42M	18.95M
802.11ax HEW40-BF_Nss1,(MCS0)_4TX	40.44M	37.818M	37M8D1D	39.9M	37.69M
802.11ax HEW80-BF_Nss1,(MCS0)_4TX	81.96M	77.386M	77M4D1D	80.76M	77.148M
5.725-5.85GHz	-	-	-	-	-
802.11ax HEW20-BF_Nss1,(MCS0)_4TX	19.02M	19.085M	19M1D1D	18.87M	18.963M
802.11ax HEW40-BF_Nss1,(MCS0)_4TX	37.98M	37.913M	37M9D1D	36.42M	37.461M
802.11ax HEW80-BF_Nss1,(MCS0)_4TX	77.28M	77.495M	77M5D1D	67.8M	77.194M

Max-N dB = Maximum 6dB down bandwidth for 5.725-5.85GHz band / Maximum 26dB down bandwidth for other band;
Max-OBW = Maximum 99% occupied bandwidth;
Min-N dB = Minimum 6dB down bandwidth for 5.725-5.85GHz band / Maximum 26dB down bandwidth for other band;
Min-OBW = Minimum 99% occupied bandwidth



Result

Mode	Result	Limit (Hz)	Port 1-N dB (Hz)	Port 1-OBW (Hz)	Port 2-N dB (Hz)	Port 2-OBW (Hz)	Port 3-N dB (Hz)	Port 3-OBW (Hz)	Port 4-N dB (Hz)	Port 4-OBW (Hz)
802.11ax HEW20-BF_Nss1,(MCS0)_4TX	-	-	-	-	-	-	-	-	-	-
5180MHz	Pass	Inf	21.63M	19.027M	21.66M	18.982M	21.51M	18.993M	21.42M	18.978M
5200MHz	Pass	Inf	21.57M	18.952M	21.78M	18.95M	21.48M	18.978M	21.69M	18.991M
5240MHz	Pass	Inf	21.69M	18.98M	21.63M	18.979M	21.63M	19.02M	21.66M	19.006M
5745MHz	Pass	500k	18.96M	19.03M	18.96M	18.994M	18.93M	18.993M	18.99M	19.023M
5785MHz	Pass	500k	18.93M	18.992M	19.02M	18.998M	18.93M	18.972M	18.96M	19.005M
5825MHz	Pass	500k	19.02M	19.075M	18.87M	18.963M	18.93M	19.005M	18.93M	19.085M
802.11ax HEW40-BF_Nss1,(MCS0)_4TX	-	-	-	-	-	-	-	-	-	-
5190MHz	Pass	Inf	40.32M	37.73M	40.44M	37.806M	39.96M	37.714M	39.9M	37.774M
5230MHz	Pass	Inf	39.9M	37.69M	40.14M	37.799M	39.96M	37.756M	40.08M	37.818M
5755MHz	Pass	500k	37.68M	37.786M	37.2M	37.678M	37.98M	37.913M	37.5M	37.87M
5795MHz	Pass	500k	37.8M	37.691M	36.42M	37.461M	37.5M	37.823M	37.62M	37.885M
802.11ax HEW80-BF_Nss1,(MCS0)_4TX	-	-	-	-	-	-	-	-	-	-
5210MHz	Pass	Inf	80.76M	77.173M	81.12M	77.148M	80.88M	77.386M	81.96M	77.355M
5775MHz	Pass	500k	75.84M	77.495M	75.24M	77.194M	67.8M	77.381M	77.28M	77.379M

Port X-N dB = Port X 6dB down bandwidth for 5.725-5.85GHz band / 26dB down bandwidth for other band
 Port X-OBW = Port X 99% occupied bandwidth

802.11ax HEW20-BF_Nss1,(MCS0)_4TX

EBW

5180MHz

07/01/2021

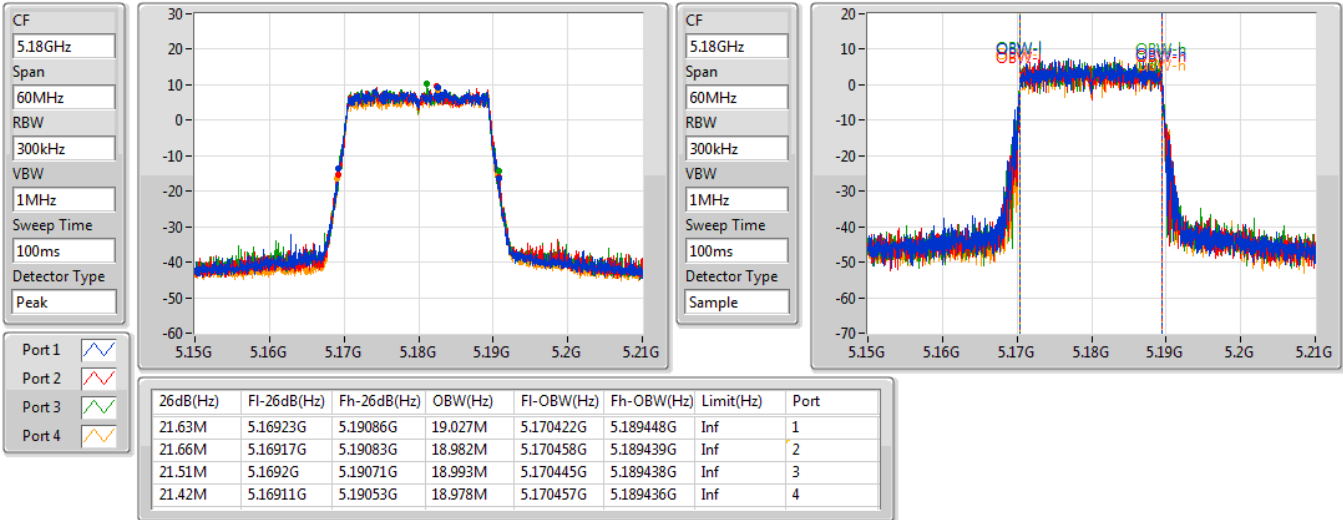

802.11ax HEW20-BF_Nss1,(MCS0)_4TX

EBW

5200MHz

07/01/2021

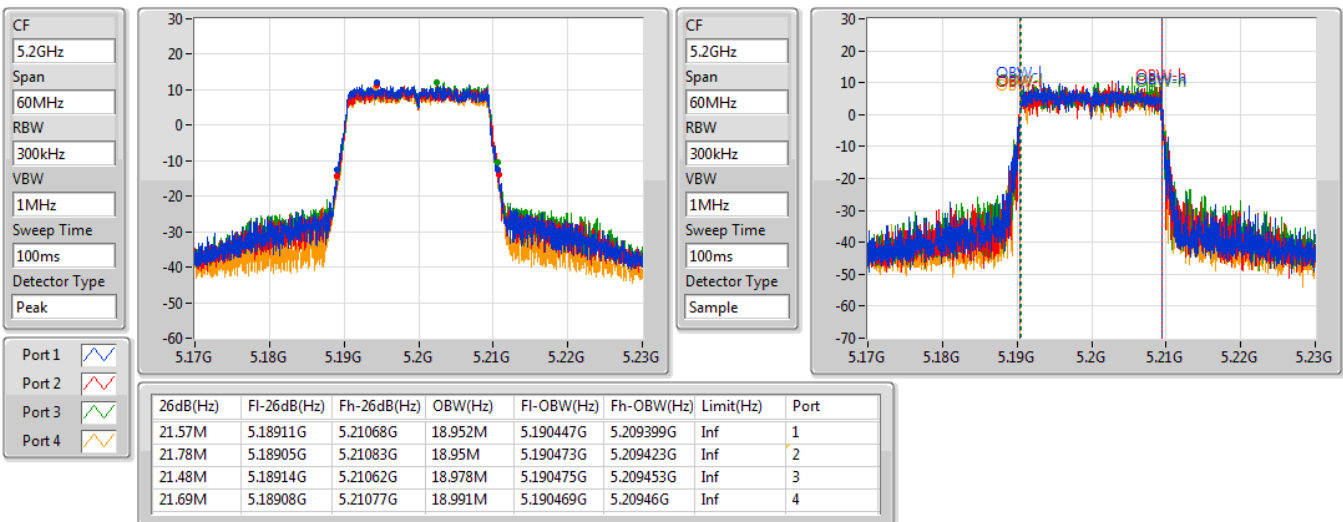

802.11ax HEW20-BF_Nss1,(MCS0)_4TX

EBW

5240MHz

07/01/2021

CF
5.24GHz
Span
60MHz
RBW
300kHz
VBW
1MHz
Sweep Time
100ms
Detector Type
Peak

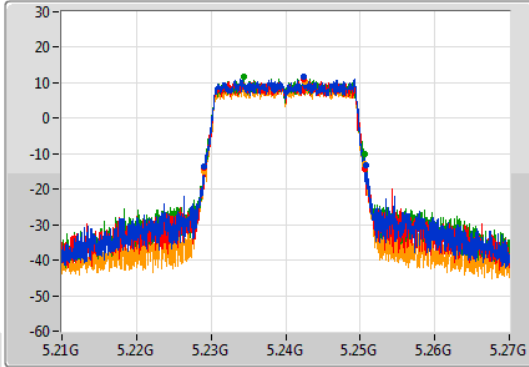

CF
5.24GHz
Span
60MHz
RBW
300kHz
VBW
1MHz
Sweep Time
100ms
Detector Type
Sample

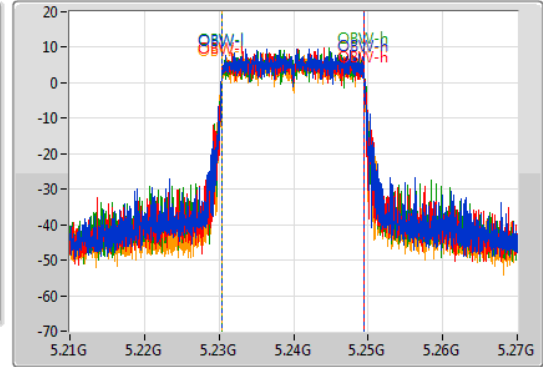

Port 1
Port 2
Port 3
Port 4

26dB(Hz)	Fl-26dB(Hz)	Fh-26dB(Hz)	OBW(Hz)	Fl-OBW(Hz)	Fh-OBW(Hz)	Limit(Hz)	Port
21.69M	5.22908G	5.25077G	18.98M	5.230449G	5.249429G	Inf	1
21.63M	5.22905G	5.25068G	18.979M	5.230445G	5.249424G	Inf	2
21.63M	5.22902G	5.25065G	19.02M	5.23043G	5.24945G	Inf	3
21.66M	5.22899G	5.25065G	19.006M	5.230437G	5.249443G	Inf	4

802.11ax HEW20-BF_Nss1,(MCS0)_4TX

EBW

5745MHz

08/01/2021

CF
5.745GHz
Span
60MHz
RBW
100kHz
VBW
300kHz
Sweep Time
100ms
Detector Type
Peak

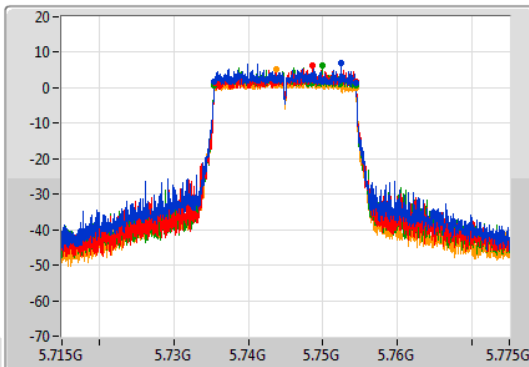

CF
5.745GHz
Span
60MHz
RBW
300kHz
VBW
1MHz
Sweep Time
100ms
Detector Type
Sample

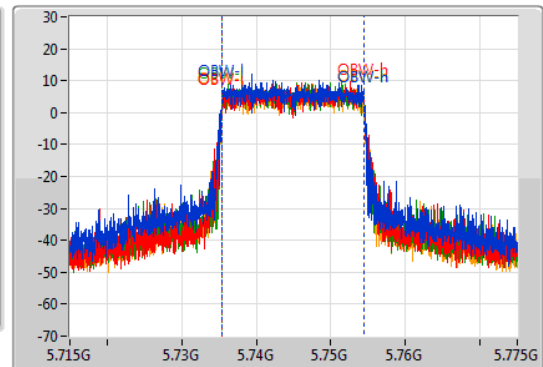

Port 1
Port 2
Port 3
Port 4

6dB(Hz)	Fl-6dB(Hz)	Fh-6dB(Hz)	OBW(Hz)	Fl-OBW(Hz)	Fh-OBW(Hz)	Limit(Hz)	Port
18.96M	5.73543G	5.75439G	19.03M	5.735399G	5.754429G	500k	1
18.96M	5.73549G	5.75445G	18.994M	5.735438G	5.754431G	500k	2
18.93M	5.73543G	5.75436G	18.993M	5.735446G	5.754439G	500k	3
18.99M	5.73543G	5.75442G	19.023M	5.735419G	5.754442G	500k	4

802.11ax HEW20-BF_Nss1,(MCS0)_4TX

EBW

5785MHz

08/01/2021

CF
5.785GHz
Span
60MHz
RBW
100kHz
VBW
300kHz
Sweep Time
100ms
Detector Type
Peak

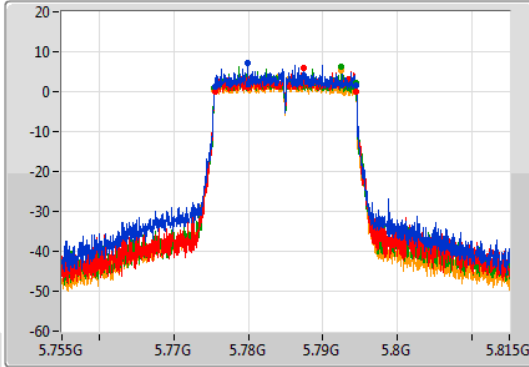

CF
5.785GHz
Span
60MHz
RBW
300kHz
VBW
1MHz
Sweep Time
100ms
Detector Type
Sample

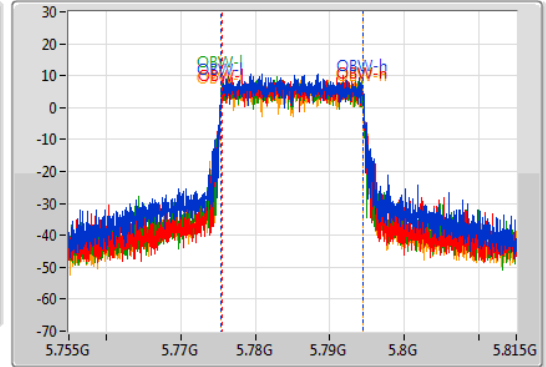

Port 1
Port 2
Port 3
Port 4

6dB(Hz)	Fl-6dB(Hz)	Fh-6dB(Hz)	OBW(Hz)	Fl-OBW(Hz)	Fh-OBW(Hz)	Limit(Hz)	Port
18.93M	5.77549G	5.79442G	18.992M	5.775459G	5.794451G	500k	1
19.02M	5.77549G	5.79451G	18.998M	5.775474G	5.794472G	500k	2
18.93M	5.77543G	5.79436G	18.972M	5.775447G	5.794419G	500k	3
18.96M	5.77543G	5.79439G	19.005M	5.775435G	5.79444G	500k	4

802.11ax HEW20-BF_Nss1,(MCS0)_4TX

EBW

5825MHz

08/01/2021

CF
5.825GHz
Span
60MHz
RBW
100kHz
VBW
300kHz
Sweep Time
100ms
Detector Type
Peak

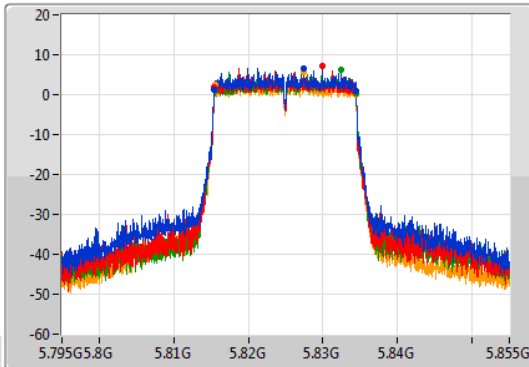

CF
5.825GHz
Span
60MHz
RBW
300kHz
VBW
1MHz
Sweep Time
100ms
Detector Type
Sample

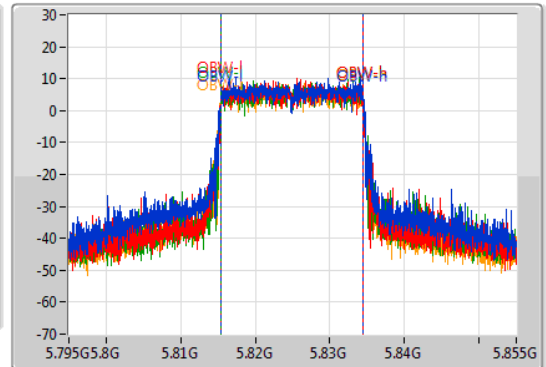

Port 1
Port 2
Port 3
Port 4

6dB(Hz)	Fl-6dB(Hz)	Fh-6dB(Hz)	OBW(Hz)	Fl-OBW(Hz)	Fh-OBW(Hz)	Limit(Hz)	Port
19.02M	5.81543G	5.83445G	19.075M	5.815414G	5.83449G	500k	1
18.87M	5.81546G	5.83433G	18.963M	5.815452G	5.834415G	500k	2
18.93M	5.81546G	5.83439G	19.005M	5.815439G	5.834444G	500k	3
18.93M	5.81549G	5.83442G	19.085M	5.815357G	5.834442G	500k	4

802.11ax HEW40-BF_Nss1,(MCS0)_4TX

EBW

5190MHz

08/01/2021

CF
5.19GHz
Span
120MHz
RBW
500kHz
VBW
2MHz
Sweep Time
100ms
Detector Type
Peak

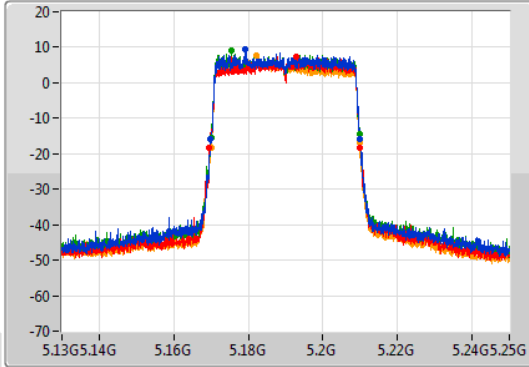

CF
5.19GHz
Span
120MHz
RBW
1MHz
VBW
3MHz
Sweep Time
100ms
Detector Type
Sample

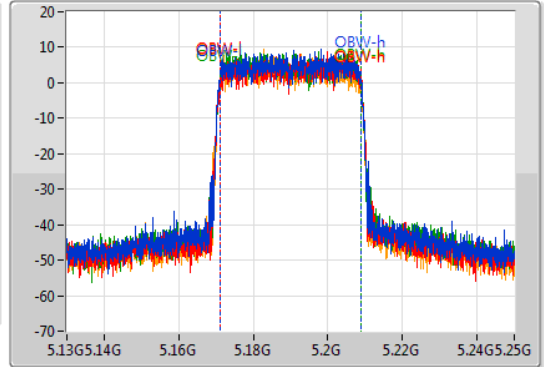

Port 1
Port 2
Port 3
Port 4

26dB(Hz)	Fl-26dB(Hz)	Fh-26dB(Hz)	OBW(Hz)	Fl-OBW(Hz)	Fh-OBW(Hz)	Limit(Hz)	Port
40.32M	5.16972G	5.21004G	37.73M	5.171011G	5.208741G	Inf	1
40.44M	5.1696G	5.21004G	37.806M	5.171089G	5.208895G	Inf	2
39.96M	5.16996G	5.20992G	37.714M	5.171057G	5.208771G	Inf	3
39.9M	5.16996G	5.20986G	37.774M	5.17105G	5.208824G	Inf	4

802.11ax HEW40-BF_Nss1,(MCS0)_4TX

EBW

5230MHz

08/01/2021

CF
5.23GHz
Span
120MHz
RBW
500kHz
VBW
2MHz
Sweep Time
100ms
Detector Type
Peak

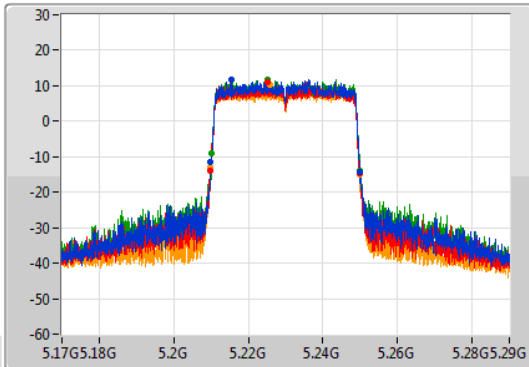

CF
5.23GHz
Span
120MHz
RBW
1MHz
VBW
3MHz
Sweep Time
100ms
Detector Type
Sample

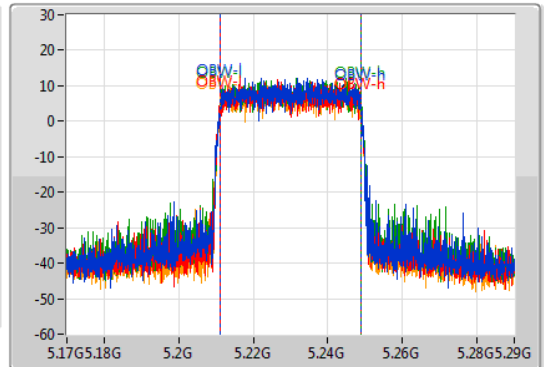

Port 1
Port 2
Port 3
Port 4

26dB(Hz)	Fl-26dB(Hz)	Fh-26dB(Hz)	OBW(Hz)	Fl-OBW(Hz)	Fh-OBW(Hz)	Limit(Hz)	Port
39.9M	5.20984G	5.24974G	37.69M	5.211089G	5.248779G	Inf	1
40.14M	5.2099G	5.25004G	37.799M	5.211001G	5.2488G	Inf	2
39.96M	5.21002G	5.24998G	37.756M	5.211075G	5.248831G	Inf	3
40.08M	5.20984G	5.24992G	37.818M	5.211084G	5.248902G	Inf	4

802.11ax HEW40-BF_Nss1,(MCS0)_4TX

EBW

5755MHz

08/01/2021

CF
5.755GHz
Span
120MHz
RBW
100kHz
VBW
300kHz
Sweep Time
100ms
Detector Type
Peak

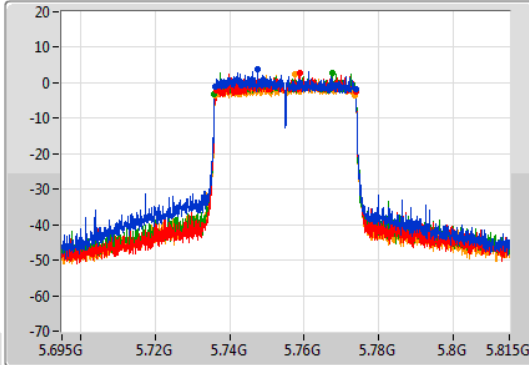

CF
5.755GHz
Span
120MHz
RBW
1MHz
VBW
3MHz
Sweep Time
100ms
Detector Type
Sample

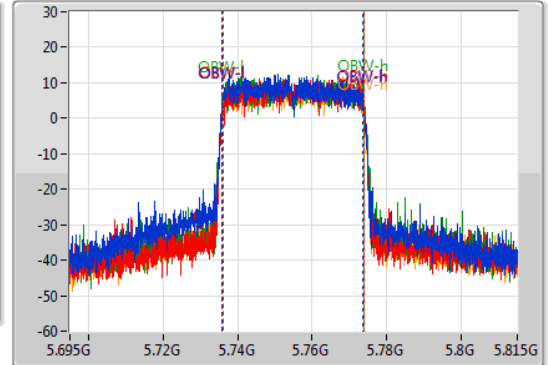

Port 1
Port 2
Port 3
Port 4

6dB(Hz)	Fl-6dB(Hz)	Fh-6dB(Hz)	OBW(Hz)	Fl-OBW(Hz)	Fh-OBW(Hz)	Limit(Hz)	Port
37.68M	5.73604G	5.77372G	37.786M	5.735881G	5.773666G	500k	1
37.2M	5.73658G	5.77378G	37.678M	5.736207G	5.773885G	500k	2
37.98M	5.73592G	5.7739G	37.913M	5.735931G	5.773844G	500k	3
37.5M	5.73616G	5.77366G	37.87M	5.736039G	5.773909G	500k	4

802.11ax HEW40-BF_Nss1,(MCS0)_4TX

EBW

5795MHz

08/01/2021

CF
5.795GHz
Span
120MHz
RBW
100kHz
VBW
300kHz
Sweep Time
100ms
Detector Type
Peak

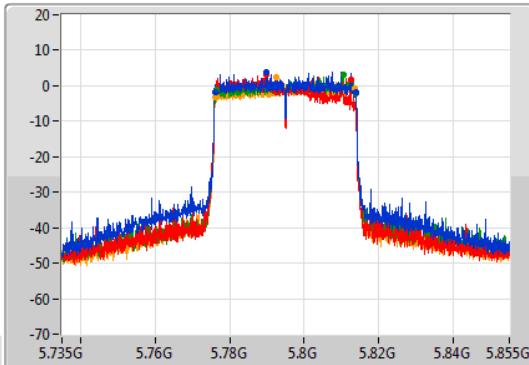

CF
5.795GHz
Span
120MHz
RBW
1MHz
VBW
3MHz
Sweep Time
100ms
Detector Type
Sample

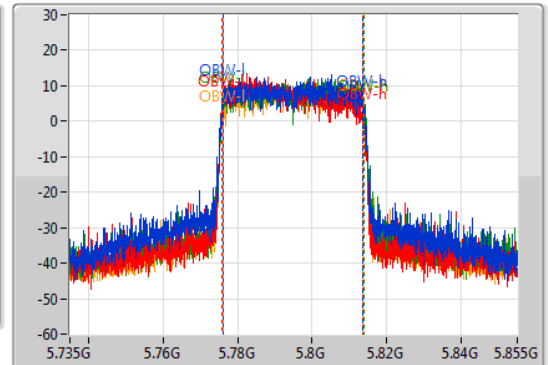

Port 1
Port 2
Port 3
Port 4

6dB(Hz)	Fl-6dB(Hz)	Fh-6dB(Hz)	OBW(Hz)	Fl-OBW(Hz)	Fh-OBW(Hz)	Limit(Hz)	Port
37.8M	5.77604G	5.81384G	37.691M	5.775979G	5.81367G	500k	1
36.42M	5.77604G	5.81246G	37.461M	5.775929G	5.81339G	500k	2
37.5M	5.7764G	5.8139G	37.823M	5.776038G	5.813861G	500k	3
37.62M	5.77604G	5.81366G	37.885M	5.776011G	5.813896G	500k	4

802.11ax HEW80-BF_Nss1,(MCS0)_4TX

EBW

5210MHz

08/01/2021

CF
5.21GHz
Span
240MHz
RBW
1MHz
VBW
3MHz
Sweep Time
100ms
Detector Type
Peak

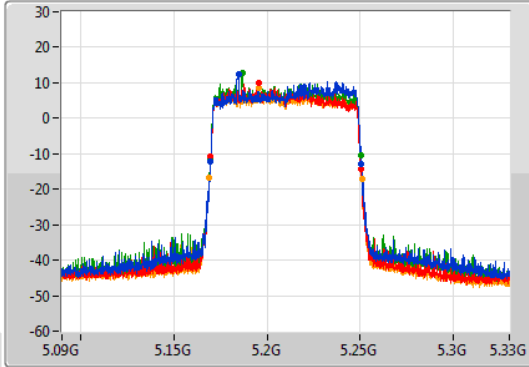

CF
5.21GHz
Span
240MHz
RBW
2MHz
VBW
8MHz
Sweep Time
100ms
Detector Type
Sample

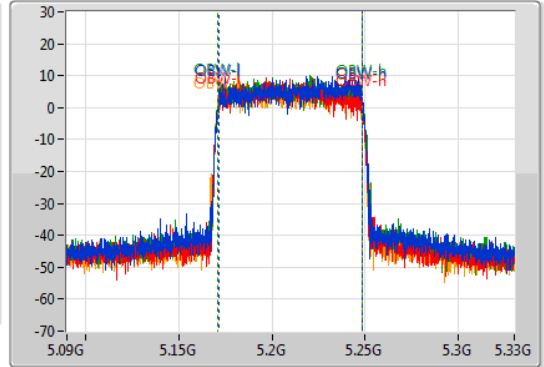

Port 1
Port 2
Port 3
Port 4

26dB(Hz)	Fl-26dB(Hz)	Fh-26dB(Hz)	OBW(Hz)	Fl-OBW(Hz)	Fh-OBW(Hz)	Limit(Hz)	Port
80.76M	5.1698G	5.25056G	77.173M	5.171439G	5.248612G	Inf	1
81.12M	5.16956G	5.25068G	77.148M	5.171276G	5.248424G	Inf	2
80.88M	5.16956G	5.25044G	77.386M	5.171145G	5.248531G	Inf	3
81.96M	5.16908G	5.25104G	77.355M	5.171092G	5.248447G	Inf	4

802.11ax HEW80-BF_Nss1,(MCS0)_4TX

EBW

5775MHz

08/01/2021

CF
5.775GHz
Span
240MHz
RBW
100kHz
VBW
300kHz
Sweep Time
100ms
Detector Type
Peak

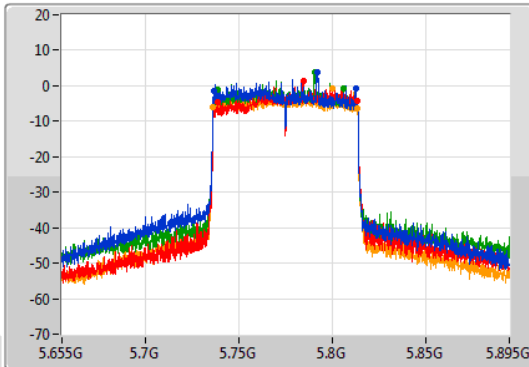

CF
5.775GHz
Span
240MHz
RBW
2MHz
VBW
8MHz
Sweep Time
100ms
Detector Type
Sample

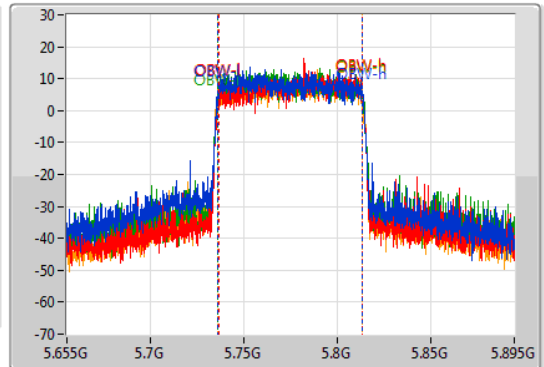

Port 1
Port 2
Port 3
Port 4

6dB(Hz)	Fl-6dB(Hz)	Fh-6dB(Hz)	OBW(Hz)	Fl-OBW(Hz)	Fh-OBW(Hz)	Limit(Hz)	Port
75.84M	5.7366G	5.81244G	77.495M	5.735968G	5.813463G	500k	1
75.24M	5.7384G	5.81364G	77.194M	5.736455G	5.813648G	500k	2
67.8M	5.7384G	5.8062G	77.381M	5.736168G	5.813549G	500k	3
77.28M	5.73612G	5.8134G	77.379M	5.736225G	5.813604G	500k	4



Summary

Mode	Max-N dB (Hz)	Max-OBW (Hz)	ITU-Code	Min-N dB (Hz)	Min-OBW (Hz)
5.15-5.25GHz	-	-	-	-	-
802.11ax HEW20-BF_Nss1,(MCS0)_2TX	39.9M	19.196M	19M2D1D	21.63M	19.016M
802.11ax HEW40-BF_Nss1,(MCS0)_2TX	65.28M	37.938M	37M9D1D	40.08M	37.738M
802.11ax HEW80-BF_Nss1,(MCS0)_2TX	81.12M	77.404M	77M4D1D	81M	77.285M
5.725-5.85GHz	-	-	-	-	-
802.11ax HEW20-BF_Nss1,(MCS0)_2TX	18.84M	25.656M	25M7D1D	18.54M	21.001M
802.11ax HEW40-BF_Nss1,(MCS0)_2TX	37.5M	48.149M	48M1D1D	34.38M	38.125M
802.11ax HEW80-BF_Nss1,(MCS0)_2TX	71.28M	77.563M	77M6D1D	43.8M	77.54M

Max-N dB = Maximum 6dB down bandwidth for 5.725-5.85GHz band / Maximum 26dB down bandwidth for other band;
Max-OBW = Maximum 99% occupied bandwidth;
Min-N dB = Minimum 6dB down bandwidth for 5.725-5.85GHz band / Maximum 26dB down bandwidth for other band;
Min-OBW = Minimum 99% occupied bandwidth



Result

Mode	Result	Limit (Hz)	Port 1-N dB (Hz)	Port 1-OBW (Hz)	Port 2-N dB (Hz)	Port 2-OBW (Hz)
802.11ax HEW20-BF_Nss1,(MCS0)_2TX	-	-	-	-	-	-
5180MHz	Pass	Inf	21.63M	19.024M	21.63M	19.032M
5200MHz	Pass	Inf	39.9M	19.133M	39.6M	19.196M
5240MHz	Pass	Inf	22.11M	19.019M	21.78M	19.016M
5745MHz	Pass	500k	18.78M	23.071M	18.54M	25.656M
5785MHz	Pass	500k	18.75M	22.088M	18.66M	24.801M
5825MHz	Pass	500k	18.84M	21.001M	18.78M	23.202M
802.11ax HEW40-BF_Nss1,(MCS0)_2TX	-	-	-	-	-	-
5190MHz	Pass	Inf	40.08M	37.738M	40.14M	37.822M
5230MHz	Pass	Inf	46.92M	37.769M	65.28M	37.938M
5755MHz	Pass	500k	37.32M	38.125M	37.32M	38.173M
5795MHz	Pass	500k	34.38M	46.597M	37.5M	48.149M
802.11ax HEW80-BF_Nss1,(MCS0)_2TX	-	-	-	-	-	-
5210MHz	Pass	Inf	81.12M	77.404M	81M	77.285M
5775MHz	Pass	500k	43.8M	77.563M	71.28M	77.54M

Port X-N dB = Port X 6dB down bandwidth for 5.725-5.85GHz band / 26dB down bandwidth for other band
 Port X-OBW = Port X 99% occupied bandwidth

802.11ax HEW20-BF_Nss1,(MCS0)_2TX

EBW

5180MHz

12/01/2021

CF: 5.18GHz
 Span: 60MHz
 RBW: 300kHz
 VBW: 1MHz
 Sweep Time: 100ms
 Detector Type: Peak

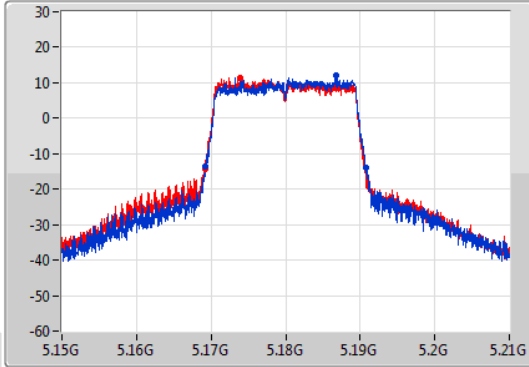

CF: 5.18GHz
 Span: 60MHz
 RBW: 300kHz
 VBW: 1MHz
 Sweep Time: 100ms
 Detector Type: Sample

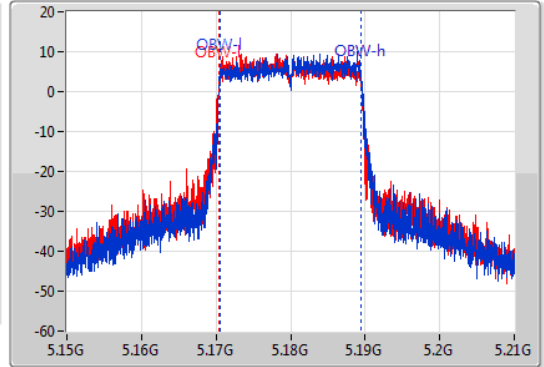

26dB(Hz)	Fl-26dB(Hz)	Fh-26dB(Hz)	OBW(Hz)	Fl-OBW(Hz)	Fh-OBW(Hz)	Limit(Hz)	Port
21.63M	5.16923G	5.19086G	19.024M	5.170486G	5.189511G	Inf	1
21.63M	5.16914G	5.19077G	19.032M	5.170411G	5.189444G	Inf	2

802.11ax HEW20-BF_Nss1,(MCS0)_2TX

EBW

5200MHz

12/01/2021

CF: 5.2GHz
 Span: 60MHz
 RBW: 300kHz
 VBW: 1MHz
 Sweep Time: 100ms
 Detector Type: Peak

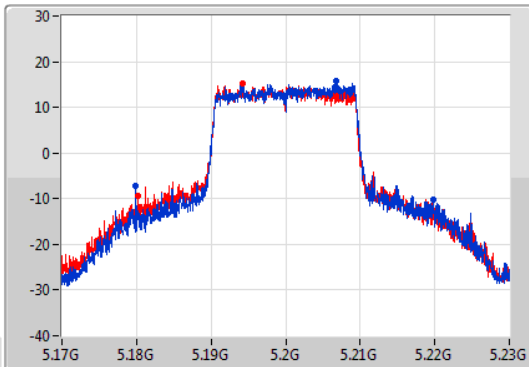

CF: 5.2GHz
 Span: 60MHz
 RBW: 300kHz
 VBW: 1MHz
 Sweep Time: 100ms
 Detector Type: Sample

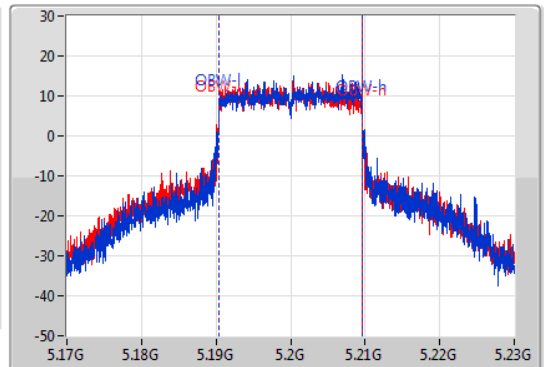

26dB(Hz)	Fl-26dB(Hz)	Fh-26dB(Hz)	OBW(Hz)	Fl-OBW(Hz)	Fh-OBW(Hz)	Limit(Hz)	Port
39.9M	5.17993G	5.21983G	19.133M	5.190434G	5.209567G	Inf	1
39.6M	5.18014G	5.21974G	19.196M	5.190334G	5.20953G	Inf	2

802.11ax HEW20-BF_Nss1,(MCS0)_2TX

EBW

5240MHz

12/01/2021

CF
5.24GHz
Span
60MHz
RBW
300kHz
VBW
1MHz
Sweep Time
100ms
Detector Type
Peak

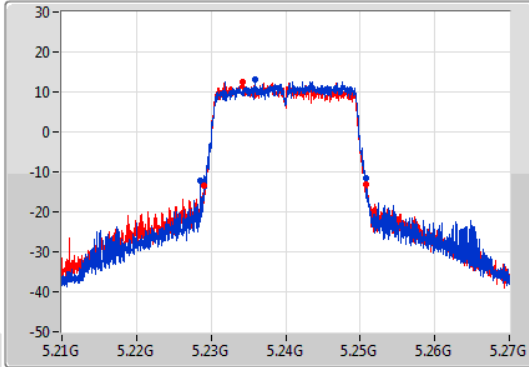

CF
5.24GHz
Span
60MHz
RBW
300kHz
VBW
1MHz
Sweep Time
100ms
Detector Type
Sample

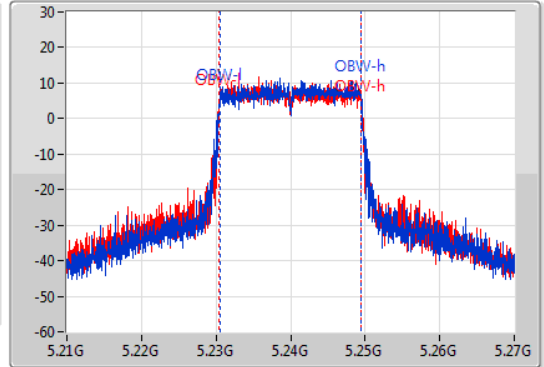

26dB(Hz)	Fl-26dB(Hz)	Fh-26dB(Hz)	OBW(Hz)	Fl-OBW(Hz)	Fh-OBW(Hz)	Limit(Hz)	Port
22.11M	5.2286G	5.25071G	19.019M	5.230489G	5.249508G	Inf	1
21.78M	5.22908G	5.25086G	19.016M	5.230451G	5.249467G	Inf	2

802.11ax HEW20-BF_Nss1,(MCS0)_2TX

EBW

5745MHz

13/01/2021

CF
5.745GHz
Span
60MHz
RBW
100kHz
VBW
300kHz
Sweep Time
100ms
Detector Type
Peak

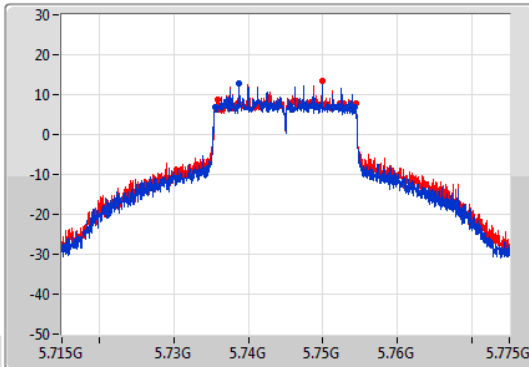

CF
5.745GHz
Span
60MHz
RBW
300kHz
VBW
1MHz
Sweep Time
100ms
Detector Type
Sample

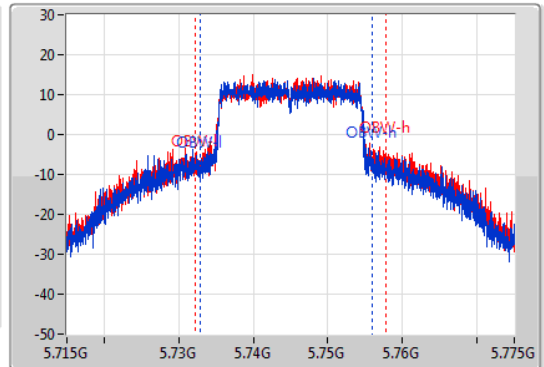

6dB(Hz)	Fl-6dB(Hz)	Fh-6dB(Hz)	OBW(Hz)	Fl-OBW(Hz)	Fh-OBW(Hz)	Limit(Hz)	Port
18.78M	5.73555G	5.75433G	23.071M	5.73287G	5.755941G	500k	1
18.54M	5.73582G	5.75436G	25.656M	5.73218G	5.757835G	500k	2

802.11ax HEW20-BF_Nss1,(MCS0)_2TX

EBW

5785MHz

13/01/2021

CF
5.785GHz
Span
60MHz
RBW
100kHz
VBW
300kHz
Sweep Time
100ms
Detector Type
Peak

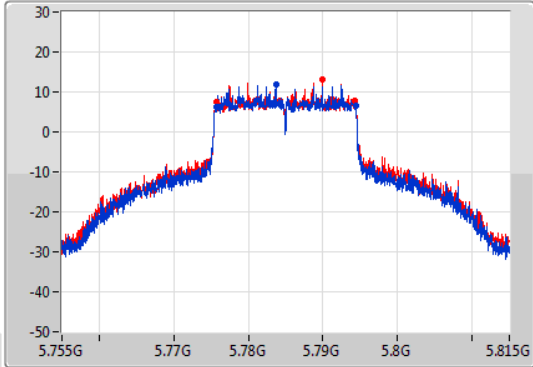

CF
5.785GHz
Span
60MHz
RBW
300kHz
VBW
1MHz
Sweep Time
100ms
Detector Type
Sample

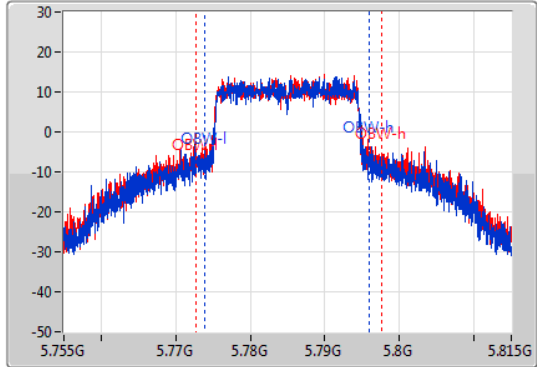

6dB(Hz)	Fl-6dB(Hz)	Fh-6dB(Hz)	OBW(Hz)	Fl-OBW(Hz)	Fh-OBW(Hz)	Limit(Hz)	Port
18.75M	5.77567G	5.79442G	22.088M	5.773886G	5.795973G	500k	1
18.66M	5.77567G	5.79433G	24.801M	5.772784G	5.797585G	500k	2

802.11ax HEW20-BF_Nss1,(MCS0)_2TX

EBW

5825MHz

13/01/2021

CF
5.825GHz
Span
60MHz
RBW
100kHz
VBW
300kHz
Sweep Time
100ms
Detector Type
Peak

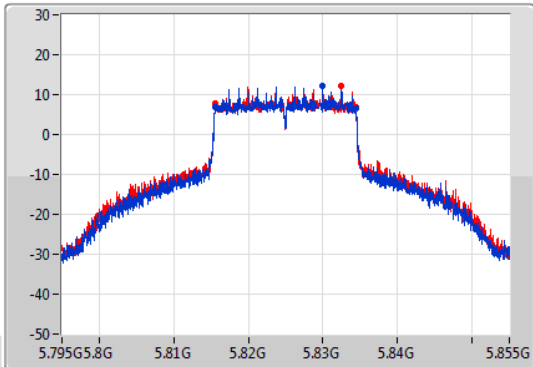

CF
5.825GHz
Span
60MHz
RBW
300kHz
VBW
1MHz
Sweep Time
100ms
Detector Type
Sample

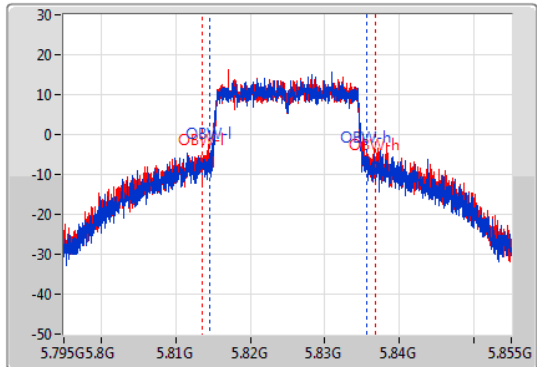

6dB(Hz)	Fl-6dB(Hz)	Fh-6dB(Hz)	OBW(Hz)	Fl-OBW(Hz)	Fh-OBW(Hz)	Limit(Hz)	Port
18.84M	5.81555G	5.83439G	21.001M	5.814595G	5.835595G	500k	1
18.78M	5.81558G	5.83436G	23.202M	5.813558G	5.83676G	500k	2

802.11ax HEW40-BF_Nss1,(MCS0)_2TX

EBW

5190MHz

13/01/2021

CF
5.19GHz
Span
120MHz
RBW
500kHz
VBW
2MHz
Sweep Time
100ms
Detector Type
Peak

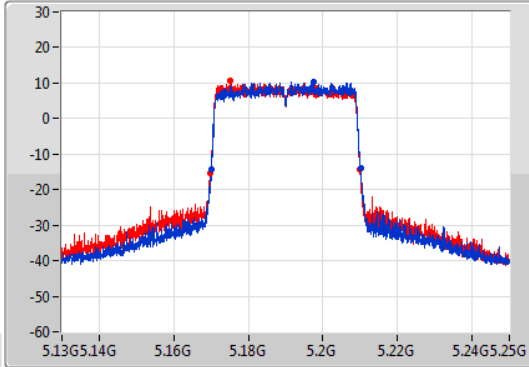

CF
5.19GHz
Span
120MHz
RBW
1MHz
VBW
3MHz
Sweep Time
100ms
Detector Type
Sample

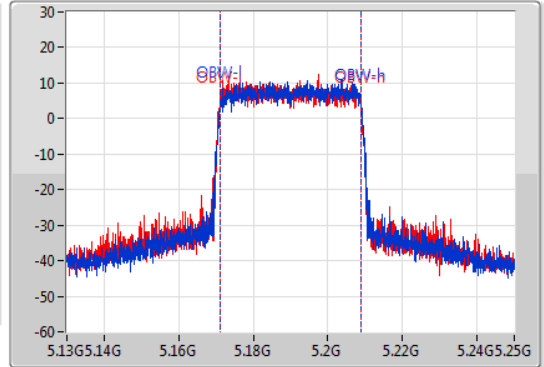

26dB(Hz)	Fl-26dB(Hz)	Fh-26dB(Hz)	OBW(Hz)	Fl-OBW(Hz)	Fh-OBW(Hz)	Limit(Hz)	Port
40.08M	5.17002G	5.2101G	37.738M	5.171194G	5.208932G	Inf	1
40.14M	5.16984G	5.20998G	37.822M	5.171018G	5.20884G	Inf	2

802.11ax HEW40-BF_Nss1,(MCS0)_2TX

EBW

5230MHz

13/01/2021

CF
5.23GHz
Span
120MHz
RBW
500kHz
VBW
2MHz
Sweep Time
100ms
Detector Type
Peak

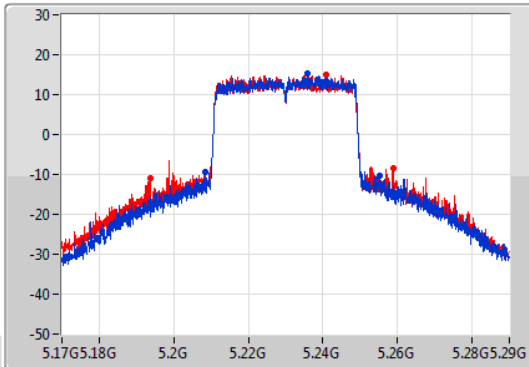

CF
5.23GHz
Span
120MHz
RBW
1MHz
VBW
3MHz
Sweep Time
100ms
Detector Type
Sample

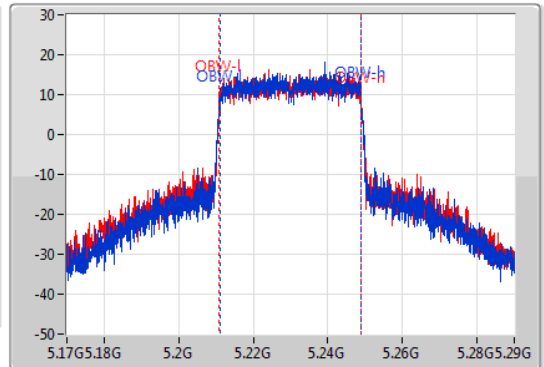

26dB(Hz)	Fl-26dB(Hz)	Fh-26dB(Hz)	OBW(Hz)	Fl-OBW(Hz)	Fh-OBW(Hz)	Limit(Hz)	Port
46.92M	5.2084G	5.25532G	37.769M	5.21111G	5.248879G	Inf	1
65.28M	5.19358G	5.25886G	37.938M	5.210925G	5.248863G	Inf	2

802.11ax HEW40-BF_Nss1,(MCS0)_2TX

EBW

5755MHz

13/01/2021

CF
5.755GHz
Span
120MHz
RBW
100kHz
VBW
300kHz
Sweep Time
100ms
Detector Type
Peak

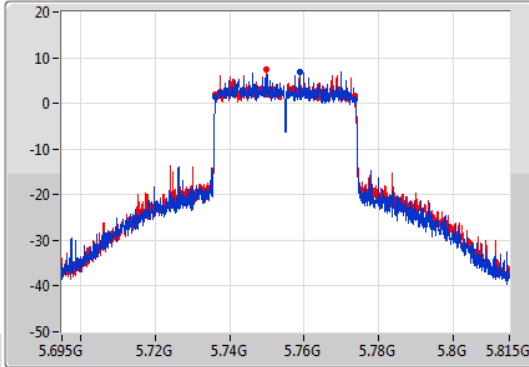

CF
5.755GHz
Span
120MHz
RBW
1MHz
VBW
3MHz
Sweep Time
100ms
Detector Type
Sample

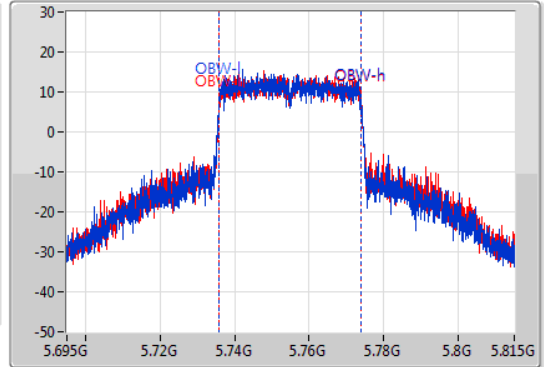

6dB(Hz)	Fl-6dB(Hz)	Fh-6dB(Hz)	OBW(Hz)	Fl-OBW(Hz)	Fh-OBW(Hz)	Limit(Hz)	Port
37.32M	5.73622G	5.77354G	38.125M	5.735837G	5.773962G	500k	1
37.32M	5.73622G	5.77354G	38.173M	5.73586G	5.774033G	500k	2

802.11ax HEW40-BF_Nss1,(MCS0)_2TX

EBW

5795MHz

13/01/2021

CF
5.795GHz
Span
120MHz
RBW
100kHz
VBW
300kHz
Sweep Time
100ms
Detector Type
Peak

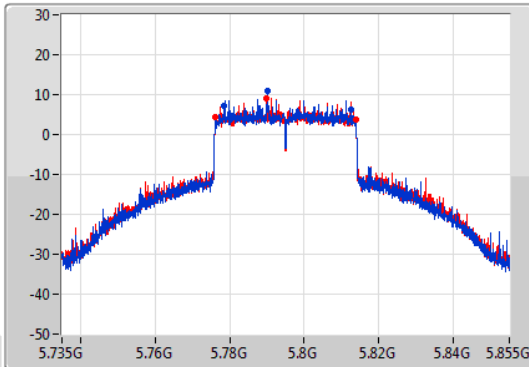

CF
5.795GHz
Span
120MHz
RBW
1MHz
VBW
3MHz
Sweep Time
100ms
Detector Type
Sample

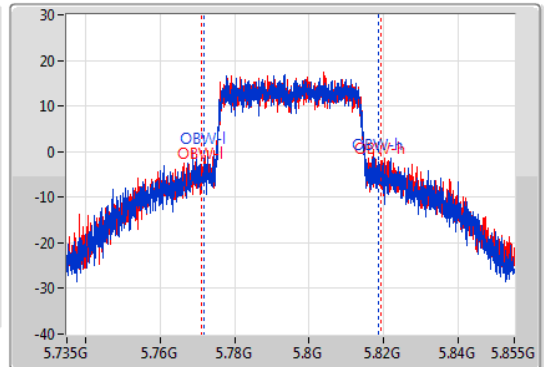

6dB(Hz)	Fl-6dB(Hz)	Fh-6dB(Hz)	OBW(Hz)	Fl-OBW(Hz)	Fh-OBW(Hz)	Limit(Hz)	Port
34.38M	5.77832G	5.8127G	46.597M	5.771818G	5.818415G	500k	1
37.5M	5.77622G	5.81372G	48.149M	5.771147G	5.819295G	500k	2

802.11ax HEW80-BF_Nss1,(MCS0)_2TX

EBW

5210MHz

13/01/2021

CF
5.21GHz
Span
240MHz
RBW
1MHz
VBW
3MHz
Sweep Time
100ms
Detector Type
Peak

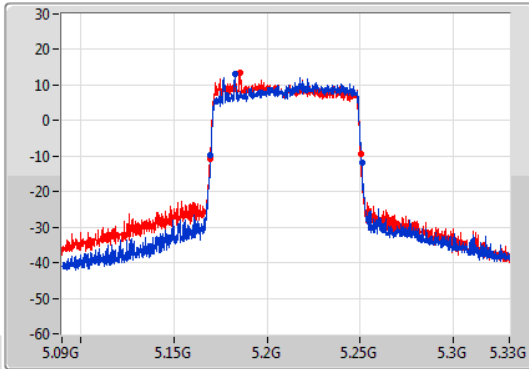

CF
5.21GHz
Span
240MHz
RBW
2MHz
VBW
8MHz
Sweep Time
100ms
Detector Type
Sample

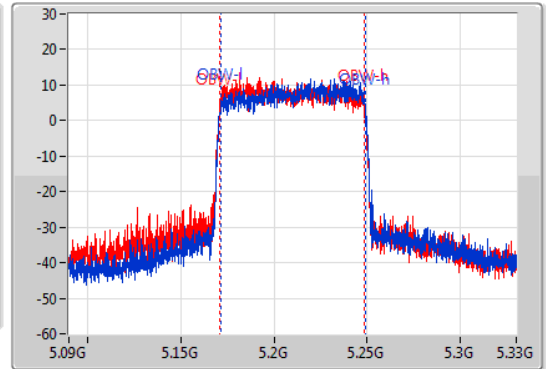

26dB(Hz)	Fl-26dB(Hz)	Fh-26dB(Hz)	OBW(Hz)	Fl-OBW(Hz)	Fh-OBW(Hz)	Limit(Hz)	Port
81.12M	5.1698G	5.25092G	77.404M	5.171439G	5.248843G	Inf	1
81M	5.16944G	5.25044G	77.285M	5.171212G	5.248497G	Inf	2

802.11ax HEW80-BF_Nss1,(MCS0)_2TX

EBW

5775MHz

13/01/2021

CF
5.775GHz
Span
240MHz
RBW
100kHz
VBW
300kHz
Sweep Time
100ms
Detector Type
Peak

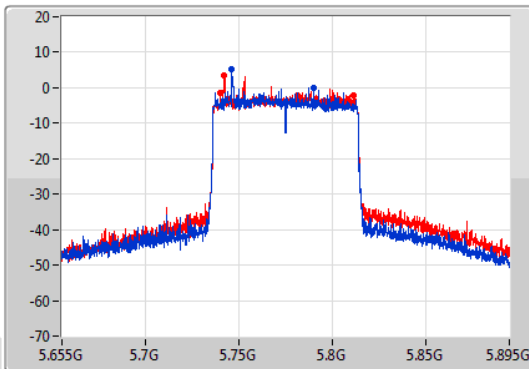

CF
5.775GHz
Span
240MHz
RBW
2MHz
VBW
8MHz
Sweep Time
100ms
Detector Type
Sample

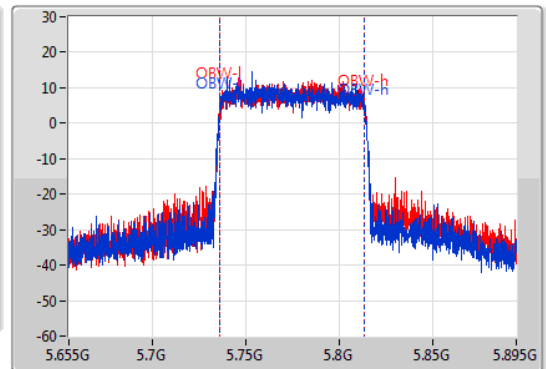

6dB(Hz)	Fl-6dB(Hz)	Fh-6dB(Hz)	OBW(Hz)	Fl-OBW(Hz)	Fh-OBW(Hz)	Limit(Hz)	Port
43.8M	5.7462G	5.79G	77.563M	5.736072G	5.813635G	500k	1
71.28M	5.73996G	5.81124G	77.54M	5.736152G	5.813692G	500k	2



Summary

Mode	Total Power (dBm)	Total Power (W)	EIRP (dBm)	EIRP (W)
5.725-5.85GHz	-	-	-	-
802.11a_Nss1,(6Mbps)_4TX	28.27	0.67143	34.77	2.99916
802.11n HT20_Nss1,(MCS0)_4TX	27.72	0.59156	34.22	2.64241
802.11n HT40_Nss1,(MCS0)_4TX	27.47	0.55847	33.97	2.49459
802.11ac VHT20_Nss1,(MCS0)_4TX	27.89	0.61518	34.39	2.74789
802.11ac VHT40_Nss1,(MCS0)_4TX	27.67	0.58479	34.17	2.61216
802.11ac VHT80_Nss1,(MCS0)_4TX	23.73	0.23605	30.23	1.05439
802.11ax HEW20_Nss1,(MCS0)_4TX	28.18	0.65766	34.68	2.93765
802.11ax HEW40_Nss1,(MCS0)_4TX	27.93	0.62087	34.43	2.77332
802.11ax HEW80_Nss1,(MCS0)_4TX	23.99	0.25061	30.49	1.11944



Result

Mode	Result	DG (dBi)	Port 1 (dBm)	Port 2 (dBm)	Port 3 (dBm)	Port 4 (dBm)	Total Power (dBm)	Power Limit (dBm)	EIRP (dBm)	EIRP Limit (dBm)
802.11a_Nss1,(6Mbps)_4TX	-	-	-	-	-	-	-	-	-	-
5745MHz	Pass	6.50	22.35	21.05	22.01	23.29	28.27	29.50	34.77	36.00
5785MHz	Pass	6.50	22.31	21.02	22.10	23.19	28.24	29.50	34.74	36.00
5825MHz	Pass	6.50	21.62	20.29	21.41	22.40	27.51	29.50	34.01	36.00
802.11n HT20_Nss1,(MCS0)_4TX	-	-	-	-	-	-	-	-	-	-
5745MHz	Pass	6.50	21.57	21.02	21.58	22.49	27.72	29.50	34.22	36.00
5785MHz	Pass	6.50	20.88	19.80	20.78	21.44	26.78	29.50	33.28	36.00
5825MHz	Pass	6.50	20.68	19.87	20.84	21.70	26.84	29.50	33.34	36.00
802.11n HT40_Nss1,(MCS0)_4TX	-	-	-	-	-	-	-	-	-	-
5755MHz	Pass	6.50	21.77	21.33	21.02	21.65	27.47	29.50	33.97	36.00
5795MHz	Pass	6.50	21.74	21.03	21.13	21.71	27.44	29.50	33.94	36.00
802.11ac VHT20_Nss1,(MCS0)_4TX	-	-	-	-	-	-	-	-	-	-
5745MHz	Pass	6.50	22.01	21.03	21.42	22.81	27.89	29.50	34.39	36.00
5785MHz	Pass	6.50	20.84	20.12	20.94	21.79	26.98	29.50	33.48	36.00
5825MHz	Pass	6.50	20.83	20.05	20.97	21.96	27.03	29.50	33.53	36.00
802.11ac VHT40_Nss1,(MCS0)_4TX	-	-	-	-	-	-	-	-	-	-
5755MHz	Pass	6.50	21.84	21.57	21.35	21.81	27.67	29.50	34.17	36.00
5795MHz	Pass	6.50	21.81	21.47	21.14	21.90	27.61	29.50	34.11	36.00
802.11ac VHT80_Nss1,(MCS0)_4TX	-	-	-	-	-	-	-	-	-	-
5775MHz	Pass	6.50	17.68	17.64	17.61	17.91	23.73	29.50	30.23	36.00
802.11ax HEW20_Nss1,(MCS0)_4TX	-	-	-	-	-	-	-	-	-	-
5745MHz	Pass	6.50	22.22	21.46	21.76	23.04	28.18	29.50	34.68	36.00
5785MHz	Pass	6.50	21.22	20.35	21.17	22.05	27.26	29.50	33.76	36.00
5825MHz	Pass	6.50	21.07	20.08	21.22	22.28	27.25	29.50	33.75	36.00
802.11ax HEW40_Nss1,(MCS0)_4TX	-	-	-	-	-	-	-	-	-	-
5755MHz	Pass	6.50	22.09	21.78	21.47	22.25	27.93	29.50	34.43	36.00
5795MHz	Pass	6.50	22.04	21.47	21.59	22.13	27.84	29.50	34.34	36.00
802.11ax HEW80_Nss1,(MCS0)_4TX	-	-	-	-	-	-	-	-	-	-
5775MHz	Pass	6.50	17.79	17.89	18.04	18.14	23.99	29.50	30.49	36.00

DG = Directional Gain; Port X = Port X output power



Summary

Mode	Total Power (dBm)	Total Power (W)	EIRP (dBm)	EIRP (W)
5.15-5.25GHz	-	-	-	-
802.11a_Nss1,(6Mbps)_4TX	25.37	0.34435	30.77	1.19399
802.11n HT20_Nss1,(MCS0)_4TX	24.12	0.25823	29.52	0.89536
802.11n HT40_Nss1,(MCS0)_4TX	23.93	0.24717	29.33	0.85704
802.11ac VHT20_Nss1,(MCS0)_4TX	24.29	0.26853	29.69	0.93111
802.11ac VHT40_Nss1,(MCS0)_4TX	24.19	0.26242	29.59	0.90991
802.11ac VHT80_Nss1,(MCS0)_4TX	19.69	0.09311	25.09	0.32285
802.11ax HEW20_Nss1,(MCS0)_4TX	24.55	0.28510	29.95	0.98855
802.11ax HEW40_Nss1,(MCS0)_4TX	24.58	0.28708	29.98	0.99541
802.11ax HEW80_Nss1,(MCS0)_4TX	19.85	0.09661	25.25	0.33497
5.725-5.85GHz	-	-	-	-
802.11a_Nss1,(6Mbps)_4TX	29.96	0.99083	35.36	3.43558
802.11n HT20_Nss1,(MCS0)_4TX	29.51	0.89331	34.91	3.09742
802.11n HT40_Nss1,(MCS0)_4TX	28.77	0.75336	34.17	2.61216
802.11ac VHT20_Nss1,(MCS0)_4TX	29.62	0.91622	35.02	3.17687
802.11ac VHT40_Nss1,(MCS0)_4TX	28.84	0.76560	34.24	2.65461
802.11ac VHT80_Nss1,(MCS0)_4TX	24.21	0.26363	29.61	0.91411
802.11ax HEW20_Nss1,(MCS0)_4TX	29.94	0.98628	35.34	3.41979
802.11ax HEW40_Nss1,(MCS0)_4TX	29.09	0.81096	34.49	2.81190
802.11ax HEW80_Nss1,(MCS0)_4TX	24.47	0.27990	29.87	0.97051



Average Power_Non-Beamforming_Radio 2

Appendix C.2

Result

Mode	Result	DG (dBi)	Port 1 (dBm)	Port 2 (dBm)	Port 3 (dBm)	Port 4 (dBm)	Total Power (dBm)	Power Limit (dBm)	EIRP (dBm)	EIRP Limit (dBm)
802.11a_Nss1,(6Mbps)_4TX	-	-	-	-	-	-	-	-	-	-
5180MHz	Pass	5.40	17.82	16.70	17.58	17.83	23.53	30.00	28.93	36.00
5200MHz	Pass	5.40	19.59	18.44	19.56	19.71	25.37	30.00	30.77	36.00
5240MHz	Pass	5.40	19.10	18.22	19.18	19.25	24.98	30.00	30.38	36.00
5745MHz	Pass	5.40	24.00	23.36	23.69	22.87	29.52	30.00	34.92	36.00
5785MHz	Pass	5.40	24.20	23.74	23.96	23.43	29.86	30.00	35.26	36.00
5825MHz	Pass	5.40	24.07	23.63	24.09	23.95	29.96	30.00	35.36	36.00
802.11n HT20_Nss1,(MCS0)_4TX	-	-	-	-	-	-	-	-	-	-
5180MHz	Pass	5.40	14.82	15.36	15.47	15.79	21.39	30.00	26.79	36.00
5200MHz	Pass	5.40	17.73	18.07	18.02	18.54	24.12	30.00	29.52	36.00
5240MHz	Pass	5.40	17.51	18.26	18.08	18.30	24.07	30.00	29.47	36.00
5745MHz	Pass	5.40	23.27	23.81	23.67	23.16	29.51	30.00	34.91	36.00
5785MHz	Pass	5.40	23.13	23.62	23.47	23.02	29.34	30.00	34.74	36.00
5825MHz	Pass	5.40	23.33	23.69	23.33	23.11	29.39	30.00	34.79	36.00
802.11n HT40_Nss1,(MCS0)_4TX	-	-	-	-	-	-	-	-	-	-
5190MHz	Pass	5.40	12.84	12.76	12.66	13.32	18.92	30.00	24.32	36.00
5230MHz	Pass	5.40	17.89	18.01	17.61	18.13	23.93	30.00	29.33	36.00
5755MHz	Pass	5.40	21.93	21.95	21.59	21.32	27.73	30.00	33.13	36.00
5795MHz	Pass	5.40	23.20	22.91	22.37	22.45	28.77	30.00	34.17	36.00
802.11ac VHT20_Nss1,(MCS0)_4TX	-	-	-	-	-	-	-	-	-	-
5180MHz	Pass	5.40	15.08	15.61	15.59	16.16	21.65	30.00	27.05	36.00
5200MHz	Pass	5.40	17.73	18.29	18.28	18.62	24.26	30.00	29.66	36.00
5240MHz	Pass	5.40	17.74	18.39	18.19	18.70	24.29	30.00	29.69	36.00
5745MHz	Pass	5.40	23.38	24.11	23.82	23.00	29.62	30.00	35.02	36.00
5785MHz	Pass	5.40	22.59	23.84	23.61	23.34	29.39	30.00	34.79	36.00
5825MHz	Pass	5.40	23.23	23.71	23.55	23.17	29.44	30.00	34.84	36.00
802.11ac VHT40_Nss1,(MCS0)_4TX	-	-	-	-	-	-	-	-	-	-
5190MHz	Pass	5.40	12.94	13.01	12.69	13.36	19.03	30.00	24.43	36.00
5230MHz	Pass	5.40	18.23	18.05	17.96	18.43	24.19	30.00	29.59	36.00
5755MHz	Pass	5.40	21.87	22.07	21.59	21.46	27.77	30.00	33.17	36.00
5795MHz	Pass	5.40	23.15	22.87	22.52	22.71	28.84	30.00	34.24	36.00
802.11ac VHT80_Nss1,(MCS0)_4TX	-	-	-	-	-	-	-	-	-	-
5210MHz	Pass	5.40	13.39	13.66	13.60	14.02	19.69	30.00	25.09	36.00
5775MHz	Pass	5.40	18.07	18.56	18.05	18.05	24.21	30.00	29.61	36.00
802.11ax HEW20_Nss1,(MCS0)_4TX	-	-	-	-	-	-	-	-	-	-
5180MHz	Pass	5.40	15.48	15.87	15.81	16.40	21.92	30.00	27.32	36.00
5200MHz	Pass	5.40	18.05	18.68	18.38	18.97	24.55	30.00	29.95	36.00
5240MHz	Pass	5.40	17.97	18.86	18.36	18.86	24.55	30.00	29.95	36.00
5745MHz	Pass	5.40	24.31	23.67	24.25	23.37	29.94	30.00	35.34	36.00
5785MHz	Pass	5.40	24.07	23.86	24.17	23.56	29.94	30.00	35.34	36.00
5825MHz	Pass	5.40	23.89	23.74	24.05	23.77	29.88	30.00	35.28	36.00
802.11ax HEW40_Nss1,(MCS0)_4TX	-	-	-	-	-	-	-	-	-	-
5190MHz	Pass	5.40	13.60	12.66	13.71	13.84	19.50	30.00	24.90	36.00
5230MHz	Pass	5.40	18.56	18.11	18.82	18.70	24.58	30.00	29.98	36.00
5755MHz	Pass	5.40	22.11	22.00	21.40	21.67	27.82	30.00	33.22	36.00
5795MHz	Pass	5.40	23.51	23.00	22.82	22.92	29.09	30.00	34.49	36.00
802.11ax HEW80_Nss1,(MCS0)_4TX	-	-	-	-	-	-	-	-	-	-
5210MHz	Pass	5.40	13.72	13.73	13.88	13.97	19.85	30.00	25.25	36.00
5775MHz	Pass	5.40	18.48	18.62	18.23	18.44	24.47	30.00	29.87	36.00

DG = Directional Gain; Port X = Port X output power



Summary

Mode	Total Power (dBm)	Total Power (W)	EIRP (dBm)	EIRP (W)
5.15-5.25GHz	-	-	-	-
802.11a_Nss1,(6Mbps)_2TX	23.19	0.20845	29.39	0.86896
802.11n HT20_Nss1,(MCS0)_2TX	23.29	0.21330	29.49	0.88920
802.11n HT40_Nss1,(MCS0)_2TX	23.23	0.21038	29.43	0.87700
802.11ac VHT20_Nss1,(MCS0)_2TX	23.40	0.21878	29.60	0.91201
802.11ac VHT40_Nss1,(MCS0)_2TX	23.30	0.21380	29.50	0.89125
802.11ac VHT80_Nss1,(MCS0)_2TX	19.24	0.08395	25.44	0.34995
802.11ax HEW20_Nss1,(MCS0)_2TX	23.49	0.22336	29.69	0.93111
802.11ax HEW40_Nss1,(MCS0)_2TX	23.44	0.22080	29.64	0.92045
802.11ax HEW80_Nss1,(MCS0)_2TX	19.56	0.09036	25.76	0.37670
5.725-5.85GHz	-	-	-	-
802.11a_Nss1,(6Mbps)_2TX	25.95	0.39355	32.15	1.64059
802.11n HT20_Nss1,(MCS0)_2TX	26.15	0.41210	32.35	1.71791
802.11n HT40_Nss1,(MCS0)_2TX	26.40	0.43652	32.60	1.81970
802.11ac VHT20_Nss1,(MCS0)_2TX	26.18	0.41495	32.38	1.72982
802.11ac VHT40_Nss1,(MCS0)_2TX	26.40	0.43652	32.60	1.81970
802.11ac VHT80_Nss1,(MCS0)_2TX	20.43	0.11041	26.63	0.46026
802.11ax HEW20_Nss1,(MCS0)_2TX	26.23	0.41976	32.43	1.74985
802.11ax HEW40_Nss1,(MCS0)_2TX	26.53	0.44978	32.73	1.87499
802.11ax HEW80_Nss1,(MCS0)_2TX	20.62	0.11535	26.82	0.48084



Average Power_Non-Beamforming_Radio 3

Appendix C.3

Result

Mode	Result	DG (dBi)	Port 1 (dBm)	Port 2 (dBm)	Total Power (dBm)	Power Limit (dBm)	EIRP (dBm)	EIRP Limit (dBm)
802.11a_Nss1,(6Mbps)_2TX	-	-	-	-	-	-	-	-
5180MHz	Pass	6.20	17.47	17.92	20.71	29.80	26.91	36.00
5200MHz	Pass	6.20	20.00	20.35	23.19	29.80	29.39	36.00
5240MHz	Pass	6.20	19.96	20.19	23.09	29.80	29.29	36.00
5745MHz	Pass	6.20	20.51	21.55	24.07	29.80	30.27	36.00
5785MHz	Pass	6.20	22.51	23.33	25.95	29.80	32.15	36.00
5825MHz	Pass	6.20	21.16	21.85	24.53	29.80	30.73	36.00
802.11n HT20_Nss1,(MCS0)_2TX	-	-	-	-	-	-	-	-
5180MHz	Pass	6.20	17.90	18.28	21.10	29.80	27.30	36.00
5200MHz	Pass	6.20	20.02	20.09	23.07	29.80	29.27	36.00
5240MHz	Pass	6.20	20.30	20.26	23.29	29.80	29.49	36.00
5745MHz	Pass	6.20	21.01	22.09	24.59	29.80	30.79	36.00
5785MHz	Pass	6.20	22.75	23.49	26.15	29.80	32.35	36.00
5825MHz	Pass	6.20	21.12	21.90	24.54	29.80	30.74	36.00
802.11n HT40_Nss1,(MCS0)_2TX	-	-	-	-	-	-	-	-
5190MHz	Pass	6.20	15.22	15.60	18.42	29.80	24.62	36.00
5230MHz	Pass	6.20	20.12	20.32	23.23	29.80	29.43	36.00
5755MHz	Pass	6.20	20.83	21.91	24.41	29.80	30.61	36.00
5795MHz	Pass	6.20	22.96	23.78	26.40	29.80	32.60	36.00
802.11ac VHT20_Nss1,(MCS0)_2TX	-	-	-	-	-	-	-	-
5180MHz	Pass	6.20	18.01	18.31	21.17	29.80	27.37	36.00
5200MHz	Pass	6.20	20.03	20.38	23.22	29.80	29.42	36.00
5240MHz	Pass	6.20	20.29	20.49	23.40	29.80	29.60	36.00
5745MHz	Pass	6.20	21.12	22.15	24.68	29.80	30.88	36.00
5785MHz	Pass	6.20	22.67	23.61	26.18	29.80	32.38	36.00
5825MHz	Pass	6.20	21.21	22.03	24.65	29.80	30.85	36.00
802.11ac VHT40_Nss1,(MCS0)_2TX	-	-	-	-	-	-	-	-
5190MHz	Pass	6.20	15.56	15.87	18.73	29.80	24.93	36.00
5230MHz	Pass	6.20	20.09	20.49	23.30	29.80	29.50	36.00
5755MHz	Pass	6.20	20.89	22.02	24.50	29.80	30.70	36.00
5795MHz	Pass	6.20	22.95	23.79	26.40	29.80	32.60	36.00
802.11ac VHT80_Nss1,(MCS0)_2TX	-	-	-	-	-	-	-	-
5210MHz	Pass	6.20	16.08	16.37	19.24	29.80	25.44	36.00
5775MHz	Pass	6.20	16.72	18.02	20.43	29.80	26.63	36.00
802.11ax HEW20_Nss1,(MCS0)_2TX	-	-	-	-	-	-	-	-
5180MHz	Pass	6.20	18.20	18.61	21.42	29.80	27.62	36.00
5200MHz	Pass	6.20	20.37	20.59	23.49	29.80	29.69	36.00
5240MHz	Pass	6.20	20.09	20.72	23.43	29.80	29.63	36.00
5745MHz	Pass	6.20	21.17	22.17	24.71	29.80	30.91	36.00
5785MHz	Pass	6.20	22.78	23.62	26.23	29.80	32.43	36.00
5825MHz	Pass	6.20	21.31	22.06	24.71	29.80	30.91	36.00
802.11ax HEW40_Nss1,(MCS0)_2TX	-	-	-	-	-	-	-	-
5190MHz	Pass	6.20	15.69	16.02	18.87	29.80	25.07	36.00
5230MHz	Pass	6.20	20.32	20.54	23.44	29.80	29.64	36.00
5755MHz	Pass	6.20	21.12	22.16	24.68	29.80	30.88	36.00
5795MHz	Pass	6.20	23.10	23.90	26.53	29.80	32.73	36.00
802.11ax HEW80_Nss1,(MCS0)_2TX	-	-	-	-	-	-	-	-
5210MHz	Pass	6.20	16.40	16.69	19.56	29.80	25.76	36.00
5775MHz	Pass	6.20	16.91	18.21	20.62	29.80	26.82	36.00

DG = Directional Gain; Port X = Port X output power



Summary

Mode	Total Power (dBm)	Total Power (W)	EIRP (dBm)	EIRP (W)
5.725-5.85GHz	-	-	-	-
802.11ax HEW20-BF_Nss1,(MCS0)_4TX	23.37	0.21727	35.72	3.73250
802.11ax HEW40-BF_Nss1,(MCS0)_4TX	23.55	0.22646	35.90	3.89045
802.11ax HEW80-BF_Nss1,(MCS0)_4TX	23.60	0.22909	35.95	3.93550



Result

Mode	Result	DG (dBi)	Port 1 (dBm)	Port 2 (dBm)	Port 3 (dBm)	Port 4 (dBm)	Total Power (dBm)	Power Limit (dBm)	EIRP (dBm)	EIRP Limit (dBm)
802.11ax HEW20-BF_Nss1,(MCS0)_4TX	-	-	-	-	-	-	-	-	-	-
5745MHz	Pass	12.35	17.69	17.01	17.11	17.21	23.28	23.65	35.63	36.00
5785MHz	Pass	12.35	17.13	17.09	16.53	17.29	23.04	23.65	35.39	36.00
5825MHz	Pass	12.35	17.81	16.81	17.33	17.39	23.37	23.65	35.72	36.00
802.11ax HEW40-BF_Nss1,(MCS0)_4TX	-	-	-	-	-	-	-	-	-	-
5755MHz	Pass	12.35	17.49	18.04	16.11	18.20	23.55	23.65	35.90	36.00
5795MHz	Pass	12.35	17.07	17.74	16.56	16.84	23.10	23.65	35.45	36.00
802.11ax HEW80-BF_Nss1,(MCS0)_4TX	-	-	-	-	-	-	-	-	-	-
5775MHz	Pass	12.35	17.68	18.11	16.26	18.04	23.60	23.65	35.95	36.00

DG = Directional Gain; Port X = Port X output power



Summary

Mode	Total Power (dBm)	Total Power (W)	EIRP (dBm)	EIRP (W)
5.15-5.25GHz	-	-	-	-
802.11ax HEW20-BF_Nss1,(MCS0)_4TX	24.40	0.27542	35.75	3.75837
802.11ax HEW40-BF_Nss1,(MCS0)_4TX	24.38	0.27416	35.73	3.74111
802.11ax HEW80-BF_Nss1,(MCS0)_4TX	21.06	0.12764	32.41	1.74181
5.725-5.85GHz	-	-	-	-
802.11ax HEW20-BF_Nss1,(MCS0)_4TX	24.57	0.28642	35.92	3.90841
802.11ax HEW40-BF_Nss1,(MCS0)_4TX	24.21	0.26363	35.56	3.59749
802.11ax HEW80-BF_Nss1,(MCS0)_4TX	24.23	0.26485	35.58	3.61410



Result

Mode	Result	DG (dBi)	Port 1 (dBm)	Port 2 (dBm)	Port 3 (dBm)	Port 4 (dBm)	Total Power (dBm)	Power Limit (dBm)	EIRP (dBm)	EIRP Limit (dBm)
802.11ax HEW20-BF_Nss1,(MCS0)_4TX	-	-	-	-	-	-	-	-	-	-
5180MHz	Pass	11.35	16.39	15.10	16.33	15.77	21.95	24.65	33.30	36.00
5200MHz	Pass	11.35	18.57	18.30	18.63	17.43	24.28	24.65	35.63	36.00
5240MHz	Pass	11.35	18.54	18.72	18.62	17.53	24.40	24.65	35.75	36.00
5745MHz	Pass	11.35	18.95	18.31	18.74	18.17	24.57	24.65	35.92	36.00
5785MHz	Pass	11.35	19.16	18.74	18.01	16.84	24.29	24.65	35.64	36.00
5825MHz	Pass	11.35	19.10	18.53	18.67	17.39	24.49	24.65	35.84	36.00
802.11ax HEW40-BF_Nss1,(MCS0)_4TX	-	-	-	-	-	-	-	-	-	-
5190MHz	Pass	11.35	15.00	13.75	14.83	13.48	20.34	24.65	31.69	36.00
5230MHz	Pass	11.35	18.93	18.35	18.57	17.44	24.38	24.65	35.73	36.00
5755MHz	Pass	11.35	18.14	17.87	18.20	17.95	24.06	24.65	35.41	36.00
5795MHz	Pass	11.35	18.48	18.15	18.32	17.76	24.21	24.65	35.56	36.00
802.11ax HEW80-BF_Nss1,(MCS0)_4TX	-	-	-	-	-	-	-	-	-	-
5210MHz	Pass	11.35	15.67	14.66	15.41	14.26	21.06	24.65	32.41	36.00
5775MHz	Pass	11.35	18.72	17.86	18.43	17.74	24.23	24.65	35.58	36.00

DG = Directional Gain; Port X = Port X output power



Summary

Mode	Total Power (dBm)	Total Power (W)	EIRP (dBm)	EIRP (W)
5.15-5.25GHz	-	-	-	-
802.11ax HEW20-BF_Nss1,(MCS0)_2TX	24.90	0.30903	34.11	2.57632
802.11ax HEW40-BF_Nss1,(MCS0)_2TX	24.66	0.29242	33.87	2.43781
802.11ax HEW80-BF_Nss1,(MCS0)_2TX	20.10	0.10233	29.31	0.85310
5.725-5.85GHz	-	-	-	-
802.11ax HEW20-BF_Nss1,(MCS0)_2TX	25.87	0.38637	35.08	3.22107
802.11ax HEW40-BF_Nss1,(MCS0)_2TX	25.62	0.36475	34.83	3.04089
802.11ax HEW80-BF_Nss1,(MCS0)_2TX	20.11	0.10257	29.32	0.85507



Result

Mode	Result	DG (dBi)	Port 1 (dBm)	Port 2 (dBm)	Total Power (dBm)	Power Limit (dBm)	EIRP (dBm)	EIRP Limit (dBm)
802.11ax HEW20-BF_Nss1,(MCS0)_2TX	-	-	-	-	-	-	-	-
5180MHz	Pass	9.21	18.10	17.99	21.06	26.79	30.27	36.00
5200MHz	Pass	9.21	21.62	22.15	24.90	26.79	34.11	36.00
5240MHz	Pass	9.21	19.42	19.63	22.54	26.79	31.75	36.00
5745MHz	Pass	9.21	22.89	22.69	25.80	26.79	35.01	36.00
5785MHz	Pass	9.21	22.69	22.83	25.77	26.79	34.98	36.00
5825MHz	Pass	9.21	22.77	22.95	25.87	26.79	35.08	36.00
802.11ax HEW40-BF_Nss1,(MCS0)_2TX	-	-	-	-	-	-	-	-
5190MHz	Pass	9.21	15.54	16.87	19.27	26.79	28.48	36.00
5230MHz	Pass	9.21	21.73	21.56	24.66	26.79	33.87	36.00
5755MHz	Pass	9.21	20.89	21.15	24.03	26.79	33.24	36.00
5795MHz	Pass	9.21	22.81	22.41	25.62	26.79	34.83	36.00
802.11ax HEW80-BF_Nss1,(MCS0)_2TX	-	-	-	-	-	-	-	-
5210MHz	Pass	9.21	17.19	16.98	20.10	26.79	29.31	36.00
5775MHz	Pass	9.21	17.28	16.92	20.11	26.79	29.32	36.00

DG = Directional Gain; Port X = Port X output power



Summary

Mode	PD (dBm/RBW)	EIRP PD (dBm/RBW)
5.725-5.85GHz	-	-
802.11a_Nss1,(6Mbps)_4TX	13.87	26.22
802.11n HT20_Nss1,(MCS0)_4TX	13.19	25.54
802.11n HT40_Nss1,(MCS0)_4TX	10.27	22.62
802.11ac VHT20_Nss1,(MCS0)_4TX	13.33	25.68
802.11ac VHT40_Nss1,(MCS0)_4TX	10.53	22.88
802.11ac VHT80_Nss1,(MCS0)_4TX	3.63	15.98
802.11ax HEW20_Nss1,(MCS0)_4TX	13.29	25.64
802.11ax HEW40_Nss1,(MCS0)_4TX	10.45	22.80
802.11ax HEW80_Nss1,(MCS0)_4TX	3.76	16.11

RBW = 500kHz for 5.725-5.85GHz band / 1MHz for other band;



Result

Mode	Result	DG (dBi)	Port 1 (dBm/RBW)	Port 2 (dBm/RBW)	Port 3 (dBm/RBW)	Port 4 (dBm/RBW)	PD (dBm/RBW)	PD Limit (dBm/RBW)	EIRP PD (dBm/RBW)	EIRP PD Limit (dBm/RBW)
802.11a_Nss1,(6Mbps)_4TX	-	-	-	-	-	-	-	-	-	-
5745MHz	Pass	12.35	8.22	6.85	7.63	9.02	13.87	23.65	26.22	36.00
5785MHz	Pass	12.35	8.03	6.64	7.67	8.92	13.72	23.65	26.07	36.00
5825MHz	Pass	12.35	7.27	5.83	7.12	8.13	13.09	23.65	25.44	36.00
802.11n HT20_Nss1,(MCS0)_4TX	-	-	-	-	-	-	-	-	-	-
5745MHz	Pass	12.35	7.25	6.80	6.96	8.20	13.19	23.65	25.54	36.00
5785MHz	Pass	12.35	6.45	5.46	6.42	7.11	12.30	23.65	24.65	36.00
5825MHz	Pass	12.35	6.39	5.77	6.38	7.37	12.26	23.65	24.61	36.00
802.11n HT40_Nss1,(MCS0)_4TX	-	-	-	-	-	-	-	-	-	-
5755MHz	Pass	12.35	4.67	4.64	4.11	4.48	10.27	23.65	22.62	36.00
5795MHz	Pass	12.35	4.53	4.11	3.83	4.40	9.91	23.65	22.26	36.00
802.11ac VHT20_Nss1,(MCS0)_4TX	-	-	-	-	-	-	-	-	-	-
5745MHz	Pass	12.35	7.41	6.89	7.13	8.13	13.33	23.65	25.68	36.00
5785MHz	Pass	12.35	6.32	5.72	6.24	7.03	12.22	23.65	24.57	36.00
5825MHz	Pass	12.35	6.22	5.79	6.33	7.27	12.27	23.65	24.62	36.00
802.11ac VHT40_Nss1,(MCS0)_4TX	-	-	-	-	-	-	-	-	-	-
5755MHz	Pass	12.35	4.88	4.67	3.96	4.63	10.53	23.65	22.88	36.00
5795MHz	Pass	12.35	4.45	4.34	3.99	4.45	10.15	23.65	22.50	36.00
802.11ac VHT80_Nss1,(MCS0)_4TX	-	-	-	-	-	-	-	-	-	-
5775MHz	Pass	12.35	-2.68	-2.29	-2.32	-2.07	3.63	23.65	15.98	36.00
802.11ax HEW20_Nss1,(MCS0)_4TX	-	-	-	-	-	-	-	-	-	-
5745MHz	Pass	12.35	7.35	6.82	7.01	8.12	13.29	23.65	25.64	36.00
5785MHz	Pass	12.35	6.26	5.57	6.27	7.12	12.28	23.65	24.63	36.00
5825MHz	Pass	12.35	6.40	5.75	6.28	7.35	12.34	23.65	24.69	36.00
802.11ax HEW40_Nss1,(MCS0)_4TX	-	-	-	-	-	-	-	-	-	-
5755MHz	Pass	12.35	4.85	4.50	4.10	4.58	10.45	23.65	22.80	36.00
5795MHz	Pass	12.35	4.57	4.37	3.94	4.80	10.27	23.65	22.62	36.00
802.11ax HEW80_Nss1,(MCS0)_4TX	-	-	-	-	-	-	-	-	-	-
5775MHz	Pass	12.35	-2.56	-1.98	-2.12	-1.88	3.76	23.65	16.11	36.00

DG = Directional Gain; RBW = 500kHz for 5.725-5.85GHz band / 1MHz for other band;
 PD = trace bin-by-bin of each transmits port summing can be performed maximum power density; Port X = Port X Power Density;

802.11a_Nss1,(6Mbps)_4TX

PSD

5745MHz

29/12/2020

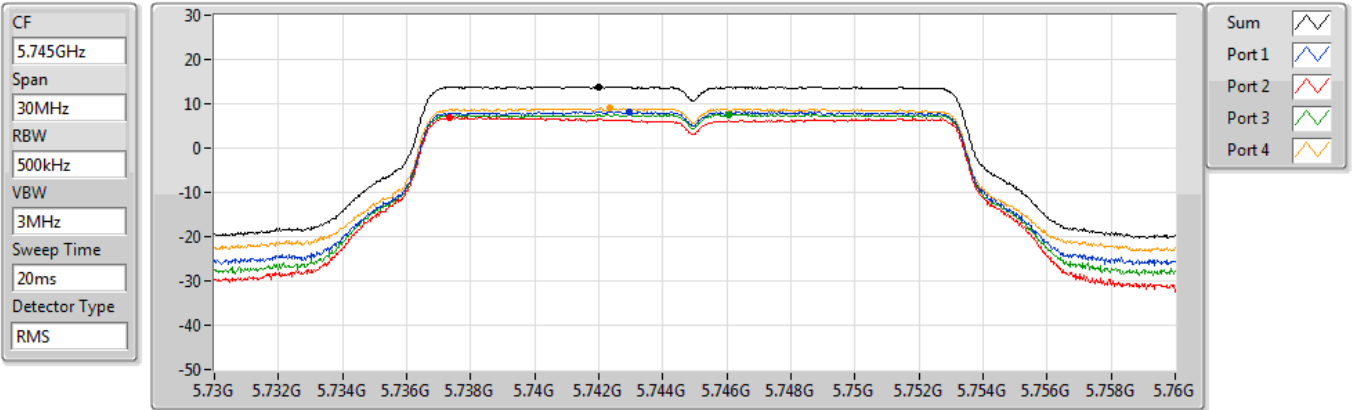

Sum	PD	Port 1	Port 2	Port 3	Port 4
(dBm/RBW)	(dBm/RBW)	(dBm/RBW)	(dBm/RBW)	(dBm/RBW)	(dBm/RBW)
13.87	13.87	8.22	6.85	7.63	9.02

802.11a_Nss1,(6Mbps)_4TX

PSD

5785MHz

29/12/2020

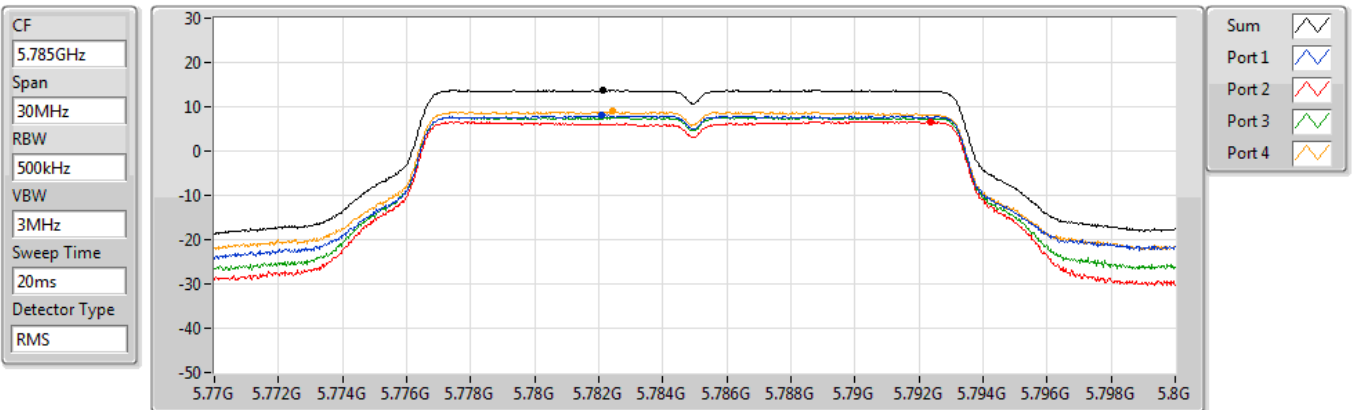

Sum	PD	Port 1	Port 2	Port 3	Port 4
(dBm/RBW)	(dBm/RBW)	(dBm/RBW)	(dBm/RBW)	(dBm/RBW)	(dBm/RBW)
13.72	13.72	8.03	6.64	7.67	8.92

802.11a_Nss1,(6Mbps)_4TX

PSD

5825MHz

29/12/2020

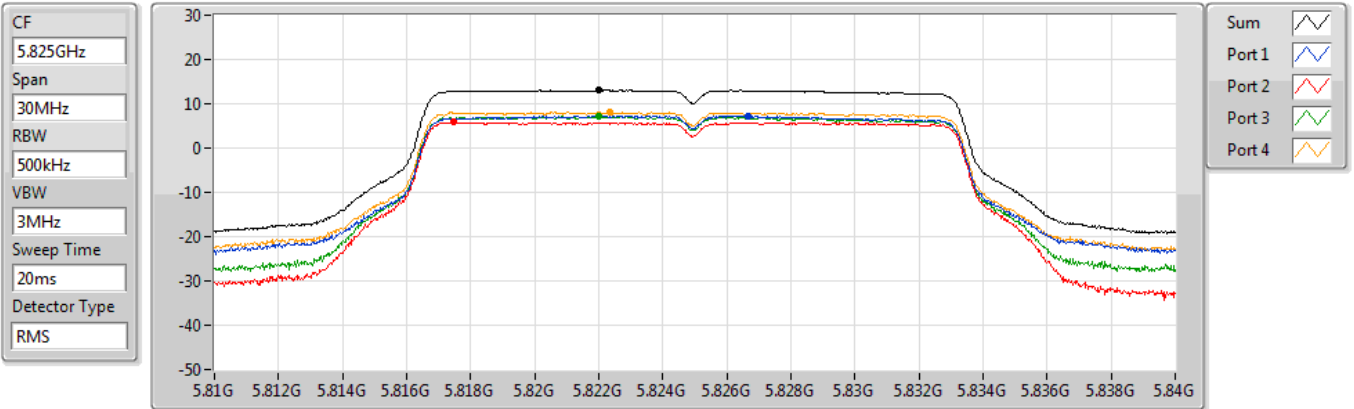

Sum	PD	Port 1	Port 2	Port 3	Port 4
(dBm/RBW)	(dBm/RBW)	(dBm/RBW)	(dBm/RBW)	(dBm/RBW)	(dBm/RBW)
13.09	13.09	7.27	5.83	7.12	8.13

802.11n HT20_Nss1,(MCS0)_4TX

PSD

5745MHz

29/12/2020

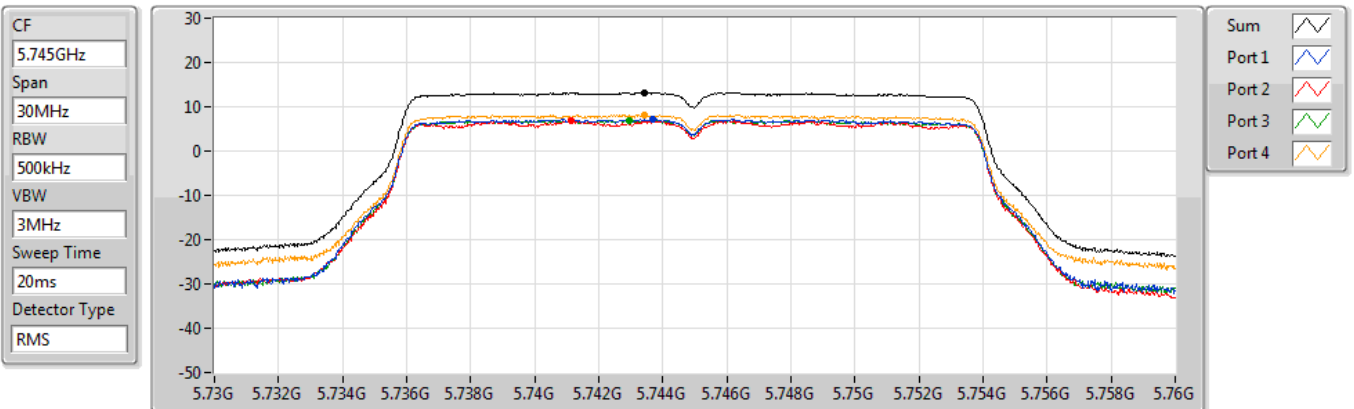

Sum	PD	Port 1	Port 2	Port 3	Port 4
(dBm/RBW)	(dBm/RBW)	(dBm/RBW)	(dBm/RBW)	(dBm/RBW)	(dBm/RBW)
13.19	13.19	7.25	6.80	6.96	8.20

802.11n HT20_Nss1,(MCS0)_4TX

PSD

5785MHz

29/12/2020

CF
5.785GHz

Span
30MHz

RBW
500kHz

VBW
3MHz

Sweep Time
20ms

Detector Type
RMS

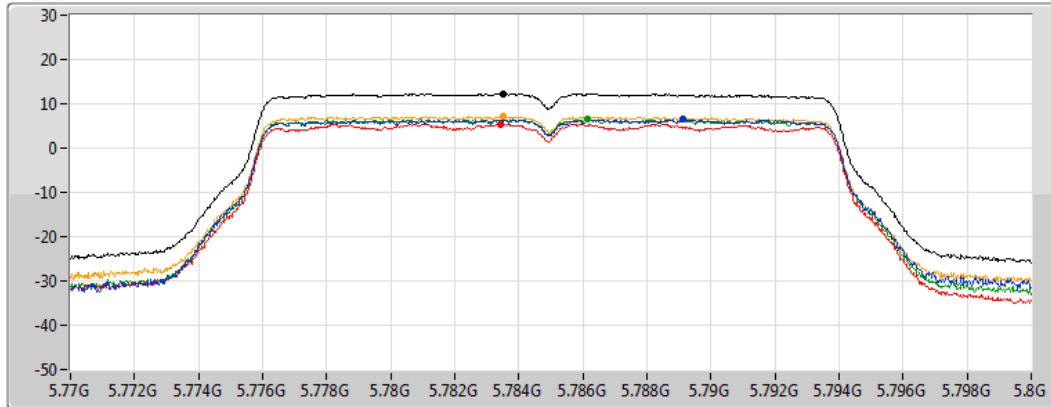

Sum 

Port 1 

Port 2 

Port 3 

Port 4 

Sum	PD	Port 1	Port 2	Port 3	Port 4
(dBm/RBW)	(dBm/RBW)	(dBm/RBW)	(dBm/RBW)	(dBm/RBW)	(dBm/RBW)
12.30	12.30	6.45	5.46	6.42	7.11

802.11n HT20_Nss1,(MCS0)_4TX

PSD

5825MHz

29/12/2020

CF
5.825GHz

Span
30MHz

RBW
500kHz

VBW
3MHz

Sweep Time
20ms

Detector Type
RMS

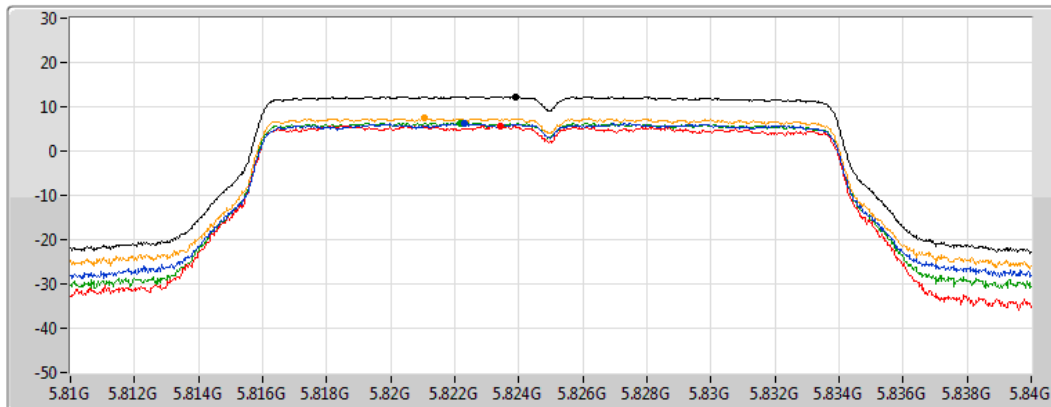

Sum 

Port 1 

Port 2 

Port 3 

Port 4 

Sum	PD	Port 1	Port 2	Port 3	Port 4
(dBm/RBW)	(dBm/RBW)	(dBm/RBW)	(dBm/RBW)	(dBm/RBW)	(dBm/RBW)
12.26	12.26	6.39	5.77	6.38	7.37

802.11n HT40_Nss1,(MCS0)_4TX

PSD

5755MHz

29/12/2020

CF
5.755GHz
Span
60MHz
RBW
500kHz
VBW
3MHz
Sweep Time
20ms
Detector Type
RMS

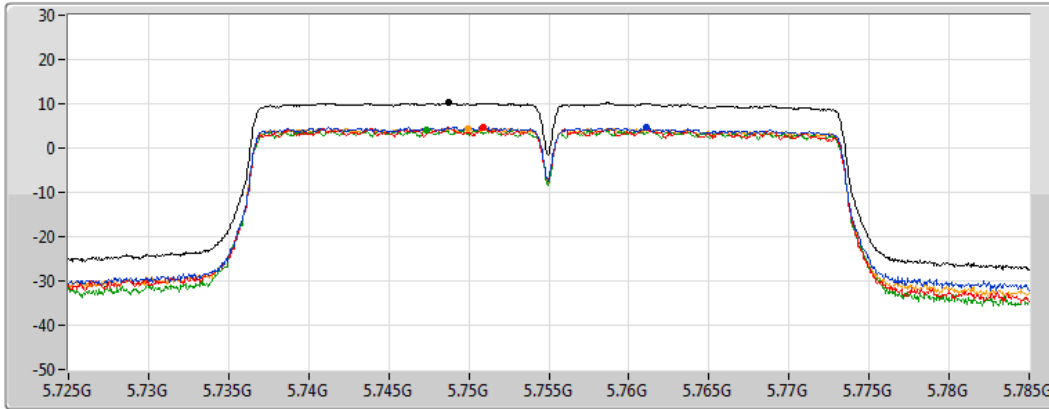

Sum
Port 1
Port 2
Port 3
Port 4

Sum	PD	Port 1	Port 2	Port 3	Port 4
(dBm/RBW)	(dBm/RBW)	(dBm/RBW)	(dBm/RBW)	(dBm/RBW)	(dBm/RBW)
10.27	10.27	4.67	4.64	4.11	4.48

802.11n HT40_Nss1,(MCS0)_4TX

PSD

5795MHz

29/12/2020

CF
5.795GHz
Span
60MHz
RBW
500kHz
VBW
3MHz
Sweep Time
20ms
Detector Type
RMS

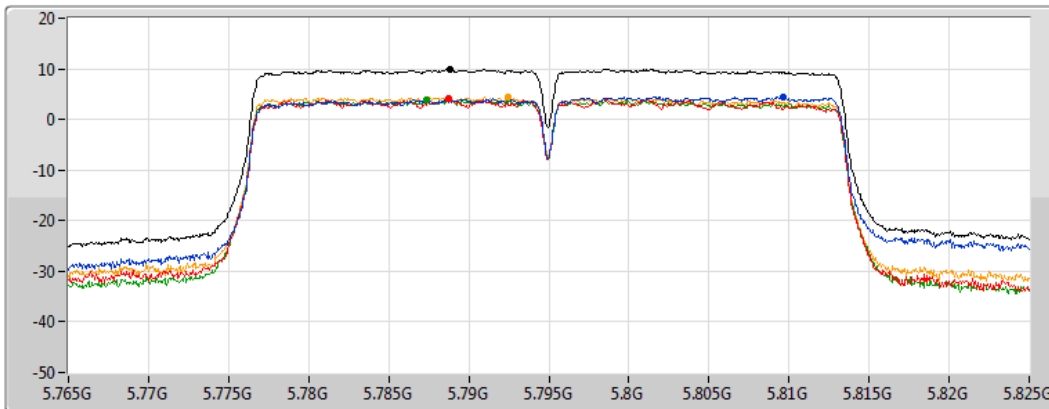

Sum
Port 1
Port 2
Port 3
Port 4

Sum	PD	Port 1	Port 2	Port 3	Port 4
(dBm/RBW)	(dBm/RBW)	(dBm/RBW)	(dBm/RBW)	(dBm/RBW)	(dBm/RBW)
9.91	9.91	4.53	4.11	3.83	4.40

802.11ac VHT20_Nss1,(MCS0)_4TX

PSD

5745MHz

29/12/2020

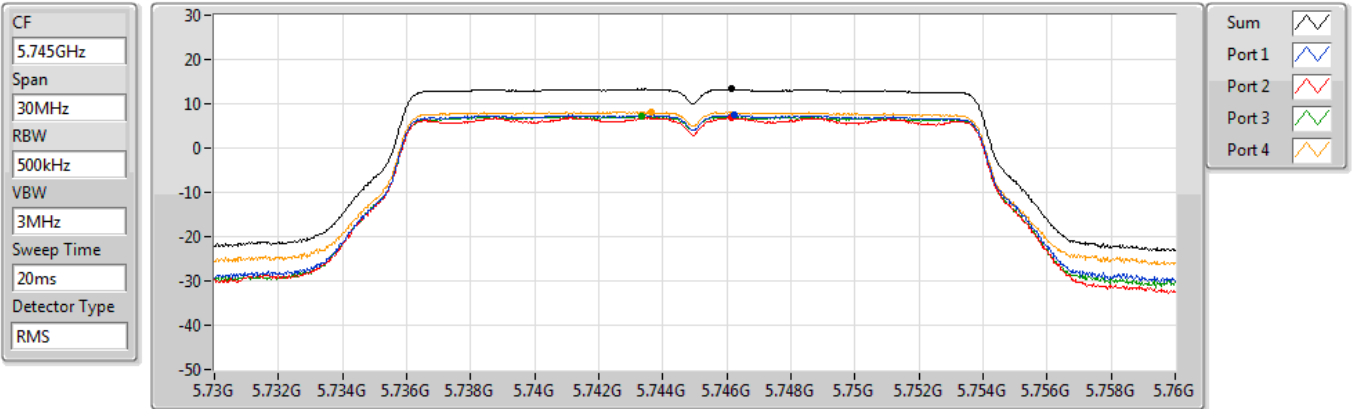

Sum	PD	Port 1	Port 2	Port 3	Port 4
(dBm/RBW)	(dBm/RBW)	(dBm/RBW)	(dBm/RBW)	(dBm/RBW)	(dBm/RBW)
13.33	13.33	7.41	6.89	7.13	8.13

802.11ac VHT20_Nss1,(MCS0)_4TX

PSD

5785MHz

29/12/2020

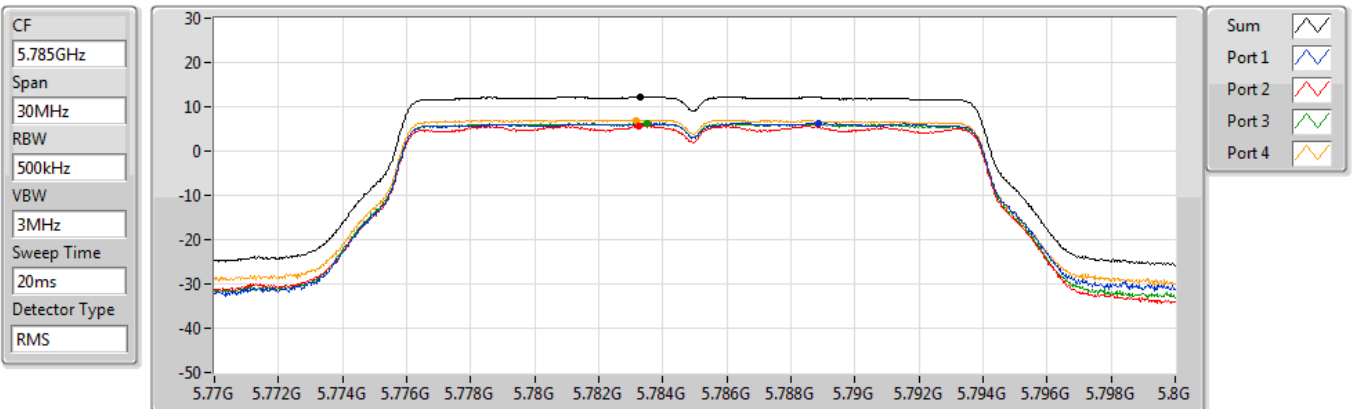

Sum	PD	Port 1	Port 2	Port 3	Port 4
(dBm/RBW)	(dBm/RBW)	(dBm/RBW)	(dBm/RBW)	(dBm/RBW)	(dBm/RBW)
12.22	12.22	6.32	5.72	6.24	7.03

802.11ac VHT20_Nss1,(MCS0)_4TX





PSD

5825MHz

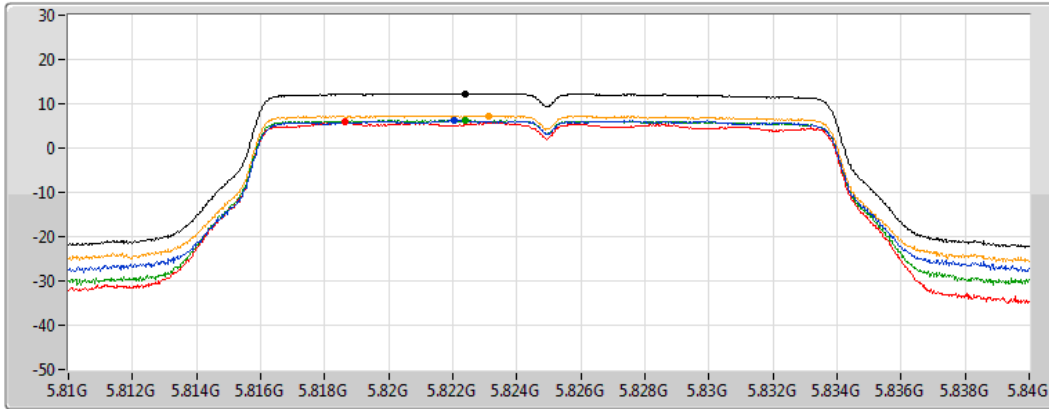
29/12/2020

CF
5.825GHz
Span
30MHz
RBW
500kHz
VBW
3MHz
Sweep Time
20ms
Detector Type
RMS



Sum 
Port 1 
Port 2 
Port 3 
Port 4 

Sum	PD	Port 1	Port 2	Port 3	Port 4
(dBm/RBW)	(dBm/RBW)	(dBm/RBW)	(dBm/RBW)	(dBm/RBW)	(dBm/RBW)
12.27	12.27	6.22	5.79	6.33	7.27

802.11ac VHT40_Nss1,(MCS0)_4TX





PSD

5755MHz

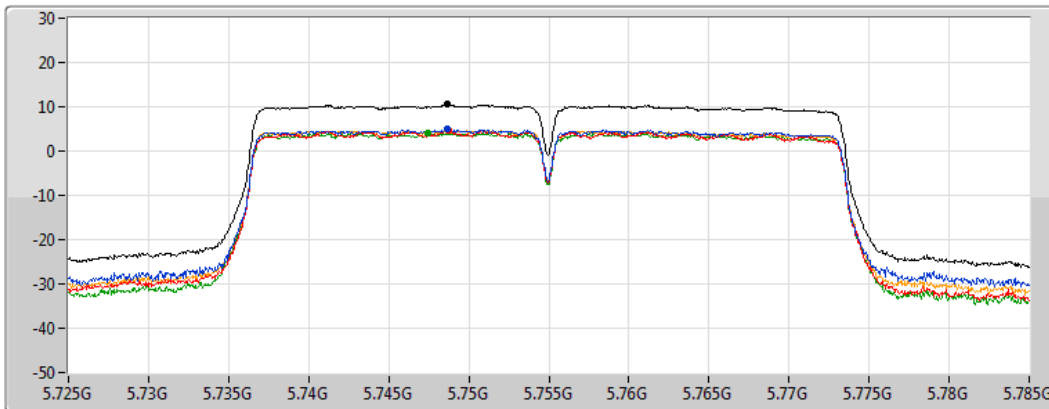
29/12/2020

CF
5.755GHz
Span
60MHz
RBW
500kHz
VBW
3MHz
Sweep Time
20ms
Detector Type
RMS



Sum 
Port 1 
Port 2 
Port 3 
Port 4 

Sum	PD	Port 1	Port 2	Port 3	Port 4
(dBm/RBW)	(dBm/RBW)	(dBm/RBW)	(dBm/RBW)	(dBm/RBW)	(dBm/RBW)
10.53	10.53	4.88	4.67	3.96	4.63

802.11ac VHT40_Nss1,(MCS0)_4TX

PSD

5795MHz

29/12/2020

CF
5.795GHz

Span
60MHz

RBW
500kHz

VBW
3MHz

Sweep Time
20ms

Detector Type
RMS

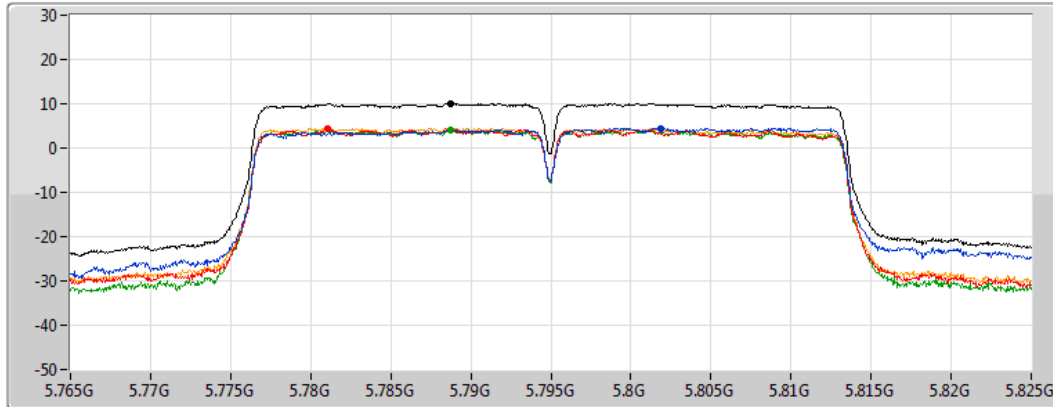

Sum 

Port 1 

Port 2 

Port 3 

Port 4 

Sum	PD	Port 1	Port 2	Port 3	Port 4
(dBm/RBW)	(dBm/RBW)	(dBm/RBW)	(dBm/RBW)	(dBm/RBW)	(dBm/RBW)
10.15	10.15	4.45	4.34	3.99	4.45

802.11ac VHT80_Nss1,(MCS0)_4TX

PSD

5775MHz

29/12/2020

CF
5.775GHz

Span
120MHz

RBW
500kHz

VBW
3MHz

Sweep Time
20ms

Detector Type
RMS

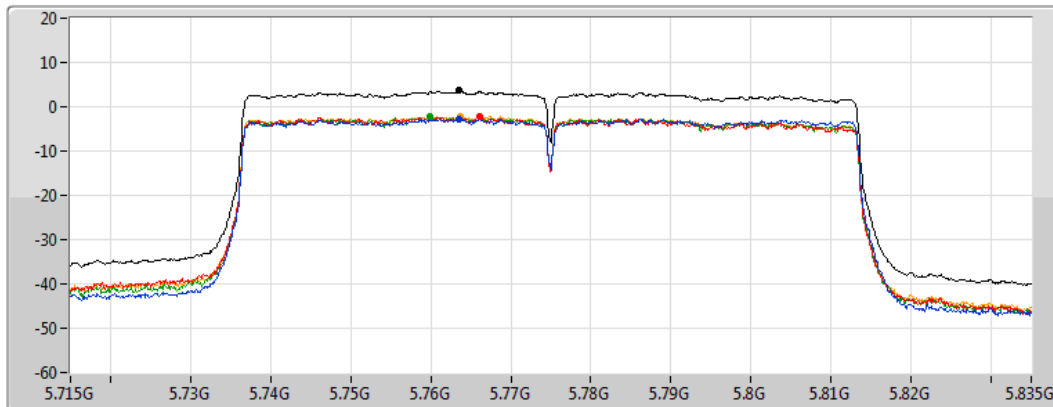

Sum 

Port 1 

Port 2 

Port 3 

Port 4 

Sum	PD	Port 1	Port 2	Port 3	Port 4
(dBm/RBW)	(dBm/RBW)	(dBm/RBW)	(dBm/RBW)	(dBm/RBW)	(dBm/RBW)
3.63	3.63	-2.68	-2.29	-2.32	-2.07

802.11ax HEW20_Nss1,(MCS0)_4TX

PSD

5745MHz

29/12/2020

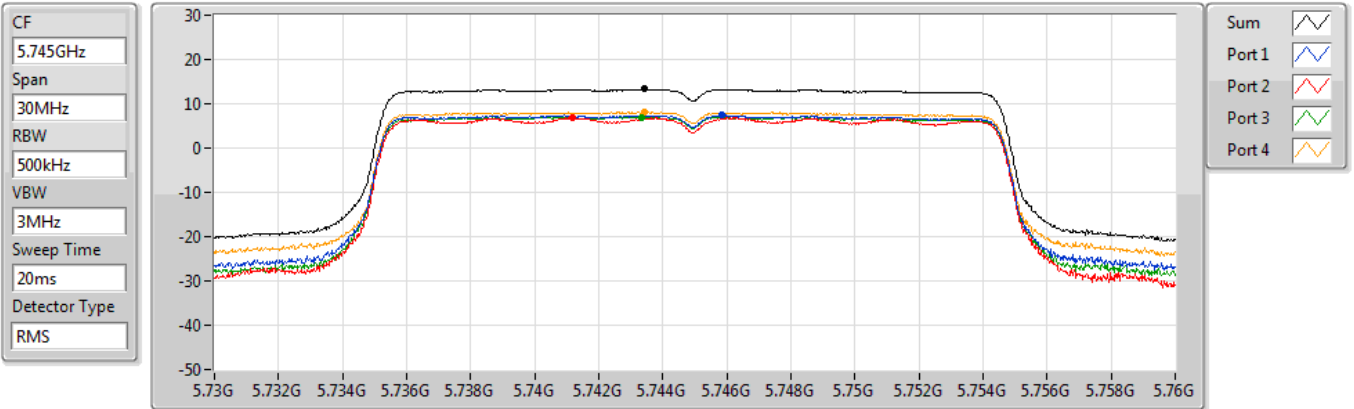

Sum	PD	Port 1	Port 2	Port 3	Port 4
(dBm/RBW)	(dBm/RBW)	(dBm/RBW)	(dBm/RBW)	(dBm/RBW)	(dBm/RBW)
13.29	13.29	7.35	6.82	7.01	8.12

802.11ax HEW20_Nss1,(MCS0)_4TX

PSD

5785MHz

29/12/2020

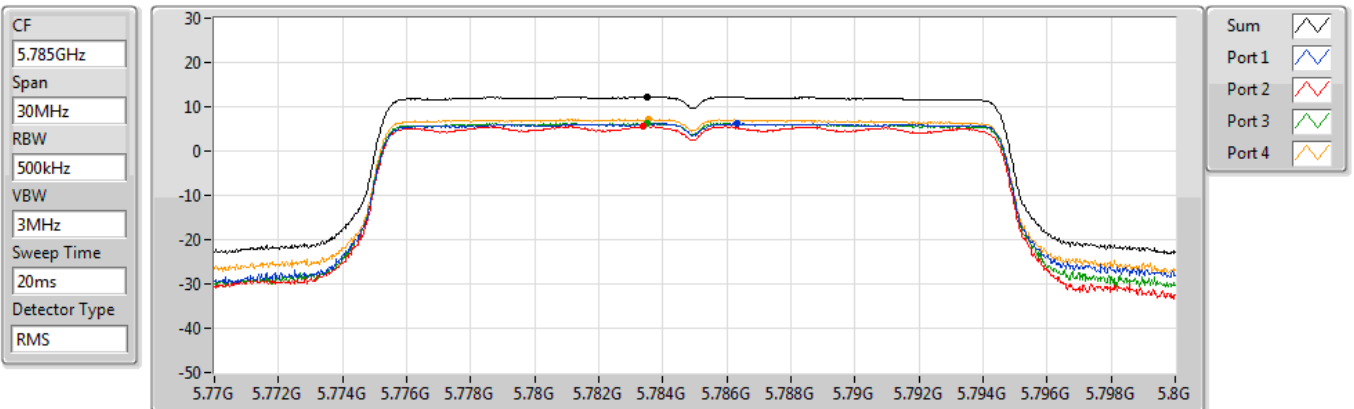

Sum	PD	Port 1	Port 2	Port 3	Port 4
(dBm/RBW)	(dBm/RBW)	(dBm/RBW)	(dBm/RBW)	(dBm/RBW)	(dBm/RBW)
12.28	12.28	6.26	5.57	6.27	7.12

802.11ax HEW20_Nss1,(MCS0)_4TX

PSD

5825MHz

29/12/2020

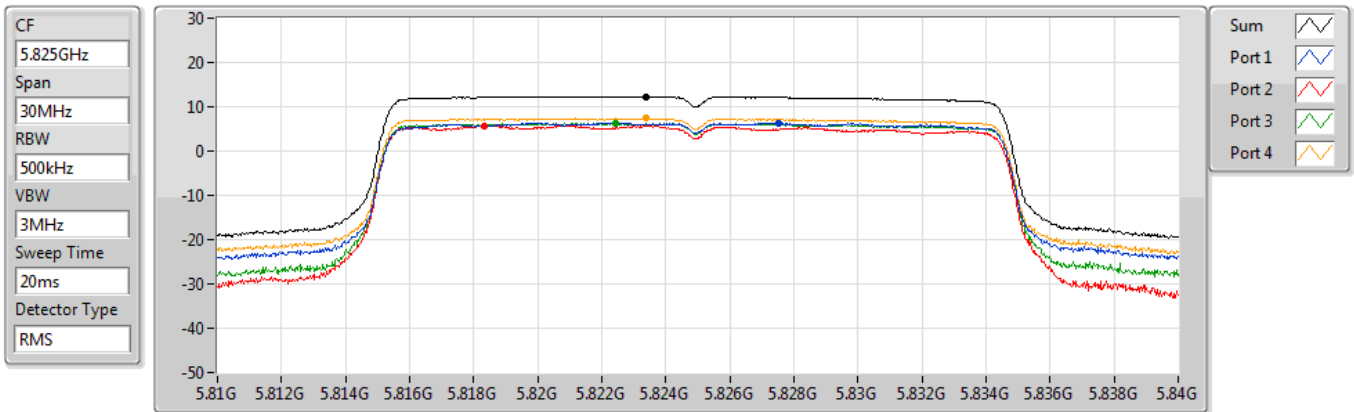

Sum	PD	Port 1	Port 2	Port 3	Port 4
(dBm/RBW)	(dBm/RBW)	(dBm/RBW)	(dBm/RBW)	(dBm/RBW)	(dBm/RBW)
12.34	12.34	6.40	5.75	6.28	7.35

802.11ax HEW40_Nss1,(MCS0)_4TX

PSD

5755MHz

29/12/2020

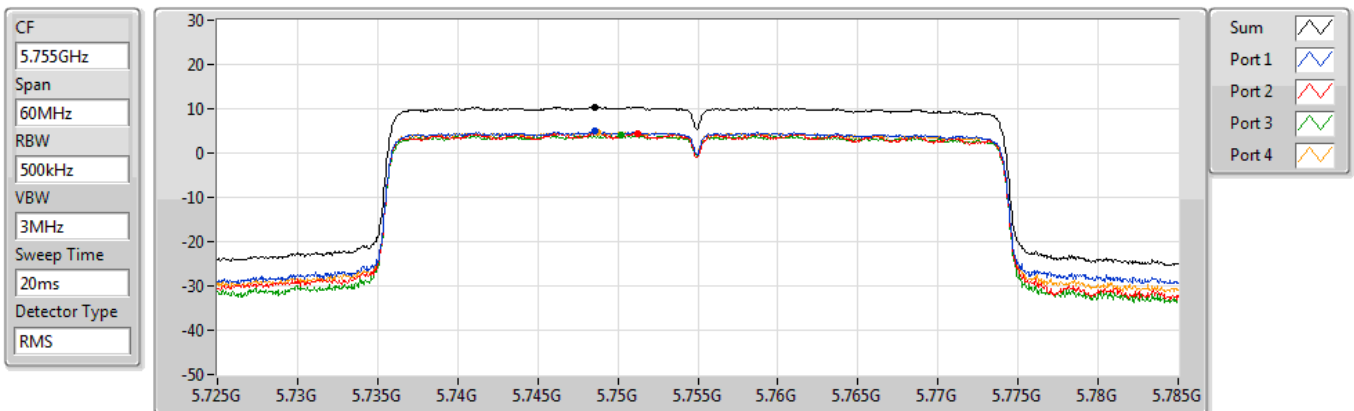

Sum	PD	Port 1	Port 2	Port 3	Port 4
(dBm/RBW)	(dBm/RBW)	(dBm/RBW)	(dBm/RBW)	(dBm/RBW)	(dBm/RBW)
10.45	10.45	4.85	4.50	4.10	4.58

802.11ax HEW40_Nss1,(MCS0)_4TX

PSD

5795MHz

29/12/2020

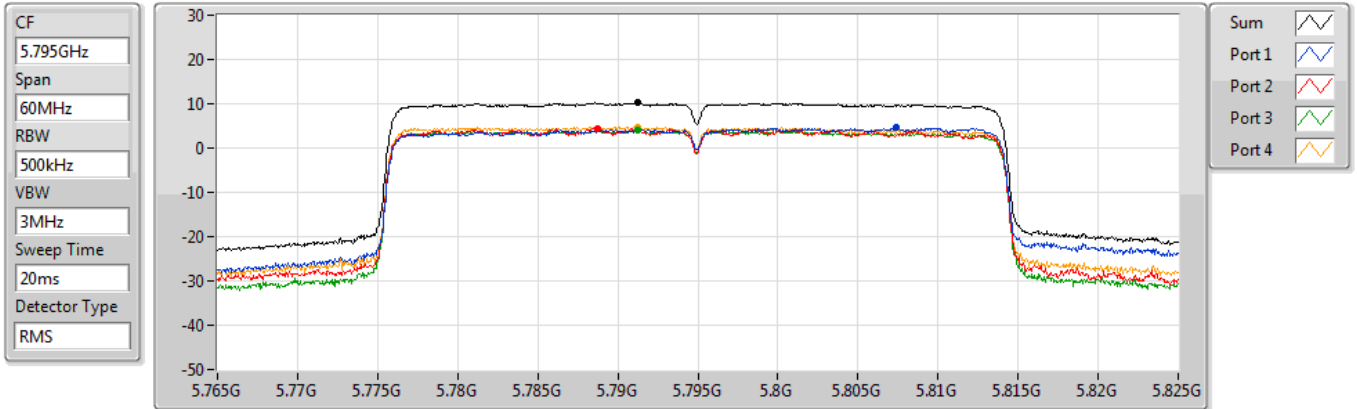

Sum	PD	Port 1	Port 2	Port 3	Port 4
(dBm/RBW)	(dBm/RBW)	(dBm/RBW)	(dBm/RBW)	(dBm/RBW)	(dBm/RBW)
10.27	10.27	4.57	4.37	3.94	4.80

802.11ax HEW80_Nss1,(MCS0)_4TX

PSD

5775MHz

29/12/2020

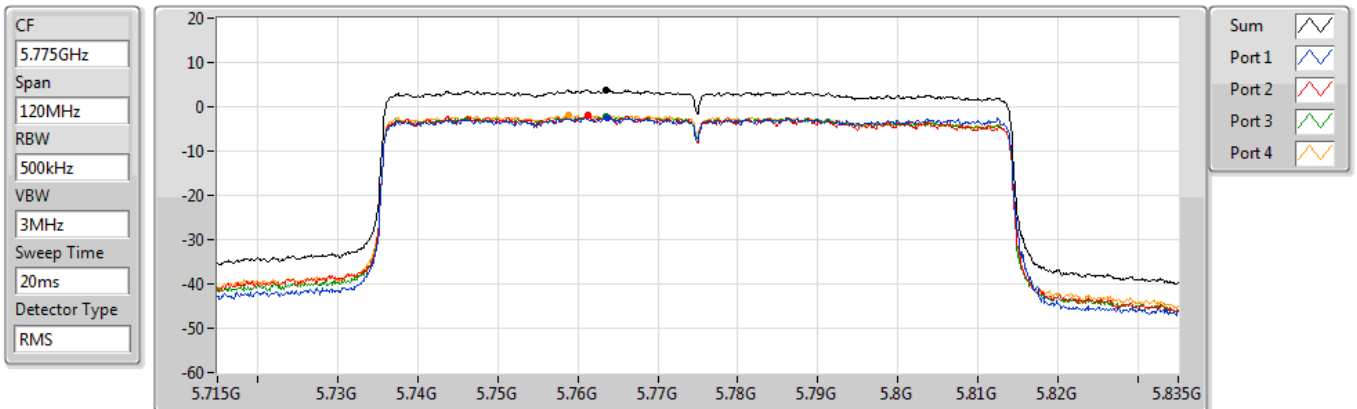

Sum	PD	Port 1	Port 2	Port 3	Port 4
(dBm/RBW)	(dBm/RBW)	(dBm/RBW)	(dBm/RBW)	(dBm/RBW)	(dBm/RBW)
3.76	3.76	-2.56	-1.98	-2.12	-1.88



Summary

Mode	PD (dBm/RBW)	EIRP PD (dBm/RBW)
5.15-5.25GHz	-	-
802.11a_Nss1,(6Mbps)_4TX	11.60	22.95
802.11n HT20_Nss1,(MCS0)_4TX	11.08	22.43
802.11n HT40_Nss1,(MCS0)_4TX	8.15	19.50
802.11ac VHT20_Nss1,(MCS0)_4TX	11.17	22.52
802.11ac VHT40_Nss1,(MCS0)_4TX	8.23	19.58
802.11ac VHT80_Nss1,(MCS0)_4TX	0.80	12.15
802.11ax HEW20_Nss1,(MCS0)_4TX	11.52	22.87
802.11ax HEW40_Nss1,(MCS0)_4TX	7.05	18.40
802.11ax HEW80_Nss1,(MCS0)_4TX	1.06	12.41
5.725-5.85GHz	-	-
802.11a_Nss1,(6Mbps)_4TX	15.17	26.52
802.11n HT20_Nss1,(MCS0)_4TX	15.08	26.43
802.11n HT40_Nss1,(MCS0)_4TX	11.52	22.87
802.11ac VHT20_Nss1,(MCS0)_4TX	15.16	26.51
802.11ac VHT40_Nss1,(MCS0)_4TX	11.46	22.81
802.11ac VHT80_Nss1,(MCS0)_4TX	4.05	15.40
802.11ax HEW20_Nss1,(MCS0)_4TX	13.66	25.01
802.11ax HEW40_Nss1,(MCS0)_4TX	11.66	23.01
802.11ax HEW80_Nss1,(MCS0)_4TX	4.26	15.61

RBW = 500kHz for 5.725-5.85GHz band / 1MHz for other band;



Result

Mode	Result	DG (dBi)	Port 1 (dBm/RBW)	Port 2 (dBm/RBW)	Port 3 (dBm/RBW)	Port 4 (dBm/RBW)	PD (dBm/RBW)	PD Limit (dBm/RBW)	EIRP PD (dBm/RBW)	EIRP PD Limit (dBm/RBW)
802.11a_Nss1,(6Mbps)_4TX	-	-	-	-	-	-	-	-	-	-
5180MHz	Pass	11.35	4.06	3.41	4.49	4.40	9.75	11.65	21.10	23.00
5200MHz	Pass	11.35	6.17	5.05	5.99	6.24	11.60	11.65	22.95	23.00
5240MHz	Pass	11.35	5.98	4.98	5.70	5.80	11.48	11.65	22.83	23.00
5745MHz	Pass	11.35	9.68	8.92	9.64	8.22	14.96	24.65	26.31	36.00
5785MHz	Pass	11.35	9.61	8.68	8.94	8.93	14.77	24.65	26.12	36.00
5825MHz	Pass	11.35	9.72	9.14	9.71	9.53	15.17	24.65	26.52	36.00
802.11n HT20_Nss1,(MCS0)_4TX	-	-	-	-	-	-	-	-	-	-
5180MHz	Pass	11.35	2.10	2.48	2.47	3.14	8.33	11.65	19.68	23.00
5200MHz	Pass	11.35	4.80	5.16	5.04	5.75	11.08	11.65	22.43	23.00
5240MHz	Pass	11.35	4.63	5.26	5.15	5.53	11.04	11.65	22.39	23.00
5745MHz	Pass	11.35	9.02	9.60	9.44	8.99	15.08	24.65	26.43	36.00
5785MHz	Pass	11.35	9.04	9.64	9.37	9.10	15.05	24.65	26.40	36.00
5825MHz	Pass	11.35	8.73	9.36	9.08	8.79	14.82	24.65	26.17	36.00
802.11n HT40_Nss1,(MCS0)_4TX	-	-	-	-	-	-	-	-	-	-
5190MHz	Pass	11.35	-2.89	-2.66	-2.92	-2.29	3.15	11.65	14.50	23.00
5230MHz	Pass	11.35	2.36	2.51	1.93	2.56	8.15	11.65	19.50	23.00
5755MHz	Pass	11.35	4.87	4.89	4.75	4.45	10.65	24.65	22.00	36.00
5795MHz	Pass	11.35	6.05	6.01	5.30	5.49	11.52	24.65	22.87	36.00
802.11ac VHT20_Nss1,(MCS0)_4TX	-	-	-	-	-	-	-	-	-	-
5180MHz	Pass	11.35	1.95	2.59	2.56	2.99	8.43	11.65	19.78	23.00
5200MHz	Pass	11.35	4.85	5.29	5.16	5.70	11.17	11.65	22.52	23.00
5240MHz	Pass	11.35	4.68	5.43	5.11	5.63	11.14	11.65	22.49	23.00
5745MHz	Pass	11.35	9.12	9.59	9.51	8.74	15.16	24.65	26.51	36.00
5785MHz	Pass	11.35	8.92	9.45	9.13	8.76	14.96	24.65	26.31	36.00
5825MHz	Pass	11.35	8.71	9.36	8.98	8.56	14.82	24.65	26.17	36.00
802.11ac VHT40_Nss1,(MCS0)_4TX	-	-	-	-	-	-	-	-	-	-
5190MHz	Pass	11.35	-3.01	-2.85	-3.29	-2.55	3.03	11.65	14.38	23.00
5230MHz	Pass	11.35	2.30	2.53	2.02	2.70	8.23	11.65	19.58	23.00
5755MHz	Pass	11.35	4.79	4.77	4.33	4.42	10.43	24.65	21.78	36.00
5795MHz	Pass	11.35	6.00	5.84	5.04	5.31	11.46	24.65	22.81	36.00
802.11ac VHT80_Nss1,(MCS0)_4TX	-	-	-	-	-	-	-	-	-	-
5210MHz	Pass	11.35	-5.25	-5.02	-5.15	-4.76	0.80	11.65	12.15	23.00
5775MHz	Pass	11.35	-1.94	-1.27	-1.99	-2.01	4.05	24.65	15.40	36.00
802.11ax HEW20_Nss1,(MCS0)_4TX	-	-	-	-	-	-	-	-	-	-
5180MHz	Pass	11.35	2.48	2.89	2.88	3.45	8.78	11.65	20.13	23.00
5200MHz	Pass	11.35	5.27	5.65	5.44	6.11	11.52	11.65	22.87	23.00
5240MHz	Pass	11.35	5.01	5.79	5.34	5.84	11.42	11.65	22.77	23.00
5745MHz	Pass	11.35	8.15	7.69	8.17	7.10	13.66	24.65	25.01	36.00
5785MHz	Pass	11.35	7.80	7.59	7.79	7.42	13.53	24.65	24.88	36.00
5825MHz	Pass	11.35	8.02	7.67	7.93	7.50	13.63	24.65	24.98	36.00
802.11ax HEW40_Nss1,(MCS0)_4TX	-	-	-	-	-	-	-	-	-	-
5190MHz	Pass	11.35	-3.88	-4.56	-3.72	-3.66	1.89	11.65	13.24	23.00
5230MHz	Pass	11.35	1.28	0.58	1.29	1.28	7.05	11.65	18.40	23.00
5755MHz	Pass	11.35	4.78	4.87	4.16	4.54	10.46	24.65	21.81	36.00
5795MHz	Pass	11.35	6.26	5.87	5.31	5.59	11.66	24.65	23.01	36.00
802.11ax HEW80_Nss1,(MCS0)_4TX	-	-	-	-	-	-	-	-	-	-
5210MHz	Pass	11.35	-5.00	-4.92	-4.83	-4.54	1.06	11.65	12.41	23.00
5775MHz	Pass	11.35	-1.64	-1.41	-2.03	-1.73	4.26	24.65	15.61	36.00

DG = Directional Gain; RBW = 500kHz for 5.725-5.85GHz band / 1MHz for other band;
 PD = trace bin-by-bin of each transmits port summing can be performed maximum power density; Port X = Port X Power Density;

802.11a_Nss1,(6Mbps)_4TX

PSD

5180MHz

30/12/2020

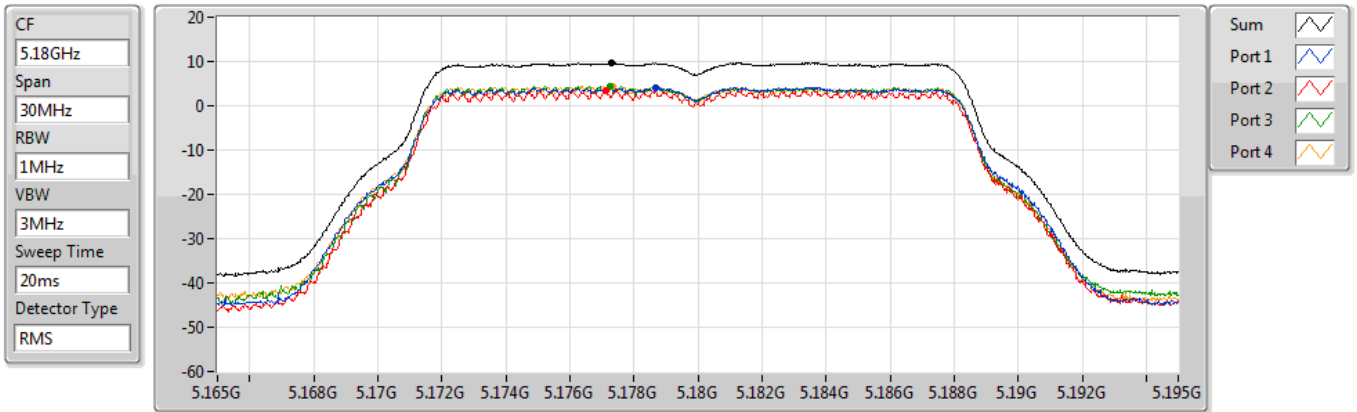

Sum	PD	Port 1	Port 2	Port 3	Port 4
(dBm/RBW)	(dBm/RBW)	(dBm/RBW)	(dBm/RBW)	(dBm/RBW)	(dBm/RBW)
9.75	9.75	4.06	3.41	4.49	4.40

802.11a_Nss1,(6Mbps)_4TX

PSD

5200MHz

30/12/2020

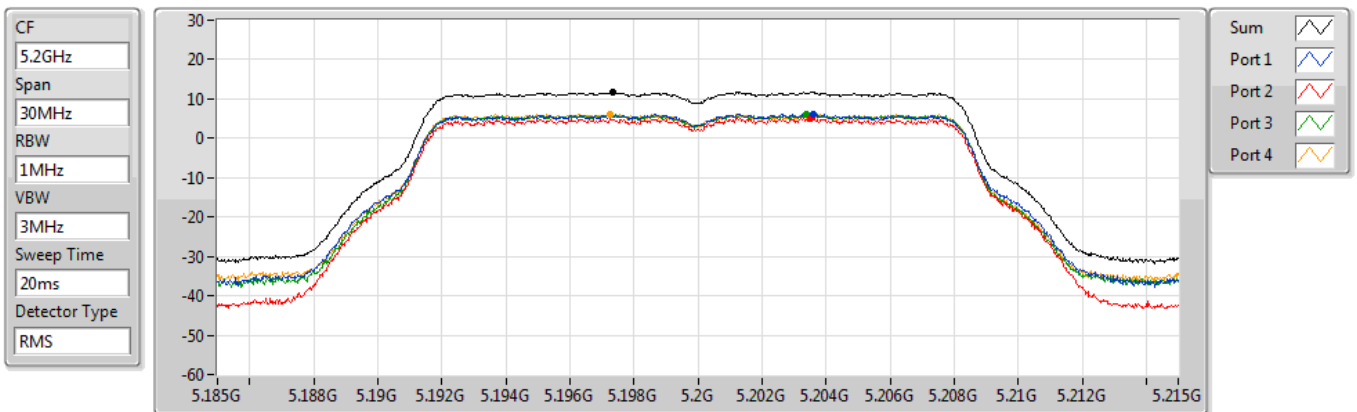

Sum	PD	Port 1	Port 2	Port 3	Port 4
(dBm/RBW)	(dBm/RBW)	(dBm/RBW)	(dBm/RBW)	(dBm/RBW)	(dBm/RBW)
11.60	11.60	6.17	5.05	5.99	6.24

802.11a_Nss1,(6Mbps)_4TX

PSD

5240MHz

30/12/2020

CF
5.24GHz
Span
30MHz
RBW
1MHz
VBW
3MHz
Sweep Time
20ms
Detector Type
RMS

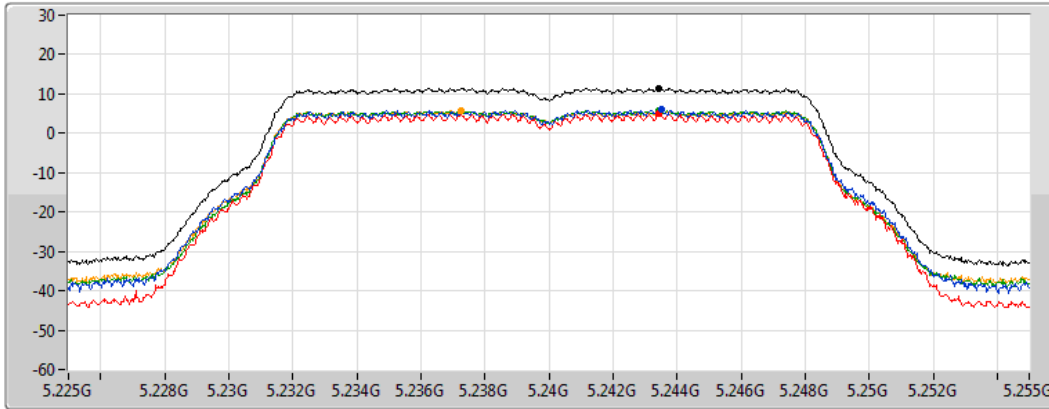

Sum
Port 1
Port 2
Port 3
Port 4

Sum	PD	Port 1	Port 2	Port 3	Port 4
(dBm/RBW)	(dBm/RBW)	(dBm/RBW)	(dBm/RBW)	(dBm/RBW)	(dBm/RBW)
11.48	11.48	5.98	4.98	5.70	5.80

802.11a_Nss1,(6Mbps)_4TX

PSD

5745MHz

30/12/2020

CF
5.745GHz
Span
30MHz
RBW
500kHz
VBW
3MHz
Sweep Time
20ms
Detector Type
RMS

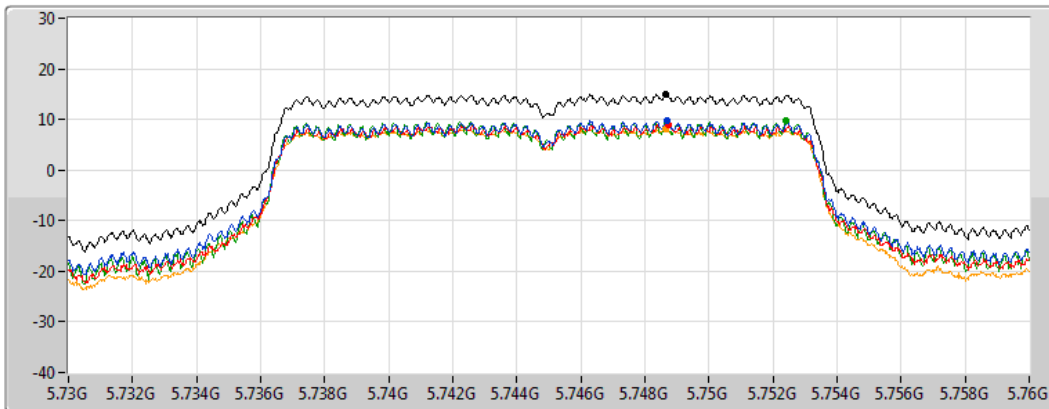

Sum
Port 1
Port 2
Port 3
Port 4

Sum	PD	Port 1	Port 2	Port 3	Port 4
(dBm/RBW)	(dBm/RBW)	(dBm/RBW)	(dBm/RBW)	(dBm/RBW)	(dBm/RBW)
14.96	14.96	9.68	8.92	9.64	8.22

802.11a_Nss1,(6Mbps)_4TX

PSD

5785MHz

30/12/2020

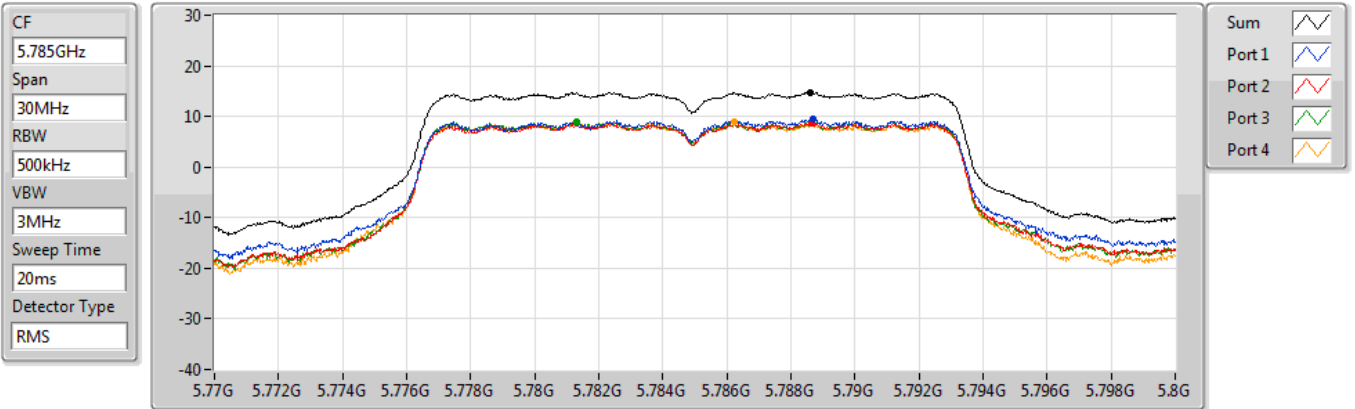

Sum	PD	Port 1	Port 2	Port 3	Port 4
(dBm/RBW)	(dBm/RBW)	(dBm/RBW)	(dBm/RBW)	(dBm/RBW)	(dBm/RBW)
14.77	14.77	9.61	8.68	8.94	8.93

802.11a_Nss1,(6Mbps)_4TX

PSD

5825MHz

30/12/2020

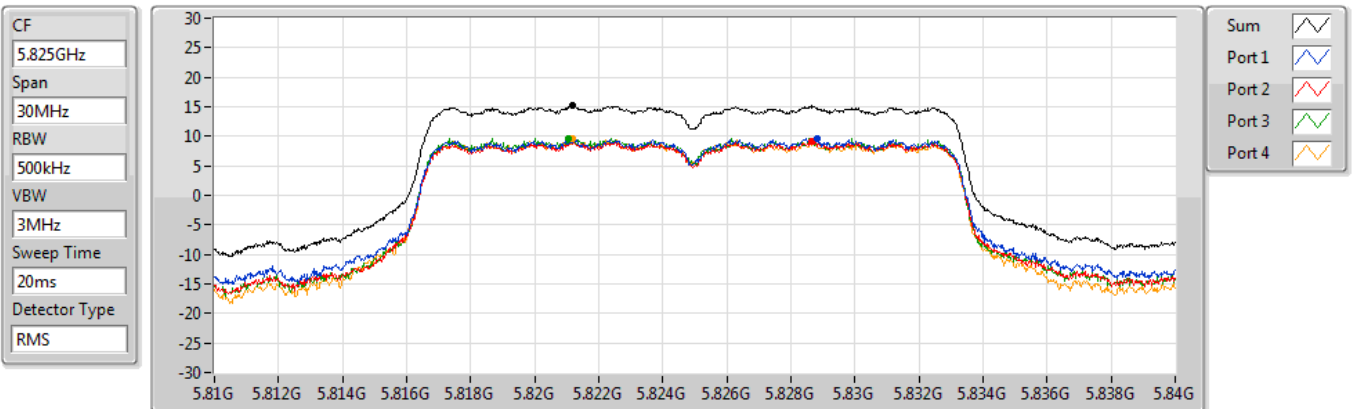

Sum	PD	Port 1	Port 2	Port 3	Port 4
(dBm/RBW)	(dBm/RBW)	(dBm/RBW)	(dBm/RBW)	(dBm/RBW)	(dBm/RBW)
15.17	15.17	9.72	9.14	9.71	9.53