

802.11ax HE20 CH 173 BF On Nss1

Total View

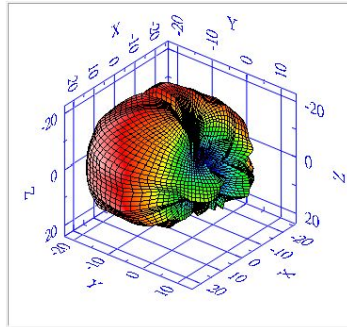

| | |
|-----------------------|---------|
| Frequency (MHz) | 5865.00 |
| TRP (dBm) | 26.79 |
| Total Peak EIRP (dBm) | 33.11 |
| NHPRP +/- 45 (dBm) | 26.13 |
| Max. Power (dBm) | 33.11 |
| NHPRP +/- 30 (dBm) | 25.13 |
| Min. Power (dBm) | 4.87 |
| Ver. Peak EIRP (dBm) | 33.03 |
| Hor. Peak EIRP (dBm) | 31.24 |

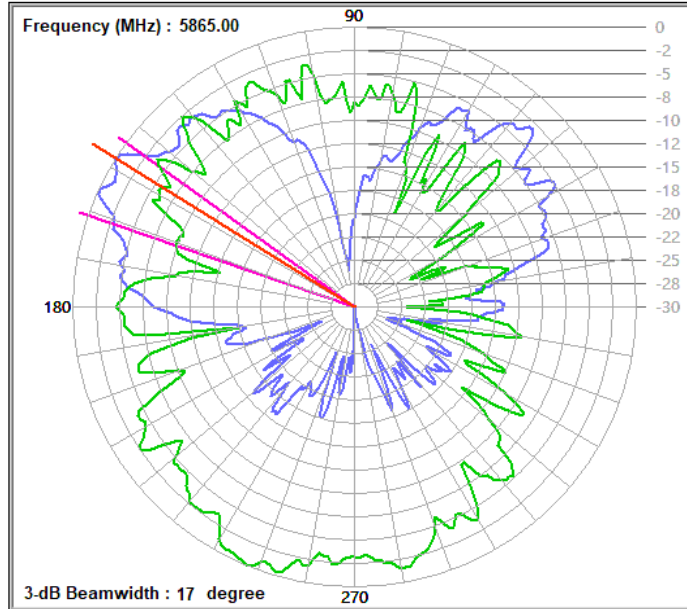
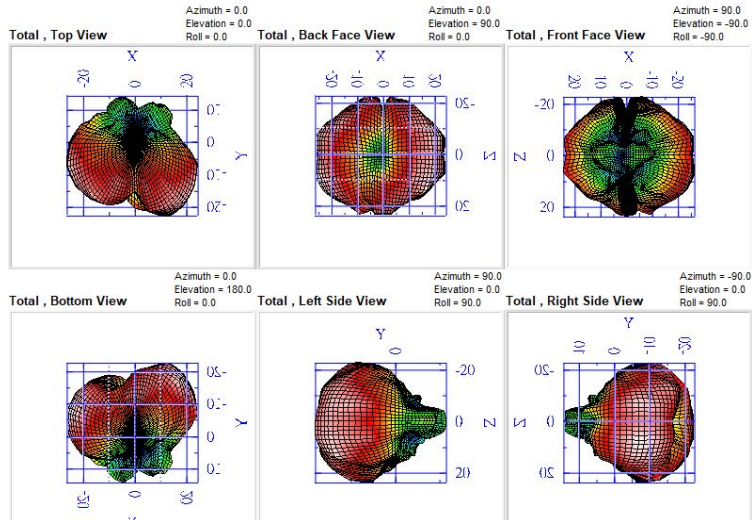

Frequency (MHz) : 5865.00 Polarity 1 : Horizontal Beamwidth 1 : 17
 Polarity 2 : Vertical Beamwidth 2 : 24
 (at the 3 dB down)

802.11ax HE20 CH 93 BF On Nss1

Total View

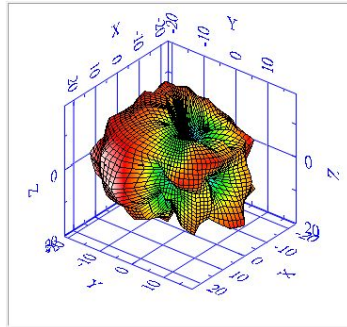

| | | |
|----------------------|---------|-----------------------|
| Frequency (MHz) | 6415.00 | |
| TRP (dBm) | 11.05 | Total Peak EIRP (dBm) |
| | | 17.49 |
| NHPRP +/- 45 (dBm) | 10.44 | Max. Power (dBm) |
| | | 17.49 |
| NHPRP +/- 30 (dBm) | 9.51 | Min. Power (dBm) |
| | | -7.49 |
| Ver. Peak EIRP (dBm) | 17.46 | Hor. Peak EIRP (dBm) |
| | | 15.82 |

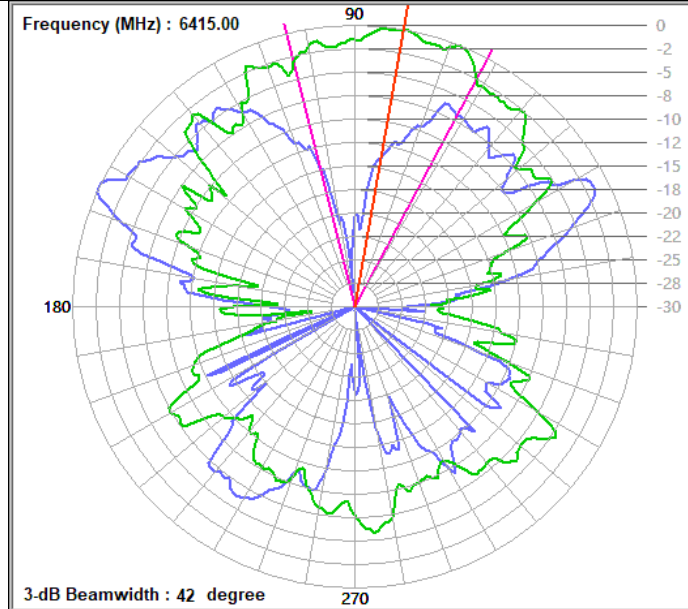
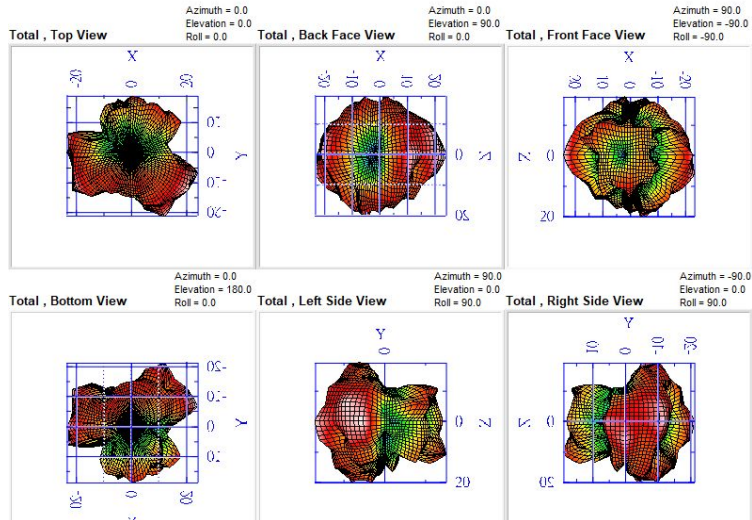

Frequency (MHz) : 6415.00 Polarity 1 : Horizontal Beamwidth 1 : 15
 Polarity 2 : Vertical Beamwidth 2 : 42
 (at the 3 dB down)

802.11ax HE20 CH 113 BF On Nss1

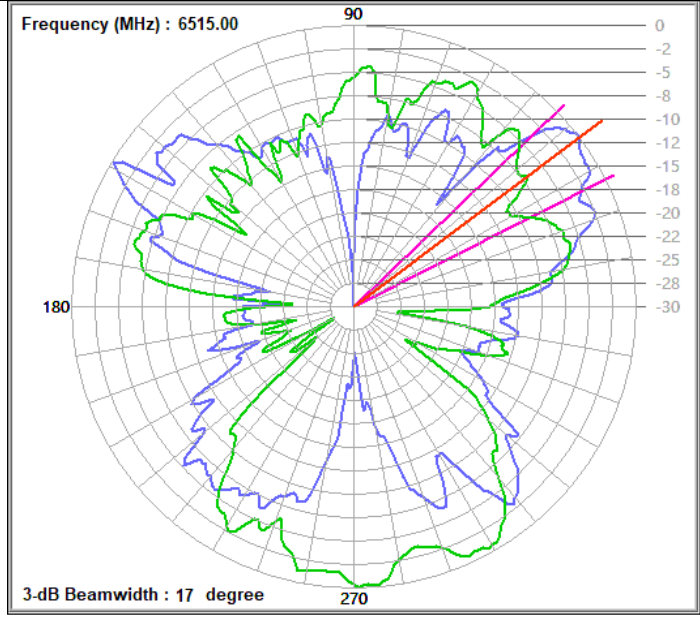
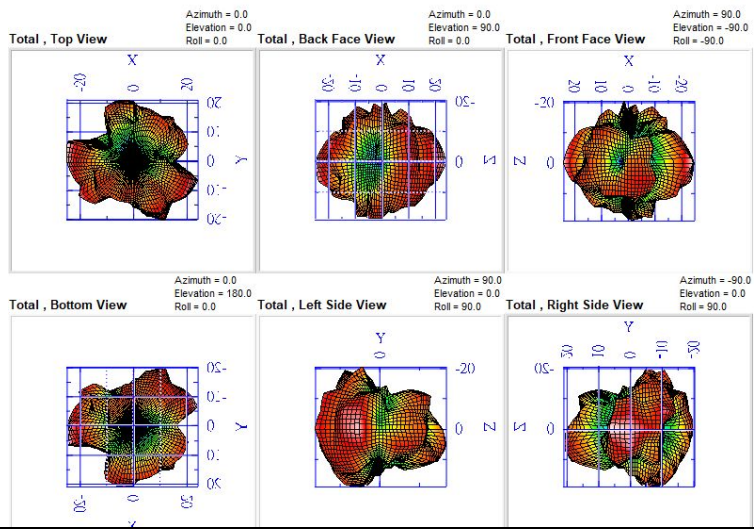
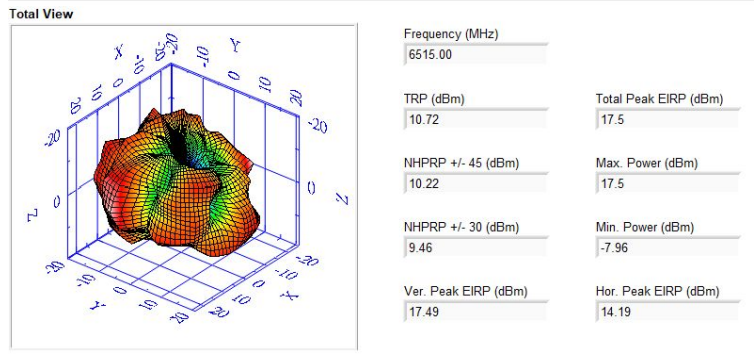

| | | |
|---------------------------|-------------------------|------------------|
| Frequency (MHz) : 6515.00 | Polarity 1 : Horizontal | Beamwidth 1 : 17 |
| | Polarity 2 : Vertical | Beamwidth 2 : 26 |
| (at the 3 dB down) | | |

802.11ax HE20 CH 181 BF On Nss1

Total View

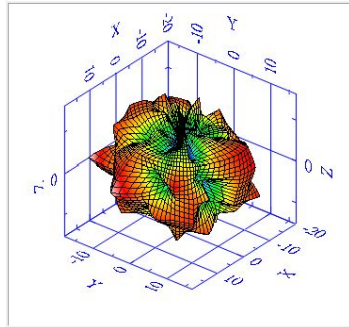

| | |
|----------------------|-----------------------|
| Frequency (MHz) | |
| 6855.00 | |
| TRP (dBm) | Total Peak EIRP (dBm) |
| 10.67 | 17.37 |
| NHPRP +/- 45 (dBm) | Max. Power (dBm) |
| 10.2 | 17.37 |
| NHPRP +/- 30 (dBm) | Min. Power (dBm) |
| 9.43 | -3.3 |
| Ver. Peak EIRP (dBm) | Hor. Peak EIRP (dBm) |
| 17.31 | 14.37 |

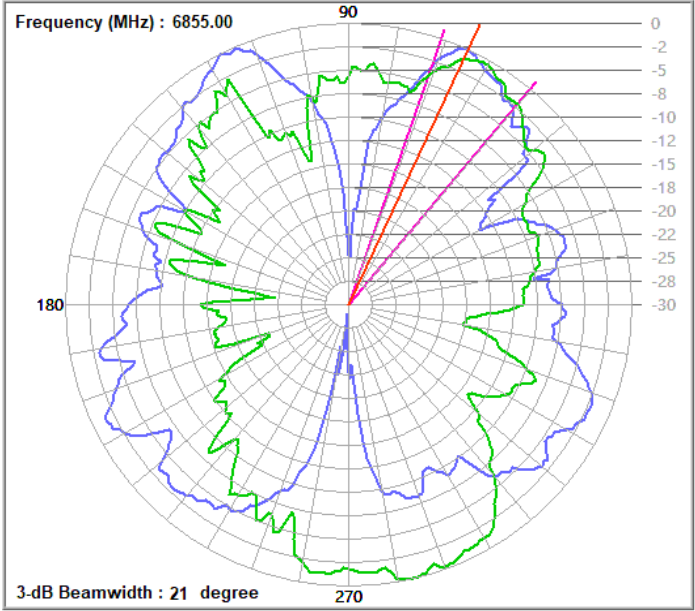
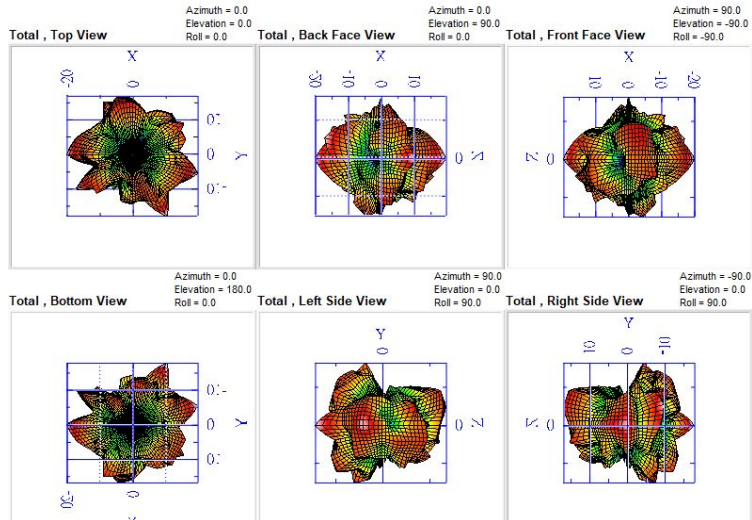

Frequency (MHz): 6855.00 Polarity 1 : Horizontal Beamwidth 1 : 21
 Polarity 2 : Vertical Beamwidth 2 : 48
 (at the 3 dB down)

802.11ax HE20 CH 233 BF On Nss1

Total View

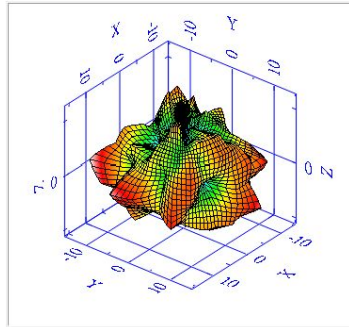

| | |
|-----------------------|---------|
| Frequency (MHz) | 7115.00 |
| TRP (dBm) | 8.45 |
| Total Peak EIRP (dBm) | 15.19 |
| NHPRP +/- 45 (dBm) | 7.93 |
| Max. Power (dBm) | 15.19 |
| NHPRP +/- 30 (dBm) | 7.24 |
| Min. Power (dBm) | -2.44 |
| Ver. Peak EIRP (dBm) | 15.15 |
| Hor. Peak EIRP (dBm) | 10.88 |

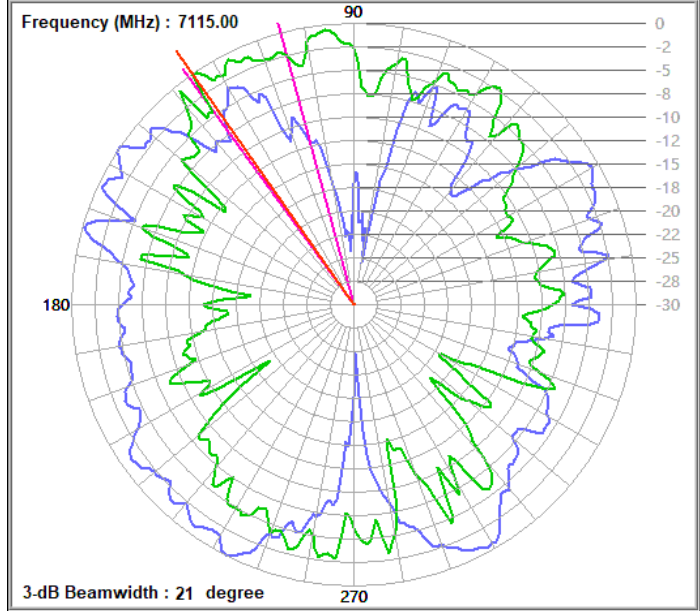
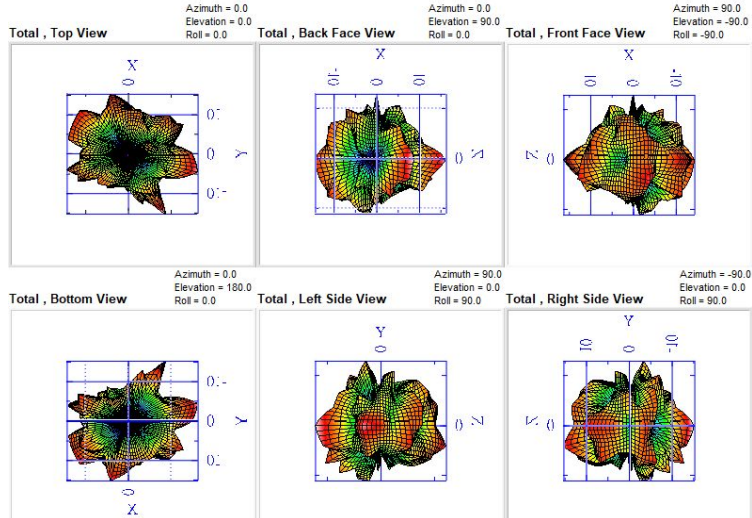

Frequency (MHz) : 7115.00 Polarity 1 : Horizontal Beamwidth 1 : 21
 Polarity 2 : Vertical Beamwidth 2 : 21
 (at the 3 dB down)

Scanning Radio - 2.4GHz, 5GHz and 6GHz bands

2.4GHz_HE20_CH 6_CDD On Nss1

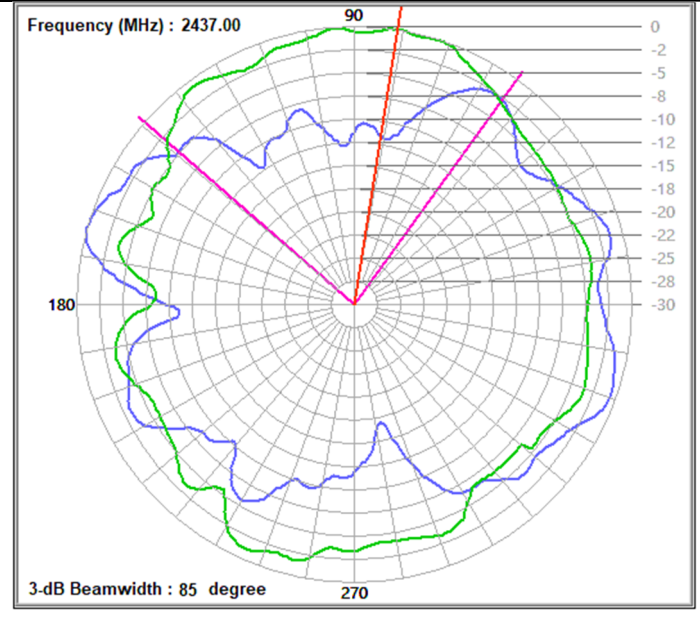
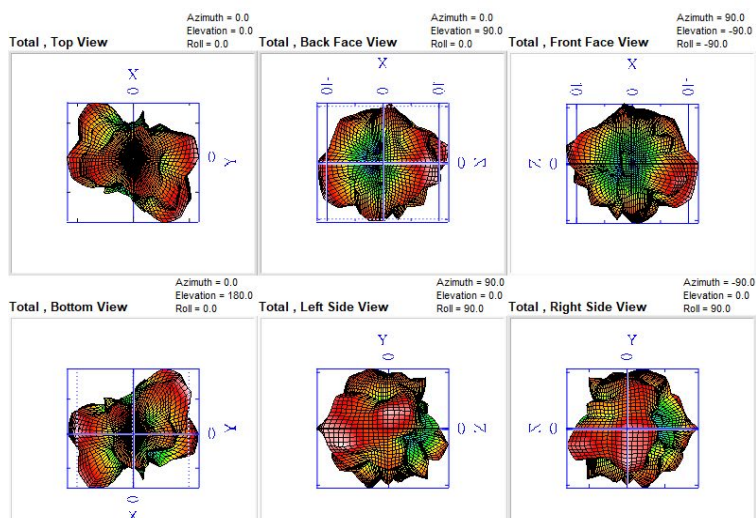
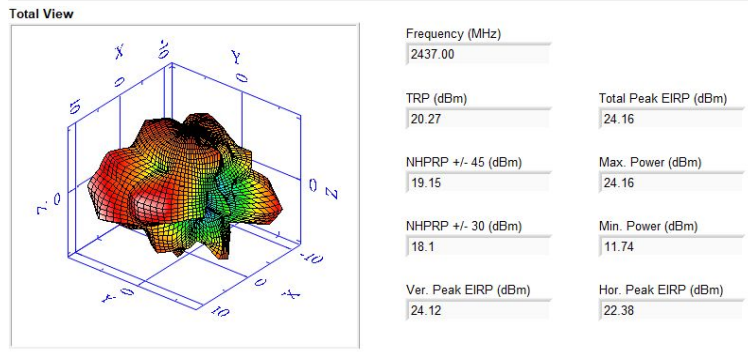

Frequency (MHz) : 2437.00 Polarity 1 : Horizontal Beamwidth 1 : 28
 Polarity 2 : Vertical Beamwidth 2 : 85
 (at the 3 dB down)

802.11ax_HE20_CH 36_CDD On Nss1

Total View

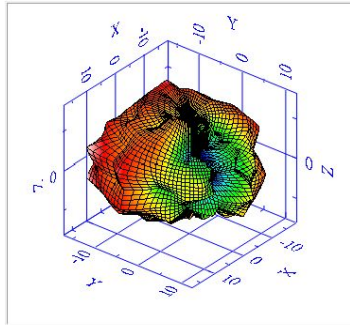

| | |
|-----------------------|---------|
| Frequency (MHz) | 5180.00 |
| TRP (dBm) | 13.69 |
| NHPRP +/- 45 (dBm) | 12.86 |
| NHPRP +/- 30 (dBm) | 11.82 |
| Ver. Peak EIRP (dBm) | 19.33 |
| Total Peak EIRP (dBm) | 19.74 |
| Max. Power (dBm) | 19.74 |
| Min. Power (dBm) | -1.14 |
| Hor. Peak EIRP (dBm) | 17.31 |

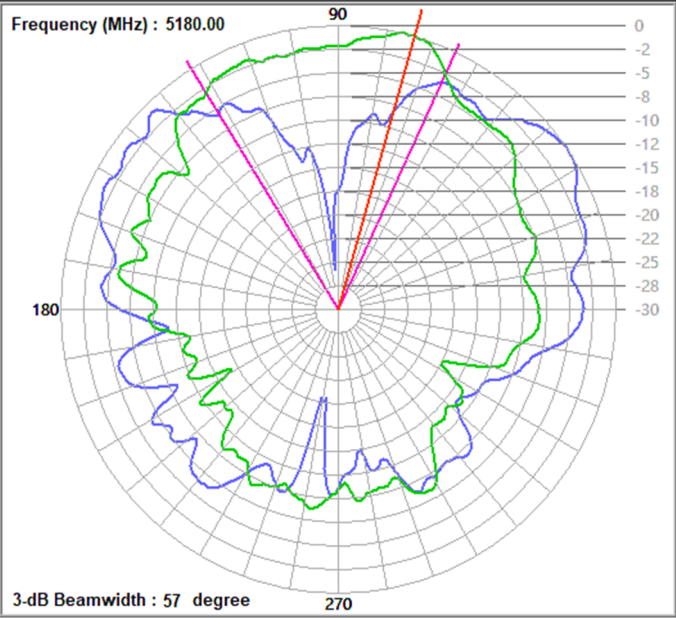
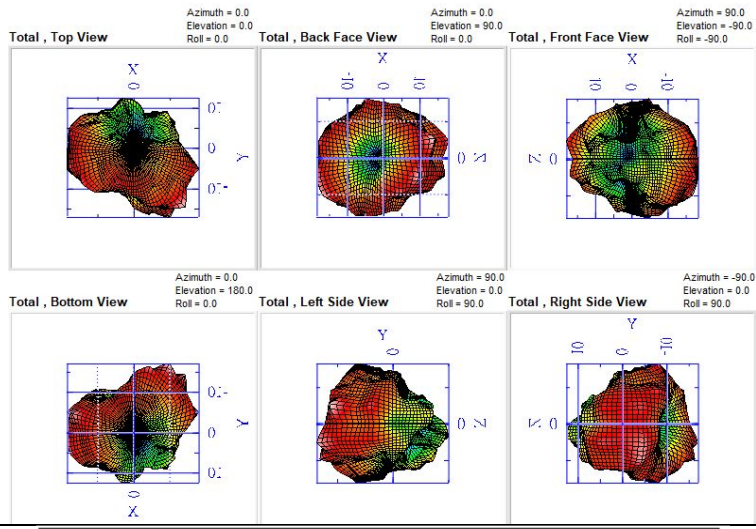

Frequency (MHz) : 5180.00 Polarity 1 : Horizontal Beamwidth 1 : 35
 Polarity 2 : Vertical Beamwidth 2 : 57
 (at the 3 dB down)