

802.11ax_HE20_CH 181_CDD On_Nss1

Total View

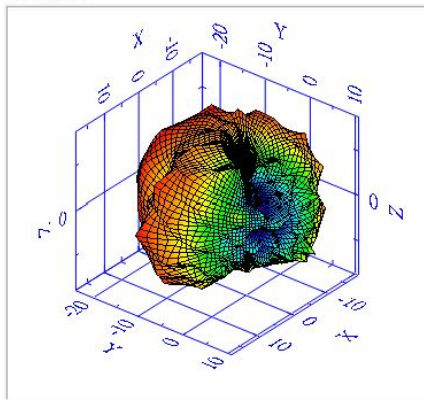

Frequency (MHz)	6855.00	
TRP (dBm)	-0.97	Total Peak EIRP (dBm) 6.1
NHPRP +/- 45 (dBm)	-1.53	Max. Power (dBm) 6.1
NHPRP +/- 30 (dBm)	-2.53	Min. Power (dBm) -18.15
Ver. Peak EIRP (dBm)	3.89	Hor. Peak EIRP (dBm) 3.22

Total , Top View

Azimuth = 0.0
Elevation = 0.0
Roll = 0.0

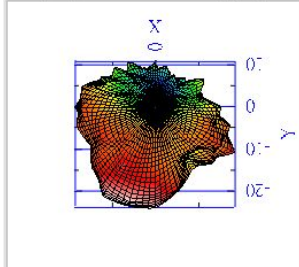

Total , Back Face View

Azimuth = 0.0
Elevation = 90.0
Roll = 0.0

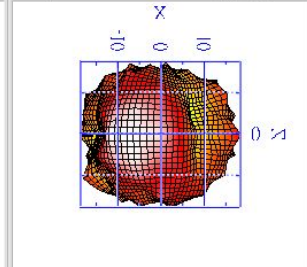

Total , Front Face View

Azimuth = 90.0
Elevation = -90.0
Roll = -90.0

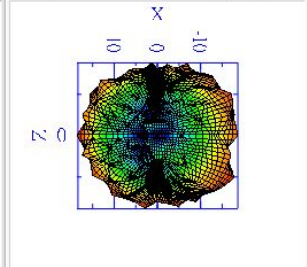

Total , Bottom View

Azimuth = 0.0
Elevation = 180.0
Roll = 0.0



Total , Left Side View

Azimuth = 90.0
Elevation = 0.0
Roll = 90.0



Total , Right Side View

Azimuth = -90.0
Elevation = 0.0
Roll = 90.0

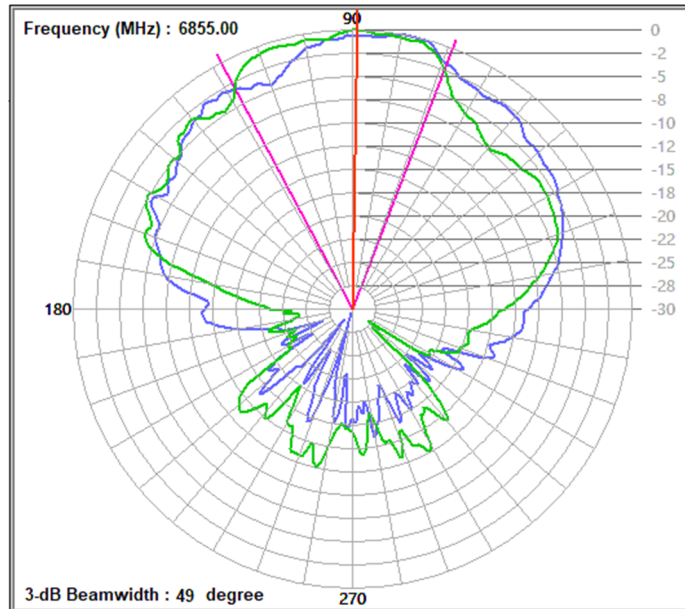
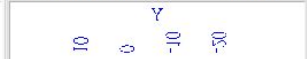

Frequency (MHz) : 6855.00 Polarity 1 : Horizontal Beamwidth 1 : 46
Polarity 2 : Vertical Beamwidth 2 : 49
(at the 3 dB down)

802.11ax_HE20_CH 233_CDD On_Nss1

Total View

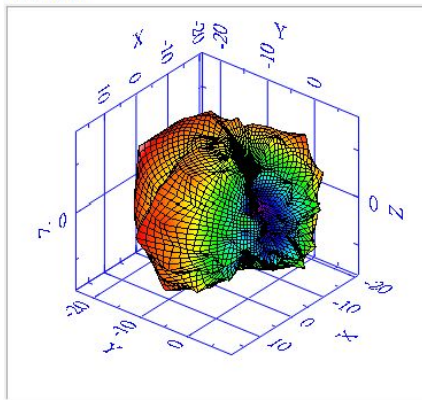

Frequency (MHz)	7115.00	
TRP (dBm)	-3.15	Total Peak EIRP (dBm) 4.44
NHPRP +/- 45 (dBm)	-3.57	Max. Power (dBm) 4.44
NHPRP +/- 30 (dBm)	-4.43	Min. Power (dBm) -20.22
Ver. Peak EIRP (dBm)	1.24	Hor. Peak EIRP (dBm) 1.61

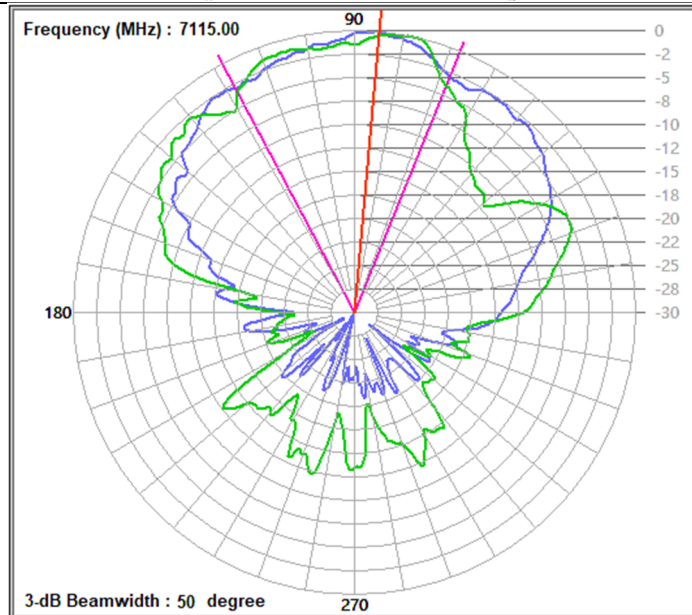
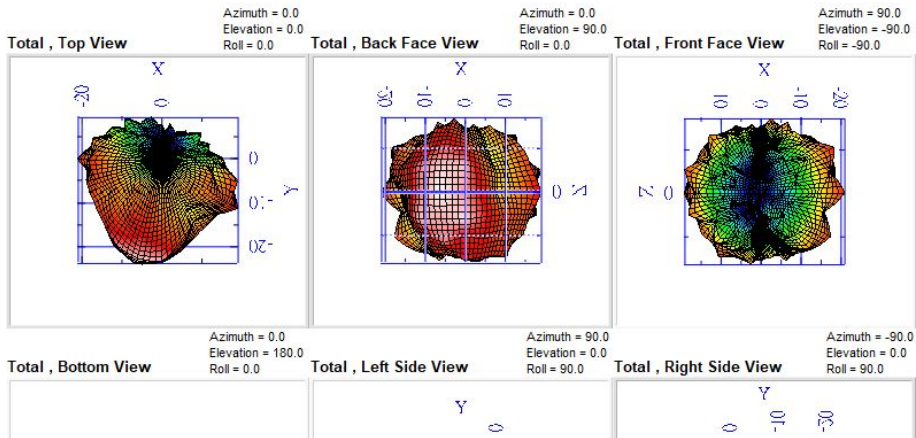

Frequency (MHz) : 7115.00 Polarity 1 : Horizontal Beamwidth 1 : 50
 Polarity 2 : Vertical Beamwidth 2 : 46
 (at the 3 dB down)

Model: FAP-433G

Radio 1 - 2.4GHz band

2.4GHz_HE20_CH 6_BF On Nss1

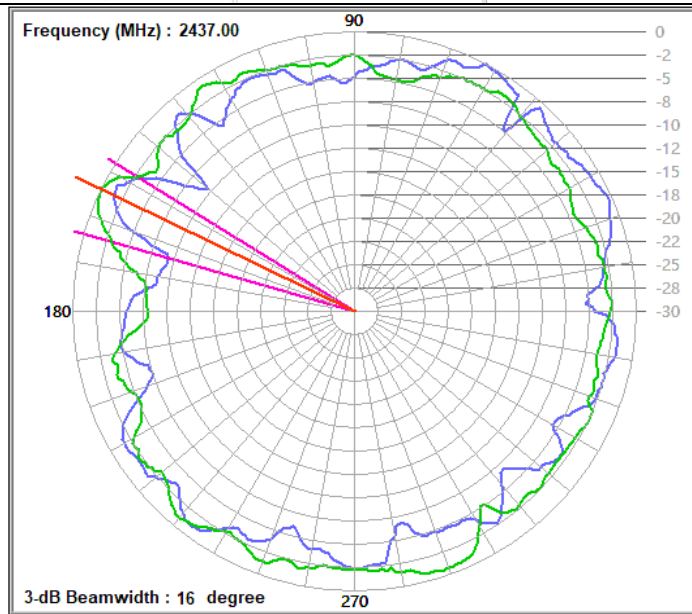
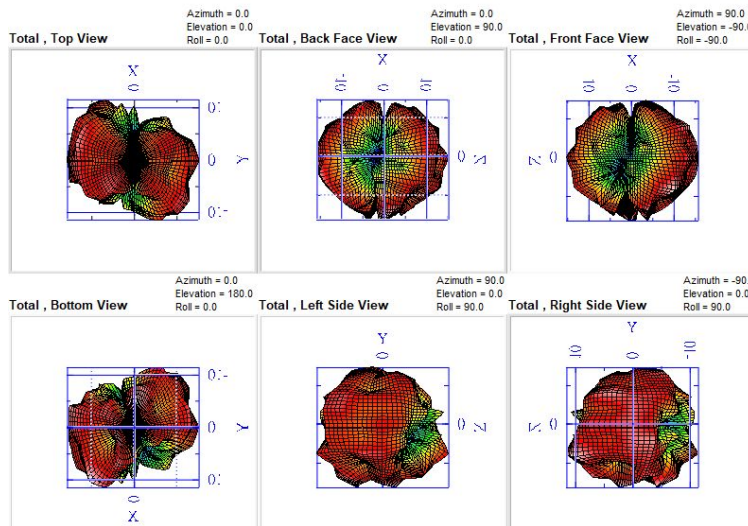
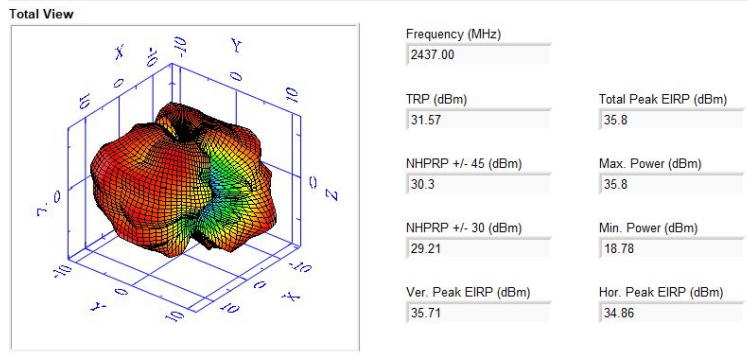

Frequency (MHz): 2437.00 Polarity 1 : Horizontal Beamwidth 1 : 21
 Polarity 2 : Vertical Beamwidth 2 : 16
 (at the 3 dB down)

Radio 2 - 5GHz band

802.11ax HE20 CH 36 BF On Nss1

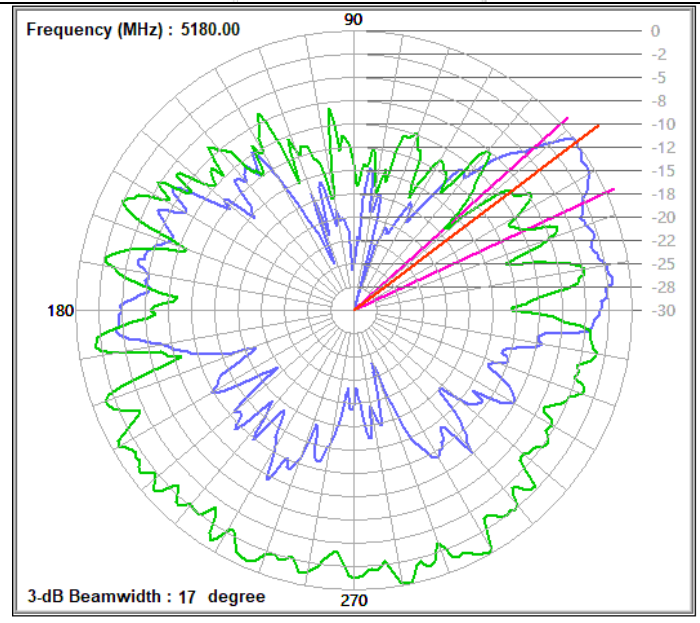
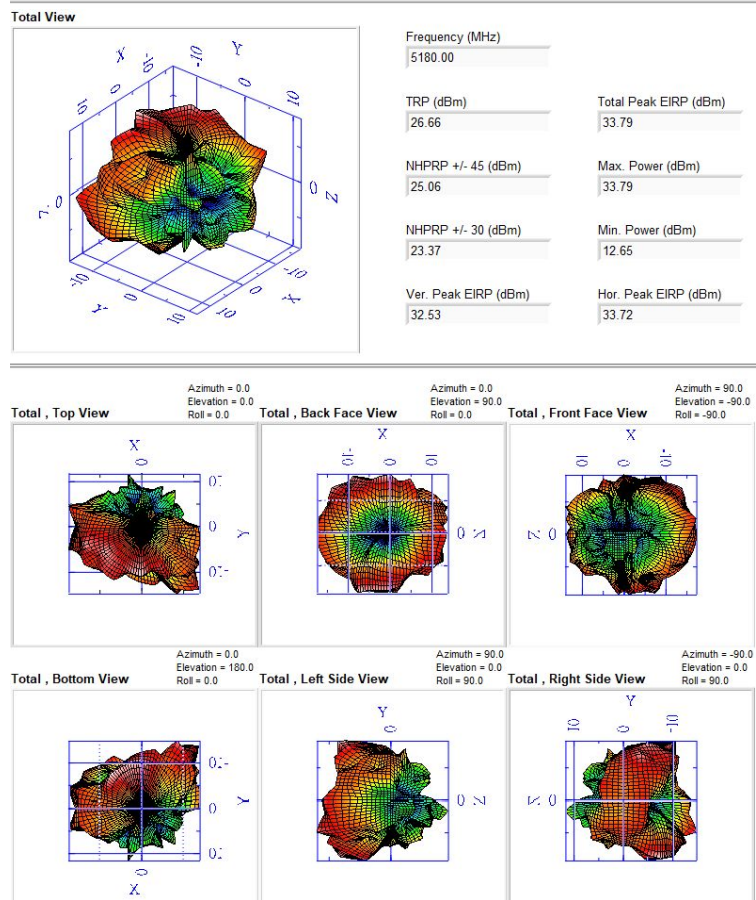

Frequency (MHz) : 5180.00 Polarity 1 : Horizontal Beamwidth 1 : 17
 Polarity 2 : Vertical Beamwidth 2 : 22
 (at the 3 dB down)

802.11ax HE20 CH 64 BF On Nss1

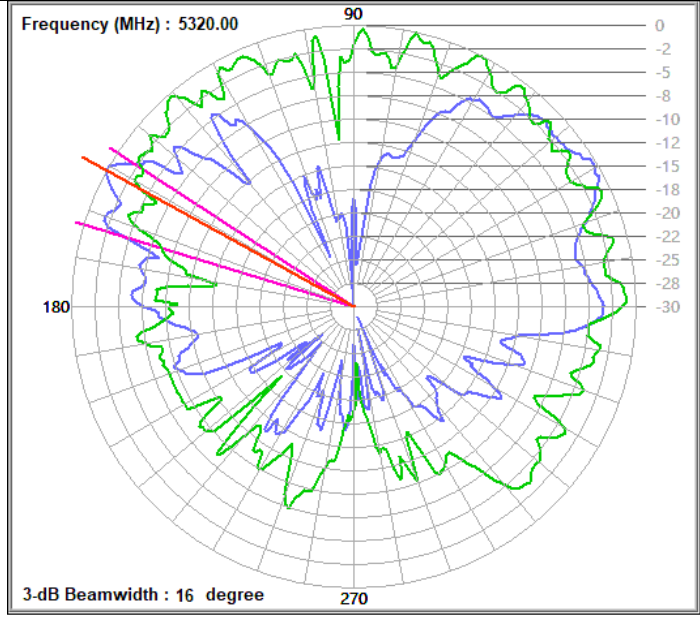
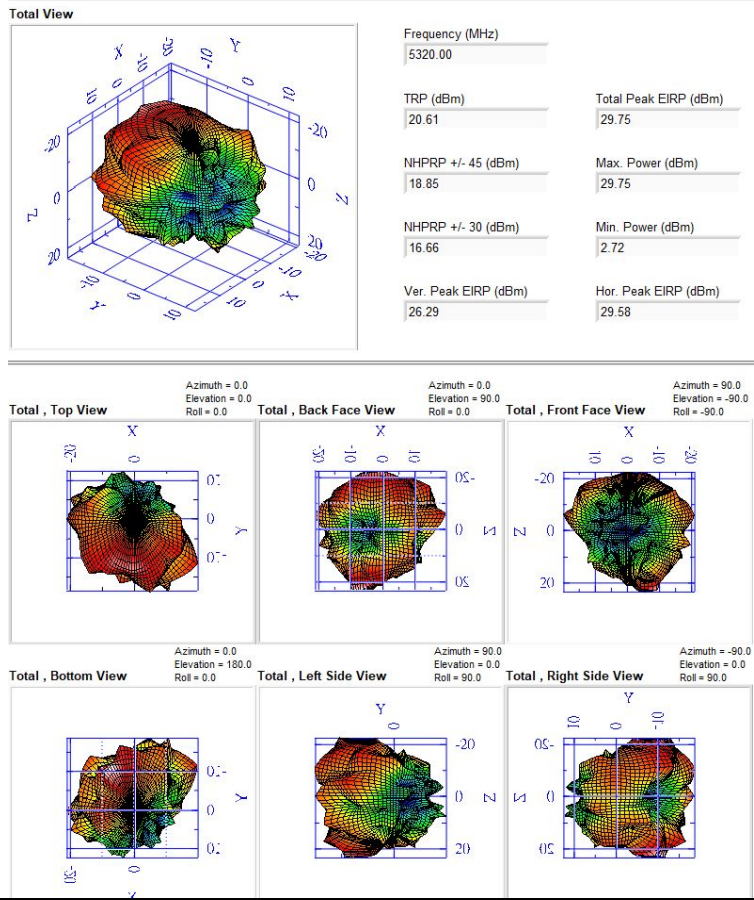

Frequency (MHz) : 5320.00 Polarity 1 : Horizontal Beamwidth 1 : 16
 Polarity 2 : Vertical Beamwidth 2 : 29
 (at the 3 dB down)

802.11ax HE20 CH 100 BF On Nss1

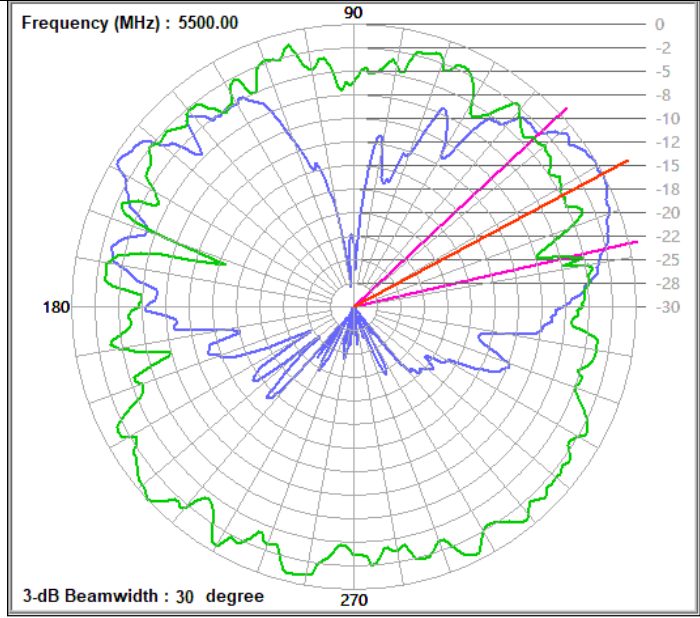
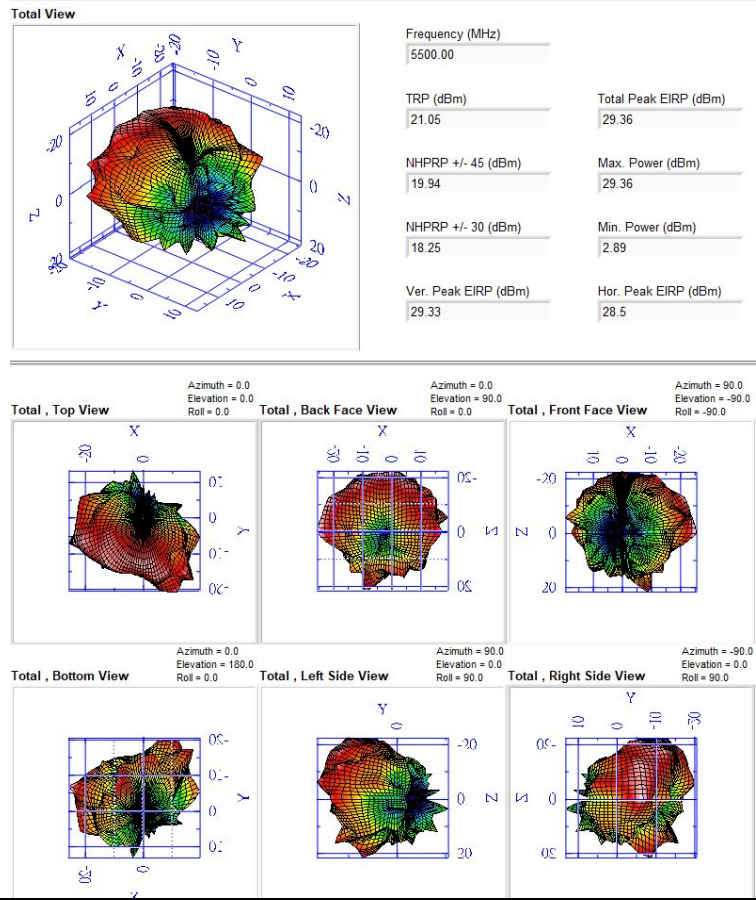

Frequency (MHz) : 5500.00 Polarity 1 : Horizontal Beamwidth 1 : 30
 Polarity 2 : Vertical Beamwidth 2 : 19
 (at the 3 dB down)

802.11ax HE20 CH 157 BF On Nss1

Total View

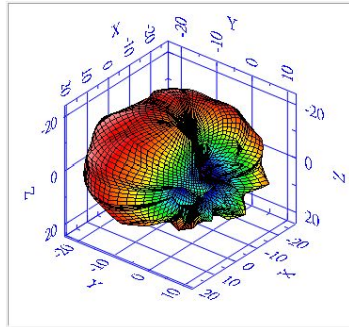

Frequency (MHz)	5785.00
TRP (dBm)	29.2
NHPRP +/- 45 (dBm)	28.35
NHPRP +/- 30 (dBm)	27.01
Ver. Peak EIRP (dBm)	35.8
Total Peak EIRP (dBm)	35.81
Max. Power (dBm)	35.81
Min. Power (dBm)	7.45
Hor. Peak EIRP (dBm)	34.24

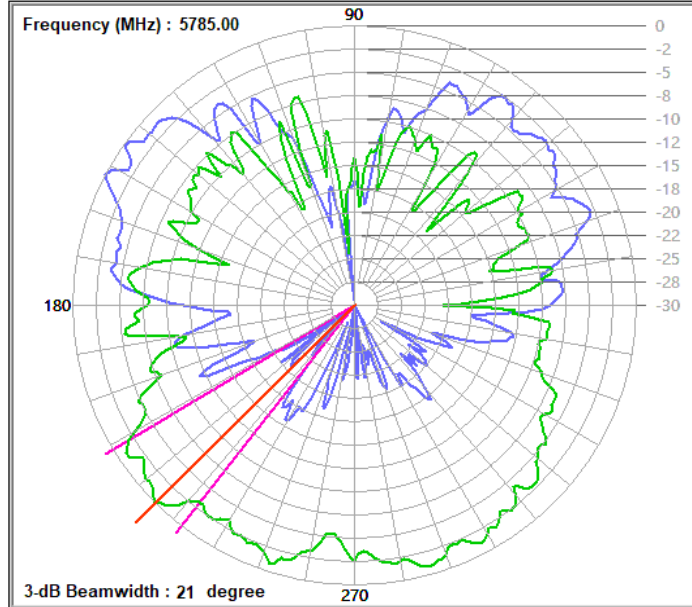
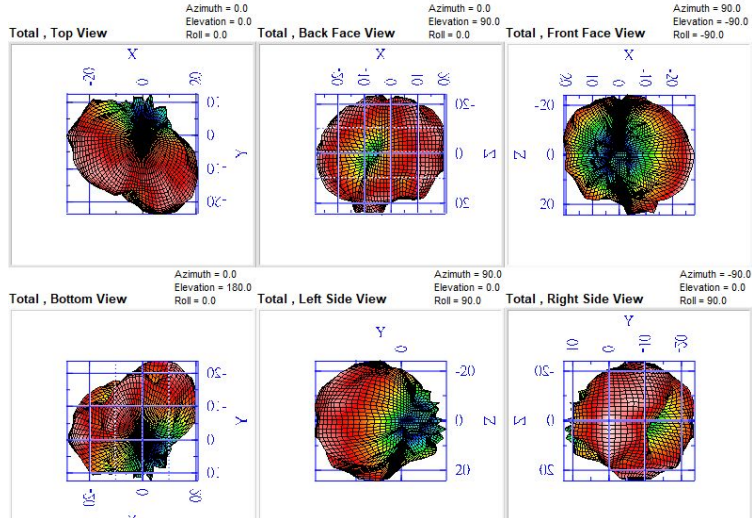

Frequency (MHz): 5785.00 Polarity 1 : Horizontal Beamwidth 1 : 25
 Polarity 2 : Vertical Beamwidth 2 : 21
 (at the 3 dB down)