

Multi-Antenna Systems Directional Gain measurement

Report No.: RFBCKS-WTW-P22051021-7

FCC ID: TVE-3918T05646

Model No.: FAP-431G, FAP-433G

Variation Model: FortiAP 431Gxxxxxx, FAP-431Gxxxxxx, FORTIAP-431Gxxxxxx, FortiAP 433Gxxxxxx, FAP-433Gxxxxxx, FORTIAP-433Gxxxxxx (Where "x" can be used as "A-Z", or "0-9", or "-", or blank for software changes or marketing purposes only) (refer to item 3.1 for more details)

Received Date: 2022/5/31

Test Date: 2022/11/1 ~ 2022/11/14

Issued Date: 2022/11/14

Applicant: Fortinet, Inc.

Address: 899 Kifer Rd. Sunnyvale CA. 94086 United States

Issued By: Bureau Veritas Consumer Products Services (H.K.) Ltd., Taoyuan Branch
Lin Kou Laboratories

Lab Address: No. 47-2, 14th Ling, Chia Pau Vil., Lin Kou Dist., New Taipei City, Taiwan

Test Location: No. 19, Hwa Ya 2nd Rd., Wen Hwa Vil., Kwei Shan Dist., Taoyuan City
33383, TAIWAN

**FCC Registration /
Designation Number:** 788550 / TW0003

This report is governed by, and incorporates by reference, the Conditions of Testing as posted at the date of issuance of this report at <http://www.bureauveritas.com/home/about-us/our-business/cps/about-us/terms-conditions/> and is intended for your exclusive use. Any copying or replication of this report to or for any other person or entity, or use of our name or trademark, is permitted only with our prior written permission. This report sets forth our findings solely with respect to the test samples identified herein. The results set forth in this report are not indicative or representative of the quality or characteristics of the lot from which a test sample was taken or any similar or identical product unless specifically and expressly noted. Our report includes all of the tests requested by you and the results thereof based upon the information that you provided to us. Measurement uncertainty is only provided upon request for accredited tests. Statements of conformity are based on simple acceptance criteria without taking measurement uncertainty into account, unless otherwise requested in writing. You have 60 days from date of issuance of this report to notify us of any material error or omission caused by our negligence or if you require measurement uncertainty; provided, however, that such notice shall be in writing and shall specifically address the issue you wish to raise. A failure to raise such issue within the prescribed time shall constitute your unqualified acceptance of the completeness of this report, the tests conducted and the correctness of the report contents.

Table of Contents

Release Control Record	3
1 EUT Antenna System Description	4
1.1 Antenna Information	4
1.2 Antenna Location	7
1.3 EUT Operation mode	8
2 Conducted Power Measurement	13
2.1 Test Setup	13
2.2 Test Instruments	13
2.3 Test Procedure	13
2.4 Test Results of RF Conducted Power (2.4GHz and 5GHz bands).....	14
3 3D Antenna Pattern Measurement and Directional gain calculation (Measurement Method and Measurement Environment).....	20
3.1 Test Location	20
3.2 Test Procedure	20
3.3 Test Setup Diagram @ Fully Anechoic Chamber (Dimension: 12m(L)*7m(W)*7m(H)).....	20
3.4 Test Setup Diagram for EUT	21
3.5 Test Instruments.....	21
3.6 Test Procedure	22
3.7 Test Results (Measurement Quantity) of EIRP Measurement & Directional Gain Calculation	23
3.8 3D EIRP Pattern and 3-dB Beam-width Test Plots	31
4 Appendix - Information of the Testing Laboratories	76

Release Control Record

Issue No.	Description	Date Issued
RFBCKS-WTW-P22051021-7	Original release.	2022/11/14

1 EUT Antenna System Description

1.1 Antenna Information

Model: FAP-431G

Antenna Type		PIFA			
Connector Type		ipex(MHF)			
Antenna No.	RF Chain No.	Brand	Model	Antenna Net Gain (dBi)	Frequency range
ANT0 (DB4)	Radio 1 2G CH0 Radio 2 5G CH0 Radio 2 5GL CH0	WNC	FortiAP-431G	1.41	2.4~2.4835GHz
				4.62	5.15~5.25GHz
				4.62	5.25~5.35GHz
				4.35	5.47~5.725GHz
				3.91	5.725~5.85GHz
				3.91	5.85~5.895GHz
ANT1 (DB3)	Radio 1 2G CH1 Radio 2 5G CH1 Radio 2 5GL CH1	WNC	FortiAP-431G	1.72	2.4~2.4835GHz
				3.38	5.15~5.25GHz
				3.61	5.25~5.35GHz
				3.72	5.47~5.725GHz
				3.72	5.725~5.85GHz
				3.72	5.85~5.895GHz
ANT2 (DB1)	Radio 1 2G CH2 Radio 2 5G CH2 Radio 2 5GL CH2	WNC	FortiAP-431G	1.54	2.4~2.4835GHz
				4.85	5.15~5.25GHz
				4.85	5.25~5.35GHz
				4.51	5.47~5.725GHz
				4.30	5.725~5.85GHz
				4.30	5.85~5.895GHz
ANT3 (DB2)	Radio 1 2G CH3 Radio 2 5G CH3 Radio 2 5GL CH3	WNC	FortiAP-431G	2.38	2.4~2.4835GHz
				3.48	5.15~5.25GHz
				3.52	5.25~5.35GHz
				3.58	5.47~5.725GHz
				3.55	5.725~5.85GHz
				3.55	5.85~5.895GHz
ANT4 (TB4)	Radio 3 5GH CH0 Radio 3 6G CH0 Scanning Radio (2/5/6G) CH0	WNC	FortiAP-431G	3.50	2.4~2.4835GHz
				4.98	5.15~5.25GHz
				4.98	5.25~5.35GHz
				4.98	5.47~5.725GHz
				4.50	5.725~5.85GHz
				4.50	5.85~5.895GHz
				4.80	5.925~6.425GHz
				4.80	6.425~6.525GHz
				5.50	6.525~6.875GHz
				5.50	6.875~7.125GHz

Antenna No.	RF Chain No.	Brand	Model	Antenna Net Gain (dBi)	Frequency range
ANT5 (TB1)	Radio 3 5GH CH1 Radio 3 6G CH1	WNC	FortiAP-431G	4.76	5.47~5.725GHz
				4.38	5.725~5.85GHz
				4.38	5.85~5.895GHz
				4.32	5.925~6.425GHz
				4.32	6.425~6.525GHz
				4.84	6.525~6.875GHz
				4.84	6.875~7.125GHz
ANT6 (TB2)	Radio 3 5GH CH2 Radio 3 6G CH2 Scanning Radio (2/5/6G) CH1	WNC	FortiAP-431G	2.58	2.4~2.4835GHz
				4.47	5.15~5.25GHz
				4.81	5.25~5.35GHz
				5.30	5.47~5.725GHz
				5.30	5.725~5.85GHz
				5.30	5.85~5.895GHz
				4.60	5.925~6.425GHz
				4.60	6.425~6.525GHz
				5.20	6.525~6.875GHz
				5.20	6.875~7.125GHz
ANT7 (TB3)	Radio 3 5GH CH3 Radio 3 6G CH3	WNC	FortiAP-431G	5.09	5.47~5.725GHz
				5.09	5.725~5.85GHz
				5.09	5.85~5.895GHz
				4.20	5.925~6.425GHz
				3.94	6.425~6.525GHz
				4.50	6.525~6.875GHz
				4.50	6.875~7.125GHz

Model: FAP-433G

Antenna Type		Dipole			
Connector Type		R-SMA (ANT0 ~ ANT3); ipex (ANT4 ~ ANT7)			
Antenna No.	RF Chain No.	Brand	Model	Antenna Net Gain (dBi)	Frequency range
ANT0	Radio 1 2G CH0 Radio 2 5G CH0 Radio 2 5GL CH0	MAGLAYERS	EDA-1410-6G0R2-A3	5.65	2.4~2.4835GHz
				5.31	5.15~5.25GHz
				5.37	5.25~5.35GHz
				5.94	5.47~5.725GHz
				5.45	5.725~5.85GHz
ANT1	Radio 1 2G CH1 Radio 2 5G CH1 Radio 2 5GL CH1	MAGLAYERS	EDA-1410-6G0R2-A3	5.65	2.4~2.4835GHz
				5.31	5.15~5.25GHz
				5.37	5.25~5.35GHz
				5.94	5.47~5.725GHz
				5.45	5.725~5.85GHz
ANT2	Radio 1 2G CH2 Radio 2 5G CH2 Radio 2 5GL CH2	MAGLAYERS	EDA-1410-6G0R2-A3	5.65	2.4~2.4835GHz
				5.31	5.15~5.25GHz
				5.37	5.25~5.35GHz
				5.94	5.47~5.725GHz
				5.45	5.725~5.85GHz
ANT3	Radio 1 2G CH3 Radio 2 5G CH3 Radio 2 5GL CH3	MAGLAYERS	EDA-1410-6G0R2-A3	5.65	2.4~2.4835GHz
				5.31	5.15~5.25GHz
				5.37	5.25~5.35GHz
				5.94	5.47~5.725GHz
				5.45	5.725~5.85GHz
ANT4	Radio 3 5GH CH0 Radio 3 6G CH0 Scanning Radio (2/5/6G) CH0	MAGLAYERS	BTEAWT14136 G0C1A02	3.11	2.4~2.4835GHz
				2.27	5.15~5.25GHz
				2.27	5.25~5.35GHz
				2.81	5.47~5.725GHz
				2.81	5.725~5.85GHz
				2.81	5.85~5.895GHz
				2.55	5.925~6.425GHz
				2.55	6.425~6.525GHz
				2.74	6.525~6.875GHz
2.74	6.875~7.125GHz				

Antenna No.	RF Chain No.	Brand	Model	Antenna Net Gain (dBi)	Frequency range
ANT5	Radio 3 5GH CH1 Radio 3 6G CH1	MAGLAYERS	BTEAWT14136 G0C1A02	2.81	5.47~5.725GHz
				2.81	5.725~5.85GHz
				2.81	5.85~5.895GHz
				2.55	5.925~6.425GHz
				2.55	6.425~6.525GHz
				2.74	6.525~6.875GHz
				2.74	6.875~7.125GHz
ANT6	Radio 3 5GH CH2 Radio 3 6G CH2 Scanning Radio (2/5/6G) CH1	MAGLAYERS	BTEAWT14136 G0C1A01	2.81	2.4~2.4835GHz
				2.39	5.15~5.25GHz
				2.39	5.25~5.35GHz
				2.39	5.47~5.725GHz
				2.39	5.725~5.85GHz
				2.21	5.85~5.895GHz
				2.71	5.925~6.425GHz
				2.71	6.425~6.525GHz
				2.61	6.525~6.875GHz
				2.61	6.875~7.125GHz
ANT7	Radio 3 5GH CH3 Radio 3 6G CH3	MAGLAYERS	BTEAWT14136 G0C1A01	2.39	5.47~5.725GHz
				2.39	5.725~5.85GHz
				2.21	5.85~5.895GHz
				2.71	5.925~6.425GHz
				2.71	6.425~6.525GHz
				2.61	6.525~6.875GHz
				2.61	6.875~7.125GHz

1.2 Antenna Location

Please refer to report BCKS-WTW-P22051021_(EUT Photo)_INT_Page 1.

1.3 EUT Operation mode

Radio 1

Band	Modulation Mode	CDD mode	Beamforming mode
2.4GHz	802.11b	Nss1	Not Support
	802.11g	Nss1	Not Support
	802.11n (HT20)	Nss1 / Nss2 / Nss3 / Nss4	Nss1 / Nss2 / Nss3 / Nss4
	802.11n (HT40)	Nss1 / Nss2 / Nss3 / Nss4	Nss1 / Nss2 / Nss3 / Nss4
	VHT20	Nss1 / Nss2 / Nss3 / Nss4	Nss1 / Nss2 / Nss3 / Nss4
	VHT40	Nss1 / Nss2 / Nss3 / Nss4	Nss1 / Nss2 / Nss3 / Nss4
	802.11ax (HE20)	Nss1 / Nss2 / Nss3 / Nss4	Nss1 (Note) / Nss2 / Nss3 / Nss4
	802.11ax (HE40)	Nss1 / Nss2 / Nss3 / Nss4	Nss1 / Nss2 / Nss3 / Nss4

Note: The 802.11ax (HE20) of Nss 1 of beamforming mode for 2.4 GHz bands is the worst case for final testing.

Band	Modulation Mode	ANT0	ANT1	ANT2	ANT3
2.4GHz	802.11b	TX/RX	TX/RX	TX/RX	TX/RX
	802.11g	TX/RX	TX/RX	TX/RX	TX/RX
	802.11n (HT20)	TX/RX	TX/RX	TX/RX	TX/RX
	802.11n (HT40)	TX/RX	TX/RX	TX/RX	TX/RX
	VHT20	TX/RX	TX/RX	TX/RX	TX/RX
	VHT40	TX/RX	TX/RX	TX/RX	TX/RX
	802.11ax (HE20)	TX/RX	TX/RX	TX/RX	TX/RX
	802.11ax (HE40)	TX/RX	TX/RX	TX/RX	TX/RX

Radio 2

Band	Modulation Mode	CDD mode	Beamforming mode
5GHz	802.11a	Nss1	Not Support
	802.11n (HT20)	Nss1 / Nss2 / Nss3 / Nss4	Nss1 / Nss2 / Nss3 / Nss4
	802.11n (HT40)	Nss1 / Nss2 / Nss3 / Nss4	Nss1 / Nss2 / Nss3 / Nss4
	802.11ac (VHT20)	Nss1 / Nss2 / Nss3 / Nss4	Nss1 / Nss2 / Nss3 / Nss4
	802.11ac (VHT40)	Nss1 / Nss2 / Nss3 / Nss4	Nss1 / Nss2 / Nss3 / Nss4
	802.11ac (VHT80)	Nss1 / Nss2 / Nss3 / Nss4	Nss1 / Nss2 / Nss3 / Nss4
	802.11ax (HE20)	Nss1 / Nss2 / Nss3 / Nss4	Nss1 (Note) / Nss2 / Nss3 / Nss4
	802.11ax (HE40)	Nss1 / Nss2 / Nss3 / Nss4	Nss1 / Nss2 / Nss3 / Nss4
	802.11ax (HE80)	Nss1 / Nss2 / Nss3 / Nss4	Nss1 / Nss2 / Nss3 / Nss4

Note: The 802.11ax (HE20) of Nss 1 of beamforming mode for 5 GHz bands is the worst case for final testing.

Band	Modulation Mode	ANT0	ANT1	ANT2	ANT3
5GHz	802.11a	TX/RX	TX/RX	TX/RX	TX/RX
	802.11n (HT20)	TX/RX	TX/RX	TX/RX	TX/RX
	802.11n (HT40)	TX/RX	TX/RX	TX/RX	TX/RX
	802.11ac (VHT20)	TX/RX	TX/RX	TX/RX	TX/RX
	802.11ac (VHT40)	TX/RX	TX/RX	TX/RX	TX/RX
	802.11ac (VHT80)	TX/RX	TX/RX	TX/RX	TX/RX
	802.11ax (HE20)	TX/RX	TX/RX	TX/RX	TX/RX
	802.11ax (HE40)	TX/RX	TX/RX	TX/RX	TX/RX
	802.11ax (HE80)	TX/RX	TX/RX	TX/RX	TX/RX

Radio 3

Band	Modulation Mode	CDD mode	Beamforming mode
5GHz	802.11a	Nss1	Not Support
	802.11n (HT20)	Nss1 / Nss2 / Nss3 / Nss4	Nss1 / Nss2 / Nss3 / Nss4
	802.11n (HT40)	Nss1 / Nss2 / Nss3 / Nss4	Nss1 / Nss2 / Nss3 / Nss4
	802.11ac (VHT20)	Nss1 / Nss2 / Nss3 / Nss4	Nss1 / Nss2 / Nss3 / Nss4
	802.11ac (VHT40)	Nss1 / Nss2 / Nss3 / Nss4	Nss1 / Nss2 / Nss3 / Nss4
	802.11ac (VHT80)	Nss1 / Nss2 / Nss3 / Nss4	Nss1 / Nss2 / Nss3 / Nss4
	802.11ac (VHT160)	Nss1 / Nss2 / Nss3 / Nss4	Nss1 / Nss2 / Nss3 / Nss4
	802.11ax (HE20)	Nss1 / Nss2 / Nss3 / Nss4	Nss1 (Note) / Nss2 / Nss3 / Nss4
	802.11ax (HE40)	Nss1 / Nss2 / Nss3 / Nss4	Nss1 / Nss2 / Nss3 / Nss4
	802.11ax (HE80)	Nss1 / Nss2 / Nss3 / Nss4	Nss1 / Nss2 / Nss3 / Nss4
6GHz	802.11a	Nss1	Not Support
	802.11ax (HE20)	Nss1 / Nss2 / Nss3 / Nss4	Nss1 (Note) / Nss2 / Nss3 / Nss4
	802.11ax (HE40)	Nss1 / Nss2 / Nss3 / Nss4	Nss1 / Nss2 / Nss3 / Nss4
	802.11ax (HE80)	Nss1 / Nss2 / Nss3 / Nss4	Nss1 / Nss2 / Nss3 / Nss4
	802.11ax (HE160)	Nss1 / Nss2 / Nss3 / Nss4	Nss1 / Nss2 / Nss3 / Nss4

Note: The 802.11ax (HE20) of Nss 1 of beamforming mode for both 5 GHz and 6 GHz bands are the worst case for final testing.

Band	Modulation Mode	ANT4	ANT5	ANT6	ANT7
5GHz	802.11a	TX/RX	TX/RX	TX/RX	TX/RX
	802.11n (HT20)	TX/RX	TX/RX	TX/RX	TX/RX
	802.11n (HT40)	TX/RX	TX/RX	TX/RX	TX/RX
	802.11ac (VHT20)	TX/RX	TX/RX	TX/RX	TX/RX
	802.11ac (VHT40)	TX/RX	TX/RX	TX/RX	TX/RX
	802.11ac (VHT80)	TX/RX	TX/RX	TX/RX	TX/RX
	802.11ac (VHT160)	TX/RX	TX/RX	TX/RX	TX/RX
	802.11ax (HE20)	TX/RX	TX/RX	TX/RX	TX/RX
	802.11ax (HE40)	TX/RX	TX/RX	TX/RX	TX/RX
	802.11ax (HE80)	TX/RX	TX/RX	TX/RX	TX/RX
6GHz	802.11a	TX/RX	TX/RX	TX/RX	TX/RX
	802.11ax (HE20)	TX/RX	TX/RX	TX/RX	TX/RX
	802.11ax (HE40)	TX/RX	TX/RX	TX/RX	TX/RX
	802.11ax (HE80)	TX/RX	TX/RX	TX/RX	TX/RX
	802.11ax (HE160)	TX/RX	TX/RX	TX/RX	TX/RX

Scanning Radio

Band	Modulation Mode	CDD mode	Beamforming mode
2.4GHz	802.11b	Nss1	Not Support
	802.11g	Nss1	Not Support
	802.11n (HT20)	Nss1 / Nss2	Not Support
	802.11n (HT40)	Nss1 / Nss2	Not Support
	VHT20	Nss1 / Nss2	Not Support
	VHT40	Nss1 / Nss2	Not Support
	802.11ax (HE20)	Nss1 (Note) / Nss2	Not Support
	802.11ax (HE40)	Nss1 / Nss2	Not Support
5GHz	802.11a	Nss1	Not Support
	802.11n (HT20)	Nss1 / Nss2	Not Support
	802.11n (HT40)	Nss1 / Nss2	Not Support
	802.11ac (VHT20)	Nss1 / Nss2	Not Support
	802.11ac (VHT40)	Nss1 / Nss2	Not Support
	802.11ac (VHT80)	Nss1 / Nss2	Not Support
	802.11ac (VHT160)	Nss1 / Nss2	Not Support
	802.11ax (HE20)	Nss1 (Note) / Nss2	Not Support
	802.11ax (HE40)	Nss1 / Nss2	Not Support
	802.11ax (HE80)	Nss1 / Nss2	Not Support
	802.11ax (HE160)	Nss1 / Nss2	Not Support
6GHz	802.11a	Nss1	Not Support
	802.11ax (HE20)	Nss1 (Note) / Nss2	Not Support
	802.11ax (HE40)	Nss1 / Nss2	Not Support
	802.11ax (HE80)	Nss1 / Nss2	Not Support
	802.11ax (HE160)	Nss1 / Nss2	Not Support

Note: The 802.11ax (HE20) of Nss 1 of CDD mode for 2.4 GHz, 5 GHz and 6GHz bands are the worst case for final testing.

Band	Modulation Mode	ANT4	ANT6
2.4GHz	802.11b	TX/RX	TX/RX
	802.11g	TX/RX	TX/RX
	802.11n (HT20)	TX/RX	TX/RX
	802.11n (HT40)	TX/RX	TX/RX
	VHT20	TX/RX	TX/RX
	VHT40	TX/RX	TX/RX
	802.11ax (HE20)	TX/RX	TX/RX
	802.11ax (HE40)	TX/RX	TX/RX
5GHz	802.11a	TX/RX	TX/RX
	802.11n (HT20)	TX/RX	TX/RX
	802.11n (HT40)	TX/RX	TX/RX
	802.11ac (VHT20)	TX/RX	TX/RX
	802.11ac (VHT40)	TX/RX	TX/RX
	802.11ac (VHT80)	TX/RX	TX/RX
	802.11ac (VHT160)	TX/RX	TX/RX
	802.11ax (HE20)	TX/RX	TX/RX
	802.11ax (HE40)	TX/RX	TX/RX
	802.11ax (HE80)	TX/RX	TX/RX
	802.11ax (HE160)	TX/RX	TX/RX
6GHz	802.11a	TX/RX	TX/RX
	802.11ax (HE20)	TX/RX	TX/RX
	802.11ax (HE40)	TX/RX	TX/RX
	802.11ax (HE80)	TX/RX	TX/RX
	802.11ax (HE160)	TX/RX	TX/RX

2 Conducted Power Measurement

2.1 Test Setup

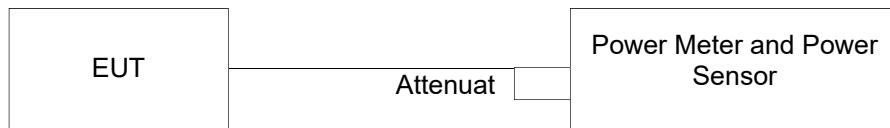

2.2 Test Instruments

Description & Manufacturer	Model No.	Serial No.	Date of Calibration	Due Date of Calibration
Peak Power Analyzer KEYSIGHT	8990B	MY51000485	Jan. 18, 2022	Jan. 17, 2023
Wideband Power Sensor KEYSIGHT	N1923A	MY58020002	Jan. 17, 2022	Jan. 16, 2023

Note: The calibration interval of the above test instruments is 12 months and the calibrations are traceable to NML/ROC and NIST/USA.

2.3 Test Procedure

Method PM is used to perform output power measurement, trigger and gating function of wide band power meter is enabled to measure max output power of TX on burst and set the detector to average. Duty factor is not added to measured value.

2.4 Test Results of RF Conducted Power

Model: FAP-431G

Radio 1

802.11 ax HE20 of Beamforming Mode / Nss=1

Channel	Frequency	ANT0		ANT1		ANT2		ANT3		Total Conducted Power
		Chain 0		Chain 1		Chain 2		Chain 3		
		(dBm)	(mW)	(dBm)	(mW)	(dBm)	(mW)	(dBm)	(mW)	(dBm)
6	2437	23.51	224.388	23.59	228.560	23.91	246.037	23.39	218.273	29.62

Note:

Total Conducted Power = Chain 0 + Chain 1 + Chain 2 + Chain 3

= Chain 0 (mW) + Chain 1 (mW) + Chain 2 (mW) + Chain 3 (mW) = Total Conducted Power (mW)

Total Conducted Power (dBm) = 10 * log (Total conducted power (mW)).

Radio 2

802.11 ax HE20 of Beamforming Mode / Nss=1

Channel	Frequency	ANT0		ANT1		ANT2		ANT3		Total Conducted Power
		Chain 0		Chain 1		Chain 2		Chain 3		
		(dBm)	(mW)	(dBm)	(mW)	(dBm)	(mW)	(dBm)	(mW)	(dBm)
36	5180	19.92	98.175	20.23	105.439	20.37	108.893	19.92	98.175	26.14
64	5320	16.72	46.989	16.84	48.306	16.95	49.545	16.64	46.132	22.81
100	5500	17.24	52.966	17.31	53.827	17.42	55.208	17.35	54.325	23.35
157	5785	23.37	217.270	23.46	221.820	23.75	237.137	22.85	192.752	29.39
173	5865	19.06	80.538	18.93	78.163	18.67	73.621	18.72	74.473	24.87

Note:

Total Conducted Power = Chain 0 + Chain 1 + Chain 2 + Chain 3

= Chain 0 (mW) + Chain 1 (mW) + Chain 2 (mW) + Chain 3 (mW) = Total Conducted Power (mW)

Total Conducted Power (dBm) = 10 * log (Total conducted power (mW)).

Radio 3

802.11 ax HE20 of Beamforming Mode / Nss=1

Channel	Frequency	ANT4		ANT5		ANT6		ANT7		Total Conducted Power (dBm)
		Chain 0		Chain 1		Chain 2		Chain 3		
		(dBm)	(mW)	(dBm)	(mW)	(dBm)	(mW)	(dBm)	(mW)	
100	5500	14.95	31.261	14.79	30.130	14.62	28.973	14.92	31.046	20.84
157	5785	22.10	162.181	22.62	182.810	22.05	160.325	23.00	199.526	28.48
173	5865	18.21	66.222	18.10	64.565	17.63	57.943	18.37	68.707	24.11
93	6415	3.60	2.291	3.65	2.317	3.48	2.228	4.37	2.735	9.81
113	6515	2.44	1.754	1.84	1.528	2.29	1.694	2.46	1.762	8.29
181	6855	2.63	1.832	2.42	1.746	2.96	1.977	2.48	1.770	8.65
233	7115	1.42	1.387	1.95	1.567	2.02	1.592	1.93	1.560	7.86

Note:

Total Conducted Power = Chain 0 + Chain 1 + Chain 2 + Chain 3
= Chain 0 (mW) + Chain 1 (mW) + Chain 2 (mW) + Chain 3 (mW) = Total Conducted Power (mW)
Total Conducted Power (dBm) = 10 * log (Total conducted power (mW)).

Scanning Radio

802.11 ax HE20 of CDD Mode / Nss=1

Channel	Frequency	ANT4		ANT6		Total Conducted Power
		Chain 0		Chain 1		
		(dBm)	(mW)	(dBm)	(mW)	(dBm)
6	2437	19.20	83.176	19.34	85.901	22.28
36	5180	14.98	31.477	14.64	29.107	17.82
64	5320	15.16	32.810	15.12	32.509	18.15
100	5500	16.64	46.132	16.60	45.709	19.63
157	5785	22.94	196.789	22.88	194.089	25.92
173	5865	23.05	201.837	23.49	223.357	26.29

Note:

Total Conducted Power = Chain 0 + Chain 1

= Chain 0 (mW) + Chain 1 (mW) = Total Conducted Power (mW)

Total Conducted Power (dBm) = $10 * \log(\text{Total conducted power (mW)})$.

Channel	Frequency	ANT4		ANT6		Total PSD
		Chain 0		Chain 1		
		(dBm/MHz)	(mW/MHz)	(dBm/MHz)	(mW/MHz)	(dBm/MHz)
93	6415	-3.51	0.446	-3.67	0.430	-0.57
113	6515	-3.67	0.430	-4.10	0.389	-0.87
181	6855	-4.44	0.360	-3.87	0.410	-1.14
233	7115	-6.46	0.226	-6.57	0.220	-3.51

Note:

Total PSD = Chain 0 + Chain 1

= Chain 0 (mW/MHz) + Chain 1 (mW/MHz) = Total PSD (mW/MHz)

Total PSD (dBm/MHz) = $10 * \log(\text{Total PSD (mW/MHz)})$.

Model: FAP-433G

Radio 1

802.11 ax HE20 of Beamforming Mode / Nss=1

Channel	Frequency	ANT0		ANT1		ANT2		ANT3		Total Conducted Power
		Chain 0		Chain 1		Chain 2		Chain 3		
		(dBm)	(mW)	(dBm)	(mW)	(dBm)	(mW)	(dBm)	(mW)	(dBm)
6	2437	23.03	200.909	23.42	219.786	23.16	207.014	22.76	188.799	29.12

Note:

Total Conducted Power = Chain 0 + Chain 1 + Chain 2 + Chain 3

= Chain 0 (mW) + Chain 1 (mW) + Chain 2 (mW) + Chain 3 (mW) = Total Conducted Power (mW)

Total Conducted Power (dBm) = 10 * log (Total conducted power (mW)).

Radio 2

802.11 ax HE20 of Beamforming Mode / Nss=1

Channel	Frequency	ANT0		ANT1		ANT2		ANT3		Total Conducted Power
		Chain 0		Chain 1		Chain 2		Chain 3		
		(dBm)	(mW)	(dBm)	(mW)	(dBm)	(mW)	(dBm)	(mW)	(dBm)
36	5180	20.37	108.893	20.79	119.950	20.79	119.950	20.59	114.551	26.66
64	5320	16.26	42.267	16.53	44.978	16.53	44.978	16.27	42.364	22.42
100	5500	15.89	38.815	15.56	35.975	15.79	37.931	15.91	38.994	21.81
157	5785	22.37	172.584	22.64	183.654	23.83	241.546	21.24	133.045	28.64

Note:

Total Conducted Power = Chain 0 + Chain 1 + Chain 2 + Chain 3

= Chain 0 (mW) + Chain 1 (mW) + Chain 2 (mW) + Chain 3 (mW) = Total Conducted Power (mW)

Total Conducted Power (dBm) = 10 * log (Total conducted power (mW)).

Radio 3

802.11 ax HE20 of Beamforming Mode / Nss=1

Channel	Frequency	ANT4		ANT5		ANT6		ANT7		Total Conducted Power
		Chain 0		Chain 1		Chain 2		Chain 3		
		(dBm)	(mW)	(dBm)	(mW)	(dBm)	(mW)	(dBm)	(mW)	(dBm)
100	5500	15.47	35.237	15.21	33.189	15.04	31.915	15.74	37.497	21.39
157	5785	20.64	115.878	22.19	165.577	20.56	113.763	22.28	169.044	27.51
173	5865	18.86	76.913	19.01	79.616	18.72	74.473	19.05	80.353	24.93
93	6415	4.32	2.704	3.91	2.460	4.37	2.735	4.65	2.917	10.34
113	6515	4.63	2.904	4.03	2.529	4.24	2.655	3.76	2.377	10.20
181	6855	4.03	2.529	3.82	2.410	4.03	2.529	3.94	2.477	9.98
233	7115	1.73	1.489	1.65	1.462	1.61	1.449	1.82	1.521	7.72

Note:

Total Conducted Power = Chain 0 + Chain 1 + Chain 2 + Chain 3

= Chain 0 (mW) + Chain 1 (mW) + Chain 2 (mW) + Chain 3 (mW) = Total Conducted Power (mW)

Total Conducted Power (dBm) = $10 * \log(\text{Total conducted power (mW)})$.

Scanning Radio

802.11 ax HE20 of CDD Mode / Nss=1

Channel	Frequency	ANT4		ANT6		Total Conducted Power
		Chain 0		Chain 1		
		(dBm)	(mW)	(dBm)	(mW)	(dBm)
6	2437	19.71	93.541	19.69	93.111	22.71
36	5180	14.23	26.485	14.33	27.102	17.29
64	5320	14.45	27.861	14.56	28.576	17.52
100	5500	14.55	28.510	14.63	29.040	17.60
157	5785	21.36	136.773	21.45	139.637	24.42
173	5865	21.16	130.617	21.02	126.474	24.10

Note:

Total Conducted Power = Chain 0 + Chain 1

= Chain 0 (mW) + Chain 1 (mW) = Total Conducted Power (mW)

Total Conducted Power (dBm) = $10 * \log(\text{Total conducted power (mW)})$.

Channel	Frequency	ANT4		ANT6		Total PSD
		Chain 0		Chain 1		
		(dBm/MHz)	(mW/MHz)	(dBm/MHz)	(mW/MHz)	(dBm/MHz)
93	6415	-2.99	0.502	-3.64	0.433	-0.29
113	6515	-3.20	0.479	-2.97	0.505	-0.07
181	6855	-3.87	0.410	-3.77	0.420	-0.81
233	7115	-11.42	0.072	-11.05	0.079	-8.21

Note:

Total PSD = Chain 0 + Chain 1

= Chain 0 (mW/MHz) + Chain 1 (mW/MHz) = Total PSD (mW/MHz)

Total PSD (dBm/MHz) = $10 * \log(\text{Total PSD (mW/MHz)})$.

3 3D Antenna Pattern Measurement and Directional gain calculation (Measurement Method and Measurement Environment)

Measurement the EIRP and compare the total conducted power values to calculation the directional gain.

3.1 Test Location

3D Antenna a Pattern Measurement in Fully Anechoic Chamber

3.2 Test Procedure

KDB 662911 D03 MIMO Antenna Gain Measurement v01

ANSI 63.10:2013 – clause 13

KDB 412172 D01 Determining ERP and EIRP v01r01

3.3 Test Setup Diagram @ Fully Anechoic Chamber (Dimension: 12m(L)*7m(W)*7m(H))

The EIRP Pattern measurement is using the conical circle cut test system (refer to Figure 1). The EUT is positioned on center of turntable, for Free Space only in fully anechoic chamber. Data (channel power level) is recorded using the spectrum analyzer for both theta and phi polarizations at each position.

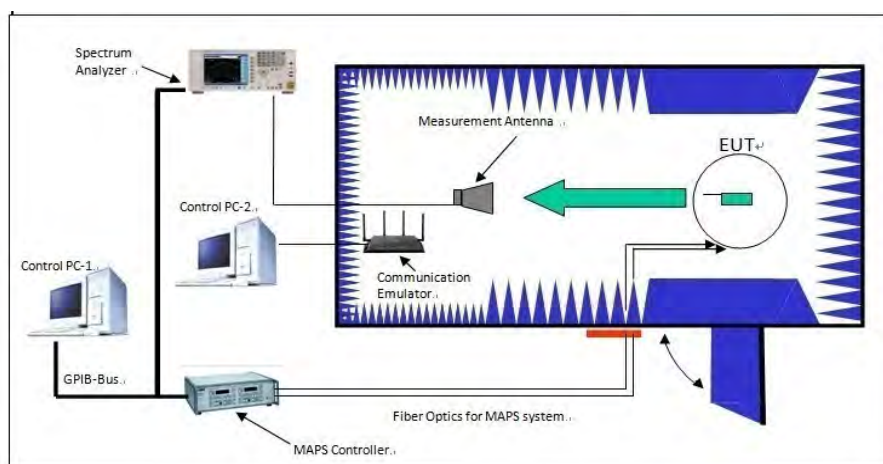

Figure 1. Conical circle cut test system.

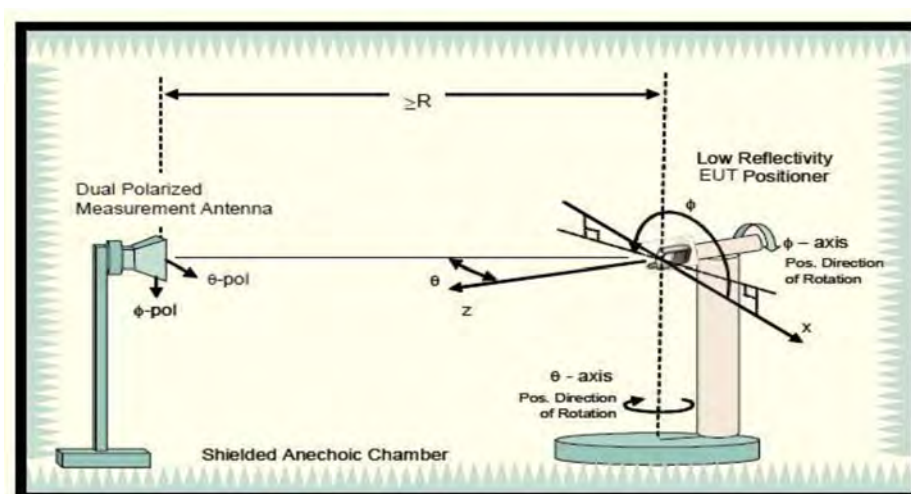

Figure 2. Configuration of Conical circle cut test system.

3.4 Test Setup Diagram for EUT

Please refer to report BCKS-WTW-P22051021_Tsup Page 9 and 16.

3.5 Test Instruments

Description & Manufacturer	Model No.	Serial No.	Date of Calibration	Due Date of Calibration
PXA Signal Analyzer KEYSIGHT	N9030B	MY57140488	Feb. 24, 2022	Feb. 23, 2023
BILOG Antenna SCHWARZBECK	VULB 9168	9168-158	Oct. 25, 2022	Oct. 24, 2023
HORN Antenna ETS	3117	00034128	Nov. 14, 2021 Nov. 13, 2022	Nov. 13, 2022 Nov. 12, 2023
HORN Antenna SCHWARZBECK	BBHA 9170	BBHA9170243	Nov. 14, 2021 Nov. 13, 2022	Nov. 13, 2022 Nov. 12, 2023
Preamplifier Agilent	8449B	3008A01963	Jul. 09, 2022	Jul. 08, 2023
Preamplifier Agilent	8447D	2944A10627	Jul. 09, 2022	Jul. 08, 2023
RF signal cable HUBER+SUHNER	SUCOFLEX 104	Cable-RF1-03 (223650/4)	Jul. 09, 2022	Jul. 08, 2023
RF signal cable WOKEN	8D-FB	Cable-RF1-01	Jul. 09, 2022	Jul. 08, 2023
RF signal cable INFINET	CA3501-3501- G.90 (3m) & CA3501-3501- F.90 (2m)	INF090 (3m)*2 & TCF427S (2m)*1	Jul. 09, 2022	Jul. 08, 2023
Software ADT	ADT_Radiated_ V7.6.15.9.5	NA	NA	NA
Antenna Tower Max-Full	MFA-440H	9707	NA	NA
Turn Table ADT	NA	SN40303	NA	NA
Controller Max-Full	MF-7802	MF7802093	NA	NA
Temperature & Humidity chamber TERCHY	MHU-225AU	920842	Jun. 21, 2022	Jun. 20, 2023
Splitters/Combiners Mini-Circuits	ZN2PD-9G	NA	Jun. 09, 2022	Jun. 08, 2023
26GHz ~ 40GHz Amplifier EMC	EMC184045B	980175	Sep. 03, 2022	Sep. 02, 2023
Absorber 30 MHz ~ 40GHz	TDK / IP-045C	NA	NA	NA

TYPICAL ABSORPTION CHARACTERISTICS (VERTICAL INCIDENCE)

Unit: dB

Material name	30MHz	50MHz	100MHz	500MHz	1GHz	5GHz	18GHz	40GHz
IP-045C	18	18	15	20	20	30	40	40

- Note:
1. The test was performed in HwaYa RF Chamber 1.
 2. The horn antenna and preamplifier (model: 8449B) are used only for the measurement of emission frequency above 1 GHz if tested.

3.6 Test Procedure

- a. Connect EUT to Spectrum Analyzer and record the power setting of EUT and the measured conducted power / conducted power spectral density.
- b. Fasten EUT on the Positioner on center of turntable, for Free Space only.
- c. Configuration EUT transmitting packages (SW: iperf) to the communication emulator in Beamforming mode. Please refer to figure 2 for detail configuration.
- d. Make sure the transmit signal stable and duty cycle greater than or equal to 98% at the maximum RF power level.
- e. Setup the channel power function and power spectral density function by spectrum analyzer.
- f. Read the channel power level and power spectral density level on spectrum analyzer and record in following positions.
 1. The EUT is then stepped between -90 to 90 degrees along the theta axis in 15-degree increments. At each theta position, the phi axis is stepped from 0 to 360 degrees or from 360 to 0 degrees in 15-degree increments.
 2. Data (channel power level / power spectral density level) is recorded using the spectrum analyzer for both theta and phi polarizations at each position.
 3. Set Phi and Theta Positioners to Boresight Phi and Theta angular position of maximum channel power level / power spectral density level.
 4. Fix the Phi angular in Step f.3, the EUT is then stepped between 0 to 360 degrees along the theta axis in 1-degree increments for E-Plane and H-Plane.
 5. Data (channel power level / power spectral density level) is recorded using the spectrum analyzer for both E-Plane and H-Plane at each position, then calculate and indicate the 3-dB beamwidth.
 6. When the 3-dB beamwidth in Step f.5 is less than 15 degree, repeat Step f.1 and Step f.2 with the 1/5/10-degree increments which is less than and close to 3-dB beamwidth.
- g. According to section 2.3 of KDB 412172 D01 Determining ERP and EIRP v01r01, the substitution horn antenna is substituted for EUT at the same position and signals generator export the CW signal to the substitution antenna via a TX cable. Rotated the Turn Table and moved receiving antenna to find the maximum radiation power. Adjust output power level of S.G to get a Value of spectrum reading equal to "Raw Value". Record the power level of S.G.

$$\text{EIRP} = P_{\text{SigGen}} + G_T - L_C$$

where:

P_{SigGen} = power setting of the signal generator that produces the same received power reading as the DUT, in dBm, dBW or psd;

G_T = gain of the substitute antenna, in dBd (ERP) or dBi (EIRP);

L_C = signal loss in the cable connecting the signal generator to the substitute antenna, in dB

- h. Directional Antenna Gain (dBi) = Max EIRP (dBm) – Total Conducted Power (dBm)

3.7 Test Results (Measurement Quantity) of EIRP Measurement & Directional Gain Calculation

Tested By	Jeff Chen
-----------	-----------

Model: FAP-431G

Radio 1

EIRP (802.11 ax HE20 of Beamforming Mode / Nss=1)

Mode	Channel	Frequency (MHz)	Polarization	Θ (degree)	Φ (degree)	Raw Value (dBm)	C.F. (dB)	Max EIRP (dBm)
BF (Nss=1)	6	2437	Ver.	30	195	-7.92	43.91	35.99

Note: Max EIRP (dBm) = Raw Value (dBm) + Correction Factor (dB)
 Correction Factor (dB) = Antenna Gain (dBi) + Cable Loss (dB) + Free Space Loss (dB)
 Peak EIRP measurement values please refer to test plots in Section 3.8.

Directional Gain Calculation (802.11 ax HE20 of Beamforming Mode / Nss=1)

Mode	Channel	Frequency (MHz)	Max EIRP (dBm)	Total Conducted Power (dBm)	Directional Ant. Gain (dBi)
BF (Nss=1)	6	2437	35.99	29.62	6.37

Note: Directional Antenna Gain (dBi) = Max EIRP – Total Conducted Power

Radio 2

EIRP (802.11 ax HE20 of Beamforming Mode / Nss=1)

Mode	Channel	Frequency (MHz)	Polarization	Θ (degree)	Φ (degree)	Raw Value (dBm)	C.F. (dB)	Max EIRP (dBm)
BF (Nss=1)	36	5180	Ver.	-15	195	-17.30	50.38	33.08
	64	5320	Ver.	15	315	-20.71	50.50	29.79
	100	5500	Ver.	15	315	-20.56	49.97	29.41
	157	5785	Ver.	15	195	-14.16	49.86	35.70
	173	5865	Ver.	-45	210	-18.96	49.86	30.90

Note: Max EIRP (dBm) = Raw Value (dBm) + Correction Factor (dB)
 Correction Factor (dB) = Antenna Gain (dBi) + Cable Loss (dB) + Free Space Loss (dB)
 Peak EIRP measurement values please refer to test plots in Section 3.8.

Directional Gain Calculation (802.11 ax HE20 of Beamforming Mode / Nss=1)

Mode	Channel	Frequency (MHz)	Max EIRP (dBm)	Total Conducted Power (dBm)	Directional Ant. Gain (dBi)
BF (Nss=1)	36	5180	33.08	26.14	6.94
	64	5320	29.79	22.81	6.98
	100	5500	29.41	23.35	6.06
	157	5785	35.70	29.39	6.31
	173	5865	30.90	24.87	6.03

Note: Directional Antenna Gain (dBi) = Max EIRP – Total Conducted Power

Radio 3

EIRP (802.11 ax HE20 of Beamforming Mode / Nss=1)

Mode	Channel	Frequency (MHz)	Polarization	Θ (degree)	Φ (degree)	Raw Value (dBm)	C.F. (dB)	Max EIRP (dBm)
BF (Nss=1)	100	5500	Ver.	-15	315	-22.02	49.97	27.95
	157	5785	Ver.	-15	330	-14.47	49.86	35.39
	173	5865	Ver.	-15	315	-19.14	49.86	30.72
	93	6415	Ver.	0	240	-34.20	50.38	16.18
	113	6515	Ver.	0	240	-35.23	50.50	15.27
	181	6855	Ver.	0	240	-34.21	49.97	15.76
	233	7115	Hor.	15	240	-34.38	49.86	15.48

Note: Max EIRP (dBm) = Raw Value (dBm) + Correction Factor (dB)
 Correction Factor (dB) = Antenna Gain (dBi) + Cable Loss (dB) + Free Space Loss (dB)
 Peak EIRP measurement values please refer to test plots in Section 3.8.

Directional Gain Calculation (802.11 ax HE20 of Beamforming Mode / Nss=1)

Mode	Channel	Frequency (MHz)	Max EIRP (dBm)	Total Conducted Power (dBm)	Directional Ant. Gain (dBi)
BF (Nss=1)	100	5500	27.95	20.84	7.11
	157	5785	35.39	28.48	6.91
	173	5865	30.72	24.11	6.61
	93	6415	16.18	9.81	6.37
	113	6515	15.27	8.29	6.98
	181	6855	15.76	8.65	7.11
	233	7115	15.48	7.86	7.62

Note: Directional Antenna Gain (dBi) = Max EIRP – Total Conducted Power

Scanning Radio

EIRP (802.11 ax HE20 of CDD Mode / Nss=1)

Mode	Channel	Frequency (MHz)	Polarization	Θ (degree)	Φ (degree)	Raw Value (dBm)	C.F. (dB)	Max EIRP (dBm)
CDD (Nss=1)	6	2437	Ver.	30	180	-20.79	43.91	23.12
	36	5180	Hor.	-60	255	-30.69	50.38	19.69
	64	5320	Ver.	45	180	-30.53	50.50	19.97
	100	5500	Hor.	-45	270	-28.24	49.97	21.73
	157	5785	Hor.	60	240	-22.37	49.86	27.49
	173	5865	Hor.	60	240	-22.08	49.86	27.78

Note: Max EIRP (dBm) = Raw Value (dBm) + Correction Factor (dB)
 Correction Factor (dB) = Antenna Gain (dBi) + Cable Loss (dB) + Free Space Loss (dB)
 Peak EIRP measurement values please refer to test plots in Section 3.8.

Mode	Channel	Frequency (MHz)	Polarization	Θ (degree)	Φ (degree)	Raw Value (dBm)	C.F. (dB)	Max EIRP PSD (dBm)
CDD (Nss=1)	93	6415	Hor.	45	270	-46.44	50.38	3.94
	113	6515	Ver.	15	255	-46.80	50.50	3.70
	181	6855	Ver.	0	255	-46.08	49.97	3.89
	233	7115	Hor.	0	255	-48.25	49.86	1.61

Note: Max EIRP PSD (dBm) = Raw Value (dBm) + Correction Factor (dB)
 Correction Factor (dB) = Antenna Gain (dBi) + Cable Loss (dB) + Free Space Loss (dB)
 Peak EIRP measurement values please refer to test plots in Section 3.8.

Directional Gain Calculation (802.11 ax HE20 of CDD Mode / Nss=1)

Mode	Channel	Frequency (MHz)	Max EIRP (dBm)	Total Conducted Power (dBm)	Directional Ant. Gain (dBi)
CDD (Nss=1)	6	2437	23.12	22.28	0.84
	36	5180	19.69	17.82	1.87
	64	5320	19.97	18.15	1.82
	100	5500	21.73	19.63	2.10
	157	5785	27.49	25.92	1.57
	173	5865	27.78	26.29	1.49

Note: Directional Antenna Gain (dBi) = Max EIRP – Total Conducted Power

Mode	Channel	Frequency (MHz)	Max EIRP PSD (dBm)	Total PSD (dBm/MHz)	Directional Ant. Gain (dBi)
CDD (Nss=1)	93	6415	3.94	-0.57	4.51
	113	6515	3.70	-0.87	4.57
	181	6855	3.89	-1.14	5.03
	233	7115	1.61	-3.51	5.12

Note: Directional Antenna Gain (dBi) = Max EIRP PSD – Total PSD

Model: FAP-433G

Radio 1

EIRP (802.11 ax HE20 of Beamforming Mode / Nss=1)

Mode	Channel	Frequency (MHz)	Polarization	Θ (degree)	Φ (degree)	Raw Value (dBm)	C.F. (dB)	Max EIRP (dBm)
BF (Nss=1)	6	2437	Ver.	75	150	-8.2	43.91	35.71

Note: Max EIRP (dBm) = Raw Value (dBm) + Correction Factor (dB)
 Correction Factor (dB) = Antenna Gain (dBi) + Cable Loss (dB) + Free Space Loss (dB)
 Peak EIRP measurement values please refer to test plots in Section 3.8.

Directional Gain Calculation (802.11 ax HE20 of Beamforming Mode / Nss=1)

Mode	Channel	Frequency (MHz)	Max EIRP (dBm)	Total Conducted Power (dBm)	Directional Ant. Gain (dBi)
BF (Nss=1)	6	2437	35.71	29.12	6.59

Note: Directional Antenna Gain (dBi) = Max EIRP – Total Conducted Power

Radio 2

EIRP (802.11 ax HE20 of Beamforming Mode / Nss=1)

Mode	Channel	Frequency (MHz)	Polarization	Θ (degree)	Φ (degree)	Raw Value (dBm)	C.F. (dB)	Max EIRP (dBm)
BF (Nss=1)	36	5180	Hor.	-60	270	-16.66	50.38	33.72
	64	5320	Hor.	60	240	-20.92	50.50	29.58
	100	5500	Ver.	0	195	-20.64	49.97	29.33
	157	5785	Ver.	0	180	-14.06	49.86	35.80

Note: Max EIRP (dBm) = Raw Value (dBm) + Correction Factor (dB)
 Correction Factor (dB) = Antenna Gain (dBi) + Cable Loss (dB) + Free Space Loss (dB)
 Peak EIRP measurement values please refer to test plots in Section 3.8.

Directional Gain Calculation (802.11 ax HE20 of Beamforming Mode / Nss=1)

Mode	Channel	Frequency (MHz)	Max EIRP (dBm)	Total Conducted Power (dBm)	Directional Ant. Gain (dBi)
BF (Nss=1)	36	5180	33.72	26.66	7.06
	64	5320	29.58	22.42	7.16
	100	5500	29.33	21.81	7.52
	157	5785	35.80	28.64	7.16

Note: Directional Antenna Gain (dBi) = Max EIRP – Total Conducted Power

Radio 3

EIRP (802.11 ax HE20 of Beamforming Mode / Nss=1)

Mode	Channel	Frequency (MHz)	Polarization	Θ (degree)	Φ (degree)	Raw Value (dBm)	C.F. (dB)	Max EIRP (dBm)
BF (Nss=1)	100	5500	Ver.	15	195	-20.23	49.97	29.74
	157	5785	Ver.	-15	195	-14.09	49.86	35.77
	173	5865	Ver.	15	195	-16.83	49.86	33.03
	93	6415	Ver.	0	345	-32.92	50.38	17.46
	113	6515	Ver.	0	165	-33.01	50.50	17.49
	181	6855	Ver.	0	300	-32.66	49.97	17.31
	233	7115	Ver.	0	300	-34.71	49.86	15.15

Note: Max EIRP (dBm) = Raw Value (dBm) + Correction Factor (dB)
 Correction Factor (dB) = Antenna Gain (dBi) + Cable Loss (dB) + Free Space Loss (dB)
 Peak EIRP measurement values please refer to test plots in Section 3.8.

Directional Gain Calculation (802.11 ax HE20 of Beamforming Mode / Nss=1)

Mode	Channel	Frequency (MHz)	Max EIRP (dBm)	Total Conducted Power (dBm)	Directional Ant. Gain (dBi)
BF (Nss=1)	100	5500	29.74	21.39	8.35
	157	5785	35.77	27.51	8.26
	173	5865	33.03	24.93	8.10
	93	6415	17.46	10.34	7.12
	113	6515	17.49	10.20	7.29
	181	6855	17.31	9.98	7.33
	233	7115	15.15	7.72	7.43

Note: Directional Antenna Gain (dBi) = Max EIRP – Total Conducted Power

Scanning Radio

EIRP (802.11 ax HE20 of CDD Mode / Nss=1)

Mode	Channel	Frequency (MHz)	Polarization	Θ (degree)	Φ (degree)	Raw Value (dBm)	C.F. (dB)	Max EIRP (dBm)
CDD (Nss=1)	6	2437	Ver.	15	330	-19.79	43.91	24.12
	36	5180	Ver.	-15	315	-31.05	50.38	19.33
	64	5320	Ver.	-15	315	-30.89	50.50	19.61
	100	5500	Ver.	-15	315	-29.86	49.97	20.11
	157	5785	Ver.	-15	315	-23.14	49.86	26.72
	173	5865	Ver.	-15	195	-23.66	49.86	26.20

Note: Max EIRP (dBm) = Raw Value (dBm) + Correction Factor (dB)
 Correction Factor (dB) = Antenna Gain (dBi) + Cable Loss (dB) + Free Space Loss (dB)
 Peak EIRP measurement values please refer to test plots in Section 3.8.

Mode	Channel	Frequency (MHz)	Polarization	Θ (degree)	Φ (degree)	Raw Value (dBm)	C.F. (dB)	Max EIRP PSD (dBm)
CDD (Nss=1)	93	6415	Ver.	15	180	-46.19	50.38	4.19
	113	6515	Ver.	15	180	-46.29	50.50	4.21
	181	6855	Ver.	0	300	-46.02	49.97	3.95
	233	7115	Ver.	0	345	-53.90	49.86	-4.04

Note: Max EIRP PSD (dBm) = Raw Value (dBm) + Correction Factor (dB)
 Correction Factor (dB) = Antenna Gain (dBi) + Cable Loss (dB) + Free Space Loss (dB)
 Peak EIRP measurement values please refer to test plots in Section 3.8.

Directional Gain Calculation (802.11 ax HE20 of CDD Mode / Nss=1)

Mode	Channel	Frequency (MHz)	Max EIRP (dBm)	Total Conducted Power (dBm)	Directional Ant. Gain (dBi)
CDD (Nss=1)	6	2437	24.12	22.71	1.41
	36	5180	19.33	17.29	2.04
	64	5320	19.61	17.52	2.09
	100	5500	20.11	17.60	2.51
	157	5785	26.72	24.42	2.30
	173	5865	26.20	24.10	2.10

Note: Directional Antenna Gain (dBi) = Max EIRP – Total Conducted Power

Mode	Channel	Frequency (MHz)	Max EIRP PSD (dBm)	Total PSD (dBm/MHz)	Directional Ant. Gain (dBi)
CDD (Nss=1)	93	6415	4.19	-0.29	4.48
	113	6515	4.21	-0.07	4.28
	181	6855	3.95	-0.81	4.76
	233	7115	-4.04	-8.21	4.17

Note: Directional Antenna Gain (dBi) = Max EIRP PSD – Total PSD

3.8 3D EIRP Pattern and 3-dB Beam-width Test Plots

Model: FAP-431G

Radio 1 - 2.4GHz band

2.4GHz_HE20_CH 6_BF On Nss1

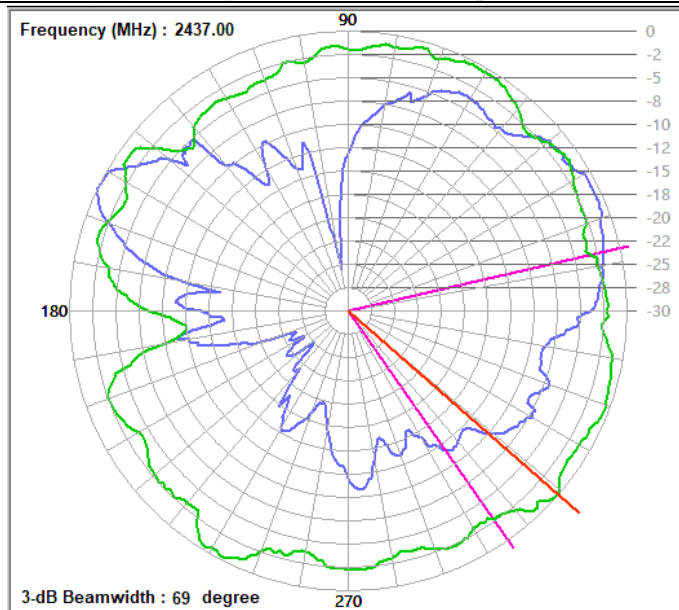
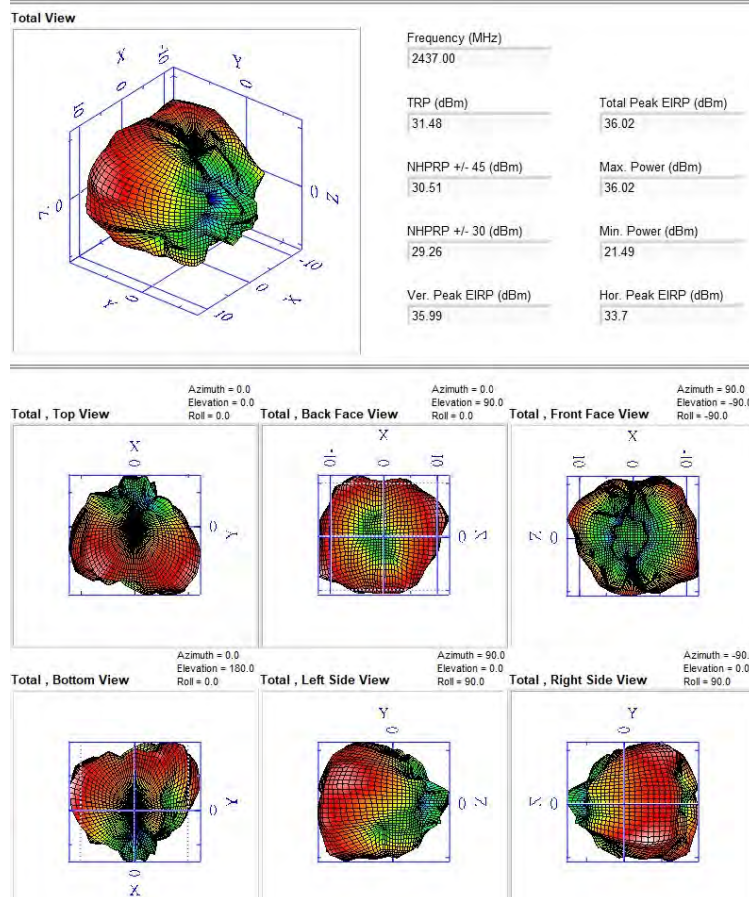

Frequency (MHz) : 2437.00 Polarity 1 : Horizontal Beamwidth 1 : 16
 Polarity 2 : Vertical Beamwidth 2 : 69
 (at the 3 dB down)

Radio 2 - 5GHz band

802.11ax HE20 CH 36 BF On Nss1

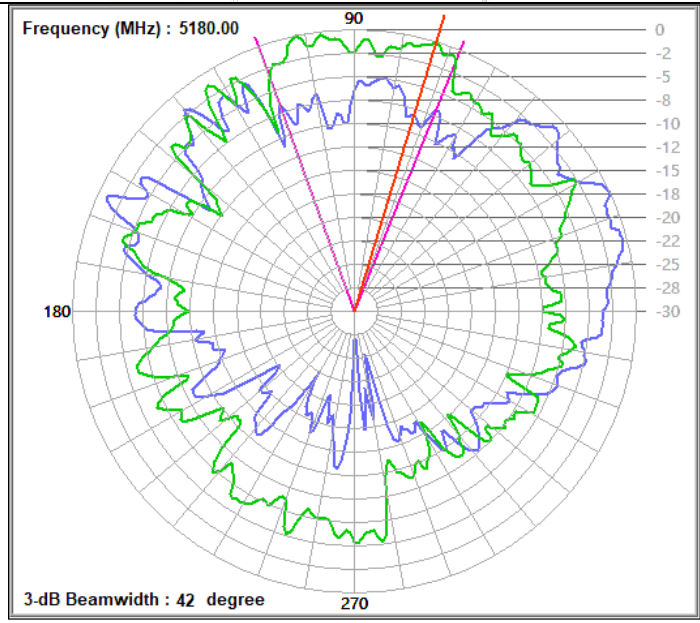
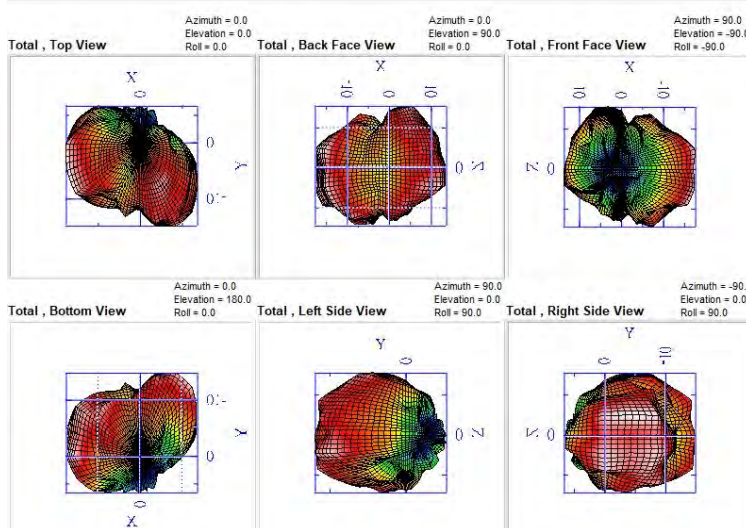
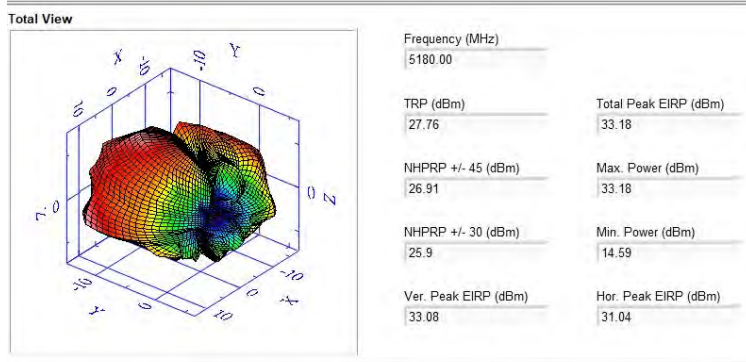

Frequency (MHz) : 5180.00 Polarity 1 : Horizontal Beamwidth 1 : 27
 Polarity 2 : Vertical Beamwidth 2 : 42
 (at the 3 dB down)

802.11ax HE20 CH 64 BF On Nss1

Total View

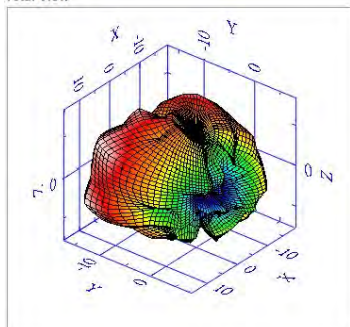

Frequency (MHz)	5320.00	
TRP (dBm)	24.47	Total Peak EIRP (dBm)
		29.89
NHPRP +/- 45 (dBm)	23.64	Max. Power (dBm)
		29.89
NHPRP +/- 30 (dBm)	22.55	Min. Power (dBm)
		9.62
Ver. Peak EIRP (dBm)	29.79	Hor. Peak EIRP (dBm)
		27.1

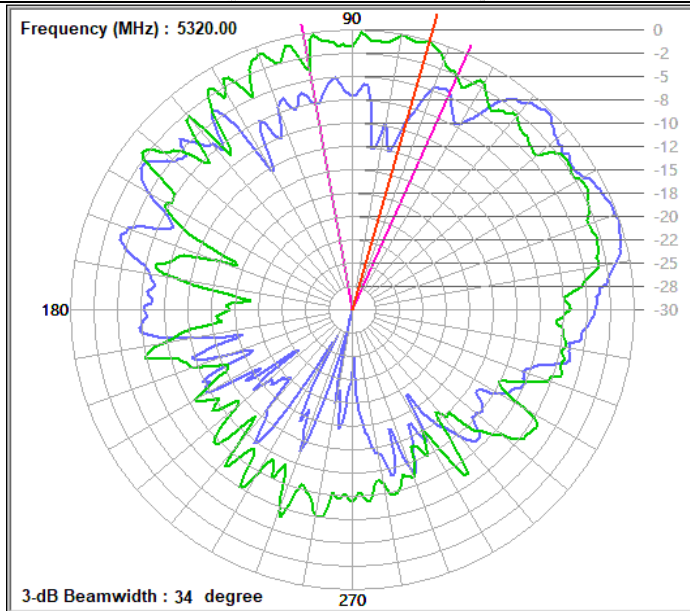
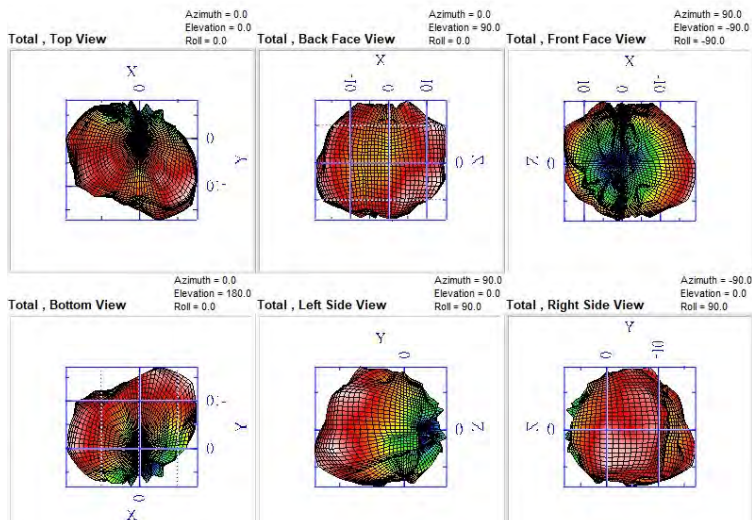

Frequency (MHz) : 5320.00 Polarity 1 : Horizontal Beamwidth 1 : 50
 Polarity 2 : Vertical Beamwidth 2 : 34
 (at the 3 dB down)

802.11ax HE20 CH 100 BF On Nss1

Total View

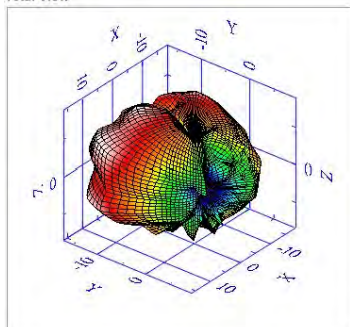

Frequency (MHz)	5500.00
TRP (dBm)	24.7
NHPRP +/- 45 (dBm)	23.77
NHPRP +/- 30 (dBm)	22.63
Ver. Peak EIRP (dBm)	29.41
Total Peak EIRP (dBm)	29.8
Max. Power (dBm)	29.8
Min. Power (dBm)	9.43
Hor. Peak EIRP (dBm)	27.4

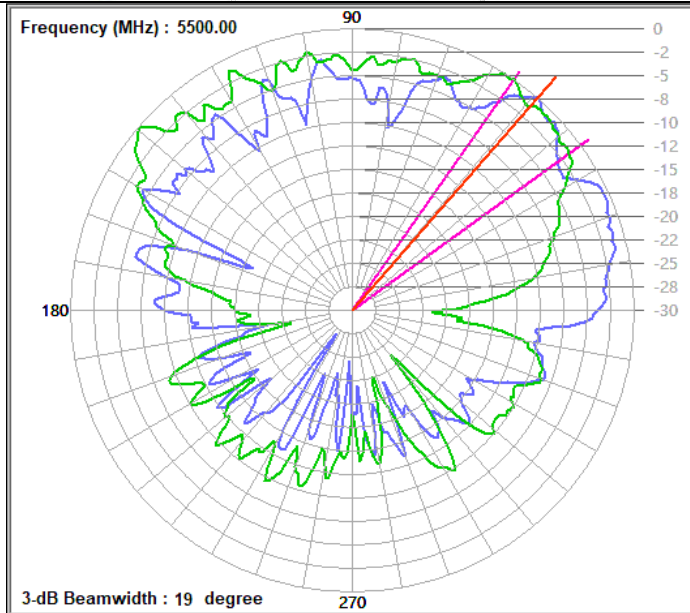
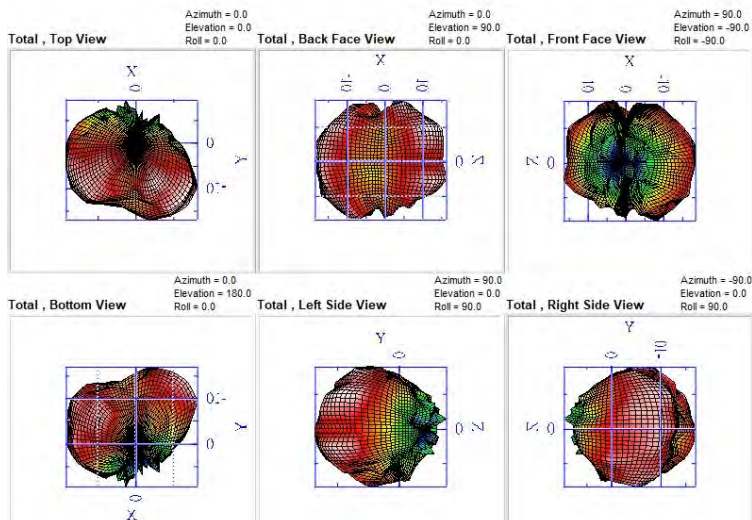

Frequency (MHz) : 5500.00 Polarity 1 : Horizontal Beamwidth 1 : 19
 Polarity 2 : Vertical Beamwidth 2 : 33
 (at the 3 dB down)

802.11ax HE20 CH 157 BF On Nss1

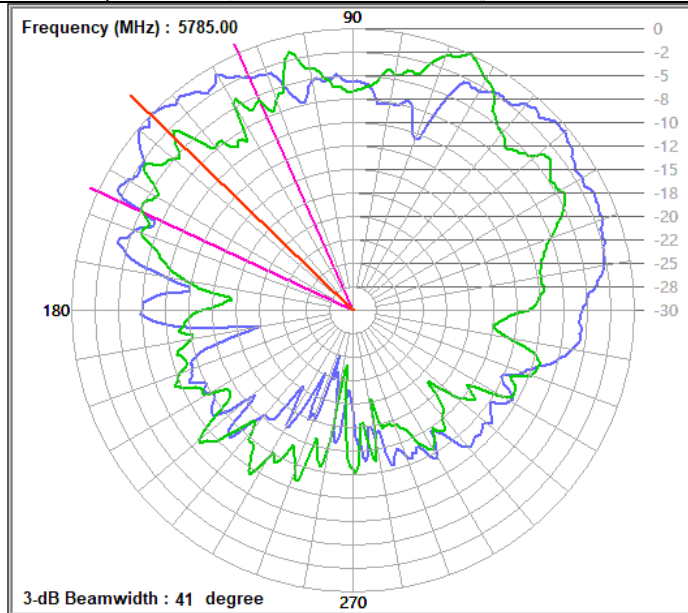
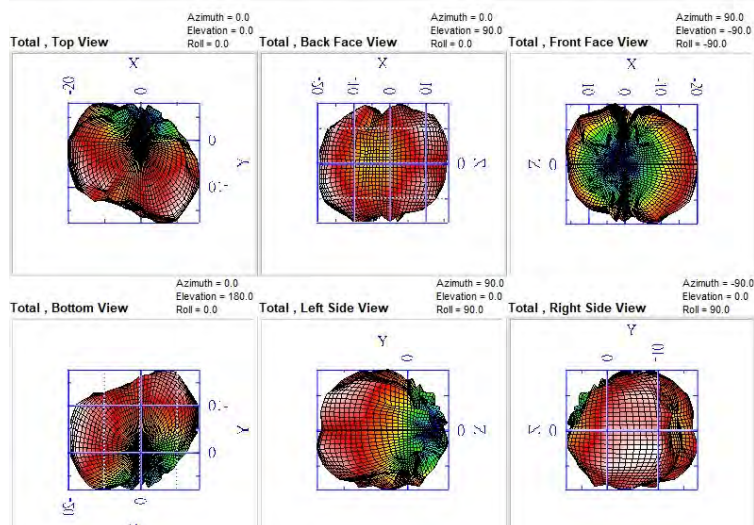
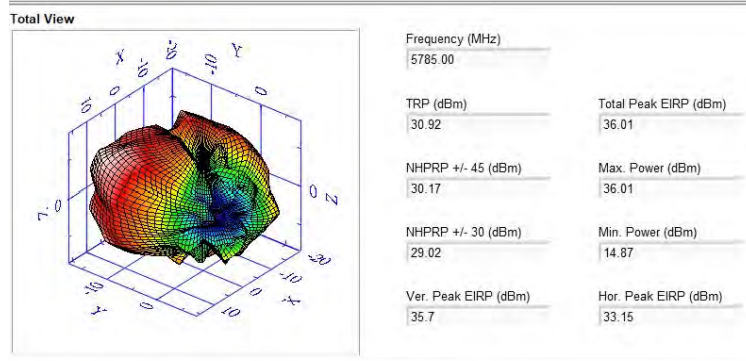

Frequency (MHz) : 5785.00	Polarity 1 : Horizontal	Beamwidth 1 : 41
	Polarity 2 : Vertical	Beamwidth 2 : 18
(at the 3 dB down)		

802.11ax HE20 CH 173 BF On Nss1

Total View

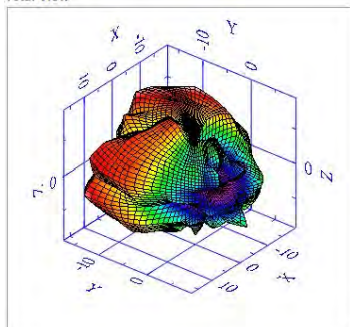

Frequency (MHz)	5865.00
TRP (dBm)	25.84
NHPRP +/- 45 (dBm)	25.07
NHPRP +/- 30 (dBm)	23.85
Ver. Peak EIRP (dBm)	30.9
Total Peak EIRP (dBm)	31.76
Max. Power (dBm)	31.76
Min. Power (dBm)	9.53
Hor. Peak EIRP (dBm)	30.16

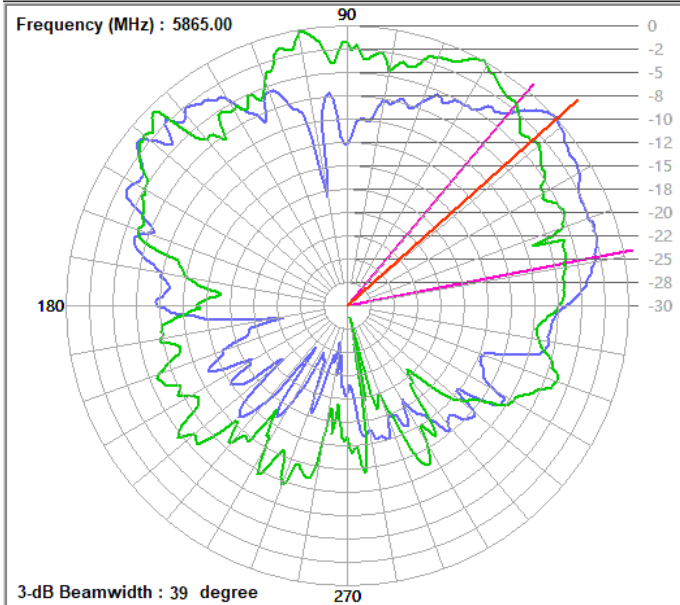
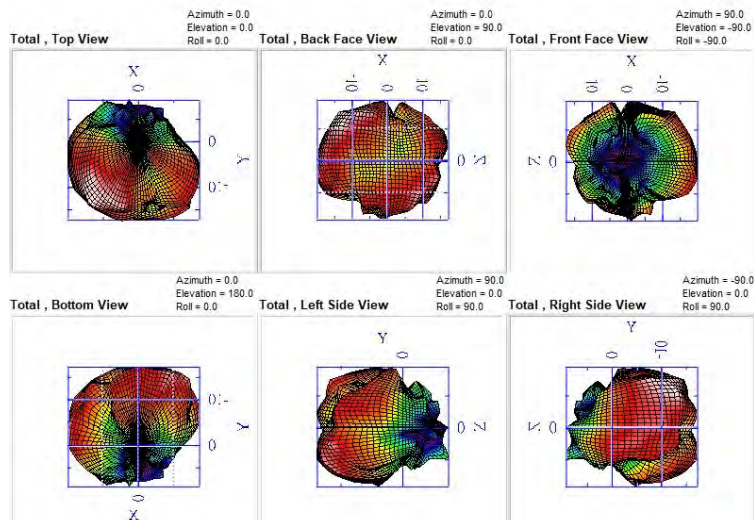

Frequency (MHz) : 5865.00 Polarity 1 : Horizontal Beamwidth 1 : 39
 Polarity 2 : Vertical Beamwidth 2 : 27
 (at the 3 dB down)

Radio 3 - 5GHz and 6GHz bands

802.11ax HE20 CH 100 BF On Nss1

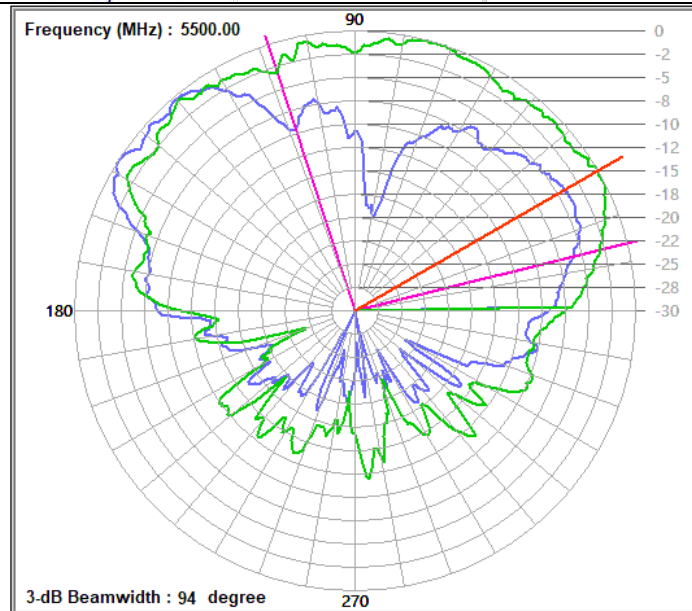
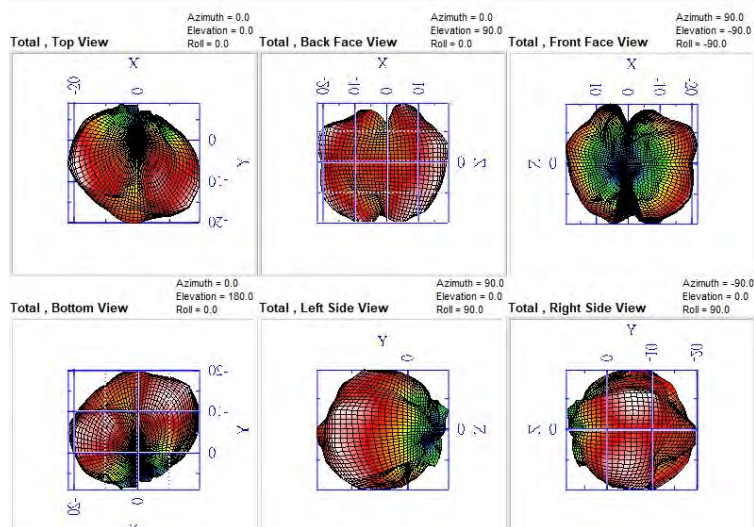
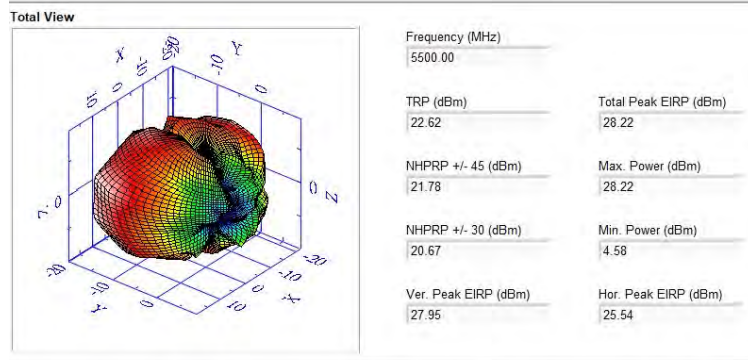

Frequency (MHz) : 5500.00 Polarity 1 : Horizontal Beamwidth 1 : 37
 Polarity 2 : Vertical Beamwidth 2 : 94
 (at the 3 dB down)

802.11ax HE20 CH 157 BF On Nss1

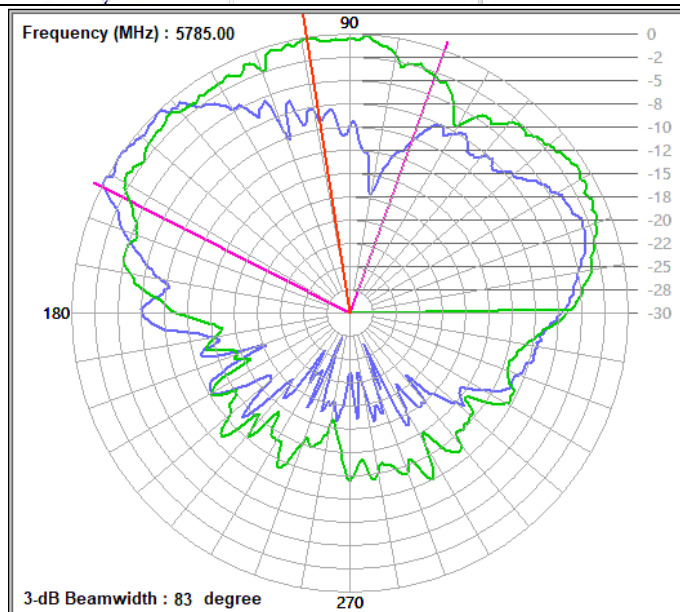
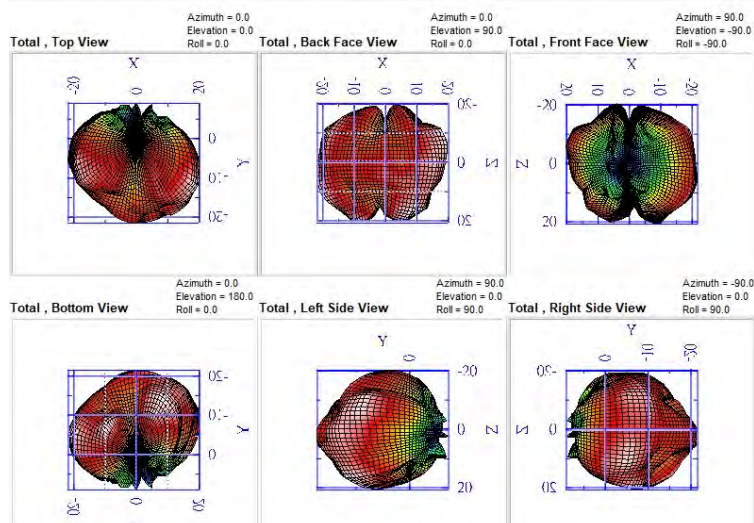
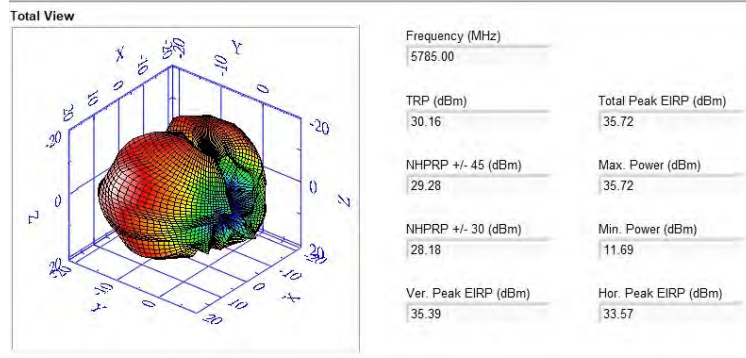

Frequency (MHz) : 5785.00 Polarity 1 : Horizontal Beamwidth 1 : 34
 Polarity 2 : Vertical Beamwidth 2 : 83
 (at the 3 dB down)

802.11ax HE20 CH 173 BF On Nss1

Total View

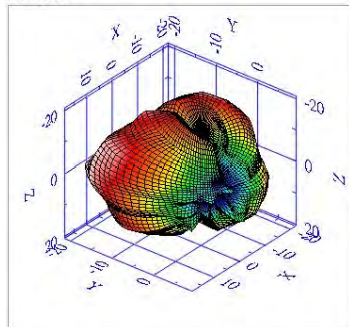

Frequency (MHz)	5865.00
TRP (dBm)	25.48
Total Peak EIRP (dBm)	31.36
NHPRP +/- 45 (dBm)	24.65
Max. Power (dBm)	31.36
NHPRP +/- 30 (dBm)	23.52
Min. Power (dBm)	7.01
Ver. Peak EIRP (dBm)	30.72
Hor. Peak EIRP (dBm)	28.1

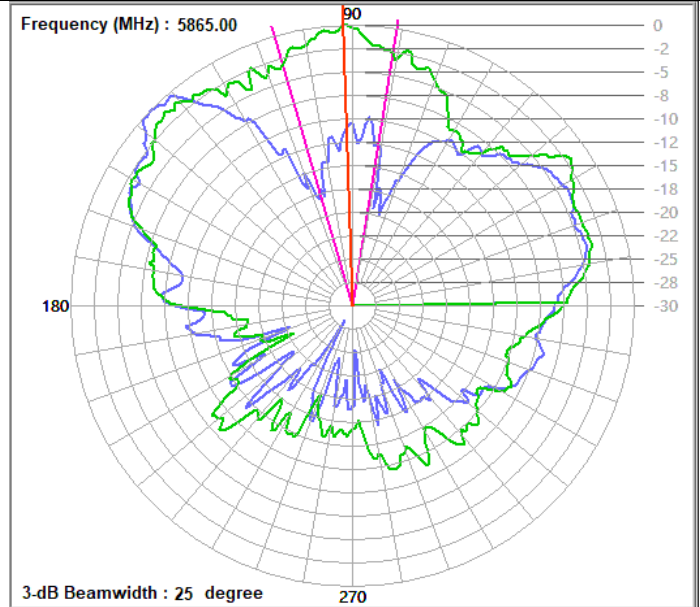
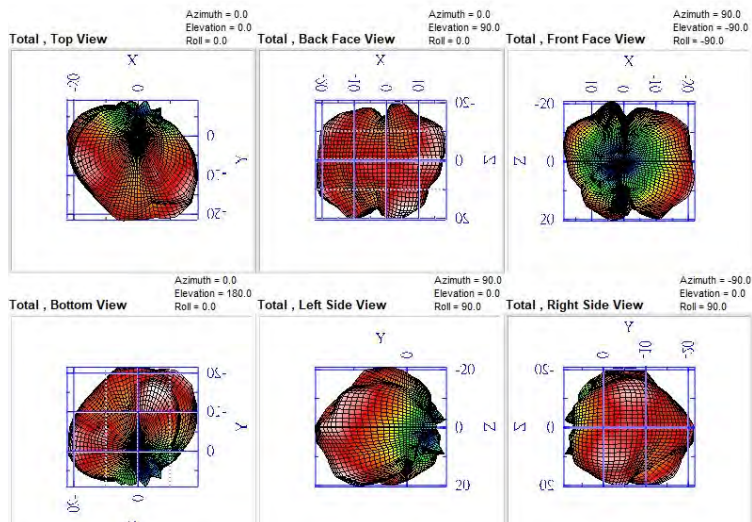

Frequency (MHz) : 5865.00 Polarity 1 : Horizontal Beamwidth 1 : 22
 Polarity 2 : Vertical Beamwidth 2 : 25
 (at the 3 dB down)

802.11ax HE20 CH 93 BF On Nss1

Total View

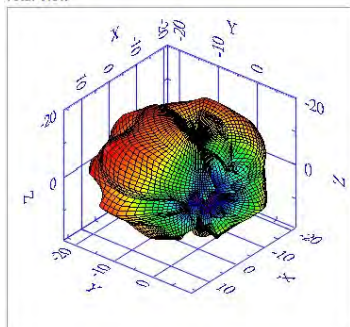

Frequency (MHz)	6415.00	
TRP (dBm)	11.25	Total Peak EIRP (dBm) 18.27
NHPRP +/- 45 (dBm)	10.61	Max. Power (dBm) 18.27
NHPRP +/- 30 (dBm)	9.65	Min. Power (dBm) -7.29
Ver. Peak EIRP (dBm)	16.18	Hor. Peak EIRP (dBm) 14.27

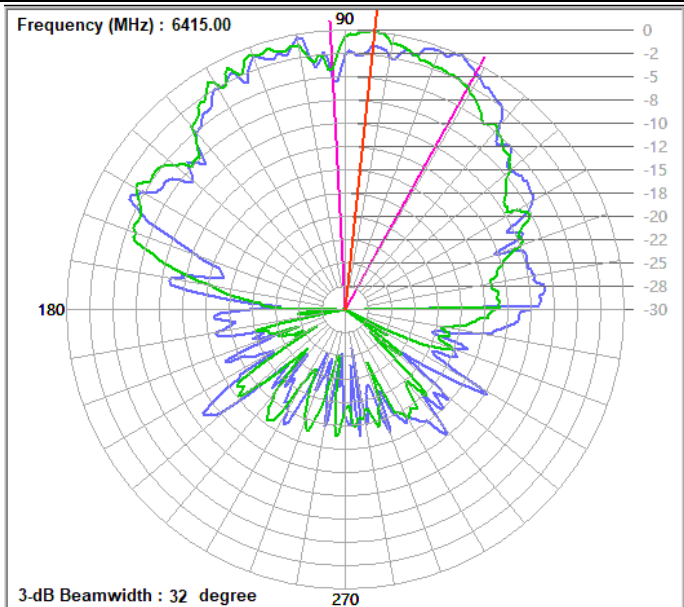
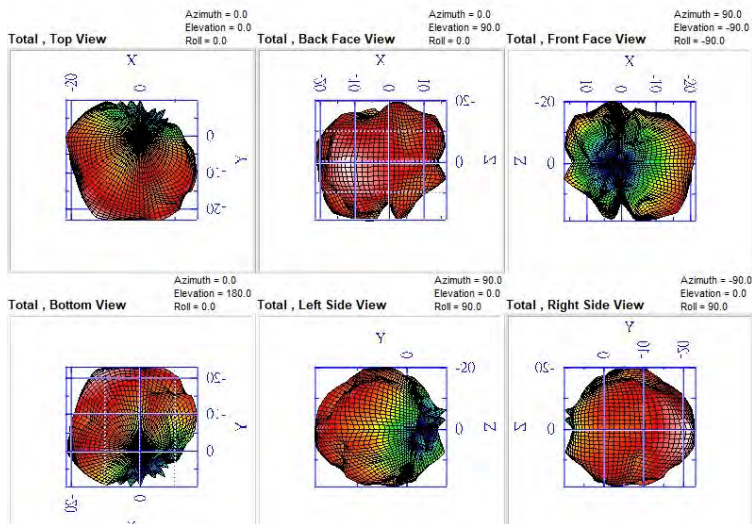

Frequency (MHz) : 6415.00 Polarity 1 : Horizontal Beamwidth 1 : 39
 Polarity 2 : Vertical Beamwidth 2 : 32
 (at the 3 dB down)

802.11ax HE20 CH 113 BF On Nss1

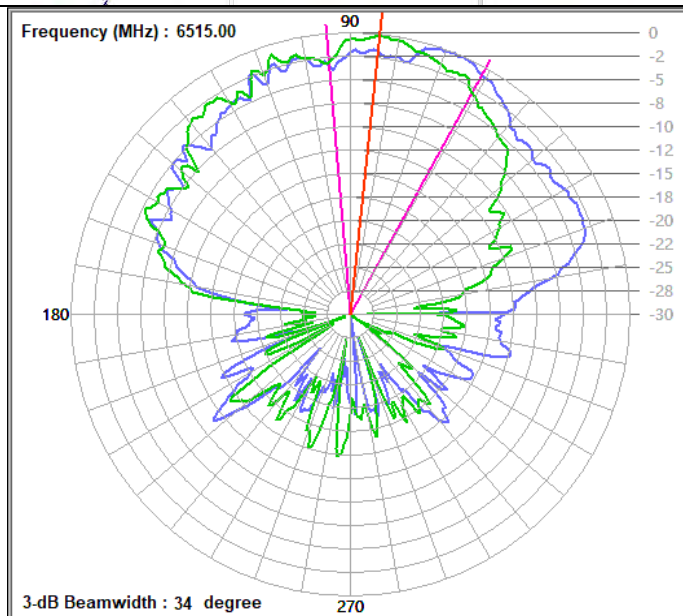
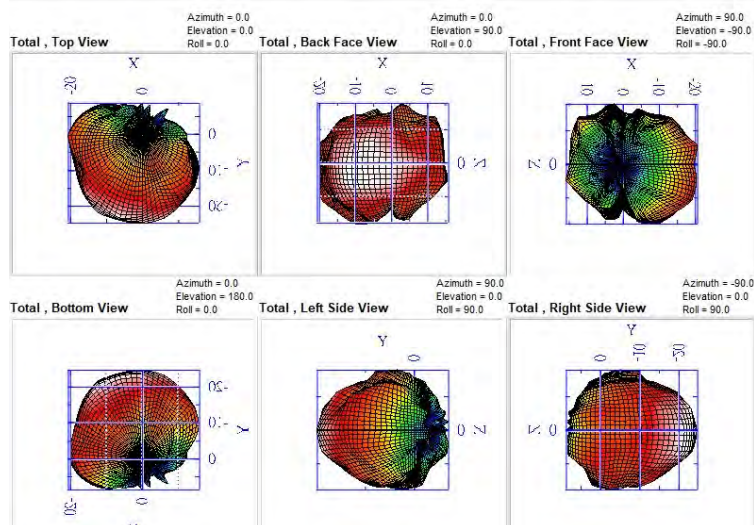
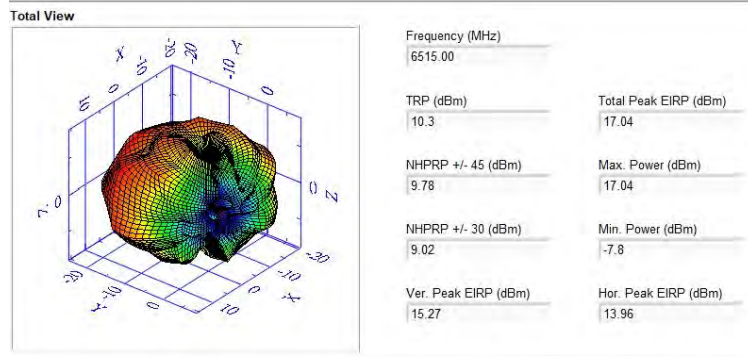

Frequency (MHz) : 6515.00	Polarity 1 : Horizontal	Beamwidth 1 : 42
	Polarity 2 : Vertical	Beamwidth 2 : 34
(at the 3 dB down)		

802.11ax HE20 CH 181 BF On Nss1

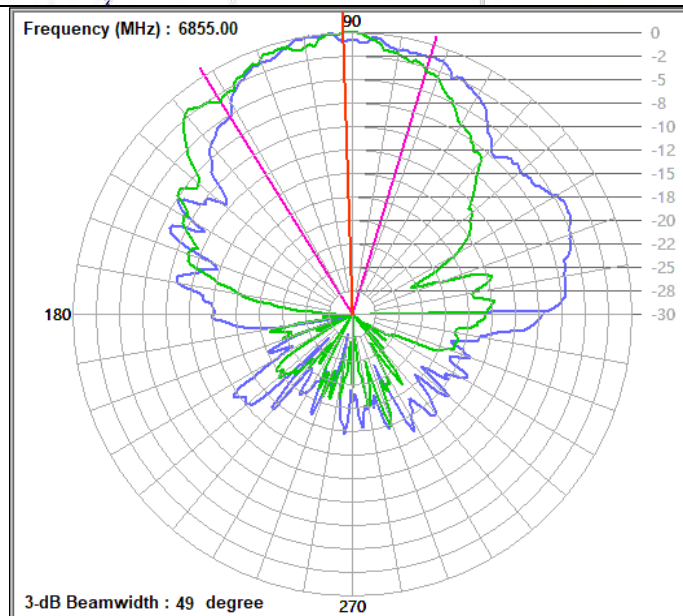
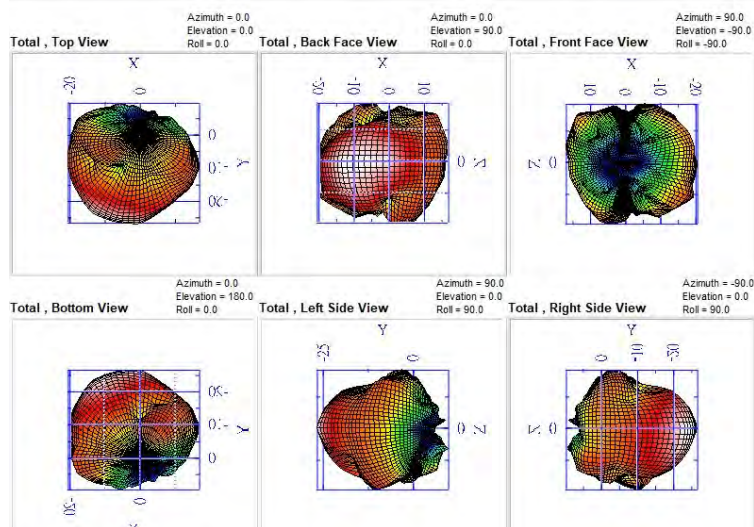
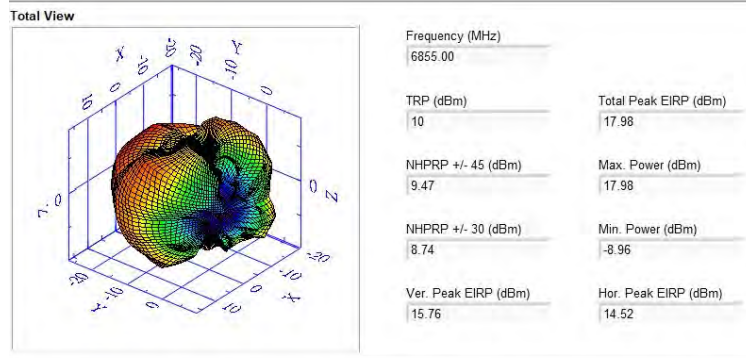

Frequency (MHz) : 6855.00	Polarity 1 : Horizontal	Beamwidth 1 : 56
	Polarity 2 : Vertical	Beamwidth 2 : 49
(at the 3 dB down)		

802.11ax HE20 CH 233 BF On Nss1

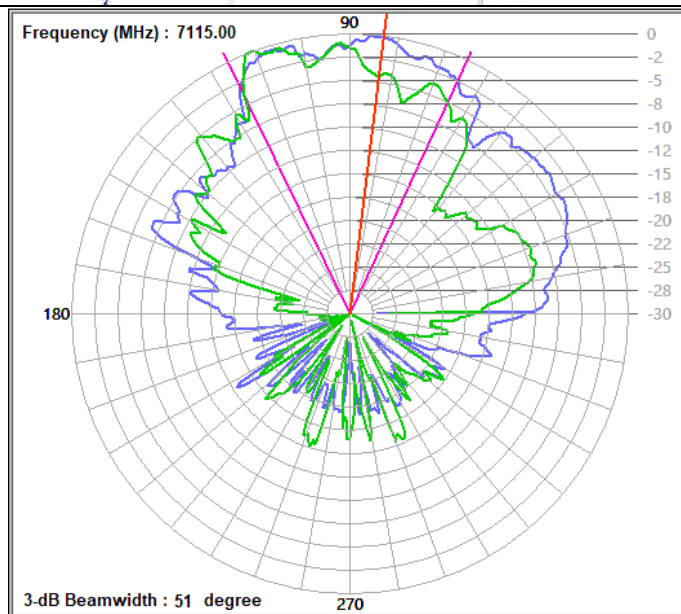
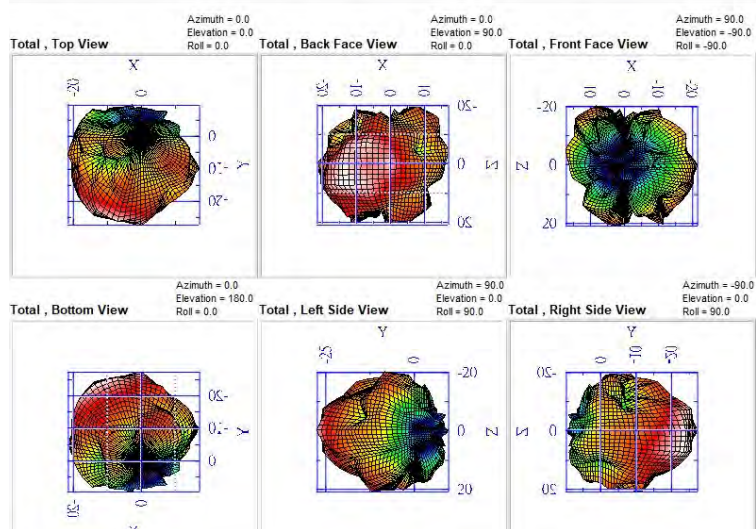
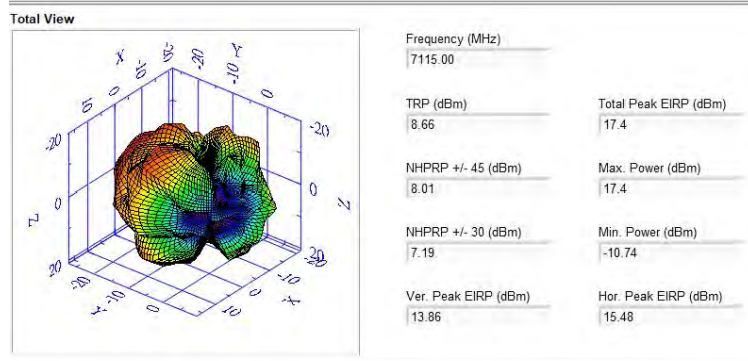

Frequency (MHz) : 7115.00	Polarity 1 : Horizontal	Beamwidth 1 : 51
	Polarity 2 : Vertical	Beamwidth 2 : 15
(at the 3 dB down)		

Scanning Radio - 2.4GHz, 5GHz and 6GHz bands

2.4GHz_HE20_CH 6_CDD On Nss1

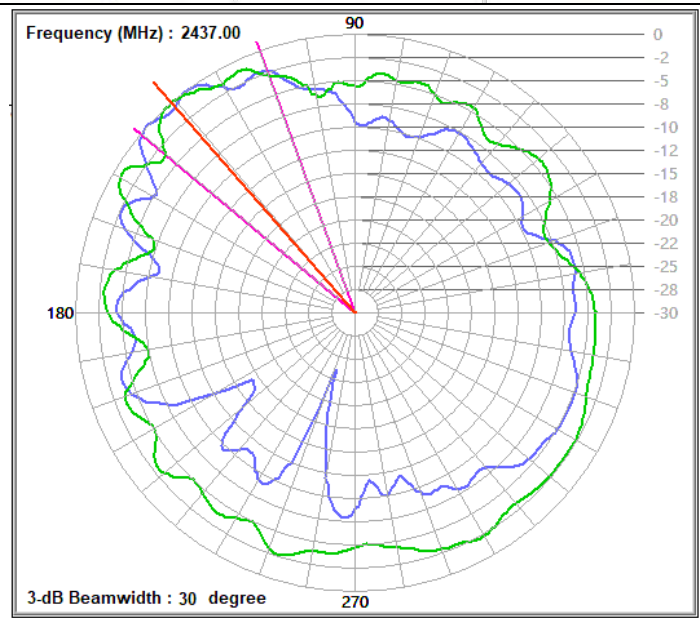
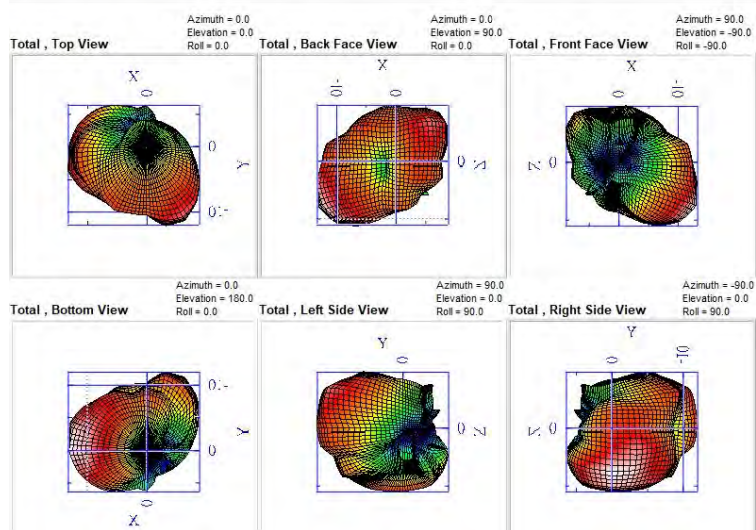
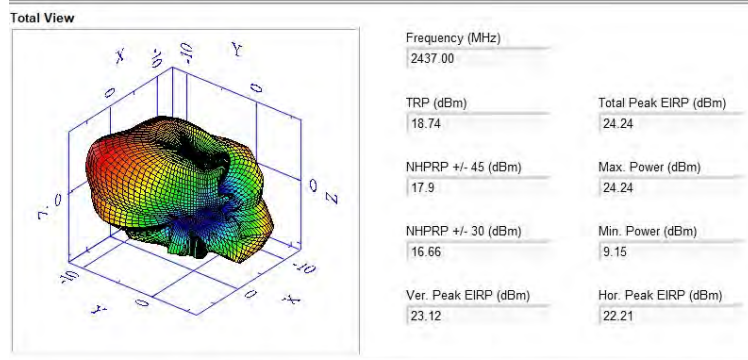

Frequency (MHz) : 2437.00 Polarity 1 : Horizontal Beamwidth 1 : 38
 Polarity 2 : Vertical Beamwidth 2 : 30
 (at the 3 dB down)

802.11ax HE20 CH 36 CDD On Nss1

Total View

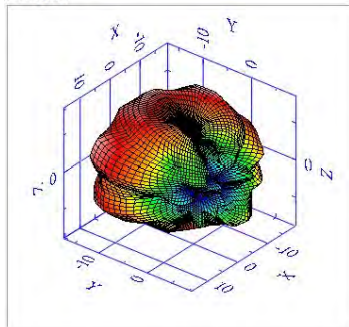

Frequency (MHz)	5180.00
TRP (dBm)	15.17
NHPRP +/- 45 (dBm)	14.14
NHPRP +/- 30 (dBm)	12.62
Ver. Peak EIRP (dBm)	19.67
Total Peak EIRP (dBm)	20.7
Max. Power (dBm)	20.7
Min. Power (dBm)	-0.06
Hor. Peak EIRP (dBm)	19.69

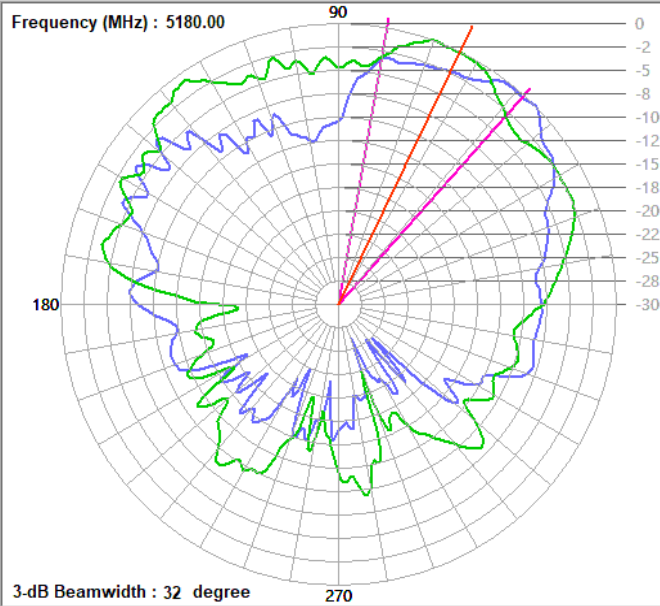
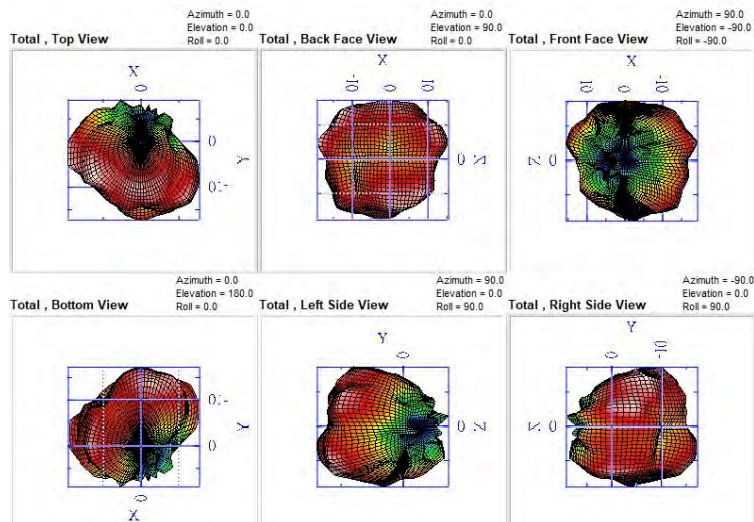

Frequency (MHz) : 5180.00 Polarity 1 : Horizontal Beamwidth 1 : 42
 Polarity 2 : Vertical Beamwidth 2 : 32
 (at the 3 dB down)

802.11ax HE20 CH 64 CDD On Nss1

Total View

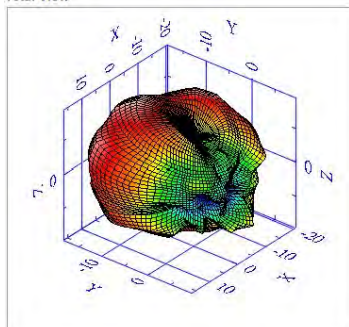

Frequency (MHz)	5320.00
TRP (dBm)	15.97
NHPRP +/- 45 (dBm)	14.86
NHPRP +/- 30 (dBm)	13.27
Ver. Peak EIRP (dBm)	19.97
Total Peak EIRP (dBm)	21.62
Max. Power (dBm)	21.62
Min. Power (dBm)	-1.12
Hor. Peak EIRP (dBm)	19.78

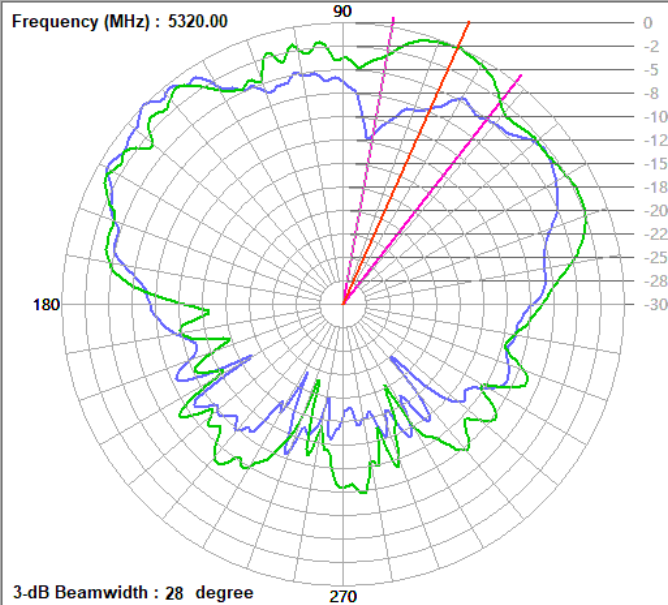
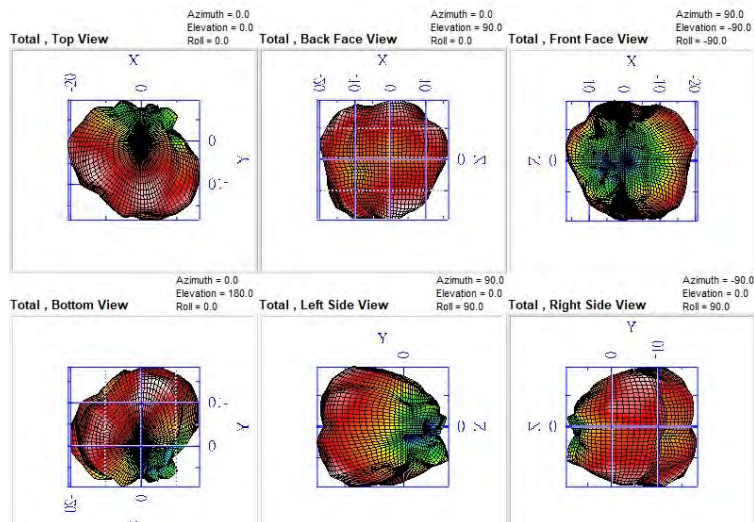

Frequency (MHz) : 5320.00 Polarity 1 : Horizontal Beamwidth 1 : 35
 Polarity 2 : Vertical Beamwidth 2 : 28
 (at the 3 dB down)

802.11ax HE20 CH 100 CDD On Nss1

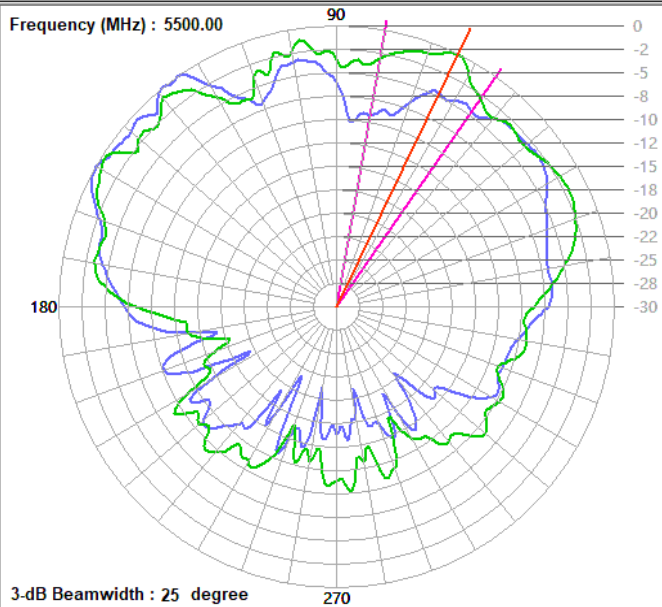
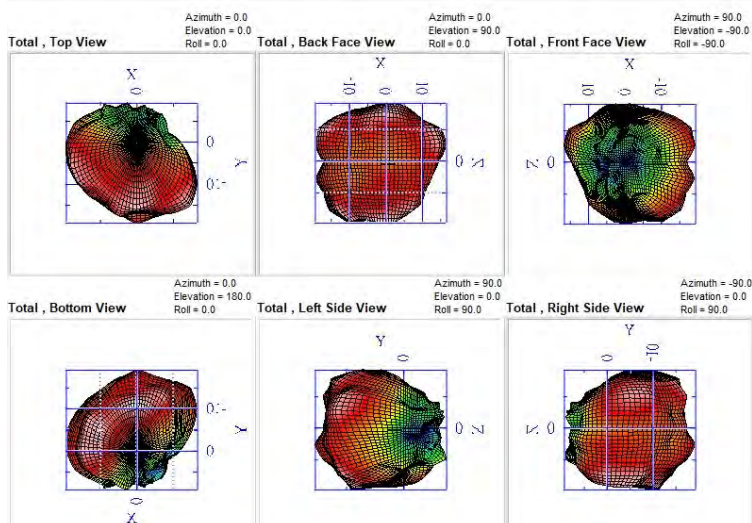
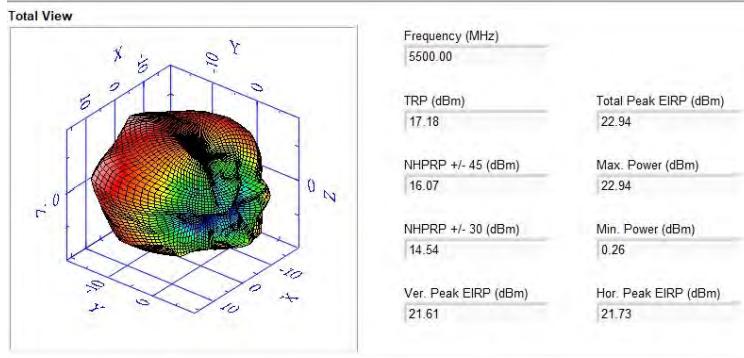

Frequency (MHz) : 5500.00	Polarity 1 : Horizontal	Beamwidth 1 : 41
	Polarity 2 : Vertical	Beamwidth 2 : 25
(at the 3 dB down)		

802.11ax HE20 CH 157 CDD On Nss1

Total View

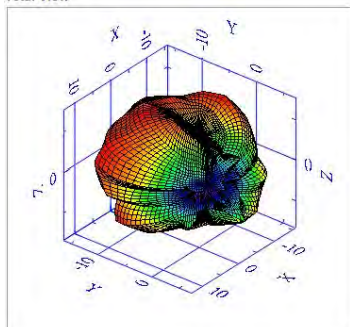

Frequency (MHz)	5785.00
TRP (dBm)	22.65
NHPRP +/- 45 (dBm)	21.47
NHPRP +/- 30 (dBm)	19.83
Ver. Peak EIRP (dBm)	26.18
Total Peak EIRP (dBm)	28.9
Max. Power (dBm)	28.9
Min. Power (dBm)	9.46
Hor. Peak EIRP (dBm)	27.49

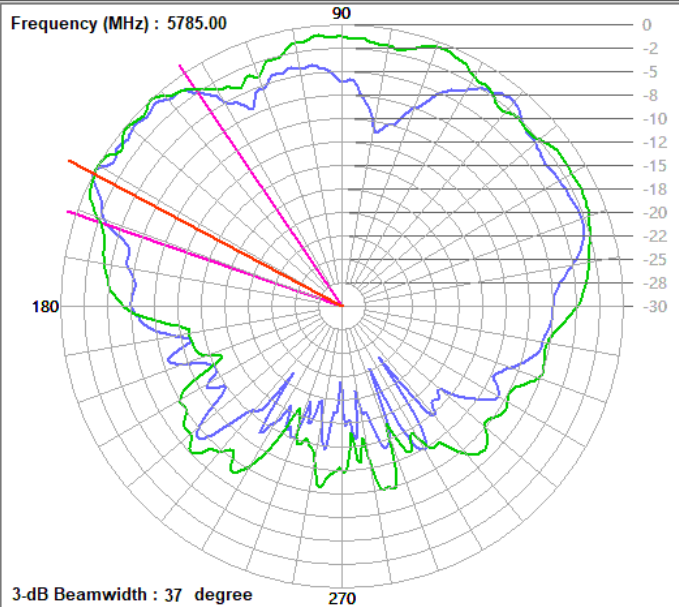
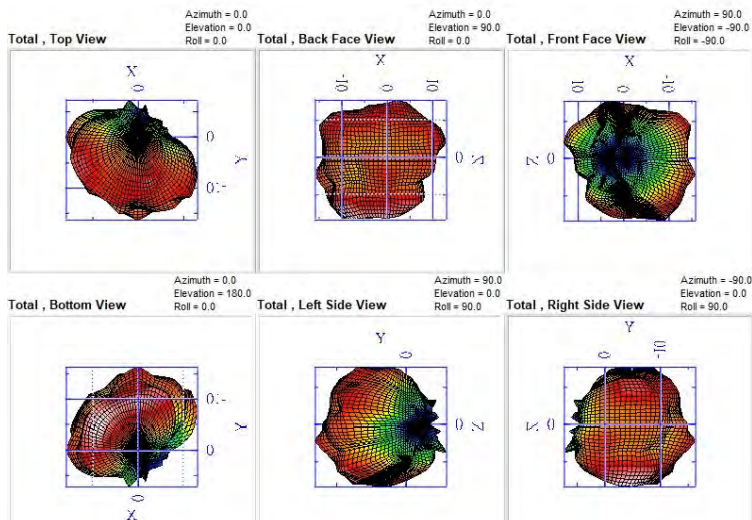

Frequency (MHz) : 5785.00 Polarity 1 : Horizontal Beamwidth 1 : 37
 Polarity 2 : Vertical Beamwidth 2 : 40
 (at the 3 dB down)

802.11ax HE20 CH 173 CDD On Nss1

Total View

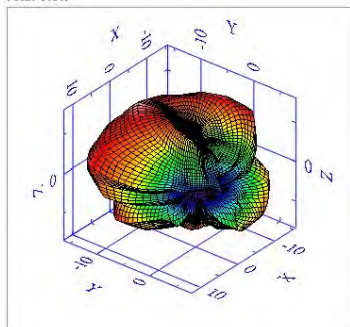

Frequency (MHz)	5865.00
TRP (dBm)	22.99
NHPRP +/- 45 (dBm)	21.82
NHPRP +/- 30 (dBm)	20.17
Ver. Peak EIRP (dBm)	26.41
Total Peak EIRP (dBm)	28.8
Max. Power (dBm)	28.8
Min. Power (dBm)	9.26
Hor. Peak EIRP (dBm)	27.78

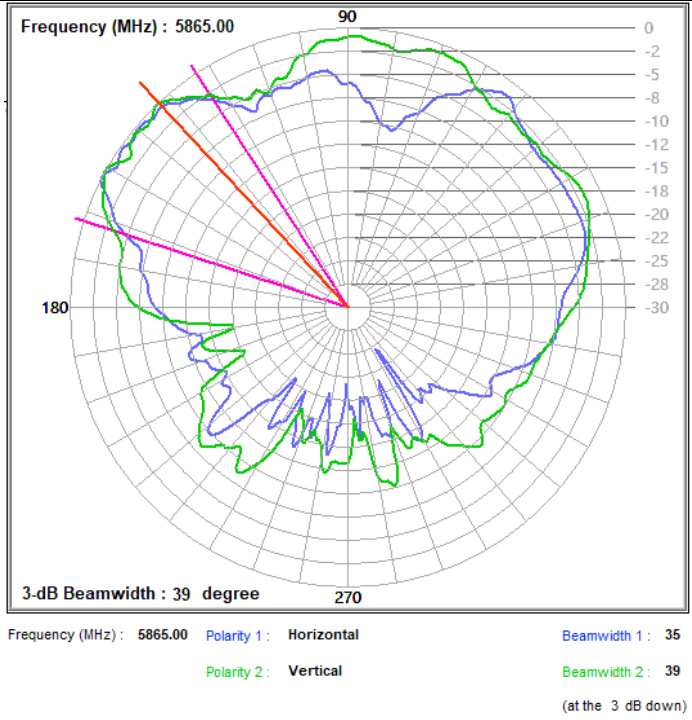
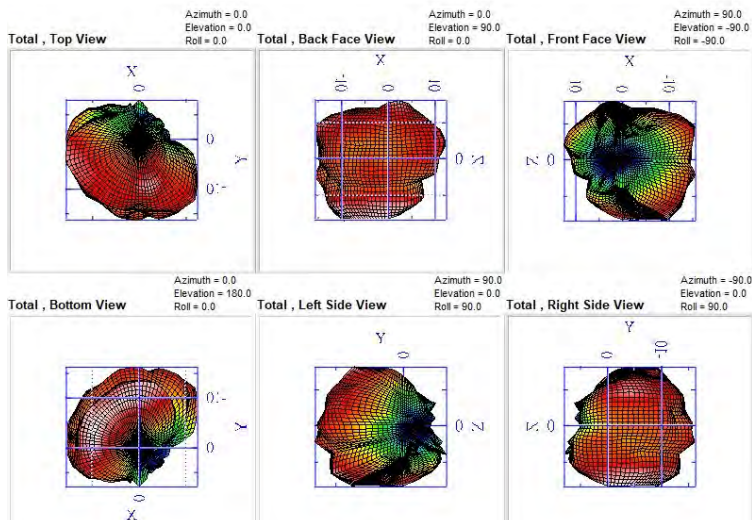

802.11ax HE20 CH 93 CDD On Nss1

Total View

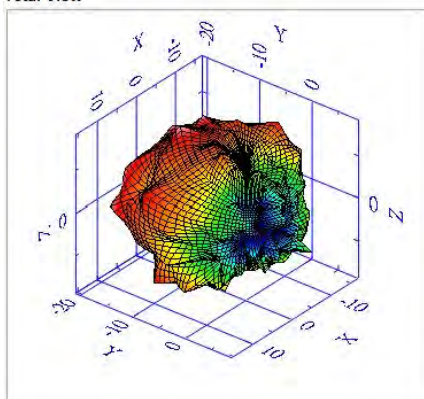

Frequency (MHz)	6415.00	
TRP (dBm)	0.08	Total Peak EIRP (dBm)
		6.64
NHPRP +/- 45 (dBm)	-0.82	Max. Power (dBm)
		6.64
NHPRP +/- 30 (dBm)	-2.15	Min. Power (dBm)
		-15.67
Ver. Peak EIRP (dBm)	3.41	Hor. Peak EIRP (dBm)
		3.94

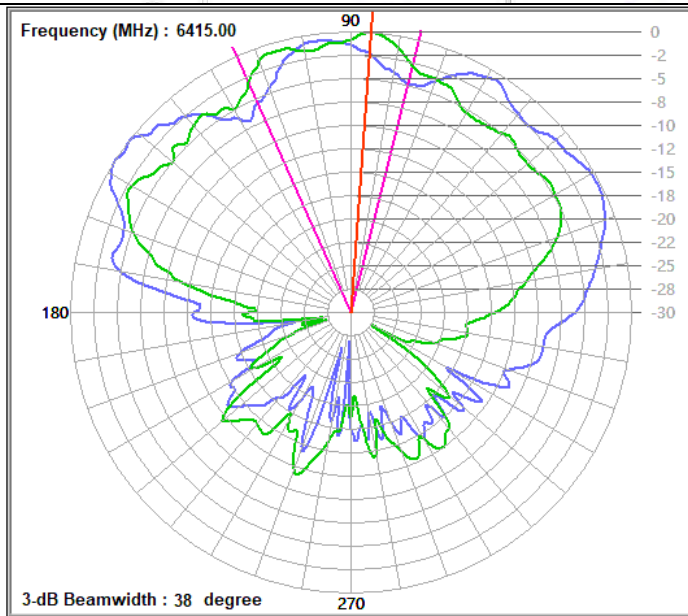
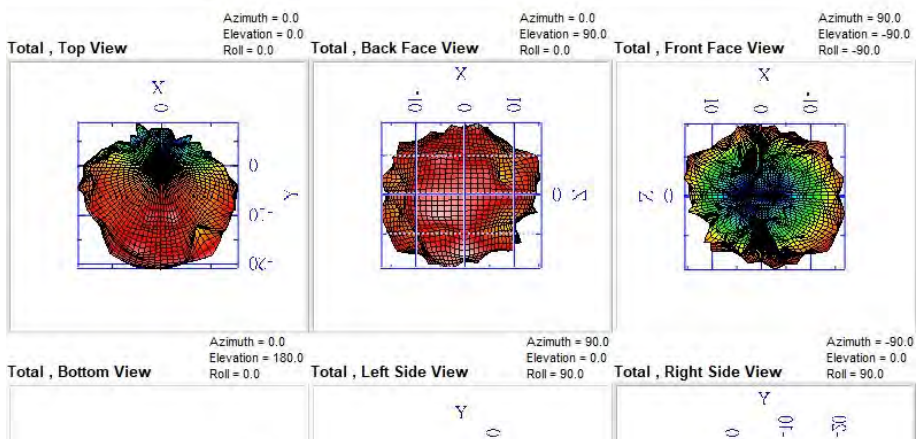

Frequency (MHz) : 6415.00 Polarity 1 : Horizontal Beamwidth 1 : 27
 Polarity 2 : Vertical Beamwidth 2 : 38
 (at the 3 dB down)

802.11ax HE20 CH 113 CDD On Nss1

Total View

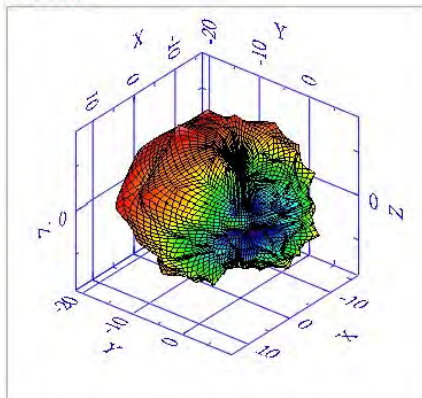

Frequency (MHz)	6515.00
TRP (dBm)	-0.48
Total Peak EIRP (dBm)	5.96
NHPRP +/- 45 (dBm)	-1.32
Max. Power (dBm)	5.96
NHPRP +/- 30 (dBm)	-2.51
Min. Power (dBm)	-16.01
Ver. Peak EIRP (dBm)	3.7
Hor. Peak EIRP (dBm)	2.47

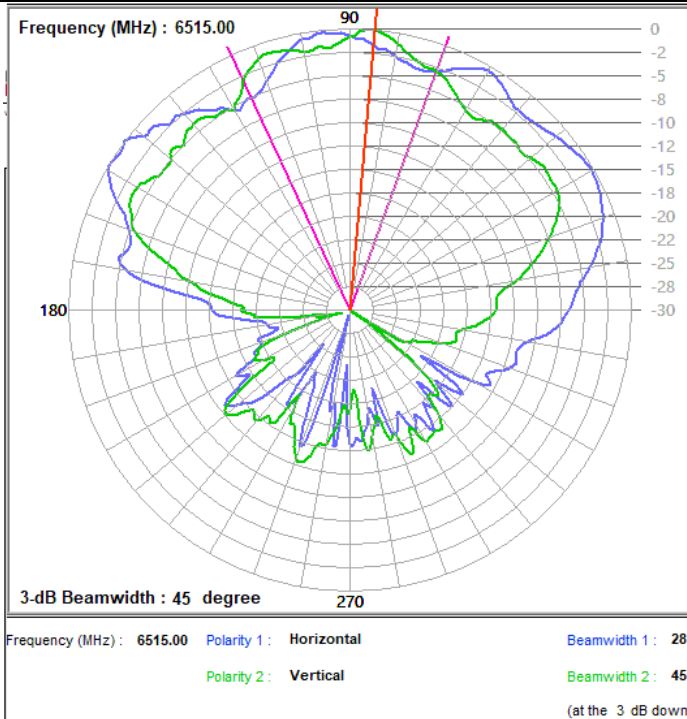
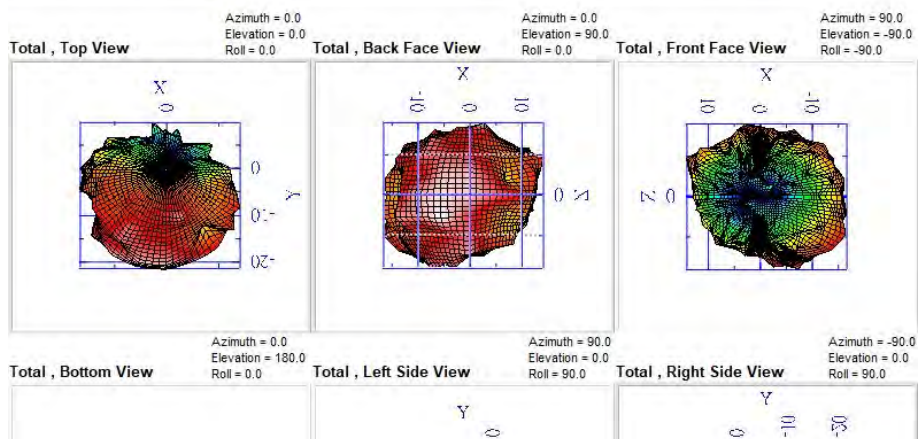

802.11ax HE20 CH 181 CDD On Nss1

Total View

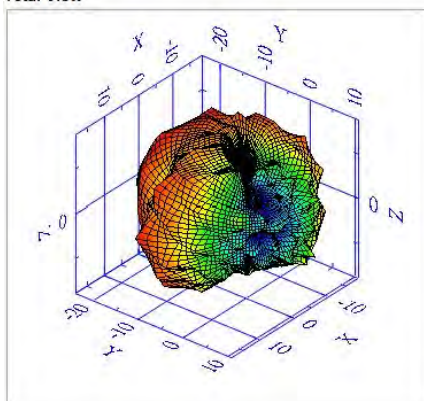

Frequency (MHz)	6855.00
TRP (dBm)	-0.97
NHPRP +/- 45 (dBm)	-1.53
NHPRP +/- 30 (dBm)	-2.53
Ver. Peak EIRP (dBm)	3.89
Total Peak EIRP (dBm)	6.1
Max. Power (dBm)	6.1
Min. Power (dBm)	-18.15
Hor. Peak EIRP (dBm)	3.22

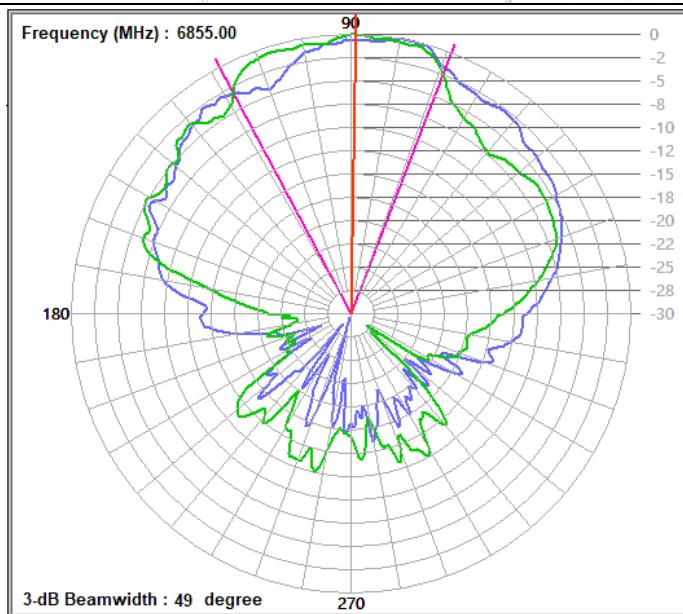
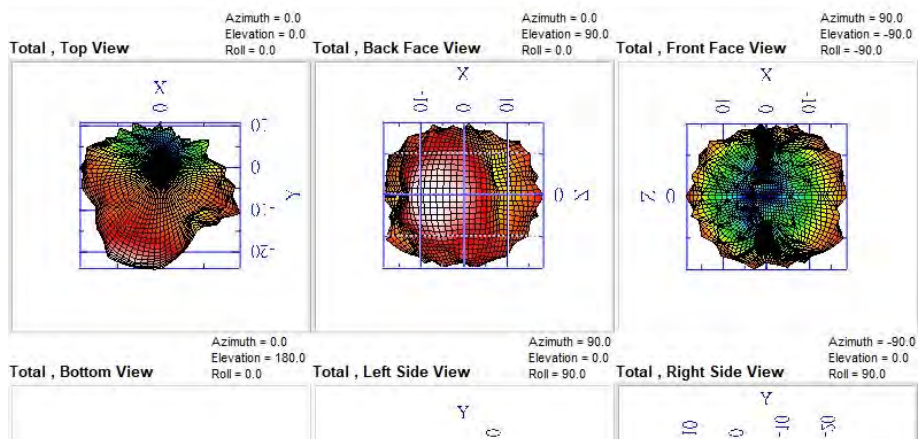

Frequency (MHz) : 6855.00 Polarity 1 : Horizontal Beamwidth 1 : 46
 Polarity 2 : Vertical Beamwidth 2 : 49
 (at the 3 dB down)

802.11ax HE20 CH 233 CDD On Nss1

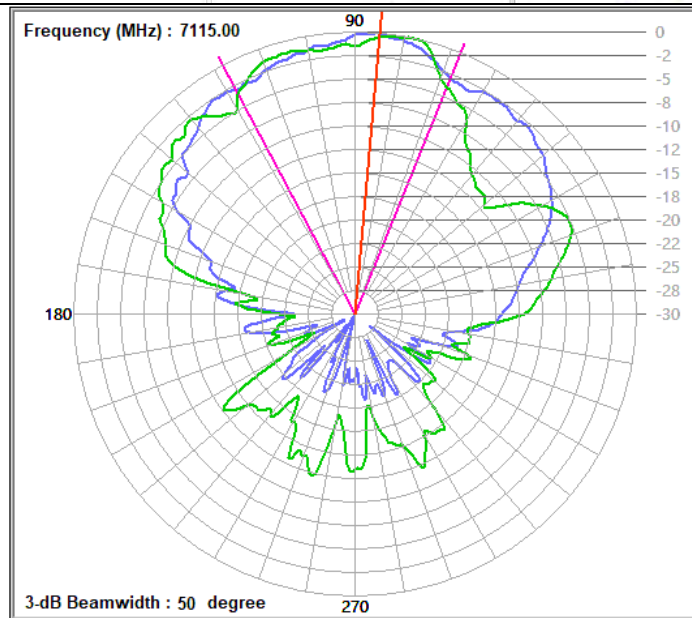
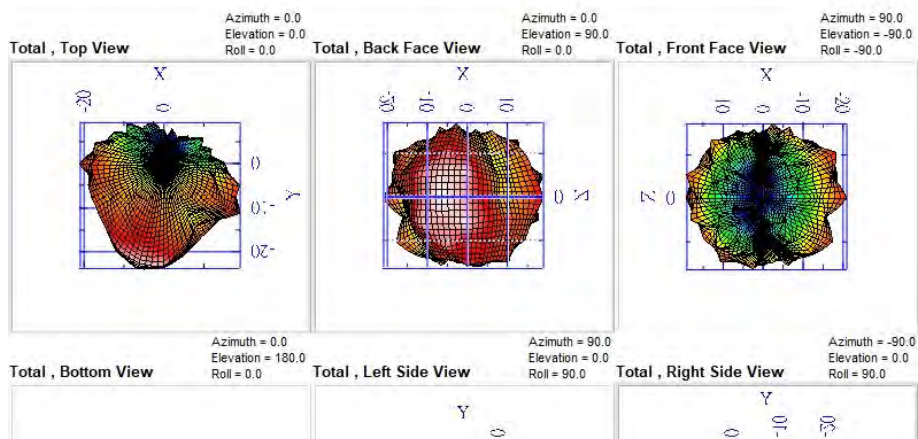
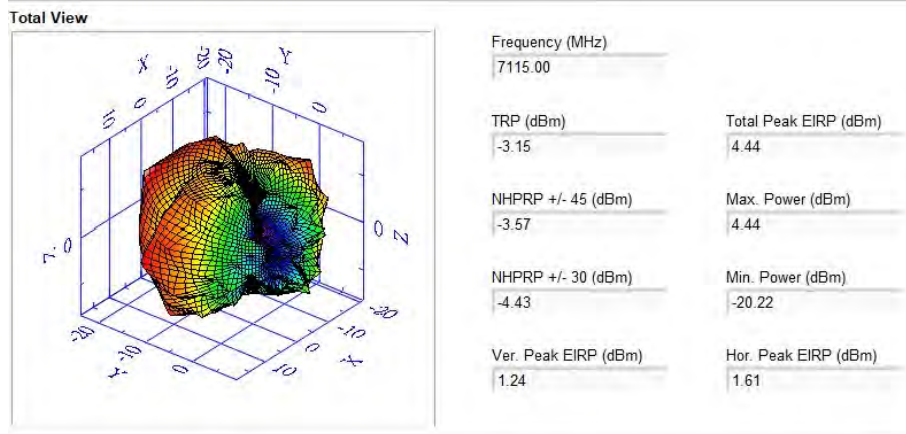

Frequency (MHz) : 7115.00	Polarity 1 : Horizontal	Beamwidth 1 : 50
	Polarity 2 : Vertical	Beamwidth 2 : 46
(at the 3 dB down)		

Model: FAP-433G

Radio 1 - 2.4GHz band

2.4GHz_HE20_CH 6_BF On Nss1

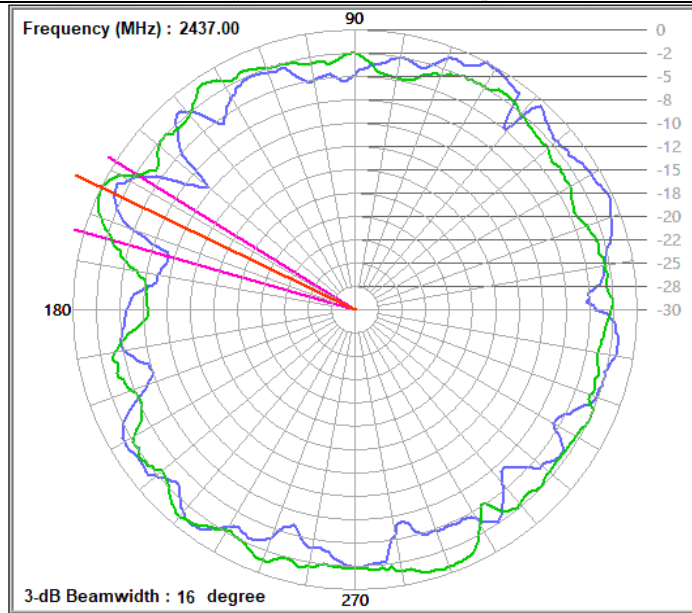
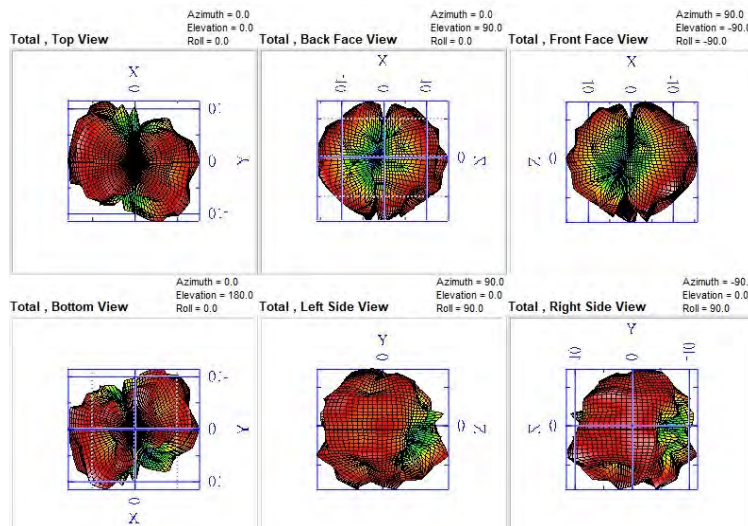
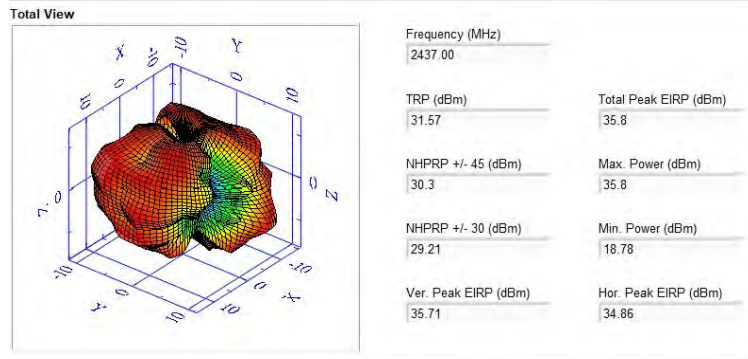

Frequency (MHz) : 2437.00 Polarity 1 : Horizontal Beamwidth 1 : 21
 Polarity 2 : Vertical Beamwidth 2 : 16
 (at the 3 dB down)

Radio 2 - 5GHz band

802.11ax HE20 CH 36 BF On Nss1

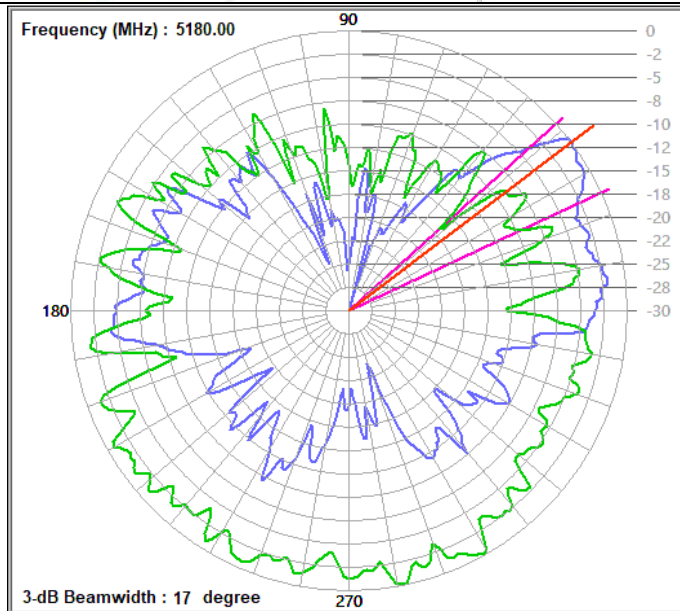
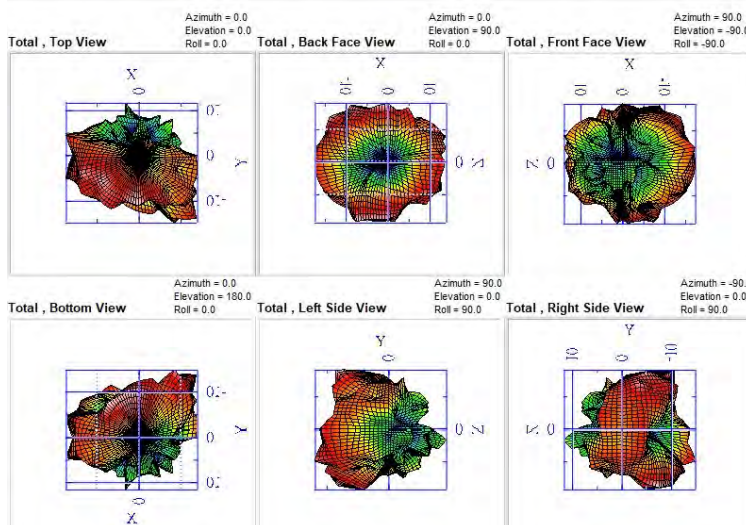
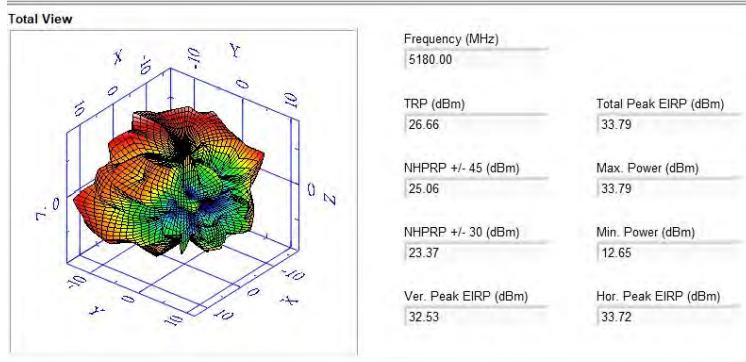

Frequency (MHz) : 5180.00 Polarity 1 : Horizontal Beamwidth 1 : 17
 Polarity 2 : Vertical Beamwidth 2 : 22
 (at the 3 dB down)

802.11ax HE20 CH 64 BF On Nss1

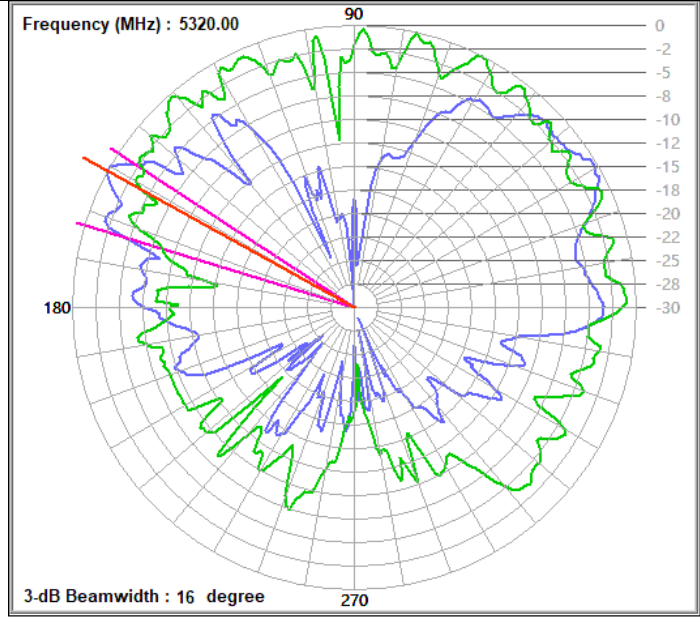
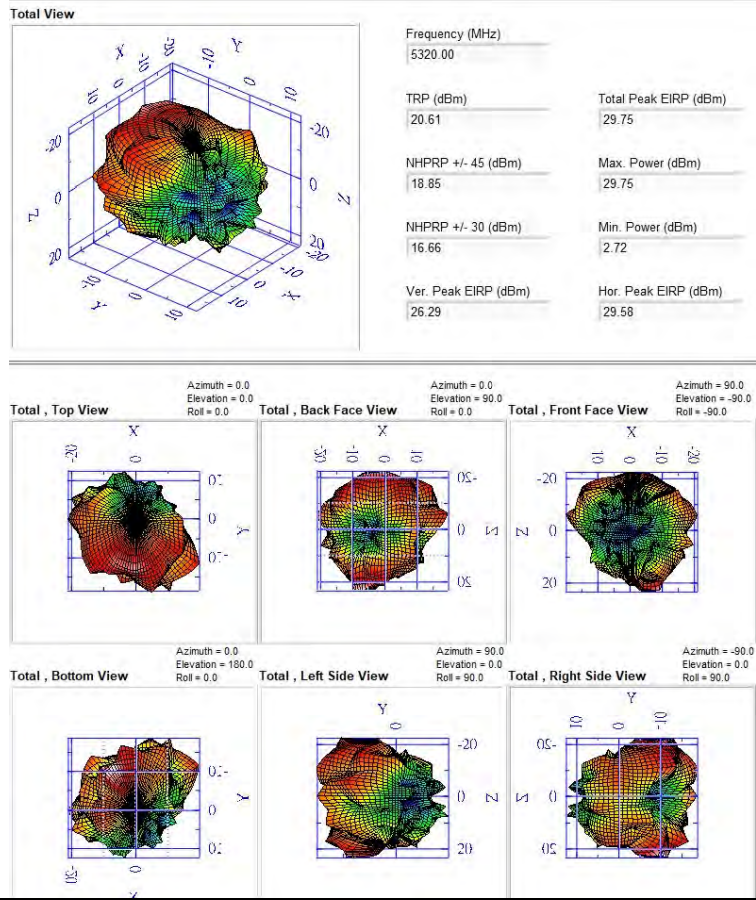

Frequency (MHz) : 5320.00 Polarity 1 : Horizontal Beamwidth 1 : 16
 Polarity 2 : Vertical Beamwidth 2 : 29
 (at the 3 dB down)

802.11ax HE20 CH 100 BF On Nss1

Total View

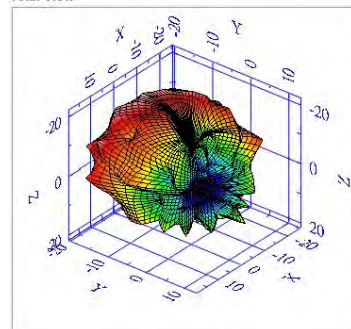

Frequency (MHz)	5500.00	
TRP (dBm)	21.05	Total Peak EIRP (dBm)
		29.36
NHPRP +/- 45 (dBm)	19.94	Max. Power (dBm)
		29.36
NHPRP +/- 30 (dBm)	18.25	Min. Power (dBm)
		2.89
Ver. Peak EIRP (dBm)	29.33	Hor. Peak EIRP (dBm)
		28.5

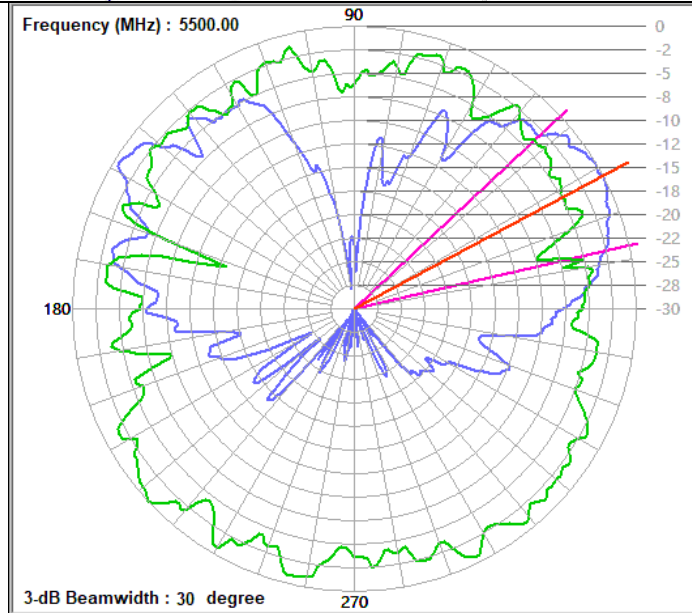
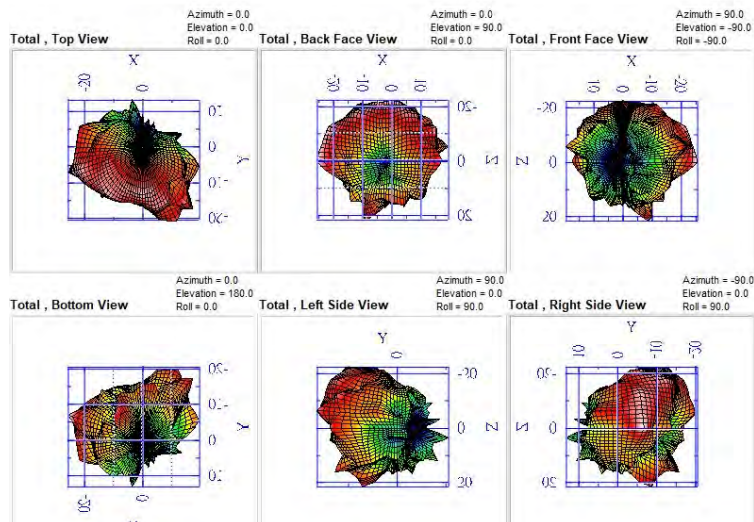

Frequency (MHz) : 5500.00 Polarity 1 : Horizontal Beamwidth 1 : 30
 Polarity 2 : Vertical Beamwidth 2 : 19
 (at the 3 dB down)

802.11ax HE20 CH 157 BF On Nss1

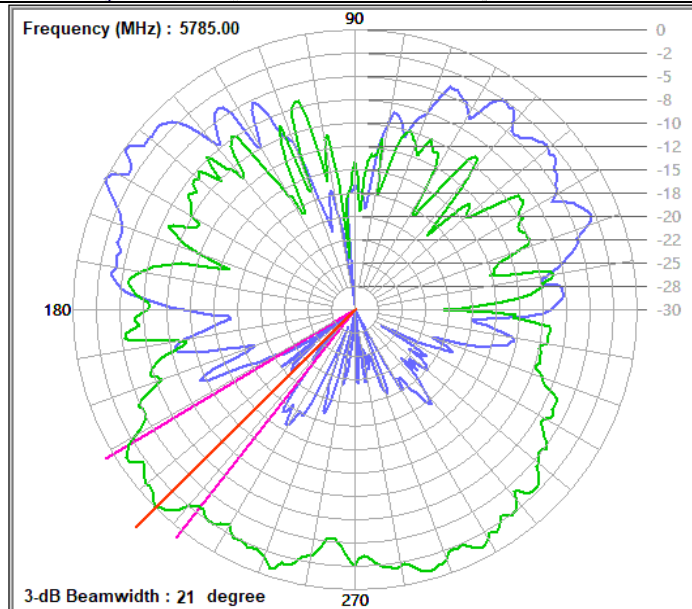
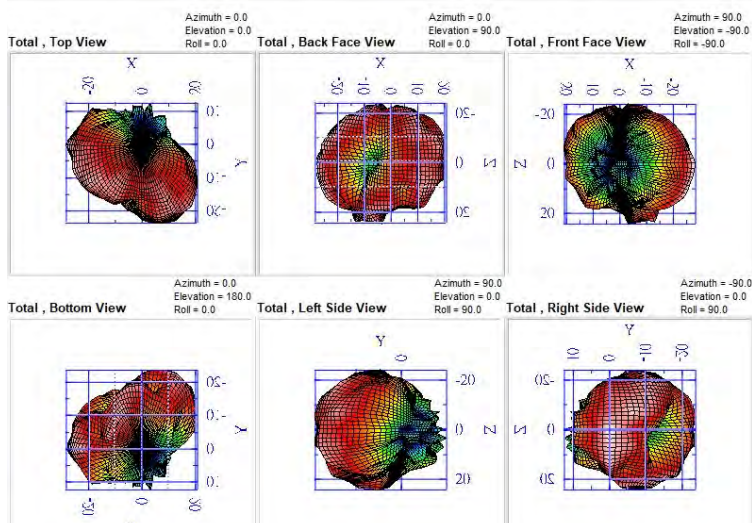
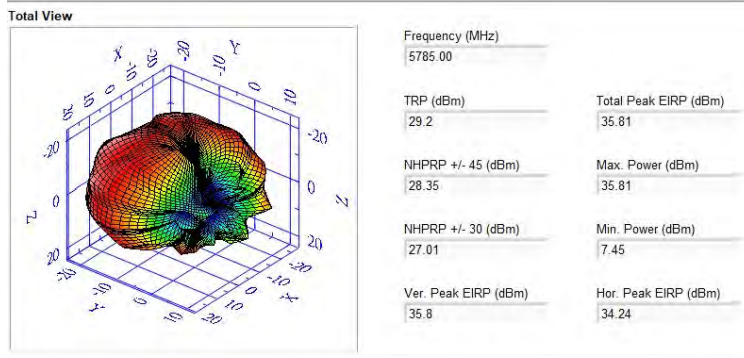

Frequency (MHz) : 5785.00	Polarity 1 : Horizontal	Beamwidth 1 : 25
	Polarity 2 : Vertical	Beamwidth 2 : 21
(at the 3 dB down)		

Radio 3 - 5GHz and 6GHz bands

802.11ax HE20 CH 100 BF On Nss1

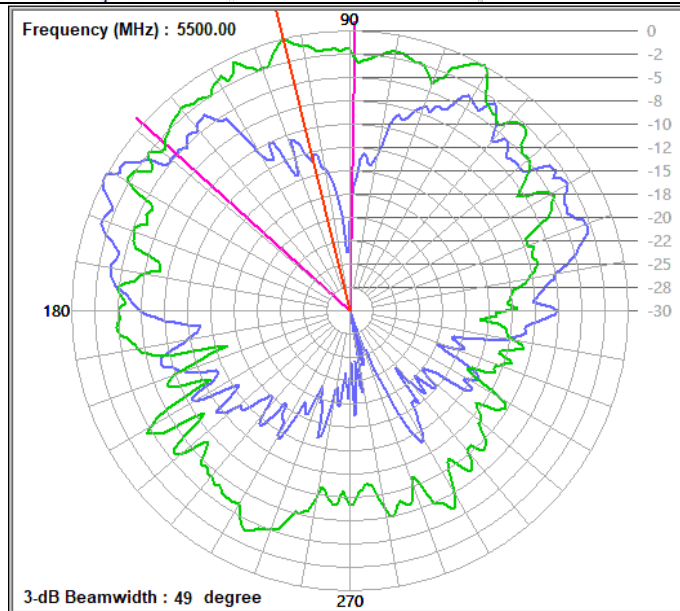
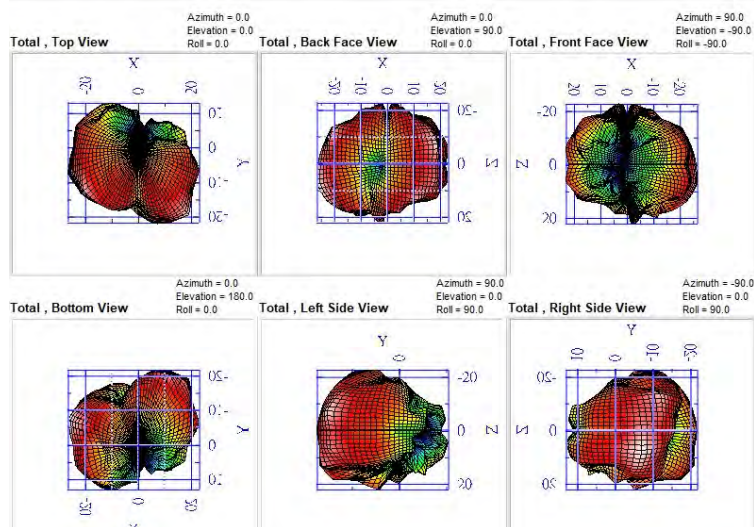
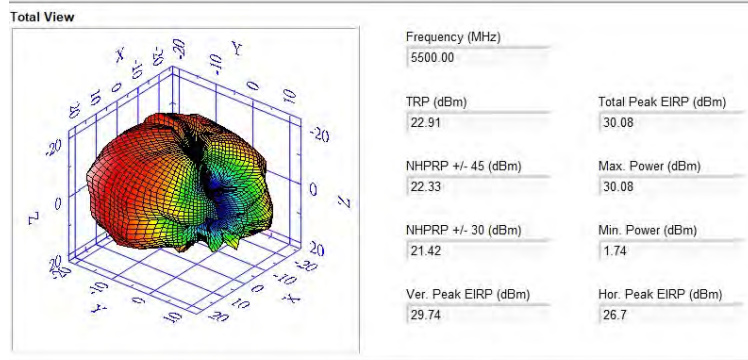

Frequency (MHz) : 5500.00 Polarity 1 : Horizontal Beamwidth 1 : 20
 Polarity 2 : Vertical Beamwidth 2 : 49
 (at the 3 dB down)

802.11ax HE20 CH 157 BF On Nss1

Total View

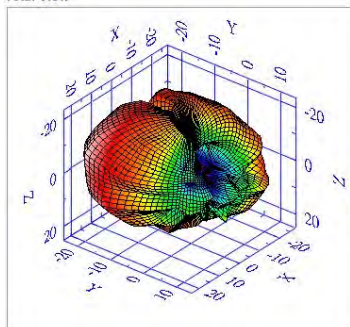

Frequency (MHz)	5785.00
TRP (dBm)	29.07
NHPRP +/- 45 (dBm)	28.39
NHPRP +/- 30 (dBm)	27.34
Ver. Peak EIRP (dBm)	35.77
Total Peak EIRP (dBm)	35.92
Max. Power (dBm)	35.92
Min. Power (dBm)	6.09
Hor. Peak EIRP (dBm)	32.89

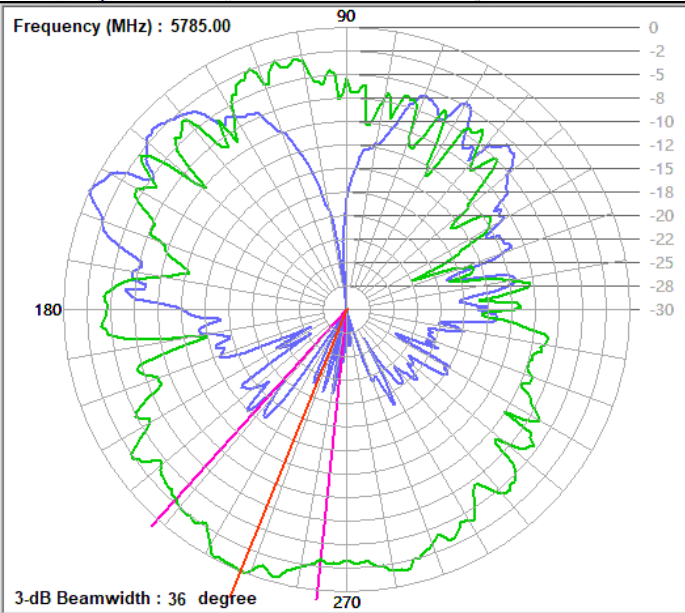
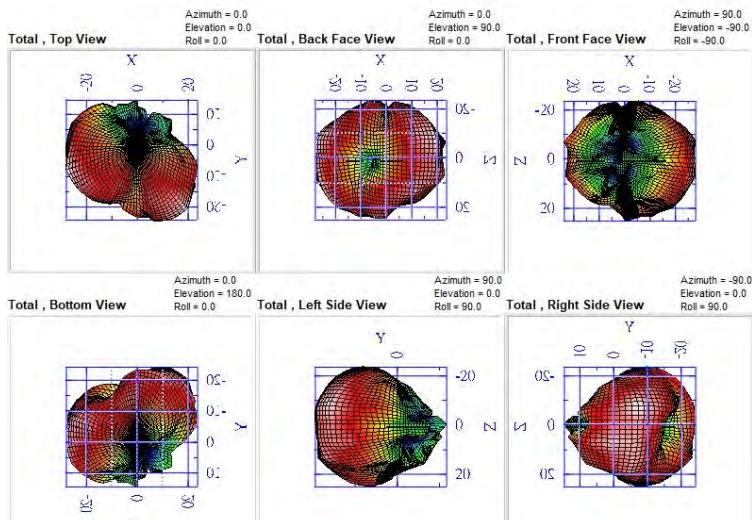

Frequency (MHz) : 5785.00 Polarity 1 : Horizontal Beamwidth 1 : 15
 Polarity 2 : Vertical Beamwidth 2 : 36
 (at the 3 dB down)

802.11ax HE20 CH 173 BF On Nss1

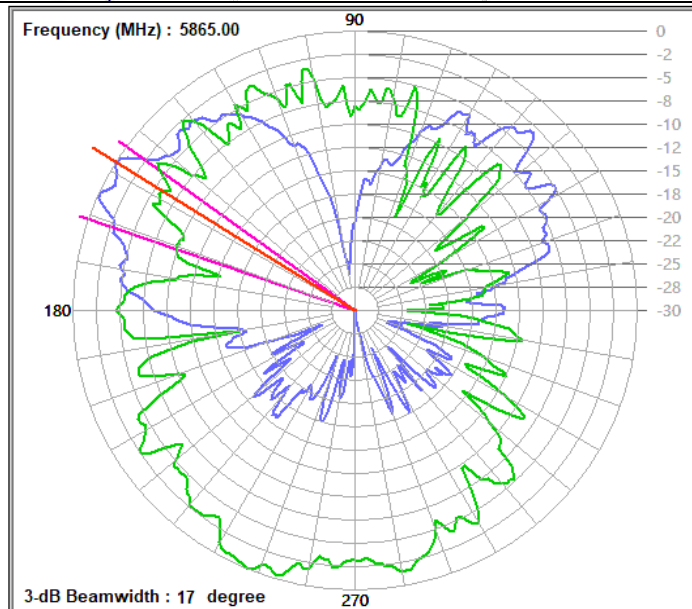
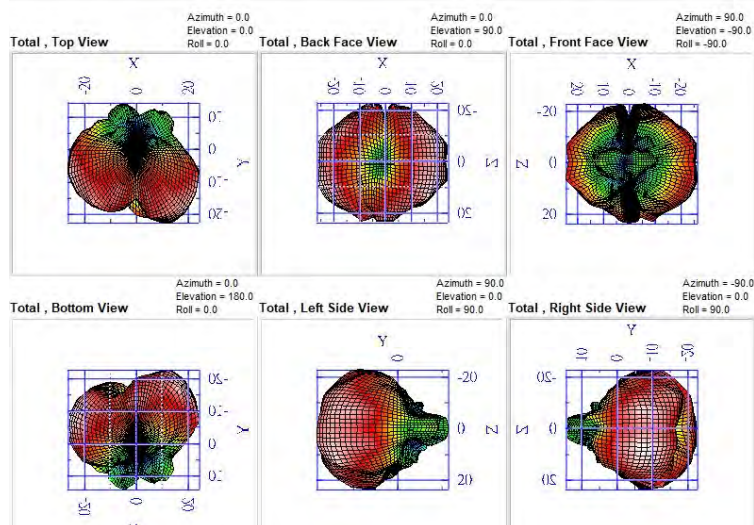
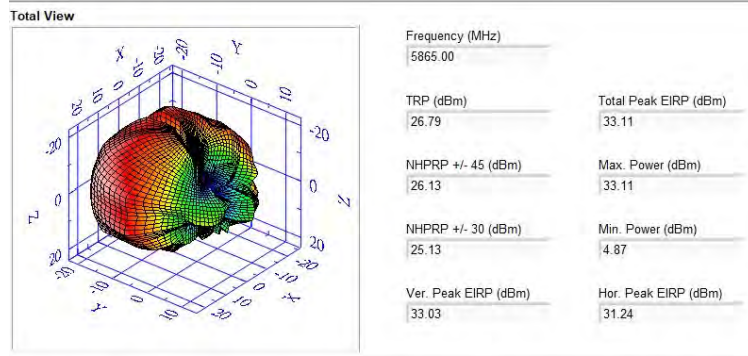

Frequency (MHz) : 5865.00	Polarity 1 : Horizontal	Beamwidth 1 : 17
	Polarity 2 : Vertical	Beamwidth 2 : 24
(at the 3 dB down)		

802.11ax HE20 CH 93 BF On Nss1

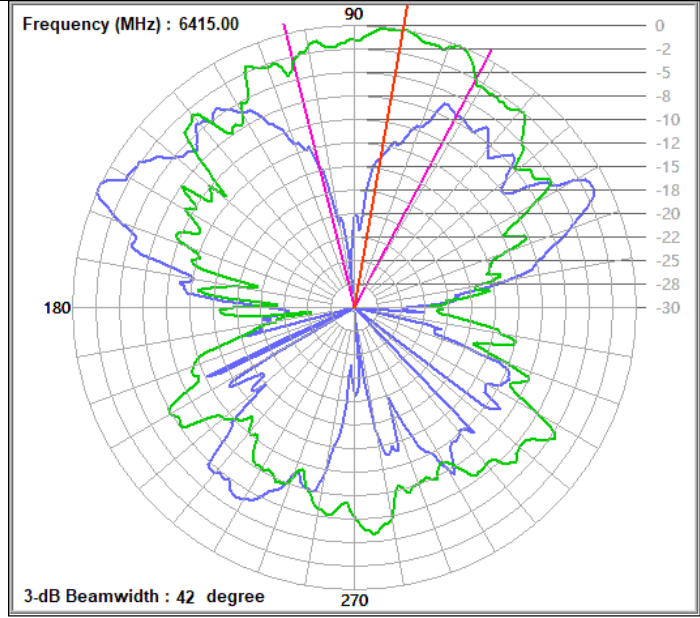
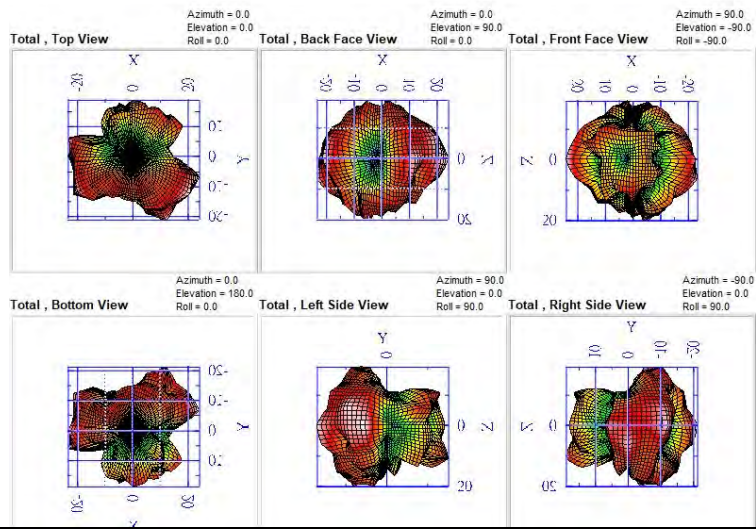
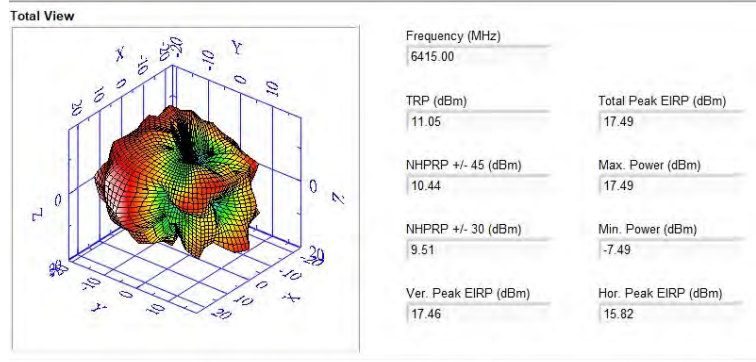

Frequency (MHz) : 6415.00	Polarity 1 : Horizontal	Beamwidth 1 : 15
	Polarity 2 : Vertical	Beamwidth 2 : 42
(at the 3 dB down)		

802.11ax HE20 CH 113 BF On Nss1

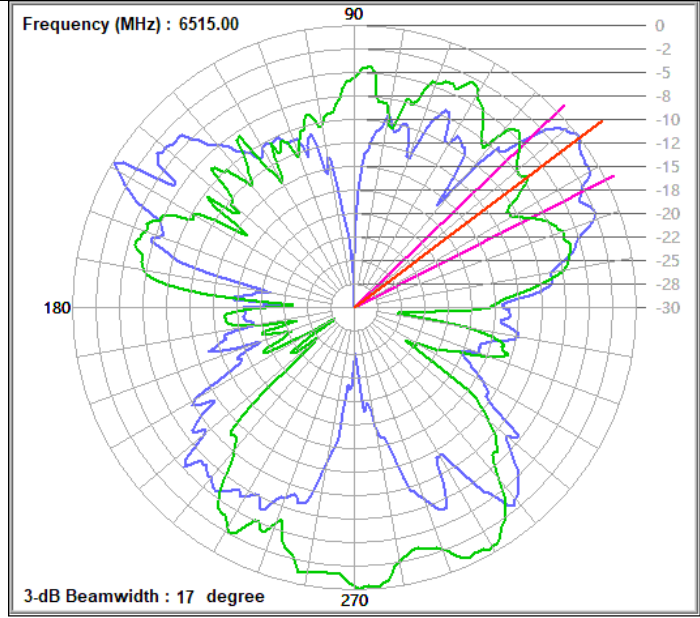
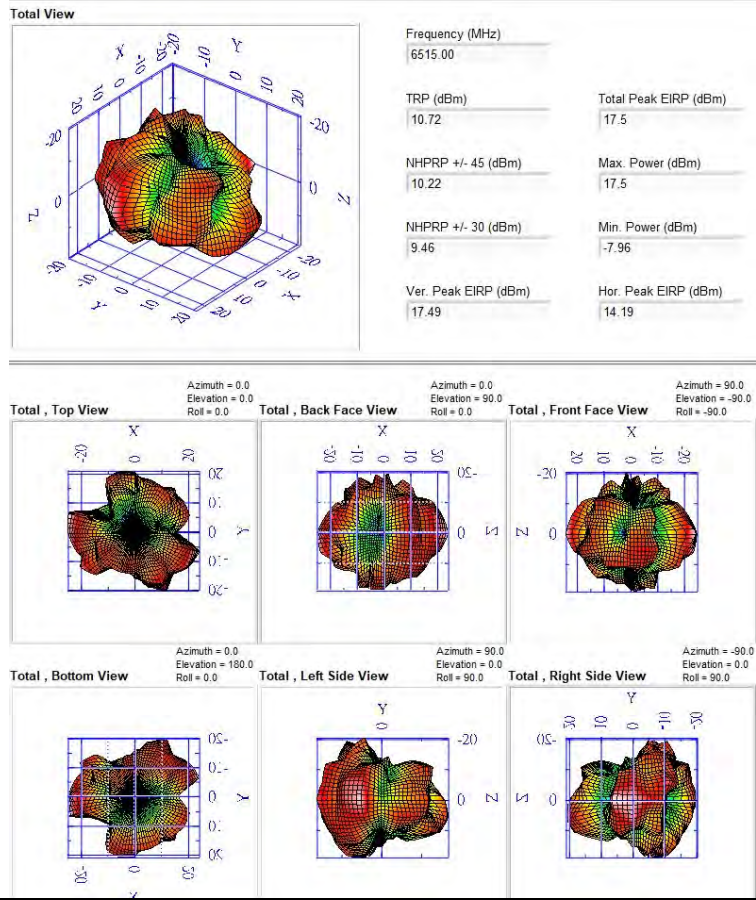

Frequency (MHz) : 6515.00 Polarity 1 : Horizontal Beamwidth 1 : 17
 Polarity 2 : Vertical Beamwidth 2 : 26
 (at the 3 dB down)

802.11ax HE20 CH 181 BF On Nss1

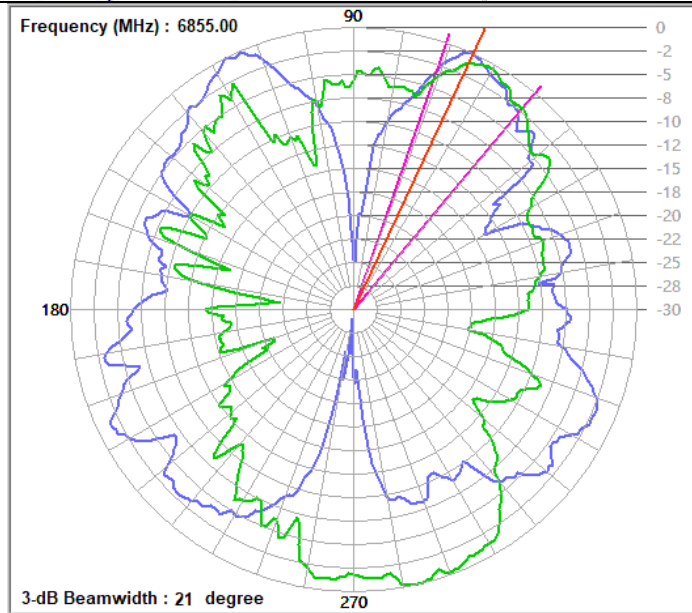
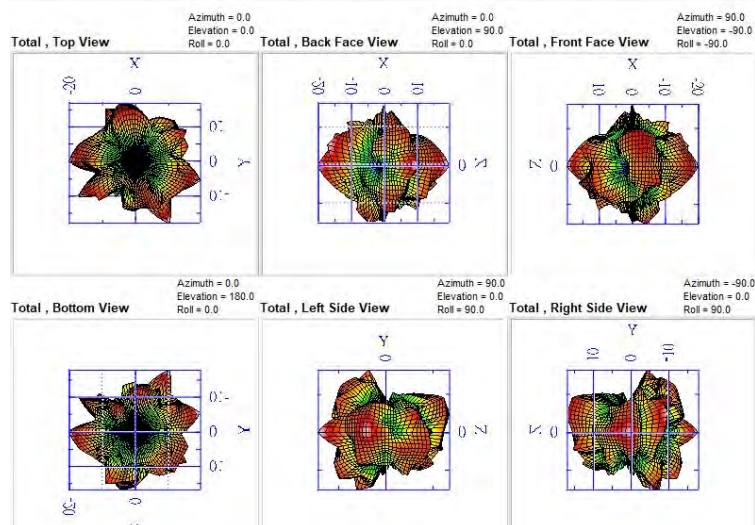
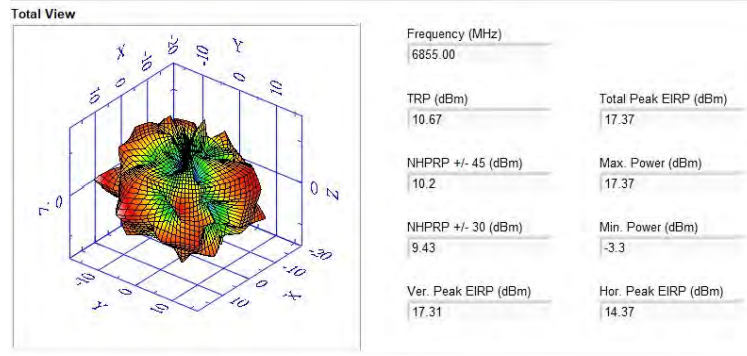

Frequency (MHz) : 6855.00	Polarity 1 : Horizontal	Beamwidth 1 : 21
	Polarity 2 : Vertical	Beamwidth 2 : 48
(at the 3 dB down)		

802.11ax HE20 CH 233 BF On Nss1

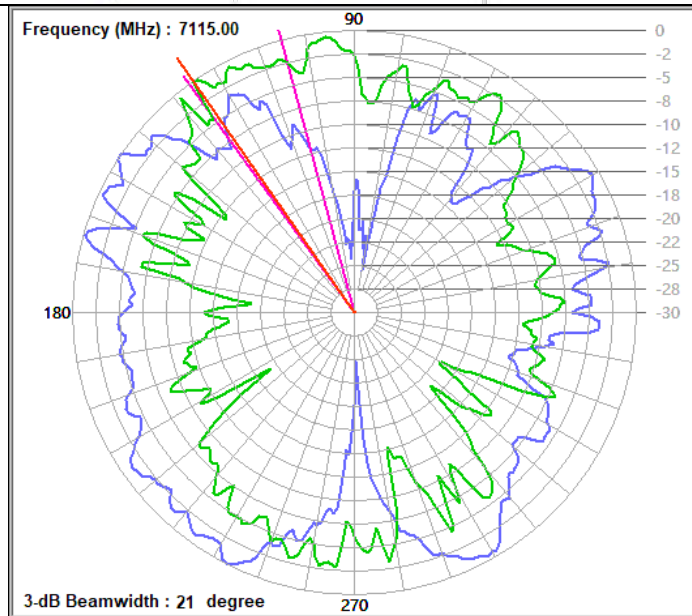
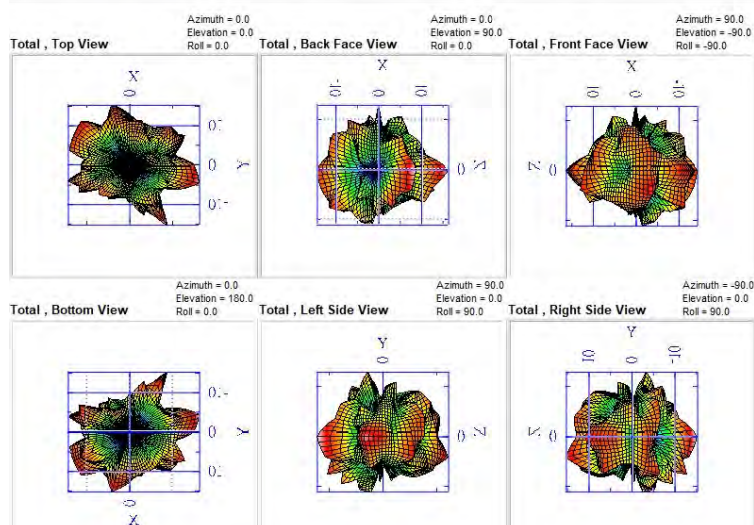
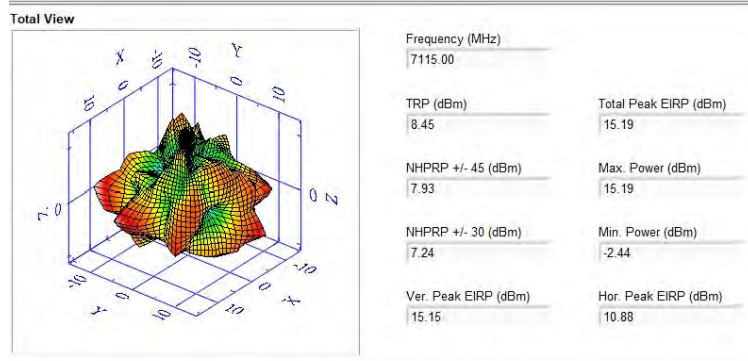

Frequency (MHz) : 7115.00	Polarity 1 : Horizontal	Beamwidth 1 : 21
	Polarity 2 : Vertical	Beamwidth 2 : 21
(at the 3 dB down)		

Scanning Radio - 2.4GHz, 5GHz and 6GHz bands

2.4GHz_HE20_CH 6_CDD On Nss1

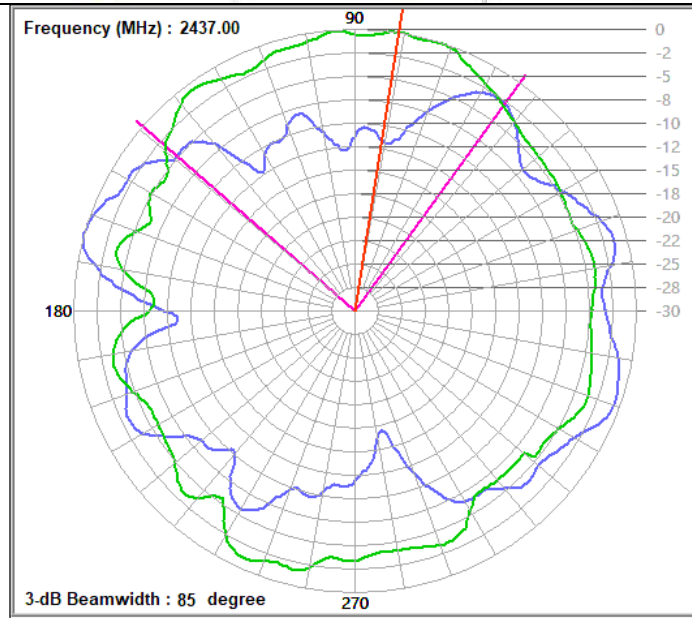
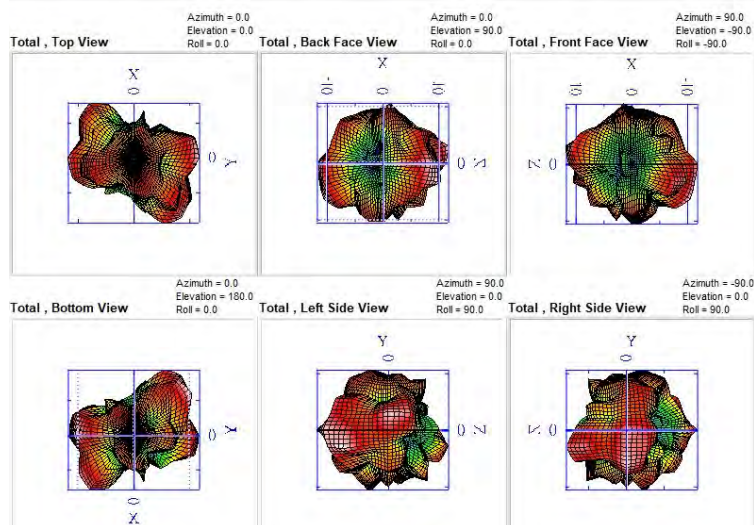
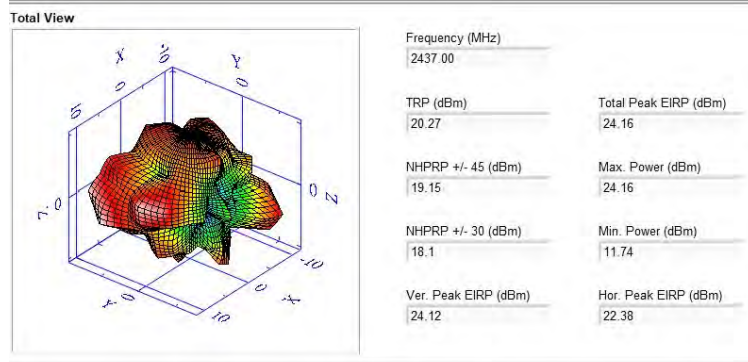

Frequency (MHz) : 2437.00 Polarity 1 : Horizontal Beamwidth 1 : 28
 Polarity 2 : Vertical Beamwidth 2 : 85
 (at the 3 dB down)

802.11ax HE20 CH 36 CDD On Nss1

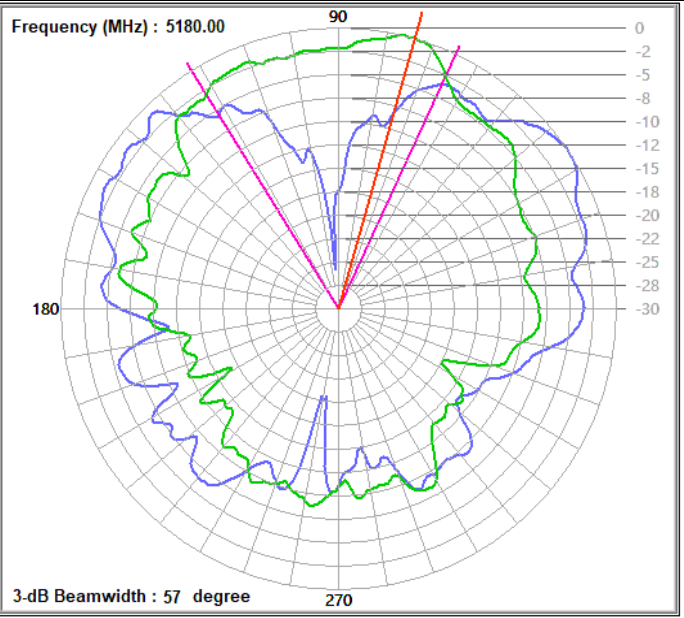
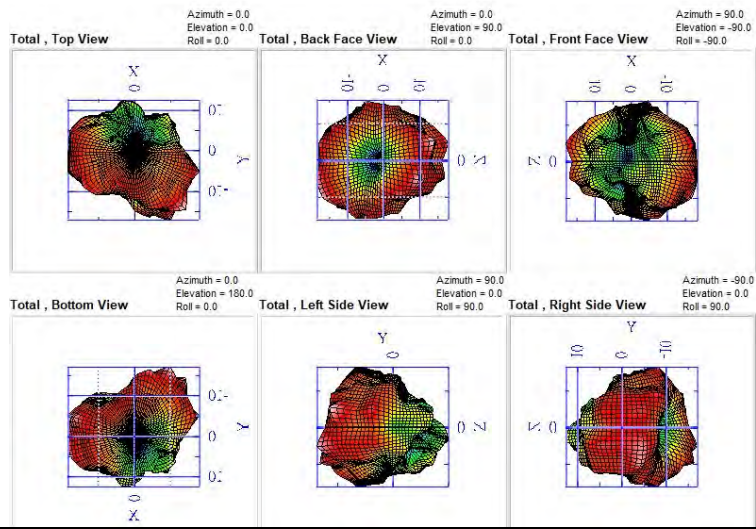
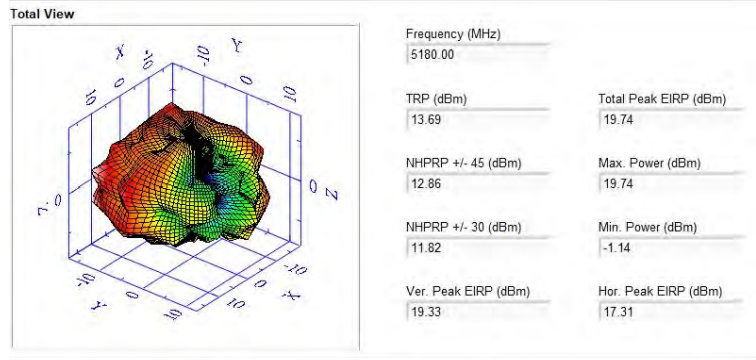

Frequency (MHz) : 5180.00	Polarity 1 : Horizontal	Beamwidth 1 : 35
	Polarity 2 : Vertical	Beamwidth 2 : 57
(at the 3 dB down)		

802.11ax HE20 CH 64 CDD On Nss1

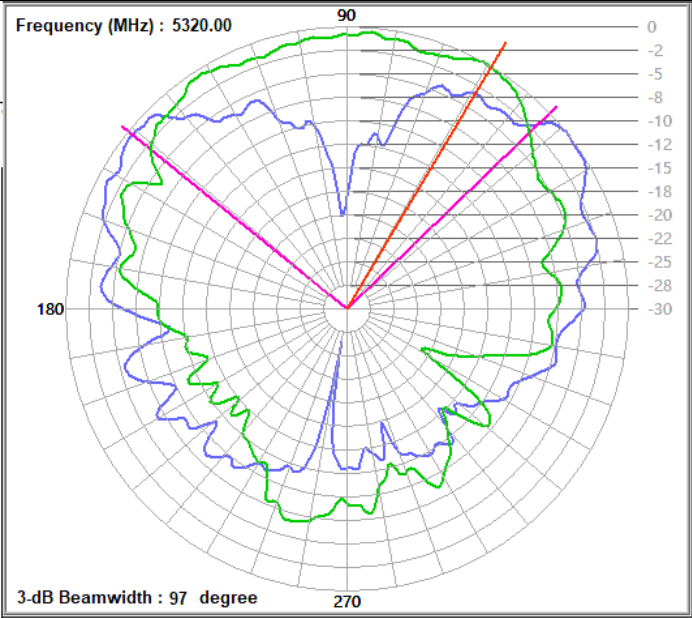
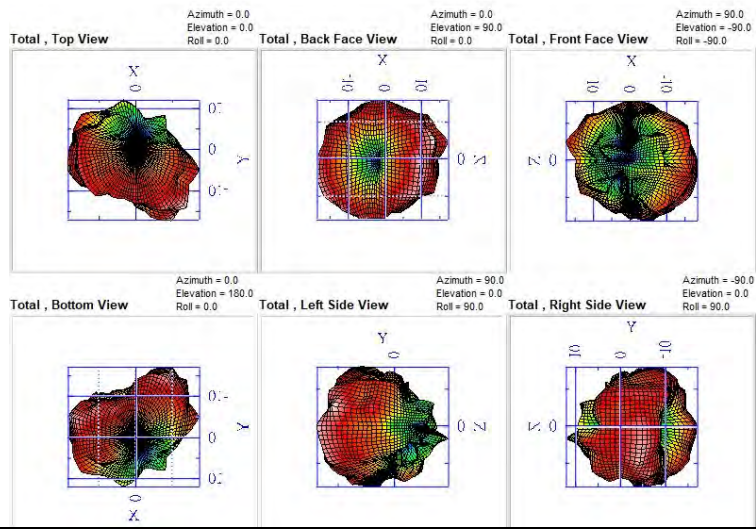
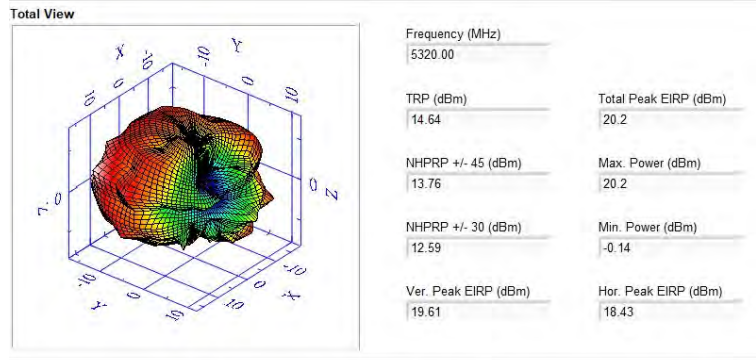

Frequency (MHz) : 5320.00	Polarity 1 : Horizontal	Beamwidth 1 : 34
	Polarity 2 : Vertical	Beamwidth 2 : 97
(at the 3 dB down)		

802.11ax HE20 CH 100 CDD On Nss1

Total View

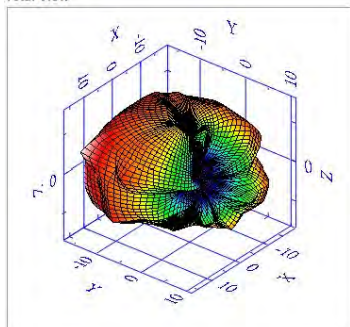

Frequency (MHz)	5500.00
TRP (dBm)	14.24
NHPRP +/- 45 (dBm)	13.4
NHPRP +/- 30 (dBm)	12.29
Ver. Peak EIRP (dBm)	20.11
Total Peak EIRP (dBm)	20.64
Max. Power (dBm)	20.64
Min. Power (dBm)	-1.04
Hor. Peak EIRP (dBm)	17.49

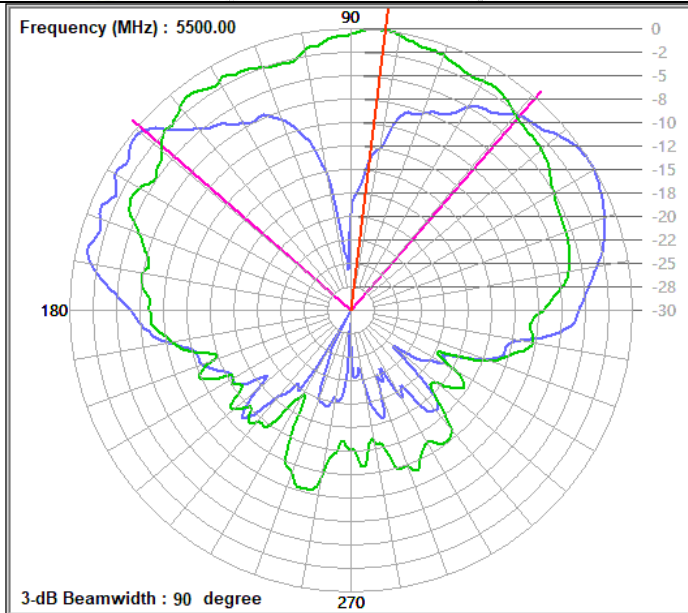
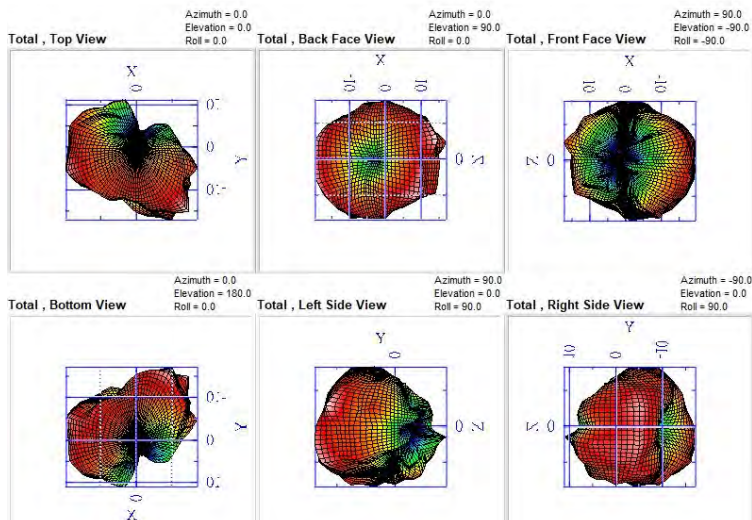

Frequency (MHz) : 5500.00 Polarity 1 : Horizontal Beamwidth 1 : 39
 Polarity 2 : Vertical Beamwidth 2 : 90
 (at the 3 dB down)

802.11ax HE20 CH 157 CDD On Nss1

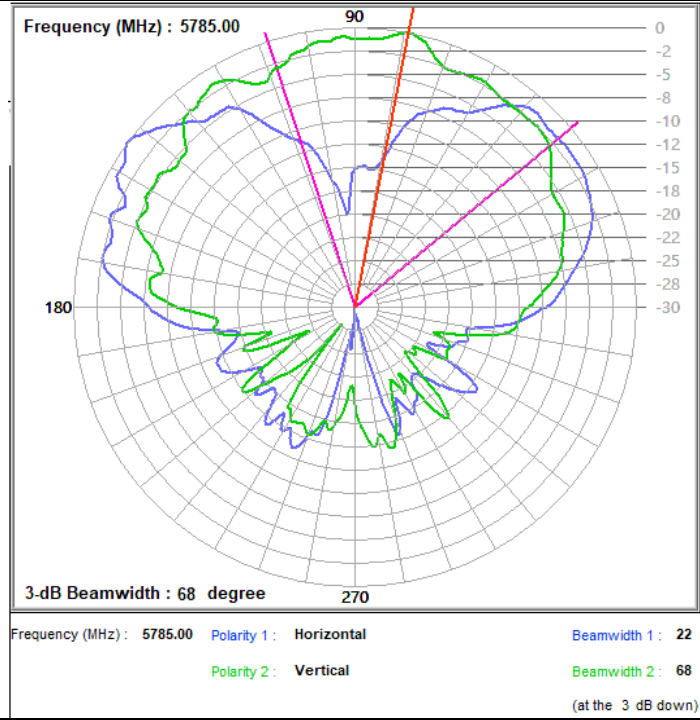
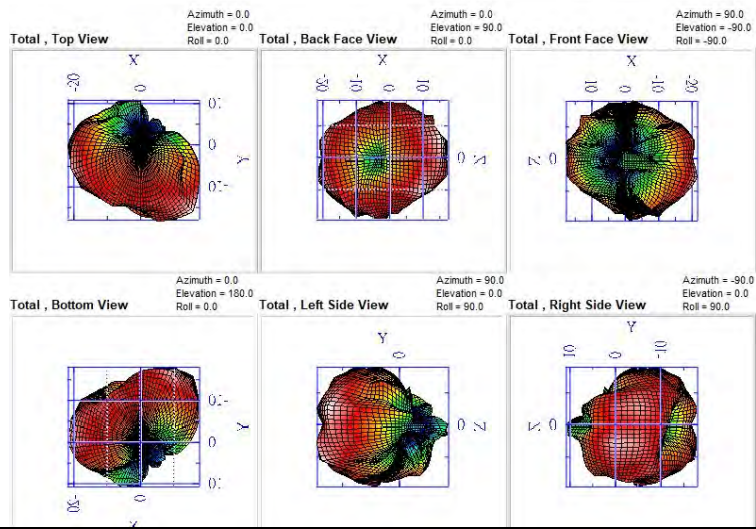
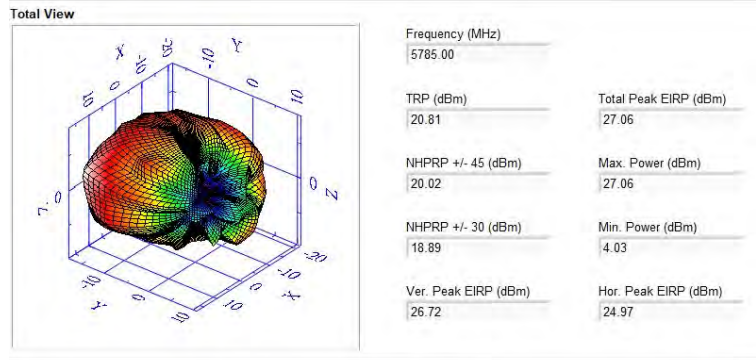

802.11ax HE20 CH 173 CDD On Nss1

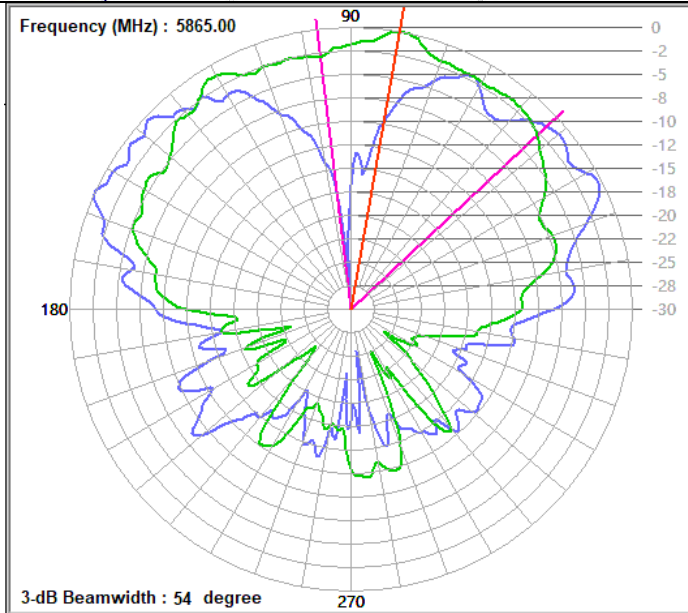
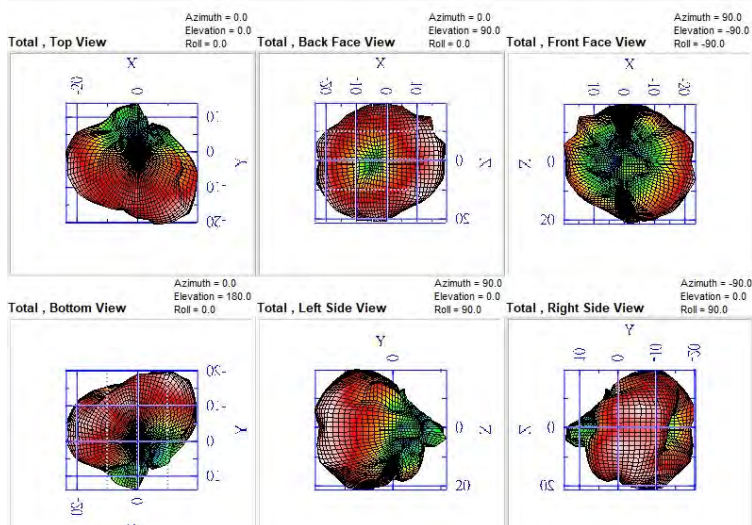
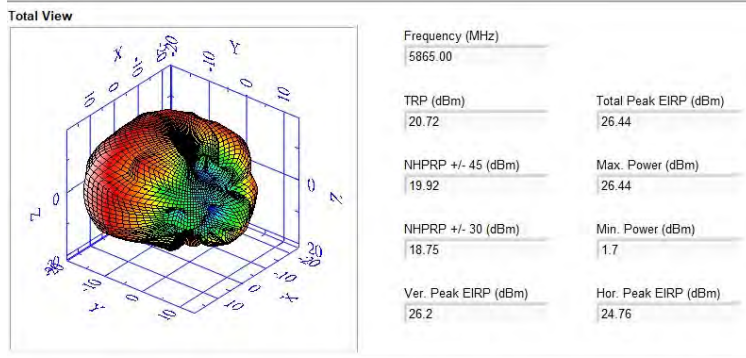

Frequency (MHz) : 5865.00	Polarity 1 : Horizontal	Beamwidth 1 : 41
	Polarity 2 : Vertical	Beamwidth 2 : 54
(at the 3 dB down)		

802.11ax HE20 CH 93 CDD On Nss1

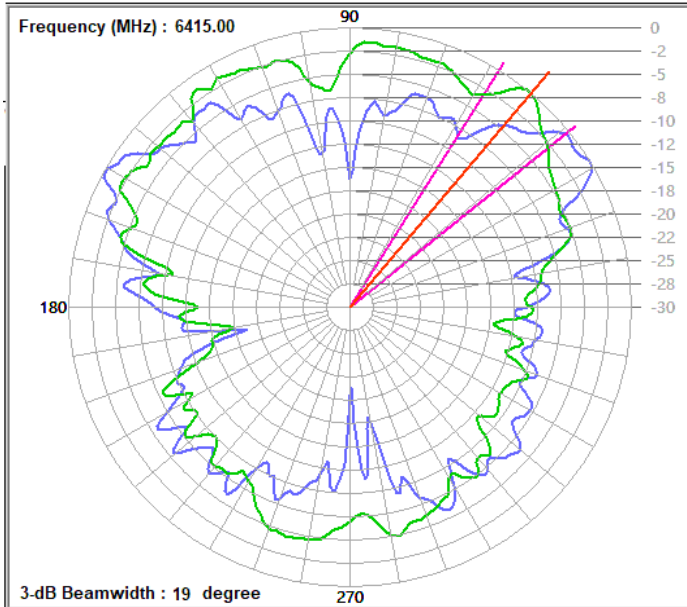
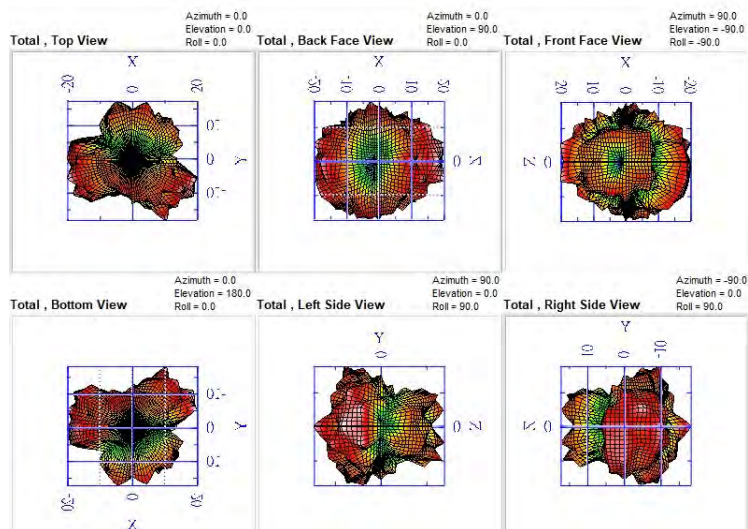
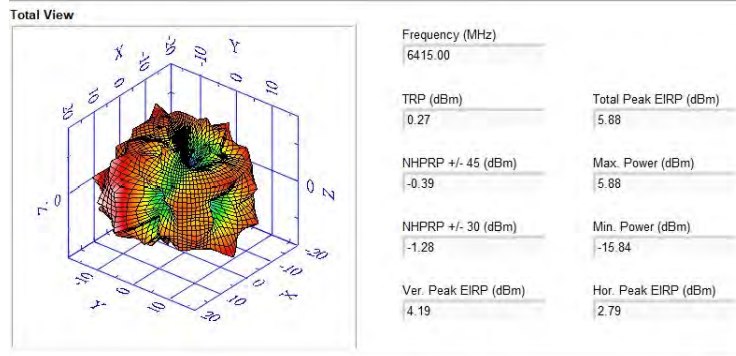

Frequency (MHz) : 6415.00 Polarity 1 : Horizontal Beamwidth 1 : 17
 Polarity 2 : Vertical Beamwidth 2 : 19
 (at the 3 dB down)

802.11ax HE20 CH 113 CDD On Nss1

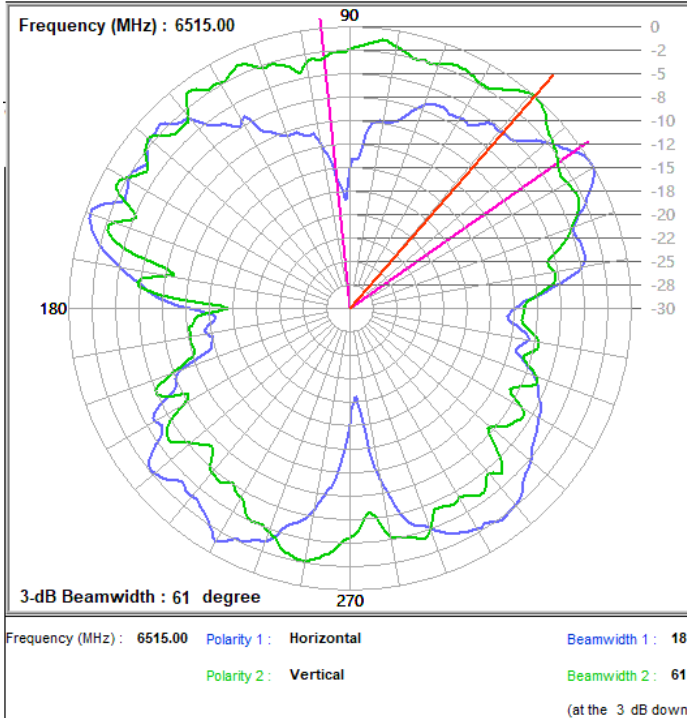
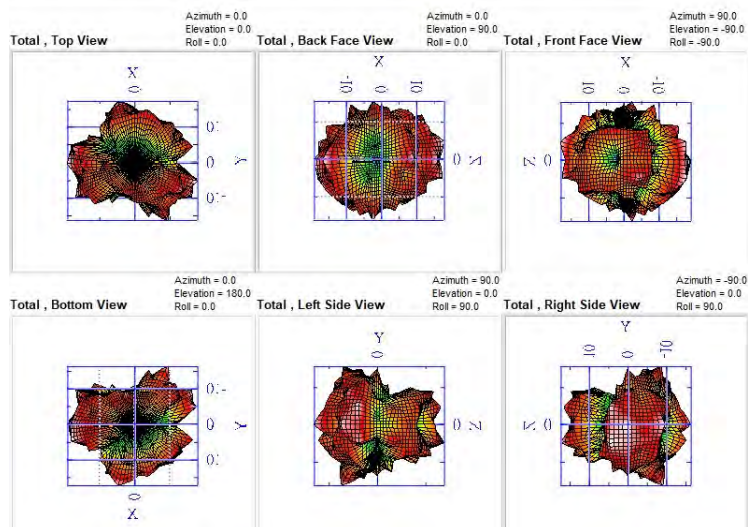
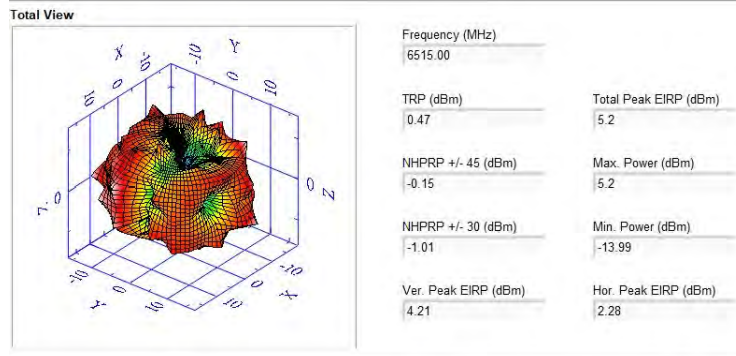

802.11ax HE20 CH 181 CDD On Nss1

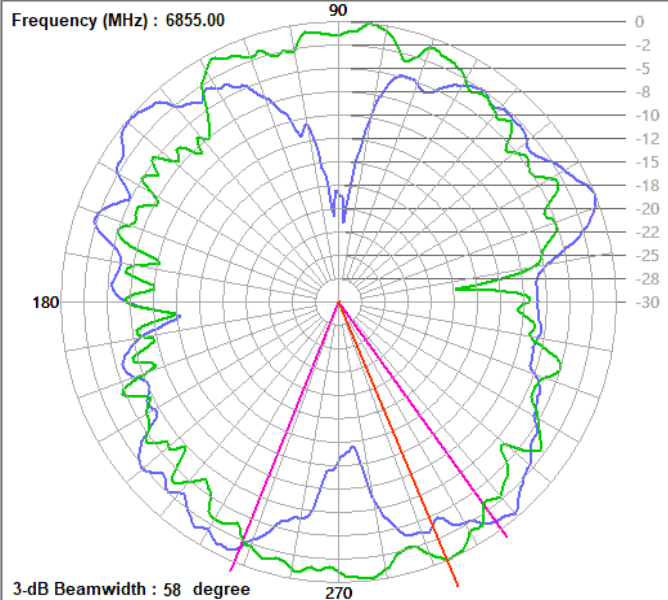
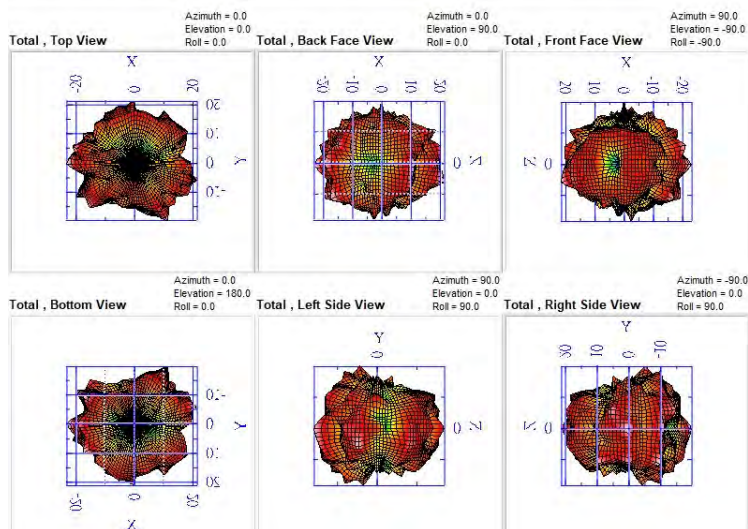
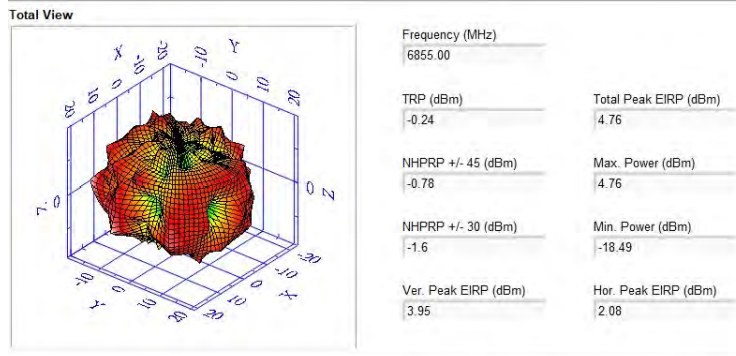

Frequency (MHz) : 6855.00 Polarity 1 : Horizontal Beamwidth 1 : 19
 Polarity 2 : Vertical Beamwidth 2 : 58
 (at the 3 dB down)

802.11ax HE20 CH 233 CDD On Nss1

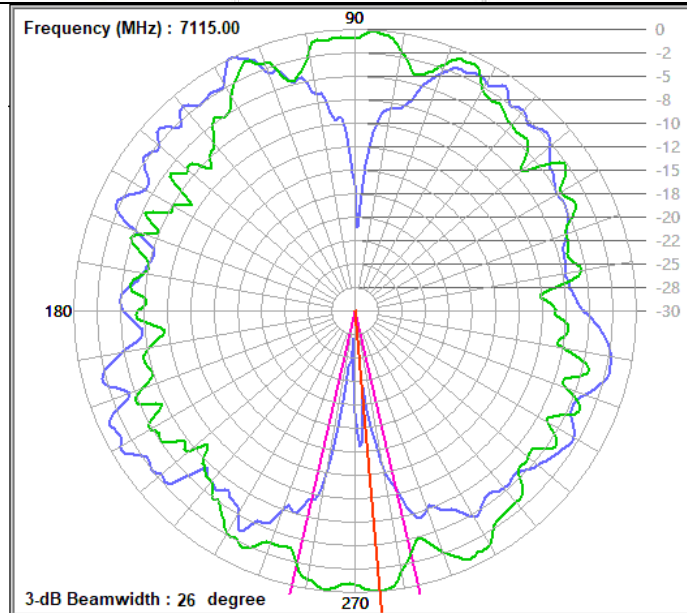
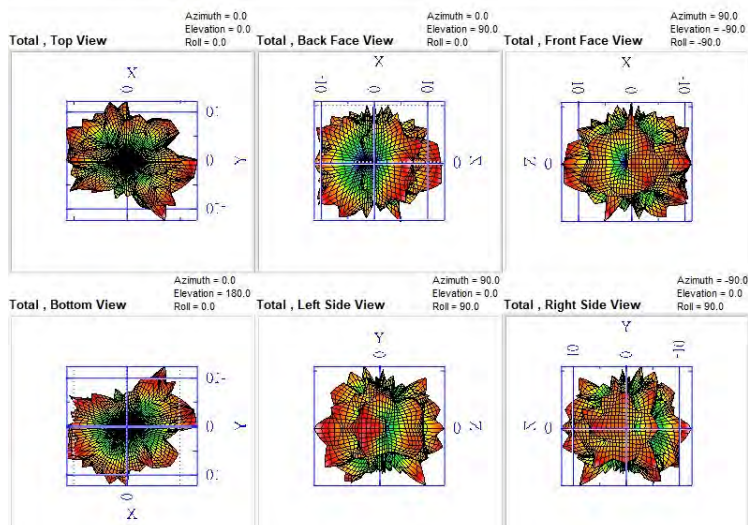
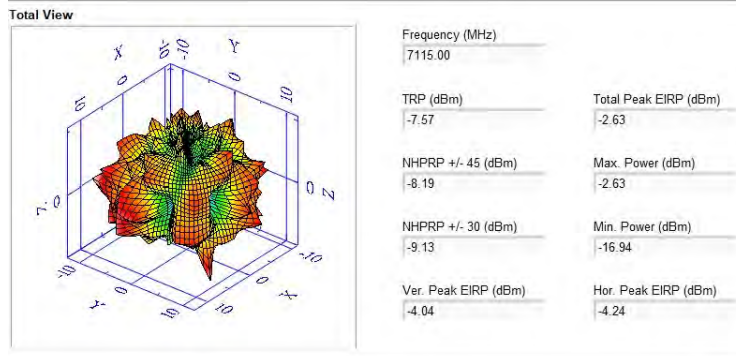

Frequency (MHz) : 7115.00 Polarity 1 : Horizontal Beamwidth 1 : 35
 Polarity 2 : Vertical Beamwidth 2 : 26
 (at the 3 dB down)

4 Appendix - Information of the Testing Laboratories

We, Bureau Veritas Consumer Products Services (H.K.) Ltd., Taoyuan Branch, were founded in 1988 to provide our best service in EMC, Radio, Telecom and Safety consultation. Our laboratories are accredited and approved according to ISO/IEC 17025.

If you have any comments, please feel free to contact us at the following:

Lin Kou EMC/RF Lab

Tel: 886-2-26052180

Fax: 886-2-26051924

Hsin Chu EMC/RF/Telecom Lab

Tel: 886-3-6668565

Fax: 886-3-6668323

Hwa Ya EMC/RF/Safety Lab

Tel: 886-3-3183232

Fax: 886-3-3270892

Email: service.adt@tw.bureauveritas.com

Web Site: www.bureauveritas-adt.com

The address and road map of all our labs can be found in our web site also.

--- END ---