



FCC DFS TEST REPORT

FCC ID : TVE-37176T0464
Equipment : Secured Wireless Access Point
Brand Name : FORTINET
Model Name : FAP-231Exxxxxx, FortiAP 231Exxxxxx,
FORTIAP-231Exxxxxx(where "x" can be used
as "A-Z" or "0-9" or "-" or blank for software
changes or marking purposes only)
Marketing Name : FortiAP 231E
Applicant : Fortinet, Inc.
899 Kifer Road
Manufacturer : Senao Networks Inc.
500 Fusing 3rd RD HWA-YA Technology Park
Kuei-shan District Taoyuan 333
Standard : FCC Part 15 Subpart E

The product was received on Dec. 06, 2019 and testing was started from Dec. 06, 2019 and completed on Dec. 20, 2019. We, Sporton International (USA) Inc., would like to declare that the tested sample has been evaluated in accordance with the procedures given in FCC Part 15 Subpart E and shown compliance with the applicable technical standards.

The report must not be used by the client to claim product certification, approval, or endorsement by A2LA or any agency of government.

The test results in this report apply exclusively to the tested model / sample. Without written approval of Sporton International (USA) Inc., the test report shall not be reproduced except in full.

Approved by: Ken Chen

Sporton International (USA) Inc.

1175 Montague Expressway, Milpitas, CA 95035



Table of Contents

| | |
|---|-----------|
| History of this test report..... | 3 |
| Summary of Test Result..... | 4 |
| 1 General Description | 5 |
| 1.1 Feature of Equipment Under Test | 5 |
| 1.2 Modification of EUT | 5 |
| 1.3 Testing Site | 5 |
| 1.4 Applied Standards | 5 |
| 1.5 Support Unit used in test configuration and system | 5 |
| 2 Requirements and Parameters for DFS Test..... | 6 |
| 2.1 Summary of Dynamic Frequency Selection Test | 6 |
| 2.2 Applicability of DFS Requirements | 7 |
| 2.3 DFS Detection Thresholds..... | 9 |
| 2.4 DFS Response requirement values..... | 10 |
| 2.5 Short Pulse Radar Test Waveforms | 11 |
| 2.6 Long Pulse Radar Test Waveform | 13 |
| 2.7 Frequency Hopping Radar Test Waveform | 15 |
| 3 Calibration Setup and DFS Test Results | 16 |
| 3.1 Calibration of Radar Waveform | 16 |
| 3.2 U-NII Detection Bandwidth | 26 |
| 3.3 Channel Availability Check | 37 |
| 3.4 In-Service Monitoring: Channel Move Time, Channel Closing Transmission Time and Non-Occupancy Period..... | 44 |
| 3.5 Statistical Performance Check | 53 |
| 4 List of Measuring Equipment..... | 70 |
| Appendix A. Setup Photographs | |



History of this test report

| Report No. | Version | Description | Issue Date |
|----------------|---------|---|---------------|
| FZ191106001-01 | 01 | Initial issue of report | Dec. 30, 2019 |
| FZ191106001-01 | 02 | Correct the company name of lab in cover page | Jan. 22, 2020 |
| | | | |
| | | | |
| | | | |
| | | | |
| | | | |
| | | | |
| | | | |
| | | | |
| | | | |
| | | | |
| | | | |
| | | | |
| | | | |



Summary of Test Result

| Report Clause | Ref Std. Clause | Test Items | Result (PASS/FAIL) | Remark |
|---------------|-----------------|-----------------------------------|--------------------|--------|
| 3.2 | 7.8.1 | U-NII Detection Bandwidth | Pass | - |
| 3.3 | 7.8.2 | Channel Availability Check Time | Pass | - |
| 3.4 | 7.8.3 | Channel Move Time | Pass | - |
| | | Channel Closing Transmission Time | Pass | - |
| | | Non-Occupancy Period Test | Pass | - |
| 3.5 | 7.8.4 | Statistical Performance Check | Pass | - |

| |
|--|
| Declaration of Conformity: |
| The test results with all measurement uncertainty excluded are presented in accordance with the regulation limits or requirements declared by manufacturers. |
| Comments and Explanations: |
| The declared of product specification for EUT presented in the report are provided by the manufacturer, and the manufacturer takes all the responsibilities for the accuracy of product specification. |



1 General Description

1.1 Feature of Equipment Under Test

Wi-Fi 2.4GHz 802.11b/g/n and Wi-Fi 5GHz 802.11a/n/ac

| Product Specification subjective to this standard | |
|---|-----------------------|
| Antenna Type | WLAN: PIFA Antenna |
| SW Version | FP231E-v6.0-build5509 |

1.2 Modification of EUT

No modifications are made to the EUT during all test items.

1.3 Testing Site

| | |
|--------------------|---|
| Test Site | Sporton International (USA) Inc. |
| Test Site Location | 1175 Montague Expressway, Milpitas, CA 95035 TEL : 408 9043300 |
| Test Site No. | Sporton Site No. |
| | DFS01-CA |

1.4 Applied Standards

According to the specifications of the manufacturer, the EUT must comply with the requirements of the following standards:

- ♦ FCC Part 15 Subpart E
- ♦ FCC KDB 905462 D02 UNII DFS Compliance Procedures New Rules v02
- ♦ FCC KDB 905462 D03 UNII Clients Without Radar Detection New Rules v01r02

Remark: All test items were verified and recorded according to the standards and without any deviation during the test.

1.5 Support Unit used in test configuration and system

| Item | Equipment | Trade Name | Model Name | FCC ID | HW / FW Version | Power Cord |
|------|-----------|------------|------------|-----------|-----------------|--|
| 1. | Notebook | MSI | MS-1615 | PD93165NG | N/A | AC I/P: Unshielded, 1.2 m DC O/P: Shielded, 1.8 m |



2 Requirements and Parameters for DFS Test

2.1 Summary of Dynamic Frequency Selection Test

| UNII | Description | Limit |
|---------------------------------|-----------------------------------|--|
| U-NII Band 2-A 5250-5350 MHz | Channel Availability Check Time | > 60sec |
| | U-NII Detection Bandwidth | > 100% of the U-NII 99% transmission power bandwidth |
| | Statistical Performance Check | Type 1,2,3,4 >= 60% Type 1~4 and 5 >= 80% Type 6 >= 70% |
| | Channel Move Time | < 10 sec |
| | Channel Closing Transmission Time | < 200 ms + aggregate of 60 ms over remaining 10 s period |
| | Non-Occupancy Period Test | > 30 minutes |
| U-NII Band 2-C 5470-5725 MHz | Channel Availability Check Time | > 60sec |
| | U-NII Detection Bandwidth | > 100% of the U-NII 99% transmission power bandwidth |
| | Statistical Performance Check | Type 1,2,3,4 >= 60% Type 1~4 and 5 >= 80% Type 6 >= 70% |
| | Channel Move Time | < 10 sec |
| | Channel Closing Transmission Time | < 200 ms + aggregate of 60 ms over remaining 10 s period |
| | Non-Occupancy Period Test | > 30 minutes |



2.2 Applicability of DFS Requirements

EUT is considered as a master device.

Table 1: Applicability of DFS Requirements Prior to Use of a Channel

| Requirement | Operational Mode | | |
|---------------------------------|------------------|--------------------------------|-----------------------------|
| | Master | Client Without Radar Detection | Client With Radar Detection |
| Non-Occupancy Period | Yes | Not required | Yes |
| DFS Detection Threshold | Yes | Not required | Yes |
| Channel Availability Check Time | Yes | Not required | Not required |
| U-NII Detection Bandwidth | Yes | Not required | Yes |



Table 2: Applicability of DFS requirements during normal operation

| Requirement | Operational Mode | | |
|-----------------------------------|------------------|--------------------------------|-----------------------------|
| | Master | Client Without Radar Detection | Client With Radar Detection |
| DFS Detection Threshold | Yes | Not required | Yes |
| Channel Closing Transmission Time | Yes | Yes | Yes |
| Channel Move Time | Yes | Yes | Yes |
| U-NII Detection Bandwidth | Yes | Not required | Yes |
| Client Beacon Test | N/A | Yes | Yes |

| Additional requirements for devices with multiple bandwidth modes | Operational Mode | |
|---|---------------------------------------|--|
| | Master or Client With Radar Detection | Client Without Radar Detection |
| U-NII Detection Bandwidth and Statistical Performance Check | All BW modes must be tested | Not required |
| Channel Move Time and Channel Closing Transmission Time | Test using widest BW mode available | Test using the widest BW mode available for the link |
| All other tests | Any single BW mode | Not required |

Note

Frequencies selected for statistical performance check (Section 7.8.4) should include several frequencies within the radar detection bandwidth and frequencies near the edge of the radar detection bandwidth. For 802.11 devices it is suggested to select frequencies in each of the bonded 20 MHz channels and the channel center frequency.



2.3 DFS Detection Thresholds

Table 3 below provides the DFS Detection Thresholds for Master Devices as well as Client Devices incorporating In-Service Monitoring.

Table 3: DFS Detection Thresholds for Master Devices

| Maximum Transmit Power | Value (see notes 1, 2, and 3) |
|--|-------------------------------|
| EIRP \geq 200 milliwatt | -64 dBm |
| EIRP < 200 milliwatt and power spectral density < 10 dBm/MHz | -62 dBm |
| EIRP < 200 milliwatt that do not meet the power spectral density requirement | -64 dBm |

Note 1: This is the level at the input of the receiver assuming a 0 dBi receive antenna.
Note 2: Throughout these test procedures an additional 1 dB has been added to the amplitude of the test transmission waveforms to account for variations in measurement equipment. This will ensure that the test signal is at or above the detection threshold level to trigger a DFS response.
Note 3: EIRP is based on the highest antenna gain. For MIMO devices refer to KDB Publication 662911 D01.

The radar *Detection Threshold*, lowest antenna gain is the parameter of Interference radar DFS detection threshold, The Interference Detection Threshold is the (-64dBm).



2.4 DFS Response requirement values

Table 4 provides the response requirements for Master and Client Devices incorporating DFS.

Table 4: DFS Response Requirement Values

| Parameter | Value |
|--|--|
| <i>Non-occupancy period</i> | Minimum 30 minutes |
| <i>Channel Availability Check Time</i> | 60 seconds |
| <i>Channel Move Time</i> | 10 seconds See Note 1. |
| <i>Channel Closing Transmission Time</i> | 200 milliseconds + an aggregate of 60 milliseconds over remaining 10 second period. See Notes 1 and 2. |
| <i>U-NII Detection Bandwidth</i> | Minimum 100% of the 99% power bandwidth See Note 3. |

Note 1: *Channel Move Time* and the *Channel Closing Transmission Time* should be performed with Radar Type 0. The measurement timing begins at the end of the Radar Type 0 burst.

Note 2: The *Channel Closing Transmission Time* is comprised of 200 milliseconds starting at the beginning of the *Channel Move Time* plus any additional intermittent control signals required to facilitate *Channel* changes (an aggregate of 60 milliseconds) during the remainder of the 10 second period. The aggregate duration of control signals will not count quiet periods in between transmissions.

Note 3: During the *U-NII Detection Bandwidth* detection test, radar type 0 is used and for each frequency step the minimum percentage of detection is 90%. Measurements are performed with no data traffic.



2.5 Short Pulse Radar Test Waveforms

Radar Type 0 was used in the evaluation of the Client device for the purpose of measuring the Channel Move Time and the Channel Closing Transmission Time.

| Radar Type | Pulse Width (μsec) | PRI (μsec) | Number of Pulses | Minimum Percentage of Successful Detection | Minimum Trials |
|---|--------------------|------------------|---|--|----------------|
| 0 | 1 | 1428 | 18 | See Note 1. | See Note 1. |
| 1 | 1 | Test A Test B | Roundup $\left\{ \begin{matrix} \left(\frac{1}{360} \right) \cdot \\ \left(\frac{19 \cdot 10^6}{PRI_{\mu sec}} \right) \end{matrix} \right\}$ | 60% | 30 |
| 2 | 1-5 | 150-230 | 23-29 | 60% | 30 |
| 3 | 6-10 | 200-500 | 16-18 | 60% | 30 |
| 4 | 11-20 | 200-500 | 12-16 | 60% | 30 |
| Aggregate (Radar Types 1-4) | | | | 80% | 120 |
| Note 1: Short Pulse Radar Type 0 should be used for the detection bandwidth test, channel move time, and channel closing time tests. | | | | | |

Test A: 15 unique PRI values randomly selected from the list of 23 PRI values in Table 5a

Test B: 15 unique PRI values randomly selected within the range of 518-3066 μsec, with a minimum increment of 1 μsec, excluding PRI values selected in Test A

A minimum of 30 unique waveforms are required for each of the Short Pulse Radar Types 2 through 4. If more than 30 waveforms are used for Short Pulse Radar Types 2 through 4, then each additional waveform must also be unique and not repeated from the previous waveforms.

If more than 30 waveforms are used for Short Pulse Radar Type 1, then each additional waveform is generated with Test B and must also be unique and not repeated from the previous waveforms in Tests A or B.

The aggregate is the average of the percentage of successful detections of short pulse radar types 1-4.



Table 5a - Pulse Repetition Intervals Values for Test A

| Pulse Repetition Frequency Number (1 to 23) | Pulse Repetition Frequency (Pulses Per Second) | Pulse Repetition Interval (Microseconds) |
|---|--|--|
| 1 | 1930.5 | 518 |
| 2 | 1858.7 | 538 |
| 3 | 1792.1 | 558 |
| 4 | 1730.1 | 578 |
| 5 | 1672.2 | 598 |
| 6 | 1618.1 | 618 |
| 7 | 1567.4 | 638 |
| 8 | 1519.8 | 658 |
| 9 | 1474.9 | 678 |
| 10 | 1432.7 | 698 |
| 11 | 1392.8 | 718 |
| 12 | 1355.0 | 738 |
| 13 | 1319.3 | 758 |
| 14 | 1285.3 | 778 |
| 15 | 1253.1 | 798 |
| 16 | 1222.5 | 818 |
| 17 | 1193.3 | 838 |
| 18 | 1165.5 | 858 |
| 19 | 1139.0 | 878 |
| 20 | 1113.6 | 898 |
| 21 | 1089.3 | 918 |
| 22 | 1066.1 | 938 |
| 23 | 326.2 | 3066 |



2.6 Long Pulse Radar Test Waveform

| Radar Type | Pulse Width (µsec) | Chirp Width (MHz) | PRI (µsec) | Number of Pulses per Burst | Number of Bursts | Minimum Percentage of Successful Detection | Minimum Trials |
|------------|--------------------|-------------------|------------|----------------------------|------------------|--|----------------|
| 5 | 50-100 | 5-20 | 1000-2000 | 1-3 | 8-20 | 80% | 30 |

The parameters for this waveform are randomly chosen. Thirty unique waveforms are required for the Long Pulse radar test signal. If more than 30 waveforms are used for the Long Pulse radar test signal, then each additional waveform must also be unique and not repeated from the previous waveforms. Each waveform is defined as follows:

Note: The center frequency for each of the 30 trials of the Bin 5 radar shall be randomly selected within 80% of the Occupied Bandwidth.

- (1) The transmission period for the Long Pulse Radar test signal is 12 seconds.
- (2) There are a total of 8 to 20 Bursts in the 12 second period, with the number of Bursts being randomly chosen. This number is Burst_Count.
- (3) Each Burst consists of 1 to 3 pulses, with the number of pulses being randomly chosen. Each Burst within the 12 second sequence may have a different number of pulses.
- (4) The pulse width is between 50 and 100 microseconds, with the pulse width being randomly chosen. Each pulse within a Burst will have the same pulse width. Pulses in different Bursts may have different pulse widths.
- (5) Each pulse has a linear frequency modulated chirp between 5 and 20 MHz, with the chirp width being randomly chosen. Each pulse within a **transmission period** will have the same chirp width. The chirp is centered on the pulse. For example, with a radar frequency of 5300 MHz and a 20 MHz chirped signal, the chirp starts at 5290 MHz and ends at 5310 MHz
- (6) If more than one pulse is present in a Burst, the time between the pulses will be between 1000 and 2000 microseconds, with the time being randomly chosen. If three pulses are present in a Burst, the time between the first and second pulses is chosen independently of the time between the second and third pulses.
- (7) The 12 second transmission period is divided into even intervals. The number of intervals is equal to Burst_Count. Each interval is of length $(12,000,000 / \text{Burst_Count})$ microseconds. Each interval contains one Burst. The start time for the Burst, relative to the beginning of the interval, is between 1 and $[(12,000,000 / \text{Burst_Count}) - (\text{Total Burst Length}) + (\text{One Random PRI Interval})]$ microseconds, with the start time being randomly chosen. The step interval for the start time is 1 microsecond. The start time for each Burst is chosen independently.

A representative example of a Long Pulse radar test waveform:

- (1) The total test signal length is 12 seconds.
- (2) 8 Bursts are randomly generated for the Burst_Count.
- (3) Burst 1 has 2 randomly generated pulses.
- (4) The pulse width (for both pulses) is randomly selected to be 75 microseconds.
- (5) The PRI is randomly selected to be at 1213 microseconds.
- (6) Bursts 2 through 8 are generated using steps 3 – 5.
- (7) Each Burst is contained in even intervals of 1,500,000 microseconds. The starting location for Pulse 1, Burst 1 is randomly generated (1 to 1,500,000 minus the total Burst 1 length + 1 random PRI interval) at the 325,001 microsecond step. Bursts 2 through 8 randomly fall in successive 1,500,000 microsecond intervals (i.e. Burst 2 falls in the 1,500,001 – 3,000,000 microsecond range).

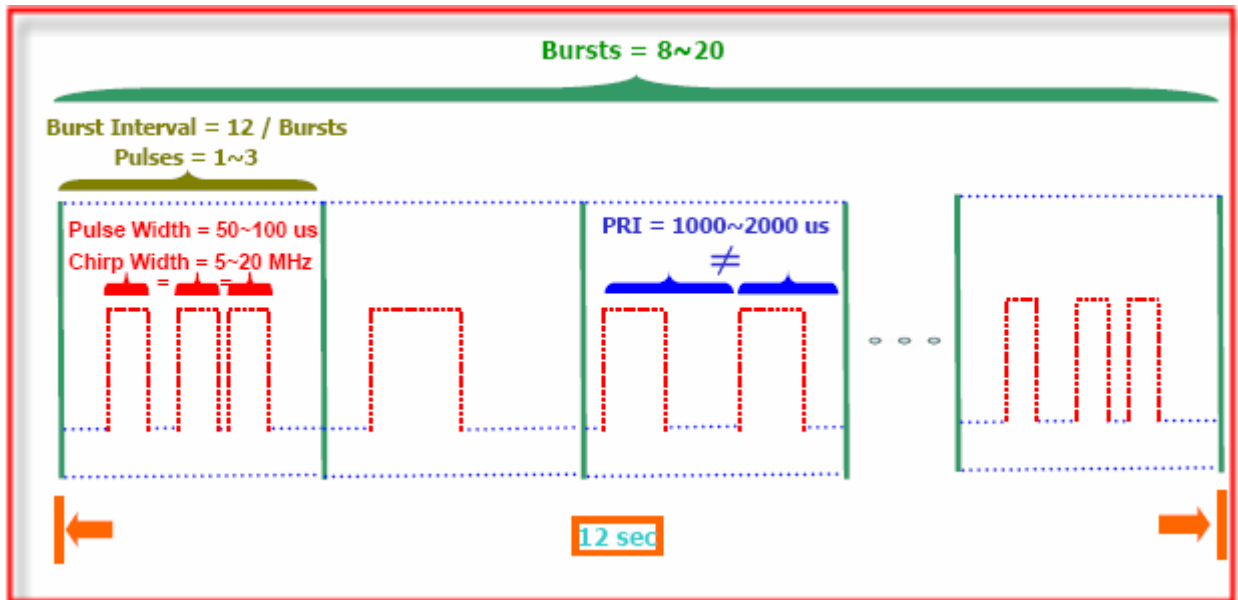

2.7 Frequency Hopping Radar Test Waveform

| Radar Type | Pulse Width (µsec) | PRI (µsec) | Pulses per Hop | Hopping Rate (kHz) | Hopping Sequence Length (msec) | Minimum Percentage of Successful Detection | Minimum Trials |
|------------|--------------------|------------|----------------|--------------------|--------------------------------|--|----------------|
| 6 | 1 | 333 | 9 | 0.333 | 300 | 70% | 30 |

For the Frequency Hopping Radar Type, the same Burst parameters are used for each waveform. The hopping sequence is different for each waveform and a 100-length segment is selected from the hopping sequence defined by the following algorithm:

The first frequency in a hopping sequence is selected randomly from the group of 475 integer frequencies from 5250 – 5724 MHz. Next, the frequency that was just chosen is removed from the group and a frequency is randomly selected from the remaining 474 frequencies in the group. This process continues until all 475 frequencies are chosen for the set. For selection of a random frequency, the frequencies remaining within the group are always treated as equally likely.

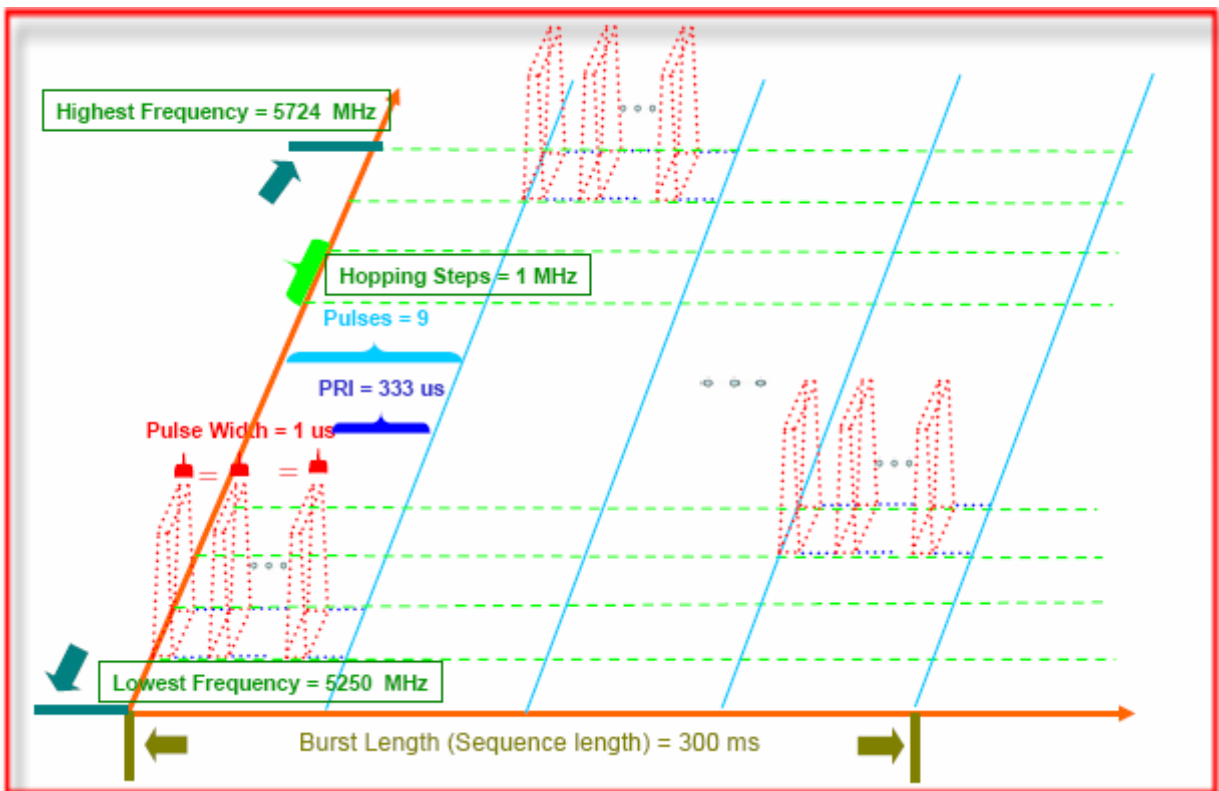

3 Calibration Setup and DFS Test Results

3.1 Calibration of Radar Waveform

3.1.1 Radar Waveform Calibration Procedure

The Interference Radar Detection Threshold Level is -64 dBm that had been taken into account the output power range and antenna gain. The following equipment setup was used to calibrate the conducted Radar Waveform. A vector signal generator was utilized to establish the test signal level for radar type 0~6. During this process there were no transmissions by either the Master or Client Device. The spectrum analyzer was switched to the zero span (Time Domain) at the frequency of the Radar Waveform generator. Peak detection was used. The spectrum analyzer resolution bandwidth (RBW) and video bandwidth (VBW) were set to 3 MHz to measure the radar waveform. The vector signal generator amplitude was set so that the power level measured at the spectrum analyzer was -64 dBm. Capture the spectrum analyzer plots on radar waveform.

3.1.2 Conducted Calibration Setup

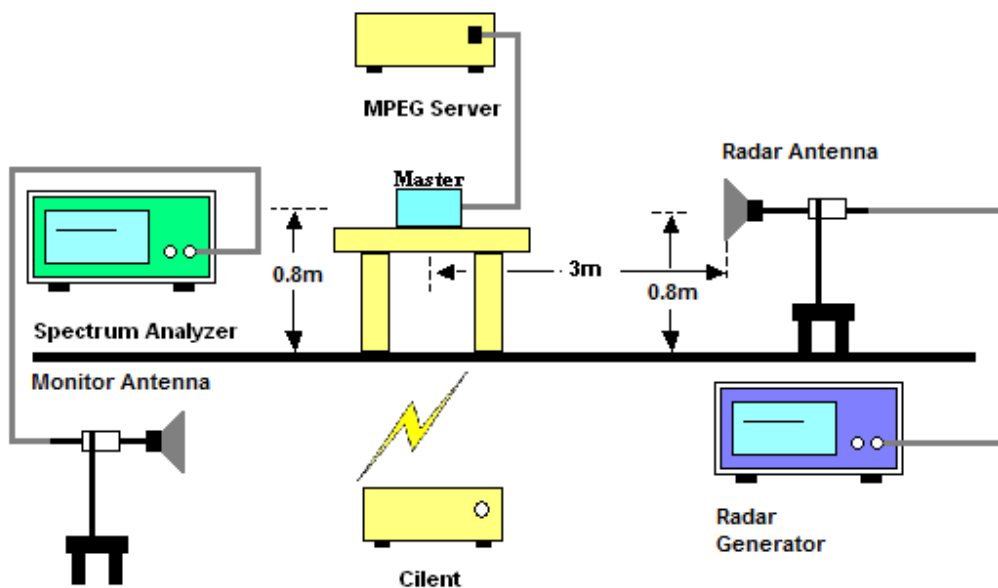

3.1.3 Calibration Deviation

There is no deviation with the original standard.



3.1.4 Radar Waveform Calibration Result

<20MHz / 5300MHz>

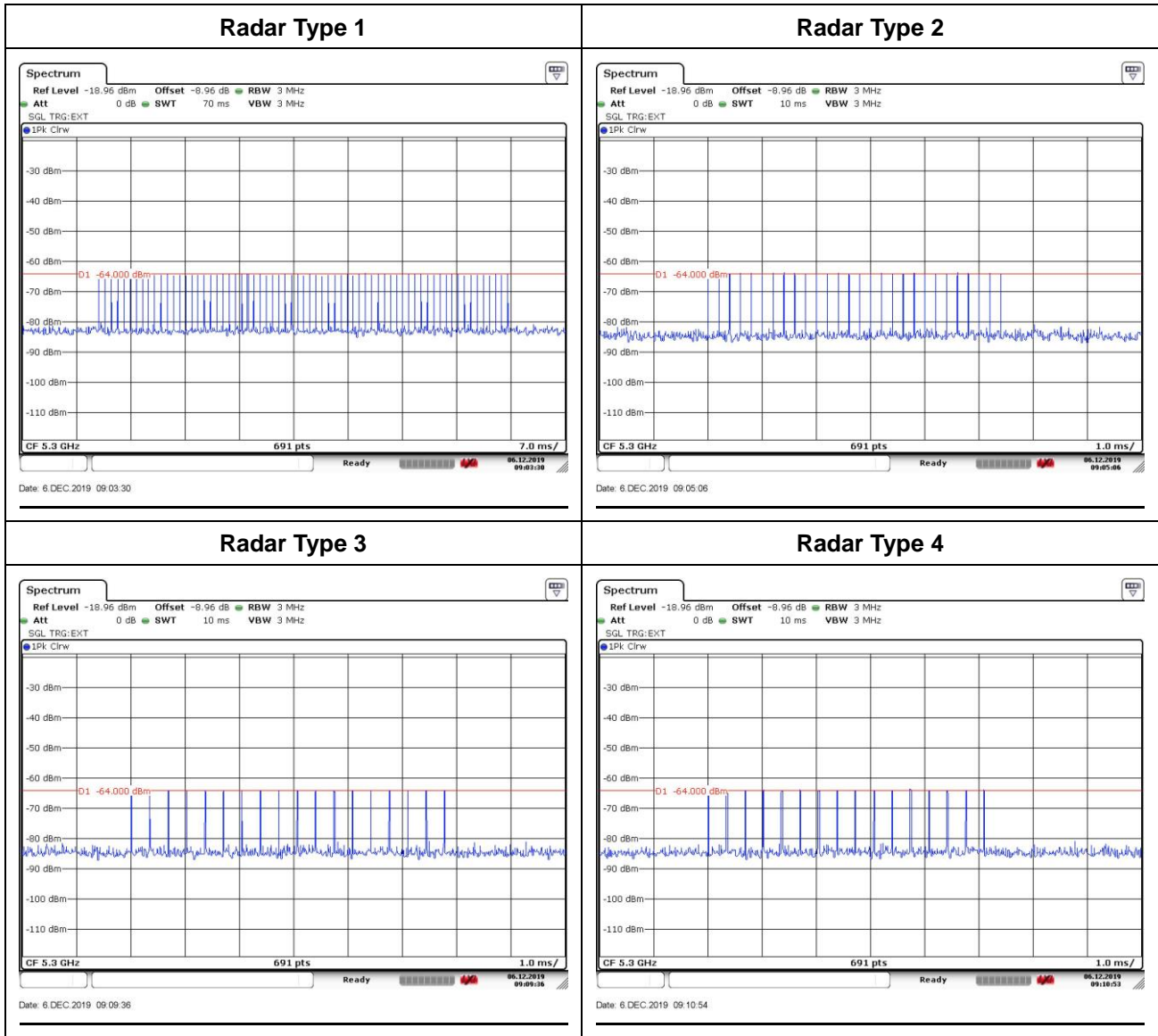

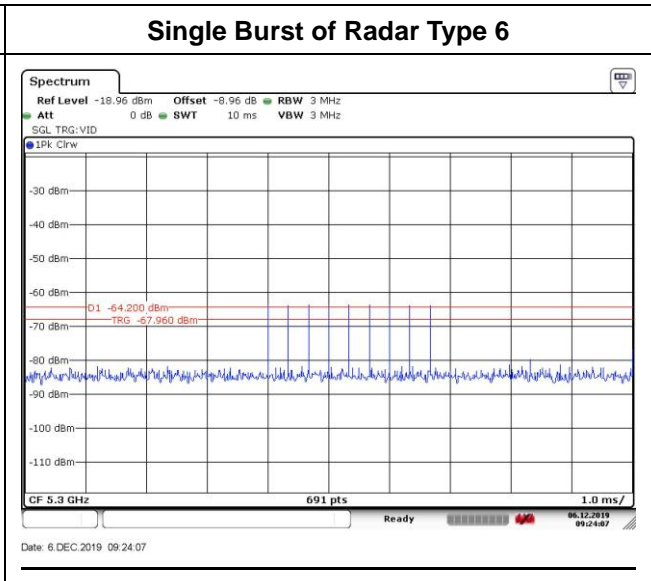
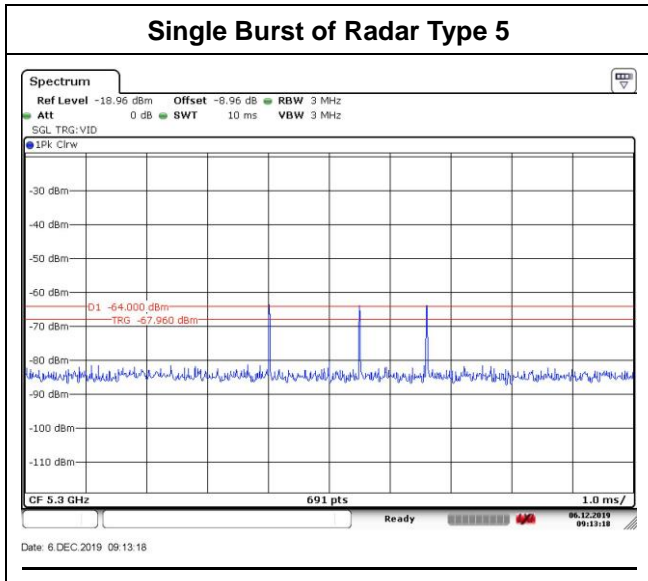

<40MHz / 5310MHz>

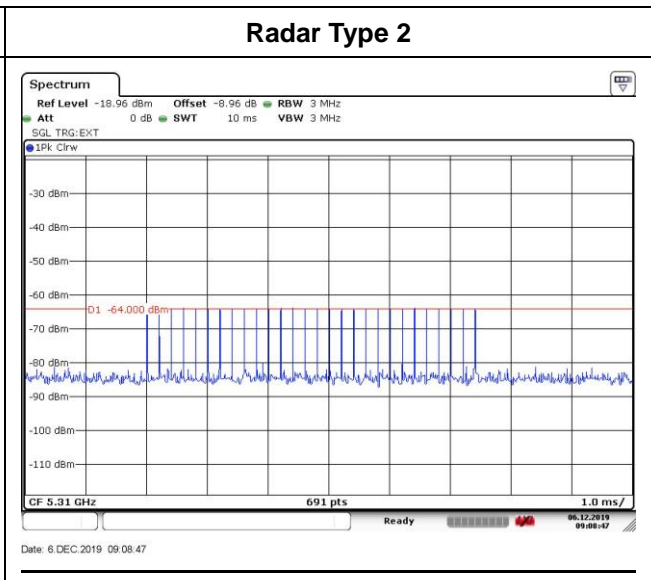
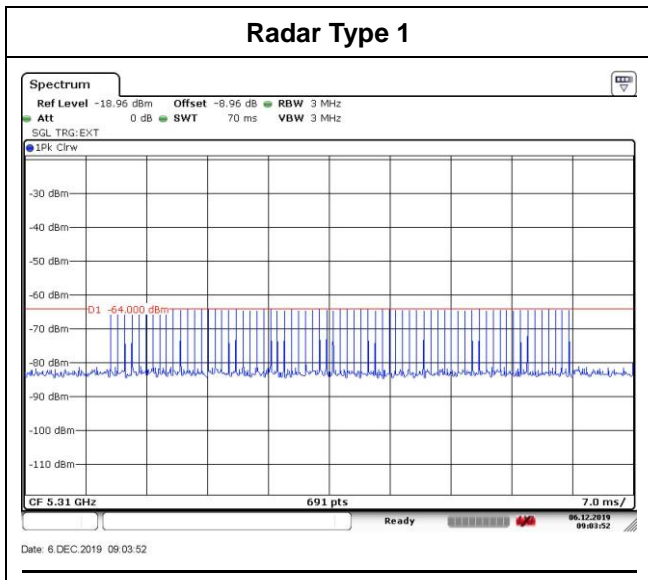

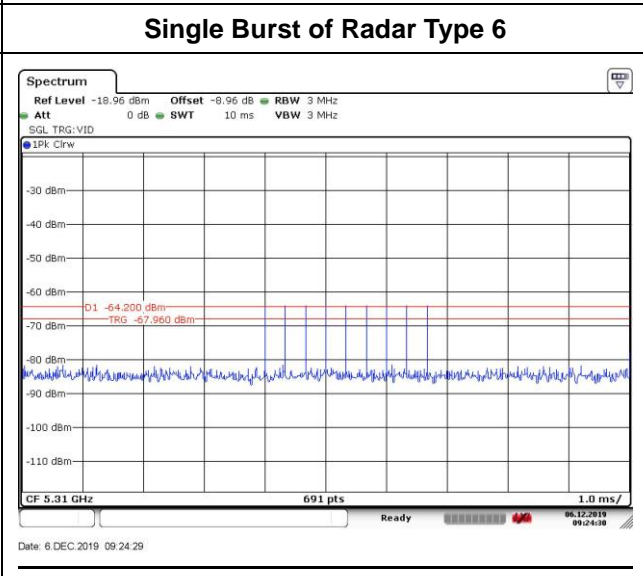
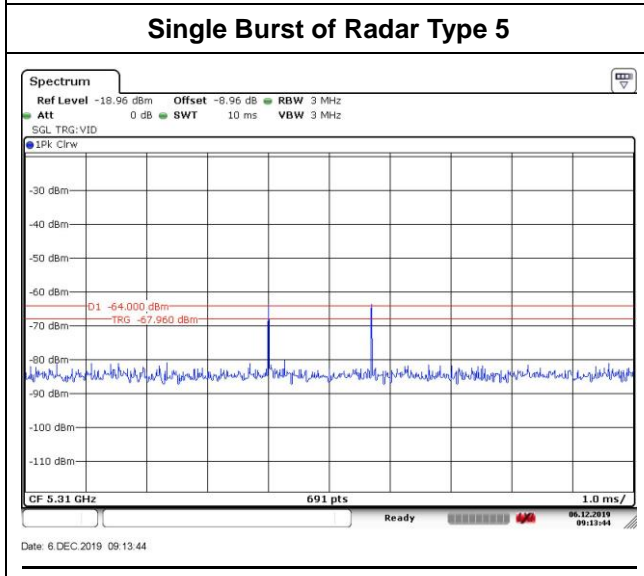
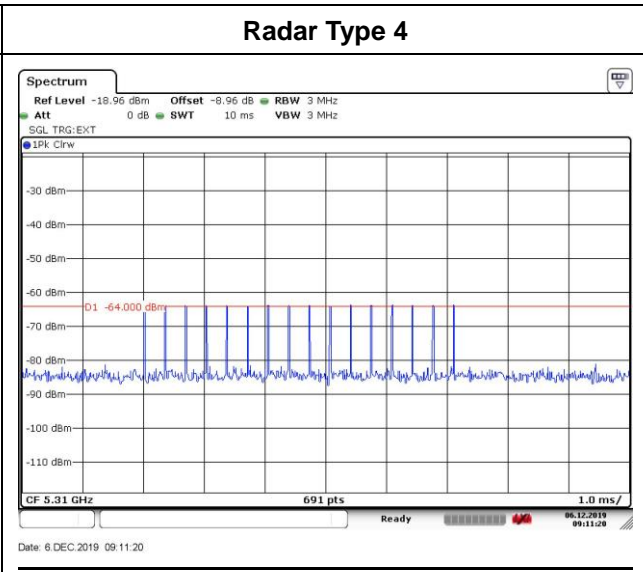
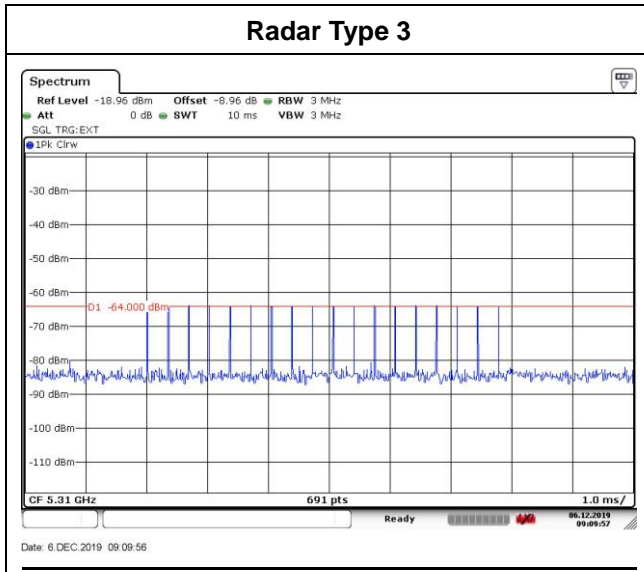



<80MHz / 5290MHz>

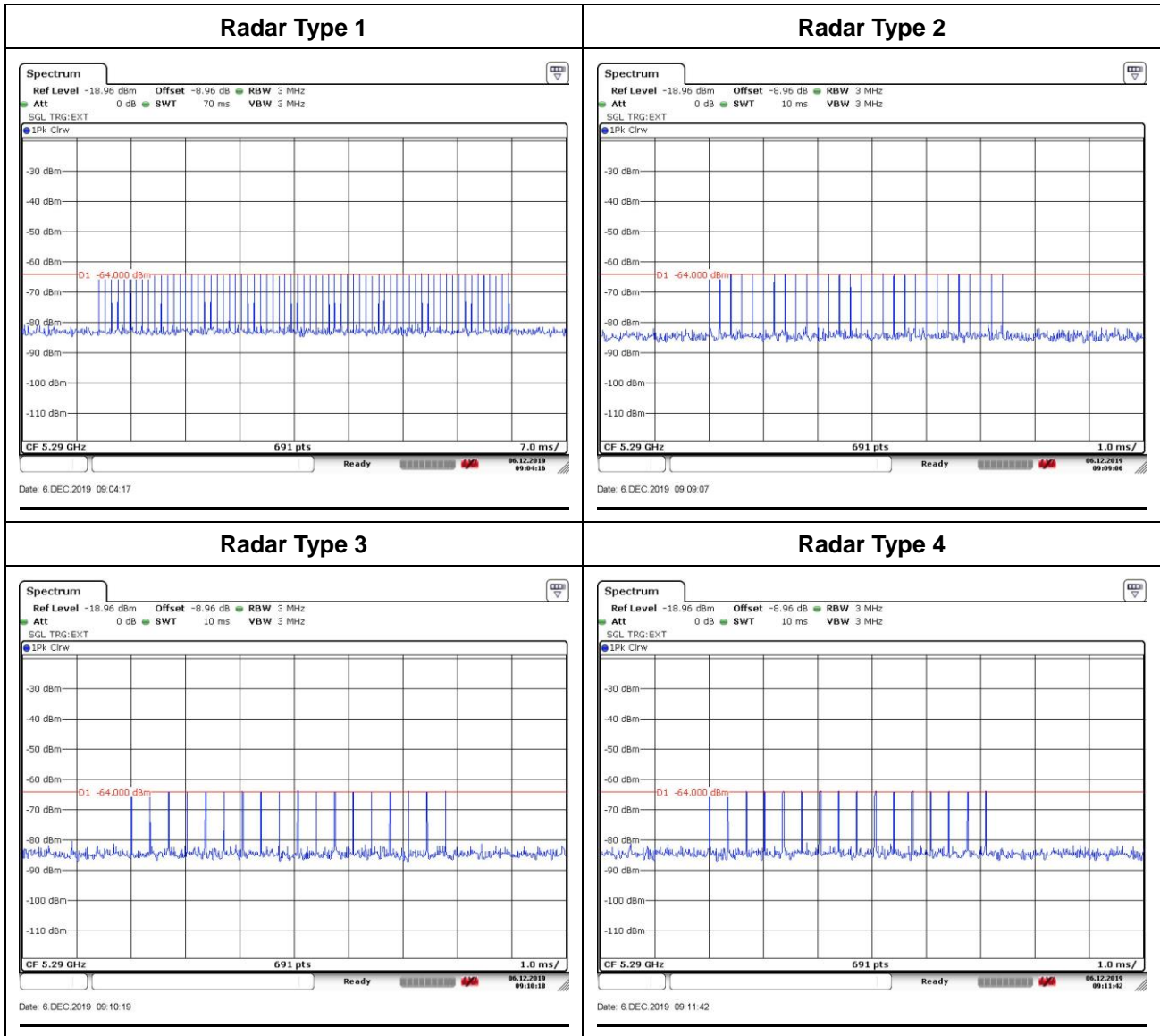

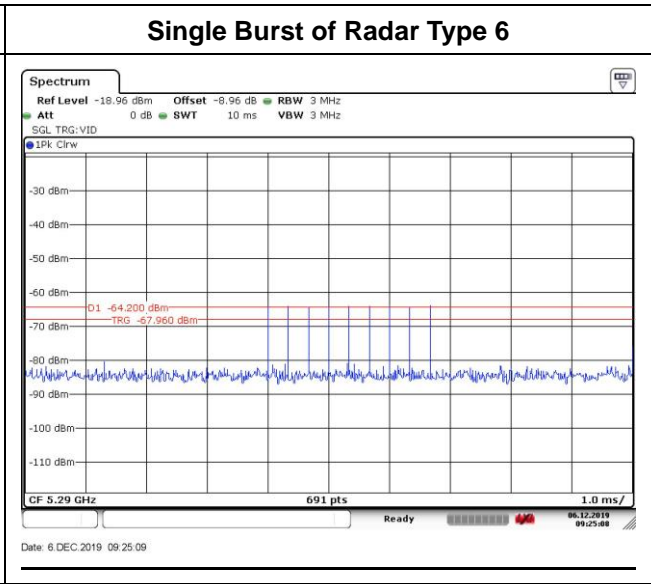
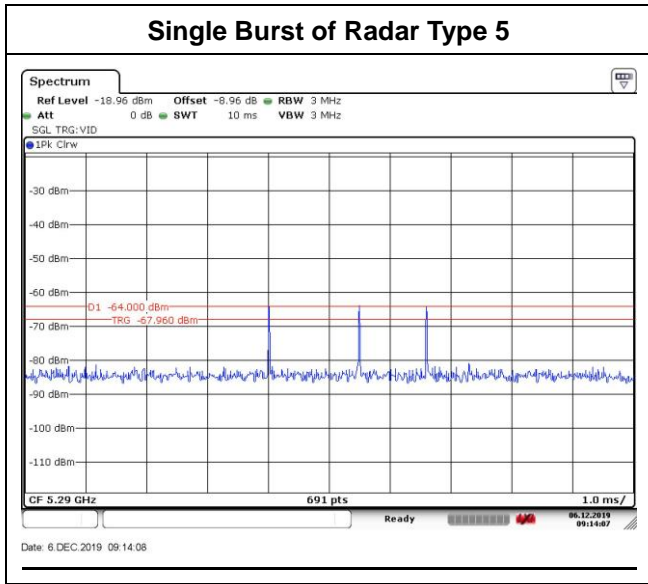

<20MHz / 5500MHz>

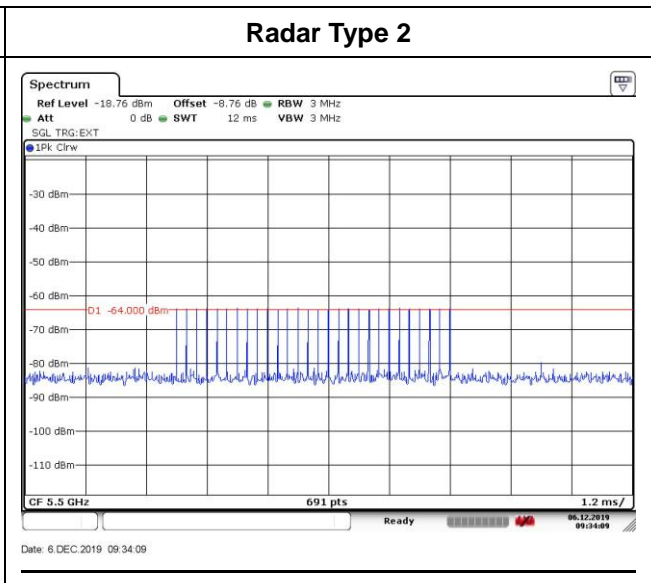
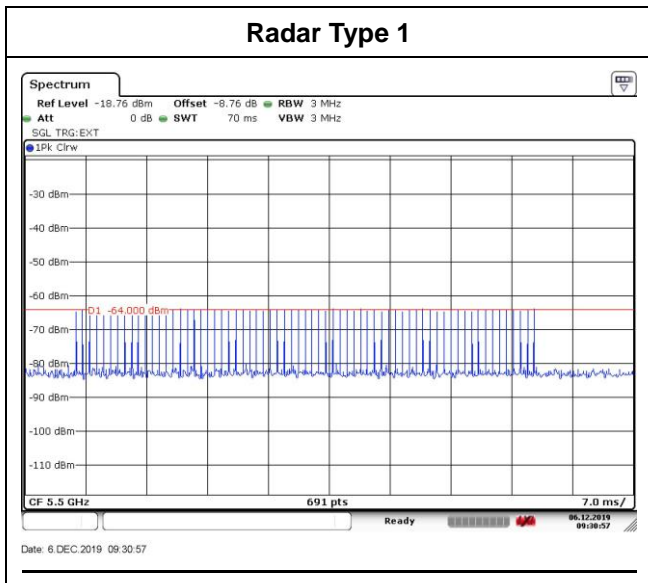

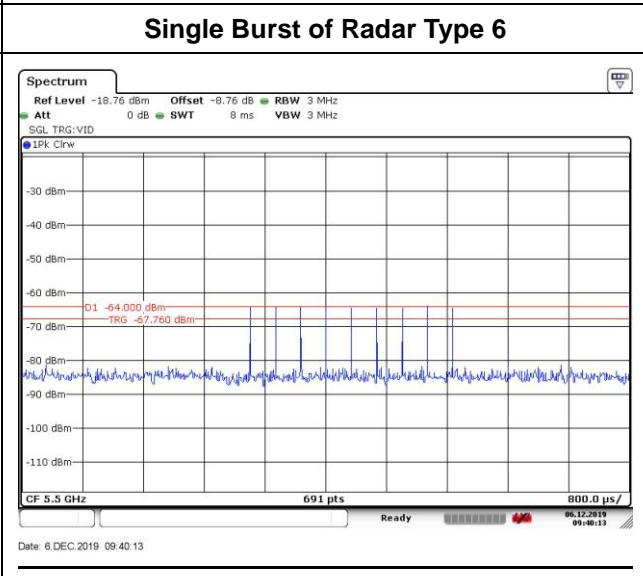
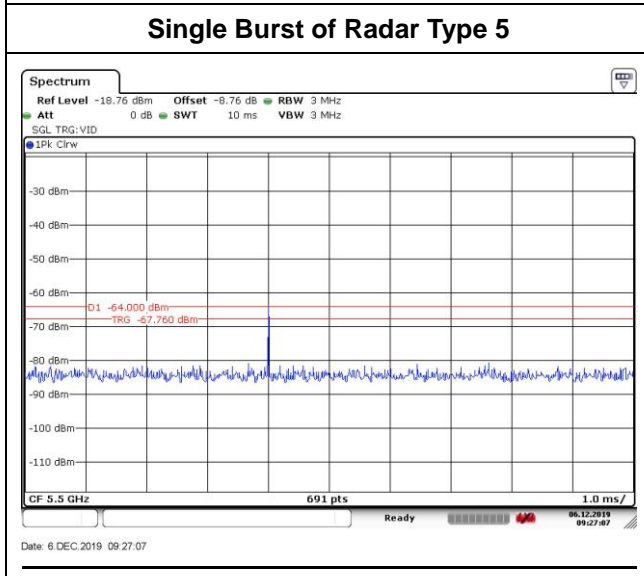
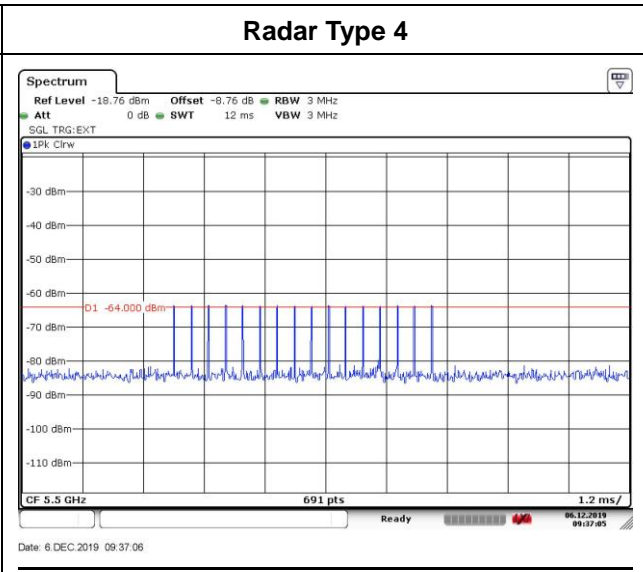
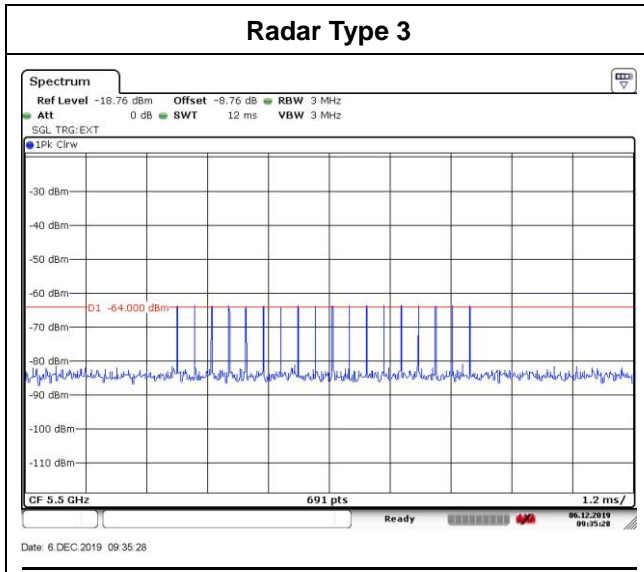



<40MHz / 5510MHz>

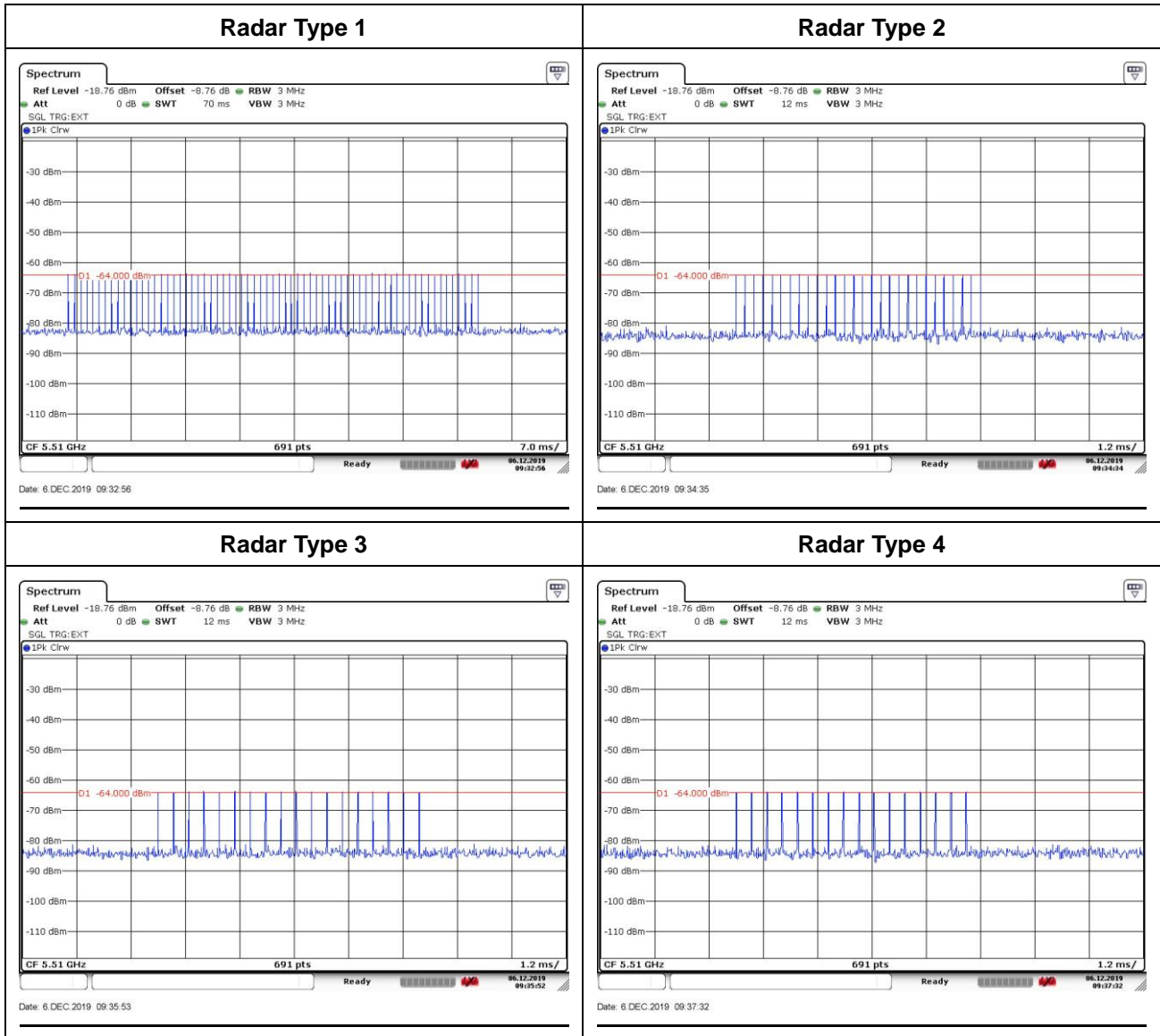

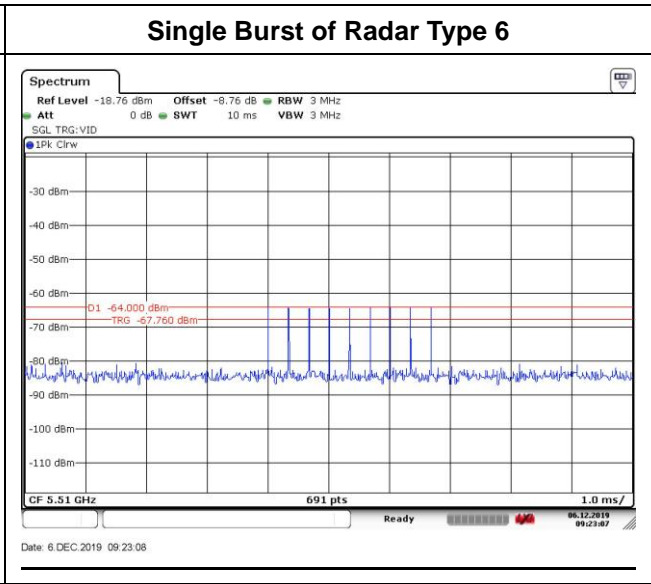
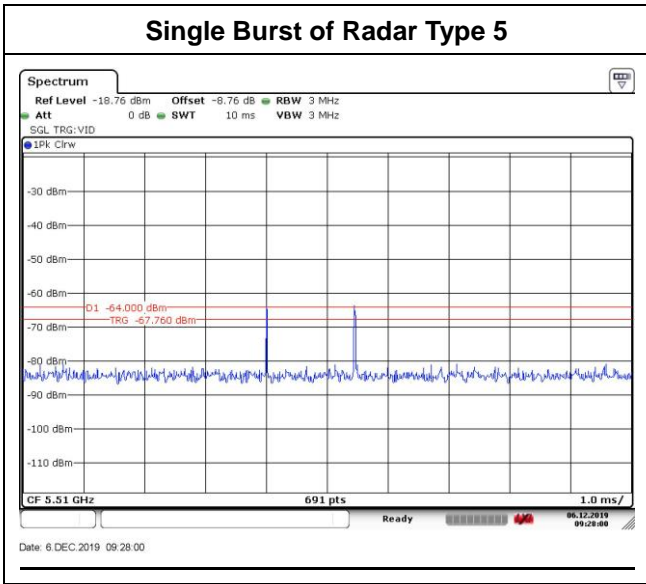

<80MHz / 5530MHz>

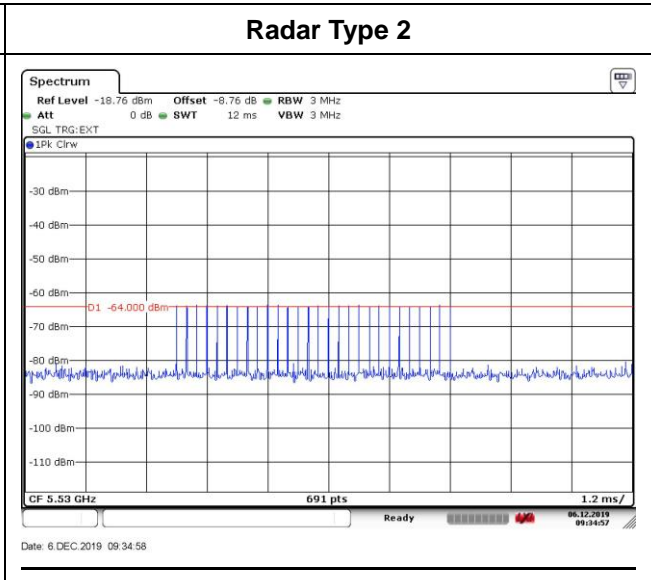
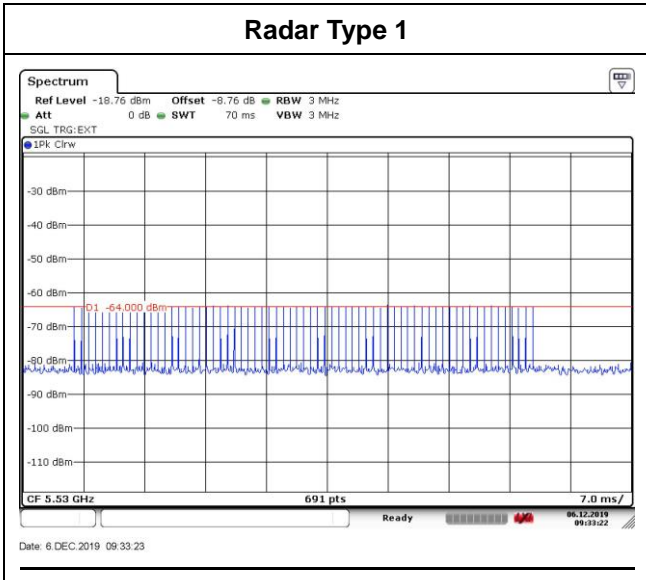

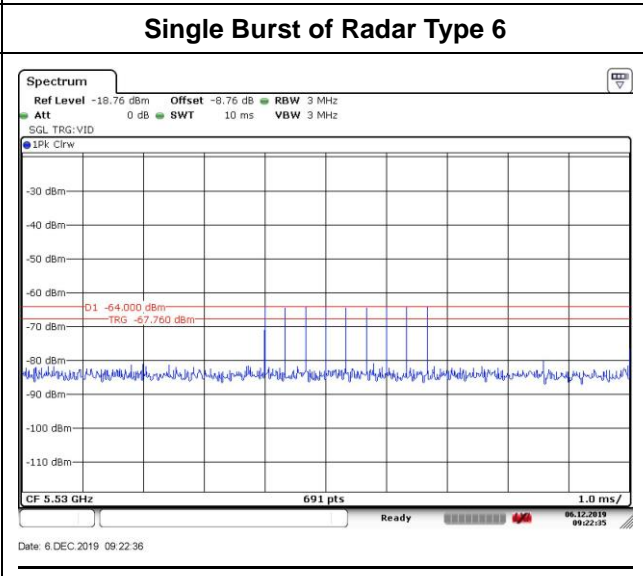
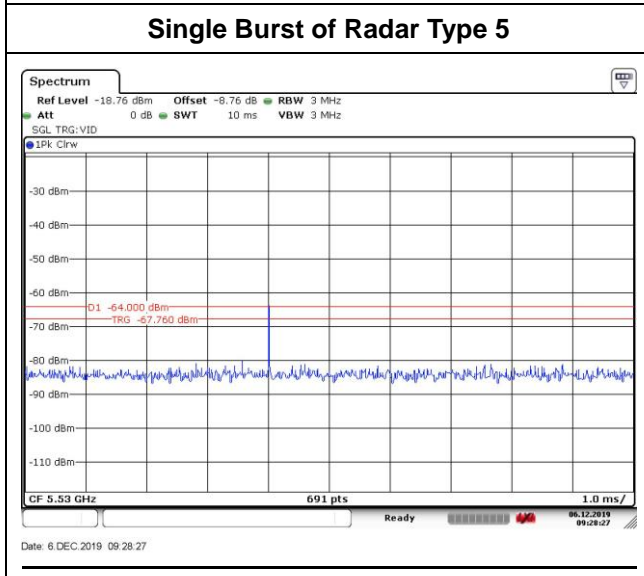
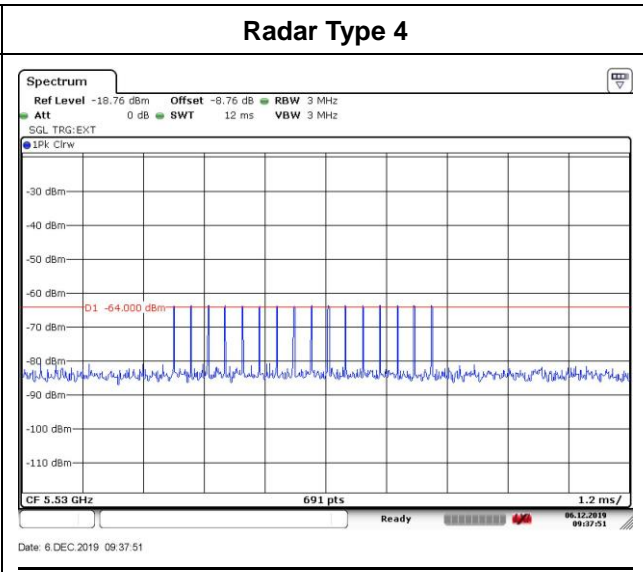
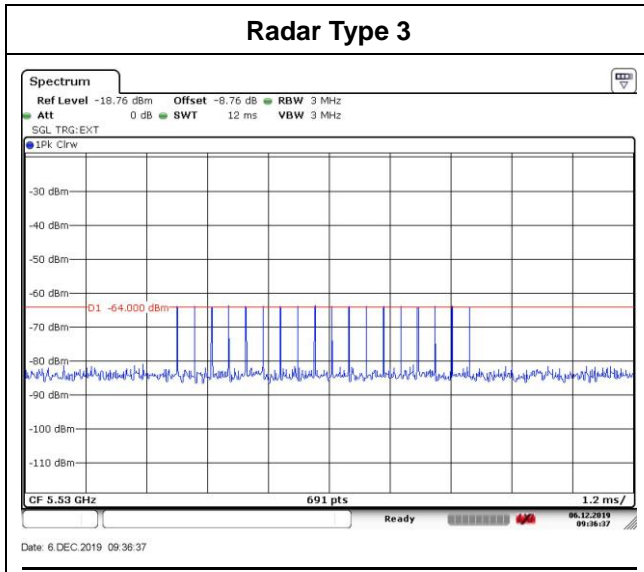



3.2 U-NII Detection Bandwidth

3.2.1 Limit of U-NII Detection Bandwidth

The U-NII Detection Bandwidth shall contain minimum 100% of the 99% power bandwidth. During the U-NII Detection Bandwidth detection test, radar type 0 is used and for each frequency step the minimum percentage of detection is 90%. Measurements are performed with no data traffic.

3.2.2 Test Procedures

- (1) Adjust the equipment to produce a single burst of the Short Pulse Radar Type 0 at the center frequency of the EUT Operating Channel at the specified DFS Detection Threshold level.
- (2) Set the EUT up as a standalone device (no associated Client or Master, as appropriate) and no traffic. Frame based systems will be set to a talk/listen ratio of 0%/100% during this test.
- (3) Generate a single radar burst, and note the response of the EUT. Repeat for a minimum of 10 trials. The EUT must detect the Radar Waveform using the specified U-NII Detection Bandwidth criterion.
- (4) Starting at the center frequency of the EUT operating Channel, increase the radar frequency in 5 MHz steps, repeating the above test sequence, until the detection rate falls below the U-NII Detection Bandwidth criterion specified in report clause 2.3. Repeat this measurement in 1MHz steps at frequencies 5 MHz below where the detection rate begins to fall. Record the highest frequency (denote as F_H) at which detection is greater than or equal to the U-NII Detection Bandwidth criterion. Recording the detection rate at frequencies above F_H is not required to demonstrate compliance.
- (5) Starting at the center frequency of the EUT operating Channel, decrease the radar frequency in 5 MHz steps, repeating the above test sequence, until the detection rate falls below the U-NII Detection Bandwidth criterion specified in report clause 2.3. Repeat this measurement in 1MHz steps at frequencies 5 MHz above where the detection rate begins to fall. Record the lowest frequency (denote as F_L) at which detection is greater than or equal to the U-NII Detection Bandwidth criterion. Recording the detection rate at frequencies below F_L is not required to demonstrate compliance.
- (6) The U-NII Detection Bandwidth is calculated as follows:
U-NII Detection Bandwidth = $F_H - F_L$

3.2.3 Test Setup

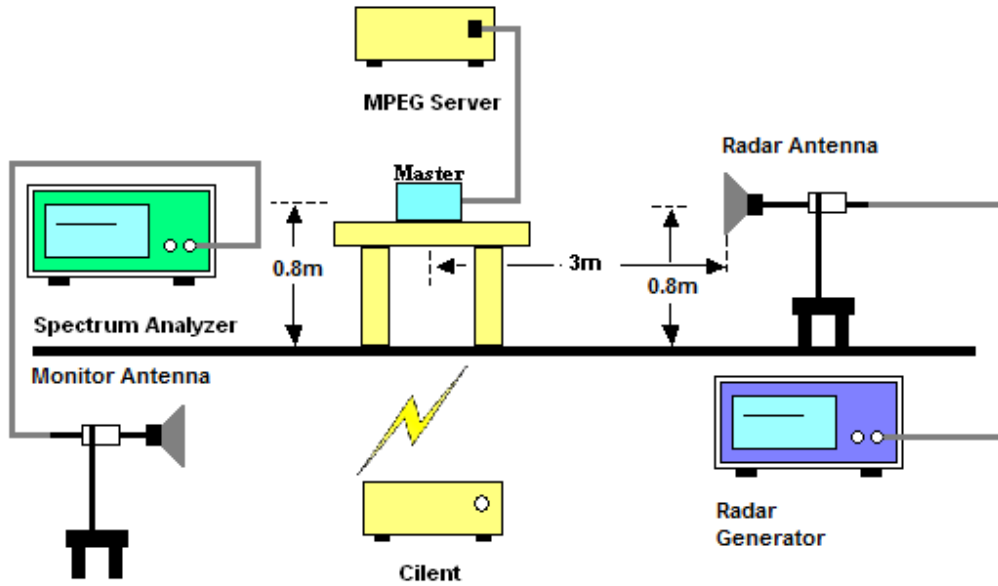

3.2.4 Test Deviation

There is no deviation with the original standard.



3.2.5 Result of U-NII Detection Bandwidth

<Mode1>

<20MHz / 5500MHz>

| Frequency (MHz) | Fc | Trial Number (Detection = V, No Detection = N) | | | | | | | | | | Rate (%) | F _H /F _L |
|-----------------|-----|--|---|---|---|---|---|---|---|---|----|----------|--------------------------------|
| | | 1 | 2 | 3 | 4 | 5 | 6 | 7 | 8 | 9 | 10 | | |
| 5489 | -11 | N | N | N | N | N | N | N | N | N | N | 0 | |
| 5490 | -10 | Y | Y | Y | Y | Y | Y | Y | Y | Y | Y | 100 | F _L |
| 5491 | -9 | Y | Y | Y | Y | Y | Y | Y | Y | Y | Y | 100 | |
| 5492 | -8 | Y | Y | Y | Y | Y | Y | Y | Y | Y | Y | 100 | |
| 5493 | -7 | Y | Y | Y | Y | Y | Y | Y | Y | Y | Y | 100 | |
| 5494 | -6 | Y | Y | Y | Y | Y | Y | Y | Y | Y | Y | 100 | |
| 5495 | -5 | Y | Y | Y | Y | Y | Y | Y | Y | Y | Y | 100 | |
| 5500 | 0 | Y | Y | Y | Y | Y | Y | Y | Y | Y | Y | 100 | |
| 5505 | +5 | Y | Y | Y | Y | Y | Y | Y | Y | Y | Y | 100 | |
| 5506 | +6 | Y | Y | Y | Y | Y | Y | Y | Y | Y | Y | 100 | |
| 5507 | +7 | Y | Y | Y | Y | Y | Y | Y | Y | Y | Y | 100 | |
| 5508 | +8 | Y | Y | Y | Y | Y | Y | Y | Y | Y | Y | 100 | |
| 5509 | +9 | Y | Y | Y | Y | Y | Y | Y | Y | Y | Y | 100 | |
| 5510 | +10 | Y | Y | Y | Y | Y | Y | Y | Y | Y | Y | 100 | F _H |
| 5511 | +11 | N | N | N | N | N | N | N | N | N | N | 0 | |

Detection Bandwidth = F_H - F_L = 5510 - 5490 = 20 MHz
EUT 99% Bandwidth = 17.8 MHz (Refer to channel 100)



<40MHz / 5510MHz>

| Frequency (MHz) | Fc | Trial Number (Detection = V, No Detection = N) | | | | | | | | | | Rate (%) | F _H /F _L |
|-----------------|-----|--|---|---|---|---|---|---|---|---|----|----------|--------------------------------|
| | | 1 | 2 | 3 | 4 | 5 | 6 | 7 | 8 | 9 | 10 | | |
| 5489 | -21 | N | N | N | N | N | N | N | N | N | N | 0 | |
| 5490 | -20 | Y | Y | Y | Y | Y | Y | Y | Y | Y | Y | 100 | F _L |
| 5491 | -19 | Y | Y | Y | Y | Y | Y | Y | Y | Y | Y | 100 | |
| 5492 | -18 | Y | Y | Y | Y | Y | Y | Y | Y | Y | Y | 100 | |
| 5493 | -17 | Y | Y | Y | Y | Y | Y | Y | Y | Y | Y | 100 | |
| 5494 | -16 | Y | Y | Y | Y | Y | Y | Y | Y | Y | Y | 100 | |
| 5495 | -15 | Y | Y | Y | Y | Y | Y | Y | Y | Y | Y | 100 | |
| 5500 | -10 | Y | Y | Y | Y | Y | Y | Y | Y | Y | Y | 100 | |
| 5505 | -5 | Y | Y | Y | Y | Y | Y | Y | Y | Y | Y | 100 | |
| 5510 | 0 | Y | Y | Y | Y | Y | Y | Y | Y | Y | Y | 100 | |
| 5515 | +5 | Y | Y | Y | Y | Y | Y | Y | Y | Y | Y | 100 | |
| 5520 | +10 | Y | Y | Y | Y | Y | Y | Y | Y | Y | Y | 100 | |
| 5525 | +15 | Y | Y | Y | Y | Y | Y | Y | Y | Y | Y | 100 | |
| 5526 | +16 | Y | Y | Y | Y | Y | Y | Y | Y | Y | Y | 100 | |
| 5527 | +17 | Y | Y | Y | Y | Y | Y | Y | Y | Y | Y | 100 | |
| 5528 | +18 | Y | Y | Y | Y | Y | Y | Y | Y | Y | Y | 100 | |
| 5529 | +19 | Y | Y | Y | Y | Y | Y | Y | Y | Y | Y | 100 | |
| 5530 | +20 | Y | Y | Y | Y | Y | Y | Y | Y | Y | Y | 100 | F _H |
| 5531 | +21 | N | N | N | N | N | N | N | N | N | N | 0 | |

Detection Bandwidth = F_H – F_L = 5530 – 5490 = 40 MHz
EUT 99% Bandwidth = 36.816 MHz (Refer to channel 102)



<80MHz / 5530MHz>

| Frequency (MHz) | Fc | Trial Number (Detection = V, No Detection = N) | | | | | | | | | | Rate (%) | F _H /F _L |
|-----------------|-----|--|---|---|---|---|---|---|---|---|----|----------|--------------------------------|
| | | 1 | 2 | 3 | 4 | 5 | 6 | 7 | 8 | 9 | 10 | | |
| 5489 | -41 | N | N | N | N | N | N | N | N | N | N | 0 | |
| 5490 | -40 | Y | Y | Y | Y | Y | Y | Y | Y | Y | Y | 100 | F _L |
| 5491 | -39 | Y | Y | Y | Y | Y | Y | Y | Y | Y | Y | 100 | |
| 5492 | -38 | Y | Y | Y | Y | Y | Y | Y | Y | Y | Y | 100 | |
| 5493 | -37 | Y | Y | Y | Y | Y | Y | Y | Y | Y | Y | 100 | |
| 5494 | -36 | Y | Y | Y | Y | Y | Y | Y | Y | Y | Y | 100 | |
| 5495 | -35 | Y | Y | Y | Y | Y | Y | Y | Y | Y | Y | 100 | |
| 5500 | -30 | Y | Y | Y | Y | Y | Y | Y | Y | Y | Y | 100 | |
| 5505 | -25 | Y | Y | Y | Y | Y | Y | Y | Y | Y | Y | 100 | |
| 5510 | -20 | Y | Y | Y | Y | Y | Y | Y | Y | Y | Y | 100 | |
| 5515 | -15 | Y | Y | Y | Y | Y | Y | Y | Y | Y | Y | 100 | |
| 5520 | -10 | Y | Y | Y | Y | Y | Y | Y | Y | Y | Y | 100 | |
| 5525 | -5 | Y | Y | Y | Y | Y | Y | Y | Y | Y | Y | 100 | |
| 5530 | 0 | Y | Y | Y | Y | Y | Y | Y | Y | Y | Y | 100 | |
| 5535 | +5 | Y | Y | Y | Y | Y | Y | Y | Y | Y | Y | 100 | |
| 5540 | +10 | Y | Y | Y | Y | Y | Y | Y | Y | Y | Y | 100 | |
| 5545 | +15 | Y | Y | Y | Y | Y | Y | Y | Y | Y | Y | 100 | |
| 5550 | +20 | Y | Y | Y | Y | Y | Y | Y | Y | Y | Y | 100 | |
| 5555 | +25 | Y | Y | Y | Y | Y | Y | Y | Y | Y | Y | 100 | |
| 5560 | +30 | Y | Y | Y | Y | Y | Y | Y | Y | Y | Y | 100 | |
| 5565 | +35 | Y | Y | Y | Y | Y | Y | Y | Y | Y | Y | 100 | |
| 5566 | +36 | Y | Y | Y | Y | Y | Y | Y | Y | Y | Y | 100 | |
| 5567 | +37 | Y | Y | Y | Y | Y | Y | Y | Y | Y | Y | 100 | |
| 5568 | +38 | Y | Y | Y | Y | Y | Y | Y | Y | Y | Y | 100 | |
| 5569 | +39 | Y | Y | Y | Y | Y | Y | Y | Y | Y | Y | 100 | |
| 5570 | +40 | Y | Y | Y | Y | Y | Y | Y | Y | Y | Y | 100 | F _H |
| 5571 | +41 | N | N | N | N | N | N | N | N | N | N | 0 | |

Detection Bandwidth = F_H – F_L = **5570 – 5490 = 80 MHz**
EUT 99% Bandwidth = **77.106 MHz** (Refer to channel 106)



<Mode2>

<20MHz / 5300MHz>

| Frequency (MHz) | Fc | Trial Number (Detection = Y, No Detection = N) | | | | | | | | | | Rate (%) | F _H /F _L |
|-----------------|-----|--|---|---|---|---|---|---|---|---|----|----------|--------------------------------|
| | | 1 | 2 | 3 | 4 | 5 | 6 | 7 | 8 | 9 | 10 | | |
| 5289 | -11 | N | N | N | N | N | N | N | N | N | N | 0 | |
| 5290 | -10 | Y | Y | Y | Y | Y | Y | Y | Y | Y | Y | 100 | F _L |
| 5291 | -9 | Y | Y | Y | Y | Y | Y | Y | Y | Y | Y | 100 | |
| 5292 | -8 | Y | Y | Y | Y | Y | Y | Y | Y | Y | Y | 100 | |
| 5293 | -7 | Y | Y | Y | Y | Y | Y | Y | Y | Y | Y | 100 | |
| 5294 | -6 | Y | Y | Y | Y | Y | Y | Y | Y | Y | Y | 100 | |
| 5295 | -5 | Y | Y | Y | Y | Y | Y | Y | Y | Y | Y | 100 | |
| 5300 | 0 | Y | Y | Y | Y | Y | Y | Y | Y | Y | Y | 100 | |
| 5305 | +5 | Y | Y | Y | Y | Y | Y | Y | Y | Y | Y | 100 | |
| 5306 | +6 | Y | Y | Y | Y | Y | Y | Y | Y | Y | Y | 100 | |
| 5307 | +7 | Y | Y | Y | Y | Y | Y | Y | Y | Y | Y | 100 | |
| 5308 | +8 | Y | Y | Y | Y | Y | Y | Y | Y | Y | Y | 100 | |
| 5309 | +9 | Y | Y | Y | Y | Y | Y | Y | Y | Y | Y | 100 | |
| 5310 | +10 | Y | Y | Y | Y | Y | Y | Y | Y | Y | Y | 100 | F _H |
| 5311 | +11 | N | N | N | N | N | N | N | N | N | N | 0 | |

Detection Bandwidth = F_H – F_L = 5310 – 5290 = 20 MHz
EUT 99% Bandwidth = 17.931 MHz (Refer to channel 60)



<40MHz / 5310MHz>

| Frequency (MHz) | Fc | Trial Number (Detection = V, No Detection = N) | | | | | | | | | | Rate (%) | F _H /F _L |
|-----------------|-----|--|---|---|---|---|---|---|---|---|----|----------|--------------------------------|
| | | 1 | 2 | 3 | 4 | 5 | 6 | 7 | 8 | 9 | 10 | | |
| 5289 | -21 | N | N | N | N | N | N | N | N | N | N | 0 | |
| 5290 | -20 | Y | Y | Y | Y | Y | Y | Y | Y | Y | Y | 100 | F _L |
| 5291 | -19 | Y | Y | Y | Y | Y | Y | Y | Y | Y | Y | 100 | |
| 5292 | -18 | Y | Y | Y | Y | Y | Y | Y | Y | Y | Y | 100 | |
| 5293 | -17 | Y | Y | Y | Y | Y | Y | Y | Y | Y | Y | 100 | |
| 5294 | -16 | Y | Y | Y | Y | Y | Y | Y | Y | Y | Y | 100 | |
| 5295 | -15 | Y | Y | Y | Y | Y | Y | Y | Y | Y | Y | 100 | |
| 5300 | -10 | Y | Y | Y | Y | Y | Y | Y | Y | Y | Y | 100 | |
| 5305 | -5 | Y | Y | Y | Y | Y | Y | Y | Y | Y | Y | 100 | |
| 5310 | 0 | Y | Y | Y | Y | Y | Y | Y | Y | Y | Y | 100 | |
| 5315 | +5 | Y | Y | Y | Y | Y | Y | Y | Y | Y | Y | 100 | |
| 5320 | +10 | Y | Y | Y | Y | Y | Y | Y | Y | Y | Y | 100 | |
| 5325 | +15 | Y | Y | Y | Y | Y | Y | Y | Y | Y | Y | 100 | |
| 5326 | +16 | Y | Y | Y | Y | Y | Y | Y | Y | Y | Y | 100 | |
| 5327 | +17 | Y | Y | Y | Y | Y | Y | Y | Y | Y | Y | 100 | |
| 5328 | +18 | Y | Y | Y | Y | Y | Y | Y | Y | Y | Y | 100 | |
| 5329 | +19 | Y | Y | Y | Y | Y | Y | Y | Y | Y | Y | 100 | |
| 5330 | +20 | Y | Y | Y | Y | Y | Y | Y | Y | Y | Y | 100 | F _H |
| 5331 | +21 | N | N | N | N | N | N | N | N | N | N | 0 | |

Detection Bandwidth = F_H – F_L = 5330 – 5290 = 40 MHz
EUT 99% Bandwidth = 36.382 MHz (Refer to channel 62)



<80MHz / 5290MHz>

| Frequency (MHz) | Fc | Trial Number (Detection = V, No Detection = N) | | | | | | | | | | Rate (%) | F _H /F _L |
|-----------------|-----|--|---|---|---|---|---|---|---|---|----|----------|--------------------------------|
| | | 1 | 2 | 3 | 4 | 5 | 6 | 7 | 8 | 9 | 10 | | |
| 5249 | -41 | N | N | N | N | N | N | N | N | N | N | 0 | |
| 5250 | -40 | Y | Y | Y | Y | Y | Y | Y | Y | Y | Y | 100 | F _L |
| 5251 | -39 | Y | Y | Y | Y | Y | Y | Y | Y | Y | Y | 100 | |
| 5252 | -38 | Y | Y | Y | Y | Y | Y | Y | Y | Y | Y | 100 | |
| 5253 | -37 | Y | Y | Y | Y | Y | Y | Y | Y | Y | Y | 100 | |
| 5254 | -36 | Y | Y | Y | Y | Y | Y | Y | Y | Y | Y | 100 | |
| 5255 | -35 | Y | Y | Y | Y | Y | Y | Y | Y | Y | Y | 100 | |
| 5260 | -30 | Y | Y | Y | Y | Y | Y | Y | Y | Y | Y | 100 | |
| 5265 | -25 | Y | Y | Y | Y | Y | Y | Y | Y | Y | Y | 100 | |
| 5270 | -20 | Y | Y | Y | Y | Y | Y | Y | Y | Y | Y | 100 | |
| 5275 | -15 | Y | Y | Y | Y | Y | Y | Y | Y | Y | Y | 100 | |
| 5380 | -10 | Y | Y | Y | Y | Y | Y | Y | Y | Y | Y | 100 | |
| 5285 | -5 | Y | Y | Y | Y | Y | Y | Y | Y | Y | Y | 100 | |
| 5290 | 0 | Y | Y | Y | Y | Y | Y | Y | Y | Y | Y | 100 | |
| 5295 | +5 | Y | Y | Y | Y | Y | Y | Y | Y | Y | Y | 100 | |
| 5300 | +10 | Y | Y | Y | Y | Y | Y | Y | Y | Y | Y | 100 | |
| 5305 | +15 | Y | Y | Y | Y | Y | Y | Y | Y | Y | Y | 100 | |
| 5310 | +20 | Y | Y | Y | Y | Y | Y | Y | Y | Y | Y | 100 | |
| 5315 | +25 | Y | Y | Y | Y | Y | Y | Y | Y | Y | Y | 100 | |
| 5320 | +30 | Y | Y | Y | Y | Y | Y | Y | Y | Y | Y | 100 | |
| 5325 | +35 | Y | Y | Y | Y | Y | Y | Y | Y | Y | Y | 100 | |
| 5326 | +36 | Y | Y | Y | Y | Y | Y | Y | Y | Y | Y | 100 | |
| 5327 | +37 | Y | Y | Y | Y | Y | Y | Y | Y | Y | Y | 100 | |
| 5328 | +38 | Y | Y | Y | Y | Y | Y | Y | Y | Y | Y | 100 | |
| 5329 | +39 | Y | Y | Y | Y | Y | Y | Y | Y | Y | Y | 100 | |
| 5330 | +40 | Y | Y | Y | Y | Y | Y | Y | Y | Y | Y | 100 | F _H |
| 5331 | +41 | N | N | N | N | N | N | N | N | N | N | 0 | |

Detection Bandwidth = F_H – F_L = 5330 – 5250 = 80 MHz
EUT 99% Bandwidth = 76.932 MHz (Refer to channel 58)



<20MHz / 5500MHz>

| Frequency (MHz) | Fc | Trial Number (Detection = Y, No Detection = N) | | | | | | | | | | Rate (%) | F _H /F _L |
|-----------------|-----|--|---|---|---|---|---|---|---|---|----|----------|--------------------------------|
| | | 1 | 2 | 3 | 4 | 5 | 6 | 7 | 8 | 9 | 10 | | |
| 5489 | -11 | N | N | N | N | N | N | N | N | N | N | 0 | |
| 5490 | -10 | Y | Y | Y | Y | Y | Y | Y | Y | Y | Y | 100 | F _L |
| 5491 | -9 | Y | Y | Y | Y | Y | Y | Y | Y | Y | Y | 100 | |
| 5492 | -8 | Y | Y | Y | Y | Y | Y | Y | Y | Y | Y | 100 | |
| 5493 | -7 | Y | Y | Y | Y | Y | Y | Y | Y | Y | Y | 100 | |
| 5494 | -6 | Y | Y | Y | Y | Y | Y | Y | Y | Y | Y | 100 | |
| 5495 | -5 | Y | Y | Y | Y | Y | Y | Y | Y | Y | Y | 100 | |
| 5500 | 0 | Y | Y | Y | Y | Y | Y | Y | Y | Y | Y | 100 | |
| 5505 | +5 | Y | Y | Y | Y | Y | Y | Y | Y | Y | Y | 100 | |
| 5506 | +6 | Y | Y | Y | Y | Y | Y | Y | Y | Y | Y | 100 | |
| 5507 | +7 | Y | Y | Y | Y | Y | Y | Y | Y | Y | Y | 100 | |
| 5508 | +8 | Y | Y | Y | Y | Y | Y | Y | Y | Y | Y | 100 | |
| 5509 | +9 | Y | Y | Y | Y | Y | Y | Y | Y | Y | Y | 100 | |
| 5510 | +10 | Y | Y | Y | Y | Y | Y | Y | Y | Y | Y | 100 | F _H |
| 5511 | +11 | N | N | N | N | N | N | N | N | N | N | 0 | |

Detection Bandwidth = F_H - F_L = 5510 - 5490 = 20 MHz
EUT 99% Bandwidth = 17.887 MHz (Refer to channel 100)



<40MHz / 5510MHz>

| Frequency (MHz) | Fc | Trial Number (Detection = V, No Detection = N) | | | | | | | | | | Rate (%) | F _H /F _L |
|-----------------|-----|--|---|---|---|---|---|---|---|---|----|----------|--------------------------------|
| | | 1 | 2 | 3 | 4 | 5 | 6 | 7 | 8 | 9 | 10 | | |
| 5489 | -21 | N | N | N | N | N | N | N | N | N | N | 0 | |
| 5490 | -20 | Y | Y | Y | Y | Y | Y | Y | Y | Y | Y | 100 | F _L |
| 5491 | -19 | Y | Y | Y | Y | Y | Y | Y | Y | Y | Y | 100 | |
| 5492 | -18 | Y | Y | Y | Y | Y | Y | Y | Y | Y | Y | 100 | |
| 5493 | -17 | Y | Y | Y | Y | Y | Y | Y | Y | Y | Y | 100 | |
| 5494 | -16 | Y | Y | Y | Y | Y | Y | Y | Y | Y | Y | 100 | |
| 5495 | -15 | Y | Y | Y | Y | Y | Y | Y | Y | Y | Y | 100 | |
| 5500 | -10 | Y | Y | Y | Y | Y | Y | Y | Y | Y | Y | 100 | |
| 5505 | -5 | Y | Y | Y | Y | Y | Y | Y | Y | Y | Y | 100 | |
| 5510 | 0 | Y | Y | Y | Y | Y | Y | Y | Y | Y | Y | 100 | |
| 5515 | +5 | Y | Y | Y | Y | Y | Y | Y | Y | Y | Y | 100 | |
| 5520 | +10 | Y | Y | Y | Y | Y | Y | Y | Y | Y | Y | 100 | |
| 5525 | +15 | Y | Y | Y | Y | Y | Y | Y | Y | Y | Y | 100 | |
| 5526 | +16 | Y | Y | Y | Y | Y | Y | Y | Y | Y | Y | 100 | |
| 5527 | +17 | Y | Y | Y | Y | Y | Y | Y | Y | Y | Y | 100 | |
| 5528 | +18 | Y | Y | Y | Y | Y | Y | Y | Y | Y | Y | 100 | |
| 5529 | +19 | Y | Y | Y | Y | Y | Y | Y | Y | Y | Y | 100 | |
| 5530 | +20 | Y | Y | Y | Y | Y | Y | Y | Y | Y | Y | 100 | F _H |
| 5531 | +21 | N | N | N | N | N | N | N | N | N | N | 0 | |

Detection Bandwidth = F_H - F_L = 5530 - 5490 = 40 MHz
EUT 99% Bandwidth = 36.208 MHz (Refer to channel 102)



<80MHz / 5530MHz>

| Frequency (MHz) | Fc | Trial Number (Detection = V, No Detection = N) | | | | | | | | | | Rate (%) | F _H /F _L |
|-----------------|-----|--|---|---|---|---|---|---|---|---|----|----------|--------------------------------|
| | | 1 | 2 | 3 | 4 | 5 | 6 | 7 | 8 | 9 | 10 | | |
| 5489 | -41 | N | N | N | N | N | N | N | N | N | N | 0 | |
| 5490 | -40 | Y | Y | Y | Y | Y | Y | Y | Y | Y | Y | 100 | F _L |
| 5491 | -39 | Y | Y | Y | Y | Y | Y | Y | Y | Y | Y | 100 | |
| 5492 | -38 | Y | Y | Y | Y | Y | Y | Y | Y | Y | Y | 100 | |
| 5493 | -37 | Y | Y | Y | Y | Y | Y | Y | Y | Y | Y | 100 | |
| 5494 | -36 | Y | Y | Y | Y | Y | Y | Y | Y | Y | Y | 100 | |
| 5495 | -35 | Y | Y | Y | Y | Y | Y | Y | Y | Y | Y | 100 | |
| 5500 | -30 | Y | Y | Y | Y | Y | Y | Y | Y | Y | Y | 100 | |
| 5505 | -25 | Y | Y | Y | Y | Y | Y | Y | Y | Y | Y | 100 | |
| 5510 | -20 | Y | Y | Y | Y | Y | Y | Y | Y | Y | Y | 100 | |
| 5515 | -15 | Y | Y | Y | Y | Y | Y | Y | Y | Y | Y | 100 | |
| 5520 | -10 | Y | Y | Y | Y | Y | Y | Y | Y | Y | Y | 100 | |
| 5525 | -5 | Y | Y | Y | Y | Y | Y | Y | Y | Y | Y | 100 | |
| 5530 | 0 | Y | Y | Y | Y | Y | Y | Y | Y | Y | Y | 100 | |
| 5535 | +5 | Y | Y | Y | Y | Y | Y | Y | Y | Y | Y | 100 | |
| 5540 | +10 | Y | Y | Y | Y | Y | Y | Y | Y | Y | Y | 100 | |
| 5545 | +15 | Y | Y | Y | Y | Y | Y | Y | Y | Y | Y | 100 | |
| 5550 | +20 | Y | Y | Y | Y | Y | Y | Y | Y | Y | Y | 100 | |
| 5555 | +25 | Y | Y | Y | Y | Y | Y | Y | Y | Y | Y | 100 | |
| 5560 | +30 | Y | Y | Y | Y | Y | Y | Y | Y | Y | Y | 100 | |
| 5565 | +35 | Y | Y | Y | Y | Y | Y | Y | Y | Y | Y | 100 | |
| 5566 | +36 | Y | Y | Y | Y | Y | Y | Y | Y | Y | Y | 100 | |
| 5567 | +37 | Y | Y | Y | Y | Y | Y | Y | Y | Y | Y | 100 | |
| 5568 | +38 | Y | Y | Y | Y | Y | Y | Y | Y | Y | Y | 100 | |
| 5569 | +39 | Y | Y | Y | Y | Y | Y | Y | Y | Y | Y | 100 | |
| 5570 | +40 | Y | Y | Y | Y | Y | Y | Y | Y | Y | Y | 100 | F _H |
| 5571 | +41 | N | N | N | N | N | N | N | N | N | N | 0 | |

Detection Bandwidth = F_H – F_L = 5570 – 5490 = 80 MHz
EUT 99% Bandwidth = 76.064 MHz (Refer to channel 106)



3.3 Channel Availability Check

3.3.1 Limit of Channel Availability Check

The Initial Channel Availability Check Time tests that the EUT does not emit beacon, control, or data signals on the test Channel until the power-up sequence has been completed and the U-NII device checks for radar waveforms for **one minute** on the test Channel.

3.3.2 Test Procedures of Initial Channel Availability Check Time

This test does not use any radar waveforms and only needs to be performed one time.

- (1) The U-NII devices will be powered on and be instructed to operate on the appropriate U-NII Channel that must incorporate DFS functions. At the same time the EUT is powered on, the spectrum analyzer will be set to zero span mode with a 3 MHz RBW and 3 MHz VBW on the Channel occupied by the radar (Chr) with a 2.5 minute sweep time. The spectrum analyzer's sweep will be started at the same time power is applied to the U-NII device.
- (2) The EUT should not transmit any beacon or data transmissions until at least 1 minute after the completion of the power-on cycle.

3.3.3 Radar Burst at the Beginning of the Channel Availability Check Time

The steps below define the procedure to verify successful radar detection on the test Channel during a period equal to the Channel Availability Check Time and avoidance of operation on that Channel when a radar Burst with a level equal to the DFS Detection Threshold + 1 dB occurs at the beginning of the Channel Availability Check Time. This is illustrated in Figure 15.

- (1) The Radar Waveform generator and EUT are connected using the applicable test setup and the power of the EUT is switched off.
- (2) The EUT is powered on at T_0 . T_1 denotes the instant when the EUT has completed its power-up sequence (T_{power_up}). The Channel Availability Check Time commences on Chr at instant T_1 and will end no sooner than $T_1 + T_{ch_avail_check}$.
- (3) A single Burst of one of the Short Pulse Radar Types 1-4 will commence within a 6 second window starting at T_1 . An additional 1 dB is added to the radar test signal to ensure it is at or above the DFS Detection Threshold, accounting for equipment variations/errors.
- (4) Visual indication or measured results on the EUT of successful detection of the radar Burst will be recorded and reported. Observation of Chr for EUT emissions will continue for 2.5 minutes after the radar Burst has been generated.
- (5) Verify that during the 2.5 minute measurement window no EUT transmissions occurred on Chr. The Channel Availability Check results will be recorded.

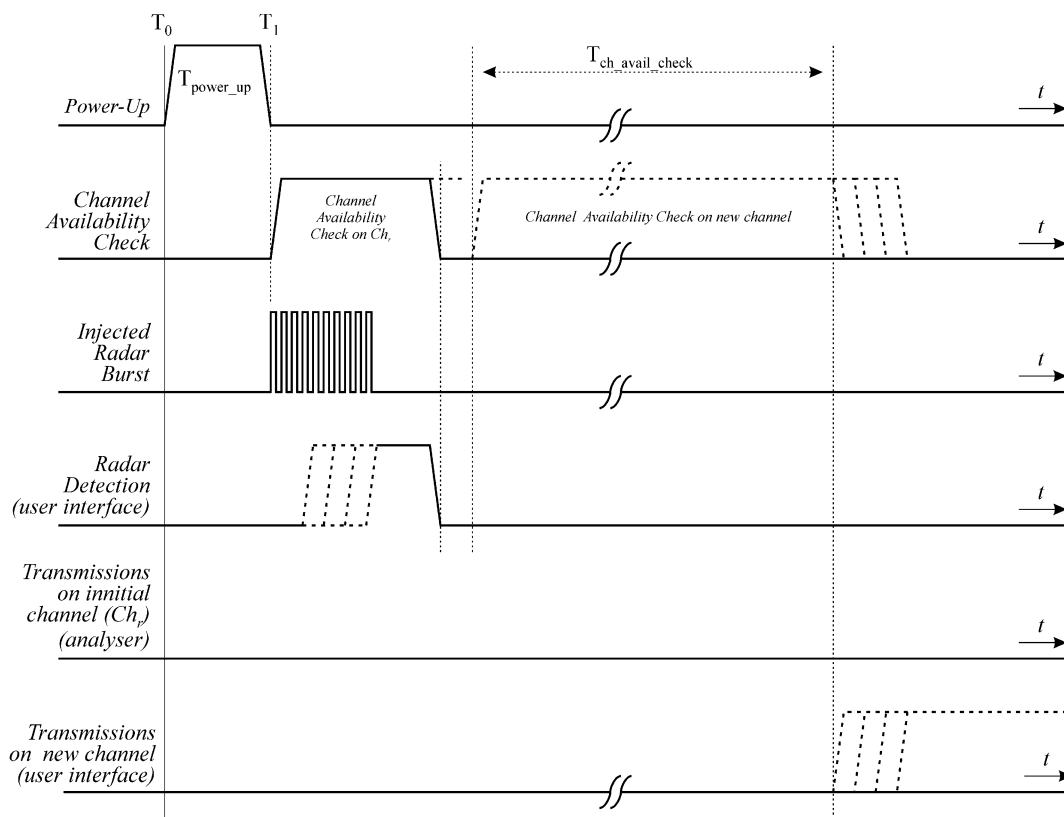

Figure 15: Example of timing for radar testing at the beginning of the Channel Availability Check Time

3.3.4 Radar Burst at the End of the Channel Availability Check Time

The steps below define the procedure to verify successful radar detection on the test Channel during a period equal to the Channel Availability Check Time and avoidance of operation on that Channel when a radar Burst with a level equal to the DFS Detection Threshold + 1dB occurs at the end of the Channel Availability Check Time. This is illustrated in Figure 16.

- (1) The Radar Waveform generator and EUT are connected using the applicable test setup and the power of the EUT is switched off.
- (2) The EUT is powered on at T_0 . T_1 denotes the instant when the EUT has completed its power-up sequence (T_{power_up}). The Channel Availability Check Time commences on Chr at instant T_1 and will end no sooner than $T_1 + T_{ch_avail_check}$.
- (3) A single Burst of one of the Short Pulse Radar Types 1-4 will commence within a 6 second window starting at $T_1 + 54$ seconds. An additional 1 dB is added to the radar test signal to ensure it is at or above the DFS Detection Threshold, accounting for equipment variations/errors.
- (4) Visual indication or measured results on the EUT of successful detection of the radar Burst will be recorded and reported. Observation of Chr for EUT emissions will continue for 2.5 minutes after the radar Burst has been generated.
- (5) Verify that during the 2.5 minute measurement window no EUT transmissions occurred on Chr. The Channel Availability Check results will be recorded.

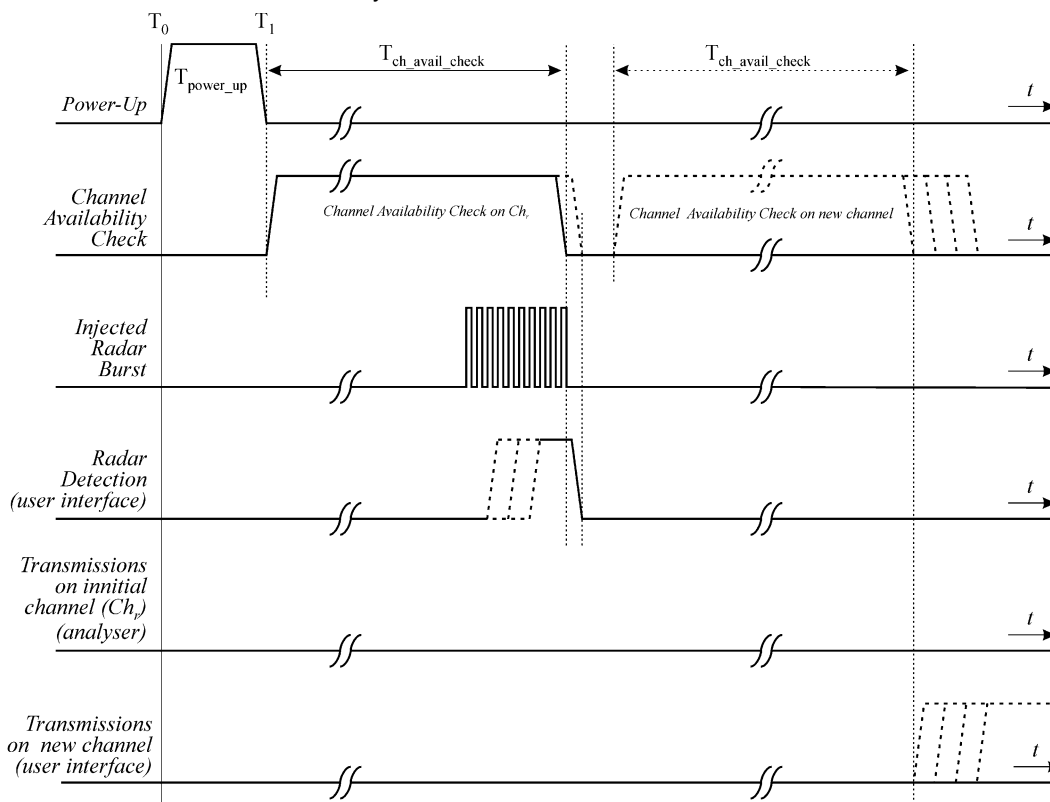
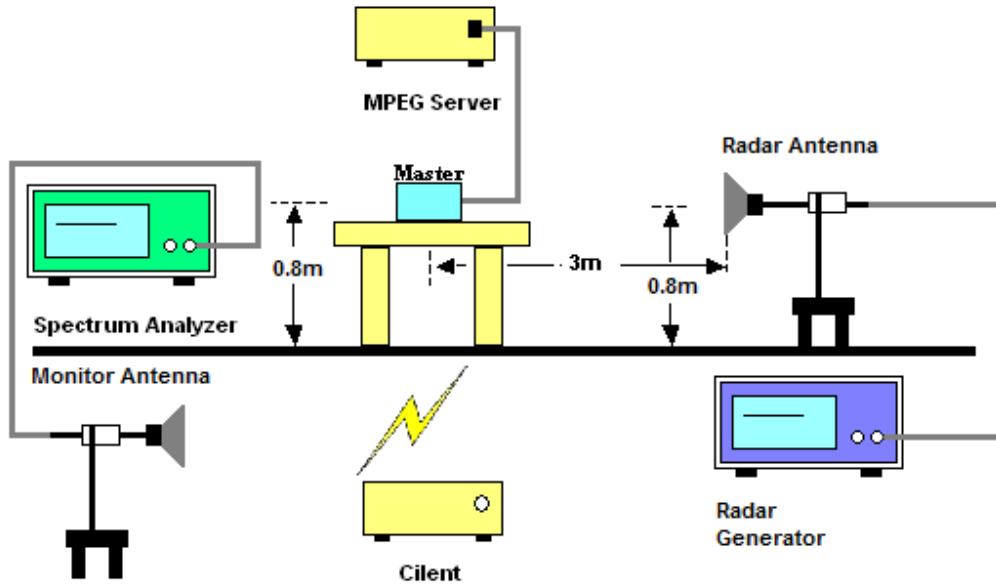

Figure 16: Example of timing for radar testing towards the end of the Channel Availability Check Time

3.3.5 Test Setup



3.3.6 Test Deviation

There is no deviation with the original standard.



3.3.7 Result of Channel Availability Check Time

<Mode1>

<80MHz / 5530MHz>

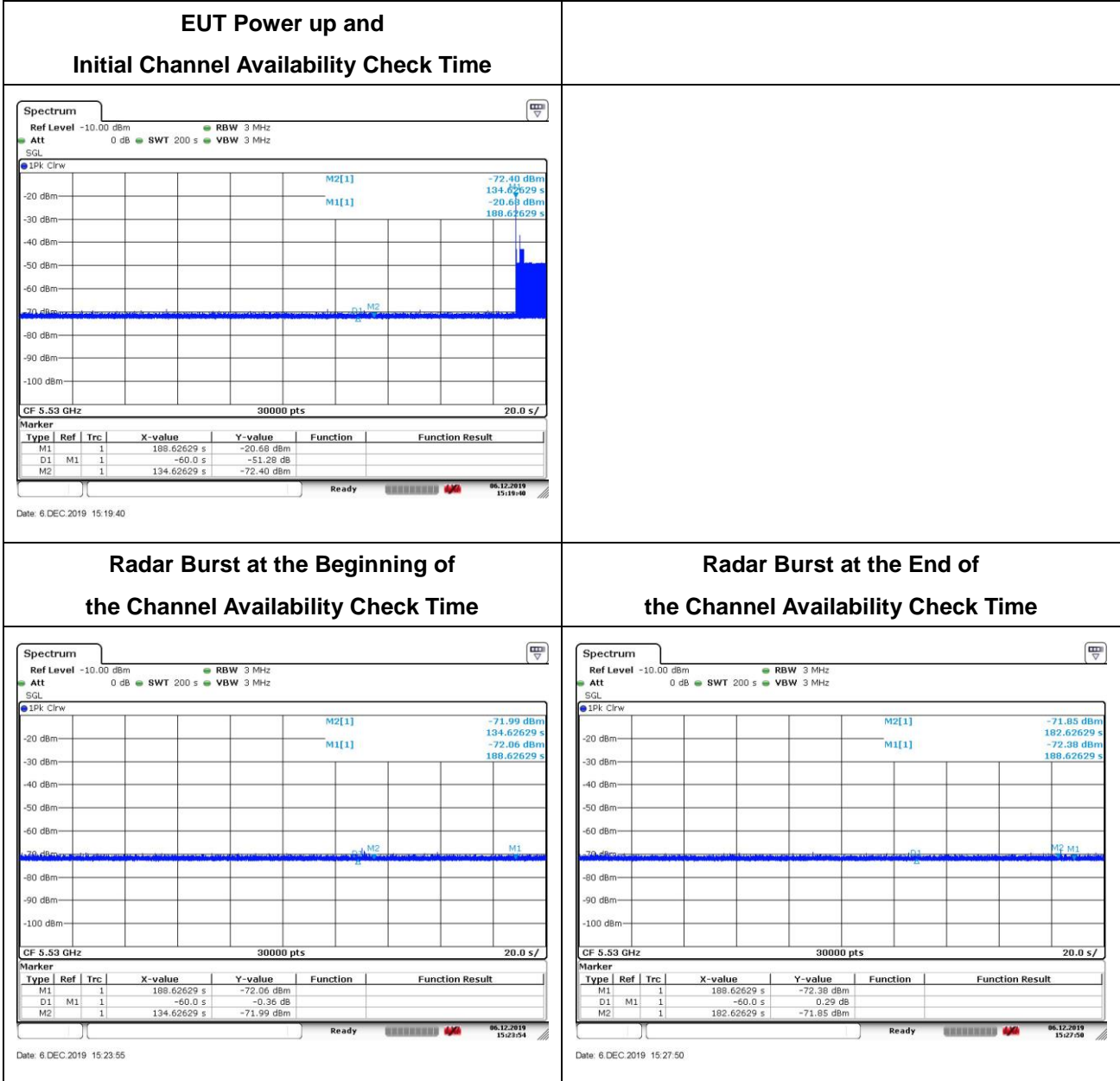



<Mode2>

<80MHz / 5290MHz>

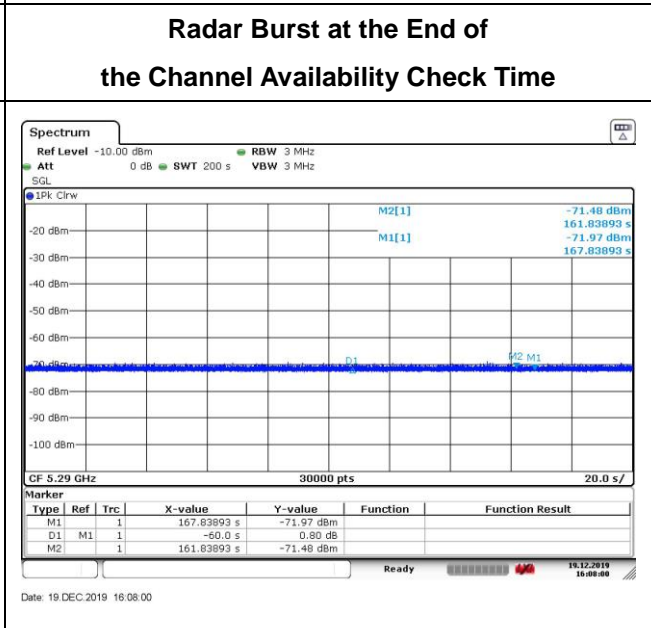
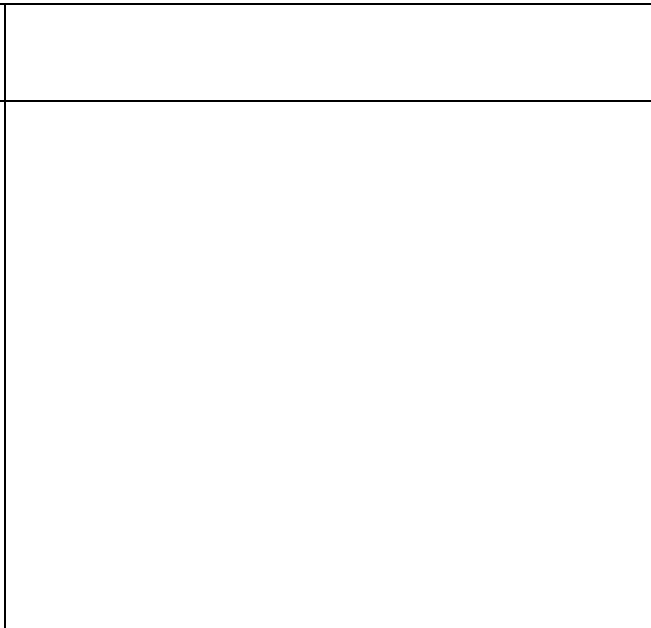
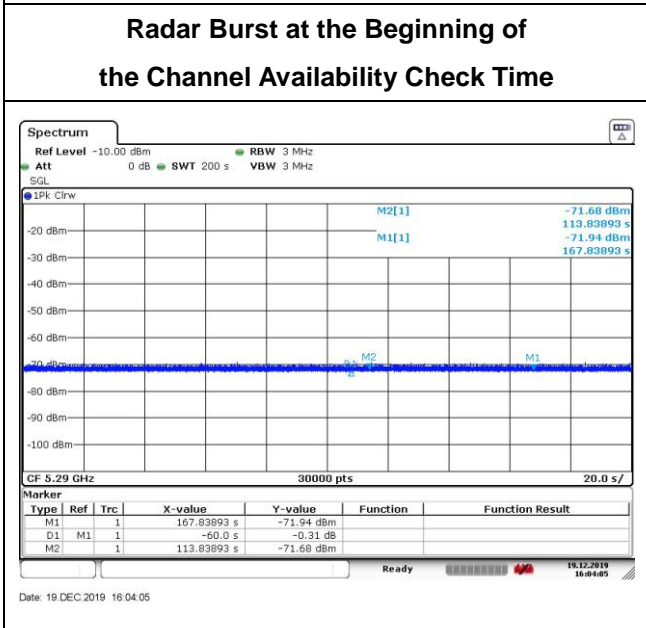
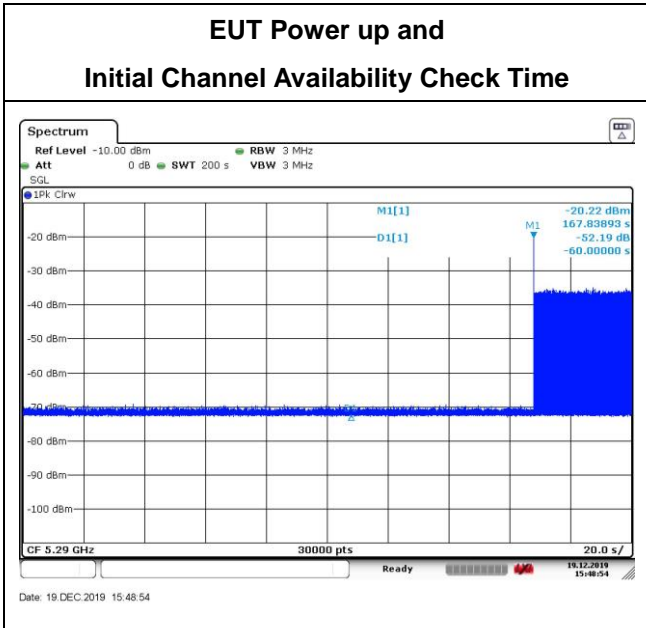



<80MHz / 5530MHz>

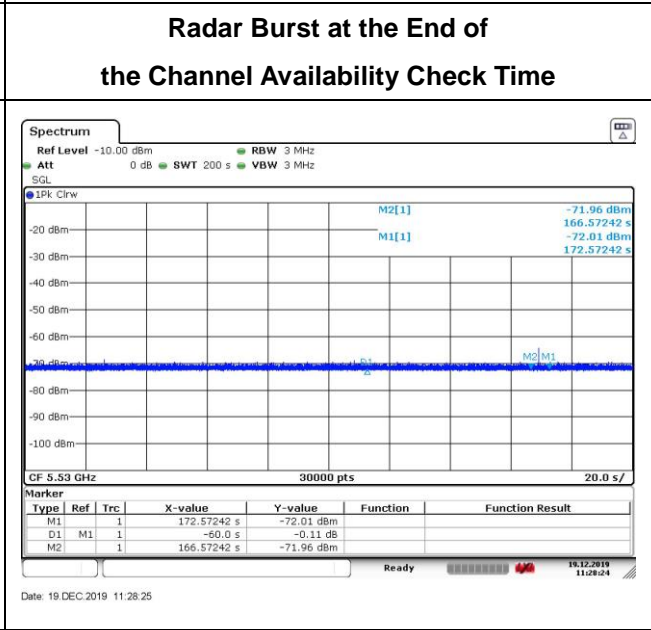
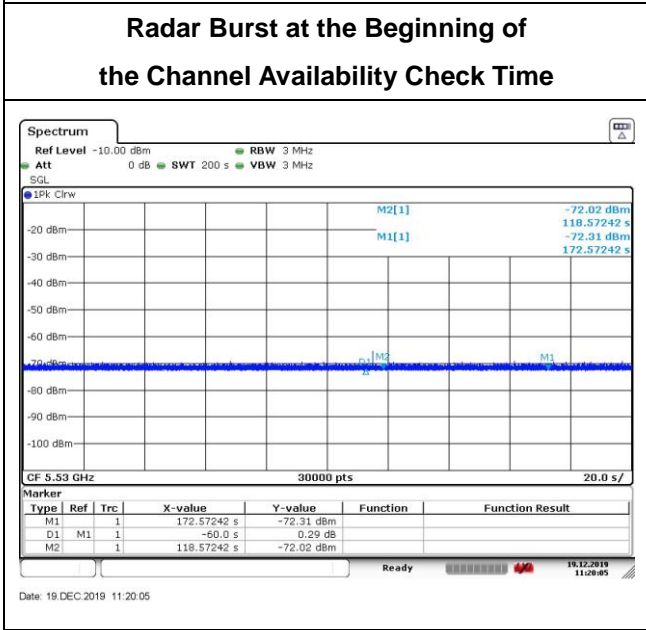
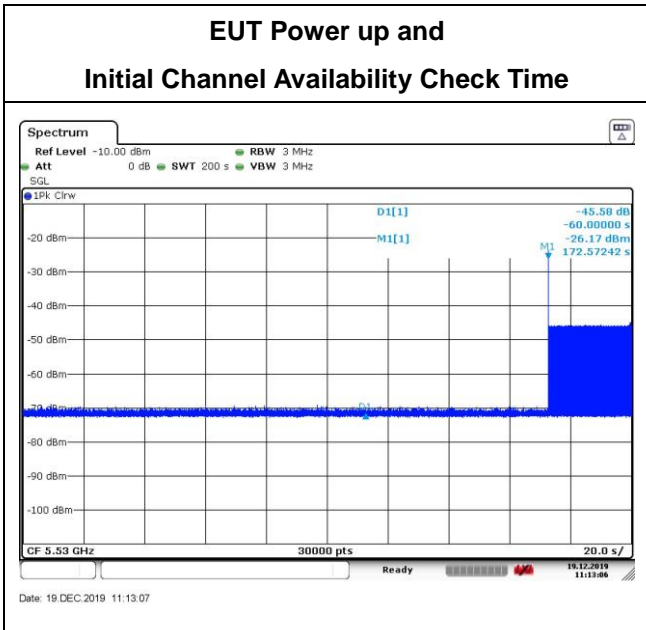



3.4 In-Service Monitoring: Channel Move Time, Channel Closing Transmission Time and Non-Occupancy Period

3.4.1 Limit of In-Service Monitoring

The EUT has In-Service Monitoring function to continuously monitor the radar signals, If radar is detected, it must leave the channel (Shutdown). The Channel Move Time to cease all transmissions on the current Channel upon detection of a Radar Waveform above the DFS Detection Threshold within 10 sec. The total duration of Channel Closing Transmission Time is comprised of 200 milliseconds starting at the beginning of the Channel Move Time plus any additional intermittent control signals required to facilitate Channel changes (an aggregate of 60 milliseconds) during the remainder of the 10 second period. The aggregate duration of control signals will not count quiet periods in between transmissions.

Non-Occupancy Period time is 30 minute during which a Channel will not be utilized after a Radar Waveform is detected on that Channel.

3.4.2 Test Procedures

- (1) One frequency will be chosen from the Operating Channels of the EUT within the 5250-5350 MHz or 5470-5725 MHz bands. For 802.11 devices, the test frequency must contain control signals. This can be verified by disabling channel loading and monitoring the spectrum analyzer. If no control signals are detected, another frequency must be selected within the emission bandwidth where control signals are detected.
- (2) In case the EUT is a Master Device, a U-NII device operating as a Client Device will be used and it is assumed that the Client will associate with the EUT (Master). For radiated tests, the emissions of the Radar Waveform generator will be directed towards the Master Device. If the Master Device has antenna gain, the main beam of the antenna will be directed toward the radar emitter. Vertical polarization is used for testing.
- (3) The TCP protocol unicast data stream was generated by the iperf software command line with at least 17% activity ratio over any 100ms period.
- (4) Timing plots are reported with calculations demonstrating a minimum channel loading of approximately 17% or greater. For example, channel loading can be estimated by setting the spectrum analyzer for zero span and approximate the Time On/ (Time On + Off Time).
- (5) At time T0 the Radar Waveform generator sends a Burst of pulses for one of the Short Pulse Radar Types 1-4 at DFS Detection Threshold levels on the Operating Channel. An additional 1 dB is added to the radar test signal to ensure it is at or above the DFS Detection Threshold, accounting for equipment variations/errors.
- (6) Observe the transmissions of the EUT at the end of the radar Burst on the Operating Channel for duration greater than 10 seconds. Measure and record the transmissions from the EUT during the observation time (Channel Move Time). Measure and record the Channel Move Time and Channel Closing Transmission Time if radar detection occurs.

- (7) When operating as a Master Device, monitor the EUT for more than 30 minutes following instant T2 to verify that the EUT does not resume any transmissions on this Channel. Perform this test once and record the measurement result.

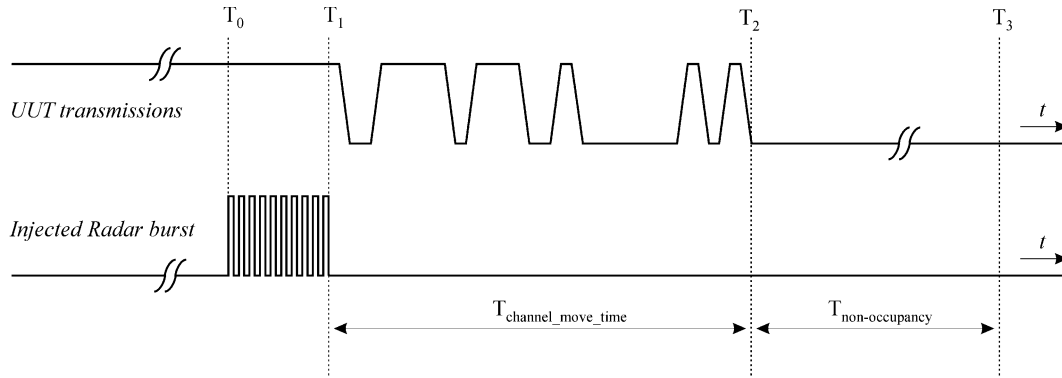

- (8) One 12 seconds plot is reported for the Short Pulse Radar Type 0.
- (9) Measurement of the aggregate duration of the Channel Closing Transmission Time method. With the spectrum analyzer set to zero span tuned to the center frequency of the EUT operating channel at the radar simulated frequency, peak detection, and max hold, the dwell time per bin is given by: $Dwell (0.4ms) = S (12000ms) / B (30000)$; where Dwell is the dwell time per spectrum analyzer sampling bin, S is the sweep time and B is the number of spectrum analyzer sampling bins. An upper bound of the aggregate duration of the intermittent control signals of Channel Closing Transmission Time is calculated by: $C (ms) = N \times Dwell (0.4 ms)$; where C is the Closing Time, N is the number of spectrum analyzer sampling bins (intermittent control signals) showing a U-NII transmission and Dwell is the dwell time per bin.

3.4.3 Test Setup

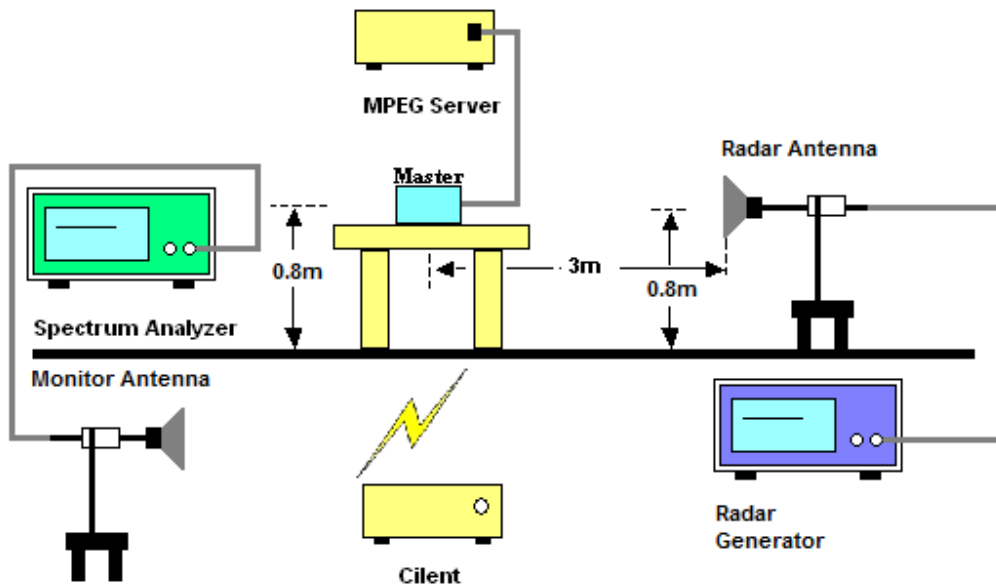

3.4.4 Test Deviation

There is no deviation with the original standard.



3.4.5 Result of Channel Move Time, Channel Closing Transmission Time and Non-Occupancy Period for Client Beacon Test

| | | | |
|-----------------|------------|---------------------|---------|
| Test Mode : | Master | Temperature : | 22~24°C |
| Test Engineer : | Andrew Van | Relative Humidity : | 44~46% |

<Mode1>

| BW / Channel | Test Item | Test Result | Limit | Pass/Fail |
|-----------------|-----------------------------------|-------------------|----------|-----------|
| 80MHz / 5530MHz | Channel Move Time | 3.672522 s | < 10s | Pass |
| | Channel Closing Transmission Time | 200ms + 2.8002 ms | < 260ms | Pass |
| | Non-Occupancy Period | ≥ 30 | ≥ 30 min | Pass |

<Mode2>

| BW / Channel | Test Item | Test Result | Limit | Pass/Fail |
|-----------------|-----------------------------------|-------------------|----------|-----------|
| 80MHz / 5290MHz | Channel Move Time | 3.780526 s | < 10s | Pass |
| | Channel Closing Transmission Time | 200ms + 4.0003 ms | < 260ms | Pass |
| | Non-Occupancy Period | ≥ 30 | ≥ 30 min | Pass |
| 80MHz / 5530MHz | Channel Move Time | 3.696923 s | < 10s | Pass |
| | Channel Closing Transmission Time | 200ms + 2.8003 ms | < 260ms | Pass |
| | Non-Occupancy Period | ≥ 30 | ≥ 30 min | Pass |

Note: The Channel Closing Transmission Time is comprised of 200 milliseconds starting at the beginning of the Channel Move Time plus any additional intermittent control signals required to facilitate a Channel move (an aggregate of 60 milliseconds) during the remainder of the 10 seconds period. The aggregate duration of control signals will not count quiet periods in between transmissions.



3.4.6 Channel Move Time, Channel Closing Transmission Time and Non-Occupancy Period Test Plots

<Mode1>

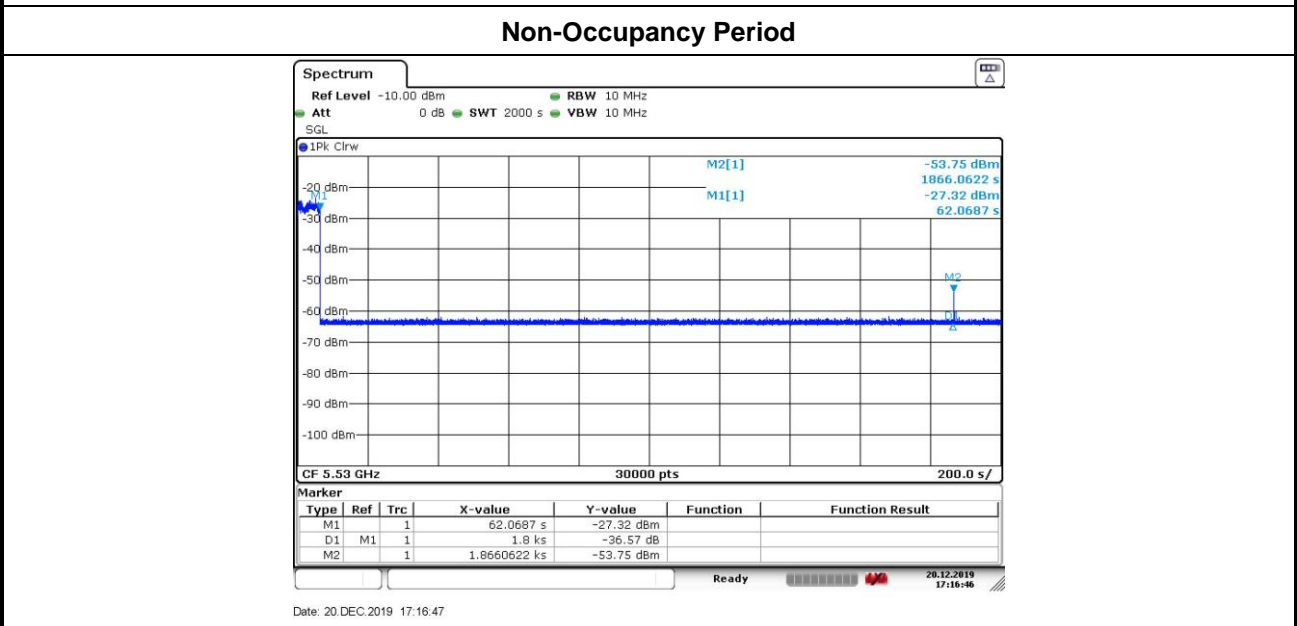
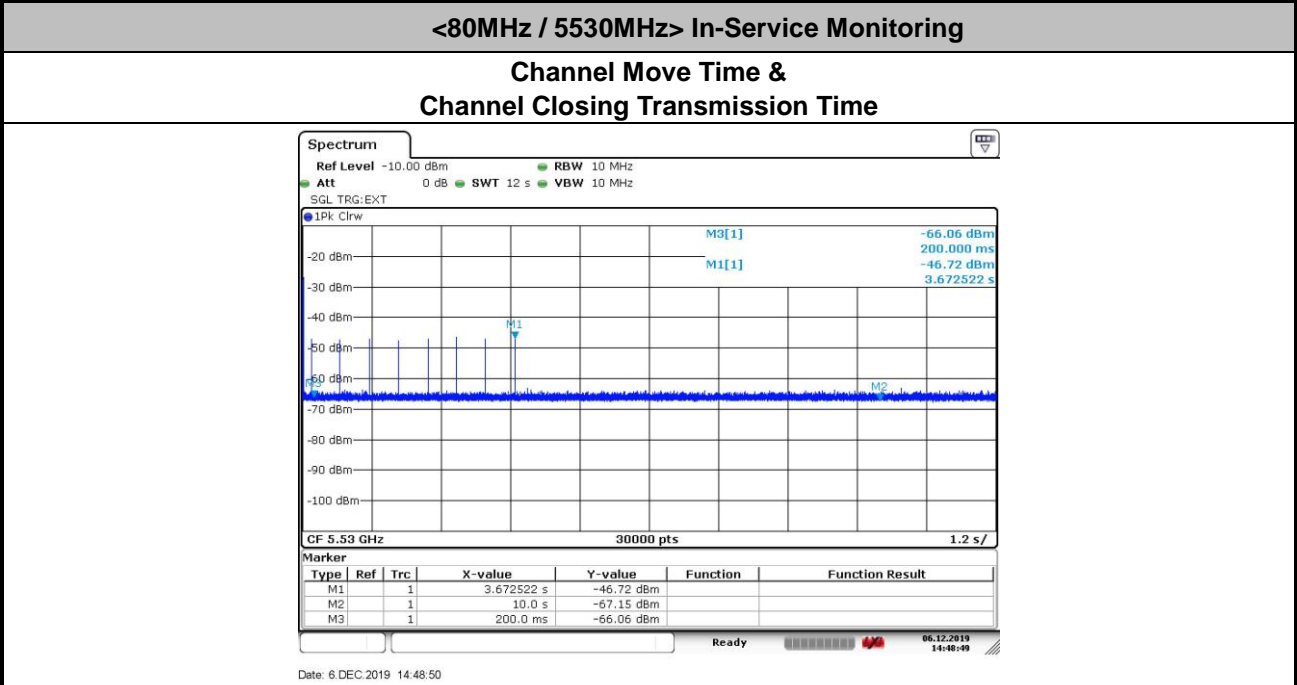

Note:

Dwell (0.4 ms)= Sweep Time (12000 ms) / Sweep Point Bins (30000)

Channel Closing Transmission Time (200 + 2.8002 ms) = 200 + Number (7) X Dwell (0.4 ms) < 260ms



<Mode2>

<80MHz / 5290MHz> In-Service Monitoring

Channel Move Time & Channel Closing Transmission Time

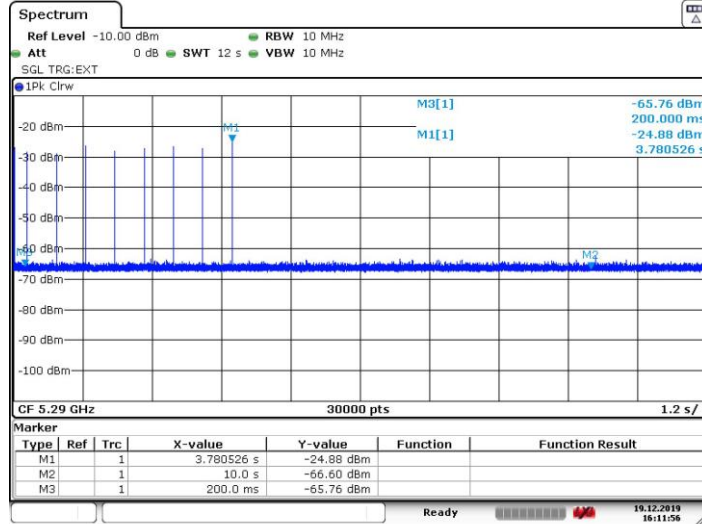

Date: 19 DEC.2019 16:11:57

Non-Occupancy Period

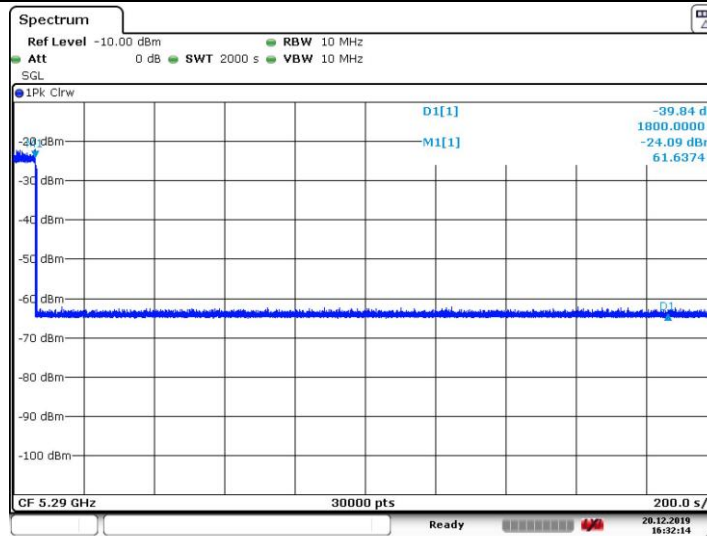

Date: 20 DEC.2019 16:32:14

Note:

Dwell (0.4 ms)= Sweep Time (12000 ms) / Sweep Point Bins (30000)

Channel Closing Transmission Time (200 + 4.0003 ms) = 200 + Number (10) X Dwell (0.4 ms) < 260ms



<80MHz / 5530MHz> In-Service Monitoring

Channel Move Time & Channel Closing Transmission Time

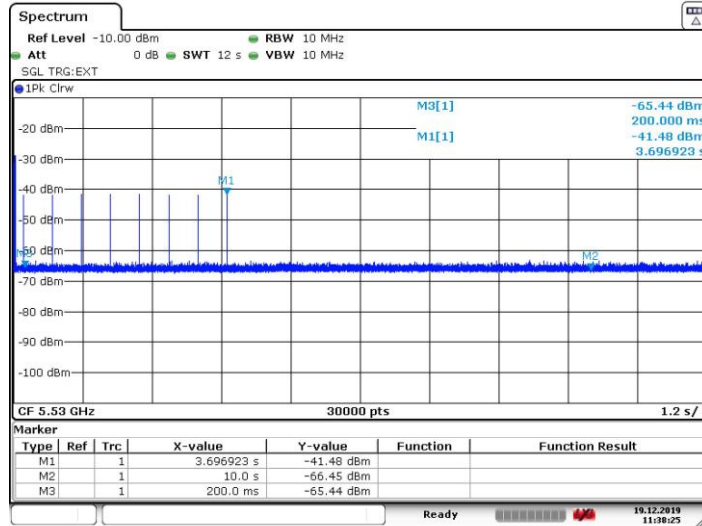

Date: 19 DEC.2019 11:38:26

Non-Occupancy Period

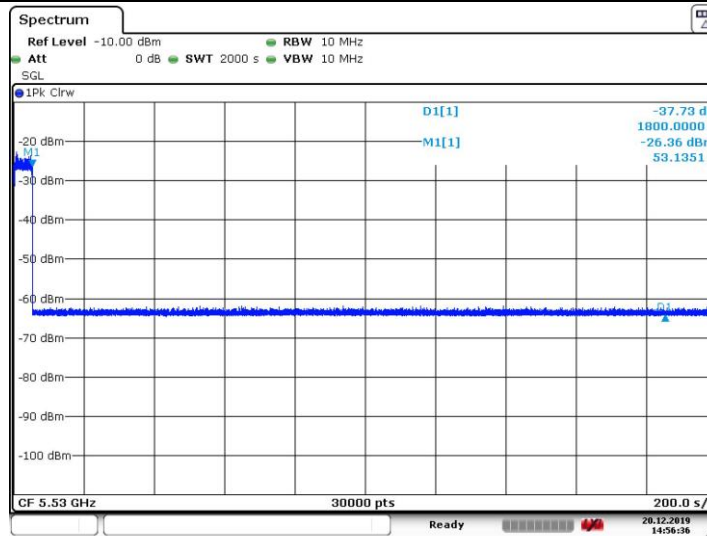

Date: 20 DEC.2019 14:56:37

Note:

Dwell (0.4 ms)= Sweep Time (12000 ms) / Sweep Point Bins (30000)

Channel Closing Transmission Time (200 + 2.8003 ms) = 200 + Number (7) X Dwell (0.4 ms) < 260ms



3.4.7 Long Pulsed Radar Type Channel Move Time Test Plots (22second)

<Mode1>

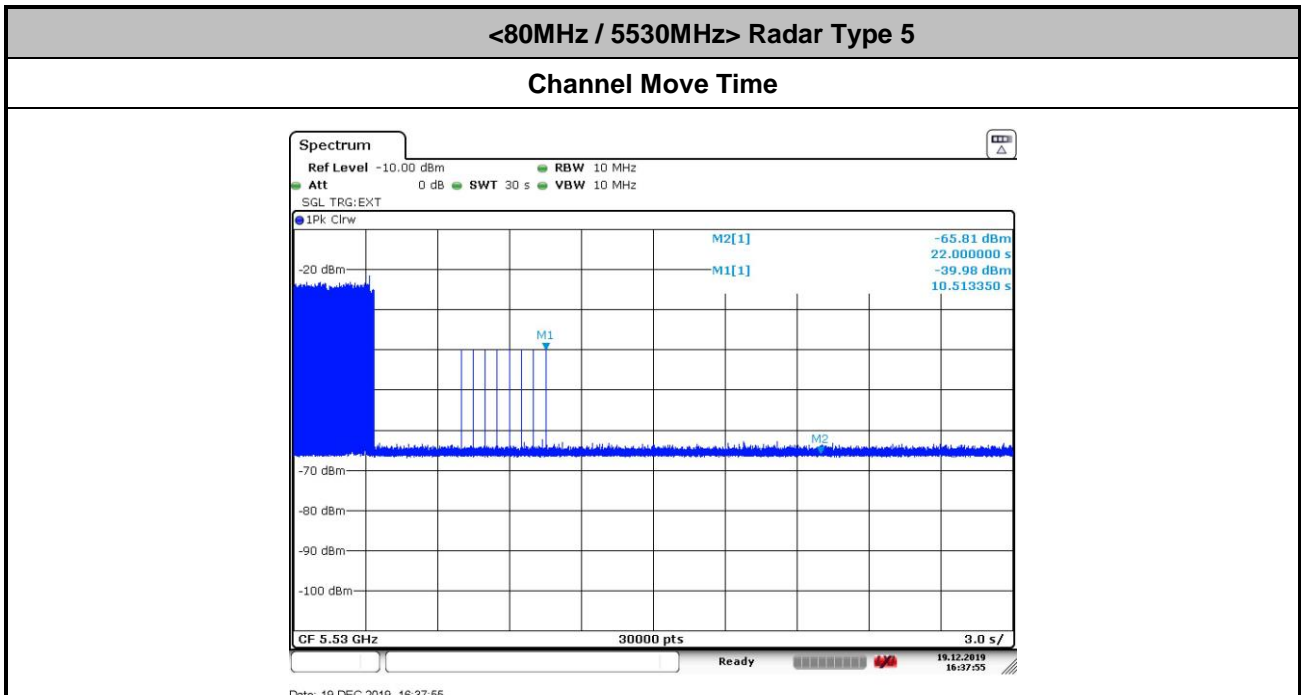



<Mode2>

<80MHz / 5290MHz> Radar Type 5

Channel Move Time

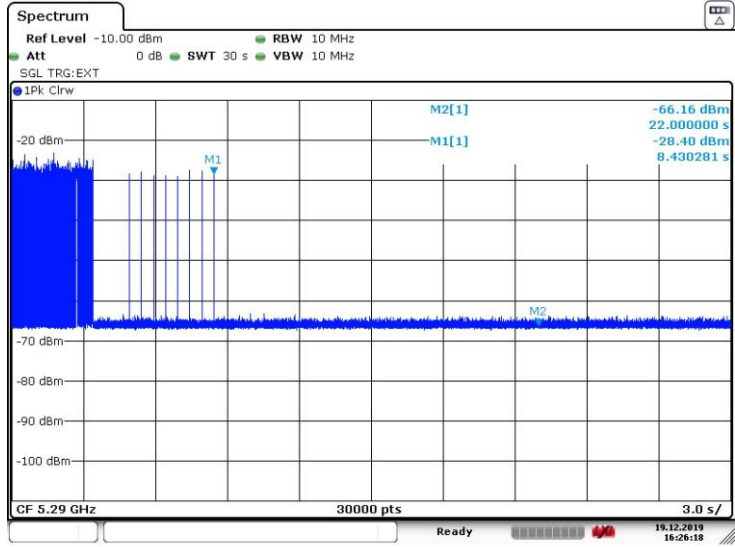

Date: 19 DEC 2019 16:26:18

<80MHz / 5530MHz> Radar Type 5

Channel Move Time

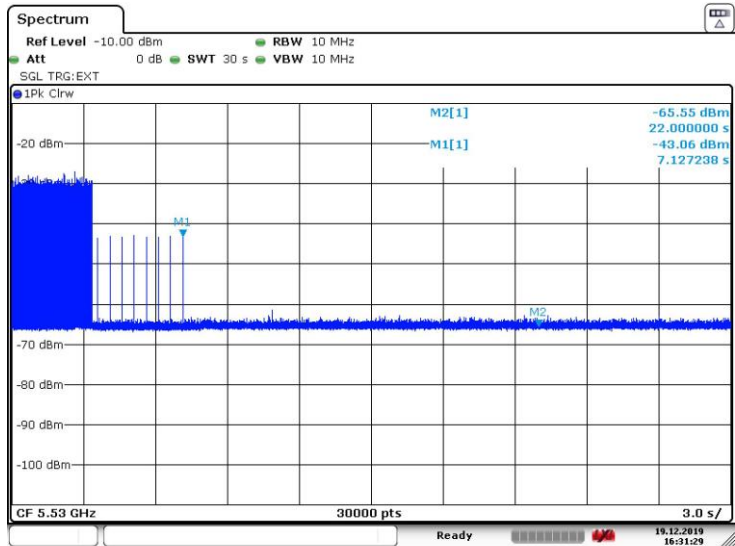

Date: 19 DEC 2019 16:31:29



3.4.8 Data Traffic Channel Loading and Noise Floor Plots

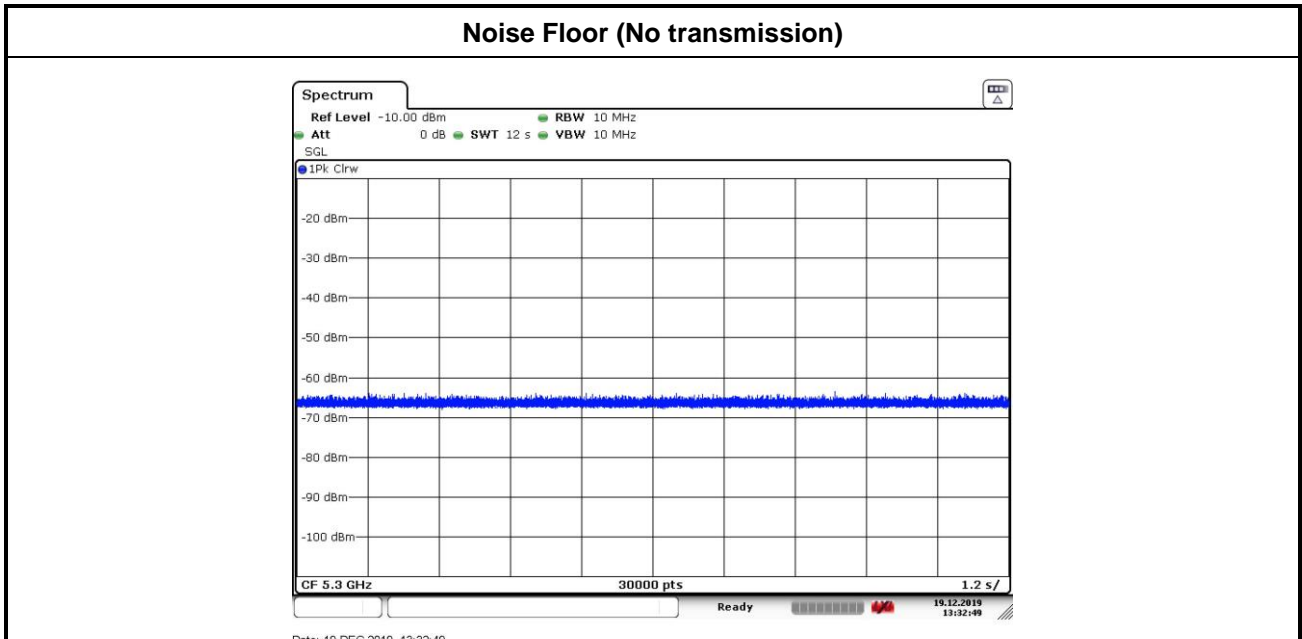
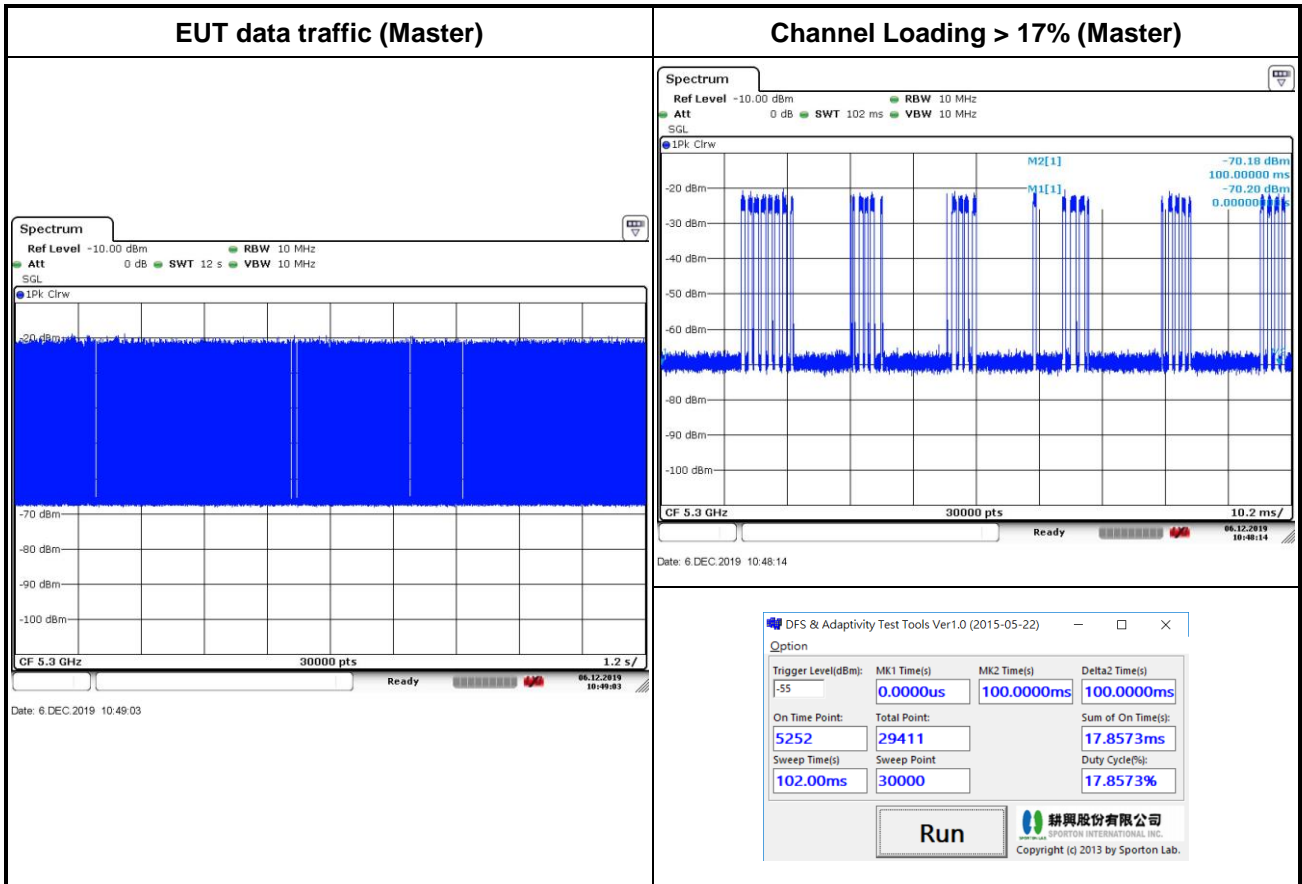



3.5 Statistical Performance Check

3.5.1 Limit of Statistical Performance Check

Short Pulse Radar Test

Once the performance requirements check is complete, statistical data will be gathered, to determine the ability of the device to detect the radar test waveforms (Short Pulse Radar Types 1-4) found in **Table 5**. The device can utilize a test mode to demonstrate when detection occurs to prevent the need to reset the device between trials. The percentage of successful detection is calculated by:

$$\frac{\text{TotalWaveformDetections}}{\text{TotalWaveformTrials}} \times 100 = \text{Percentage of Successful Detection Radar Waveform } N = P_d N$$

In addition an aggregate minimum percentage of successful detection across all Short Pulse Radar Types 1-4 is required and is calculated as follows:

$$\frac{P_d 1 + P_d 2 + P_d 3 + P_d 4}{4}$$

The minimum number of trails, minimum percentage of successful detection and the aggregate minimum percentage of successful detection are found in **Table 5**.

Table 5 – Short Pulse Radar Test Waveforms

| Radar Type | Pulse Width (µsec) | PRI (µsec) | Number of Pulses | Minimum Percentage of Successful Detection | Minimum Number of Trials |
|-----------------------------|--------------------|------------|------------------|--|--------------------------|
| 1 | 1 | 1428 | 18 | 60% | 30 |
| 2 | 1-5 | 150-230 | 23-29 | 60% | 30 |
| 3 | 6-10 | 200-500 | 16-18 | 60% | 30 |
| 4 | 11-20 | 200-500 | 12-16 | 60% | 30 |
| Aggregate (Radar Types 1-4) | | | | 80% | 120 |



A minimum of 30 unique waveforms are required for each of the Short Pulse Radar Types 1 through 4. For Short Pulse Radar Type 0, the same waveform is used a minimum of 30 times. If more than 30 waveforms are used for Short Pulse Radar Types 1 through 4, then each additional waveform must also be unique and not repeated from the previous waveforms.

| Radar Type | Number of Trials | Number of Successful Detections | Minimum Percentage of Successful Detection |
|--|------------------|---------------------------------|--|
| 1 | 35 | 29 | 82.9% |
| 2 | 30 | 18 | 60% |
| 3 | 30 | 27 | 90% |
| 4 | 50 | 44 | 88% |
| Aggregate $(82.9\% + 60\% + 90\% + 88\%)/4 = 80.2\%$ | | | |



Long Pulse Radar Test

Statistical data will be gathered to determine the ability of the device to detect the Long Pulse Radar Type 5 found in **Table 6**. The device can utilize a test mode to demonstrate when detection occurs to prevent the need to reset the device between trials.

Table 6 – Long Pulse Radar Test Waveform

| Radar Type | Pulse Width (μsec) | Chirp Width (MHz) | PRI (μsec) | Number of Pulses per Burst | Number of Bursts | Minimum Percentage of Successful Detection | Minimum Number of Trials |
|------------|--------------------|-------------------|------------|----------------------------|------------------|--|--------------------------|
| 5 | 50-100 | 5-20 | 1000-2000 | 1-3 | 8-20 | 80% | 30 |

The parameters for this waveform are randomly chosen. Thirty unique waveforms are required for the Long Pulse Radar Type waveforms. If more than 30 waveforms are used for the Long Pulse Radar Type waveforms, then each additional waveform must also be unique and not repeated from the previous waveforms.

Three subsets of trials will be performed with a minimum of ten trials per subset.

The subset of trials differs in where the Long Pulse Type 5 Signal is tuned in frequency:

- a) The Channel center frequency (subset case 1).
- b) Tuned frequencies such that 90% of the Long Pulse Type 5 frequency modulation is within the low edge of the UUT Occupied Bandwidth (subset case 2).
- c) Tuned frequencies such that 90% of the Long Pulse Type 5 frequency modulation is within the high edge of the UUT Occupied Bandwidth (subset case 3).

For subset case 1: the center frequency of the signal generator will remain fixed at the center of the UUT Channel.

For subset case 2: to retain 90% frequency overlap between the radar signal and the UUT Occupied Bandwidth, the center frequency of the signal generator will vary for each of the ten trials in subset case 2.

The center frequency of the signal generator for each trial is calculated by: $FL + (0.4 * Chirp\ Width\ [in\ MHz])$

For subset case 3: to retain 90% frequency overlap between the radar signal and the UUT Occupied Bandwidth, the center frequency of the signal generator will vary for each of the ten trials in subset case 3.

The center frequency of the signal generator for each trial is calculated by: $FH - (0.4 * Chirp\ Width\ [in\ MHz])$

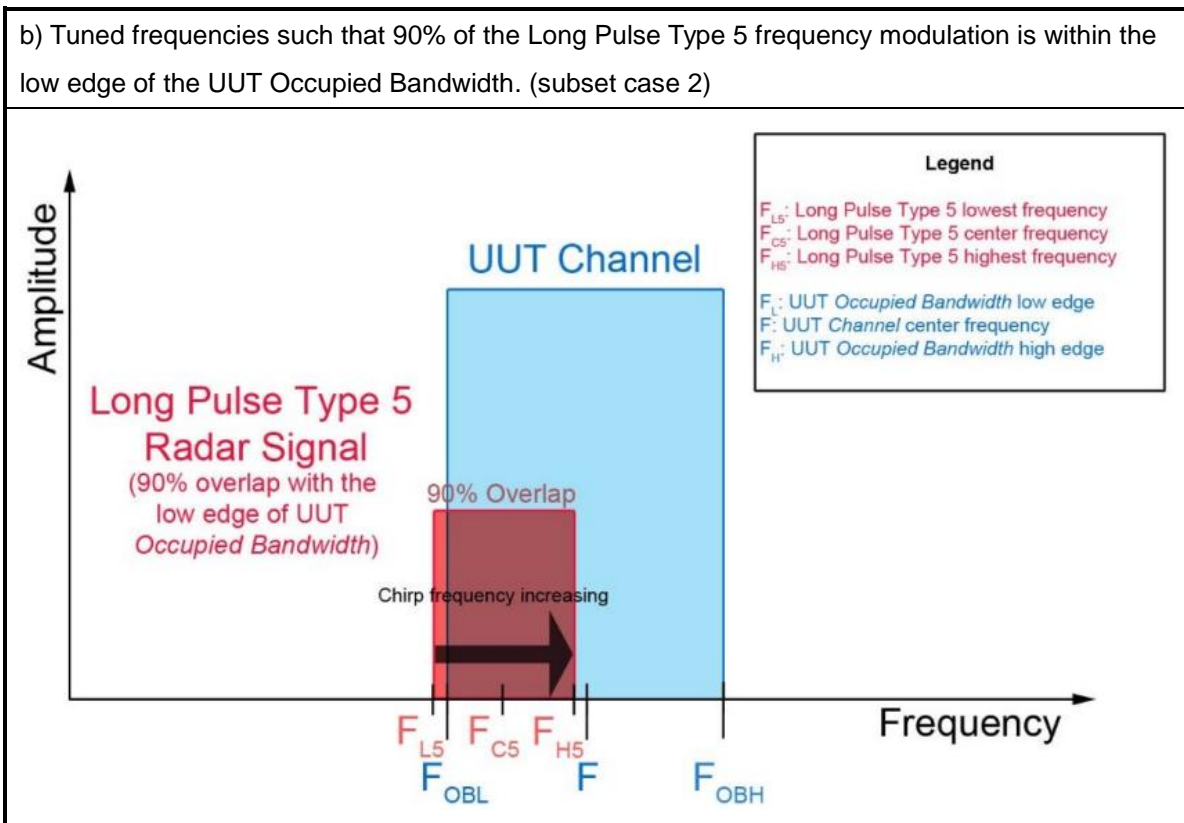
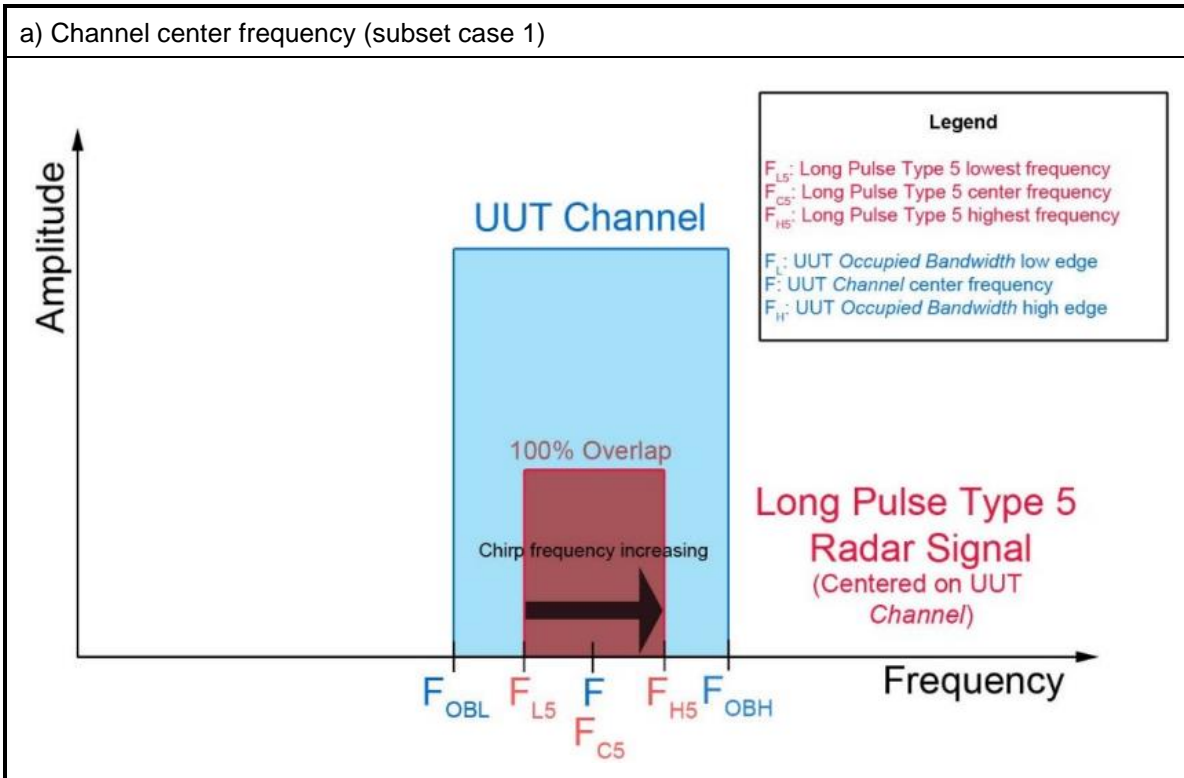

c) Tuned frequencies such that 90% of the Long Pulse Type 5 frequency modulation is within the high edge of the UUT Occupied Bandwidth. (subset case 3)

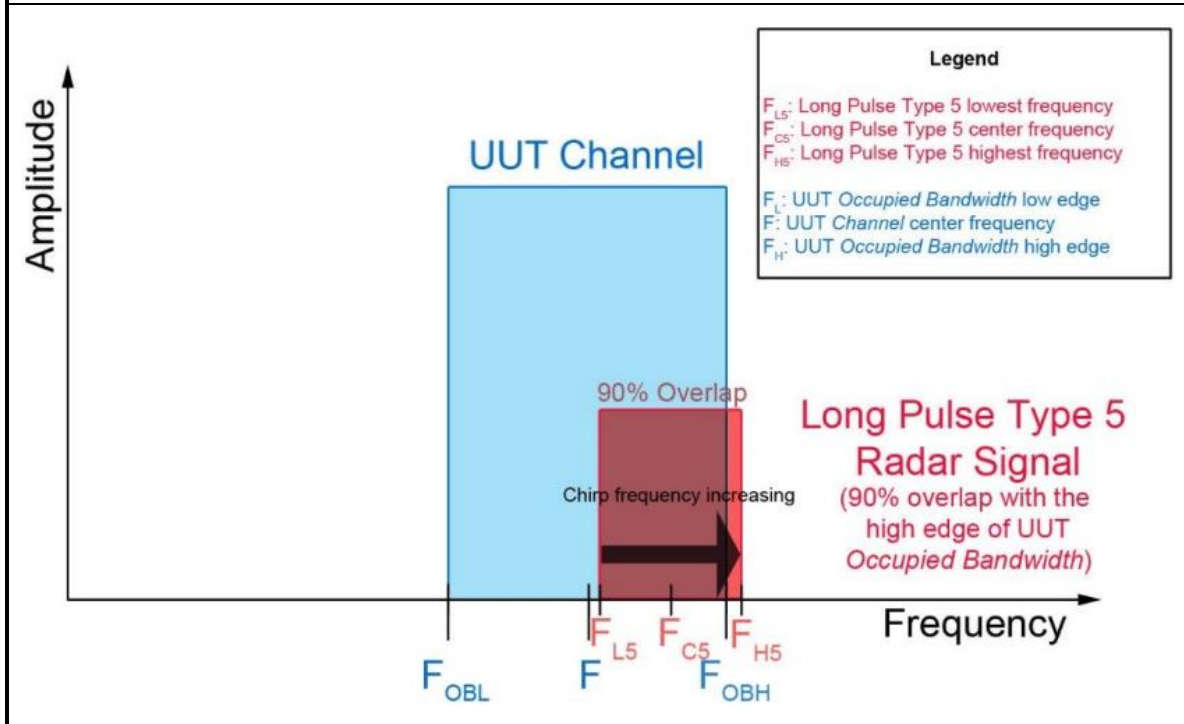

The percentage of successful detection is calculated by:

$$\frac{\text{TotalWaveformDetections}}{\text{TotalWaveformTrials}} \times 100$$



Frequency Hopping Radar Test

Statistical data will be gathered to determine the ability of the device to detect the Frequency Hopping radar test signal (radar type 6) found in **Table 7**. The device can utilize a test mode to demonstrate when detection occurs to prevent the need to reset the device between trial runs. The probability of successful detection is calculated by:

$$\frac{TotalWaveformDetections}{TotalWaveformTrials} \times 100$$

Table 7 – Frequency Hopping Radar Test Waveform

| Radars Type | Pulse Width (µsec) | PRI (µsec) | Pulses per Hop | Hopping Rate (kHz) | Hopping Sequence Length (msec) | Minimum Percentage of Successful Detection | Minimum Number of Trials |
|-------------|--------------------|------------|----------------|--------------------|--------------------------------|--|--------------------------|
| 6 | 1 | 333 | 9 | 0.333 | 300 | 70% | 30 |

For the Frequency Hopping Radar Type, the same *Burst* parameters are used for each waveform. The hopping sequence is different for each waveform and a 100-length segment is selected from the hopping sequence defined by the following algorithm:

The first frequency in a hopping sequence is selected randomly from the group of 475 integer frequencies from 5250 – 5724 MHz. Next, the frequency that was just chosen is removed from the group and a frequency is randomly selected from the remaining 474 frequencies in the group. This process continues until all 475 frequencies are chosen for the set. For selection of a random frequency, the frequencies remaining within the group are always treated as equally likely.

3.5.2 Test Procedures

- (1) One frequency will be chosen from the Operating Channels of the EUT within the 5250-5350 MHz or 5470-5725 MHz bands.
- (2) In case the EUT is a Master Device, a U-NII device operating as a Client Device will be used and it is assumed that the Client will associate with the EUT (Master). If the Master Device has antenna gain, the main beam of the antenna will be directed toward the radar emitter. Vertical polarization is used for testing.
- (3) The TCP protocol unicast data stream was generated by the iperf software command line with at least 17% activity ratio over any 100ms period.
- (4) At time T_0 the Radar Waveform generator sends a Burst of pulses for each of the Radar Types 1-6 at DFS Detection Threshold levels on the Operating Channel. An additional 1 dB is added to the radar test signal to ensure it is at or above the DFS Detection Threshold, accounting for equipment variations/errors.
- (5) Observe the transmissions of the EUT at the end of the Burst on the Operating Channel for duration greater than 10 seconds for Short Pulse Radar Types 1-4 and 6 to ensure detection occurs.
- (6) Observe the transmissions of the EUT at the end of the Burst on the Operating Channel for duration greater than 22 seconds for Long Pulse Radar Type 5 to ensure detection occurs.

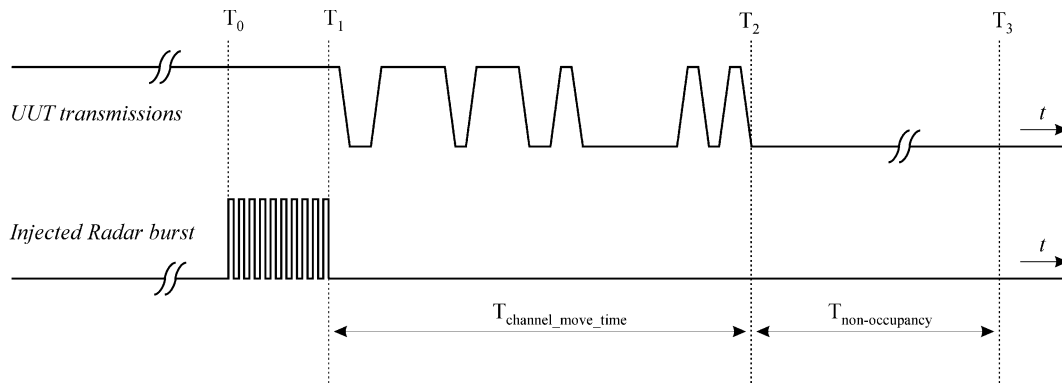

3.5.3 Test Setup

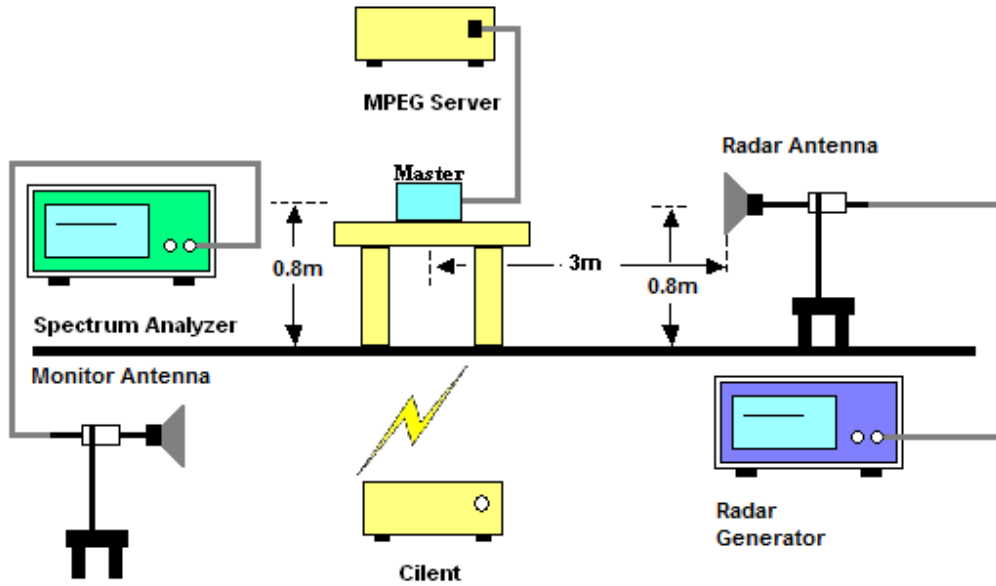

3.5.4 Test Deviation

There is no deviation with the original standard.



3.5.5 Result of Statistical Performance Check

<Mode1>

<20MHz / 5500MHz>

| (Detection = Y, No Detection = N) | | | | | | |
|--|----------------------------|------------------|------------------|------------------|------------------|------------------|
| Trial Number | Type 1 | Type 2 | Type 3 | Type 4 | Type 5 | Type 6 |
| 1 | Y | Y | Y | Y | Y | Y |
| 2 | Y | Y | Y | Y | Y | Y |
| 3 | Y | Y | Y | Y | Y | Y |
| 4 | Y | Y | Y | Y | Y | Y |
| 5 | Y | Y | Y | Y | Y | Y |
| 6 | Y | Y | Y | Y | Y | Y |
| 7 | Y | Y | Y | N | Y | Y |
| 8 | Y | N | Y | Y | Y | Y |
| 9 | Y | Y | Y | Y | Y | Y |
| 10 | Y | Y | Y | Y | Y | Y |
| 11 | Y | Y | Y | Y | Y | Y |
| 12 | Y | Y | Y | Y | Y | Y |
| 13 | Y | N | Y | Y | Y | Y |
| 14 | Y | Y | Y | Y | Y | Y |
| 15 | Y | Y | Y | Y | Y | Y |
| 16 | Y | Y | Y | Y | Y | Y |
| 17 | Y | Y | Y | Y | Y | Y |
| 18 | Y | Y | Y | Y | Y | Y |
| 19 | Y | Y | Y | Y | Y | Y |
| 20 | Y | Y | Y | Y | Y | Y |
| 21 | Y | Y | N | Y | Y | Y |
| 22 | Y | Y | Y | Y | Y | Y |
| 23 | Y | Y | Y | Y | Y | Y |
| 24 | Y | Y | Y | Y | Y | Y |
| 25 | Y | Y | Y | Y | Y | Y |
| 26 | Y | Y | Y | Y | Y | Y |
| 27 | Y | Y | Y | Y | Y | Y |
| 28 | Y | Y | Y | Y | Y | Y |
| 29 | Y | Y | Y | Y | Y | Y |
| 30 | Y | Y | Y | Y | Y | Y |
| Trial of Detection | 30/30 | 28/30 | 29/30 | 29/30 | 30/30 | 30/30 |
| Probability (%) | 100% | 93% | 97% | 97% | 100% | 100% |
| Limit (%) | >= 60% | >= 60% | >= 60% | >= 60% | >= 80% | >= 70% |
| Average Probability of Radar Type 1~4 (%) | 96.75% (>=80%) | | | | | |



<40MHz / 5510MHz>

| (Detection = Y, No Detection = N) | | | | | | |
|--|------------------|------------------|------------------|----------------------------|------------------|------------------|
| Trial Number | Type 1 | Type 2 | Type 3 | Type 4 | Type 5 | Type 6 |
| 1 | Y | Y | Y | Y | Y | Y |
| 2 | Y | Y | Y | Y | Y | Y |
| 3 | Y | Y | Y | N | Y | Y |
| 4 | Y | Y | Y | Y | Y | Y |
| 5 | Y | Y | Y | N | Y | Y |
| 6 | Y | Y | Y | Y | Y | Y |
| 7 | Y | Y | N | Y | Y | Y |
| 8 | Y | Y | N | N | Y | Y |
| 9 | Y | Y | Y | Y | Y | Y |
| 10 | Y | Y | Y | Y | Y | Y |
| 11 | Y | Y | N | Y | Y | Y |
| 12 | Y | Y | Y | Y | Y | Y |
| 13 | Y | N | Y | Y | Y | Y |
| 14 | Y | Y | Y | Y | Y | Y |
| 15 | Y | Y | Y | Y | Y | Y |
| 16 | Y | Y | Y | Y | Y | Y |
| 17 | Y | Y | Y | N | Y | Y |
| 18 | Y | Y | Y | Y | Y | Y |
| 19 | Y | Y | Y | Y | Y | Y |
| 20 | Y | Y | Y | Y | Y | Y |
| 21 | Y | Y | Y | Y | Y | Y |
| 22 | Y | Y | Y | Y | Y | Y |
| 23 | Y | Y | Y | N | Y | Y |
| 24 | Y | Y | N | Y | Y | Y |
| 25 | Y | N | Y | Y | Y | Y |
| 26 | Y | Y | N | Y | Y | Y |
| 27 | Y | Y | Y | Y | Y | Y |
| 28 | Y | Y | Y | Y | Y | Y |
| 29 | Y | N | Y | Y | Y | Y |
| 30 | Y | Y | | N | Y | Y |
| Trial of Detection | 30/30 | 27/30 | 25/30 | 24/30 | 30/30 | 30/30 |
| Probability (%) | 100% | 90% | 83% | 80% | 100% | 100% |
| Limit (%) | >= 60% | >= 60% | >= 60% | >= 60% | >= 80% | >= 70% |
| Average Probability of Radar Type 1~4 (%) | | | | 88.25% (>=80%) | | |



<80MHz / 5530MHz>

| (Detection = Y, No Detection = N) | | | | | | |
|--|------------------|------------------|----------------------------|------------------|------------------|------------------|
| Trial Number | Type 1 | Type 2 | Type 3 | Type 4 | Type 5 | Type 6 |
| 1 | Y | Y | Y | Y | Y | Y |
| 2 | Y | Y | Y | Y | Y | Y |
| 3 | Y | Y | Y | Y | Y | Y |
| 4 | Y | Y | Y | Y | Y | Y |
| 5 | Y | Y | Y | Y | Y | Y |
| 6 | Y | Y | Y | Y | Y | Y |
| 7 | Y | Y | Y | N | Y | Y |
| 8 | Y | Y | Y | Y | Y | Y |
| 9 | Y | Y | N | Y | Y | Y |
| 10 | Y | Y | Y | Y | Y | Y |
| 11 | Y | Y | Y | N | Y | Y |
| 12 | Y | Y | Y | Y | Y | Y |
| 13 | Y | Y | Y | Y | Y | Y |
| 14 | Y | Y | Y | Y | Y | Y |
| 15 | Y | Y | Y | Y | Y | Y |
| 16 | Y | Y | Y | Y | Y | Y |
| 17 | Y | Y | Y | Y | Y | Y |
| 18 | Y | Y | Y | Y | Y | Y |
| 19 | Y | Y | Y | Y | N | Y |
| 20 | Y | Y | Y | Y | Y | Y |
| 21 | Y | Y | Y | Y | Y | Y |
| 22 | Y | Y | Y | Y | Y | Y |
| 23 | Y | Y | Y | N | Y | Y |
| 24 | Y | Y | Y | Y | Y | Y |
| 25 | Y | Y | Y | Y | Y | Y |
| 26 | Y | Y | Y | Y | Y | Y |
| 27 | Y | Y | N | Y | Y | Y |
| 28 | Y | Y | Y | Y | Y | Y |
| 29 | Y | Y | Y | Y | Y | Y |
| 30 | Y | Y | Y | Y | Y | Y |
| Trial of Detection | 30/30 | 30/30 | 28/30 | 27/30 | 29/30 | 30/30 |
| Probability (%) | 100% | 100% | 93% | 90% | 97% | 100% |
| Limit (%) | >= 60% | >= 60% | >= 60% | >= 60% | >= 80% | >= 70% |
| Average Probability of Radar Type 1~4 (%) | | | 95.75% (>=80%) | | | |



<Mode2>

<20MHz / 5300MHz>

| (Detection = Y, No Detection = N) | | | | | | |
|--|------------------|------------------|------------------|----------------------------|------------------|------------------|
| Trial Number | Type 1 | Type 2 | Type 3 | Type 4 | Type 5 | Type 6 |
| 1 | Y | Y | Y | Y | Y | Y |
| 2 | Y | Y | Y | Y | Y | Y |
| 3 | Y | Y | Y | Y | Y | Y |
| 4 | Y | Y | Y | Y | Y | Y |
| 5 | Y | Y | Y | N | Y | Y |
| 6 | Y | Y | Y | Y | Y | Y |
| 7 | Y | Y | Y | Y | Y | Y |
| 8 | Y | Y | Y | Y | Y | Y |
| 9 | Y | Y | Y | Y | Y | Y |
| 10 | Y | Y | Y | Y | Y | Y |
| 11 | Y | Y | Y | Y | Y | Y |
| 12 | Y | Y | Y | Y | Y | Y |
| 13 | Y | Y | Y | N | Y | Y |
| 14 | Y | Y | Y | Y | Y | Y |
| 15 | Y | Y | Y | Y | Y | Y |
| 16 | Y | Y | Y | N | Y | Y |
| 17 | Y | Y | Y | Y | Y | Y |
| 18 | Y | N | Y | Y | Y | Y |
| 19 | Y | Y | N | Y | Y | Y |
| 20 | Y | Y | N | Y | Y | Y |
| 21 | Y | Y | Y | Y | Y | Y |
| 22 | Y | Y | Y | Y | Y | Y |
| 23 | Y | Y | Y | Y | Y | Y |
| 24 | Y | Y | Y | N | Y | Y |
| 25 | Y | Y | Y | Y | Y | Y |
| 26 | Y | Y | Y | Y | Y | Y |
| 27 | Y | Y | Y | Y | Y | Y |
| 28 | Y | Y | Y | Y | Y | Y |
| 29 | Y | Y | Y | Y | Y | Y |
| 30 | Y | Y | Y | Y | Y | Y |
| Trial of Detection | 30/30 | 29/30 | 28/30 | 26/30 | 30/30 | 30/30 |
| Probability (%) | 100% | 97% | 93% | 87% | 100% | 100% |
| Limit (%) | >= 60% | >= 60% | >= 60% | >= 60% | >= 80% | >= 70% |
| Average Probability of Radar Type 1~4 (%) | | | | 94.25% (>=80%) | | |



<40MHz /5310MHz>

| (Detection = Y, No Detection = N) | | | | | | |
|--|----------------------------|------------------|------------------|------------------|------------------|------------------|
| Trial Number | Type 1 | Type 2 | Type 3 | Type 4 | Type 5 | Type 6 |
| 1 | Y | Y | Y | Y | Y | Y |
| 2 | Y | Y | Y | Y | Y | Y |
| 3 | Y | Y | N | Y | Y | Y |
| 4 | Y | Y | Y | Y | Y | Y |
| 5 | Y | Y | Y | Y | Y | Y |
| 6 | Y | Y | Y | Y | Y | Y |
| 7 | Y | N | Y | Y | Y | Y |
| 8 | Y | Y | Y | Y | Y | Y |
| 9 | Y | Y | Y | Y | Y | Y |
| 10 | Y | Y | Y | Y | Y | Y |
| 11 | Y | Y | Y | Y | Y | Y |
| 12 | Y | Y | Y | Y | Y | Y |
| 13 | Y | Y | Y | Y | Y | Y |
| 14 | Y | Y | Y | Y | Y | Y |
| 15 | Y | Y | Y | Y | Y | Y |
| 16 | Y | Y | Y | Y | Y | Y |
| 17 | Y | N | Y | N | Y | Y |
| 18 | Y | N | Y | N | Y | Y |
| 19 | Y | Y | Y | Y | Y | Y |
| 20 | Y | Y | Y | Y | Y | Y |
| 21 | Y | Y | Y | Y | Y | Y |
| 22 | Y | Y | Y | Y | Y | Y |
| 23 | Y | Y | Y | Y | Y | Y |
| 24 | Y | Y | Y | Y | Y | Y |
| 25 | Y | Y | Y | Y | Y | Y |
| 26 | Y | Y | Y | Y | Y | Y |
| 27 | Y | Y | Y | Y | Y | Y |
| 28 | Y | Y | Y | Y | Y | Y |
| 29 | Y | Y | Y | N | Y | Y |
| 30 | Y | Y | Y | Y | Y | Y |
| Trial of Detection | 30/30 | 27/30 | 29/30 | 27/30 | 30/30 | 30/30 |
| Probability (%) | 100% | 90% | 97% | 90% | 100% | 100% |
| Limit (%) | >= 60% | >= 60% | >= 60% | >= 60% | >= 80% | >= 70% |
| Average Probability of Radar Type 1~4 (%) | 94.25% (>=80%) | | | | | |



<80MHz / 5290MHz>

| (Detection = Y, No Detection = N) | | | | | | |
|--|---------------------------|------------------|------------------|------------------|------------------|------------------|
| Trial Number | Type 1 | Type 2 | Type 3 | Type 4 | Type 5 | Type 6 |
| 1 | Y | Y | Y | Y | Y | Y |
| 2 | Y | Y | Y | Y | Y | Y |
| 3 | Y | N | Y | Y | Y | Y |
| 4 | Y | N | Y | Y | Y | Y |
| 5 | Y | Y | Y | Y | Y | Y |
| 6 | Y | Y | Y | N | Y | Y |
| 7 | Y | Y | Y | Y | Y | Y |
| 8 | Y | Y | Y | Y | Y | Y |
| 9 | Y | Y | Y | Y | Y | Y |
| 10 | Y | Y | Y | Y | Y | Y |
| 11 | Y | Y | Y | Y | Y | Y |
| 12 | Y | Y | Y | Y | Y | Y |
| 13 | Y | Y | Y | Y | Y | Y |
| 14 | Y | Y | Y | Y | Y | Y |
| 15 | Y | Y | Y | Y | Y | Y |
| 16 | Y | Y | Y | Y | Y | Y |
| 17 | Y | N | Y | Y | Y | Y |
| 18 | Y | Y | N | Y | Y | Y |
| 19 | Y | Y | Y | Y | Y | Y |
| 20 | Y | Y | Y | Y | Y | Y |
| 21 | Y | Y | Y | Y | Y | Y |
| 22 | Y | Y | Y | Y | Y | Y |
| 23 | Y | Y | Y | N | Y | Y |
| 24 | Y | Y | Y | Y | Y | Y |
| 25 | Y | Y | Y | Y | Y | Y |
| 26 | Y | Y | Y | Y | Y | Y |
| 27 | Y | N | N | N | Y | Y |
| 28 | Y | Y | Y | Y | Y | Y |
| 29 | Y | Y | Y | Y | Y | Y |
| 30 | Y | Y | Y | Y | Y | Y |
| Trial of Detection | 30/30 | 26/30 | 28/30 | 27/30 | 30/30 | 30/30 |
| Probability (%) | 100% | 87% | 93% | 90% | 100% | 100% |
| Limit (%) | >= 60% | >= 60% | >= 60% | >= 60% | >= 80% | >= 70% |
| Average Probability of Radar Type 1~4 (%) | 92.5% (>=80%) | | | | | |



<20MHz / 5500MHz>

| (Detection = Y, No Detection = N) | | | | | | |
|--|-------------------------|------------------|------------------|------------------|------------------|------------------|
| Trial Number | Type 1 | Type 2 | Type 3 | Type 4 | Type 5 | Type 6 |
| 1 | Y | Y | Y | Y | Y | Y |
| 2 | Y | Y | Y | Y | Y | Y |
| 3 | Y | Y | Y | Y | Y | Y |
| 4 | Y | Y | Y | Y | Y | Y |
| 5 | Y | Y | Y | Y | Y | Y |
| 6 | Y | Y | Y | Y | Y | Y |
| 7 | Y | Y | Y | Y | Y | Y |
| 8 | Y | N | Y | Y | Y | Y |
| 9 | Y | Y | Y | Y | Y | Y |
| 10 | Y | Y | Y | Y | Y | Y |
| 11 | Y | Y | Y | Y | Y | Y |
| 12 | Y | Y | Y | Y | Y | Y |
| 13 | Y | Y | Y | Y | Y | Y |
| 14 | Y | Y | Y | Y | Y | Y |
| 15 | Y | Y | Y | Y | Y | Y |
| 16 | Y | Y | Y | N | Y | Y |
| 17 | Y | Y | Y | Y | Y | Y |
| 18 | Y | Y | Y | Y | Y | Y |
| 19 | Y | Y | Y | Y | Y | Y |
| 20 | Y | Y | Y | Y | Y | Y |
| 21 | Y | Y | N | Y | Y | Y |
| 22 | Y | N | Y | Y | Y | Y |
| 23 | Y | Y | N | N | Y | Y |
| 24 | Y | N | Y | Y | Y | Y |
| 25 | Y | Y | Y | Y | Y | Y |
| 26 | Y | Y | Y | Y | Y | Y |
| 27 | Y | Y | Y | Y | Y | Y |
| 28 | Y | Y | Y | Y | Y | Y |
| 29 | Y | Y | Y | Y | Y | Y |
| 30 | Y | Y | Y | Y | Y | Y |
| Trial of Detection | 30/30 | 27/30 | 28/30 | 28/30 | 30/30 | 30/30 |
| Probability (%) | 100% | 90% | 93% | 93% | 100% | 100% |
| Limit (%) | >= 60% | >= 60% | >= 60% | >= 60% | >= 80% | >= 70% |
| Average Probability of Radar Type 1~4 (%) | 94% (>=80%) | | | | | |



<40MHz / 5510MHz>

| (Detection = Y, No Detection = N) | | | | | | |
|--|-------------------------|------------------|------------------|------------------|------------------|------------------|
| Trial Number | Type 1 | Type 2 | Type 3 | Type 4 | Type 5 | Type 6 |
| 1 | Y | Y | Y | Y | Y | Y |
| 2 | Y | Y | Y | Y | Y | Y |
| 3 | Y | Y | N | Y | Y | Y |
| 4 | Y | Y | Y | Y | Y | Y |
| 5 | Y | Y | Y | Y | Y | Y |
| 6 | Y | N | Y | Y | Y | Y |
| 7 | Y | Y | N | Y | Y | Y |
| 8 | Y | Y | Y | Y | Y | Y |
| 9 | Y | Y | Y | Y | Y | Y |
| 10 | Y | N | Y | Y | Y | Y |
| 11 | Y | Y | Y | Y | Y | Y |
| 12 | Y | Y | Y | Y | Y | Y |
| 13 | Y | Y | Y | Y | Y | Y |
| 14 | Y | Y | Y | Y | Y | Y |
| 15 | Y | Y | N | Y | Y | Y |
| 16 | Y | Y | Y | Y | Y | Y |
| 17 | Y | Y | Y | Y | Y | Y |
| 18 | Y | Y | N | N | Y | Y |
| 19 | Y | N | Y | Y | Y | Y |
| 20 | Y | Y | Y | Y | Y | Y |
| 21 | Y | Y | Y | Y | Y | Y |
| 22 | Y | Y | Y | Y | Y | Y |
| 23 | Y | Y | Y | Y | Y | Y |
| 24 | Y | Y | Y | Y | Y | Y |
| 25 | Y | Y | Y | Y | Y | Y |
| 26 | Y | Y | Y | Y | Y | Y |
| 27 | Y | Y | N | Y | Y | Y |
| 28 | Y | N | Y | Y | Y | Y |
| 29 | Y | Y | Y | Y | Y | Y |
| 30 | Y | Y | N | Y | Y | Y |
| Trial of Detection | 30/30 | 26/30 | 24/30 | 29/30 | 30/30 | 30/30 |
| Probability (%) | 100% | 87% | 80% | 97% | 100% | 100% |
| Limit (%) | >= 60% | >= 60% | >= 60% | >= 60% | >= 80% | >= 70% |
| Average Probability of Radar Type 1~4 (%) | 91% (>=80%) | | | | | |



<80MHz / 5530MHz>

| (Detection = Y, No Detection = N) | | | | | | |
|--|------------------|------------------|----------------------------|------------------|------------------|------------------|
| Trial Number | Type 1 | Type 2 | Type 3 | Type 4 | Type 5 | Type 6 |
| 1 | Y | Y | Y | Y | Y | Y |
| 2 | Y | Y | Y | Y | Y | Y |
| 3 | Y | Y | Y | N | Y | Y |
| 4 | Y | Y | Y | N | Y | Y |
| 5 | Y | Y | Y | Y | Y | Y |
| 6 | Y | Y | N | N | Y | Y |
| 7 | Y | Y | N | Y | Y | Y |
| 8 | Y | Y | Y | Y | Y | Y |
| 9 | Y | Y | Y | Y | Y | Y |
| 10 | Y | Y | Y | Y | Y | Y |
| 11 | Y | Y | Y | N | Y | Y |
| 12 | Y | Y | Y | Y | Y | Y |
| 13 | Y | Y | Y | Y | Y | Y |
| 14 | Y | Y | Y | Y | Y | Y |
| 15 | Y | Y | Y | N | Y | Y |
| 16 | Y | Y | N | Y | Y | Y |
| 17 | Y | Y | Y | Y | Y | Y |
| 18 | Y | N | Y | Y | Y | Y |
| 19 | Y | Y | Y | Y | Y | Y |
| 20 | Y | Y | Y | Y | Y | Y |
| 21 | Y | Y | N | Y | Y | Y |
| 22 | Y | Y | Y | N | Y | Y |
| 23 | Y | Y | N | N | Y | Y |
| 24 | Y | Y | Y | Y | Y | Y |
| 25 | Y | Y | Y | Y | Y | Y |
| 26 | Y | Y | Y | Y | Y | Y |
| 27 | Y | Y | Y | Y | Y | Y |
| 28 | Y | Y | Y | Y | Y | Y |
| 29 | Y | Y | Y | N | Y | Y |
| 30 | Y | Y | Y | Y | Y | Y |
| Trial of Detection | 30/30 | 29/30 | 25/30 | 22/30 | 30/30 | 30/30 |
| Probability (%) | 100% | 97% | 83% | 73% | 100% | 100% |
| Limit (%) | >= 60% | >= 60% | >= 60% | >= 60% | >= 80% | >= 70% |
| Average Probability of Radar Type 1~4 (%) | | | 88.25% (>=80%) | | | |



4 List of Measuring Equipment

| Instrument | Manufacturer | Model No. | Serial No. | Characteristics | Calibration Date | Test Date | Due Date | Remark |
|---------------------|-----------------|-----------|-----------------|-----------------|------------------|---------------------------------|---------------|-------------------|
| RF Vector Generator | Keysight | N5182B | MY573009 63 | 9KHz~6GHz | Jan. 31, 2019 | Dec. 06, 2019~ Dec. 20, 2019 | Jan. 30, 2020 | DFS (DFS01-CA) |
| Spectrum Analyzer | R&S | FSV13 | 101559 | 10Hz~13.6GHz | Jun. 12, 2019 | Dec. 06, 2019~ Dec. 20, 2019 | Jun. 11, 2020 | DFS (DFS01-CA) |
| Horn Antenna | SCHWARZBE CK | 9120D | 9120D_02 113 | N/A | Jul. 22, 2019 | Dec. 06, 2019~ Dec. 20, 2019 | Jul. 21, 2020 | DFS (DFS01-CA) |
| Horn Antenna | SCHWARZBE CK | 9120D | 9120D_02 115 | N/A | Jul. 22, 2019 | Dec. 06, 2019~ Dec. 20, 2019 | Jul. 21, 2020 | DFS (DFS01-CA) |