

FCC Test Report

Report No.: RF190624C08A

FCC ID: TVE-37176T0464

Test Model: FAP-231E

Series Model: FortiAP 231Exxxxxx, FAP-231E xxxxxx, FORTIAP-231E xxxxxx (where "x" can be used as "A-Z", or "-0-9", or "-", or blank for software changes or marketing purposes only) (refer to item 3.1 for more details)

Received Date: Sep. 10, 2019

Test Date: Sep. 17 ~ Nov. 11, 2019

Issued Date: Nov. 11, 2019

Applicant: Fortinet Inc.

Address: 899 Kifer Road Sunnyvale, CA 94086 USA

Issued By: Bureau Veritas Consumer Products Services (H.K.) Ltd., Taoyuan Branch
Lin Kou Laboratories

Lab Address: No. 47-2, 14th Ling, Chia Pau Vil., Lin Kou Dist., New Taipei City, Taiwan

Test Location: No. 19, Hwa Ya 2nd Rd., Wen Hwa Vil., Kwei Shan Dist., Taoyuan City
33383, TAIWAN

**FCC Registration /
Designation Number:** 788550 / TW0003



This report is for your exclusive use. Any copying or replication of this report to or for any other person or entity, or use of our name or trademark, is permitted only with our prior written permission. This report sets forth our findings solely with respect to the test samples identified herein. The results set forth in this report are not indicative or representative of the quality or characteristics of the lot from which a test sample was taken or any similar or identical product unless specifically and expressly noted. Our report includes all of the tests requested by you and the results thereof based upon the information that you provided to us. You have 60 days from date of issuance of this report to notify us of any material error or omission caused by our negligence, provided, however, that such notice shall be in writing and shall specifically address the issue you wish to raise. A failure to raise such issue within the prescribed time shall constitute your unqualified acceptance of the completeness of this report, the tests conducted and the correctness of the report contents. Unless specific mention, the uncertainty of measurement has been explicitly taken into account to declare the compliance or non-compliance to the specification. This report should not be used by the client to claim product certification, approval, or endorsement by TAF or any government agencies.

Table of Contents

Release Control Record	4
1 Certificate of Conformity	5
2 Summary of Test Results	6
2.1 Measurement Uncertainty.....	6
2.2 Modification Record.....	6
3 General Information	7
3.1 General Description of EUT.....	7
3.2 Description of Test Modes.....	10
3.2.1 Test Mode Applicability and Tested Channel Detail.....	11
3.3 Duty Cycle of Test Signal.....	14
3.4 Description of Support Units.....	16
3.4.1 Configuration of System under Test.....	16
3.5 General Description of Applied Standards and References.....	17
4 Test Types and Results	18
4.1 Radiated Emission and Bandedge Measurement.....	18
4.1.1 Limits of Radiated Emission and Bandedge Measurement.....	18
4.1.2 Test Instruments.....	19
4.1.3 Test Procedures.....	20
4.1.4 Deviation from Test Standard.....	20
4.1.5 Test Setup.....	21
4.1.6 EUT Operating Conditions.....	22
4.1.7 Test Results.....	23
4.2 Conducted Emission Measurement.....	70
4.2.1 Limits of Conducted Emission Measurement.....	70
4.2.2 Test Instruments.....	70
4.2.3 Test Procedures.....	71
4.2.4 Deviation from Test Standard.....	71
4.2.5 Test Setup.....	71
4.2.6 EUT Operating Conditions.....	71
4.2.7 Test Results.....	72
4.3 Transmit Power Measurement.....	80
4.3.1 Limits of Transmit Power Measurement.....	80
4.3.2 Test Setup.....	80
4.3.3 Test Instruments.....	81
4.3.4 Test Procedure.....	81
4.3.5 Deviation from Test Standard.....	81
4.3.6 EUT Operating Conditions.....	81
4.3.7 Test Result.....	82
4.4 Occupied Bandwidth Measurement.....	102
4.4.1 Test Setup.....	102
4.4.2 Test Instruments.....	102
4.4.3 Test Procedure.....	102
4.4.4 Test Result.....	103
4.5 Peak Power Spectral Density Measurement.....	107
4.5.1 Limits of Peak Power Spectral Density Measurement.....	107
4.5.2 Test Setup.....	107
4.5.3 Test Instruments.....	107
4.5.4 Test Procedures.....	107
4.5.5 Deviation from Test Standard.....	108
4.5.6 EUT Operating Conditions.....	108
4.5.7 Test Results.....	109
4.6 Frequency Stability.....	119
4.6.1 Limits of Frequency Stability Measurement.....	119

4.6.2	Test Setup.....	119
4.6.3	Test Instruments	119
4.6.4	Test Procedure	119
4.6.5	Deviation from Test Standard	120
4.6.6	EUT Operating Condition	120
4.6.7	Test Results	120
4.7	6dB Bandwidth Measurement.....	122
4.7.1	Limits of 6dB Bandwidth Measurement.....	122
4.7.2	Test Setup.....	122
4.7.3	Test Instruments	122
4.7.4	Test Procedure	122
4.7.5	Deviation from Test Standard	122
4.7.6	EUT Operating Condition	122
4.7.7	Test Results	123
5	Pictures of Test Arrangements.....	127
	Appendix – Information of the Testing Laboratories	128

Release Control Record

Issue No.	Description	Date Issued
RF190624C08A	Original release.	Nov. 11, 2019

1 Certificate of Conformity

Product: Wireless Access Point

Brand: Fortinet

Test Model: FAP-231E

Series Model: FortiAP 231Exxxxxx, FAP-231E xxxxxx, FORTIAP-231E xxxxxx (where “x” can be used as “A-Z”, or “-0-9”, or “-”, or blank for software changes or marketing purposes only) (refer to item 3.1 for more details)

Sample Status: Engineering sample

Applicant: Fortinet Inc.

Test Date: Sep. 17 ~ Nov. 11, 2019

Standards: 47 CFR FCC Part 15, Subpart E (Section 15.407)
ANSI C63.10:2013

The above equipment has been tested by **Bureau Veritas Consumer Products Services (H.K.) Ltd., Taoyuan Branch**, and found compliance with the requirement of the above standards. The test record, data evaluation & Equipment Under Test (EUT) configurations represented herein are true and accurate accounts of the measurements of the sample’s RF characteristics under the conditions specified in this report.

Prepared by :  , **Date:** Nov. 11, 2019
Polly Chien / Specialist

Approved by :  , **Date:** Nov. 11, 2019
Bruce Chen / Senior Project Engineer

2 Summary of Test Results

47 CFR FCC Part 15, Subpart E (Section 15.407)			
FCC Clause	Test Item	Result	Remarks
15.407(b)(6)	AC Power Conducted Emissions	Pass	Meet the requirement of limit. Minimum passing margin is -7.28dB at 0.47915MHz.
15.407(b) (1/2/3/4(i/ii)/6)	Radiated Emissions & Band Edge Measurement	Pass	Meet the requirement of limit. Minimum passing margin is -0.3dB at 5725.00MHz.
15.407(a)(1/2/3)	Max Average Transmit Power	Pass	Meet the requirement of limit.
---	Occupied Bandwidth Measurement	-	Reference only.
15.407(a)(1/2/3)	Peak Power Spectral Density	Pass	Meet the requirement of limit.
15.407(g)	Frequency Stability	Pass	Meet the requirement of limit.
15.203	Antenna Requirement	Pass	Antenna connector is IPEX not a standard connector.

Note:

Determining compliance based on the results of the compliance measurement, not taking into account measurement instrumentation uncertainty.

2.1 Measurement Uncertainty

Where relevant, the following measurement uncertainty levels have been estimated for tests performed on the EUT as specified in CISPR 16-4-2:

Measurement	Frequency	Expanded Uncertainty (k=2) (\pm)
Conducted Emissions at mains ports	150kHz ~ 30MHz	2.94 dB
Radiated Emissions up to 1 GHz	9kHz ~ 30MHz	3.04 dB
	30MHz ~ 200MHz	3.86 dB
	200MHz ~ 1000MHz	3.87 dB
Radiated Emissions above 1 GHz	1GHz ~ 18GHz	2.29 dB
	18GHz ~ 40GHz	2.29 dB

2.2 Modification Record

There were no modifications required for compliance.

3 General Information

3.1 General Description of EUT

Product	Wireless Access Point
Brand	Fortinet
Test Model	FAP-231E
Series Model	FortiAP 231Exxxxxx, FAP-231E xxxxxx, FORTIAP-231E xxxxxx (where "x" can be used as "A-Z", or "-0-9", or "-", or blank for software changes or marketing purposes only)
Model Difference	Refer to note
Sample Status	Engineering sample
Power Supply rating	12Vdc from Adapter 54Vdc from PoE
Modulation Type	256QAM, 64QAM, 16QAM, QPSK, BPSK
Modulation Technology	OFDM
Transfer Rate	802.11a: 54/48/36/24/18/12/9/6Mbps 802.11n: up to 300Mbps 802.11ac: up to 867Mbps
Operating Frequency	5260 ~ 5320MHz, 5500 ~ 5720MHz
Number of Channel	5260 ~ 5320MHz: 802.11a, 802.11n (HT20), 802.11ac (VHT20): 4 802.11n (HT40), 802.11ac (VHT40): 2 802.11ac (VHT80): 1 5500 ~ 5720MHz: 802.11a, 802.11n (HT20), 802.11ac (VHT20): 12 802.11n (HT40), 802.11ac (VHT40): 6 802.11ac (VHT80): 3
Output Power	Radio 1: CDD Mode: 5500 ~ 5720MHz: 239.245mW Beamforming Mode: 5500 ~ 5720MHz: 119.631mW Radio 2: CDD Mode: 5260 ~ 5320MHz: 238.848mW 5500 ~ 5720MHz: 239.366mW Beamforming Mode: 5260 ~ 5320MHz: 119.433mW 5500 ~ 5720MHz: 119.691mW
Antenna Type	Refer to Note
Antenna Connector	Refer to Note
Accessory Device	NA
Cable Supplied	NA

Note:

1. This report is prepared for FCC class II permissive change. The difference compared with the original report (BV CPS report no.: RF190624C08-1) is adding 5.26GHz to 5.32GHz and 5.50GHz to 5.72GHz by software.
2. The following models are provided to this EUT. The model FAP-231E was chosen for final test.

Brand	Model	Description
Fortinet	FAP-231E	where "x" can be used as "A-Z", or "-0-9", or "-", or blank for software changes or marketing purposes only
	FortiAP 231Exxxxxx	
	FAP-231E xxxxxx	
	FORTIAP-231E xxxxxx	

3. The EUT incorporates a MIMO function. Physically, the EUT provides 2 completed transmitters and 2 receivers.

Modulation Mode	CDD Mode	Beamforming Mode	TX Function
802.11a	Support	Not Support	2TX
802.11n (HT20)	Support	Support	2TX
802.11n (HT40)	Support	Support	2TX
802.11ac (VHT20)	Support	Support	2TX
802.11ac (VHT40)	Support	Support	2TX
802.11ac (VHT80)	Support	Support	2TX

* The modulation and bandwidth are similar for 802.11n mode for 20MHz/40MHz and 802.11ac mode for 20MHz/40MHz, therefore investigated worst case to representative mode in test report. (Final test mode refer section 3.2.1)

* For 802.11n and 802.11ac, CDD mode and Beamforming mode are presented in power output test item. For other test items, CDD mode is the worst case for final tests after pretesting.

4. Operation mode and channels.

Mode	Radio 1	Radio 2	Radio 3
1	2.4GHz Band (Service) Ch 1 to 13	5.0GHz full Band (Service) Ch 36 to 165	2.4GHz/5.0GHz Dual Band Scanning (RX only)
2	5.0GHz High Band (Service) Ch 100 to 165	5.0GHz Low Band (Service) Ch 36 to 64	2.4GHz Band (Service) Ch 1 to 13 (TX)
3	5.0GHz High Band (Service) Ch 100 to 165	5.0GHz Low Band (Service) Ch 36 to 64	2.4GHz/5.0GHz Dual Band Scanning (RX only)

5. The EUT consumes power from the following adapter and POE. (support units only)

Adapter	
Brand	Asian Power Devices Inc.
Model	WA-30J12R
Input Power	100-240Vac, 50/60Hz, 0.9A MAX
Output Power	12Vdc, 2.5A
Power Line	1.46m cable without core attached on adapter

POE	
Brand	EnGenius
Model	EPA5006GR
Input Power	100-240Vac, 50-60Hz, 0.8A
Output Power	54Vdc, 0.6A

6. The EUT uses following antennas.

Type	PIFA				Connector		IPEX		
Radio	2		1		1		3		BLE
Antenna No.	1	2	3	4	5	6	7	8	
Frequency (MHz)	5150~5850				2400~2500		2400~2500/ 5150~5850		2400~2500
Gain (dBi)	5.5	5.4	5.4	5.5	4.7	4.3	4.5/5.6	5.1/5.6	5.1

* The maximum antenna gains of Radio 1, 2, 3 are chosen for final test.

7. Radio 1 & Radio 2 & Radio 3 technologies can transmit at same time.

3.2 Description of Test Modes

5260~5320MHz:

4 channels are provided for 802.11a, 802.11n (HT20), 802.11ac (VHT20):

Channel	Frequency	Channel	Frequency
52	5260 MHz	60	5300 MHz
56	5280 MHz	64	5320 MHz

2 channels are provided for 802.11n (HT40), 802.11ac (VHT40):

Channel	Frequency	Channel	Frequency
54	5270 MHz	62	5310 MHz

1 channel is provided for 802.11ac (VHT80):

Channel	Frequency
58	5290MHz

5500~5700MHz:

12 channels are provided for 802.11a, 802.11n (HT20), 802.11ac (VHT20):

Channel	Frequency	Channel	Frequency
100	5500 MHz	124	5620 MHz
104	5520 MHz	128	5640 MHz
108	5540 MHz	132	5660 MHz
112	5560 MHz	136	5680 MHz
116	5580 MHz	140	5700 MHz
120	5600 MHz	144	5720 MHz

6 channels are provided for 802.11n (HT40), 802.11ac (VHT40):

Channel	Frequency	Channel	Frequency
102	5510 MHz	126	5630 MHz
110	5550 MHz	134	5670 MHz
118	5590 MHz	142	5710 MHz

3 channels are provided for 802.11ac (VHT80):

Channel	Frequency	Channel	Frequency
106	5530 MHz	138	5690 MHz
122	5610 MHz		

3.2.1 Test Mode Applicability and Tested Channel Detail

EUT Configure Mode	Applicable to				Description	
	RE \geq 1G	RE<1G	PLC	APCM		
A1	-	√	√	-	Radio 1	Power from adapter
A2	√	√	√	√		Power from PoE
B1	-	√	√	-	Radio 2	Power from adapter
B2	√	√	√	√		Power from PoE

Where RE \geq 1G: Radiated Emission above 1GHz & Bandedge Measurement
 RE<1G: Radiated Emission below 1GHz
 PLC: Power Line Conducted Emission
 APCM: Antenna Port Conducted Measurement

Note:

- The EUT had been pre-tested on the positioned of each 3 axis. The worst case was found when positioned on Y-plane.
- "-" means no effect.
- Radiated emission (below 1GHz) and power line conducted emission test items chosen the worst maximum power.

Radiated Emission Test (Above 1GHz):

- Pre-Scan has been conducted to determine the worst-case mode from all possible combinations between available modulations, data rates and antenna ports (if EUT with antenna diversity architecture).
- Following channel(s) was (were) selected for the final test as listed below.

EUT Configure Mode	Mode	Frequency Band (MHz)	Available Channel	Tested Channel	Modulation Technology	Data Rate (Mbps)
Radio 1						
A2	802.11a	5500-5720	100 to 144	100, 116, 140, 144	OFDM	6.0
	802.11n (HT20)		100 to 144	100, 116, 140, 144	OFDM	6.5
	802.11n (HT40)		102 to 142	102, 110, 134, 142	OFDM	13.5
	802.11ac (VHT80)		106 to 138	106, 122, 138	OFDM	58.5
Radio 2						
B2	802.11a	5260-5320	52 to 64	52, 60, 64	OFDM	6.0
	802.11n (HT20)		52 to 64	52, 60, 64	OFDM	6.5
	802.11n (HT40)		54 to 62	54, 62	OFDM	13.5
	802.11ac (VHT80)		58	58	OFDM	58.5
B2	802.11a	5500-5720	100 to 144	100, 116, 140, 144	OFDM	6.0
	802.11n (HT20)		100 to 144	100, 116, 140, 144	OFDM	6.5
	802.11n (HT40)		102 to 142	102, 110, 134, 142	OFDM	13.5
	802.11ac (VHT80)		106 to 138	106, 122, 138	OFDM	58.5

Radiated Emission Test (Below 1GHz):

- Pre-Scan has been conducted to determine the worst-case mode from all possible combinations between available modulations, data rates and antenna ports (if EUT with antenna diversity architecture).
- Following channel(s) was (were) selected for the final test as listed below.

EUT Configure Mode	Mode	Frequency Band (MHz)	Available Channel	Tested Channel	Modulation Technology	Data Rate (Mbps)
Radio 1						
A1, A2	802.11n (HT40)	5500-5720	102 to 142	110	OFDM	13.5
Radio 2						
B1, B2	802.11n (HT40)	5500-5720	102 to 142	110	OFDM	13.5

Power Line Conducted Emission Test:

- Pre-Scan has been conducted to determine the worst-case mode from all possible combinations between available modulations, data rates and antenna ports (if EUT with antenna diversity architecture).
- Following channel(s) was (were) selected for the final test as listed below.

EUT Configure Mode	Mode	Frequency Band (MHz)	Available Channel	Tested Channel	Modulation Technology	Data Rate (Mbps)
Radio 1						
A1, A2	802.11n (HT40)	5500-5720	102 to 142	110	OFDM	13.5
Radio 2						
B1, B2	802.11n (HT40)	5500-5720	102 to 142	110	OFDM	13.5

Transmit Power Measurement:

- This item includes all test value of each mode, but only includes spectrum plot of worst value of each mode.
- Pre-Scan has been conducted to determine the worst-case mode from all possible combinations between available modulations, data rates and antenna ports (if EUT with antenna diversity architecture).
- Following channel(s) was (were) selected for the final test as listed below.

EUT Configure Mode	Mode	Frequency Band (MHz)	Available Channel	Tested Channel	Modulation Technology	Data Rate (Mbps)
Radio 1_CDD Mode						
A2	802.11a	5500-5720	100 to 144	100, 116, 140, 144	OFDM	6.0
	802.11n (HT20)		100 to 144	100, 116, 140, 144	OFDM	6.5
	802.11n (HT40)		102 to 142	102, 110, 134, 142	OFDM	13.5
	802.11ac (VHT80)		106 to 138	106, 122, 138	OFDM	58.5
Radio 1_Beamforming Mode						
A2	802.11n (HT20)	5500-5720	100 to 144	100, 116, 140, 144	OFDM	6.5
	802.11n (HT40)		102 to 142	102, 110, 134, 142	OFDM	13.5
	802.11ac (VHT80)		106 to 138	106, 122, 138	OFDM	58.5
Radio 2_CDD Mode						
B2	802.11a	5260-5320	52 to 64	52, 60, 64	OFDM	6.0
	802.11n (HT20)		52 to 64	52, 60, 64	OFDM	6.5
	802.11n (HT40)		54 to 62	54, 62	OFDM	13.5
	802.11ac (VHT80)		58	58	OFDM	58.5
B2	802.11a	5500-5720	100 to 144	100, 116, 140, 144	OFDM	6.0
	802.11n (HT20)		100 to 144	100, 116, 140, 144	OFDM	6.5
	802.11n (HT40)		102 to 142	102, 110, 134, 142	OFDM	13.5
	802.11ac (VHT80)		106 to 138	106, 122, 138	OFDM	58.5
Radio 2_Beamforming Mode						
B2	802.11n (HT20)	5260-5320	52 to 64	52, 60, 64	OFDM	6.5
	802.11n (HT40)		54 to 62	54, 62	OFDM	13.5
	802.11ac (VHT80)		58	58	OFDM	58.5
B2	802.11n (HT20)	5500-5720	100 to 144	100, 116, 140, 144	OFDM	6.5
	802.11n (HT40)		102 to 142	102, 110, 134, 142	OFDM	13.5
	802.11ac (VHT80)		106 to 138	106, 122, 138	OFDM	58.5

Peak Power Spectral Density, Bandwidth and Frequency Stability Measurement:

- This item includes all test value of each mode, but only includes spectrum plot of worst value of each mode.
- Pre-Scan has been conducted to determine the worst-case mode from all possible combinations between available modulations, data rates and antenna ports (if EUT with antenna diversity architecture).
- Following channel(s) was (were) selected for the final test as listed below.

EUT Configure Mode	Mode	Frequency Band (MHz)	Available Channel	Tested Channel	Modulation Technology	Data Rate (Mbps)
Radio 1						
A2	802.11a	5500-5720	100 to 140	100, 116, 140, 144	OFDM	6.0
	802.11n (HT20)		100 to 140	100, 116, 140, 144	OFDM	6.5
	802.11n (HT40)		102 to 134	102, 110, 134, 142	OFDM	13.5
	802.11ac (VHT80)		106 to 122	106, 122, 138	OFDM	58.5
Radio 2						
B2	802.11a	5260-5320	52 to 64	52, 60, 64	OFDM	6.0
	802.11n (HT20)		52 to 64	52, 60, 64	OFDM	6.5
	802.11n (HT40)		54 to 62	54, 62	OFDM	13.5
	802.11ac (VHT80)		58	58	OFDM	58.5
B2	802.11a	5500-5720	100 to 140	100, 116, 140, 144	OFDM	6.0
	802.11n (HT20)		100 to 140	100, 116, 140, 144	OFDM	6.5
	802.11n (HT40)		102 to 134	102, 110, 134, 142	OFDM	13.5
	802.11ac (VHT80)		106 to 122	106, 122, 138	OFDM	58.5

Test Condition:

Applicable to	Environmental Conditions	Input Power	Tested by
RE \geq 1G	23 deg. C, 67% RH 24 deg. C, 69% RH	120Vac, 60Hz	Adair Peng
RE<1G	24 deg. C, 69% RH	120Vac, 60Hz 54Vdc	Adair Peng
PLC	25 deg. C, 66% RH	120Vac, 60Hz 54Vdc	Titan Hsu
APCM	25 deg. C, 60% RH	120Vac, 60Hz	Ivan Tseng, Jisyong Wang

3.3 Duty Cycle of Test Signal

Duty cycle of test signal is < 98%, duty factor shall be considered.

Radio 1

802.11a: Duty cycle = 2.042/2.142 = 0.953, Duty factor = $10 * \log(1/0.953) = 0.21$

802.11n (HT20): Duty cycle = 4.94/5.07 = 0.974, Duty factor = $10 * \log(1/0.974) = 0.11$

802.11n (HT40): Duty cycle = 2.395/2.498 = 0.959, Duty factor = $10 * \log(1/0.959) = 0.18$

802.11ac (VHT80): Duty cycle = 1.126/1.218 = 0.924, Duty factor = $10 * \log(1/0.924) = 0.34$



Radio 2

802.11a: Duty cycle = $2.022/2.157 = 0.937$, Duty factor = $10 * \log(1/0.937) = 0.28$

802.11n (HT20): Duty cycle = $4.97/5.085 = 0.977$, Duty factor = $10 * \log(1/0.977) = 0.10$

802.11n (HT40): Duty cycle = $2.42/2.515 = 0.962$, Duty factor = $10 * \log(1/0.962) = 0.17$

802.11ac (VHT80): Duty cycle = $1.141/1.228 = 0.929$, Duty factor = $10 * \log(1/0.929) = 0.32$

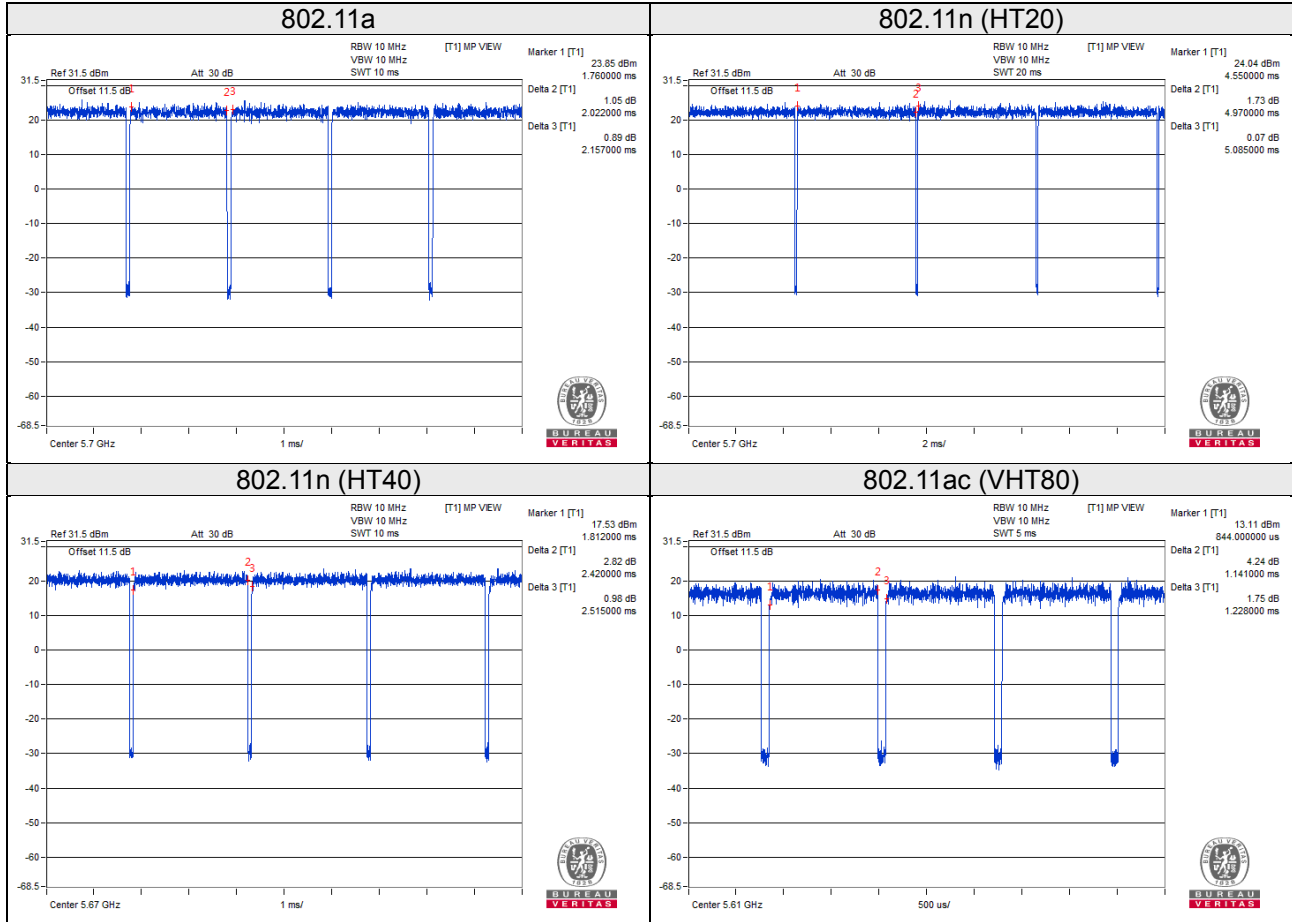

3.4 Description of Support Units

The EUT has been tested as an independent unit together with other necessary accessories or support units. The following support units or accessories were used to form a representative test configuration during the tests.

ID	Product	Brand	Model No.	Serial No.	FCC ID	Remarks
A.	Notebook	DELL	E5410	1HC2XM1	FCC DoC Approved	-
B.	Load	NA	NA	NA	NA	-
C.	Adapter	Asian Power Devices Inc.	WA-30J12R	N/A	N/A	Provided by client
D.	POE	EnGenius	EPA5006GR	N/A	N/A	Provided by client

Note:

1. All power cords of the above support units are non-shielded (1.8m).
2. Item A acted as a communication partner to transfer data.

ID	Descriptions	Qty.	Length (m)	Shielding (Yes/No)	Cores (Qty.)	Remarks
1.	RJ45, Cat5e	1	6	N	0	-
2.	RJ45, Cat5e	2	1.5	N	0	-
3.	RJ45, Cat5e	1	1.5	N	0	-
4.	Power cable	1	1.46	-	0	Provided by client

3.4.1 Configuration of System under Test

Adapter Mode

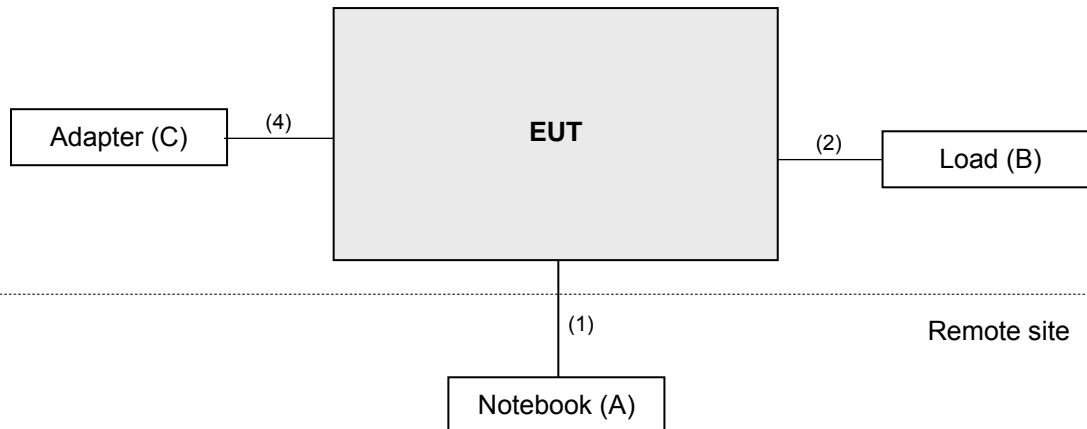

PoE Mode

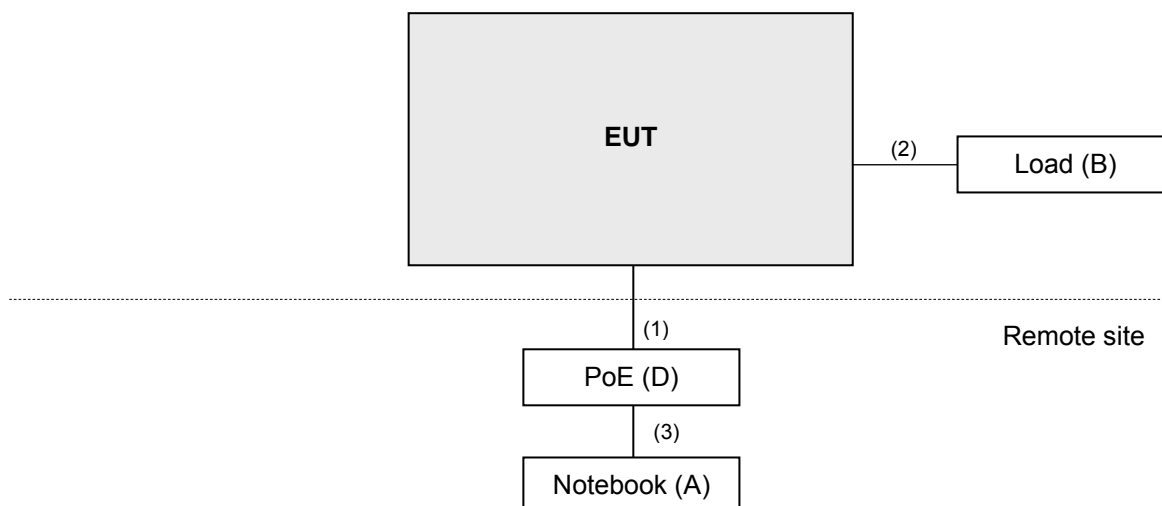

3.5 General Description of Applied Standards and References

The EUT is a RF Product. According to the specifications of the manufacturer, it must comply with the requirements of the following standards and references:

Test standard:

FCC Part 15, Subpart E (15.407)

ANSI C63.10:2013

All test items have been performed and recorded as per the above standards.

KD References Test Guidance:

B 789033 D02 General UNII Test Procedure New Rules v02r01

KDB 662911 D01 Multiple Transmitter Output v02r01

All test items have been performed as a reference to the above KDB test guidance.

4 Test Types and Results

4.1 Radiated Emission and Bandedge Measurement

4.1.1 Limits of Radiated Emission and Bandedge Measurement

Radiated emissions which fall in the restricted bands must comply with the radiated emission limits specified as below table.

Frequencies (MHz)	Field Strength (microvolts/meter)	Measurement Distance (meters)
0.009 ~ 0.490	2400/F(kHz)	300
0.490 ~ 1.705	24000/F(kHz)	30
1.705 ~ 30.0	30	30
30 ~ 88	100	3
88 ~ 216	150	3
216 ~ 960	200	3
Above 960	500	3

Note:

1. The lower limit shall apply at the transition frequencies.
2. Emission level (dBuV/m) = 20 log Emission level (uV/m).
3. For frequencies above 1000MHz, the field strength limits are based on average detector, however, the peak field strength of any emission shall not exceed the maximum permitted average limits, specified above by more than 20dB under any condition of modulation.

Limits of unwanted emission out of the restricted bands

Applicable To		Limit	
789033 D02 General UNII Test Procedure New Rules v02r01		Field Strength at 3m	
		PK: 74 (dBuV/m)	AV: 54 (dBuV/m)
Frequency Band	Applicable To	EIRP Limit	Equivalent Field Strength at 3m
5150~5250 MHz	15.407(b)(1)	PK: -27 (dBm/MHz)	PK: 68.2(dBuV/m)
5250~5350 MHz	15.407(b)(2)		
5470~5725 MHz	15.407(b)(3)		
5725~5850 MHz	<input checked="" type="checkbox"/> 15.407(b)(4)(i)	PK: -27 (dBm/MHz) ^{*1} PK: 10 (dBm/MHz) ^{*2} PK: 15.6 (dBm/MHz) ^{*3} PK: 27 (dBm/MHz) ^{*4}	PK: 68.2(dBuV/m) ^{*1} PK: 105.2 (dBuV/m) ^{*2} PK: 110.8(dBuV/m) ^{*3} PK: 122.2 (dBuV/m) ^{*4}
	<input type="checkbox"/> 15.407(b)(4)(ii)	Emission limits in section 15.247(d)	
^{*1} beyond 75 MHz or more above of the band edge.		^{*2} below the band edge increasing linearly to 10 dBm/MHz at 25 MHz above.	
^{*3} below the band edge increasing linearly to a level of 15.6 dBm/MHz at 5 MHz above.		^{*4} from 5 MHz above or below the band edge increasing linearly to a level of 27 dBm/MHz at the band edge.	

Note: The following formula is used to convert the equipment isotropic radiated power (eirp) to field strength:

$$E = \frac{1000000 \sqrt{30P}}{3} \text{ } \mu\text{V/m, where P is the eirp (Watts).}$$

4.1.2 Test Instruments

Description & Manufacturer	Model No.	Serial No.	Date of Calibration	Due Date of Calibration
Test Receiver ROHDE & SCHWARZ	ESIB7	100187	May 30, 2019	May 29, 2020
BILOG Antenna SCHWARZBECK	VULB9168	9168-171	Nov. 22, 2018	Nov. 21, 2019
HORN Antenna SCHWARZBECK	9120D	209	Nov. 25, 2018	Nov. 24, 2019
HORN Antenna SCHWARZBECK	BBHA 9170	BBHA9170241	Nov. 25, 2018	Nov. 24, 2019
Loop Antenna TESEQ	HLA 6121	45745	Jul. 01, 2019	Jun. 30, 2020
Preamplifier Agilent (Below 1GHz)	8447D	2944A10738	Aug. 20, 2019	Aug. 19, 2020
Preamplifier Agilent (Above 1GHz)	8449B	3008A02465	Mar. 27, 2019	Mar. 26, 2020
RF Coaxial Cable WOKEN With 5dB PAD	8D-FB	Cable-CH3-01	Aug. 20, 2019	Aug. 19, 2020
RF signal cable HUBER+SUHNER	SUCOFLEX 104	Cable-CH3-03 (223653/4)	Aug. 20, 2019	Aug. 19, 2020
RF signal cable HUBER+SUHNER& EMCI	SUCOFLEX 104&EMC104-SM- SM-8000	Cable-CH3-03 (309224+170907)	Aug. 20, 2019	Aug. 19, 2020
Software BV ADT	ADT_Radiated_ V7.6.15.9.5	NA	NA	NA
Antenna Tower inn-co GmbH	MA 4000	013303	NA	NA
Antenna Tower Controller BV ADT	AT100	AT93021702	NA	NA
Turn Table BV ADT	TT100	TT93021702	NA	NA
Turn Table Controller BV ADT	SC100	SC93021702	NA	NA
Boresight Antenna Fixture	FBA-01	FBA-SIP01	NA	NA
Pre-amplifier (18GHz-40GHz) EMC	EMC184045B	980175	Nov. 14, 2018	Nov. 13, 2019
USB Wideband Power Sensor KEYSIGHT	U2021XA	MY55050005/MY5 5190004/MY55190 007/MY55210005	Jul. 15, 2019	Jul. 14, 2020

Note: 1. The calibration interval of the above test instruments is 12 months and the calibrations are traceable to NML/ROC and NIST/USA.
2. The test was performed in HwaYa Chamber 3.

4.1.3 Test Procedures

For Radiated emission below 30MHz

- a. The EUT was placed on the top of a rotating table 0.8 meters above the ground at a 3 meter chamber room. The table was rotated 360 degrees to determine the position of the highest radiation.
- b. The EUT was set 3 meters away from the interference-receiving antenna, which was mounted on the top of a variable-height antenna tower.
- c. Parallel, perpendicular, and ground-parallel orientations of the antenna are set to make the measurement.
- d. For each suspected emission, the EUT was arranged to its worst case and the rotatable table was turned from 0 degrees to 360 degrees to find the maximum reading.
- e. The test-receiver system was set to Quasi-Peak Detect Function and Specified Bandwidth with Maximum Hold Mode.

Note:

1. The resolution bandwidth and video bandwidth of test receiver/spectrum analyzer is 9kHz at frequency below 30MHz.

For Radiated emission above 30MHz

- a. The EUT was placed on the top of a rotating table 0.8 meters (for 30MHz ~ 1GHz) / 1.5 meters (for above 1GHz) above the ground at 3 meter chamber room for test. The table was rotated 360 degrees to determine the position of the highest radiation.
- b. The EUT was set 3 meters away from the interference-receiving antenna, which was mounted on the top of a variable-height antenna tower.
- c. The height of antenna is varied from one meter to four meters above the ground to determine the maximum value of the field strength. Both horizontal and vertical polarizations of the antenna are set to make the measurement.
- d. For each suspected emission, the EUT was arranged to its worst case and then the antenna was tuned to heights from 1 meter to 4 meters and the rotatable table was turned from 0 degrees to 360 degrees to find the maximum reading.
- e. The test-receiver system was set to quasi-peak detect function and specified bandwidth with maximum hold mode when the test frequency is below 1 GHz.
- f. The test-receiver system was set to peak and average detect function and specified bandwidth with maximum hold mode when the test frequency is above 1 GHz. If the peak reading value also meets average limit, measurement with the average detector is unnecessary.

Note:

1. The resolution bandwidth and video bandwidth of test receiver/spectrum analyzer is 120kHz for Quasi-peak detection (QP) at frequency below 1GHz.
2. The resolution bandwidth of test receiver/spectrum analyzer is 1 MHz and the video bandwidth is 3 MHz for Peak detection (PK) at frequency above 1GHz.
3. The resolution bandwidth of test receiver/spectrum analyzer is 1MHz and the video bandwidth is $\geq 1/T$ (Duty cycle < 98%) or 10Hz (Duty cycle $\geq 98\%$) for Average detection (AV) at frequency above 1GHz.
4. All modes of operation were investigated and the worst-case emissions are reported.

4.1.4 Deviation from Test Standard

No deviation.

4.1.5 Test Setup

For Radiated emission below 30MHz

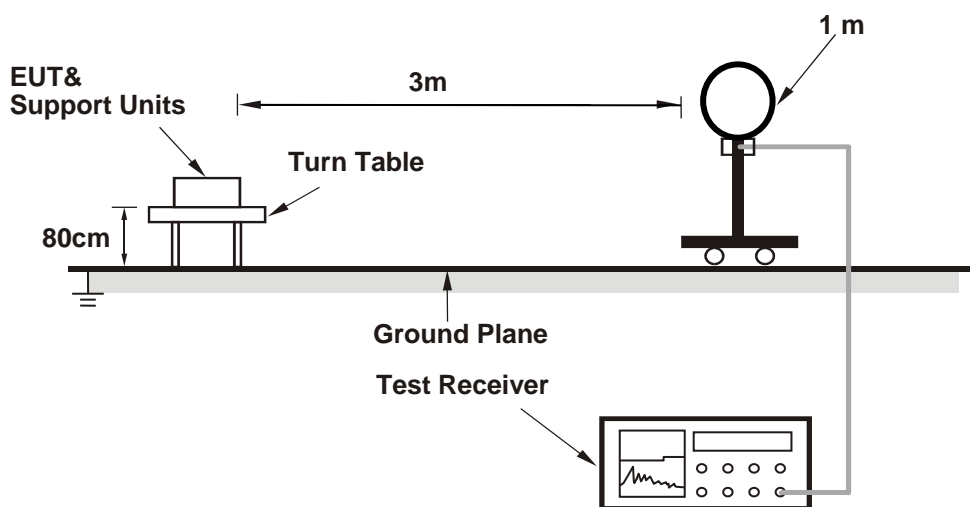

For Radiated emission 30MHz to 1GHz

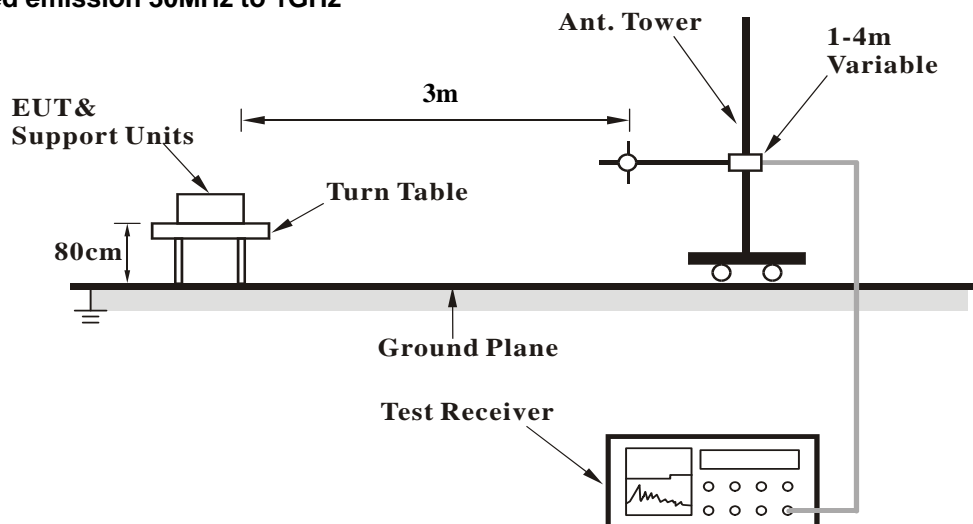

For Radiated emission above 1GHz

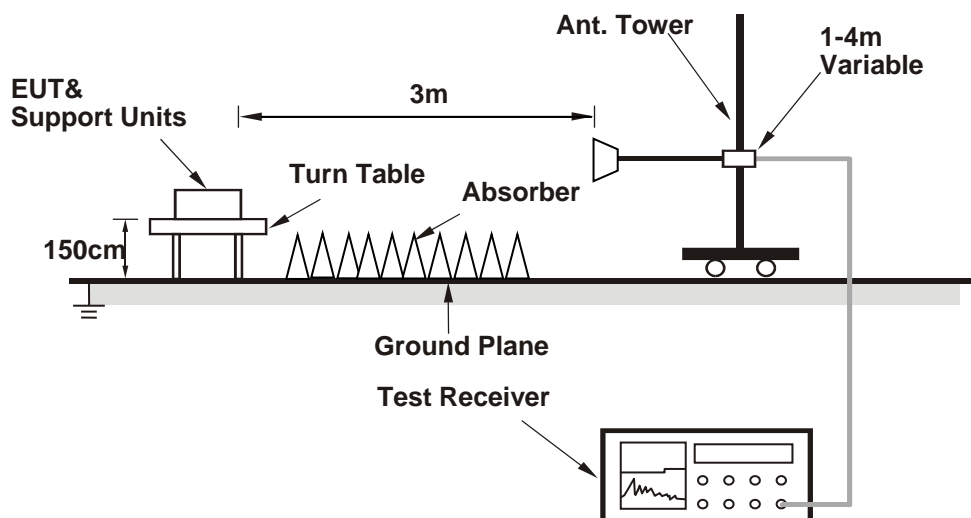

For the actual test configuration, please refer to the attached file (Test Setup Photo).

4.1.6 EUT Operating Conditions

- a. Placed the EUT on the testing table.
- b. Prepared a notebook to act as a communication partner and placed it outside of testing area.
- c. The communication partner connected with EUT via a RJ45 cable and ran a test program (provided by manufacturer) to enable EUT under transmission condition continuously at specific channel frequency.
- d. The communication partner sent data to EUT by command "PING".

4.1.7 Test Results

Mode A2: Radio 1

Above 1GHz data:

802.11a

CHANNEL	TX Channel 100	DETECTOR FUNCTION	Peak (PK)
FREQUENCY RANGE	1GHz ~ 40GHz		Average (AV)

ANTENNA POLARITY & TEST DISTANCE: HORIZONTAL AT 3 M								
NO.	FREQ. (MHz)	EMISSION LEVEL (dBuV/m)	LIMIT (dBuV/m)	MARGIN (dB)	ANTENNA HEIGHT (m)	TABLE ANGLE (Degree)	RAW VALUE (dBuV)	CORRECTION FACTOR (dB/m)
1	5460.00	58.3 PK	74.0	-15.7	1.75 H	309	53.8	4.5
2	5460.00	43.7 AV	54.0	-10.3	1.75 H	309	39.2	4.5
3	#5470.00	63.0 PK	68.2	-5.2	1.80 H	297	58.5	4.5
4	*5500.00	115.4 PK			1.78 H	300	75.6	39.8
5	*5500.00	104.3 AV			1.78 H	300	64.5	39.8
6	11000.00	60.9 PK	74.0	-13.1	2.23 H	197	40.9	20.0
7	11000.00	47.3 AV	54.0	-6.7	2.23 H	197	27.3	20.0

ANTENNA POLARITY & TEST DISTANCE: VERTICAL AT 3 M								
NO.	FREQ. (MHz)	EMISSION LEVEL (dBuV/m)	LIMIT (dBuV/m)	MARGIN (dB)	ANTENNA HEIGHT (m)	TABLE ANGLE (Degree)	RAW VALUE (dBuV)	CORRECTION FACTOR (dB/m)
1	5460.00	61.3 PK	74.0	-12.7	1.56 V	346	56.8	4.5
2	5460.00	45.3 AV	54.0	-8.7	1.56 V	346	40.8	4.5
3	#5470.00	67.0 PK	68.2	-1.2	1.44 V	354	62.5	4.5
4	*5500.00	116.8 PK			1.65 V	346	77.0	39.8
5	*5500.00	106.1 AV			1.65 V	346	66.3	39.8
6	11000.00	60.5 PK	74.0	-13.5	1.89 V	254	40.5	20.0
7	11000.00	46.9 AV	54.0	-7.1	1.89 V	254	26.9	20.0

Remarks:

1. Emission Level(dBuV/m) = Raw Value(dBuV) + Correction Factor(dB/m)
2. Correction Factor(dB/m) = Antenna Factor(dB/m) + Cable Factor(dB) – Pre-Amplifier Factor(dB)
3. The other emission levels were very low against the limit.
4. Margin value = Emission Level – Limit value
5. " * ": Fundamental frequency.
6. " # ": The radiated frequency is out of the restricted band.

CHANNEL	TX Channel 116	DETECTOR FUNCTION	Peak (PK)
FREQUENCY RANGE	1GHz ~ 40GHz		Average (AV)

ANTENNA POLARITY & TEST DISTANCE: HORIZONTAL AT 3 M

NO.	FREQ. (MHz)	EMISSION LEVEL (dBuV/m)	LIMIT (dBuV/m)	MARGIN (dB)	ANTENNA HEIGHT (m)	TABLE ANGLE (Degree)	RAW VALUE (dBuV)	CORRECTION FACTOR (dB/m)
1	*5580.00	116.4 PK			1.73 H	306	76.7	39.7
2	*5580.00	105.7 AV			1.73 H	306	66.0	39.7
3	11160.00	60.3 PK	74.0	-13.7	1.97 H	223	41.1	19.2
4	11160.00	46.8 AV	54.0	-7.2	1.97 H	223	27.6	19.2

ANTENNA POLARITY & TEST DISTANCE: VERTICAL AT 3 M

NO.	FREQ. (MHz)	EMISSION LEVEL (dBuV/m)	LIMIT (dBuV/m)	MARGIN (dB)	ANTENNA HEIGHT (m)	TABLE ANGLE (Degree)	RAW VALUE (dBuV)	CORRECTION FACTOR (dB/m)
1	*5580.00	117.6 PK			1.49 V	352	77.9	39.7
2	*5580.00	106.9 AV			1.49 V	352	67.2	39.7
3	11160.00	60.7 PK	74.0	-13.3	1.87 V	210	41.5	19.2
4	11160.00	47.3 AV	54.0	-6.7	1.87 V	210	28.1	19.2

Remarks:

1. Emission Level(dBuV/m) = Raw Value(dBuV) + Correction Factor(dB/m)
2. Correction Factor(dB/m) = Antenna Factor(dB/m) + Cable Factor(dB) – Pre-Amplifier Factor(dB)
3. The other emission levels were very low against the limit.
4. Margin value = Emission Level – Limit value
5. " * ": Fundamental frequency.
6. " # ": The radiated frequency is out of the restricted band.

CHANNEL	TX Channel 140	DETECTOR FUNCTION	Peak (PK)
FREQUENCY RANGE	1GHz ~ 40GHz		Average (AV)

ANTENNA POLARITY & TEST DISTANCE: HORIZONTAL AT 3 M

NO.	FREQ. (MHz)	EMISSION LEVEL (dBuV/m)	LIMIT (dBuV/m)	MARGIN (dB)	ANTENNA HEIGHT (m)	TABLE ANGLE (Degree)	RAW VALUE (dBuV)	CORRECTION FACTOR (dB/m)
1	*5700.00	112.0 PK			1.92 H	304	72.2	39.8
2	*5700.00	101.2 AV			1.92 H	304	61.4	39.8
3	#5725.00	66.2 PK	68.2	-2.0	1.89 H	309	61.5	4.7
4	11400.00	60.6 PK	74.0	-13.4	1.88 H	203	41.5	19.1
5	11400.00	47.9 AV	54.0	-6.1	1.88 H	203	28.8	19.1

ANTENNA POLARITY & TEST DISTANCE: VERTICAL AT 3 M

NO.	FREQ. (MHz)	EMISSION LEVEL (dBuV/m)	LIMIT (dBuV/m)	MARGIN (dB)	ANTENNA HEIGHT (m)	TABLE ANGLE (Degree)	RAW VALUE (dBuV)	CORRECTION FACTOR (dB/m)
1	*5700.00	110.8 PK			2.87 V	339	71.0	39.8
2	*5700.00	100.3 AV			2.87 V	339	60.5	39.8
3	#5725.00	66.5 PK	68.2	-1.7	1.28 V	351	61.8	4.7
4	11400.00	61.1 PK	74.0	-12.9	2.19 V	192	42.0	19.1
5	11400.00	48.3 AV	54.0	-5.7	2.19 V	192	29.2	19.1

Remarks:

1. Emission Level(dBuV/m) = Raw Value(dBuV) + Correction Factor(dB/m)
2. Correction Factor(dB/m) = Antenna Factor(dB/m) + Cable Factor(dB) – Pre-Amplifier Factor(dB)
3. The other emission levels were very low against the limit.
4. Margin value = Emission Level – Limit value
5. " * ": Fundamental frequency.
6. " # ": The radiated frequency is out of the restricted band.

CHANNEL	TX Channel 144	DETECTOR FUNCTION	Peak (PK)
FREQUENCY RANGE	1GHz ~ 40GHz		Average (AV)

ANTENNA POLARITY & TEST DISTANCE: HORIZONTAL AT 3 M

NO.	FREQ. (MHz)	EMISSION LEVEL (dBuV/m)	LIMIT (dBuV/m)	MARGIN (dB)	ANTENNA HEIGHT (m)	TABLE ANGLE (Degree)	RAW VALUE (dBuV)	CORRECTION FACTOR (dB/m)
1	5460.00	59.0 PK	74.0	-15.0	2.49 H	357	54.5	4.5
2	5460.00	45.5 AV	54.0	-8.5	2.49 H	357	41.0	4.5
3	#5470.00	59.4 PK	68.2	-8.8	2.52 H	358	54.9	4.5
4	*5720.00	116.7 PK			2.50 H	359	76.7	40.0
5	*5720.00	105.7 AV			2.50 H	359	65.7	40.0
6	#5850.00	59.5 PK	68.2	-8.7	2.54 H	6	54.2	5.3
7	11440.00	62.3 PK	74.0	-11.7	2.09 H	211	43.1	19.2
8	11440.00	49.4 AV	54.0	-4.6	2.09 H	211	30.2	19.2

ANTENNA POLARITY & TEST DISTANCE: VERTICAL AT 3 M

NO.	FREQ. (MHz)	EMISSION LEVEL (dBuV/m)	LIMIT (dBuV/m)	MARGIN (dB)	ANTENNA HEIGHT (m)	TABLE ANGLE (Degree)	RAW VALUE (dBuV)	CORRECTION FACTOR (dB/m)
1	5460.00	58.8 PK	74.0	-15.2	1.42 V	291	54.3	4.5
2	5460.00	45.2 AV	54.0	-8.8	1.42 V	291	40.7	4.5
3	#5470.00	59.1 PK	68.2	-9.1	1.36 V	282	54.6	4.5
4	*5720.00	111.8 PK			1.32 V	281	71.8	40.0
5	*5720.00	101.4 AV			1.32 V	281	61.4	40.0
6	#5850.00	58.9 PK	68.2	-9.3	1.41 V	291	53.6	5.3
7	11440.00	62.2 PK	74.0	-11.8	1.82 V	202	43.0	19.2
8	11440.00	48.7 AV	54.0	-5.3	1.82 V	202	29.5	19.2

Remarks:

1. Emission Level(dBuV/m) = Raw Value(dBuV) + Correction Factor(dB/m)
2. Correction Factor(dB/m) = Antenna Factor(dB/m) + Cable Factor(dB) – Pre-Amplifier Factor(dB)
3. The other emission levels were very low against the limit.
4. Margin value = Emission Level – Limit value
5. " * ": Fundamental frequency.
6. " # ": The radiated frequency is out of the restricted band.

802.11n (HT20)

CHANNEL	TX Channel 100	DETECTOR	Peak (PK)
FREQUENCY RANGE	1GHz ~ 40GHz	FUNCTION	Average (AV)

ANTENNA POLARITY & TEST DISTANCE: HORIZONTAL AT 3 M

NO.	FREQ. (MHz)	EMISSION LEVEL (dBuV/m)	LIMIT (dBuV/m)	MARGIN (dB)	ANTENNA HEIGHT (m)	TABLE ANGLE (Degree)	RAW VALUE (dBuV)	CORRECTION FACTOR (dB/m)
1	5460.00	61.3 PK	74.0	-12.7	1.91 H	311	56.8	4.5
2	5460.00	43.9 AV	54.0	-10.1	1.91 H	311	39.4	4.5
3	#5470.00	62.8 PK	68.2	-5.4	1.83 H	299	58.3	4.5
4	*5500.00	115.8 PK			1.77 H	303	76.0	39.8
5	*5500.00	104.9 AV			1.77 H	303	65.1	39.8
6	11000.00	61.9 PK	74.0	-12.1	2.23 H	203	41.9	20.0
7	11000.00	49.3 AV	54.0	-4.7	2.23 H	203	29.3	20.0

ANTENNA POLARITY & TEST DISTANCE: VERTICAL AT 3 M

NO.	FREQ. (MHz)	EMISSION LEVEL (dBuV/m)	LIMIT (dBuV/m)	MARGIN (dB)	ANTENNA HEIGHT (m)	TABLE ANGLE (Degree)	RAW VALUE (dBuV)	CORRECTION FACTOR (dB/m)
1	5460.00	64.6 PK	74.0	-9.4	1.48 V	349	60.1	4.5
2	5460.00	46.6 AV	54.0	-7.4	1.48 V	349	42.1	4.5
3	#5470.00	66.7 PK	68.2	-1.5	1.66 V	347	62.2	4.5
4	*5500.00	117.3 PK			1.59 V	345	77.5	39.8
5	*5500.00	106.6 AV			1.59 V	345	66.8	39.8
6	11000.00	62.0 PK	74.0	-12.0	2.01 V	213	42.0	20.0
7	11000.00	49.1 AV	54.0	-4.9	2.01 V	213	29.1	20.0

Remarks:

1. Emission Level(dBuV/m) = Raw Value(dBuV) + Correction Factor(dB/m)
2. Correction Factor(dB/m) = Antenna Factor(dB/m) + Cable Factor(dB) – Pre-Amplifier Factor(dB)
3. The other emission levels were very low against the limit.
4. Margin value = Emission Level – Limit value
5. " * ": Fundamental frequency.
6. " # ": The radiated frequency is out of the restricted band.

CHANNEL	TX Channel 116	DETECTOR FUNCTION	Peak (PK)
FREQUENCY RANGE	1GHz ~ 40GHz		Average (AV)

ANTENNA POLARITY & TEST DISTANCE: HORIZONTAL AT 3 M

NO.	FREQ. (MHz)	EMISSION LEVEL (dBuV/m)	LIMIT (dBuV/m)	MARGIN (dB)	ANTENNA HEIGHT (m)	TABLE ANGLE (Degree)	RAW VALUE (dBuV)	CORRECTION FACTOR (dB/m)
1	*5580.00	116.8 PK			1.91 H	301	77.1	39.7
2	*5580.00	105.7 AV			1.91 H	301	66.0	39.7
3	11160.00	61.2 PK	74.0	-12.8	1.93 H	213	42.0	19.2
4	11160.00	47.7 AV	54.0	-6.3	1.93 H	213	28.5	19.2

ANTENNA POLARITY & TEST DISTANCE: VERTICAL AT 3 M

NO.	FREQ. (MHz)	EMISSION LEVEL (dBuV/m)	LIMIT (dBuV/m)	MARGIN (dB)	ANTENNA HEIGHT (m)	TABLE ANGLE (Degree)	RAW VALUE (dBuV)	CORRECTION FACTOR (dB/m)
1	*5580.00	117.9 PK			1.70 V	351	78.2	39.7
2	*5580.00	106.7 AV			1.70 V	351	67.0	39.7
3	11160.00	61.0 PK	74.0	-13.0	1.94 V	209	41.8	19.2
4	11160.00	47.6 AV	54.0	-6.4	1.94 V	209	28.4	19.2

Remarks:

1. Emission Level(dBuV/m) = Raw Value(dBuV) + Correction Factor(dB/m)
2. Correction Factor(dB/m) = Antenna Factor(dB/m) + Cable Factor(dB) – Pre-Amplifier Factor(dB)
3. The other emission levels were very low against the limit.
4. Margin value = Emission Level – Limit value
5. " * ": Fundamental frequency.
6. " # ": The radiated frequency is out of the restricted band.

CHANNEL	TX Channel 140	DETECTOR FUNCTION	Peak (PK)
FREQUENCY RANGE	1GHz ~ 40GHz		Average (AV)

ANTENNA POLARITY & TEST DISTANCE: HORIZONTAL AT 3 M

NO.	FREQ. (MHz)	EMISSION LEVEL (dBuV/m)	LIMIT (dBuV/m)	MARGIN (dB)	ANTENNA HEIGHT (m)	TABLE ANGLE (Degree)	RAW VALUE (dBuV)	CORRECTION FACTOR (dB/m)
1	*5700.00	111.7 PK			1.91 H	301	71.9	39.8
2	*5700.00	100.7 AV			1.91 H	301	60.9	39.8
3	#5725.00	66.7 PK	68.2	-1.5	1.71 H	303	62.0	4.7
4	11400.00	61.0 PK	74.0	-13.0	1.93 H	213	41.9	19.1
5	11400.00	48.8 AV	54.0	-5.2	1.93 H	213	29.7	19.1

ANTENNA POLARITY & TEST DISTANCE: VERTICAL AT 3 M

NO.	FREQ. (MHz)	EMISSION LEVEL (dBuV/m)	LIMIT (dBuV/m)	MARGIN (dB)	ANTENNA HEIGHT (m)	TABLE ANGLE (Degree)	RAW VALUE (dBuV)	CORRECTION FACTOR (dB/m)
1	*5700.00	111.3 PK			2.52 V	341	71.5	39.8
2	*5700.00	100.5 AV			2.52 V	341	60.7	39.8
3	#5725.00	66.5 PK	68.2	-1.7	1.43 V	354	61.8	4.7
4	11400.00	61.2 PK	74.0	-12.8	2.03 V	213	42.1	19.1
5	11400.00	48.6 AV	54.0	-5.4	2.03 V	213	29.5	19.1

Remarks:

1. Emission Level(dBuV/m) = Raw Value(dBuV) + Correction Factor(dB/m)
2. Correction Factor(dB/m) = Antenna Factor(dB/m) + Cable Factor(dB) – Pre-Amplifier Factor(dB)
3. The other emission levels were very low against the limit.
4. Margin value = Emission Level – Limit value
5. " * ": Fundamental frequency.
6. " # ": The radiated frequency is out of the restricted band.

CHANNEL	TX Channel 144	DETECTOR FUNCTION	Peak (PK)
FREQUENCY RANGE	1GHz ~ 40GHz		Average (AV)

ANTENNA POLARITY & TEST DISTANCE: HORIZONTAL AT 3 M

NO.	FREQ. (MHz)	EMISSION LEVEL (dBuV/m)	LIMIT (dBuV/m)	MARGIN (dB)	ANTENNA HEIGHT (m)	TABLE ANGLE (Degree)	RAW VALUE (dBuV)	CORRECTION FACTOR (dB/m)
1	5460.00	58.7 PK	74.0	-15.3	2.41 H	335	54.2	4.5
2	5460.00	45.7 AV	54.0	-8.3	2.41 H	335	41.2	4.5
3	#5470.00	59.1 PK	68.2	-9.1	2.42 H	337	54.6	4.5
4	*5720.00	115.6 PK			2.39 H	334	75.6	40.0
5	*5720.00	105.5 AV			2.39 H	334	65.5	40.0
6	#5850.00	60.3 PK	68.2	-7.9	2.44 H	341	55.0	5.3
7	11440.00	63.2 PK	74.0	-10.8	2.21 H	233	44.0	19.2
8	11440.00	49.4 AV	54.0	-4.6	2.21 H	233	30.2	19.2

ANTENNA POLARITY & TEST DISTANCE: VERTICAL AT 3 M

NO.	FREQ. (MHz)	EMISSION LEVEL (dBuV/m)	LIMIT (dBuV/m)	MARGIN (dB)	ANTENNA HEIGHT (m)	TABLE ANGLE (Degree)	RAW VALUE (dBuV)	CORRECTION FACTOR (dB/m)
1	5460.00	58.7 PK	74.0	-15.3	1.32 V	287	54.2	4.5
2	5460.00	45.3 AV	54.0	-8.7	1.32 V	287	40.8	4.5
3	#5470.00	59.1 PK	68.2	-9.1	1.38 V	291	54.6	4.5
4	*5720.00	111.6 PK			1.34 V	285	71.6	40.0
5	*5720.00	101.0 AV			1.34 V	285	61.0	40.0
6	#5850.00	59.3 PK	68.2	-8.9	1.41 V	292	54.0	5.3
7	11440.00	62.1 PK	74.0	-11.9	1.92 V	213	42.9	19.2
8	11440.00	48.9 AV	54.0	-5.1	1.92 V	213	29.7	19.2

Remarks:

1. Emission Level(dBuV/m) = Raw Value(dBuV) + Correction Factor(dB/m)
2. Correction Factor(dB/m) = Antenna Factor(dB/m) + Cable Factor(dB) – Pre-Amplifier Factor(dB)
3. The other emission levels were very low against the limit.
4. Margin value = Emission Level – Limit value
5. " * ": Fundamental frequency.
6. " # ": The radiated frequency is out of the restricted band.

802.11n (HT40)

CHANNEL	TX Channel 102	DETECTOR FUNCTION	Peak (PK) Average (AV)
FREQUENCY RANGE	1GHz ~ 40GHz		

ANTENNA POLARITY & TEST DISTANCE: HORIZONTAL AT 3 M

NO.	FREQ. (MHz)	EMISSION LEVEL (dBuV/m)	LIMIT (dBuV/m)	MARGIN (dB)	ANTENNA HEIGHT (m)	TABLE ANGLE (Degree)	RAW VALUE (dBuV)	CORRECTION FACTOR (dB/m)
1	5460.00	63.6 PK	74.0	-10.4	1.90 H	301	59.1	4.5
2	5460.00	45.8 AV	54.0	-8.2	1.90 H	301	41.3	4.5
3	#5470.00	62.2 PK	68.2	-6.0	1.94 H	306	57.7	4.5
4	*5510.00	111.9 PK			1.82 H	304	72.1	39.8
5	*5510.00	101.5 AV			1.82 H	304	61.7	39.8
6	11020.00	59.9 PK	74.0	-14.1	1.99 H	207	40.1	19.8
7	11020.00	47.2 AV	54.0	-6.8	1.99 H	207	27.4	19.8

ANTENNA POLARITY & TEST DISTANCE: VERTICAL AT 3 M

NO.	FREQ. (MHz)	EMISSION LEVEL (dBuV/m)	LIMIT (dBuV/m)	MARGIN (dB)	ANTENNA HEIGHT (m)	TABLE ANGLE (Degree)	RAW VALUE (dBuV)	CORRECTION FACTOR (dB/m)
1	5460.00	61.7 PK	74.0	-12.3	1.80 V	351	57.2	4.5
2	5460.00	45.0 AV	54.0	-9.0	1.80 V	351	40.5	4.5
3	#5470.00	66.7 PK	68.2	-1.5	2.02 V	7	62.2	4.5
4	*5510.00	112.2 PK			1.60 V	351	72.4	39.8
5	*5510.00	102.1 AV			1.60 V	351	62.3	39.8
6	11020.00	60.1 PK	74.0	-13.9	1.82 V	210	40.3	19.8
7	11020.00	46.7 AV	54.0	-7.3	1.82 V	210	26.9	19.8

Remarks:

1. Emission Level(dBuV/m) = Raw Value(dBuV) + Correction Factor(dB/m)
2. Correction Factor(dB/m) = Antenna Factor(dB/m) + Cable Factor(dB) – Pre-Amplifier Factor(dB)
3. The other emission levels were very low against the limit.
4. Margin value = Emission Level – Limit value
5. " * ": Fundamental frequency.
6. " # ": The radiated frequency is out of the restricted band.

CHANNEL	TX Channel 110	DETECTOR FUNCTION	Peak (PK)
FREQUENCY RANGE	1GHz ~ 40GHz		Average (AV)

ANTENNA POLARITY & TEST DISTANCE: HORIZONTAL AT 3 M

NO.	FREQ. (MHz)	EMISSION LEVEL (dBuV/m)	LIMIT (dBuV/m)	MARGIN (dB)	ANTENNA HEIGHT (m)	TABLE ANGLE (Degree)	RAW VALUE (dBuV)	CORRECTION FACTOR (dB/m)
1	*5550.00	114.7 PK			1.97 H	306	75.0	39.7
2	*5550.00	104.4 AV			1.97 H	306	64.7	39.7
3	11100.00	59.5 PK	74.0	-14.5	1.82 H	204	40.2	19.3
4	11100.00	46.6 AV	54.0	-7.4	1.82 H	204	27.3	19.3

ANTENNA POLARITY & TEST DISTANCE: VERTICAL AT 3 M

NO.	FREQ. (MHz)	EMISSION LEVEL (dBuV/m)	LIMIT (dBuV/m)	MARGIN (dB)	ANTENNA HEIGHT (m)	TABLE ANGLE (Degree)	RAW VALUE (dBuV)	CORRECTION FACTOR (dB/m)
1	*5550.00	115.8 PK			1.55 V	353	76.1	39.7
2	*5550.00	105.8 AV			1.55 V	353	66.1	39.7
3	11100.00	60.3 PK	74.0	-13.7	1.86 V	201	41.0	19.3
4	11100.00	46.9 AV	54.0	-7.1	1.86 V	201	27.6	19.3

Remarks:

1. Emission Level(dBuV/m) = Raw Value(dBuV) + Correction Factor(dB/m)
2. Correction Factor(dB/m) = Antenna Factor(dB/m) + Cable Factor(dB) – Pre-Amplifier Factor(dB)
3. The other emission levels were very low against the limit.
4. Margin value = Emission Level – Limit value
5. " * ": Fundamental frequency.
6. " # ": The radiated frequency is out of the restricted band.

CHANNEL	TX Channel 134	DETECTOR FUNCTION	Peak (PK)
FREQUENCY RANGE	1GHz ~ 40GHz		Average (AV)

ANTENNA POLARITY & TEST DISTANCE: HORIZONTAL AT 3 M

NO.	FREQ. (MHz)	EMISSION LEVEL (dBuV/m)	LIMIT (dBuV/m)	MARGIN (dB)	ANTENNA HEIGHT (m)	TABLE ANGLE (Degree)	RAW VALUE (dBuV)	CORRECTION FACTOR (dB/m)
1	*5670.00	108.8 PK			1.84 H	295	69.1	39.7
2	*5670.00	97.4 AV			1.84 H	295	57.7	39.7
3	#5725.00	62.8 PK	68.2	-5.4	1.95 H	299	58.1	4.7
4	11340.00	60.9 PK	74.0	-13.1	2.35 H	193	41.6	19.3
5	11340.00	49.0 AV	54.0	-5.0	2.35 H	193	29.7	19.3

ANTENNA POLARITY & TEST DISTANCE: VERTICAL AT 3 M

NO.	FREQ. (MHz)	EMISSION LEVEL (dBuV/m)	LIMIT (dBuV/m)	MARGIN (dB)	ANTENNA HEIGHT (m)	TABLE ANGLE (Degree)	RAW VALUE (dBuV)	CORRECTION FACTOR (dB/m)
1	*5670.00	110.2 PK			1.48 V	349	70.5	39.7
2	*5670.00	99.0 AV			1.48 V	349	59.3	39.7
3	#5725.00	67.1 PK	68.2	-1.1	1.44 V	352	62.4	4.7
4	11340.00	60.8 PK	74.0	-13.2	2.02 V	223	41.5	19.3
5	11340.00	48.8 AV	54.0	-5.2	2.02 V	223	29.5	19.3

Remarks:

1. Emission Level(dBuV/m) = Raw Value(dBuV) + Correction Factor(dB/m)
2. Correction Factor(dB/m) = Antenna Factor(dB/m) + Cable Factor(dB) – Pre-Amplifier Factor(dB)
3. The other emission levels were very low against the limit.
4. Margin value = Emission Level – Limit value
5. " * ": Fundamental frequency.
6. " # ": The radiated frequency is out of the restricted band.

CHANNEL	TX Channel 142	DETECTOR FUNCTION	Peak (PK)
FREQUENCY RANGE	1GHz ~ 40GHz		Average (AV)

ANTENNA POLARITY & TEST DISTANCE: HORIZONTAL AT 3 M

NO.	FREQ. (MHz)	EMISSION LEVEL (dBuV/m)	LIMIT (dBuV/m)	MARGIN (dB)	ANTENNA HEIGHT (m)	TABLE ANGLE (Degree)	RAW VALUE (dBuV)	CORRECTION FACTOR (dB/m)
1	5460.00	59.1 PK	74.0	-14.9	2.85 H	338	54.6	4.5
2	5460.00	45.7 AV	54.0	-8.3	2.85 H	338	41.2	4.5
3	#5470.00	59.3 PK	68.2	-8.9	2.87 H	340	54.8	4.5
4	*5710.00	113.6 PK			2.88 H	342	73.7	39.9
5	*5710.00	103.3 AV			2.88 H	342	63.4	39.9
6	#5850.00	60.0 PK	68.2	-8.2	2.90 H	341	54.7	5.3
7	11420.00	62.0 PK	74.0	-12.0	2.16 H	221	42.9	19.1
8	11420.00	49.2 AV	54.0	-4.8	2.16 H	221	30.1	19.1

ANTENNA POLARITY & TEST DISTANCE: VERTICAL AT 3 M

NO.	FREQ. (MHz)	EMISSION LEVEL (dBuV/m)	LIMIT (dBuV/m)	MARGIN (dB)	ANTENNA HEIGHT (m)	TABLE ANGLE (Degree)	RAW VALUE (dBuV)	CORRECTION FACTOR (dB/m)
1	5460.00	58.3 PK	74.0	-15.7	1.36 V	284	53.8	4.5
2	5460.00	45.4 AV	54.0	-8.6	1.36 V	284	40.9	4.5
3	#5470.00	59.2 PK	68.2	-9.0	1.38 V	288	54.7	4.5
4	*5710.00	108.6 PK			1.34 V	283	68.7	39.9
5	*5710.00	98.4 AV			1.34 V	283	58.5	39.9
6	#5850.00	59.1 PK	68.2	-9.1	1.41 V	291	53.8	5.3
7	11420.00	62.2 PK	74.0	-11.8	2.02 V	213	43.1	19.1
8	11420.00	49.0 AV	54.0	-5.0	2.02 V	213	29.9	19.1

Remarks:

1. Emission Level(dBuV/m) = Raw Value(dBuV) + Correction Factor(dB/m)
2. Correction Factor(dB/m) = Antenna Factor(dB/m) + Cable Factor(dB) – Pre-Amplifier Factor(dB)
3. The other emission levels were very low against the limit.
4. Margin value = Emission Level – Limit value
5. " * ": Fundamental frequency.
6. " # ": The radiated frequency is out of the restricted band.

802.11ac (VHT80)

CHANNEL	TX Channel 106	DETECTOR FUNCTION	Peak (PK)
FREQUENCY RANGE	1GHz ~ 40GHz		Average (AV)

ANTENNA POLARITY & TEST DISTANCE: HORIZONTAL AT 3 M

NO.	FREQ. (MHz)	EMISSION LEVEL (dBuV/m)	LIMIT (dBuV/m)	MARGIN (dB)	ANTENNA HEIGHT (m)	TABLE ANGLE (Degree)	RAW VALUE (dBuV)	CORRECTION FACTOR (dB/m)
1	5460.00	61.6 PK	74.0	-12.4	1.86 H	303	57.1	4.5
2	5460.00	46.6 AV	54.0	-7.4	1.86 H	303	42.1	4.5
3	#5470.00	66.4 PK	68.2	-1.8	1.81 H	297	61.9	4.5
4	*5530.00	109.1 PK			1.84 H	294	69.3	39.8
5	*5530.00	98.6 AV			1.84 H	294	58.8	39.8
6	#5725.00	53.2 PK	68.2	-15.0	1.79 H	299	48.5	4.7
7	11060.00	61.0 PK	74.0	-13.0	2.43 H	213	41.5	19.5
8	11060.00	48.4 AV	54.0	-5.6	2.43 H	213	28.9	19.5

ANTENNA POLARITY & TEST DISTANCE: VERTICAL AT 3 M

NO.	FREQ. (MHz)	EMISSION LEVEL (dBuV/m)	LIMIT (dBuV/m)	MARGIN (dB)	ANTENNA HEIGHT (m)	TABLE ANGLE (Degree)	RAW VALUE (dBuV)	CORRECTION FACTOR (dB/m)
1	5460.00	64.5 PK	74.0	-9.5	1.59 V	353	60.0	4.5
2	5460.00	48.1 AV	54.0	-5.9	1.59 V	353	43.6	4.5
3	#5470.00	67.4 PK	68.2	-0.8	1.50 V	348	62.9	4.5
4	*5530.00	110.6 PK			1.52 V	346	70.8	39.8
5	*5530.00	100.4 AV			1.52 V	346	60.6	39.8
6	#5725.00	56.2 PK	68.2	-12.0	1.54 V	357	51.5	4.7
7	11060.00	61.1 PK	74.0	-12.9	2.16 V	233	41.6	19.5
8	11060.00	48.0 AV	54.0	-6.0	2.16 V	233	28.5	19.5

Remarks:

1. Emission Level(dBuV/m) = Raw Value(dBuV) + Correction Factor(dB/m)
2. Correction Factor(dB/m) = Antenna Factor(dB/m) + Cable Factor(dB) – Pre-Amplifier Factor(dB)
3. The other emission levels were very low against the limit.
4. Margin value = Emission Level – Limit value
5. " * ": Fundamental frequency.
6. " # ": The radiated frequency is out of the restricted band.

CHANNEL	TX Channel 122	DETECTOR FUNCTION	Peak (PK)
FREQUENCY RANGE	1GHz ~ 40GHz		Average (AV)

ANTENNA POLARITY & TEST DISTANCE: HORIZONTAL AT 3 M

NO.	FREQ. (MHz)	EMISSION LEVEL (dBuV/m)	LIMIT (dBuV/m)	MARGIN (dB)	ANTENNA HEIGHT (m)	TABLE ANGLE (Degree)	RAW VALUE (dBuV)	CORRECTION FACTOR (dB/m)
1	5460.00	61.6 PK	74.0	-12.4	1.84 H	290	57.1	4.5
2	5460.00	48.4 AV	54.0	-5.6	1.84 H	290	43.9	4.5
3	#5470.00	64.1 PK	68.2	-4.1	1.80 H	300	59.6	4.5
4	*5610.00	109.3 PK			1.76 H	293	69.5	39.8
5	*5610.00	98.7 AV			1.76 H	293	58.9	39.8
6	#5725.00	67.2 PK	68.2	-1.0	1.75 H	311	62.5	4.7
7	11220.00	62.3 PK	74.0	-11.7	2.12 H	199	43.0	19.3
8	11220.00	47.4 AV	54.0	-6.6	2.12 H	199	28.1	19.3

ANTENNA POLARITY & TEST DISTANCE: VERTICAL AT 3 M

NO.	FREQ. (MHz)	EMISSION LEVEL (dBuV/m)	LIMIT (dBuV/m)	MARGIN (dB)	ANTENNA HEIGHT (m)	TABLE ANGLE (Degree)	RAW VALUE (dBuV)	CORRECTION FACTOR (dB/m)
1	5460.00	65.0 PK	74.0	-9.0	1.44 V	351	60.5	4.5
2	5460.00	50.1 AV	54.0	-3.9	1.44 V	351	45.6	4.5
3	#5470.00	66.9 PK	68.2	-1.3	1.48 V	355	62.4	4.5
4	*5610.00	110.8 PK			1.48 V	349	71.0	39.8
5	*5610.00	100.5 AV			1.48 V	349	60.7	39.8
6	#5725.00	67.9 PK	68.2	-0.3	1.41 V	357	63.2	4.7
7	11220.00	62.5 PK	74.0	-11.5	1.92 V	203	43.2	19.3
8	11220.00	47.8 AV	54.0	-6.2	1.92 V	203	28.5	19.3

Remarks:

1. Emission Level(dBuV/m) = Raw Value(dBuV) + Correction Factor(dB/m)
2. Correction Factor(dB/m) = Antenna Factor(dB/m) + Cable Factor(dB) – Pre-Amplifier Factor(dB)
3. The other emission levels were very low against the limit.
4. Margin value = Emission Level – Limit value
5. " * ": Fundamental frequency.
6. " # ": The radiated frequency is out of the restricted band.

CHANNEL	TX Channel 138	DETECTOR FUNCTION	Peak (PK)
FREQUENCY RANGE	1GHz ~ 40GHz		Average (AV)

ANTENNA POLARITY & TEST DISTANCE: HORIZONTAL AT 3 M

NO.	FREQ. (MHz)	EMISSION LEVEL (dBuV/m)	LIMIT (dBuV/m)	MARGIN (dB)	ANTENNA HEIGHT (m)	TABLE ANGLE (Degree)	RAW VALUE (dBuV)	CORRECTION FACTOR (dB/m)
1	5460.00	59.1 PK	74.0	-14.9	2.48 H	281	54.6	4.5
2	5460.00	46.0 AV	54.0	-8.0	2.48 H	281	41.5	4.5
3	#5470.00	59.8 PK	68.2	-8.4	2.50 H	282	55.3	4.5
4	*5690.00	110.2 PK			2.52 H	279	70.4	39.8
5	*5690.00	99.7 AV			2.52 H	279	59.9	39.8
6	#5850.00	60.9 PK	68.2	-7.3	2.55 H	283	55.6	5.3
7	11380.00	62.3 PK	74.0	-11.7	2.02 H	213	43.2	19.1
8	11380.00	49.1 AV	54.0	-4.9	2.02 H	213	30.0	19.1

ANTENNA POLARITY & TEST DISTANCE: VERTICAL AT 3 M

NO.	FREQ. (MHz)	EMISSION LEVEL (dBuV/m)	LIMIT (dBuV/m)	MARGIN (dB)	ANTENNA HEIGHT (m)	TABLE ANGLE (Degree)	RAW VALUE (dBuV)	CORRECTION FACTOR (dB/m)
1	5460.00	58.8 PK	74.0	-15.2	1.36 V	281	54.3	4.5
2	5460.00	45.2 AV	54.0	-8.8	1.36 V	281	40.7	4.5
3	#5470.00	58.8 PK	68.2	-9.4	1.38 V	283	54.3	4.5
4	*5690.00	104.9 PK			1.37 V	282	65.1	39.8
5	*5690.00	94.7 AV			1.37 V	282	54.9	39.8
6	#5850.00	59.7 PK	68.2	-8.5	1.40 V	286	54.4	5.3
7	11380.00	62.2 PK	74.0	-11.8	1.92 V	201	43.1	19.1
8	11380.00	49.1 AV	54.0	-4.9	1.92 V	201	30.0	19.1

Remarks:

1. Emission Level(dBuV/m) = Raw Value(dBuV) + Correction Factor(dB/m)
2. Correction Factor(dB/m) = Antenna Factor(dB/m) + Cable Factor(dB) – Pre-Amplifier Factor(dB)
3. The other emission levels were very low against the limit.
4. Margin value = Emission Level – Limit value
5. " * ": Fundamental frequency.
6. " # ": The radiated frequency is out of the restricted band.

Mode B2: Radio 2

Above 1GHz data:

802.11a

CHANNEL	TX Channel 52	DETECTOR FUNCTION	Peak (PK)
FREQUENCY RANGE	1GHz ~ 40GHz		Average (AV)

ANTENNA POLARITY & TEST DISTANCE: HORIZONTAL AT 3 M								
NO.	FREQ. (MHz)	EMISSION LEVEL (dBuV/m)	LIMIT (dBuV/m)	MARGIN (dB)	ANTENNA HEIGHT (m)	TABLE ANGLE (Degree)	RAW VALUE (dBuV)	CORRECTION FACTOR (dB/m)
1	5150.00	56.0 PK	74.0	-18.0	2.09 H	357	51.8	4.2
2	5150.00	42.7 AV	54.0	-11.3	2.09 H	357	38.5	4.2
3	*5260.00	115.7 PK			1.85 H	347	76.6	39.1
4	*5260.00	105.1 AV			1.85 H	347	66.0	39.1
5	#10520.00	60.2 PK	68.2	-8.0	2.17 H	251	41.5	18.7
ANTENNA POLARITY & TEST DISTANCE: VERTICAL AT 3 M								
NO.	FREQ. (MHz)	EMISSION LEVEL (dBuV/m)	LIMIT (dBuV/m)	MARGIN (dB)	ANTENNA HEIGHT (m)	TABLE ANGLE (Degree)	RAW VALUE (dBuV)	CORRECTION FACTOR (dB/m)
1	5150.00	55.2 PK	74.0	-18.8	1.47 V	312	51.0	4.2
2	5150.00	42.4 AV	54.0	-11.6	1.47 V	312	38.2	4.2
3	*5260.00	110.6 PK			1.28 V	297	71.5	39.1
4	*5260.00	99.6 AV			1.28 V	297	60.5	39.1
5	#10520.00	60.1 PK	68.2	-8.1	1.71 V	188	41.4	18.7

Remarks:

1. Emission Level(dBuV/m) = Raw Value(dBuV) + Correction Factor(dB/m)
2. Correction Factor(dB/m) = Antenna Factor(dB/m) + Cable Factor(dB) – Pre-Amplifier Factor(dB)
3. The other emission levels were very low against the limit.
4. Margin value = Emission Level – Limit value
5. " * ": Fundamental frequency.
6. " # ": The radiated frequency is out of the restricted band.

CHANNEL	TX Channel 60	DETECTOR FUNCTION	Peak (PK)
FREQUENCY RANGE	1GHz ~ 40GHz		Average (AV)

ANTENNA POLARITY & TEST DISTANCE: HORIZONTAL AT 3 M

NO.	FREQ. (MHz)	EMISSION LEVEL (dBuV/m)	LIMIT (dBuV/m)	MARGIN (dB)	ANTENNA HEIGHT (m)	TABLE ANGLE (Degree)	RAW VALUE (dBuV)	CORRECTION FACTOR (dB/m)
1	*5300.00	116.6 PK			1.92 H	347	77.5	39.1
2	*5300.00	106.1 AV			1.92 H	347	67.0	39.1
3	10600.00	60.2 PK	74.0	-13.8	2.01 H	263	41.1	19.1
4	10600.00	47.0 AV	54.0	-7.0	2.01 H	263	27.9	19.1

ANTENNA POLARITY & TEST DISTANCE: VERTICAL AT 3 M

NO.	FREQ. (MHz)	EMISSION LEVEL (dBuV/m)	LIMIT (dBuV/m)	MARGIN (dB)	ANTENNA HEIGHT (m)	TABLE ANGLE (Degree)	RAW VALUE (dBuV)	CORRECTION FACTOR (dB/m)
1	*5300.00	111.3 PK			1.33 V	299	72.2	39.1
2	*5300.00	100.7 AV			1.33 V	299	61.6	39.1
3	10600.00	59.8 PK	74.0	-14.2	1.80 V	193	40.7	19.1
4	10600.00	46.7 AV	54.0	-7.3	1.80 V	193	27.6	19.1

Remarks:

1. Emission Level(dBuV/m) = Raw Value(dBuV) + Correction Factor(dB/m)
2. Correction Factor(dB/m) = Antenna Factor(dB/m) + Cable Factor(dB) – Pre-Amplifier Factor(dB)
3. The other emission levels were very low against the limit.
4. Margin value = Emission Level – Limit value
5. " * ": Fundamental frequency.
6. " # ": The radiated frequency is out of the restricted band.

CHANNEL	TX Channel 64	DETECTOR FUNCTION	Peak (PK)
FREQUENCY RANGE	1GHz ~ 40GHz		Average (AV)

ANTENNA POLARITY & TEST DISTANCE: HORIZONTAL AT 3 M

NO.	FREQ. (MHz)	EMISSION LEVEL (dBuV/m)	LIMIT (dBuV/m)	MARGIN (dB)	ANTENNA HEIGHT (m)	TABLE ANGLE (Degree)	RAW VALUE (dBuV)	CORRECTION FACTOR (dB/m)
1	*5320.00	116.7 PK			2.04 H	345	77.5	39.2
2	*5320.00	106.4 AV			2.04 H	345	67.2	39.2
3	5350.00	67.4 PK	74.0	-6.6	2.09 H	330	63.3	4.1
4	5350.00	51.9 AV	54.0	-2.1	2.09 H	330	47.8	4.1
5	10640.00	60.2 PK	74.0	-13.8	2.22 H	255	41.3	18.9
6	10640.00	46.7 AV	54.0	-7.3	2.22 H	255	27.8	18.9

ANTENNA POLARITY & TEST DISTANCE: VERTICAL AT 3 M

NO.	FREQ. (MHz)	EMISSION LEVEL (dBuV/m)	LIMIT (dBuV/m)	MARGIN (dB)	ANTENNA HEIGHT (m)	TABLE ANGLE (Degree)	RAW VALUE (dBuV)	CORRECTION FACTOR (dB/m)
1	*5320.00	111.2 PK			1.33 V	299	72.0	39.2
2	*5320.00	100.9 AV			1.33 V	299	61.7	39.2
3	5350.00	59.2 PK	74.0	-14.8	1.11 V	295	55.1	4.1
4	5350.00	45.8 AV	54.0	-8.2	1.11 V	295	41.7	4.1
5	10640.00	59.7 PK	74.0	-14.3	1.79 V	193	40.8	18.9
6	10640.00	46.3 AV	54.0	-7.7	1.79 V	193	27.4	18.9

Remarks:

1. Emission Level(dBuV/m) = Raw Value(dBuV) + Correction Factor(dB/m)
2. Correction Factor(dB/m) = Antenna Factor(dB/m) + Cable Factor(dB) – Pre-Amplifier Factor(dB)
3. The other emission levels were very low against the limit.
4. Margin value = Emission Level – Limit value
5. " * ": Fundamental frequency.
6. " # ": The radiated frequency is out of the restricted band.

CHANNEL	TX Channel 100	DETECTOR FUNCTION	Peak (PK)
FREQUENCY RANGE	1GHz ~ 40GHz		Average (AV)

ANTENNA POLARITY & TEST DISTANCE: HORIZONTAL AT 3 M								
NO.	FREQ. (MHz)	EMISSION LEVEL (dBuV/m)	LIMIT (dBuV/m)	MARGIN (dB)	ANTENNA HEIGHT (m)	TABLE ANGLE (Degree)	RAW VALUE (dBuV)	CORRECTION FACTOR (dB/m)
1	5460.00	62.4 PK	74.0	-11.6	2.05 H	346	57.9	4.5
2	5460.00	46.6 AV	54.0	-7.4	2.05 H	346	42.1	4.5
3	#5470.00	66.5 PK	68.2	-1.7	1.86 H	328	62.0	4.5
4	*5500.00	116.2 PK			2.20 H	357	76.4	39.8
5	*5500.00	106.8 AV			2.20 H	357	67.0	39.8
6	11000.00	61.7 PK	74.0	-12.3	2.18 H	272	41.7	20.0
7	11000.00	47.9 AV	54.0	-6.1	2.18 H	272	27.9	20.0

ANTENNA POLARITY & TEST DISTANCE: VERTICAL AT 3 M								
NO.	FREQ. (MHz)	EMISSION LEVEL (dBuV/m)	LIMIT (dBuV/m)	MARGIN (dB)	ANTENNA HEIGHT (m)	TABLE ANGLE (Degree)	RAW VALUE (dBuV)	CORRECTION FACTOR (dB/m)
1	5460.00	58.8 PK	74.0	-15.2	1.29 V	299	54.3	4.5
2	5460.00	44.6 AV	54.0	-9.4	1.29 V	299	40.1	4.5
3	#5470.00	60.5 PK	74.0	-13.5	1.21 V	292	56.0	4.5
4	*5500.00	111.4 PK			1.30 V	291	71.6	39.8
5	*5500.00	101.8 AV			1.30 V	291	62.0	39.8
6	11000.00	60.3 PK	74.0	-13.7	1.93 V	199	40.3	20.0
7	11000.00	47.4 AV	54.0	-6.6	1.93 V	199	27.4	20.0

Remarks:

1. Emission Level(dBuV/m) = Raw Value(dBuV) + Correction Factor(dB/m)
2. Correction Factor(dB/m) = Antenna Factor(dB/m) + Cable Factor(dB) – Pre-Amplifier Factor(dB)
3. The other emission levels were very low against the limit.
4. Margin value = Emission Level – Limit value
5. " * ": Fundamental frequency.
6. " # ": The radiated frequency is out of the restricted band.

CHANNEL	TX Channel 116	DETECTOR FUNCTION	Peak (PK)
FREQUENCY RANGE	1GHz ~ 40GHz		Average (AV)

ANTENNA POLARITY & TEST DISTANCE: HORIZONTAL AT 3 M

NO.	FREQ. (MHz)	EMISSION LEVEL (dBuV/m)	LIMIT (dBuV/m)	MARGIN (dB)	ANTENNA HEIGHT (m)	TABLE ANGLE (Degree)	RAW VALUE (dBuV)	CORRECTION FACTOR (dB/m)
1	*5580.00	116.7 PK			2.33 H	331	77.0	39.7
2	*5580.00	106.2 AV			2.33 H	331	66.5	39.7
3	11160.00	61.2 PK	74.0	-12.8	1.89 H	254	42.0	19.2
4	11160.00	47.3 AV	54.0	-6.7	1.89 H	254	28.1	19.2

ANTENNA POLARITY & TEST DISTANCE: VERTICAL AT 3 M

NO.	FREQ. (MHz)	EMISSION LEVEL (dBuV/m)	LIMIT (dBuV/m)	MARGIN (dB)	ANTENNA HEIGHT (m)	TABLE ANGLE (Degree)	RAW VALUE (dBuV)	CORRECTION FACTOR (dB/m)
1	*5580.00	112.1 PK			1.31 V	298	72.4	39.7
2	*5580.00	101.8 AV			1.31 V	298	62.1	39.7
3	11160.00	60.1 PK	74.0	-13.9	1.93 V	213	40.9	19.2
4	11160.00	46.6 AV	54.0	-7.4	1.93 V	213	27.4	19.2

Remarks:

1. Emission Level(dBuV/m) = Raw Value(dBuV) + Correction Factor(dB/m)
2. Correction Factor(dB/m) = Antenna Factor(dB/m) + Cable Factor(dB) – Pre-Amplifier Factor(dB)
3. The other emission levels were very low against the limit.
4. Margin value = Emission Level – Limit value
5. " * ": Fundamental frequency.
6. " # ": The radiated frequency is out of the restricted band.

CHANNEL	TX Channel 140	DETECTOR FUNCTION	Peak (PK)
FREQUENCY RANGE	1GHz ~ 40GHz		Average (AV)

ANTENNA POLARITY & TEST DISTANCE: HORIZONTAL AT 3 M

NO.	FREQ. (MHz)	EMISSION LEVEL (dBuV/m)	LIMIT (dBuV/m)	MARGIN (dB)	ANTENNA HEIGHT (m)	TABLE ANGLE (Degree)	RAW VALUE (dBuV)	CORRECTION FACTOR (dB/m)
1	*5700.00	112.9 PK			2.64 H	343	73.1	39.8
2	*5700.00	102.3 AV			2.64 H	343	62.5	39.8
3	#5725.00	66.7 PK	68.2	-1.5	2.35 H	331	62.0	4.7
4	11400.00	61.7 PK	74.0	-12.3	2.01 H	263	42.6	19.1
5	11400.00	47.9 AV	54.0	-6.1	2.01 H	263	28.8	19.1

ANTENNA POLARITY & TEST DISTANCE: VERTICAL AT 3 M

NO.	FREQ. (MHz)	EMISSION LEVEL (dBuV/m)	LIMIT (dBuV/m)	MARGIN (dB)	ANTENNA HEIGHT (m)	TABLE ANGLE (Degree)	RAW VALUE (dBuV)	CORRECTION FACTOR (dB/m)
1	*5700.00	108.3 PK			1.29 V	303	68.5	39.8
2	*5700.00	97.9 AV			1.29 V	303	58.1	39.8
3	#5725.00	61.0 PK	68.2	-7.2	1.19 V	299	56.3	4.7
4	11400.00	61.0 PK	74.0	-13.0	1.85 V	194	41.9	19.1
5	11400.00	47.2 AV	54.0	-6.8	1.85 V	194	28.1	19.1

Remarks:

1. Emission Level(dBuV/m) = Raw Value(dBuV) + Correction Factor(dB/m)
2. Correction Factor(dB/m) = Antenna Factor(dB/m) + Cable Factor(dB) – Pre-Amplifier Factor(dB)
3. The other emission levels were very low against the limit.
4. Margin value = Emission Level – Limit value
5. " * ": Fundamental frequency.
6. " # ": The radiated frequency is out of the restricted band.

CHANNEL	TX Channel 144	DETECTOR FUNCTION	Peak (PK)
FREQUENCY RANGE	1GHz ~ 40GHz		Average (AV)

ANTENNA POLARITY & TEST DISTANCE: HORIZONTAL AT 3 M

NO.	FREQ. (MHz)	EMISSION LEVEL (dBuV/m)	LIMIT (dBuV/m)	MARGIN (dB)	ANTENNA HEIGHT (m)	TABLE ANGLE (Degree)	RAW VALUE (dBuV)	CORRECTION FACTOR (dB/m)
1	5460.00	58.1 PK	74.0	-15.9	2.66 H	6	53.6	4.5
2	5460.00	45.5 AV	54.0	-8.5	2.66 H	6	41.0	4.5
3	#5470.00	59.2 PK	68.2	-9.0	2.64 H	7	54.7	4.5
4	*5720.00	118.2 PK			2.62 H	4	78.2	40.0
5	*5720.00	107.8 AV			2.62 H	4	67.8	40.0
6	#5850.00	59.8 PK	68.2	-8.4	2.71 H	10	54.5	5.3
7	11440.00	62.5 PK	74.0	-11.5	1.92 H	244	43.3	19.2
8	11440.00	49.2 AV	54.0	-4.8	1.92 H	244	30.0	19.2

ANTENNA POLARITY & TEST DISTANCE: VERTICAL AT 3 M

NO.	FREQ. (MHz)	EMISSION LEVEL (dBuV/m)	LIMIT (dBuV/m)	MARGIN (dB)	ANTENNA HEIGHT (m)	TABLE ANGLE (Degree)	RAW VALUE (dBuV)	CORRECTION FACTOR (dB/m)
1	5460.00	58.6 PK	74.0	-15.4	1.55 V	288	54.1	4.5
2	5460.00	44.7 AV	54.0	-9.3	1.55 V	288	40.2	4.5
3	#5470.00	58.8 PK	68.2	-9.4	1.57 V	290	54.3	4.5
4	*5720.00	112.6 PK			1.52 V	286	72.6	40.0
5	*5720.00	102.4 AV			1.52 V	286	62.4	40.0
6	#5850.00	59.9 PK	68.2	-8.3	1.62 V	292	54.6	5.3
7	11440.00	62.4 PK	74.0	-11.6	2.09 V	214	43.2	19.2
8	11440.00	49.5 AV	54.0	-4.5	2.09 V	214	30.3	19.2

Remarks:

1. Emission Level(dBuV/m) = Raw Value(dBuV) + Correction Factor(dB/m)
2. Correction Factor(dB/m) = Antenna Factor(dB/m) + Cable Factor(dB) – Pre-Amplifier Factor(dB)
3. The other emission levels were very low against the limit.
4. Margin value = Emission Level – Limit value
5. " * ": Fundamental frequency.
6. " # ": The radiated frequency is out of the restricted band.

802.11n (HT20)

CHANNEL	TX Channel 52	DETECTOR FUNCTION	Peak (PK) Average (AV)
FREQUENCY RANGE	1GHz ~ 40GHz		

ANTENNA POLARITY & TEST DISTANCE: HORIZONTAL AT 3 M

NO.	FREQ. (MHz)	EMISSION LEVEL (dBuV/m)	LIMIT (dBuV/m)	MARGIN (dB)	ANTENNA HEIGHT (m)	TABLE ANGLE (Degree)	RAW VALUE (dBuV)	CORRECTION FACTOR (dB/m)
1	5150.00	55.4 PK	74.0	-18.6	1.97 H	353	51.2	4.2
2	5150.00	42.6 AV	54.0	-11.4	1.97 H	353	38.4	4.2
3	*5260.00	116.6 PK			2.16 H	331	77.5	39.1
4	*5260.00	105.9 AV			2.16 H	331	66.8	39.1
5	#10520.00	59.9 PK	68.2	-8.3	1.99 H	249	41.2	18.7

ANTENNA POLARITY & TEST DISTANCE: VERTICAL AT 3 M

NO.	FREQ. (MHz)	EMISSION LEVEL (dBuV/m)	LIMIT (dBuV/m)	MARGIN (dB)	ANTENNA HEIGHT (m)	TABLE ANGLE (Degree)	RAW VALUE (dBuV)	CORRECTION FACTOR (dB/m)
1	5150.00	54.3 PK	74.0	-19.7	1.20 V	309	50.1	4.2
2	5150.00	42.2 AV	54.0	-11.8	1.20 V	309	38.0	4.2
3	*5260.00	75.9 PK			1.28 V	289	72.1	3.8
4	*5260.00	65.3 AV			1.28 V	289	61.5	3.8
5	#10520.00	59.4 PK	68.2	-8.8	1.83 V	203	40.7	18.7

Remarks:

1. Emission Level(dBuV/m) = Raw Value(dBuV) + Correction Factor(dB/m)
2. Correction Factor(dB/m) = Antenna Factor(dB/m) + Cable Factor(dB) – Pre-Amplifier Factor(dB)
3. The other emission levels were very low against the limit.
4. Margin value = Emission Level – Limit value
5. " * ": Fundamental frequency.
6. " # ": The radiated frequency is out of the restricted band.

CHANNEL	TX Channel 60	DETECTOR FUNCTION	Peak (PK)
FREQUENCY RANGE	1GHz ~ 40GHz		Average (AV)

ANTENNA POLARITY & TEST DISTANCE: HORIZONTAL AT 3 M

NO.	FREQ. (MHz)	EMISSION LEVEL (dBuV/m)	LIMIT (dBuV/m)	MARGIN (dB)	ANTENNA HEIGHT (m)	TABLE ANGLE (Degree)	RAW VALUE (dBuV)	CORRECTION FACTOR (dB/m)
1	*5300.00	117.4 PK			2.37 H	332	78.3	39.1
2	*5300.00	106.2 AV			2.37 H	332	67.1	39.1
3	10600.00	60.4 PK	74.0	-13.6	2.13 H	258	41.3	19.1
4	10600.00	46.9 AV	54.0	-7.1	2.13 H	258	27.8	19.1

ANTENNA POLARITY & TEST DISTANCE: VERTICAL AT 3 M

NO.	FREQ. (MHz)	EMISSION LEVEL (dBuV/m)	LIMIT (dBuV/m)	MARGIN (dB)	ANTENNA HEIGHT (m)	TABLE ANGLE (Degree)	RAW VALUE (dBuV)	CORRECTION FACTOR (dB/m)
1	*5300.00	112.1 PK			1.33 V	299	73.0	39.1
2	*5300.00	101.1 AV			1.33 V	299	62.0	39.1
3	10600.00	59.8 PK	74.0	-14.2	1.83 V	193	40.7	19.1
4	10600.00	46.6 AV	54.0	-7.4	1.83 V	193	27.5	19.1

Remarks:

1. Emission Level(dBuV/m) = Raw Value(dBuV) + Correction Factor(dB/m)
2. Correction Factor(dB/m) = Antenna Factor(dB/m) + Cable Factor(dB) – Pre-Amplifier Factor(dB)
3. The other emission levels were very low against the limit.
4. Margin value = Emission Level – Limit value
5. " * ": Fundamental frequency.
6. " # ": The radiated frequency is out of the restricted band.

CHANNEL	TX Channel 64	DETECTOR FUNCTION	Peak (PK)
FREQUENCY RANGE	1GHz ~ 40GHz		Average (AV)

ANTENNA POLARITY & TEST DISTANCE: HORIZONTAL AT 3 M

NO.	FREQ. (MHz)	EMISSION LEVEL (dBuV/m)	LIMIT (dBuV/m)	MARGIN (dB)	ANTENNA HEIGHT (m)	TABLE ANGLE (Degree)	RAW VALUE (dBuV)	CORRECTION FACTOR (dB/m)
1	*5320.00	117.7 PK			2.02 H	347	78.5	39.2
2	*5320.00	106.4 AV			2.02 H	347	67.2	39.2
3	5350.00	66.7 PK	74.0	-7.3	2.29 H	283	62.6	4.1
4	5350.00	52.4 AV	54.0	-1.6	2.29 H	283	48.3	4.1
5	10640.00	60.4 PK	74.0	-13.6	2.30 H	263	41.5	18.9
6	10640.00	46.9 AV	54.0	-7.1	2.30 H	263	28.0	18.9

ANTENNA POLARITY & TEST DISTANCE: VERTICAL AT 3 M

NO.	FREQ. (MHz)	EMISSION LEVEL (dBuV/m)	LIMIT (dBuV/m)	MARGIN (dB)	ANTENNA HEIGHT (m)	TABLE ANGLE (Degree)	RAW VALUE (dBuV)	CORRECTION FACTOR (dB/m)
1	*5320.00	112.3 PK			1.27 V	297	73.1	39.2
2	*5320.00	101.2 AV			1.27 V	297	62.0	39.2
3	5350.00	61.2 PK	74.0	-12.8	1.11 V	291	57.1	4.1
4	5350.00	48.1 AV	54.0	-5.9	1.11 V	291	44.0	4.1
5	10640.00	59.8 PK	74.0	-14.2	1.79 V	193	40.9	18.9
6	10640.00	46.3 AV	54.0	-7.7	1.79 V	193	27.4	18.9

Remarks:

1. Emission Level(dBuV/m) = Raw Value(dBuV) + Correction Factor(dB/m)
2. Correction Factor(dB/m) = Antenna Factor(dB/m) + Cable Factor(dB) – Pre-Amplifier Factor(dB)
3. The other emission levels were very low against the limit.
4. Margin value = Emission Level – Limit value
5. " * ": Fundamental frequency.
6. " # ": The radiated frequency is out of the restricted band.

CHANNEL	TX Channel 100	DETECTOR FUNCTION	Peak (PK)
FREQUENCY RANGE	1GHz ~ 40GHz		Average (AV)

ANTENNA POLARITY & TEST DISTANCE: HORIZONTAL AT 3 M

NO.	FREQ. (MHz)	EMISSION LEVEL (dBuV/m)	LIMIT (dBuV/m)	MARGIN (dB)	ANTENNA HEIGHT (m)	TABLE ANGLE (Degree)	RAW VALUE (dBuV)	CORRECTION FACTOR (dB/m)
1	5460.00	60.0 PK	74.0	-14.0	2.33 H	351	55.5	4.5
2	5460.00	45.7 AV	54.0	-8.3	2.33 H	351	41.2	4.5
3	#5470.00	66.8 PK	68.2	-1.4	2.54 H	8	62.3	4.5
4	*5500.00	116.8 PK			2.21 H	329	77.0	39.8
5	*5500.00	106.3 AV			2.21 H	329	66.5	39.8
6	11000.00	62.1 PK	74.0	-11.9	2.04 H	261	42.1	20.0
7	11000.00	48.3 AV	54.0	-5.7	2.04 H	261	28.3	20.0

ANTENNA POLARITY & TEST DISTANCE: VERTICAL AT 3 M

NO.	FREQ. (MHz)	EMISSION LEVEL (dBuV/m)	LIMIT (dBuV/m)	MARGIN (dB)	ANTENNA HEIGHT (m)	TABLE ANGLE (Degree)	RAW VALUE (dBuV)	CORRECTION FACTOR (dB/m)
1	5460.00	56.5 PK	74.0	-17.5	1.23 V	293	52.0	4.5
2	5460.00	42.7 AV	54.0	-11.3	1.23 V	293	38.2	4.5
3	#5470.00	62.0 PK	68.2	-6.2	1.16 V	292	57.5	4.5
4	*5500.00	112.3 PK			1.25 V	297	72.5	39.8
5	*5500.00	101.8 AV			1.25 V	297	62.0	39.8
6	11000.00	61.4 PK	74.0	-12.6	1.97 V	219	41.4	20.0
7	11000.00	47.6 AV	54.0	-6.4	1.97 V	219	27.6	20.0

Remarks:

1. Emission Level(dBuV/m) = Raw Value(dBuV) + Correction Factor(dB/m)
2. Correction Factor(dB/m) = Antenna Factor(dB/m) + Cable Factor(dB) – Pre-Amplifier Factor(dB)
3. The other emission levels were very low against the limit.
4. Margin value = Emission Level – Limit value
5. " * ": Fundamental frequency.
6. " # ": The radiated frequency is out of the restricted band.

CHANNEL	TX Channel 116	DETECTOR FUNCTION	Peak (PK)
FREQUENCY RANGE	1GHz ~ 40GHz		Average (AV)

ANTENNA POLARITY & TEST DISTANCE: HORIZONTAL AT 3 M

NO.	FREQ. (MHz)	EMISSION LEVEL (dBuV/m)	LIMIT (dBuV/m)	MARGIN (dB)	ANTENNA HEIGHT (m)	TABLE ANGLE (Degree)	RAW VALUE (dBuV)	CORRECTION FACTOR (dB/m)
1	*5580.00	116.9 PK			2.33 H	329	77.2	39.7
2	*5580.00	106.4 AV			2.33 H	329	66.7	39.7
3	11160.00	61.5 PK	74.0	-12.5	1.99 H	260	42.3	19.2
4	11160.00	47.2 AV	54.0	-6.8	1.99 H	260	28.0	19.2

ANTENNA POLARITY & TEST DISTANCE: VERTICAL AT 3 M

NO.	FREQ. (MHz)	EMISSION LEVEL (dBuV/m)	LIMIT (dBuV/m)	MARGIN (dB)	ANTENNA HEIGHT (m)	TABLE ANGLE (Degree)	RAW VALUE (dBuV)	CORRECTION FACTOR (dB/m)
1	*5580.00	112.1 PK			1.29 V	299	72.4	39.7
2	*5580.00	101.7 AV			1.29 V	299	62.0	39.7
3	11160.00	60.9 PK	74.0	-13.1	1.85 V	209	41.7	19.2
4	11160.00	46.4 AV	54.0	-7.6	1.85 V	209	27.2	19.2

Remarks:

1. Emission Level(dBuV/m) = Raw Value(dBuV) + Correction Factor(dB/m)
2. Correction Factor(dB/m) = Antenna Factor(dB/m) + Cable Factor(dB) – Pre-Amplifier Factor(dB)
3. The other emission levels were very low against the limit.
4. Margin value = Emission Level – Limit value
5. " * ": Fundamental frequency.
6. " # ": The radiated frequency is out of the restricted band.

CHANNEL	TX Channel 140	DETECTOR FUNCTION	Peak (PK)
FREQUENCY RANGE	1GHz ~ 40GHz		Average (AV)

ANTENNA POLARITY & TEST DISTANCE: HORIZONTAL AT 3 M

NO.	FREQ. (MHz)	EMISSION LEVEL (dBuV/m)	LIMIT (dBuV/m)	MARGIN (dB)	ANTENNA HEIGHT (m)	TABLE ANGLE (Degree)	RAW VALUE (dBuV)	CORRECTION FACTOR (dB/m)
1	*5700.00	112.7 PK			2.66 H	339	72.9	39.8
2	*5700.00	101.8 AV			2.66 H	339	62.0	39.8
3	#5725.00	66.6 PK	68.2	-1.6	2.62 H	337	61.9	4.7
4	11400.00	61.6 PK	74.0	-12.4	1.97 H	251	42.5	19.1
5	11400.00	47.4 AV	54.0	-6.6	1.97 H	251	28.3	19.1

ANTENNA POLARITY & TEST DISTANCE: VERTICAL AT 3 M

NO.	FREQ. (MHz)	EMISSION LEVEL (dBuV/m)	LIMIT (dBuV/m)	MARGIN (dB)	ANTENNA HEIGHT (m)	TABLE ANGLE (Degree)	RAW VALUE (dBuV)	CORRECTION FACTOR (dB/m)
1	*5700.00	107.9 PK			1.22 V	303	68.1	39.8
2	*5700.00	97.0 AV			1.22 V	303	57.2	39.8
3	#5725.00	60.4 PK	68.2	-7.8	1.30 V	288	55.7	4.7
4	11400.00	60.7 PK	74.0	-13.3	1.91 V	201	41.6	19.1
5	11400.00	46.8 AV	54.0	-7.2	1.91 V	201	27.7	19.1

Remarks:

1. Emission Level(dBuV/m) = Raw Value(dBuV) + Correction Factor(dB/m)
2. Correction Factor(dB/m) = Antenna Factor(dB/m) + Cable Factor(dB) – Pre-Amplifier Factor(dB)
3. The other emission levels were very low against the limit.
4. Margin value = Emission Level – Limit value
5. " * ": Fundamental frequency.
6. " # ": The radiated frequency is out of the restricted band.

CHANNEL	TX Channel 144	DETECTOR FUNCTION	Peak (PK)
FREQUENCY RANGE	1GHz ~ 40GHz		Average (AV)

ANTENNA POLARITY & TEST DISTANCE: HORIZONTAL AT 3 M

NO.	FREQ. (MHz)	EMISSION LEVEL (dBuV/m)	LIMIT (dBuV/m)	MARGIN (dB)	ANTENNA HEIGHT (m)	TABLE ANGLE (Degree)	RAW VALUE (dBuV)	CORRECTION FACTOR (dB/m)
1	5460.00	59.8 PK	74.0	-14.2	2.65 H	281	55.3	4.5
2	5460.00	45.4 AV	54.0	-8.6	2.65 H	281	40.9	4.5
3	#5470.00	60.4 PK	68.2	-7.8	2.69 H	290	55.9	4.5
4	*5720.00	117.2 PK			2.63 H	278	77.2	40.0
5	*5720.00	106.8 AV			2.63 H	278	66.8	40.0
6	#5850.00	59.8 PK	68.2	-8.4	2.72 H	288	54.5	5.3
7	11440.00	62.7 PK	74.0	-11.3	2.01 H	251	43.5	19.2
8	11440.00	49.3 AV	54.0	-4.7	2.01 H	251	30.1	19.2

ANTENNA POLARITY & TEST DISTANCE: VERTICAL AT 3 M

NO.	FREQ. (MHz)	EMISSION LEVEL (dBuV/m)	LIMIT (dBuV/m)	MARGIN (dB)	ANTENNA HEIGHT (m)	TABLE ANGLE (Degree)	RAW VALUE (dBuV)	CORRECTION FACTOR (dB/m)
1	5460.00	58.8 PK	74.0	-15.2	1.53 V	284	54.3	4.5
2	5460.00	44.9 AV	54.0	-9.1	1.53 V	284	40.4	4.5
3	#5470.00	58.9 PK	68.2	-9.3	1.55 V	286	54.4	4.5
4	*5720.00	112.6 PK			1.51 V	282	72.6	40.0
5	*5720.00	102.2 AV			1.51 V	282	62.2	40.0
6	#5850.00	59.8 PK	68.2	-8.4	1.59 V	292	54.5	5.3
7	11440.00	62.4 PK	74.0	-11.6	2.01 V	214	43.2	19.2
8	11440.00	49.4 AV	54.0	-4.6	2.01 V	214	30.2	19.2

Remarks:

1. Emission Level(dBuV/m) = Raw Value(dBuV) + Correction Factor(dB/m)
2. Correction Factor(dB/m) = Antenna Factor(dB/m) + Cable Factor(dB) – Pre-Amplifier Factor(dB)
3. The other emission levels were very low against the limit.
4. Margin value = Emission Level – Limit value
5. " * ": Fundamental frequency.
6. " # ": The radiated frequency is out of the restricted band.

802.11n (HT40)

CHANNEL	TX Channel 54	DETECTOR FUNCTION	Peak (PK) Average (AV)
FREQUENCY RANGE	1GHz ~ 40GHz		

ANTENNA POLARITY & TEST DISTANCE: HORIZONTAL AT 3 M

NO.	FREQ. (MHz)	EMISSION LEVEL (dBuV/m)	LIMIT (dBuV/m)	MARGIN (dB)	ANTENNA HEIGHT (m)	TABLE ANGLE (Degree)	RAW VALUE (dBuV)	CORRECTION FACTOR (dB/m)
1	*5270.00	113.4 PK			2.62 H	348	74.3	39.1
2	*5270.00	103.1 AV			2.62 H	348	64.0	39.1
3	5350.00	60.1 PK	74.0	-13.9	2.09 H	330	56.0	4.1
4	5350.00	45.7 AV	54.0	-8.3	2.09 H	330	41.6	4.1
5	#10540.00	60.1 PK	68.2	-8.1	2.05 H	274	41.3	18.8

ANTENNA POLARITY & TEST DISTANCE: VERTICAL AT 3 M

NO.	FREQ. (MHz)	EMISSION LEVEL (dBuV/m)	LIMIT (dBuV/m)	MARGIN (dB)	ANTENNA HEIGHT (m)	TABLE ANGLE (Degree)	RAW VALUE (dBuV)	CORRECTION FACTOR (dB/m)
1	*5270.00	108.0 PK			1.37 V	300	68.9	39.1
2	*5270.00	97.6 AV			1.37 V	300	58.5	39.1
3	5350.00	58.2 PK	74.0	-15.8	1.20 V	284	54.1	4.1
4	5350.00	43.0 AV	54.0	-11.0	1.20 V	284	38.9	4.1
5	#10540.00	59.8 PK	68.2	-8.4	1.85 V	201	41.0	18.8

Remarks:

1. Emission Level(dBuV/m) = Raw Value(dBuV) + Correction Factor(dB/m)
2. Correction Factor(dB/m) = Antenna Factor(dB/m) + Cable Factor(dB) – Pre-Amplifier Factor(dB)
3. The other emission levels were very low against the limit.
4. Margin value = Emission Level – Limit value
5. " * ": Fundamental frequency.
6. " # ": The radiated frequency is out of the restricted band.

CHANNEL	TX Channel 62	DETECTOR FUNCTION	Peak (PK)
FREQUENCY RANGE	1GHz ~ 40GHz		Average (AV)

ANTENNA POLARITY & TEST DISTANCE: HORIZONTAL AT 3 M

NO.	FREQ. (MHz)	EMISSION LEVEL (dBuV/m)	LIMIT (dBuV/m)	MARGIN (dB)	ANTENNA HEIGHT (m)	TABLE ANGLE (Degree)	RAW VALUE (dBuV)	CORRECTION FACTOR (dB/m)
1	*5310.00	111.0 PK			2.38 H	333	71.8	39.2
2	*5310.00	100.6 AV			2.38 H	333	61.4	39.2
3	5350.00	68.2 PK	74.0	-5.8	2.10 H	331	64.1	4.1
4	5350.00	52.3 AV	54.0	-1.7	2.10 H	331	48.2	4.1
5	10620.00	60.4 PK	74.0	-13.6	2.10 H	264	41.4	19.0
6	10620.00	47.0 AV	54.0	-7.0	2.10 H	264	28.0	19.0

ANTENNA POLARITY & TEST DISTANCE: VERTICAL AT 3 M

NO.	FREQ. (MHz)	EMISSION LEVEL (dBuV/m)	LIMIT (dBuV/m)	MARGIN (dB)	ANTENNA HEIGHT (m)	TABLE ANGLE (Degree)	RAW VALUE (dBuV)	CORRECTION FACTOR (dB/m)
1	*5310.00	105.5 PK			1.26 V	296	66.3	39.2
2	*5310.00	95.2 AV			1.26 V	296	56.0	39.2
3	5350.00	61.2 PK	74.0	-12.8	1.19 V	281	57.1	4.1
4	5350.00	46.0 AV	54.0	-8.0	1.19 V	281	41.9	4.1
5	10620.00	59.8 PK	74.0	-14.2	1.90 V	199	40.8	19.0
6	10620.00	46.6 AV	54.0	-7.4	1.90 V	199	27.6	19.0

Remarks:

1. Emission Level(dBuV/m) = Raw Value(dBuV) + Correction Factor(dB/m)
2. Correction Factor(dB/m) = Antenna Factor(dB/m) + Cable Factor(dB) – Pre-Amplifier Factor(dB)
3. The other emission levels were very low against the limit.
4. Margin value = Emission Level – Limit value
5. " * ": Fundamental frequency.
6. " # ": The radiated frequency is out of the restricted band.

CHANNEL	TX Channel 102	DETECTOR FUNCTION	Peak (PK)
FREQUENCY RANGE	1GHz ~ 40GHz		Average (AV)

ANTENNA POLARITY & TEST DISTANCE: HORIZONTAL AT 3 M

NO.	FREQ. (MHz)	EMISSION LEVEL (dBuV/m)	LIMIT (dBuV/m)	MARGIN (dB)	ANTENNA HEIGHT (m)	TABLE ANGLE (Degree)	RAW VALUE (dBuV)	CORRECTION FACTOR (dB/m)
1	5460.00	60.2 PK	74.0	-13.8	1.84 H	350	55.7	4.5
2	5460.00	46.8 AV	54.0	-7.2	1.84 H	350	42.3	4.5
3	#5470.00	66.6 PK	68.2	-1.6	1.91 H	335	62.1	4.5
4	*5510.00	111.3 PK			2.22 H	328	71.5	39.8
5	*5510.00	101.2 AV			2.22 H	328	61.4	39.8
6	11020.00	61.3 PK	74.0	-12.7	2.01 H	251	41.5	19.8
7	11020.00	47.8 AV	54.0	-6.2	2.01 H	251	28.0	19.8

ANTENNA POLARITY & TEST DISTANCE: VERTICAL AT 3 M

NO.	FREQ. (MHz)	EMISSION LEVEL (dBuV/m)	LIMIT (dBuV/m)	MARGIN (dB)	ANTENNA HEIGHT (m)	TABLE ANGLE (Degree)	RAW VALUE (dBuV)	CORRECTION FACTOR (dB/m)
1	5460.00	57.6 PK	74.0	-16.4	1.39 V	288	53.1	4.5
2	5460.00	44.1 AV	54.0	-9.9	1.39 V	288	39.6	4.5
3	#5470.00	60.3 PK	68.2	-7.9	1.28 V	298	55.8	4.5
4	*5510.00	106.8 PK			1.39 V	297	67.0	39.8
5	*5510.00	96.6 AV			1.39 V	297	56.8	39.8
6	11020.00	60.5 PK	74.0	-13.5	1.82 V	199	40.7	19.8
7	11020.00	47.4 AV	54.0	-6.6	1.82 V	199	27.6	19.8

Remarks:

1. Emission Level(dBuV/m) = Raw Value(dBuV) + Correction Factor(dB/m)
2. Correction Factor(dB/m) = Antenna Factor(dB/m) + Cable Factor(dB) – Pre-Amplifier Factor(dB)
3. The other emission levels were very low against the limit.
4. Margin value = Emission Level – Limit value
5. " * ": Fundamental frequency.
6. " # ": The radiated frequency is out of the restricted band.

CHANNEL	TX Channel 110	DETECTOR FUNCTION	Peak (PK)
FREQUENCY RANGE	1GHz ~ 40GHz		Average (AV)

ANTENNA POLARITY & TEST DISTANCE: HORIZONTAL AT 3 M

NO.	FREQ. (MHz)	EMISSION LEVEL (dBuV/m)	LIMIT (dBuV/m)	MARGIN (dB)	ANTENNA HEIGHT (m)	TABLE ANGLE (Degree)	RAW VALUE (dBuV)	CORRECTION FACTOR (dB/m)
1	5460.00	58.5 PK	74.0	-15.5	2.03 H	333	54.0	4.5
2	5460.00	44.4 AV	54.0	-9.6	2.03 H	333	39.9	4.5
3	#5470.00	59.6 PK	68.2	-8.6	2.26 H	344	55.1	4.5
4	*5550.00	114.1 PK			2.09 H	326	74.4	39.7
5	*5550.00	103.7 AV			2.09 H	326	64.0	39.7
6	11100.00	60.6 PK	74.0	-13.4	1.94 H	269	41.3	19.3
7	11100.00	47.5 AV	54.0	-6.5	1.94 H	269	28.2	19.3

ANTENNA POLARITY & TEST DISTANCE: VERTICAL AT 3 M

NO.	FREQ. (MHz)	EMISSION LEVEL (dBuV/m)	LIMIT (dBuV/m)	MARGIN (dB)	ANTENNA HEIGHT (m)	TABLE ANGLE (Degree)	RAW VALUE (dBuV)	CORRECTION FACTOR (dB/m)
1	5460.00	55.6 PK	74.0	-18.4	1.50 V	301	51.1	4.5
2	5460.00	42.5 AV	54.0	-11.5	1.50 V	301	38.0	4.5
3	#5470.00	56.0 PK	68.2	-12.2	1.39 V	299	51.5	4.5
4	*5550.00	109.3 PK			1.41 V	289	69.6	39.7
5	*5550.00	99.2 AV			1.41 V	289	59.5	39.7
6	11100.00	60.0 PK	74.0	-14.0	1.89 V	209	40.7	19.3
7	11100.00	46.9 AV	54.0	-7.1	1.89 V	209	27.6	19.3

Remarks:

1. Emission Level(dBuV/m) = Raw Value(dBuV) + Correction Factor(dB/m)
2. Correction Factor(dB/m) = Antenna Factor(dB/m) + Cable Factor(dB) – Pre-Amplifier Factor(dB)
3. The other emission levels were very low against the limit.
4. Margin value = Emission Level – Limit value
5. " * ": Fundamental frequency.
6. " # ": The radiated frequency is out of the restricted band.

CHANNEL	TX Channel 134	DETECTOR FUNCTION	Peak (PK)
FREQUENCY RANGE	1GHz ~ 40GHz		Average (AV)

ANTENNA POLARITY & TEST DISTANCE: HORIZONTAL AT 3 M

NO.	FREQ. (MHz)	EMISSION LEVEL (dBuV/m)	LIMIT (dBuV/m)	MARGIN (dB)	ANTENNA HEIGHT (m)	TABLE ANGLE (Degree)	RAW VALUE (dBuV)	CORRECTION FACTOR (dB/m)
1	*5670.00	111.3 PK			2.79 H	344	71.6	39.7
2	*5670.00	101.1 AV			2.79 H	344	61.4	39.7
3	#5725.00	66.7 PK	68.2	-1.5	2.64 H	278	62.0	4.7
4	11340.00	62.3 PK	74.0	-11.7	2.11 H	266	43.0	19.3
5	11340.00	48.2 AV	54.0	-5.8	2.11 H	266	28.9	19.3

ANTENNA POLARITY & TEST DISTANCE: VERTICAL AT 3 M

NO.	FREQ. (MHz)	EMISSION LEVEL (dBuV/m)	LIMIT (dBuV/m)	MARGIN (dB)	ANTENNA HEIGHT (m)	TABLE ANGLE (Degree)	RAW VALUE (dBuV)	CORRECTION FACTOR (dB/m)
1	*5670.00	106.6 PK			1.31 V	280	66.9	39.7
2	*5670.00	96.5 AV			1.31 V	280	56.8	39.7
3	#5725.00	63.3 PK	68.2	-4.9	1.34 V	287	58.6	4.7
4	11340.00	61.3 PK	74.0	-12.7	1.80 V	201	42.0	19.3
5	11340.00	47.8 AV	54.0	-6.2	1.80 V	201	28.5	19.3

Remarks:

1. Emission Level(dBuV/m) = Raw Value(dBuV) + Correction Factor(dB/m)
2. Correction Factor(dB/m) = Antenna Factor(dB/m) + Cable Factor(dB) – Pre-Amplifier Factor(dB)
3. The other emission levels were very low against the limit.
4. Margin value = Emission Level – Limit value
5. " * ": Fundamental frequency.
6. " # ": The radiated frequency is out of the restricted band.

CHANNEL	TX Channel 142	DETECTOR FUNCTION	Peak (PK)
FREQUENCY RANGE	1GHz ~ 40GHz		Average (AV)

ANTENNA POLARITY & TEST DISTANCE: HORIZONTAL AT 3 M

NO.	FREQ. (MHz)	EMISSION LEVEL (dBuV/m)	LIMIT (dBuV/m)	MARGIN (dB)	ANTENNA HEIGHT (m)	TABLE ANGLE (Degree)	RAW VALUE (dBuV)	CORRECTION FACTOR (dB/m)
1	5460.00	59.1 PK	74.0	-14.9	2.55 H	342	54.6	4.5
2	5460.00	45.6 AV	54.0	-8.4	2.55 H	342	41.1	4.5
3	#5470.00	59.2 PK	68.2	-9.0	2.56 H	344	54.7	4.5
4	*5710.00	115.2 PK			2.53 H	339	75.3	39.9
5	*5710.00	104.7 AV			2.53 H	339	64.8	39.9
6	#5850.00	60.0 PK	68.2	-8.2	2.60 H	345	54.7	5.3
7	11420.00	62.2 PK	74.0	-11.8	2.06 H	244	43.1	19.1
8	11420.00	49.2 AV	54.0	-4.8	2.06 H	244	30.1	19.1

ANTENNA POLARITY & TEST DISTANCE: VERTICAL AT 3 M

NO.	FREQ. (MHz)	EMISSION LEVEL (dBuV/m)	LIMIT (dBuV/m)	MARGIN (dB)	ANTENNA HEIGHT (m)	TABLE ANGLE (Degree)	RAW VALUE (dBuV)	CORRECTION FACTOR (dB/m)
1	5460.00	57.9 PK	74.0	-16.1	1.42 V	287	53.4	4.5
2	5460.00	45.0 AV	54.0	-9.0	1.42 V	287	40.5	4.5
3	#5470.00	59.1 PK	68.2	-9.1	1.44 V	289	54.6	4.5
4	*5710.00	109.7 PK			1.41 V	285	69.8	39.9
5	*5710.00	99.4 AV			1.41 V	285	59.5	39.9
6	#5850.00	59.0 PK	68.2	-9.2	1.46 V	291	53.7	5.3
7	11420.00	62.2 PK	74.0	-11.8	2.02 V	213	43.1	19.1
8	11420.00	49.1 AV	54.0	-4.9	2.02 V	213	30.0	19.1

Remarks:

1. Emission Level(dBuV/m) = Raw Value(dBuV) + Correction Factor(dB/m)
2. Correction Factor(dB/m) = Antenna Factor(dB/m) + Cable Factor(dB) – Pre-Amplifier Factor(dB)
3. The other emission levels were very low against the limit.
4. Margin value = Emission Level – Limit value
5. " * ": Fundamental frequency.
6. " # ": The radiated frequency is out of the restricted band.

802.11ac (VHT80)

CHANNEL	TX Channel 58	DETECTOR FUNCTION	Peak (PK) Average (AV)
FREQUENCY RANGE	1GHz ~ 40GHz		

ANTENNA POLARITY & TEST DISTANCE: HORIZONTAL AT 3 M

NO.	FREQ. (MHz)	EMISSION LEVEL (dBuV/m)	LIMIT (dBuV/m)	MARGIN (dB)	ANTENNA HEIGHT (m)	TABLE ANGLE (Degree)	RAW VALUE (dBuV)	CORRECTION FACTOR (dB/m)
1	5150.00	58.1 PK	74.0	-15.9	1.85 H	342	53.9	4.2
2	5150.00	44.4 AV	54.0	-9.6	1.85 H	342	40.2	4.2
3	*5290.00	106.0 PK			2.47 H	339	66.9	39.1
4	*5290.00	95.4 AV			2.47 H	339	56.3	39.1
5	5350.00	65.2 PK	74.0	-8.8	1.26 H	331	61.1	4.1
6	5350.00	52.3 AV	54.0	-1.7	1.26 H	331	48.2	4.1
7	#10580.00	60.8 PK	68.2	-7.4	2.14 H	259	41.8	19.0

ANTENNA POLARITY & TEST DISTANCE: VERTICAL AT 3 M

NO.	FREQ. (MHz)	EMISSION LEVEL (dBuV/m)	LIMIT (dBuV/m)	MARGIN (dB)	ANTENNA HEIGHT (m)	TABLE ANGLE (Degree)	RAW VALUE (dBuV)	CORRECTION FACTOR (dB/m)
1	5150.00	56.0 PK	74.0	-18.0	1.30 V	291	51.8	4.2
2	5150.00	42.7 AV	54.0	-11.3	1.30 V	291	38.5	4.2
3	*5290.00	100.2 PK			1.21 V	285	61.1	39.1
4	*5290.00	89.5 AV			1.21 V	285	50.4	39.1
5	5350.00	59.2 PK	74.0	-14.8	1.29 V	289	55.1	4.1
6	5350.00	46.1 AV	54.0	-7.9	1.29 V	289	42.0	4.1
7	#10580.00	60.3 PK	68.2	-7.9	1.79 V	191	41.3	19.0

Remarks:

1. Emission Level(dBuV/m) = Raw Value(dBuV) + Correction Factor(dB/m)
2. Correction Factor(dB/m) = Antenna Factor(dB/m) + Cable Factor(dB) – Pre-Amplifier Factor(dB)
3. The other emission levels were very low against the limit.
4. Margin value = Emission Level – Limit value
5. " * ": Fundamental frequency.
6. " # ": The radiated frequency is out of the restricted band.

CHANNEL	TX Channel 106	DETECTOR FUNCTION	Peak (PK)
FREQUENCY RANGE	1GHz ~ 40GHz		Average (AV)

ANTENNA POLARITY & TEST DISTANCE: HORIZONTAL AT 3 M								
NO.	FREQ. (MHz)	EMISSION LEVEL (dBuV/m)	LIMIT (dBuV/m)	MARGIN (dB)	ANTENNA HEIGHT (m)	TABLE ANGLE (Degree)	RAW VALUE (dBuV)	CORRECTION FACTOR (dB/m)
1	5460.00	64.1 PK	74.0	-9.9	2.48 H	6	59.6	4.5
2	5460.00	51.3 AV	54.0	-2.7	2.48 H	6	46.8	4.5
3	#5470.00	66.8 PK	68.2	-1.4	2.47 H	285	62.3	4.5
4	*5530.00	107.7 PK			2.51 H	4	67.9	39.8
5	*5530.00	97.8 AV			2.51 H	4	58.0	39.8
6	#5725.00	55.5 PK	68.2	-12.7	2.39 H	309	50.8	4.7
7	11060.00	60.1 PK	74.0	-13.9	1.96 H	248	40.6	19.5
8	11060.00	46.8 AV	54.0	-7.2	1.96 H	248	27.3	19.5
ANTENNA POLARITY & TEST DISTANCE: VERTICAL AT 3 M								
NO.	FREQ. (MHz)	EMISSION LEVEL (dBuV/m)	LIMIT (dBuV/m)	MARGIN (dB)	ANTENNA HEIGHT (m)	TABLE ANGLE (Degree)	RAW VALUE (dBuV)	CORRECTION FACTOR (dB/m)
1	5460.00	58.8 PK	74.0	-15.2	1.19 V	297	54.3	4.5
2	5460.00	47.3 AV	54.0	-6.7	1.19 V	297	42.8	4.5
3	#5470.00	62.8 PK	68.2	-5.4	1.21 V	305	58.3	4.5
4	*5530.00	103.0 PK			1.39 V	288	63.2	39.8
5	*5530.00	93.3 AV			1.39 V	288	53.5	39.8
6	#5725.00	54.4 PK	68.2	-13.8	1.30 V	291	49.7	4.7
7	11060.00	59.6 PK	74.0	-14.4	1.77 V	188	40.1	19.5
8	11060.00	46.5 AV	54.0	-7.5	1.77 V	188	27.0	19.5

Remarks:

1. Emission Level(dBuV/m) = Raw Value(dBuV) + Correction Factor(dB/m)
2. Correction Factor(dB/m) = Antenna Factor(dB/m) + Cable Factor(dB) – Pre-Amplifier Factor(dB)
3. The other emission levels were very low against the limit.
4. Margin value = Emission Level – Limit value
5. " * ": Fundamental frequency.
6. " # ": The radiated frequency is out of the restricted band.

CHANNEL	TX Channel 122	DETECTOR FUNCTION	Peak (PK)
FREQUENCY RANGE	1GHz ~ 40GHz		Average (AV)

ANTENNA POLARITY & TEST DISTANCE: HORIZONTAL AT 3 M								
NO.	FREQ. (MHz)	EMISSION LEVEL (dBuV/m)	LIMIT (dBuV/m)	MARGIN (dB)	ANTENNA HEIGHT (m)	TABLE ANGLE (Degree)	RAW VALUE (dBuV)	CORRECTION FACTOR (dB/m)
1	5460.00	64.0 PK	74.0	-10.0	2.47 H	299	59.5	4.5
2	5460.00	46.7 AV	54.0	-7.3	2.47 H	299	42.2	4.5
3	#5470.00	65.3 PK	68.2	-2.9	2.25 H	324	60.8	4.5
4	*5610.00	109.5 PK			2.87 H	347	69.7	39.8
5	*5610.00	99.4 AV			2.87 H	347	59.6	39.8
6	#5725.00	66.5 PK	68.2	-1.7	2.62 H	283	61.8	4.7
7	11220.00	60.6 PK	74.0	-13.4	2.13 H	263	41.3	19.3
8	11220.00	47.3 AV	54.0	-6.7	2.13 H	263	28.0	19.3
ANTENNA POLARITY & TEST DISTANCE: VERTICAL AT 3 M								
NO.	FREQ. (MHz)	EMISSION LEVEL (dBuV/m)	LIMIT (dBuV/m)	MARGIN (dB)	ANTENNA HEIGHT (m)	TABLE ANGLE (Degree)	RAW VALUE (dBuV)	CORRECTION FACTOR (dB/m)
1	5460.00	59.0 PK	74.0	-15.0	1.20 V	313	54.5	4.5
2	5460.00	43.6 AV	54.0	-10.4	1.20 V	313	39.1	4.5
3	#5470.00	59.6 PK	68.2	-8.6	1.31 V	288	55.1	4.5
4	*5610.00	104.9 PK			1.33 V	298	65.1	39.8
5	*5610.00	94.8 AV			1.33 V	298	55.0	39.8
6	#5725.00	60.6 PK	68.2	-7.6	1.20 V	322	55.9	4.7
7	11220.00	60.0 PK	74.0	-14.0	1.71 V	219	40.7	19.3
8	11220.00	46.6 AV	54.0	-7.4	1.71 V	219	27.3	19.3

Remarks:

1. Emission Level(dBuV/m) = Raw Value(dBuV) + Correction Factor(dB/m)
2. Correction Factor(dB/m) = Antenna Factor(dB/m) + Cable Factor(dB) – Pre-Amplifier Factor(dB)
3. The other emission levels were very low against the limit.
4. Margin value = Emission Level – Limit value
5. " * ": Fundamental frequency.
6. " # ": The radiated frequency is out of the restricted band.

CHANNEL	TX Channel 138	DETECTOR FUNCTION	Peak (PK)
FREQUENCY RANGE	1GHz ~ 40GHz		Average (AV)

ANTENNA POLARITY & TEST DISTANCE: HORIZONTAL AT 3 M

NO.	FREQ. (MHz)	EMISSION LEVEL (dBuV/m)	LIMIT (dBuV/m)	MARGIN (dB)	ANTENNA HEIGHT (m)	TABLE ANGLE (Degree)	RAW VALUE (dBuV)	CORRECTION FACTOR (dB/m)
1	5460.00	62.1 PK	74.0	-11.9	2.35 H	335	57.6	4.5
2	5460.00	46.9 AV	54.0	-7.1	2.35 H	335	42.4	4.5
3	#5470.00	60.6 PK	68.2	-7.6	2.37 H	338	56.1	4.5
4	*5690.00	111.6 PK			2.43 H	3	71.8	39.8
5	*5690.00	101.1 AV			2.43 H	3	61.3	39.8
6	#5850.00	61.9 PK	68.2	-6.3	2.26 H	338	56.6	5.3
7	11380.00	61.5 PK	74.0	-12.5	2.04 H	261	42.4	19.1
8	11380.00	49.3 AV	54.0	-4.7	2.04 H	261	30.2	19.1

ANTENNA POLARITY & TEST DISTANCE: VERTICAL AT 3 M

NO.	FREQ. (MHz)	EMISSION LEVEL (dBuV/m)	LIMIT (dBuV/m)	MARGIN (dB)	ANTENNA HEIGHT (m)	TABLE ANGLE (Degree)	RAW VALUE (dBuV)	CORRECTION FACTOR (dB/m)
1	5460.00	58.7 PK	74.0	-15.3	1.53 V	287	54.2	4.5
2	5460.00	45.3 AV	54.0	-8.7	1.53 V	287	40.8	4.5
3	#5470.00	59.3 PK	68.2	-8.9	1.55 V	288	54.8	4.5
4	*5690.00	106.3 PK			1.55 V	285	66.5	39.8
5	*5690.00	96.0 AV			1.55 V	285	56.2	39.8
6	#5850.00	59.7 PK	68.2	-8.5	1.61 V	291	54.4	5.3
7	11380.00	61.8 PK	74.0	-12.2	1.92 V	206	42.7	19.1
8	11380.00	48.9 AV	54.0	-5.1	1.92 V	206	29.8	19.1

Remarks:

1. Emission Level(dBuV/m) = Raw Value(dBuV) + Correction Factor(dB/m)
2. Correction Factor(dB/m) = Antenna Factor(dB/m) + Cable Factor(dB) – Pre-Amplifier Factor(dB)
3. The other emission levels were very low against the limit.
4. Margin value = Emission Level – Limit value
5. " * ": Fundamental frequency.
6. " # ": The radiated frequency is out of the restricted band.

Below 1GHz Worst-Case

802.11n (HT40)

CHANNEL	TX Channel 110	DETECTOR FUNCTION	Quasi-Peak (QP)
FREQUENCY RANGE	9kHz ~ 1GHz	TEST MODE	A1

ANTENNA POLARITY & TEST DISTANCE: HORIZONTAL AT 3 M								
NO.	FREQ. (MHz)	EMISSION LEVEL (dBuV/m)	LIMIT (dBuV/m)	MARGIN (dB)	ANTENNA HEIGHT (m)	TABLE ANGLE (Degree)	RAW VALUE (dBuV)	CORRECTION FACTOR (dB/m)
1	57.16	27.2 QP	40.0	-12.8	2.00 H	47	36.5	-9.3
2	123.12	26.7 QP	43.5	-16.8	1.51 H	195	37.4	-10.7
3	247.28	29.9 QP	46.0	-16.1	1.00 H	283	39.2	-9.3
4	342.34	35.1 QP	46.0	-10.9	1.00 H	182	41.5	-6.4
5	445.16	33.1 QP	46.0	-12.9	2.00 H	172	35.8	-2.7
6	670.20	30.7 QP	46.0	-15.3	1.00 H	244	29.0	1.7

Remarks:

1. Emission Level(dBuV/m) = Raw Value(dBuV) + Correction Factor(dB/m)
2. Correction Factor(dB/m) = Antenna Factor(dB/m) + Cable Factor(dB) – Pre-Amplifier Factor(dB)
3. Margin value = Emission Level – Limit value
4. The emission levels were very low against the limit of frequency range 9kHz~30MHz: the amplitude of spurious emissions attenuated more than 20dB below the permissible value to be report.

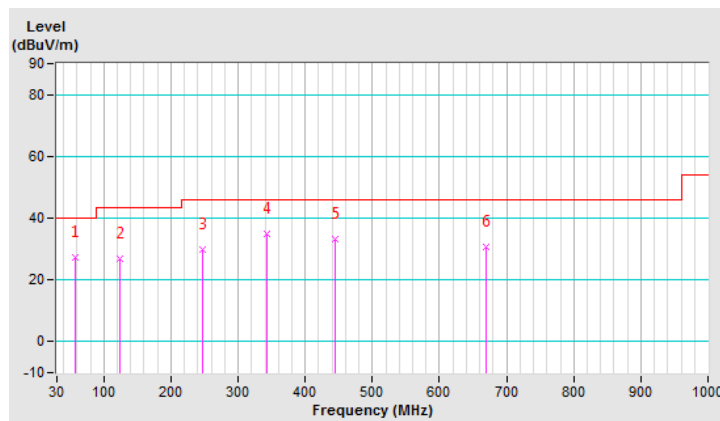

CHANNEL	TX Channel 110	DETECTOR FUNCTION	Quasi-Peak (QP)
FREQUENCY RANGE	9kHz ~ 1GHz	TEST MODE	A1

ANTENNA POLARITY & TEST DISTANCE: VERTICAL AT 3 M

NO.	FREQ. (MHz)	EMISSION LEVEL (dBuV/m)	LIMIT (dBuV/m)	MARGIN (dB)	ANTENNA HEIGHT (m)	TABLE ANGLE (Degree)	RAW VALUE (dBuV)	CORRECTION FACTOR (dB/m)
1	49.40	30.9 QP	40.0	-9.1	1.50 V	298	39.9	-9.0
2	62.98	34.8 QP	40.0	-5.2	1.50 V	227	44.4	-9.6
3	247.28	29.6 QP	46.0	-16.4	1.00 V	310	38.9	-9.3
4	342.34	34.0 QP	46.0	-12.0	1.00 V	158	40.4	-6.4
5	445.16	31.5 QP	46.0	-14.5	1.99 V	145	34.2	-2.7
6	561.56	29.3 QP	46.0	-16.7	1.50 V	15	29.6	-0.3

Remarks:

1. Emission Level(dBuV/m) = Raw Value(dBuV) + Correction Factor(dB/m)
2. Correction Factor(dB/m) = Antenna Factor(dB/m) + Cable Factor(dB) – Pre-Amplifier Factor(dB)
3. Margin value = Emission Level – Limit value
4. The emission levels were very low against the limit of frequency range 9kHz~30MHz: the amplitude of spurious emissions attenuated more than 20dB below the permissible value to be report.

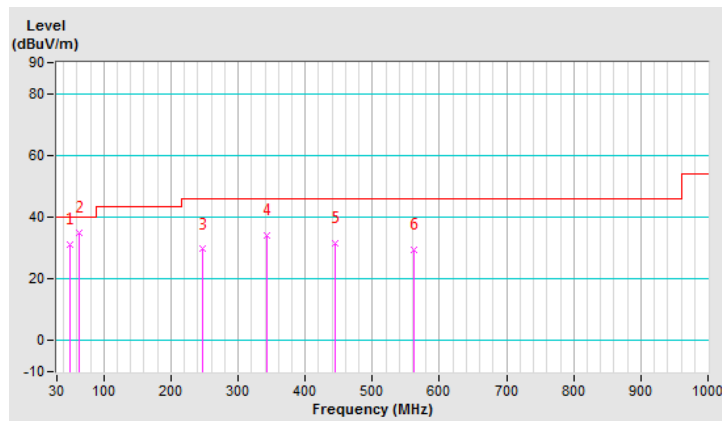

CHANNEL	TX Channel 110	DETECTOR FUNCTION	Quasi-Peak (QP)
FREQUENCY RANGE	9kHz ~ 1GHz	TEST MODE	A2

ANTENNA POLARITY & TEST DISTANCE: HORIZONTAL AT 3 M								
NO.	FREQ. (MHz)	EMISSION LEVEL (dBuV/m)	LIMIT (dBuV/m)	MARGIN (dB)	ANTENNA HEIGHT (m)	TABLE ANGLE (Degree)	RAW VALUE (dBuV)	CORRECTION FACTOR (dB/m)
1	57.16	28.8 QP	40.0	-11.2	2.00 H	161	38.1	-9.3
2	97.90	29.1 QP	43.5	-14.4	2.00 H	224	42.4	-13.3
3	154.16	29.2 QP	43.5	-14.3	2.00 H	66	37.8	-8.6
4	342.34	33.9 QP	46.0	-12.1	1.00 H	161	40.3	-6.4
5	443.22	31.9 QP	46.0	-14.1	2.00 H	191	34.7	-2.8
6	615.88	30.8 QP	46.0	-15.2	1.00 H	11	29.5	1.3

Remarks:

1. Emission Level(dBuV/m) = Raw Value(dBuV) + Correction Factor(dB/m)
2. Correction Factor(dB/m) = Antenna Factor(dB/m) + Cable Factor(dB) – Pre-Amplifier Factor(dB)
3. Margin value = Emission Level – Limit value
4. The emission levels were very low against the limit of frequency range 9kHz~30MHz: the amplitude of spurious emissions attenuated more than 20dB below the permissible value to be report.

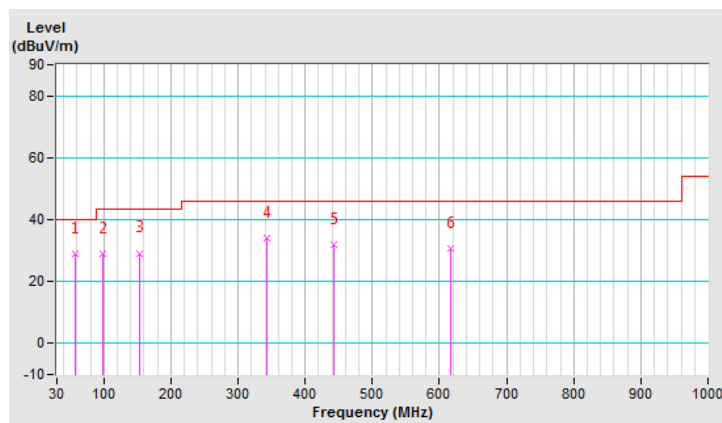

CHANNEL	TX Channel 110	DETECTOR FUNCTION	Quasi-Peak (QP)
FREQUENCY RANGE	9kHz ~ 1GHz	TEST MODE	A2

ANTENNA POLARITY & TEST DISTANCE: VERTICAL AT 3 M								
NO.	FREQ. (MHz)	EMISSION LEVEL (dBuV/m)	LIMIT (dBuV/m)	MARGIN (dB)	ANTENNA HEIGHT (m)	TABLE ANGLE (Degree)	RAW VALUE (dBuV)	CORRECTION FACTOR (dB/m)
1	55.22	36.1 QP	40.0	-3.9	1.00 V	57	45.1	-9.0
2	107.60	29.3 QP	43.5	-14.2	1.50 V	119	41.3	-12.0
3	330.70	22.5 QP	46.0	-23.5	1.50 V	309	28.9	-6.4
4	443.22	27.0 QP	46.0	-19.0	2.00 V	117	29.8	-2.8
5	503.36	26.1 QP	46.0	-19.9	1.00 V	111	27.5	-1.4
6	672.14	30.0 QP	46.0	-16.0	1.50 V	99	28.3	1.7

Remarks:

1. Emission Level(dBuV/m) = Raw Value(dBuV) + Correction Factor(dB/m)
2. Correction Factor(dB/m) = Antenna Factor(dB/m) + Cable Factor(dB) – Pre-Amplifier Factor(dB)
3. Margin value = Emission Level – Limit value
4. The emission levels were very low against the limit of frequency range 9kHz~30MHz: the amplitude of spurious emissions attenuated more than 20dB below the permissible value to be report.

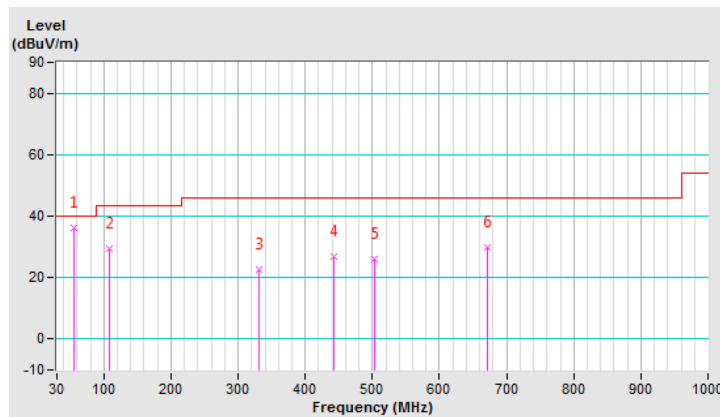

CHANNEL	TX Channel 110	DETECTOR FUNCTION	Quasi-Peak (QP)
FREQUENCY RANGE	9kHz ~ 1GHz	TEST MODE	B1

ANTENNA POLARITY & TEST DISTANCE: HORIZONTAL AT 3 M								
NO.	FREQ. (MHz)	EMISSION LEVEL (dBuV/m)	LIMIT (dBuV/m)	MARGIN (dB)	ANTENNA HEIGHT (m)	TABLE ANGLE (Degree)	RAW VALUE (dBuV)	CORRECTION FACTOR (dB/m)
1	57.16	27.8 QP	40.0	-12.2	1.99 H	9	37.1	-9.3
2	105.66	28.2 QP	43.5	-15.3	1.99 H	9	40.5	-12.3
3	245.34	30.4 QP	46.0	-15.6	1.00 H	155	39.7	-9.3
4	340.40	34.5 QP	46.0	-11.5	1.00 H	177	40.9	-6.4
5	447.10	32.3 QP	46.0	-13.7	1.49 H	176	35.0	-2.7
6	600.36	30.1 QP	46.0	-15.9	1.49 H	15	29.1	1.0

Remarks:

1. Emission Level(dBuV/m) = Raw Value(dBuV) + Correction Factor(dB/m)
2. Correction Factor(dB/m) = Antenna Factor(dB/m) + Cable Factor(dB) – Pre-Amplifier Factor(dB)
3. Margin value = Emission Level – Limit value
4. The emission levels were very low against the limit of frequency range 9kHz~30MHz: the amplitude of spurious emissions attenuated more than 20dB below the permissible value to be report.

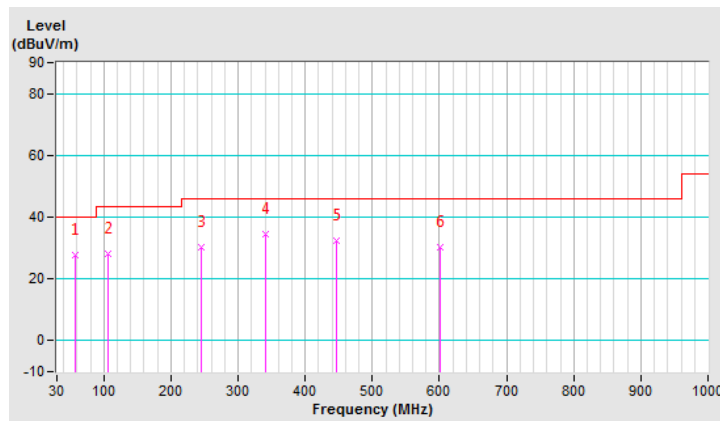

CHANNEL	TX Channel 110	DETECTOR FUNCTION	Quasi-Peak (QP)
FREQUENCY RANGE	9kHz ~ 1GHz	TEST MODE	B1

ANTENNA POLARITY & TEST DISTANCE: VERTICAL AT 3 M								
NO.	FREQ. (MHz)	EMISSION LEVEL (dBuV/m)	LIMIT (dBuV/m)	MARGIN (dB)	ANTENNA HEIGHT (m)	TABLE ANGLE (Degree)	RAW VALUE (dBuV)	CORRECTION FACTOR (dB/m)
1	49.40	34.5 QP	40.0	-5.5	1.01 V	337	43.5	-9.0
2	99.84	31.7 QP	43.5	-11.8	1.01 V	34	44.7	-13.0
3	247.28	30.8 QP	46.0	-15.2	1.01 V	287	40.1	-9.3
4	330.70	35.9 QP	46.0	-10.1	1.01 V	183	42.3	-6.4
5	443.22	31.7 QP	46.0	-14.3	1.01 V	148	34.5	-2.8
6	629.46	30.5 QP	46.0	-15.5	2.00 V	6	29.0	1.5

Remarks:

1. Emission Level(dBuV/m) = Raw Value(dBuV) + Correction Factor(dB/m)
2. Correction Factor(dB/m) = Antenna Factor(dB/m) + Cable Factor(dB) – Pre-Amplifier Factor(dB)
3. Margin value = Emission Level – Limit value
4. The emission levels were very low against the limit of frequency range 9kHz~30MHz: the amplitude of spurious emissions attenuated more than 20dB below the permissible value to be report.

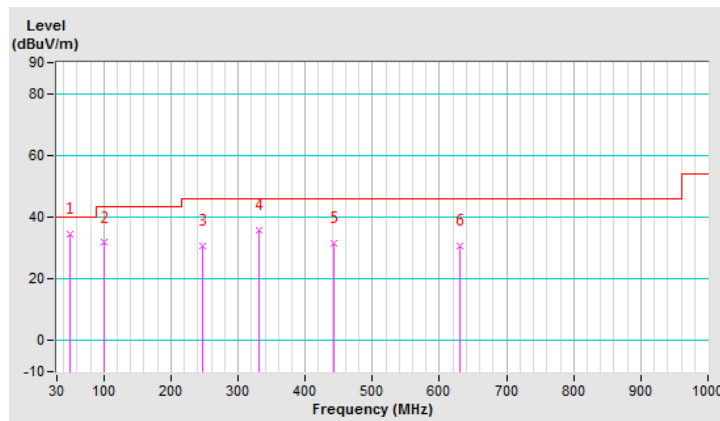

CHANNEL	TX Channel 110	DETECTOR FUNCTION	Quasi-Peak (QP)
FREQUENCY RANGE	9kHz ~ 1GHz	TEST MODE	B2

ANTENNA POLARITY & TEST DISTANCE: HORIZONTAL AT 3 M								
NO.	FREQ. (MHz)	EMISSION LEVEL (dBuV/m)	LIMIT (dBuV/m)	MARGIN (dB)	ANTENNA HEIGHT (m)	TABLE ANGLE (Degree)	RAW VALUE (dBuV)	CORRECTION FACTOR (dB/m)
1	57.16	28.6 QP	40.0	-11.4	1.50 H	1	37.9	-9.3
2	107.60	29.2 QP	43.5	-14.3	1.50 H	188	41.2	-12.0
3	150.28	30.1 QP	43.5	-13.4	1.00 H	56	38.8	-8.7
4	245.34	29.3 QP	46.0	-16.7	1.00 H	162	38.6	-9.3
5	344.28	35.5 QP	46.0	-10.5	1.00 H	172	42.0	-6.5
6	445.16	31.0 QP	46.0	-15.0	1.99 H	286	33.7	-2.7

Remarks:

1. Emission Level(dBuV/m) = Raw Value(dBuV) + Correction Factor(dB/m)
2. Correction Factor(dB/m) = Antenna Factor(dB/m) + Cable Factor(dB) – Pre-Amplifier Factor(dB)
3. Margin value = Emission Level – Limit value
4. The emission levels were very low against the limit of frequency range 9kHz~30MHz: the amplitude of spurious emissions attenuated more than 20dB below the permissible value to be report.

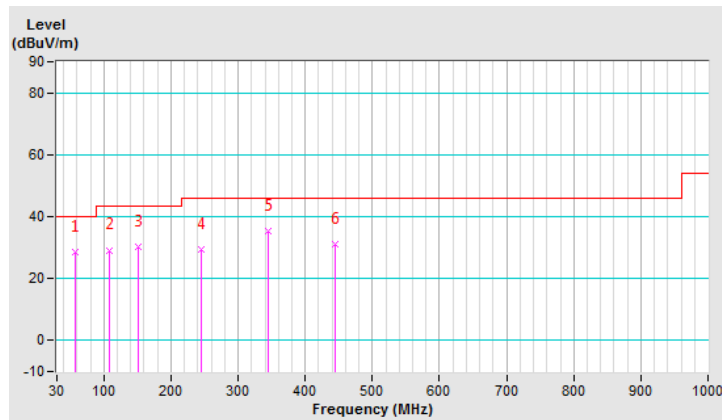

CHANNEL	TX Channel 110	DETECTOR FUNCTION	Quasi-Peak (QP)
FREQUENCY RANGE	9kHz ~ 1GHz	TEST MODE	B2

ANTENNA POLARITY & TEST DISTANCE: VERTICAL AT 3 M								
NO.	FREQ. (MHz)	EMISSION LEVEL (dBuV/m)	LIMIT (dBuV/m)	MARGIN (dB)	ANTENNA HEIGHT (m)	TABLE ANGLE (Degree)	RAW VALUE (dBuV)	CORRECTION FACTOR (dB/m)
1	45.52	35.5 QP	40.0	-4.5	1.00 V	11	44.6	-9.1
2	95.96	29.3 QP	43.5	-14.2	1.00 V	222	42.7	-13.4
3	247.28	22.1 QP	46.0	-23.9	1.50 V	188	31.4	-9.3
4	338.46	23.8 QP	46.0	-22.2	2.00 V	139	30.2	-6.4
5	443.22	26.9 QP	46.0	-19.1	1.00 V	333	29.7	-2.8
6	676.02	29.6 QP	46.0	-16.4	1.00 V	11	27.8	1.8

Remarks:

1. Emission Level(dBuV/m) = Raw Value(dBuV) + Correction Factor(dB/m)
2. Correction Factor(dB/m) = Antenna Factor(dB/m) + Cable Factor(dB) – Pre-Amplifier Factor(dB)
3. Margin value = Emission Level – Limit value
4. The emission levels were very low against the limit of frequency range 9kHz~30MHz: the amplitude of spurious emissions attenuated more than 20dB below the permissible value to be report.

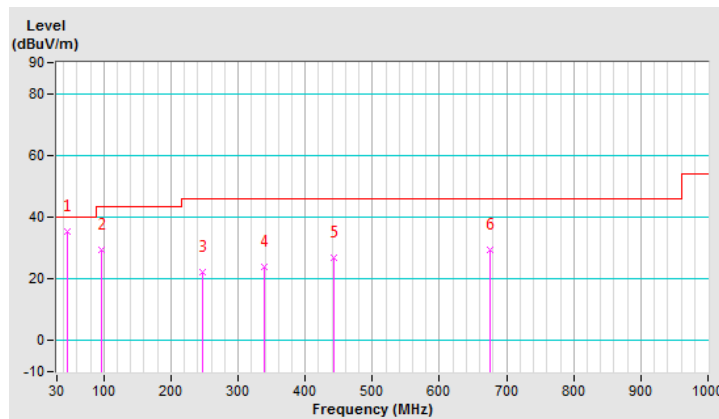

4.2 Conducted Emission Measurement

4.2.1 Limits of Conducted Emission Measurement

Frequency (MHz)	Conducted Limit (dBuV)	
	Quasi-peak	Average
0.15 - 0.5	66 - 56	56 - 46
0.50 - 5.0	56	46
5.0 - 30.0	60	50

Note: 1. The lower limit shall apply at the transition frequencies.

2. The limit decreases in line with the logarithm of the frequency in the range of 0.15 to 0.50MHz.

4.2.2 Test Instruments

Tested date: Sep. 23, 2019

Description & Manufacturer	Model No.	Serial No.	Cal. Date	Cal. Due
Test Receiver ROHDE & SCHWARZ	ESCI	100613	Dec. 10, 2018	Dec. 09, 2019
RF signal cable Woken	5D-FB	Cable-cond1-01	Sep. 05, 2019	Sep. 04, 2020
LISN ROHDE & SCHWARZ (EUT)	ESH3-Z5	101826	Feb. 21, 2019	Feb. 20, 2020
LISN ROHDE & SCHWARZ (Peripheral)	ESH3-Z5	100311	Aug. 22, 2019	Aug. 21, 2020
Software ADT	BV ADT_Cond_ V7.3.7.4	NA	NA	NA

Note: 1. The calibration interval of the above test instruments is 12 months and the calibrations are traceable to NML/ROC and NIST/USA.

2. The test was performed in HwaYa Shielded Room 1.

3. The VCCI Site Registration No. is C-12040.

4.2.3 Test Procedures

- The EUT was placed 0.4 meters from the conducting wall of the shielded room with EUT being connected to the power mains through a line impedance stabilization network (LISN). Other support units were connected to the power mains through another LISN. The two LISNs provide 50 ohm/ 50uH of coupling impedance for the measuring instrument.
- Both lines of the power mains connected to the EUT were checked for maximum conducted interference.
- The frequency range from 150kHz to 30MHz was searched. Emission levels under (Limit - 20dB) was not recorded.

Note: The resolution bandwidth and video bandwidth of test receiver is 9kHz for quasi-peak detection (QP) and average detection (AV) at frequency 0.15MHz-30MHz.

4.2.4 Deviation from Test Standard

No deviation.

4.2.5 Test Setup

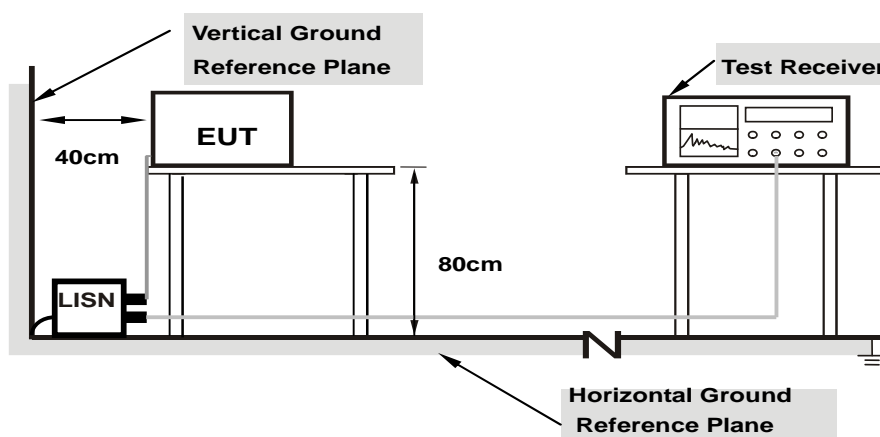

Note: 1.Support units were connected to second LISN.

For the actual test configuration, please refer to the attached file (Test Setup Photo).

4.2.6 EUT Operating Conditions

Same as 4.1.6.

4.2.7 Test Results

Worst-case data:

Radio 1

802.11n (HT40)

Phase	Line (L)	Detector Function	Quasi-Peak (QP) / Average (AV)
Test Mode	A1		

No	Freq. [MHz]	Corr. Factor (dB)	Reading Value		Emission Level		Limit		Margin	
			[dB (uV)]		[dB (uV)]		[dB (uV)]		(dB)	
			Q.P.	AV.	Q.P.	AV.	Q.P.	AV.	Q.P.	AV.
1	0.15391	9.71	37.72	23.14	47.43	32.85	65.79	55.79	-18.36	-22.94
2	0.17346	9.74	34.25	20.07	43.99	29.81	64.79	54.79	-20.80	-24.98
3	0.21256	9.79	29.63	17.17	39.42	26.96	63.10	53.10	-23.68	-26.14
4	0.25166	9.81	25.28	14.44	35.09	24.25	61.70	51.70	-26.61	-27.45
5	0.34198	9.87	38.23	31.26	48.10	41.13	59.16	49.16	-11.06	-8.03
6	0.41197	9.90	22.24	15.36	32.14	25.26	57.61	47.61	-25.47	-22.35

Remarks:

1. Q.P. and AV. are abbreviations of quasi-peak and average individually.
2. The emission levels of other frequencies were very low against the limit.
3. Margin value = Emission level - Limit value
4. Correction factor = Insertion loss + Cable loss
5. Emission Level = Correction Factor + Reading Value.

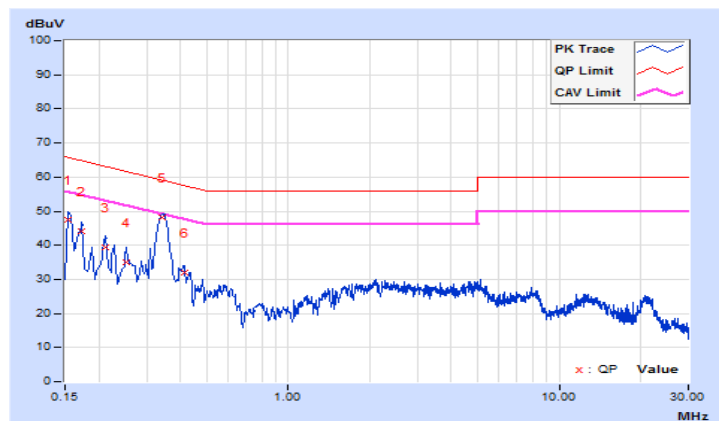

Phase	Neutral (N)	Detector Function	Quasi-Peak (QP) / Average (AV)
Test Mode	A1		

No	Freq. [MHz]	Corr. Factor (dB)	Reading Value [dB (uV)]		Emission Level [dB (uV)]		Limit [dB (uV)]		Margin (dB)	
			Q.P.	AV.	Q.P.	AV.	Q.P.	AV.	Q.P.	AV.
			1	0.17744	9.75	34.44	22.04	44.19	31.79	64.60
2	0.20084	9.80	31.22	19.75	41.02	29.55	63.58	53.58	-22.56	-24.03
3	0.23211	9.81	25.99	17.31	35.80	27.12	62.37	52.37	-26.57	-25.25
4	0.33768	9.84	36.99	30.64	46.83	40.48	59.26	49.26	-12.43	-8.78
5	0.40055	9.86	24.80	18.04	34.66	27.90	57.84	47.84	-23.18	-19.94
6	0.51363	9.88	16.33	8.78	26.21	18.66	56.00	46.00	-29.79	-27.34

Remarks:

1. Q.P. and AV. are abbreviations of quasi-peak and average individually.
2. The emission levels of other frequencies were very low against the limit.
3. Margin value = Emission level - Limit value
4. Correction factor = Insertion loss + Cable loss
5. Emission Level = Correction Factor + Reading Value.

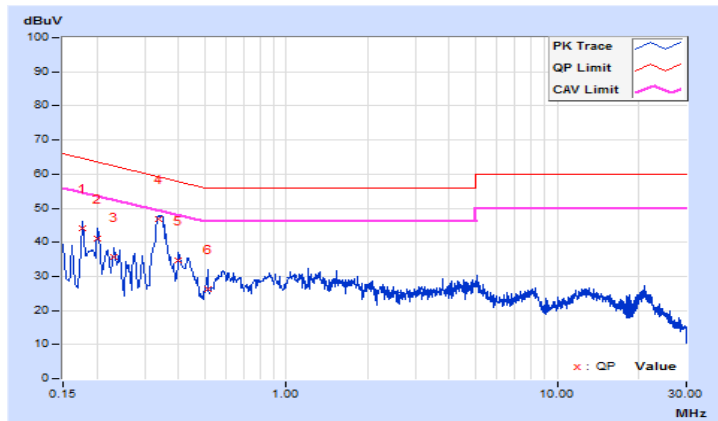

Phase	Line (L)	Detector Function	Quasi-Peak (QP) / Average (AV)
Test Mode	A2		

No	Freq. [MHz]	Corr. Factor (dB)	Reading Value [dB (uV)]		Emission Level [dB (uV)]		Limit [dB (uV)]		Margin (dB)	
			Q.P.	AV.	Q.P.	AV.	Q.P.	AV.	Q.P.	AV.
			1	0.17374	9.67	39.44	25.76	49.11	35.43	64.78
2	0.20458	9.66	34.23	21.07	43.89	30.73	63.42	53.42	-19.53	-22.69
3	0.22851	9.66	31.32	20.35	40.98	30.01	62.50	52.50	-21.52	-22.49
4	0.24775	9.67	28.26	18.09	37.93	27.76	61.83	51.83	-23.90	-24.07
5	0.47915	9.70	34.06	29.37	43.76	39.07	56.35	46.35	-12.59	-7.28
6	0.57228	9.70	20.15	10.50	29.85	20.20	56.00	46.00	-26.15	-25.80

Remarks:

1. Q.P. and AV. are abbreviations of quasi-peak and average individually.
2. The emission levels of other frequencies were very low against the limit.
3. Margin value = Emission level - Limit value
4. Correction factor = Insertion loss + Cable loss
5. Emission Level = Correction Factor + Reading Value.

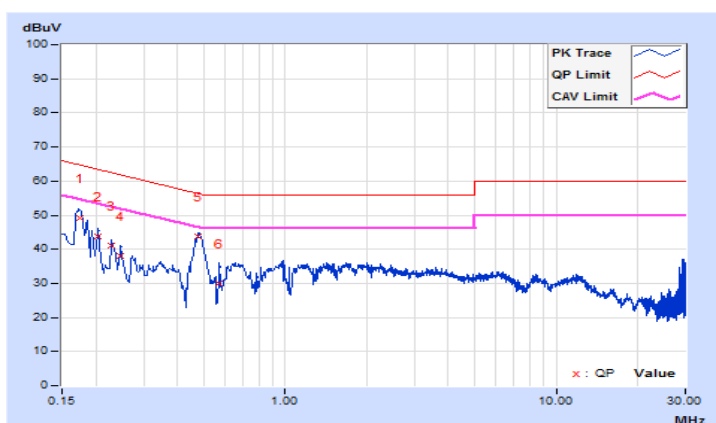

Phase	Neutral (N)	Detector Function	Quasi-Peak (QP) / Average (AV)
Test Mode	A2		

No	Freq. [MHz]	Corr. Factor (dB)	Reading Value [dB (uV)]		Emission Level [dB (uV)]		Limit [dB (uV)]		Margin (dB)	
			Q.P.	AV.	Q.P.	AV.	Q.P.	AV.	Q.P.	AV.
			1	0.17346	9.64	40.10	25.45	49.74	35.09	64.79
2	0.18519	9.64	38.26	23.65	47.90	33.29	64.25	54.25	-16.35	-20.96
3	0.20084	9.64	35.30	19.15	44.94	28.79	63.58	53.58	-18.64	-24.79
4	0.27120	9.65	25.86	14.79	35.51	24.44	61.08	51.08	-25.57	-26.64
5	0.47789	9.67	33.47	28.65	43.14	38.32	56.38	46.38	-13.24	-8.06
6	0.97084	9.70	21.54	17.39	31.24	27.09	56.00	46.00	-24.76	-18.91

Remarks:

1. Q.P. and AV. are abbreviations of quasi-peak and average individually.
2. The emission levels of other frequencies were very low against the limit.
3. Margin value = Emission level - Limit value
4. Correction factor = Insertion loss + Cable loss
5. Emission Level = Correction Factor + Reading Value.

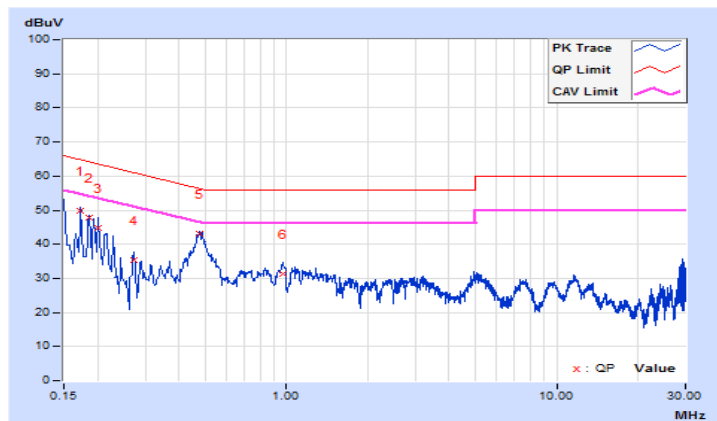

Radio 2

Phase	Line (L)	Detector Function	Quasi-Peak (QP) / Average (AV)
Test Mode	B1		

No	Freq. [MHz]	Corr. Factor (dB)	Reading Value		Emission Level		Limit		Margin	
			[dB (uV)]		[dB (uV)]		[dB (uV)]		(dB)	
			Q.P.	AV.	Q.P.	AV.	Q.P.	AV.	Q.P.	AV.
1	0.15391	9.71	37.51	22.89	47.22	32.60	65.79	55.79	-18.57	-23.19
2	0.16181	9.72	35.57	18.15	45.29	27.87	65.37	55.37	-20.08	-27.50
3	0.18075	9.75	33.71	20.44	43.46	30.19	64.45	54.45	-20.99	-24.26
4	0.20084	9.78	30.25	18.13	40.03	27.91	63.58	53.58	-23.55	-25.67
5	0.27903	9.83	24.76	15.04	34.59	24.87	60.84	50.84	-26.25	-25.97
6	0.34941	9.87	37.80	30.31	47.67	40.18	58.98	48.98	-11.31	-8.80

Remarks:

1. Q.P. and AV. are abbreviations of quasi-peak and average individually.
2. The emission levels of other frequencies were very low against the limit.
3. Margin value = Emission level - Limit value
4. Correction factor = Insertion loss + Cable loss
5. Emission Level = Correction Factor + Reading Value.

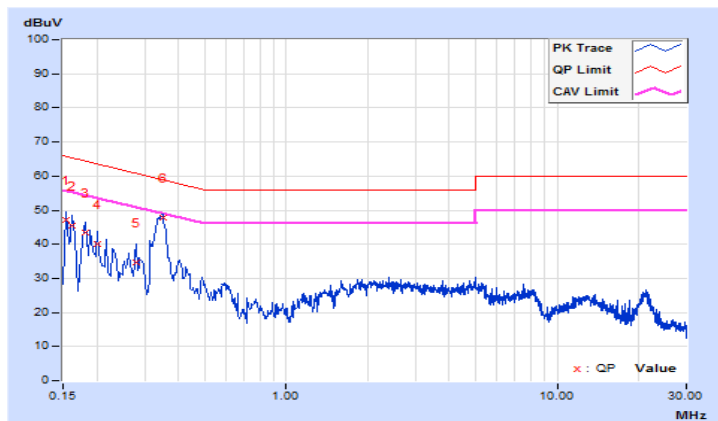

Phase	Neutral (N)	Detector Function	Quasi-Peak (QP) / Average (AV)
Test Mode	B1		

No	Freq. [MHz]	Corr. Factor (dB)	Reading Value [dB (uV)]		Emission Level [dB (uV)]		Limit [dB (uV)]		Margin (dB)	
			Q.P.	AV.	Q.P.	AV.	Q.P.	AV.	Q.P.	AV.
			1	0.15391	9.69	37.95	24.24	47.64	33.93	65.79
2	0.18128	9.76	34.13	21.42	43.89	31.18	64.43	54.43	-20.54	-23.25
3	0.19692	9.79	31.12	18.81	40.91	28.60	63.74	53.74	-22.83	-25.14
4	0.29076	9.83	26.84	14.40	36.67	24.23	60.50	50.50	-23.83	-26.27
5	0.34108	9.84	37.41	30.69	47.25	40.53	59.18	49.18	-11.93	-8.65
6	0.40415	9.86	25.23	18.36	35.09	28.22	57.77	47.77	-22.68	-19.55

Remarks:

1. Q.P. and AV. are abbreviations of quasi-peak and average individually.
2. The emission levels of other frequencies were very low against the limit.
3. Margin value = Emission level - Limit value
4. Correction factor = Insertion loss + Cable loss
5. Emission Level = Correction Factor + Reading Value.

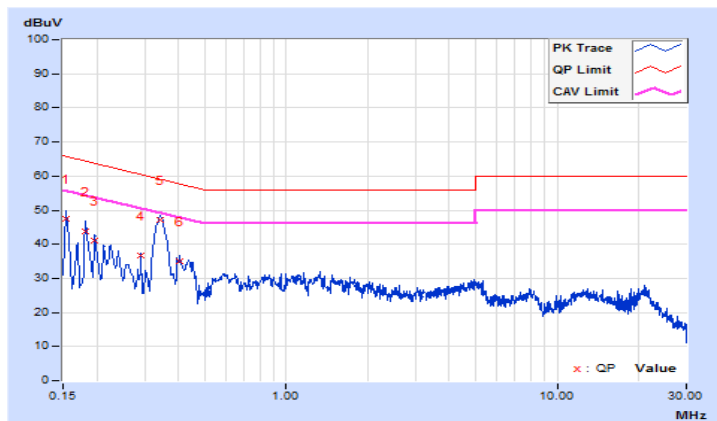

Phase	Line (L)	Detector Function	Quasi-Peak (QP) / Average (AV)
Test Mode	B2		

No	Freq. [MHz]	Corr. Factor (dB)	Reading Value [dB (uV)]		Emission Level [dB (uV)]		Limit [dB (uV)]		Margin (dB)	
			Q.P.	AV.	Q.P.	AV.	Q.P.	AV.	Q.P.	AV.
			1	0.15760	9.67	41.86	27.95	51.53	37.62	65.59
2	0.17374	9.67	38.89	25.33	48.56	35.00	64.78	54.78	-16.22	-19.78
3	0.19692	9.66	34.43	20.05	44.09	29.71	63.74	53.74	-19.65	-24.03
4	0.47412	9.69	33.66	28.20	43.35	37.89	56.44	46.44	-13.09	-8.55
5	0.56837	9.70	21.07	10.55	30.77	20.25	56.00	46.00	-25.23	-25.75
6	29.31469	10.01	26.34	24.92	36.35	34.93	60.00	50.00	-23.65	-15.07

Remarks:

1. Q.P. and AV. are abbreviations of quasi-peak and average individually.
2. The emission levels of other frequencies were very low against the limit.
3. Margin value = Emission level - Limit value
4. Correction factor = Insertion loss + Cable loss
5. Emission Level = Correction Factor + Reading Value.

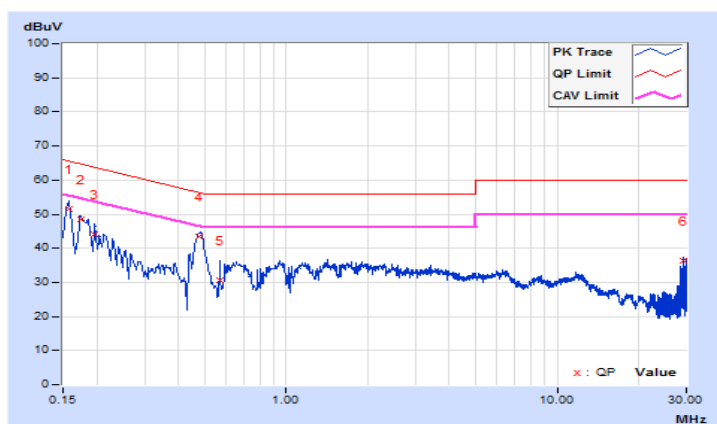

Phase	Neutral (N)	Detector Function	Quasi-Peak (QP) / Average (AV)
Test Mode	B2		

No	Freq. [MHz]	Corr. Factor (dB)	Reading Value [dB (uV)]		Emission Level [dB (uV)]		Limit [dB (uV)]		Margin (dB)	
			Q.P.	AV.	Q.P.	AV.	Q.P.	AV.	Q.P.	AV.
			1	0.16967	9.64	39.28	25.10	48.92	34.74	64.98
2	0.18508	9.64	37.04	22.74	46.68	32.38	64.25	54.25	-17.57	-21.87
3	0.19717	9.64	34.12	18.70	43.76	28.34	63.73	53.73	-19.97	-25.39
4	0.47287	9.66	32.83	27.24	42.49	36.90	56.46	46.46	-13.97	-9.56
5	0.77169	9.68	16.34	11.39	26.02	21.07	56.00	46.00	-29.98	-24.93
6	29.31860	10.10	25.19	20.53	35.29	30.63	60.00	50.00	-24.71	-19.37

Remarks:

1. Q.P. and AV. are abbreviations of quasi-peak and average individually.
2. The emission levels of other frequencies were very low against the limit.
3. Margin value = Emission level - Limit value
4. Correction factor = Insertion loss + Cable loss
5. Emission Level = Correction Factor + Reading Value.

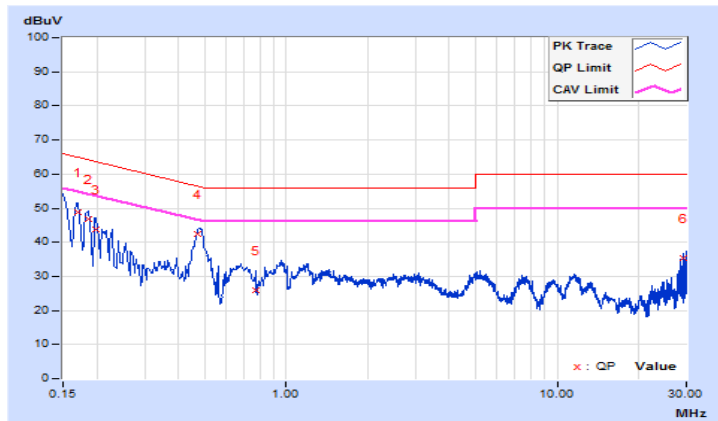

4.3 Transmit Power Measurement

4.3.1 Limits of Transmit Power Measurement

Operation Band	EUT Category	Limit
U-NII-1	Outdoor Access Point	1 Watt (30 dBm) (Max. e.i.r.p \leq 125mW(21 dBm) at any elevation angle above 30 degrees as measured from the horizon)
	Fixed point-to-point Access Point	1 Watt (30 dBm)
	Indoor Access Point	1 Watt (30 dBm)
	Mobile and Portable client device	250mW (24 dBm)
U-NII-2A	√	250mW (24 dBm) or 11 dBm+10 log B*
U-NII-2C	√	250mW (24 dBm) or 11 dBm+10 log B*
U-NII-3	√	1 Watt (30 dBm)

*B is the 26 dB emission bandwidth in megahertz

Per KDB 662911 Method of conducted output power measurement on IEEE 802.11 devices,

Array Gain = 0 dB (i.e., no array gain) for $N_{ANT} \leq 4$;

Array Gain = 0 dB (i.e., no array gain) for channel widths ≥ 40 MHz for any N_{ANT} ;

Array Gain = $5 \log(N_{ANT}/N_{SS})$ dB or 3 dB, whichever is less for 20-MHz channel widths with $N_{ANT} \geq 5$.

For power measurements on all other devices: Array Gain = $10 \log(N_{ANT}/N_{SS})$ dB.

4.3.2 Test Setup

For Power Output

802.11a, 802.11n (HT20), 802.11n (HT40)

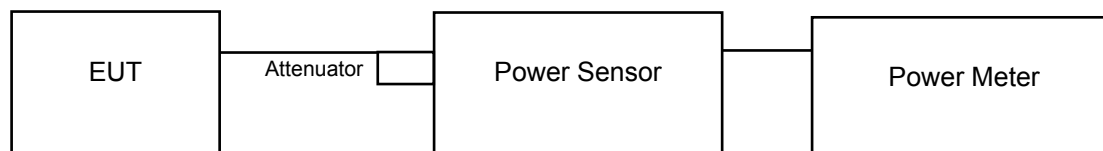

802.11ac (VHT80), 802.11ac (VHT80+VHT80)

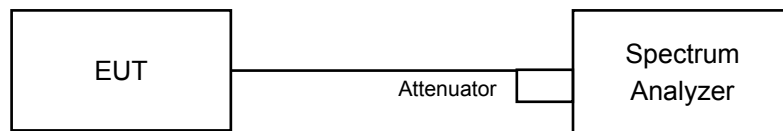

For 26dB Bandwidth

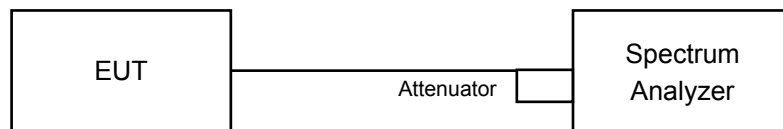

4.3.3 Test Instruments

Refer to section 4.1.2 to get information of above instrument.

4.3.4 Test Procedure

For Average Power Measurement

For 802.11a, 802.11n (HT20), 802.11n (HT40)

Method PM is used to perform output power measurement, trigger and gating function of wide band power meter is enabled to measure max output power of TX on burst. Duty factor is not added to measured value.

802.11ac (VHT80), 802.11ac (VHT80+VHT80)

- a. Set span to encompass the entire 26 dB EBW (or, alternatively, the entire 99% occupied bandwidth) of the signal.
- b. Set sweep trigger to "free run".
- c. Set RBW = 1 MHz
- d. Set VBW \geq 3 MHz
- e. Number of points in sweep \geq 2 Span / RBW
- f. Sweep time \leq (number of points in sweep) * T
- g. Using emission bandwidth to determine the frequency span for integration the channel bandwidth.
- h. Detector = RMS
- i. Trace mode = max hold
- j. Allow max hold to run for at least 60 seconds, or longer as needed to allow the trace to stabilize.
- k. Compute power by integrating the spectrum across the EBW (or, alternatively, the entire 99% occupied bandwidth) of the signal using the instrument's band power measurement function with band limits set equal to the EBW (or occupied bandwidth) band edges. If the instrument does not have a band power function, sum the spectrum levels (in power units) at 1 MHz intervals extending across the EBW (or, alternatively, the entire 99% occupied bandwidth) of the spectrum.

For 26dB Bandwidth

- a. Set RBW = approximately 1% of the emission bandwidth.
- b. Set the VBW > RBW.
- c. Detector = Peak.
- d. Trace mode = max hold.
- e. Measure the maximum width of the emission that is 26 dB down from the peak of the emission. Compare this with the RBW setting of the analyzer. Readjust RBW and repeat measurement as needed until the RBW/EBW ratio is approximately 1%.

4.3.5 Deviation from Test Standard

No deviation.

4.3.6 EUT Operating Conditions

The software provided by client to enable the EUT under transmission condition continuously at lowest, middle and highest channel frequencies individually.

4.3.7 Test Result

Power Output:

Mode A2: Radio 1

CDD Mode

802.11a

Chan.	Freq. (MHz)	Maximum Conducted Power (dBm)		Total Power (mW)	Total Power (dBm)	Power Limit (dBm)	Pass / Fail
		Chain 0	Chain 1				
100	5500	17.80	17.63	118.199	20.73	23.96	Pass
116	5580	18.11	18.76	139.876	21.46	23.80	Pass
140	5700	17.22	17.07	103.656	20.16	23.80	Pass
144	5720 For U-NII-2C	16.04	16.03	84.197	19.25	22.66	Pass
144	5720 For U-NII-3	11.02	10.98	26.411	14.22	30.00	Pass

Note:

For U-NII-2C Band:

Chain 0

1. $11\text{dBm} + 10\log(19.86) = 23.97 < 24\text{dBm}$
2. $11\text{dBm} + 10\log(19.50) = 23.90 < 24\text{dBm}$
3. $11\text{dBm} + 10\log(19.25) = 23.84 < 24\text{dBm}$
4. $11\text{dBm} + 10\log(5725.00 - 5710.21) = 22.69 < 24\text{dBm}$

Chain 1

1. $11\text{dBm} + 10\log(19.79) = 23.96 < 24\text{dBm}$
2. $11\text{dBm} + 10\log(19.07) = 23.80 < 24\text{dBm}$
3. $11\text{dBm} + 10\log(19.08) = 23.80 < 24\text{dBm}$
4. $11\text{dBm} + 10\log(5725.00 - 5710.33) = 22.66 < 24\text{dBm}$

802.11n (HT20)

Chan.	Freq. (MHz)	Maximum Conducted Power (dBm)		Total Power (mW)	Total Power (dBm)	Power Limit (dBm)	Pass / Fail
		Chain 0	Chain 1				
100	5500	18.36	17.97	131.21	21.18	24.00	Pass
116	5580	19.12	19.31	166.968	22.23	24.00	Pass
140	5700	17.30	17.41	108.784	20.37	24.00	Pass
144	5720 For U-NII-2C	16.50	16.38	90.438	19.56	22.82	Pass
144	5720 For U-NII-3	12.59	11.69	33.778	15.29	30.00	Pass

Note:

For U-NII-2C Band:

Chain 0

1. $11\text{dBm} + 10\log(20.42) = 24.10 > 24\text{dBm}$
2. $11\text{dBm} + 10\log(22.22) = 24.46 > 24\text{dBm}$
3. $11\text{dBm} + 10\log(20.01) = 24.01 > 24\text{dBm}$
4. $11\text{dBm} + 10\log(5725.00 - 5709.40) = 22.93 < 24\text{dBm}$

Chain 1

1. $11\text{dBm} + 10\log(20.58) = 24.13 > 24\text{dBm}$
2. $11\text{dBm} + 10\log(20.24) = 24.06 > 24\text{dBm}$
3. $11\text{dBm} + 10\log(20.22) = 24.05 > 24\text{dBm}$
4. $11\text{dBm} + 10\log(5725.00 - 5709.78) = 22.82 < 24\text{dBm}$

802.11n (HT40)

Chan.	Freq. (MHz)	Maximum Conducted Power (dBm)		Total Power (mW)	Total Power (dBm)	Power Limit (dBm)	Pass / Fail
		Chain 0	Chain 1				
102	5510	17.29	16.93	102.897	20.12	24.00	Pass
110	5550	20.94	20.61	239.245	23.79	24.00	Pass
134	5670	17.01	17.12	101.757	20.08	24.00	Pass
142	5710 For U-NII-2C	16.96	17.16	106.031	20.25	24.00	Pass
142	5710 For U-NII-3	14.61	12.84	50.208	17.01	30.00	Pass

Note:

For U-NII-2C Band:

Chain 0

1. $11\text{dBm} + 10\log(40.53) = 27.07 > 24\text{dBm}$
2. $11\text{dBm} + 10\log(74.82) = 29.74 > 24\text{dBm}$
3. $11\text{dBm} + 10\log(41.03) = 27.13 > 24\text{dBm}$
4. $11\text{dBm} + 10\log(5725.00 - 5674.11) = 28.06 > 24\text{dBm}$

Chain 1

1. $11\text{dBm} + 10\log(40.82) = 27.10 > 24\text{dBm}$
2. $11\text{dBm} + 10\log(73.18) = 29.64 > 24\text{dBm}$
3. $11\text{dBm} + 10\log(40.97) = 27.12 > 24\text{dBm}$
4. $11\text{dBm} + 10\log(5725.00 - 5673.45) = 28.12 > 24\text{dBm}$

802.11ac (VHT80)

Chan.	Freq. (MHz)	Maximum Conducted Power (dBm)		Total Power (mW)	Total Power (dBm)	Power Limit (dBm)	Pass / Fail
		Chain 0	Chain 1				
106	5530	18.67	18.27	140.764	21.48	24.00	Pass
122	5610	19.15	18.83	158.608	22.00	24.00	Pass
138	5690 For U-NII-2C	17.65	17.87	129.204	21.11	24.00	Pass
138	5690 For U-NII-3	12.01	8.75	25.295	14.03	30.00	Pass

Note:

For U-NII-2C Band:

Chain 0

1. $11\text{dBm} + 10\log(86.02) = 30.34 > 24\text{dBm}$
2. $11\text{dBm} + 10\log(84.73) = 30.28 > 24\text{dBm}$
3. $11\text{dBm} + 10\log(5725.00 - 5636.29) = 30.47 > 24\text{dBm}$

Chain 1

1. $11\text{dBm} + 10\log(86.03) = 30.34 > 24\text{dBm}$
2. $11\text{dBm} + 10\log(84.90) = 30.28 > 24\text{dBm}$
3. $11\text{dBm} + 10\log(5725.00 - 5646.99) = 29.92 > 24\text{dBm}$

Beamforming Mode

802.11n (HT20)

Chan.	Freq. (MHz)	Maximum Conducted Power (dBm)		Total Power (mW)	Total Power (dBm)	Power Limit (dBm)	Pass / Fail
		Chain 0	Chain 1				
100	5500	15.35	14.96	65.610	18.17	21.49	Pass
116	5580	16.11	16.30	83.490	19.22	21.49	Pass
140	5700	14.29	14.40	54.395	17.36	21.49	Pass
144	5720 For U-NII-2C	13.49	13.37	45.223	16.55	21.49	Pass
144	5720 For U-NII-3	9.58	8.68	16.89	12.28	27.49	Pass

Note:

5500~5720MHz Gain = $5.5 + 10\log(2) = 8.51\text{dBi} > 6\text{dBi}$, so the limit shall be reduced to $24 - (8.51 - 6) = 21.49\text{dBm}$

5720~5825MHz Gain = $5.5 + 10\log(2) = 8.51\text{dBi} > 6\text{dBi}$, so the limit shall be reduced to $30 - (8.51 - 6) = 27.49\text{dBm}$

For U-NII-2C Band:

Chain 0

1. $11\text{dBm} + 10\log(20.42) = 24.10 > 21.49\text{dBm}$
2. $11\text{dBm} + 10\log(22.22) = 24.46 > 21.49\text{dBm}$
3. $11\text{dBm} + 10\log(20.01) = 24.01 > 21.49\text{dBm}$
4. $11\text{dBm} + 10\log(5725.00 - 5709.40) = 22.93 > 21.49\text{dBm}$

Chain 1

1. $11\text{dBm} + 10\log(20.58) = 24.13 > 21.49\text{dBm}$
2. $11\text{dBm} + 10\log(20.24) = 24.06 > 21.49\text{dBm}$
3. $11\text{dBm} + 10\log(20.22) = 24.05 > 21.49\text{dBm}$
4. $11\text{dBm} + 10\log(5725.00 - 5709.78) = 22.82 > 21.49\text{dBm}$

802.11n (HT40)

Chan.	Freq. (MHz)	Maximum Conducted Power (dBm)		Total Power (mW)	Total Power (dBm)	Power Limit (dBm)	Pass / Fail
		Chain 0	Chain 1				
102	5510	14.28	13.92	51.452	17.11	21.49	Pass
110	5550	17.93	17.60	119.631	20.78	21.49	Pass
134	5670	14.00	14.11	50.882	17.07	21.49	Pass
142	5710 For U-NII-2C	13.95	14.15	53.019	17.24	21.49	Pass
142	5710 For U-NII-3	11.60	9.83	25.105	14.00	27.49	Pass

Note:

5500~5720MHz Gain = $5.5 + 10\log(2) = 8.51\text{dBi} > 6\text{dBi}$, so the limit shall be reduced to $24-(8.51-6) = 21.49\text{dBm}$

5720~5825MHz Gain = $5.5 + 10\log(2) = 8.51\text{dBi} > 6\text{dBi}$, so the limit shall be reduced to $30-(8.51-6) = 27.49\text{dBm}$

For U-NII-2C Band:

Chain 0

1. $11\text{dBm} + 10\log(40.53) = 27.07 > 21.49\text{dBm}$
2. $11\text{dBm} + 10\log(74.82) = 29.74 > 21.49\text{dBm}$
3. $11\text{dBm} + 10\log(41.03) = 27.13 > 21.49\text{dBm}$
4. $11\text{dBm} + 10\log(5725.00 - 5674.11) = 28.06 > 21.49\text{dBm}$

Chain 1

1. $11\text{dBm} + 10\log(40.82) = 27.10 > 21.49\text{dBm}$
2. $11\text{dBm} + 10\log(73.18) = 29.64 > 21.49\text{dBm}$
3. $11\text{dBm} + 10\log(40.97) = 27.12 > 21.49\text{dBm}$
4. $11\text{dBm} + 10\log(5725.00 - 5673.45) = 28.12 > 21.49\text{dBm}$

802.11ac (VHT80)

Chan.	Freq. (MHz)	Maximum Conducted Power (dBm)		Total Power (mW)	Total Power (dBm)	Power Limit (dBm)	Pass / Fail
		Chain 0	Chain 1				
106	5530	15.66	15.26	70.387	18.47	21.49	Pass
122	5610	16.14	15.82	79.309	18.99	21.49	Pass
138	5690 For U-NII-2C	14.64	14.86	64.607	18.10	21.49	Pass
138	5690 For U-NII-3	9.00	5.74	12.648	11.02	27.49	Pass

Note:

5500~5720MHz Gain = $5.5 + 10\log(2) = 8.51\text{dBi} > 6\text{dBi}$, so the limit shall be reduced to $24 - (8.51 - 6) = 21.49\text{dBm}$

5720~5825MHz Gain = $5.5 + 10\log(2) = 8.51\text{dBi} > 6\text{dBi}$, so the limit shall be reduced to $30 - (8.51 - 6) = 27.49\text{dBm}$

For U-NII-2C Band:

Chain 0

1. $11\text{dBm} + 10\log(86.02) = 30.34 > 21.49\text{dBm}$
2. $11\text{dBm} + 10\log(84.73) = 30.28 > 21.49\text{dBm}$
3. $11\text{dBm} + 10\log(5725.00 - 5636.29) = 30.47 > 21.49\text{dBm}$

Chain 1

1. $11\text{dBm} + 10\log(86.03) = 30.34 > 21.49\text{dBm}$
2. $11\text{dBm} + 10\log(84.90) = 30.28 > 21.49\text{dBm}$
3. $11\text{dBm} + 10\log(5725.00 - 5646.99) = 29.92 > 21.49\text{dBm}$

Mode B2: Radio 2

CDD Mode

802.11a

Chan.	Freq. (MHz)	Maximum Conducted Power (dBm)		Total Power (mW)	Total Power (dBm)	Power Limit (dBm)	Pass / Fail
		Chain 0	Chain 1				
52	5260	18.99	18.20	145.319	21.62	23.82	Pass
60	5300	18.00	17.63	121.039	20.83	23.86	Pass
64	5320	17.96	17.53	119.141	20.76	23.85	Pass
100	5500	18.84	17.90	138.220	21.41	23.84	Pass
116	5580	18.86	18.24	143.594	21.57	23.88	Pass
140	5700	18.24	18.30	134.289	21.28	23.91	Pass
144	5720 For U-NII-2C	16.83	16.92	103.902	20.17	22.67	Pass
144	5720 For U-NII-3	11.77	11.92	32.633	15.14	30.00	Pass

Note:

For U-NII-2A, U-NII-2C Band:

Chain 0

1. $11\text{dBm} + 10\log(19.80) = 23.96 < 24\text{dBm}$
2. $11\text{dBm} + 10\log(19.61) = 23.92 < 24\text{dBm}$
3. $11\text{dBm} + 10\log(19.79) = 23.96 < 24\text{dBm}$
4. $11\text{dBm} + 10\log(19.94) = 23.99 < 24\text{dBm}$
5. $11\text{dBm} + 10\log(19.84) = 23.97 < 24\text{dBm}$
6. $11\text{dBm} + 10\log(19.57) = 23.91 < 24\text{dBm}$
7. $11\text{dBm} + 10\log(5725.00 - 5710.08) = 22.73 < 24\text{dBm}$

Chain 1

1. $11\text{dBm} + 10\log(19.18) = 23.82 < 24\text{dBm}$
2. $11\text{dBm} + 10\log(19.35) = 23.86 < 24\text{dBm}$
3. $11\text{dBm} + 10\log(19.30) = 23.85 < 24\text{dBm}$
4. $11\text{dBm} + 10\log(19.26) = 23.84 < 24\text{dBm}$
5. $11\text{dBm} + 10\log(19.41) = 23.88 < 24\text{dBm}$
6. $11\text{dBm} + 10\log(19.88) = 23.98 < 24\text{dBm}$
7. $11\text{dBm} + 10\log(5725.00 - 5710.31) = 22.67 < 24\text{dBm}$

802.11n (HT20)

Chan.	Freq. (MHz)	Maximum Conducted Power (dBm)		Total Power (mW)	Total Power (dBm)	Power Limit (dBm)	Pass / Fail
		Chain 0	Chain 1				
52	5260	19.31	18.41	154.653	21.89	24.00	Pass
60	5300	18.41	17.70	128.227	21.08	24.00	Pass
64	5320	18.44	17.74	129.252	21.11	24.00	Pass
100	5500	17.83	17.90	122.334	20.88	24.00	Pass
116	5580	18.96	18.25	145.539	21.63	24.00	Pass
140	5700	18.11	18.13	129.727	21.13	24.00	Pass
144	5720 For U-NII-2C	16.80	16.86	98.622	19.94	22.84	Pass
144	5720 For U-NII-3	12.08	12.16	33.342	15.23	30.00	Pass

Note:

For U-NII-2A, U-NII-2C Band:

Chain 0

1. $11\text{dBm} + 10\log(20.69) = 24.15 > 24\text{dBm}$
2. $11\text{dBm} + 10\log(20.57) = 24.13 > 24\text{dBm}$
3. $11\text{dBm} + 10\log(20.69) = 24.15 > 24\text{dBm}$
4. $11\text{dBm} + 10\log(20.63) = 24.14 > 24\text{dBm}$
5. $11\text{dBm} + 10\log(20.70) = 24.15 > 24\text{dBm}$
6. $11\text{dBm} + 10\log(20.56) = 24.13 > 24\text{dBm}$
7. $11\text{dBm} + 10\log(5725.00 - 5709.66) = 22.85 < 24\text{dBm}$

Chain 1

1. $11\text{dBm} + 10\log(20.66) = 24.15 > 24\text{dBm}$
2. $11\text{dBm} + 10\log(20.46) = 24.10 > 24\text{dBm}$
3. $11\text{dBm} + 10\log(20.47) = 24.11 > 24\text{dBm}$
4. $11\text{dBm} + 10\log(20.46) = 24.10 > 24\text{dBm}$
5. $11\text{dBm} + 10\log(20.41) = 24.09 > 24\text{dBm}$
6. $11\text{dBm} + 10\log(20.63) = 24.14 > 24\text{dBm}$
7. $11\text{dBm} + 10\log(5725.00 - 5709.71) = 22.84 < 24\text{dBm}$

802.11n (HT40)

Chan.	Freq. (MHz)	Maximum Conducted Power (dBm)		Total Power (mW)	Total Power (dBm)	Power Limit (dBm)	Pass / Fail
		Chain 0	Chain 1				
54	5270	21.22	20.27	238.848	23.78	24.00	Pass
62	5310	18.01	17.91	125.043	20.97	24.00	Pass
102	5510	17.17	16.05	92.391	19.66	24.00	Pass
110	5550	21.13	20.40	239.366	23.79	24.00	Pass
134	5670	19.72	19.66	186.226	22.70	24.00	Pass
142	5710 For U-NII-2C	20.18	19.41	199.048	22.99	24.00	Pass
142	5710 For U-NII-3	14.18	13.12	48.527	16.86	30.00	Pass

Note:

For U-NII-2A, U-NII-2C Band:

Chain 0

1. $11\text{dBm} + 10\log(43.50) = 27.38 > 24\text{dBm}$
2. $11\text{dBm} + 10\log(40.75) = 27.10 > 24\text{dBm}$
3. $11\text{dBm} + 10\log(40.61) = 27.08 > 24\text{dBm}$
4. $11\text{dBm} + 10\log(56.71) = 28.53 > 24\text{dBm}$
5. $11\text{dBm} + 10\log(41.11) = 27.13 > 24\text{dBm}$
6. $11\text{dBm} + 10\log(5725.00 - 5673.77) = 28.09 > 24\text{dBm}$

Chain 1

1. $11\text{dBm} + 10\log(40.70) = 27.09 > 24\text{dBm}$
2. $11\text{dBm} + 10\log(40.53) = 27.07 > 24\text{dBm}$
3. $11\text{dBm} + 10\log(40.74) = 27.10 > 24\text{dBm}$
4. $11\text{dBm} + 10\log(41.63) = 27.19 > 24\text{dBm}$
5. $11\text{dBm} + 10\log(42.11) = 27.24 > 24\text{dBm}$
6. $11\text{dBm} + 10\log(5725.00 - 5673.98) = 28.07 > 24\text{dBm}$

802.11ac (VHT80)

Chan.	Freq. (MHz)	Maximum Conducted Power (dBm)		Total Power (mW)	Total Power (dBm)	Power Limit (dBm)	Pass / Fail
		Chain 0	Chain 1				
58	5290	16.85	16.55	93.603	19.71	24.00	Pass
106	5530	17.40	16.48	99.417	19.97	24.00	Pass
122	5610	20.08	19.66	194.329	22.89	24.00	Pass
138	5690 For U-NII-2C	19.35	18.87	175.632	22.45	24.00	Pass
138	5690 For U-NII-3	9.23	11.79	25.266	14.03	30.00	Pass

Note:

For U-NII-2A, U-NII-2C Band:

Chain 0

1. $11\text{dBm} + 10\log(83.87) = 30.23 > 24\text{dBm}$
2. $11\text{dBm} + 10\log(83.67) = 30.22 > 24\text{dBm}$
3. $11\text{dBm} + 10\log(84.67) = 30.27 > 24\text{dBm}$
4. $11\text{dBm} + 10\log(5725.00 - 5647.89) = 29.87 > 24\text{dBm}$

Chain 1

1. $11\text{dBm} + 10\log(84.13) = 30.24 > 24\text{dBm}$
2. $11\text{dBm} + 10\log(84.16) = 30.25 > 24\text{dBm}$
3. $11\text{dBm} + 10\log(83.64) = 30.22 > 24\text{dBm}$
4. $11\text{dBm} + 10\log(5725.00 - 5643.79) = 30.09 > 24\text{dBm}$

Beamforming Mode

802.11n (HT20)

Chan.	Freq. (MHz)	Maximum Conducted Power (dBm)		Total Power (mW)	Total Power (dBm)	Power Limit (dBm)	Pass / Fail
		Chain 0	Chain 1				
52	5260	16.30	15.40	77.332	18.88	21.49	Pass
60	5300	15.40	14.69	64.118	18.07	21.49	Pass
64	5320	15.43	14.73	64.631	18.10	21.49	Pass
100	5500	14.82	14.89	61.171	17.87	21.49	Pass
116	5580	15.95	15.24	72.775	18.62	21.49	Pass
140	5700	15.10	15.12	64.868	18.12	21.49	Pass
144	5720 For U-NII-2C	13.79	13.85	49.314	16.93	21.49	Pass
144	5720 For U-NII-3	9.07	9.15	16.671	12.22	27.49	Pass

Note:

5260~5320MHz & 5500~5720MHz Gain = $5.5 + 10\log(2) = 8.51\text{dBi} > 6\text{dBi}$, so the limit shall be reduced to $24-(8.51-6) = 21.49\text{dBm}$

5720~5825MHz Gain = $5.5 + 10\log(2) = 8.51\text{dBi} > 6\text{dBi}$, so the limit shall be reduced to $30-(8.51-6) = 27.49\text{dBm}$

For U-NII-2A, U-NII-2C Band:

Chain 0

- $11\text{dBm} + 10\log(20.69) = 24.15 > 21.49\text{dBm}$
- $11\text{dBm} + 10\log(20.57) = 24.13 > 21.49\text{dBm}$
- $11\text{dBm} + 10\log(20.69) = 24.15 > 21.49\text{dBm}$
- $11\text{dBm} + 10\log(20.63) = 24.14 > 21.49\text{dBm}$
- $11\text{dBm} + 10\log(20.70) = 24.15 > 21.49\text{dBm}$
- $11\text{dBm} + 10\log(20.56) = 24.13 > 21.49\text{dBm}$
- $11\text{dBm} + 10\log(5725.00 - 5709.66) = 22.85 > 21.49\text{dBm}$

Chain 1

- $11\text{dBm} + 10\log(20.66) = 24.15 > 21.49\text{dBm}$
- $11\text{dBm} + 10\log(20.46) = 24.10 > 21.49\text{dBm}$
- $11\text{dBm} + 10\log(20.47) = 24.11 > 21.49\text{dBm}$
- $11\text{dBm} + 10\log(20.46) = 24.10 > 21.49\text{dBm}$
- $11\text{dBm} + 10\log(20.41) = 24.09 > 21.49\text{dBm}$
- $11\text{dBm} + 10\log(20.63) = 24.14 > 21.49\text{dBm}$
- $11\text{dBm} + 10\log(5725.00 - 5709.71) = 22.84 > 21.49\text{dBm}$

802.11n (HT40)

Chan.	Freq. (MHz)	Maximum Conducted Power (dBm)		Total Power (mW)	Total Power (dBm)	Power Limit (dBm)	Pass / Fail
		Chain 0	Chain 1				
54	5270	18.21	17.26	119.433	20.77	21.49	Pass
62	5310	15.00	14.90	62.526	17.96	21.49	Pass
102	5510	14.16	13.04	46.199	16.65	21.49	Pass
110	5550	18.12	17.39	119.691	20.78	21.49	Pass
134	5670	16.71	16.65	93.119	19.69	21.49	Pass
142	5710 For U-NII-2C	17.17	16.40	99.531	19.98	21.49	Pass
142	5710 For U-NII-3	11.17	10.11	24.266	13.85	27.49	Pass

Note:

5260~5320MHz & 5500~5720MHz Gain = $5.5 + 10\log(2) = 8.51\text{dBi} > 6\text{dBi}$, so the limit shall be reduced to $24 - (8.51 - 6) = 21.49\text{dBm}$

5720~5825MHz Gain = $5.5 + 10\log(2) = 8.51\text{dBi} > 6\text{dBi}$, so the limit shall be reduced to $30 - (8.51 - 6) = 27.49\text{dBm}$

For U-NII-2A, U-NII-2C Band:

Chain 0

1. $11\text{dBm} + 10\log(43.50) = 27.38 > 21.49\text{dBm}$
2. $11\text{dBm} + 10\log(40.75) = 27.10 > 21.49\text{dBm}$
3. $11\text{dBm} + 10\log(40.61) = 27.08 > 21.49\text{dBm}$
4. $11\text{dBm} + 10\log(56.71) = 28.53 > 21.49\text{dBm}$
5. $11\text{dBm} + 10\log(41.11) = 27.13 > 21.49\text{dBm}$
6. $11\text{dBm} + 10\log(5725.00 - 5673.77) = 28.09 > 21.49\text{dBm}$

Chain 1

1. $11\text{dBm} + 10\log(40.70) = 27.09 > 21.49\text{dBm}$
2. $11\text{dBm} + 10\log(40.53) = 27.07 > 21.49\text{dBm}$
3. $11\text{dBm} + 10\log(40.74) = 27.10 > 21.49\text{dBm}$
4. $11\text{dBm} + 10\log(41.63) = 27.19 > 21.49\text{dBm}$
5. $11\text{dBm} + 10\log(42.11) = 27.24 > 21.49\text{dBm}$
6. $11\text{dBm} + 10\log(5725.00 - 5673.98) = 28.07 > 21.49\text{dBm}$

802.11ac (VHT80)

Chan.	Freq. (MHz)	Maximum Conducted Power (dBm)		Total Power (mW)	Total Power (dBm)	Power Limit (dBm)	Pass / Fail
		Chain 0	Chain 1				
58	5290	13.84	13.54	46.804	16.70	21.49	Pass
106	5530	14.39	13.47	49.712	16.96	21.49	Pass
122	5610	17.07	16.65	97.171	19.88	21.49	Pass
138	5690 For U-NII-2C	16.34	15.86	87.823	19.44	21.49	Pass
138	5690 For U-NII-3	6.22	8.78	12.634	11.02	27.49	Pass

Note:

5260~5320MHz & 5500~5720MHz Gain = $5.5 + 10\log(2) = 8.51\text{dBi} > 6\text{dBi}$, so the limit shall be reduced to $24 - (8.51 - 6) = 21.49\text{dBm}$

5720~5825MHz Gain = $5.5 + 10\log(2) = 8.51\text{dBi} > 6\text{dBi}$, so the limit shall be reduced to $30 - (8.51 - 6) = 27.49\text{dBm}$

For U-NII-2A, U-NII-2C Band:

Chain 0

- $11\text{dBm} + 10\log(83.87) = 30.23 > 21.49\text{dBm}$
- $11\text{dBm} + 10\log(83.67) = 30.22 > 21.49\text{dBm}$
- $11\text{dBm} + 10\log(84.67) = 30.27 > 21.49\text{dBm}$
- $11\text{dBm} + 10\log(5725.00 - 5647.89) = 29.87 > 21.49\text{dBm}$

Chain 1

- $11\text{dBm} + 10\log(84.13) = 30.24 > 21.49\text{dBm}$
- $11\text{dBm} + 10\log(84.16) = 30.25 > 21.49\text{dBm}$
- $11\text{dBm} + 10\log(83.64) = 30.22 > 21.49\text{dBm}$
- $11\text{dBm} + 10\log(5725.00 - 5643.79) = 30.09 > 21.49\text{dBm}$

26dB Bandwidth:

Mode A2: Radio 1

802.11a

Channel	Frequency (MHz)	26dBc Bandwidth (MHz)	
		Chain 0	Chain 1
100	5500	19.86	19.79
116	5580	19.50	19.07
140	5700	19.25	19.08
144	5720 For U-NII-2C	14.79	14.67

802.11n (HT20)

Channel	Frequency (MHz)	26dBc Bandwidth (MHz)	
		Chain 0	Chain 1
100	5500	20.42	20.58
116	5580	22.22	20.24
140	5700	20.01	20.22
144	5720 For U-NII-2C	15.60	15.22

802.11n (HT40)

Channel	Frequency (MHz)	26dBc Bandwidth (MHz)	
		Chain 0	Chain 1
102	5510	40.53	40.82
110	5550	74.82	73.18
134	5670	41.03	40.97
142	5710 For U-NII-2C	50.89	51.55

802.11ac (VHT80)

Channel	Frequency (MHz)	26dBc Bandwidth (MHz)	
		Chain 0	Chain 1
106	5530	86.02	86.03
122	5610	84.73	84.90
138	5690 For U-NII-2C	88.71	78.01

Spectrum Plot of Worst Value

802.11a

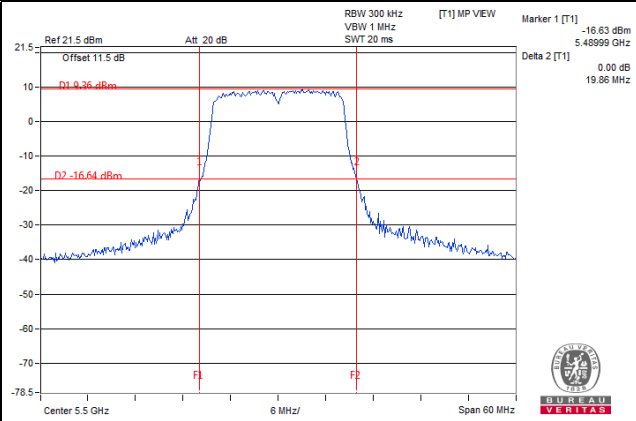

802.11n (HT20)

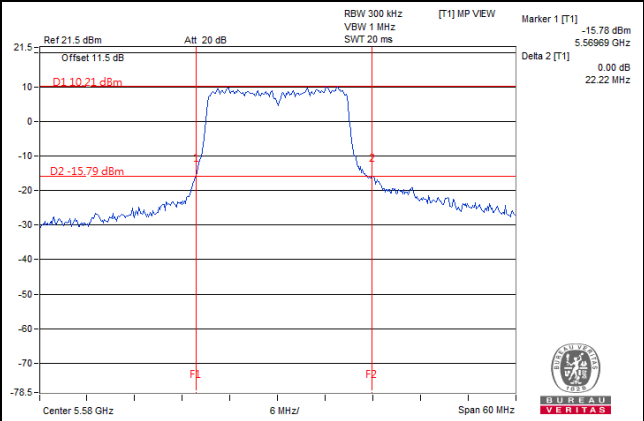

802.11n (HT40)

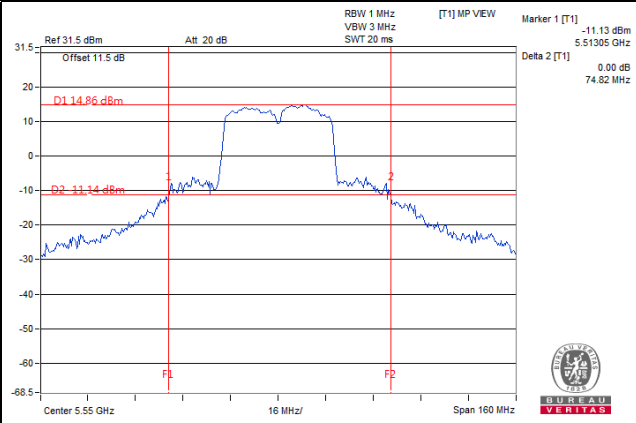

802.11ac (VHT80)

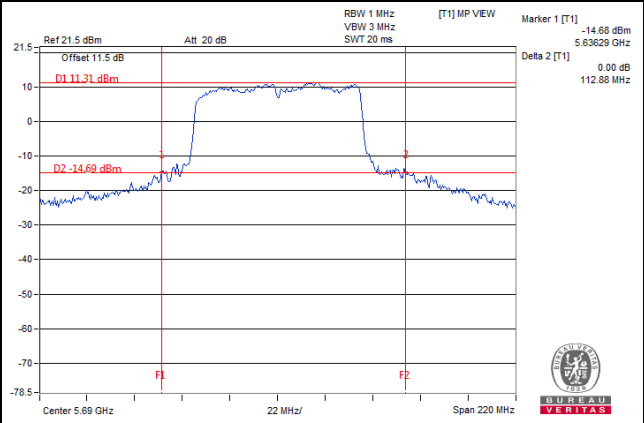

Mode B2: Radio 2

802.11a

Channel	Frequency (MHz)	26dBc Bandwidth (MHz)	
		Chain 0	Chain 1
52	5260	19.80	19.18
60	5300	19.61	19.35
64	5320	19.79	19.30
100	5500	19.94	19.26
116	5580	19.84	19.41
140	5700	19.57	19.88
144	5720 For U-NII-2C	14.92	14.69

802.11n (HT20)

Channel	Frequency (MHz)	26dBc Bandwidth (MHz)	
		Chain 0	Chain 1
52	5260	20.69	20.66
60	5300	20.57	20.46
64	5320	20.69	20.47
100	5500	20.63	20.46
116	5580	20.70	20.41
140	5700	20.56	20.63
144	5720 For U-NII-2C	15.34	15.29

802.11n (HT40)

Channel	Frequency (MHz)	26dBc Bandwidth (MHz)	
		Chain 0	Chain 1
54	5270	43.50	40.70
62	5310	40.75	40.53
102	5510	40.61	40.74
110	5550	56.71	41.63
134	5670	41.11	42.11
142	5710 For U-NII-2C	51.23	51.02

802.11ac (VHT80)

Channel	Frequency (MHz)	26dBc Bandwidth (MHz)	
		Chain 0	Chain 1
58	5290	83.87	84.13
106	5530	83.67	84.16
122	5610	84.67	83.64
138	5690 For U-NII-2C	77.11	81.21

Spectrum Plot of Worst Value

802.11a

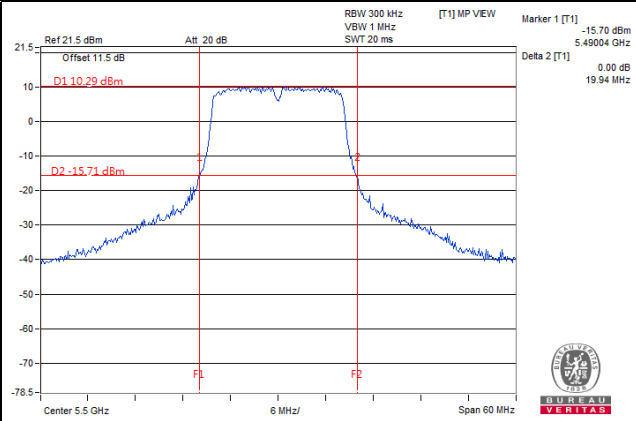

802.11n (HT20)

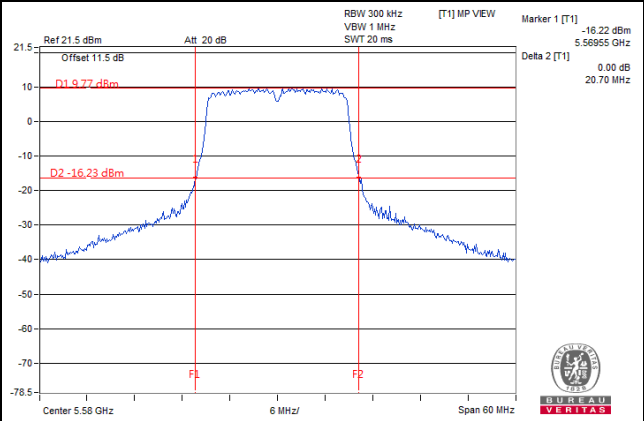

802.11n (HT40)

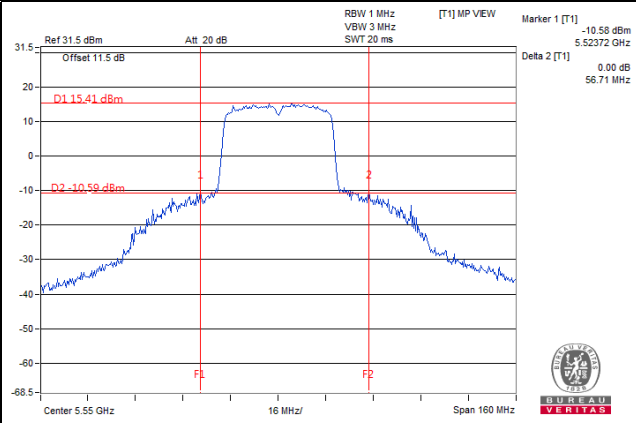

802.11ac (VHT80)

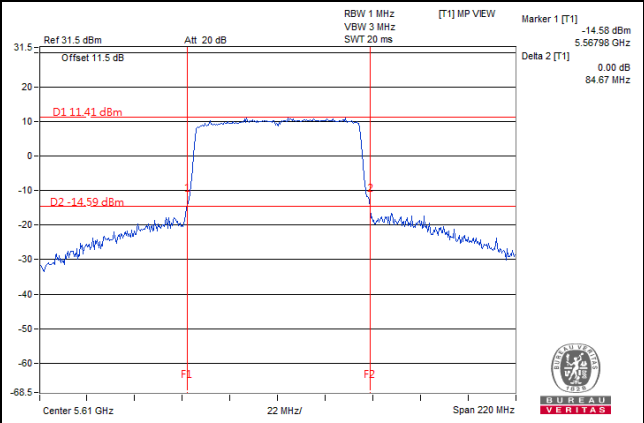

EUT Maximum Conducted Power

CDD Mode

Mode A2: Radio 1

802.11a

Frequency Band (MHz)	Max. Power	
	Output Power (mW)	Output Power (dBm)
5470~5725	139.876	21.46

802.11n (HT20)

Frequency Band (MHz)	Max. Power	
	Output Power (mW)	Output Power (dBm)
5470~5725	166.968	22.23

802.11n (HT40)

Frequency Band (MHz)	Max. Power	
	Output Power (mW)	Output Power (dBm)
5470~5725	239.245	23.79

802.11ac (VHT80)

Frequency Band (MHz)	Max. Power	
	Output Power (mW)	Output Power (dBm)
5470~5725	158.608	22.00

Beamforming Mode

802.11n (HT20)

Frequency Band (MHz)	Max. Power	
	Output Power (mW)	Output Power (dBm)
5470~5725	83.490	19.22

802.11n (HT40)

Frequency Band (MHz)	Max. Power	
	Output Power (mW)	Output Power (dBm)
5470~5725	119.631	20.78

802.11ac (VHT80)

Frequency Band (MHz)	Max. Power	
	Output Power (mW)	Output Power (dBm)
5470~5725	79.309	18.99

Mode B2: Radio 2

802.11a

Frequency Band (MHz)	Max. Power	
	Output Power (mW)	Output Power (dBm)
5250~5350	145.319	21.62
5470~5725	143.594	21.57

802.11n (HT20)

Frequency Band (MHz)	Max. Power	
	Output Power (mW)	Output Power (dBm)
5250~5350	154.653	21.89
5470~5725	145.539	21.63

802.11n (HT40)

Frequency Band (MHz)	Max. Power	
	Output Power (mW)	Output Power (dBm)
5250~5350	238.848	23.78
5470~5725	239.366	23.79

802.11ac (VHT80)

Frequency Band (MHz)	Max. Power	
	Output Power (mW)	Output Power (dBm)
5250~5350	93.603	19.71
5470~5725	194.329	22.89

Beamforming Mode

802.11n (HT20)

Frequency Band (MHz)	Max. Power	
	Output Power (mW)	Output Power (dBm)
5250~5350	77.332	18.88
5470~5725	72.775	18.62

802.11n (HT40)

Frequency Band (MHz)	Max. Power	
	Output Power (mW)	Output Power (dBm)
5250~5350	119.433	20.77
5470~5725	119.691	20.78

802.11ac (VHT80)

Frequency Band (MHz)	Max. Power	
	Output Power (mW)	Output Power (dBm)
5250~5350	46.804	16.70
5470~5725	97.171	19.88

4.4 Occupied Bandwidth Measurement

4.4.1 Test Setup

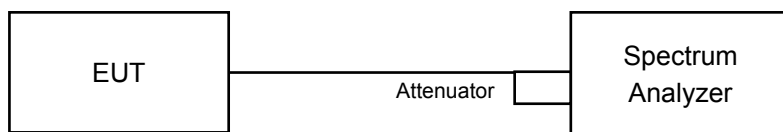

4.4.2 Test Instruments

Refer to section 4.1.2 to get information of above instrument.

4.4.3 Test Procedure

The transmitter output was connected to the spectrum analyzer through an attenuator. The bandwidth of the fundamental frequency was measured by spectrum analyzer with resolution bandwidth in the range of 1% to 5% of the anticipated emission bandwidth, and a video bandwidth at least 3x the resolution bandwidth and set the detector to sampling. The width of a frequency band such that, below the lower and above the upper frequency limits, the mean powers emitted are each equal to a specified percentage 0.5 %of the total mean power of a given emission.

4.4.4 Test Result

Mode A2: Radio 1

802.11a

Channel	Frequency (MHz)	Occupied Bandwidth (MHz)	
		Chain 0	Chain 1
100	5500	16.44	16.44
116	5580	16.68	16.44
140	5700	16.44	16.44
144	5720 For U-NII-2C	13.28	13.28
144	5720 For U-NII-3	3.16	3.16

802.11n (HT20)

Channel	Frequency (MHz)	Occupied Bandwidth (MHz)	
		Chain 0	Chain 1
100	5500	17.64	17.64
116	5580	17.76	17.64
140	5700	17.52	17.52
144	5720 For U-NII-2C	13.88	13.88
144	5720 For U-NII-3	3.76	3.64

802.11n (HT40)

Channel	Frequency (MHz)	Occupied Bandwidth (MHz)	
		Chain 0	Chain 1
102	5510	36.12	36.12
110	5550	36.48	36.36
134	5670	36.24	36.24
142	5710 For U-NII-2C	33.12	33.12
142	5710 For U-NII-3	3.36	3.12

802.11ac (VHT80)

Channel	Frequency (MHz)	Occupied Bandwidth (MHz)	
		Chain 0	Chain 1
106	5530	75.60	75.84
122	5610	76.32	76.56
138	5690 For U-NII-2C	72.68	73.16
138	5690 For U-NII-3	3.40	2.92

Spectrum Plot of Worst Value

802.11a

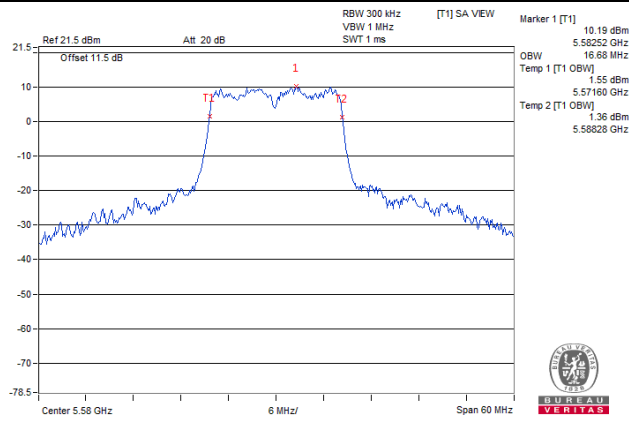

802.11n (HT20)

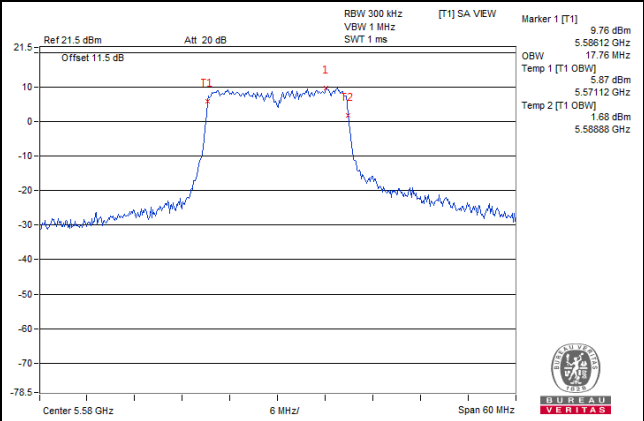

802.11n (HT40)

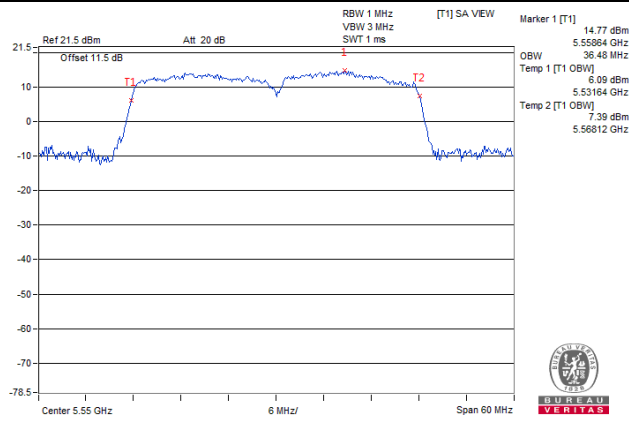

802.11ac (VHT80)

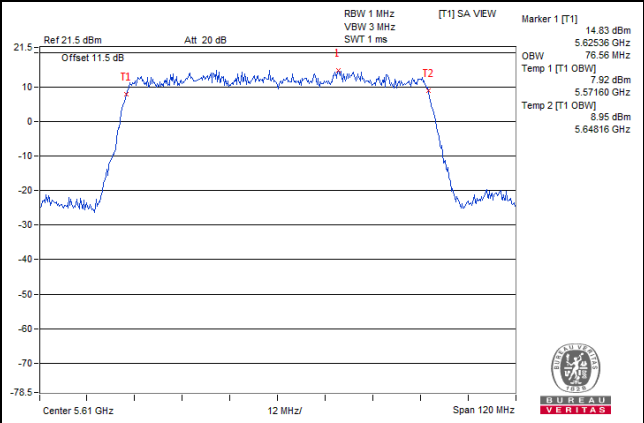

Mode B2: Radio 2

802.11a

Channel	Frequency (MHz)	Occupied Bandwidth (MHz)	
		Chain 0	Chain 1
52	5260	16.44	16.44
60	5300	16.44	16.44
64	5320	16.44	16.44
100	5500	16.44	16.44
116	5580	16.44	16.44
140	5700	16.44	16.44
144	5720 For U-NII-2C	13.28	13.28
144	5720 For U-NII-3	3.04	3.16

802.11n (HT20)

Channel	Frequency (MHz)	Occupied Bandwidth (MHz)	
		Chain 0	Chain 1
52	5260	17.64	17.64
60	5300	17.64	17.64
64	5320	17.64	17.64
100	5500	17.64	17.64
116	5580	17.64	17.64
140	5700	17.64	17.64
144	5720 For U-NII-2C	13.88	13.88
144	5720 For U-NII-3	3.64	3.64

802.11n (HT40)

Channel	Frequency (MHz)	Occupied Bandwidth (MHz)	
		Chain 0	Chain 1
54	5270	36.24	36.24
62	5310	36.12	36.12
102	5510	36.12	36.24
110	5550	36.36	36.36
134	5670	36.24	36.36
142	5710 For U-NII-2C	33.12	33.24
142	5710 For U-NII-3	3.12	3.12

802.11ac (VHT80)

Channel	Frequency (MHz)	Occupied Bandwidth (MHz)	
		Chain 0	Chain 1
58	5290	75.84	75.84
106	5530	75.84	75.84
122	5610	75.84	76.08
138	5690 For U-NII-2C	73.16	73.16
138	5690 For U-NII-3	2.92	2.92

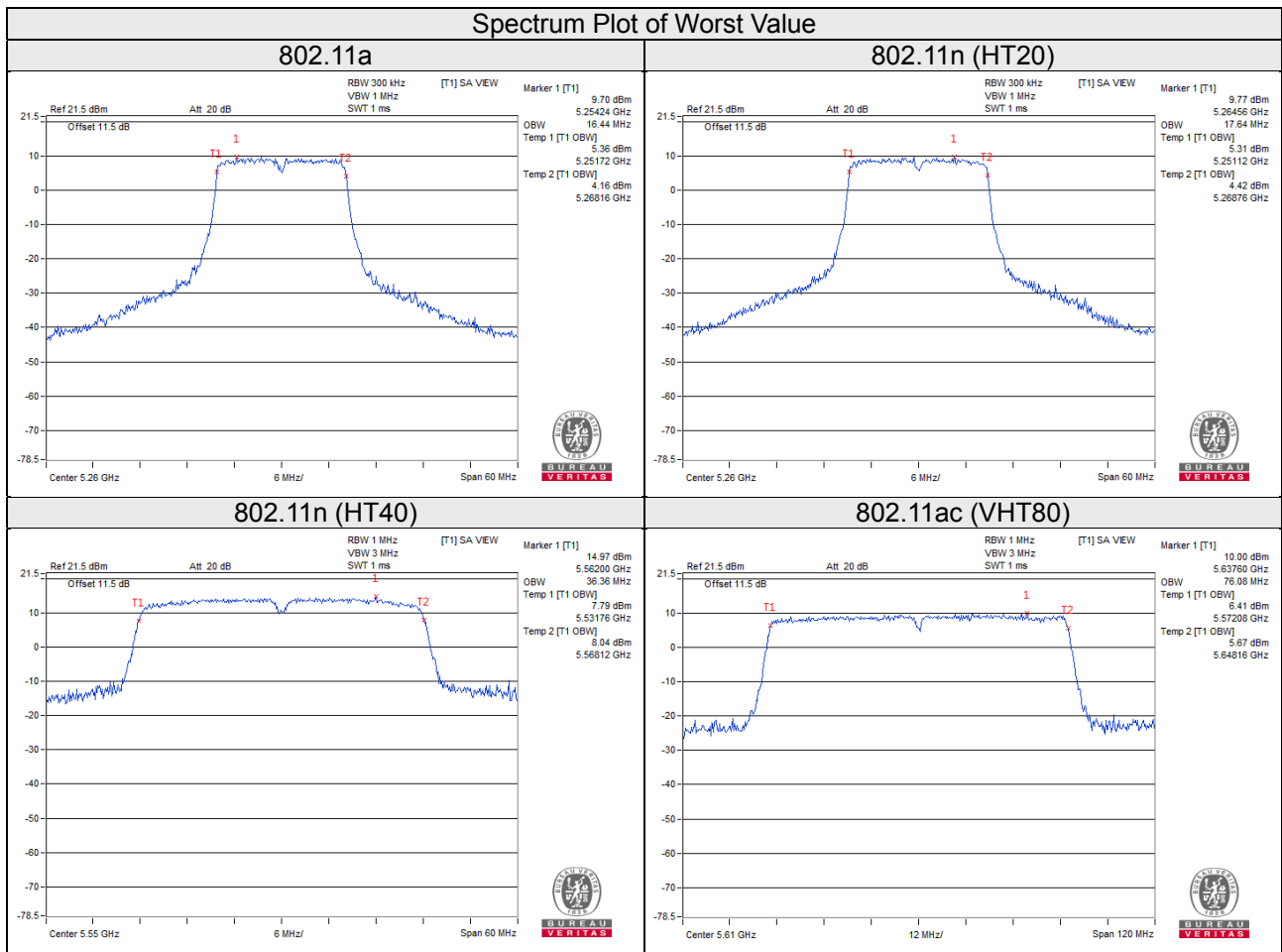

4.5 Peak Power Spectral Density Measurement

4.5.1 Limits of Peak Power Spectral Density Measurement

Operation Band	EUT Category		Limit
U-NII-1		Outdoor Access Point	17dBm/ MHz
		Fixed point-to-point Access Point	
		Indoor Access Point	
		Mobile and Portable client device	11dBm/ MHz
U-NII-2A	√		11dBm/ MHz
U-NII-2C	√		11dBm/ MHz
U-NII-3	√		30dBm/ 500kHz

4.5.2 Test Setup

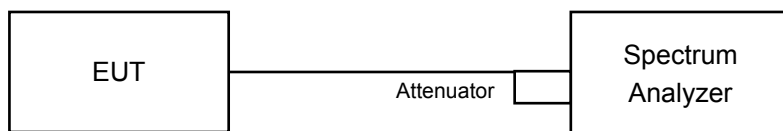

4.5.3 Test Instruments

Refer to section 4.1.2 to get information of above instrument.

4.5.4 Test Procedures

For U-NII-2A, U-NII-2C band:

Duty cycle of test signal is < 98%

Using method SA-2

- 1) Set span to encompass the entire emission bandwidth (EBW) of the signal.
- 2) Set RBW = 1MHz, Set VBW ≥ 3 MHz, Detector = RMS
- 3) Set Channel power measure = 1MHz
- 4) Sweep time = auto, trigger set to “free run”.
- 5) Trace average at least 100 traces in power averaging mode.
- 6) Record the max value and add 10 log (1/duty cycle)

For U-NII-3 band

Duty cycle <98%

- 1) Set span to encompass the entire emission bandwidth (EBW) of the signal.
- 2) Set RBW = 300 kHz, Set VBW ≥ 1 MHz, Detector = RMS
- 3) Use the peak marker function to determine the maximum power level in any 300 kHz band segment within the fundamental EBW.
- 4) Scale the observed power level to an equivalent value in 500 kHz by adjusting (reducing) the measured power by a bandwidth correction factor (BWCF) where $BWCF = 10\log(500\text{ kHz}/300\text{kHz})$
- 5) Sweep time = auto, trigger set to “free run”.
- 6) Trace average at least 100 traces in power averaging mode.
- 7) Record the max value and add 10 log (1/duty cycle)

4.5.5 Deviation from Test Standard

No deviation.

4.5.6 EUT Operating Conditions

Same as 4.3.6.

4.5.7 Test Results

For U-NII-2A, U-NII-2C band:

Mode A2: Radio 1

802.11a

Chan.	Freq. (MHz)	PSD W/O Duty Factor (dBm/MHz)		Duty Factor (dB)	Total PSD With Duty Factor (dBm/MHz)	Max. Limit (dBm/MHz)	Pass / Fail
		Chain 0	Chain 1				
100	5500	4.82	4.66	0.21	7.96	8.49	Pass
116	5580	5.39	4.98	0.21	8.41	8.49	Pass
140	5700	5.27	4.12	0.21	7.95	8.49	Pass
144	5720 For U-NII-2C	5.22	4.22	0.21	7.97	8.49	Pass

Note:

- Method E) 2) a) of power density measurement of KDB 662911 is using for calculating total power density. Total power density is summing entire spectra across corresponding frequency bins on the various outputs by computer.
- Directional Gain = $5.5 + 10\log(2) = 8.51\text{dBi} > 6\text{dBi}$, so the limit shall be reduced to $11 - (8.51 - 6) = 8.49\text{dBm}$.
- Refer to section 3.3 for duty cycle spectrum plot.

802.11n (HT20)

Chan.	Freq. (MHz)	PSD W/O Duty Factor (dBm/MHz)		Duty Factor (dB)	Total PSD With Duty Factor (dBm/MHz)	Max. Limit (dBm/MHz)	Pass / Fail
		Chain 0	Chain 1				
100	5500	4.78	4.89	0.11	7.96	8.49	Pass
116	5580	5.34	5.36	0.11	8.47	8.49	Pass
140	5700	5.25	4.00	0.11	7.79	8.49	Pass
144	5720 For U-NII-2C	5.16	4.42	0.11	7.93	8.49	Pass

Note:

- Method E) 2) a) of power density measurement of KDB 662911 is using for calculating total power density. Total power density is summing entire spectra across corresponding frequency bins on the various outputs by computer.
- Directional Gain = $5.5 + 10\log(2) = 8.51\text{dBi} > 6\text{dBi}$, so the limit shall be reduced to $11 - (8.51 - 6) = 8.49\text{dBm}$.
- Refer to section 3.3 for duty cycle spectrum plot.

802.11n (HT40)

Chan.	Freq. (MHz)	PSD W/O Duty Factor (dBm/MHz)		Duty Factor (dB)	Total PSD With Duty Factor (dBm/MHz)	Max. Limit (dBm/MHz)	Pass / Fail
		Chain 0	Chain 1				
102	5510	1.74	1.33	0.18	4.73	8.49	Pass
110	5550	4.67	4.14	0.18	7.60	8.49	Pass
134	5670	0.76	0.88	0.18	4.01	8.49	Pass
142	5710 For U-NII-2C	4.50	4.08	0.18	7.49	8.49	Pass

Note:

- Method E) 2) a) of power density measurement of KDB 662911 is using for calculating total power density. Total power density is summing entire spectra across corresponding frequency bins on the various outputs by computer.
- Directional Gain = $5.5 + 10\log(2) = 8.51\text{dBi} > 6\text{dBi}$, so the limit shall be reduced to $11 - (8.51 - 6) = 8.49\text{dBm}$.
- Refer to section 3.3 for duty cycle spectrum plot.

802.11ac (VHT80)

Chan.	Freq. (MHz)	PSD W/O Duty Factor (dBm/MHz)		Duty Factor (dB)	Total PSD With Duty Factor (dBm/MHz)	Max. Limit (dBm/MHz)	Pass / Fail
		Chain 0	Chain 1				
106	5530	-0.93	-1.03	0.34	2.37	8.49	Pass
122	5610	0.17	-0.78	0.34	3.07	8.49	Pass
138	5690 For U-NII-2C	0.56	0.53	0.34	3.90	8.49	Pass

Note:

- Method E) 2) a) of power density measurement of KDB 662911 is using for calculating total power density. Total power density is summing entire spectra across corresponding frequency bins on the various outputs by computer.
- Directional Gain = $5.5 + 10\log(2) = 8.51\text{dBi} > 6\text{dBi}$, so the limit shall be reduced to $11 - (8.51 - 6) = 8.49\text{dBm}$.
- Refer to section 3.3 for duty cycle spectrum plot.

Spectrum Plot of Worst Value

802.11a / Chain 0 / CH 116

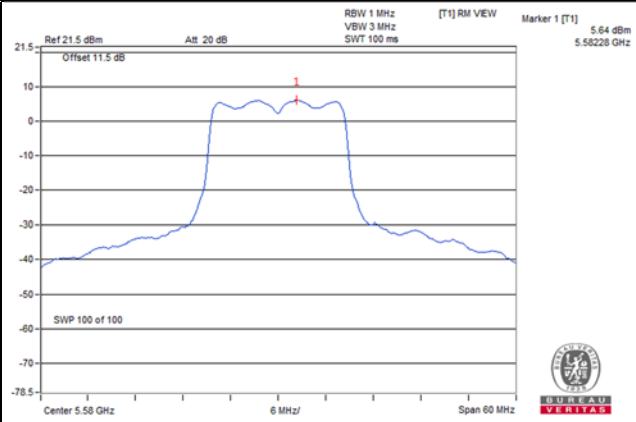

802.11n (HT20) / Chain 1 / CH 116

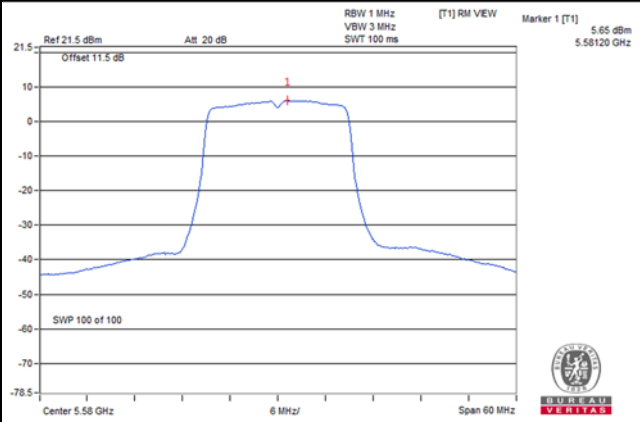

802.11n (HT40) / Chain 0 / CH 110

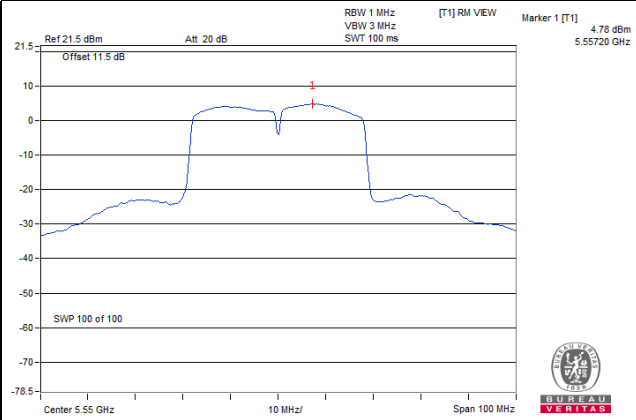

802.11ac (VHT80) / Chain 0 / CH 138

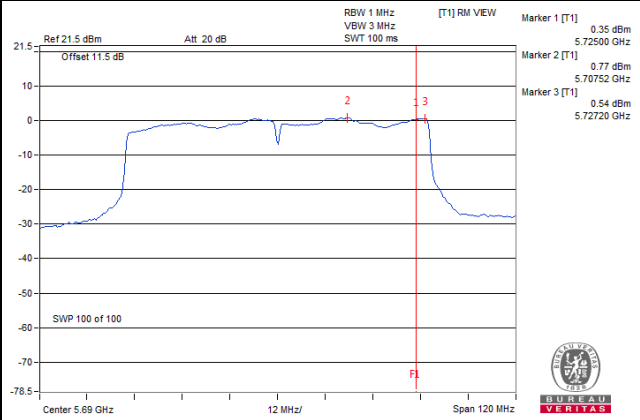

Mode B2: Radio 2

802.11a

Chan.	Freq. (MHz)	PSD W/O Duty Factor (dBm/MHz)		Duty Factor (dB)	Total PSD With Duty Factor (dBm/MHz)	Max. Limit (dBm/MHz)	Pass / Fail
		Chain 0	Chain 1				
52	5260	5.20	4.90	0.28	8.34	8.49	Pass
60	5300	5.05	4.85	0.28	8.24	8.49	Pass
64	5320	5.14	4.99	0.28	8.36	8.49	Pass
100	5500	5.45	4.67	0.28	8.37	8.49	Pass
116	5580	5.42	4.77	0.28	8.40	8.49	Pass
140	5700	4.92	5.01	0.28	8.26	8.49	Pass
144	5720 For U-NII-2C	4.52	5.06	0.28	8.09	8.49	Pass

Note:

- Method E) 2) a) of power density measurement of KDB 662911 is using for calculating total power density. Total power density is summing entire spectra across corresponding frequency bins on the various outputs by computer.
- Directional Gain = $5.5 + 10\log(2) = 8.51\text{dBi} > 6\text{dBi}$, so the limit shall be reduced to $11 - (8.51 - 6) = 8.49\text{dBm}$.
- Refer to section 3.3 for duty cycle spectrum plot.

802.11n (HT20)

Chan.	Freq. (MHz)	PSD W/O Duty Factor (dBm/MHz)		Duty Factor (dB)	Total PSD With Duty Factor (dBm/MHz)	Max. Limit (dBm/MHz)	Pass / Fail
		Chain 0	Chain 1				
52	5260	5.44	5.03	0.10	8.35	8.49	Pass
60	5300	5.26	4.88	0.10	8.18	8.49	Pass
64	5320	5.09	5.16	0.10	8.24	8.49	Pass
100	5500	5.28	4.51	0.10	8.02	8.49	Pass
116	5580	5.28	4.78	0.10	8.15	8.49	Pass
140	5700	5.18	5.41	0.10	8.41	8.49	Pass
144	5720 For U-NII-2C	4.20	5.03	0.10	7.75	8.49	Pass

Note:

- Method E) 2) a) of power density measurement of KDB 662911 is using for calculating total power density. Total power density is summing entire spectra across corresponding frequency bins on the various outputs by computer.
- Directional Gain = $5.5 + 10\log(2) = 8.51\text{dBi} > 6\text{dBi}$, so the limit shall be reduced to $11 - (8.51 - 6) = 8.49\text{dBm}$.
- Refer to section 3.3 for duty cycle spectrum plot.

802.11n (HT40)

Chan.	Freq. (MHz)	PSD W/O Duty Factor (dBm/MHz)		Duty Factor (dB)	Total PSD With Duty Factor (dBm/MHz)	Max. Limit (dBm/MHz)	Pass / Fail
		Chain 0	Chain 1				
54	5270	4.39	4.12	0.17	7.44	8.49	Pass
62	5310	1.54	1.45	0.17	4.68	8.49	Pass
102	5510	0.71	-0.02	0.17	3.54	8.49	Pass
110	5550	4.53	3.78	0.17	7.35	8.49	Pass
134	5670	3.46	3.67	0.17	6.75	8.49	Pass
142	5710 For U-NII-2C	4.01	4.35	0.17	7.36	8.49	Pass

Note:

- Method E) 2) a) of power density measurement of KDB 662911 is using for calculating total power density. Total power density is summing entire spectra across corresponding frequency bins on the various outputs by computer.
- Directional Gain = $5.5 + 10\log(2) = 8.51\text{dBi} > 6\text{dBi}$, so the limit shall be reduced to $11 - (8.51 - 6) = 8.49\text{dBm}$.
- Refer to section 3.3 for duty cycle spectrum plot.

802.11ac (VHT80)

Chan.	Freq. (MHz)	PSD W/O Duty Factor (dBm/MHz)		Duty Factor (dB)	Total PSD With Duty Factor (dBm/MHz)	Max. Limit (dBm/MHz)	Pass / Fail
		Chain 0	Chain 1				
58	5290	-3.15	-3.27	0.32	0.12	8.49	Pass
106	5530	-2.65	-3.69	0.32	0.19	8.49	Pass
122	5610	0.30	-0.47	0.32	3.26	8.49	Pass
138	5690 For U-NII-2C	0.34	0.32	0.32	3.66	8.49	Pass

Note:

- Method E) 2) a) of power density measurement of KDB 662911 is using for calculating total power density. Total power density is summing entire spectra across corresponding frequency bins on the various outputs by computer.
- Directional Gain = $5.5 + 10\log(2) = 8.51\text{dBi} > 6\text{dBi}$, so the limit shall be reduced to $11 - (8.51 - 6) = 8.49\text{dBm}$.
- Refer to section 3.3 for duty cycle spectrum plot.

Spectrum Plot of Worst Value

802.11a / Chain 0 / CH 100

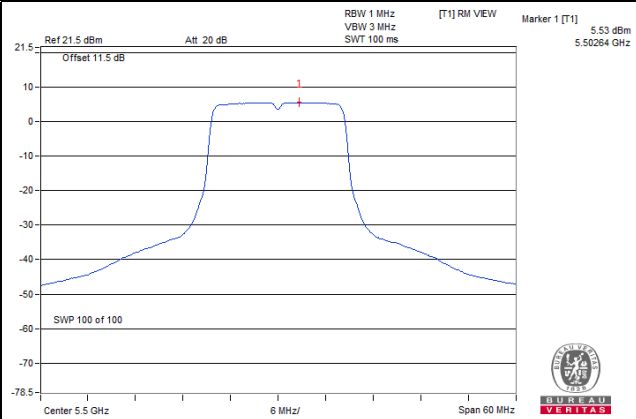

802.11n (HT20) / Chain 0 / CH 52

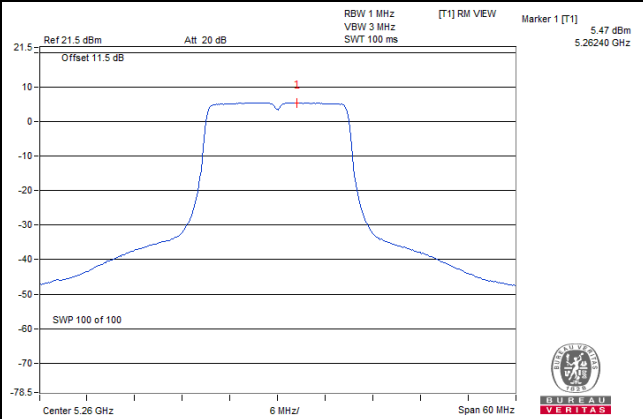

802.11n (HT40) / Chain 0 / CH 110

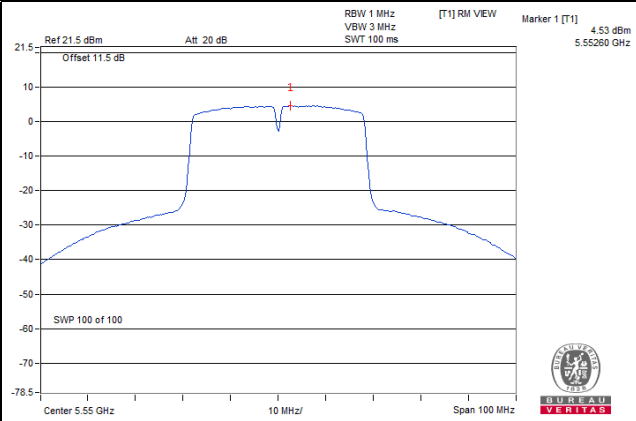

802.11ac (VHT80) / Chain 0 / CH 138

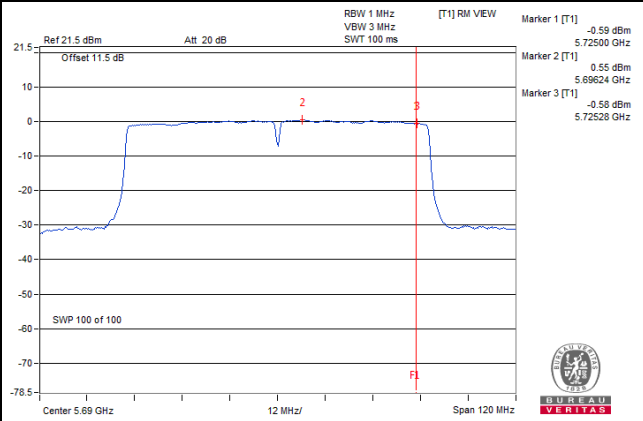

For U-NII-3 band:

Mode A2: Radio 1

802.11a

TX chain	Chan.	Chan. Freq. (MHz)	PSD W/O Duty Factor		10 log (N=2) dB	Duty Factor (dB)	Total PSD With Duty Factor (dBm/ 500kHz)	Limit (dBm/ 500kHz)	Pass / Fail
			(dBm/ 300kHz)	(dBm/ 500kHz)					
0	144	5720 For U-NII-3	-3.87	-1.65	3.01	0.21	1.57	27.49	Pass
1	144	5720 For U-NII-3	-4.45	-2.23	3.01	0.21	0.99	27.49	Pass

Note:

1. Method a) of power density measurement of KDB 662911 is using for calculating total power density. Total power density is summing entire spectra across corresponding frequency bins on the various outputs by computer.
2. 5745~5825MHz Directional Gain = $5.5 + 10\log(2) = 8.51\text{dBi} > 6\text{dBi}$, so the limit shall be reduced to $30-(8.51-6) = 27.49\text{dBm}$.
3. Refer to section 3.3 for duty cycle spectrum plot.

802.11n (HT20)

TX chain	Chan.	Chan. Freq. (MHz)	PSD W/O Duty Factor		10 log (N=2) dB	Duty Factor (dB)	Total PSD With Duty Factor (dBm/ 500kHz)	Limit (dBm/ 500kHz)	Pass / Fail
			(dBm/ 300kHz)	(dBm/ 500kHz)					
0	144	5720 For U-NII-3	-4.25	-2.03	3.01	0.11	1.09	27.49	Pass
1	144	5720 For U-NII-3	-4.19	-1.97	3.01	0.11	1.15	27.49	Pass

Note:

1. Method a) of power density measurement of KDB 662911 is using for calculating total power density. Total power density is summing entire spectra across corresponding frequency bins on the various outputs by computer.
2. 5745~5825MHz Directional Gain = $5.5 + 10\log(2) = 8.51\text{dBi} > 6\text{dBi}$, so the limit shall be reduced to $30-(8.51-6) = 27.49\text{dBm}$.
3. Refer to section 3.3 for duty cycle spectrum plot.

802.11n (HT40)

TX chain	Chan.	Chan. Freq. (MHz)	PSD W/O Duty Factor		10 log (N=2) dB	Duty Factor (dB)	Total PSD With Duty Factor (dBm/ 500kHz)	Limit (dBm/ 500kHz)	Pass / Fail
			(dBm/ 300kHz)	(dBm/ 500kHz)					
0	142	5710 For U-NII-3	-5.24	-3.02	3.01	0.18	0.17	27.49	Pass
1	142	5710 For U-NII-3	-6.42	-4.20	3.01	0.18	-1.01	27.49	Pass

Note:

1. Method a) of power density measurement of KDB 662911 is using for calculating total power density. Total power density is summing entire spectra across corresponding frequency bins on the various outputs by computer.
2. 5745~5825MHz Directional Gain = $5.5 + 10\log(2) = 8.51\text{dBi} > 6\text{dBi}$, so the limit shall be reduced to $30-(8.51-6) = 27.49\text{dBm}$.
3. Refer to section 3.3 for duty cycle spectrum plot.

802.11ac (VHT80)

TX chain	Chan.	Chan. Freq. (MHz)	PSD W/O Duty Factor		10 log (N=2) dB	Duty Factor (dB)	Total PSD With Duty Factor (dBm/ 500kHz)	Limit (dBm/ 500kHz)	Pass / Fail
			(dBm/ 300kHz)	(dBm/ 500kHz)					
0	138	5690 For U-NII-3	-8.39	-6.17	3.01	0.34	-2.82	27.49	Pass
1	138	5690 For U-NII-3	-9.79	-7.57	3.01	0.34	-4.22	27.49	Pass

Note:

- Method a) of power density measurement of KDB 662911 is using for calculating total power density. Total power density is summing entire spectra across corresponding frequency bins on the various outputs by computer.
- 5745~5825MHz Directional Gain = $5.5 + 10\log(2) = 8.51\text{dBi} > 6\text{dBi}$, so the limit shall be reduced to $30 - (8.51 - 6) = 27.49\text{dBm}$.
- Refer to section 3.3 for duty cycle spectrum plot.

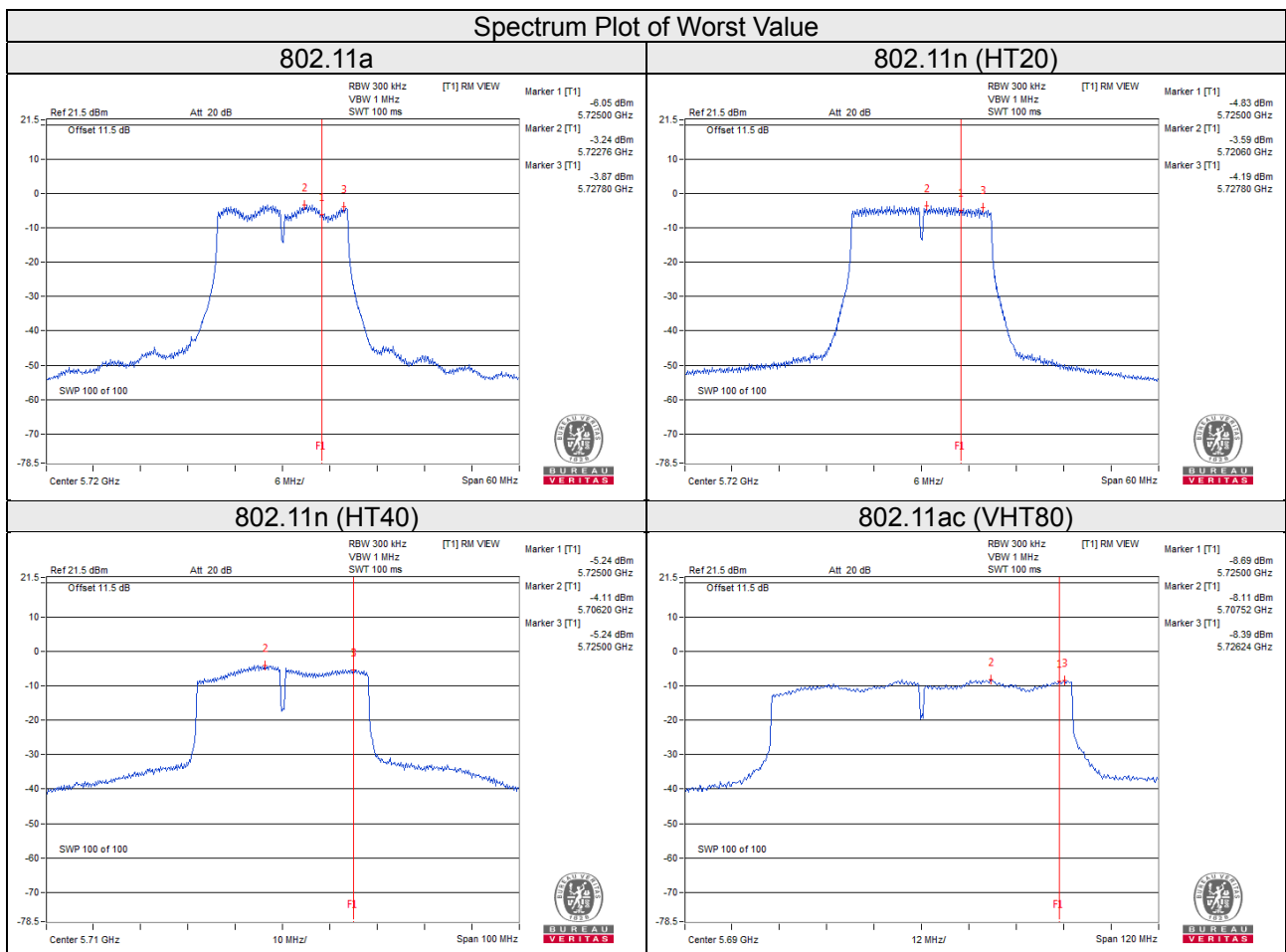

Mode B2: Radio 2

802.11a

TX chain	Chan.	Chan. Freq. (MHz)	PSD W/O Duty Factor		10 log (N=2) dB	Duty Factor (dB)	Total PSD With Duty Factor (dBm/ 500kHz)	Limit (dBm/ 500kHz)	Pass / Fail
			(dBm/ 300kHz)	(dBm/ 500kHz)					
0	144	5720 For U-NII-3	-3.94	-1.72	3.01	0.28	1.57	27.49	Pass
1	144	5720 For U-NII-3	-3.78	-1.56	3.01	0.28	1.73	27.49	Pass

Note:

1. Method a) of power density measurement of KDB 662911 is using for calculating total power density. Total power density is summing entire spectra across corresponding frequency bins on the various outputs by computer.
2. 5745~5825MHz Directional Gain = $5.5 + 10\log(2) = 8.51\text{dBi} > 6\text{dBi}$, so the limit shall be reduced to $30-(8.51-6) = 27.49\text{dBm}$.
3. Refer to section 3.3 for duty cycle spectrum plot.

802.11n (HT20)

TX chain	Chan.	Chan. Freq. (MHz)	PSD W/O Duty Factor		10 log (N=2) dB	Duty Factor (dB)	Total PSD With Duty Factor (dBm/ 500kHz)	Limit (dBm/ 500kHz)	Pass / Fail
			(dBm/ 300kHz)	(dBm/ 500kHz)					
0	144	5720 For U-NII-3	-4.19	-1.97	3.01	0.10	1.14	27.49	Pass
1	144	5720 For U-NII-3	-4.15	-1.93	3.01	0.10	1.18	27.49	Pass

Note:

1. Method a) of power density measurement of KDB 662911 is using for calculating total power density. Total power density is summing entire spectra across corresponding frequency bins on the various outputs by computer.
2. 5745~5825MHz Directional Gain = $5.5 + 10\log(2) = 8.51\text{dBi} > 6\text{dBi}$, so the limit shall be reduced to $30-(8.51-6) = 27.49\text{dBm}$.
3. Refer to section 3.3 for duty cycle spectrum plot.

802.11n (HT40)

TX chain	Chan.	Chan. Freq. (MHz)	PSD W/O Duty Factor		10 log (N=2) dB	Duty Factor (dB)	Total PSD With Duty Factor (dBm/ 500kHz)	Limit (dBm/ 500kHz)	Pass / Fail
			(dBm/ 300kHz)	(dBm/ 500kHz)					
0	142	5710 For U-NII-3	-6.12	-3.90	3.01	0.17	-0.72	27.49	Pass
1	142	5710 For U-NII-3	-5.67	-3.45	3.01	0.17	-0.27	27.49	Pass

Note:

1. Method a) of power density measurement of KDB 662911 is using for calculating total power density. Total power density is summing entire spectra across corresponding frequency bins on the various outputs by computer.
2. 5745~5825MHz Directional Gain = $5.5 + 10\log(2) = 8.51\text{dBi} > 6\text{dBi}$, so the limit shall be reduced to $30-(8.51-6) = 27.49\text{dBm}$.
3. Refer to section 3.3 for duty cycle spectrum plot.

802.11ac (VHT80)

TX chain	Chan.	Chan. Freq. (MHz)	PSD W/O Duty Factor		10 log (N=2) dB	Duty Factor (dB)	Total PSD With Duty Factor (dBm/ 500kHz)	Limit (dBm/ 500kHz)	Pass / Fail
			(dBm/ 300kHz)	(dBm/ 500kHz)					
0	138	5690 For U-NII-3	-9.49	-7.27	3.01	0.32	-3.94	27.49	Pass
1	138	5690 For U-NII-3	-9.20	-6.98	3.01	0.32	-3.65	27.49	Pass

Note:

- Method a) of power density measurement of KDB 662911 is using for calculating total power density. Total power density is summing entire spectra across corresponding frequency bins on the various outputs by computer.
- 5745~5825MHz Directional Gain = $5.5 + 10\log(2) = 8.51\text{dBi} > 6\text{dBi}$, so the limit shall be reduced to $30 - (8.51 - 6) = 27.49\text{dBm}$.
- Refer to section 3.3 for duty cycle spectrum plot.

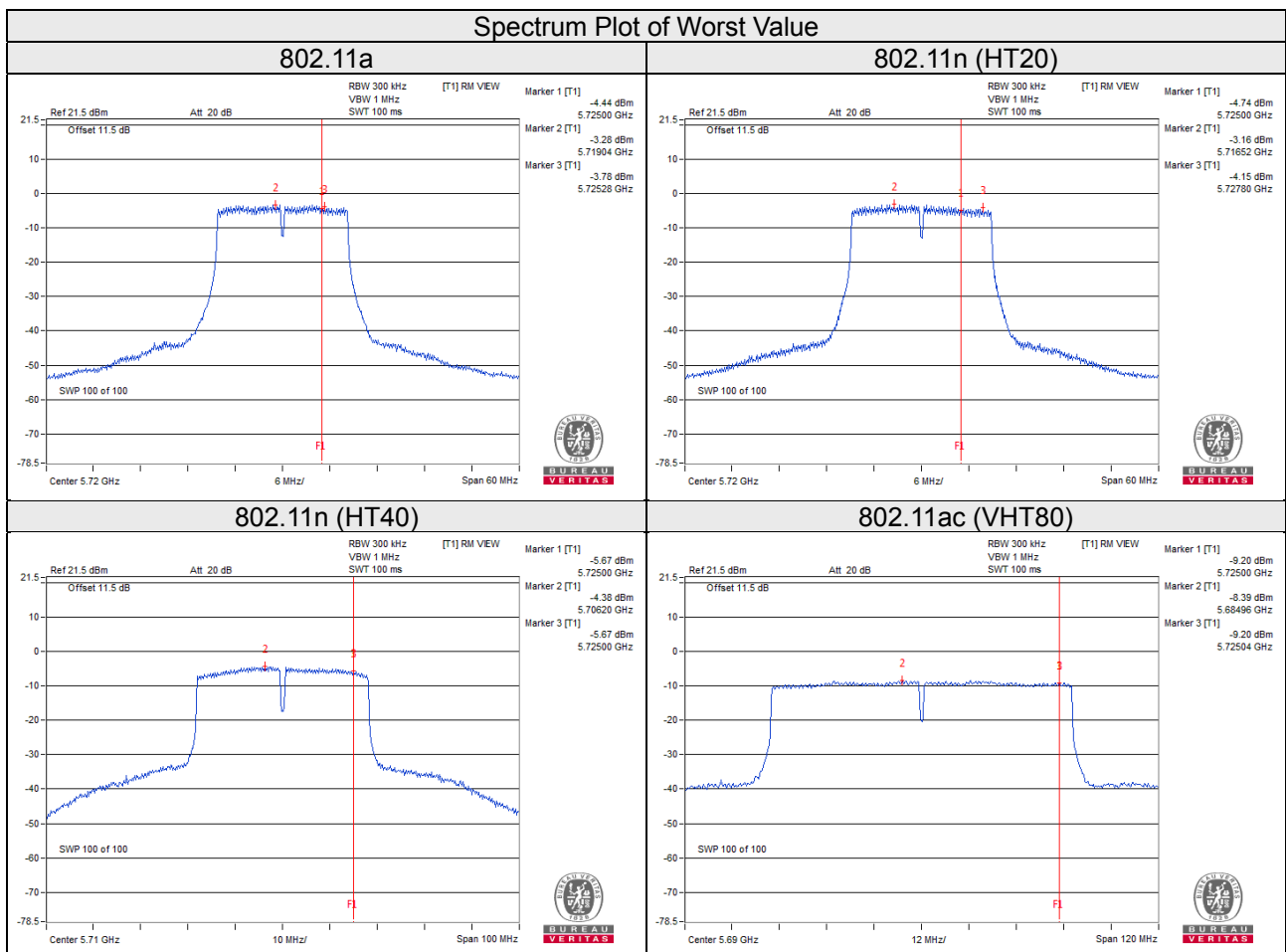

4.6 Frequency Stability

4.6.1 Limits of Frequency Stability Measurement

The frequency of the carrier signal shall be maintained within band of operation

4.6.2 Test Setup

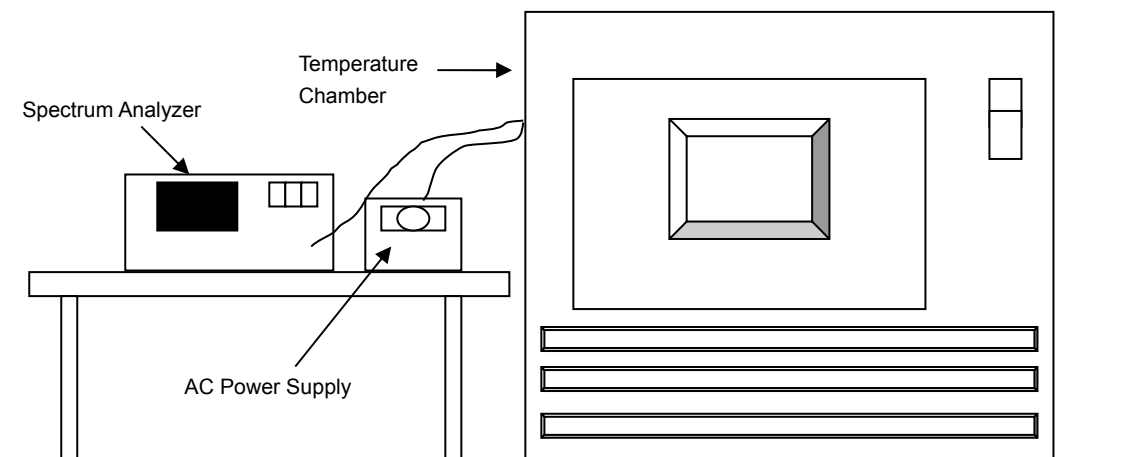

4.6.3 Test Instruments

Description & Manufacturer	Model No.	Serial No.	Cal. Date	Cal. Due
Spectrum Analyzer ROHDE & SCHWARZ	FSP40	100039	Jun. 12, 2019	Jun. 11, 2020
WIT Standard Temperature And Humidity Chamber	TH-4S-C	W981030	Jun. 03, 2019	Jun. 02, 2020
Digital Multimeter Fluke	87-III	70360742	Jun. 27, 2019	Jun. 26, 2020
AC Power Supply Extech	CFW-105	E000603	NA	NA
True RMS Clamp Meter / Fluke	325	31130711WS	May 21, 2019	May 20, 2020

Note: 1. The calibration interval of the above test instruments is 12 months and the calibrations are traceable to NML/ROC and NIST/USA.

4.6.4 Test Procedure

- The EUT was placed inside the environmental test chamber and powered by nominal AC voltage.
- Turn the EUT on and couple its output to a spectrum analyzer.
- Turn the EUT off and set the chamber to the highest temperature specified.
- Allow sufficient time (approximately 30 min) for the temperature of the chamber to stabilize, turn the EUT on and measure the operating frequency after 2, 5, and 10 minutes.
- Repeat step (d) with the temperature chamber set to the next desired temperature until measurements down to the lowest specified temperature have been completed.
- The test chamber was allowed to stabilize at +20 degree C for a minimum of 30 minutes. The supply voltage was then adjusted on the EUT from 85% to 115% and the frequency record.

4.6.5 Deviation from Test Standard

No deviation.

4.6.6 EUT Operating Condition

Set the EUT transmit at un-modulation mode to test frequency stability.

4.6.7 Test Results

Mode A2: Radio 1

Frequency Stability Versus Temp.									
Operating Frequency: 5500MHz									
Temp. (°C)	Power Supply (Vac)	0 Minute		2 Minute		5 Minute		10 Minute	
		Measured Frequency (MHz)	Result	Measured Frequency (MHz)	Result	Measured Frequency (MHz)	Result	Measured Frequency (MHz)	Result
50	120	5500.0019	PASS	5500.0064	PASS	5500.0049	PASS	5500.0049	PASS
40	120	5500.0191	PASS	5500.0199	PASS	5500.0195	PASS	5500.0197	PASS
30	120	5500.0131	PASS	5500.0121	PASS	5500.01	PASS	5500.0105	PASS
20	120	5500.0198	PASS	5500.0194	PASS	5500.0206	PASS	5500.0192	PASS
10	120	5500.0048	PASS	5500.0056	PASS	5500.0072	PASS	5500.0054	PASS
0	120	5500.0137	PASS	5500.0156	PASS	5500.0141	PASS	5500.0115	PASS
-10	120	5500.0057	PASS	5500.0056	PASS	5500.0031	PASS	5500.0035	PASS
-20	120	5500.0074	PASS	5500.0063	PASS	5500.0077	PASS	5500.0058	PASS

Frequency Stability Versus Voltage									
Operating Frequency: 5500MHz									
Temp. (°C)	Power Supply (Vac)	0 Minute		2 Minute		5 Minute		10 Minute	
		Measured Frequency (MHz)	Result	Measured Frequency (MHz)	Result	Measured Frequency (MHz)	Result	Measured Frequency (MHz)	Result
20	138	5500.019	PASS	5500.0197	PASS	5500.021	PASS	5500.0201	PASS
	120	5500.0198	PASS	5500.0194	PASS	5500.0206	PASS	5500.0192	PASS
	102	5500.0207	PASS	5500.0186	PASS	5500.0198	PASS	5500.0199	PASS

Mode B2: Radio 2

Frequency Stability Versus Temp.									
Operating Frequency: 5260MHz									
Temp. (°C)	Power Supply (Vac)	0 Minute		2 Minute		5 Minute		10 Minute	
		Measured Frequency (MHz)	Result	Measured Frequency (MHz)	Result	Measured Frequency (MHz)	Result	Measured Frequency (MHz)	Result
50	120	5719.9755	PASS	5719.975	PASS	5719.9763	PASS	5719.9767	PASS
40	120	5720.0206	PASS	5720.0184	PASS	5720.0188	PASS	5720.0186	PASS
30	120	5719.9841	PASS	5719.9867	PASS	5719.9868	PASS	5719.9865	PASS
20	120	5720.003	PASS	5720.0013	PASS	5720.0012	PASS	5720.0027	PASS
10	120	5719.9785	PASS	5719.9807	PASS	5719.9827	PASS	5719.9773	PASS
0	120	5719.9976	PASS	5719.9946	PASS	5719.9941	PASS	5719.9954	PASS
-10	120	5720.0142	PASS	5720.0183	PASS	5720.0164	PASS	5720.015	PASS
-20	120	5719.9768	PASS	5719.9797	PASS	5719.981	PASS	5719.9784	PASS

Frequency Stability Versus Voltage									
Operating Frequency: 5260MHz									
Temp. (°C)	Power Supply (Vac)	0 Minute		2 Minute		5 Minute		10 Minute	
		Measured Frequency (MHz)	Result	Measured Frequency (MHz)	Result	Measured Frequency (MHz)	Result	Measured Frequency (MHz)	Result
20	138	5720.004	PASS	5720.0023	PASS	5720.0011	PASS	5720.0036	PASS
	120	5720.003	PASS	5720.0013	PASS	5720.0012	PASS	5720.0027	PASS
	102	5720.0028	PASS	5720.002	PASS	5720.0019	PASS	5720.0027	PASS

4.7 6dB Bandwidth Measurement

4.7.1 Limits of 6dB Bandwidth Measurement

The minimum of 6dB Bandwidth Measurement is 0.5MHz.

4.7.2 Test Setup

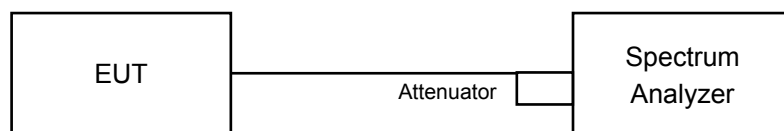

4.7.3 Test Instruments

Refer to section 4.1.2 to get information of above instrument.

4.7.4 Test Procedure

Measurement Procedure REF

- Set resolution bandwidth (RBW) = 100kHz
- Set the video bandwidth (VBW) $\geq 3 \times$ RBW, Detector = Peak.
- Trace mode = max hold.
- Sweep = auto couple.
- Measure the maximum width of the emission that is constrained by the frequencies associated with the two amplitude points (upper and lower) that are attenuated by 6 dB relative to the maximum level measured in the fundamental emission

4.7.5 Deviation from Test Standard

No deviation.

4.7.6 EUT Operating Condition

The software provided by client to enable the EUT under transmission condition continuously at lowest, middle and highest channel frequencies individually.

4.7.7 Test Results

Mode A2: Radio 1

802.11a

Channel	Frequency (MHz)	6dB Bandwidth (MHz)		Minimum Limit (MHz)	Pass / Fail
		Chain 0	Chain 1		
144	5720 For U-NII-3	3.18	3.18	0.5	Pass

802.11n (HT20)

Channel	Frequency (MHz)	6dB Bandwidth (MHz)		Minimum Limit (MHz)	Pass / Fail
		Chain 0	Chain 1		
144	5720 For U-NII-3	3.78	3.77	0.5	Pass

802.11n (HT40)

Channel	Frequency (MHz)	6dB Bandwidth (MHz)		Minimum Limit (MHz)	Pass / Fail
		Chain 0	Chain 1		
142	5710 For U-NII-3	2.57	2.53	0.5	Pass

802.11ac (VHT80)

Channel	Frequency (MHz)	6dB Bandwidth (MHz)		Minimum Limit (MHz)	Pass / Fail
		Chain 0	Chain 1		
138	5690 For U-NII-3	3.23	2.77	0.5	Pass

Spectrum Plot of Worst Value

802.11a

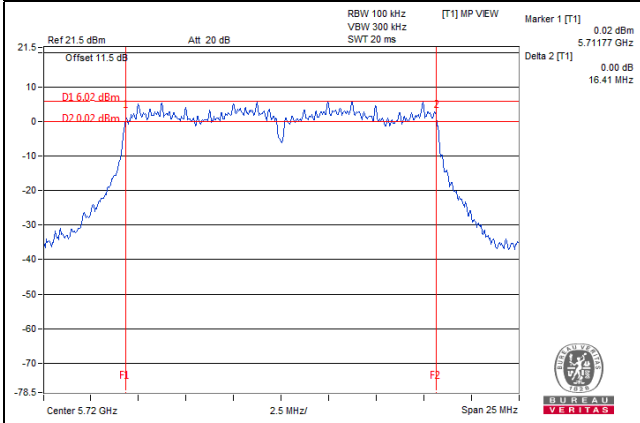

802.11n (HT20)

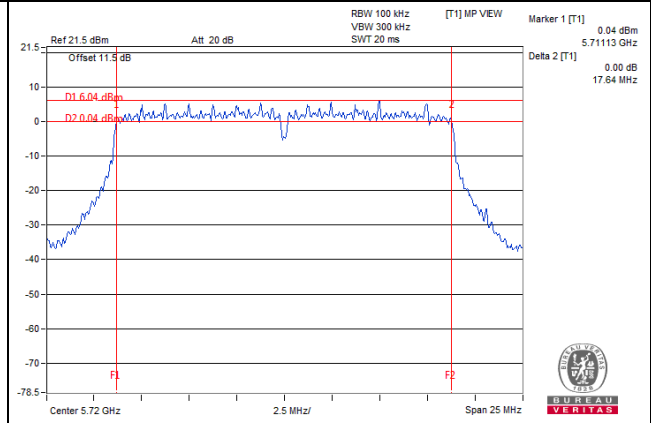

802.11n (HT40)

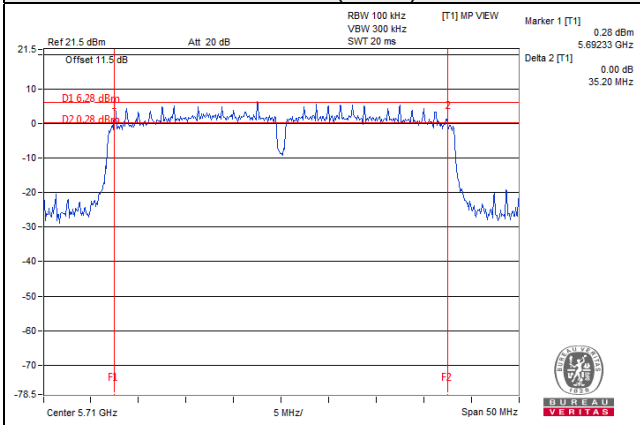

802.11ac (VHT80)

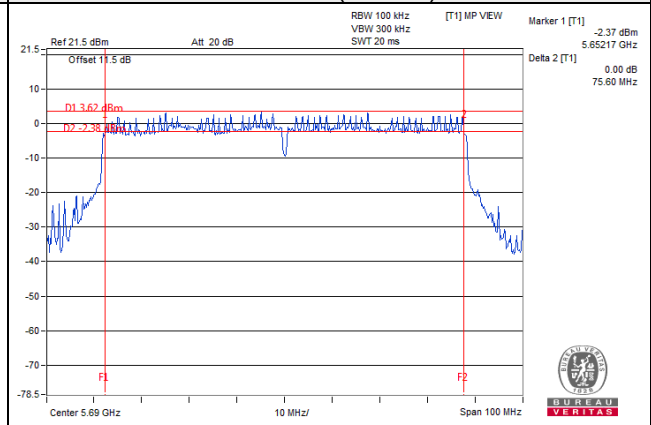

- *802.11a: Ch 144 (5720MHz for U-NII-3): $16.44 - (5725 - 5711.77) = 3.18$
- *802.11n (HT20): Ch 144 (5720MHz for U-NII-3): $17.64 - (5725 - 5711.13) = 3.77$
- *802.11n (HT40): Ch 142 (5710MHz for U-NII-3): $35.20 - (5725 - 5692.33) = 2.53$
- *802.11ac (VHT80): Ch 138 (5690MHz for U-NII-3): $75.60 - (5725 - 5652.17) = 2.77$

Mode B2: Radio 2

802.11a

Channel	Frequency (MHz)	6dB Bandwidth (MHz)		Minimum Limit (MHz)	Pass / Fail
		Chain 0	Chain 1		
144	5720 For U-NII-3	3.17	3.17	0.5	Pass

802.11n (HT20)

Channel	Frequency (MHz)	6dB Bandwidth (MHz)		Minimum Limit (MHz)	Pass / Fail
		Chain 0	Chain 1		
144	5720 For U-NII-3	3.77	3.77	0.5	Pass

802.11n (HT40)

Channel	Frequency (MHz)	6dB Bandwidth (MHz)		Minimum Limit (MHz)	Pass / Fail
		Chain 0	Chain 1		
142	5710 For U-NII-3	2.57	2.68	0.5	Pass

802.11ac (VHT80)

Channel	Frequency (MHz)	6dB Bandwidth (MHz)		Minimum Limit (MHz)	Pass / Fail
		Chain 0	Chain 1		
138	5690 For U-NII-3	3.20	3.01	0.5	Pass

Spectrum Plot of Worst Value

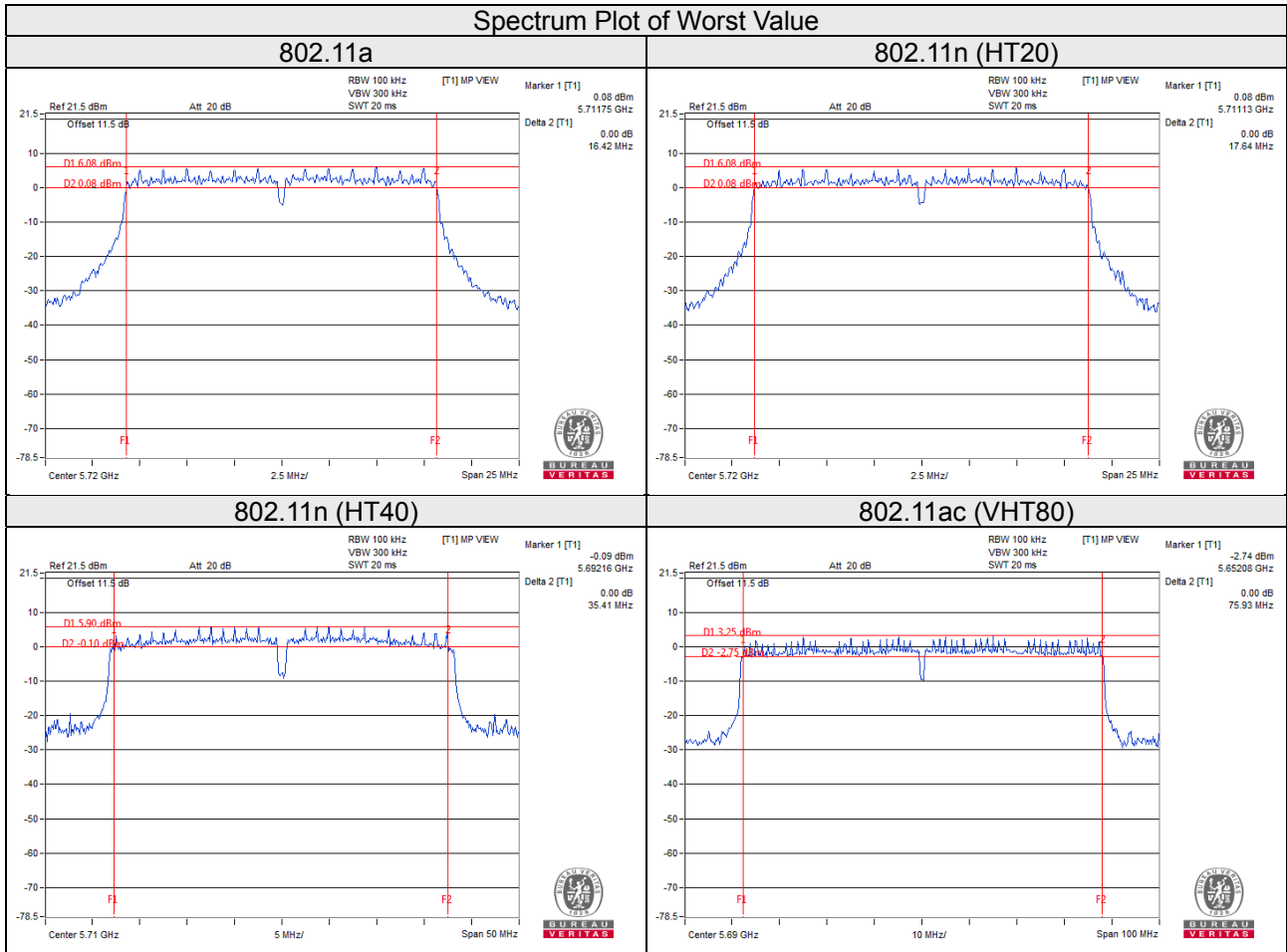

- *802.11a: Ch 144 (5720MHz for U-NII-3): 16.42-(5725-5711.75) = 3.17
- *802.11n (HT20): Ch 144 (5720MHz for U-NII-3): 17.64-(5725-5711.13) = 3.77
- *802.11n (HT40): Ch 142 (5710MHz for U-NII-3): 35.41-(5725-5692.16) = 2.57
- *802.11ac (VHT80): Ch 138 (5690MHz for U-NII-3): 75.93-(5725-5652.08) = 3.01

5 Pictures of Test Arrangements

Please refer to the attached file (Test Setup Photo).

Appendix – Information of the Testing Laboratories

We, Bureau Veritas Consumer Products Services (H.K.) Ltd., Taoyuan Branch, were founded in 1988 to provide our best service in EMC, Radio, Telecom and Safety consultation. Our laboratories are FCC recognized accredited test firms and accredited and approved according to ISO/IEC 17025.

If you have any comments, please feel free to contact us at the following:

Lin Kou EMC/RF Lab

Tel: 886-2-26052180

Fax: 886-2-26051924

Hsin Chu EMC/RF/Telecom Lab

Tel: 886-3-6668565

Fax: 886-3-6668323

Hwa Ya EMC/RF/Safety

Tel: 886-3-3183232

Fax: 886-3-3270892

Email: service.adt@tw.bureauveritas.com

Web Site: www.bureauveritas-adt.com

The address and road map of all our labs can be found in our web site also.

--- END ---