

FCC Radio Test Report

FCC ID: TVE-37146T064

This report concerns: **Original Grant**

Project No. : 1906C186
Equipment : Secured Wireless Access Point
Brand Name : FORTINET
Test Model : FAP-321E
Series Model : FAP-321Exxxxxx, FortiAP 321Exxxxxx, FORTIAP-321Exxxxxx
(where "x" can be used as "A-Z" or "0-9" or "-" or blank for software changes or marking purposes only)

Applicant : Fortinet, Inc.
Address : 899 Kifer Road, Sunnyvale, CA 94086 USA
Manufacturer : SHENZHEN TENDA TECHNOLOGY CO.,LTD
Address : 6-8 Floor, Tower E3, No. 1001, Zhongshanyuan Road, Nanshan District, Shenzhen, China. 518052

Date of Receipt : Jun. 28, 2019
Date of Test : Jul. 01, 2019 ~ Oct. 10, 2019
Issued Date : Oct. 23, 2019
Report Version : R00
Test Sample : Engineering Sample No.: DG19062851.
Standard(s) : FCC Part15, Subpart E(15.407)
ANSI C63.10-2013
FCC KDB 789033 D02 General UNII Test Procedures New Rules v02r01
FCC KDB 662911 D01 Multiple Transmitter Output v02r01

The above equipment has been tested and found compliance with the requirement of the relative standards by BTL Inc.

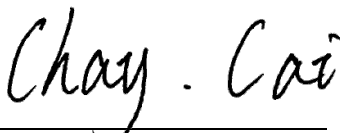

Prepared by: Chay Cai



Approved by: Ethan Ma



Certificate #5123.02

Add: No.3, Jinshagang 1st Road, Shixia, Dalang Town,Dongguan, Guangdong, China.

Tel: +86-769-8318-3000

Web: www.newbtl.com

Declaration

BTL represents to the client that testing is done in accordance with standard procedures as applicable and that test instruments used has been calibrated with standards traceable to international standard(s) and/or national standard(s).

BTL's reports apply only to the specific samples tested under conditions. It is manufacture's responsibility to ensure that additional production units of this model are manufactured with the identical electrical and mechanical components. **BTL** shall have no liability for any declarations, inferences or generalizations drawn by the client or others from **BTL** issued reports.

The report must not be used by the client to claim product certification, approval, or endorsement by NVLAP, NIST, A2LA, or any agency of the U.S. Government.

This report is the confidential property of the client. As a mutual protection to the clients, the public and ourselves, the test report shall not be reproduced, except in full, without our written approval.

BTL's laboratory quality assurance procedures are in compliance with the **ISO/IEC 17025** requirements, and accredited by the conformity assessment authorities listed in this test report.

BTL is not responsible for the sampling stage, so the results only apply to the sample as received.

The information, data and test plan are provided by manufacturer which may affect the validity of results, so it is manufacturer's responsibility to ensure that the apparatus meets the essential requirements of applied standards and in all the possible configurations as representative of its intended use.

Limitation

For the use of the authority's logo is limited unless the Test Standard(s)/Scope(s)/Item(s) mentioned in this test report is (are) included in the conformity assessment authorities acceptance respective.

Table of Contents	Page
REPORT ISSUED HISTORY	6
1 . SUMMARY OF TEST RESULTS	7
1.1 TEST FACILITY	8
1.2 MEASUREMENT UNCERTAINTY	8
1.3 TEST ENVIRONMENT CONDITIONS	8
2 . GENERAL INFORMATION	9
2.1 GENERAL DESCRIPTION OF EUT	9
2.2 TEST MODES	12
2.3 PARAMETERS OF TEST SOFTWARE	14
2.4 DUTY CYCLE	16
2.5 BLOCK DIAGRAM SHOWING THE CONFIGURATION OF SYSTEM TESTED	18
2.6 SUPPORT UNITS	18
3 . AC POWER LINE CONDUCTED EMISSIONS TEST	19
3.1 LIMIT	19
3.2 TEST PROCEDURE	19
3.3 DEVIATION FROM TEST STANDARD	19
3.4 TEST SETUP	20
3.5 EUT OPERATION CONDITIONS	20
3.6 TEST RESULTS	20
4 . RADIATED EMISSIONS TEST	21
4.1 LIMIT	21
4.2 TEST PROCEDURE	22
4.3 DEVIATION FROM TEST STANDARD	22
4.4 TEST SETUP	23
4.5 EUT OPERATION CONDITIONS	24
4.6 TEST RESULTS - 9 KHZ to 30 MHZ	24
4.7 TEST RESULTS - 30 MHz TO 1000 MHz	24
4.8 TEST RESULTS - ABOVE 1000 MHz	24
5 . BANDWIDTH TEST	25
5.1 LIMIT	25
5.2 TEST PROCEDURE	25
5.3 TEST PROCEDURE	25
5.4 TEST SETUP	26

Table of Contents	Page
5.5 EUT OPERATION CONDITIONS	26
5.6 TEST RESULTS	26
6 . MAXIMUM OUTPUT POWER TEST	27
6.1 LIMIT	27
6.2 TEST PROCEDURE	27
6.3 DEVIATION FROM STANDARD	27
6.4 TEST SETUP	27
6.5 EUT OPERATION CONDITIONS	27
6.6 TEST RESULTS	27
7 . POWER SPECTRAL DENSITY TEST	28
7.1 LIMIT	28
7.2 TEST PROCEDURE	28
7.3 DEVIATION FROM STANDARD	28
7.4 TEST SETUP	28
7.5 EUT OPERATION CONDITIONS	28
7.6 TEST RESULTS	28
8 . FREQUENCY STABILITY MEASUREMENT	29
8.1 LIMIT	29
8.2 TEST PROCEDURE	29
8.3 DEVIATION FROM STANDARD	29
8.4 TEST SETUP	29
8.5 EUT OPERATION CONDITIONS	29
8.6 TEST RESULTS	29
9 . MEASUREMENT INSTRUMENTS LIST	30
10 . EUT TEST PHOTOS	32
APPENDIX A - AC POWER LINE CONDUCTED EMISSIONS	36
APPENDIX B - RADIATED EMISSION - 9 KHZ TO 30 MHZ	39
APPENDIX C - RADIATED EMISSION - 30 MHZ TO 1 GHZ	44
APPENDIX D - RADIATED EMISSION - ABOVE 1000 MHZ	47
APPENDIX E - BANDWIDTH	120
APPENDIX F - CONDUCTED OUTPUT POWER	126
APPENDIX G - POWER SPECTRAL DENSITY	149

Table of Contents

Page

APPENDIX H - FREQUENCY STABILITY

166

REPORT ISSUED HISTORY

Report Version	Description	Issued Date
R00	Original Issue.	Oct. 23, 2019

1. SUMMARY OF TEST RESULTS

Test procedures according to the technical standard(s):

FCC Part15, Subpart E(15.407)				
Standard(s) Section	Test Item	Test Result	Judgement	Remark
15.207 15.407(b)	AC Power Line Conducted Emissions	APPENDIX A	PASS	-----
15.407(b) 15.205(a) 15.209(a)	Radiated Emissions	APPENDIX B APPENDIX C APPENDIX D	PASS	-----
15.407(a) 15.407(e)	Spectrum Bandwidth	APPENDIX E	PASS	-----
15.407(a)	Maximum Output Power	APPENDIX F	PASS	-----
15.407(a)	Power Spectral Density	APPENDIX G	PASS	-----
15.407(g)	Frequency Stability	APPENDIX H	PASS	-----
15.203	Antenna Requirements	-----	PASS	Note(2)
15.407(c)	Automatically Discontinue Transmission	-----	PASS	Note(3)

Note:

- (1) "N/A" denotes test is not applicable in this test report.
- (2) The device what use a permanently attached antenna were considered sufficient to comply with the provisions of 15.203.
- (3) During no any information transmission, the EUT can automatically discontinue transmission and become standby mode for power saving. the EUT can detect the controlling signal of ACK message transmitting from remote device and verify whether it shall resend or discontinue transmission.
- (4) For UNII-1 this device was functioned as a
 Access point device Client device

1.1 TEST FACILITY

The test facilities used to collect the test data in this report is at the location of No.3,Jinshagang 1st Road, Shixia, Dalang Town, Dongguan, Guangdong, China.

BTL's Test Firm Registration Number for FCC: 357015

BTL's Designation Number for FCC: CN1240

1.2 MEASUREMENT UNCERTAINTY

ISO/IEC 17025 requires that an estimate of the measurement uncertainties associated with the emissions test results be included in the report. The measurement uncertainties given below are based on a 95% confidence level (based on a coverage factor (k=2))

The BTL measurement uncertainty as below table:

A. AC power line conducted emissions test:

Test Site	Method	Measurement Frequency Range	U, (dB)
DG-C02	CISPR	150 kHz ~ 30 MHz	2.32

B. Radiated emissions test:

Test Site	Method	Measurement Frequency Range	Ant. H / V	U, (dB)
DG-CB03	CISPR	9kHz ~ 30MHz	V	3.79
		9kHz ~ 30MHz	H	3.57
		30MHz ~ 200MHz	V	4.88
		30MHz ~ 200MHz	H	4.14
		200MHz ~ 1,000MHz	V	4.62
		200MHz ~ 1,000MHz	H	4.80
		1GHz ~ 6GHz	-	4.58
		6GHz ~ 18GHz	-	5.18
		18GHz ~ 26.5GHz	-	3.80
		26.5GHz ~ 40GHz	-	4.30

Note: Unless specifically mentioned, the uncertainty of measurement has not been taken into account to declare the compliance or non-compliance to the specification.

1.3 TEST ENVIRONMENT CONDITIONS

Test Item	Temperature	Humidity	Test Voltage	Tested By
AC Power Line Conducted Emissions	25°C	53%	AC 120V/60Hz	Robin Zhuang
Radiated Emissions-9K-30MHz	25°C	60%	AC 120V/60Hz	Robin Zhuang
Radiated Emissions-30 MHz to 1GHz	24°C	68%	AC 120V/60Hz	Sheldon Ou
Radiated Emissions-Above 1000 MHz	24°C	68%	AC 120V/60Hz	Sheldon Ou
Spectrum Bandwidth	24°C	65%	AC 120V/60Hz	Jonas Chen
Maximum Output Power	24°C	65%	AC 120V/60Hz	Jonas Chen
Power Spectral Density	24°C	65%	AC 120V/60Hz	Jonas Chen
Frequency Stability	24°C	65%	AC 120V/60Hz	Jonas Chen

2. GENERAL INFORMATION

2.1 GENERAL DESCRIPTION OF EUT

Equipment	Secured Wirele Access Point
Brand Name	FORTINET
Test Model	FAP-321E
Series Model	FAP-321Exxxxxx, FortiAP 321Exxxxxx, FORTIAP-321Exxxxxx (where "x" can be used as "A-Z" or "0-9" or "-" or blank for software changes or marking purposes only)
Model Difference(s)	Only differ in model name.
Power Source	1# DC voltage supplied from AC/DC adapter. Model: WA-30J12R 2# DC voltage supplied from POE adapter.
Power Rating	1# I/P: 100-240V~ 50-60Hz 0.9A Max. O/P: 12V --- 2.5A 2# DC 48V
Operation Frequency	UNII-1: 5150 MHz~5250 MHz UNII-3: 5725 MHz~5850 MHz
Modulation Type	OFDM
Bit Rate of Transmitter	Up to 1300 Mbps
Maximum Conducted Output Power for UNII-1 Non-Beamforming	IEEE 802.11a: 25.42 dBm (0.3483 W) IEEE 802.11n (HT20): 23.59 dBm (0.2286 W) IEEE 802.11n (HT40): 23.68 dBm (0.2333 W) IEEE 802.11ac (VHT20): 23.66 dBm (0.2323 W) IEEE 802.11ac (VHT40): 23.76 dBm (0.2377 W) IEEE 802.11ac (VHT80): 20.77 dBm (0.1194 W)
Maximum Conducted Output Power for UNII-3 Non-Beamforming	IEEE 802.11a: 17.97 dBm (0.0627 W) IEEE 802.11n (HT20): 29.84 dBm (0.9638 W) IEEE 802.11n (HT40): 29.04 dBm (0.8017 W) IEEE 802.11ac (VHT20): 29.96 dBm (0.9908 W) IEEE 802.11ac (VHT40): 29.05 dBm (0.8035 W) IEEE 802.11ac (VHT80): 23.30 dBm (0.2138 W)
Maximum Conducted Output Power for UNII-1 Beamforming	IEEE 802.11n (HT20): 23.42 dBm (0.2198 W) IEEE 802.11n (HT40): 23.60 dBm (0.2291 W) IEEE 802.11ac (VHT20): 23.42 dBm (0.2198 W) IEEE 802.11ac (VHT40): 23.63 dBm (0.2307 W) IEEE 802.11ac (VHT80): 20.72 dBm (0.1180 W)
Maximum Conducted Output Power for UNII-3 Beamforming	IEEE 802.11n (HT20): 27.45 dBm (0.5559 W) IEEE 802.11n (HT40): 27.48 dBm (0.5598 W) IEEE 802.11ac (VHT20): 27.49 dBm (0.5610 W) IEEE 802.11ac (VHT40): 27.49 dBm (0.5610 W) IEEE 802.11ac (VHT80): 23.08 dBm (0.2032 W)

Note:

1. For a more detailed features description, please refer to the manufacturer's specifications or the user's manual.

2. Channel List:

IEEE 802.11a IEEE 802.11n (HT20) IEEE 802.11ac (VHT20)		IEEE 802.11n (HT40) IEEE 802.11ac (VHT40)		IEEE 802.11ac (VHT80)	
UNII-1		UNII-1		UNII-1	
Channel	Frequency (MHz)	Channel	Frequency (MHz)	Channel	Frequency (MHz)
36	5180	38	5190	42	5210
40	5200	46	5230		
44	5220				
48	5240				

IEEE 802.11a IEEE 802.11n (HT20) IEEE 802.11ac (VHT20)		IEEE 802.11n (HT40) IEEE 802.11ac (VHT40)		IEEE 802.11ac (VHT80)	
UNII-3		UNII-3		UNII-3	
Channel	Frequency (MHz)	Channel	Frequency (MHz)	Channel	Frequency (MHz)
149	5745	151	5755	155	5775
153	5765	159	5795		
157	5785				
161	5805				
165	5825				

3. Antenna Specification:

Ant.	Brand	Model Name	Antenna Type	Connector	Gain (dBi)
1	Tenda	N/A	Internal	IPEX	4.0
2	Tenda	N/A	Internal	IPEX	4.0
3	Tenda	N/A	Internal	IPEX	4.0

Note: This EUT supports CDD, and all antennas have the same gain,

- (1) For Non Beamforming function, Directional gain= $G_{ANT} + \text{Array Gain}$,
 For output power measurements, Array Gain=0, so, Directional gain=4.0
 For power spectral density measurements, Array Gain= $10\log(N_{ANT}/N_{SS})$ dB
 Directional gain= $4.0 + 10\log(3/1) = 8.77$.
 So, the UNII-1 power density limit is $17 - 8.77 + 6 = 14.23$
 the UNII-3 power density limit is $30 - 8.77 + 6 = 27.23$

- (2) For Beamforming function, Beamforming gain: 4.5dB, so Directional gain= $4.0 + 4.5 = 8.50$
 Then, the output Power limit is $30 - 8.50 + 6 = 27.50$

4. The worst case for 3TX as follow:

For Non Beamforming:

Operating Mode / TX Mode	3TX
IEEE 802.11a	V (Ant. 1+Ant. 2+Ant. 3)
IEEE 802.11n (HT20)	V (Ant. 1+Ant. 2+Ant. 3)
IEEE 802.11n (HT40)	V (Ant. 1+Ant. 2+Ant. 3)
IEEE 802.11ac(VHT20)	V (Ant. 1+Ant. 2+Ant. 3)
IEEE 802.11ac(VHT40)	V (Ant. 1+Ant. 2+Ant. 3)
IEEE 802.11ac(VHT80)	V (Ant. 1+Ant. 2+Ant. 3)

For Beamforming:

Operating Mode / TX Mode	3TX
IEEE 802.11n (HT20)	V (Ant. 1+Ant. 2+Ant. 3)
IEEE 802.11n (HT40)	V (Ant. 1+Ant. 2+Ant. 3)
IEEE 802.11ac(VHT20)	V (Ant. 1+Ant. 2+Ant. 3)
IEEE 802.11ac(VHT40)	V (Ant. 1+Ant. 2+Ant. 3)
IEEE 802.11ac(VHT80)	V (Ant. 1+Ant. 2+Ant. 3)

2.2 TEST MODES

The test system was pre-tested based on the consideration of all possible combinations of EUT operation mode.

Pretest Mode	Description
Mode 1	TX A Mode / CH36, CH40, CH48 (UNII-1)
Mode 2	TX N (HT20) Mode / CH36, CH40, CH48 (UNII-1)
Mode 3	TX N (HT40) Mode / CH38, CH46 (UNII-1)
Mode 4	TX AC (VHT20) Mode / CH36, CH40, CH48 (UNII-1)
Mode 5	TX AC (VHT40) Mode / CH38, CH46 (UNII-1)
Mode 6	TX AC (VHT80) Mode / CH42 (UNII-1)
Mode 7	TX A Mode / CH149,CH157,CH165 (UNII-3)
Mode 8	TX N (HT20) Mode / CH149,CH157,CH165 (UNII-3)
Mode 9	TX N (HT40) Mode / CH151,CH159 (UNII-3)
Mode 10	TX AC (VHT20) Mode / CH149,CH157,CH165 (UNII-3)
Mode 11	TX AC (VHT40) Mode / CH151,CH159 (UNII-3)
Mode 12	TX AC (VHT80) Mode / CH155 (UNII-3)
Mode 13	TX AC(VHT20) Mode / CH165 (UNII-3)

Following mode(s) was (were) found to be the worst case(s) and selected for the final test.

AC power line conducted emissions test	
Final Test Mode	Description
Mode 13	TX AC(VHT20) Mode / CH165 (UNII-3)

Radiated emissions test - Below 1GHz	
Final Test Mode	Description
Mode 13	TX AC(VHT20) Mode / CH165 (UNII-3)

Radiated emissions test - Above 1GHz	
Final Test Mode	Description
Mode 1	TX A Mode / CH36, CH40, CH48 (UNII-1)
Mode 4	TX AC (VHT20) Mode / CH36, CH40, CH48 (UNII-1)
Mode 5	TX AC (VHT40) Mode / CH38, CH46 (UNII-1)
Mode 6	TX AC (VHT80) Mode / CH42 (UNII-1)
Mode 7	TX A Mode / CH149,CH157,CH165 (UNII-3)
Mode 10	TX AC (VHT20) Mode / CH149,CH157,CH165 (UNII-3)
Mode 11	TX AC (VHT40) Mode / CH151,CH159 (UNII-3)
Mode 12	TX AC (VHT80) Mode / CH155 (UNII-3)

Output Power test for Non Beamforming	
Final Test Mode	Description
Mode 1	TX A Mode / CH36, CH40, CH48 (UNII-1)
Mode 2	TX N (HT20) Mode / CH36, CH40, CH48 (UNII-1)
Mode 3	TX N (HT40) Mode / CH38, CH46 (UNII-1)
Mode 4	TX AC (VHT20) Mode / CH36, CH40, CH48 (UNII-1)
Mode 5	TX AC (VHT40) Mode / CH38, CH46 (UNII-1)
Mode 6	TX AC (VHT80) Mode / CH42 (UNII-1)
Mode 7	TX A Mode / CH149,CH157,CH165 (UNII-3)
Mode 8	TX N (HT20) Mode / CH149,CH157,CH165 (UNII-3)
Mode 9	TX N (HT40) Mode / CH151,CH159 (UNII-3)
Mode 10	TX AC (VHT20) Mode / CH149,CH157,CH165 (UNII-3)
Mode 11	TX AC (VHT40) Mode / CH151,CH159 (UNII-3)
Mode 12	TX AC (VHT80) Mode / CH155 (UNII-3)

Output Power test for With Beamforming	
Final Test Mode	Description
Mode 2	TX N (HT20) Mode / CH36, CH40, CH48 (UNII-1)
Mode 3	TX N (HT40) Mode / CH38, CH46 (UNII-1)
Mode 4	TX AC (VHT20) Mode / CH36, CH40, CH48 (UNII-1)
Mode 5	TX AC (VHT40) Mode / CH38, CH46 (UNII-1)
Mode 6	TX AC (VHT80) Mode / CH42 (UNII-1)
Mode 8	TX N (HT20) Mode / CH149,CH157,CH165 (UNII-3)
Mode 9	TX N (HT40) Mode / CH151,CH159 (UNII-3)
Mode 10	TX AC (VHT20) Mode / CH149,CH157,CH165 (UNII-3)
Mode 11	TX AC (VHT40) Mode / CH151,CH159 (UNII-3)
Mode 12	TX AC (VHT80) Mode / CH155 (UNII-3)

Others Conducted test for Non Beamforming	
Final Test Mode	Description
Mode 1	TX A Mode / CH36, CH40, CH48 (UNII-1)
Mode 4	TX AC (VHT20) Mode / CH36, CH40, CH48 (UNII-1)
Mode 5	TX AC (VHT40) Mode / CH38, CH46 (UNII-1)
Mode 6	TX AC (VHT80) Mode / CH42 (UNII-1)
Mode 7	TX A Mode / CH149,CH157,CH165 (UNII-3)
Mode 10	TX AC (VHT20) Mode / CH149,CH157,CH165 (UNII-3)
Mode 11	TX AC (VHT40) Mode / CH151,CH159 (UNII-3)
Mode 12	TX AC (VHT80) Mode / CH155 (UNII-3)

Note:

- (1) For radiated emission below 1 GHz test, the IEEE 802.11ac20 Channel165 is found to be the worst case and recorded.
- (2) For radiated emission above 1 GHz test, 1GHz~26.5GHz and 26.5GHz~40GHz have been pre-tested and in this report only recorded the worst case. The remaining spurious points are all below the limit value of 20dB.
- (3) The measurements for Power were tested, the worst case were IEEE 802.11a mode, IEEE 802.11ac(VHT20) mode, IEEE 802.11ac(VHT40) mode, IEEE 802.11ac(VHT80), only worst case were documented for other test items.
- (4) The measurements for Power were tested, the worst case were Non - Beamforming, only worst case were documented for other test items.

2.3 PARAMETERS OF TEST SOFTWARE
Non-Beamforming

UNII-1			
Test Software	QRCT v3.0.187.0		
Test Frequency (MHz)	5180	5200	5240
IEEE 802.11a	19.5	19.5	19.5
IEEE 802.11n (HT20)	19	19	19
IEEE 802.11ac (VHT20)	19	19	19
Test Frequency (MHz)	5190	5230	
IEEE 802.11n (HT40)	19	19	
IEEE 802.11ac (VHT40)	19	19	
Test Frequency (MHz)	5210		
IEEE 802.11ac (VHT80)	16		

UNII-3			
Test Software	QRCT v3.0.187.0		
Test Frequency (MHz)	5745	5785	5825
IEEE 802.11a	13	13	12
IEEE 802.11n (HT20)	25.5	25	27
IEEE 802.11ac (VHT20)	25.5	25	27
Test Frequency (MHz)	5755	5795	
IEEE 802.11n (HT40)	24	25	
IEEE 802.11ac (VHT40)	24	25	
Test Frequency (MHz)	5775		
IEEE 802.11ac (VHT80)	19		

Beamforming

UNII-1			
Test Software	QRCT v3.0.187.0		
Test Frequency (MHz)	5180	5200	5240
IEEE 802.11n (HT20)	19	19	19
IEEE 802.11ac (VHT20)	19	19	19
Test Frequency (MHz)	5190	5230	/
IEEE 802.11n (HT40)	19	19	/
IEEE 802.11ac (VHT40)	19	19	/
Test Frequency (MHz)	5210	/	/
IEEE 802.11ac (VHT80)	16	/	/

UNII-3			
Test Software	QRCT v3.0.187.0		
Test Frequency (MHz)	5745	5785	5825
IEEE 802.11n (HT20)	23.5	23.5	23.5
IEEE 802.11ac (VHT20)	23.5	22.5	23.5
Test Frequency (MHz)	5755	5795	/
IEEE 802.11n (HT40)	23.5	23.5	/
IEEE 802.11ac (VHT40)	23.5	23.5	/
Test Frequency (MHz)	5775	/	/
IEEE 802.11ac (VHT80)	19	/	/

2.4 DUTY CYCLE

If duty cycle is $\geq 98\%$, duty factor is not required.
 If duty cycle is $< 98\%$, duty factor shall be considered.
 The output power = measured power + duty factor.

IEEE 802.11a

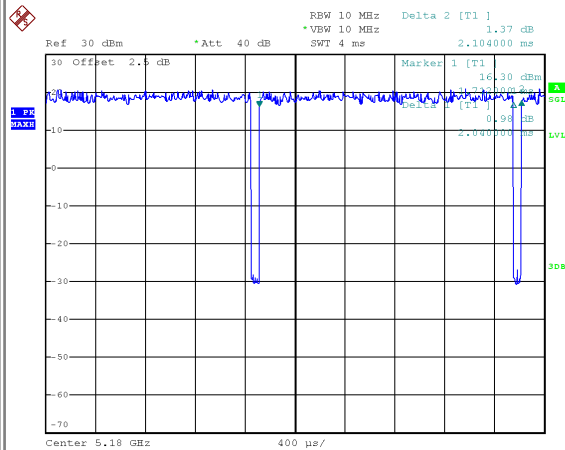

IEEE 802.11n (HT20)

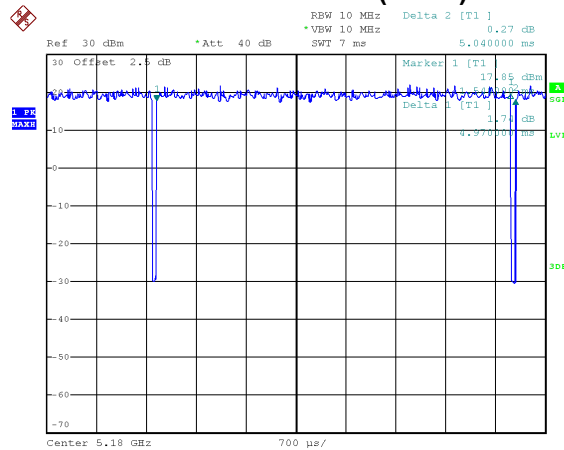

Date: 20.JUL.2019 14:01:00

Date: 20.JUL.2019 14:37:24

Duty cycle = $2.040 \text{ ms} / 2.104 \text{ ms} = 96.96\%$
 Duty Factor = $10 * \log(1 / 96.96\%) = 0.13 \text{ dB}$

Duty cycle = $4.970 \text{ ms} / 5.040 \text{ ms} = 98.61\%$
 Duty Factor = $10 * \log(1 / 98.61\%) = 0.00 \text{ dB}$

IEEE 802.11n (HT40)

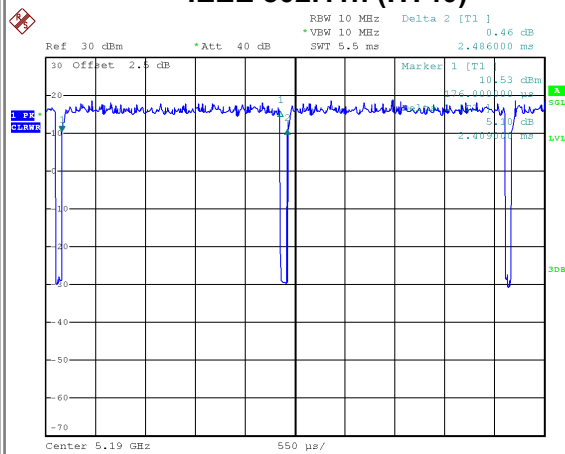

IEEE 802.11ac (VHT20)

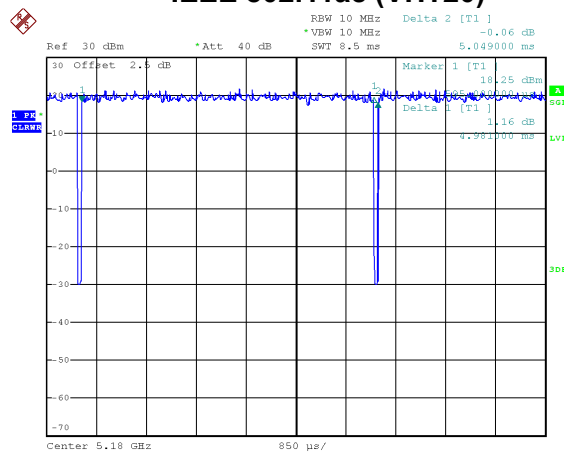

Date: 20.JUL.2019 14:38:09

Date: 20.JUL.2019 14:39:00

Duty cycle = $2.409 \text{ ms} / 2.486 \text{ ms} = 96.90\%$
 Duty Factor = $10 * \log(1 / 96.90\%) = 0.14 \text{ dB}$

Duty cycle = $4.981 \text{ ms} / 5.049 \text{ ms} = 98.65\%$
 Duty Factor = $10 * \log(1 / 98.65\%) = 0.00 \text{ dB}$

IEEE 802.11ac (VHT40)

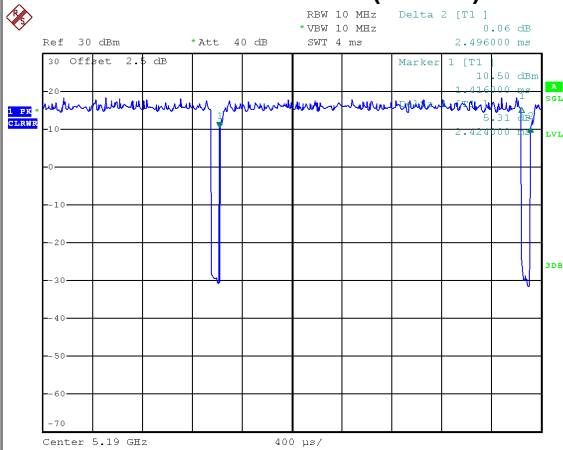

Date: 20.JUL.2019 14:39:34

Duty cycle = 2.424 ms / 2.496 ms = 97.12%
 Duty Factor = 10 * log(1 / 97.12%) = 0.13 dB

IEEE 802.11ac (VHT80)

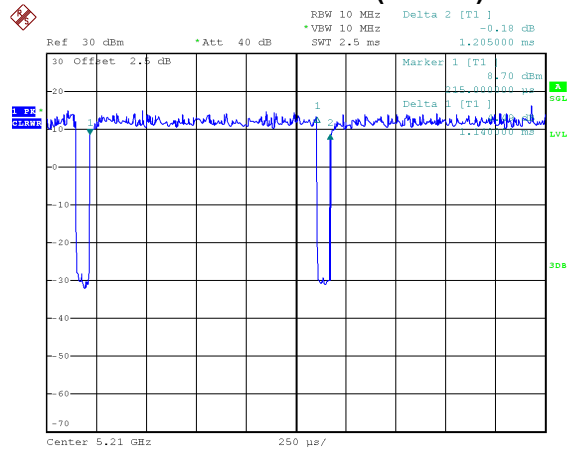

Date: 20.JUL.2019 14:40:22

Duty cycle = 1.140 ms / 1.205 ms = 94.61%
 Duty Factor = 10 * log(1 / 94.61%) = 0.24 dB

NOTE:

For IEEE 802.11a, IEEE 802.11n (HT20) and IEEE 802.11ac (VHT20):

For radiated emissions frequency above 1 GHz, the resolution bandwidth of test receiver/spectrum analyzer is 1 MHz and the video bandwidth is 1 kHz (Duty cycle < 98%).

For IEEE 802.11n (HT40) and IEEE 802.11ac (VHT40):

For radiated emissions frequency above 1 GHz, the resolution bandwidth of test receiver/spectrum analyzer is 1 MHz and the video bandwidth is 2 kHz (Duty cycle < 98%).

For IEEE 802.11ac (VHT80):

For radiated emissions frequency above 1 GHz, the resolution bandwidth of test receiver/spectrum analyzer is 1 MHz and the video bandwidth is 3 kHz (Duty cycle < 98%).

2.5 BLOCK DIAGRAM SHOWING THE CONFIGURATION OF SYSTEM TESTED

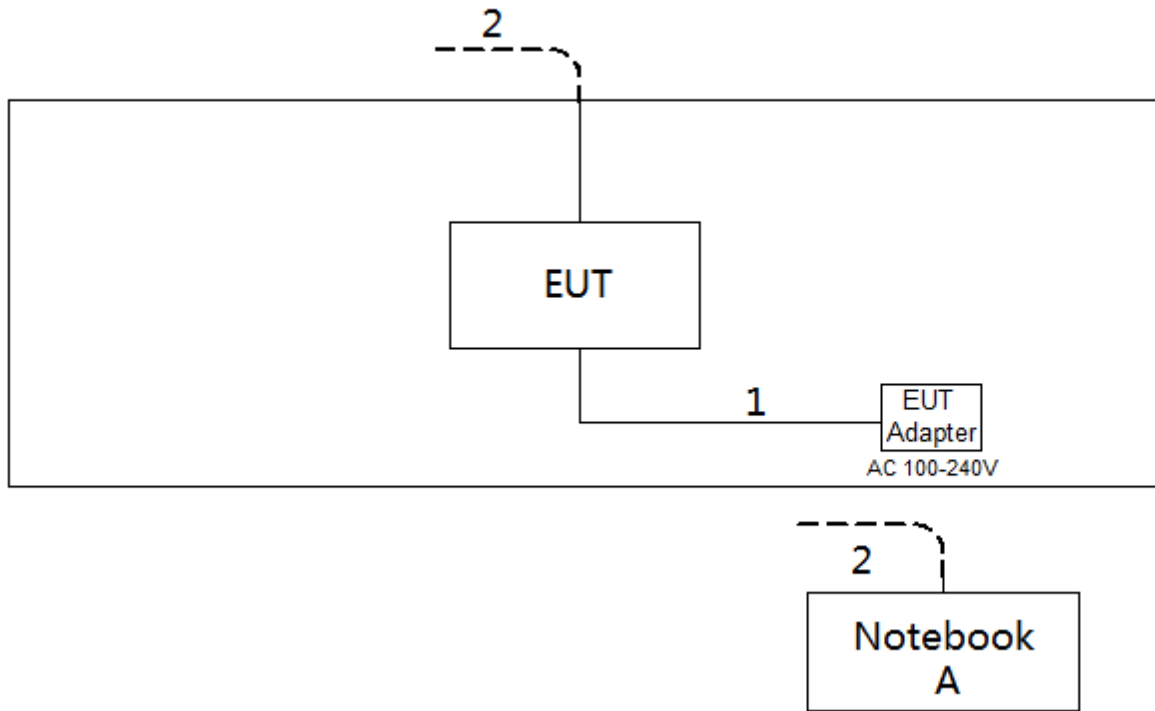

2.6 SUPPORT UNITS

Item	Equipment	Brand	Model No.	Series No.
A	Notebook	Dell	Inspiron 15-7559	N/A

Item	Cable Type	Shielded Type	Ferrite Core	Length
1	DC Cable	NO	NO	1.5m
2	RJ45 Cable	NO	NO	10m

3. AC POWER LINE CONDUCTED EMISSIONS TEST

3.1 LIMIT

Frequency (MHz)	Limit (dB μ V)	
	Quasi-peak	Average
0.15 - 0.50	66 to 56*	56 to 46*
0.50 - 5.0	56	46
5.0 - 30.0	60	50

NOTE:

- (1) The tighter limit applies at the band edges.
- (2) The limit of " * " marked band means the limitation decreases linearly with the logarithm of the frequency in the range.

The following table is the setting of the receiver

Receiver Parameter	Setting
Attenuation	10 dB
Start Frequency	0.15 MHz
Stop Frequency	30 MHz
IF Bandwidth	9 KHz

3.2 TEST PROCEDURE

- a. The EUT was placed 0.8 meters from the horizontal ground plane with EUT being connected to the power mains through a line impedance stabilization network (LISN). All other support equipment powered from additional LISN(s). The LISN provide 50 Ohm/ 50uH of coupling impedance for the measuring instrument.
- b. Interconnecting cables that hang closer than 40 cm to the ground plane shall be folded back and forth in the center forming a bundle 30 to 40 cm long.
- c. I/O cables that are not connected to a peripheral shall be bundled in the center. The end of the cable may be terminated, if required, using the correct terminating impedance. The overall length shall not exceed 1 m.
- d. LISN at least 80 cm from nearest part of EUT chassis.
- e. For the actual test configuration, please refer to the related Item -EUT Test Photos.

3.3 DEVIATION FROM TEST STANDARD

No deviation

3.4 TEST SETUP

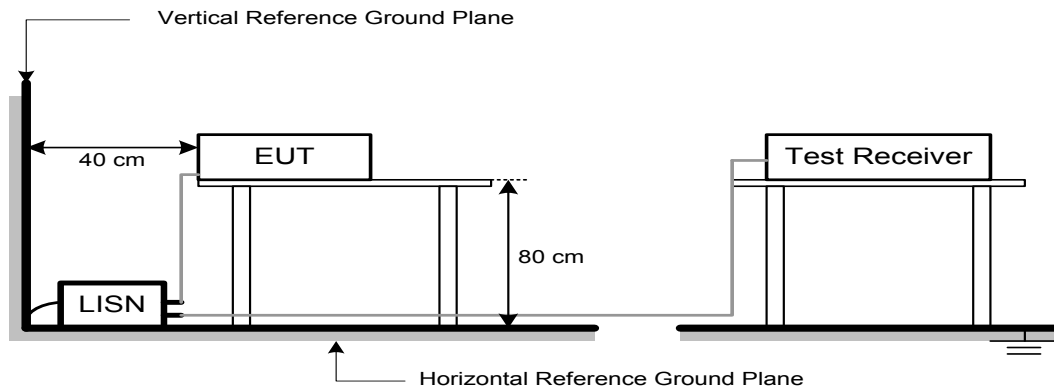

3.5 EUT OPERATION CONDITIONS

The EUT was configured for testing in a typical fashion (as a customer would normally use it). The EUT has been programmed to continuously transmit during test. This operating condition was tested and used to collect the included data.

The EUT was programmed to be in continuously transmitting/TX mode.

3.6 TEST RESULTS

Please refer to the APPENDIX A.

4. RADIATED EMISSIONS TEST

4.1 LIMIT

In case the emission fall within the restricted band specified on 15.205(a), then the 15.209(a) limit in the table below has to be followed.

LIMITS OF RADIATED EMISSIONS MEASUREMENT (9 kHz to 1000 MHz)

Frequency (MHz)	Field Strength (microvolts/meter)	Measurement Distance (meters)
0.009-0.490	2400/F(kHz)	300
0.490-1.705	24000/F(kHz)	30
1.705-30.0	30	30
30-88	100	3
88-216	150	3
216-960	200	3
Above 960	500	3

LIMITS OF UNWANTED EMISSION OUT OF THE RESTRICTED BANDS

Frequency (MHz)	EIRP Limit (dBm/MHz)	Equivalent Field Strength at 3m (dBμV/m)
5150-5250	-27	68.3
5725-5850	-27 NOTE (2)	68.3
	10 NOTE (2)	105.3
	15.6 NOTE (2)	110.9
	27 NOTE (2)	122.3

NOTE:

(1) The following formula is used to convert the equipment isotropic radiated power (eirp) to field

strength:
$$E = \frac{1000000\sqrt{30P}}{3} \mu\text{V/m, where } P \text{ is the eirp (Watts)}$$

(2) According to 15.407(b)(4)(i), all emissions shall be limited to a level of -27 dBm/MHz at 75 MHz or more above or below the band edge increasing linearly to 10 dBm/MHz at 25 MHz above or below the band edge, and from 25 MHz above or below the band edge increasing linearly to a level of 15.6 dBm/MHz at 5 MHz above or below the band edge, and from 5 MHz above or below the band edge increasing linearly to a level of 27 dBm/MHz at the band edge.

4.2 TEST PROCEDURE

- a. The measuring distance of 3 m shall be used for measurements. The EUT was placed on the top of a rotating table 0.8 meter above the ground at a 3 meter semi-anechoic chamber. The table was rotated 360 degrees to determine the position of the highest radiation.(below 1GHz)
- b. The measuring distance of 3 m shall be used for measurements. The EUT was placed on the top of a rotating table 1.5 meter above the ground at a 3 meter semi-anechoic chamber. The table was rotated 360 degrees to determine the position of the highest radiation.(above 1GHz)
- c. The height of the equipment or of the substitution antenna shall be 0.8m or 1.5m; the height of the test antenna shall vary between 1 m to 4 m. Both horizontal and vertical polarizations of the antenna are set to make the measurement.
- d. For each suspected emission, the EUT was arranged to its worst case and then the antenna was tuned to heights find the maximum reading (used Bore sight function).
- e. The receiver system was set to peak and average detect function and specified bandwidth with maximum hold mode when the test frequency is above 1 GHz.
- f. The initial step in collecting radiated emission data is a receiver peak detector mode pre-scanning the measurement frequency range. Significant peaks are then marked and then Quasi Peak detector mode re-measured.
- g. All readings are Peak unless otherwise stated QP in column of Note. Peak denotes that the Peak reading compliance with the QP Limits and then QP Mode measurement didn't perform. (below 1 GHz)
- h. All readings are Peak Mode value unless otherwise stated AVG in column of Note. If the Peak Mode Measured value compliance with the Peak Limits and lower than AVG Limits, the EUT shall be deemed to meet both Peak & AVG Limits and then only Peak Mode was measured, but AVG Mode didn't perform. (above 1 GHz)
- i. For the actual test configuration, please refer to the related Item –EUT Test Photos.

4.3 DEVIATION FROM TEST STANDARD

No deviation

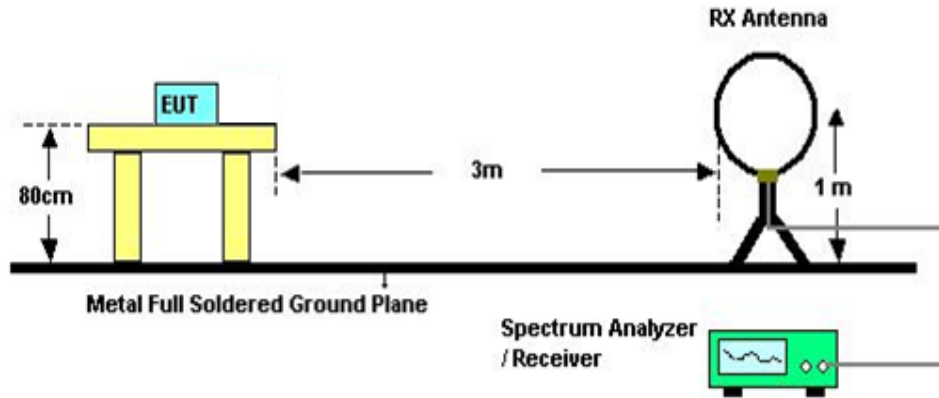
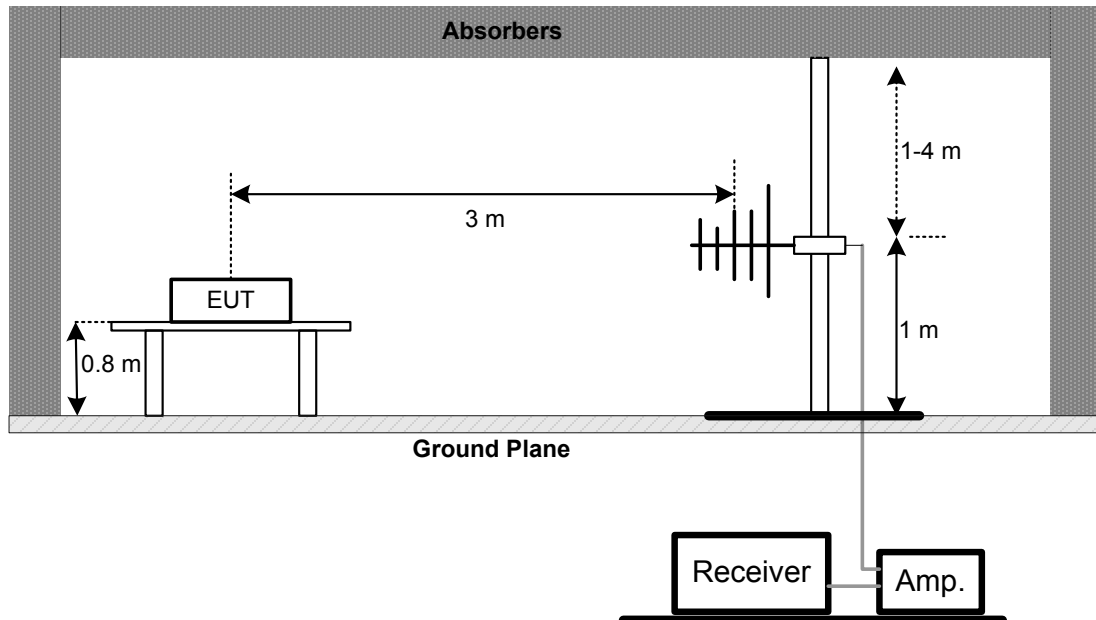
4.4 TEST SETUP**9 kHz to 30 MHz****30 MHz to 1 GHz**

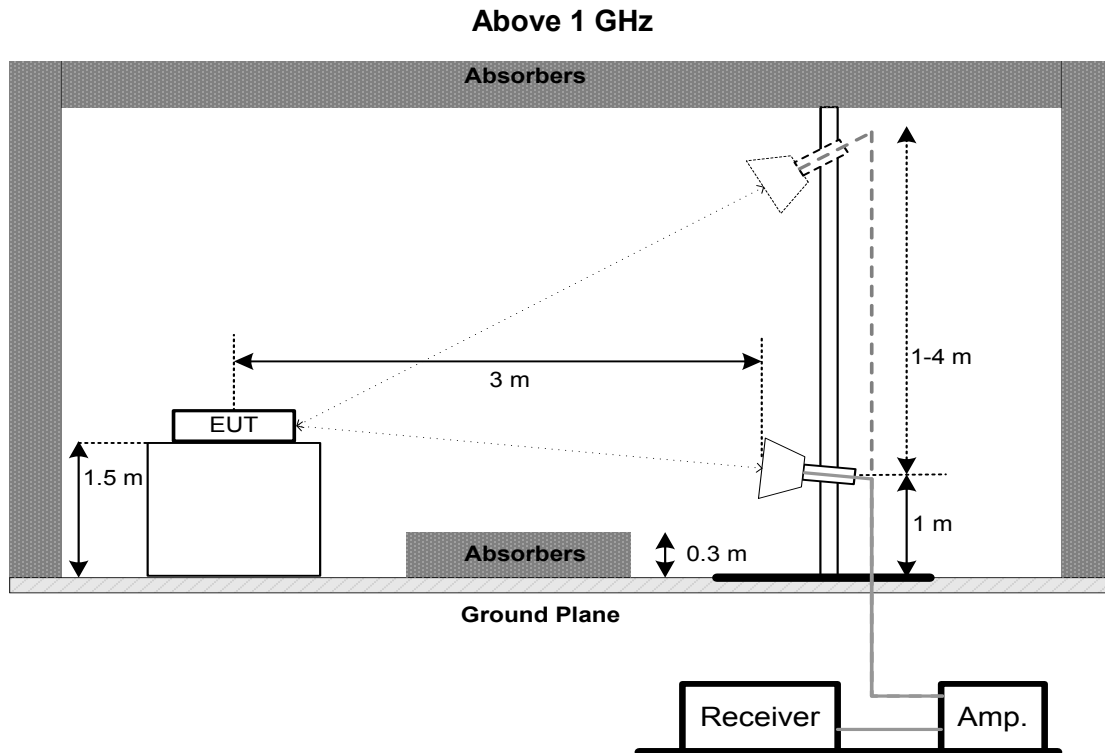

4.5 EUT OPERATION CONDITIONS

The EUT tested system was configured as the statements of 3.5 unless otherwise a special operating condition is specified in the follows during the testing.

4.6 TEST RESULTS - 9 KHZ to 30 MHZ

Please refer to the APPENDIX B

Remark:

- (1) Distance extrapolation factor = $40 \log (\text{specific distance} / \text{test distance})$ (dB).
- (2) Limit line = specific limits (dBuV) + distance extrapolation factor.

4.7 TEST RESULTS - 30 MHz TO 1000 MHz

Please refer to the APPENDIX C.

4.8 TEST RESULTS - ABOVE 1000 MHz

Please refer to the APPENDIX D.

Remark:

- (1) No limit: This is fundamental signal, the judgment is not applicable.
For fundamental signal judgment was referred to Peak output test.

5. BANDWIDTH TEST

5.1 LIMIT

FCC Part15, Subpart E (15.407)			
Section	Test Item	Limit	Frequency Range (MHz)
15.407(a)	26 dB Bandwidth	-	5150-5250
15.407(e)	6 dB Bandwidth	Minimum 500 kHz	5725-5850

5.2 TEST PROCEDURE

- a. The EUT was directly connected to the spectrum analyzer and antenna output port as show in the block diagram below
- b. Spectrum Setting:
For UNII-1:

Spectrum Parameter	Setting
Attenuation	Auto
Span Frequency	> 26 dB Bandwidth
RBW	300 kHz (Bandwidth 20 MHz) 1 MHz (Bandwidth 40 MHz and 80 MHz)
VBW	1 MHz (Bandwidth 20 MHz) 3 MHz (Bandwidth 40 MHz and 80 MHz)
Detector	Peak
Trace	Max Hold
Sweep Time	Auto

For UNII-3:

Spectrum Parameter	Setting
Attenuation	Auto
Span Frequency	6 dB Bandwidth
RBW	100 kHz
VBW	300 kHz
Detector	Peak
Trace	Max Hold
Sweep Time	Auto

- c. Measured the spectrum width with power higher than 26 dB below carrier

5.3 TEST PROCEDURE

No deviation.

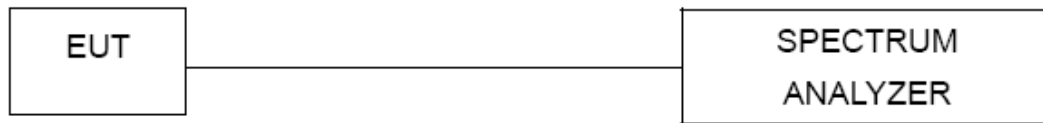
5.4 TEST SETUP**5.5 EUT OPERATION CONDITIONS**

The EUT was programmed to be in continuously transmitting mode.

5.6 TEST RESULTS

Please refer to the APPENDIX E.

6. MAXIMUM OUTPUT POWER TEST

6.1 LIMIT

FCC Part15, Subpart E (15.407)			
Section	Test Item	Limit	Frequency Range (MHz)
15.407(a)	Conducted Output Power	AP device: 1 Watt (30 dBm) Client device: 250 mW (24 dBm)	5150-5250
		1 Watt (30dBm)	5725-5850

Note:

- a. For an indoor access point operating in the band 5.15-5.25 GHz, the maximum conducted output power over the frequency band of operation shall not exceed 1 W provided the maximum antenna gain does not exceed 6 dBi. In addition, the maximum power spectral density shall not exceed 17 dBm in any 1 megahertz band. If transmitting antennas of directional gain greater than 6 dBi are used, both the maximum conducted output power and the maximum power spectral density shall be reduced by the amount in dB that the directional gain of the antenna exceeds 6 dBi.
- b. For the 5.25-5.35 GHz and 5.47-5.725 GHz bands, the maximum conducted output power over the frequency bands of operation shall not exceed the lesser of 250 mW or 11 dBm + 10log B, where B is the 26dB Bandwidth in megahertz.

6.2 TEST PROCEDURE

- a. The EUT was directly connected to the power meter and antenna output port as show in the block diagram below.
- b. Test test was performed in accordance with method of FCC KDB 789033 D02 General UNII Test Procedures New Rules v02r01.

6.3 DEVIATION FROM STANDARD

No deviation.

6.4 TEST SETUP



6.5 EUT OPERATION CONDITIONS

The EUT was programmed to be in continuously transmitting mode.

6.6 TEST RESULTS

Please refer to the APPENDIX F.

7. POWER SPECTRAL DENSITY TEST

7.1 LIMIT

FCC Part15, Subpart E (15.407)			
Section	Test Item	Limit	Frequency Range (MHz)
15.407(a)	Power Spectral Density	AP device: 17 dBm/MHz Client device: 11 dBm/MHz	5150-5250
		30 dBm/500 kHz	5725-5850

7.2 TEST PROCEDURE

- a. The EUT was directly connected to the spectrum analyzer and antenna output port as show in the block diagram below.
- b. Spectrum Setting

Spectrum Parameter	Setting
Attenuation	Auto
Span Frequency	Encompass the entire emissions bandwidth (EBW) of the signal
RBW	= 1 MHz.
VBW	≥ 3 MHz.
Detector	RMS
Trace average	100 trace
Sweep Time	Auto

Note:

1. For UNII-3, according to KDB publication 789033 D02 General UNII Test Procedures New Rules v02r01, section II.F.5., it is acceptable to set RBW at 1 MHz and VBW at 3 MHz if the spectrum analyzer does not have 500 kHz RBW.
2. The value measured with RBW=1 MHz is to be added with $10\log(500\text{ kHz}/1\text{ MHz})$ which is -3 dB. For example, if the measured value is +10dBm using RBW=1 MHz (that is +10 dBm/MHz), then the converted value will be +7dBm/500kHz.

7.3 DEVIATION FROM STANDARD

No deviation.

7.4 TEST SETUP

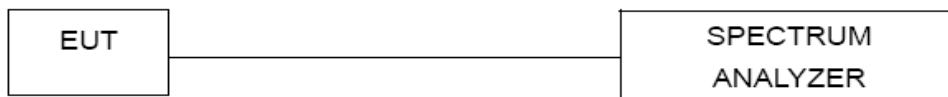

7.5 EUT OPERATION CONDITIONS

The EUT was programmed to be in continuously transmitting mode.

7.6 TEST RESULTS

Please refer to the APPENDIX H.

8. FREQUENCY STABILITY MEASUREMENT

8.1 LIMIT

FCC Part15, Subpart E (15.407)			
Section	Test Item	Limit	Frequency Range (MHz)
15.407(g)	Frequency Stability	Specified in the user's manual	5150-5250
			5725-5850

8.2 TEST PROCEDURE

- a. The EUT was directly connected to the spectrum analyzer and antenna output port as show in the block diagram below.
- b. Spectrum Setting:

Spectrum Parameter	Setting
Attenuation	Auto
Span Frequency	Entire absence of modulation emissions bandwidth
RBW	10 kHz
VBW	10 kHz
Sweep Time	Auto

- c. The test extreme voltage is to change the primary supply voltage from 85 to 115 percent of the nominal value.
- d. User manual temperature is 0°C~40°C.

8.3 DEVIATION FROM STANDARD

No deviation.

8.4 TEST SETUP

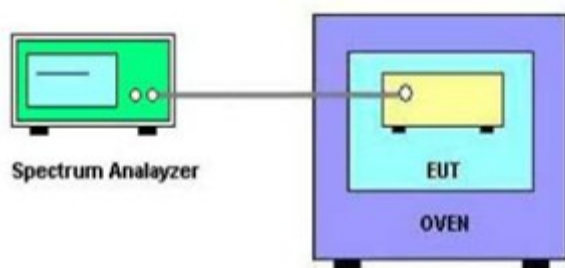

8.5 EUT OPERATION CONDITIONS

The EUT was programmed to be in continuously transmitting mode.

8.6 TEST RESULTS

Please refer to the APPENDIX I.

9. MEASUREMENT INSTRUMENTS LIST

AC Power Line Conducted Emissions					
Item	Kind of Equipment	Manufacturer	Type No.	Serial No.	Calibrated until
1	EMI Test Receiver	R&S	ESCI	100382	Mar. 10, 2020
2	LISN	EMCO	3816/2	52765	Mar. 10, 2020
3	50ohm Terminator	SHX	TF5-3	15041305	Mar. 10, 2020
4	TWO-LINE V-NETWORK	R&S	ENV216	101447	May 19, 2020
5	Measurement Software	Farad	EZ-EMC Ver.NB-03A1-01	N/A	N/A
6	Cable	N/A	RG223	12m	Mar. 12, 2020

Radiated Emissions - 9 kHz to 30 MHz					
Item	Kind of Equipment	Manufacturer	Type No.	Serial No.	Calibrated until
1	Loop Antenna	EM	EM-6876-1	230	Jan. 15, 2020
2	Cable	N/A	RG 213/U	C-102	May 31, 2020
3	EMI Test Receiver	R&S	ESCI	100895	Mar. 10, 2020
4	Measurement Software	Farad	EZ-EMC Ver.NB-03A1-01	N/A	N/A

Radiated Emissions - 30 MHz to 1 GHz					
Item	Kind of Equipment	Manufacturer	Type No.	Serial No.	Calibrated until
1	Antenna	Schwarzbeck	VULB9160	9160-3232	Mar. 09, 2020
2*	Amplifier	HP	8447D	2944A09673	Aug. 11, 2021
3	Receiver	Agilent	N9038A	MY52130039	Aug. 03, 2020
4	Cable	emci	LMR-400(30MHz-1GHz)(8m+5m)	N/A	May 24, 2020
5	Controller	CT	SC100	N/A	N/A
6	Controller	MF	MF-7802	MF780208416	N/A
7	Measurement Software	Farad	EZ-EMC Ver.NB-03A1-01	N/A	N/A

Radiated Emissions - Above 1 GHz					
Item	Kind of Equipment	Manufacturer	Type No.	Serial No.	Calibrated until
1	Double Ridged Guide Antenna	ETS	3115	75789	Mar. 09, 2020
2	Broad-Band Horn Antenna	Schwarzbeck	BBHA 9170	9170319	Jun. 23, 2020
3	Amplifier	Agilent	8449B	3008A02333	Mar. 10, 2020
4	Microwave Preamplifier With Adaptor	EMC INSTRUMENT	EMC2654045	980039 & HA01	Mar. 10, 2020
5	Receiver	Agilent	N9038A	MY52130039	Aug. 03, 2020
6	Controller	CT	SC100	N/A	N/A
7	Controller	MF	MF-7802	MF780208416	N/A
8	Cable	mitron	B10-01-01-12M	18072744	Jun. 29, 2020
9	Measurement Software	Farad	EZ-EMC Ver.NB-03A1-01	N/A	N/A

Bandwidth & Power Spectral Density					
Item	Kind of Equipment	Manufacturer	Type No.	Serial No.	Calibrated until
1	Spectrum Analyzer	R&S	FSP40	100185	Aug. 03, 2020

Maximum Output Power					
Item	Kind of Equipment	Manufacturer	Type No.	Serial No.	Calibrated until
1	Peak Power Analyzer	Keysight	8990B	MY51000506	Aug. 03, 2020
2	Wideband power sensor	Keysight	N1923A	MY58310004	Aug. 03, 2020

Frequency Stability					
Item	Kind of Equipment	Manufacturer	Type No.	Serial No.	Calibrated until
1	Spectrum Analyzer	R&S	FSP40	100185	Aug. 03, 2020
2	Precision Oven Tester	Bell	BTH-50C	20170306001	Mar. 10, 2020

Remark: "N/A" denotes no model name, serial no. or calibration specified.

"*" calibration period of equipment list is three year.

Except * item, all calibration period of equipment list is one year.

10. EUT TEST PHOTOS**AC Power Line Conducted Emissions Test Photos**

Radiated Emissions Test Photos**9 kHz to 30 MHz**

Radiated Emissions Test Photos
30 MHz to 1 GHz

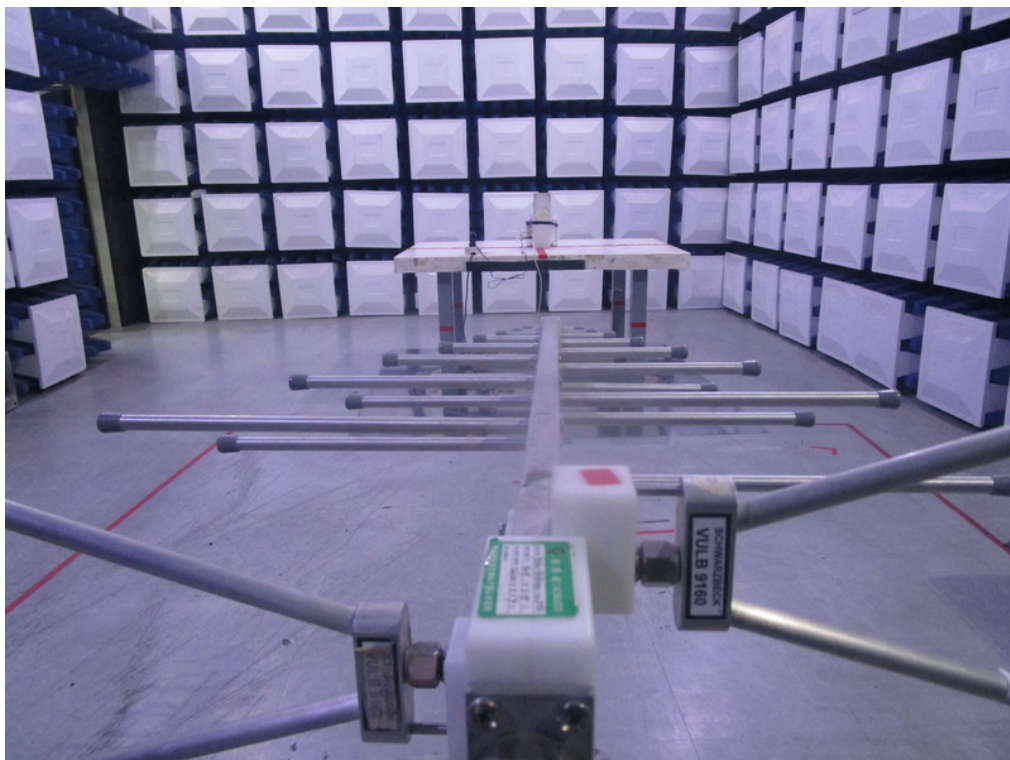

Radiated Emissions Test Photos
Above 1 GHz

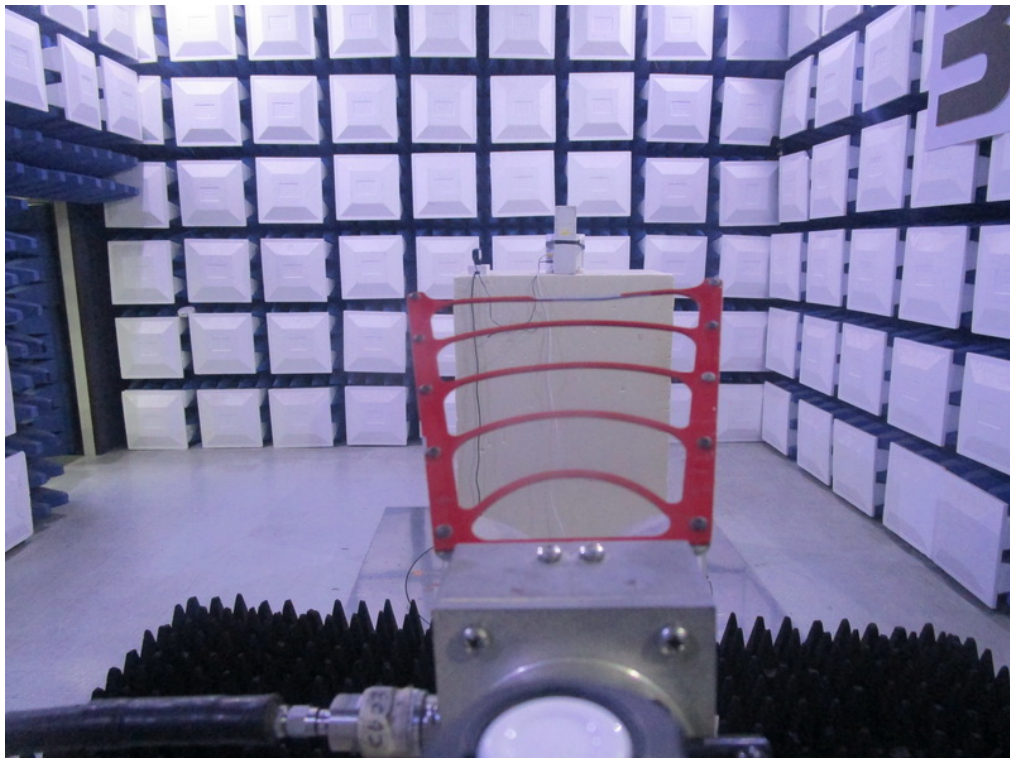
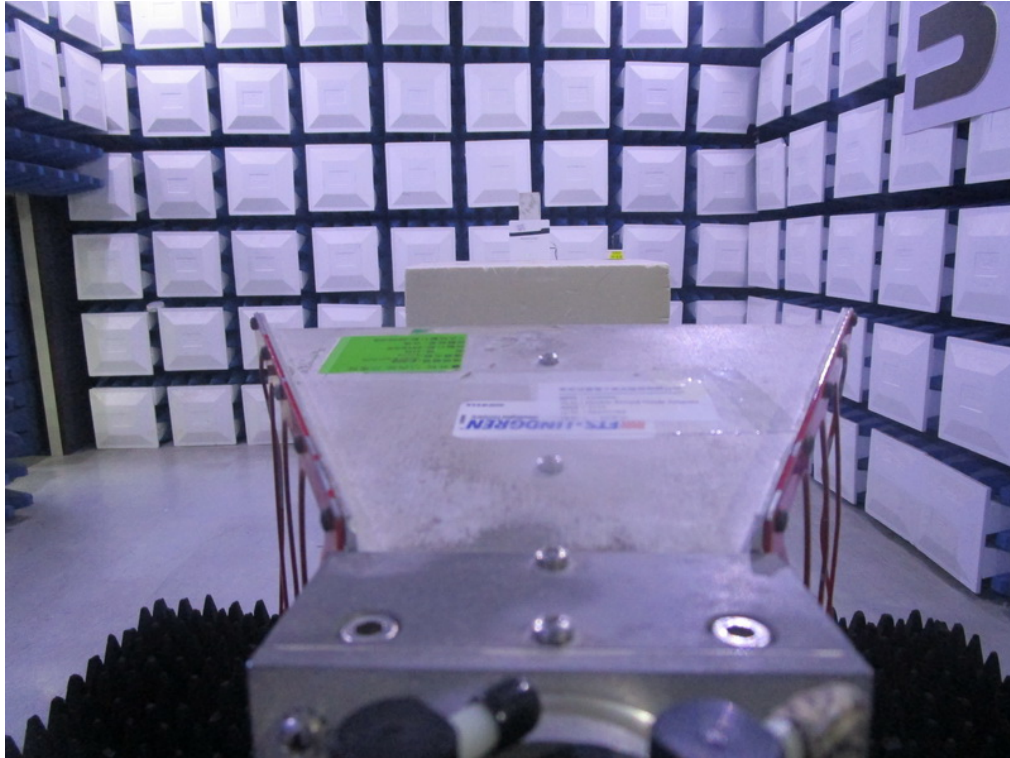

APPENDIX A - AC POWER LINE CONDUCTED EMISSIONS

Test Mode: TX AC20 MODE CHANNEL 165

Line

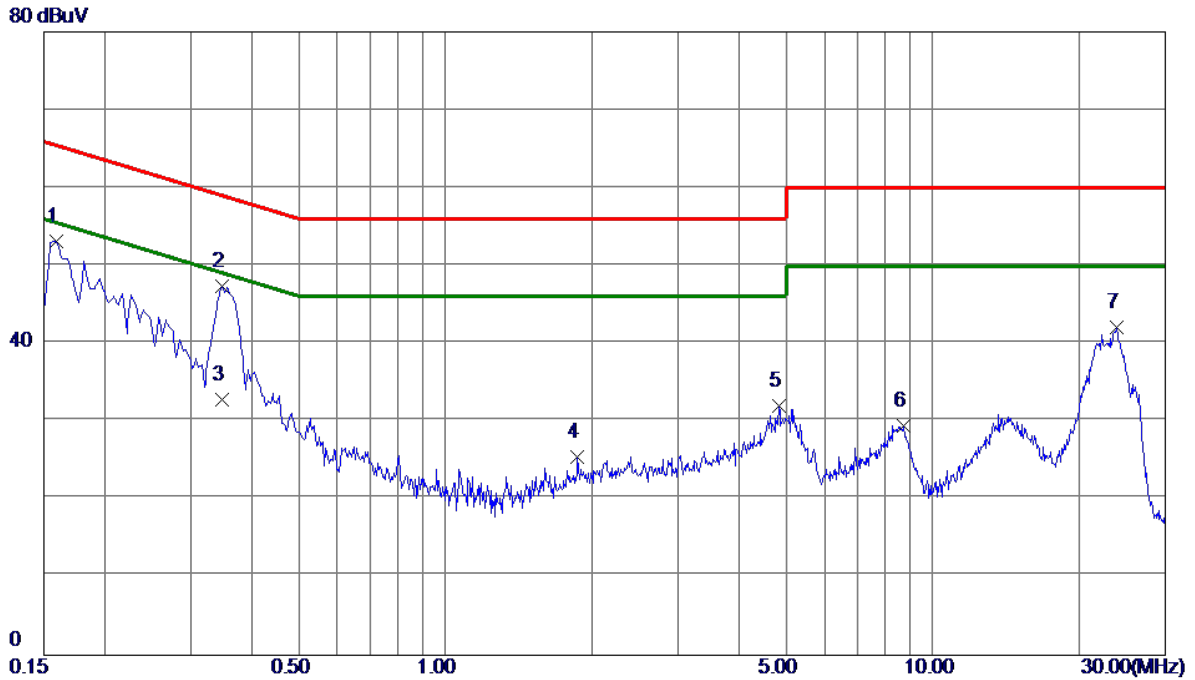

No.	Freq. MHz	Reading Level dBuV	Correct Factor dB	Measure ment dBuV	Limit dBuV	Margin dB	Detector	Comment
1	0.1590	43.34	9.82	53.16	65.52	-12.36	Peak	
2 *	0.3480	37.58	9.85	47.43	59.01	-11.58	Peak	
3	0.3480	22.90	9.85	32.75	49.01	-16.26	AVG	
4	1.8690	15.45	9.99	25.44	56.00	-30.56	Peak	
5	4.8255	21.78	10.18	31.96	56.00	-24.04	Peak	
6	8.6955	19.09	10.42	29.51	60.00	-30.49	Peak	
7	23.8785	30.93	11.14	42.07	60.00	-17.93	Peak	

REMARKS:

- (1) Measurement Value = Reading Level + Correct Factor.
- (2) Margin Level = Measurement Value - Limit Value.
- (3) The test result has included the cable loss.

Test Mode: TX AC20 MODE CHANNEL 165

Neutral

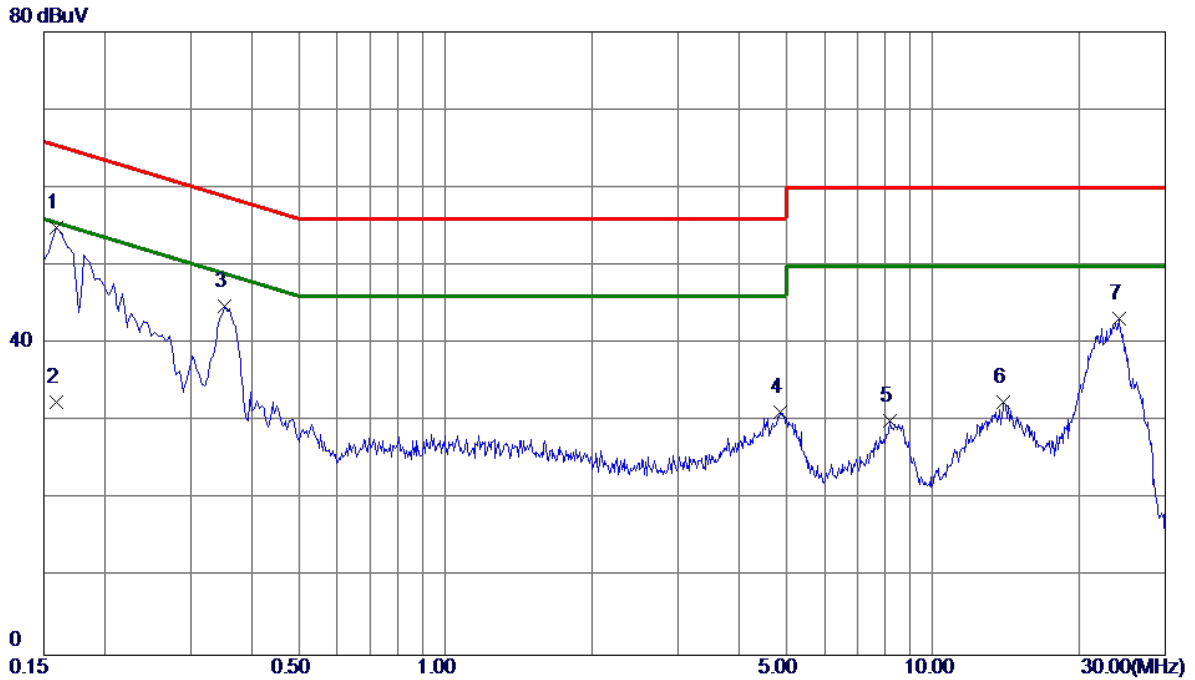

No.	Freq. MHz	Reading Level dBuV	Correct Factor dB	Measure ment dBuV	Limit dBuV	Margin dB	Detector	Comment
1 *	0.1590	44.91	9.91	54.82	65.52	-10.70	Peak	
2	0.1590	22.60	9.91	32.51	55.52	-23.01	AVG	
3	0.3525	34.74	9.99	44.73	58.90	-14.17	Peak	
4	4.8570	20.88	10.39	31.27	56.00	-24.73	Peak	
5	8.1915	19.44	10.65	30.09	60.00	-29.91	Peak	
6	13.9965	21.47	11.01	32.48	60.00	-27.52	Peak	
7	24.0630	31.78	11.48	43.26	60.00	-16.74	Peak	

REMARKS:

- (1) Measurement Value = Reading Level + Correct Factor.
- (2) Margin Level = Measurement Value - Limit Value.
- (3) The test result has included the cable loss.

APPENDIX B - RADIATED EMISSION - 9 KHZ TO 30 MHZ

Test Mode: TX AC20 MODE CHANNEL 165

Ant 0°

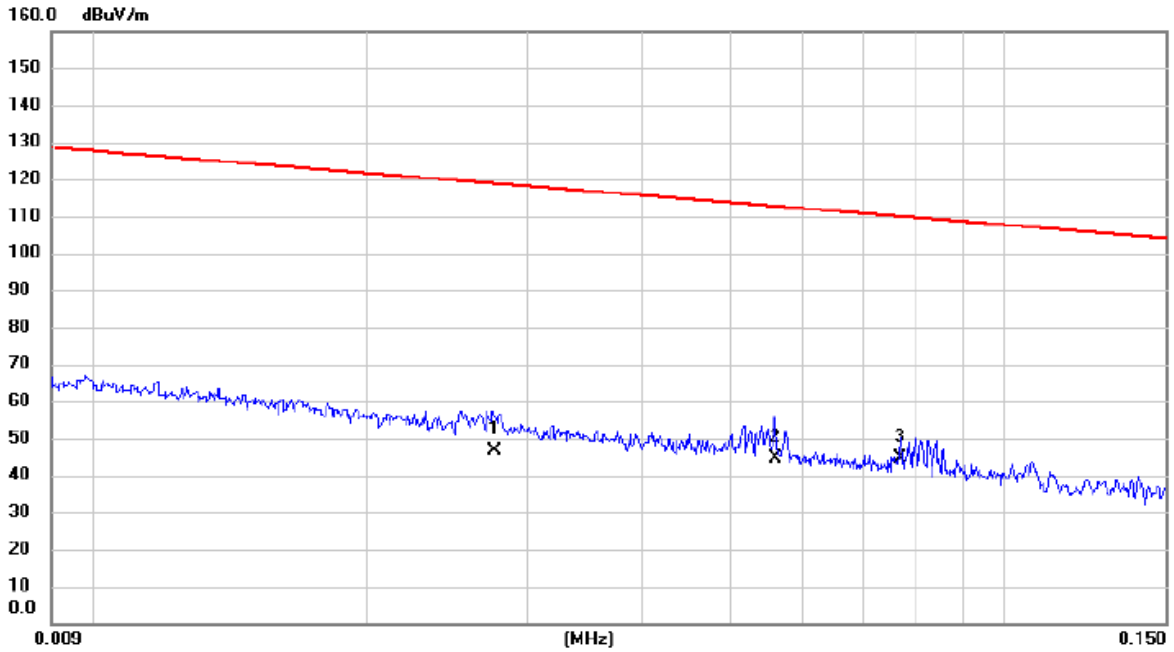

No.	Mk.	Freq. MHz	Reading Level dBuV	Correct Factor dB	Measure- ment dBuV/m	Limit dBuV/m	Margin dB	Detector	Comment
1		0.0276	32.60	13.85	46.45	118.79	-72.34	AVG	
2		0.0560	30.81	13.83	44.64	112.64	-68.00	AVG	
3	*	0.0768	31.20	13.53	44.73	109.90	-65.17	AVG	

REMARKS:

(1) Measurement Value = Reading Level + Correct Factor.

(2) Margin Level = Measurement Value - Limit Value.

Test Mode: TX AC20 MODE CHANNEL 165

Ant 0°

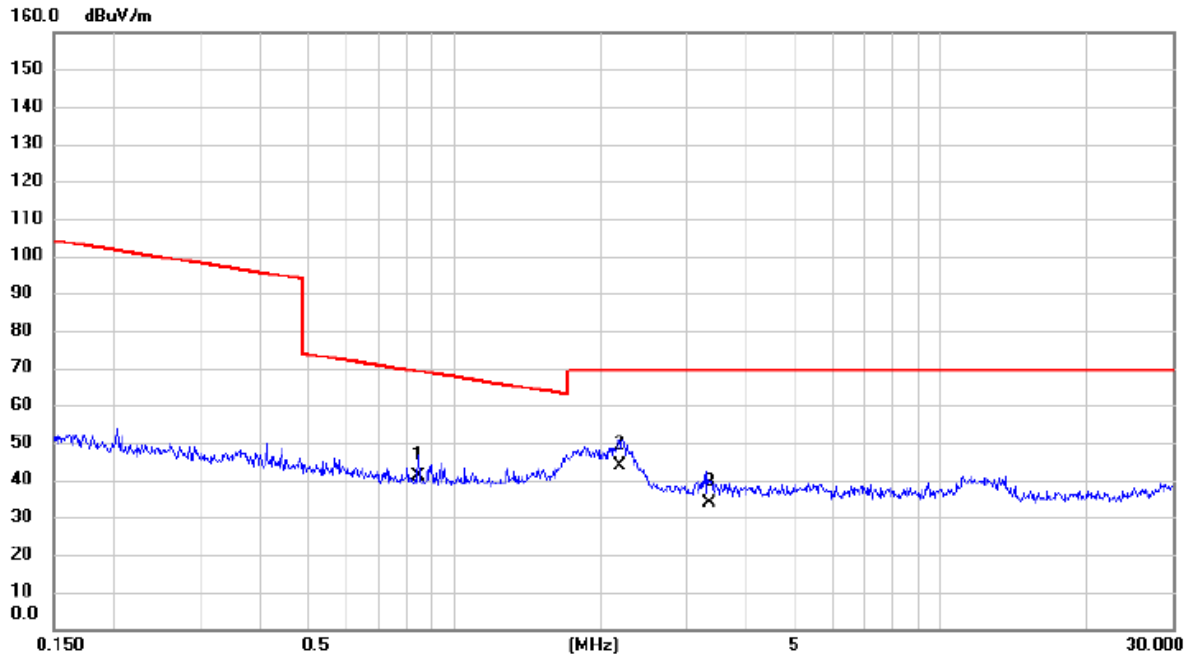

No.	Mk.	Freq. MHz	Reading Level dBuV	Correct Factor dB	Measure- ment dBuV/m	Limit dBuV/m	Margin dB	Detector	Comment
1		0.8438	28.30	12.55	40.85	69.08	-28.23	QP	
2	*	2.1898	32.10	11.71	43.81	69.54	-25.73	QP	
3		3.3458	22.80	11.14	33.94	69.54	-35.60	QP	

REMARKS:

- (1) Measurement Value = Reading Level + Correct Factor.
- (2) Margin Level = Measurement Value - Limit Value.

Test Mode: TX AC20 MODE CHANNEL 165

Ant 90°

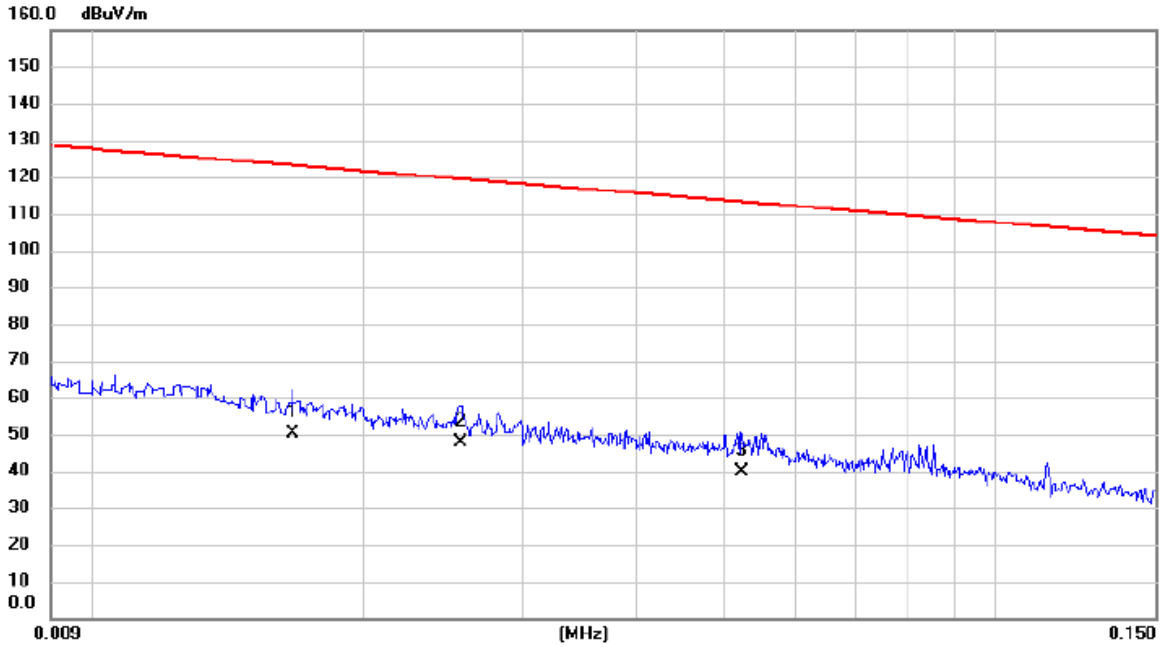

No.	Mk.	Freq. MHz	Reading Level dBuV	Correct Factor dB	Measure- ment dBuV/m	Limit dBuV/m	Margin dB	Detector	Comment
1		0.0167	35.20	14.81	50.01	123.15	-73.14	AVG	
2	*	0.0256	33.80	13.84	47.64	119.44	-71.80	AVG	
3		0.0524	26.10	13.89	39.99	113.22	-73.23	AVG	

REMARKS:

- (1) Measurement Value = Reading Level + Correct Factor.
- (2) Margin Level = Measurement Value - Limit Value.

Test Mode: TX AC20 MODE CHANNEL 165

Ant 90°

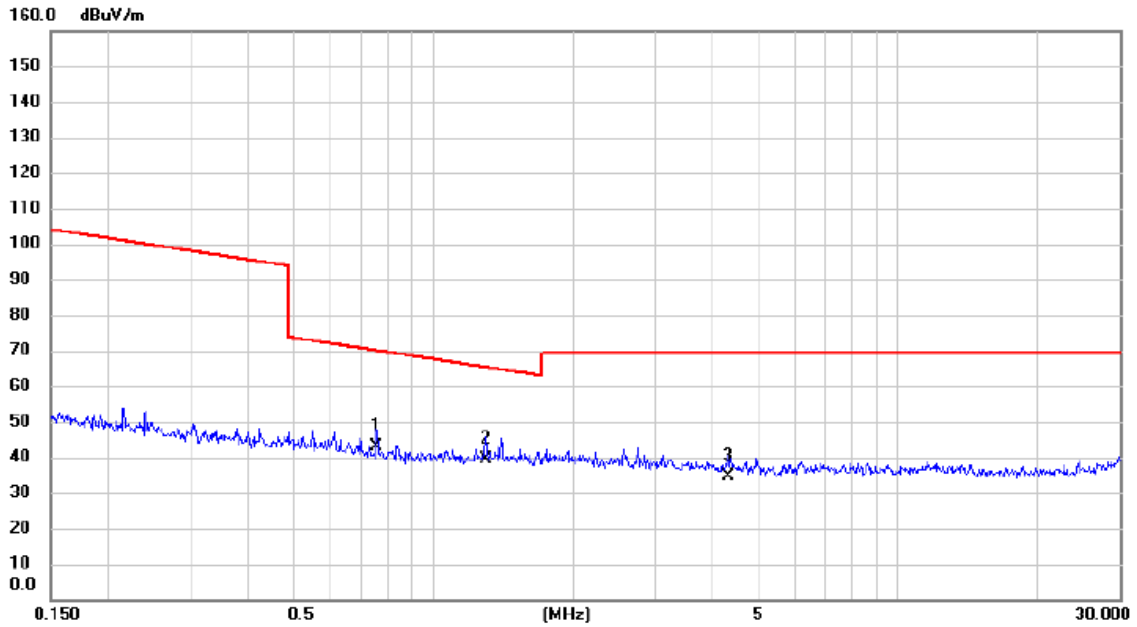

No.	Mk.	Freq. MHz	Reading Level dBuV	Correct Factor dB	Measure- ment dBuV/m	Limit dBuV/m	Margin dB	Detector	Comment
1		0.7550	30.30	12.58	42.88	70.05	-27.17	QP	
2	*	1.2960	27.20	12.29	39.49	65.35	-25.86	QP	
3		4.3146	23.80	10.92	34.72	69.54	-34.82	QP	

REMARKS:

- (1) Measurement Value = Reading Level + Correct Factor.
- (2) Margin Level = Measurement Value - Limit Value.

APPENDIX C - RADIATED EMISSION - 30 MHZ TO 1 GHZ

Test Mode: TX AC20 MODE CHANNEL 165

Vertical

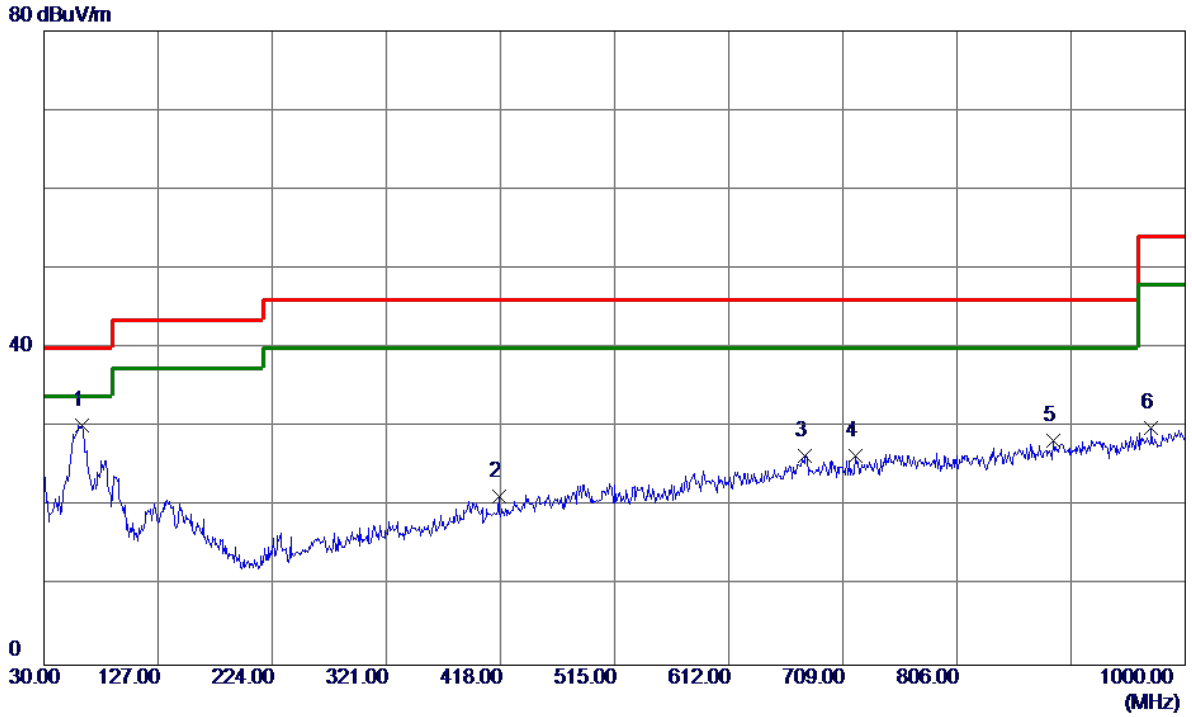

No.	Freq. MHz	Reading Level dBuV/m	Correct Factor dB	Measure ment dBuV/m	Limit dBuV/m	Margin dB	Detector	Comment
1 *	62.4950	45.28	-15.00	30.28	40.00	-9.72	Peak	
2	416.5450	30.27	-9.01	21.26	46.00	-24.74	Peak	
3	676.9900	30.68	-4.32	26.36	46.00	-19.64	Peak	
4	719.6700	30.25	-3.87	26.38	46.00	-19.62	Peak	
5	887.9650	30.29	-2.02	28.27	46.00	-17.73	Peak	
6	971.3850	30.37	-0.41	29.96	54.00	-24.04	Peak	

REMARKS:

- (1) Measurement Value = Reading Level + Correct Factor.
- (2) Margin Level = Measurement Value - Limit Value.

Test Mode: TX AC20 MODE CHANNEL 165

Horizontal

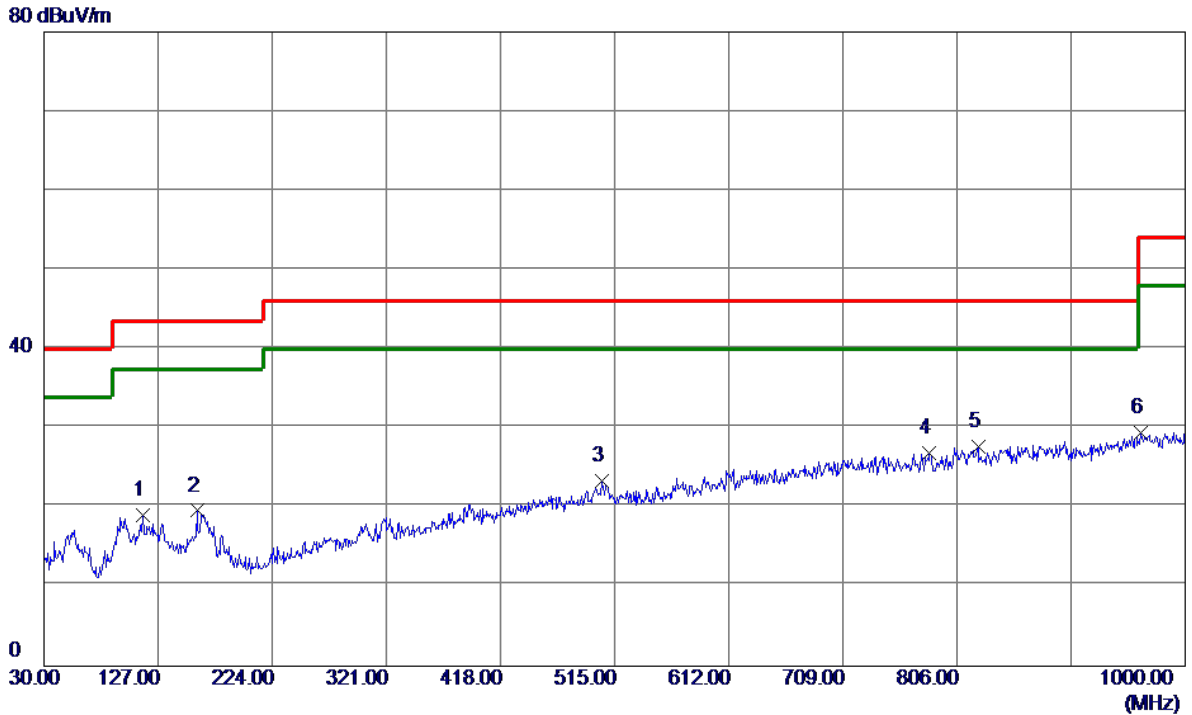

No.	Freq. MHz	Reading Level dBuV/m	Correct Factor dB	Measure ment dBuV/m	Limit dBuV/m	Margin dB	Detector	Comment
1	114.3900	32.86	-13.87	18.99	43.50	-24.51	Peak	
2	160.4650	30.67	-11.07	19.60	43.50	-23.90	Peak	
3	503.8450	31.02	-7.65	23.37	46.00	-22.63	Peak	
4	782.7199	30.06	-3.23	26.83	46.00	-19.17	Peak	
5 *	823.9450	30.33	-2.69	27.64	46.00	-18.36	Peak	
6	962.1700	30.01	-0.57	29.44	54.00	-24.56	Peak	

REMARKS:

- (1) Measurement Value = Reading Level + Correct Factor.
- (2) Margin Level = Measurement Value - Limit Value.

APPENDIX D - RADIATED EMISSION - ABOVE 1000 MHZ

Orthogonal Axis	X
Test Mode	UNII-1_TX A Mode 5180 MHz

Vertical

130 dBuV/m

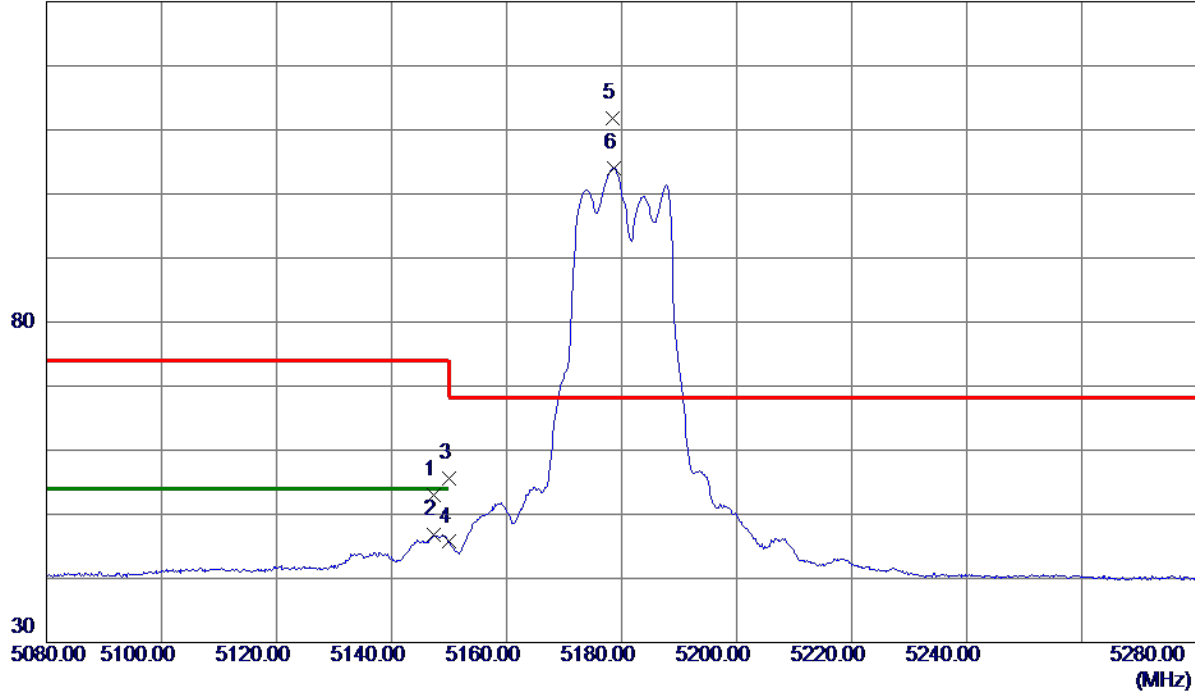

No.	Freq. MHz	Reading Level dBuV/m	Correct Factor dB	Measure ment dBuV/m	Limit dBuV/m	Margin dB	Detector	Comment
1	5147.3000	39.50	13.44	52.94	74.00	-21.06	Peak	
2	5147.3000	33.35	13.44	46.79	54.00	-7.21	AVG	
3	5150.0000	42.16	13.45	55.61	74.00	-18.39	Peak	
4	5150.0000	32.25	13.45	45.70	54.00	-8.30	AVG	
5 *	5178.4000	98.32	13.52	111.84	68.30	43.54	Peak	No Limit
6	5178.6000	90.51	13.52	104.03	999.00	-894.97	AVG	No Limit

REMARKS:

(1) Measurement Value = Reading Level + Correct Factor.

(2) Margin Level = Measurement Value - Limit Value.

Orthogonal Axis	X
Test Mode	UNII-1_TX A Mode 5180 MHz

Vertical

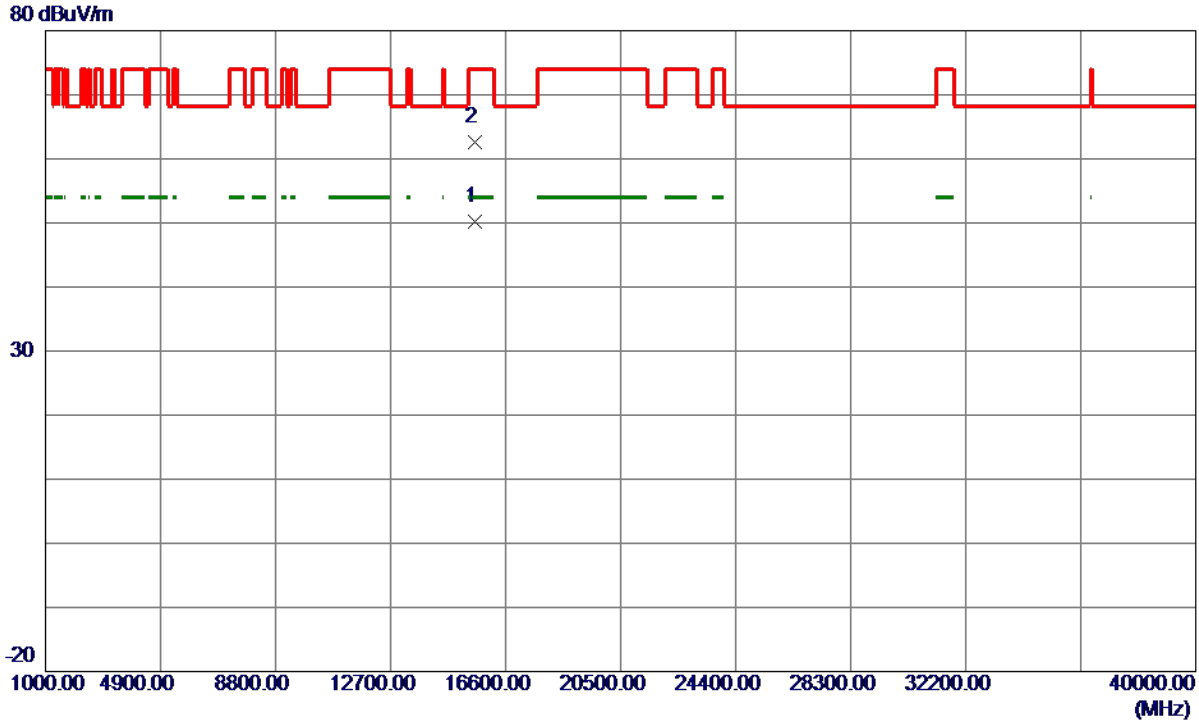

No.	Freq. MHz	Reading Level dBuV/m	Correct Factor dB	Measure ment dBuV/m	Limit dBuV/m	Margin dB	Detector	Comment
1 *	15539.0850	35.26	14.98	50.24	54.00	-3.76	AVG	
2	15540.1750	47.60	14.98	62.58	74.00	-11.42	Peak	

REMARKS:

(1) Measurement Value = Reading Level + Correct Factor.

(2) Margin Level = Measurement Value - Limit Value.

Orthogonal Axis	X
Test Mode	UNII-1_TX A Mode 5180 MHz

Horizontal

130 dBuV/m

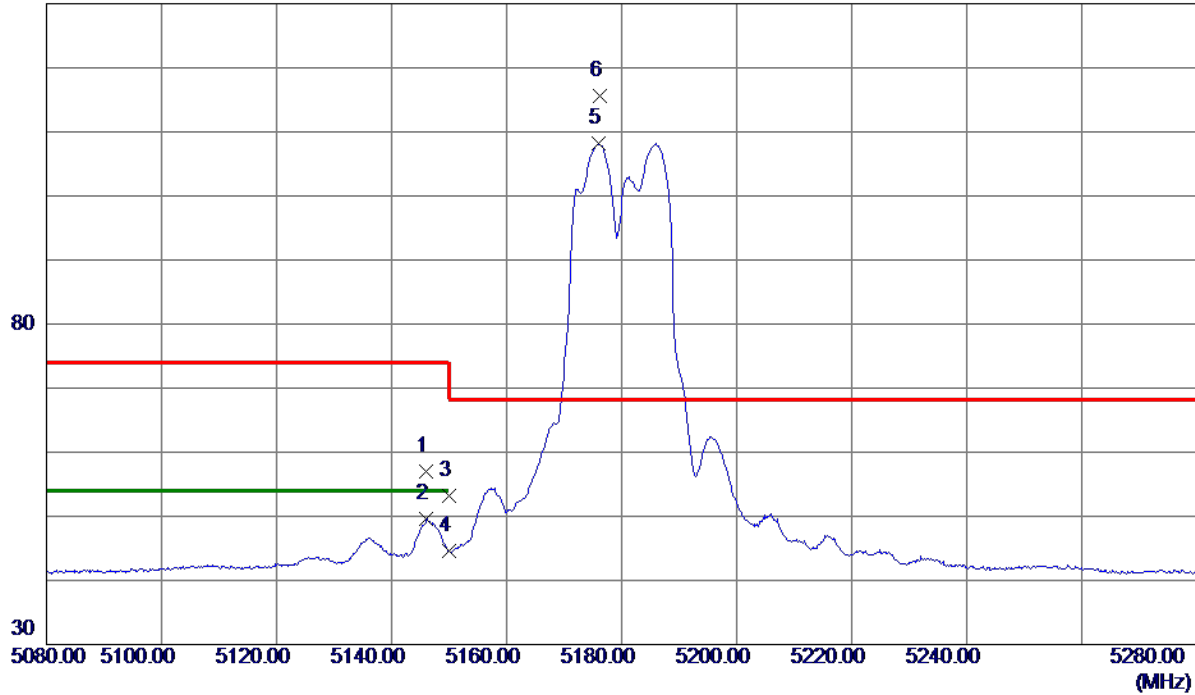

No.	Freq. MHz	Reading Level dBuV/m	Correct Factor dB	Measure ment dBuV/m	Limit dBuV/m	Margin dB	Detector	Comment
1	5146.1000	43.60	13.44	57.04	74.00	-16.96	Peak	
2	5146.1000	36.21	13.44	49.65	54.00	-4.35	AVG	
3	5150.0000	39.82	13.45	53.27	74.00	-20.73	Peak	
4	5150.0000	31.14	13.45	44.59	54.00	-9.41	AVG	
5	5175.9000	94.62	13.51	108.13	999.00	-890.87	AVG	No Limit
6 *	5176.2000	102.09	13.51	115.60	68.30	47.30	Peak	No Limit

REMARKS:

(1) Measurement Value = Reading Level + Correct Factor.

(2) Margin Level = Measurement Value - Limit Value.

Orthogonal Axis	X
Test Mode	UNII-1_TX A Mode 5180 MHz

Horizontal

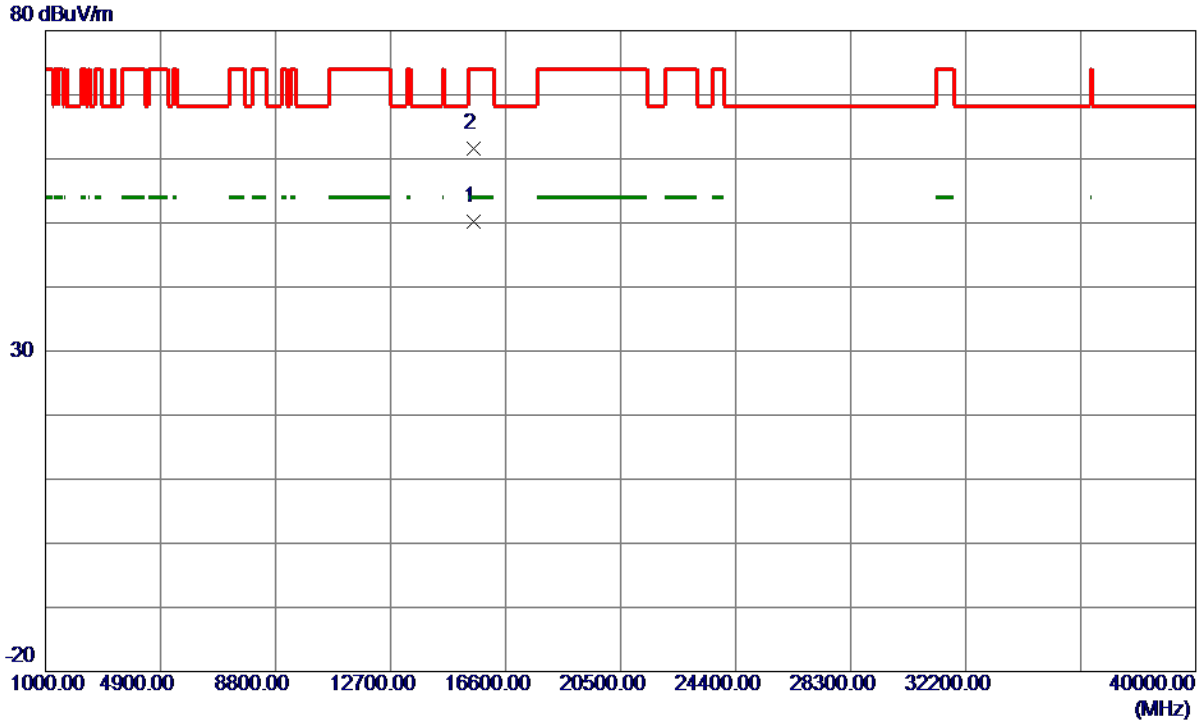

No.	Freq. MHz	Reading Level dBuV/m	Correct Factor dB	Measure ment dBuV/m	Limit dBuV/m	Margin dB	Detector	Comment
1 *	15535.1950	35.30	14.98	50.28	54.00	-3.72	AVG	
2	15535.8600	46.66	14.98	61.64	74.00	-12.36	Peak	

REMARKS:

(1) Measurement Value = Reading Level + Correct Factor.

(2) Margin Level = Measurement Value - Limit Value.

Orthogonal Axis	X
Test Mode	UNII-1_TX A Mode 5200 MHz

Vertical

130 dBuV/m

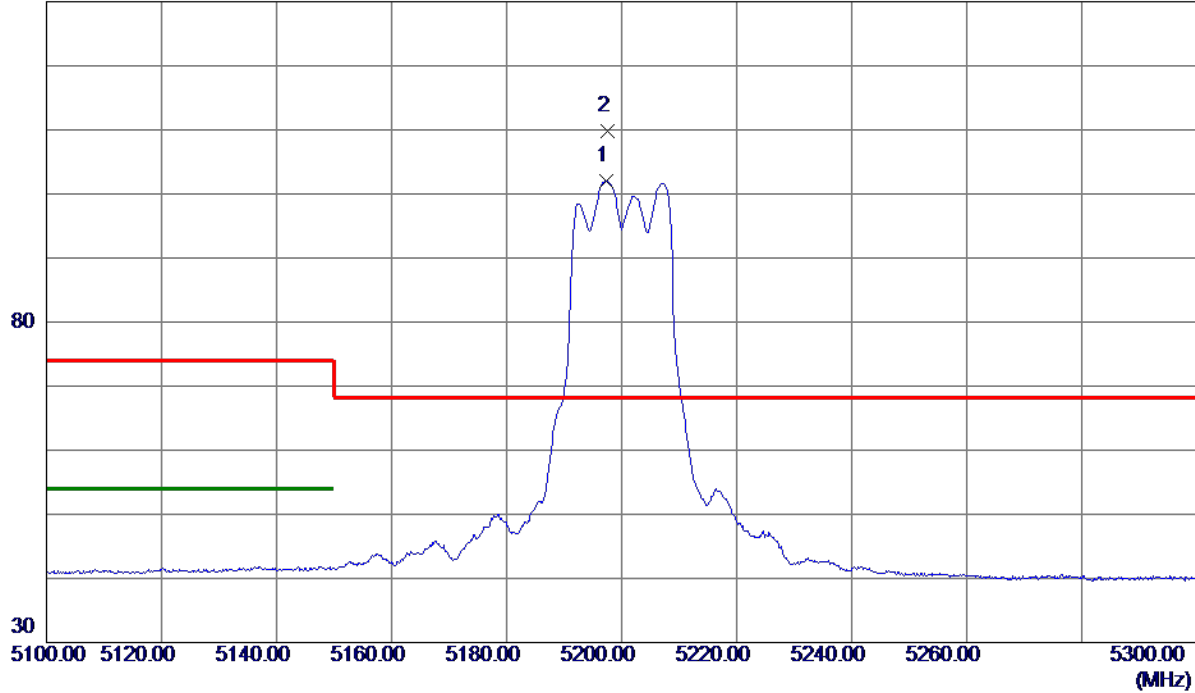

No.	Freq. MHz	Reading Level dBuV/m	Correct Factor dB	Measure ment dBuV/m	Limit dBuV/m	Margin dB	Detector	Comment
1	5197.4000	88.46	13.57	102.03	999.00	-896.97	AVG	No Limit
2 *	5197.5000	96.14	13.57	109.71	68.30	41.41	Peak	No Limit

REMARKS:

(1) Measurement Value = Reading Level + Correct Factor.

(2) Margin Level = Measurement Value - Limit Value.

Orthogonal Axis	X
Test Mode	UNII-1_TX A Mode 5200 MHz

Vertical

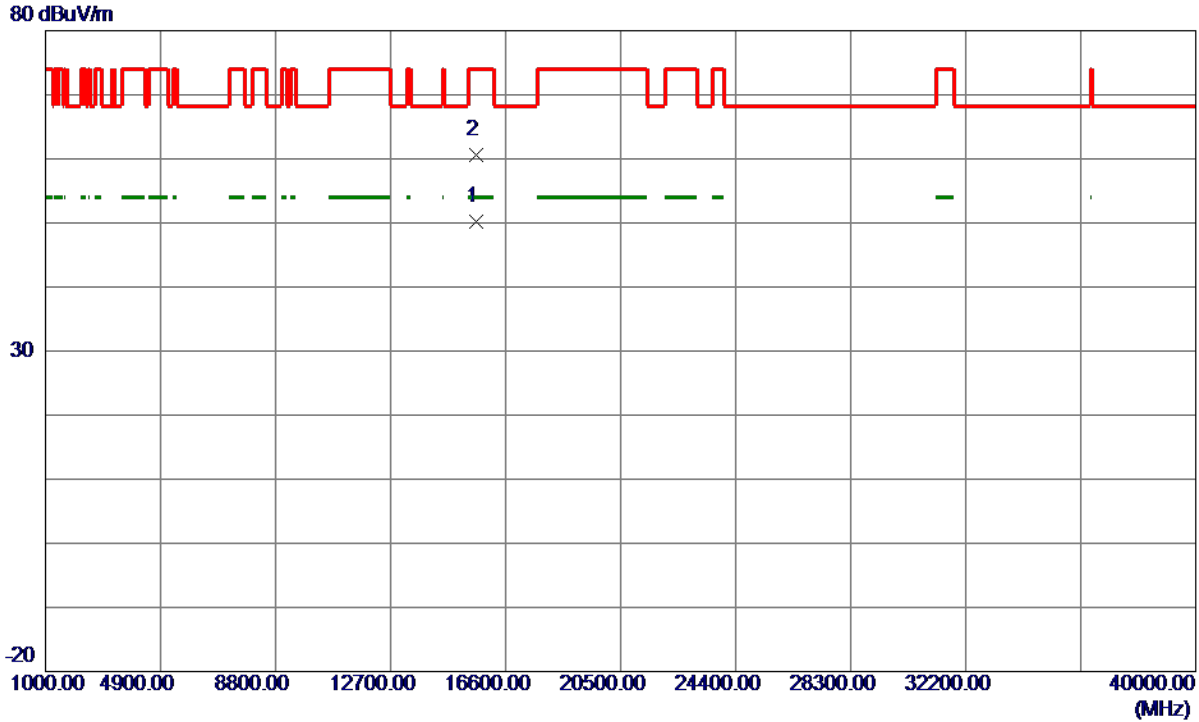

No.	Freq. MHz	Reading Level dBuV/m	Correct Factor dB	Measure ment dBuV/m	Limit dBuV/m	Margin dB	Detector	Comment
1 *	15596.6200	35.18	14.95	50.13	54.00	-3.87	AVG	
2	15604.7300	45.69	14.95	60.64	74.00	-13.36	Peak	

REMARKS:

(1) Measurement Value = Reading Level + Correct Factor.

(2) Margin Level = Measurement Value - Limit Value.

Orthogonal Axis	X
Test Mode	UNII-1_TX A Mode 5200 MHz

Horizontal

130 dBuV/m

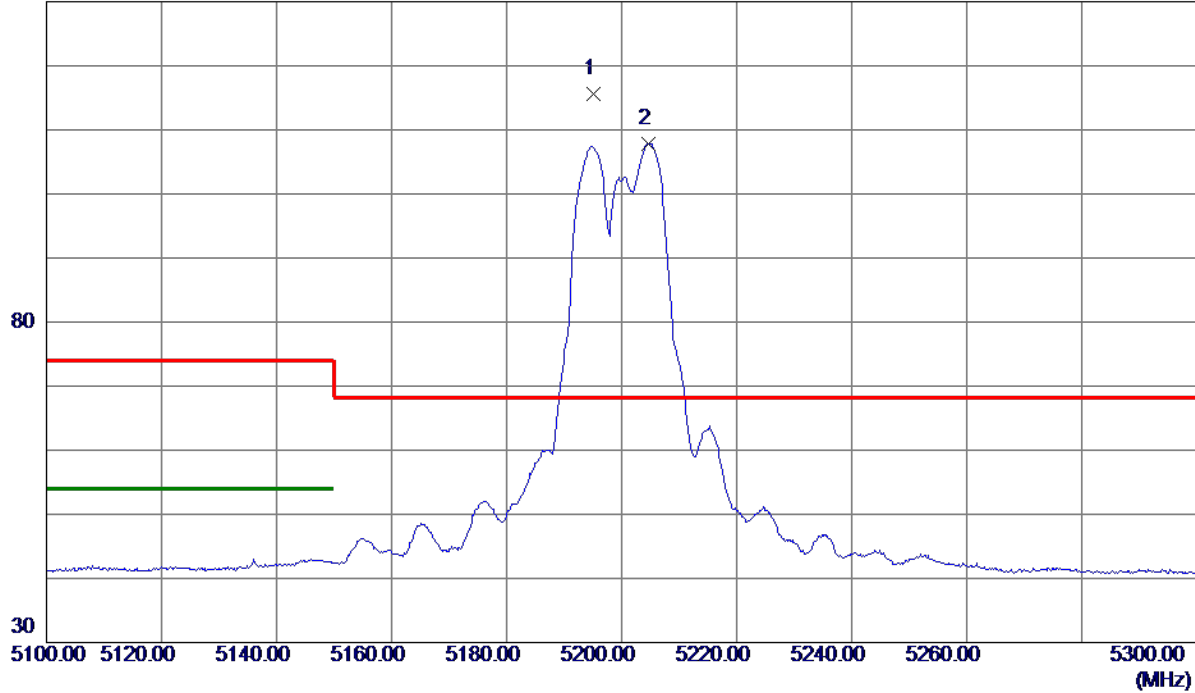

No.	Freq. MHz	Reading Level dBuV/m	Correct Factor dB	Measure ment dBuV/m	Limit dBuV/m	Margin dB	Detector	Comment
1 *	5195.1000	102.05	13.56	115.61	68.30	47.31	Peak	No Limit
2	5204.7000	94.29	13.59	107.88	999.00	-891.12	AVG	No Limit

REMARKS:

(1) Measurement Value = Reading Level + Correct Factor.

(2) Margin Level = Measurement Value - Limit Value.

Orthogonal Axis	X
Test Mode	UNII-1_TX A Mode 5200 MHz

Horizontal

80 dBuV/m

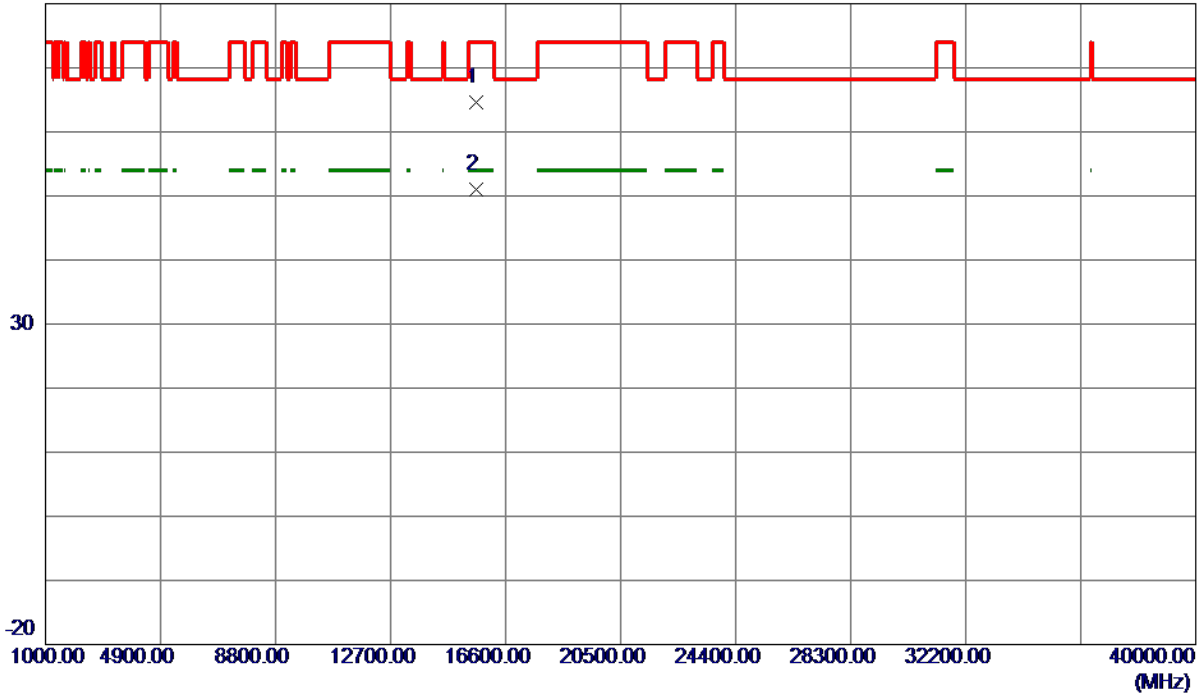

No.	Freq. MHz	Reading Level dBuV/m	Correct Factor dB	Measure ment dBuV/m	Limit dBuV/m	Margin dB	Detector	Comment
1	15595.0000	49.65	14.95	64.60	74.00	-9.40	Peak	
2 *	15595.2700	36.06	14.95	51.01	54.00	-2.99	AVG	

REMARKS:

(1) Measurement Value = Reading Level + Correct Factor.

(2) Margin Level = Measurement Value - Limit Value.

Orthogonal Axis	X
Test Mode	UNII-1_TX A Mode 5240 MHz

Vertical

130 dBuV/m

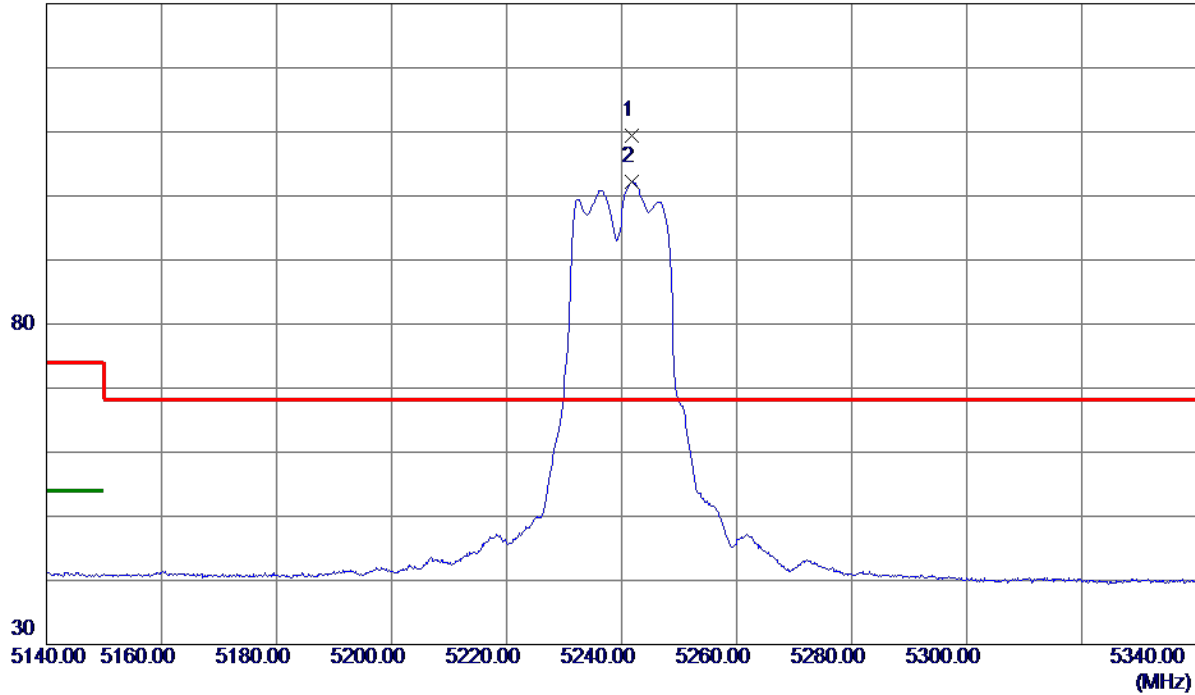

No.	Freq. MHz	Reading Level dBuV/m	Correct Factor dB	Measure ment dBuV/m	Limit dBuV/m	Margin dB	Detector	Comment
1 *	5241.7000	95.77	13.68	109.45	68.30	41.15	Peak	No Limit
2	5241.8000	88.49	13.68	102.17	999.00	-896.83	AVG	No Limit

REMARKS:

(1) Measurement Value = Reading Level + Correct Factor.

(2) Margin Level = Measurement Value - Limit Value.

Orthogonal Axis	X
Test Mode	UNII-1_TX A Mode 5240 MHz

Vertical

80 dBuV/m

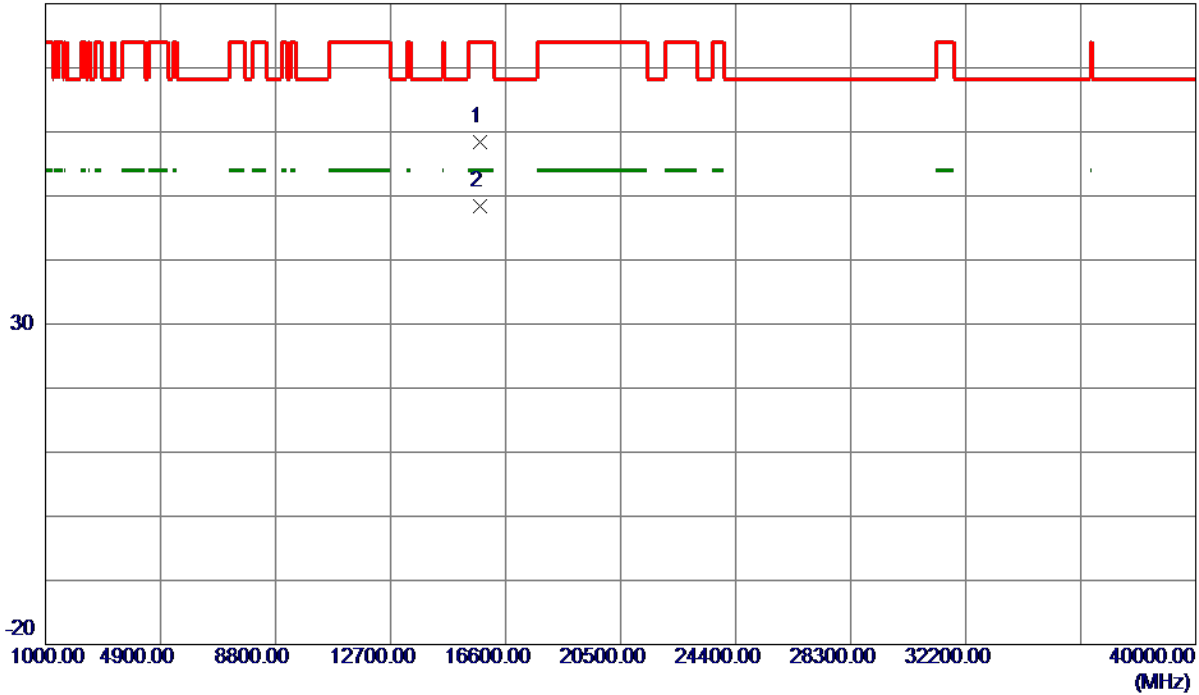

No.	Freq. MHz	Reading Level dBuV/m	Correct Factor dB	Measure ment dBuV/m	Limit dBuV/m	Margin dB	Detector	Comment
1	15716.1200	43.53	14.89	58.42	74.00	-15.58	Peak	
2 *	15716.7400	33.58	14.89	48.47	54.00	-5.53	AVG	

REMARKS:

(1) Measurement Value = Reading Level + Correct Factor.

(2) Margin Level = Measurement Value - Limit Value.

Orthogonal Axis	X
Test Mode	UNII-1_TX A Mode 5240 MHz

Horizontal

130 dBuV/m

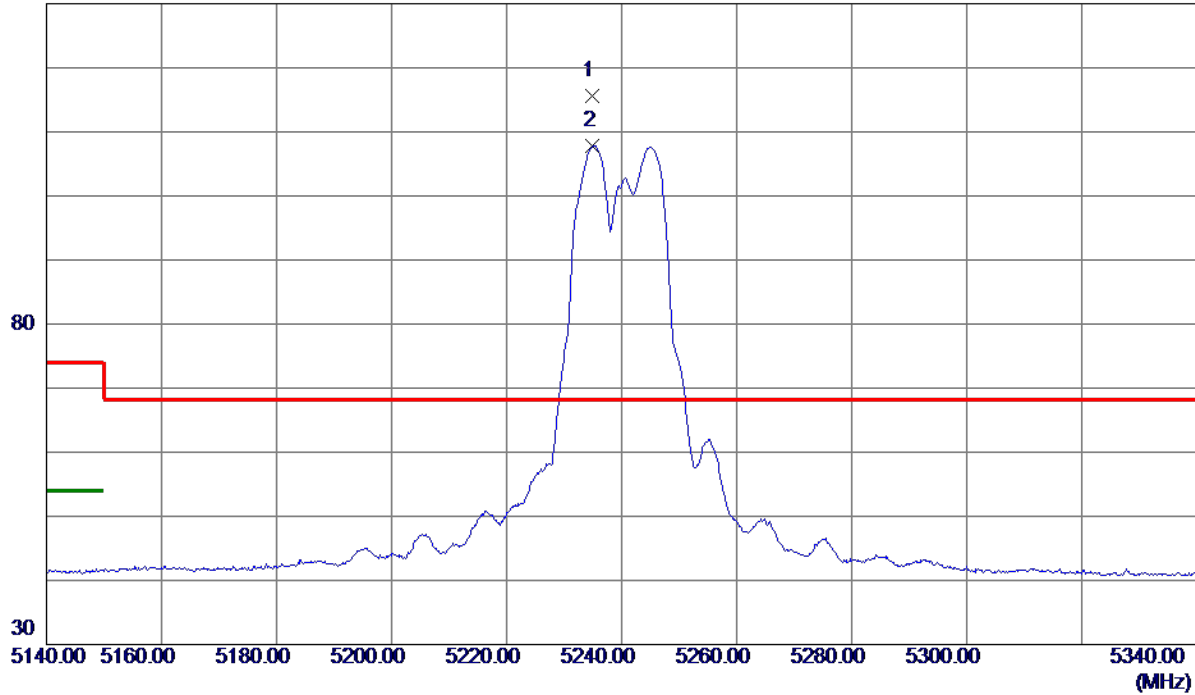

No.	Freq. MHz	Reading Level dBuV/m	Correct Factor dB	Measure ment dBuV/m	Limit dBuV/m	Margin dB	Detector	Comment
1 *	5234.8000	101.95	13.66	115.61	68.30	47.31	Peak	No Limit
2	5235.0000	94.12	13.66	107.78	999.00	-891.22	AVG	No Limit

REMARKS:

(1) Measurement Value = Reading Level + Correct Factor.

(2) Margin Level = Measurement Value - Limit Value.

Orthogonal Axis	X
Test Mode	UNII-1_TX A Mode 5240 MHz

Horizontal

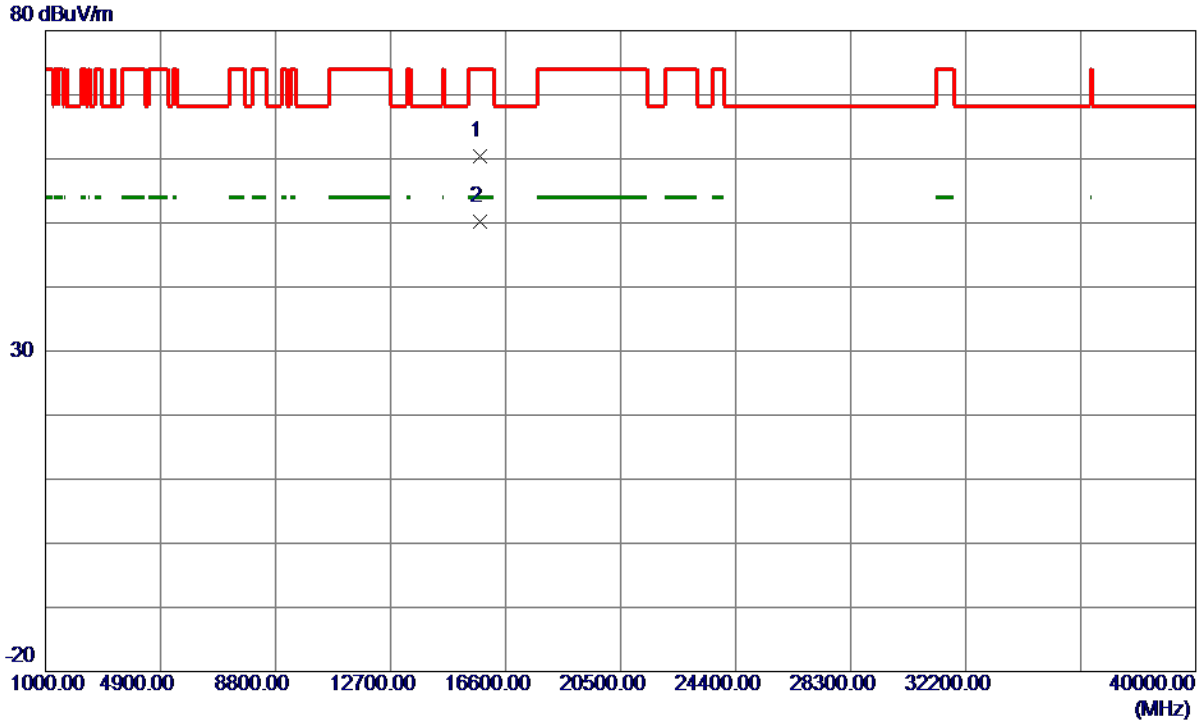

No.	Freq. MHz	Reading Level dBuV/m	Correct Factor dB	Measure ment dBuV/m	Limit dBuV/m	Margin dB	Detector	Comment
1	15715.1050	45.52	14.89	60.41	74.00	-13.59	Peak	
2 *	15724.1600	35.27	14.89	50.16	54.00	-3.84	AVG	

REMARKS:

(1) Measurement Value = Reading Level + Correct Factor.

(2) Margin Level = Measurement Value - Limit Value.

Orthogonal Axis	X
Test Mode	UNII-3_TX A Mode 5745 MHz

Vertical

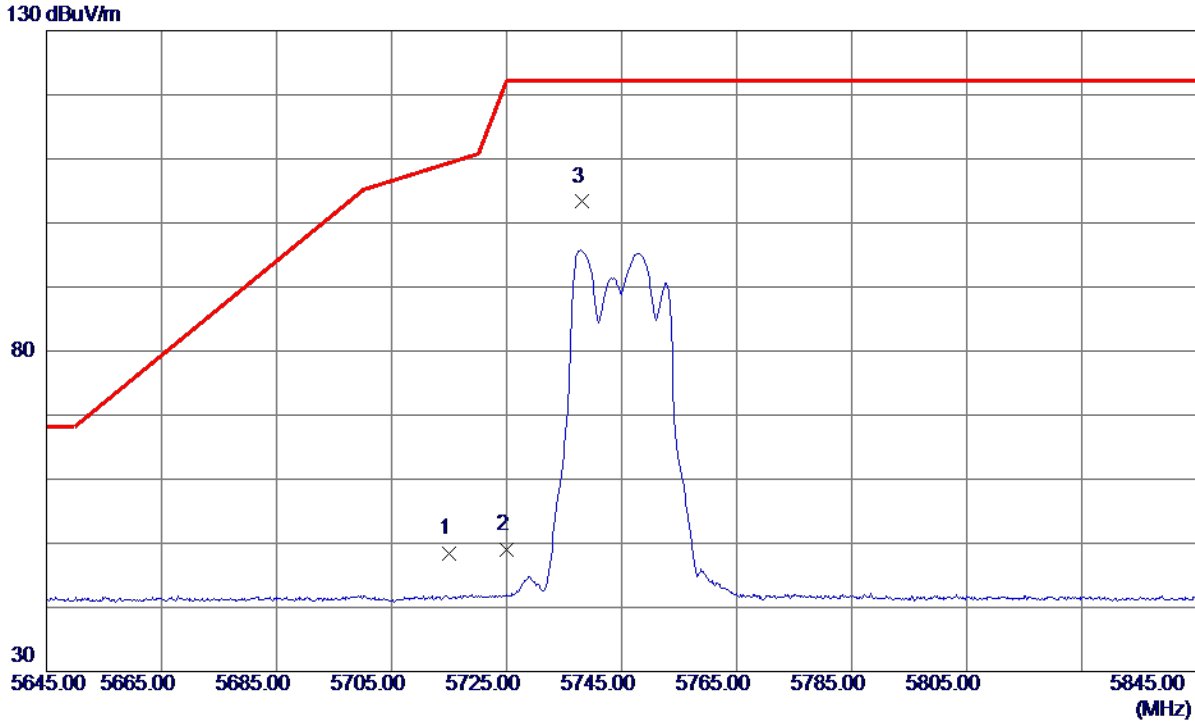

No.	Freq. MHz	Reading Level dBuV/m	Correct Factor dB	Measure ment dBuV/m	Limit dBuV/m	Margin dB	Detector	Comment
1	5715.0000	33.52	14.90	48.42	109.40	-60.98	Peak	
2	5725.0000	34.03	14.92	48.95	122.20	-73.25	Peak	
3 *	5738.2000	88.34	14.96	103.30	122.20	-18.90	Peak	No Limit

REMARKS:

(1) Measurement Value = Reading Level + Correct Factor.

(2) Margin Level = Measurement Value - Limit Value.

Orthogonal Axis	X
Test Mode	UNII-3_TX A Mode 5745 MHz

Vertical

80 dBuV/m

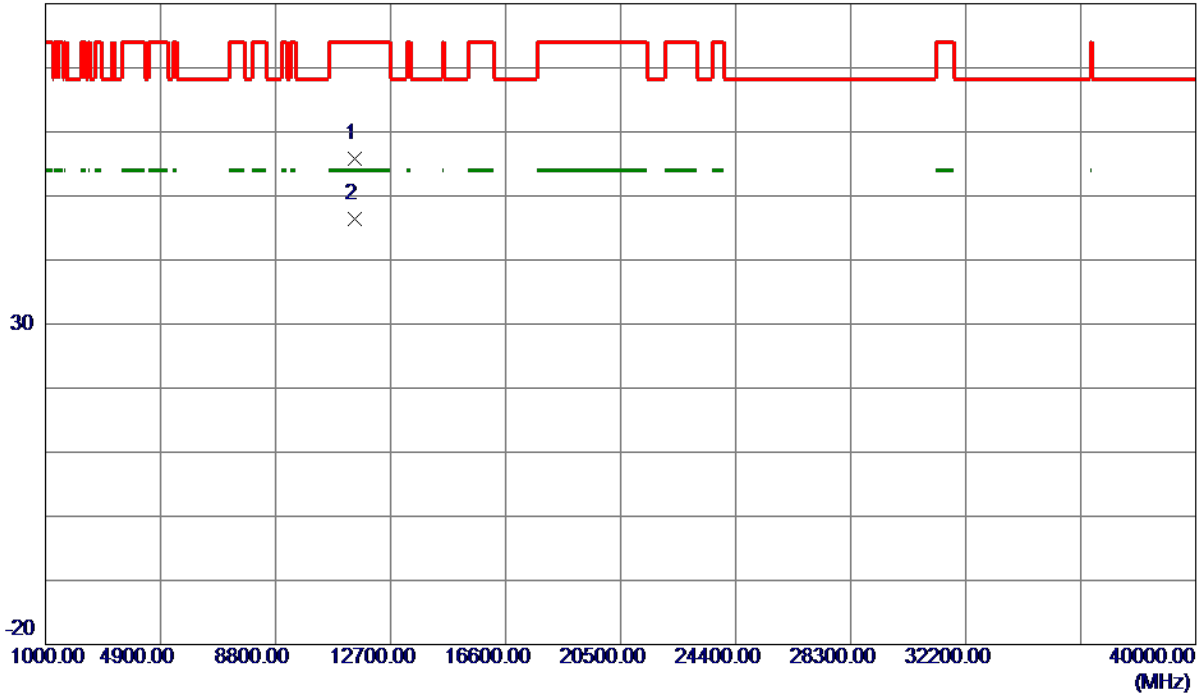

No.	Freq. MHz	Reading Level dBuV/m	Correct Factor dB	Measure ment dBuV/m	Limit dBuV/m	Margin dB	Detector	Comment
1	11488.6050	43.58	12.24	55.82	74.00	-18.18	Peak	
2 *	11488.6600	34.11	12.24	46.35	54.00	-7.65	AVG	

REMARKS:

(1) Measurement Value = Reading Level + Correct Factor.

(2) Margin Level = Measurement Value - Limit Value.

Orthogonal Axis	X
Test Mode	UNII-3_TX A Mode 5745 MHz

Horizontal

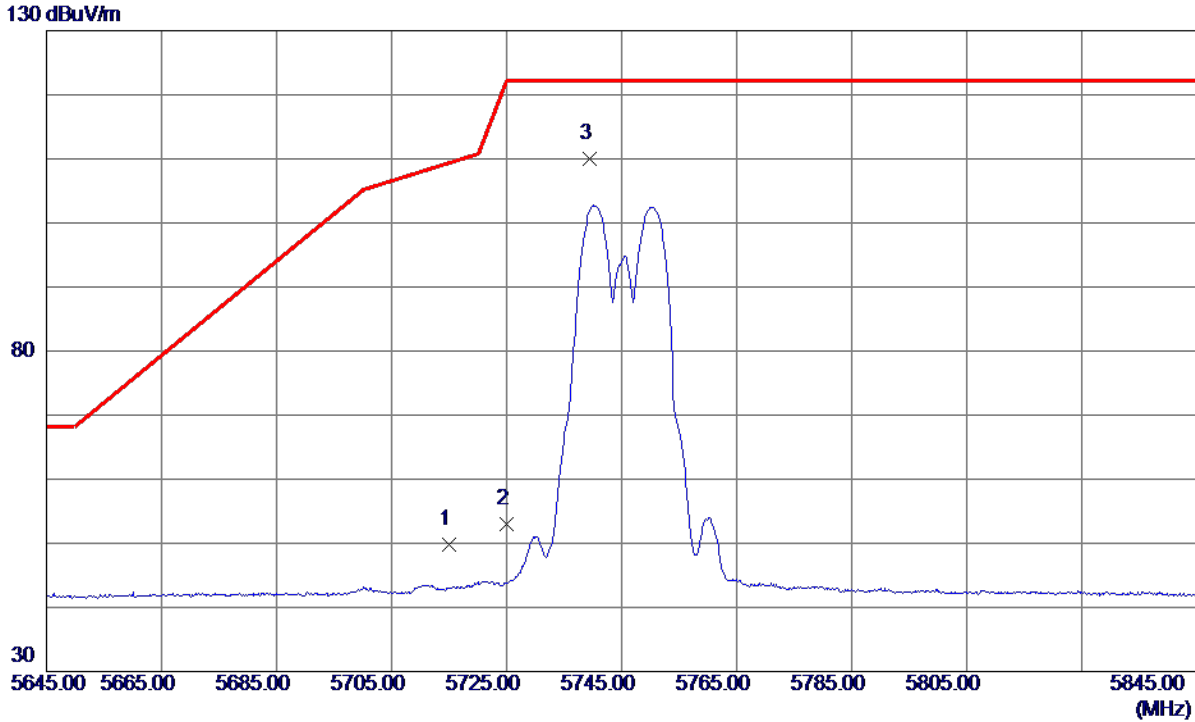

No.	Freq. MHz	Reading Level dBuV/m	Correct Factor dB	Measure ment dBuV/m	Limit dBuV/m	Margin dB	Detector	Comment
1	5715.0000	34.97	14.90	49.87	109.40	-59.53	Peak	
2	5725.0000	38.13	14.92	53.05	122.20	-69.15	Peak	
3 *	5739.5000	95.07	14.96	110.03	122.20	-12.17	Peak	No Limit

REMARKS:

(1) Measurement Value = Reading Level + Correct Factor.

(2) Margin Level = Measurement Value - Limit Value.

Orthogonal Axis	X
Test Mode	UNII-3_TX A Mode 5745 MHz

Horizontal

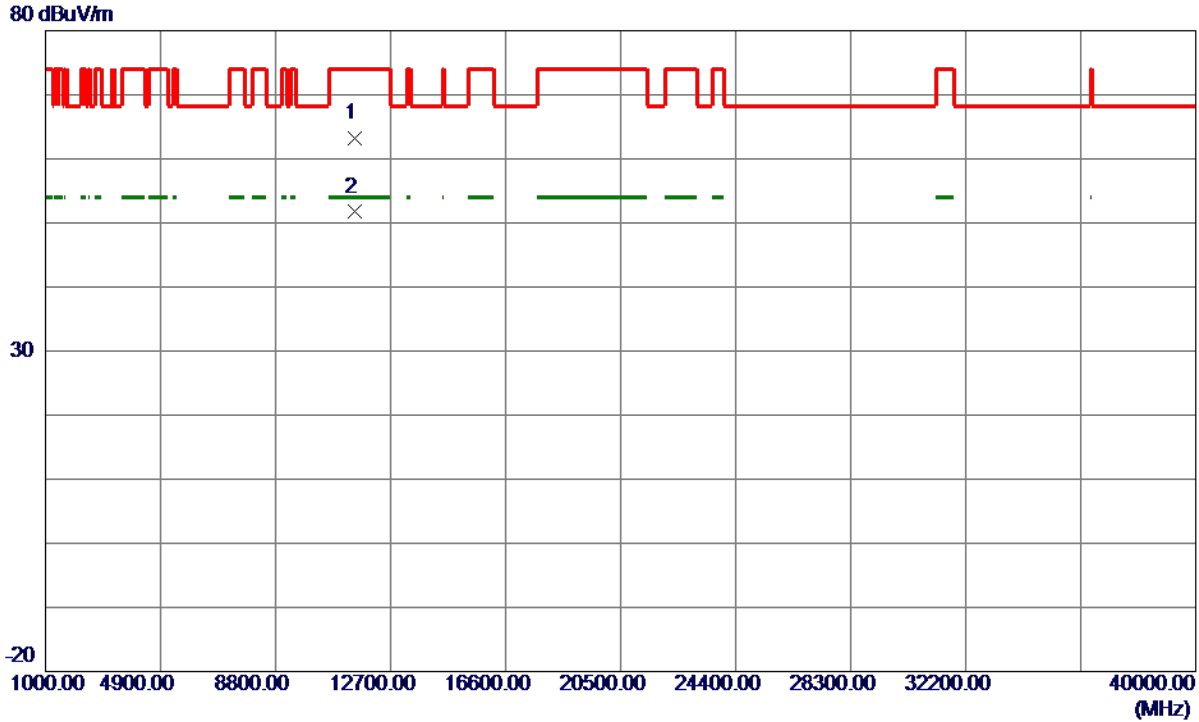

No.	Freq. MHz	Reading Level dBuV/m	Correct Factor dB	Measure ment dBuV/m	Limit dBuV/m	Margin dB	Detector	Comment
1	11493.4600	50.94	12.24	63.18	74.00	-10.82	Peak	
2 *	11493.4950	39.46	12.24	51.70	54.00	-2.30	AVG	

REMARKS:

(1) Measurement Value = Reading Level + Correct Factor.

(2) Margin Level = Measurement Value - Limit Value.

Orthogonal Axis	X
Test Mode	UNII-3_TX A Mode 5785 MHz

Vertical

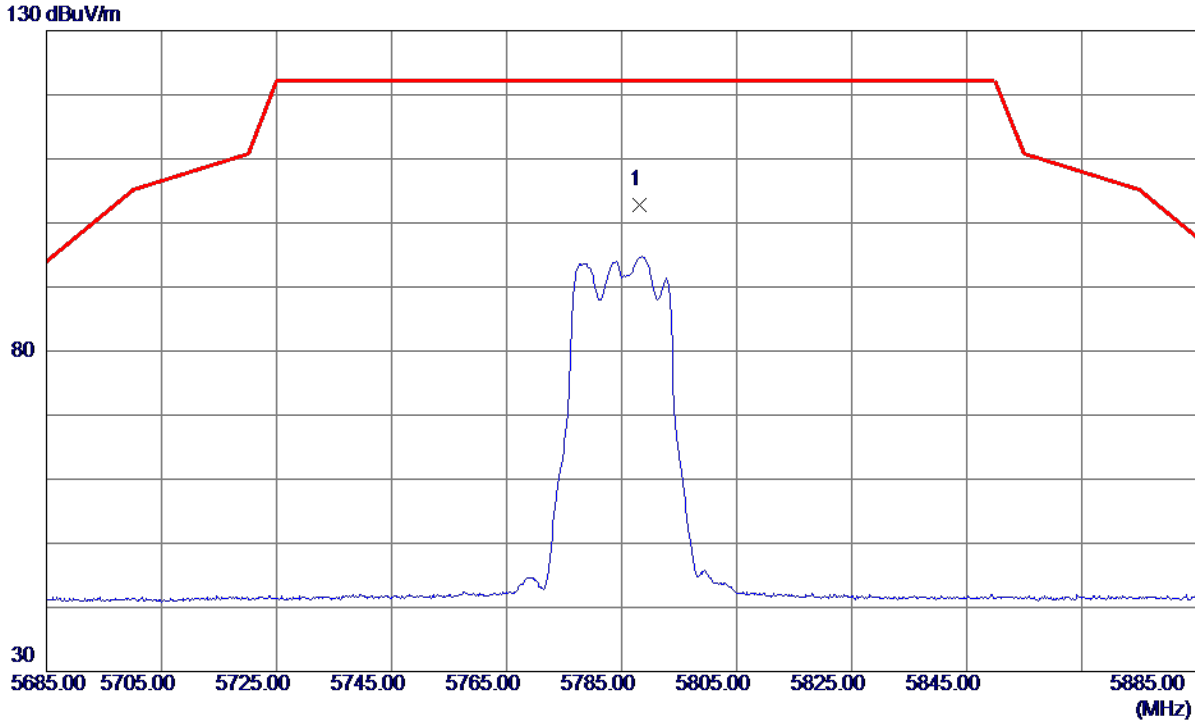

No.	Freq. MHz	Reading Level dBuV/m	Correct Factor dB	Measure ment dBuV/m	Limit dBuV/m	Margin dB	Detector	Comment
1 *	5788.1000	87.80	15.09	102.89	122.20	-19.31	Peak	No Limit

REMARKS:

(1) Measurement Value = Reading Level + Correct Factor.

(2) Margin Level = Measurement Value - Limit Value.

Orthogonal Axis	X
Test Mode	UNII-3_TX A Mode 5785 MHz

Vertical

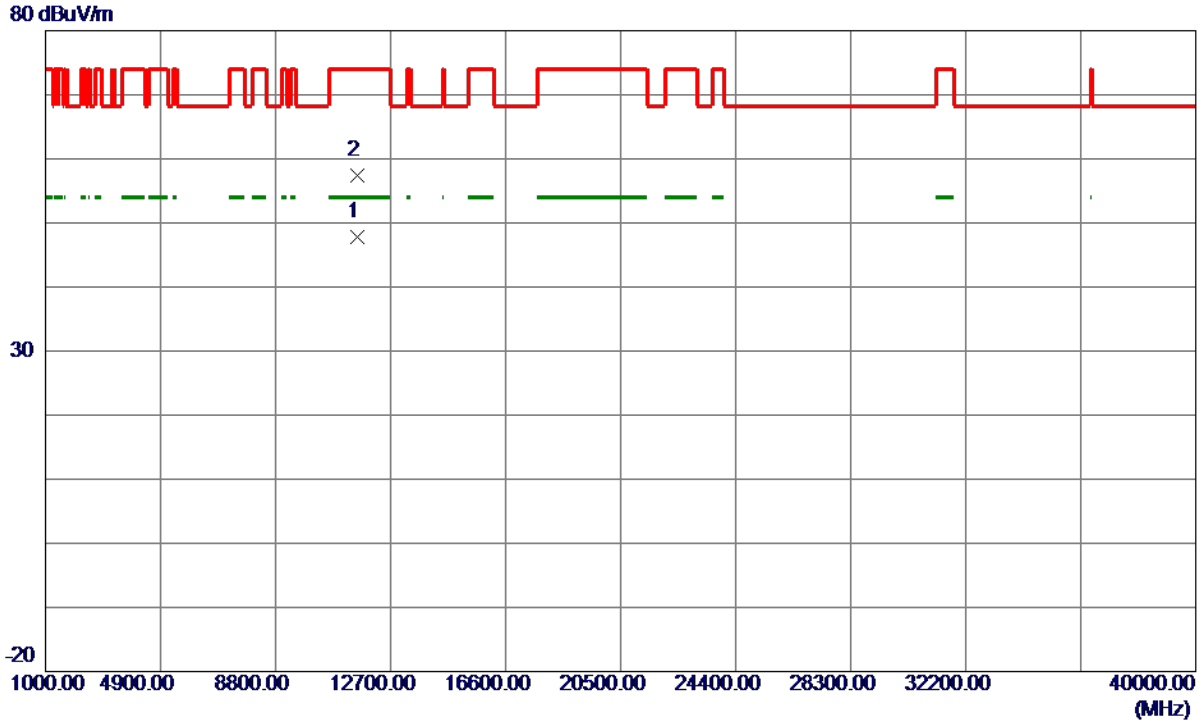

No.	Freq. MHz	Reading Level dBuV/m	Correct Factor dB	Measure ment dBuV/m	Limit dBuV/m	Margin dB	Detector	Comment
1 *	11568.5500	35.46	12.34	47.80	54.00	-6.20	AVG	
2	11573.4400	45.03	12.34	57.37	74.00	-16.63	Peak	

REMARKS:

(1) Measurement Value = Reading Level + Correct Factor.

(2) Margin Level = Measurement Value - Limit Value.

Orthogonal Axis	X
Test Mode	UNII-3_TX A Mode 5785 MHz

Horizontal

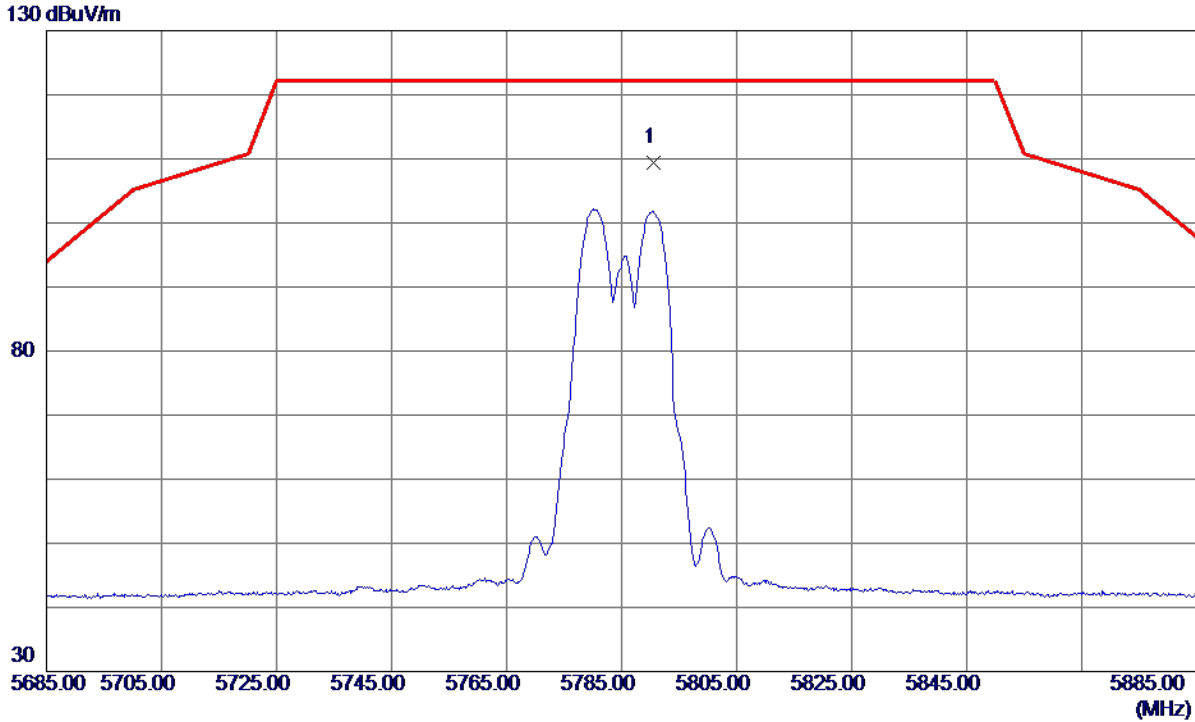

No.	Freq. MHz	Reading Level dBuV/m	Correct Factor dB	Measure ment dBuV/m	Limit dBuV/m	Margin dB	Detector	Comment
1 *	5790.5000	94.38	15.09	109.47	122.20	-12.73	Peak	No Limit

REMARKS:

(1) Measurement Value = Reading Level + Correct Factor.

(2) Margin Level = Measurement Value - Limit Value.

Orthogonal Axis	X
Test Mode	UNII-3_TX A Mode 5785 MHz

Horizontal

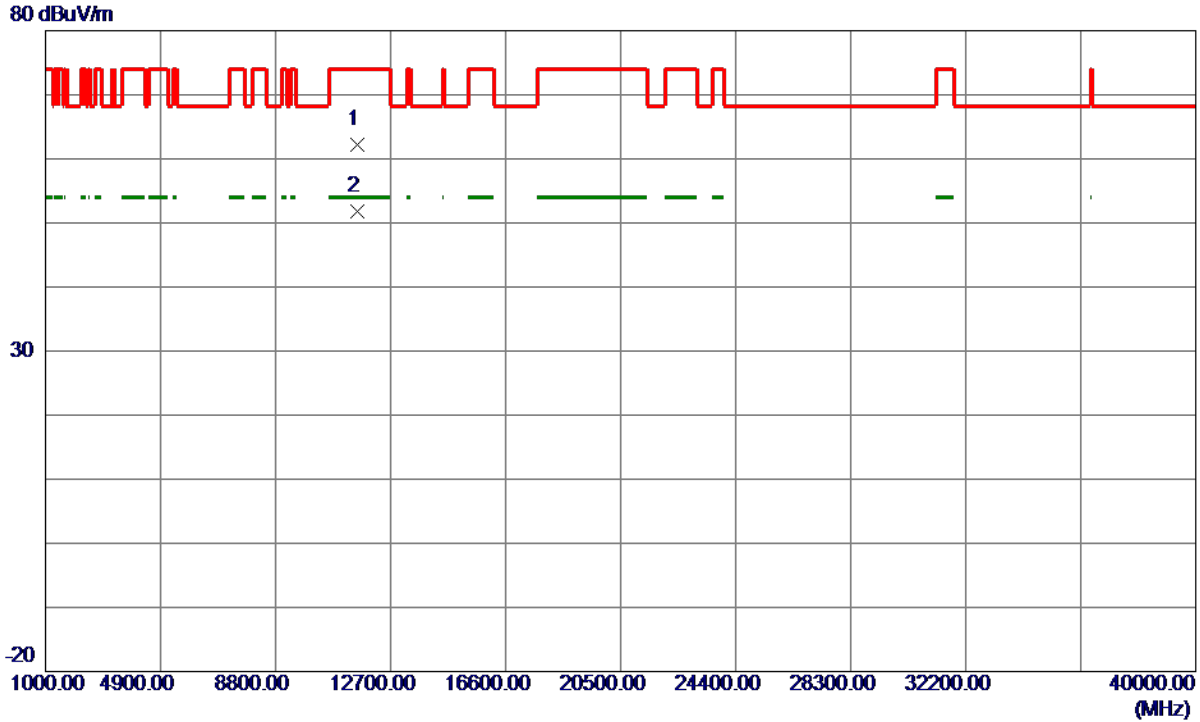

No.	Freq. MHz	Reading Level dBuV/m	Correct Factor dB	Measure ment dBuV/m	Limit dBuV/m	Margin dB	Detector	Comment
1	11573.0400	49.79	12.34	62.13	74.00	-11.87	Peak	
2 *	11573.4850	39.45	12.34	51.79	54.00	-2.21	AVG	

REMARKS:

(1) Measurement Value = Reading Level + Correct Factor.

(2) Margin Level = Measurement Value - Limit Value.

Orthogonal Axis	X
Test Mode	UNII-3_TX A Mode 5825 MHz

Vertical

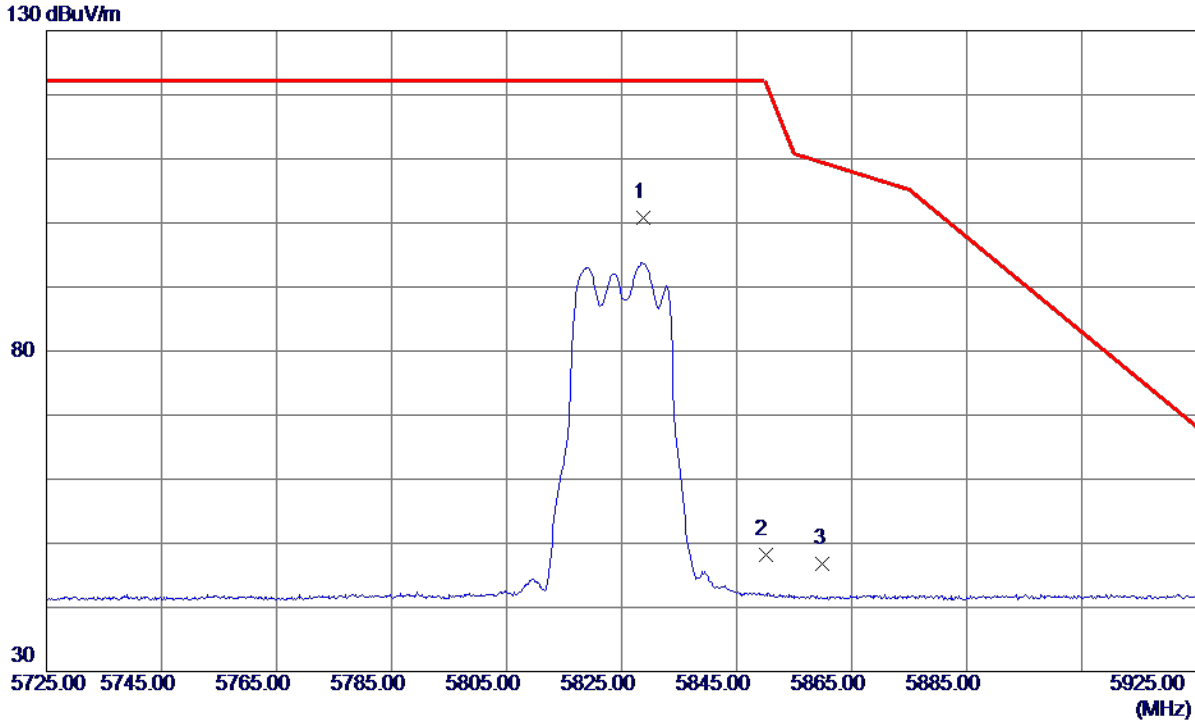

No.	Freq. MHz	Reading Level dBuV/m	Correct Factor dB	Measure ment dBuV/m	Limit dBuV/m	Margin dB	Detector	Comment
1 *	5828.7000	85.55	15.19	100.74	122.20	-21.46	Peak	No Limit
2	5850.0000	32.92	15.24	48.16	122.20	-74.04	Peak	
3	5860.0000	31.54	15.27	46.81	109.40	-62.59	Peak	

REMARKS:

(1) Measurement Value = Reading Level + Correct Factor.

(2) Margin Level = Measurement Value - Limit Value.

Orthogonal Axis	X
Test Mode	UNII-3_TX A Mode 5825 MHz

Vertical

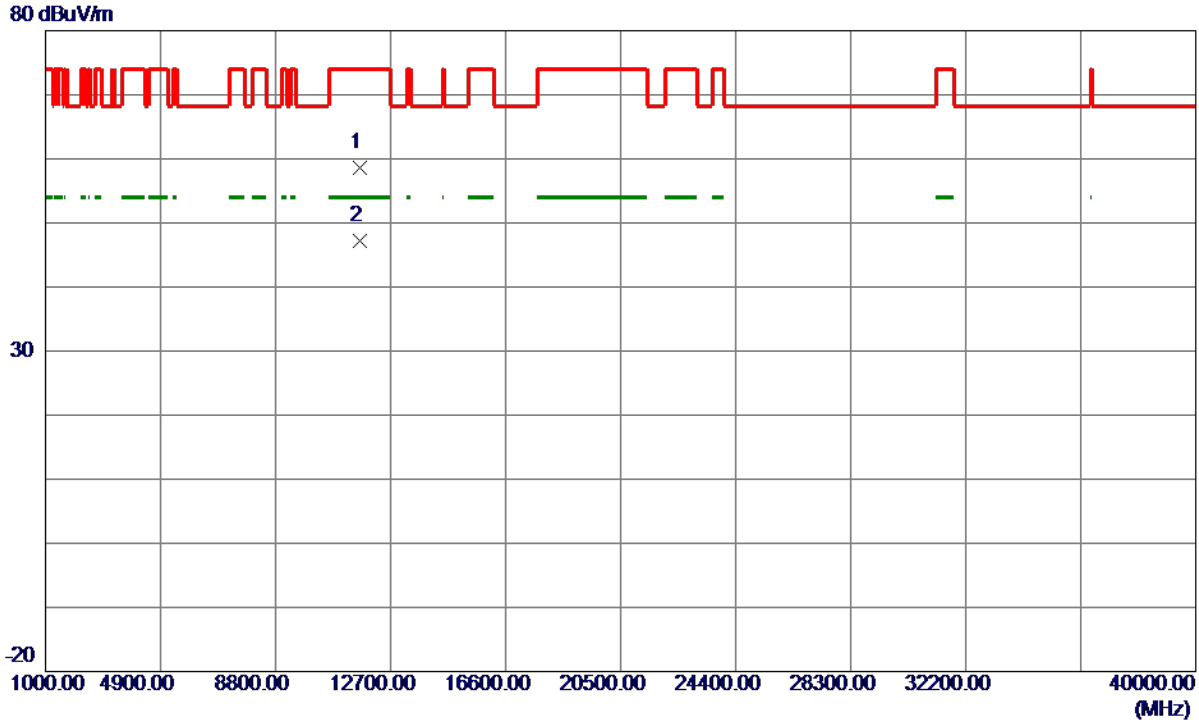

No.	Freq. MHz	Reading Level dBuV/m	Correct Factor dB	Measure ment dBuV/m	Limit dBuV/m	Margin dB	Detector	Comment
1	11648.9600	46.10	12.44	58.54	74.00	-15.46	Peak	
2 *	11649.1500	34.76	12.44	47.20	54.00	-6.80	AVG	

REMARKS:

(1) Measurement Value = Reading Level + Correct Factor.

(2) Margin Level = Measurement Value - Limit Value.

Orthogonal Axis	X
Test Mode	UNII-3_TX A Mode 5825 MHz

Horizontal

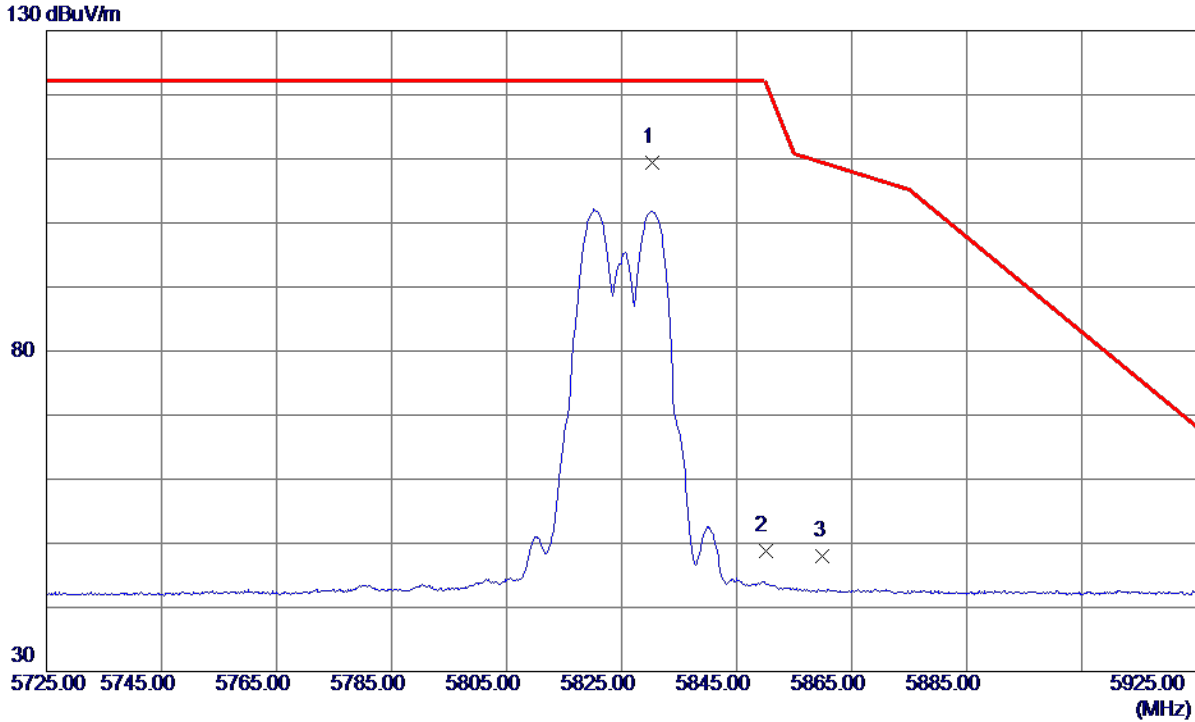

No.	Freq. MHz	Reading Level dBuV/m	Correct Factor dB	Measure ment dBuV/m	Limit dBuV/m	Margin dB	Detector	Comment
1 *	5830.3000	94.22	15.19	109.41	122.20	-12.79	Peak	No Limit
2	5850.0000	33.62	15.24	48.86	122.20	-73.34	Peak	
3	5860.0000	32.65	15.27	47.92	109.40	-61.48	Peak	

REMARKS:

(1) Measurement Value = Reading Level + Correct Factor.

(2) Margin Level = Measurement Value - Limit Value.

Orthogonal Axis	X
Test Mode	UNII-3_TX A Mode 5825 MHz

Horizontal

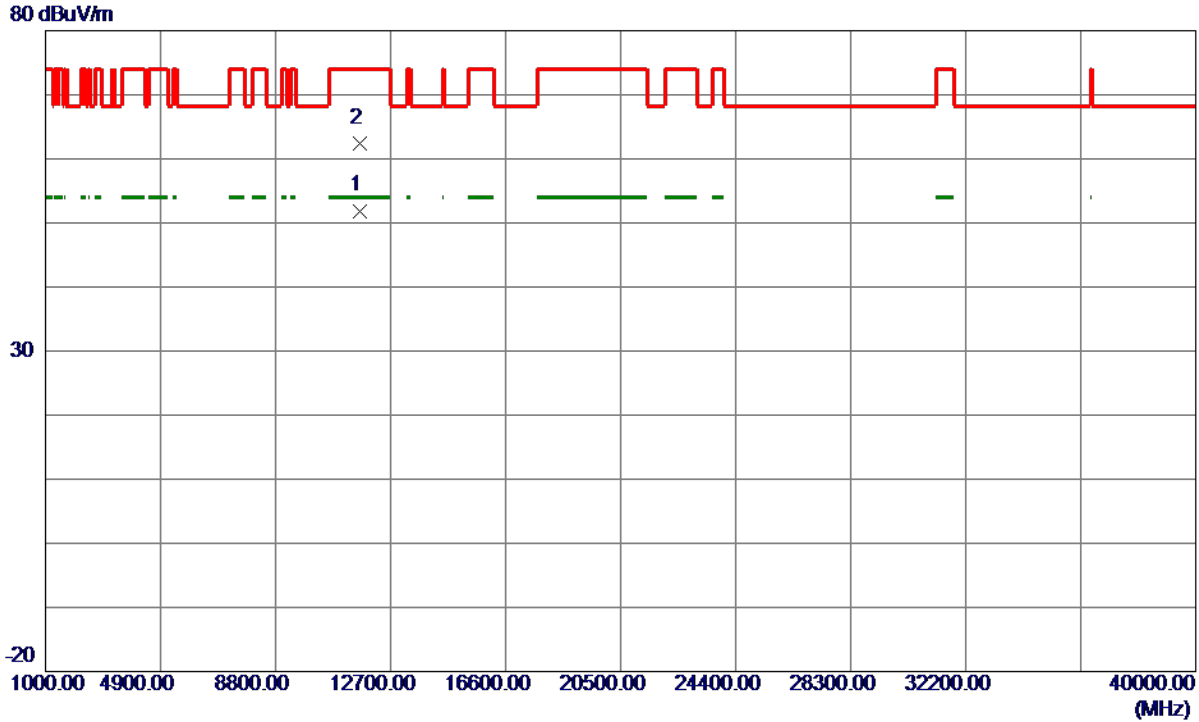

No.	Freq. MHz	Reading Level dBuV/m	Correct Factor dB	Measure ment dBuV/m	Limit dBuV/m	Margin dB	Detector	Comment
1 *	11653.5550	39.46	12.44	51.90	54.00	-2.10	AVG	
2	11653.7950	50.01	12.44	62.45	74.00	-11.55	Peak	

REMARKS:

(1) Measurement Value = Reading Level + Correct Factor.

(2) Margin Level = Measurement Value - Limit Value.

Orthogonal Axis	X
Test Mode	UNII-1_TX AC (VHT20) Mode 5180 MHz

Vertical

130 dBuV/m

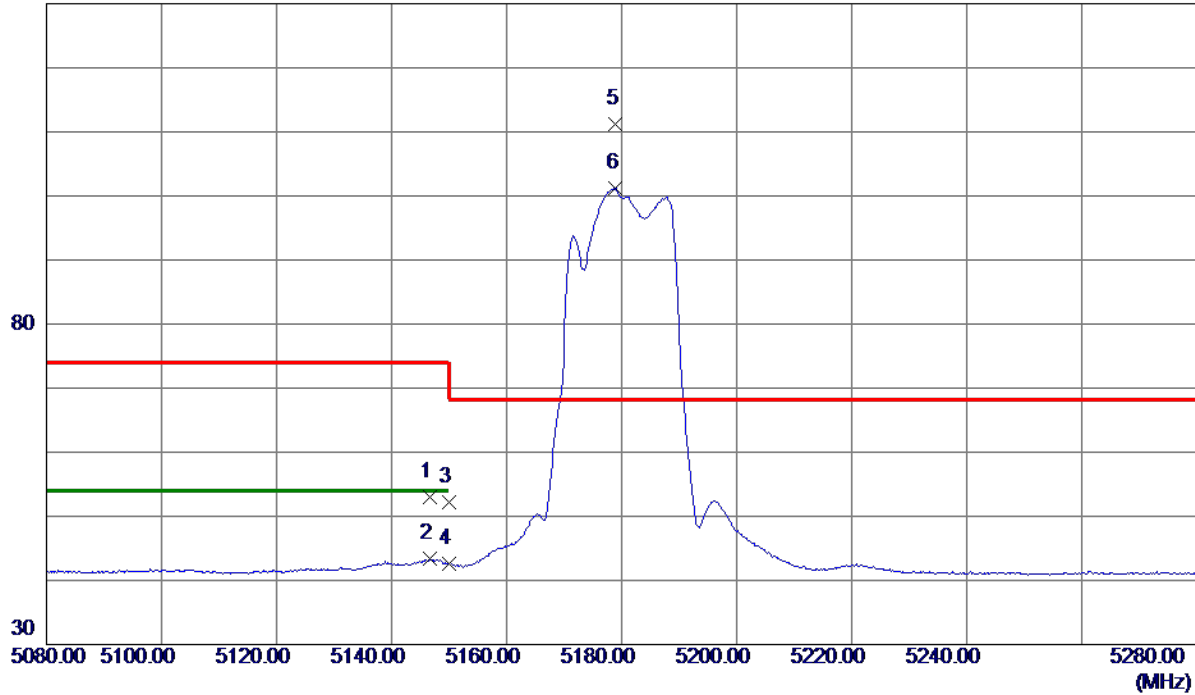

No.	Freq. MHz	Reading Level dBuV/m	Correct Factor dB	Measure ment dBuV/m	Limit dBuV/m	Margin dB	Detector	Comment
1	5146.7000	37.41	15.68	53.09	74.00	-20.91	Peak	
2	5146.7000	27.68	15.68	43.36	54.00	-10.64	AVG	
3	5150.0000	36.44	15.68	52.12	74.00	-21.88	Peak	
4	5150.0000	26.83	15.68	42.51	54.00	-11.49	AVG	
5 *	5179.0000	95.52	15.70	111.22	68.30	42.92	Peak	No Limit
6	5179.0000	85.45	15.70	101.15	999.00	-897.85	AVG	No Limit

REMARKS:

(1) Measurement Value = Reading Level + Correct Factor.

(2) Margin Level = Measurement Value - Limit Value.

Orthogonal Axis	X
Test Mode	UNII-1_TX AC (VHT20) Mode 5180 MHz

Vertical

80 dBuV/m

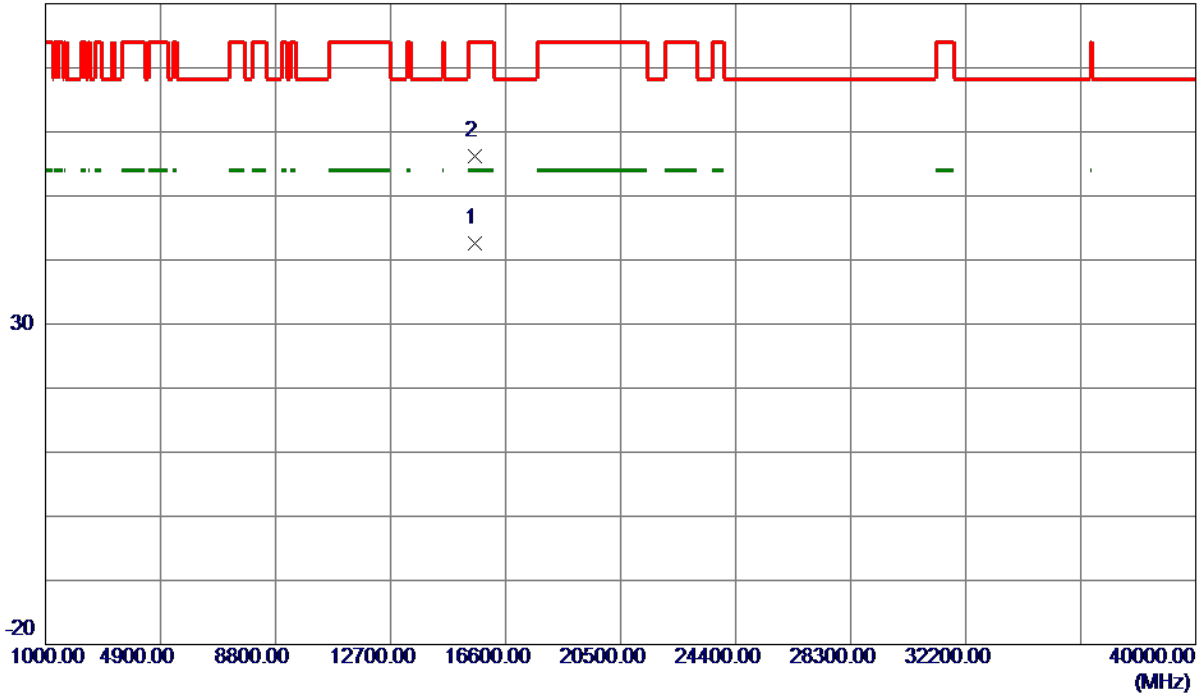

No.	Freq. MHz	Reading Level dBuV/m	Correct Factor dB	Measure ment dBuV/m	Limit dBuV/m	Margin dB	Detector	Comment
1 *	15542.9800	27.14	15.49	42.63	54.00	-11.37	AVG	
2	15544.0900	40.65	15.49	56.14	74.00	-17.86	Peak	

REMARKS:

(1) Measurement Value = Reading Level + Correct Factor.

(2) Margin Level = Measurement Value - Limit Value.

Orthogonal Axis	X
Test Mode	UNII-1_TX AC (VHT20) Mode 5180 MHz

Horizontal

130 dBuV/m

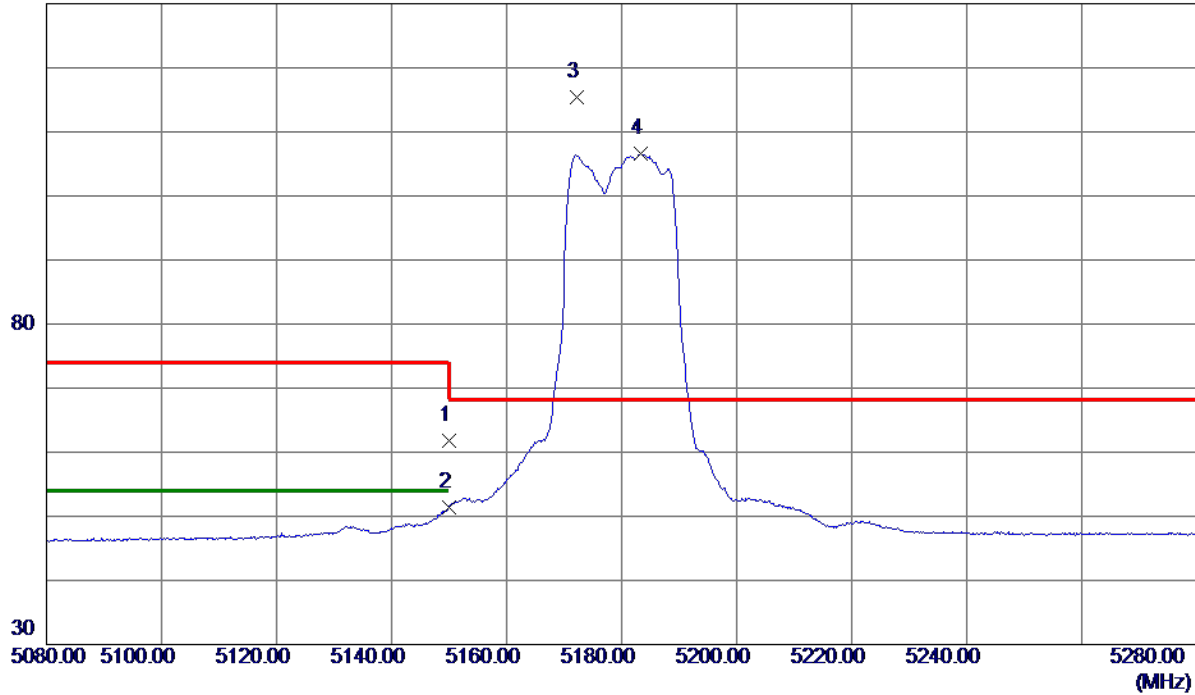

No.	Freq. MHz	Reading Level dBuV/m	Correct Factor dB	Measure ment dBuV/m	Limit dBuV/m	Margin dB	Detector	Comment
1	5150.0000	46.10	15.68	61.78	74.00	-12.22	Peak	
2	5150.0000	35.75	15.68	51.43	54.00	-2.57	AVG	
3 *	5172.3000	99.72	15.70	115.42	68.30	47.12	Peak	No Limit
4	5183.4000	90.95	15.70	106.65	999.00	-892.35	AVG	No Limit

REMARKS:

(1) Measurement Value = Reading Level + Correct Factor.

(2) Margin Level = Measurement Value - Limit Value.

Orthogonal Axis	X
Test Mode	UNII-1_TX AC (VHT20) Mode 5180 MHz

Horizontal

80 dBuV/m

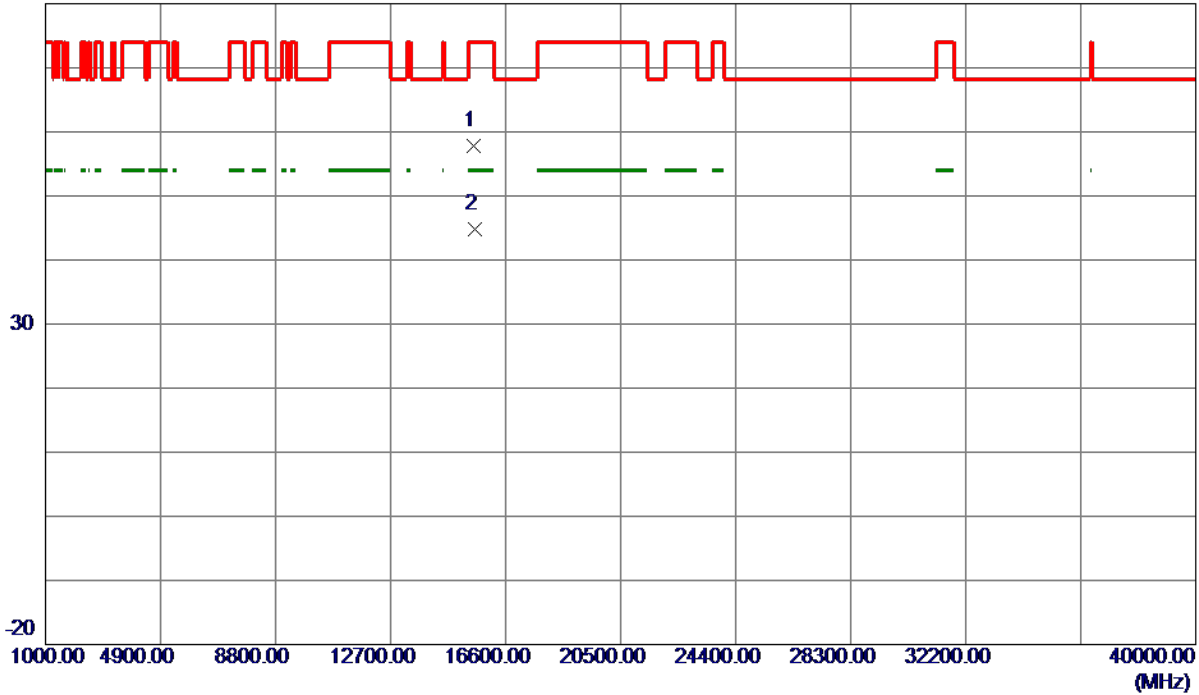

No.	Freq. MHz	Reading Level dBuV/m	Correct Factor dB	Measure ment dBuV/m	Limit dBuV/m	Margin dB	Detector	Comment
1	15535.8500	42.36	15.50	57.86	74.00	-16.14	Peak	
2 *	15539.4000	29.22	15.49	44.71	54.00	-9.29	AVG	

REMARKS:

(1) Measurement Value = Reading Level + Correct Factor.

(2) Margin Level = Measurement Value - Limit Value.

Orthogonal Axis	X
Test Mode	UNII-1_TX AC (VHT20) Mode 5200 MHz

Vertical

130 dBuV/m

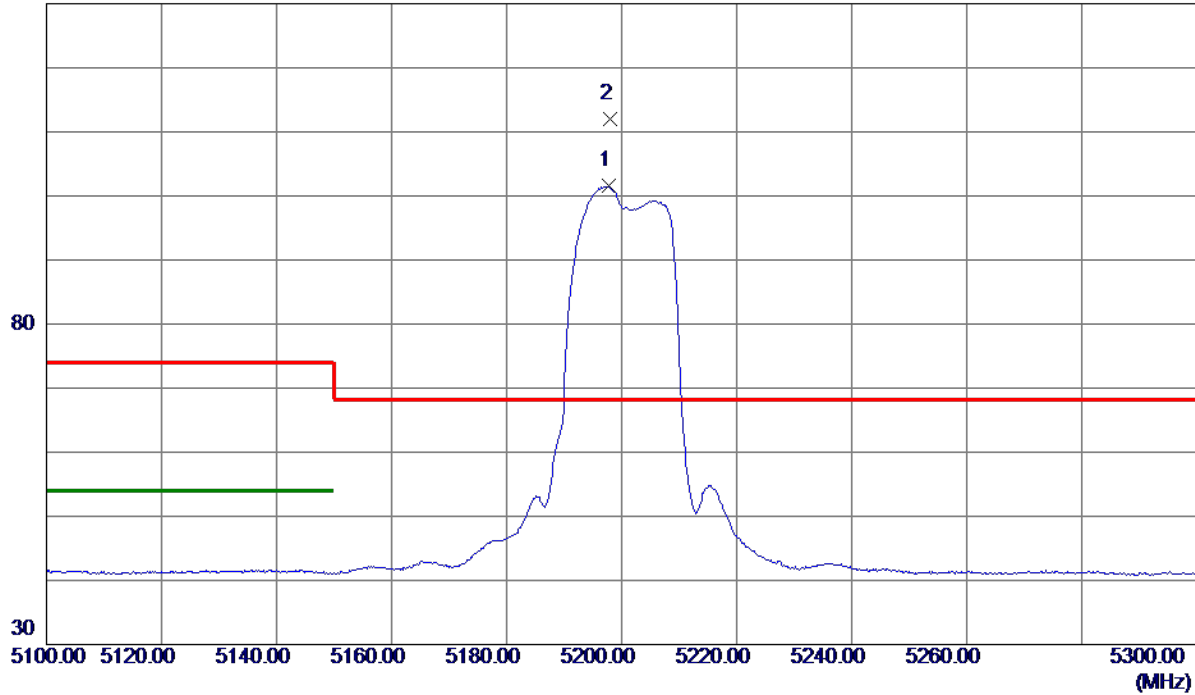

No.	Freq. MHz	Reading Level dBuV/m	Correct Factor dB	Measure ment dBuV/m	Limit dBuV/m	Margin dB	Detector	Comment
1	5197.7000	85.85	15.71	101.56	999.00	-897.44	AVG	No Limit
2 *	5198.0000	96.21	15.71	111.92	68.30	43.62	Peak	No Limit

REMARKS:

(1) Measurement Value = Reading Level + Correct Factor.

(2) Margin Level = Measurement Value - Limit Value.

Orthogonal Axis	X
Test Mode	UNII-1_TX AC (VHT20) Mode 5200 MHz

Vertical

80 dBuV/m

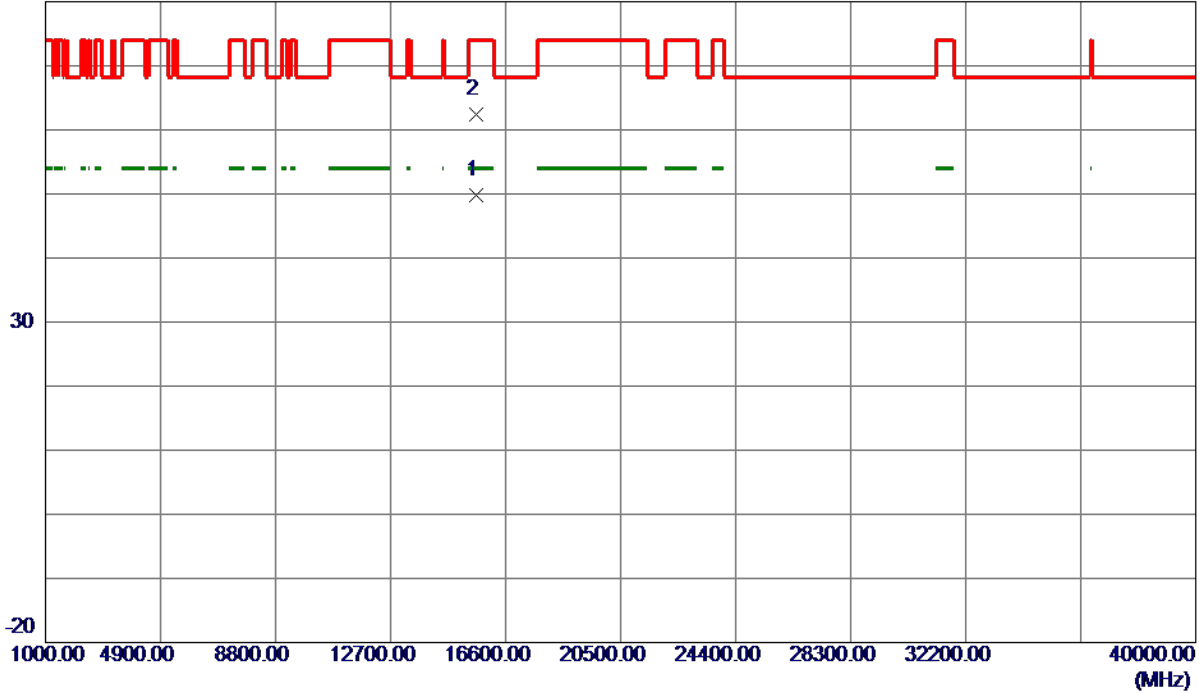

No.	Freq. MHz	Reading Level dBuV/m	Correct Factor dB	Measure ment dBuV/m	Limit dBuV/m	Margin dB	Detector	Comment
1 *	15600.4300	34.25	15.47	49.72	54.00	-4.28	AVG	
2	15609.1400	46.87	15.47	62.34	74.00	-11.66	Peak	

REMARKS:

(1) Measurement Value = Reading Level + Correct Factor.

(2) Margin Level = Measurement Value - Limit Value.

Orthogonal Axis	X
Test Mode	UNII-1_TX AC (VHT20) Mode 5200 MHz

Horizontal

130 dBuV/m

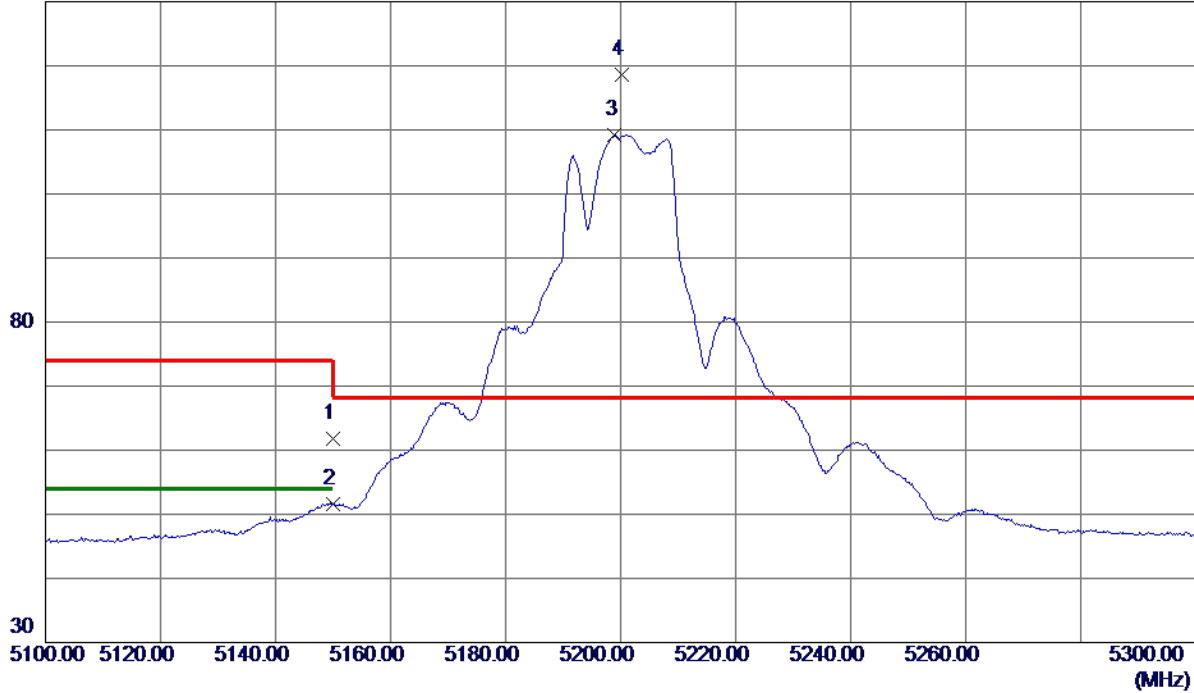

No.	Freq. MHz	Reading Level dBuV/m	Correct Factor dB	Measure ment dBuV/m	Limit dBuV/m	Margin dB	Detector	Comment
1	5150.0000	46.13	15.68	61.81	74.00	-12.19	Peak	
2	5150.0000	35.91	15.68	51.59	54.00	-2.41	AVG	
3	5199.0000	93.48	15.71	109.19	999.00	-889.81	AVG	No Limit
4 *	5200.2000	102.81	15.71	118.52	68.30	50.22	Peak	No Limit

REMARKS:

(1) Measurement Value = Reading Level + Correct Factor.

(2) Margin Level = Measurement Value - Limit Value.

Orthogonal Axis	X
Test Mode	UNII-1_TX AC (VHT20) Mode 5200 MHz

Horizontal

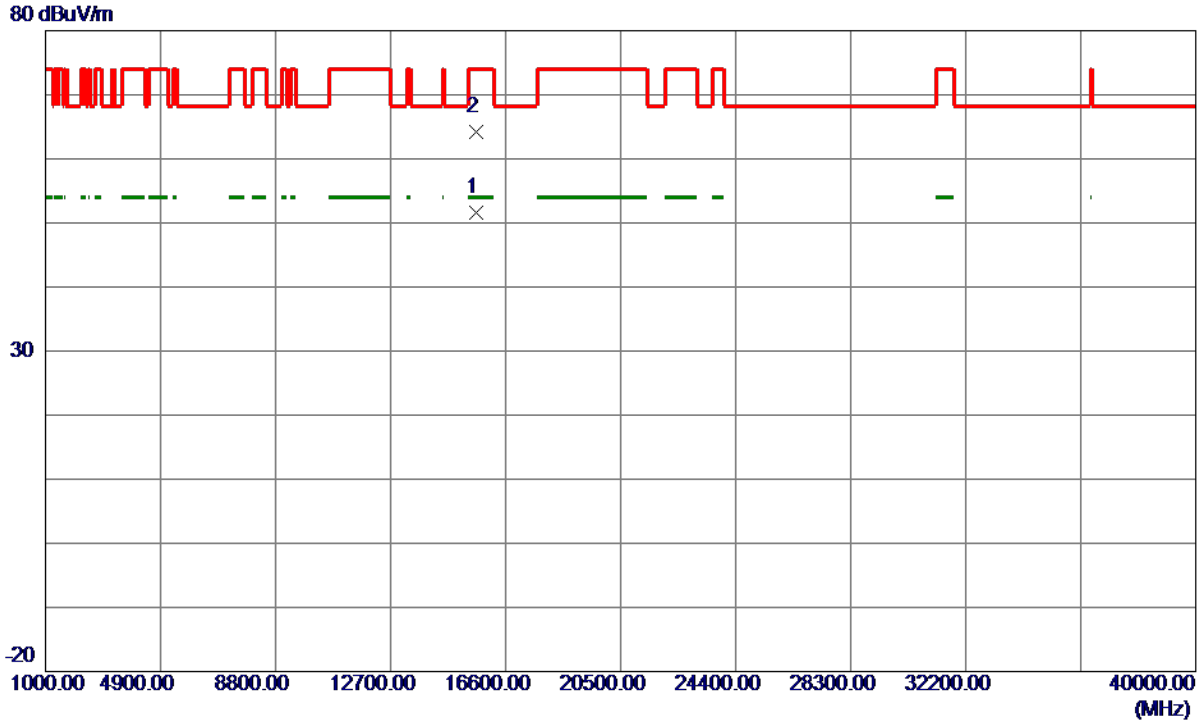

No.	Freq. MHz	Reading Level dBuV/m	Correct Factor dB	Measure ment dBuV/m	Limit dBuV/m	Margin dB	Detector	Comment
1 *	15593.6000	36.06	15.47	51.53	54.00	-2.47	AVG	
2	15594.7500	48.64	15.47	64.11	74.00	-9.89	Peak	

REMARKS:

(1) Measurement Value = Reading Level + Correct Factor.

(2) Margin Level = Measurement Value - Limit Value.

Orthogonal Axis	X
Test Mode	UNII-1_TX AC (VHT20) Mode 5240 MHz

Vertical

130 dBuV/m

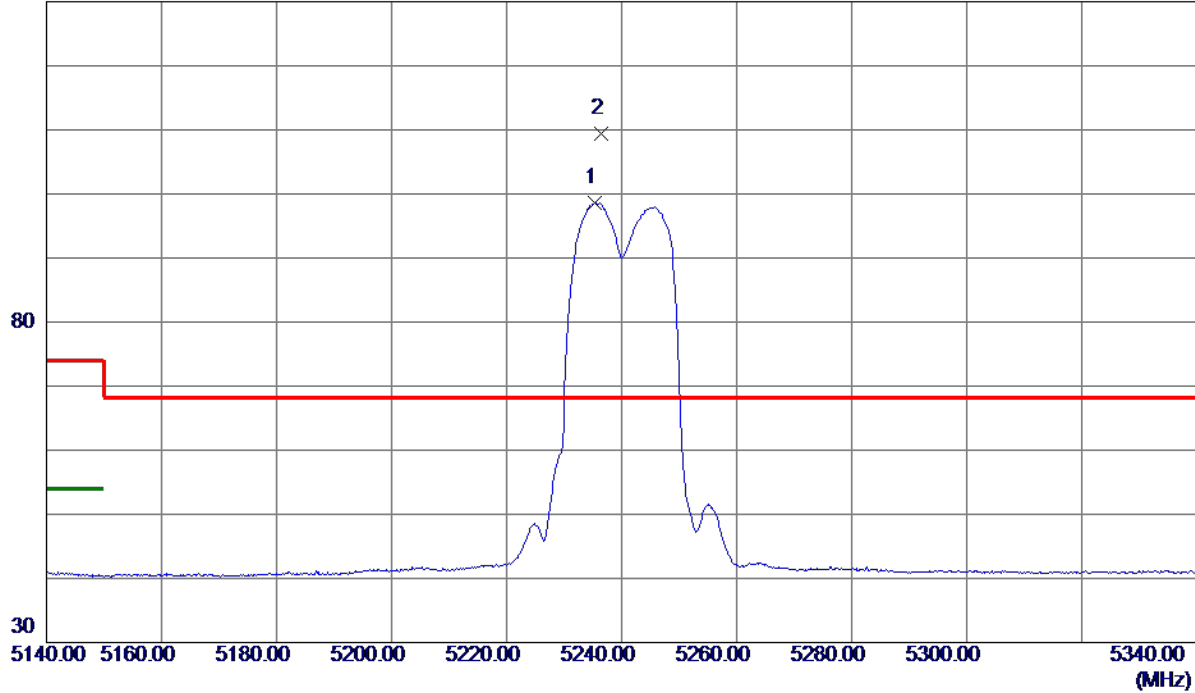

No.	Freq. MHz	Reading Level dBuV/m	Correct Factor dB	Measure ment dBuV/m	Limit dBuV/m	Margin dB	Detector	Comment
1	5235.4000	82.85	15.73	98.58	999.00	-900.42	AVG	No Limit
2 *	5236.4000	93.63	15.73	109.36	68.30	41.06	Peak	No Limit

REMARKS:

(1) Measurement Value = Reading Level + Correct Factor.

(2) Margin Level = Measurement Value - Limit Value.

Orthogonal Axis	X
Test Mode	UNII-1_TX AC (VHT20) Mode 5240 MHz

Vertical

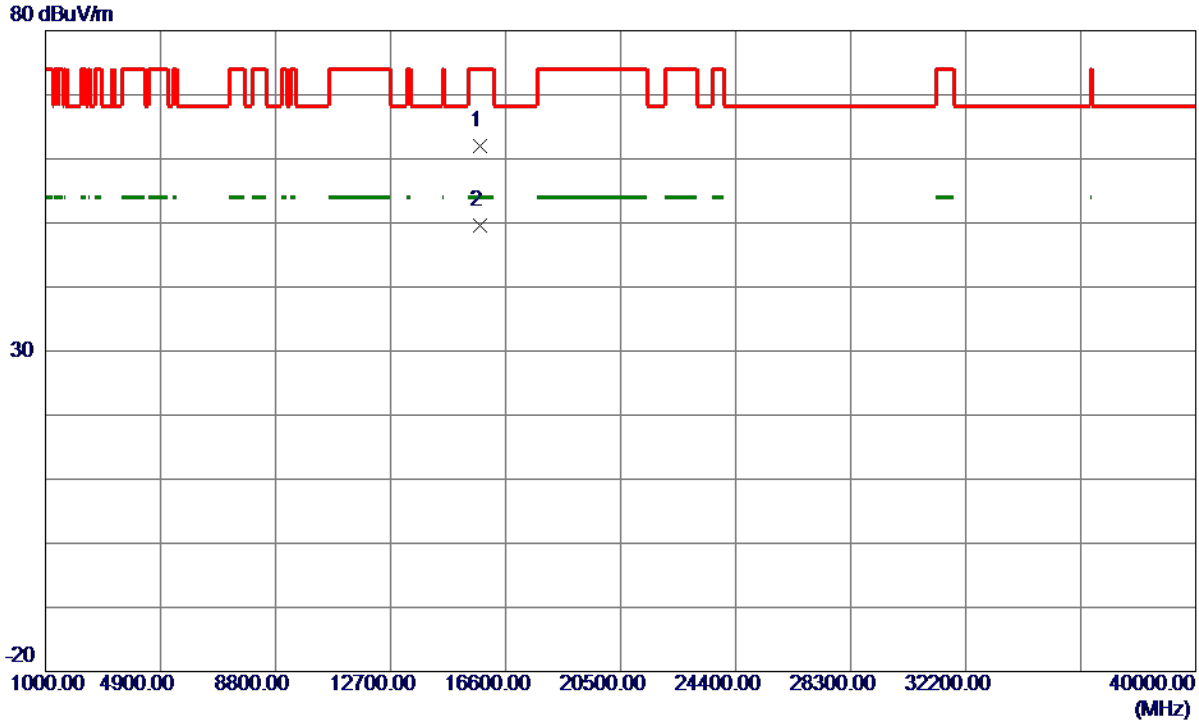

No.	Freq. MHz	Reading Level dBuV/m	Correct Factor dB	Measure ment dBuV/m	Limit dBuV/m	Margin dB	Detector	Comment
1	15720.2100	46.50	15.42	61.92	74.00	-12.08	Peak	
2 *	15728.7300	34.12	15.42	49.54	54.00	-4.46	AVG	

REMARKS:

(1) Measurement Value = Reading Level + Correct Factor.

(2) Margin Level = Measurement Value - Limit Value.

Orthogonal Axis	X
Test Mode	UNII-1_TX AC (VHT20) Mode 5240 MHz

Horizontal

130 dBuV/m

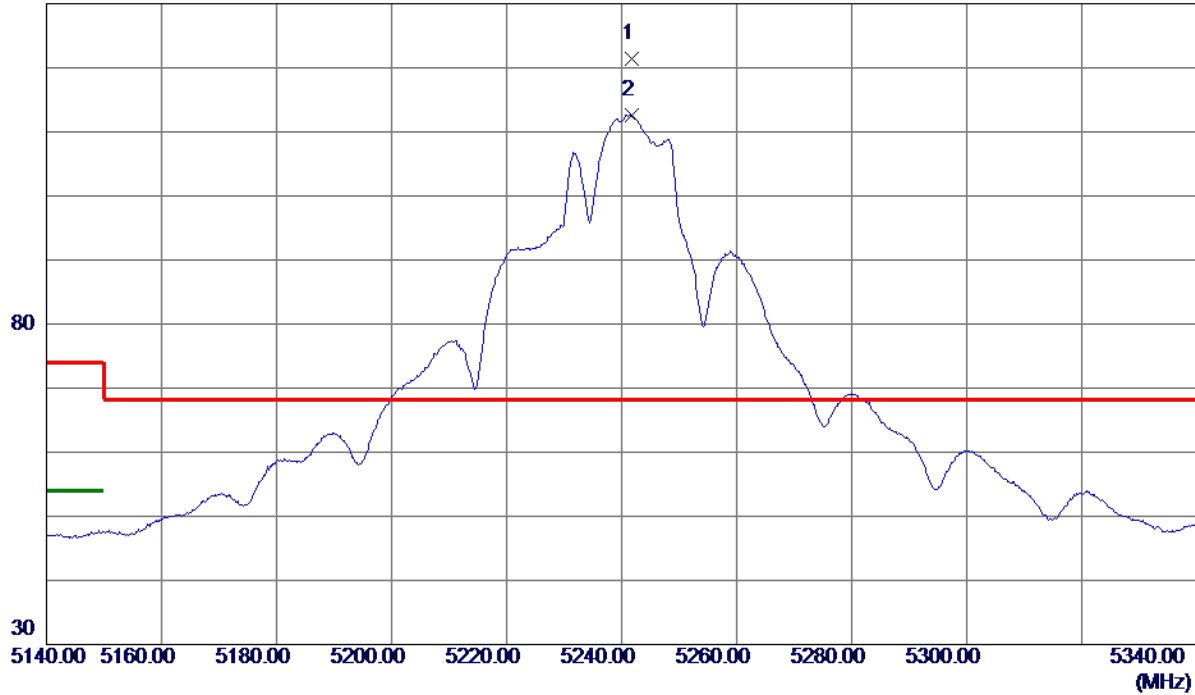

No.	Freq. MHz	Reading Level dBuV/m	Correct Factor dB	Measure ment dBuV/m	Limit dBuV/m	Margin dB	Detector	Comment
1 *	5241.7000	105.69	15.73	121.42	68.30	53.12	Peak	No Limit
2	5241.7000	96.84	15.73	112.57	999.00	-886.43	AVG	No Limit

REMARKS:

(1) Measurement Value = Reading Level + Correct Factor.

(2) Margin Level = Measurement Value - Limit Value.

Orthogonal Axis	X
Test Mode	UNII-1_TX AC (VHT20) Mode 5240 MHz

Horizontal

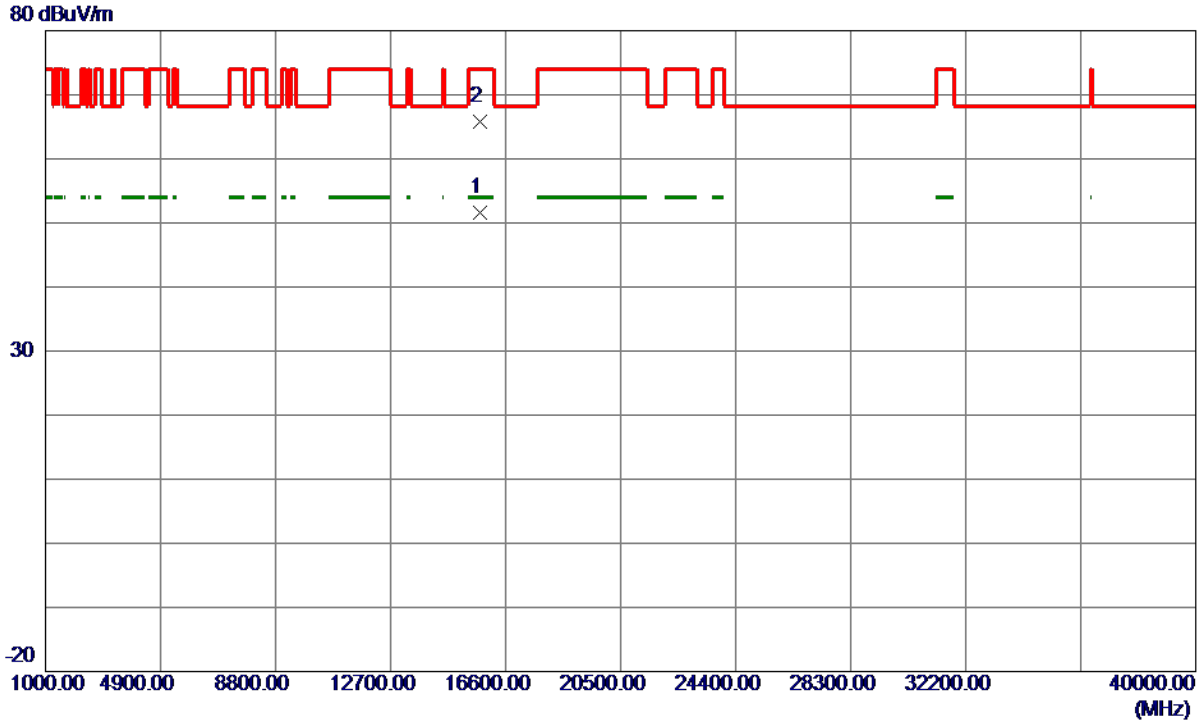

No.	Freq. MHz	Reading Level dBuV/m	Correct Factor dB	Measure ment dBuV/m	Limit dBuV/m	Margin dB	Detector	Comment
1 *	15724.2000	36.14	15.42	51.56	54.00	-2.44	AVG	
2	15724.3000	50.28	15.42	65.70	74.00	-8.30	Peak	

REMARKS:

(1) Measurement Value = Reading Level + Correct Factor.

(2) Margin Level = Measurement Value - Limit Value.

Orthogonal Axis	X
Test Mode	UNII-1_TX AC (VHT40) Mode 5190 MHz

Vertical

130 dBuV/m

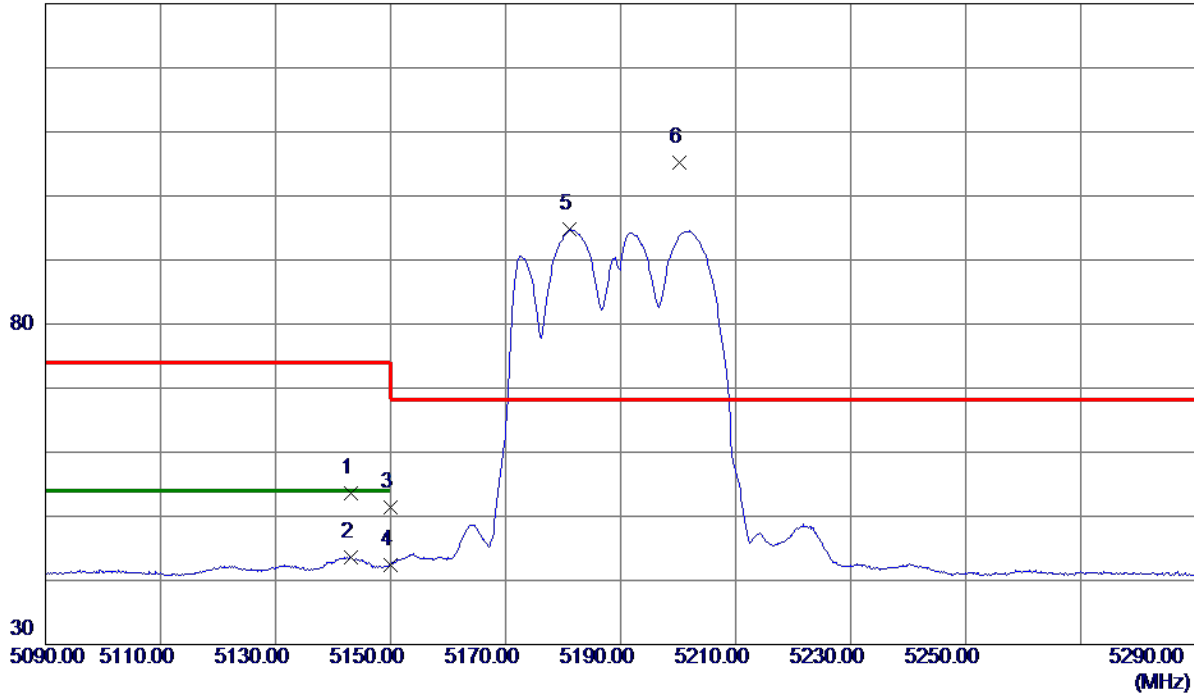

No.	Freq. MHz	Reading Level dBuV/m	Correct Factor dB	Measure ment dBuV/m	Limit dBuV/m	Margin dB	Detector	Comment
1	5143.1000	37.86	15.68	53.54	74.00	-20.46	Peak	
2	5143.1000	27.95	15.68	43.63	54.00	-10.37	AVG	
3	5150.0000	35.74	15.68	51.42	74.00	-22.58	Peak	
4	5150.0000	26.81	15.68	42.49	54.00	-11.51	AVG	
5	5181.2000	79.02	15.70	94.72	999.00	-904.28	AVG	No Limit
6 *	5200.3000	89.41	15.71	105.12	68.30	36.82	Peak	No Limit

REMARKS:

(1) Measurement Value = Reading Level + Correct Factor.

(2) Margin Level = Measurement Value - Limit Value.

Orthogonal Axis	X
Test Mode	UNII-1_TX AC (VHT40) Mode 5190 MHz

Vertical

80 dBuV/m

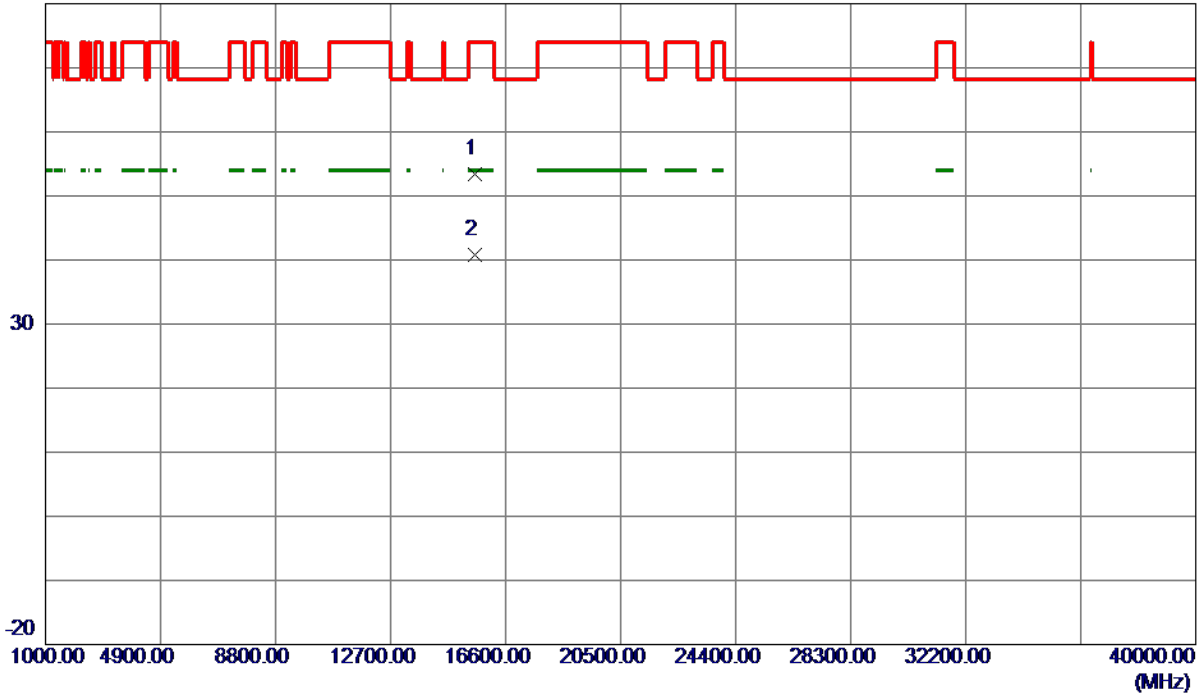

No.	Freq. MHz	Reading Level dBuV/m	Correct Factor dB	Measure ment dBuV/m	Limit dBuV/m	Margin dB	Detector	Comment
1	15565.3200	37.95	15.48	53.43	74.00	-20.57	Peak	
2 *	15576.9600	25.35	15.48	40.83	54.00	-13.17	AVG	

REMARKS:

(1) Measurement Value = Reading Level + Correct Factor.

(2) Margin Level = Measurement Value - Limit Value.

Orthogonal Axis	X
Test Mode	UNII-1_TX AC (VHT40) Mode 5190 MHz

Horizontal

130 dBuV/m

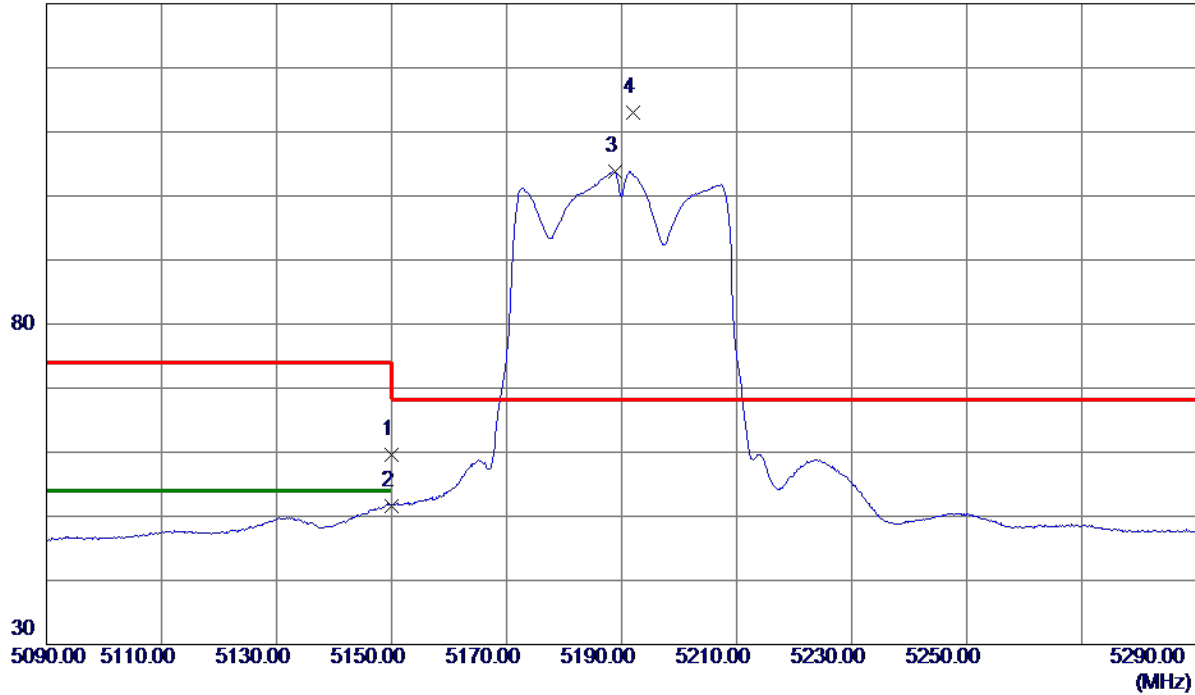

No.	Freq. MHz	Reading Level dBuV/m	Correct Factor dB	Measure ment dBuV/m	Limit dBuV/m	Margin dB	Detector	Comment
1	5150.0000	43.93	15.68	59.61	74.00	-14.39	Peak	
2	5150.0000	35.99	15.68	51.67	54.00	-2.33	AVG	
3	5188.8000	88.12	15.70	103.82	999.00	-895.18	AVG	No Limit
4 *	5192.0000	97.21	15.71	112.92	68.30	44.62	Peak	No Limit

REMARKS:

(1) Measurement Value = Reading Level + Correct Factor.

(2) Margin Level = Measurement Value - Limit Value.

Orthogonal Axis	X
Test Mode	UNII-1_TX AC (VHT40) Mode 5190 MHz

Horizontal

80 dBuV/m

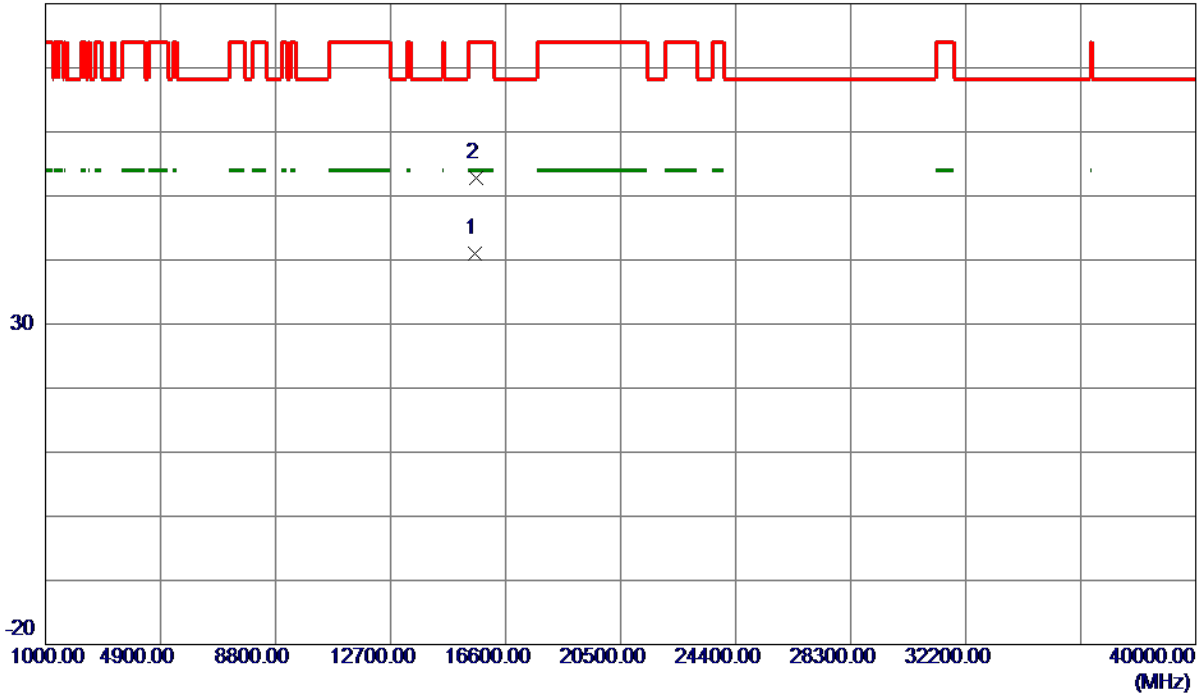

No.	Freq. MHz	Reading Level dBuV/m	Correct Factor dB	Measure ment dBuV/m	Limit dBuV/m	Margin dB	Detector	Comment
1 *	15561.8000	25.50	15.49	40.99	54.00	-13.01	AVG	
2	15604.9500	37.25	15.47	52.72	74.00	-21.28	Peak	

REMARKS:

(1) Measurement Value = Reading Level + Correct Factor.

(2) Margin Level = Measurement Value - Limit Value.

Orthogonal Axis	X
Test Mode	UNII-1_TX AC (VHT40) Mode 5230 MHz

Vertical

130 dBuV/m

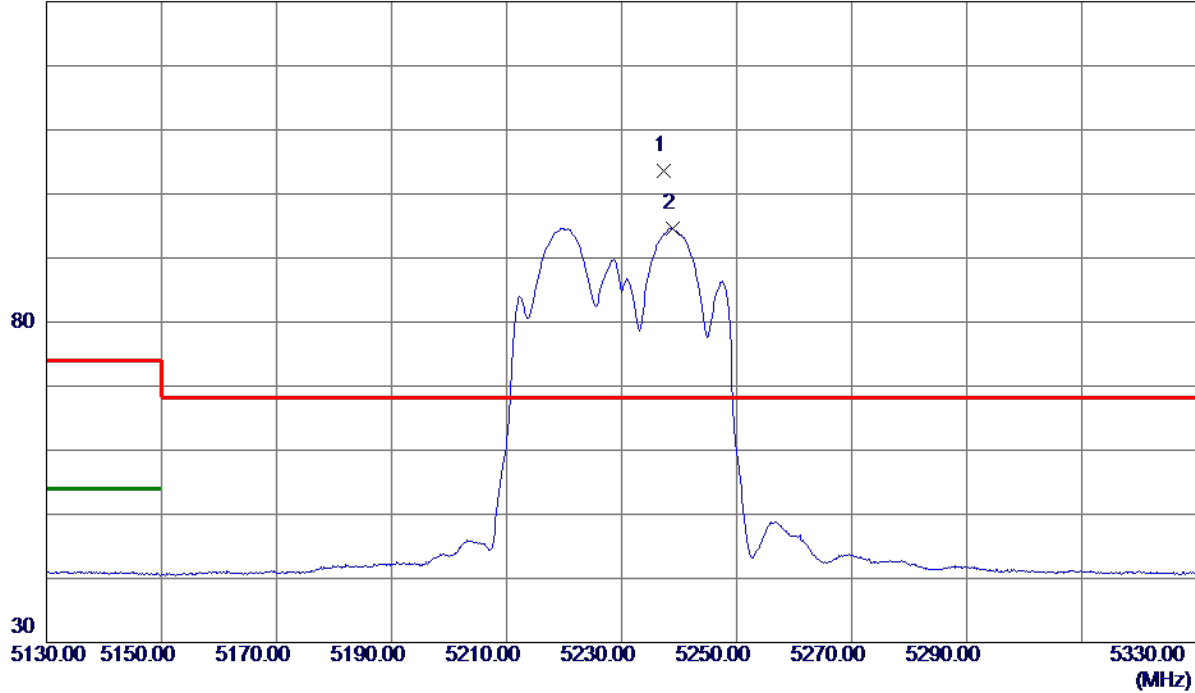

No.	Freq. MHz	Reading Level dBuV/m	Correct Factor dB	Measure ment dBuV/m	Limit dBuV/m	Margin dB	Detector	Comment
1 *	5237.4000	87.93	15.73	103.66	68.30	35.36	Peak	No Limit
2	5238.9000	78.90	15.73	94.63	999.00	-904.37	AVG	No Limit

REMARKS:

(1) Measurement Value = Reading Level + Correct Factor.

(2) Margin Level = Measurement Value - Limit Value.

Orthogonal Axis	X
Test Mode	UNII-1_TX AC (VHT40) Mode 5230 MHz

Vertical

80 dBuV/m

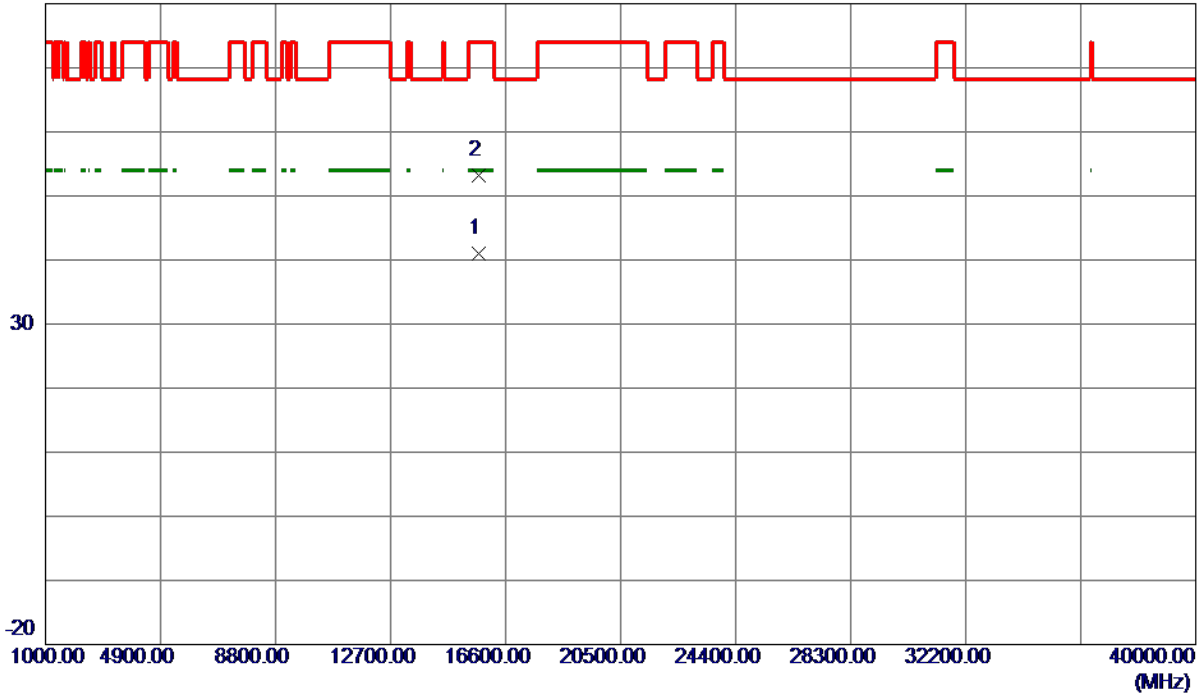

No.	Freq. MHz	Reading Level dBuV/m	Correct Factor dB	Measure ment dBuV/m	Limit dBuV/m	Margin dB	Detector	Comment
1 *	15688.9200	25.51	15.43	40.94	54.00	-13.06	AVG	
2	15696.8300	37.84	15.43	53.27	74.00	-20.73	Peak	

REMARKS:

(1) Measurement Value = Reading Level + Correct Factor.

(2) Margin Level = Measurement Value - Limit Value.

Orthogonal Axis	X
Test Mode	UNII-1_TX AC (VHT40) Mode 5230 MHz

Horizontal

130 dBuV/m

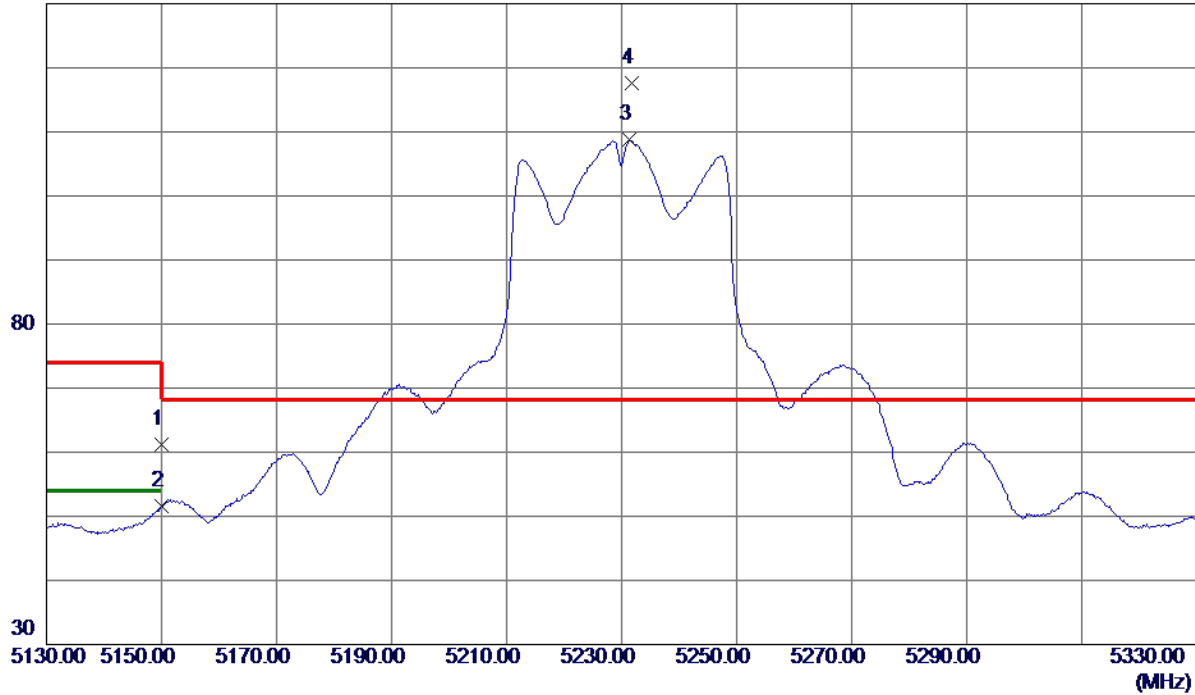

No.	Freq. MHz	Reading Level dBuV/m	Correct Factor dB	Measure ment dBuV/m	Limit dBuV/m	Margin dB	Detector	Comment
1	5150.0000	45.59	15.68	61.27	74.00	-12.73	Peak	
2	5150.0000	35.92	15.68	51.60	54.00	-2.40	AVG	
3	5231.3000	93.01	15.73	108.74	999.00	-890.26	AVG	No Limit
4 *	5231.7000	101.81	15.73	117.54	68.30	49.24	Peak	No Limit

REMARKS:

(1) Measurement Value = Reading Level + Correct Factor.

(2) Margin Level = Measurement Value - Limit Value.

Orthogonal Axis	X
Test Mode	UNII-1_TX AC (VHT40) Mode 5230 MHz

Horizontal

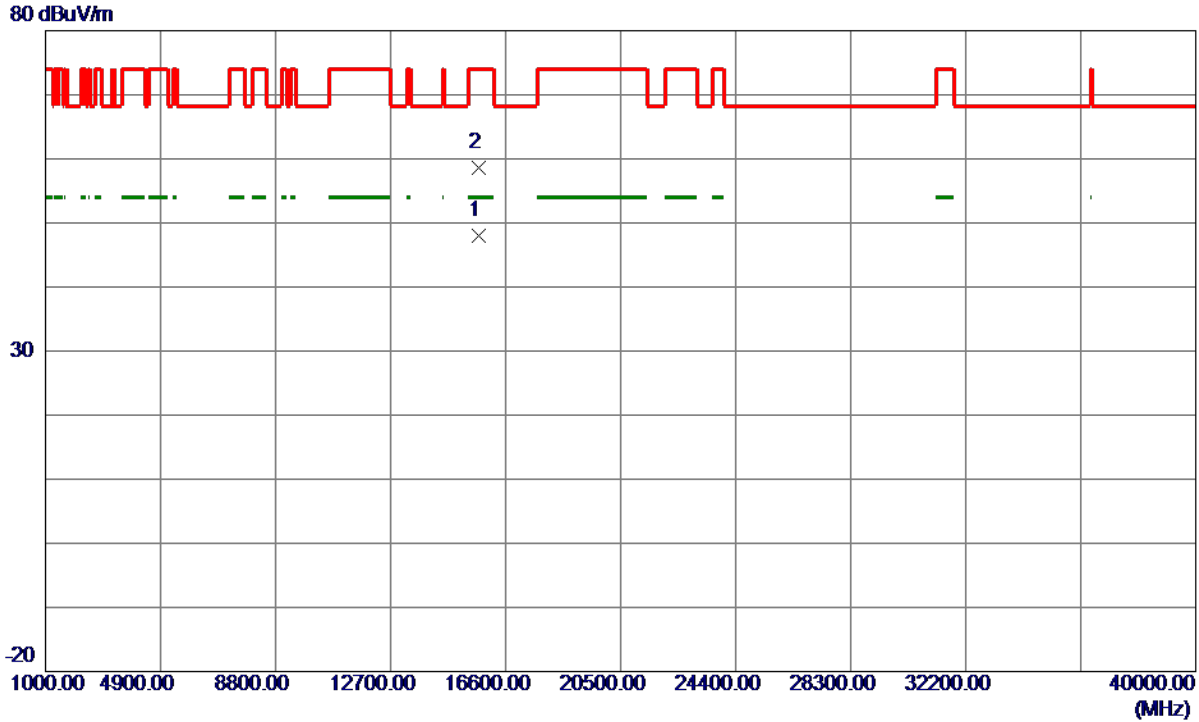

No.	Freq. MHz	Reading Level dBuV/m	Correct Factor dB	Measure ment dBuV/m	Limit dBuV/m	Margin dB	Detector	Comment
1 *	15685.3000	32.63	15.44	48.07	54.00	-5.93	AVG	
2	15704.8000	43.25	15.43	58.68	74.00	-15.32	Peak	

REMARKS:

(1) Measurement Value = Reading Level + Correct Factor.

(2) Margin Level = Measurement Value - Limit Value.

Orthogonal Axis	X
Test Mode	UNII-1_TX AC (VHT80) Mode 5210 MHz

Vertical

130 dBuV/m

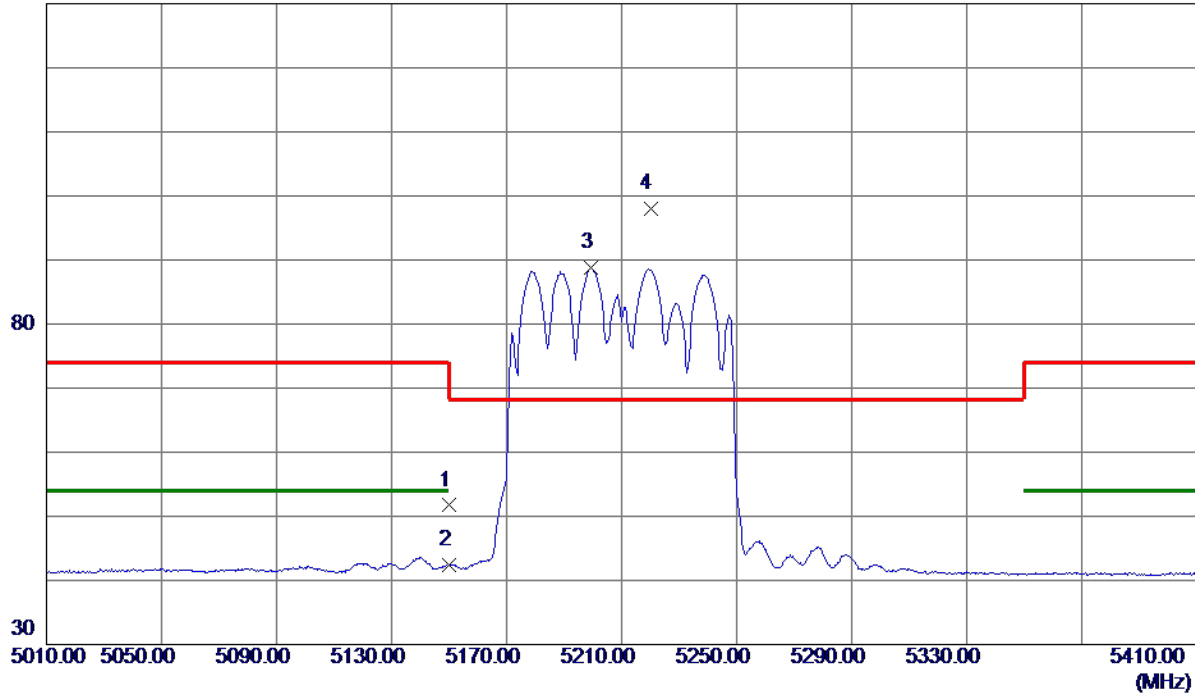

No.	Freq. MHz	Reading Level dBuV/m	Correct Factor dB	Measure ment dBuV/m	Limit dBuV/m	Margin dB	Detector	Comment
1	5150.0000	36.02	15.68	51.70	74.00	-22.30	Peak	
2	5150.0000	26.63	15.68	42.31	54.00	-11.69	AVG	
3	5199.4000	73.00	15.71	88.71	999.00	-910.29	AVG	No Limit
4 *	5220.0000	82.35	15.72	98.07	68.30	29.77	Peak	No Limit

REMARKS:

(1) Measurement Value = Reading Level + Correct Factor.

(2) Margin Level = Measurement Value - Limit Value.

Orthogonal Axis	X
Test Mode	UNII-1_TX AC (VHT80) Mode 5210 MHz

Vertical

80 dBuV/m

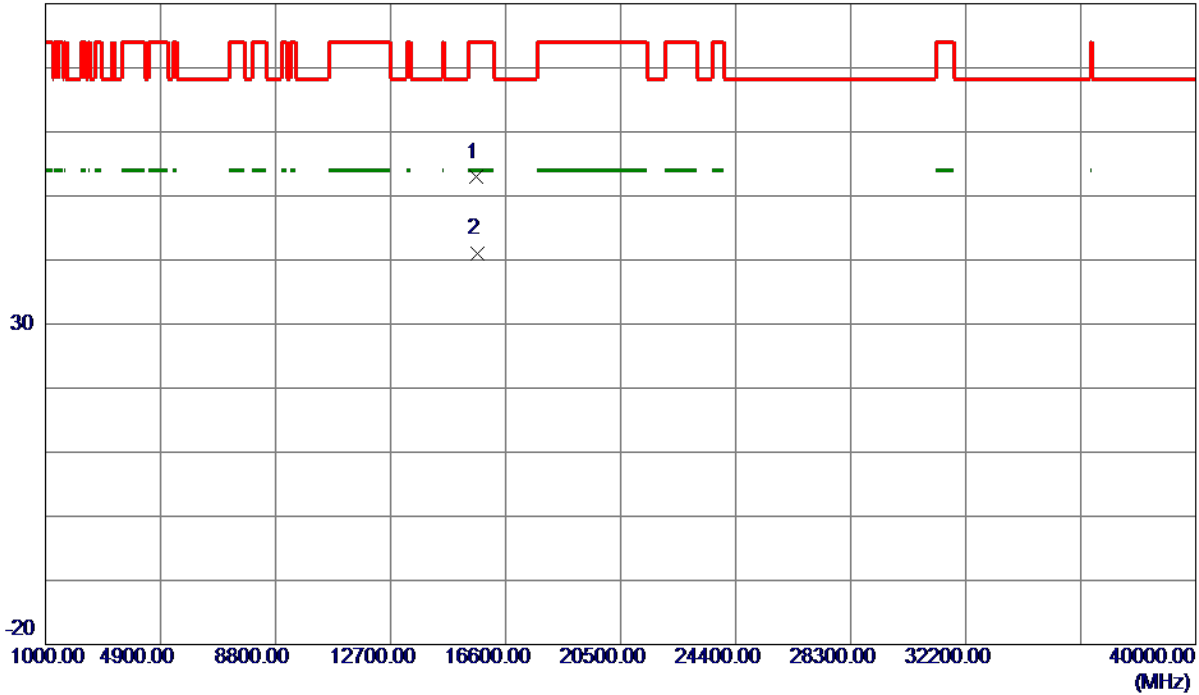

No.	Freq. MHz	Reading Level dBuV/m	Correct Factor dB	Measure ment dBuV/m	Limit dBuV/m	Margin dB	Detector	Comment
1	15621.0400	37.44	15.46	52.90	74.00	-21.10	Peak	
2 *	15635.5600	25.46	15.46	40.92	54.00	-13.08	AVG	

REMARKS:

(1) Measurement Value = Reading Level + Correct Factor.

(2) Margin Level = Measurement Value - Limit Value.

Orthogonal Axis	X
Test Mode	UNII-1_TX AC (VHT80) Mode 5210 MHz

Horizontal

130 dBuV/m

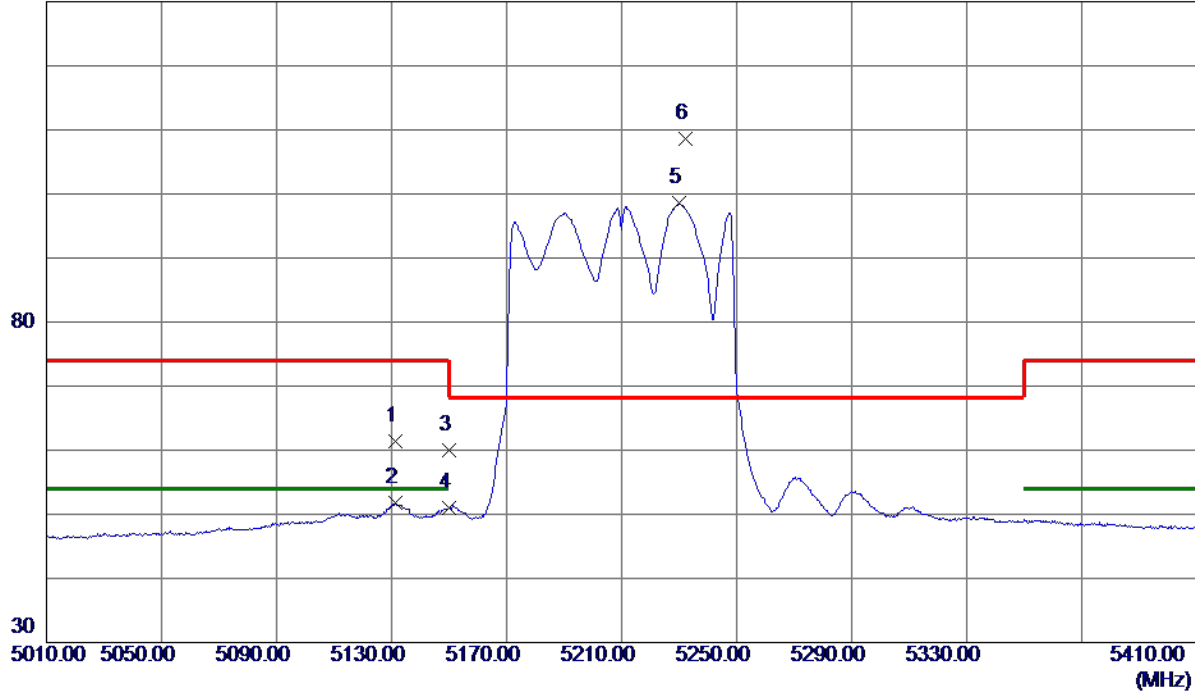

No.	Freq. MHz	Reading Level dBuV/m	Correct Factor dB	Measure ment dBuV/m	Limit dBuV/m	Margin dB	Detector	Comment
1	5131.2000	45.64	15.68	61.32	74.00	-12.68	Peak	
2	5131.2000	36.07	15.68	51.75	54.00	-2.25	AVG	
3	5150.0000	44.41	15.68	60.09	74.00	-13.91	Peak	
4	5150.0000	35.28	15.68	50.96	54.00	-3.04	AVG	
5	5229.8000	82.80	15.72	98.52	999.00	-900.48	AVG	No Limit
6 *	5232.2000	92.82	15.73	108.55	68.30	40.25	Peak	No Limit

REMARKS:

(1) Measurement Value = Reading Level + Correct Factor.

(2) Margin Level = Measurement Value - Limit Value.

Orthogonal Axis	X
Test Mode	UNII-1_TX AC (VHT80) Mode 5210 MHz

Horizontal

80 dBuV/m

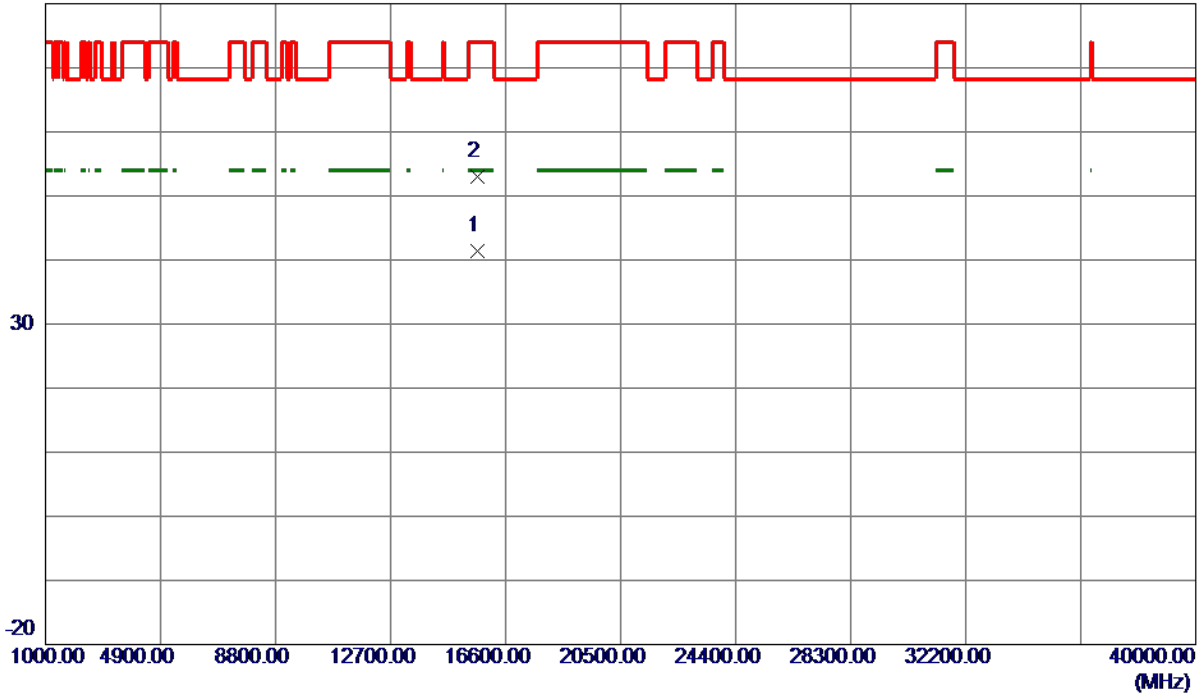

No.	Freq. MHz	Reading Level dBuV/m	Correct Factor dB	Measure ment dBuV/m	Limit dBuV/m	Margin dB	Detector	Comment
1 *	15633.0000	25.94	15.46	41.40	54.00	-12.60	AVG	
2	15636.8000	37.56	15.46	53.02	74.00	-20.98	Peak	

REMARKS:

(1) Measurement Value = Reading Level + Correct Factor.

(2) Margin Level = Measurement Value - Limit Value.

Orthogonal Axis	X
Test Mode	UNII-3_TX AC (VHT20) Mode 5745 MHz

Vertical

130 dBuV/m

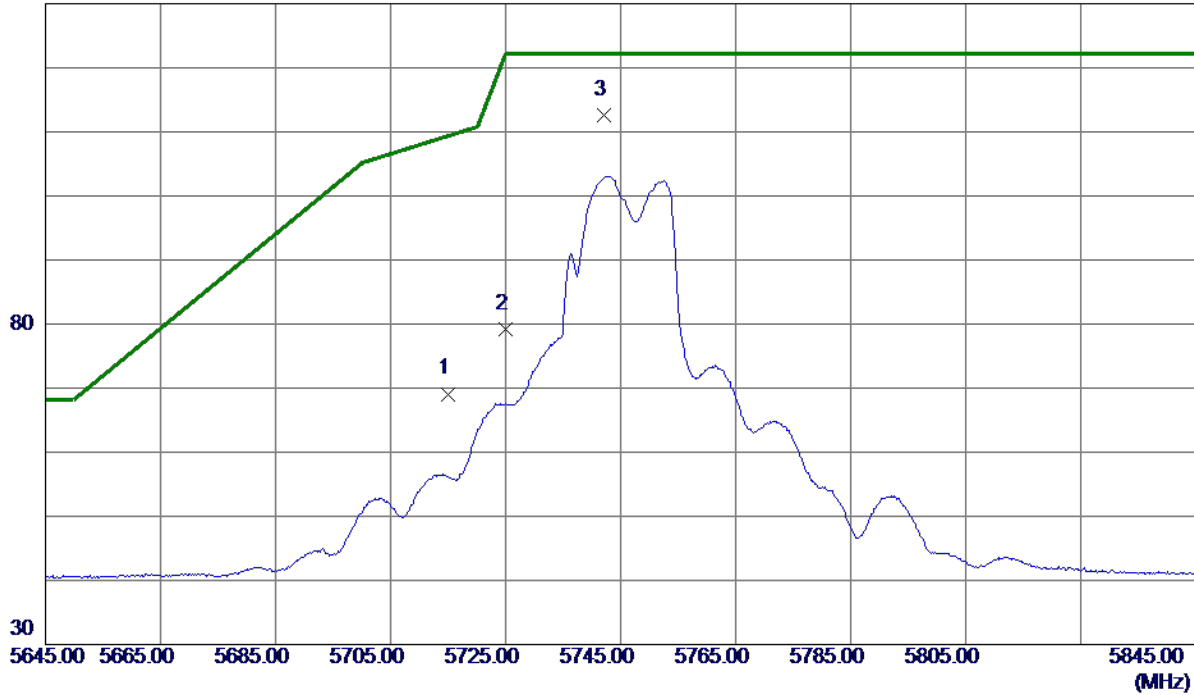

No.	Freq. MHz	Reading Level dBuV/m	Correct Factor dB	Measure ment dBuV/m	Limit dBuV/m	Margin dB	Detector	Comment
1	5715.0000	53.11	15.99	69.10	109.40	-40.30	Peak	
2	5725.0000	63.21	16.00	79.21	122.20	-42.99	Peak	
3 *	5742.2000	96.51	16.01	112.52	122.20	-9.68	Peak	No Limit

REMARKS:

(1) Measurement Value = Reading Level + Correct Factor.

(2) Margin Level = Measurement Value - Limit Value.

Orthogonal Axis	X
Test Mode	UNII-3_TX AC (VHT20) Mode 5745 MHz

Vertical

80 dBuV/m

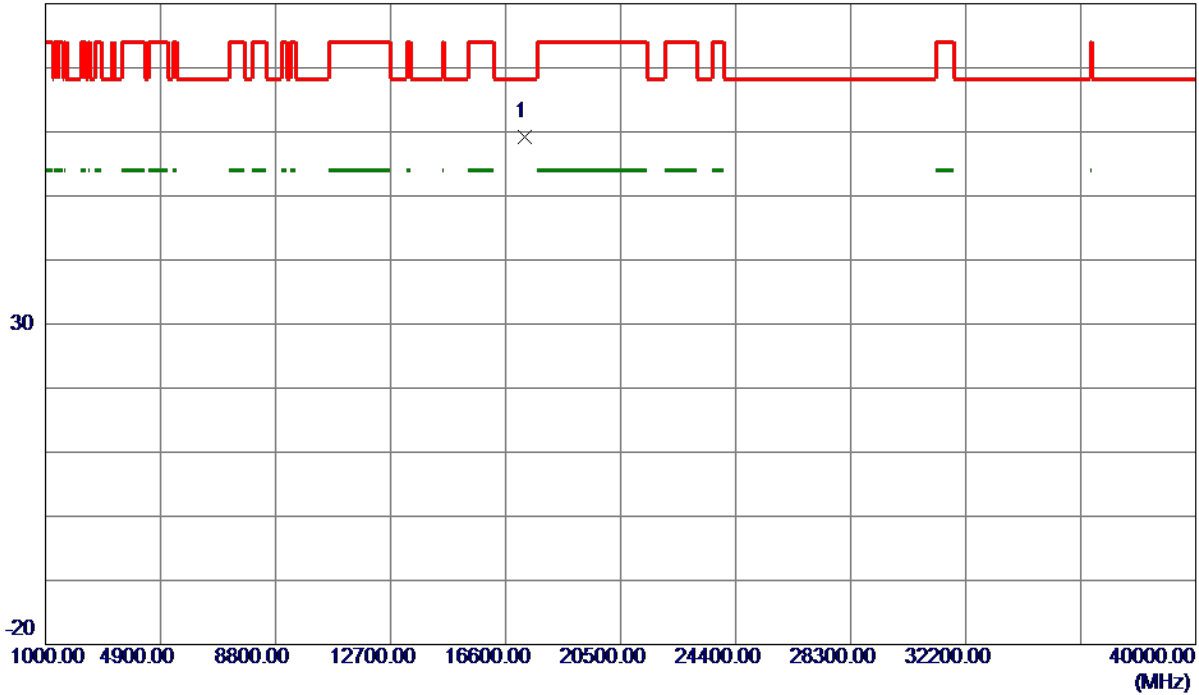

No.	Freq. MHz	Reading Level dBuV/m	Correct Factor dB	Measure ment dBuV/m	Limit dBuV/m	Margin dB	Detector	Comment
1 *	17235.7200	40.25	18.95	59.20	68.30	-9.10	Peak	

REMARKS:

(1) Measurement Value = Reading Level + Correct Factor.

(2) Margin Level = Measurement Value - Limit Value.

Orthogonal Axis	X
Test Mode	UNII-3_TX AC (VHT20) Mode 5745 MHz

Horizontal

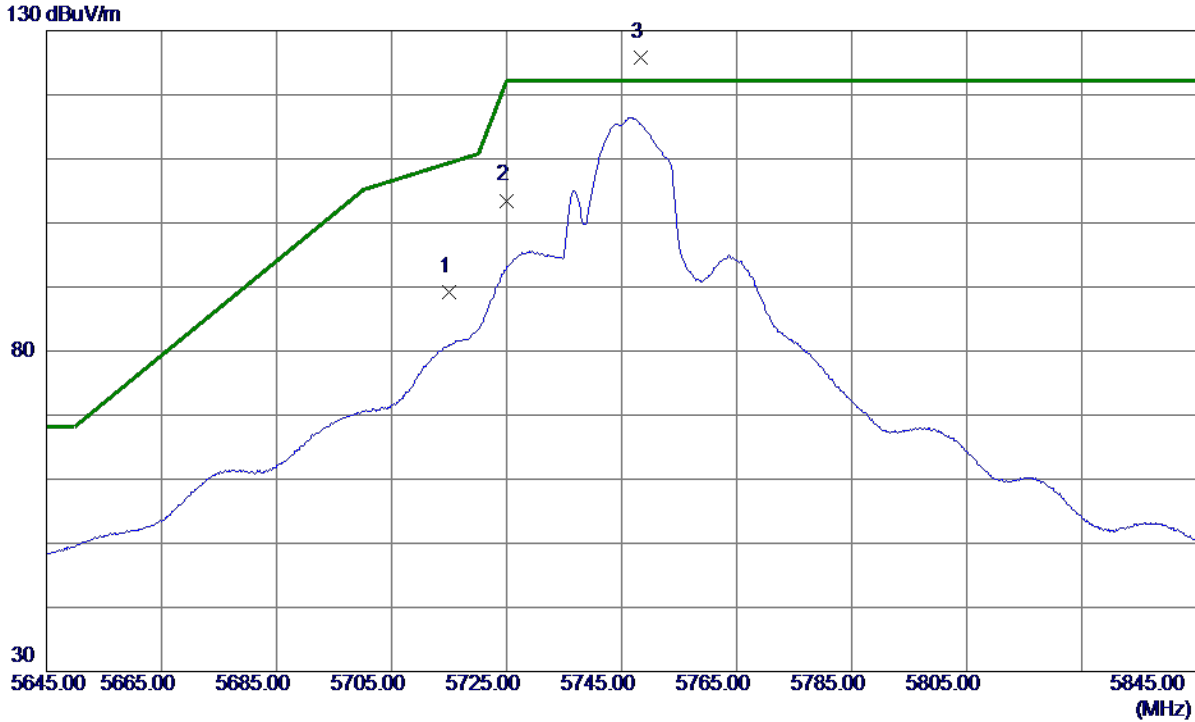

No.	Freq. MHz	Reading Level dBuV/m	Correct Factor dB	Measurement dBuV/m	Limit dBuV/m	Margin dB	Detector	Comment
1	5715.0000	73.27	15.99	89.26	109.40	-20.14	Peak	
2	5725.0000	87.50	16.00	103.50	122.20	-18.70	Peak	
3 *	5748.4000	109.70	16.01	125.71	122.20	3.51	Peak	No Limit

REMARKS:

(1) Measurement Value = Reading Level + Correct Factor.

(2) Margin Level = Measurement Value - Limit Value.

Orthogonal Axis	X
Test Mode	UNII-3_TX AC (VHT20) Mode 5745 MHz

Horizontal

80 dBuV/m

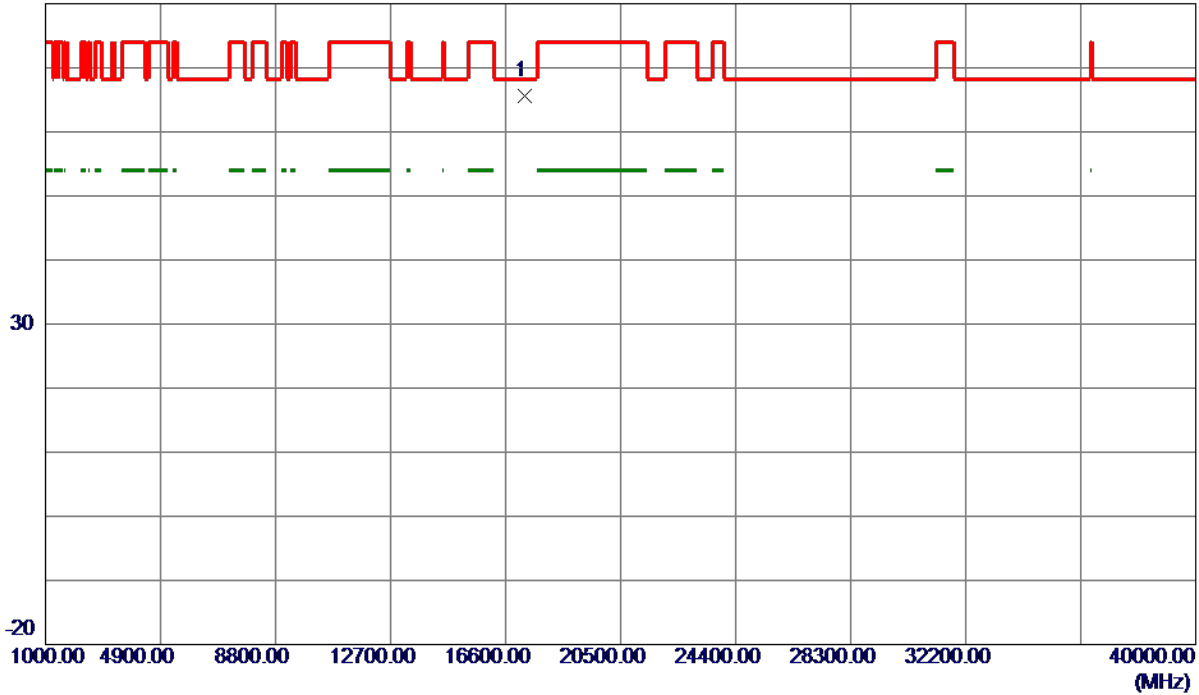

No.	Freq. MHz	Reading Level dBuV/m	Correct Factor dB	Measure ment dBuV/m	Limit dBuV/m	Margin dB	Detector	Comment
1 *	17236.1000	46.66	18.95	65.61	68.30	-2.69	Peak	

REMARKS:

(1) Measurement Value = Reading Level + Correct Factor.

(2) Margin Level = Measurement Value - Limit Value.

Orthogonal Axis	X
Test Mode	UNII-3_TX AC (VHT20) Mode 5785 MHz

Vertical

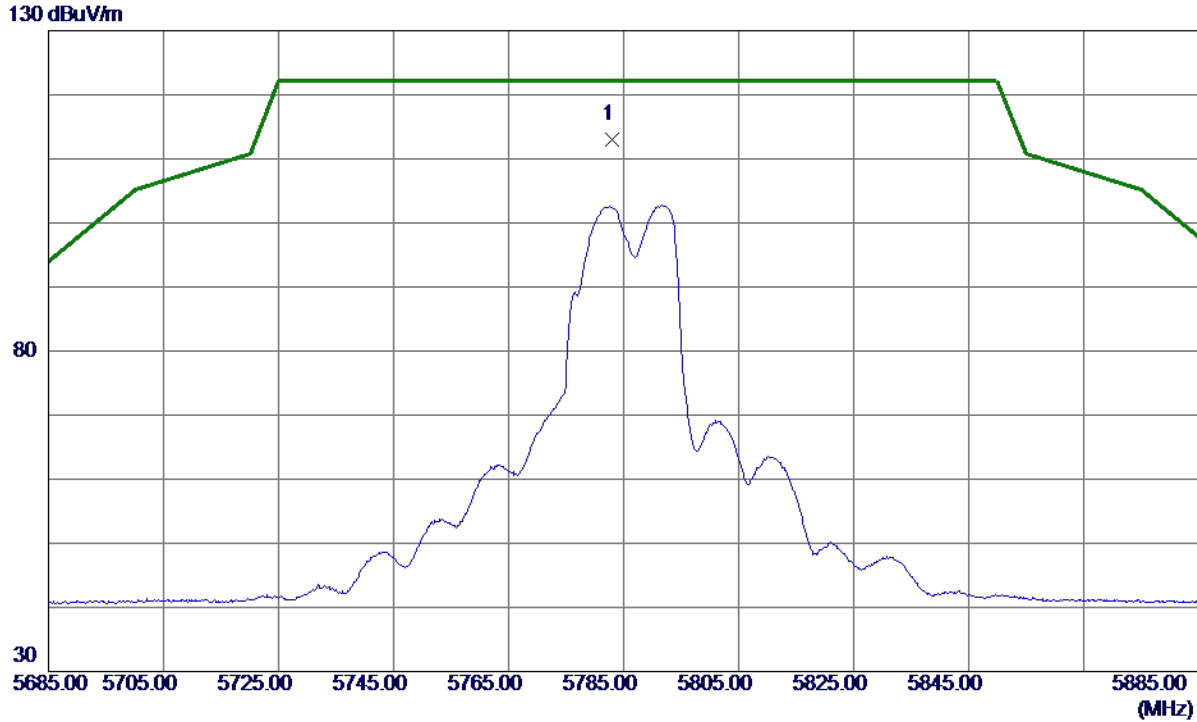

No.	Freq. MHz	Reading Level dBuV/m	Correct Factor dB	Measure ment dBuV/m	Limit dBuV/m	Margin dB	Detector	Comment
1 *	5783.1000	96.98	16.04	113.02	122.20	-9.18	Peak	No Limit

REMARKS:

(1) Measurement Value = Reading Level + Correct Factor.

(2) Margin Level = Measurement Value - Limit Value.

Orthogonal Axis	X
Test Mode	UNII-3_TX AC (VHT20) Mode 5785 MHz

Vertical

80 dBuV/m

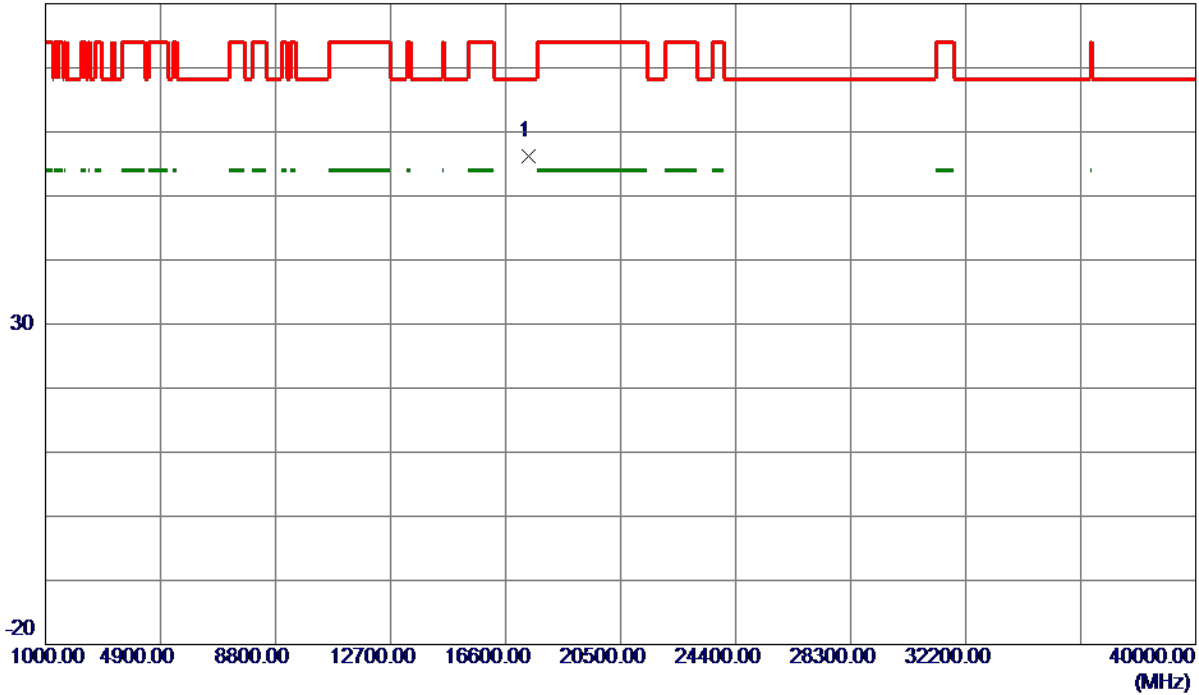

No.	Freq. MHz	Reading Level dBuV/m	Correct Factor dB	Measure ment dBuV/m	Limit dBuV/m	Margin dB	Detector	Comment
1 *	17363.5500	36.76	19.40	56.16	68.30	-12.14	Peak	

REMARKS:

(1) Measurement Value = Reading Level + Correct Factor.

(2) Margin Level = Measurement Value - Limit Value.

Orthogonal Axis	X
Test Mode	UNII-3_TX AC (VHT20) Mode 5785 MHz

Horizontal

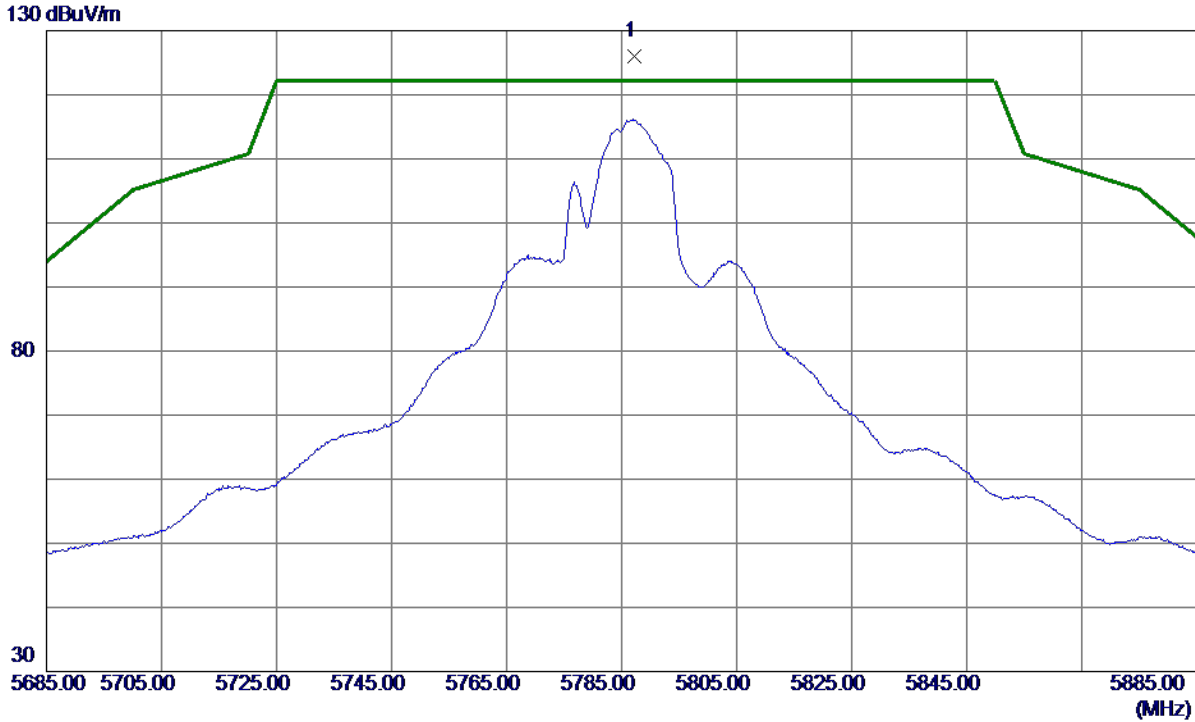

No.	Freq. MHz	Reading Level dBuV/m	Correct Factor dB	Measure ment dBuV/m	Limit dBuV/m	Margin dB	Detector	Comment
1 *	5787.2000	109.91	16.04	125.95	122.20	3.75	Peak	No Limit

REMARKS:

(1) Measurement Value = Reading Level + Correct Factor.

(2) Margin Level = Measurement Value - Limit Value.

Orthogonal Axis	X
Test Mode	UNII-3_TX AC (VHT20) Mode 5785 MHz

Horizontal

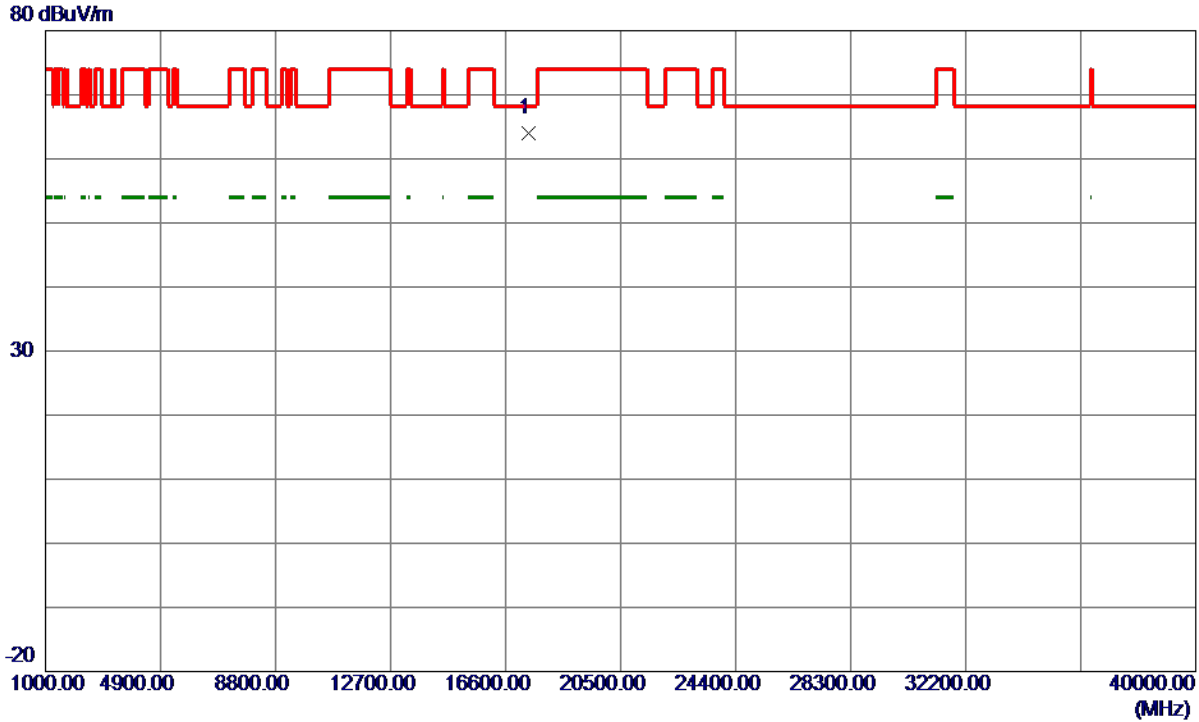

No.	Freq. MHz	Reading Level dBuV/m	Correct Factor dB	Measure ment dBuV/m	Limit dBuV/m	Margin dB	Detector	Comment
1 *	17359.0000	44.69	19.38	64.07	68.30	-4.23	Peak	

REMARKS:

(1) Measurement Value = Reading Level + Correct Factor.

(2) Margin Level = Measurement Value - Limit Value.

Orthogonal Axis	X
Test Mode	UNII-3_TX AC (VHT20) Mode 5825 MHz

Vertical

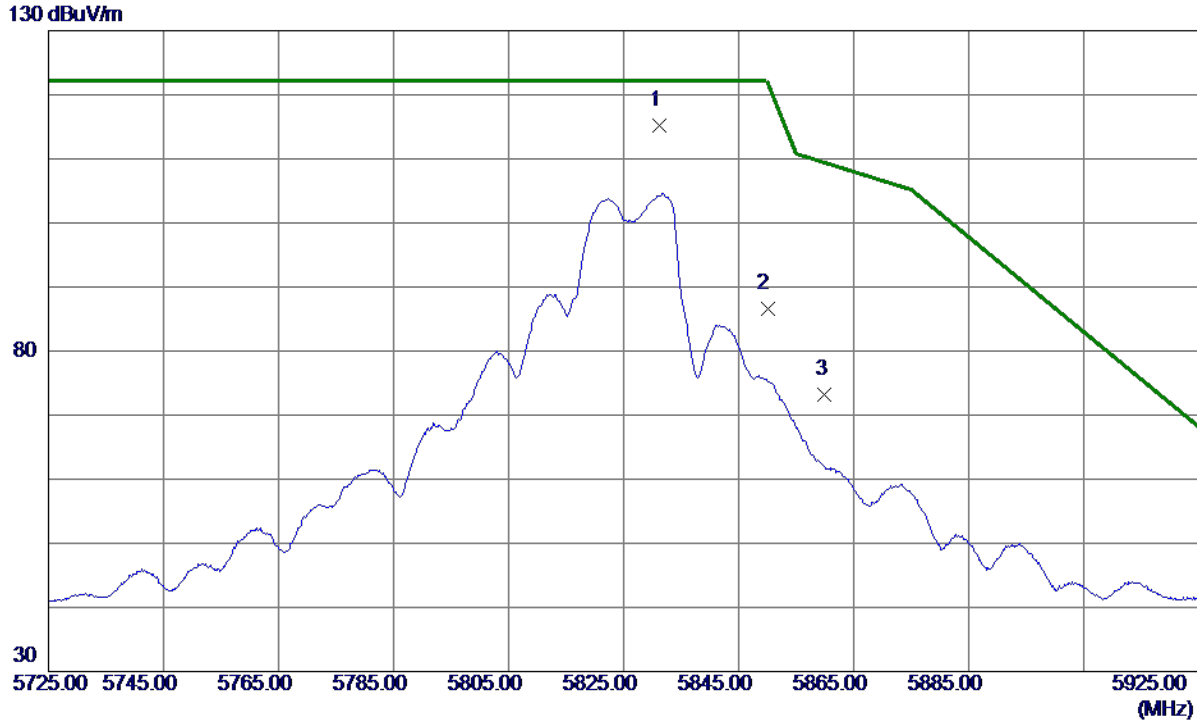

No.	Freq. MHz	Reading Level dBuV/m	Correct Factor dB	Measure ment dBuV/m	Limit dBuV/m	Margin dB	Detector	Comment
1 *	5831.3000	99.19	16.07	115.26	122.20	-6.94	Peak	No Limit
2	5850.0000	70.44	16.08	86.52	122.20	-35.68	Peak	
3	5860.0000	57.21	16.08	73.29	109.40	-36.11	Peak	

REMARKS:

(1) Measurement Value = Reading Level + Correct Factor.

(2) Margin Level = Measurement Value - Limit Value.

Orthogonal Axis	X
Test Mode	UNII-3_TX AC (VHT20) Mode 5825 MHz

Vertical

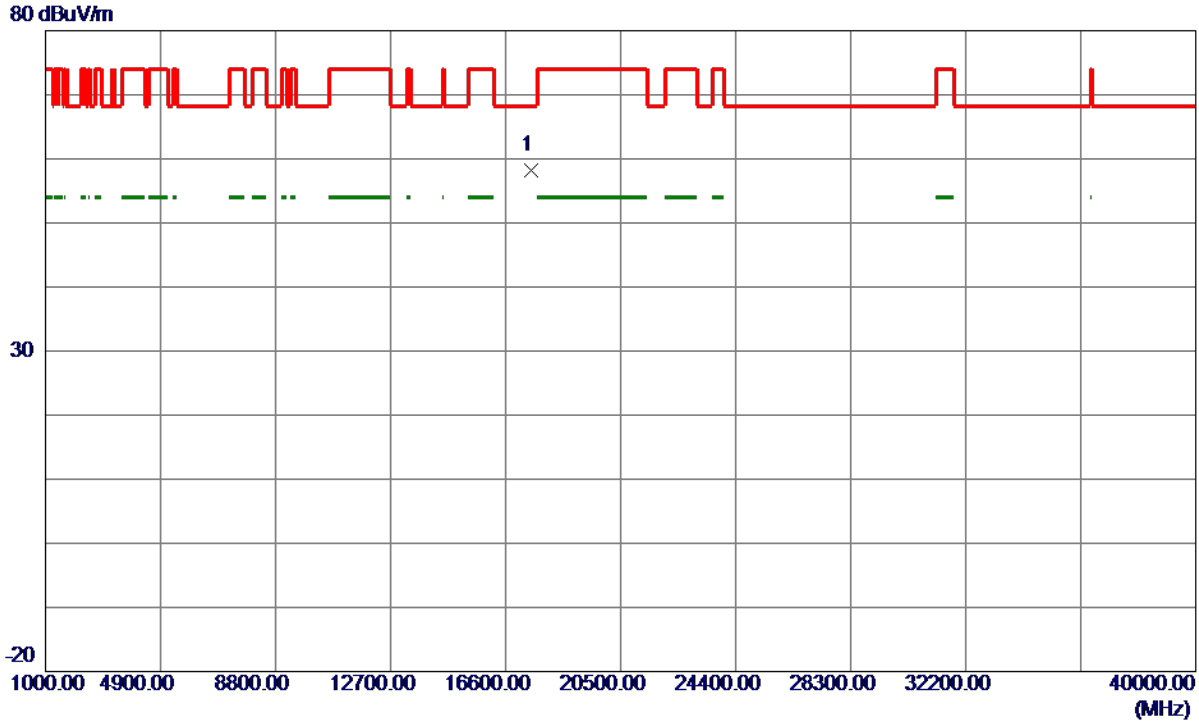

No.	Freq. MHz	Reading Level dBuV/m	Correct Factor dB	Measure ment dBuV/m	Limit dBuV/m	Margin dB	Detector	Comment
1 *	17467.6800	38.48	19.76	58.24	68.30	-10.06	Peak	

REMARKS:

(1) Measurement Value = Reading Level + Correct Factor.

(2) Margin Level = Measurement Value - Limit Value.

Orthogonal Axis	X
Test Mode	UNII-3_TX AC (VHT20) Mode 5825 MHz

Horizontal

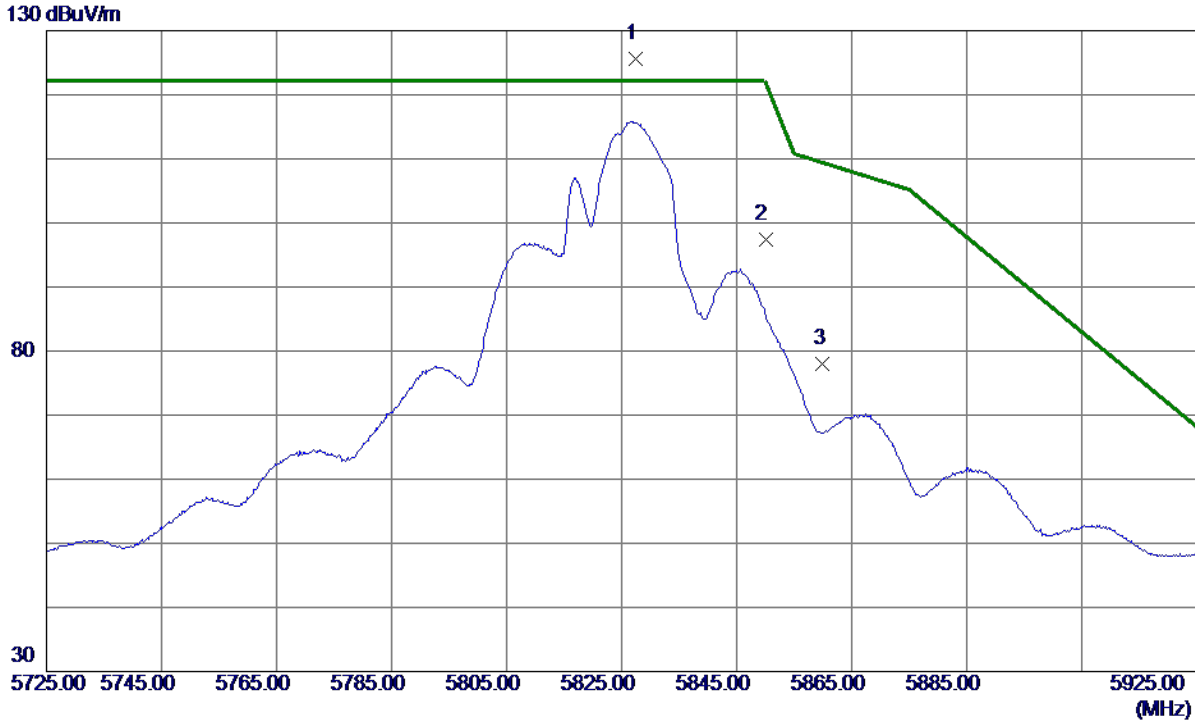

No.	Freq. MHz	Reading Level dBuV/m	Correct Factor dB	Measure ment dBuV/m	Limit dBuV/m	Margin dB	Detector	Comment
1 *	5827.4000	109.63	16.06	125.69	122.20	3.49	Peak	No Limit
2	5850.0000	81.39	16.08	97.47	122.20	-24.73	Peak	
3	5860.0000	61.92	16.08	78.00	109.40	-31.40	Peak	

REMARKS:

(1) Measurement Value = Reading Level + Correct Factor.

(2) Margin Level = Measurement Value - Limit Value.

Orthogonal Axis	X
Test Mode	UNII-3_TX AC (VHT20) Mode 5825 MHz

Horizontal

80 dBuV/m

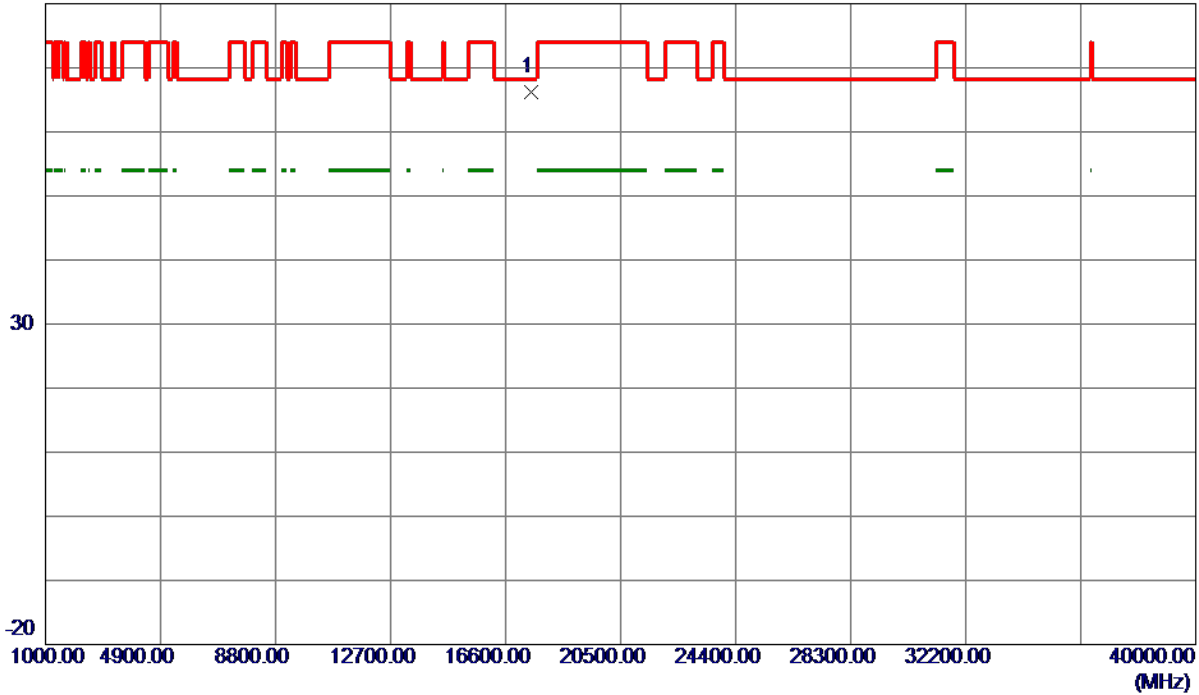

No.	Freq. MHz	Reading Level dBuV/m	Correct Factor dB	Measure ment dBuV/m	Limit dBuV/m	Margin dB	Detector	Comment
1 *	17477.0000	46.32	19.79	66.11	68.30	-2.19	Peak	

REMARKS:

(1) Measurement Value = Reading Level + Correct Factor.

(2) Margin Level = Measurement Value - Limit Value.

Orthogonal Axis	X
Test Mode	UNII-3_TX AC (VHT40) Mode 5755 MHz

Vertical

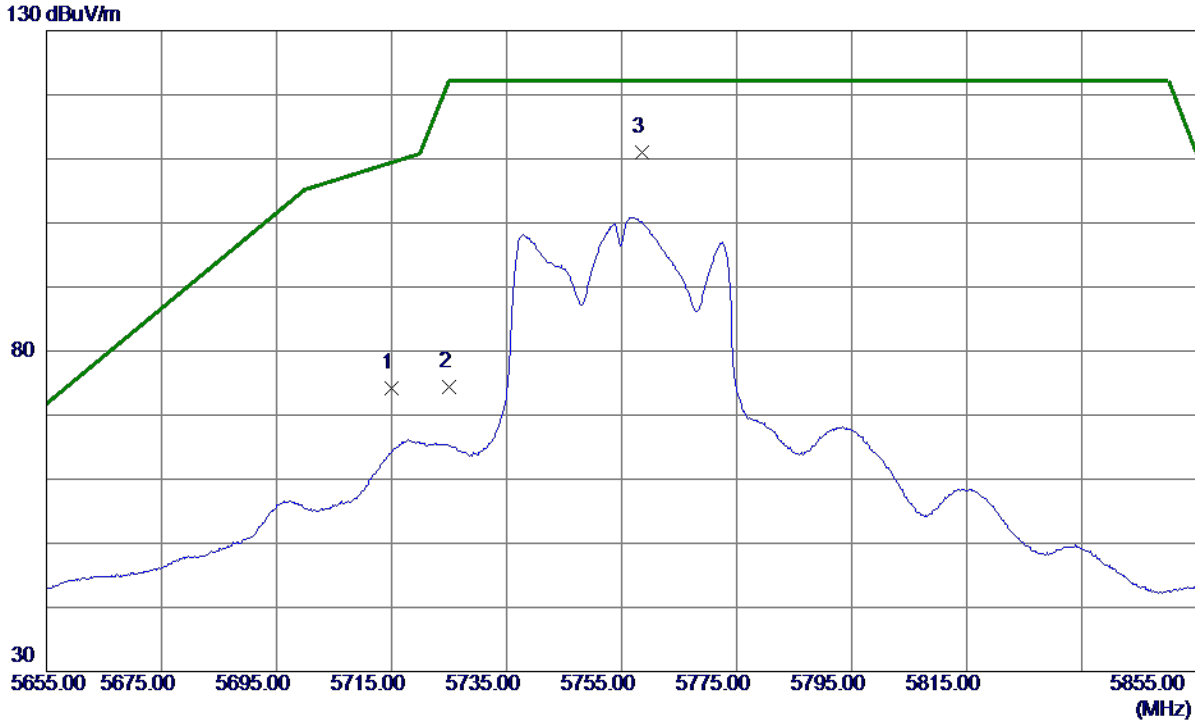

No.	Freq. MHz	Reading Level dBuV/m	Correct Factor dB	Measure ment dBuV/m	Limit dBuV/m	Margin dB	Detector	Comment
1	5715.0000	58.29	15.99	74.28	109.40	-35.12	Peak	
2	5725.0000	58.44	16.00	74.44	122.20	-47.76	Peak	
3 *	5758.5000	94.93	16.02	110.95	122.20	-11.25	Peak	No Limit

REMARKS:

(1) Measurement Value = Reading Level + Correct Factor.

(2) Margin Level = Measurement Value - Limit Value.

Orthogonal Axis	X
Test Mode	UNII-3_TX AC (VHT40) Mode 5755 MHz

Vertical

80 dBuV/m

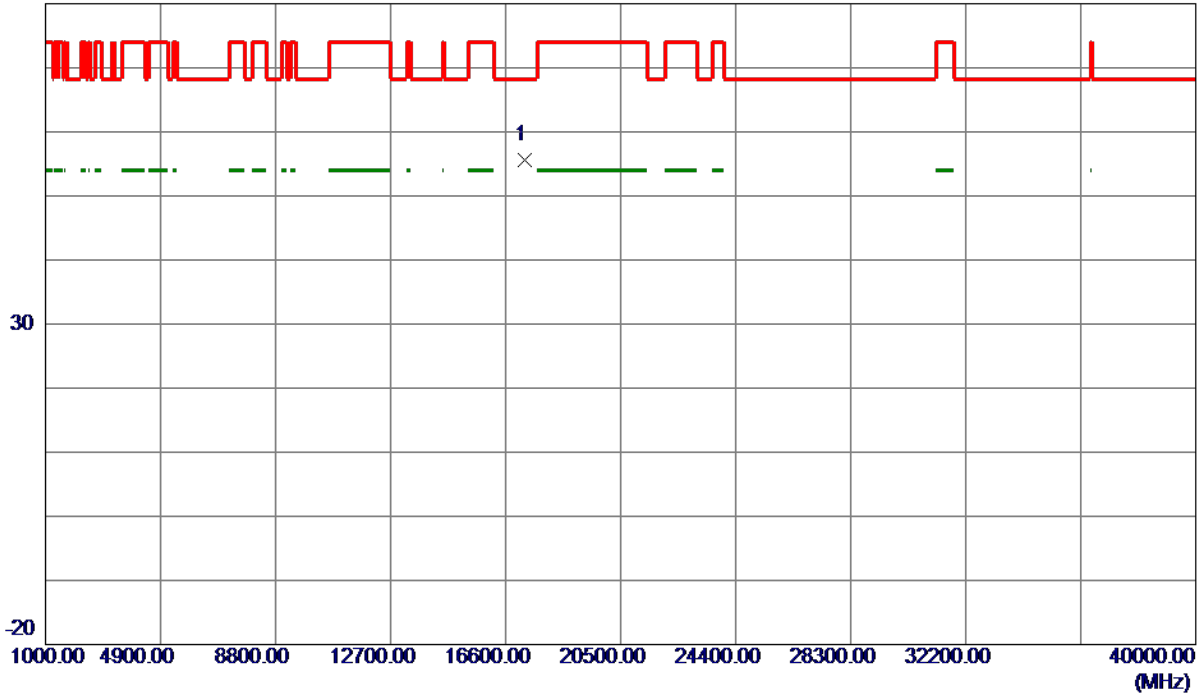

No.	Freq. MHz	Reading Level dBuV/m	Correct Factor dB	Measure ment dBuV/m	Limit dBuV/m	Margin dB	Detector	Comment
1 *	17257.6300	36.60	19.03	55.63	68.30	-12.67	Peak	

REMARKS:

(1) Measurement Value = Reading Level + Correct Factor.

(2) Margin Level = Measurement Value - Limit Value.

Orthogonal Axis	X
Test Mode	UNII-3_TX AC (VHT40) Mode 5755 MHz

Horizontal

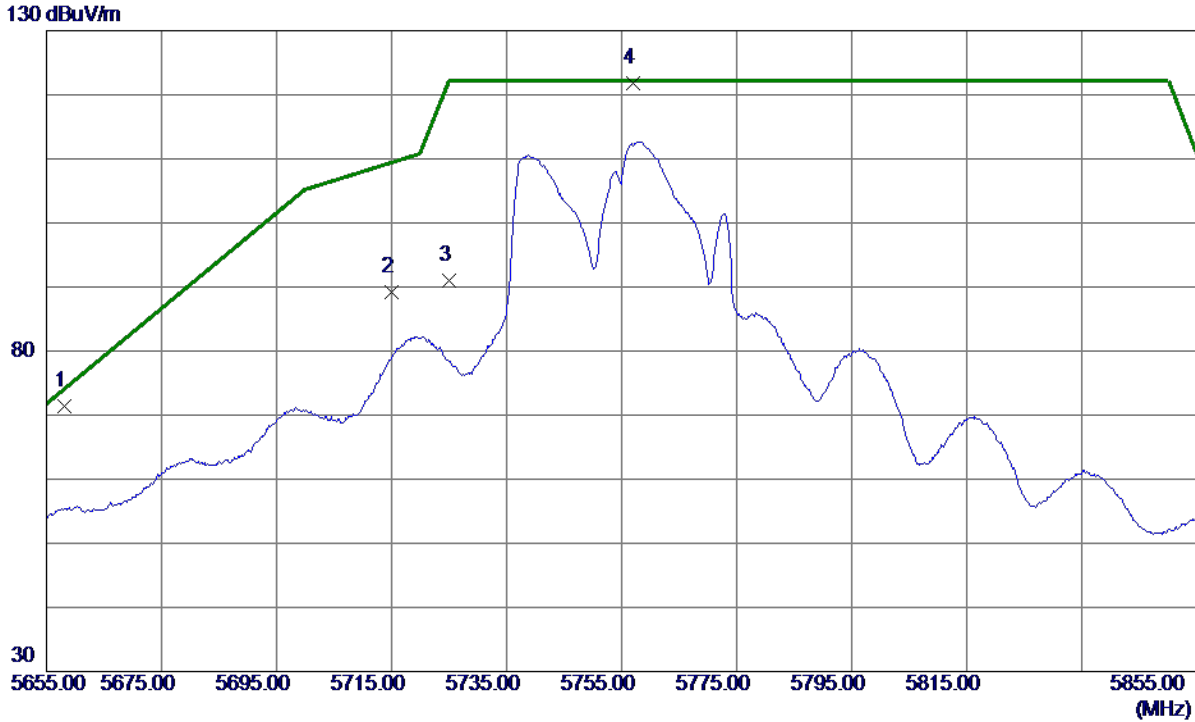

No.	Freq. MHz	Reading Level dBuV/m	Correct Factor dB	Measurement dBuV/m	Limit dBuV/m	Margin dB	Detector	Comment
1	5658.1000	55.52	15.96	71.48	74.19	-2.71	Peak	
2	5715.0000	73.24	15.99	89.23	109.40	-20.17	Peak	
3	5725.0000	75.02	16.00	91.02	122.20	-31.18	Peak	
4 *	5756.9000	105.76	16.02	121.78	122.20	-0.42	Peak	No Limit

REMARKS:

(1) Measurement Value = Reading Level + Correct Factor.

(2) Margin Level = Measurement Value - Limit Value.

Orthogonal Axis	X
Test Mode	UNII-3_TX AC (VHT40) Mode 5755 MHz

Horizontal

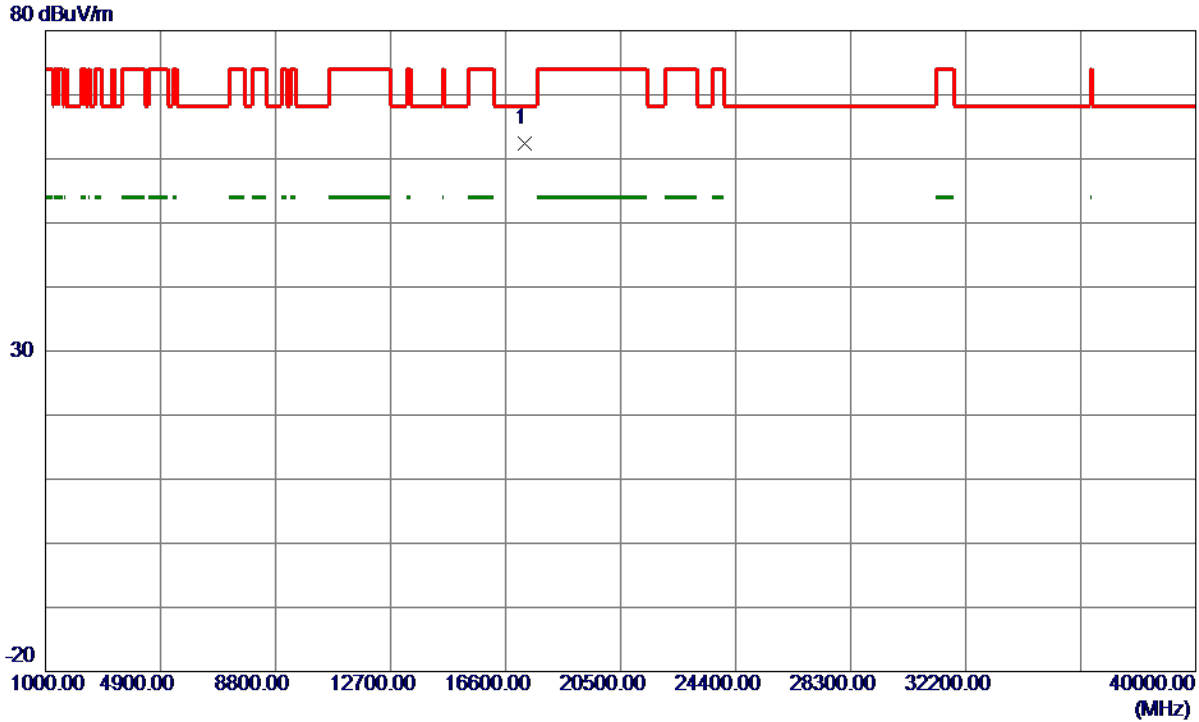

No.	Freq. MHz	Reading Level dBuV/m	Correct Factor dB	Measure ment dBuV/m	Limit dBuV/m	Margin dB	Detector	Comment
1 *	17266.8000	43.35	19.06	62.41	68.30	-5.89	Peak	

REMARKS:

(1) Measurement Value = Reading Level + Correct Factor.

(2) Margin Level = Measurement Value - Limit Value.

Orthogonal Axis	X
Test Mode	UNII-3_TX AC (VHT40) Mode 5795 MHz

Vertical

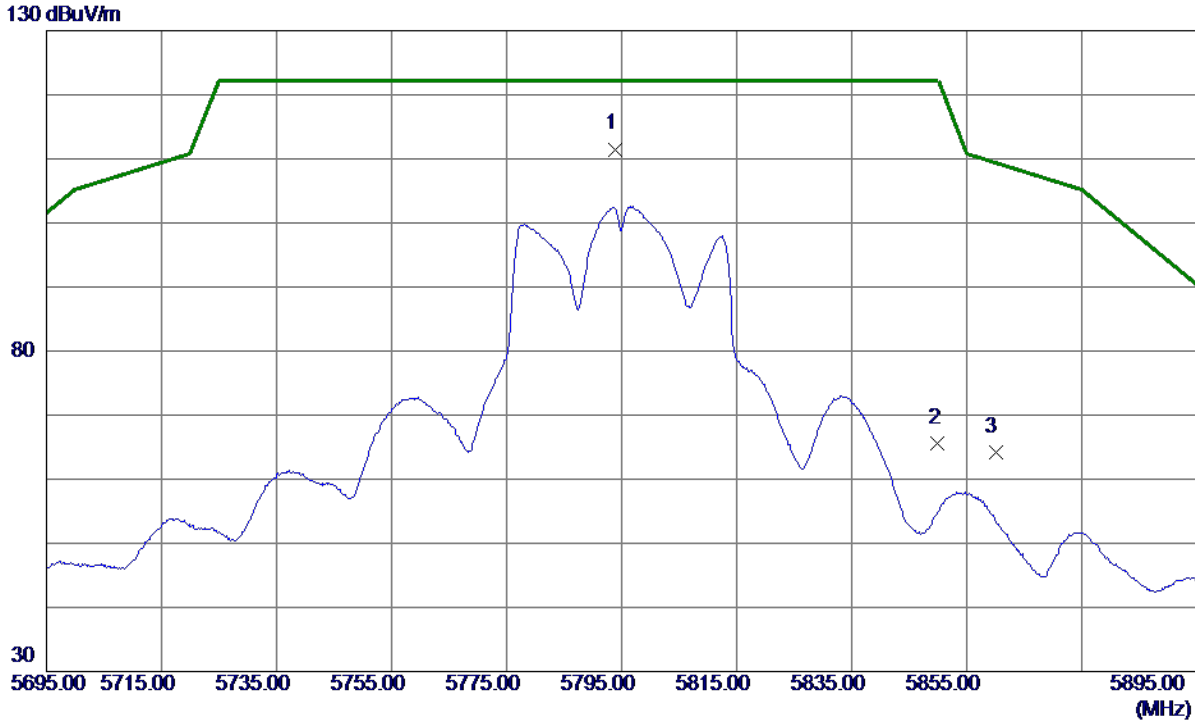

No.	Freq. MHz	Reading Level dBuV/m	Correct Factor dB	Measurement dBuV/m	Limit dBuV/m	Margin dB	Detector	Comment
1 *	5793.8000	95.46	16.04	111.50	122.20	-10.70	Peak	No Limit
2	5850.0000	49.46	16.08	65.54	122.20	-56.66	Peak	
3	5860.0000	48.12	16.08	64.20	109.40	-45.20	Peak	

REMARKS:

(1) Measurement Value = Reading Level + Correct Factor.

(2) Margin Level = Measurement Value - Limit Value.

Orthogonal Axis	X
Test Mode	UNII-3_TX AC (VHT40) Mode 5795 MHz

Vertical

80 dBuV/m

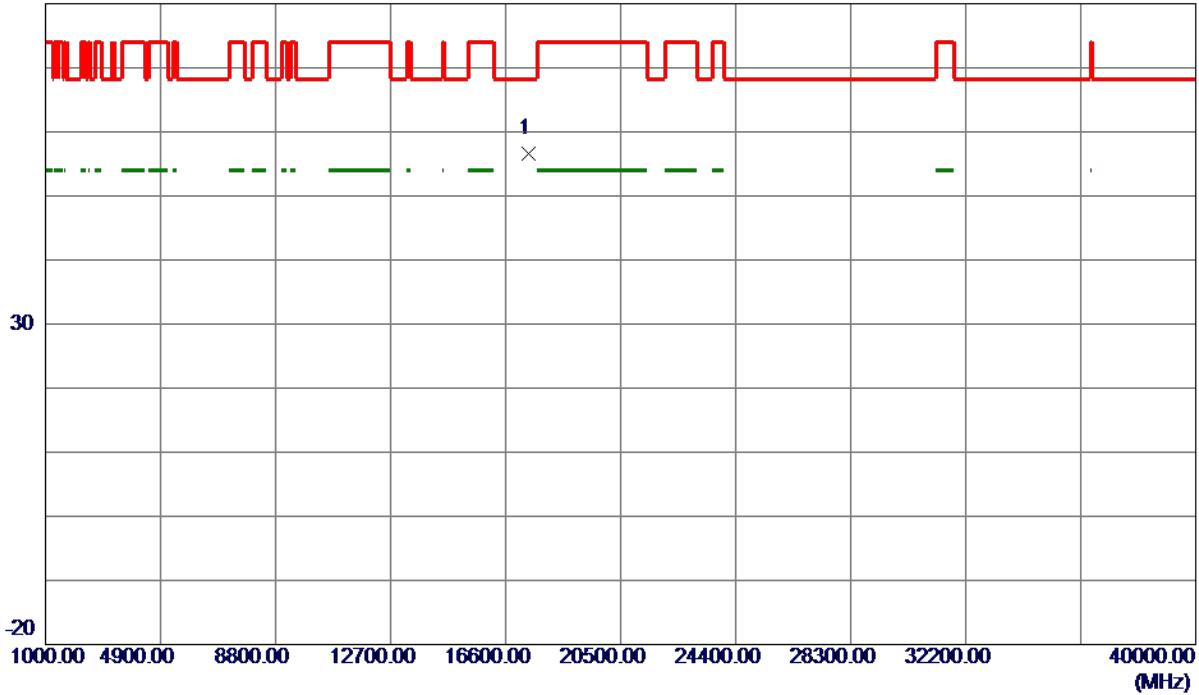

No.	Freq. MHz	Reading Level dBuV/m	Correct Factor dB	Measure ment dBuV/m	Limit dBuV/m	Margin dB	Detector	Comment
1 *	17383.0200	37.21	19.46	56.67	68.30	-11.63	Peak	

REMARKS:

(1) Measurement Value = Reading Level + Correct Factor.

(2) Margin Level = Measurement Value - Limit Value.

Orthogonal Axis	X
Test Mode	UNII-3_TX AC (VHT40) Mode 5795 MHz

Horizontal

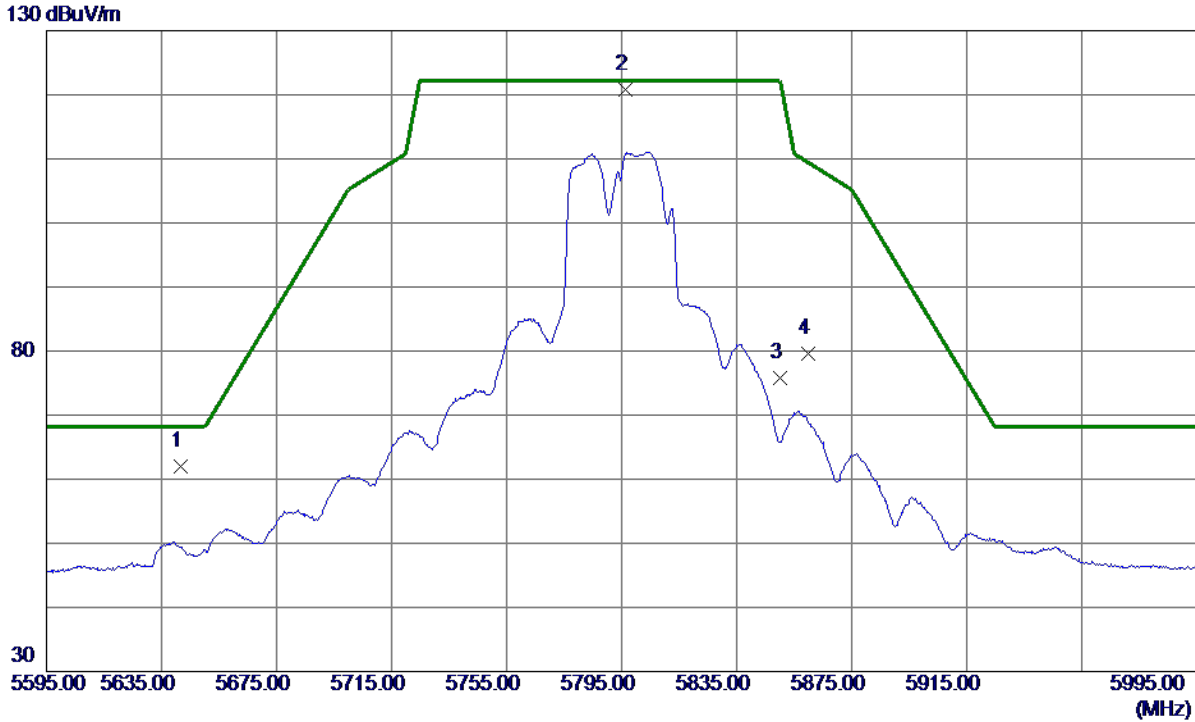

No.	Freq. MHz	Reading Level dBuV/m	Correct Factor dB	Measure ment dBuV/m	Limit dBuV/m	Margin dB	Detector	Comment
1	5641.8000	46.39	15.52	61.91	68.20	-6.29	Peak	
2 *	5796.2000	104.97	15.80	120.77	122.20	-1.43	Peak	No Limit
3	5850.0000	59.88	15.90	75.78	122.20	-46.42	Peak	
4	5860.0000	63.72	15.92	79.64	109.40	-29.76	Peak	

REMARKS:

(1) Measurement Value = Reading Level + Correct Factor.

(2) Margin Level = Measurement Value - Limit Value.

Orthogonal Axis	X
Test Mode	UNII-3_TX AC (VHT40) Mode 5795 MHz

Horizontal

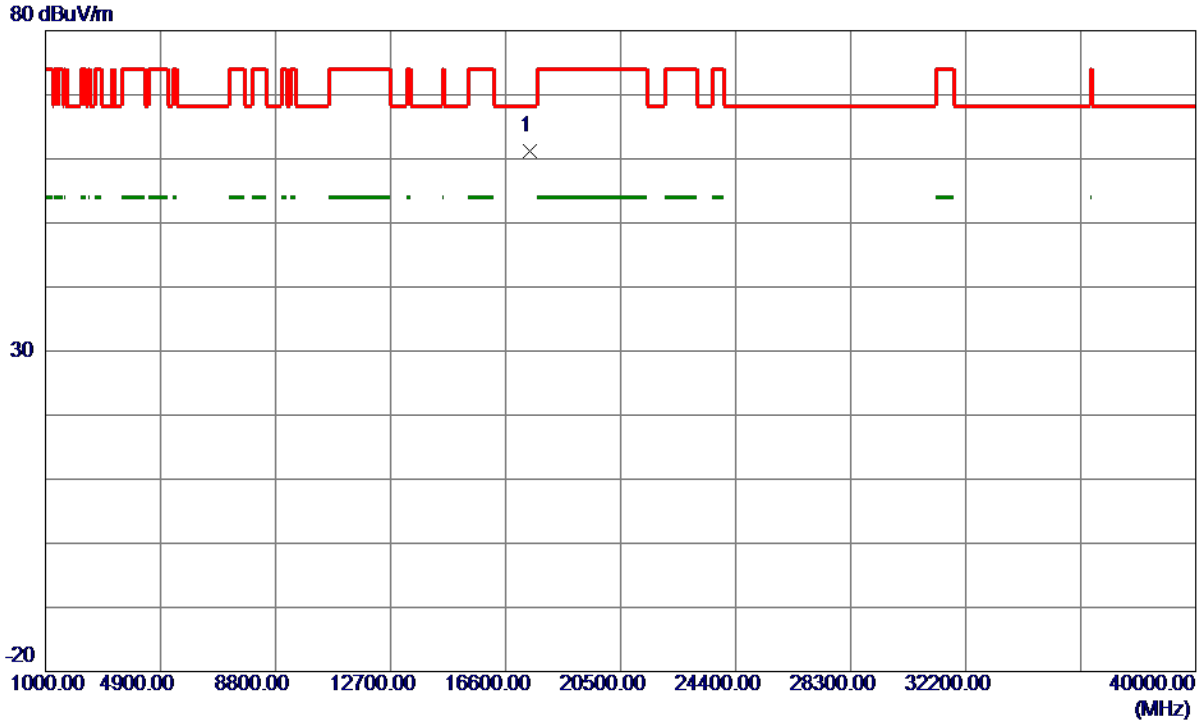

No.	Freq. MHz	Reading Level dBuV/m	Correct Factor dB	Measure ment dBuV/m	Limit dBuV/m	Margin dB	Detector	Comment
1 *	17406.5500	41.72	19.54	61.26	68.30	-7.04	Peak	

REMARKS:

(1) Measurement Value = Reading Level + Correct Factor.

(2) Margin Level = Measurement Value - Limit Value.

Orthogonal Axis	X
Test Mode	UNII-3_TX AC (VHT80) Mode 5775 MHz

Vertical

130 dBuV/m

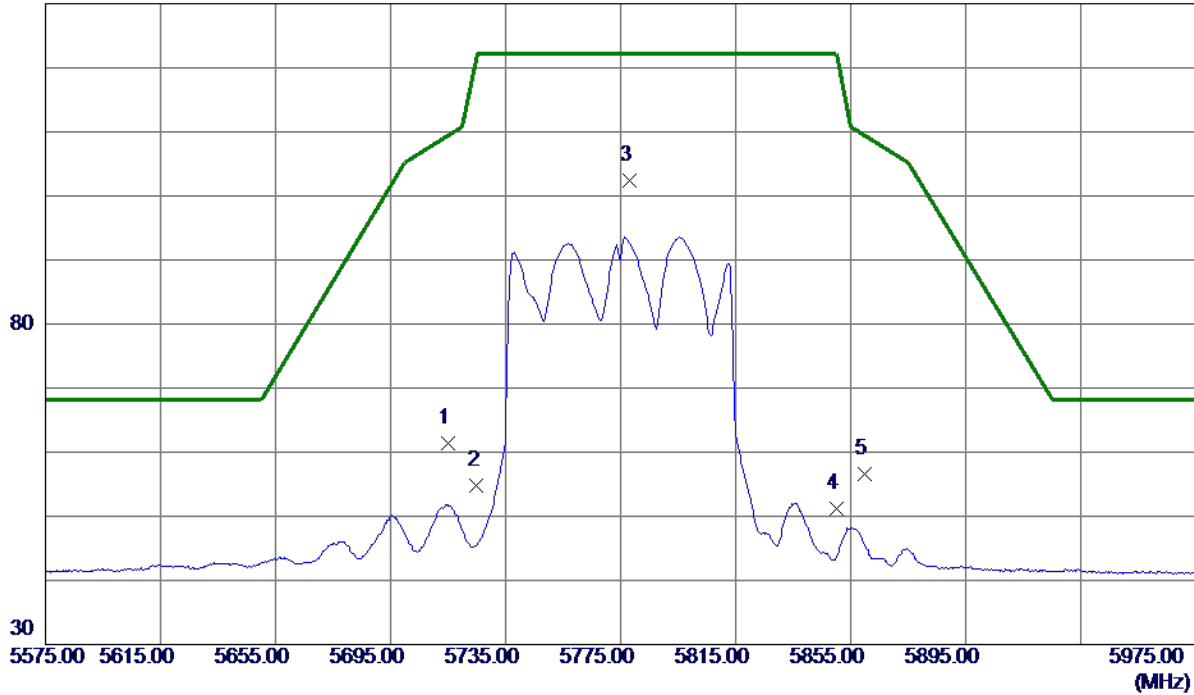

No.	Freq. MHz	Reading Level dBuV/m	Correct Factor dB	Measure ment dBuV/m	Limit dBuV/m	Margin dB	Detector	Comment
1	5715.0000	45.48	15.99	61.47	109.40	-47.93	Peak	
2	5725.0000	38.78	16.00	54.78	122.20	-67.42	Peak	
3 *	5778.2000	86.43	16.03	102.46	122.20	-19.74	Peak	No Limit
4	5850.0000	35.08	16.08	51.16	122.20	-71.04	Peak	
5	5860.0000	40.53	16.08	56.61	109.40	-52.79	Peak	

REMARKS:

(1) Measurement Value = Reading Level + Correct Factor.

(2) Margin Level = Measurement Value - Limit Value.

Orthogonal Axis	X
Test Mode	UNII-3_TX AC (VHT80) Mode 5775 MHz

Vertical

80 dBuV/m

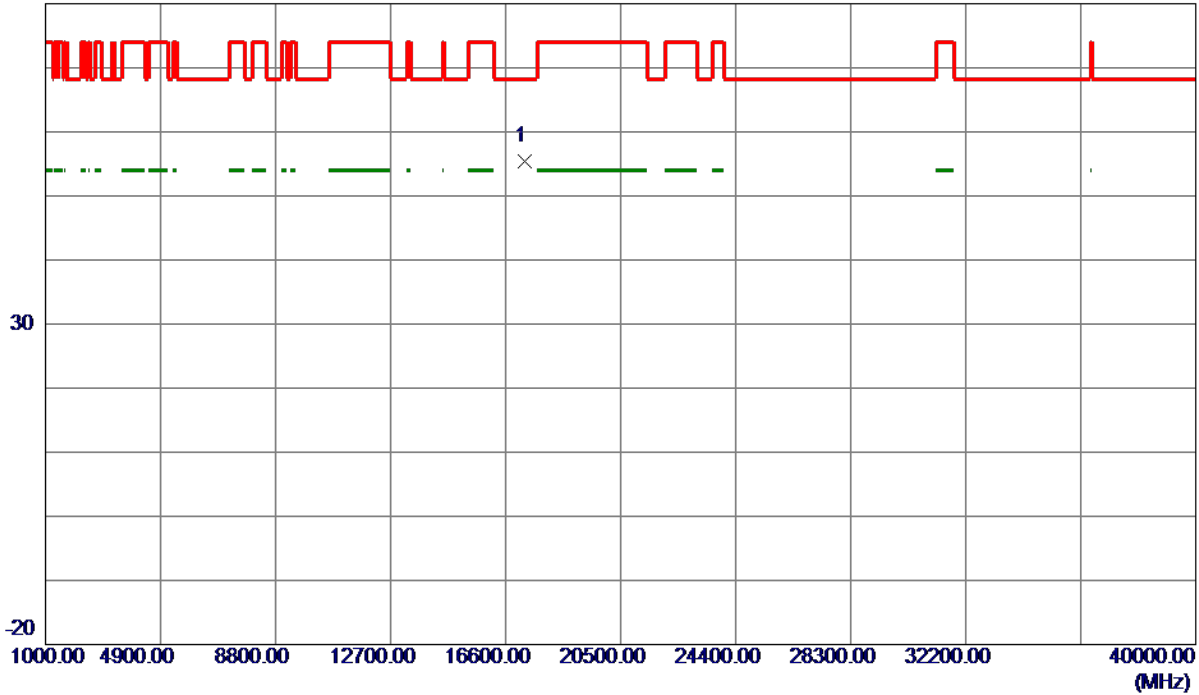

No.	Freq. MHz	Reading Level dBuV/m	Correct Factor dB	Measure ment dBuV/m	Limit dBuV/m	Margin dB	Detector	Comment
1 *	17239.4500	36.39	18.96	55.35	68.30	-12.95	Peak	

REMARKS:

(1) Measurement Value = Reading Level + Correct Factor.

(2) Margin Level = Measurement Value - Limit Value.

Orthogonal Axis	X
Test Mode	UNII-3_TX AC (VHT80) Mode 5775 MHz

Horizontal

130 dBuV/m

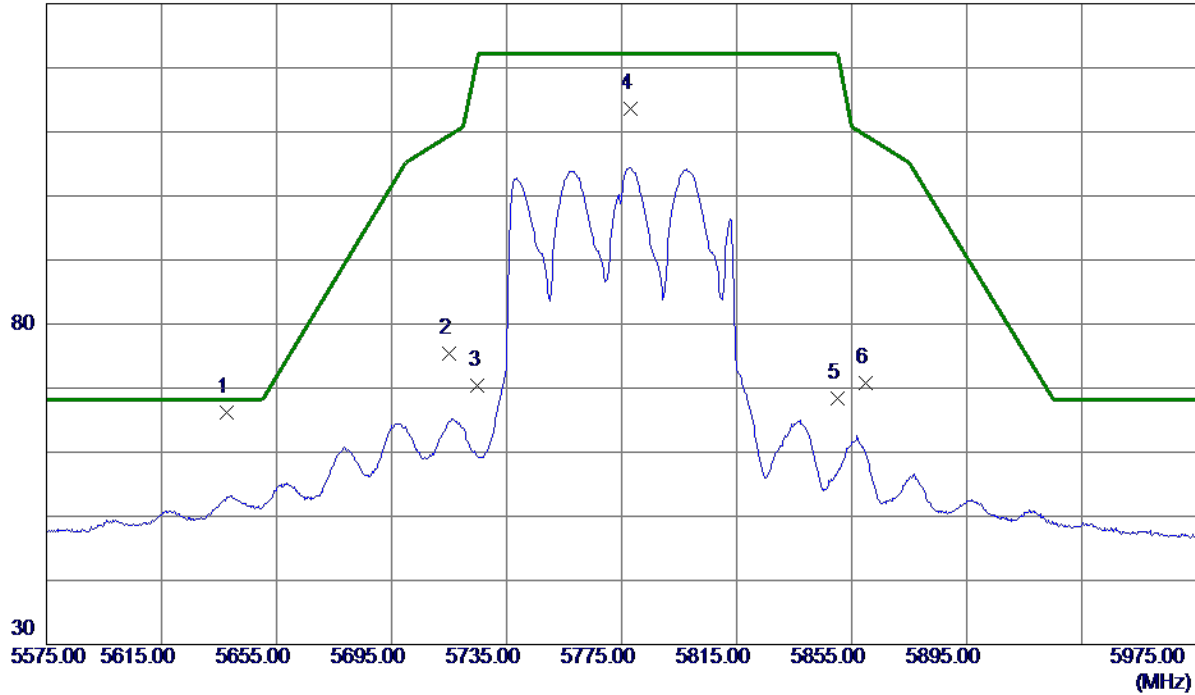

No.	Freq. MHz	Reading Level dBuV/m	Correct Factor dB	Measure ment dBuV/m	Limit dBuV/m	Margin dB	Detector	Comment
1 *	5637.6000	50.21	15.95	66.16	68.20	-2.04	Peak	
2	5715.0000	59.48	15.99	75.47	109.40	-33.93	Peak	
3	5725.0000	54.42	16.00	70.42	122.20	-51.78	Peak	
4	5778.0000	97.65	16.03	113.68	122.20	-8.52	Peak	No Limit
5	5850.0000	52.40	16.08	68.48	122.20	-53.72	Peak	
6	5860.0000	54.71	16.08	70.79	109.40	-38.61	Peak	

REMARKS:

(1) Measurement Value = Reading Level + Correct Factor.

(2) Margin Level = Measurement Value - Limit Value.

Orthogonal Axis	X
Test Mode	UNII-3_TX AC (VHT80) Mode 5775 MHz

Horizontal

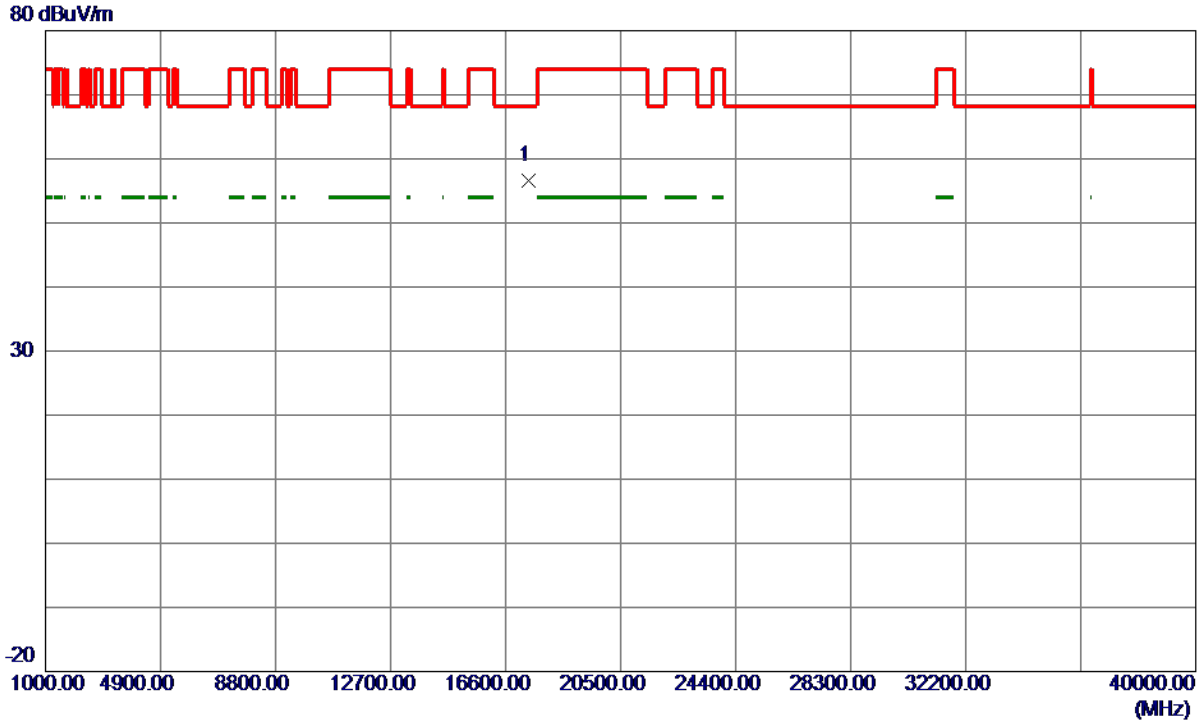

No.	Freq. MHz	Reading Level dBuV/m	Correct Factor dB	Measure ment dBuV/m	Limit dBuV/m	Margin dB	Detector	Comment
1 *	17359.0000	37.15	19.38	56.53	68.30	-11.77	Peak	

REMARKS:

(1) Measurement Value = Reading Level + Correct Factor.

(2) Margin Level = Measurement Value - Limit Value.

APPENDIX E - BANDWIDTH

Non-Beamforming

Test Mode	UNII-1_TX A Mode
-----------	------------------

Channel	Frequency (MHz)	26 dB Bandwidth (MHz)	99 % Emission Bandwidth (MHz)
36	5180	19.95	16.60
40	5200	19.99	16.50
48	5240	20.10	16.60

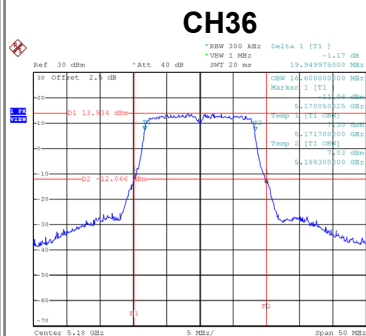

Date: 30_SEP.2019 07:58:32

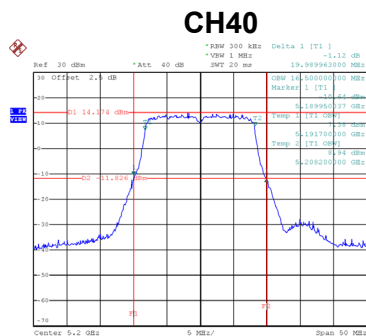

Date: 30_SEP.2019 07:59:13

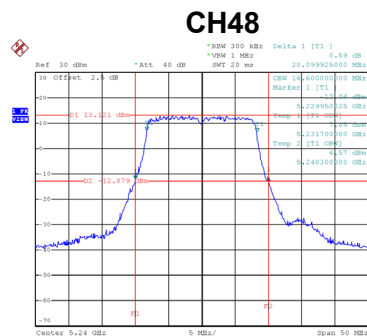

Date: 30_SEP.2019 07:59:55

Test Mode	UNII-3_TX A Mode
-----------	------------------

Channel	Frequency (MHz)	6 dB Bandwidth (MHz)	99 % Emission Bandwidth (MHz)	6 dB Bandwidth Min. Limit (kHz)	Result
149	5745	16.35	16.40	500	Complies
157	5785	16.45	16.50	500	Complies
165	5825	16.35	16.40	500	Complies

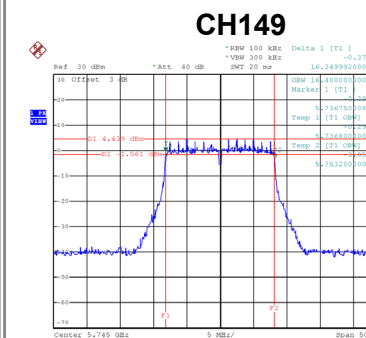

Date: 30_SEP.2019 08:07:41

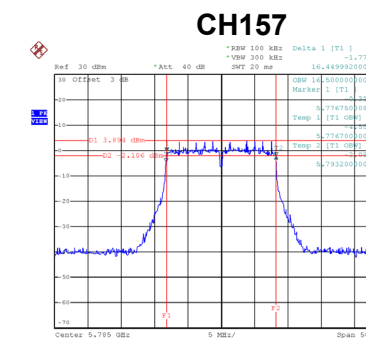

Date: 30_SEP.2019 08:11:20

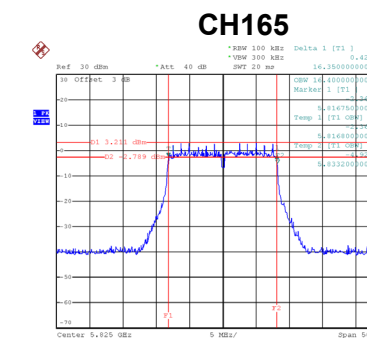

Date: 30_SEP.2019 08:12:10

Test Mode UNII-1_TX AC (VHT20) Mode

Channel	Frequency (MHz)	26 dB Bandwidth (MHz)	99 % Emission Bandwidth (MHz)
36	5180	24.00	18.00
40	5200	34.49	18.50
48	5240	21.60	17.70

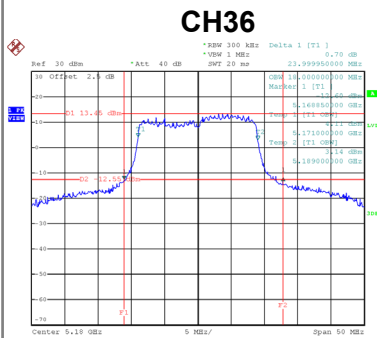

Date: 20.JUL.2019 16:34:13

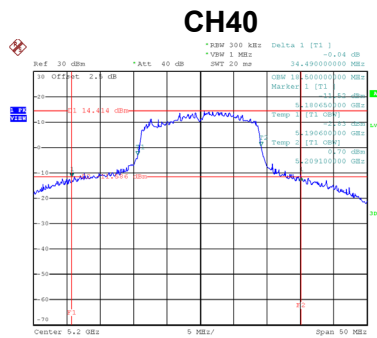

Date: 20.JUL.2019 16:35:04

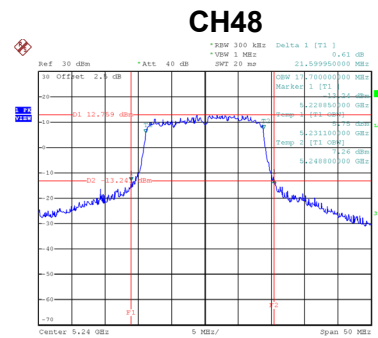

Date: 20.JUL.2019 16:35:54

Test Mode UNII-1_TX AC (VHT40) Mode

Channel	Frequency (MHz)	26 dB Bandwidth (MHz)	99 % Emission Bandwidth (MHz)
38	5190	57.30	37.00
46	5230	60.59	37.40

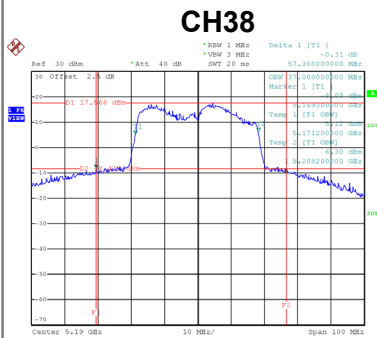

Date: 20.JUL.2019 16:40:22

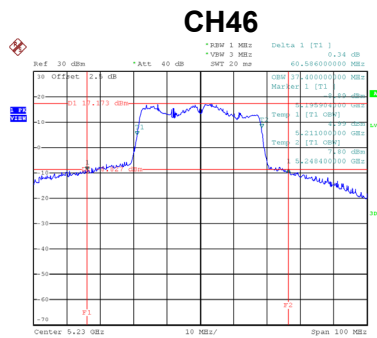

Date: 20.JUL.2019 16:41:19

Test Mode	UNII-1_TX AC (VHT80)
-----------	----------------------

Channel	Frequency (MHz)	26 dB Bandwidth (MHz)	99 % Emission Bandwidth (MHz)
42	5210	83.40	76.00

CH42

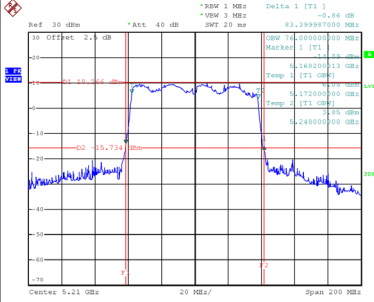

Date: 20_JUL.2019 16:45:27

Test Mode	UNII-3_TX AC (VHT20) Mode
-----------	---------------------------

Channel	Frequency (MHz)	6 dB Bandwidth (MHz)	99 % Emission Bandwidth (MHz)	6 dB Bandwidth Min. Limit (kHz)	Result
149	5745	17.25	19.70	500	Complies
157	5785	17.00	18.30	500	Complies
165	5825	17.80	38.20	500	Complies

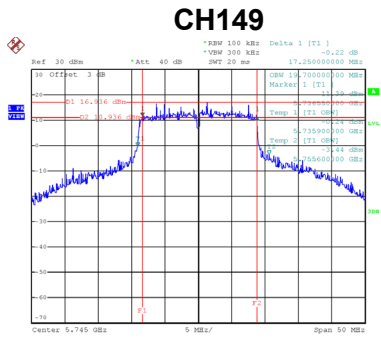

Date: 20.JUL.2019 16:37:08

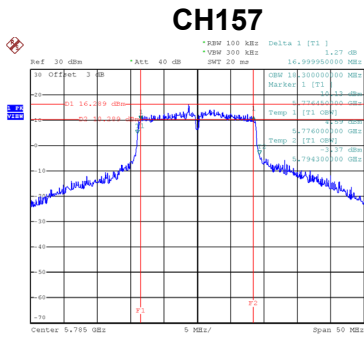

Date: 20.JUL.2019 16:37:59

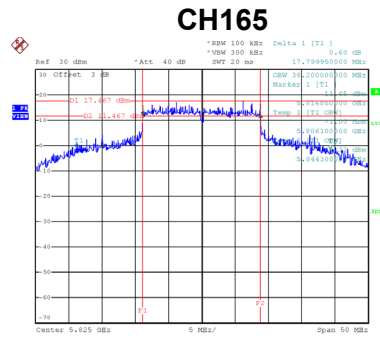

Date: 20.JUL.2019 16:38:54

Test Mode	UNII-3_TX AC (VHT40) Mode
-----------	---------------------------

Channel	Frequency (MHz)	6 dB Bandwidth (MHz)	99 % Emission Bandwidth (MHz)	6 dB Bandwidth Min. Limit (kHz)	Result
151	5755	35.90	36.40	500	Complies
159	5795	36.00	39.00	500	Complies

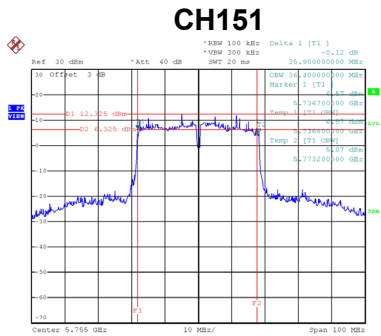

Date: 20.JUL.2019 16:43:03

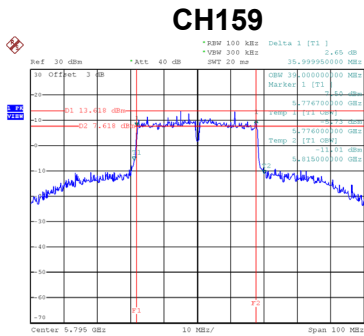

Date: 20.JUL.2019 16:43:38

Test Mode UNII-3_TX AC (VHT80)

Channel	Frequency (MHz)	6 dB Bandwidth (MHz)	99 % Emission Bandwidth (MHz)	6 dB Bandwidth Min. Limit (kHz)	Result
155	5775	77.00	76.40	500	Complies

CH155

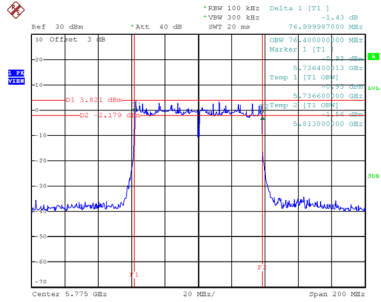

Date: 20 JUL 2019 16:48:34

APPENDIX F - CONDUCTED OUTPUT POWER

Non-Beamforming

Test Mode	UNII-1_TX A Mode_Ant. 1
-----------	-------------------------

Channel	Frequency (MHz)	Conducted Output Power (dBm)	Duty Factor	Conducted Output Power + Duty Factor (dBm)	Max. Limit (dBm)	Max. Limit (W)	Result
36	5180	20.32	0.13	20.45	30.00	1.00	Complies
40	5200	20.38	0.13	20.51	30.00	1.00	Complies
48	5240	20.09	0.13	20.22	30.00	1.00	Complies

Test Mode	UNII-1_TX A Mode_Ant. 2
-----------	-------------------------

Channel	Frequency (MHz)	Conducted Output Power (dBm)	Duty Factor	Conducted Output Power + Duty Factor (dBm)	Max. Limit (dBm)	Max. Limit (W)	Result
36	5180	20.86	0.13	20.99	30.00	1.00	Complies
40	5200	20.83	0.13	20.96	30.00	1.00	Complies
48	5240	20.66	0.13	20.79	30.00	1.00	Complies

Test Mode	UNII-1_TX A Mode_Ant. 3
-----------	-------------------------

Channel	Frequency (MHz)	Conducted Output Power (dBm)	Duty Factor	Conducted Output Power + Duty Factor (dBm)	Max. Limit (dBm)	Max. Limit (W)	Result
36	5180	20.35	0.13	20.48	30.00	1.00	Complies
40	5200	20.31	0.13	20.44	30.00	1.00	Complies
48	5240	20.41	0.13	20.54	30.00	1.00	Complies

Test Mode	UNII-1_TX A Mode_Total
-----------	------------------------

Channel	Frequency (MHz)	Conducted Output Power (dBm)	Max. Limit (dBm)	Max. Limit (W)	Result
36	5180	25.42	30.00	1.00	Complies
40	5200	25.42	30.00	1.00	Complies
48	5240	25.30	30.00	1.00	Complies

Test Mode	UNII-1_TX N (HT20) Mode_Ant. 1
-----------	--------------------------------

Channel	Frequency (MHz)	Conducted Output Power (dBm)	Duty Factor	Conducted Output Power + Duty Factor (dBm)	Max. Limit (dBm)	Max. Limit (W)	Result
36	5180	18.43	0.00	18.43	30.00	1.00	Complies
40	5200	18.41	0.00	18.41	30.00	1.00	Complies
48	5240	17.89	0.00	17.89	30.00	1.00	Complies

Test Mode	UNII-1_TX N (HT20) Mode_Ant. 2
-----------	--------------------------------

Channel	Frequency (MHz)	Conducted Output Power (dBm)	Duty Factor	Conducted Output Power + Duty Factor (dBm)	Max. Limit (dBm)	Max. Limit (W)	Result
36	5180	19.37	0.00	19.37	30.00	1.00	Complies
40	5200	19.28	0.00	19.28	30.00	1.00	Complies
48	5240	18.58	0.00	18.58	30.00	1.00	Complies

Test Mode	UNII-1_TX N (HT20) Mode_Ant. 3
-----------	--------------------------------

Channel	Frequency (MHz)	Conducted Output Power (dBm)	Duty Factor	Conducted Output Power + Duty Factor (dBm)	Max. Limit (dBm)	Max. Limit (W)	Result
36	5180	18.57	0.00	18.57	30.00	1.00	Complies
40	5200	18.71	0.00	18.71	30.00	1.00	Complies
48	5240	18.51	0.00	18.51	30.00	1.00	Complies

Test Mode	UNII-1_TX N (HT20) Mode_Total
-----------	-------------------------------

Channel	Frequency (MHz)	Conducted Output Power (dBm)	Max. Limit (dBm)	Max. Limit (W)	Result
36	5180	23.58	30.00	1.00	Complies
40	5200	23.59	30.00	1.00	Complies
48	5240	23.11	30.00	1.00	Complies

Test Mode	UNII-1_TX N (HT40) Mode_Ant. 1
-----------	--------------------------------

Channel	Frequency (MHz)	Conducted Output Power (dBm)	Duty Factor	Conducted Output Power + Duty Factor (dBm)	Max. Limit (dBm)	Max. Limit (W)	Result
38	5190	18.31	0.14	18.45	30.00	1.00	Complies
46	5230	18.17	0.14	18.31	30.00	1.00	Complies

Test Mode	UNII-1_TX N (HT40) Mode_Ant. 2
-----------	--------------------------------

Channel	Frequency (MHz)	Conducted Output Power (dBm)	Duty Factor	Conducted Output Power + Duty Factor (dBm)	Max. Limit (dBm)	Max. Limit (W)	Result
38	5190	19.26	0.14	19.40	30.00	1.00	Complies
46	5230	19.03	0.14	19.17	30.00	1.00	Complies

Test Mode	UNII-1_TX N (HT40) Mode_Ant. 3
-----------	--------------------------------

Channel	Frequency (MHz)	Conducted Output Power (dBm)	Duty Factor	Conducted Output Power + Duty Factor (dBm)	Max. Limit (dBm)	Max. Limit (W)	Result
38	5190	18.64	0.14	18.78	30.00	1.00	Complies
46	5230	19.06	0.14	19.20	30.00	1.00	Complies

Test Mode	UNII-1_TX N (HT40) Mode_Total
-----------	-------------------------------

Channel	Frequency (MHz)	Conducted Output Power (dBm)	Max. Limit (dBm)	Max. Limit (W)	Result
38	5190	23.66	30.00	1.00	Complies
46	5230	23.68	30.00	1.00	Complies

Test Mode	UNII-3_TX A Mode_Ant. 1
-----------	-------------------------

Channel	Frequency (MHz)	Conducted Output Power (dBm)	Duty Factor	Conducted Output Power + Duty Factor (dBm)	Max. Limit (dBm)	Max. Limit (W)	Result
149	5745	12.95	0.13	13.08	30.00	1.00	Complies
157	5785	12.72	0.13	12.85	30.00	1.00	Complies
165	5825	11.53	0.13	11.66	30.00	1.00	Complies

Test Mode	UNII-3_TX A Mode_Ant. 2
-----------	-------------------------

Channel	Frequency (MHz)	Conducted Output Power (dBm)	Duty Factor	Conducted Output Power + Duty Factor (dBm)	Max. Limit (dBm)	Max. Limit (W)	Result
149	5745	13.09	0.13	13.22	30.00	1.00	Complies
157	5785	12.66	0.13	12.79	30.00	1.00	Complies
165	5825	11.46	0.13	11.59	30.00	1.00	Complies

Test Mode	UNII-3_TX A Mode_Ant. 3
-----------	-------------------------

Channel	Frequency (MHz)	Conducted Output Power (dBm)	Duty Factor	Conducted Output Power + Duty Factor (dBm)	Max. Limit (dBm)	Max. Limit (W)	Result
149	5745	13.14	0.13	13.27	30.00	1.00	Complies
157	5785	12.68	0.13	12.81	30.00	1.00	Complies
165	5825	11.51	0.13	11.64	30.00	1.00	Complies

Test Mode	UNII-3_TX A Mode_Total
-----------	------------------------

Channel	Frequency (MHz)	Conducted Output Power (dBm)	Max. Limit (dBm)	Max. Limit (W)	Result
149	5745	17.97	30.00	1.00	Complies
157	5785	17.59	30.00	1.00	Complies
165	5825	16.41	30.00	1.00	Complies

Test Mode	UNII-3_TX N (HT20) Mode_Ant. 1
-----------	--------------------------------

Channel	Frequency (MHz)	Conducted Output Power (dBm)	Duty Factor	Conducted Output Power + Duty Factor (dBm)	Max. Limit (dBm)	Max. Limit (W)	Result
149	5745	24.38	0.00	24.38	30.00	1.00	Complies
157	5785	23.87	0.00	23.87	30.00	1.00	Complies
165	5825	25.22	0.00	25.22	30.00	1.00	Complies

Test Mode	UNII-3_TX N (HT20) Mode_Ant. 2
-----------	--------------------------------

Channel	Frequency (MHz)	Conducted Output Power (dBm)	Duty Factor	Conducted Output Power + Duty Factor (dBm)	Max. Limit (dBm)	Max. Limit (W)	Result
149	5745	24.84	0.00	24.84	30.00	1.00	Complies
157	5785	24.17	0.00	24.17	30.00	1.00	Complies
165	5825	25.04	0.00	25.04	30.00	1.00	Complies

Test Mode	UNII-3_TX N (HT20) Mode_Ant. 3
-----------	--------------------------------

Channel	Frequency (MHz)	Conducted Output Power (dBm)	Duty Factor	Conducted Output Power + Duty Factor (dBm)	Max. Limit (dBm)	Max. Limit (W)	Result
149	5745	24.75	0.00	24.75	30.00	1.00	Complies
157	5785	24.32	0.00	24.32	30.00	1.00	Complies
165	5825	24.95	0.00	24.95	30.00	1.00	Complies

Test Mode	UNII-3_TX N (HT20) Mode_Total
-----------	-------------------------------

Channel	Frequency (MHz)	Conducted Output Power (dBm)	Max. Limit (dBm)	Max. Limit (W)	Result
149	5745	29.43	30.00	1.00	Complies
157	5785	28.90	30.00	1.00	Complies
165	5825	29.84	30.00	1.00	Complies

Test Mode	UNII-3_TX N (HT40) Mode_Ant. 1
-----------	--------------------------------

Channel	Frequency (MHz)	Conducted Output Power (dBm)	Duty Factor	Conducted Output Power + Duty Factor (dBm)	Max. Limit (dBm)	Max. Limit (W)	Result
151	5755	23.03	0.14	23.17	30.00	1.00	Complies
159	5795	24.12	0.14	24.26	30.00	1.00	Complies

Test Mode	UNII-3_TX N (HT40) Mode_Ant. 2
-----------	--------------------------------

Channel	Frequency (MHz)	Conducted Output Power (dBm)	Duty Factor	Conducted Output Power + Duty Factor (dBm)	Max. Limit (dBm)	Max. Limit (W)	Result
151	5755	24.11	0.14	24.25	30.00	1.00	Complies
159	5795	24.05	0.14	24.19	30.00	1.00	Complies

Test Mode	UNII-3_TX N (HT40) Mode_Ant. 3
-----------	--------------------------------

Channel	Frequency (MHz)	Conducted Output Power (dBm)	Duty Factor	Conducted Output Power + Duty Factor (dBm)	Max. Limit (dBm)	Max. Limit (W)	Result
151	5755	23.05	0.14	23.19	30.00	1.00	Complies
159	5795	24.22	0.14	24.36	30.00	1.00	Complies

Test Mode	UNII-3_TX N (HT40) Mode_Total
-----------	-------------------------------

Channel	Frequency (MHz)	Conducted Output Power (dBm)	Max. Limit (dBm)	Max. Limit (W)	Result
151	5755	28.33	30.00	1.00	Complies
159	5795	29.04	30.00	1.00	Complies

Test Mode	UNII-1_TX AC (VHT20) Mode_Ant. 1
-----------	----------------------------------

Channel	Frequency (MHz)	Conducted Output Power (dBm)	Duty Factor	Conducted Output Power + Duty Factor (dBm)	Max. Limit (dBm)	Max. Limit (W)	Result
36	5180	18.56	0.00	18.56	30.00	1.00	Complies
40	5200	18.47	0.00	18.47	30.00	1.00	Complies
48	5240	17.97	0.00	17.97	30.00	1.00	Complies

Test Mode	UNII-1_TX AC (VHT20) Mode_Ant. 2
-----------	----------------------------------

Channel	Frequency (MHz)	Conducted Output Power (dBm)	Duty Factor	Conducted Output Power + Duty Factor (dBm)	Max. Limit (dBm)	Max. Limit (W)	Result
36	5180	19.41	0.00	19.41	30.00	1.00	Complies
40	5200	19.30	0.00	19.30	30.00	1.00	Complies
48	5240	18.63	0.00	18.63	30.00	1.00	Complies

Test Mode	UNII-1_TX AC (VHT20) Mode_Ant. 3
-----------	----------------------------------

Channel	Frequency (MHz)	Conducted Output Power (dBm)	Duty Factor	Conducted Output Power + Duty Factor (dBm)	Max. Limit (dBm)	Max. Limit (W)	Result
36	5180	18.65	0.00	18.65	30.00	1.00	Complies
40	5200	18.74	0.00	18.74	30.00	1.00	Complies
48	5240	18.57	0.00	18.57	30.00	1.00	Complies

Test Mode	UNII-1_TX AC (VHT20) Mode_Total
-----------	---------------------------------

Channel	Frequency (MHz)	Conducted Output Power (dBm)	Max. Limit (dBm)	Max. Limit (W)	Result
36	5180	23.66	30.00	1.00	Complies
40	5200	23.62	30.00	1.00	Complies
48	5240	23.17	30.00	1.00	Complies

Test Mode	UNII-1_TX AC (VHT40) Mode_Ant. 1
-----------	----------------------------------

Channel	Frequency (MHz)	Conducted Output Power (dBm)	Duty Factor	Conducted Output Power + Duty Factor (dBm)	Max. Limit (dBm)	Max. Limit (W)	Result
38	5190	18.44	0.13	18.57	30.00	1.00	Complies
46	5230	18.27	0.13	18.40	30.00	1.00	Complies

Test Mode	UNII-1_TX AC (VHT40) Mode_Ant. 2
-----------	----------------------------------

Channel	Frequency (MHz)	Conducted Output Power (dBm)	Duty Factor	Conducted Output Power + Duty Factor (dBm)	Max. Limit (dBm)	Max. Limit (W)	Result
38	5190	19.34	0.13	19.47	30.00	1.00	Complies
46	5230	19.03	0.13	19.16	30.00	1.00	Complies

Test Mode	UNII-1_TX AC (VHT40) Mode_Ant. 3
-----------	----------------------------------

Channel	Frequency (MHz)	Conducted Output Power (dBm)	Duty Factor	Conducted Output Power + Duty Factor (dBm)	Max. Limit (dBm)	Max. Limit (W)	Result
38	5190	18.77	0.13	18.90	30.00	1.00	Complies
46	5230	19.06	0.13	19.19	30.00	1.00	Complies

Test Mode	UNII-1_TX AC (VHT40) Mode_Total
-----------	---------------------------------

Channel	Frequency (MHz)	Conducted Output Power (dBm)	Max. Limit (dBm)	Max. Limit (W)	Result
38	5190	23.76	30.00	1.00	Complies
46	5230	23.70	30.00	1.00	Complies

Test Mode	UNII-1_TX AC (VHT80) Mode_Ant. 1
-----------	----------------------------------

Channel	Frequency (MHz)	Conducted Output Power (dBm)	Duty Factor	Conducted Output Power + Duty Factor (dBm)	Max. Limit (dBm)	Max. Limit (W)	Result
42	5210	15.33	0.24	15.57	30.00	1.00	Complies

Test Mode	UNII-1_TX AC (VHT80) Mode_Ant. 2
-----------	----------------------------------

Channel	Frequency (MHz)	Conducted Output Power (dBm)	Duty Factor	Conducted Output Power + Duty Factor (dBm)	Max. Limit (dBm)	Max. Limit (W)	Result
42	5210	16.20	0.24	16.44	30.00	1.00	Complies

Test Mode	UNII-1_TX AC (VHT80) Mode_Ant. 3
-----------	----------------------------------

Channel	Frequency (MHz)	Conducted Output Power (dBm)	Duty Factor	Conducted Output Power + Duty Factor (dBm)	Max. Limit (dBm)	Max. Limit (W)	Result
42	5210	15.71	0.24	15.95	30.00	1.00	Complies

Test Mode	UNII-1_TX AC (VHT80) Mode_Total
-----------	---------------------------------

Channel	Frequency (MHz)	Conducted Output Power (dBm)	Max. Limit (dBm)	Max. Limit (W)	Result
42	5210	20.77	30.00	1.00	Complies

Test Mode	UNII-3_TX AC (VHT20) Mode_Ant. 1
-----------	----------------------------------

Channel	Frequency (MHz)	Conducted Output Power (dBm)	Duty Factor	Conducted Output Power + Duty Factor (dBm)	Max. Limit (dBm)	Max. Limit (W)	Result
149	5745	24.41	0.00	24.41	30.00	1.00	Complies
157	5785	23.90	0.00	23.90	30.00	1.00	Complies
165	5825	25.07	0.00	25.07	30.00	1.00	Complies

Test Mode	UNII-3_TX AC (VHT20) Mode_Ant. 2
-----------	----------------------------------

Channel	Frequency (MHz)	Conducted Output Power (dBm)	Duty Factor	Conducted Output Power + Duty Factor (dBm)	Max. Limit (dBm)	Max. Limit (W)	Result
149	5745	24.89	0.00	24.89	30.00	1.00	Complies
157	5785	24.21	0.00	24.21	30.00	1.00	Complies
165	5825	25.11	0.00	25.11	30.00	1.00	Complies

Test Mode	UNII-3_TX AC (VHT20) Mode_Ant. 3
-----------	----------------------------------

Channel	Frequency (MHz)	Conducted Output Power (dBm)	Duty Factor	Conducted Output Power + Duty Factor (dBm)	Max. Limit (dBm)	Max. Limit (W)	Result
149	5745	24.77	0.00	24.77	30.00	1.00	Complies
157	5785	24.30	0.00	24.30	30.00	1.00	Complies
165	5825	25.37	0.00	25.37	30.00	1.00	Complies

Test Mode	UNII-3_TX AC (VHT20) Mode_Total
-----------	---------------------------------

Channel	Frequency (MHz)	Conducted Output Power (dBm)	Max. Limit (dBm)	Max. Limit (W)	Result
149	5745	29.47	30.00	1.00	Complies
157	5785	28.91	30.00	1.00	Complies
165	5825	29.96	30.00	1.00	Complies

Test Mode	UNII-3_TX AC (VHT40) Mode_Ant. 1
-----------	----------------------------------

Channel	Frequency (MHz)	Conducted Output Power (dBm)	Duty Factor	Conducted Output Power + Duty Factor (dBm)	Max. Limit (dBm)	Max. Limit (W)	Result
151	5755	23.03	0.13	23.16	30.00	1.00	Complies
159	5795	24.14	0.13	24.27	30.00	1.00	Complies

Test Mode	UNII-3_TX AC (VHT40) Mode_Ant. 2
-----------	----------------------------------

Channel	Frequency (MHz)	Conducted Output Power (dBm)	Duty Factor	Conducted Output Power + Duty Factor (dBm)	Max. Limit (dBm)	Max. Limit (W)	Result
151	5755	24.14	0.13	24.27	30.00	1.00	Complies
159	5795	24.05	0.13	24.18	30.00	1.00	Complies

Test Mode	UNII-3_TX AC (VHT40) Mode_Ant. 3
-----------	----------------------------------

Channel	Frequency (MHz)	Conducted Output Power (dBm)	Duty Factor	Conducted Output Power + Duty Factor (dBm)	Max. Limit (dBm)	Max. Limit (W)	Result
151	5755	23.09	0.13	23.22	30.00	1.00	Complies
159	5795	24.27	0.13	24.40	30.00	1.00	Complies

Test Mode	UNII-3_TX AC (VHT40) Mode_Total
-----------	---------------------------------

Channel	Frequency (MHz)	Conducted Output Power (dBm)	Max. Limit (dBm)	Max. Limit (W)	Result
151	5755	28.35	30.00	1.00	Complies
159	5795	29.05	30.00	1.00	Complies

Test Mode	UNII-3_TX AC (VHT80) Mode_Ant. 1
-----------	----------------------------------

Channel	Frequency (MHz)	Conducted Output Power (dBm)	Duty Factor	Conducted Output Power + Duty Factor (dBm)	Max. Limit (dBm)	Max. Limit (W)	Result
155	5775	18.12	0.24	18.36	30.00	1.00	Complies

Test Mode	UNII-3_TX AC (VHT80) Mode_Ant. 2
-----------	----------------------------------

Channel	Frequency (MHz)	Conducted Output Power (dBm)	Duty Factor	Conducted Output Power + Duty Factor (dBm)	Max. Limit (dBm)	Max. Limit (W)	Result
155	5775	18.51	0.24	18.75	30.00	1.00	Complies

Test Mode	UNII-3_TX AC (VHT80) Mode_Ant. 3
-----------	----------------------------------

Channel	Frequency (MHz)	Conducted Output Power (dBm)	Duty Factor	Conducted Output Power + Duty Factor (dBm)	Max. Limit (dBm)	Max. Limit (W)	Result
155	5775	18.22	0.24	18.46	30.00	1.00	Complies

Test Mode	UNII-3_TX AC (VHT80) Mode_Total
-----------	---------------------------------

Channel	Frequency (MHz)	Conducted Output Power (dBm)	Max. Limit (dBm)	Max. Limit (W)	Result
155	5775	23.30	30.00	1.00	Complies

Beamforming

Test Mode	UNII-1_TX N (HT20) Mode_Ant. 1
-----------	--------------------------------

Channel	Frequency (MHz)	Conducted Output Power (dBm)	Duty Factor	Conducted Output Power + Duty Factor (dBm)	Max. Limit (dBm)	Max. Limit (W)	Result
36	5180	18.33	0.00	18.33	27.50	0.56	Complies
40	5200	18.17	0.00	18.17	27.50	0.56	Complies
48	5240	17.81	0.00	17.81	27.50	0.56	Complies

Test Mode	UNII-1_TX N (HT20) Mode_Ant. 2
-----------	--------------------------------

Channel	Frequency (MHz)	Conducted Output Power (dBm)	Duty Factor	Conducted Output Power + Duty Factor (dBm)	Max. Limit (dBm)	Max. Limit (W)	Result
36	5180	19.34	0.00	19.34	27.50	0.56	Complies
40	5200	18.95	0.00	18.95	27.50	0.56	Complies
48	5240	18.52	0.00	18.52	27.50	0.56	Complies

Test Mode	UNII-1_TX N (HT20) Mode_Ant. 3
-----------	--------------------------------

Channel	Frequency (MHz)	Conducted Output Power (dBm)	Duty Factor	Conducted Output Power + Duty Factor (dBm)	Max. Limit (dBm)	Max. Limit (W)	Result
36	5180	18.19	0.00	18.19	27.50	0.56	Complies
40	5200	18.64	0.00	18.64	27.50	0.56	Complies
48	5240	18.26	0.00	18.26	27.50	0.56	Complies

Test Mode	UNII-1_TX N (HT20) Mode_Total
-----------	-------------------------------

Channel	Frequency (MHz)	Conducted Output Power (dBm)	Max. Limit (dBm)	Max. Limit (W)	Result
36	5180	23.42	27.50	0.56	Complies
40	5200	23.37	27.50	0.56	Complies
48	5240	22.98	27.50	0.56	Complies

Test Mode	UNII-1_TX N (HT40) Mode_Ant. 1
-----------	--------------------------------

Channel	Frequency (MHz)	Conducted Output Power (dBm)	Duty Factor	Conducted Output Power + Duty Factor (dBm)	Max. Limit (dBm)	Max. Limit (W)	Result
38	5190	18.15	0.14	18.29	27.50	0.56	Complies
46	5230	18.12	0.14	18.26	27.50	0.56	Complies

Test Mode	UNII-1_TX N (HT40) Mode_Ant. 2
-----------	--------------------------------

Channel	Frequency (MHz)	Conducted Output Power (dBm)	Duty Factor	Conducted Output Power + Duty Factor (dBm)	Max. Limit (dBm)	Max. Limit (W)	Result
38	5190	19.26	0.14	19.40	27.50	0.56	Complies
46	5230	19.21	0.14	19.35	27.50	0.56	Complies

Test Mode	UNII-1_TX N (HT40) Mode_Ant. 3
-----------	--------------------------------

Channel	Frequency (MHz)	Conducted Output Power (dBm)	Duty Factor	Conducted Output Power + Duty Factor (dBm)	Max. Limit (dBm)	Max. Limit (W)	Result
38	5190	18.41	0.14	18.55	27.50	0.56	Complies
46	5230	18.68	0.14	18.82	27.50	0.56	Complies

Test Mode	UNII-1_TX N (HT40) Mode_Total
-----------	-------------------------------

Channel	Frequency (MHz)	Conducted Output Power (dBm)	Max. Limit (dBm)	Max. Limit (W)	Result
38	5190	23.54	27.50	0.56	Complies
46	5230	23.60	27.50	0.56	Complies

Test Mode	UNII-3_TX N (HT20) Mode_Ant. 1
-----------	--------------------------------

Channel	Frequency (MHz)	Conducted Output Power (dBm)	Duty Factor	Conducted Output Power + Duty Factor (dBm)	Max. Limit (dBm)	Max. Limit (W)	Result
149	5745	22.43	0.00	22.43	27.50	0.56	Complies
157	5785	22.35	0.00	22.35	27.50	0.56	Complies
165	5825	22.36	0.00	22.36	27.50	0.56	Complies

Test Mode	UNII-3_TX N (HT20) Mode_Ant. 2
-----------	--------------------------------

Channel	Frequency (MHz)	Conducted Output Power (dBm)	Duty Factor	Conducted Output Power + Duty Factor (dBm)	Max. Limit (dBm)	Max. Limit (W)	Result
149	5745	22.78	0.00	22.78	27.50	0.56	Complies
157	5785	22.79	0.00	22.79	27.50	0.56	Complies
165	5825	22.78	0.00	22.78	27.50	0.56	Complies

Test Mode	UNII-3_TX N (HT20) Mode_Ant. 3
-----------	--------------------------------

Channel	Frequency (MHz)	Conducted Output Power (dBm)	Duty Factor	Conducted Output Power + Duty Factor (dBm)	Max. Limit (dBm)	Max. Limit (W)	Result
149	5745	22.53	0.00	22.53	27.50	0.56	Complies
157	5785	22.67	0.00	22.67	27.50	0.56	Complies
165	5825	22.87	0.00	22.87	27.50	0.56	Complies

Test Mode	UNII-3_TX N (HT20) Mode_Total
-----------	-------------------------------

Channel	Frequency (MHz)	Conducted Output Power (dBm)	Max. Limit (dBm)	Max. Limit (W)	Result
149	5745	27.35	27.50	0.56	Complies
157	5785	27.38	27.50	0.56	Complies
165	5825	27.45	27.50	0.56	Complies

Test Mode	UNII-3_TX N (HT40) Mode_Ant. 1
-----------	--------------------------------

Channel	Frequency (MHz)	Conducted Output Power (dBm)	Duty Factor	Conducted Output Power + Duty Factor (dBm)	Max. Limit (dBm)	Max. Limit (W)	Result
151	5755	22.35	0.14	22.49	27.50	0.56	Complies
159	5795	22.28	0.14	22.42	27.50	0.56	Complies

Test Mode	UNII-3_TX N (HT40) Mode_Ant. 2
-----------	--------------------------------

Channel	Frequency (MHz)	Conducted Output Power (dBm)	Duty Factor	Conducted Output Power + Duty Factor (dBm)	Max. Limit (dBm)	Max. Limit (W)	Result
151	5755	22.91	0.14	23.05	27.50	0.56	Complies
159	5795	22.86	0.14	23.00	27.50	0.56	Complies

Test Mode	UNII-3_TX N (HT40) Mode_Ant. 3
-----------	--------------------------------

Channel	Frequency (MHz)	Conducted Output Power (dBm)	Duty Factor	Conducted Output Power + Duty Factor (dBm)	Max. Limit (dBm)	Max. Limit (W)	Result
151	5755	22.41	0.14	22.55	27.50	0.56	Complies
159	5795	22.57	0.14	22.71	27.50	0.56	Complies

Test Mode	UNII-3_TX N (HT40) Mode_Total
-----------	-------------------------------

Channel	Frequency (MHz)	Conducted Output Power (dBm)	Max. Limit (dBm)	Max. Limit (W)	Result
151	5755	27.47	27.50	0.56	Complies
159	5795	27.48	27.50	0.56	Complies

Test Mode	UNII-1_TX AC (VHT20) Mode_Ant. 1
-----------	----------------------------------

Channel	Frequency (MHz)	Conducted Output Power (dBm)	Duty Factor	Conducted Output Power + Duty Factor (dBm)	Max. Limit (dBm)	Max. Limit (W)	Result
36	5180	18.36	0.00	18.36	27.50	0.56	Complies
40	5200	18.21	0.00	18.21	27.50	0.56	Complies
48	5240	17.86	0.00	17.86	27.50	0.56	Complies

Test Mode	UNII-1_TX AC (VHT20) Mode_Ant. 2
-----------	----------------------------------

Channel	Frequency (MHz)	Conducted Output Power (dBm)	Duty Factor	Conducted Output Power + Duty Factor (dBm)	Max. Limit (dBm)	Max. Limit (W)	Result
36	5180	19.28	0.00	19.28	27.50	0.56	Complies
40	5200	18.96	0.00	18.96	27.50	0.56	Complies
48	5240	18.54	0.00	18.54	27.50	0.56	Complies

Test Mode	UNII-1_TX AC (VHT20) Mode_Ant. 3
-----------	----------------------------------

Channel	Frequency (MHz)	Conducted Output Power (dBm)	Duty Factor	Conducted Output Power + Duty Factor (dBm)	Max. Limit (dBm)	Max. Limit (W)	Result
36	5180	18.23	0.00	18.23	27.50	0.56	Complies
40	5200	18.62	0.00	18.62	27.50	0.56	Complies
48	5240	18.32	0.00	18.32	27.50	0.56	Complies

Test Mode	UNII-1_TX AC (VHT20) Mode_Total
-----------	---------------------------------

Channel	Frequency (MHz)	Conducted Output Power (dBm)	Max. Limit (dBm)	Max. Limit (W)	Result
36	5180	23.42	27.50	0.56	Complies
40	5200	23.38	27.50	0.56	Complies
48	5240	23.02	27.50	0.56	Complies

Test Mode	UNII-1_TX AC (VHT40) Mode_Ant. 1
-----------	----------------------------------

Channel	Frequency (MHz)	Conducted Output Power (dBm)	Duty Factor	Conducted Output Power + Duty Factor (dBm)	Max. Limit (dBm)	Max. Limit (W)	Result
38	5190	18.18	0.13	18.31	27.50	0.56	Complies
46	5230	18.15	0.13	18.28	27.50	0.56	Complies

Test Mode	UNII-1_TX AC (VHT40) Mode_Ant. 2
-----------	----------------------------------

Channel	Frequency (MHz)	Conducted Output Power (dBm)	Duty Factor	Conducted Output Power + Duty Factor (dBm)	Max. Limit (dBm)	Max. Limit (W)	Result
38	5190	19.29	0.13	19.42	27.50	0.56	Complies
46	5230	19.21	0.13	19.34	27.50	0.56	Complies

Test Mode	UNII-1_TX AC (VHT40) Mode_Ant. 3
-----------	----------------------------------

Channel	Frequency (MHz)	Conducted Output Power (dBm)	Duty Factor	Conducted Output Power + Duty Factor (dBm)	Max. Limit (dBm)	Max. Limit (W)	Result
38	5190	18.45	0.13	18.58	27.50	0.56	Complies
46	5230	18.76	0.13	18.89	27.50	0.56	Complies

Test Mode	UNII-1_TX AC (VHT40) Mode_Total
-----------	---------------------------------

Channel	Frequency (MHz)	Conducted Output Power (dBm)	Max. Limit (dBm)	Max. Limit (W)	Result
38	5190	23.56	27.50	0.56	Complies
46	5230	23.63	27.50	0.56	Complies

Test Mode	UNII-1_TX AC (VHT80) Mode_Ant. 1
-----------	----------------------------------

Channel	Frequency (MHz)	Conducted Output Power (dBm)	Duty Factor	Conducted Output Power + Duty Factor (dBm)	Max. Limit (dBm)	Max. Limit (W)	Result
42	5210	15.08	0.24	15.32	27.50	0.56	Complies

Test Mode	UNII-1_TX AC (VHT80) Mode_Ant. 2
-----------	----------------------------------

Channel	Frequency (MHz)	Conducted Output Power (dBm)	Duty Factor	Conducted Output Power + Duty Factor (dBm)	Max. Limit (dBm)	Max. Limit (W)	Result
42	5210	16.21	0.24	16.45	27.50	0.56	Complies

Test Mode	UNII-1_TX AC (VHT80) Mode_Ant. 3
-----------	----------------------------------

Channel	Frequency (MHz)	Conducted Output Power (dBm)	Duty Factor	Conducted Output Power + Duty Factor (dBm)	Max. Limit (dBm)	Max. Limit (W)	Result
42	5210	15.76	0.24	16.00	27.50	0.56	Complies

Test Mode	UNII-1_TX AC (VHT80) Mode_Total
-----------	---------------------------------

Channel	Frequency (MHz)	Conducted Output Power (dBm)	Max. Limit (dBm)	Max. Limit (W)	Result
42	5210	20.72	27.50	0.56	Complies

Test Mode	UNII-3_TX AC (VHT20) Mode_Ant. 1
-----------	----------------------------------

Channel	Frequency (MHz)	Conducted Output Power (dBm)	Duty Factor	Conducted Output Power + Duty Factor (dBm)	Max. Limit (dBm)	Max. Limit (W)	Result
149	5745	22.44	0.00	22.44	27.50	0.56	Complies
157	5785	22.36	0.00	22.36	27.50	0.56	Complies
165	5825	22.41	0.00	22.41	27.50	0.56	Complies

Test Mode	UNII-3_TX AC (VHT20) Mode_Ant. 2
-----------	----------------------------------

Channel	Frequency (MHz)	Conducted Output Power (dBm)	Duty Factor	Conducted Output Power + Duty Factor (dBm)	Max. Limit (dBm)	Max. Limit (W)	Result
149	5745	22.78	0.00	22.78	27.50	0.56	Complies
157	5785	22.77	0.00	22.77	27.50	0.56	Complies
165	5825	22.85	0.00	22.85	27.50	0.56	Complies

Test Mode	UNII-3_TX AC (VHT20) Mode_Ant. 3
-----------	----------------------------------

Channel	Frequency (MHz)	Conducted Output Power (dBm)	Duty Factor	Conducted Output Power + Duty Factor (dBm)	Max. Limit (dBm)	Max. Limit (W)	Result
149	5745	22.51	0.00	22.51	27.50	0.56	Complies
157	5785	22.73	0.00	22.73	27.50	0.56	Complies
165	5825	22.88	0.00	22.88	27.50	0.56	Complies

Test Mode	UNII-3_TX AC (VHT20) Mode_Total
-----------	---------------------------------

Channel	Frequency (MHz)	Conducted Output Power (dBm)	Max. Limit (dBm)	Max. Limit (W)	Result
149	5745	27.35	27.50	0.56	Complies
157	5785	27.40	27.50	0.56	Complies
165	5825	27.49	27.50	0.56	Complies

Test Mode	UNII-3_TX AC (VHT40) Mode_Ant. 1
-----------	----------------------------------

Channel	Frequency (MHz)	Conducted Output Power (dBm)	Duty Factor	Conducted Output Power + Duty Factor (dBm)	Max. Limit (dBm)	Max. Limit (W)	Result
151	5755	22.34	0.13	22.47	27.50	0.56	Complies
159	5795	22.31	0.13	22.44	27.50	0.56	Complies

Test Mode	UNII-3_TX AC (VHT40) Mode_Ant. 2
-----------	----------------------------------

Channel	Frequency (MHz)	Conducted Output Power (dBm)	Duty Factor	Conducted Output Power + Duty Factor (dBm)	Max. Limit (dBm)	Max. Limit (W)	Result
151	5755	22.90	0.13	23.03	27.50	0.56	Complies
159	5795	22.88	0.13	23.01	27.50	0.56	Complies

Test Mode	UNII-3_TX AC (VHT40) Mode_Ant. 3
-----------	----------------------------------

Channel	Frequency (MHz)	Conducted Output Power (dBm)	Duty Factor	Conducted Output Power + Duty Factor (dBm)	Max. Limit (dBm)	Max. Limit (W)	Result
151	5755	22.46	0.13	22.59	27.50	0.56	Complies
159	5795	22.56	0.13	22.69	27.50	0.56	Complies

Test Mode	UNII-3_TX AC (VHT40) Mode_Total
-----------	---------------------------------

Channel	Frequency (MHz)	Conducted Output Power (dBm)	Max. Limit (dBm)	Max. Limit (W)	Result
151	5755	27.47	27.50	0.56	Complies
159	5795	27.49	27.50	0.56	Complies

Test Mode	UNII-3_TX AC (VHT80) Mode_Ant. 1
-----------	----------------------------------

Channel	Frequency (MHz)	Conducted Output Power (dBm)	Duty Factor	Conducted Output Power + Duty Factor (dBm)	Max. Limit (dBm)	Max. Limit (W)	Result
155	5775	17.86	0.24	18.10	27.50	0.56	Complies

Test Mode	UNII-3_TX AC (VHT80) Mode_Ant. 2
-----------	----------------------------------

Channel	Frequency (MHz)	Conducted Output Power (dBm)	Duty Factor	Conducted Output Power + Duty Factor (dBm)	Max. Limit (dBm)	Max. Limit (W)	Result
155	5775	18.14	0.24	18.38	27.50	0.56	Complies

Test Mode	UNII-3_TX AC (VHT80) Mode_Ant. 3
-----------	----------------------------------

Channel	Frequency (MHz)	Conducted Output Power (dBm)	Duty Factor	Conducted Output Power + Duty Factor (dBm)	Max. Limit (dBm)	Max. Limit (W)	Result
155	5775	18.21	0.24	18.45	27.50	0.56	Complies

Test Mode	UNII-3_TX AC (VHT80) Mode_Total
-----------	---------------------------------

Channel	Frequency (MHz)	Conducted Output Power (dBm)	Max. Limit (dBm)	Max. Limit (W)	Result
155	5775	23.08	27.50	0.56	Complies

APPENDIX G - POWER SPECTRAL DENSITY

Non-Beamforming

Test Mode UNII-1_TX A Mode_Ant. 1

Channel	Frequency (MHz)	Power Spectral Density (dBm/MHz)	Duty Factor	Power Spectral Density + Duty Factor (dBm/MHz)	Max. Limit (dBm/MHz)	Result
36	5180	8.93	0.13	9.06	14.23	Complies
40	5200	8.59	0.13	8.72	14.23	Complies
48	5240	8.30	0.13	8.43	14.23	Complies

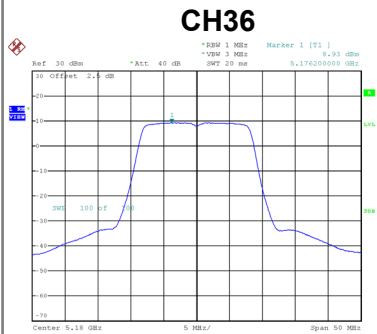

Date: 30_SEP.2019 07:58:08

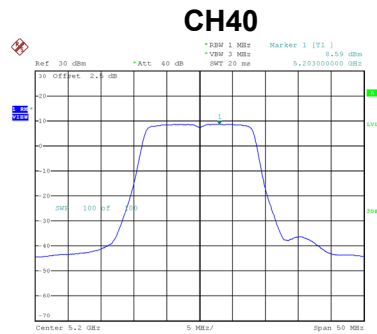

Date: 30_SEP.2019 07:59:22

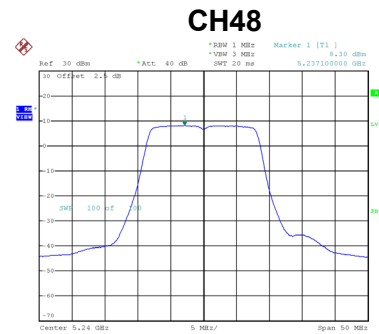

Date: 30_SEP.2019 08:00:03

Test Mode UNII-1_TX A Mode_Ant. 2

Channel	Frequency (MHz)	Power Spectral Density (dBm/MHz)	Duty Factor	Power Spectral Density + Duty Factor (dBm/MHz)	Max. Limit (dBm/MHz)	Result
36	5180	9.28	0.13	9.41	14.23	Complies
40	5200	9.04	0.13	9.17	14.23	Complies
48	5240	8.54	0.13	8.67	14.23	Complies

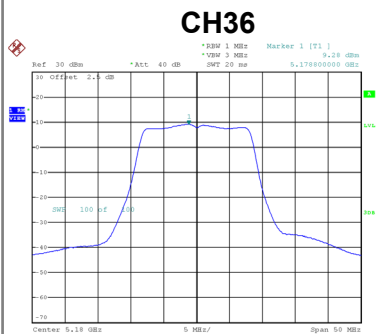

Date: 30_SEP.2019 08:00:53

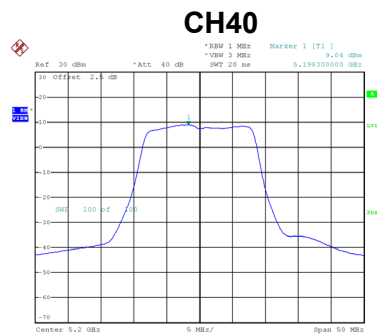

Date: 30_SEP.2019 08:01:28

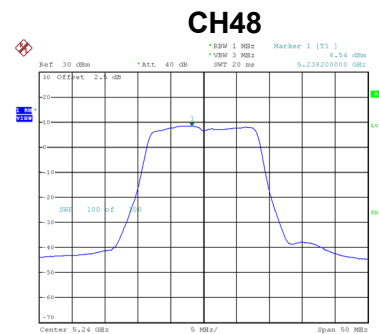

Date: 30_SEP.2019 08:01:45

Test Mode	UNII-1_TX A Mode_Ant. 3
-----------	-------------------------

Channel	Frequency (MHz)	Power Spectral Density (dBm/MHz)	Duty Factor	Power Spectral Density + Duty Factor (dBm/MHz)	Max. Limit (dBm/MHz)	Result
36	5180	9.42	0.13	9.55	14.23	Complies
40	5200	10.17	0.13	10.30	14.23	Complies
48	5240	9.53	0.13	9.66	14.23	Complies

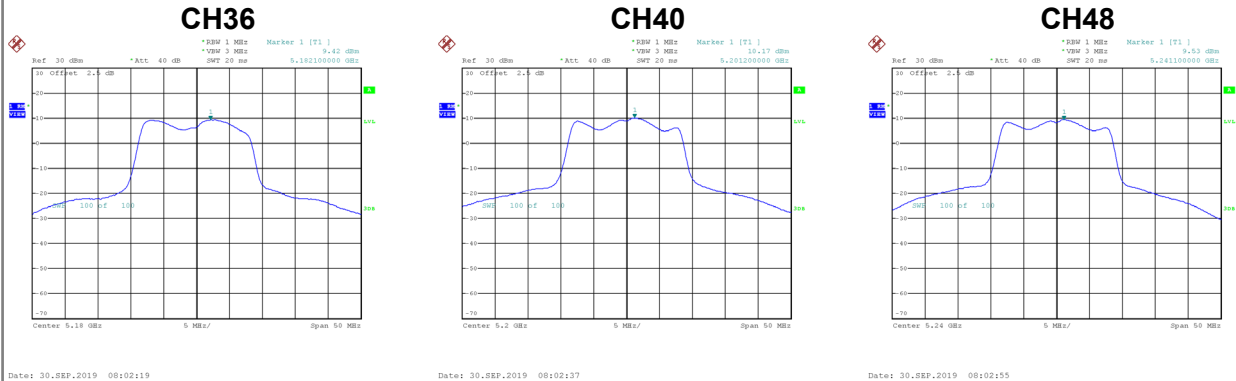

Test Mode	UNII-1_TX A Mode_Total
-----------	------------------------

Channel	Frequency (MHz)	Power Spectral Density (dBm/MHz)	Max. Limit (dBm/MHz)	Result
36	5180	14.12	14.23	Complies
40	5200	14.22	14.23	Complies
48	5240	13.73	14.23	Complies

Test Mode UNII-3_TX A Mode_Ant. 1

Channel	Frequency (MHz)	Power Spectral Density (dBm/500 kHz)	Duty Factor	Power Spectral Density + Duty Factor (dBm/500 kHz)	Max. Limit (dBm/500 kHz)	Result
149	5745	1.05	0.13	1.18	27.23	Complies
157	5785	0.60	0.13	0.73	27.23	Complies
165	5825	-0.68	0.13	-0.55	27.23	Complies

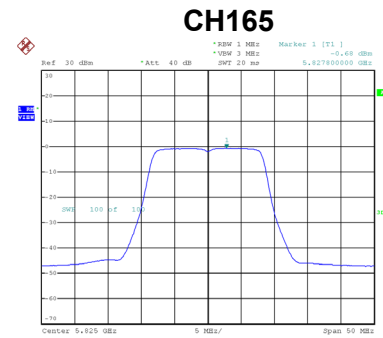
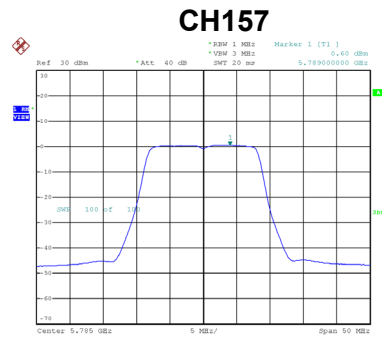
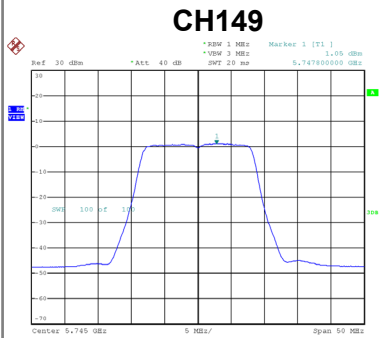

Test Mode UNII-3_TX A Mode_Ant. 2

Channel	Frequency (MHz)	Power Spectral Density (dBm/500 kHz)	Duty Factor	Power Spectral Density + Duty Factor (dBm/500 kHz)	Max. Limit (dBm/500 kHz)	Result
149	5745	1.92	0.13	2.05	27.23	Complies
157	5785	1.52	0.13	1.65	27.23	Complies
165	5825	0.50	0.13	0.63	27.23	Complies

