

## FCC Test Report

**Report No.:** RFBDYS-WTW-P20110362-2

**FCC ID:** TVE-3617T01066

**Test Model:** FAP-234F

**Series Model:** FortiAP 234Fxxxxxx, FAP-234Fxxxxxx, FORTIAP-234Fxxxxxx (Where "x" can be used as "A-Z", or "0-9", or "-", or blank for software changes or marketing purposes only)

**Received Date:** Nov. 11, 2020

**Test Date:** Nov. 24 ~ Dec. 30, 2020

**Issued Date:** Jan. 27, 2021

**Applicant:** Fortinet Inc.

**Address:** 899 Kifer Road Sunnyvale, CA 94086 USA

**Issued By:** Bureau Veritas Consumer Products Services (H.K.) Ltd., Taoyuan Branch  
Lin Kou Laboratories

**Lab Address:** No. 47-2, 14th Ling, Chia Pau Vil., Lin Kou Dist., New Taipei City, Taiwan

**Test Location:** No. 19, Hwa Ya 2nd Rd., Wen Hwa Vil., Kwei Shan Dist., Taoyuan City  
33383, TAIWAN

**FCC Registration /  
Designation Number:** 788550 / TW0003



This report is for your exclusive use. Any copying or replication of this report to or for any other person or entity, or use of our name or trademark, is permitted only with our prior written permission. This report sets forth our findings solely with respect to the test samples identified herein. The results set forth in this report are not indicative or representative of the quality or characteristics of the lot from which a test sample was taken or any similar or identical product specifically and expressly noted. Our report includes all of the tests requested by you and the results thereof based upon the information that you provided to us. You have 60 days from date of issuance of this report to notify us of any material error or omission caused by our negligence, provided, however, that such notice shall be in writing and shall specifically address the issue you wish to raise. A failure to raise such issue within the prescribed time shall constitute your unqualified acceptance of the completeness of this report, the tests conducted and the correctness of the report contents. Unless specific mention, the uncertainty of measurement has been explicitly taken into account to declare the compliance or non-compliance to the specification.

## Table of Contents

<b>Release Control Record</b> .....	<b>4</b>
<b>1 Certificate of Conformity</b> .....	<b>5</b>
<b>2 Summary of Test Results</b> .....	<b>6</b>
2.1 Measurement Uncertainty.....	6
2.2 Modification Record.....	6
<b>3 General Information</b> .....	<b>7</b>
3.1 General Description of EUT.....	7
3.2 Description of Test Modes.....	8
3.2.1 Test Mode Applicability and Tested Channel Detail.....	9
3.3 Duty Cycle of Test Signal.....	10
3.4 Description of Support Units.....	11
3.4.1 Configuration of System under Test.....	11
3.5 General Description of Applied Standards and References.....	12
<b>4 Test Types and Results</b> .....	<b>13</b>
4.1 Radiated Emission and Bandedge Measurement.....	13
4.1.1 Limits of Radiated Emission and Bandedge Measurement.....	13
4.1.2 Test Instruments.....	14
4.1.3 Test Procedures.....	15
4.1.4 Deviation from Test Standard.....	15
4.1.5 Test Setup.....	16
4.1.6 EUT Operating Conditions.....	17
4.1.7 Test Results.....	18
4.2 Conducted Emission Measurement.....	26
4.2.1 Limits of Conducted Emission Measurement.....	26
4.2.2 Test Instruments.....	26
4.2.3 Test Procedures.....	27
4.2.4 Deviation from Test Standard.....	27
4.2.5 Test Setup.....	27
4.2.6 EUT Operating Conditions.....	27
4.2.7 Test Results.....	28
4.3 6dB Bandwidth Measurement.....	30
4.3.1 Limits of 6dB Bandwidth Measurement.....	30
4.3.2 Test Setup.....	30
4.3.3 Test Instruments.....	30
4.3.4 Test Procedure.....	30
4.3.5 Deviation from Test Standard.....	30
4.3.6 EUT Operating Conditions.....	30
4.3.7 Test Result.....	31
4.4 Conducted Output Power Measurement.....	32
4.4.1 Limits of Conducted Output Power Measurement.....	32
4.4.2 Test Setup.....	32
4.4.3 Test Instruments.....	32
4.4.4 Test Procedures.....	32
4.4.5 Deviation from Test Standard.....	32
4.4.6 EUT Operating Conditions.....	32
4.4.7 Test Results.....	33
4.5 Power Spectral Density Measurement.....	34
4.5.1 Limits of Power Spectral Density Measurement.....	34
4.5.2 Test Setup.....	34
4.5.3 Test Instruments.....	34
4.5.4 Test Procedure.....	34
4.5.5 Deviation from Test Standard.....	34
4.5.6 EUT Operating Condition.....	34

4.5.7 Test Results .....	35
4.6 Conducted Out of Band Emission Measurement.....	36
4.6.1 Limits of Conducted Out of Band Emission Measurement .....	36
4.6.2 Test Setup.....	36
4.6.3 Test Instruments .....	36
4.6.4 Test Procedure .....	36
4.6.5 Deviation from Test Standard .....	36
4.6.6 EUT Operating Condition .....	36
4.6.7 Test Results .....	36
<b>Annex A - Band Edge Measurement .....</b>	<b>39</b>
<b>5 Pictures of Test Arrangements.....</b>	<b>41</b>
<b>Appendix – Information of the Testing Laboratories .....</b>	<b>42</b>

### Release Control Record

Issue No.	Description	Date Issued
RFBDIS-WTW-P20110362-2	Original release	Jan. 27, 2021

## 1 Certificate of Conformity

**Product:** Secured Wireless Access Point

**Brand:** Fortinet

**Test Model:** FAP-234F

**Series Model:** FortiAP 234Fxxxxxx, FAP-234Fxxxxxx, FORTIAP-234Fxxxxxx (Where "x" can be used as "A-Z", or "0-9", or "-", or blank for software changes or marketing purposes only)

**Sample Status:** Engineering sample

**Applicant:** Fortinet Inc.

**Test Date:** Nov. 24 ~ Dec. 30, 2020

**Standards:** 47 CFR FCC Part 15, Subpart C (Section 15.247)  
ANSI C63.10:2013

The above equipment has been tested by **Bureau Veritas Consumer Products Services (H.K.) Ltd., Taoyuan Branch**, and found compliance with the requirement of the above standards. The test record, data evaluation & Equipment Under Test (EUT) configurations represented herein are true and accurate accounts of the measurements of the sample's RF characteristics under the conditions specified in this report.

**Prepared by :** Celine Chou , **Date:** Jan. 27, 2021  
Celine Chou / Senior Specialist

**Approved by :** Bruce Chen , **Date:** Jan. 27, 2021  
Bruce Chen / Senior Project Engineer

## 2 Summary of Test Results

47 CFR FCC Part 15, Subpart C (Section 15.247)			
FCC Clause	Test Item	Result	Remarks
15.207	AC Power Conducted Emission	Pass	Meet the requirement of limit. Minimum passing margin is -4.86dB at 0.46936MHz.
15.205 / 15.209 / 15.247(d)	Radiated Emissions and Band Edge Measurement	Pass	Meet the requirement of limit. Minimum passing margin is -0.3dB at 59.92MHz.
15.247(d)	Antenna Port Emission	Pass	Meet the requirement of limit.
15.247(a)(2)	6dB bandwidth	Pass	Meet the requirement of limit.
15.247(b)	Conducted power	Pass	Meet the requirement of limit.
15.247(e)	Power Spectral Density	Pass	Meet the requirement of limit.
15.203	Antenna Requirement	Pass	Antenna connector is IPEX not a standard connector.

Note:

- For 2.4G band compliance with rule 15.247(d) of the band-edge items, the test plots were recorded in Annex A. Test Procedures refer to report 4.1.3.
- Determining compliance based on the results of the compliance measurement, not taking into account measurement instrumentation uncertainty.

### 2.1 Measurement Uncertainty

Where relevant, the following measurement uncertainty levels have been estimated for tests performed on the EUT as specified in CISPR 16-4-2:

Measurement	Frequency	Expanded Uncertainty (k=2) (±)
Conducted Emissions at mains ports	150kHz ~ 30MHz	2.79 dB
Radiated Emissions up to 1 GHz	9kHz ~ 30MHz	3.04 dB
	30MHz ~ 200MHz	3.86 dB
	200MHz ~ 1000MHz	3.87 dB
Radiated Emissions above 1 GHz	1GHz ~ 18GHz	2.29 dB
	18GHz ~ 40GHz	2.29 dB

### 2.2 Modification Record

There were no modifications required for compliance.

### 3 General Information

#### 3.1 General Description of EUT

Product	Secured Wireless Access Point
Brand	Fortinet
Test Model	FAP-234F
Series Model	FortiAP 234Fxxxxxx, FAP-234Fxxxxxx, FORTIAP-234Fxxxxxx (Where "x" can be used as "A-Z", or "0-9", or "-", or blank for software changes or marketing purposes only)
Model Difference	Refer to note
Sample Status	Engineering sample
Power Supply Rating	54Vdc from POE
Modulation Type	GFSK
Transfer Rate	Bluetooth LE 4.0: 1Mbps Bluetooth LE 5.0: 2Mbps
Operating Frequency	2402 ~ 2480MHz
Number of Channel	40
Channel Spacing	2MHz
Output Power	Bluetooth LE 4.0: 17.061mW Bluetooth LE 5.0: 17.022mW
Antenna Type	Refer to note
Antenna Connector	Refer to note
Accessory Device	POE
Cable Supplied	NA

Note:

1. The following models are provided to this EUT. The model FAP-234F was chosen for final test.

Brand	Model	Description
Fortinet	FAP-234F	Series model for marketing purpose
	FortiAP 234Fxxxxxx, FAP-234Fxxxxxx, FORTIAP-234Fxxxxxx (Where "x" can be used as "A-Z", or "0-9", or "-", or blank for software changes or marketing purposes only)	

2. The EUT consumes power from the following POEs.

POE 1	
Brand	SENAO
Model	EPA5006GPR
Input Power	100-240Vac, 50-60Hz, 0.8A
Output Power	54Vdc, 0.6A

POE 2 (Optional)	
Brand	SENAO
Model	EPA5006GP
Input Power	100-240Vac, 50-60Hz, 0.8A
Output Power	54Vdc, 0.6A

3. The following antennas were provided to the EUT.

No.	Type	Connector	Gain (dBi)						Remark
			2400MHz	2450MHz	2500MHz	5150MHz	5500MHz	5850MHz	
1	Patch Array	IPEX	9.47	10.20	10.16	-	-	-	2G traffic radio (Radio 1)
2	Patch Array	IPEX	9.24	10.25	9.73	-	-	-	
3	Patch Array	IPEX	-	-	-	9.75	9.94	10.02	5G traffic radio (Radio 2)
4	Patch Array	IPEX	-	-	-	9.81	10.17	10.02	
5	Dipole	IPEX	4.25	4.99	4.15	-	-	-	BT LE / Zigbee
6	Dipole	IPEX	3.38	3.38	3.84	4.92	4.54	4.80	Scanning radio (Radio 3)

\* The above Antenna information is declared by manufacturer and for more detailed features description, please refer to the manufacturer's specifications, the laboratory shall not be held responsible.

4. The simultaneous operation mode was determined by client.

No	Mode
1	2G traffic radio (Radio 1) + 5GHz traffic radio (Radio 2) + 5G Scanning radio (Radio 3) + BLE
2	2G traffic radio (Radio 1) + 5GHz traffic radio (Radio 2) + 5G Scanning radio (Radio 3) + Zigbee
3	5GHz traffic radio (Radio 2) + 2G Scanning radio (Radio 3) + BLE
4	5GHz traffic radio (Radio 2) + 2G Scanning radio (Radio 3) + Zigbee

\* 5GHz traffic radio (Radio 2) and 5G Scanning radio (Radio 3) cannot transmit in the same band at same time. 2G traffic radio (Radio 1) and 2G Scanning radio (Radio 3) cannot transmit at same time.

\* Zigbee and BT technologies cannot transmit at same time.

\* Spurious emission of the simultaneous operation has been evaluated and no non-compliance was found.

### 3.2 Description of Test Modes

40 channels are provided to this EUT:

Channel	Freq. (MHz)	Channel	Freq. (MHz)	Channel	Freq. (MHz)	Channel	Freq. (MHz)
0	2402	10	2422	20	2442	30	2462
1	2404	11	2424	21	2444	31	2464
2	2406	12	2426	22	2446	32	2466
3	2408	13	2428	23	2448	33	2468
4	2410	14	2430	24	2450	34	2470
5	2412	15	2432	25	2452	35	2472
6	2414	16	2434	26	2454	36	2474
7	2416	17	2436	27	2456	37	2476
8	2418	18	2438	28	2458	38	2478
9	2420	19	2440	29	2460	39	2480



### 3.2.1 Test Mode Applicability and Tested Channel Detail

EUT Configure Mode	Applicable to				Description
	RE $\geq$ 1G	RE<1G	PLC	APCM	
-	√	√	√	√	-

Where RE $\geq$ 1G: Radiated Emission above 1GHz & Bandedge Measurement  
 RE<1G: Radiated Emission below 1GHz  
 PLC: Power Line Conducted Emission  
 APCM: Antenna Port Conducted Measurement

Note:

- The EUT had been pre-tested on the positioned of each 3 axis. The worst case was found when positioned on **Z-plane**.
- Radiated emission test (below 1GHz) and power line conducted emission test items chosen the worst maximum power.

#### **Radiated Emission Test (Above 1GHz):**

- Pre-Scan has been conducted to determine the worst-case mode from all possible combinations between available modulations, data rates and antenna ports (if EUT with antenna diversity architecture).
- Following channel(s) was (were) selected for the final test as listed below.

EUT Configure Mode	Available Channel	Tested Channel	Modulation Type	Data Rate (Mbps)
-	0 to 39	0, 19, 39	GFSK	1, 2

#### **Radiated Emission Test (Below 1GHz):**

- Pre-Scan has been conducted to determine the worst-case mode from all possible combinations between available modulations, data rates and antenna ports (if EUT with antenna diversity architecture).
- Following channel(s) was (were) selected for the final test as listed below.

EUT Configure Mode	Available Channel	Tested Channel	Modulation Type	Data Rate (Mbps)
-	0 to 39	19	GFSK	1

#### **Power Line Conducted Emission Test:**

- Pre-Scan has been conducted to determine the worst-case mode from all possible combinations between available modulations, data rates and antenna ports (if EUT with antenna diversity architecture).
- Following channel(s) was (were) selected for the final test as listed below.

EUT Configure Mode	Available Channel	Tested Channel	Modulation Type	Data Rate (Mbps)
-	0 to 39	19	GFSK	1

#### **Antenna Port Conducted Measurement:**

- This item includes all test value of each mode, but only includes spectrum plot of worst value of each mode.
- Pre-Scan has been conducted to determine the worst-case mode from all possible combinations between available modulations, data rates and antenna ports (if EUT with antenna diversity architecture).
- Following channel(s) was (were) selected for the final test as listed below.

EUT Configure Mode	Available Channel	Tested Channel	Modulation Type	Data Rate (Mbps)
-	0 to 39	0, 19, 39	GFSK	1, 2

#### **Test Condition:**

Applicable to	Environmental Conditions	Input Power	Tested by
RE $\geq$ 1G	23 deg. C, 67% RH	54Vdc	Adair Peng
RE<1G	23 deg. C, 67% RH	54Vdc	Titan Hsu
PLC	23 deg. C, 67% RH	54Vdc	Adair Peng
APCM	25 deg. C, 60% RH	54Vdc	Chris Lin

### 3.3 Duty Cycle of Test Signal

Duty cycle of test signal is 100%.

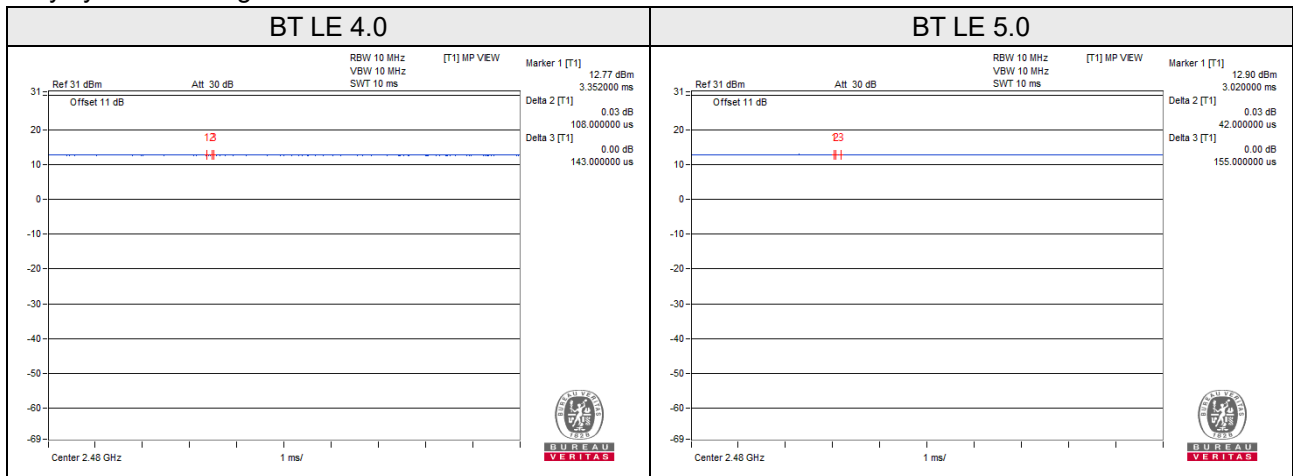

### 3.4 Description of Support Units

The EUT has been tested as an independent unit together with other necessary accessories or support units. The following support units or accessories were used to form a representative test configuration during the tests.

ID	Product	Brand	Model No.	Serial No.	FCC ID	Remarks
A.	Notebook	DELL	E5410	1HC2XM1	FCC DoC Approved	-
B.	Load	NA	NA	NA	NA	-

Note:

1. All power cords of the above support units are non-shielded (1.8m).
2. Item A acted as a communication partner to transfer data.

ID	Descriptions	Qty.	Length (m)	Shielding (Yes/No)	Cores (Qty.)	Remarks
1.	LAN	1	1.5	N	0	RJ45, Cat5e
2.	LAN	1	1.5	N	0	RJ45, Cat5e
3.	LAN	1	7	N	0	RJ45, Cat5e
4.	LAN	1	1.5	N	0	RJ45, Cat5e

#### 3.4.1 Configuration of System under Test

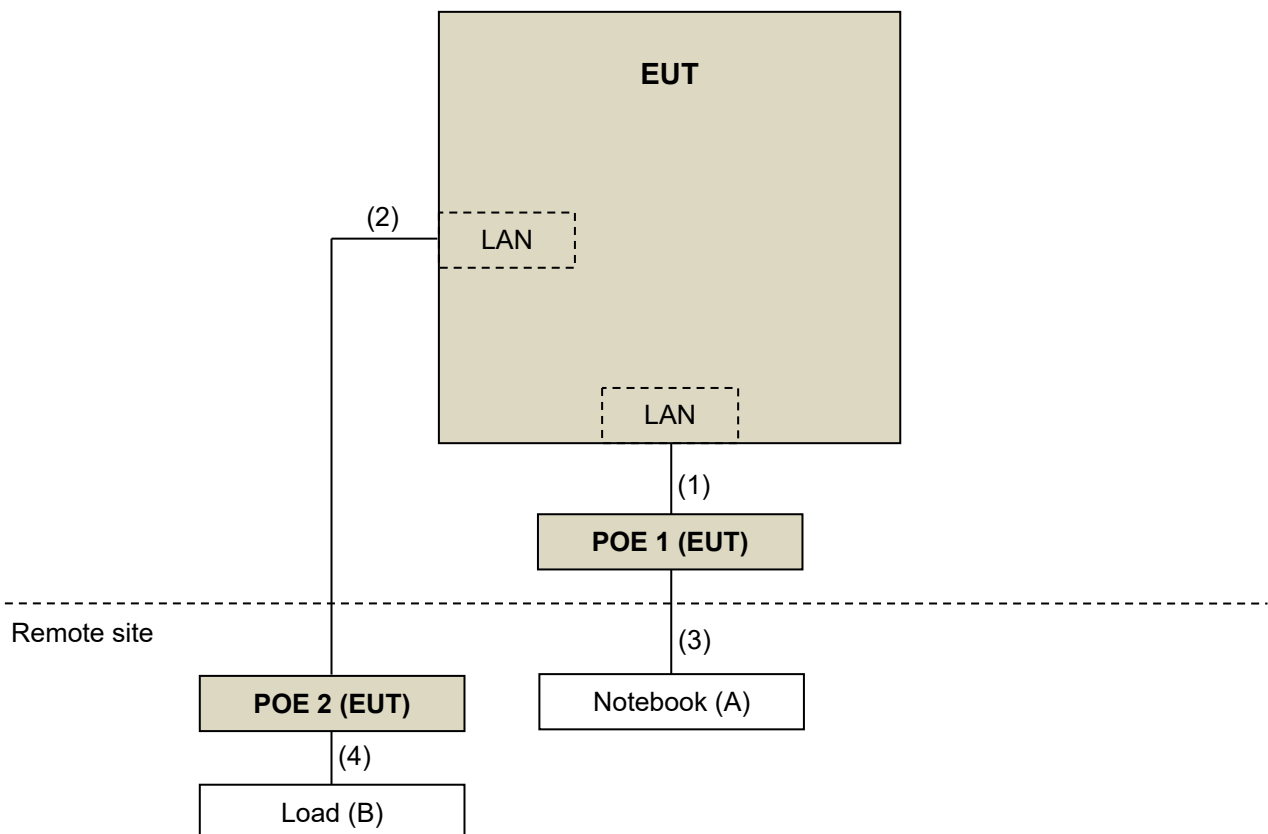

### **3.5 General Description of Applied Standards and References**

The EUT is a RF Product. According to the specifications of the manufacturer, it must comply with the requirements of the following standards and references:

**Test standard:**

**FCC Part 15, Subpart C (15.247)**

ANSI C63.10:2013

All test items have been performed and recorded as per the above standards.

**References Test Guidance:**

**KDB 558074 D01 15.247 Meas Guidance v05r02**

All test items have been performed as a reference to the above KDB test guidance.

## 4 Test Types and Results

### 4.1 Radiated Emission and Bandedge Measurement

#### 4.1.1 Limits of Radiated Emission and Bandedge Measurement

Radiated emissions which fall in the restricted bands must comply with the radiated emission limits specified as below table. Other emissions shall be at least 20dB below the highest level of the desired power:

Frequencies (MHz)	Field Strength (microvolts/meter)	Measurement Distance (meters)
0.009 ~ 0.490	2400/F(kHz)	300
0.490 ~ 1.705	24000/F(kHz)	30
1.705 ~ 30.0	30	30
30 ~ 88	100	3
88 ~ 216	150	3
216 ~ 960	200	3
Above 960	500	3

**Note:**

1. The lower limit shall apply at the transition frequencies.
2. Emission level (dBuV/m) = 20 log Emission level (uV/m).
3. For frequencies above 1000MHz, the field strength limits are based on average detector, however, the peak field strength of any emission shall not exceed the maximum permitted average limits, specified above by more than 20dB under any condition of modulation.

#### 4.1.2 Test Instruments

Description & Manufacturer	Model No.	Serial No.	Cal. Date	Cal. Due
Test Receiver ROHDE & SCHWARZ	ESR3	102579	Jul. 07, 2020	Jul. 06, 2021
Spectrum Analyzer ROHDE & SCHWARZ	FSP40	100269	Jun. 09, 2020	Jun. 08, 2021
BILOG Antenna SCHWARZBECK	VULB9168	9168-171	Nov. 04, 2020	Nov. 03, 2021
HORN Antenna SCHWARZBECK	9120D	209	Nov. 22, 2020	Nov. 21, 2021
HORN Antenna SCHWARZBECK	BBHA 9170	BBHA9170241	Nov. 22, 2020	Nov. 21, 2021
Loop Antenna TESEQ	HLA 6121	45745	Jul. 06, 2020	Jul. 05, 2021
Preamplifier Agilent (Below 1GHz)	8447D	2944A10738	Aug. 16, 2020	Aug. 15, 2021
Preamplifier Agilent (Above 1GHz)	8449B	3008A02465	Mar. 23, 2020	Mar. 22, 2021
RF Coaxial Cable WOKEN With 5dB PAD	8D-FB	Cable-CH3-01	Aug. 16, 2020	Aug. 15, 2021
RF signal cable HUBER+SUHNER	SUCOFLEX 104	Cable-CH3-03 (223653/4)	Aug. 16, 2020	Aug. 15, 2021
RF signal cable HUBER+SUHNER& EMCI	SUCOFLEX 104&EMC104-SM-S M-8000	Cable-CH3-03 (309224+170907)	Aug. 16, 2020	Aug. 15, 2021
Software BV ADT	ADT_Radiated_ V7.6.15.9.5	NA	NA	NA
Antenna Tower inn-co GmbH	MA 4000	013303	NA	NA
Antenna Tower Controller BV ADT	AT100	AT93021702	NA	NA
Turn Table BV ADT	TT100	TT93021702	NA	NA
Turn Table Controller BV ADT	SC100	SC93021702	NA	NA
Boresight Antenna Fixture	FBA-01	FBA-SIP01	NA	NA
USB Wideband Power Sensor KEYSIGHT	U2021XA	MY55050005/MY5519 0004/MY55190007/MY 55210005	Jul. 13, 2020	Jul. 12, 2021

- Note: 1. The calibration interval of the above test instruments is 12 months and the calibrations are traceable to NML/ROC and NIST/USA.  
2. The test was performed in HwaYa Chamber 3.

### 4.1.3 Test Procedures

#### For Radiated emission below 30MHz

- a. The EUT was placed on the top of a rotating table 0.8 meters above the ground at a 3 meter chamber room. The table was rotated 360 degrees to determine the position of the highest radiation.
- b. The EUT was set 3 meters away from the interference-receiving antenna, which was mounted on the top of a variable-height antenna tower.
- c. Parallel, perpendicular, and ground-parallel orientations of the antenna are set to make the measurement.
- d. For each suspected emission, the EUT was arranged to its worst case and the rotatable table was turned from 0 degrees to 360 degrees to find the maximum reading.
- e. The test-receiver system was set to Quasi-Peak Detect Function and Specified Bandwidth with Maximum Hold Mode.

Note:

1. The resolution bandwidth and video bandwidth of test receiver/spectrum analyzer is 9kHz at frequency below 30MHz.

#### For Radiated emission above 30MHz

- a. The EUT was placed on the top of a rotating table 0.8 meters (for 30MHz ~ 1GHz) / 1.5 meters (for above 1GHz) above the ground at 3 meter chamber room for test. The table was rotated 360 degrees to determine the position of the highest radiation.
- b. The EUT was set 3 meters away from the interference-receiving antenna, which was mounted on the top of a variable-height antenna tower.
- c. The height of antenna is varied from one meter to four meters above the ground to determine the maximum value of the field strength. Both horizontal and vertical polarizations of the antenna are set to make the measurement.
- d. For each suspected emission, the EUT was arranged to its worst case and then the antenna was tuned to heights from 1 meter to 4 meters and the rotatable table was turned from 0 degrees to 360 degrees to find the maximum reading.
- e. The test-receiver system was set to quasi-peak detect function and specified bandwidth with maximum hold mode when the test frequency is below 1 GHz.
- f. The test-receiver system was set to peak and average detect function and specified bandwidth with maximum hold mode when the test frequency is above 1 GHz. If the peak reading value also meets average limit, measurement with the average detector is unnecessary.

Note:

1. The resolution bandwidth and video bandwidth of test receiver/spectrum analyzer is 120kHz for Quasi-peak detection (QP) at frequency below 1GHz.
2. The resolution bandwidth of test receiver/spectrum analyzer is 1 MHz and the video bandwidth is 3 MHz for Peak detection (PK) at frequency above 1GHz.
3. The resolution bandwidth of test receiver/spectrum analyzer is 1MHz and the video bandwidth is  $\geq 1/T$  (Duty cycle < 98%) or 10Hz (Duty cycle  $\geq 98\%$ ) for Average detection (AV) at frequency above 1GHz. (BT LE 4.0: RBW = 1MHz, VBW = 10Hz, BT LE 5.0: RBW = 1MHz, VBW = 10Hz)
4. All modes of operation were investigated and the worst-case emissions are reported.

### 4.1.4 Deviation from Test Standard

No deviation.

#### 4.1.5 Test Setup

##### For Radiated emission below 30MHz

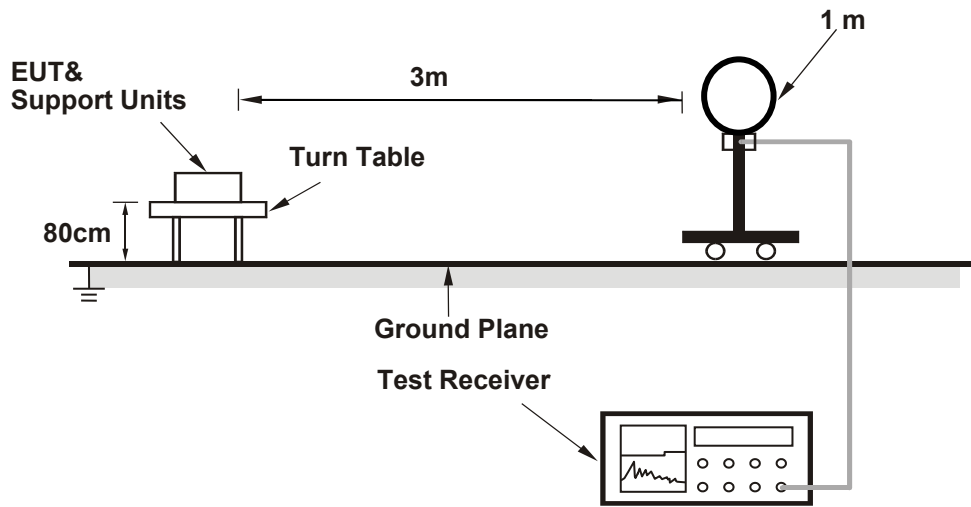

##### For Radiated emission 30MHz to 1GHz

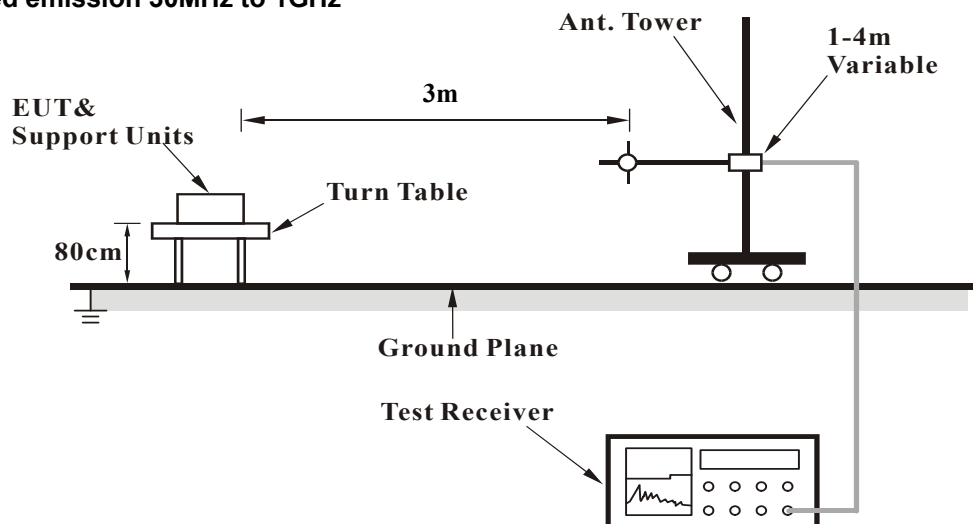



### For Radiated emission above 1GHz

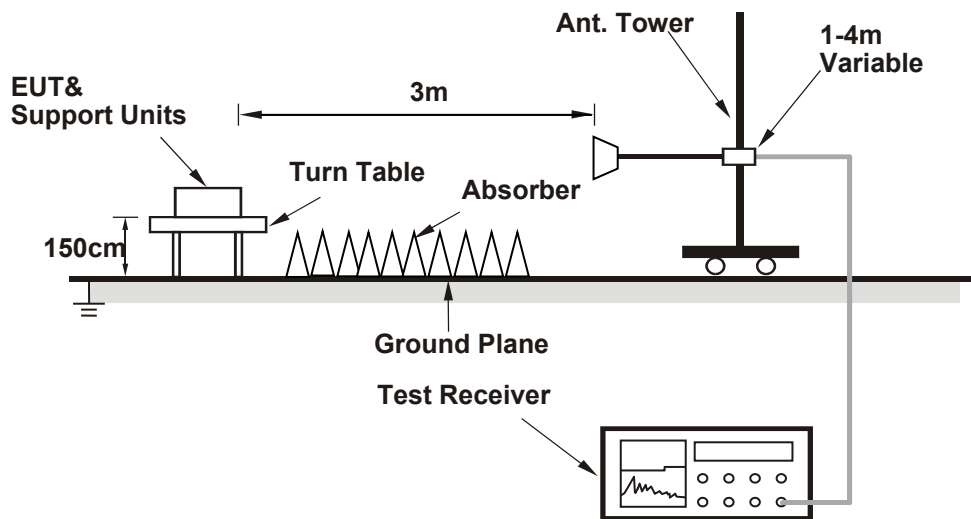

For the actual test configuration, please refer to the attached file (Test Setup Photo).

#### 4.1.6 EUT Operating Conditions

- a. Placed the EUT on the testing table.
- b. Prepared a notebook to act as a communication partner and placed it outside of testing area.
- c. The communication partner connected with EUT via a RJ45 cable and ran a test program (provided by manufacturer) to enable EUT under transmission condition continuously at specific channel frequency.
- d. The communication partner sent data to EUT by command "PING".

#### 4.1.7 Test Results

##### Above 1 GHz Data:

RF Mode	TX BT LE 4.0	Channel	CH 0 : 2402 MHz
Frequency Range	1GHz ~ 25GHz	Detector Function	Peak (PK) Average (AV)

Antenna Polarity & Test Distance : Horizontal at 3 m								
No	Frequency (MHz)	Emission Level (dBuV/m)	Limit (dBuV/m)	Margin (dB)	Antenna Height (m)	Table Angle (Degree)	Raw Value (dBuV)	Correction Factor (dB/m)
1	2390.00	63.3 PK	74.0	-10.7	2.20 H	12	29.0	34.3
2	2390.00	49.2 AV	54.0	-4.8	2.20 H	12	14.9	34.3
3	*2402.00	110.5 PK			2.35 H	3	76.2	34.3
4	*2402.00	109.5 AV			2.35 H	3	75.2	34.3
5	4804.00	56.1 PK	74.0	-17.9	1.37 H	16	50.7	5.4
6	4804.00	49.6 AV	54.0	-4.4	1.37 H	16	44.2	5.4
Antenna Polarity & Test Distance : Vertical at 3 m								
No	Frequency (MHz)	Emission Level (dBuV/m)	Limit (dBuV/m)	Margin (dB)	Antenna Height (m)	Table Angle (Degree)	Raw Value (dBuV)	Correction Factor (dB/m)
1	2390.00	61.3 PK	74.0	-12.7	3.65 V	335	27.0	34.3
2	2390.00	48.6 AV	54.0	-5.4	3.65 V	335	14.3	34.3
3	*2402.00	101.7 PK			3.74 V	322	67.4	34.3
4	*2402.00	100.6 AV			3.74 V	322	66.3	34.3
5	4804.00	55.6 PK	74.0	-18.4	3.35 V	306	50.2	5.4
6	4804.00	48.6 AV	54.0	-5.4	3.35 V	306	43.2	5.4

##### Remarks:

1. Emission Level(dBuV/m) = Raw Value(dBuV) + Correction Factor(dB/m).
2. Correction Factor(dB/m) = Antenna Factor(dB/m) + Cable Factor(dB) – Pre-Amplifier Factor(dB).
3. Margin value = Emission Level – Limit value.
4. The other emission levels were very low against the limit.
5. " \* ": Fundamental frequency.

RF Mode	TX BT LE 4.0	Channel	CH 19 : 2440 MHz
Frequency Range	1GHz ~ 25GHz	Detector Function	Peak (PK) Average (AV)

Antenna Polarity & Test Distance : Horizontal at 3 m								
No	Frequency (MHz)	Emission Level (dBuV/m)	Limit (dBuV/m)	Margin (dB)	Antenna Height (m)	Table Angle (Degree)	Raw Value (dBuV)	Correction Factor (dB/m)
1	*2440.00	111.0 PK			2.32 H	0	76.7	34.3
2	*2440.00	109.8 AV			2.32 H	0	75.5	34.3
3	4874.00	59.3 PK	74.0	-14.7	1.41 H	17	53.8	5.5
4	4874.00	52.8 AV	54.0	-1.2	1.41 H	17	47.3	5.5

Antenna Polarity & Test Distance : Vertical at 3 m								
No	Frequency (MHz)	Emission Level (dBuV/m)	Limit (dBuV/m)	Margin (dB)	Antenna Height (m)	Table Angle (Degree)	Raw Value (dBuV)	Correction Factor (dB/m)
1	*2440.00	102.3 PK			3.69 V	321	68.0	34.3
2	*2440.00	100.8 AV			3.69 V	321	66.5	34.3
3	4874.00	58.5 PK	74.0	-15.5	3.27 V	311	53.0	5.5
4	4874.00	51.6 AV	54.0	-2.4	3.27 V	311	46.1	5.5

Remarks:

1. Emission Level(dBuV/m) = Raw Value(dBuV) + Correction Factor(dB/m).
2. Correction Factor(dB/m) = Antenna Factor(dB/m) + Cable Factor(dB) – Pre-Amplifier Factor(dB).
3. Margin value = Emission Level – Limit value.
4. The other emission levels were very low against the limit.
5. " \* " : Fundamental frequency.

RF Mode	TX BT LE 4.0	Channel	CH 39 : 2480 MHz
Frequency Range	1GHz ~ 25GHz	Detector Function	Peak (PK) Average (AV)

Antenna Polarity & Test Distance : Horizontal at 3 m								
No	Frequency (MHz)	Emission Level (dBuV/m)	Limit (dBuV/m)	Margin (dB)	Antenna Height (m)	Table Angle (Degree)	Raw Value (dBuV)	Correction Factor (dB/m)
1	*2480.00	109.5 PK			2.23 H	350	75.1	34.4
2	*2480.00	108.6 AV			2.23 H	350	74.2	34.4
3	2483.50	63.3 PK	74.0	-10.7	2.31 H	359	28.9	34.4
4	2483.50	50.3 AV	54.0	-3.7	2.31 H	359	15.9	34.4
5	4960.00	56.3 PK	74.0	-17.7	1.45 H	14	50.7	5.6
6	4960.00	48.9 AV	54.0	-5.1	1.45 H	14	43.3	5.6

Antenna Polarity & Test Distance : Vertical at 3 m								
No	Frequency (MHz)	Emission Level (dBuV/m)	Limit (dBuV/m)	Margin (dB)	Antenna Height (m)	Table Angle (Degree)	Raw Value (dBuV)	Correction Factor (dB/m)
1	*2480.00	103.7 PK			3.76 V	337	69.3	34.4
2	*2480.00	102.7 AV			3.76 V	337	68.3	34.4
3	2483.50	61.8 PK	74.0	-12.2	3.59 V	340	27.4	34.4
4	2483.50	48.8 AV	54.0	-5.2	3.59 V	340	14.4	34.4
5	4960.00	55.7 PK	74.0	-18.3	3.45 V	301	50.1	5.6
6	4960.00	47.9 AV	54.0	-6.1	3.45 V	301	42.3	5.6

Remarks:

1. Emission Level(dBuV/m) = Raw Value(dBuV) + Correction Factor(dB/m).
2. Correction Factor(dB/m) = Antenna Factor(dB/m) + Cable Factor(dB) – Pre-Amplifier Factor(dB).
3. Margin value = Emission Level – Limit value.
4. The other emission levels were very low against the limit.
5. " \* ": Fundamental frequency.

RF Mode	TX BT LE 5.0	Channel	CH 0 : 2402 MHz
Frequency Range	1GHz ~ 25GHz	Detector Function	Peak (PK) Average (AV)

Antenna Polarity & Test Distance : Horizontal at 3 m								
No	Frequency (MHz)	Emission Level (dBuV/m)	Limit (dBuV/m)	Margin (dB)	Antenna Height (m)	Table Angle (Degree)	Raw Value (dBuV)	Correction Factor (dB/m)
1	2390.00	64.0 PK	74.0	-10.0	2.41 H	11	29.7	34.3
2	2390.00	49.1 AV	54.0	-4.9	2.41 H	11	14.8	34.3
3	*2402.00	110.0 PK			2.36 H	4	75.7	34.3
4	*2402.00	107.0 AV			2.36 H	4	72.7	34.3
5	4804.00	55.4 PK	74.0	-18.6	1.30 H	18	50.0	5.4
6	4804.00	45.3 AV	54.0	-8.7	1.30 H	18	39.9	5.4

Antenna Polarity & Test Distance : Vertical at 3 m								
No	Frequency (MHz)	Emission Level (dBuV/m)	Limit (dBuV/m)	Margin (dB)	Antenna Height (m)	Table Angle (Degree)	Raw Value (dBuV)	Correction Factor (dB/m)
1	2390.00	61.2 PK	74.0	-12.8	3.67 V	325	26.9	34.3
2	2390.00	48.6 AV	54.0	-5.4	3.67 V	325	14.3	34.3
3	*2402.00	102.2 PK			3.72 V	322	67.9	34.3
4	*2402.00	99.4 AV			3.72 V	322	65.1	34.3
5	4804.00	54.9 PK	74.0	-19.1	3.23 V	306	49.5	5.4
6	4804.00	44.1 AV	54.0	-9.9	3.23 V	306	38.7	5.4

Remarks:

1. Emission Level(dBuV/m) = Raw Value(dBuV) + Correction Factor(dB/m).
2. Correction Factor(dB/m) = Antenna Factor(dB/m) + Cable Factor(dB) – Pre-Amplifier Factor(dB).
3. Margin value = Emission Level – Limit value.
4. The other emission levels were very low against the limit.
5. " \* ": Fundamental frequency.

RF Mode	TX BT LE 5.0	Channel	CH 19 : 2440 MHz
Frequency Range	1GHz ~ 25GHz	Detector Function	Peak (PK) Average (AV)

Antenna Polarity & Test Distance : Horizontal at 3 m								
No	Frequency (MHz)	Emission Level (dBuV/m)	Limit (dBuV/m)	Margin (dB)	Antenna Height (m)	Table Angle (Degree)	Raw Value (dBuV)	Correction Factor (dB/m)
1	*2440.00	109.5 PK			2.51 H	357	75.2	34.3
2	*2440.00	106.4 AV			2.51 H	357	72.1	34.3
3	4880.00	58.6 PK	74.0	-15.4	1.40 H	18	53.2	5.4
4	4880.00	48.4 AV	54.0	-5.6	1.40 H	18	43.0	5.4
Antenna Polarity & Test Distance : Vertical at 3 m								
No	Frequency (MHz)	Emission Level (dBuV/m)	Limit (dBuV/m)	Margin (dB)	Antenna Height (m)	Table Angle (Degree)	Raw Value (dBuV)	Correction Factor (dB/m)
1	*2440.00	100.5 PK			3.77 V	325	66.2	34.3
2	*2440.00	97.4 AV			3.77 V	325	63.1	34.3
3	4880.00	58.0 PK	74.0	-16.0	3.51 V	314	52.6	5.4
4	4880.00	47.4 AV	54.0	-6.6	3.51 V	314	42.0	5.4

Remarks:

1. Emission Level(dBuV/m) = Raw Value(dBuV) + Correction Factor(dB/m).
2. Correction Factor(dB/m) = Antenna Factor(dB/m) + Cable Factor(dB) – Pre-Amplifier Factor(dB).
3. Margin value = Emission Level – Limit value.
4. The other emission levels were very low against the limit.
5. " \* " : Fundamental frequency.

RF Mode	TX BT LE 5.0	Channel	CH 39 : 2480 MHz
Frequency Range	1GHz ~ 25GHz	Detector Function	Peak (PK) Average (AV)

Antenna Polarity & Test Distance : Horizontal at 3 m								
No	Frequency (MHz)	Emission Level (dBuV/m)	Limit (dBuV/m)	Margin (dB)	Antenna Height (m)	Table Angle (Degree)	Raw Value (dBuV)	Correction Factor (dB/m)
1	*2480.00	109.3 PK			2.25 H	350	74.9	34.4
2	*2480.00	106.4 AV			2.25 H	350	72.0	34.4
3	2483.50	63.4 PK	74.0	-10.6	2.22 H	349	29.0	34.4
4	2483.50	52.9 AV	54.0	-1.1	2.22 H	349	18.5	34.4
5	4960.00	55.6 PK	74.0	-18.4	1.43 H	10	50.0	5.6
6	4960.00	44.9 AV	54.0	-9.1	1.43 H	10	39.3	5.6

Antenna Polarity & Test Distance : Vertical at 3 m								
No	Frequency (MHz)	Emission Level (dBuV/m)	Limit (dBuV/m)	Margin (dB)	Antenna Height (m)	Table Angle (Degree)	Raw Value (dBuV)	Correction Factor (dB/m)
1	*2480.00	103.3 PK			3.76 V	336	68.9	34.4
2	*2480.00	100.4 AV			3.76 V	336	66.0	34.4
3	2483.50	62.9 PK	74.0	-11.1	3.71 V	333	28.5	34.4
4	2483.50	50.2 AV	54.0	-3.8	3.71 V	333	15.8	34.4
5	4960.00	54.9 PK	74.0	-19.1	3.43 V	308	49.3	5.6
6	4960.00	43.8 AV	54.0	-10.2	3.43 V	308	38.2	5.6

Remarks:

1. Emission Level(dBuV/m) = Raw Value(dBuV) + Correction Factor(dB/m).
2. Correction Factor(dB/m) = Antenna Factor(dB/m) + Cable Factor(dB) – Pre-Amplifier Factor(dB).
3. Margin value = Emission Level – Limit value.
4. The other emission levels were very low against the limit.
5. " \* ": Fundamental frequency.

Below 1GHz worst-case data:

RF Mode	TX BT LE 4.0	Channel	CH 19 : 2440 MHz
Frequency Range	30MHz ~ 1GHz	Detector Function	Quasi-Peak (QP)

ANTENNA POLARITY & TEST DISTANCE: HORIZONTAL AT 3 M								
NO.	FREQ. (MHz)	EMISSION LEVEL (dBuV/m)	LIMIT (dBuV/m)	MARGIN (dB)	ANTENNA HEIGHT (m)	TABLE ANGLE (Degree)	RAW VALUE (dBuV)	CORRECTION FACTOR (dB/m)
1	62.33	31.4 QP	40.0	-8.6	1.50 H	266	41.1	-9.7
2	105.91	34.1 QP	43.5	-9.4	1.50 H	277	46.5	-12.4
3	139.65	37.2 QP	43.5	-6.3	1.50 H	97	46.2	-9.0
4	205.72	28.7 QP	43.5	-14.8	1.00 H	81	39.8	-11.1
5	356.14	29.0 QP	46.0	-17.0	1.00 H	90	34.5	-5.5
6	713.22	39.8 QP	46.0	-6.2	1.50 H	97	37.8	2.0

Remarks:

1. Emission Level(dBuV/m) = Raw Value(dBuV) + Correction Factor(dB/m).
2. Correction Factor(dB/m) = Antenna Factor(dB/m) + Cable Factor(dB) – Pre-Amplifier Factor(dB).
3. The other emission levels were very low against the limit of frequency range 30MHz ~ 1000MHz.
4. Margin value = Emission Level – Limit value.
5. The emission levels were very low against the limit of frequency range 9kHz ~ 30MHz: the amplitude of spurious emissions attenuated more than 20 dB below the permissible value to be report.

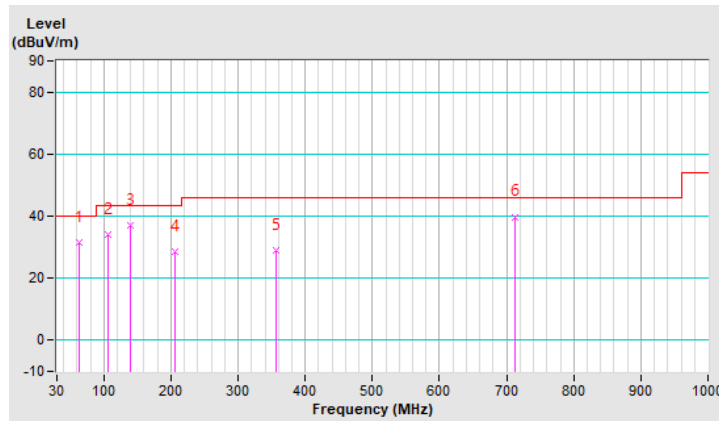



RF Mode	TX BT LE 4.0	Channel	CH 19 : 2440 MHz
Frequency Range	30MHz ~ 1GHz	Detector Function	Quasi-Peak (QP)

ANTENNA POLARITY & TEST DISTANCE: VERTICAL AT 3 M								
NO.	FREQ. (MHz)	EMISSION LEVEL (dBuV/m)	LIMIT (dBuV/m)	MARGIN (dB)	ANTENNA HEIGHT (m)	TABLE ANGLE (Degree)	RAW VALUE (dBuV)	CORRECTION FACTOR (dB/m)
1	59.92	39.7 QP	40.0	-0.3	1.00 V	13	49.1	-9.4
2	153.71	34.2 QP	43.5	-9.3	1.00 V	73	42.6	-8.4
3	374.42	29.1 QP	46.0	-16.9	1.50 V	332	34.2	-5.1
4	493.91	33.4 QP	46.0	-12.6	1.00 V	14	35.9	-2.5
5	519.22	39.0 QP	46.0	-7.0	1.00 V	351	40.9	-1.9
6	717.43	36.8 QP	46.0	-9.2	1.00 V	59	34.6	2.2

Remarks:

1. Emission Level(dBuV/m) = Raw Value(dBuV) + Correction Factor(dB/m).
2. Correction Factor(dB/m) = Antenna Factor(dB/m) + Cable Factor(dB) – Pre-Amplifier Factor(dB).
3. The other emission levels were very low against the limit of frequency range 30MHz ~ 1000MHz.
4. Margin value = Emission Level – Limit value.
5. The emission levels were very low against the limit of frequency range 9kHz ~ 30MHz: the amplitude of spurious emissions attenuated more than 20 dB below the permissible value to be report.

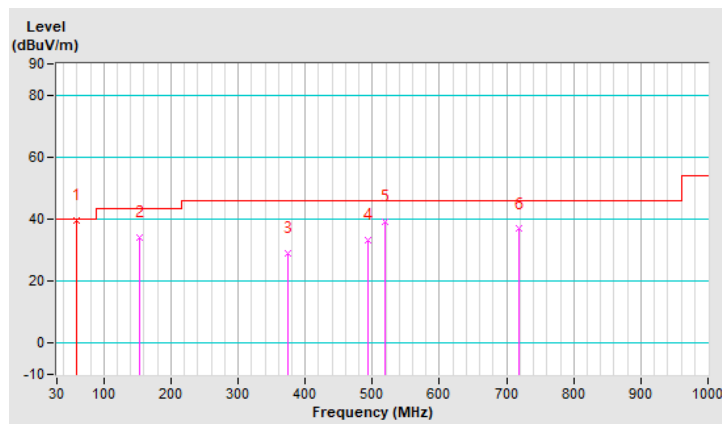

## 4.2 Conducted Emission Measurement

### 4.2.1 Limits of Conducted Emission Measurement

Frequency (MHz)	Conducted Limit (dBuV)	
	Quasi-peak	Average
0.15 - 0.5	66 - 56	56 - 46
0.50 - 5.0	56	46
5.0 - 30.0	60	50

Note: 1. The lower limit shall apply at the transition frequencies.  
 2. The limit decreases in line with the logarithm of the frequency in the range of 0.15 to 0.50MHz.

### 4.2.2 Test Instruments

Description & Manufacturer	Model No.	Serial No.	Cal. Date	Cal. Due
Test Receiver ROHDE & SCHWARZ	ESCI	100424	Dec. 31, 2019	Dec. 30, 2020
RF signal cable Woken	5D-FB	Cable-cond1-01	Sep. 04, 2020	Sep. 03, 2021
LISN ROHDE & SCHWARZ (EUT)	ENV216	101826	Feb. 20, 2020	Feb. 19, 2021
LISN ROHDE & SCHWARZ (Peripheral)	ESH3-Z5	100311	Aug. 28, 2020	Aug. 27, 2021
Software ADT	BV ADT_Cond_ V7.3.7.4	NA	NA	NA

Note: 1. The calibration interval of the above test instruments is 12 months and the calibrations are traceable to NML/ROC and NIST/USA.  
 2. The test was performed in HwaYa Shielded Room 1 (Conduction 1).  
 3. The VCCI Site Registration No. is C-12040.

#### 4.2.3 Test Procedures

- The EUT was placed 0.4 meters from the conducting wall of the shielded room with EUT being connected to the power mains through a line impedance stabilization network (LISN). Other support units were connected to the power mains through another LISN. The two LISNs provide 50 ohm/ 50uH of coupling impedance for the measuring instrument.
- Both lines of the power mains connected to the EUT were checked for maximum conducted interference.
- The frequency range from 150kHz to 30MHz was searched. Emission levels under (Limit - 20dB) was not recorded.

Note: The resolution bandwidth and video bandwidth of test receiver is 9kHz for quasi-peak detection (QP) and average detection (AV) at frequency 0.15MHz-30MHz.

#### 4.2.4 Deviation from Test Standard

No deviation.

#### 4.2.5 Test Setup

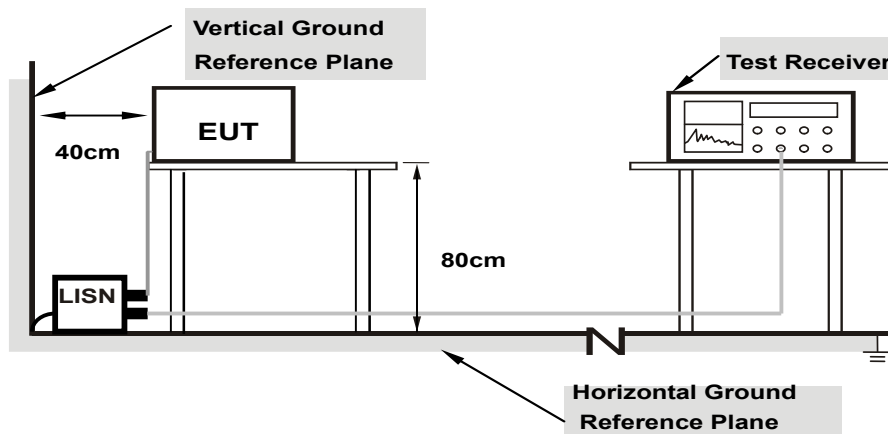

Note: 1.Support units were connected to second LISN.

For the actual test configuration, please refer to the attached file (Test Setup Photo).

#### 4.2.6 EUT Operating Conditions

Same as 4.1.6.

#### 4.2.7 Test Results

##### BT LE 4.0

Phase	Line (L)	Detector Function	Quasi-Peak (QP) / Average (AV)
-------	----------	-------------------	--------------------------------

No	Freq. [MHz]	Corr. Factor (dB)	Reading Value [dB (uV)]		Emission Level [dB (uV)]		Limit [dB (uV)]		Margin (dB)	
			Q.P.	AV.	Q.P.	AV.	Q.P.	AV.	Q.P.	AV.
			1	0.17400	9.83	36.83	26.37	46.66	36.20	64.77
2	0.22152	9.85	27.32	18.67	37.17	28.52	62.76	52.76	-25.59	-24.24
<b>3</b>	<b>0.46936</b>	<b>9.87</b>	<b>37.68</b>	<b>31.80</b>	<b>47.55</b>	<b>41.67</b>	<b>56.53</b>	<b>46.53</b>	<b>-8.98</b>	<b>-4.86</b>
4	0.79800	9.90	27.26	22.65	37.16	32.55	56.00	46.00	-18.84	-13.45
5	1.39335	9.92	28.06	23.55	37.98	33.47	56.00	46.00	-18.02	-12.53
6	11.32600	10.08	26.57	21.05	36.65	31.13	60.00	50.00	-23.35	-18.87

#### Remarks:

1. Q.P. and AV. are abbreviations of quasi-peak and average individually.
2. The emission levels of other frequencies were very low against the limit.
3. Margin value = Emission level - Limit value
4. Correction factor = Insertion loss + Cable loss
5. Emission Level = Correction Factor + Reading Value.

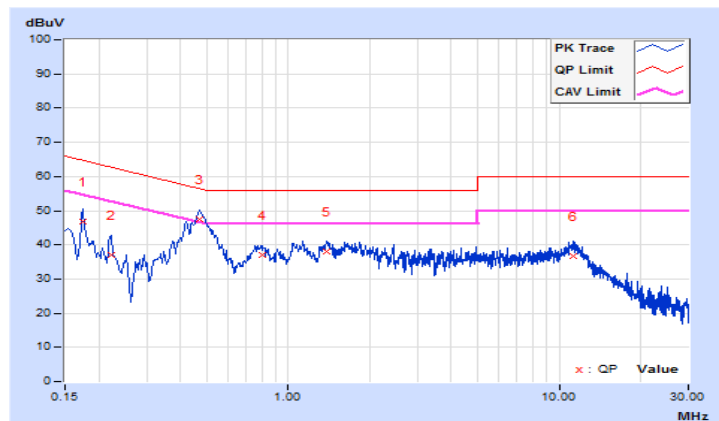

Phase	Neutral (N)	Detector Function	Quasi-Peak (QP) / Average (AV)
-------	-------------	-------------------	--------------------------------

No	Freq. [MHz]	Corr. Factor (dB)	Reading Value [dB (uV)]		Emission Level [dB (uV)]		Limit [dB (uV)]		Margin (dB)	
			Q.P.	AV.	Q.P.	AV.	Q.P.	AV.	Q.P.	AV.
			1	0.15400	9.84	34.00	29.64	43.84	39.48	65.78
2	0.19400	9.85	32.75	23.98	42.60	33.83	63.86	53.86	-21.26	-20.03
3	0.45716	9.90	37.64	31.74	47.54	41.64	56.74	46.74	-9.20	-5.10
4	1.00600	9.94	24.31	19.93	34.25	29.87	56.00	46.00	-21.75	-16.13
5	3.71400	10.03	23.12	17.30	33.15	27.33	56.00	46.00	-22.85	-18.67
6	11.15800	10.16	25.85	20.36	36.01	30.52	60.00	50.00	-23.99	-19.48

Remarks:

1. Q.P. and AV. are abbreviations of quasi-peak and average individually.
2. The emission levels of other frequencies were very low against the limit.
3. Margin value = Emission level - Limit value
4. Correction factor = Insertion loss + Cable loss
5. Emission Level = Correction Factor + Reading Value.

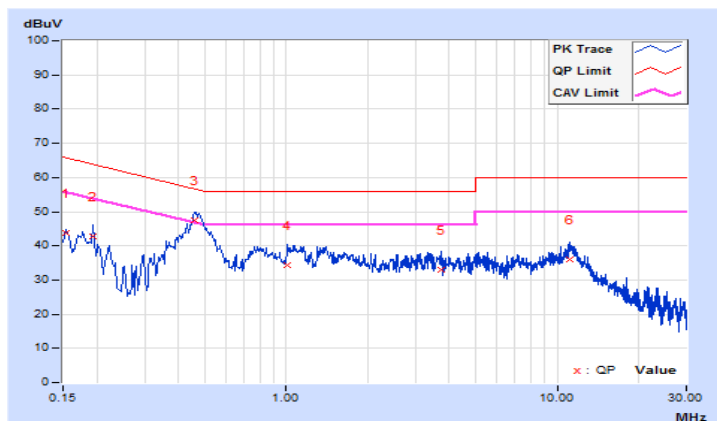

### 4.3 6dB Bandwidth Measurement

#### 4.3.1 Limits of 6dB Bandwidth Measurement

The minimum of 6dB Bandwidth Measurement is 0.5 MHz.

#### 4.3.2 Test Setup

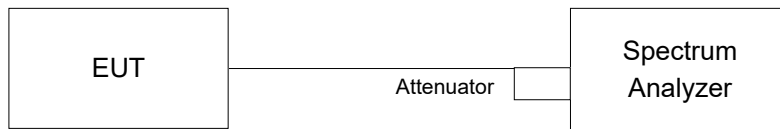

#### 4.3.3 Test Instruments

Refer to section 4.1.2 to get information of above instrument.

#### 4.3.4 Test Procedure

- a. Set resolution bandwidth (RBW) = 100kHz.
- b. Set the video bandwidth (VBW)  $\geq 3 \times$  RBW, Detector = peak.
- c. Trace mode = max hold.
- d. Sweep = auto couple.
- e. Measure the maximum width of the emission that is constrained by the frequencies associated with the two amplitude points (upper and lower) that are attenuated by 6 dB relative to the maximum level measured in the fundamental emission.

#### 4.3.5 Deviation from Test Standard

No deviation.

#### 4.3.6 EUT Operating Conditions

The software provided by client to enable the EUT under transmission condition continuously at lowest, middle and highest channel frequencies individually.

### 4.3.7 Test Result

#### BT LE 4.0

Channel	Frequency (MHz)	6dB Bandwidth (MHz)	Minimum Limit (MHz)	Pass / Fail
0	2402	0.68	0.50	Pass
19	2440	0.69	0.50	Pass
39	2480	0.70	0.50	Pass

#### BT LE 5.0

Channel	Frequency (MHz)	6dB Bandwidth (MHz)	Minimum Limit (MHz)	Pass / Fail
0	2402	1.37	0.50	Pass
19	2440	1.39	0.50	Pass
39	2480	1.40	0.50	Pass

### Spectrum Plot of Worst Value

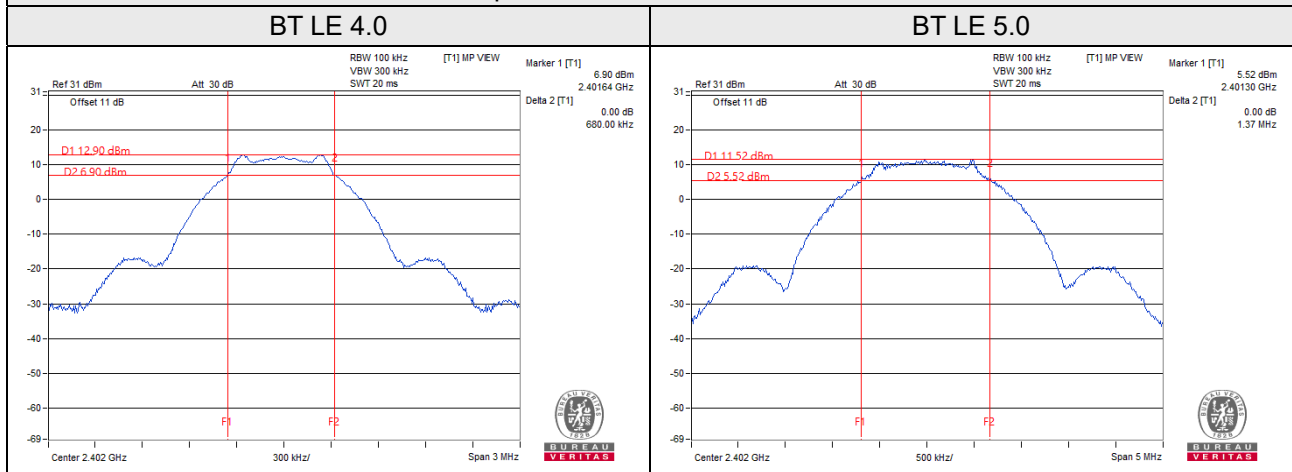

## 4.4 Conducted Output Power Measurement

### 4.4.1 Limits of Conducted Output Power Measurement

For systems using digital modulation in the 2400–2483.5 MHz bands: 1 Watt (30dBm)

### 4.4.2 Test Setup

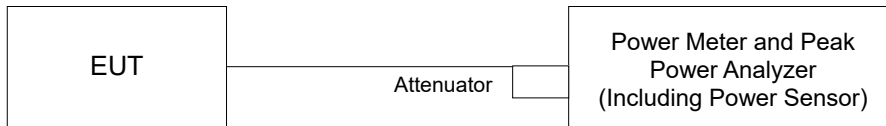

### 4.4.3 Test Instruments

Refer to section 4.1.2 to get information of above instrument.

### 4.4.4 Test Procedures

For Peak Power

A peak power sensor was used on the output port of the EUT. A power meter was used to read the response of the peak power sensor. Record the power level.

For Average Power

Average power sensor was used to perform output power measurement, trigger and gating function of wide band power meter is enabled to measure max output power of TX on burst. Duty factor is not added to measured value.

### 4.4.5 Deviation from Test Standard

No deviation.

### 4.4.6 EUT Operating Conditions

Same as item 4.3.6.



#### 4.4.7 Test Results

For Peak Power

##### BT LE 4.0

Channel	Frequency (MHz)	Peak Power (mW)	Peak Power (dBm)	Limit (dBm)	Pass/Fail
0	2402	16.788	12.25	30.00	Pass
19	2440	<b>17.061</b>	12.32	30.00	Pass
39	2480	16.982	12.30	30.00	Pass

##### BT LE 5.0

Channel	Frequency (MHz)	Peak Power (mW)	Peak Power (dBm)	Limit (dBm)	Pass/Fail
0	2402	16.866	12.27	30.00	Pass
19	2440	<b>17.022</b>	12.31	30.00	Pass
39	2480	16.943	12.29	30.00	Pass

For Average Power

##### BT LE 4.0

Channel	Frequency (MHz)	Average Power (mW)	Average Power (dBm)
0	2402	16.293	12.12
19	2440	16.711	12.23
39	2480	16.634	12.21

##### BT LE 5.0

Channel	Frequency (MHz)	Average Power (mW)	Average Power (dBm)
0	2402	16.406	12.15
19	2440	16.672	12.22
39	2480	16.596	12.20

## 4.5 Power Spectral Density Measurement

### 4.5.1 Limits of Power Spectral Density Measurement

The Maximum of Power Spectral Density Measurement is 8dBm per 3kHz.

### 4.5.2 Test Setup

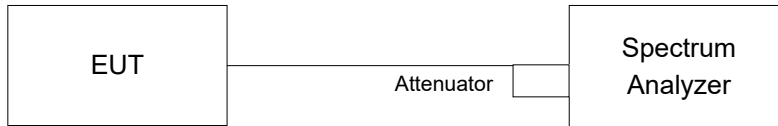

### 4.5.3 Test Instruments

Refer to section 4.1.2 to get information of above instrument.

### 4.5.4 Test Procedure

- a. Set analyzer center frequency to DTS channel center frequency.
- b. Set the span to 1.5 times the DTS bandwidth.
- c. Set the RBW to:  $3 \text{ kHz} \leq \text{RBW} \leq 100 \text{ kHz}$ .
- d. Set the VBW  $\geq 3 \times \text{RBW}$ .
- e. Detector = peak.
- f. Sweep time = auto couple.
- g. Trace mode = max hold.
- h. Allow trace to fully stabilize.
- i. Use the peak marker function to determine the maximum amplitude level within the RBW.

### 4.5.5 Deviation from Test Standard

No deviation.

### 4.5.6 EUT Operating Condition

Same as item 4.3.6

### 4.5.7 Test Results

#### BT LE 4.0

Channel	Freq. (MHz)	PSD (dBm/3kHz)	Limit (dBm/3kHz)	Pass / Fail
0	2402	0.99	8.00	Pass
19	2440	0.56	8.00	Pass
39	2480	0.55	8.00	Pass

#### BT LE 5.0

Channel	Freq. (MHz)	PSD (dBm/3kHz)	Limit (dBm/3kHz)	Pass / Fail
0	2402	-2.06	8.00	Pass
19	2440	-0.24	8.00	Pass
39	2480	-2.51	8.00	Pass

#### Spectrum Plot of Worst Value

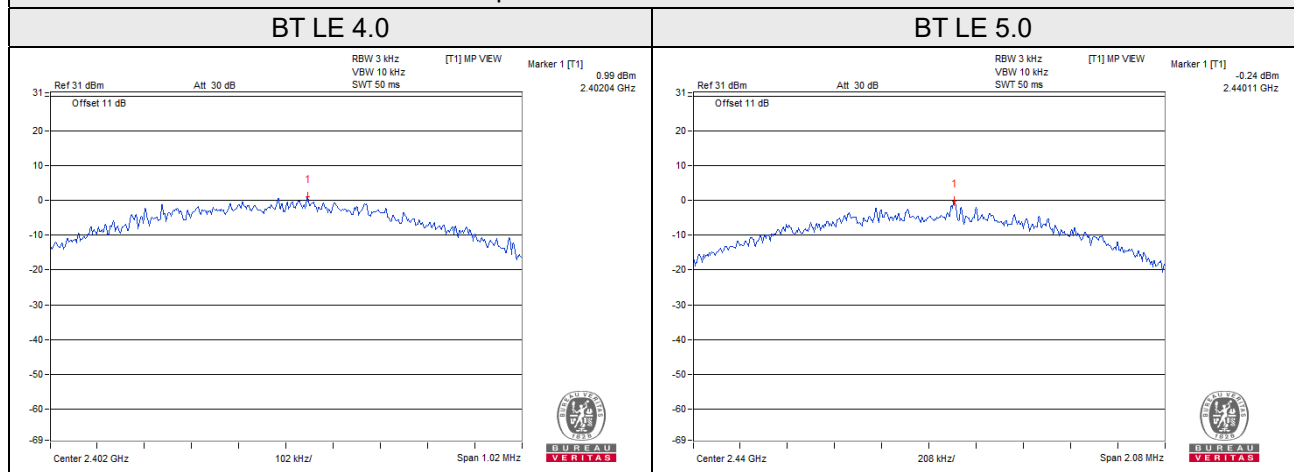

## 4.6 Conducted Out of Band Emission Measurement

### 4.6.1 Limits of Conducted Out of Band Emission Measurement

Below -20dB of the highest emission level of operating band (in 100kHz Resolution Bandwidth).

### 4.6.2 Test Setup

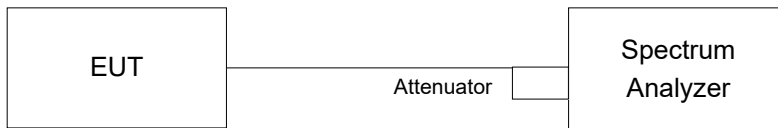

### 4.6.3 Test Instruments

Refer to section 4.1.2 to get information of above instrument.

### 4.6.4 Test Procedure

#### MEASUREMENT PROCEDURE REF

- Set the RBW = 100 kHz.
- Set the VBW  $\geq$  300 kHz.
- Detector = peak.
- Sweep time = auto couple.
- Trace mode = max hold.
- Allow trace to fully stabilize.
- Use the peak marker function to determine the maximum power level in any 100 kHz band segment within the fundamental EBW.

#### MEASUREMENT PROCEDURE OOB

- Set RBW = 100 kHz.
- Set VBW  $\geq$  300 kHz.
- Detector = peak.
- Sweep = auto couple.
- Trace Mode = max hold.
- Allow trace to fully stabilize.
- Use the peak marker function to determine the maximum amplitude level.

### 4.6.5 Deviation from Test Standard

No deviation.

### 4.6.6 EUT Operating Condition

Same as item 4.3.6

### 4.6.7 Test Results

The conducted emission test is performed on each TX port of operating mode without summing or adding 10log (N) since the limit is relative emission limit.

The spectrum plots are attached on the following pages. D1 line indicates the highest level, and D2 line indicates the 20dB offset below D1. It shows compliance with the requirement.

BT LE 4.0

CH 0

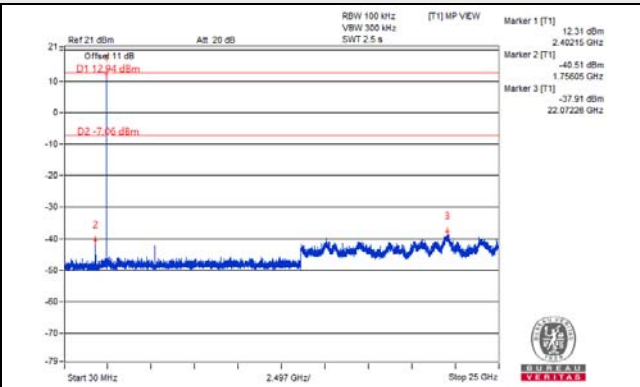
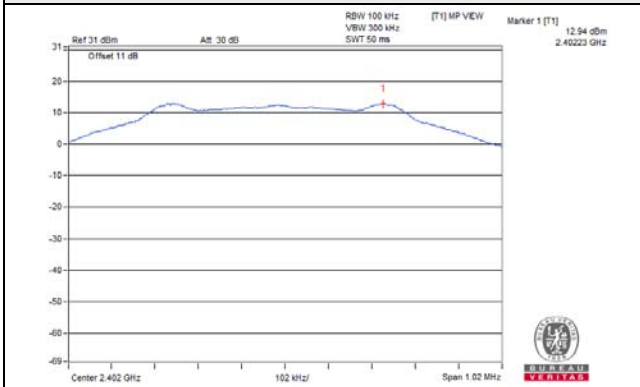

CH 19

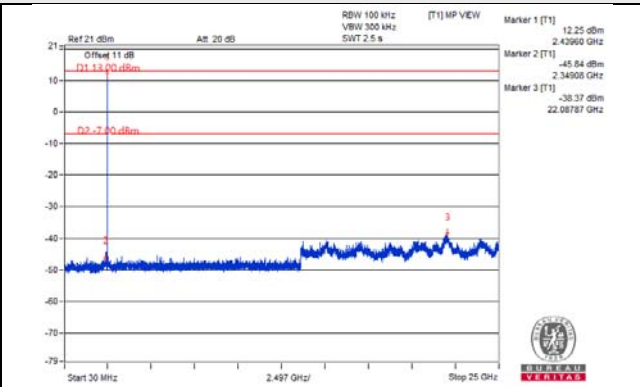
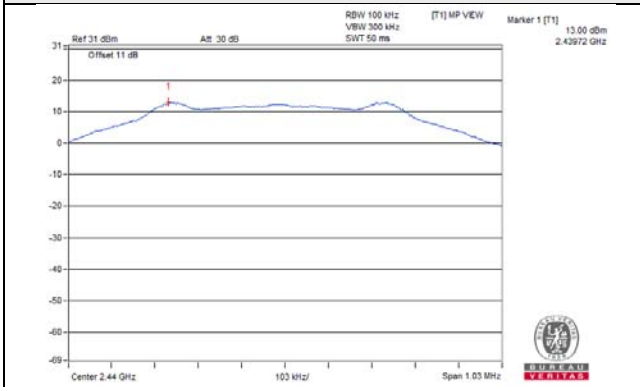

CH 39

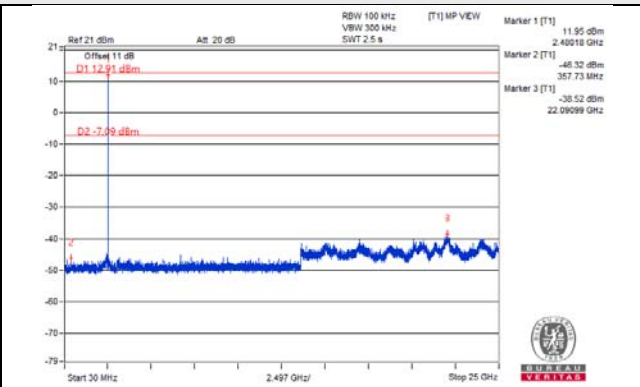
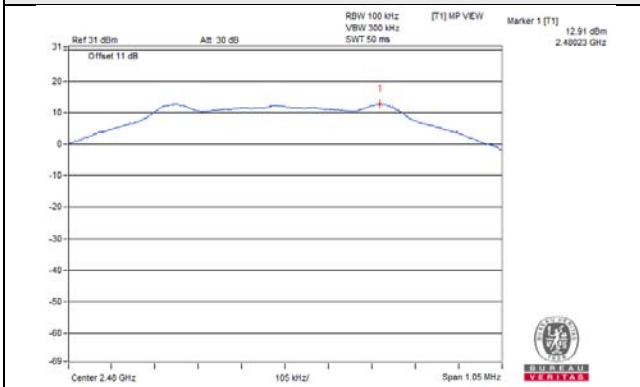

CH 0 Band edge

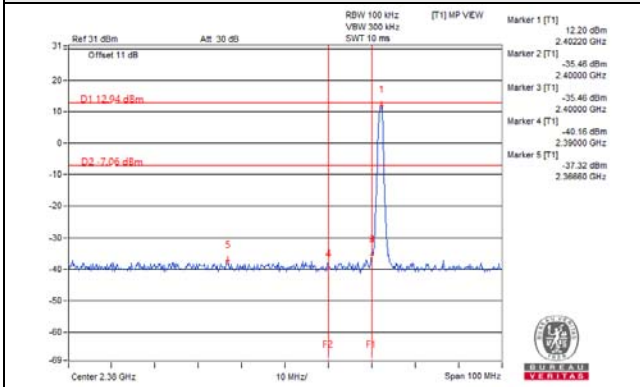

CH 39 Band edge

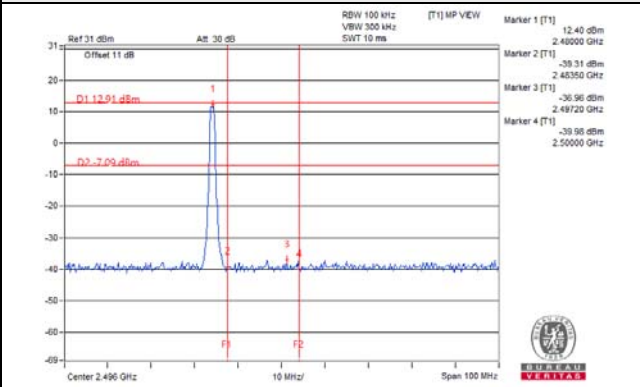

BT LE 5.0

CH 0

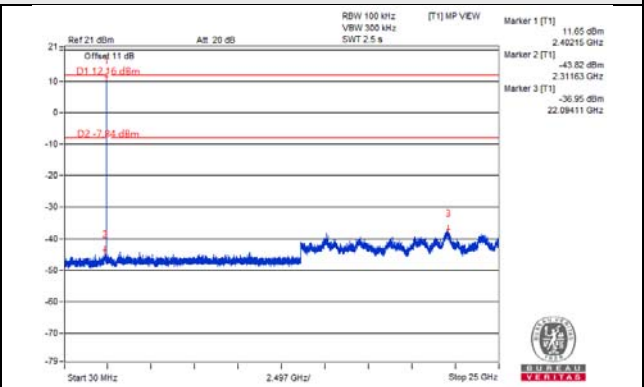
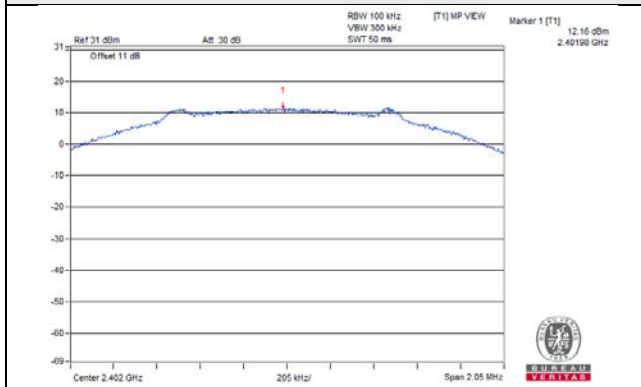

CH 19

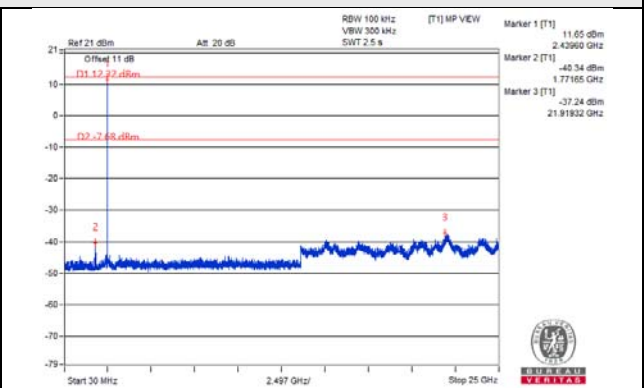
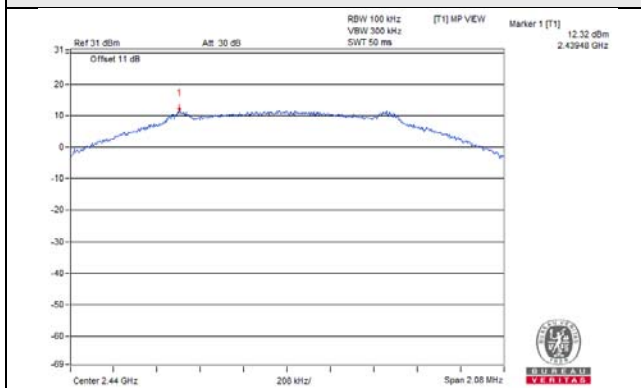

CH 39

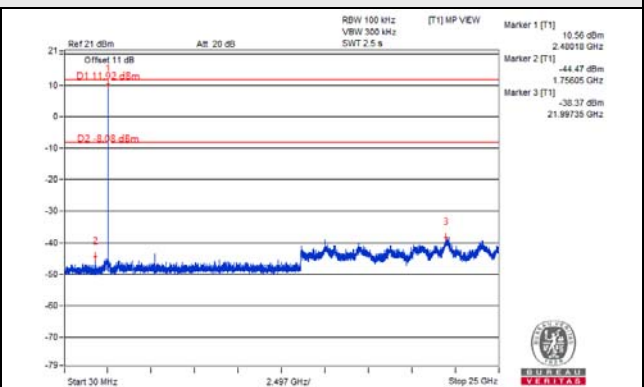
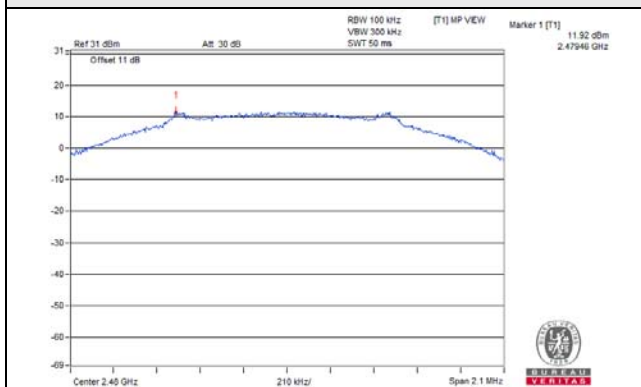

CH 0 Band edge

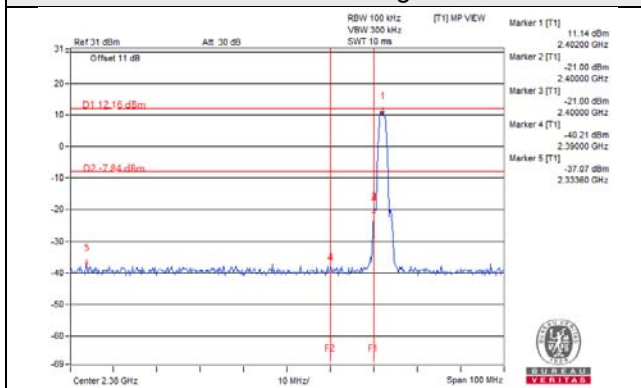

CH 39 Band edge

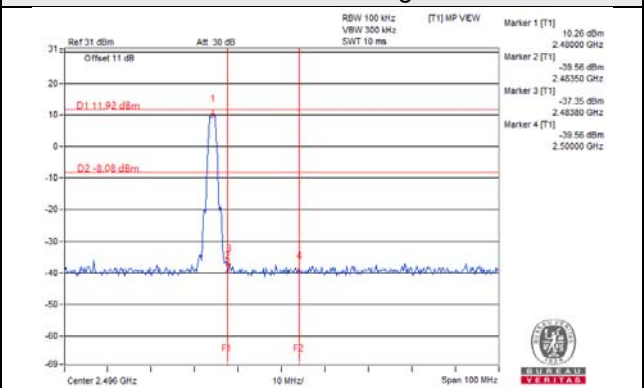

## Annex A - Band Edge Measurement

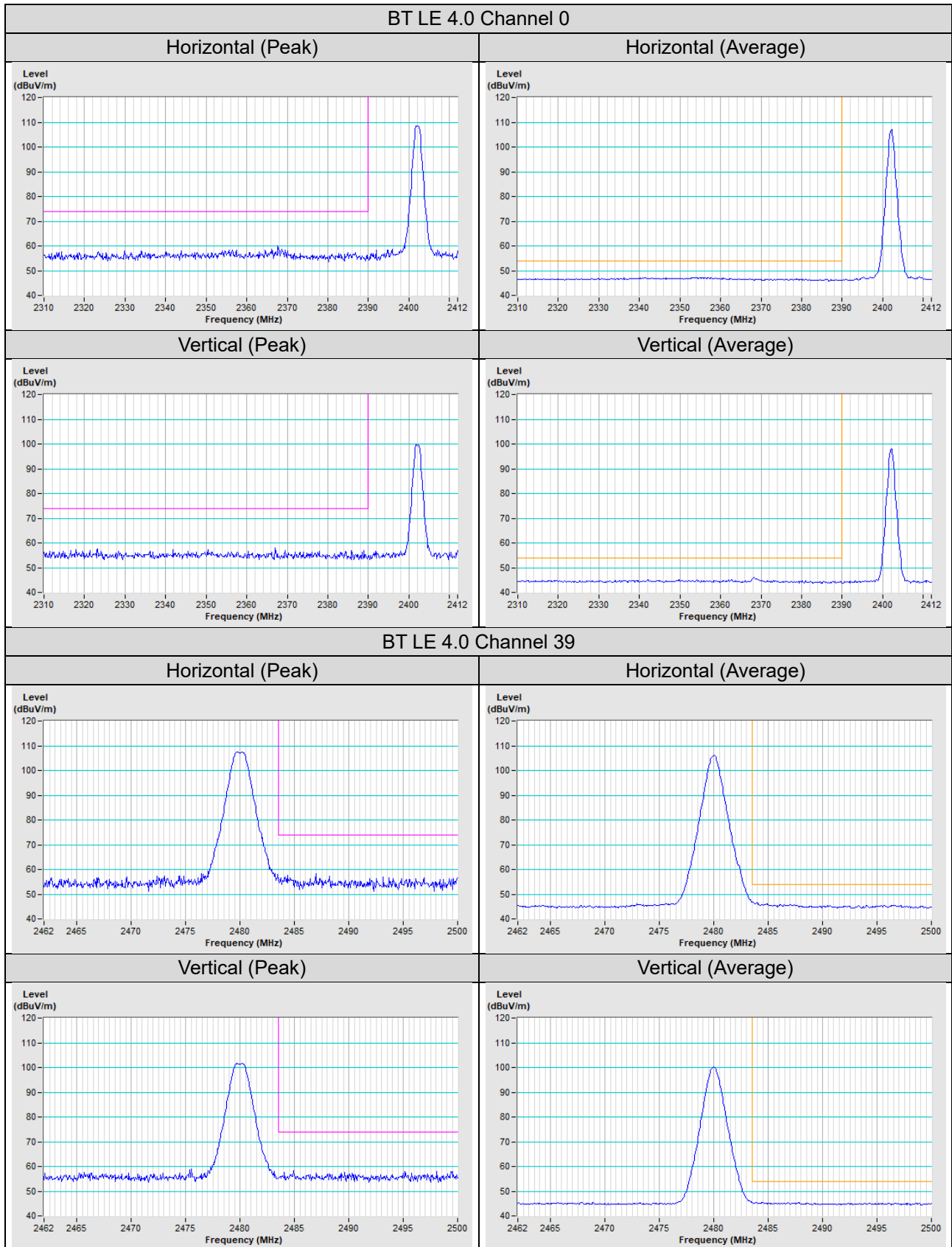

### BT LE 5.0 Channel 0

Horizontal (Peak)

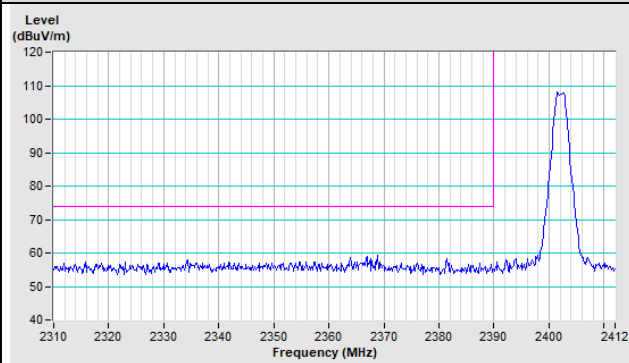

Horizontal (Average)

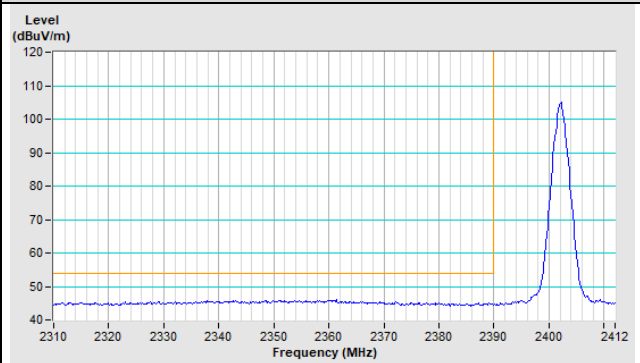

Vertical (Peak)

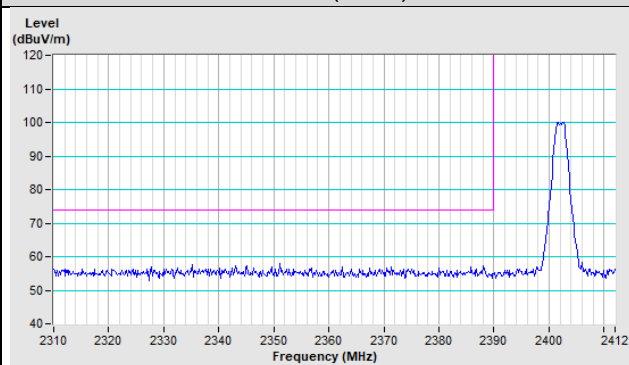

Vertical (Average)

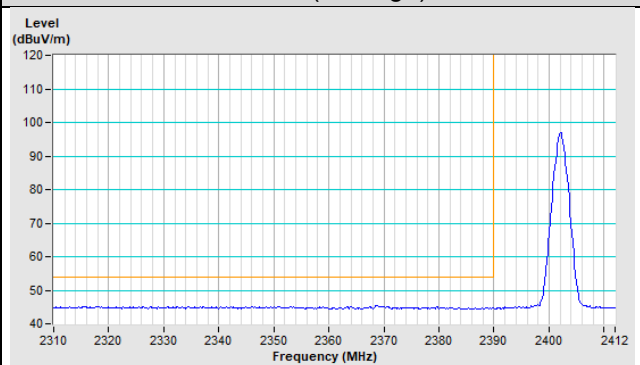

### BT LE 5.0 Channel 39

Horizontal (Peak)

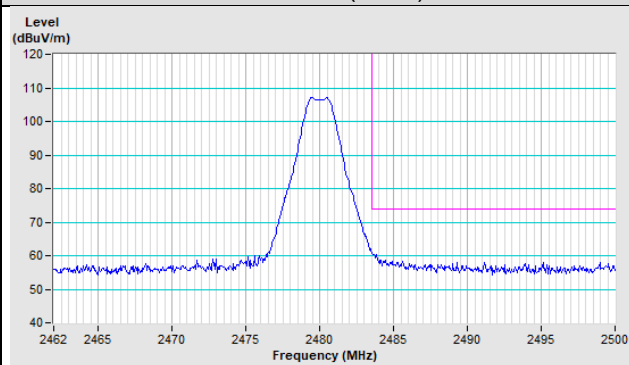

Horizontal (Average)

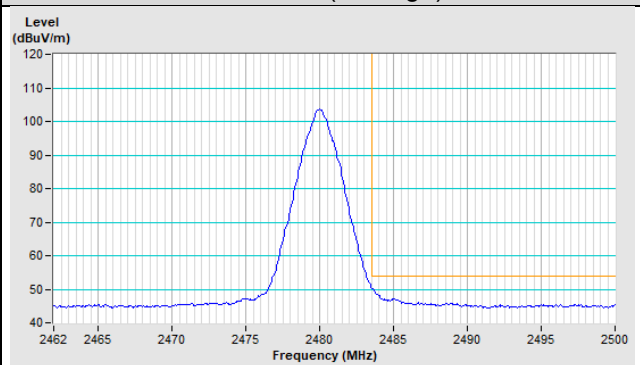

Vertical (Peak)

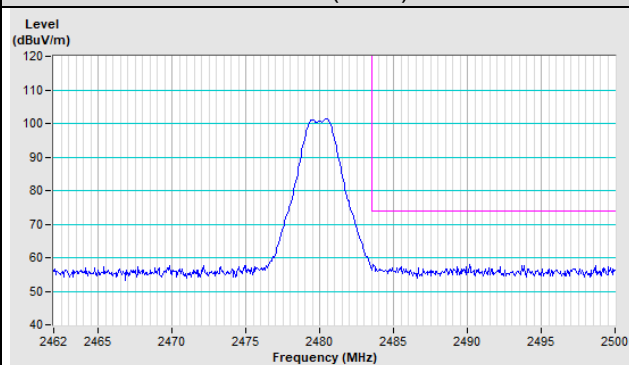

Vertical (Average)

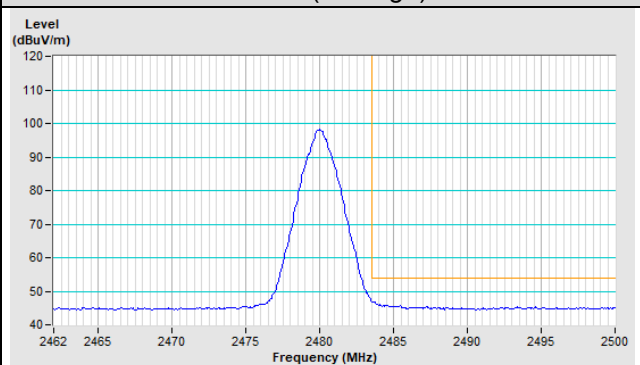



## 5 Pictures of Test Arrangements

Please refer to the attached file (Test Setup Photo).

## Appendix – Information of the Testing Laboratories

We, Bureau Veritas Consumer Products Services (H.K.) Ltd., Taoyuan Branch, were founded in 1988 to provide our best service in EMC, Radio, Telecom and Safety consultation. Our laboratories are FCC recognized accredited test firms and accredited and approved according to ISO/IEC 17025.

If you have any comments, please feel free to contact us at the following:

### Lin Kou EMC/RF Lab

Tel: 886-2-26052180

Fax: 886-2-26051924

### Hsin Chu EMC/RF/Telecom Lab

Tel: 886-3-6668565

Fax: 886-3-6668323

### Hwa Ya EMC/RF/Safety Lab

Tel: 886-3-3183232

Fax: 886-3-3270892

**Email:** [service.adt@tw.bureauveritas.com](mailto:service.adt@tw.bureauveritas.com)

**Web Site:** [www.bureauveritas-adt.com](http://www.bureauveritas-adt.com)

The address and road map of all our labs can be found in our web site also.

--- END ---