





FCC PART 15.407
 IC RSS-247, ISSUE 1, MAY 2015
 DYNAMIC FREQUENCY SELECTION
 TEST REPORT

For

Fortinet, Inc.

899 Kifer Road,
 Sunnyvale, CA 94086, USA

FCC ID: TVE-281BB022
IC: 7280B-281BB022

Report Type: Original Report	Product Type: Secured Wireless Access Point
Prepared By: <u>Xiao Lin</u> Test Engineer	
Report Number: <u>R16111516-DFS</u>	
Report Date: <u>2017-03-07</u>	
Reviewed By: <u>Bo Li</u> RF Supervisor	
Bay Area Compliance Laboratories Corporation (BACL) 1274 Anvilwood Avenue, Sunnyvale, CA 94089, USA Tel: 1 (408) 732-9162 Fax: 1 (408) 732-9164	

Note: This test report is prepared for the customer shown above and for the device described herein. It may not be duplicated or used in part without prior written consent from Bay Area Compliance Laboratories Corp. This report **must not** be used by the customer to claim product certification, approval, or endorsement by A2LA* or any agency of the Federal Government.

* This report may contain data that are not covered by the A2LA accreditation and are marked with an asterisk "*" (Rev. 1)

TABLE OF CONTENTS

1	GENERAL DESCRIPTION.....	5
1.1	PRODUCT DESCRIPTION FOR EQUIPMENT UNDER TEST (EUT).....	5
1.2	MECHANICAL DESCRIPTION OF EUT.....	5
1.3	OBJECTIVE.....	5
1.4	RELATED SUBMITTAL(S)/GRANT(S).....	5
1.5	TEST METHODOLOGY.....	5
1.6	TEST FACILITY REGISTRATIONS.....	6
1.7	TEST FACILITY ACCREDITATIONS.....	6
2	EUT TEST CONFIGURATION.....	9
2.1	JUSTIFICATION.....	9
2.2	EUT EXERCISE SOFTWARE.....	9
2.3	EQUIPMENT MODIFICATIONS.....	9
2.4	LOCAL SUPPORT EQUIPMENT.....	9
2.5	INTERFACE PORTS AND CABLES.....	9
2.6	POWER SUPPLY AND LINE FILTERS.....	9
3	SUMMARY OF TEST RESULTS.....	10
4	APPLICABLE STANDARDS.....	11
4.1	DFS REQUIREMENT.....	11
4.2	DFS MEASUREMENT SYSTEM.....	14
4.3	SYSTEM BLOCK DIAGRAM.....	14
4.4	CONDUCTED METHOD.....	14
4.5	RADIATED METHOD.....	16
4.6	TEST PROCEDURE.....	16
5	TEST RESULTS.....	17
5.1	DESCRIPTION OF EUT.....	17
5.2	ANTENNA DESCRIPTION.....	17
5.3	TEST EQUIPMENT LIST AND DETAILS.....	17
5.4	RADAR WAVEFORM CALIBRATION.....	18
5.5	TEST ENVIRONMENTAL CONDITIONS.....	18
6	CHANNEL AVAILABILITY CHECK TIME (CAC).....	43
6.1	TEST PROCEDURE.....	43
7	CHANNEL MOVE TIME AND CHANNEL CLOSING TRANSMISSION TIME.....	50
7.1	TEST PROCEDURE.....	50
7.2	TEST RESULTS.....	50
8	NON-OCCUPANCY PERIOD.....	53
8.1	TEST PROCEDURE.....	53
8.2	TEST RESULTS.....	53
9	RADAR DETECTION BANDWIDTH & RADAR DETECTION PERFORMANCE CHECK.....	55
9.1	DETECTION BANDWIDTH.....	55
9.2	RADAR DETECTION PERFORMANCE CHECK.....	60
10	BRIDGE AND/OR MESH MODE.....	261
10.1	TEST STANDARD.....	261
10.2	TEST RESULT.....	261
11	ANNEX A (NORMATIVE) – TEST SETUP PHOTOGRAPHS.....	264

11.1	SETUP PHOTO	264
12	ANNEX B (NORMATIVE) - EUT PHOTOGRAPHS	265
12.1	EUT- TOP VIEW – FAP-U423EV	265
12.2	EUT- OVER VIEW– FAP-U423EV	265
12.3	EUT- SIDEVIEW– FAP-U423EV.....	266
12.4	EUT- BOTTOM VIEW – FAP-U423EV	266
12.5	EUT- TOP VIEW – FAP-U421EV	267
12.6	EUT- OVER VIEW– FAP-U421EV	267
12.7	EUT- SIDEVIEW– FAP-U421EV.....	268
12.8	EUT- BOTTOM VIEW – FAP-U421EV	268
12.9	OPEN CASE TOP VIEW	269
12.10	EUT- MAIN BOARD TOP VIEW	269
12.11	EUT- MAIN BOARD TOP REMOVE MODULE VIEW	270
12.12	EUT- MAIN BOARD BOTTOM VIEW.....	270
12.13	EUT- MAIN BOARD TOP REMOVE SHIELDING VIEW.....	271
12.14	EUT- MODULE 1 TOP VIEW	271
12.15	EUT- MODULE 1 BOTTOM VIEW.....	272
12.16	EUT- MODULE 1 SHIELDING OFF VIEW	272
12.17	EUT- MODULE 1 SHIELDING OFF TOP VIEW.....	273
12.18	EUT- MODULE 2 TOP VIEW	273
12.19	EUT- MODULE 2 BOTTOM VIEW.....	274
12.20	EUT- MODULE 2 SHIELDING OFF VIEW	274
12.21	EUT- MODULE 2 SHIELDING OFF TOP VIEW.....	275
12.22	ADAPTER VIEW	275
12.23	ADAPTER DETAIL VIEW	276
13	ANNEX C (INFORMATIVE) –DECLARATION OF SIMILARITY.....	277

DOCUMENT REVISION HISTORY

Revision Number	Report Number	Description of Revision	Date of Revision
0	R16111516-DFS	Original	2016-12-12
1	R16111516-DFS	Update Channel move time plots	2017-03-07

1 General Description

1.1 Product Description for Equipment under Test (EUT)

This test and measurement report has been compiled on behalf of *Fortinet, Inc.* and their product Model: FORTIAP-U421EVxxxxxx, FortiAP U421EVxxxxxx, FAP-U421EVxxxxxx, FORTIAP-U423EVxxxxxx, FortiAP U423EVxxxxxx, FAP-U423EVxxxxxx (where “x” can be “0-9”, or “A-Z”, or “-”, or blank for marketing purposes or software changes only and no Safety or EMC related changes) which will henceforth be referred to as the EUT (Equipment under Test). The EUT is a Secured Wireless Access Point.

1.2 Mechanical Description of EUT

The EUT measures approximately 21.6cm (Diameter) x 3.5cm (Height) and weighs approximately 500 g.

The data gathered are from production sample provided by the manufacturer, serial number: R16111516-1, assigned by BACL.

Testing was performed at FAP-U423EV unit.

1.3 Objective

This report is prepared on behalf of *Fortinet, Inc.* in accordance with FCC CFR47 §15.407 (h) & RSS 247 §6.3 and KDB: 905462 D02 UNII DFS Compliance Procedures New Rules v02.

The objective is to determine compliance with FCC rules for DFS Detection Threshold, Channel Availability Check Time, Uniform Spreading U-NII Detection Bandwidth, Channel Closing Transmission Time, and Channel Move time in Master Mode.

1.4 Related Submittal(s)/Grant(s)

N/A

1.5 Test Methodology

FCC CFR 47 Part2, Part15.407 (h)

RSS 247 §6.3

KDB: 905462 D02 UNII DFS Compliance Procedures New Rules v02.

COMPLIANCE MEASUREMENT PROCEDURES FOR UNLICENSED-NATIONAL INFORMATION INFRASTRUCTURE DEVICES OPERATING IN THE 5250-5350 MHz AND 5470-5725 MHz BANDS INCORPORATING DYNAMIC FREQUENCY SELECTION

1.6 Test Facility Registrations

BACLs test facilities that are used to perform Radiated and Conducted Emissions tests are currently recognized by the Federal Communications Commission as Accredited with NIST Designation Number US1129.

BACL's test facilities that are used to perform Radiated and Conducted Emissions tests are currently registered with Industry Canada under Registration Numbers: 3062A-1, 3062A-2, and 3062A-3.

BACL is a Chinese Taipei Bureau of Standards Metrology and Inspection (BSMI) validated Conformity Assessment Body (CAB), under Annex B, Phase I Procedures of the APEC Mutual Recognition Arrangement (MRA). BACL's BSMI Lab Code Number is: SL2-IN-E-1002R

BACL's test facilities that are used to perform AC Line Conducted Emissions, Telecommunications Line Conducted Emissions, Radiated Emissions from 30 MHz to 1 GHz, and Radiated Emissions from 1 GHz to 6 GHz are currently recognized as Accredited in accordance with the Voluntary Control Council for Interference [VCCI] Article 15 procedures under Registration Number A-0027.

1.7 Test Facility Accreditations

Bay Area Compliance Laboratories Corp. (BACL) is:

A- An independent, 3rd-Party, Commercial Test Laboratory accredited to ISO/IEC 17025:2005 by A2LA (Test Laboratory Accreditation Certificate Number 3297.02), in the fields of: Electromagnetic Compatibility and Telecommunications. Unless noted by an Asterisk (*) in the Compliance Matrix (See Section 3 of this Test Report), BACL's ISO/IEC 17025:2005 Scope of Accreditation includes all of the Test Method Standards and/or the Product Family Standards detailed in this Test Report..

BACL's ISO/IEC 17025:2005 Scope of Accreditation includes a comprehensive suite of EMC Emissions, EMC Immunity, Radio, RF Exposure, Safety and wireline Telecommunications test methods applicable to a wide range of product categories. These product categories include Central Office Telecommunications Equipment [including NEBS - Network Equipment Building Systems], Unlicensed and Licensed Wireless and RF devices, Information Technology Equipment (ITE); Telecommunications Terminal Equipment (TTE); Medical Electrical Equipment; Industrial, Scientific and Medical Test Equipment; Professional Audio and Video Equipment; Industrial and Scientific Instruments and Laboratory Apparatus; Cable Distribution Systems, and Energy Efficient Lighting.

B- A Product Certification Body accredited to ISO/IEC 17065:2012 by A2LA (Product Certification Body Accreditation Certificate Number 3297.03) to certify

- For the USA (Federal Communications Commission):
 - 1- All Unlicensed radio frequency devices within FCC Scopes A1, A2, A3, and A4;
 - 2- All Licensed radio frequency devices within FCC Scopes B1, B2, B3, and B4;
 - 3- All Telephone Terminal Equipment within FCC Scope C.
- For the Canada (Industry Canada):
 - 1 All Scope 1-Licence-Exempt Radio Frequency Devices;
 - 2 All Scope 2-Licensed Personal Mobile Radio Services;
 - 3 All Scope 3-Licensed General Mobile & Fixed Radio Services;
 - 4 All Scope 4-Licensed Maritime & Aviation Radio Services;
 - 5 All Scope 5-Licensed Fixed Microwave Radio Services
 - 6 All Broadcasting Technical Standards (BETS) in the Category I Equipment Standards List.
- For Singapore (Info-Communications Development Authority (IDA)):
 - 1 All Line Terminal Equipment: All Technical Specifications for Line Terminal Equipment – Table 1 of IDA MRA Recognition Scheme: 2011, Annex 2
 - 2. All Radio-Communication Equipment: All Technical Specifications for Radio-Communication Equipment – Table 2 of IDA MRA Recognition Scheme: 2011, Annex 2
- For the Hong Kong Special Administrative Region:
 - 1 All Radio Equipment, per KHCA 10XX-series Specifications;
 - 2 All GMDSS Marine Radio Equipment, per HKCA 12XX-series Specifications;
 - 3 All Fixed Network Equipment, per HKCA 20XX-series Specifications.
- For Japan:
 - 1 MIC Telecommunication Business Law (Terminal Equipment):
 - All Scope A1 - Terminal Equipment for the Purpose of Calls;
 - All Scope A2 - Other Terminal Equipment
 - 2 Radio Law (Radio Equipment):
 - All Scope B1 - Specified Radio Equipment specified in Article 38-2-2, paragraph 1, item 1 of the Radio Law
 - All Scope B2 - Specified Radio Equipment specified in Article 38-2-2, paragraph 1, item 2 of the Radio Law
 - All Scope B3 - Specified Radio Equipment specified in Article 38-2-2, paragraph 1, item 3 of the Radio Law

C- A Product Certification Body accredited to ISO/IEC 17065:2012 by A2LA (Product Certification Body Accreditation Certificate Number 3297.01) to certify Products to USA's Environmental Protection Agency (EPA) ENERGY STAR Product Specifications for:

- 1 Electronics and Office Equipment:
 - for Telephony (ver. 3.0)
 - for Audio/Video (ver. 3.0)
 - for Battery Charging Systems (ver. 1.1)
 - for Set-top Boxes & Cable Boxes (ver. 4.1)
 - for Televisions (ver. 6.1)
 - for Computers (ver. 6.0)
 - for Displays (ver. 6.0)
 - for Imaging Equipment (ver. 2.0)
 - for Computer Servers (ver. 2.0)
- 2 Commercial Food Service Equipment
 - for Commercial Dishwashers (ver. 2.0)
 - for Commercial Ice Machines (ver. 2.0)
 - for Commercial Ovens (ver. 2.1)
 - for Commercial Refrigerators and Freezers
- 3 Lighting Products
 - For Decorative Light Strings (ver. 1.5)
 - For Luminaires (including sub-components) and Lamps (ver. 1.2)
 - For Compact Fluorescent Lamps (CFLs) (ver. 4.3)
 - For Integral LED Lamps (ver. 1.4)
- 4 Heating, Ventilation, and AC Products
 - for Residential Ceiling Fans (ver. 3.0)
 - for Residential Ventilating Fans (ver. 3.2)
- 5 Other
 - For Water Coolers (ver. 3.0)

D. A NIST Designated Phase-I and Phase-II Conformity Assessment Body (CAB) for the following economies and regulatory authorities under the terms of the stated MRAs/Treaties:

- Australia: ACMA (Australian Communication and Media Authority) – APEC Tel MRA -Phase I;
- Canada: (Industry Canada - IC) Foreign Certification Body – FCB – APEC Tel MRA -Phase I & Phase II;
- Chinese Taipei (Republic of China – Taiwan):
 - o BSMI (Bureau of Standards, Metrology and Inspection) APEC Tel MRA -Phase I;
 - o NCC (National Communications Commission) APEC Tel MRA -Phase I;
- European Union:
 - o EMC Directive 2014/30/EC US-EU EMC & Telecom MRA CAB
 - o Radio & Teleterminal Equipment (R&TTE) Directive 1995/5/EC
US -EU EMC & Telecom MRA CAB
- Hong Kong Special Administrative Region: (Office of the Telecommunications Authority – OFTA)
APEC Tel MRA -Phase I & Phase II
- Israel – US-Israel MRA Phase I
- Republic of Korea (Ministry of Communications - Radio Research Laboratory) APEC Tel MRA -Phase I
- Singapore: (Infocomm Development Authority - IDA) APEC Tel MRA -Phase I & Phase II;
- Japan: VCCI - Voluntary Control Council for Interference US-Japan Telecom Treaty VCCI Side Letter-
- USA:
 - o ENERGY STAR Recognized Test Laboratory – US EPA
 - o Telecommunications Certification Body (TCB) – US FCC;

Vietnam: APEC Tel MRA -Phase I;

2 EUT Test Configuration

2.1 Justification

The EUT was configured for testing according to FCC CFR47 §15.407 (h) & RSS 247 §6.3, and KDB: 905462 D02 UNII DFS Compliance Procedures New Rules v02.

2.2 EUT Exercise Software

The test firmware is 8.2-4dfs-0 and FortiOS.

2.3 Equipment Modifications

N/A

2.4 Local Support Equipment

Manufacturer	Description	Model	Serial Number
Dell Inc.	Laptop	E6410	N/A
Fortinet	Controller-1	FortiWiFi 60D	FWF60D4614012915
Meru	Controller-2	MC1550	-
D-Link	Switch	DGS-1005G	PVF34D8000092

2.5 Interface Ports and Cables

Cable Description	Length (M)	From	To
RJ 45 (CAT 5)	< 3	Switch	POE
RJ 45 (CAT 5)	< 3	Controller-1	Switch
RJ 45 (CAT 5)	< 3	Controller-2	Switch
RJ 45 (CAT 5)	< 3	Laptop	Controller -1
RJ 45 (CAT 5)	< 3	AP	POE
Serial Cable	< 3	AP	Supporting Laptop

2.6 Power Supply and Line Filters

Manufacturer	Description	Model	Part Number
N/A	POE injector	N/A	N/A

3 Summary of Test Results

The following result table represents the list of measurements required under the FCC CFR47 §15.407 (h) & RSS 247 §6.3, and KDB: 905462 D02 UNII DFS Compliance Procedures New Rules v02. This report is to update from KDB: 905462 D02 UNII DFS Compliance Procedures Old rules v01 to KDB: 905462 D02 UNII DFS Compliance Procedures New Rules v02.

Items	Description of Test	Results
Detection Bandwidth	UNII Detection Bandwidth	Compliant
Performance Requirements Check	Initial Channel Availability Check Time (CAC)	Compliant
	Radar Burst at the Beginning of the CAC	Compliant
	Radar Burst at the End of the CAC	Compliant
In-Service Monitoring	Channel Move Time	Compliant
	Channel Closing Transmission Time	Compliant
	Non-Occupancy Period	Compliant
Radar Detection	Statistical Performance Check	Compliant

4 Applicable Standards

4.1 DFS Requirement

FCC CFR47 §15.407 (h) & RSS 247 §6.3, and KDB: 905462 D02 UNII DFS Compliance Procedures New Rules v02.

Table 1: Applicability of DFS requirements prior to use of a channel

Requirement	Operational Mode		
	Master	Client (Without radar detection)	Client (With radar detection)
Non-Occupancy Period	Yes	Not Required	Yes
DFS Detection Threshold	Yes	Not Required	Yes
Channel Availability Check Time	Yes	Not Required	Not Required
U-NII Detection Bandwidth	Yes	Not Required	Yes

Table 2: Applicability of DFS requirements during normal operation

Requirement	Operational Mode	
	Master Device or Client with Radar Detection	Client Without Radar Detection
DFS Detection Threshold	Yes	Not Required
Channel Closing Transmission Time	Yes	Yes
Channel Move Time	Yes	Yes
U-NII Detection Bandwidth	Yes	Not Required

Additional requirements for devices with multiple bandwidth modes	Master Device or Client with Radar Detection	Client Without Radar Detection
U-NII Detection Bandwidth and Statistical Performance Check	All BW modes must be tested	Not required
Channel Move Time and Channel Closing Transmission Time	Test using widest BW mode available	Test using the widest BW mode available for the link
All other tests	Any single BW mode	Not required

Note: Frequencies selected for statistical performance check (Section 7.8.4) should include several frequencies within the radar detection bandwidth and frequencies near the edge of the radar detection bandwidth. For 802.11 devices it is suggested to select frequencies in each of the bonded 20 MHz channels and the channel center frequency.

Table 3: Interference Threshold for Master and Client with Radar Detection

Maximum Transmit Power	Value (See Notes 1, 2 and 3)
EIRP \geq 200 milliwatt	-64 dBm
EIRP< 200 milliwatt and power spectral density < 10dBm/MHz	-62 dBm
EIRP< 200 milliwatt that do not meet the power spectral density requirement	-64 dBm

Note 1: This is the level at the input of the receiver assuming a 0 dBi receive antenna.
Note 2: Throughout these test procedures an additional 1 dB has been added to the amplitude of the test transmission waveforms to account for variations in measurement equipment. This will ensure that the test signal is at or above the detection threshold level to trigger a DFS response.
Note3: EIRP is based on the highest antenna gain. For MIMO devices refer to KDB Publication 662911 D01.

Table 4: DFS Response Requirement Values

Parameter	Value
Non-occupancy period	Minimum 30 minutes
Channel Availability Check Time	60 seconds
Channel Move Time	10 seconds <i>See Note 1.</i>
Channel Closing Transmission Time	200 milliseconds + an aggregate of 60 milliseconds over remaining 10 second period. <i>See Notes 1 and 2.</i>
U-NII Detection Bandwidth	Minimum 100% of the UNII 99% transmission power bandwidth. <i>See Note 3.</i>

Note 1: Channel Move Time and the Channel Closing Transmission Time should be performed with Radar Type 0. The measurement timing begins at the end of the Radar Type 0 burst.

Note 2: The Channel Closing Transmission Time is comprised of 200 milliseconds starting at the beginning of the Channel Move Time plus any additional intermittent control signals required to facilitate a Channel move (an aggregate of 60 milliseconds) during the remainder of the 10 second period. The aggregate duration of control signals will not count quiet periods in between transmissions.

Note 3: During the U-NII Detection Bandwidth detection test, radar type 0 should be used. For each frequency step the minimum percentage of detection is 90 percent. Measurements are performed with no data traffic.

Table 5: Short Pulse Radar Test Waveforms

Radar Type	Pulse Width (Microseconds)	PRI (Microseconds)	Pulses	Minimum Percentage of Successful Detection	Minimum Number of Trials
0	1	1428	18	See Note 1	See Note 1
1	1	Test A: 15 unique PRI values randomly selected from the list of 23 PRI values in Table 5a Test B: 15 unique PRI values randomly selected within the range of 518-3066 μsec, with a minimum increment of 1 μsec, excluding PRI values selected in Test A	$\text{Roundup} \left\{ \begin{matrix} \left(\frac{1}{360} \right) \\ \left(\frac{19 \cdot 10^6}{\text{PRI}_{\mu\text{sec}}} \right) \end{matrix} \right.$	60%	30
2	1-5	150-230	23-29	60%	30
3	6-10	200-500	16-18	60%	30
4	11-20	200-500	12-16	60%	30
Aggregate (Radar Types 1-4)				80%	120
Note 1: Short Pulse Radar Type 0 should be used for the detection bandwidth test, channel move time, and channel closing time tests.					

Table 6: Long Pulse Radar Test Signal

Radar Type	Bursts	Chirp Width (MHz)	PRI (usec)	Number of Pulses per Burst	Number of Bursts	Minimum Percentage of Successful Detection	Minimum Number of Trials
5	50-100	5-20	1000-2000	1-3	8-20	80%	30

Table 7: Frequency Hopping Radar Test Signal

Radar Type	Pulse Width (usec)	PRI (usec)	Pulses per Hop	Hopping Rate (kHz)	Hopping Sequence Length (msec)	Minimum Percentage of Successful Detection	Minimum Number of Trials
6	1	333	9	0.333	300	70%	30

4.2 DFS Measurement System

BACL DFS measurement system consists of two subsystems: (1) The radar signal generating subsystem and (2) the traffic monitoring subsystem.

4.3 System Block Diagram

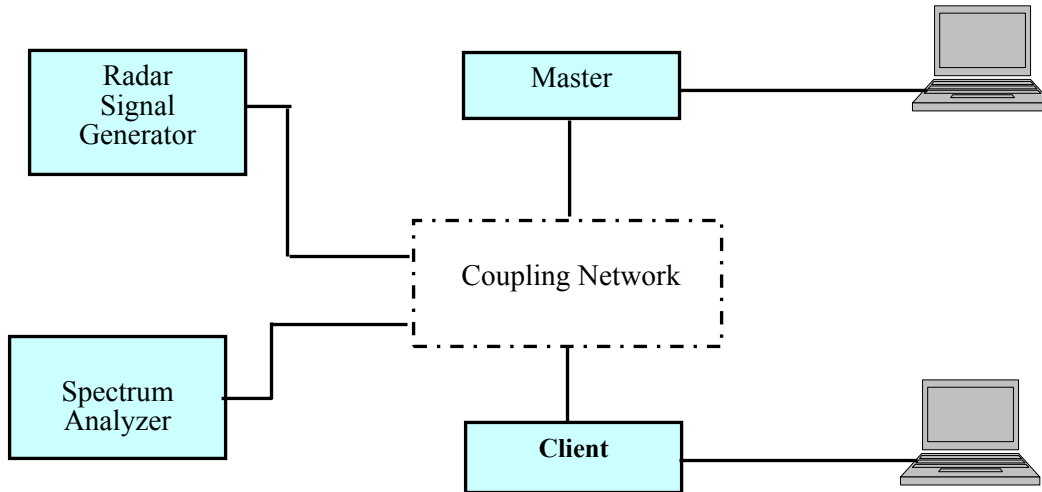

4.4 Conducted Method

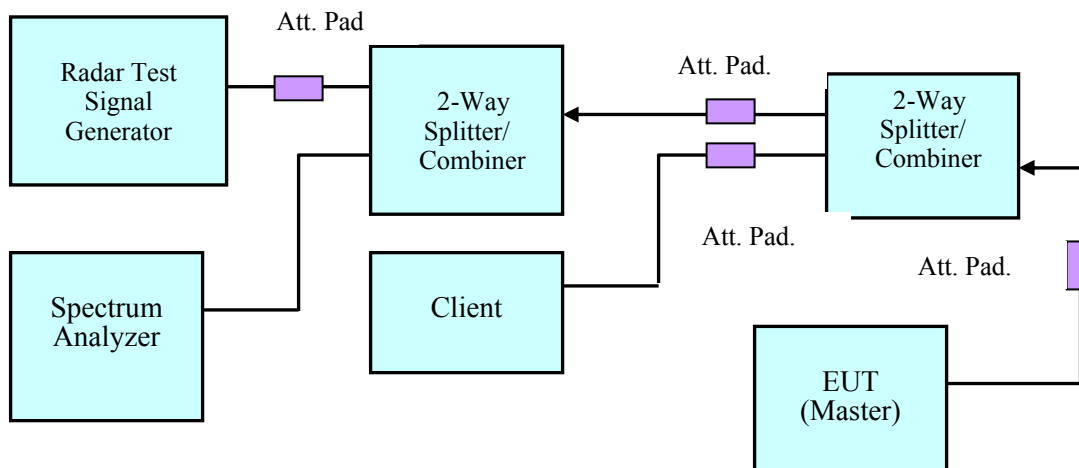

Setup for Master with injection at the Master

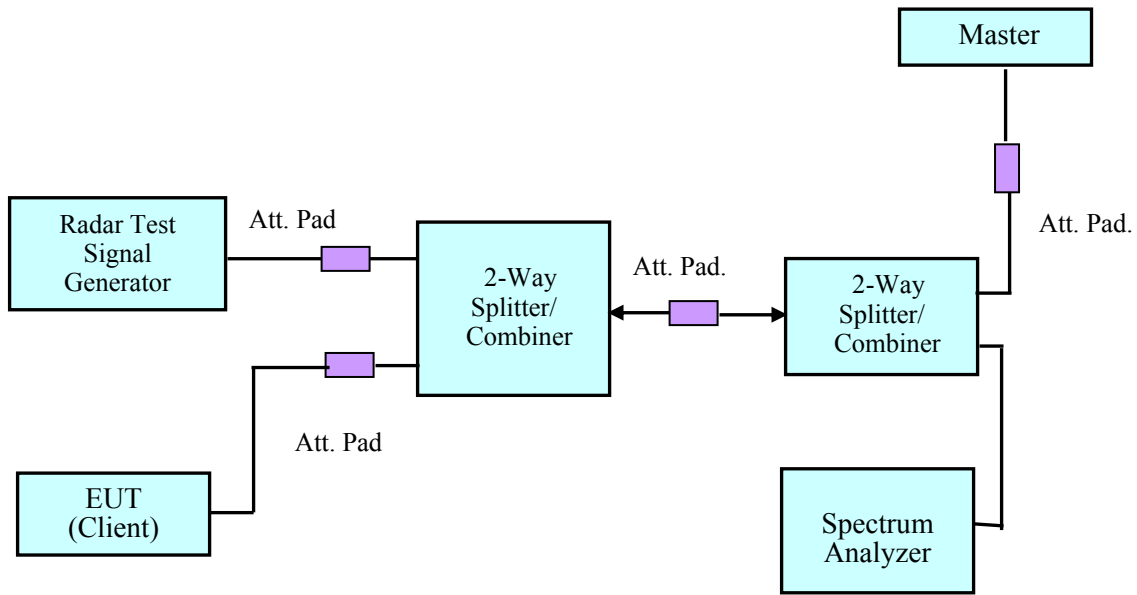

Setup for Client with injection at the Master

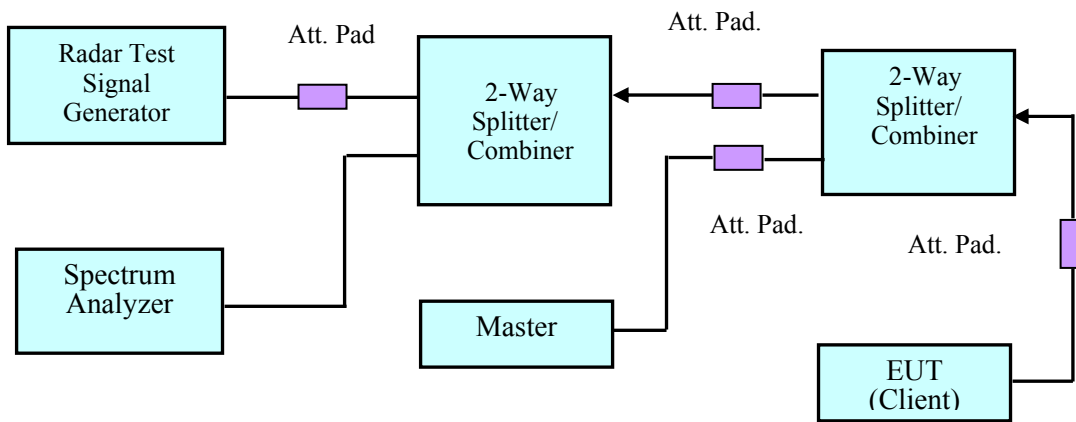

Setup for Client with injection at the Client

4.5 Radiated Method

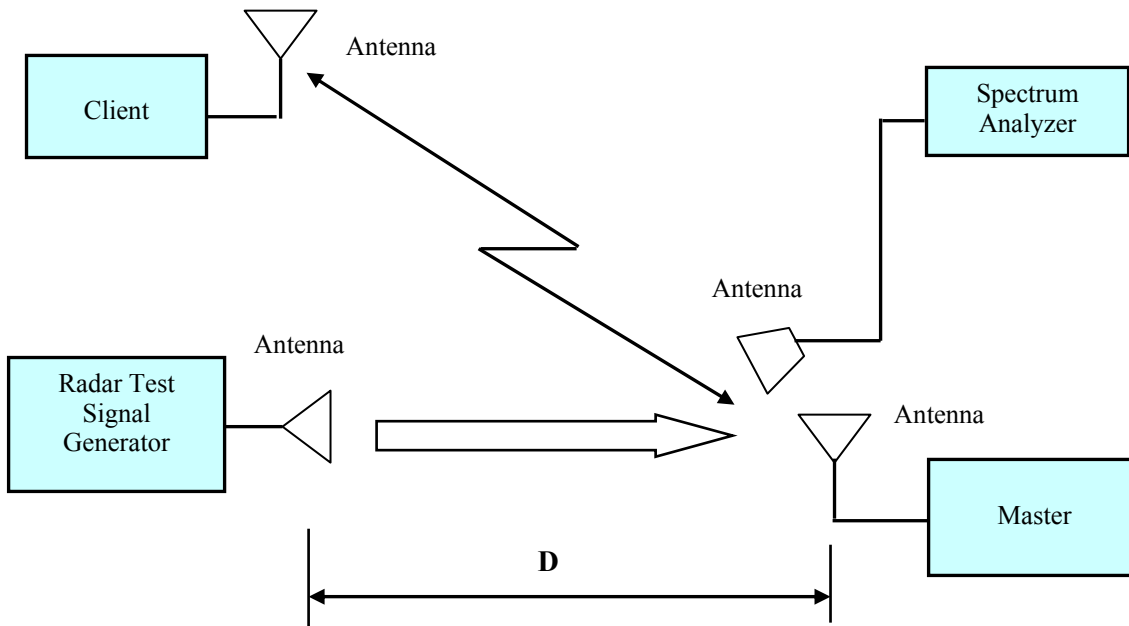

4.6 Test Procedure

A spectrum analyzer is used as a monitor that verifies the EUT's status, which includes the Channel Closing Transmission Time and the Channel Move Time. The Spectrum analyzer is used to monitor the equipment under test (EUT) does not transmit on the same channel during the Non-Occupied Period after the radar detection. It is also used to monitor EUT transmissions during the Channel Availability Check Time.

5 Test Results

5.1 Description of EUT

The EUT operates in 5230-5350 MHz and 5470-5725 MHz range in Master Mode.

The rated output power of EUT is > 23 dBm (EIRP), Therefore the required interference threshold level is -64 dBm, the required radiated threshold at antenna port is -64 dBm.

The calibrated radiated DFS detection threshold level is set to -64 dBm.

WLAN traffic is generated by streaming the video file TestFile.mpg, this file is used by IP and Frame based systems for loading the test channel during the In-service compliance testing of the U-NII device. The file is streamed from the Access Point to the Client in full motion video mode using the media player with the V2.61 Codec package.

5.2 Antenna Description

Antenna Type	Antenna Gain (dBi) @ 5 GHz
Internal (S421E)	4.78
External (S423E)	3.18

5.3 Test Equipment List and Details

Manufacturer	Equipment Description	Model	S/N	Calibration Date	Calibration Interval
National Instruments	NI PXI-1042 8-Slot chassis	PXI-1042	V08X01EE1	N/A	N/A
National Instruments	Arbitrary Waveform Generator	PXI-5421	N/A	N/A	N/A
National Instruments	RF Upconverter	PXI-5610	N/A	N/A	N/A
ASCOR	Upconverter	AS-7206	N/A	N/A	N/A
Agilent	Analyzer, Spectrum	E4440A	US45303156	2016-01-19	1 year
A.R.A.	Antenna Horn	DRG-118/A	1132	2016-01-29	2 years
EMCO	Antenna Horn	3115	9511-4627	2015-10-17	2 years
Mini-Circuits	Splitter/Combiner	2FSC-2-10G	0349	N/A	N/A
Narda	Splitter/Combiner	4326B-2	03514	N/A	N/A
Midwest	Attenuator	290-30	N/A	N/A	N/A
Mini-Circuits	Attenuator	BW-S30W2	N/A	N/A	N/A

Statement of Traceability: BACL Corp. attests that all calibrations have been performed per the A2LA requirements, traceable to the NIST.

5.4 Radar Waveform Calibration

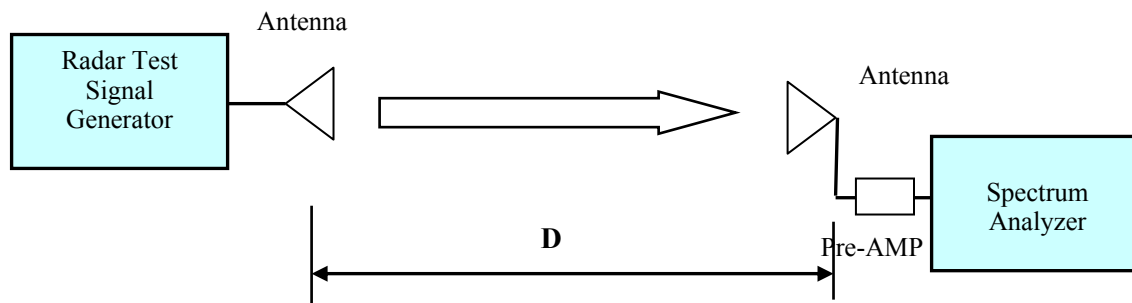

Radiated Calibration Setup Block Diagram

5.5 Test Environmental Conditions

Temperature:	22-25° C
Relative Humidity:	45-48 %
ATM Pressure:	102.1 kPa

Testing was performed by Jin Yang from 2016-11-09 to 2016-11-18 at the DFS site.

Plots of Radar Waveforms

5280 MHz

Radar Type 0

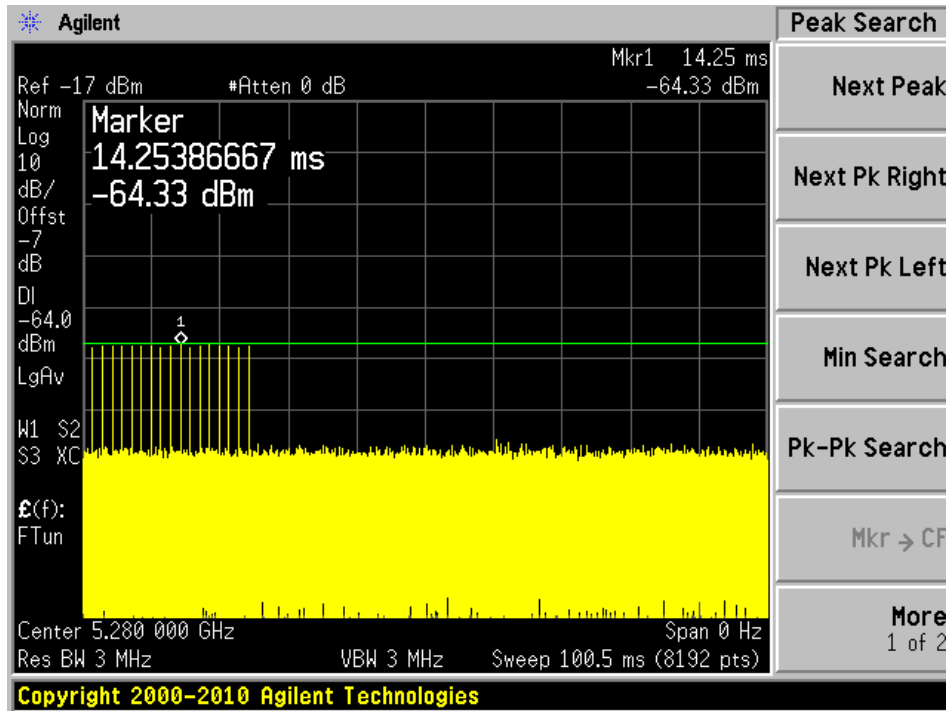

Radar Type 1A

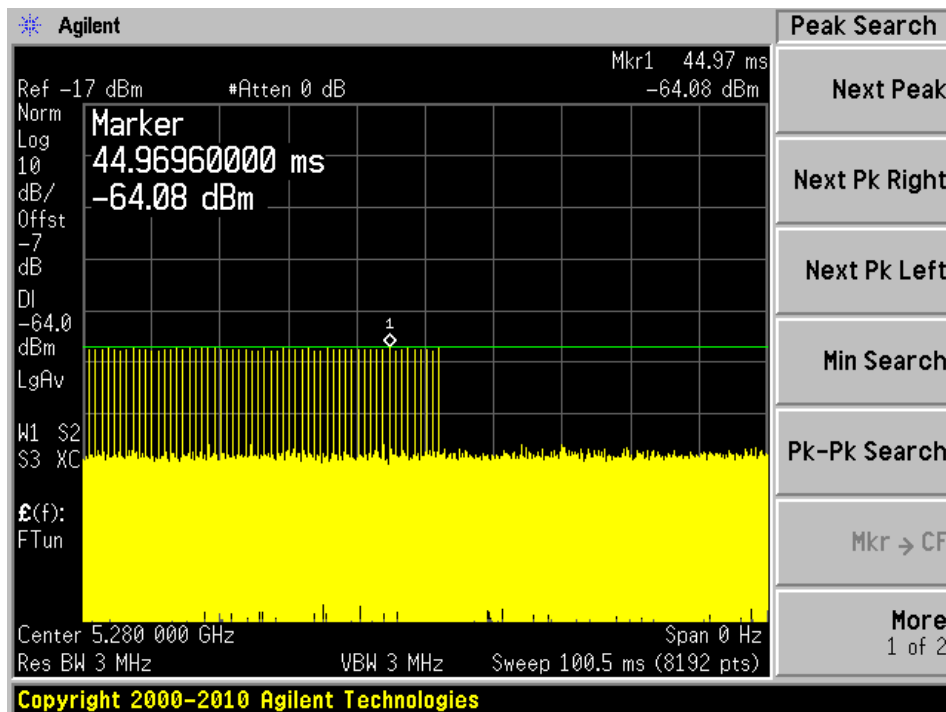

Radar Type 1B

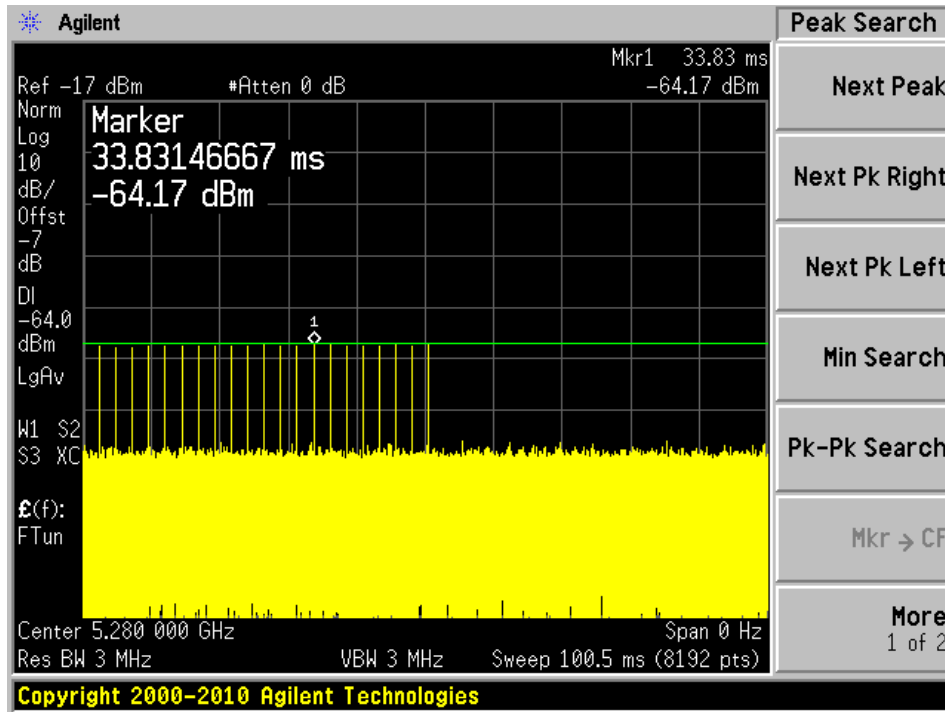

Radar Type 2

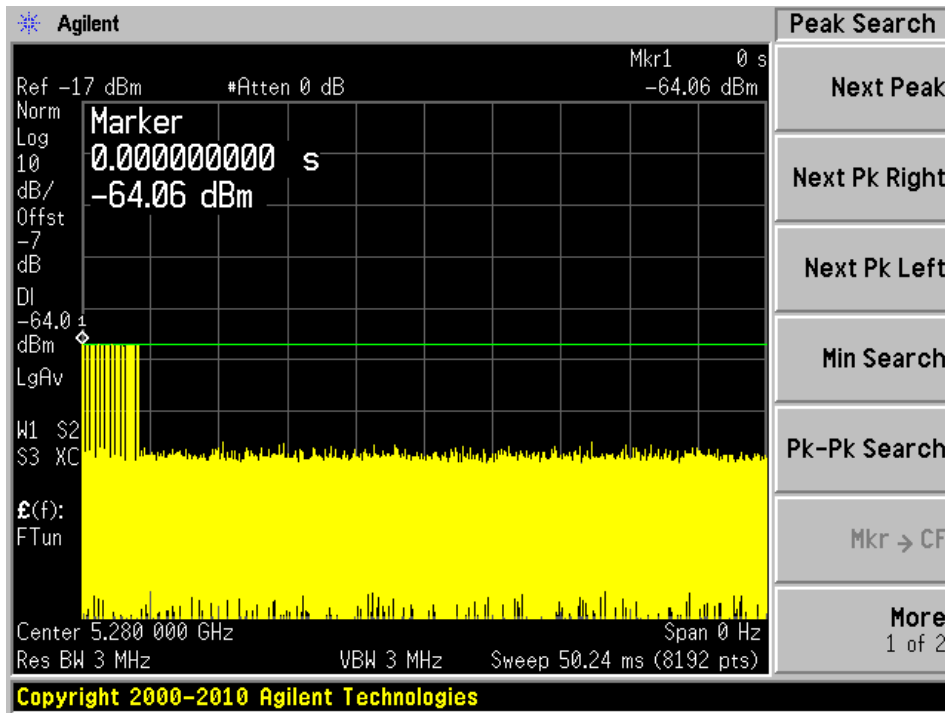

Radar Type 3

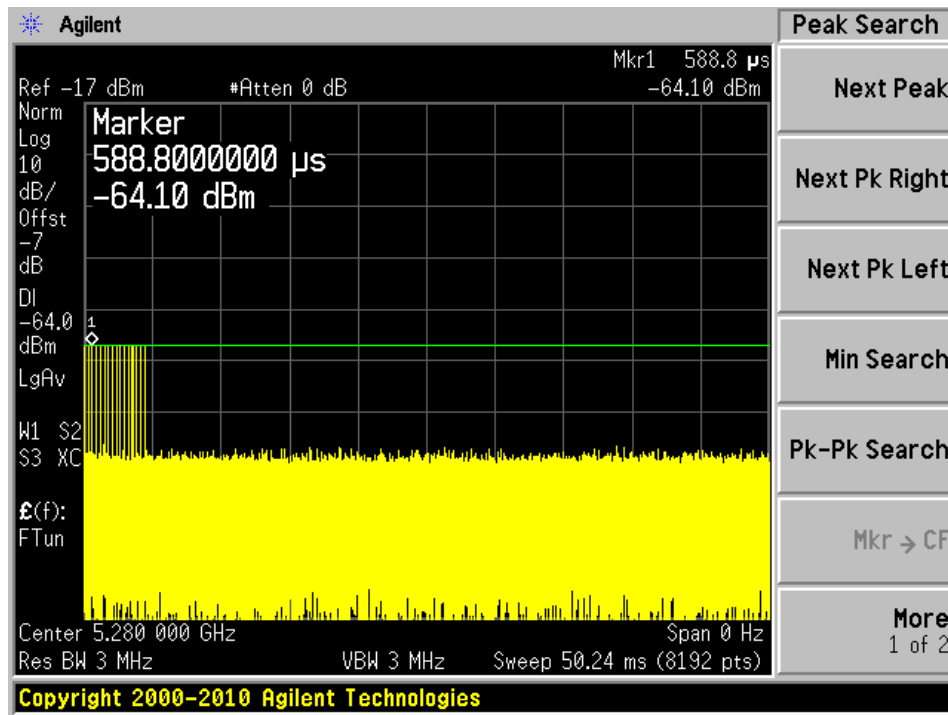

Radar Type 4

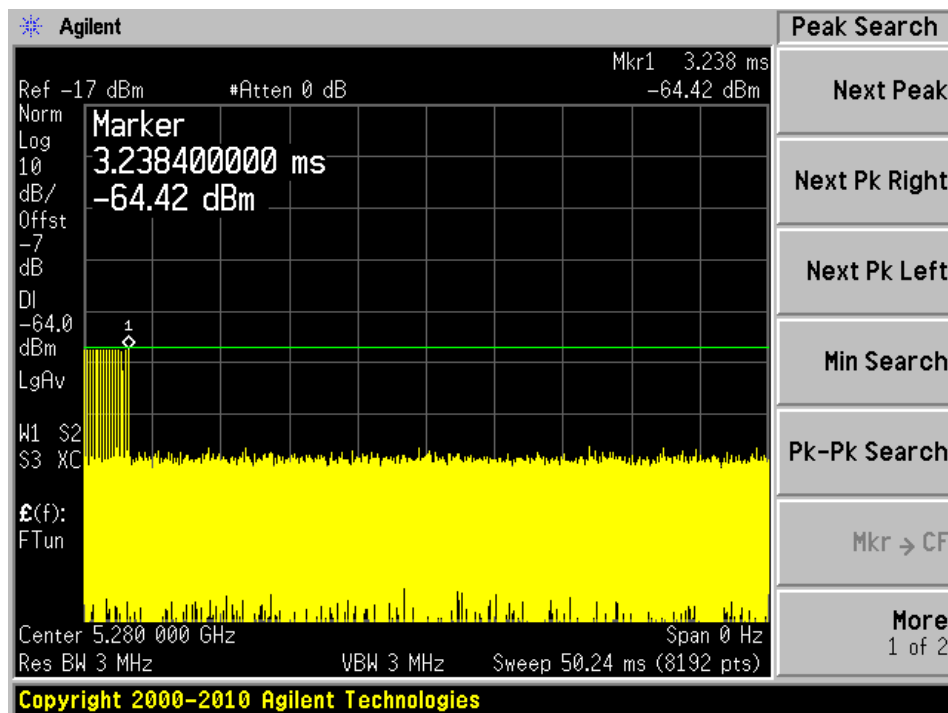

Radar Type 5

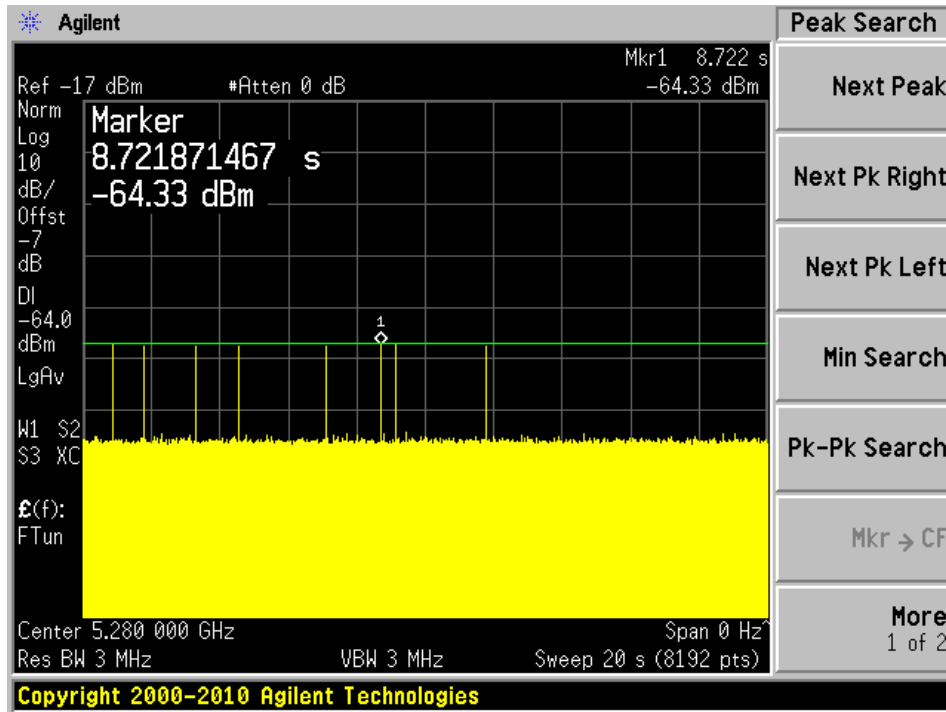

Radar Type 6

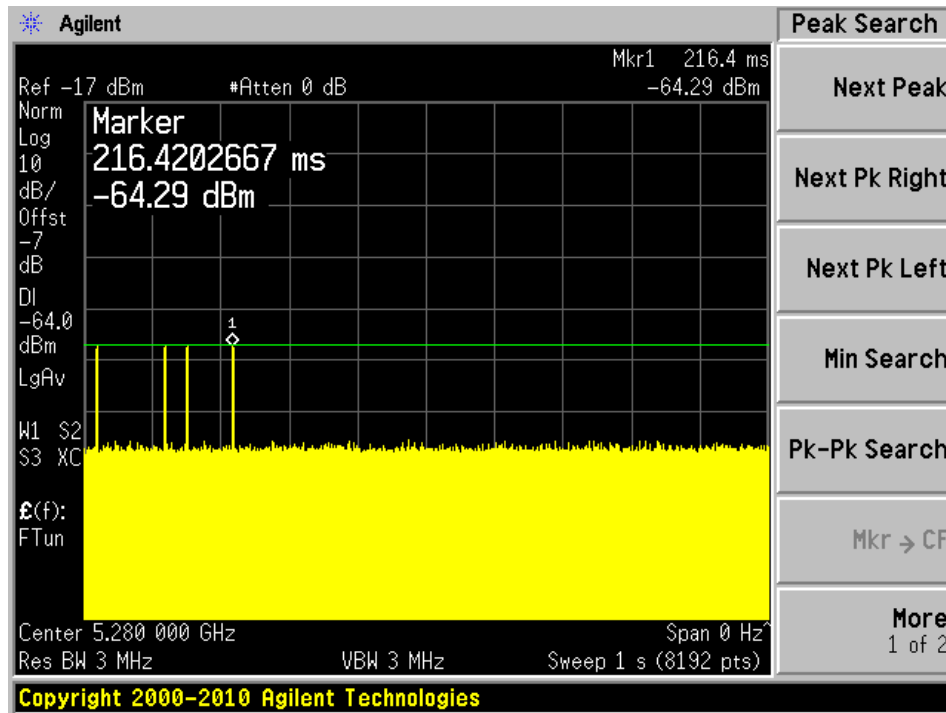

5540 MHz

Radar Type 0

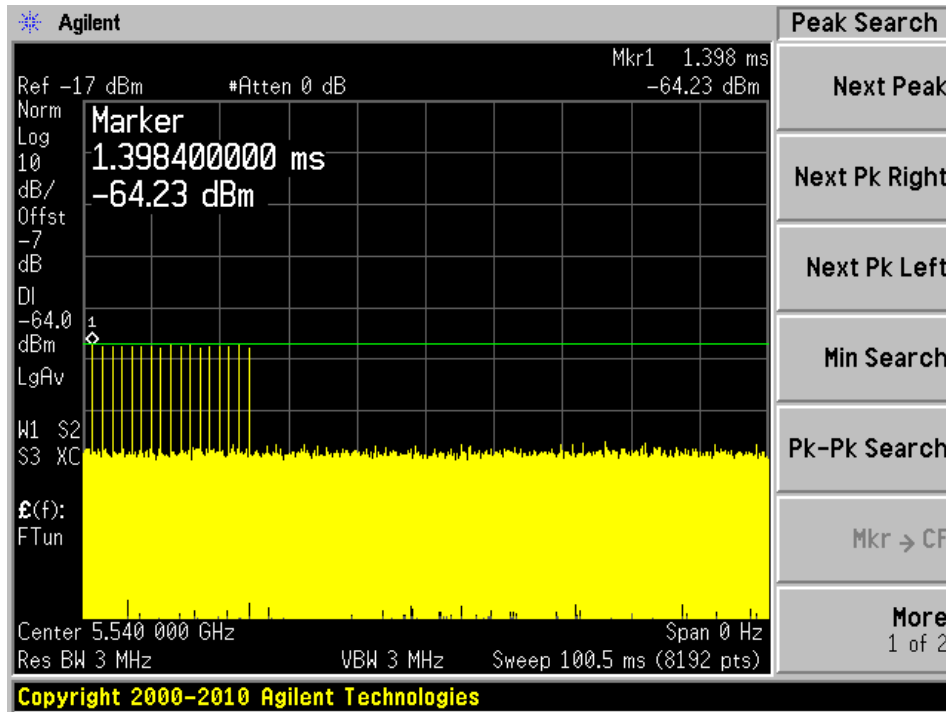

Radar Type 1A

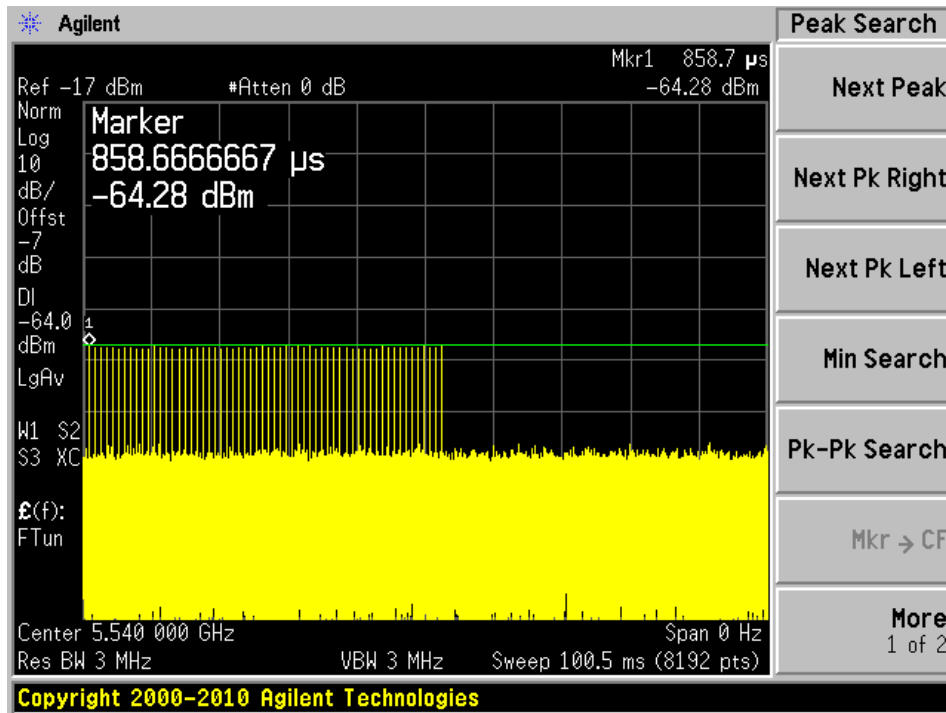

Radar Type 1B

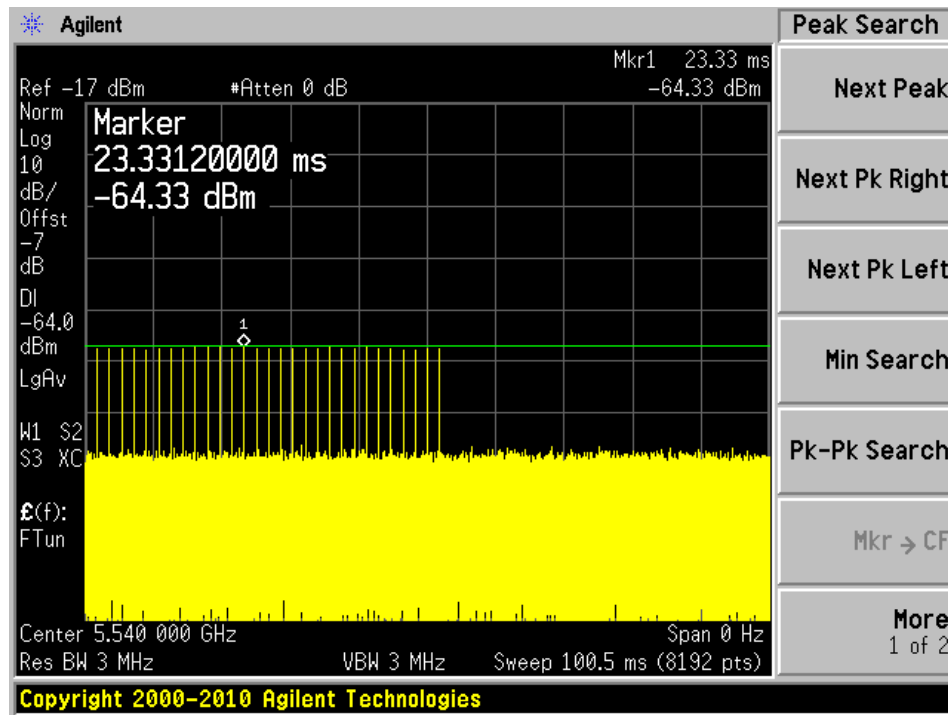

Radar Type 2

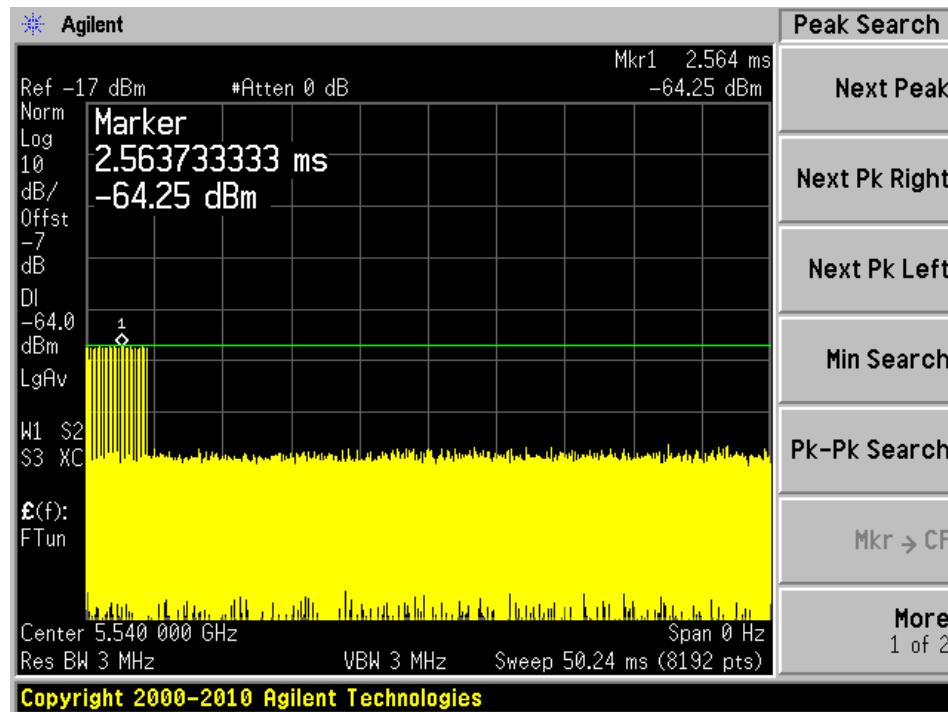

Radar Type 3

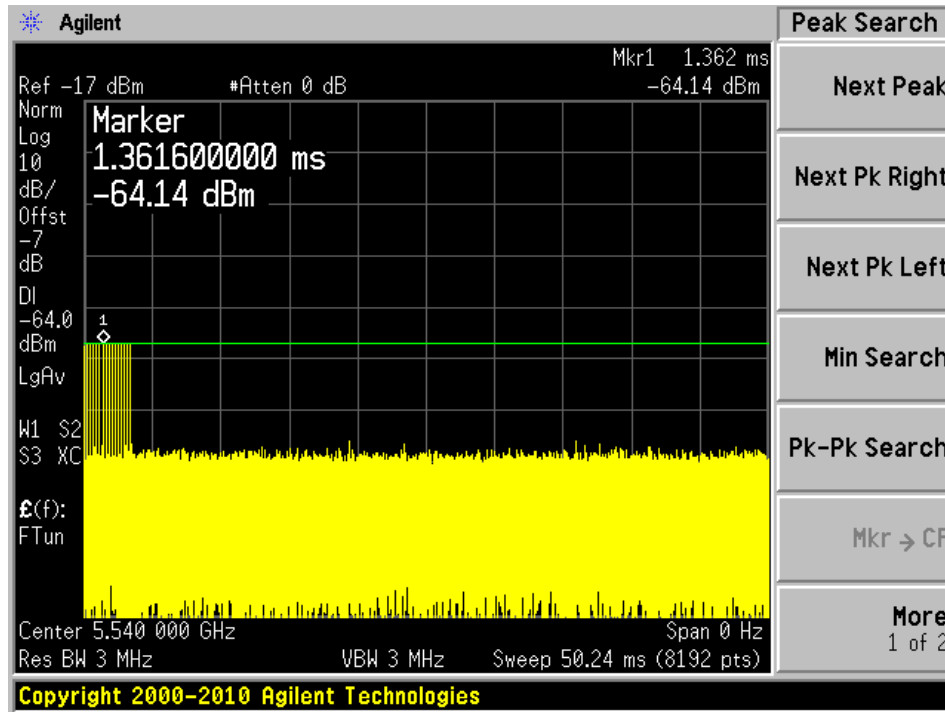

Radar Type 4

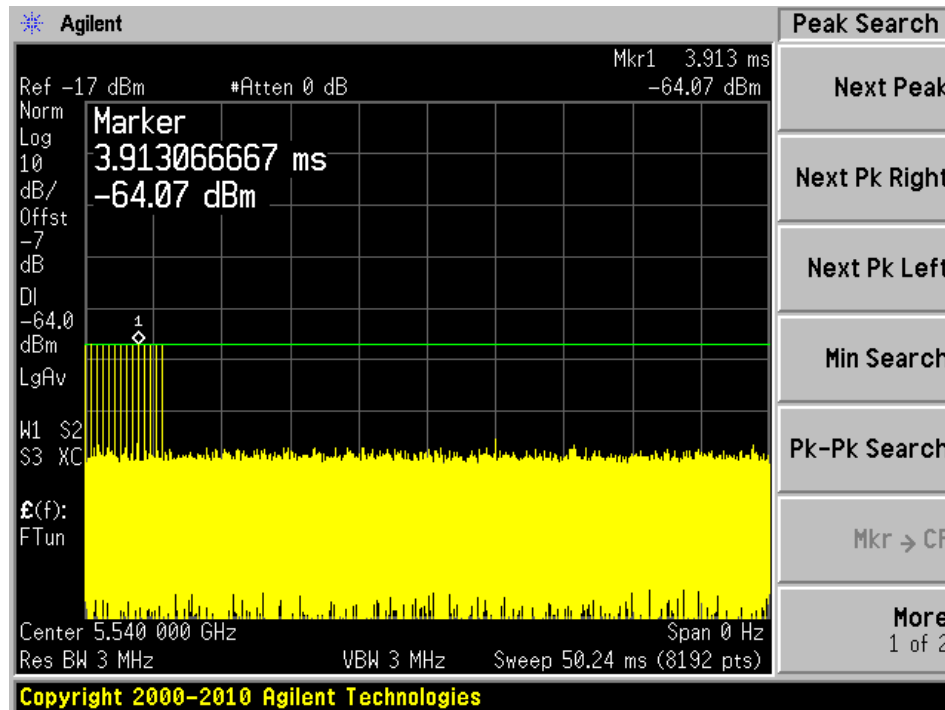

Radar Type 5

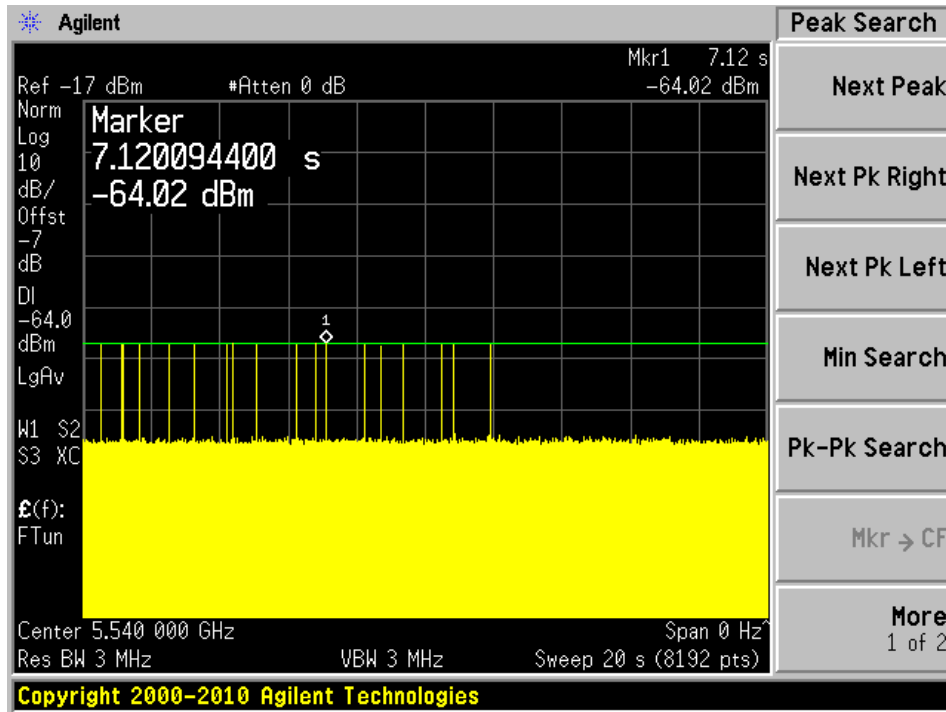

Radar Type 6

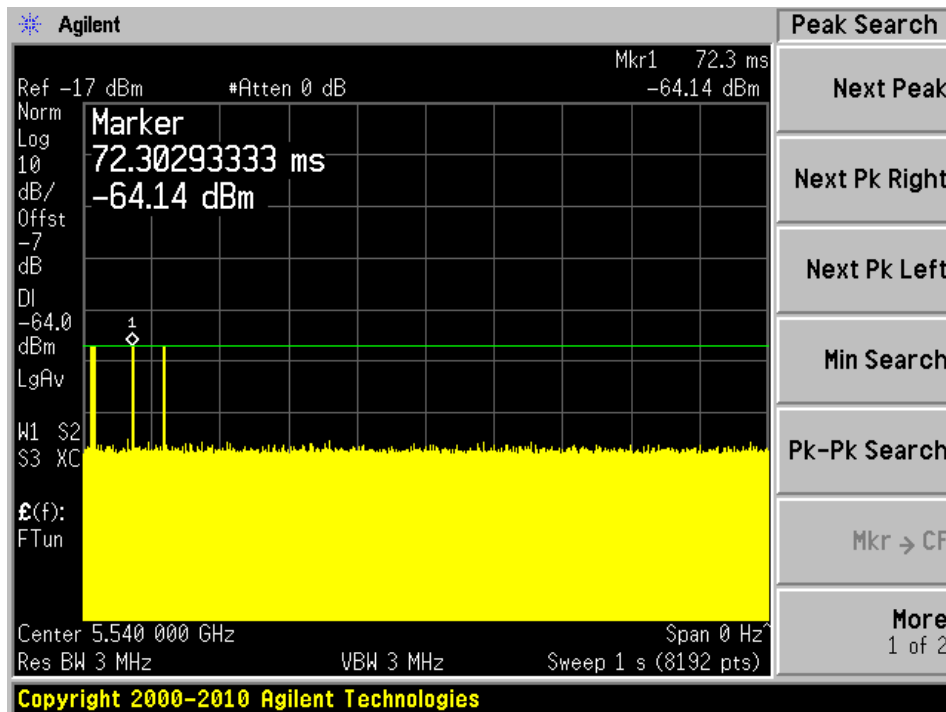

5270 MHz

Radar Type 0

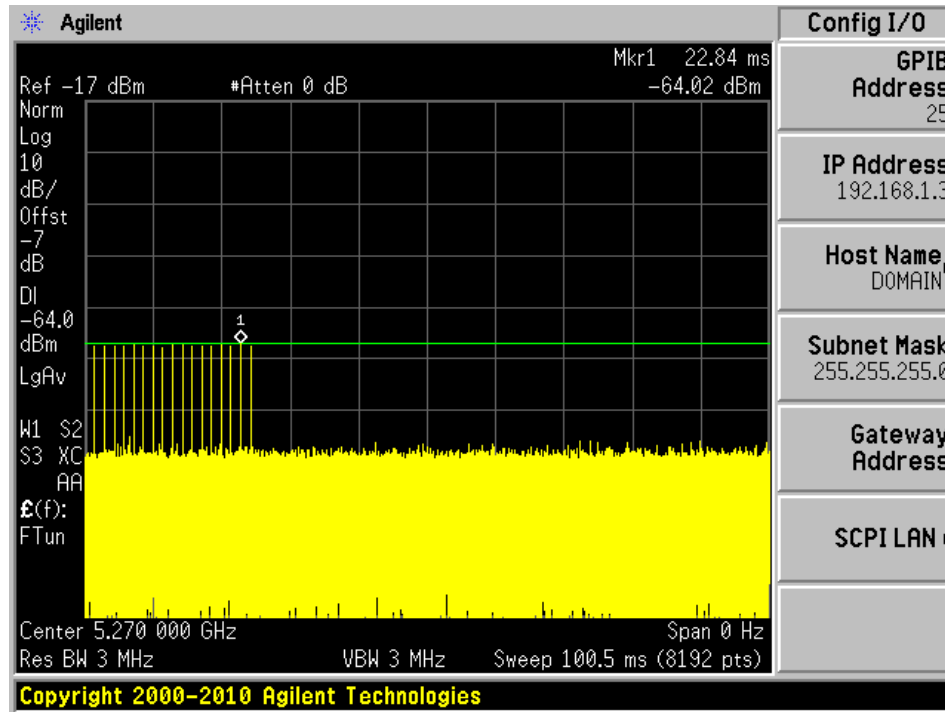

Radar Type 1A

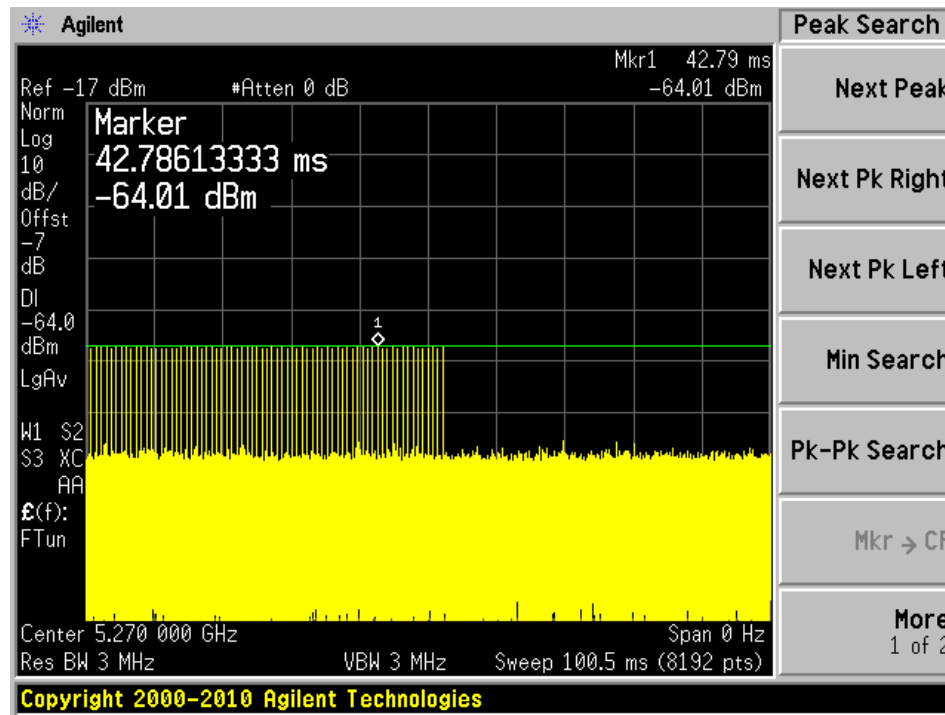

Radar Type 1B

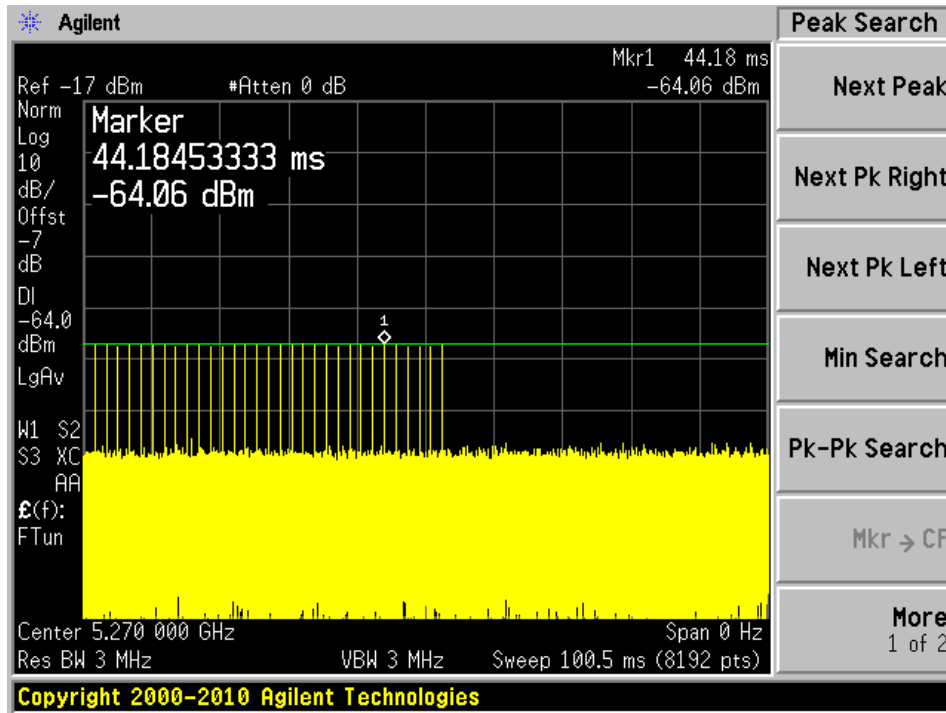

Radar Type 2

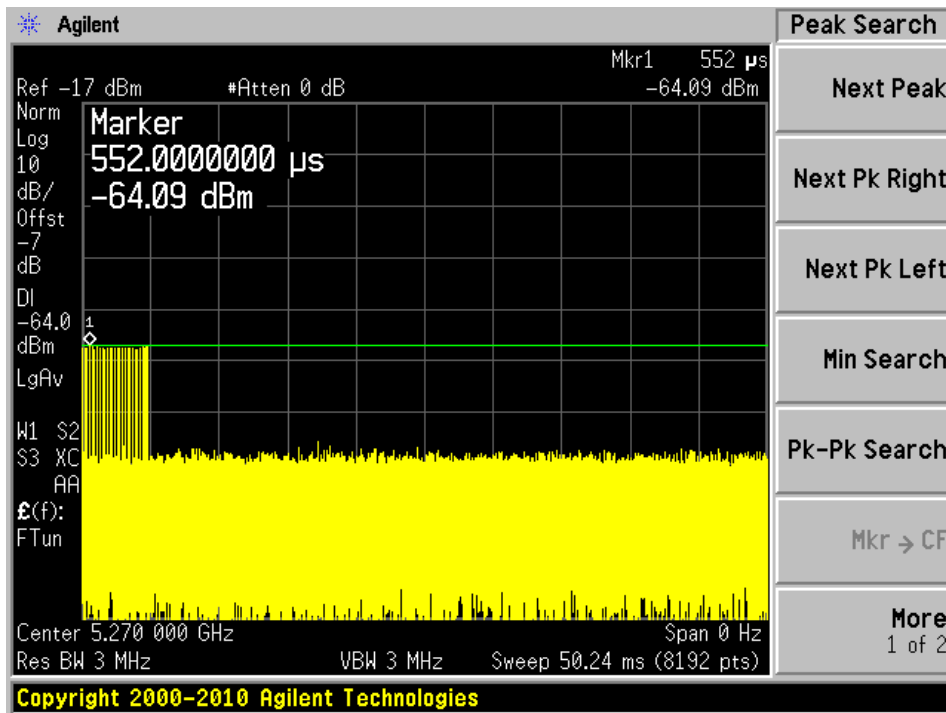

Radar Type 3

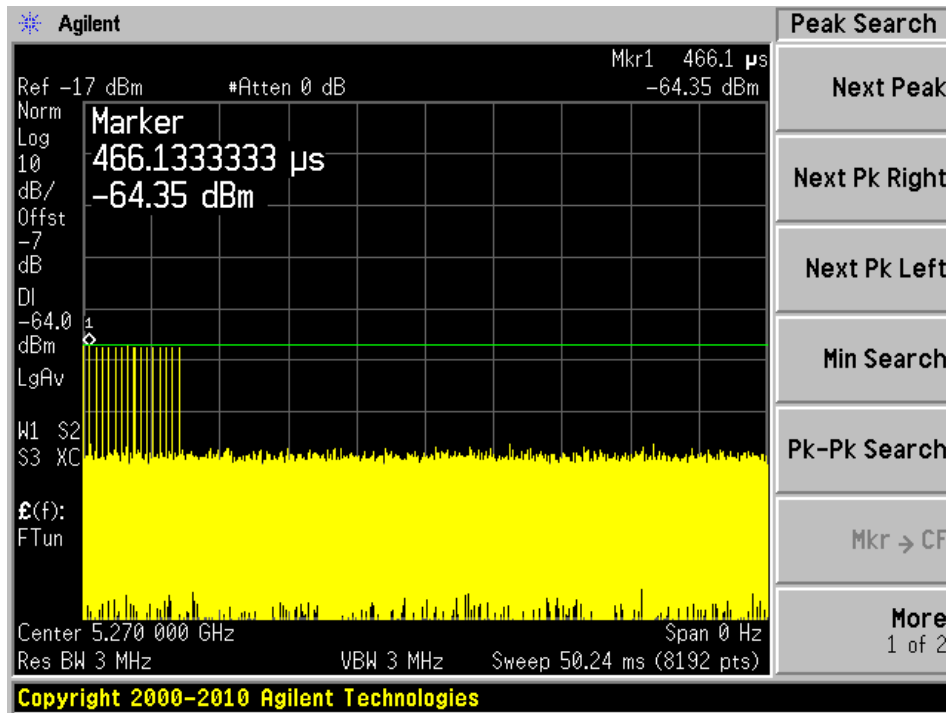

Radar Type 4

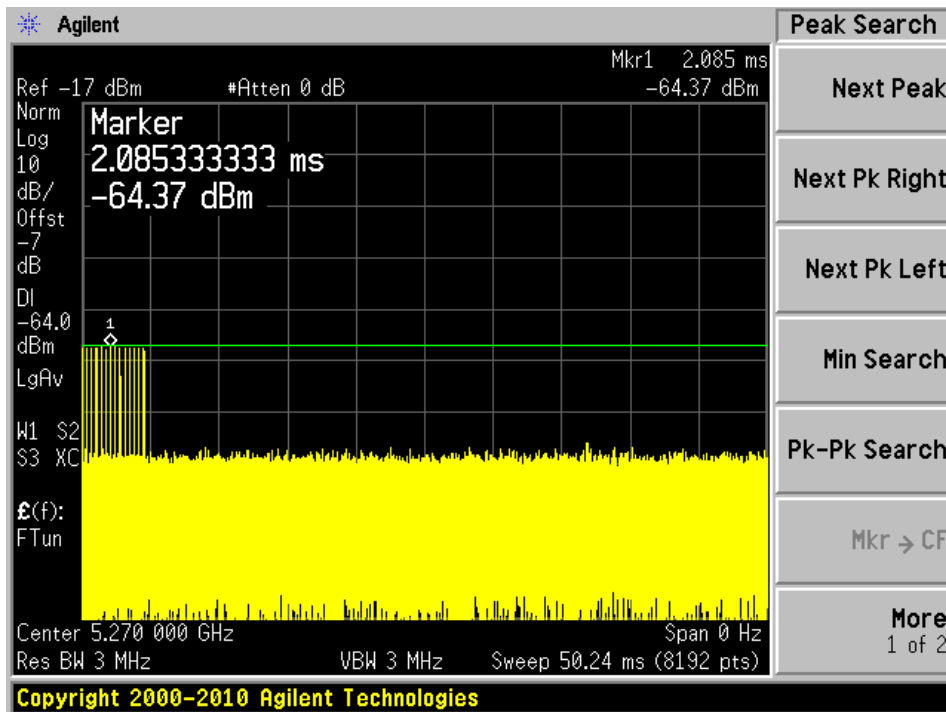

Radar Type 5

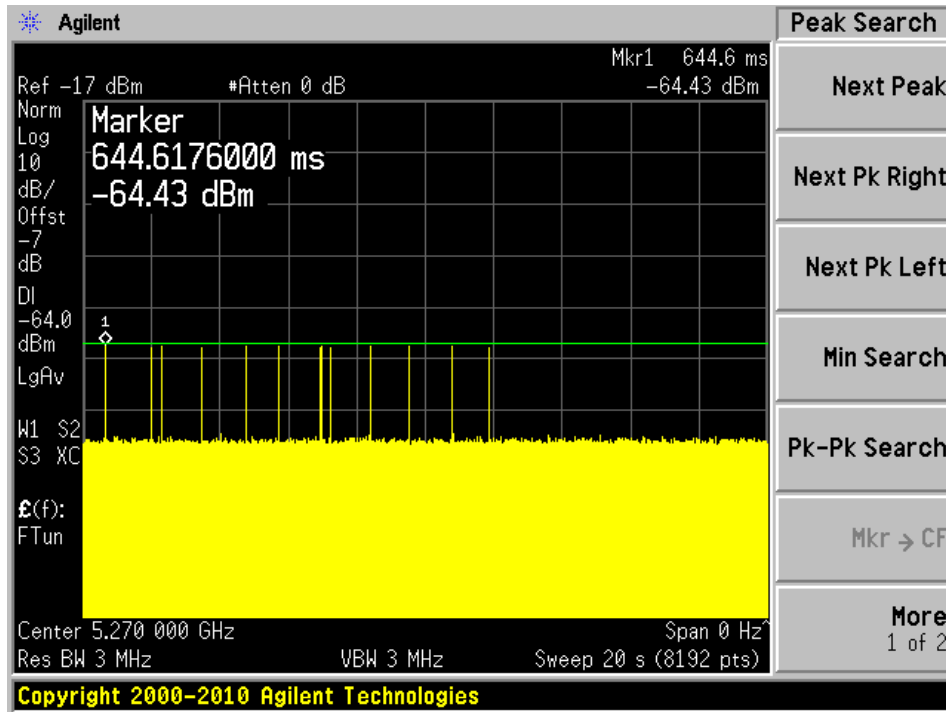

Radar Type 6

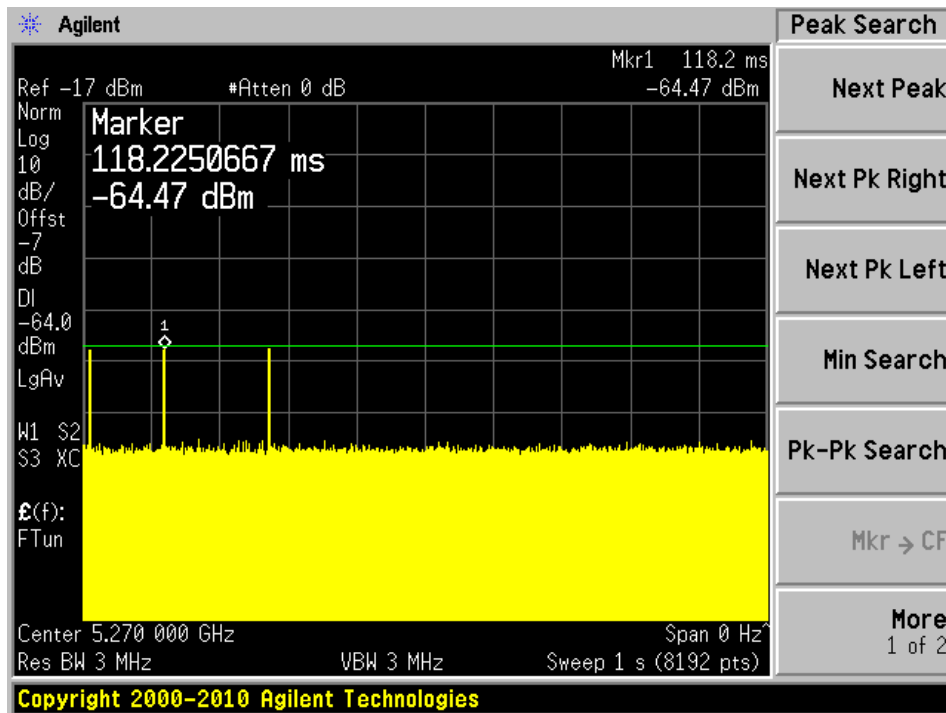

5550 MHz

Radar Type 0

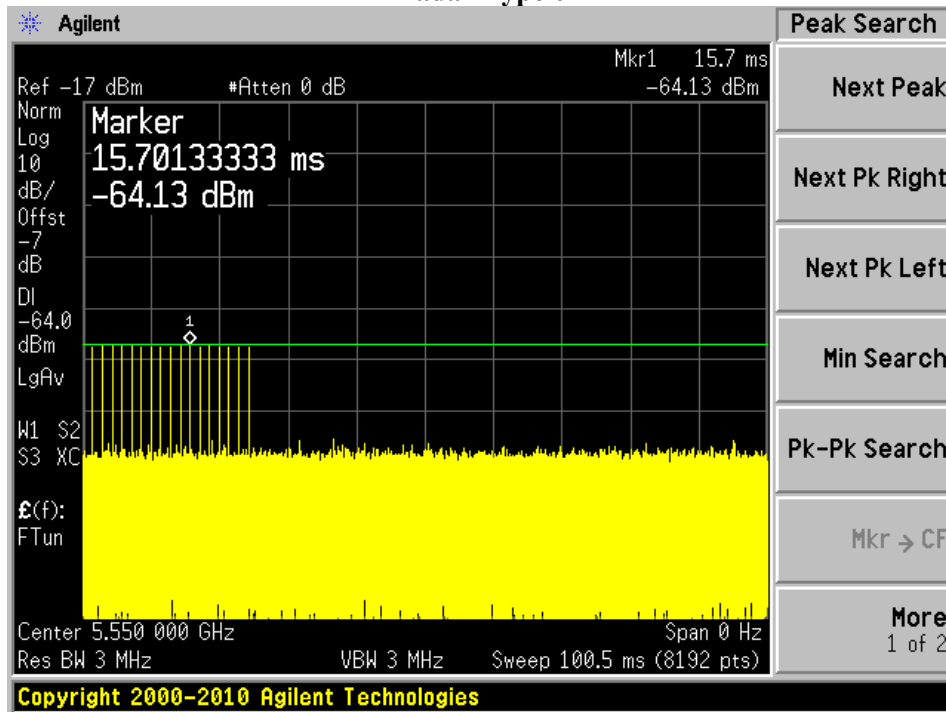

Radar Type 1A

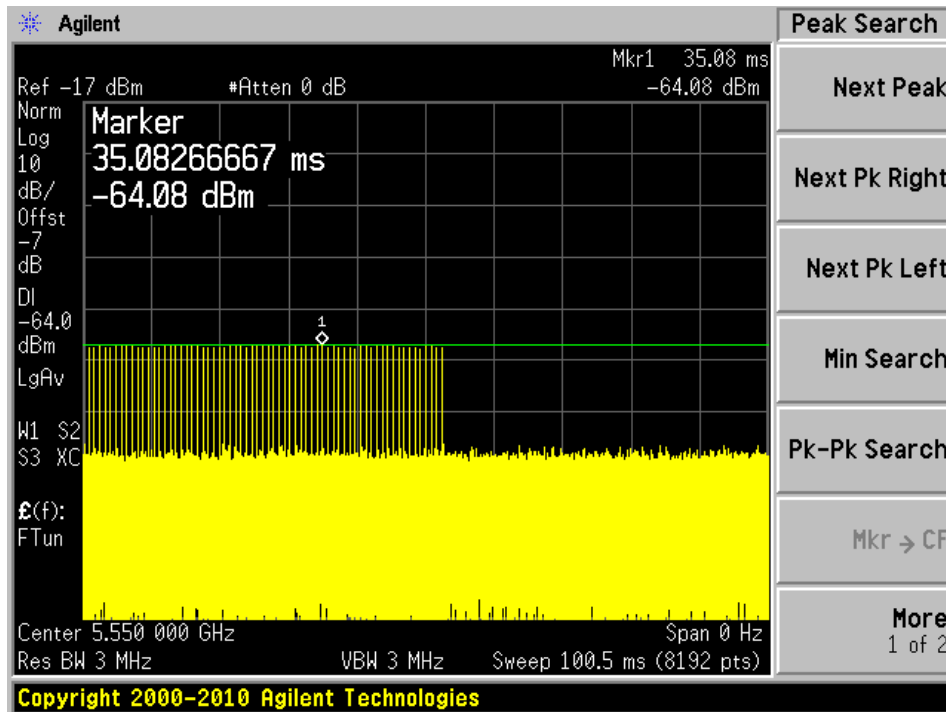

Radar Type 1B

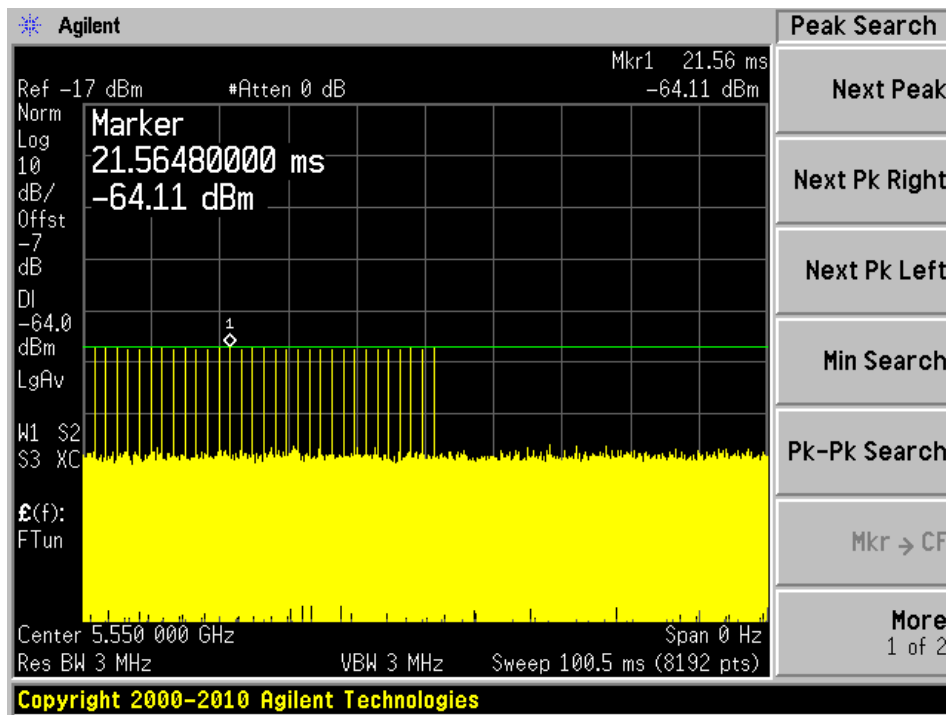

Radar Type 2

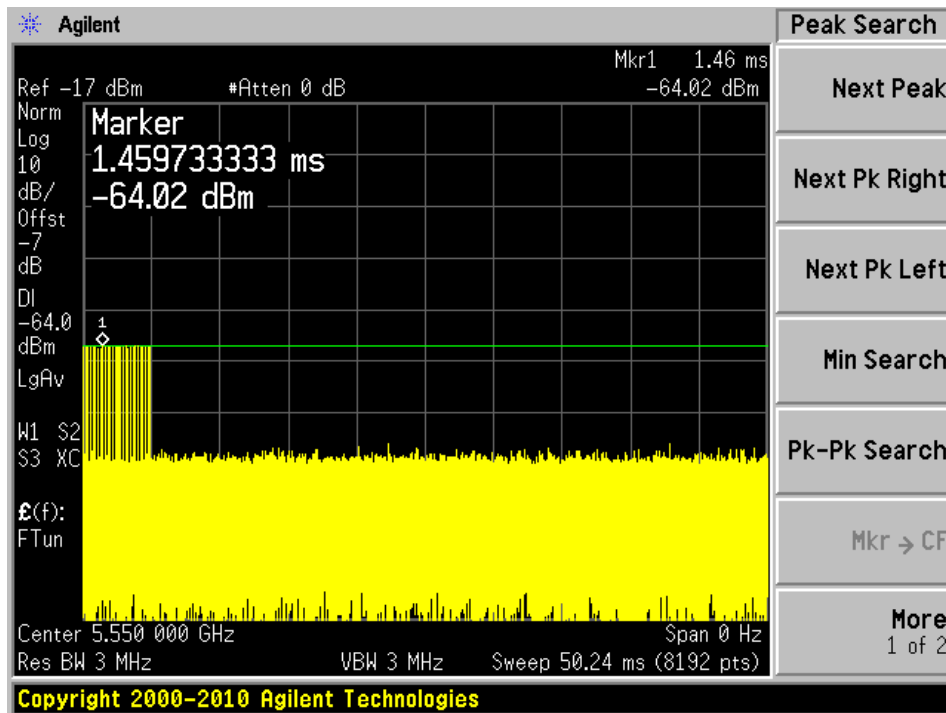

Radar Type 3

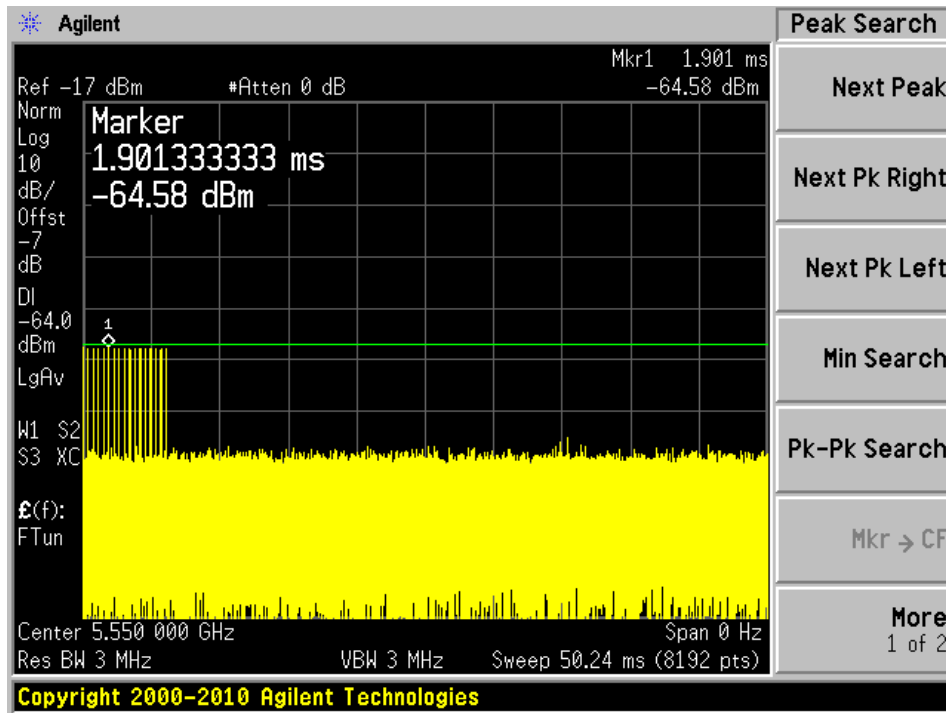

Radar Type 4

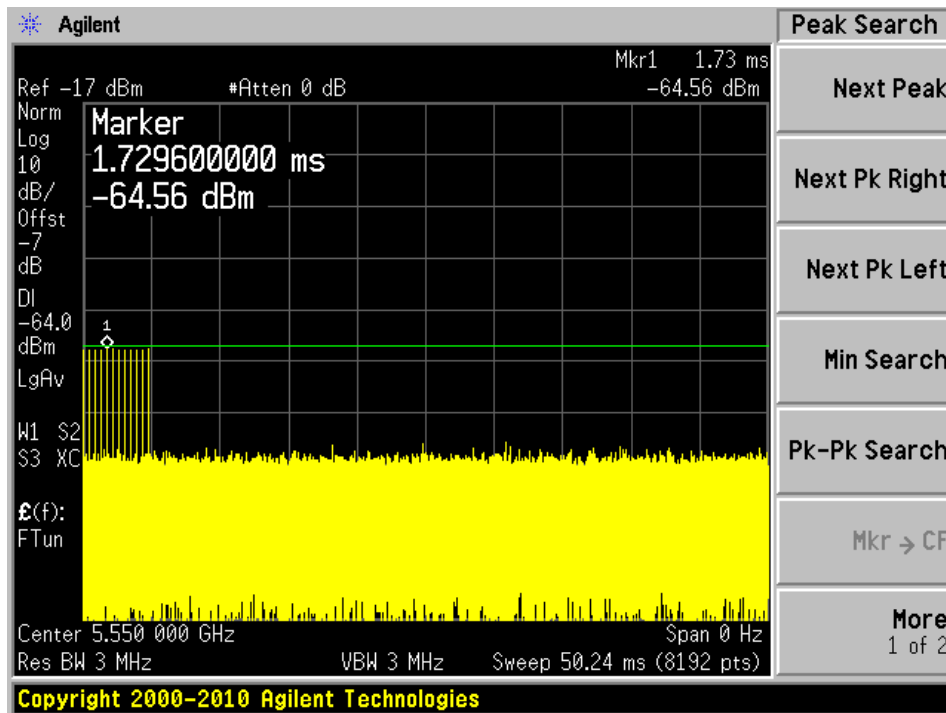

Radar Type 5

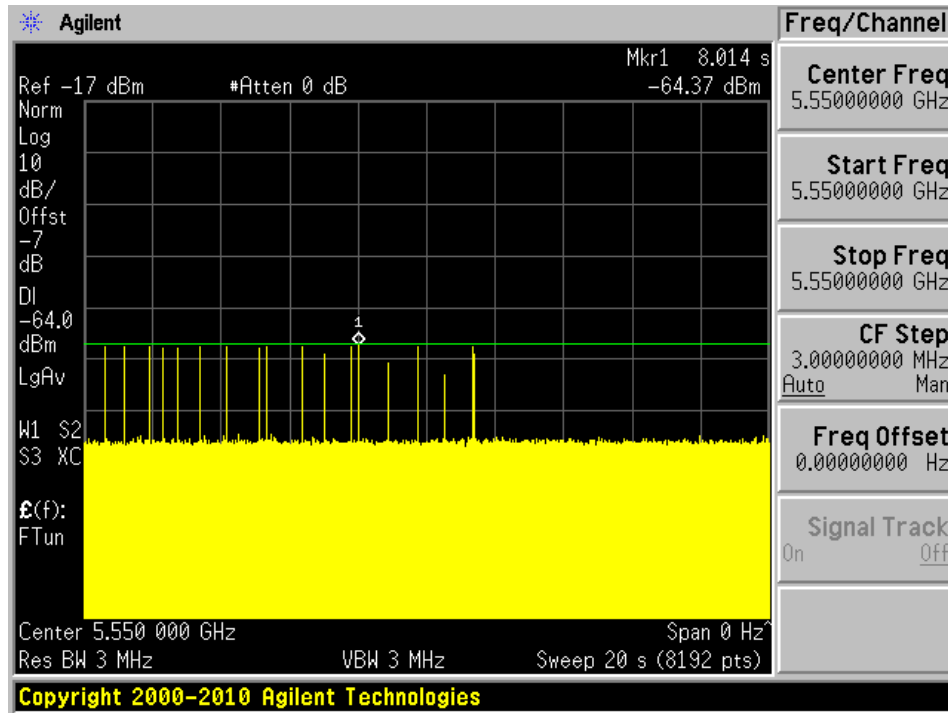

Radar Type 6

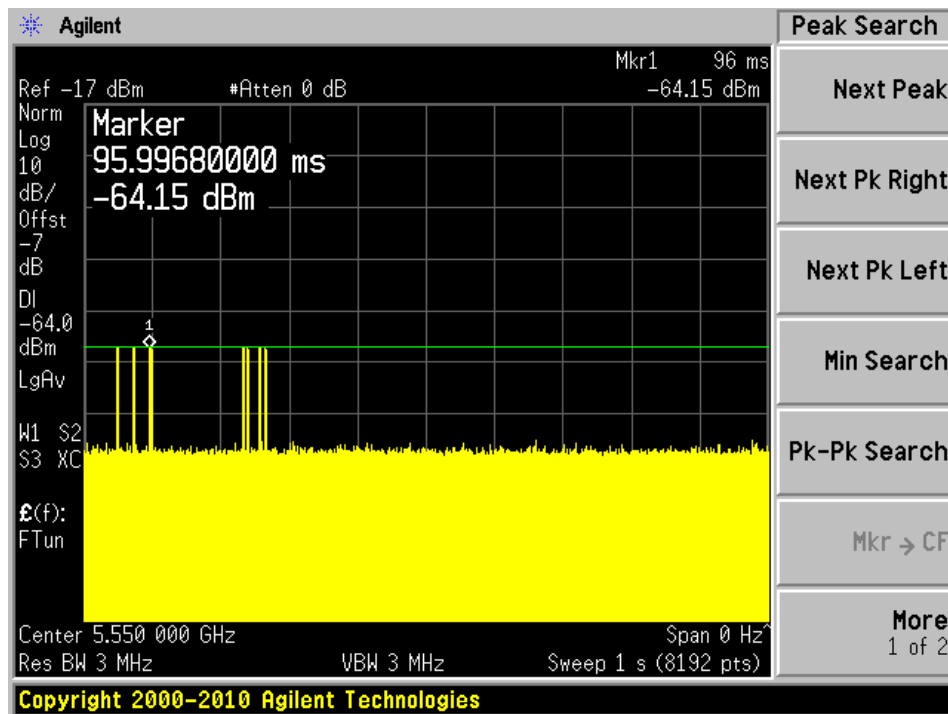

5290 MHz

Radar Type 0

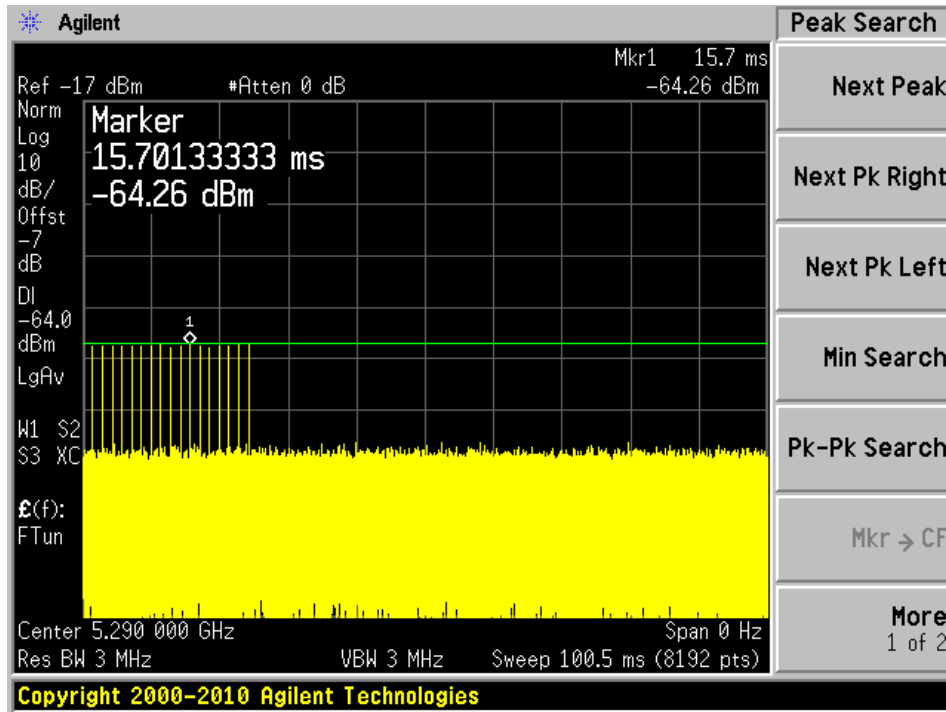

Radar Type 1A

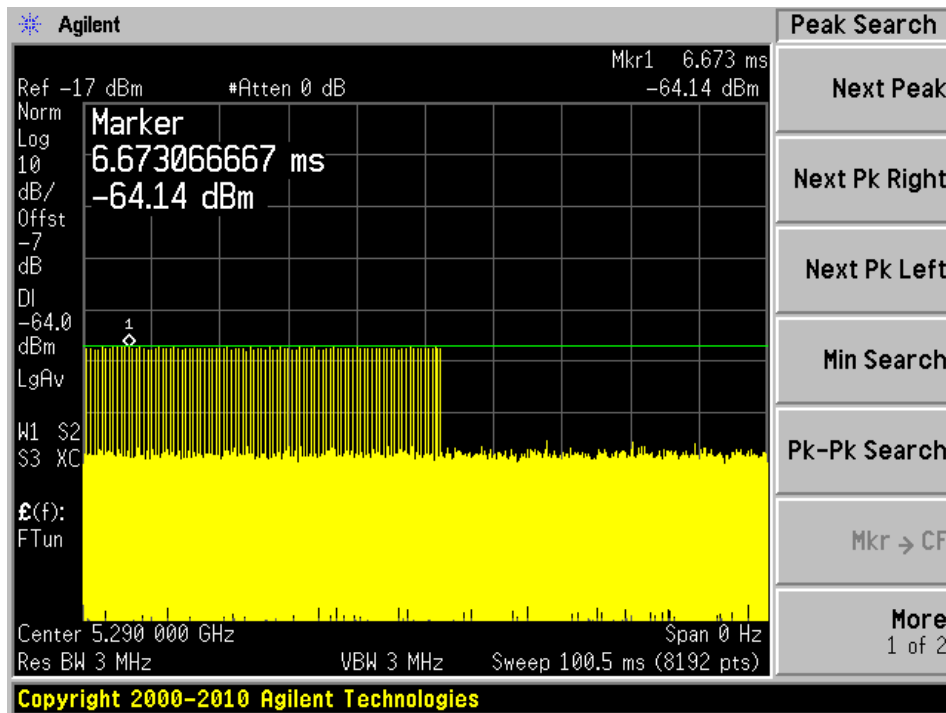

Radar Type 1B

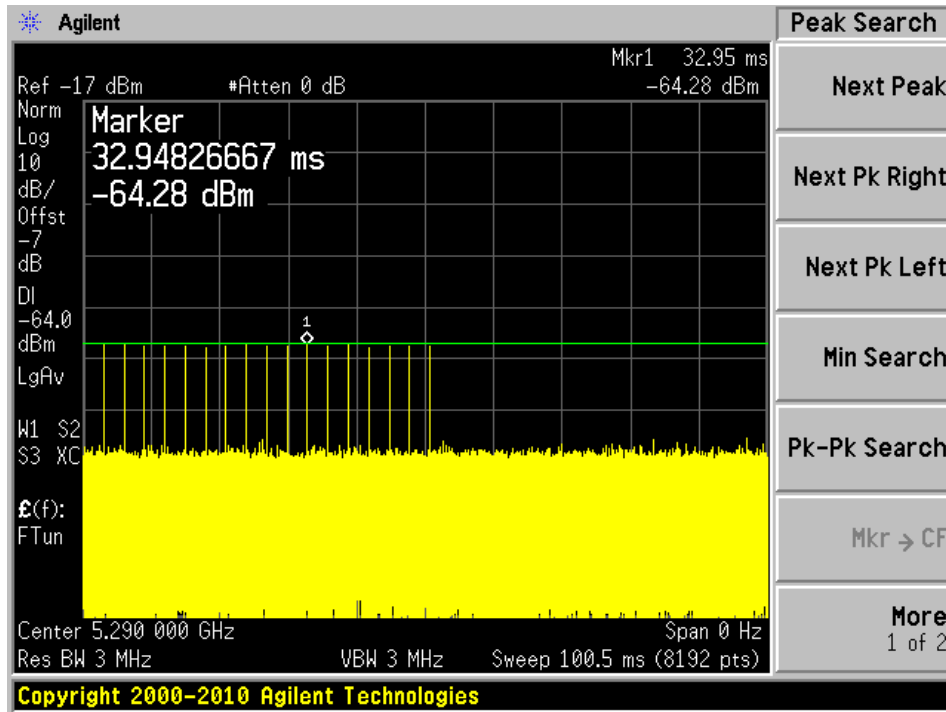

Radar Type 2

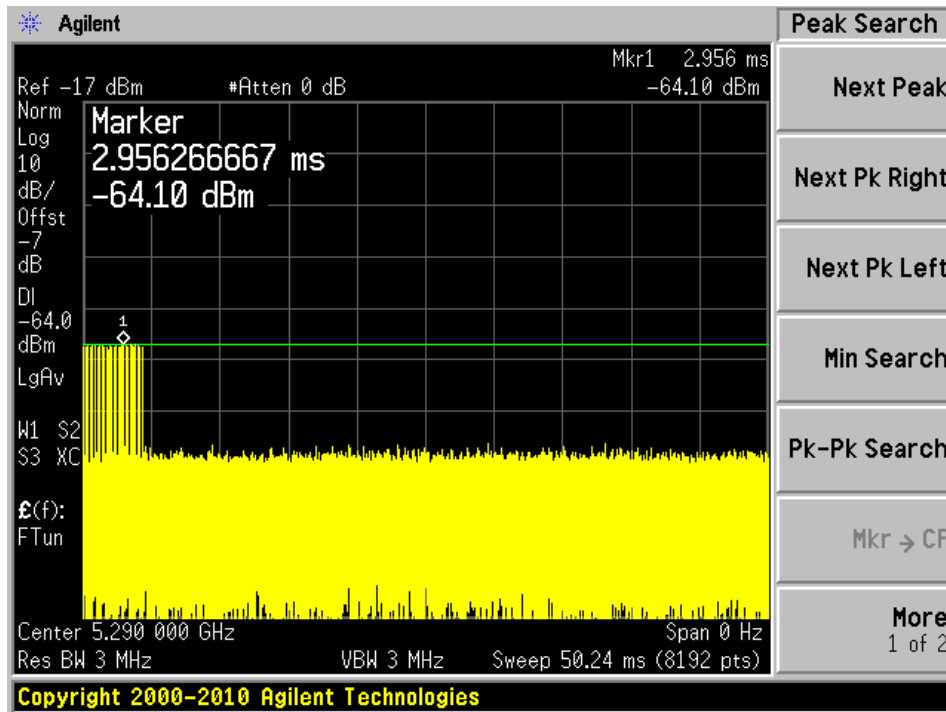

Radar Type 3

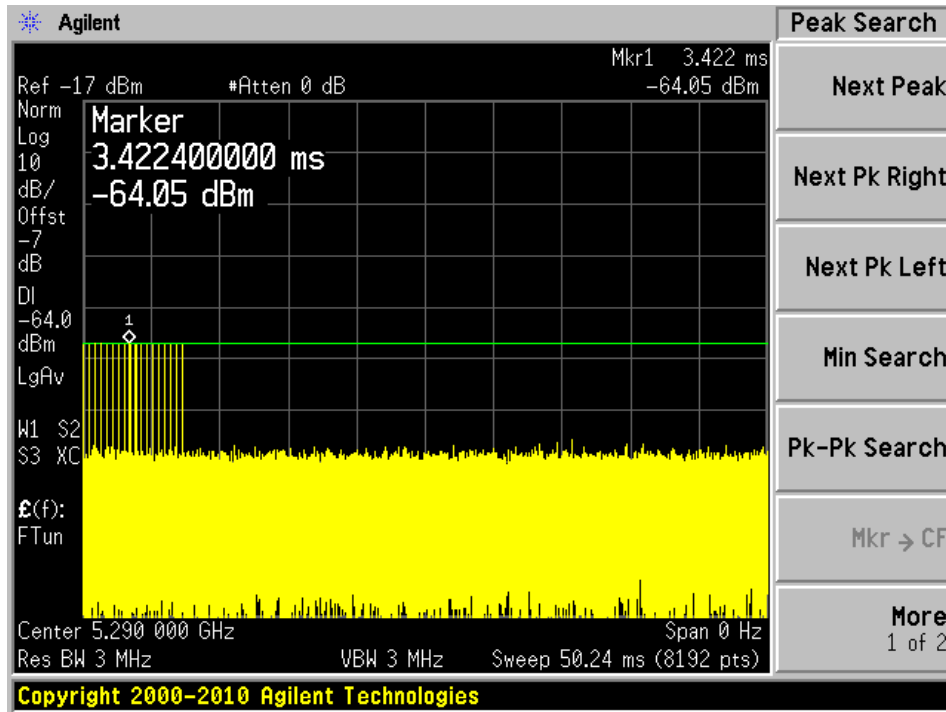

Radar Type 4

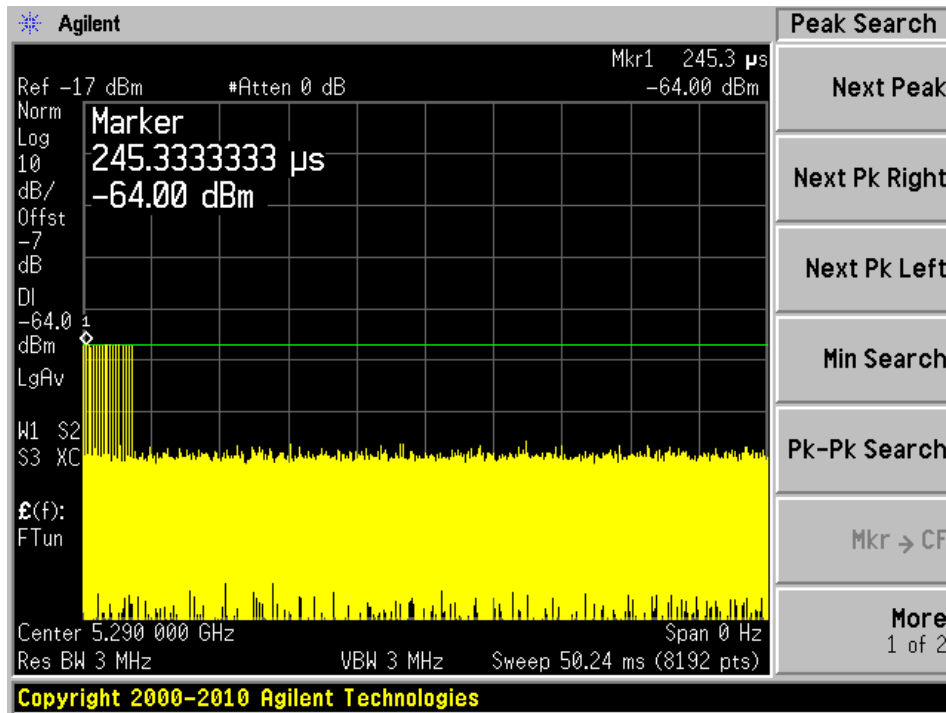

Radar Type 5

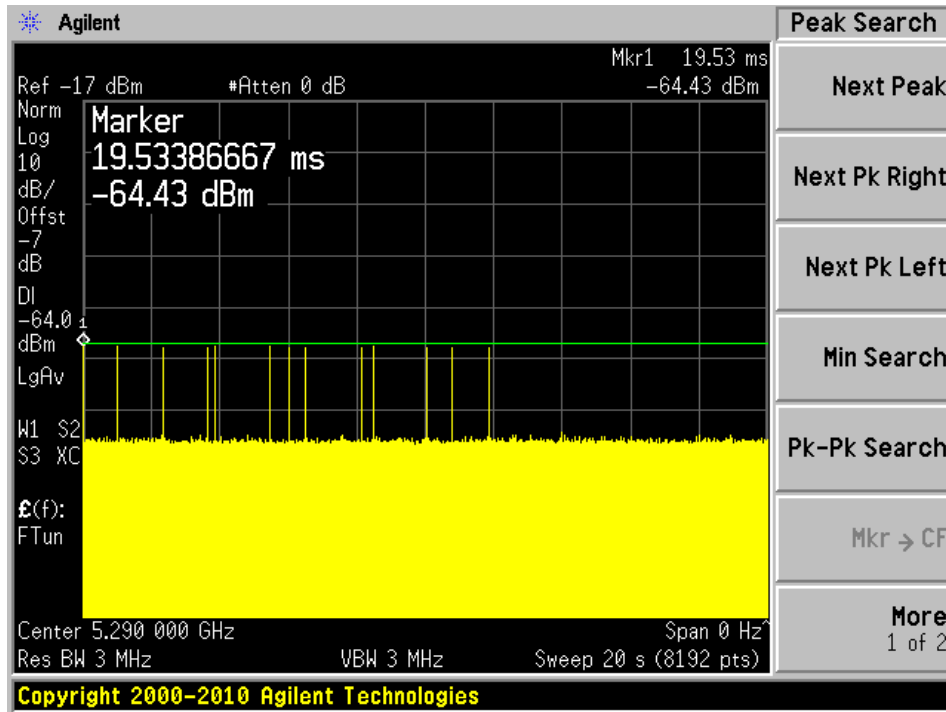

Radar Type 6

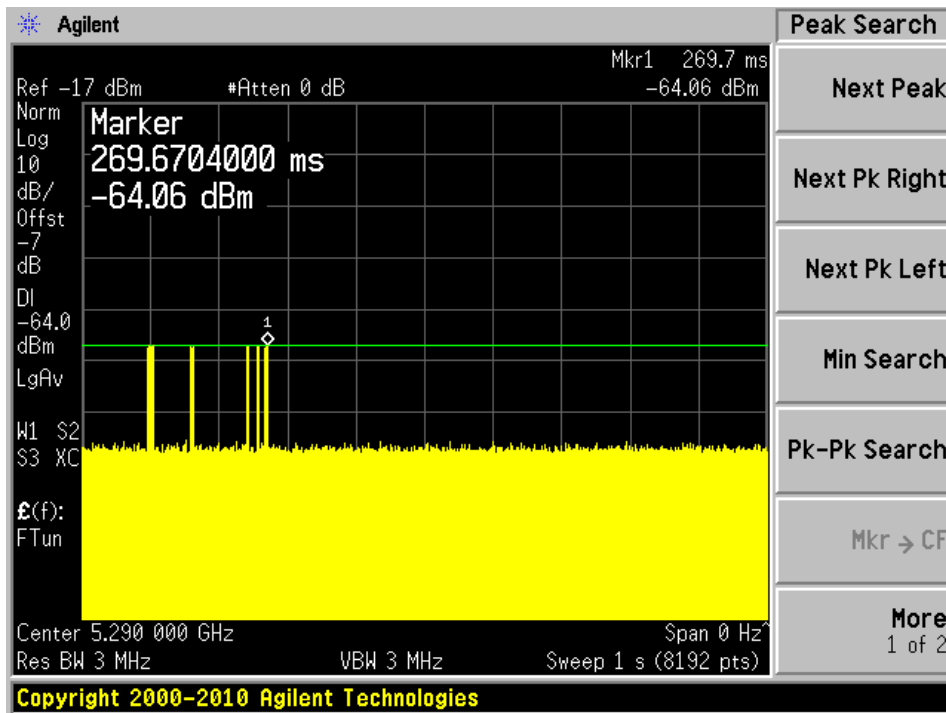

5530 MHz

Radar Type 0

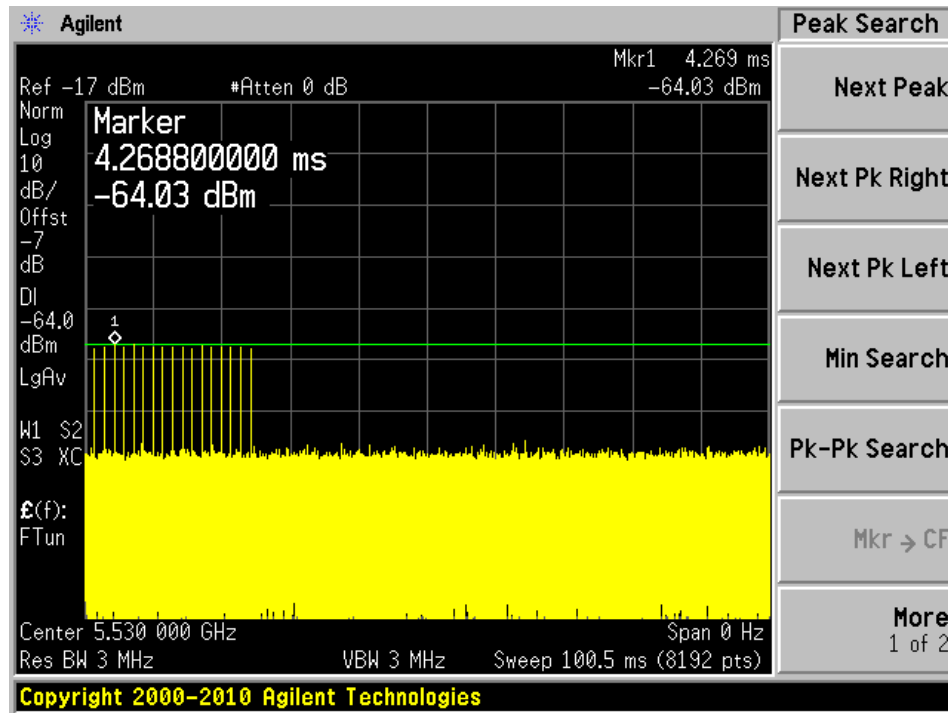

Radar Type 1A

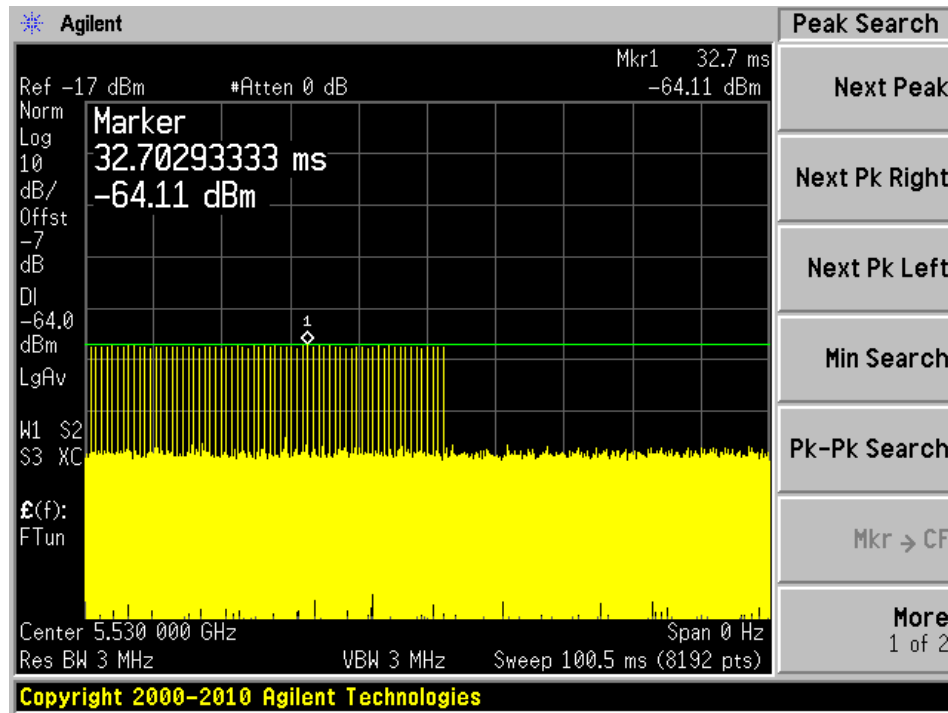

Radar Type 1B

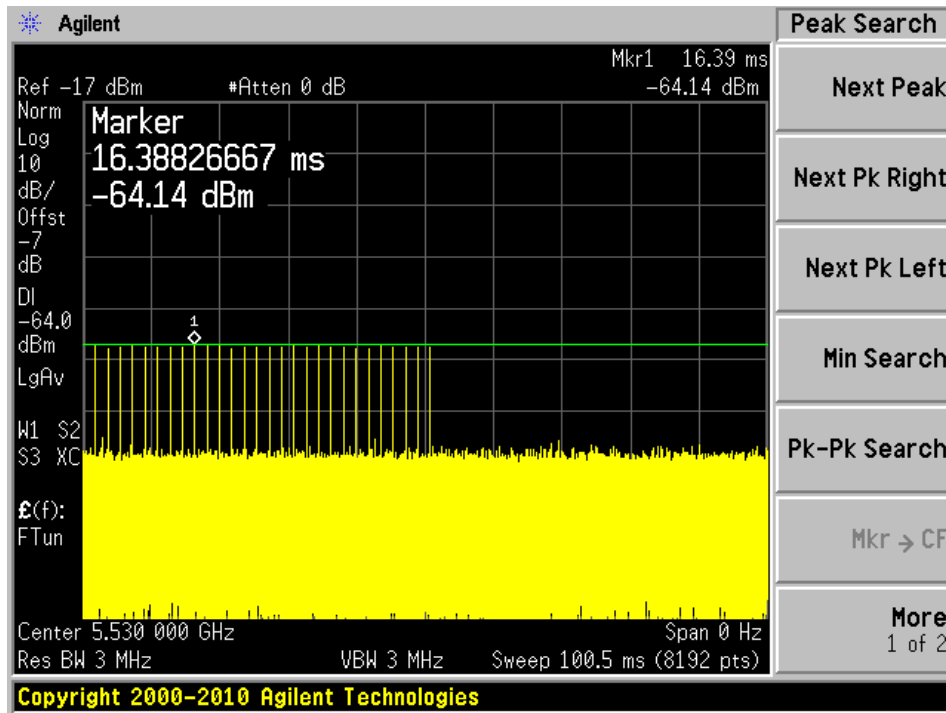

Radar Type 2

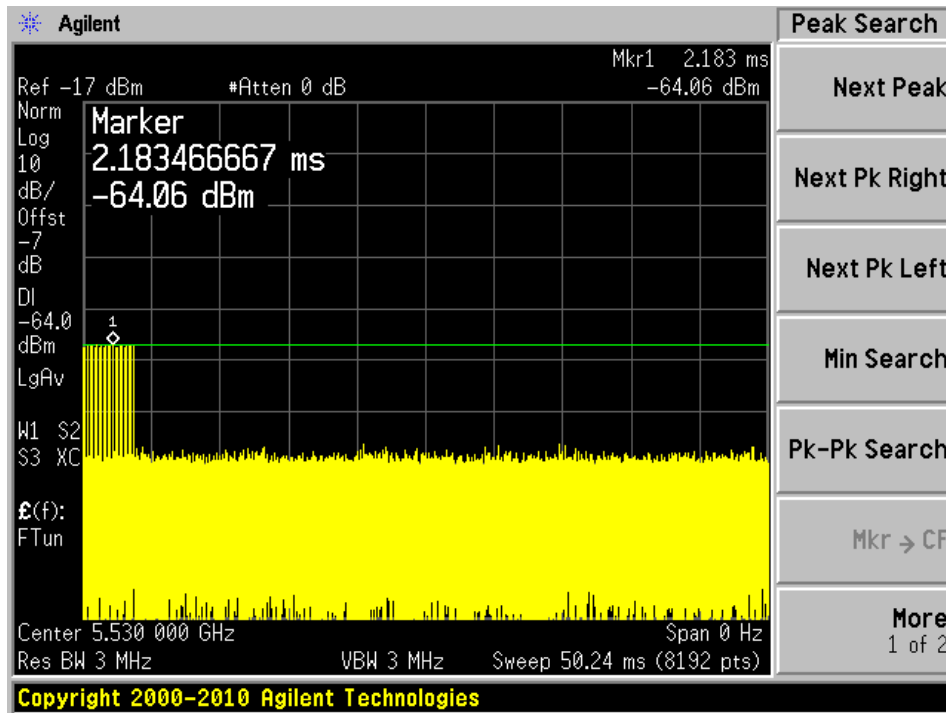

Radar Type 3

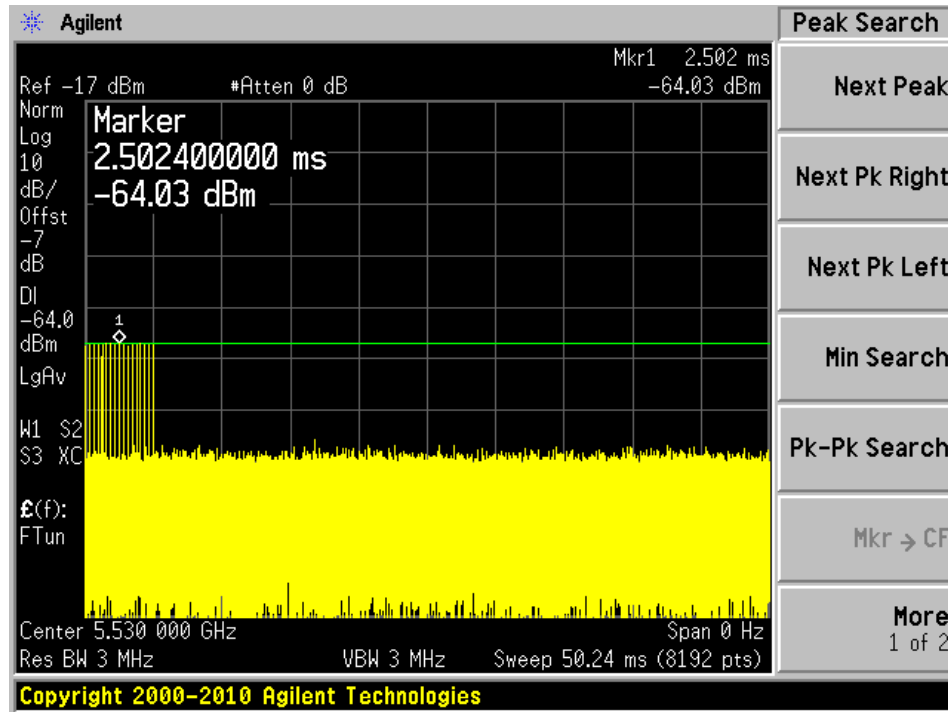

Radar Type 4

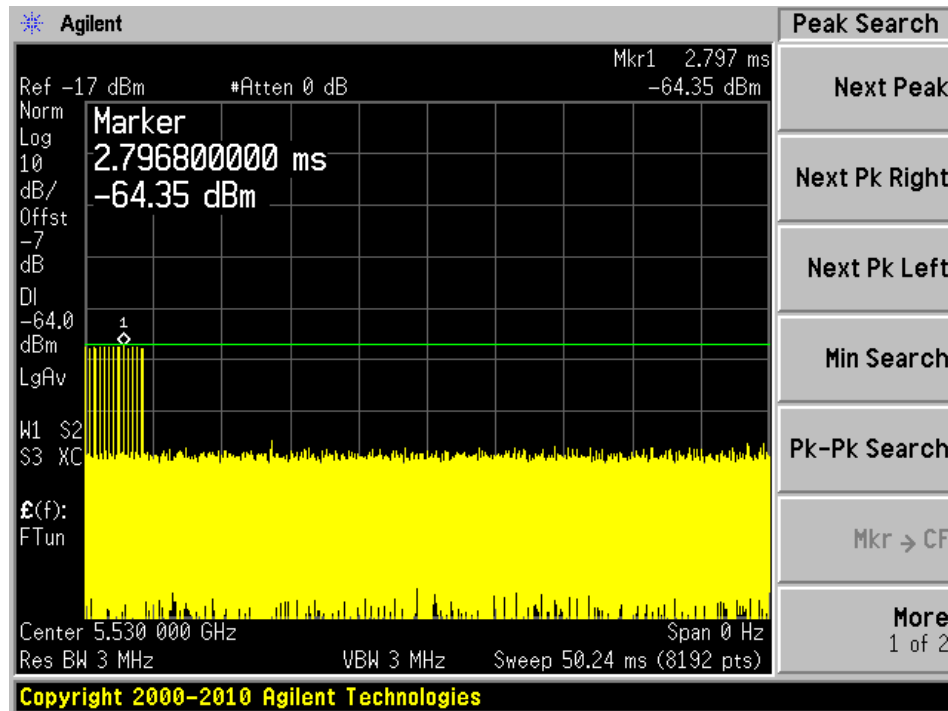

Radar Type 5

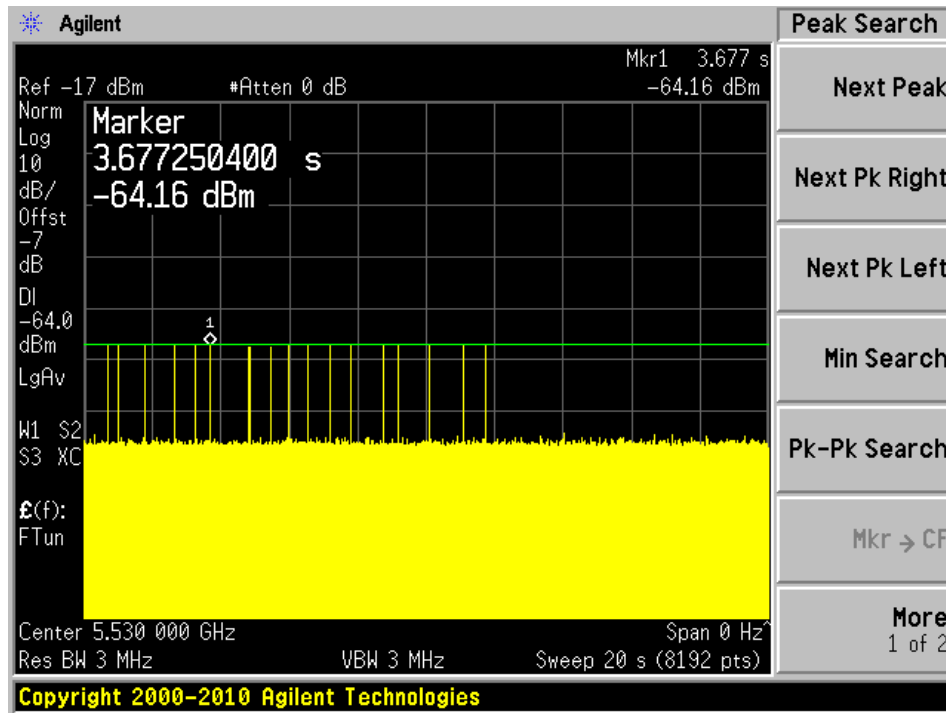

Radar Type 6

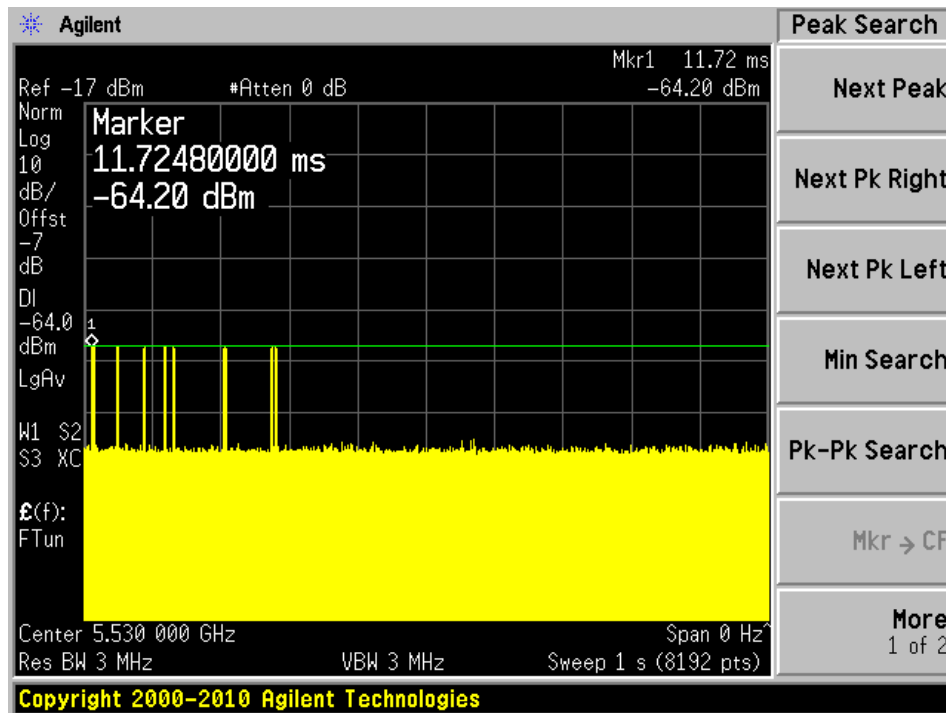

6 Channel Availability Check Time (CAC)

6.1 Test Procedure

- 1) Measure the initial power-up time of EUT.
- 2) With link established on channel, apply a radar signal within 0~6 seconds after the initial power-up period; monitor the transmissions on channel from the spectrum analyzer.
- 3) Reboot EUT, with a link established on channel, apply a radar signal within 54~60 seconds after the initial power-up period, and monitor the transmission on channel from the spectrum analyzer.

EUT Initial power-up Cycle Time

Note: EUT initial Power-up cycle is vary, this testing was performed with software monitor function that shows the start time of CAC, once the monitor shows the CAC start time, we used the stop watch to keep the accuracy of the testing.

Results:

Timing of Radar Burst	Spectrum Analyzer Display	Result
No Radar Triggered	Transmission begin after power-up cycle +62 seconds CAC	Pass
Within 6 seconds of the CAC starting	No transmission	Pass
Within the last 6 seconds of the CAC	No transmission	Pass

Note: The CAC test is with the Radar type 0.

5290 MHz

Plot of without Radar signal applied

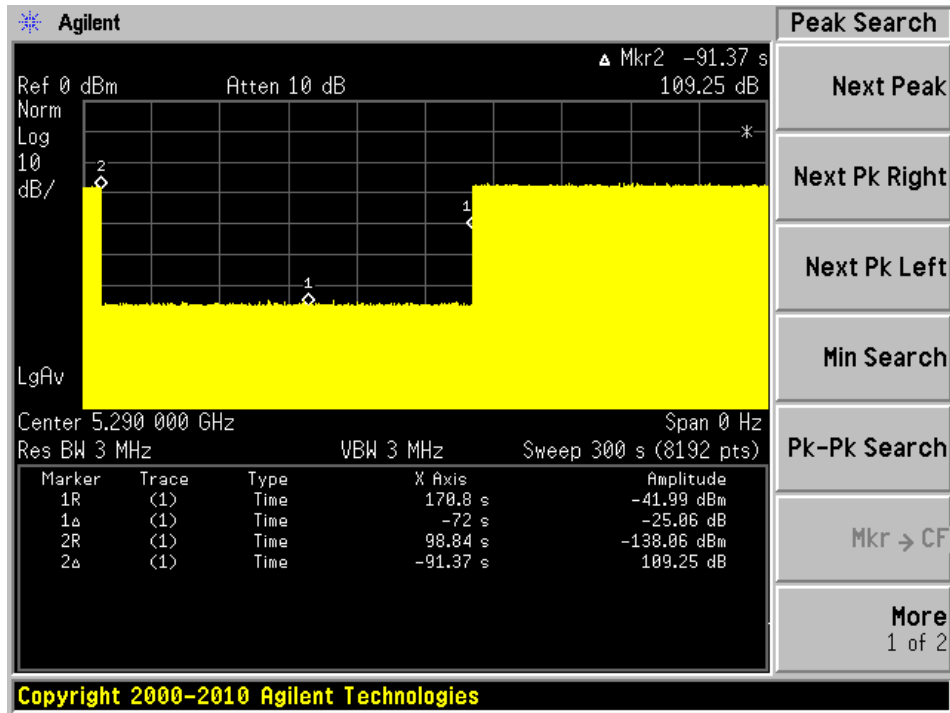

Plot of Radar signal applied within 6 seconds of start of CAC

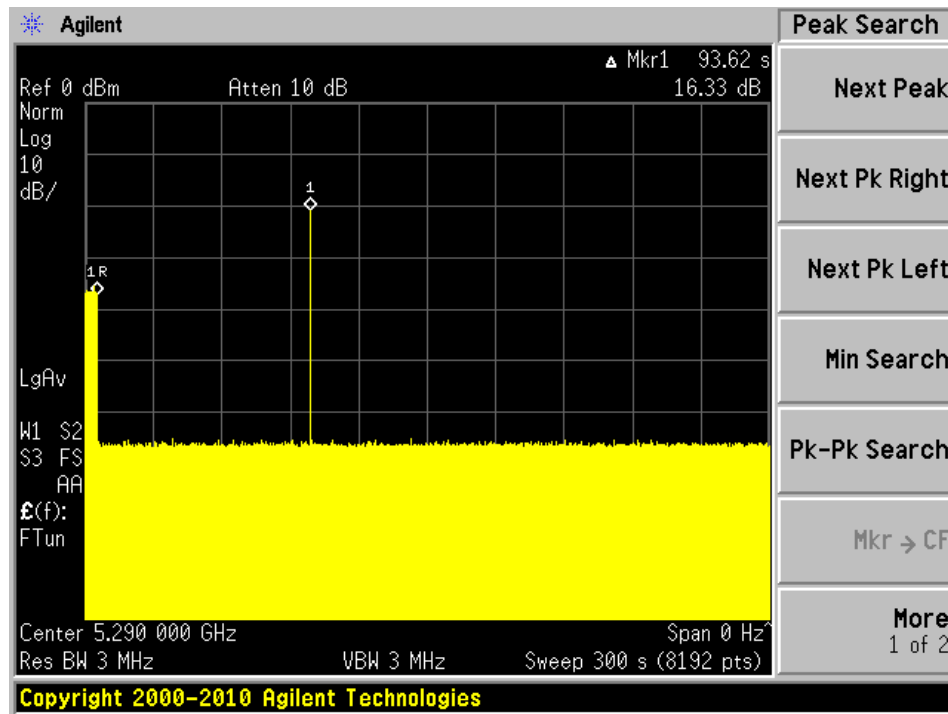

No transmissions found after radar signal applied.

Plot of Radar signal applied at the end of 6 seconds of CAC

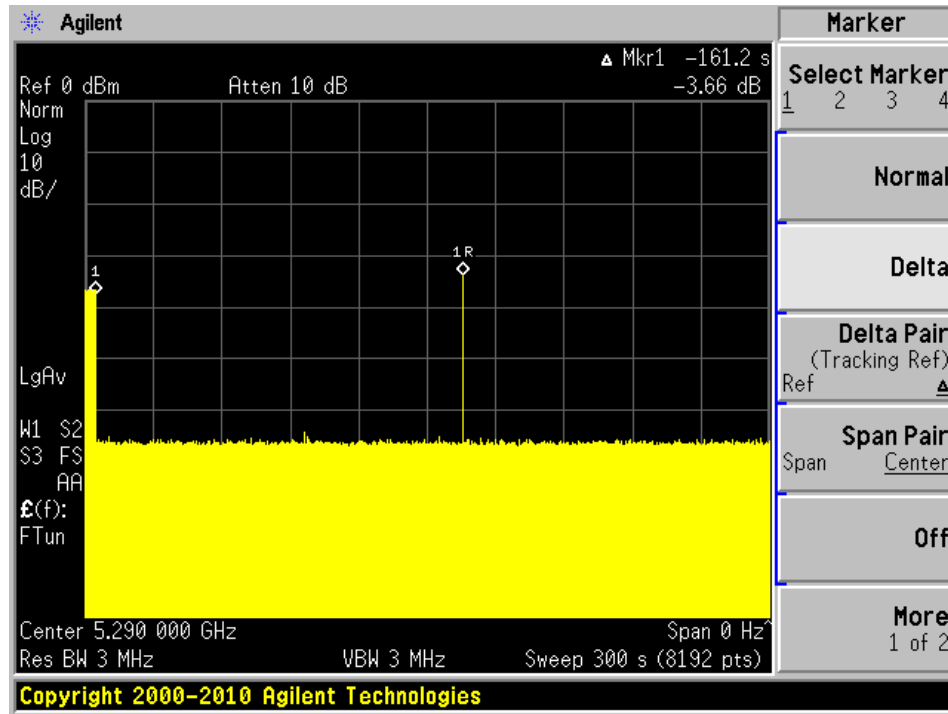

No transmissions found after radar signal applied.

5530 MHz

Plot of without Radar signal applied

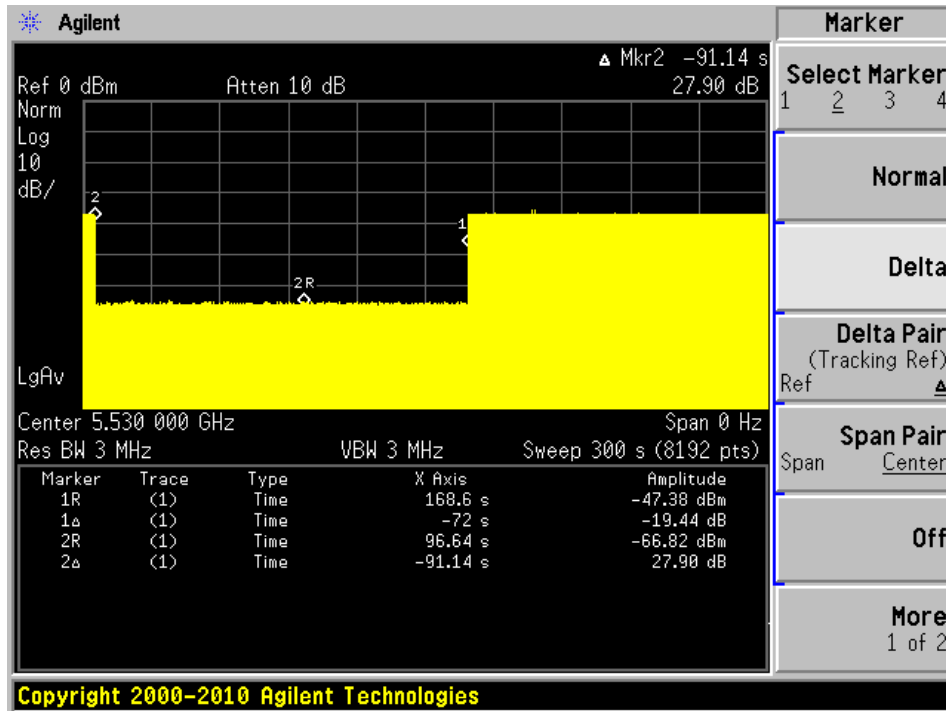

Plot of Radar signal applied within 6 seconds of start of CAC

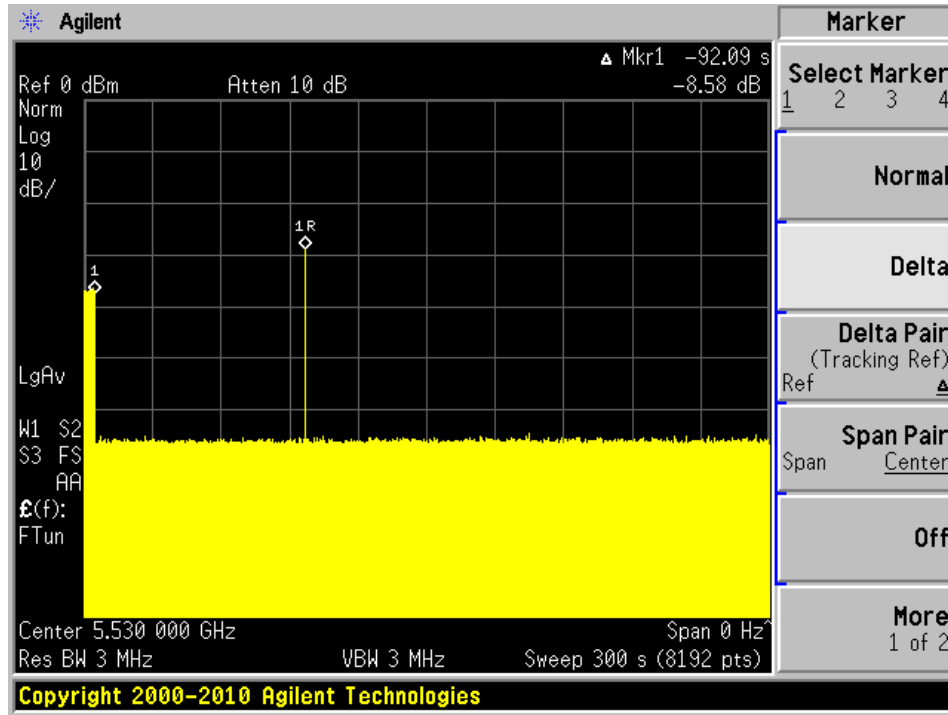

No transmissions found after radar signal applied.

Plot of Radar signal applied at the end of 6 seconds of CAC

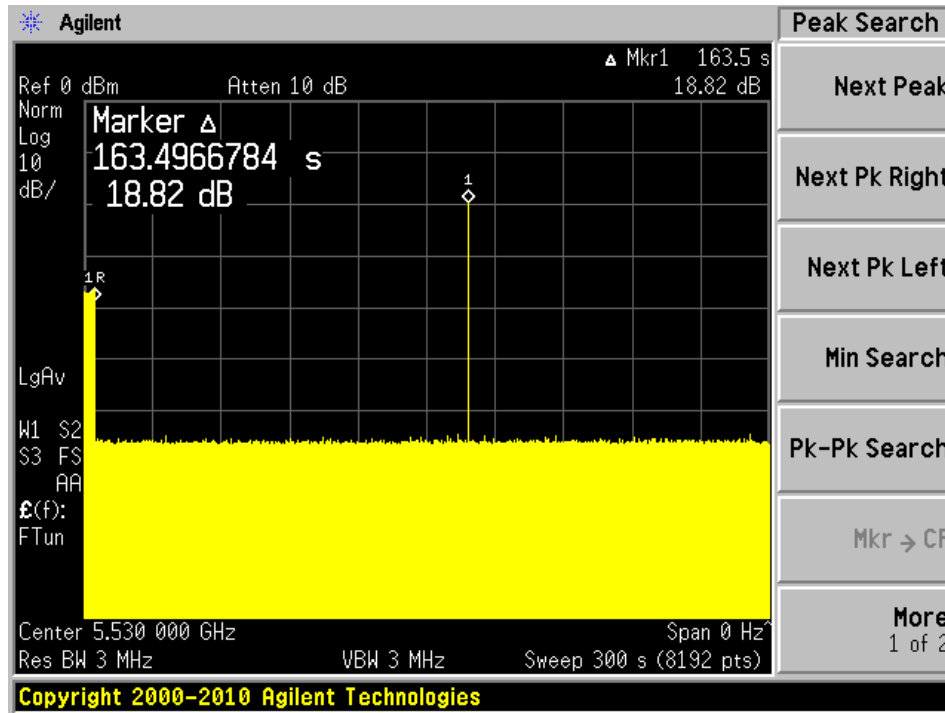

No transmissions found after radar signal applied.

7 Channel Move Time and Channel Closing Transmission Time

7.1 Test Procedure

BACL use type 0 radar signal to test the channel move time and channel closing transmission time.

The aggregate channel closing transmission time is calculated as follows:

Aggregate Transmission Time = N * Dwell Time

N is the number of spectrum analyzer bins showing a device transmission

Dwell Time is the dwell time per bin (i.e. Dwell Time = S/B, S is the sweep time and B is the number of bin, i.e. 8192)

7.2 Test Results

Frequency (MHz)	Bandwidth (MHz)	Radar Type	Results
5290	80	Type 0	Compliant
5530	80	Type 0	Compliant

Please refer to the following tables and plots.

5290 MHz, Bandwidth 80 MHz

Type 0 radar channel move time and channel closing transmission time result:

Channel closing transmitting time (ms)	Limit (ms)	Result
51.11 + 2.441	200+60	Pass

Channel move time (s)	Limit (s)	Result
< 10	10	Pass

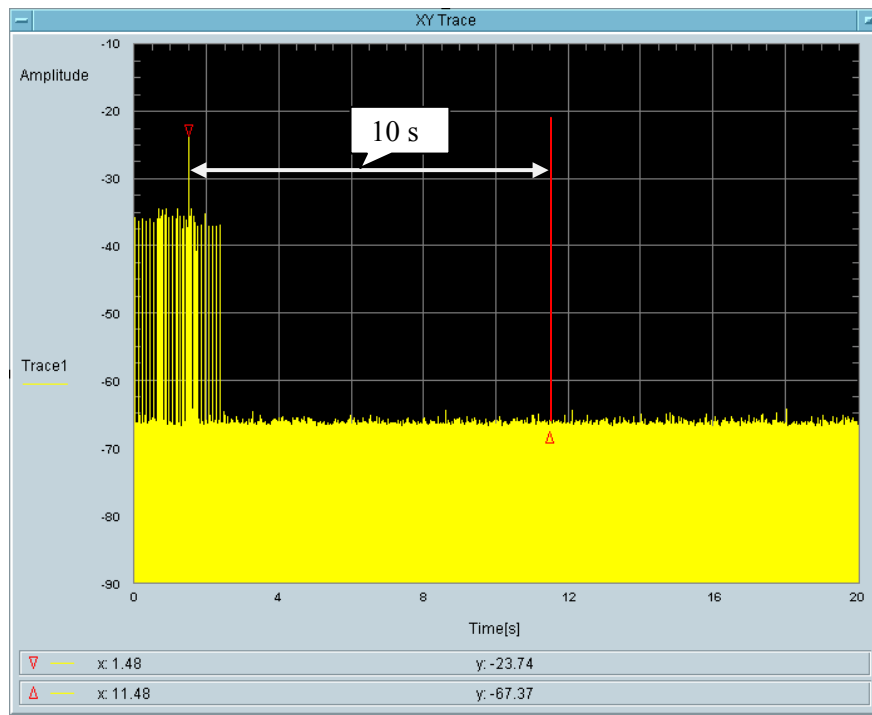

Total On Time [s]
51.11m

Total On Time After Delay [s]
2.441m

5530 MHz, Bandwidth 80 MHz

Type 0 radar channel move time and channel closing transmission time result:

Channel closing transmitting time (ms)	Limit (ms)	Result
22.62	200+60	Pass

Channel move time (s)	Limit (s)	Result
< 10	10	Pass

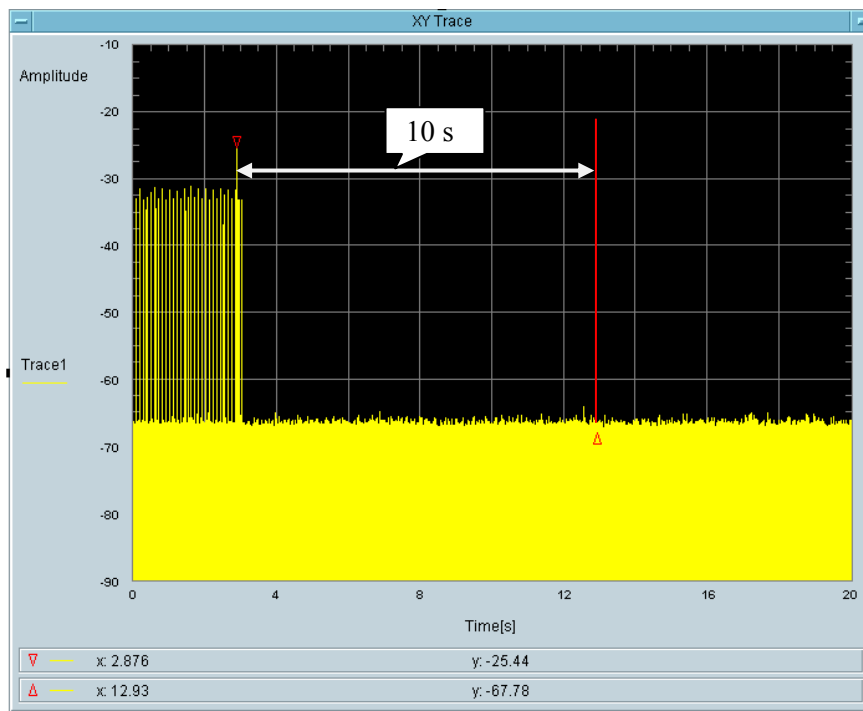

Total On Time [s]
22.62m

Total On Time After Delay [s]
0m

8 Non-Occupancy Period

8.1 Test Procedure

Measure the EUT for more than 30 minutes following the channel close/move time to verify that the EUT does not resume any transmissions on this channel. Provide one plot to demonstrate no transmission on the channel for the non-occupancy period (30 minutes observation time)

8.2 Test Results

Frequency (MHz)	Bandwidth (MHz)	Spectrum Analyzer Display
5290	80	No transmission within 30 minutes
5530	80	No transmission within 30 minutes

Please refer to the following plots.

5290 MHz, Bandwidth 80 MHz

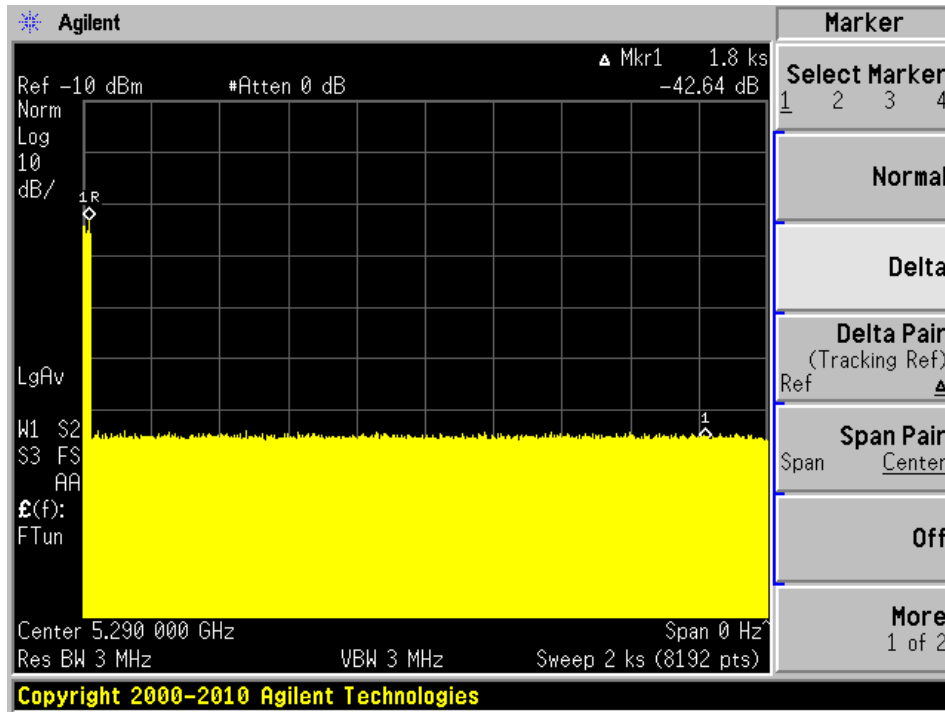

5530 MHz, Bandwidth 80 MHz

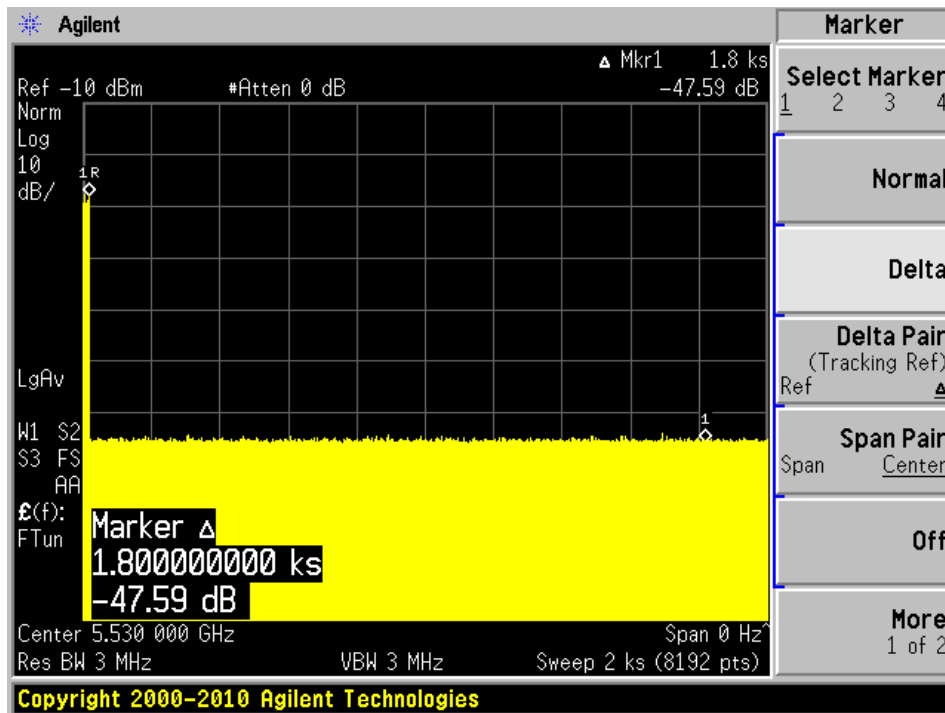

9 Radar Detection Bandwidth & Radar Detection Performance Check

9.1 Detection Bandwidth

Procedure:

Performed with any one of the short pulse radar waveforms type 0

Starting at the center frequency of the UUT operating Channel, increase the radar frequency in 5 MHz steps, repeating the above test sequence, until the detection rate falls below the U-NII Detection Bandwidth criterion specified in Table 4. Repeat this measurement in 1MHz steps at frequencies 5 MHz below where the detection rate begins to fall. Record the highest frequency (denote as FH) at which detection is greater than or equal to the U-NII Detection Bandwidth criterion. Recording the detection rate at frequencies above FH is not required to demonstrate compliance.

Starting at the center frequency of the UUT operating Channel, decrease the radar frequency in 5 MHz steps, repeating the above test sequence, until the detection rate falls below the U-NII Detection Bandwidth criterion specified in Table 4. Repeat this measurement in 1MHz steps at frequencies 5 MHz above where the detection rate begins to fall. Record the lowest frequency (denote as FL) at which detection is greater than or equal to the U-NII Detection Bandwidth criterion. Recording the detection rate at frequencies below FL is not required to demonstrate compliance.

The U-NII Detection Bandwidth is calculated as follows: U-NII Detection Bandwidth = FH – FL

Test Results

Frequency (MHz)	F _L (MHz)	F _H (MHz)	Detection Bandwidth (MHz)	Minimum Limit	Result
5270	5250	5290	40	100%	Compliance
5280	5270	5290	20	100%	Compliance
5290	5250	5330	80	100%	Compliance
5530	5490	5570	80	100%	Compliance
5540	5530	5550	20	100%	Compliance
5550	5530	5570	40	100%	Compliance

Please refer to the following tables.

Results of Detection Bandwidth:

EUT Frequency = 5280 MHz											
DFS Detection Trials (1 = Detected, 0 = No Detected)											
Radar Frequency (MHz)	1	2	3	4	5	6	7	8	9	10	Detection Rate (%)
5269	0	0	0	0	0	0	0	0	0	0	0 %
5270(F_L)	1	1	1	1	1	1	1	1	1	1	100 %
5275	1	1	1	1	1	1	1	1	1	1	100 %
5280(F _c)	1	1	1	1	1	1	1	1	1	1	100 %
5285	1	1	1	1	1	1	1	1	1	1	100 %
5290(F_H)	1	1	1	1	1	1	1	1	1	1	100 %
5291	0	0	0	0	0	0	0	0	0	0	0 %
Detection Bandwidth = F_H - F_L=5290-5270=20 MHz											
EUT 99% OBW = 17.16 MHz; 17.16 x 100% = 17.16 MHz Result: Pass											

EUT Frequency = 5540 MHz											
DFS Detection Trials (1 = Detected, 0 = No Detected)											
Radar Frequency (MHz)	1	2	3	4	5	6	7	8	9	10	Detection Rate (%)
5529	0	0	0	0	0	0	0	0	0	0	0 %
5530(F_L)	1	1	1	1	1	1	1	1	1	1	100 %
5535	1	1	1	1	1	1	1	1	1	1	100 %
5540(F _c)	1	1	1	1	1	1	1	1	1	1	100 %
5545	1	1	1	1	1	1	1	1	1	1	100 %
5550(F_H)	1	1	1	1	1	1	1	1	1	1	100 %
5551	0	0	0	0	0	0	0	0	0	0	0 %
Detection Bandwidth = F_H - F_L=5550-5530=20 MHz											
EUT 99% OBW = 17.16 MHz; 17.16 x 100% = 17.16 MHz Result: Pass											

Results of Detection Bandwidth:

EUT Frequency = 5270 MHz											
DFS Detection Trials (1 = Detected, 0 = No Detected)											
Radar Frequency (MHz)	1	2	3	4	5	6	7	8	9	10	Detection Rate (%)
5249	0	0	0	0	0	0	0	0	0	0	0 %
5250(F_L)	1	1	1	1	1	1	1	1	1	1	100 %
5255	1	1	1	1	1	1	1	1	1	1	100 %
5260	1	1	1	1	1	1	1	1	1	1	100 %
5265	1	1	1	1	1	1	1	1	1	1	100 %
5270(F _c)	1	1	1	1	1	1	1	1	1	1	100 %
5275	1	1	1	1	1	1	1	1	1	1	100 %
5280	1	1	1	1	1	1	1	1	1	1	100 %
5285	1	1	1	1	1	1	1	1	1	1	100 %
5290(F_H)	1	1	1	1	1	1	1	1	1	1	100 %
5291	0	0	0	0	0	0	0	0	0	0	0 %
Detection Bandwidth = F_H - F_L=5290-5250=40 MHz											
EUT 99% OBW = 37.08 MHz; 37.08 x 100% = 37.08 MHz						Result:		Pass			

EUT Frequency = 5550 MHz											
DFS Detection Trials (1 = Detected, 0 = No Detected)											
Radar Frequency (MHz)	1	2	3	4	5	6	7	8	9	10	Detection Rate (%)
5529	0	0	0	0	0	0	0	0	0	0	0 %
5530(F_L)	1	1	1	1	1	1	1	1	1	1	100 %
5535	1	1	1	1	1	1	1	1	1	1	100 %
5540	1	1	1	1	1	1	1	1	1	1	100 %
5545	1	1	1	1	1	1	1	1	1	1	100 %
5550(F _c)	1	1	1	1	1	1	1	1	1	1	100 %
5555	1	1	1	1	1	1	1	1	1	1	100 %
5560	1	1	1	1	1	1	1	1	1	1	100 %
5565	1	1	1	1	1	1	1	1	1	1	100 %
5570(F_H)	1	1	1	1	1	1	1	1	1	1	100 %
5571	0	0	0	0	0	0	0	0	0	0	0 %
Detection Bandwidth = F_H - F_L=5570-5530=40 MHz											
EUT 99% OBW = 37.08 MHz; 37.08 x 100% = 37.08 MHz						Result:		Pass			

Results of Detection Bandwidth:

EUT Frequency = 5290 MHz											
DFS Detection Trials (1 = Detected, 0 = No Detected)											
Radar Frequency (MHz)	1	2	3	4	5	6	7	8	9	10	Detection Rate (%)
5249	0	0	0	0	0	0	0	0	0	0	0 %
5250(F_L)	1	1	1	1	1	1	1	1	1	1	100 %
5255	1	1	1	1	1	1	1	1	1	1	100 %
5260	1	1	1	1	1	1	1	1	1	1	100 %
5265	1	1	1	1	1	1	1	1	1	1	100 %
5270	1	1	1	1	1	1	1	1	1	1	100 %
5275	1	1	1	1	1	1	1	1	1	1	100 %
5280	1	1	1	1	1	1	1	1	1	1	100 %
5285	1	1	1	1	1	1	1	1	1	1	100 %
5290(F _c)	1	1	1	1	1	1	1	1	1	1	100 %
5295	1	1	1	1	1	1	1	1	1	1	100 %
5300	1	1	1	1	1	1	1	1	1	1	100 %
5305	1	1	1	1	1	1	1	1	1	1	100 %
5310	1	1	1	1	1	1	1	1	1	1	100 %
5315	1	1	1	1	1	1	1	1	1	1	100 %
5320	1	1	1	1	1	1	1	1	1	1	100 %
5325	1	1	1	1	1	1	1	1	1	1	100 %
5330(F_H)	1	1	1	1	1	1	1	1	1	1	100 %
5291	0	0	0	0	0	0	0	0	0	0	0 %
Detection Bandwidth = F_H - F_L = 5330 - 5250 = 80 MHz											
EUT 99% OBW = 76.08 MHz; 76.08 x 100% = 76.08 MHz Result: Pass											

EUT Frequency = 5530 MHz											
DFS Detection Trials (1 = Detected, 0 = No Detected)											
Radar Frequency (MHz)	1	2	3	4	5	6	7	8	9	10	Detection Rate (%)
5489	0	0	0	0	0	0	0	0	0	0	0 %
5490(F_L)	1	1	1	1	1	1	1	1	1	1	100 %
5495	1	1	1	1	1	1	1	1	1	1	100 %
5500	1	1	1	1	1	1	1	1	1	1	100 %
5505	1	1	1	1	1	1	1	1	1	1	100 %
5510	1	1	1	1	1	1	1	1	1	1	100 %
5515	1	1	1	1	1	1	1	1	1	1	100 %
5520	1	1	1	1	1	1	1	1	1	1	100 %
5525	1	1	1	1	1	1	1	1	1	1	100 %
5530(F _c)	1	1	1	1	1	1	1	1	1	1	100 %
5535	1	1	1	1	1	1	1	1	1	1	100 %
5540	1	1	1	1	1	1	1	1	1	1	100 %
5545	1	1	1	1	1	1	1	1	1	1	100 %
5550	1	1	1	1	1	1	1	1	1	1	100 %
5555	1	1	1	1	1	1	1	1	1	1	100 %
5560	1	1	1	1	1	1	1	1	1	1	100 %
5565	1	1	1	1	1	1	1	1	1	1	100 %
5570(F_H)	1	1	1	1	1	1	1	1	1	1	100 %
5571	0	0	0	0	0	0	0	0	0	0	0 %
Detection Bandwidth = F_H – F_L=5570-5490=80 MHz											
EUT 99% OBW = 76.08 MHz; 76.08 x 100% = 76.08 MHz Result: Pass											

9.2 Radar Detection Performance Check

Procedure:

Stream MPEG file from master to slave

Generate radar waveform

Record whether or not the waveform was detected

At least 30 trials are applied for each radar type

For radar types with randomized parameters, each trial uses a unique waveform

Perform with each of the radar types 1-6

Confirm that the detection rate for each radar type meets the minimum requirement

Type 1A&1B, 2, 3, 4: 60% each

Type 5: 80%

Type 6: 70%

Confirm that the mean of the rates for radar types 1 through 4 meets the requirement of 80%

$$\text{Detection Ratio} = \frac{\text{Total Waveform Detections}}{\text{Total Waveform Trials}} \times 100$$

Test Results:

5280 MHz, 20 MHz Bandwidth

Radar Signal Type	Waveform/Trial Number	Detection (%)	Limit (%)	Pass/Fail
Type 1A/1B	30	100 %	60%	Pass
Type 2	30	100 %	60%	Pass
Type 3	30	100 %	60%	Pass
Type 4	30	100 %	60%	Pass
Aggregate (Type1 to 4)	120	100 %	80%	Pass
Type 5	30	96.7 %	80%	Pass
Type 6	30	100 %	70%	Pass

Please refer to the following statistical tables:

5280 MHz, 20 MHz Bandwidth

Table-1A/1B Radar Type 1A/1B Statistical Performance

Trial #	Fc (MHz)	Pulse/Burst	Pulse Width (µS)	PRI (µs)	Detection (1:yes; 0:no)
1	5280	67	1	798	1
2	5280	57	1	938	1
3	5280	61	1	878	1
4	5280	68	1	778	1
5	5280	70	1	758	1
6	5280	70	1	758	1
7	5280	58	1	918	1
8	5280	74	1	718	1
9	5280	78	1	678	1
10	5280	89	1	598	1
11	5280	76	1	698	1
12	5280	65	1	818	1
13	5280	18	1	3066	1
14	5280	95	1	558	1
15	5280	92	1	578	1
16	5280	26	1	2071	1
17	5280	38	1	1390	1
18	5280	30	1	1769	1
19	5280	20	1	2712	1
20	5280	25	1	2153	1
21	5280	21	1	2523	1
22	5280	41	1	1304	1
23	5280	32	1	1666	1
24	5280	19	1	2797	1
25	5280	43	1	1247	1
26	5280	75	1	712	1
27	5280	69	1	766	1
28	5280	20	1	2766	1
29	5280	19	1	2817	1
30	5280	60	1	880	1
Detection Percentage: 100 % (>60%)					

Table-2 Radar Type 2 Statistical Performance

Trial #	Fc (MHz)	Pulse/Burst	Pulse Width (μS)	PRI (μs)	Detection (1:yes; 0:no)
1	5280	26	4.1	214	1
2	5280	24	1.9	227	1
3	5280	26	3.9	204	1
4	5280	29	4.8	197	1
5	5280	25	4.4	206	1
6	5280	24	1.8	166	1
7	5280	23	2.2	165	1
8	5280	27	3.4	204	1
9	5280	26	1.4	173	1
10	5280	28	2.5	168	1
11	5280	27	2.3	213	1
12	5280	28	5	215	1
13	5280	29	1	196	1
14	5280	24	3.7	180	1
15	5280	25	3	168	1
16	5280	28	2.4	164	1
17	5280	28	1.6	185	1
18	5280	23	4.5	164	1
19	5280	24	3.1	210	1
20	5280	29	5	153	1
21	5280	26	2.1	226	1
22	5280	27	4.7	222	1
23	5280	28	3.5	223	1
24	5280	25	2.6	227	1
25	5280	28	4.7	155	1
26	5280	23	2.9	158	1
27	5280	29	4.3	211	1
28	5280	25	3.3	200	1
29	5280	23	2	164	1
30	5280	27	4.1	187	1
Detection Percentage: 100 % (>60%)					

Table-3 Radar Type 3 Statistical Performance

Trial #	Fc (MHz)	Pulse/Burst	Pulse Width (μS)	PRI (μs)	Detection (1:yes; 0:no)
1	5280	17	6.3	490	1
2	5280	18	6.5	381	1
3	5280	16	9.6	273	1
4	5280	17	9.7	356	1
5	5280	18	7.2	399	1
6	5280	18	6.8	380	1
7	5280	18	9.1	406	1
8	5280	16	7.1	303	1
9	5280	17	9.3	463	1
10	5280	17	9.3	367	1
11	5280	18	7.6	204	1
12	5280	16	6.8	382	1
13	5280	17	9.2	363	1
14	5280	17	8	487	1
15	5280	17	9.8	486	1
16	5280	17	9.1	392	1
17	5280	16	7.8	327	1
18	5280	17	6.9	336	1
19	5280	18	8.7	473	1
20	5280	17	8.9	455	1
21	5280	16	9.8	436	1
22	5280	16	8.3	364	1
23	5280	16	8.9	356	1
24	5280	16	8.8	215	1
25	5280	17	8.2	409	1
26	5280	17	9.7	330	1
27	5280	18	9.7	486	1
28	5280	18	7.9	367	1
29	5280	18	9.9	456	1
30	5280	17	7.1	457	1
Detection Percentage: 100 % (>60%)					

Table-4 Radar Type 4 Statistical Performance

Trial #	Fc (MHz)	Pulse/Burst	Pulse Width (µS)	PRI (µs)	Detection (1:yes; 0:no)
1	5280	15	18.9	436	1
2	5280	15	16	464	1
3	5280	12	17.1	405	1
4	5280	16	16	258	1
5	5280	16	12.2	357	1
6	5280	15	19.2	459	1
7	5280	14	16.1	448	1
8	5280	12	17.9	213	1
9	5280	15	14.8	333	1
10	5280	16	14.7	291	1
11	5280	12	11.7	427	1
12	5280	15	13.9	257	1
13	5280	13	14.3	360	1
14	5280	13	18.1	231	1
15	5280	14	14	304	1
16	5280	13	18.3	484	1
17	5280	12	13.8	398	1
18	5280	13	11.3	381	1
19	5280	16	12.6	274	1
20	5280	13	13	433	1
21	5280	13	18	480	1
22	5280	12	18.4	421	1
23	5280	16	18.1	254	1
24	5280	15	17.9	463	1
25	5280	13	14.4	394	1
26	5280	14	12.8	233	1
27	5280	14	19.7	211	1
28	5280	15	18.9	361	1
29	5280	13	19.3	340	1
30	5280	12	16.3	457	1
Detection Percentage: 100% (>60%)					

Table-5 Radar Type 5 Statistical Performance

Trial #	Fc (MHz)	Detection (1:yes; 0:no)
1	5280	1
2	5280	1
3	5280	1
4	5280	1
5	5280	1
6	5280	1
7	5280	1
8	5280	1
9	5280	0
10	5280	1
11	5274.7	1
12	5275.1	1
13	5277.1	1
14	5278.7	1
15	5277.9	1
16	5275.9	1
17	5273.9	1
18	5278.7	1
19	5277.9	1
20	5278.7	1
21	5281.7	1
22	5285.3	1
23	5281.7	1
24	5283.7	1
25	5285.7	1
26	5282.5	1
27	5280.5	1
28	5281.3	1
29	5286.1	1
30	5284.9	1
Detection Percentage: 96.7 % (>80%)		

Bin5 Statistics 1

Trial #	Pulse	Chirp (MHz)	Pulse Width (µS)	Pulse 1-2 spacing (µS)	Pulse 2-3 spacing (µS)	Pulse Start(S)	Detection (1:yes; 0:no)
0	3	8	77.7	1492	1008	0.662277	1
1	1	8	81.6			1.393666	
2	2	8	59.4	1061		2.500482	
3	2	8	60	1472		3.095555	
4	2	8	68.6	1985		4.138225	
5	2	8	87.2	1653		5.085999	
6	1	8	55.9			5.167637	
7	2	8	60	1472		6.436102	
8	2	8	81.1	1419		6.905152	
9	3	8	80.8	1642	1639	7.823944	
10	2	8	93.1	1952		8.753985	
11	2	8	74.5	1197		9.903537	
12	3	8	95	1122	1682	10.906372	
13	1	8	72.7			11.712938	

Bin5 Statistics 2

Trial #	Pulse	Chirp (MHz)	Pulse Width (µS)	Pulse 1-2 spacing (uS)	Pulse 2-3 spacing (uS)	Pulse Start(S)	Detection (1:yes; 0:no)
0	2	6	85.3	1072		0.522352	1
1	2	6	65.3	1566		0.962938	
2	2	6	83	1765		1.700614	
3	1	6	99.7			2.442505	
4	3	6	52.9	1487		3.299782	
5	3	6	70.4	1608	1161	3.698703	
6	2	6	89.7	1282		4.183542	
7	3	6	87.2	1649	1823	5.003903	
8	2	6	74.8	1326		5.558222	
9	1	6	70.7			6.598896	
10	2	6	50.9	1938		7.122723	
11	2	6	87.3	1307		7.985704	
12	2	6	96.5	1203		8.659186	
13	2	6	81.9	1692		8.816359	
14	2	6	88.6	1362		9.854563	
15	2	6	94.1	1644		10.550452	
16	3	6	72.5	1774	1581	11.269132	
17	2	6	61.5	1928		11.489404	

Bin5 Statistics 3

Trial #	Pulse	Chirp (MHz)	Pulse Width (µS)	Pulse 1-2 spacing (uS)	Pulse 2-3 spacing (uS)	Pulse Start(S)	Detection (1:yes; 0:no)
0	1	13	79.6			0.332996	1
1	2	13	92.1	1805		1.722235	
2	1	13	72.5			2.432978	
3	2	13	94.9	1243		3.088885	
4	2	13	55.1	1400		3.873049	
5	3	13	62.8	1458	1787	4.949171	
6	3	13	81	1406	1396	6.046567	
7	3	13	58.9	1634	1420	6.834819	
8	3	13	96.3	1629	1135	7.469973	
9	3	13	89.1	1619	1635	8.697142	
10	3	13	72.7	1439	1800	9.77757	
11	2	13	68.1	1150		10.738	
12	3	13	52	1090	1668	11.19532	

Bin5 Statistics 4

Trial #	Pulse	Chirp (MHz)	Pulse Width (µS)	Pulse 1-2 spacing (µS)	Pulse 2-3 spacing (µS)	Pulse Start(S)	Detection (1:yes; 0:no)
0	1	10	94.1			0.455882	1
1	1	10	98.9			1.407364	
2	2	10	67.2	1851		1.847098	
3	2	10	50	1583		2.77676	
4	2	10	73.3	1119		3.897955	
5	2	10	64.7	1364		5.076064	
6	2	10	50.5	1706		5.658099	
7	2	10	57.7	1443		6.717527	
8	3	10	84.8	1609		7.288005	
9	3	10	72.2	1671		8.492145	
10	2	10	92.1	1676		8.609472	
11	2	10	53.9	1794		10.101687	
12	1	10	92.5			10.82839	
13	2	10	69.5	1863		11.420934	

Bin5 Statistics 5

Trial #	Pulse	Chirp (MHz)	Pulse Width (µS)	Pulse 1-2 spacing (µS)	Pulse 2-3 spacing (µS)	Pulse Start(S)	Detection (1:yes; 0:no)
0	1	11	57.2			0.097058	1
1	2	11	81.6	1566		1.261274	
2	2	11	80.8	1085		3.243511	
3	3	11	92.4	1332	1089	4.122554	
4	1	11	81.9			4.530559	
5	2	11	84.7	1564		5.973967	
6	3	11	67.5	1915	1560	6.787774	
7	2	11	97.9	1604		7.653679	
8	1	11	61.9			9.519989	
9	2	11	98.6	1801		10.62526	
10	2	11	69.2	1359		11.97025	

Bin5 Statistics 6

Trial #	Pulse	Chirp (MHz)	Pulse Width (µS)	Pulse 1-2 spacing (µS)	Pulse 2-3 spacing (µS)	Pulse Start(S)	Detection (1:yes; 0:no)
0	2	18	67.8	1554		0.048343	1
1	3	18	56.8	1528	1288	0.898098	
2	1	18	86.7			1.416512	
3	2	18	53.9	1357		2.39047	
4	2	18	89.4	1422		2.685114	
5	3	18	52.8	1213	1698	3.20184	
6	1	18	65.1			3.910011	
7	2	18	87.3	1090		5.039768	
8	3	18	80.7	1659	1239	5.492699	
9	1	18	60.8			6.303683	
10	2	18	86.9	1862		6.725996	
11	1	18	53.2			7.031367	
12	2	18	93.7	1277		8.16107	
13	1	18	58.5			8.292794	
14	2	18	59	1021		8.879328	
15	2	18	69.8	1761		9.678089	
16	3	18	71.2	1939	1233	10.595435	
17	3	18	64.8	1567	1441	10.793974	
18	1	18	90.1			11.372688	

Bin5 Statistics 7

Trial #	Pulse	Chirp (MHz)	Pulse Width (µS)	Pulse 1-2 spacing (µS)	Pulse 2-3 spacing (µS)	Pulse Start(S)	Detection (1:yes; 0:no)
0	1	8	87.1			0.596766	1
1	3	8	81.4	1701	1067	1.472755	
2	3	8	75.2	1696	1304	2.240985	
3	3	8	90.5	1864	1595	3.43474	
4	2	8	72.8	1247		4.055535	
5	1	8	52.7			5.811267	
6	3	8	58.3	1302	1431	6.673656	
7	2	8	90.8	1224		7.469613	
8	1	8	90.2			8.792006	
9	2	8	63.5	1445		9.444024	
10	2	8	59.8	1030		10.352228	
11	2	8	82.4	1630		11.270559	

Bin5 Statistics 8

Trial #	Pulse	Chirp (MHz)	Pulse Width (µS)	Pulse 1-2 spacing (µS)	Pulse 2-3 spacing (µS)	Pulse Start(S)	Detection (1:yes; 0:no)
0	1	5	53.5			0.497344	1
1	2	5	80.8	1092		1.634078	
2	2	5	62.6	1044		2.096543	
3	2	5	93.4	1467		2.863872	
4	1	5	78.7			3.844603	
5	3	5	79	1083	1738	5.112328	
6	2	5	62.9	1574		5.558768	
7	2	5	98.9	1296		6.258687	
8	2	5	87.2	1171		7.020164	
9	1	5	95.5			8.059692	
10	1	5	72			9.069944	
11	3	5	73	1419	1403	9.994151	
12	1	5	60.2			10.88658	
13	2	5	83.2	1911		11.18475	

Bin5 Statistics 9

Trial #	Pulse	Chirp (MHz)	Pulse Width (µS)	Pulse 1-2 spacing (uS)	Pulse 2-3 spacing (uS)	Pulse Start(S)	Detection (1:yes; 0:no)
0	1	16	63.5			0.128374	0
1	3	16	72.3	1492	1960	1.957063	
2	3	16	59	1985	1240	3.013415	
3	2	16	83	1996		4.26961	
4	3	16	92.5	1756	1872	5.486927	
5	2	16	82.5	1947		6.746609	
6	3	16	88.7	1358	1971	8.326183	
7	1	16	76.2			9.040232	
8	1	16	64.7			10.217842	
9	1	16	85.8			10.870288	

Bin5 Statistics 10

Trial #	Pulse	Chirp (MHz)	Pulse Width (µS)	Pulse 1-2 spacing (uS)	Pulse 2-3 spacing (uS)	Pulse Start(S)	Detection (1:yes; 0:no)
0	1	19	81.7			0.930975	1
1	3	19	54.3	1535	1223	2.019752	
2	3	19	99	1419	1685	2.23869	
3	2	19	90.9	1704		3.907274	
4	2	19	86	1917		4.960943	
5	1	19	57			6.447639	
6	2	19	75.4	1065		7.461782	
7	2	19	51.7	1672		8.468153	
8	3	19	52.9	1684	1833	9.688462	
9	3	19	55.5	1356	1327	10.004441	
10	1	19	73.8			11.359489	

Bin5 Statistics 11

Trial #	Pulse	Chirp (MHz)	Pulse Width (µS)	Pulse 1-2 spacing (uS)	Pulse 2-3 spacing (uS)	Pulse Start(S)	Detection (1:yes; 0:no)
0	1	8	76.5			0.153449	1
1	2	8	81.8	1625		1.605711	
2	2	8	74.4	1819		1.870218	
3	2	8	80.8	1296		3.028359	
4	3	8	82.9	1487	1416	4.273293	
5	3	8	84.6	1995	1567	5.39722	
6	3	8	71.7	1612	1006	6.025312	
7	2	8	61.1	1190		6.818805	
8	3	8	61.9	1097	1395	7.845843	
9	2	8	60.8	1827		8.851147	
10	2	8	60.3	1864		9.973736	
11	2	8	96.5	1150		10.48995	
12	1	8	86.1			11.62755	

Bin5 Statistics 12

Trial #	Pulse	Chirp (MHz)	Pulse Width (µS)	Pulse 1-2 spacing (uS)	Pulse 2-3 spacing (uS)	Pulse Start(S)	Detection (1:yes; 0:no)
0	3	9	93.8	1651	1975	0.013154	1
1	1	9	67.4			0.843557	
2	3	9	85.8	1690	1462	1.593757	
3	3	9	82.1	1014	1677	1.805723	
4	2	9	52.9	1613		2.637113	
5	1	9	55.1			3.407588	
6	1	9	56			3.759167	
7	2	9	56.7	1263		4.391547	
8	2	9	97.1	1577		4.969056	
9	2	9	78.7	1472		5.677952	
10	2	9	68	1746		6.036201	
11	3	9	64.6	1665	1059	7.09095	
12	1	9	70.7			7.655731	
13	3	9	73.6	1141	1133	7.924563	
14	2	9	59.6	1883		8.530285	
15	2	9	66.7	1064		9.034223	
16	3	9	97.7	1136	1245	10.101613	
17	1	9	62			10.430639	
18	2	9	78.6	1692		11.164646	
19	2	9	81.9	1916		11.863012	

Bin5 Statistics 13

Trial #	Pulse	Chirp (MHz)	Pulse Width (µS)	Pulse 1-2 spacing (uS)	Pulse 2-3 spacing (uS)	Pulse Start(S)	Detection (1:yes; 0:no)
0	3	14	73.1	1587	1992	0.670421	1
1	2	14	96.9	1103		1.276956	
2	2	14	89.4	1452		1.960048	
3	1	14	75.4			3.646536	
4	1	14	89.3			4.608681	
5	2	14	74.2	1665		4.818739	
6	2	14	61.4	1399		5.947669	
7	2	14	76.9	1137		6.718677	
8	3	14	69.7	1064	1240	7.663639	
9	1	14	70.4			9.013346	
10	1	14	79.7			9.560963	
11	1	14	62.9			10.224178	
12	2	14	71.3	1325		11.809238	

Bin5 Statistics 14

Trial #	Pulse	Chirp (MHz)	Pulse Width (µS)	Pulse 1-2 spacing (uS)	Pulse 2-3 spacing (uS)	Pulse Start(S)	Detection (1:yes; 0:no)
0	2	18	87.2	1663		0.224267	1
1	1	18	90.8			0.634971	
2	2	18	83	1604		1.885275	
3	1	18	60			1.996541	
4	2	18	62.9	1487		2.908343	
5	1	18	58.5			3.3392	
6	2	18	81.6	1209		4.025468	
7	1	18	66.2			4.805537	
8	2	18	51.3	1820		5.639654	
9	3	18	59.5	1195	1600	5.901415	
10	1	18	53.8			6.47058	
11	2	18	77.3	1691		7.401953	
12	1	18	77.2			8.083266	
13	1	18	76.8			8.667636	
14	2	18	50.2	1956		9.235877	
15	3	18	80.7	1249	1495	9.795425	
16	2	18	82.8	1432		10.31297	
17	2	18	61.4	1233		11.16046	
18	2	18	93.9	1167		11.48948	

Bin5 Statistics 15

Trial #	Pulse	Chirp (MHz)	Pulse Width (µS)	Pulse 1-2 spacing (uS)	Pulse 2-3 spacing (uS)	Pulse Start(S)	Detection (1:yes; 0:no)
0	1	16	79.5			0.333068	1
1	3	16	99.1	1849	1303	1.057716	
2	2	16	66.2	1575		1.772476	
3	1	16	54.3			2.179957	
4	2	16	69.6	1932		2.878215	
5	1	16	80.9			3.302495	
6	3	16	67.5	1649	1684	3.692285	
7	2	16	96.3	1613		4.765561	
8	1	16	88.8			5.040927	
9	2	16	99.5	1637		5.624095	
10	1	16	76.1			6.075057	
11	2	16	96.2	1084		7.152522	
12	3	16	97.1	1951	1242	7.553219	
13	3	16	60.1	1432	1022	8.048203	
14	2	16	84.9	1711		8.586667	
15	2	16	99.9	1707		9.542229	
16	2	16	88.7	1993		10.00219	
17	2	16	66.5	1829		10.343707	
18	2	16	79.2	1005		10.952242	
19	2	16	63	1742		11.88177	

Bin5 Statistics 16

Trial #	Pulse	Chirp (MHz)	Pulse Width (µS)	Pulse 1-2 spacing (uS)	Pulse 2-3 spacing (uS)	Pulse Start(S)	Detection (1:yes; 0:no)
0	2	11	53.5	1393		0.643359	1
1	2	11	52.4	1878		2.458179	
2	1	11	96.7			3.239133	
3	2	11	64.7	1041		4.07371	
4	3	11	53.1	1126	1147	5.944874	
5	1	11	80.7			7.952401	
6	3	11	98.6	1979	1644	9.223413	
7	2	11	70.7	1603		9.383635	
8	1	11	50			11.162092	

Bin5 Statistics 17

Trial #	Pulse	Chirp (MHz)	Pulse Width (µS)	Pulse 1-2 spacing (uS)	Pulse 2-3 spacing (uS)	Pulse Start(S)	Detection (1:yes; 0:no)
0	1	6	98.8			0.084778	1
1	2	6	98.5	1929		1.484414	
2	1	6	52.7			2.017523	
3	2	6	59.5	1317		2.813418	
4	3	6	65.9	1225	1612	3.40396	
5	2	6	85.8	1472		4.25452	
6	3	6	90.9	1995	1674	5.486619	
7	1	6	88.2			5.69717	
8	2	6	77.4	1370		7.03784	
9	2	6	77.9	1624		7.68237	
10	1	6	57.9			8.568857	
11	2	6	50.4	1346		9.29148	
12	2	6	97.8	1865		9.715155	
13	2	6	60.1	1111		10.55127	
14	3	6	53.6	1722	1432	11.78079	

Bin5 Statistics 18

Trial #	Pulse	Chirp (MHz)	Pulse Width (µS)	Pulse 1-2 spacing (uS)	Pulse 2-3 spacing (uS)	Pulse Start(S)	Detection (1:yes; 0:no)
0	2	18	85.5	1995		0.445968	1
1	2	18	95	1685		1.661031	
2	2	18	62.9	1489		2.800332	
3	2	18	59.2	1743		5.015078	
4	1	18	57.4			5.644719	
5	1	18	60.3			6.943168	
6	2	18	68.8	1360		8.657556	
7	1	18	81			9.993004	
8	1	18	66.5			11.994247	

Bin5 Statistics 19

Trial #	Pulse	Chirp (MHz)	Pulse Width (µS)	Pulse 1-2 spacing (uS)	Pulse 2-3 spacing (uS)	Pulse Start(S)	Detection (1:yes; 0:no)
0	3	16	76.3	1936	1213	0.236814	1
1	1	16	60.7			1.191498	
2	3	16	87.1	1821	1834	1.673094	
3	1	16	78.2			2.145735	
4	2	16	81.5	1154		3.383456	
5	3	16	77.4	1359	1273	3.923262	
6	3	16	58.4	1152	1392	4.889736	
7	3	16	95	1294	1947	5.222841	
8	1	16	74.5			5.897796	
9	2	16	94.6	1445		6.471635	
10	1	16	64.3			7.706801	
11	2	16	51.1	1214		8.26173	
12	1	16	60.8			9.147857	
13	2	16	86.3	1890		9.459191	
14	2	16	51.2	1375		10.218042	
15	2	16	69.5	1245		10.686923	
16	2	16	99.7	1108		11.398283	

Bin5 Statistics 20

Trial #	Pulse	Chirp (MHz)	Pulse Width (µS)	Pulse 1-2 spacing (uS)	Pulse 2-3 spacing (uS)	Pulse Start(S)	Detection (1:yes; 0:no)
0	1	18	85.3			0.308887	1
1	2	18	88.2	1912		2.127935	
2	2	18	66.3	1994		2.962191	
3	3	18	60.3	1443	1732	4.531364	
4	3	18	95.3	1674	1364	6.449244	
5	3	18	91.8	1371	1340	6.787815	
6	3	18	96.1	1686	1570	8.488346	
7	3	18	76.2	1515	1695	9.695718	
8	3	18	84	1764	1277	11.89271	

Bin5 Statistics 21

Trial #	Pulse	Chirp (MHz)	Pulse Width (µS)	Pulse 1-2 spacing (uS)	Pulse 2-3 spacing (uS)	Pulse Start(S)	Detection (1:yes; 0:no)
0	2	17	70.8	1933		0.243382	1
1	2	17	54.6	1275		2.10164	
2	2	17	97.1	1036		3.461296	
3	3	17	66.7	1127	1090	4.314299	
4	2	17	99.8	1712		6.584344	
5	2	17	81.3	1078		6.666669	
6	3	17	80.3	1239	1529	8.119131	
7	2	17	98	1692		9.738695	
8	3	17	71	1510	1637	11.257594	

Bin5 Statistics 22

Trial #	Pulse	Chirp (MHz)	Pulse Width (µS)	Pulse 1-2 spacing (uS)	Pulse 2-3 spacing (uS)	Pulse Start(S)	Detection (1:yes; 0:no)
0	2	8	83.6	1402		0.702414	1
1	3	8	90.1	1911	1397	1.353587	
2	1	8	68.2			2.349664	
3	2	8	56.9	1616		3.212242	
4	2	8	74	1901		3.753377	
5	1	8	59.1			4.565871	
6	1	8	84			5.314026	
7	3	8	85.7	1144	1167	6.008116	
8	2	8	94.5	1954		7.098347	
9	1	8	54.7			8.143636	
10	2	8	87.6	1426		8.859665	
11	2	8	55.6	1274		9.511139	
12	1	8	65.1			10.684555	
13	1	8	61.6			11.204237	

Bin5 Statistics 23

Trial #	Pulse	Chirp (MHz)	Pulse Width (µS)	Pulse 1-2 spacing (uS)	Pulse 2-3 spacing (uS)	Pulse Start(S)	Detection (1:yes; 0:no)
0	2	17	69.1	1779		0.128203	1
1	2	17	89.7	1909		1.653889	
2	2	17	98.7	1626		2.911821	
3	1	17	61.5			3.881385	
4	2	17	88.1	1014		5.09631	
5	2	17	87.8	1511		6.043177	
6	3	17	69.4	1304	1707	7.034243	
7	2	17	89.6	1584		8.510919	
8	2	17	59.6	1766		9.288821	
9	2	17	63.5	1896		10.15153	
10	2	17	86.4	1411		11.38949	

Bin5 Statistics 24

Trial #	Pulse	Chirp (MHz)	Pulse Width (µS)	Pulse 1-2 spacing (uS)	Pulse 2-3 spacing (uS)	Pulse Start(S)	Detection (1:yes; 0:no)
0	1	12	87.6			0.193442	1
1	1	12	90.7			1.473998	
2	3	12	70	1477	1635	1.826991	
3	2	12	80.2	1284		3.197792	
4	3	12	57	1181	1892	4.048592	
5	3	12	56.7	1317	1490	4.911876	
6	3	12	51.4	1366	1713	5.553748	
7	2	12	95.1	1002		6.634157	
8	2	12	66.6	1812		6.911844	
9	2	12	77.1	1357		8.322997	
10	2	12	81.4	1056		8.876401	
11	1	12	99.1			9.860713	
12	3	12	64.7	1404	1265	10.834321	
13	2	12	77.9	1643		11.552847	

Bin5 Statistics 25

Trial #	Pulse	Chirp (MHz)	Pulse Width (µS)	Pulse 1-2 spacing (uS)	Pulse 2-3 spacing (uS)	Pulse Start(S)	Detection (1:yes; 0:no)
0	1	7	76.2			0.294247	1
1	1	7	60.6			2.391816	
2	1	7	87			3.03664	
3	1	7	95			4.020829	
4	1	7	83.2			5.530792	
5	3	7	55.4	1292	1212	6.868604	
6	3	7	67	1978	1383	8.752943	
7	3	7	85.5	1320	1729	10.43312	
8	2	7	86.9	1397		10.769541	

Bin5 Statistics 26

Trial #	Pulse	Chirp (MHz)	Pulse Width (µS)	Pulse 1-2 spacing (uS)	Pulse 2-3 spacing (uS)	Pulse Start(S)	Detection (1:yes; 0:no)
0	2	15	76.9	1310		0.301557	1
1	1	15	58.4			1.592923	
2	2	15	92.5	1968		3.053345	
3	2	15	51.9	1359		4.610251	
4	3	15	89.6	1014	1235	5.335664	
5	2	15	55.5	1506		6.453358	
6	3	15	84.6	1279	1508	7.246012	
7	2	15	86.4	1196		8.683326	
8	1	15	55.9			10.381618	
9	2	15	97.4	1012		11.109252	

Bin5 Statistics 27

Trial #	Pulse	Chirp (MHz)	Pulse Width (µS)	Pulse 1-2 spacing (µS)	Pulse 2-3 spacing (µS)	Pulse Start(S)	Detection (1:yes; 0:no)
0	2	20	67.9	1827		0.267828	1
1	2	20	52	1612		1.476768	
2	3	20	52.2	1338	1204	2.164631	
3	1	20	53.2			3.181909	
4	2	20	68	1658		4.255791	
5	2	20	63.1	1149		4.840836	
6	2	20	77.5	1236		5.555898	
7	3	20	51.9	1571	1676	6.603947	
8	1	20	51.2			7.266524	
9	2	20	65.5	1361		8.060011	
10	1	20	64.5			8.691351	
11	2	20	63.1	1757		9.637882	
12	2	20	68.2	1384		10.861748	
13	3	20	99.1	1790	1948	11.551475	

Bin5 Statistics 28

Trial #	Pulse	Chirp (MHz)	Pulse Width (µS)	Pulse 1-2 spacing (µS)	Pulse 2-3 spacing (µS)	Pulse Start(S)	Detection (1:yes; 0:no)
0	2	18	61.3	1824		0.536359	1
1	2	18	75.7	1310		1.129864	
2	3	18	96	1628	1046	1.762893	
3	2	18	90.5	1691		2.680636	
4	1	18	65.4			3.13576	
5	2	18	80	1956		4.17263	
6	3	18	83	1787	1094	4.563254	
7	3	18	64.6	1959	1382	5.049553	
8	2	18	92.6	1718		5.749165	
9	3	18	74.5	1322	1164	6.562345	
10	3	18	91.3	1148	1294	7.44748	
11	2	18	69.1	1825		8.161157	
12	2	18	65.4	1508		8.754005	
13	3	18	54.4	1855	1572	9.8594	
14	2	18	58.3	1569		10.558896	
15	2	18	77.4	1773		10.605011	
16	3	18	53.2	1446	1795	11.966028	

Bin5 Statistics 29

Trial #	Pulse	Chirp (MHz)	Pulse Width (µS)	Pulse 1-2 spacing (uS)	Pulse 2-3 spacing (uS)	Pulse Start(S)	Detection (1:yes; 0:no)
0	2	6	79.4	1956		0.488229	1
1	2	6	67	1031		1.43542	
2	3	6	81	1879	1608	2.093106	
3	3	6	89.4	1240	1822	2.485355	
4	1	6	78.6			3.303567	
5	3	6	80.5	1933	1999	3.782364	
6	1	6	50.1			4.975479	
7	2	6	83.6	1320		5.439264	
8	1	6	59.8			6.020143	
9	3	6	77.7	1817	1026	6.867421	
10	2	6	98.7	1246		7.932297	
11	1	6	61.2			8.497912	
12	3	6	51.1	1752	1069	9.088397	
13	2	6	77.2	1361		10.318099	
14	1	6	66.6			10.568117	
15	2	6	58.3	1203		11.682569	

Bin5 Statistics 30

Trial #	Pulse	Chirp (MHz)	Pulse Width (µS)	Pulse 1-2 spacing (uS)	Pulse 2-3 spacing (uS)	Pulse Start(S)	Detection (1:yes; 0:no)
0	1	9	91.6			0.730664	1
1	3	9	75.6	1480	1804	2.013155	
2	3	9	77.8	1897	1530	3.428262	
3	2	9	87.2	1127		4.40601	
4	1	9	87.3			6.053401	
5	2	9	61.7	1707		6.689003	
6	1	9	51.7			8.93508	
7	3	9	79.2	1005	1139	10.559215	
8	3	9	73	1276	1214	11.835191	

Table-6 Radar Type 6 Statistical Performance

Trial #	Fc (MHz)	Pulse /Burst	Pulse Width (µS)	PRI (µs)	Detection (1:yes; 0:no)	Hopping Sequence
1	5280	9	1	333	1	5601.0, 5542.0, 5420.0, 5399.0, 5698.0, 5499.0, 5422.0, 5650.0, 5681.0, 5365.0, 5451.0, 5674.0, 5282.0, 5659.0, 5639.0, 5598.0, 5383.0, 5620.0, 5435.0, 5382.0, 5377.0, 5254.0, 5350.0, 5589.0, 5363.0, 5706.0, 5429.0, 5415.0, 5503.0, 5430.0, 5682.0, 5697.0, 5563.0, 5547.0, 5565.0, 5326.0, 5583.0, 5308.0, 5708.0, 5561.0, 5459.0, 5512.0, 5664.0, 5516.0, 5509.0, 5333.0, 5476.0, 5473.0, 5378.0, 5312.0, 5714.0, 5369.0, 5344.0, 5705.0, 5616.0, 5528.0, 5418.0, 5358.0, 5283.0, 5401.0, 5532.0, 5304.0, 5426.0, 5357.0, 5409.0, 5320.0, 5269.0, 5564.0, 5539.0, 5310.0, 5489.0, 5425.0, 5537.0, 5631.0, 5331.0, 5675.0, 5337.0, 5271.0, 5284.0, 5443.0, 5676.0, 5495.0, 5268.0, 5552.0, 5398.0, 5384.0, 5444.0, 5319.0, 5258.0, 5385.0, 5266.0, 5646.0, 5545.0, 5466.0, 5263.0, 5529.0, 5330.0, 5677.0, 5704.0, 5436.0 (number of hits: 7)
2	5280	9	1	333	1	5500.0, 5721.0, 5281.0, 5667.0, 5433.0, 5595.0, 5313.0, 5452.0, 5317.0, 5475.0, 5386.0, 5614.0, 5357.0, 5618.0, 5662.0, 5484.0, 5330.0, 5629.0, 5657.0, 5519.0, 5418.0, 5638.0, 5516.0, 5419.0, 5711.0, 5389.0, 5607.0, 5693.0, 5597.0, 5259.0, 5431.0, 5550.0, 5659.0, 5325.0, 5302.0, 5393.0, 5722.0, 5396.0, 5456.0, 5480.0, 5429.0, 5331.0, 5518.0, 5552.0, 5501.0, 5478.0, 5505.0, 5700.0, 5566.0, 5541.0, 5559.0, 5494.0, 5548.0, 5253.0, 5645.0, 5582.0, 5557.0, 5524.0, 5676.0, 5473.0, 5273.0, 5621.0, 5580.0, 5399.0, 5610.0, 5482.0, 5682.0, 5347.0, 5611.0, 5670.0, 5553.0, 5523.0, 5328.0, 5609.0, 5675.0, 5506.0, 5368.0, 5613.0, 5406.0, 5544.0, 5537.0, 5285.0, 5412.0, 5397.0, 5512.0, 5470.0, 5322.0, 5549.0, 5546.0, 5496.0, 5488.0, 5266.0, 5290.0, 5417.0, 5601.0, 5606.0, 5297.0, 5270.0, 5679.0, 5416.0 (number of hits: 8)
3	5280	9	1	333	1	5686.0, 5320.0, 5609.0, 5465.0, 5256.0, 5435.0, 5669.0, 5412.0, 5387.0, 5547.0, 5346.0, 5353.0, 5585.0, 5281.0, 5715.0, 5617.0, 5287.0, 5584.0, 5469.0, 5332.0, 5302.0, 5658.0, 5478.0, 5571.0, 5679.0, 5605.0, 5548.0, 5253.0, 5638.0, 5550.0, 5531.0, 5369.0, 5330.0, 5514.0, 5691.0, 5372.0, 5575.0, 5417.0, 5456.0, 5309.0, 5265.0, 5308.0, 5453.0, 5593.0, 5301.0, 5295.0, 5608.0, 5542.0, 5341.0, 5405.0, 5428.0, 5483.0, 5381.0, 5396.0, 5714.0,

						5269.0, 5641.0, 5366.0, 5521.0, 5263.0, 5694.0, 5549.0, 5657.0, 5541.0, 5297.0, 5704.0, 5632.0, 5306.0, 5416.0, 5702.0, 5556.0, 5458.0, 5340.0, 5624.0, 5564.0, 5388.0, 5706.0, 5386.0, 5615.0, 5299.0, 5698.0, 5688.0, 5426.0, 5324.0, 5616.0, 5258.0, 5347.0, 5509.0, 5582.0, 5316.0, 5610.0, 5389.0, 5687.0, 5338.0, 5392.0, 5551.0, 5327.0, 5612.0, 5274.0, 5326.0 (number of hits: 13)
4	5280	9	1	333	1	5592.0, 5387.0, 5511.0, 5381.0, 5516.0, 5317.0, 5383.0, 5478.0, 5443.0, 5547.0, 5393.0, 5517.0, 5636.0, 5384.0, 5371.0, 5376.0, 5452.0, 5536.0, 5397.0, 5570.0, 5396.0, 5537.0, 5723.0, 5504.0, 5301.0, 5467.0, 5263.0, 5485.0, 5454.0, 5718.0, 5686.0, 5474.0, 5400.0, 5428.0, 5267.0, 5390.0, 5329.0, 5705.0, 5664.0, 5695.0, 5607.0, 5388.0, 5302.0, 5433.0, 5647.0, 5411.0, 5291.0, 5391.0, 5499.0, 5563.0, 5261.0, 5287.0, 5657.0, 5529.0, 5422.0, 5460.0, 5345.0, 5585.0, 5442.0, 5576.0, 5554.0, 5421.0, 5477.0, 5509.0, 5694.0, 5260.0, 5688.0, 5327.0, 5635.0, 5646.0, 5259.0, 5596.0, 5618.0, 5380.0, 5507.0, 5611.0, 5710.0, 5321.0, 5353.0, 5468.0, 5693.0, 5549.0, 5574.0, 5404.0, 5486.0, 5363.0, 5441.0, 5587.0, 5416.0, 5256.0, 5415.0, 5316.0, 5555.0, 5318.0, 5544.0, 5696.0, 5335.0, 5522.0, 5370.0, 5492.0 (number of hits: 9)
5	5280	9	1	333	1	5683.0, 5434.0, 5658.0, 5443.0, 5626.0, 5505.0, 5447.0, 5554.0, 5663.0, 5483.0, 5286.0, 5623.0, 5455.0, 5555.0, 5535.0, 5435.0, 5343.0, 5413.0, 5573.0, 5636.0, 5544.0, 5437.0, 5284.0, 5314.0, 5292.0, 5546.0, 5563.0, 5415.0, 5622.0, 5699.0, 5405.0, 5404.0, 5715.0, 5386.0, 5467.0, 5524.0, 5503.0, 5495.0, 5637.0, 5337.0, 5611.0, 5497.0, 5516.0, 5619.0, 5493.0, 5255.0, 5489.0, 5671.0, 5459.0, 5643.0, 5358.0, 5341.0, 5299.0, 5632.0, 5714.0, 5530.0, 5590.0, 5354.0, 5629.0, 5264.0, 5707.0, 5517.0, 5588.0, 5297.0, 5365.0, 5585.0, 5698.0, 5374.0, 5296.0, 5601.0, 5409.0, 5433.0, 5449.0, 5680.0, 5257.0, 5509.0, 5364.0, 5504.0, 5313.0, 5548.0, 5315.0, 5366.0, 5385.0, 5351.0, 5547.0, 5431.0, 5575.0, 5446.0, 5396.0, 5293.0, 5705.0, 5723.0, 5574.0, 5679.0, 5531.0, 5484.0, 5552.0, 5576.0, 5378.0, 5429.0 (number of hits: 8)
6	5280	9	1	333	1	5390.0, 5314.0, 5705.0, 5594.0, 5599.0, 5620.0, 5277.0, 5636.0, 5642.0, 5301.0, 5553.0, 5498.0, 5416.0, 5422.0, 5375.0, 5613.0, 5718.0, 5556.0, 5571.0, 5374.0, 5358.0, 5367.0, 5338.0, 5546.0, 5427.0, 5404.0, 5550.0, 5361.0, 5562.0, 5673.0, 5321.0, 5254.0, 5286.0, 5510.0, 5349.0,

						5394.0, 5499.0, 5612.0, 5373.0, 5681.0, 5388.0, 5282.0, 5473.0, 5517.0, 5463.0, 5678.0, 5597.0, 5545.0, 5492.0, 5540.0, 5397.0, 5429.0, 5380.0, 5570.0, 5533.0, 5518.0, 5677.0, 5324.0, 5714.0, 5287.0, 5382.0, 5415.0, 5554.0, 5639.0, 5284.0, 5408.0, 5450.0, 5667.0, 5482.0, 5591.0, 5507.0, 5351.0, 5505.0, 5622.0, 5298.0, 5578.0, 5720.0, 5307.0, 5629.0, 5655.0, 5582.0, 5538.0, 5641.0, 5291.0, 5665.0, 5369.0, 5513.0, 5496.0, 5483.0, 5621.0, 5651.0, 5638.0, 5685.0, 5372.0, 5551.0, 5423.0, 5256.0, 5379.0, 5568.0, 5368.0 (number of hits: 7)
7	5280	9	1	333	1	5628.0, 5509.0, 5250.0, 5323.0, 5347.0, 5556.0, 5604.0, 5654.0, 5555.0, 5659.0, 5469.0, 5254.0, 5679.0, 5315.0, 5582.0, 5272.0, 5598.0, 5650.0, 5468.0, 5380.0, 5388.0, 5407.0, 5455.0, 5635.0, 5599.0, 5398.0, 5637.0, 5465.0, 5406.0, 5348.0, 5405.0, 5397.0, 5577.0, 5588.0, 5655.0, 5319.0, 5578.0, 5614.0, 5474.0, 5694.0, 5368.0, 5664.0, 5448.0, 5325.0, 5436.0, 5551.0, 5334.0, 5302.0, 5559.0, 5504.0, 5464.0, 5453.0, 5338.0, 5621.0, 5624.0, 5671.0, 5652.0, 5310.0, 5292.0, 5656.0, 5638.0, 5686.0, 5435.0, 5487.0, 5678.0, 5713.0, 5545.0, 5689.0, 5480.0, 5667.0, 5618.0, 5673.0, 5573.0, 5356.0, 5517.0, 5394.0, 5523.0, 5362.0, 5278.0, 5442.0, 5672.0, 5617.0, 5579.0, 5419.0, 5481.0, 5303.0, 5439.0, 5355.0, 5502.0, 5609.0, 5703.0, 5339.0, 5721.0, 5585.0, 5632.0, 5370.0, 5269.0, 5587.0, 5533.0, 5615.0 (number of hits: 8)
8	5280	9	1	333	1	5721.0, 5502.0, 5417.0, 5715.0, 5685.0, 5309.0, 5402.0, 5323.0, 5579.0, 5582.0, 5564.0, 5422.0, 5395.0, 5342.0, 5499.0, 5530.0, 5666.0, 5667.0, 5313.0, 5596.0, 5618.0, 5543.0, 5386.0, 5577.0, 5576.0, 5610.0, 5253.0, 5341.0, 5480.0, 5458.0, 5428.0, 5450.0, 5487.0, 5414.0, 5702.0, 5639.0, 5373.0, 5711.0, 5374.0, 5396.0, 5464.0, 5289.0, 5686.0, 5631.0, 5454.0, 5370.0, 5293.0, 5383.0, 5449.0, 5602.0, 5660.0, 5572.0, 5335.0, 5474.0, 5654.0, 5597.0, 5496.0, 5625.0, 5433.0, 5476.0, 5284.0, 5397.0, 5250.0, 5546.0, 5264.0, 5326.0, 5538.0, 5372.0, 5330.0, 5607.0, 5305.0, 5424.0, 5550.0, 5459.0, 5259.0, 5566.0, 5339.0, 5391.0, 5277.0, 5500.0, 5718.0, 5684.0, 5561.0, 5334.0, 5653.0, 5318.0, 5308.0, 5541.0, 5311.0, 5589.0, 5406.0, 5636.0, 5336.0, 5510.0, 5630.0, 5501.0, 5352.0, 5570.0, 5525.0, 5619.0 (number of hits: 9)
9	5280	9	1	333	1	5446.0, 5323.0, 5643.0, 5640.0, 5518.0, 5356.0, 5387.0, 5378.0, 5535.0, 5319.0, 5609.0, 5512.0, 5256.0, 5514.0, 5488.0,

						5467.0, 5480.0, 5463.0, 5432.0, 5353.0, 5545.0, 5559.0, 5705.0, 5388.0, 5370.0, 5415.0, 5663.0, 5471.0, 5584.0, 5479.0, 5711.0, 5302.0, 5258.0, 5470.0, 5346.0, 5255.0, 5495.0, 5293.0, 5469.0, 5474.0, 5349.0, 5547.0, 5552.0, 5402.0, 5379.0, 5292.0, 5650.0, 5438.0, 5523.0, 5342.0, 5596.0, 5571.0, 5461.0, 5625.0, 5361.0, 5359.0, 5644.0, 5275.0, 5613.0, 5718.0, 5279.0, 5309.0, 5555.0, 5311.0, 5403.0, 5558.0, 5452.0, 5522.0, 5433.0, 5568.0, 5498.0, 5507.0, 5411.0, 5646.0, 5380.0, 5278.0, 5350.0, 5615.0, 5532.0, 5448.0, 5494.0, 5437.0, 5365.0, 5683.0, 5689.0, 5306.0, 5289.0, 5619.0, 5407.0, 5511.0, 5652.0, 5308.0, 5696.0, 5605.0, 5645.0, 5266.0, 5382.0, 5581.0, 5268.0, 5606.0 (number of hits: 9)
10	5280	9	1	333	1	5438.0, 5631.0, 5650.0, 5599.0, 5253.0, 5677.0, 5645.0, 5644.0, 5584.0, 5519.0, 5655.0, 5375.0, 5466.0, 5415.0, 5592.0, 5366.0, 5568.0, 5626.0, 5693.0, 5328.0, 5690.0, 5422.0, 5359.0, 5280.0, 5405.0, 5331.0, 5417.0, 5313.0, 5252.0, 5671.0, 5540.0, 5499.0, 5579.0, 5408.0, 5304.0, 5665.0, 5576.0, 5653.0, 5342.0, 5646.0, 5583.0, 5694.0, 5640.0, 5363.0, 5670.0, 5490.0, 5522.0, 5505.0, 5649.0, 5700.0, 5263.0, 5582.0, 5611.0, 5441.0, 5322.0, 5262.0, 5281.0, 5496.0, 5717.0, 5296.0, 5630.0, 5480.0, 5285.0, 5483.0, 5625.0, 5718.0, 5420.0, 5430.0, 5564.0, 5528.0, 5360.0, 5557.0, 5542.0, 5523.0, 5618.0, 5643.0, 5597.0, 5436.0, 5474.0, 5414.0, 5589.0, 5255.0, 5577.0, 5284.0, 5444.0, 5327.0, 5293.0, 5610.0, 5647.0, 5555.0, 5347.0, 5720.0, 5703.0, 5268.0, 5312.0, 5543.0, 5514.0, 5492.0, 5612.0, 5527.0 (number of hits: 3)
11	5280	9	1	333	1	5362.0, 5670.0, 5526.0, 5549.0, 5514.0, 5646.0, 5340.0, 5439.0, 5660.0, 5555.0, 5694.0, 5502.0, 5352.0, 5523.0, 5559.0, 5699.0, 5444.0, 5478.0, 5552.0, 5517.0, 5457.0, 5592.0, 5322.0, 5671.0, 5477.0, 5551.0, 5524.0, 5463.0, 5648.0, 5720.0, 5304.0, 5325.0, 5394.0, 5379.0, 5580.0, 5610.0, 5545.0, 5591.0, 5566.0, 5446.0, 5365.0, 5460.0, 5724.0, 5252.0, 5431.0, 5508.0, 5396.0, 5579.0, 5654.0, 5412.0, 5333.0, 5323.0, 5316.0, 5650.0, 5492.0, 5308.0, 5282.0, 5471.0, 5253.0, 5491.0, 5366.0, 5329.0, 5657.0, 5369.0, 5680.0, 5350.0, 5691.0, 5255.0, 5682.0, 5696.0, 5475.0, 5385.0, 5536.0, 5710.0, 5251.0, 5348.0, 5432.0, 5618.0, 5572.0, 5395.0, 5561.0, 5719.0, 5616.0, 5548.0, 5302.0, 5473.0, 5712.0, 5626.0, 5557.0, 5270.0, 5384.0, 5278.0, 5706.0, 5342.0, 5498.0, 5534.0, 5320.0, 5378.0, 5678.0, 5306.0

						(number of hits: 4)
12	5280	9	1	333	1	5578.0, 5551.0, 5422.0, 5628.0, 5273.0, 5285.0, 5586.0, 5719.0, 5664.0, 5400.0, 5724.0, 5560.0, 5622.0, 5310.0, 5693.0, 5403.0, 5677.0, 5275.0, 5647.0, 5439.0, 5315.0, 5612.0, 5448.0, 5328.0, 5529.0, 5554.0, 5701.0, 5449.0, 5540.0, 5621.0, 5591.0, 5600.0, 5610.0, 5346.0, 5292.0, 5431.0, 5306.0, 5462.0, 5557.0, 5467.0, 5547.0, 5356.0, 5274.0, 5533.0, 5440.0, 5460.0, 5423.0, 5604.0, 5644.0, 5348.0, 5381.0, 5706.0, 5570.0, 5598.0, 5681.0, 5358.0, 5428.0, 5330.0, 5710.0, 5545.0, 5641.0, 5345.0, 5261.0, 5496.0, 5301.0, 5365.0, 5494.0, 5402.0, 5703.0, 5337.0, 5263.0, 5649.0, 5531.0, 5571.0, 5340.0, 5637.0, 5705.0, 5316.0, 5369.0, 5317.0, 5652.0, 5493.0, 5674.0, 5464.0, 5270.0, 5482.0, 5376.0, 5505.0, 5323.0, 5481.0, 5548.0, 5717.0, 5640.0, 5354.0, 5590.0, 5314.0, 5697.0, 5508.0, 5329.0, 5281.0
						(number of hits: 3)
13	5280	9	1	333	1	5388.0, 5536.0, 5651.0, 5480.0, 5263.0, 5702.0, 5703.0, 5544.0, 5269.0, 5494.0, 5378.0, 5307.0, 5705.0, 5483.0, 5364.0, 5425.0, 5653.0, 5381.0, 5508.0, 5719.0, 5593.0, 5441.0, 5404.0, 5393.0, 5355.0, 5535.0, 5298.0, 5356.0, 5540.0, 5614.0, 5468.0, 5337.0, 5322.0, 5336.0, 5672.0, 5523.0, 5551.0, 5452.0, 5624.0, 5513.0, 5275.0, 5375.0, 5321.0, 5491.0, 5481.0, 5532.0, 5472.0, 5391.0, 5358.0, 5706.0, 5581.0, 5627.0, 5585.0, 5502.0, 5252.0, 5709.0, 5561.0, 5440.0, 5488.0, 5710.0, 5596.0, 5445.0, 5426.0, 5701.0, 5334.0, 5318.0, 5587.0, 5634.0, 5691.0, 5688.0, 5722.0, 5282.0, 5279.0, 5489.0, 5572.0, 5699.0, 5286.0, 5649.0, 5478.0, 5589.0, 5444.0, 5549.0, 5399.0, 5518.0, 5550.0, 5721.0, 5573.0, 5681.0, 5619.0, 5422.0, 5626.0, 5486.0, 5400.0, 5662.0, 5578.0, 5718.0, 5371.0, 5418.0, 5505.0, 5696.0
						(number of hits: 2)
14	5280	9	1	333	1	5412.0, 5656.0, 5310.0, 5481.0, 5375.0, 5567.0, 5712.0, 5261.0, 5439.0, 5580.0, 5708.0, 5663.0, 5440.0, 5673.0, 5262.0, 5706.0, 5332.0, 5560.0, 5277.0, 5346.0, 5684.0, 5625.0, 5368.0, 5286.0, 5427.0, 5609.0, 5423.0, 5270.0, 5367.0, 5289.0, 5350.0, 5467.0, 5309.0, 5679.0, 5550.0, 5426.0, 5635.0, 5526.0, 5340.0, 5474.0, 5671.0, 5598.0, 5471.0, 5335.0, 5596.0, 5604.0, 5472.0, 5555.0, 5563.0, 5529.0, 5313.0, 5512.0, 5351.0, 5505.0, 5390.0, 5329.0, 5597.0, 5434.0, 5451.0, 5458.0, 5276.0, 5253.0, 5711.0, 5416.0, 5511.0, 5581.0, 5269.0, 5627.0, 5508.0, 5498.0, 5540.0, 5406.0, 5316.0, 5365.0, 5610.0, 5515.0, 5413.0, 5371.0, 5345.0, 5664.0,

						5645.0, 5479.0, 5525.0, 5595.0, 5520.0, 5328.0, 5366.0, 5473.0, 5431.0, 5690.0, 5256.0, 5657.0, 5718.0, 5514.0, 5617.0, 5385.0, 5636.0, 5424.0, 5658.0, 5333.0 (number of hits: 1)
15	5280	9	1	333	1	5627.0, 5319.0, 5305.0, 5353.0, 5389.0, 5482.0, 5610.0, 5498.0, 5332.0, 5324.0, 5544.0, 5617.0, 5672.0, 5604.0, 5261.0, 5344.0, 5515.0, 5669.0, 5288.0, 5661.0, 5506.0, 5440.0, 5321.0, 5283.0, 5525.0, 5620.0, 5461.0, 5266.0, 5600.0, 5497.0, 5686.0, 5445.0, 5424.0, 5381.0, 5529.0, 5687.0, 5599.0, 5357.0, 5555.0, 5510.0, 5655.0, 5448.0, 5275.0, 5444.0, 5519.0, 5578.0, 5478.0, 5402.0, 5417.0, 5351.0, 5711.0, 5721.0, 5562.0, 5346.0, 5300.0, 5676.0, 5557.0, 5255.0, 5391.0, 5273.0, 5328.0, 5292.0, 5612.0, 5539.0, 5552.0, 5616.0, 5369.0, 5703.0, 5287.0, 5495.0, 5605.0, 5309.0, 5619.0, 5518.0, 5484.0, 5542.0, 5490.0, 5308.0, 5425.0, 5483.0, 5315.0, 5642.0, 5277.0, 5453.0, 5422.0, 5652.0, 5265.0, 5312.0, 5540.0, 5304.0, 5317.0, 5534.0, 5602.0, 5463.0, 5592.0, 5696.0, 5723.0, 5409.0, 5523.0, 5630.0 (number of hits: 6)
16	5280	9	1	333	1	5683.0, 5393.0, 5713.0, 5567.0, 5600.0, 5346.0, 5298.0, 5528.0, 5430.0, 5257.0, 5495.0, 5512.0, 5440.0, 5449.0, 5538.0, 5501.0, 5340.0, 5578.0, 5475.0, 5482.0, 5700.0, 5631.0, 5682.0, 5433.0, 5258.0, 5505.0, 5608.0, 5703.0, 5381.0, 5485.0, 5435.0, 5295.0, 5330.0, 5347.0, 5286.0, 5500.0, 5312.0, 5659.0, 5299.0, 5276.0, 5582.0, 5266.0, 5367.0, 5543.0, 5486.0, 5380.0, 5368.0, 5607.0, 5609.0, 5280.0, 5618.0, 5305.0, 5524.0, 5522.0, 5626.0, 5297.0, 5616.0, 5325.0, 5598.0, 5595.0, 5667.0, 5462.0, 5655.0, 5425.0, 5552.0, 5315.0, 5585.0, 5563.0, 5265.0, 5412.0, 5413.0, 5723.0, 5401.0, 5274.0, 5351.0, 5663.0, 5590.0, 5403.0, 5388.0, 5343.0, 5620.0, 5604.0, 5287.0, 5385.0, 5431.0, 5415.0, 5675.0, 5493.0, 5591.0, 5535.0, 5656.0, 5715.0, 5339.0, 5476.0, 5404.0, 5614.0, 5464.0, 5597.0, 5426.0, 5473.0 (number of hits: 5)
17	5280	9	1	333	1	5290.0, 5346.0, 5670.0, 5279.0, 5719.0, 5640.0, 5370.0, 5607.0, 5625.0, 5574.0, 5458.0, 5337.0, 5403.0, 5690.0, 5675.0, 5609.0, 5485.0, 5504.0, 5434.0, 5257.0, 5487.0, 5409.0, 5697.0, 5637.0, 5621.0, 5696.0, 5342.0, 5642.0, 5596.0, 5573.0, 5471.0, 5635.0, 5588.0, 5522.0, 5394.0, 5415.0, 5421.0, 5445.0, 5259.0, 5289.0, 5701.0, 5608.0, 5381.0, 5577.0, 5470.0, 5523.0, 5636.0, 5536.0, 5436.0, 5575.0, 5273.0, 5264.0, 5493.0, 5297.0, 5317.0, 5713.0, 5538.0, 5606.0, 5496.0, 5700.0

						5665.0, 5256.0, 5397.0, 5602.0, 5428.0, 5567.0, 5494.0, 5595.0, 5351.0, 5266.0, 5546.0, 5631.0, 5489.0, 5406.0, 5618.0, 5316.0, 5542.0, 5605.0, 5253.0, 5683.0, 5269.0, 5357.0, 5490.0, 5437.0, 5539.0, 5304.0, 5584.0, 5603.0, 5581.0, 5724.0, 5579.0, 5388.0, 5411.0, 5617.0, 5271.0, 5262.0, 5598.0, 5486.0, 5659.0, 5711.0 (number of hits: 3)
18	5280	9	1	333	1	5636.0, 5611.0, 5651.0, 5709.0, 5479.0, 5354.0, 5307.0, 5570.0, 5472.0, 5489.0, 5440.0, 5531.0, 5398.0, 5720.0, 5561.0, 5627.0, 5283.0, 5648.0, 5586.0, 5655.0, 5612.0, 5597.0, 5470.0, 5504.0, 5696.0, 5318.0, 5557.0, 5492.0, 5690.0, 5356.0, 5707.0, 5698.0, 5278.0, 5254.0, 5295.0, 5517.0, 5548.0, 5511.0, 5595.0, 5362.0, 5670.0, 5326.0, 5337.0, 5654.0, 5610.0, 5355.0, 5359.0, 5383.0, 5327.0, 5599.0, 5291.0, 5338.0, 5381.0, 5433.0, 5444.0, 5544.0, 5414.0, 5409.0, 5300.0, 5306.0, 5582.0, 5493.0, 5321.0, 5484.0, 5320.0, 5578.0, 5309.0, 5301.0, 5294.0, 5360.0, 5349.0, 5316.0, 5455.0, 5374.0, 5282.0, 5441.0, 5590.0, 5671.0, 5253.0, 5583.0, 5711.0, 5350.0, 5348.0, 5393.0, 5564.0, 5534.0, 5682.0, 5310.0, 5693.0, 5401.0, 5634.0, 5678.0, 5618.0, 5526.0, 5551.0, 5592.0, 5501.0, 5314.0, 5413.0, 5495.0 (number of hits: 8)
19	5280	9	1	333	1	5555.0, 5294.0, 5612.0, 5640.0, 5613.0, 5465.0, 5506.0, 5298.0, 5674.0, 5403.0, 5534.0, 5366.0, 5686.0, 5521.0, 5476.0, 5419.0, 5620.0, 5413.0, 5442.0, 5397.0, 5354.0, 5367.0, 5591.0, 5563.0, 5641.0, 5451.0, 5665.0, 5538.0, 5543.0, 5372.0, 5542.0, 5365.0, 5679.0, 5539.0, 5626.0, 5416.0, 5308.0, 5645.0, 5651.0, 5353.0, 5378.0, 5711.0, 5508.0, 5577.0, 5439.0, 5450.0, 5548.0, 5323.0, 5351.0, 5430.0, 5709.0, 5418.0, 5409.0, 5622.0, 5414.0, 5519.0, 5316.0, 5352.0, 5611.0, 5395.0, 5475.0, 5621.0, 5284.0, 5504.0, 5703.0, 5438.0, 5310.0, 5677.0, 5373.0, 5643.0, 5685.0, 5290.0, 5584.0, 5278.0, 5531.0, 5559.0, 5658.0, 5444.0, 5445.0, 5480.0, 5592.0, 5386.0, 5670.0, 5319.0, 5273.0, 5567.0, 5463.0, 5269.0, 5708.0, 5272.0, 5406.0, 5698.0, 5299.0, 5583.0, 5312.0, 5722.0, 5549.0, 5453.0, 5408.0, 5720.0 (number of hits: 5)
20	5280	9	1	333	1	5505.0, 5453.0, 5508.0, 5665.0, 5493.0, 5250.0, 5696.0, 5677.0, 5256.0, 5302.0, 5690.0, 5355.0, 5334.0, 5264.0, 5406.0, 5708.0, 5522.0, 5379.0, 5374.0, 5621.0, 5297.0, 5580.0, 5657.0, 5553.0, 5440.0, 5289.0, 5591.0, 5402.0, 5676.0, 5668.0, 5438.0, 5662.0, 5589.0, 5715.0, 5577.0, 5280.0, 5463.0, 5367.0, 5437.0, 5606.0,

						5295.0, 5473.0, 5511.0, 5558.0, 5458.0, 5562.0, 5670.0, 5711.0, 5605.0, 5266.0, 5360.0, 5332.0, 5465.0, 5305.0, 5303.0, 5576.0, 5431.0, 5566.0, 5674.0, 5598.0, 5253.0, 5341.0, 5340.0, 5579.0, 5607.0, 5644.0, 5399.0, 5330.0, 5496.0, 5322.0, 5494.0, 5685.0, 5542.0, 5358.0, 5339.0, 5415.0, 5703.0, 5441.0, 5345.0, 5688.0, 5320.0, 5364.0, 5661.0, 5405.0, 5545.0, 5551.0, 5326.0, 5325.0, 5439.0, 5461.0, 5617.0, 5385.0, 5618.0, 5641.0, 5489.0, 5498.0, 5283.0, 5636.0, 5414.0, 5590.0 (number of hits: 5)
21	5280	9	1	333	1	5582.0, 5464.0, 5644.0, 5568.0, 5393.0, 5463.0, 5721.0, 5290.0, 5655.0, 5690.0, 5635.0, 5429.0, 5288.0, 5422.0, 5505.0, 5256.0, 5650.0, 5449.0, 5386.0, 5700.0, 5588.0, 5689.0, 5300.0, 5680.0, 5365.0, 5356.0, 5594.0, 5692.0, 5512.0, 5475.0, 5473.0, 5419.0, 5471.0, 5389.0, 5627.0, 5720.0, 5683.0, 5592.0, 5324.0, 5455.0, 5283.0, 5556.0, 5303.0, 5708.0, 5453.0, 5660.0, 5264.0, 5269.0, 5654.0, 5561.0, 5476.0, 5446.0, 5719.0, 5274.0, 5285.0, 5438.0, 5293.0, 5332.0, 5611.0, 5294.0, 5308.0, 5629.0, 5338.0, 5595.0, 5333.0, 5623.0, 5659.0, 5337.0, 5589.0, 5696.0, 5420.0, 5668.0, 5514.0, 5354.0, 5347.0, 5496.0, 5532.0, 5560.0, 5710.0, 5447.0, 5545.0, 5326.0, 5369.0, 5276.0, 5479.0, 5263.0, 5632.0, 5513.0, 5674.0, 5352.0, 5652.0, 5339.0, 5366.0, 5684.0, 5396.0, 5598.0, 5425.0, 5346.0, 5566.0, 5619.0 (number of hits: 6)
22	5280	9	1	333	1	5639.0, 5521.0, 5341.0, 5483.0, 5339.0, 5439.0, 5573.0, 5566.0, 5293.0, 5413.0, 5707.0, 5615.0, 5438.0, 5536.0, 5345.0, 5560.0, 5705.0, 5592.0, 5476.0, 5436.0, 5275.0, 5497.0, 5623.0, 5272.0, 5637.0, 5607.0, 5717.0, 5417.0, 5700.0, 5316.0, 5400.0, 5559.0, 5685.0, 5588.0, 5513.0, 5392.0, 5624.0, 5450.0, 5723.0, 5562.0, 5555.0, 5712.0, 5397.0, 5462.0, 5453.0, 5277.0, 5256.0, 5314.0, 5357.0, 5464.0, 5569.0, 5693.0, 5541.0, 5385.0, 5602.0, 5261.0, 5312.0, 5403.0, 5626.0, 5554.0, 5718.0, 5479.0, 5550.0, 5289.0, 5495.0, 5330.0, 5309.0, 5402.0, 5367.0, 5565.0, 5381.0, 5532.0, 5545.0, 5469.0, 5667.0, 5350.0, 5579.0, 5488.0, 5590.0, 5596.0, 5429.0, 5630.0, 5465.0, 5313.0, 5401.0, 5478.0, 5674.0, 5677.0, 5344.0, 5271.0, 5408.0, 5621.0, 5315.0, 5258.0, 5553.0, 5486.0, 5416.0, 5576.0, 5266.0, 5568.0 (number of hits: 2)
23	5280	9	1	333	1	5710.0, 5696.0, 5644.0, 5609.0, 5400.0, 5630.0, 5553.0, 5467.0, 5598.0, 5441.0, 5404.0, 5446.0, 5464.0, 5369.0, 5304.0, 5498.0, 5252.0, 5685.0, 5389.0, 5634.0,

						5439.0, 5562.0, 5419.0, 5286.0, 5639.0, 5603.0, 5296.0, 5688.0, 5492.0, 5327.0, 5306.0, 5407.0, 5514.0, 5262.0, 5318.0, 5691.0, 5481.0, 5274.0, 5675.0, 5478.0, 5587.0, 5431.0, 5251.0, 5399.0, 5348.0, 5365.0, 5501.0, 5585.0, 5457.0, 5281.0, 5275.0, 5329.0, 5331.0, 5657.0, 5293.0, 5601.0, 5502.0, 5599.0, 5689.0, 5336.0, 5539.0, 5466.0, 5647.0, 5488.0, 5717.0, 5700.0, 5624.0, 5316.0, 5669.0, 5668.0, 5653.0, 5546.0, 5576.0, 5521.0, 5597.0, 5259.0, 5625.0, 5701.0, 5715.0, 5424.0, 5499.0, 5556.0, 5505.0, 5623.0, 5645.0, 5302.0, 5720.0, 5438.0, 5279.0, 5611.0, 5629.0, 5357.0, 5519.0, 5352.0, 5723.0, 5379.0, 5460.0, 5651.0, 5490.0, 5495.0 (number of hits: 5)
24	5280	9	1	333	1	5530.0, 5328.0, 5506.0, 5584.0, 5671.0, 5425.0, 5615.0, 5523.0, 5296.0, 5603.0, 5431.0, 5414.0, 5385.0, 5558.0, 5424.0, 5494.0, 5335.0, 5438.0, 5324.0, 5534.0, 5465.0, 5346.0, 5312.0, 5705.0, 5386.0, 5707.0, 5404.0, 5272.0, 5490.0, 5271.0, 5564.0, 5594.0, 5592.0, 5410.0, 5347.0, 5405.0, 5419.0, 5653.0, 5398.0, 5268.0, 5554.0, 5549.0, 5349.0, 5285.0, 5537.0, 5264.0, 5716.0, 5457.0, 5345.0, 5684.0, 5517.0, 5452.0, 5351.0, 5283.0, 5509.0, 5402.0, 5685.0, 5666.0, 5596.0, 5307.0, 5639.0, 5505.0, 5704.0, 5699.0, 5291.0, 5496.0, 5626.0, 5674.0, 5423.0, 5443.0, 5578.0, 5393.0, 5575.0, 5388.0, 5657.0, 5652.0, 5306.0, 5399.0, 5677.0, 5565.0, 5525.0, 5275.0, 5711.0, 5629.0, 5569.0, 5254.0, 5417.0, 5498.0, 5559.0, 5721.0, 5469.0, 5287.0, 5281.0, 5356.0, 5561.0, 5379.0, 5330.0, 5276.0, 5590.0, 5717.0 (number of hits: 4)
25	5280	9	1	333	1	5366.0, 5255.0, 5490.0, 5500.0, 5395.0, 5456.0, 5400.0, 5681.0, 5332.0, 5713.0, 5347.0, 5258.0, 5513.0, 5336.0, 5399.0, 5365.0, 5664.0, 5281.0, 5402.0, 5266.0, 5314.0, 5485.0, 5597.0, 5427.0, 5506.0, 5621.0, 5507.0, 5592.0, 5464.0, 5509.0, 5690.0, 5586.0, 5288.0, 5682.0, 5309.0, 5278.0, 5540.0, 5313.0, 5648.0, 5430.0, 5408.0, 5494.0, 5703.0, 5361.0, 5639.0, 5491.0, 5340.0, 5668.0, 5551.0, 5460.0, 5372.0, 5378.0, 5423.0, 5289.0, 5598.0, 5627.0, 5286.0, 5437.0, 5706.0, 5254.0, 5578.0, 5553.0, 5373.0, 5406.0, 5711.0, 5292.0, 5545.0, 5417.0, 5701.0, 5602.0, 5679.0, 5433.0, 5274.0, 5691.0, 5424.0, 5390.0, 5461.0, 5440.0, 5285.0, 5652.0, 5398.0, 5328.0, 5641.0, 5501.0, 5453.0, 5550.0, 5715.0, 5685.0, 5635.0, 5283.0, 5488.0, 5670.0, 5375.0, 5454.0, 5591.0, 5684.0, 5616.0, 5480.0, 5590.0, 5325.0 (number of hits: 2)

26	5280	9	1	333	1	<p>5669.0, 5453.0, 5342.0, 5308.0, 5558.0, 5526.0, 5322.0, 5542.0, 5522.0, 5676.0, 5309.0, 5473.0, 5413.0, 5409.0, 5432.0, 5700.0, 5320.0, 5550.0, 5706.0, 5714.0, 5386.0, 5379.0, 5546.0, 5707.0, 5468.0, 5352.0, 5252.0, 5712.0, 5302.0, 5633.0, 5625.0, 5469.0, 5449.0, 5255.0, 5256.0, 5561.0, 5306.0, 5679.0, 5296.0, 5345.0, 5580.0, 5301.0, 5527.0, 5307.0, 5339.0, 5638.0, 5286.0, 5369.0, 5566.0, 5667.0, 5312.0, 5547.0, 5622.0, 5699.0, 5334.0, 5397.0, 5325.0, 5648.0, 5419.0, 5357.0, 5672.0, 5584.0, 5698.0, 5272.0, 5479.0, 5694.0, 5523.0, 5721.0, 5684.0, 5417.0, 5365.0, 5287.0, 5668.0, 5708.0, 5649.0, 5609.0, 5560.0, 5381.0, 5720.0, 5285.0, 5617.0, 5346.0, 5401.0, 5472.0, 5355.0, 5673.0, 5630.0, 5553.0, 5423.0, 5402.0, 5704.0, 5579.0, 5314.0, 5556.0, 5654.0, 5498.0, 5338.0, 5661.0, 5267.0, 5497.0 (number of hits: 7)</p>
27	5280	9	1	333	1	<p>5572.0, 5644.0, 5313.0, 5430.0, 5658.0, 5388.0, 5585.0, 5271.0, 5663.0, 5545.0, 5650.0, 5295.0, 5291.0, 5677.0, 5389.0, 5458.0, 5611.0, 5273.0, 5624.0, 5329.0, 5710.0, 5355.0, 5399.0, 5272.0, 5454.0, 5442.0, 5353.0, 5348.0, 5275.0, 5690.0, 5330.0, 5543.0, 5279.0, 5460.0, 5554.0, 5321.0, 5489.0, 5443.0, 5366.0, 5416.0, 5708.0, 5433.0, 5560.0, 5525.0, 5424.0, 5524.0, 5361.0, 5459.0, 5576.0, 5334.0, 5335.0, 5474.0, 5646.0, 5696.0, 5689.0, 5378.0, 5404.0, 5423.0, 5278.0, 5288.0, 5569.0, 5374.0, 5401.0, 5256.0, 5492.0, 5605.0, 5351.0, 5632.0, 5573.0, 5640.0, 5382.0, 5607.0, 5621.0, 5437.0, 5372.0, 5370.0, 5267.0, 5257.0, 5699.0, 5648.0, 5599.0, 5316.0, 5394.0, 5652.0, 5488.0, 5390.0, 5299.0, 5547.0, 5563.0, 5490.0, 5413.0, 5414.0, 5609.0, 5343.0, 5721.0, 5501.0, 5386.0, 5439.0, 5292.0, 5504.0 (number of hits: 4)</p>
28	5280	9	1	333	1	<p>5384.0, 5311.0, 5457.0, 5349.0, 5405.0, 5703.0, 5530.0, 5544.0, 5693.0, 5370.0, 5651.0, 5521.0, 5305.0, 5654.0, 5500.0, 5625.0, 5606.0, 5614.0, 5368.0, 5268.0, 5497.0, 5576.0, 5464.0, 5427.0, 5354.0, 5588.0, 5309.0, 5261.0, 5596.0, 5426.0, 5713.0, 5562.0, 5304.0, 5350.0, 5372.0, 5721.0, 5683.0, 5322.0, 5266.0, 5258.0, 5626.0, 5534.0, 5524.0, 5550.0, 5595.0, 5276.0, 5378.0, 5430.0, 5706.0, 5627.0, 5470.0, 5494.0, 5461.0, 5587.0, 5503.0, 5463.0, 5539.0, 5330.0, 5577.0, 5269.0, 5502.0, 5358.0, 5611.0, 5541.0, 5712.0, 5572.0, 5425.0, 5598.0, 5292.0, 5290.0, 5298.0, 5628.0, 5360.0, 5343.0, 5682.0, 5287.0, 5352.0, 5437.0, 5313.0, 5618.0, 5371.0, 5460.0, 5364.0, 5690.0, 5272.0,</p>

						5468.0, 5573.0, 5413.0, 5520.0, 5409.0, 5635.0, 5701.0, 5686.0, 5661.0, 5549.0, 5476.0, 5351.0, 5359.0, 5667.0, 5256.0 (number of hits: 6)
29	5280	9	1	333	1	5713.0, 5560.0, 5553.0, 5604.0, 5447.0, 5439.0, 5361.0, 5484.0, 5300.0, 5384.0, 5497.0, 5532.0, 5359.0, 5443.0, 5594.0, 5674.0, 5343.0, 5450.0, 5630.0, 5613.0, 5567.0, 5507.0, 5707.0, 5317.0, 5354.0, 5479.0, 5420.0, 5527.0, 5537.0, 5472.0, 5572.0, 5559.0, 5253.0, 5570.0, 5723.0, 5696.0, 5673.0, 5715.0, 5311.0, 5710.0, 5327.0, 5267.0, 5286.0, 5536.0, 5421.0, 5598.0, 5684.0, 5411.0, 5708.0, 5264.0, 5451.0, 5415.0, 5533.0, 5506.0, 5305.0, 5408.0, 5584.0, 5272.0, 5663.0, 5401.0, 5372.0, 5585.0, 5402.0, 5575.0, 5346.0, 5661.0, 5648.0, 5328.0, 5491.0, 5281.0, 5288.0, 5683.0, 5449.0, 5373.0, 5377.0, 5282.0, 5693.0, 5256.0, 5464.0, 5399.0, 5504.0, 5593.0, 5645.0, 5703.0, 5662.0, 5605.0, 5406.0, 5441.0, 5380.0, 5335.0, 5541.0, 5543.0, 5274.0, 5433.0, 5457.0, 5362.0, 5430.0, 5538.0, 5444.0, 5657.0 (number of hits: 2)
30	5280	9	1	333	1	5322.0, 5621.0, 5663.0, 5360.0, 5253.0, 5550.0, 5465.0, 5428.0, 5470.0, 5643.0, 5597.0, 5515.0, 5478.0, 5298.0, 5678.0, 5564.0, 5485.0, 5370.0, 5308.0, 5657.0, 5689.0, 5366.0, 5430.0, 5603.0, 5658.0, 5380.0, 5543.0, 5356.0, 5350.0, 5554.0, 5688.0, 5499.0, 5701.0, 5698.0, 5297.0, 5321.0, 5313.0, 5439.0, 5285.0, 5406.0, 5284.0, 5526.0, 5277.0, 5292.0, 5583.0, 5271.0, 5255.0, 5529.0, 5677.0, 5620.0, 5299.0, 5587.0, 5712.0, 5528.0, 5471.0, 5336.0, 5510.0, 5302.0, 5617.0, 5513.0, 5250.0, 5640.0, 5692.0, 5259.0, 5507.0, 5714.0, 5469.0, 5278.0, 5458.0, 5375.0, 5307.0, 5349.0, 5479.0, 5394.0, 5294.0, 5647.0, 5267.0, 5569.0, 5362.0, 5523.0, 5508.0, 5691.0, 5426.0, 5306.0, 5415.0, 5534.0, 5456.0, 5369.0, 5423.0, 5467.0, 5553.0, 5644.0, 5720.0, 5304.0, 5312.0, 5383.0, 5651.0, 5504.0, 5266.0, 5365.0 (number of hits: 10)

5270 MHz, 40 MHz Bandwidth

Radar Signal Type	Waveform/Trial Number	Detection (%)	Limit (%)	Pass/Fail
Type 1A/1B	30	100 %	60%	Pass
Type 2	30	100 %	60%	Pass
Type 3	30	100 %	60%	Pass
Type 4	30	100 %	60%	Pass
Aggregate (Type1 to 4)	120	100 %	80%	Pass
Type 5	30	96.7 %	80%	Pass
Type 6	30	100 %	70%	Pass

Please refer to the following statistical tables:

5270 MHz, 40 MHz Bandwidth

Table-1A/1B Radar Type 1A/1B Statistical Performance

Trial #	Fc (MHz)	Pulse/Burst	Pulse Width (μS)	PRI (μs)	Detection (1:yes; 0:no)
1	5270	62	1	858	1
2	5270	63	1	838	1
3	5270	81	1	658	1
4	5270	59	1	898	1
5	5270	67	1	798	1
6	5270	89	1	598	1
7	5270	58	1	918	1
8	5270	63	1	838	1
9	5270	68	1	778	1
10	5270	86	1	618	1
11	5270	61	1	878	1
12	5270	99	1	538	1
13	5270	89	1	598	1
14	5270	95	1	558	1
15	5270	67	1	798	1
16	5270	22	1	2413	1
17	5270	23	1	2331	1
18	5270	50	1	1066	1
19	5270	26	1	2035	1
20	5270	46	1	1171	1
21	5270	31	1	1710	1
22	5270	84	1	630	1
23	5270	22	1	2506	1
24	5270	20	1	2668	1
25	5270	18	1	2993	1
26	5270	27	1	2020	1
27	5270	20	1	2750	1
28	5270	44	1	1204	1
29	5270	19	1	2883	1
30	5270	44	1	1209	1
Detection Percentage: 100 % (>60%)					

Table-2 Radar Type 2 Statistical Performance

Trial #	Fc (MHz)	Pulse/Burst	Pulse Width (µS)	PRI (µs)	Detection (1:yes; 0:no)
1	5270	29	4.4	175	1
2	5270	25	1	176	1
3	5270	28	5	150	1
4	5270	25	3.8	204	1
5	5270	23	2.7	191	1
6	5270	26	3.7	159	1
7	5270	26	2.8	222	1
8	5270	26	1	203	1
9	5270	27	2.8	154	1
10	5270	23	3.8	159	1
11	5270	27	2.5	151	1
12	5270	27	4.4	171	1
13	5270	29	1.8	202	1
14	5270	28	4.1	154	1
15	5270	28	4.3	200	1
16	5270	23	3.6	163	1
17	5270	28	4.5	186	1
18	5270	26	3	152	1
19	5270	28	3.6	229	1
20	5270	24	3.5	166	1
21	5270	24	4.6	225	1
22	5270	23	4	161	1
23	5270	29	3.5	191	1
24	5270	29	4.6	162	1
25	5270	27	4.8	213	1
26	5270	23	4.7	191	1
27	5270	27	4.7	201	1
28	5270	26	4.1	219	1
29	5270	28	3.9	162	1
30	5270	25	3.3	167	1
Detection Percentage: 100 % (>60%)					

Table-3 Radar Type 3 Statistical Performance

Trial #	Fc (MHz)	Pulse/Burst	Pulse Width (µS)	PRI (µs)	Detection (1:yes; 0:no)
1	5270	16	6.9	440	1
2	5270	16	8.7	352	1
3	5270	18	8	282	1
4	5270	17	7.2	203	1
5	5270	17	7.4	417	1
6	5270	18	8.5	447	1
7	5270	17	8	234	1
8	5270	16	9	283	1
9	5270	18	6.2	223	1
10	5270	16	7.8	368	1
11	5270	18	7.9	306	1
12	5270	17	6.5	287	1
13	5270	17	8	469	1
14	5270	17	7	419	1
15	5270	18	10	391	1
16	5270	18	8.2	460	1
17	5270	17	9.2	487	1
18	5270	17	6.9	246	1
19	5270	18	6.9	492	1
20	5270	16	10	451	1
21	5270	17	7	411	1
22	5270	18	7.4	380	1
23	5270	17	7.5	228	1
24	5270	17	7.3	334	1
25	5270	18	9.9	231	1
26	5270	16	7.1	269	1
27	5270	17	9.6	322	1
28	5270	16	7.6	417	1
29	5270	18	9.2	434	1
30	5270	17	9.4	209	1
Detection Percentage: 100 % (>60%)					

Table-4 Radar Type 4 Statistical Performance

Trial #	Fc (MHz)	Pulse/Burst	Pulse Width (μS)	PRI (μs)	Detection (1:yes; 0:no)
1	5270	13	17.3	228	1
2	5270	12	11.4	495	1
3	5270	16	17.9	229	1
4	5270	16	18.9	329	1
5	5270	14	20	459	1
6	5270	16	14.4	230	1
7	5270	13	19.2	455	1
8	5270	14	11.7	210	1
9	5270	12	16.3	491	1
10	5270	15	15.5	398	1
11	5270	14	11.7	219	1
12	5270	13	13.4	478	1
13	5270	16	13.4	297	1
14	5270	12	16.1	203	1
15	5270	14	11.1	381	1
16	5270	15	13.9	489	1
17	5270	16	11.7	261	1
18	5270	12	12.7	326	1
19	5270	12	18.3	228	1
20	5270	15	12.2	281	1
21	5270	12	14.5	315	1
22	5270	13	16.9	248	1
23	5270	15	13.4	353	1
24	5270	16	11.8	451	1
25	5270	15	13.5	439	1
26	5270	14	18.4	483	1
27	5270	12	12.1	372	1
28	5270	15	18.7	461	1
29	5270	13	14.5	237	1
30	5270	13	17.7	350	1
Detection Percentage: 100 % (>60%)					

Table-5 Radar Type 5 Statistical Performance

Trial #	Fc (MHz)	Detection (1:yes; 0:no)
1	5270	1
2	5270	1
3	5270	1
4	5270	1
5	5270	0
6	5270	1
7	5270	1
8	5270	1
9	5270	1
10	5270	1
11	5253.4	1
12	5256.2	1
13	5255.4	1
14	5257.8	1
15	5253.8	1
16	5254.6	1
17	5258.6	1
18	5257	1
19	5255.8	1
20	5253.4	1
21	5287	1
22	5283.8	1
23	5285.4	1
24	5284.2	1
25	5285.8	1
26	5284.6	1
27	5285.4	1
28	5286.6	1
29	5283.4	1
30	5286.6	1
Detection Percentage: 96.7 % (>80%)		

Bin5 Statistics 1

Trial #	Pulse	Chirp (MHz)	Pulse Width (µS)	Pulse 1-2 spacing (µS)	Pulse 2-3 spacing (µS)	Pulse Start(S)	Detection (1:yes; 0:no)
0	3	7	66.5	1853	1818	0.827961	1
1	2	7	99.2	1604		1.14127	
2	2	7	75	1484		2.211809	
3	2	7	90.3	1619		3.006554	
4	3	7	85.9	1279	1080	4.128597	
5	1	7	94.7			5.256829	
6	2	7	76.1	1682		6.779144	
7	1	7	99.6			7.921494	
8	2	7	72.7	1837		8.402081	
9	3	7	63.4	1790	1985	9.75978	
10	1	7	77.3			10.144097	
11	2	7	66	1992		11.16945	

Bin5 Statistics 2

Trial #	Pulse	Chirp (MHz)	Pulse Width (μS)	Pulse 1-2 spacing (uS)	Pulse 2-3 spacing (uS)	Pulse Start(S)	Detection (1:yes; 0:no)
0	3	6	79.9	1651	1185	0.527891	1
1	1	6	80.5			1.21225	
2	2	6	68.9	1754		1.793349	
3	3	6	79.5	1242	1058	2.495955	
4	2	6	93	1354		2.663612	
5	2	6	63.1	1659		3.640071	
6	1	6	55.5			4.315569	
7	1	6	64			4.786924	
8	2	6	72.2	1624		5.211053	
9	3	6	77.8	1121	1198	6.193209	
10	1	6	59.1			6.935419	
11	2	6	64.5	1516		7.194355	
12	2	6	89.1	1812		7.901724	
13	2	6	81.8	1453		8.34278	
14	3	6	65.9	1447	1323	9.422494	
15	1	6	79			9.929338	
16	2	6	71.5	1489		10.323262	
17	2	6	66.9	1307		11.299295	
18	2	6	85.3	1335		11.750911	

Bin5 Statistics 3

Trial #	Pulse	Chirp (MHz)	Pulse Width (µS)	Pulse 1-2 spacing (uS)	Pulse 2-3 spacing (uS)	Pulse Start(S)	Detection (1:yes; 0:no)
0	2	9	64	1018		0.634841	1
1	2	9	98.1	1706		1.039705	
2	2	9	92.5	1502		1.565521	
3	2	9	79.9	1240		2.659511	
4	1	9	72.6			2.712499	
5	3	9	56.7	1176	1237	3.556233	
6	1	9	55.2			4.170435	
7	1	9	55.4			5.045159	
8	3	9	76.8	1535	1980	5.936204	
9	1	9	62.4			6.467771	
10	3	9	55.7	1539	1112	6.765392	
11	2	9	96.6	1673		7.807729	
12	3	9	95.5	1744	1750	8.599453	
13	1	9	53.6			9.153429	
14	2	9	66.3	1309		9.799463	
15	2	9	82.3	1511		10.099619	
16	2	9	84	1944		11.281608	
17	3	9	62.8	1077	1401	11.65499	

Bin5 Statistics 4

Trial #	Pulse	Chirp (MHz)	Pulse Width (µS)	Pulse 1-2 spacing (uS)	Pulse 2-3 spacing (uS)	Pulse Start(S)	Detection (1:yes; 0:no)
0	1	13	55.2			1.029891	1
1	3	13	51.9	1593	1096	1.304778	
2	3	13	86.0	1096	1017	2.549461	
3	2	13	79.1	1778		3.801516	
4	2	13	96.7	1666		4.4252	
5	1	13	83.0			5.979644	
6	3	13	55.2	1029	1274	6.848209	
7	2	13	74.7	1548		7.679594	
8	3	13	75.5	1250	1817	9.699457	
9	3	13	75.7	1037	1699	10.160746	
10	3	13	52.7	1633	1489	11.49277	

Bin5 Statistics 5

Trial #	Pulse	Chirp (MHz)	Pulse Width (µS)	Pulse 1-2 spacing (uS)	Pulse 2-3 spacing (uS)	Pulse Start(S)	Detection (1:yes; 0:no)
0	1	8	54.7			0.186402	0
1	2	8	76.6	1997		1.243807	
2	2	8	66.2	1407		2.331871	
3	1	8	87.4			4.209633	
4	2	8	51.5	1954		4.800901	
5	2	8	53.4	1486		5.895227	
6	3	8	98.7	1820	1029	7.19904	
7	1	8	99.9			7.747421	
8	1	8	74			9.293396	
9	3	8	87.1	1292	1093	10.770018	
10	3	8	68.7	1215	1795	11.95605	

Bin5 Statistics 6

Trial #	Pulse	Chirp (MHz)	Pulse Width (µS)	Pulse 1-2 spacing (uS)	Pulse 2-3 spacing (uS)	Pulse Start(S)	Detection (1:yes; 0:no)
0	3	17	93.4	1484	1501	0.306398	1
1	2	17	85.1	1413		1.615791	
2	2	17	58.8	1872		2.881898	
3	3	17	97	1879	1018	3.625654	
4	2	17	87.9	1873		4.858178	
5	2	17	97.9	1500		6.92492	
6	2	17	86.2	1982		8.337485	
7	2	17	93.7	1230		9.026384	
8	3	17	88.1	1340	1306	9.696568	
9	3	17	67.6	1532	1387	11.58941	

Bin5 Statistics 7

Trial #	Pulse	Chirp (MHz)	Pulse Width (µS)	Pulse 1-2 spacing (µS)	Pulse 2-3 spacing (µS)	Pulse Start(S)	Detection (1:yes; 0:no)
0	3	10	78.8	1388	1616	0.367416	1
1	1	10	84.3			1.532479	
2	1	10	89.7			2.406686	
3	3	10	81.5	1819	1418	3.315318	
4	1	10	69.4			4.372187	
5	2	10	61.7	1681		4.903497	
6	2	10	97.7	1381		6.16179	
7	1	10	57.2			7.342811	
8	3	10	80.7	1668	1667	7.539941	
9	1	10	91.8			9.114508	
10	1	10	83.1			9.988872	
11	2	10	96.4	1953		10.831158	
12	2	10	95.9	1799		11.239051	

Bin5 Statistics 8

Trial #	Pulse	Chirp (MHz)	Pulse Width (µS)	Pulse 1-2 spacing (uS)	Pulse 2-3 spacing (uS)	Pulse Start(S)	Detection (1:yes; 0:no)
0	2	13	82.1	1563		0.089248	1
1	1	13	50.6			1.2015	
2	1	13	97.8			1.704648	
3	3	13	96.2	1782	1150	2.625875	
4	1	13	68.6			3.054862	
5	1	13	53			4.128203	
6	1	13	76.2			4.746111	
7	2	13	86.6	1635		5.283528	
8	2	13	86	1447		6.508622	
9	2	13	59.4	1406		7.325555	
10	2	13	68.8	1081		7.819234	
11	2	13	89	1862		8.482234	
12	1	13	74.3			9.47185	
13	2	13	90.6	1987		10.464824	
14	2	13	68.5	1818		10.930866	
15	3	13	51.3	1365	1952	11.505689	

Bin5 Statistics 9

Trial #	Pulse	Chirp (MHz)	Pulse Width (µS)	Pulse 1-2 spacing (uS)	Pulse 2-3 spacing (uS)	Pulse Start(S)	Detection (1:yes; 0:no)
0	1	9	63.5			0.333972	1
1	3	9	85.6	1075	1069	1.248699	
2	2	9	90.4	1494		2.155262	
3	1	9	91.3			2.625457	
4	3	9	79.8	1717	1356	3.472016	
5	3	9	81.2	1937	1572	3.792512	
6	1	9	99.4			4.530187	
7	3	9	92.1	1174	1769	5.610205	
8	1	9	92.7			6.001565	
9	2	9	99.3	1705		7.388136	
10	1	9	73.3			7.61603	
11	2	9	73	1893		8.611142	
12	3	9	71	1096	1317	9.245663	
13	2	9	87.7	1119		10.025019	
14	2	9	59	1722		10.507615	
15	2	9	83.7	1301		11.580429	

Bin5 Statistics 10

Trial #	Pulse	Chirp (MHz)	Pulse Width (µS)	Pulse 1-2 spacing (uS)	Pulse 2-3 spacing (uS)	Pulse Start(S)	Detection (1:yes; 0:no)
0	2	18	83.2	1268		0.389064	1
1	2	18	86.8	1424		1.403618	
2	2	18	72.1	1196		2.007858	
3	2	18	96.7	1975		2.607174	
4	1	18	75.3			3.26948	
5	2	18	75.3	1790		4.103065	
6	2	18	55.2	1038		4.41354	
7	2	18	74.8	1926		5.233959	
8	2	18	83.9	1955		5.807673	
9	2	18	98	1989		6.458119	
10	2	18	59.4	1341		7.389382	
11	3	18	91.2	1263	1286	7.956834	
12	1	18	70.7			8.620586	
13	1	18	71.9			9.605507	
14	2	18	69.1	1140		10.364835	
15	2	18	90.3	1922		10.61215	
16	1	18	58.8			11.466772	

Bin5 Statistics 11

Trial #	Pulse	Chirp (MHz)	Pulse Width (µS)	Pulse 1-2 spacing (uS)	Pulse 2-3 spacing (uS)	Pulse Start(S)	Detection (1:yes; 0:no)
0	3	6	89.8	1095	1295	0.338826	1
1	3	6	78.3	1145	1235	1.747328	
2	2	6	90.3	1335		3.014479	
3	2	6	76.9	1928		4.024322	
4	2	6	83.2	1012		4.95025	
5	2	6	78.6	1889		6.138583	
6	3	6	80.8	1628	1060	7.62094	
7	3	6	98.7	1827	1605	8.303227	
8	2	6	82.5	1537		8.875264	
9	1	6	65.3			10.428699	
10	2	6	99.8	1114		11.651344	

Bin5 Statistics 12

Trial #	Pulse	Chirp (MHz)	Pulse Width (µS)	Pulse 1-2 spacing (uS)	Pulse 2-3 spacing (uS)	Pulse Start(S)	Detection (1:yes; 0:no)
0	3	13	52.9	1984	1506	0.30489	1
1	3	13	56.6	1078	1224	1.325478	
2	3	13	80.2	1498	1613	2.928497	
3	2	13	53.7	1924		3.7355	
4	3	13	82.9	1792	1284	4.584465	
5	3	13	81.7	1371	1522	6.490656	
6	3	13	81.8	1100	1869	6.983234	
7	2	13	51.8	1129		8.375037	
8	1	13	73.6			9.779105	
9	1	13	86.6			10.215154	
10	1	13	94.9			11.873062	

Bin5 Statistics 13

Trial #	Pulse	Chirp (MHz)	Pulse Width (µS)	Pulse 1-2 spacing (uS)	Pulse 2-3 spacing (uS)	Pulse Start(S)	Detection (1:yes; 0:no)
0	3	11	68.5	1640	1781	0.049741	1
1	2	11	73.4	1918		1.724845	
2	2	11	69.8	1055		2.780567	
3	1	11	79.7			4.087284	
4	1	11	78.6			5.893325	
5	2	11	80.8	1300		6.295141	
6	2	11	88.4	1696		7.316355	
7	3	11	66.8	1816	1809	8.838539	
8	3	11	83.7	1425	1816	10.303578	
9	1	11	75.8			10.977796	

Bin5 Statistics 14

Trial #	Pulse	Chirp (MHz)	Pulse Width (µS)	Pulse 1-2 spacing (uS)	Pulse 2-3 spacing (uS)	Pulse Start(S)	Detection (1:yes; 0:no)
0	2	17	81.5	1210		0.185989	1
1	1	17	92.3			0.985588	
2	1	17	98.5			2.01716	
3	2	17	82.4	1586		2.695778	
4	1	17	79.7			3.404388	
5	1	17	93.4			4.200241	
6	2	17	63.2	1675		4.760285	
7	2	17	64.5	1866		5.030796	
8	2	17	82.8	1583		5.70366	
9	2	17	56	1695		7.035987	
10	3	17	96.2	1980	1861	7.221205	
11	2	17	64.9	1516		8.050403	
12	1	17	94.7			8.483499	
13	3	17	63.9	1770	1100	9.429867	
14	1	17	84.4			9.897755	
15	3	17	98.2	1409	1541	10.883653	
16	1	17	60.3			11.479724	

Bin5 Statistics 15

Trial #	Pulse	Chirp (MHz)	Pulse Width (µS)	Pulse 1-2 spacing (µS)	Pulse 2-3 spacing (µS)	Pulse Start(S)	Detection (1:yes; 0:no)
0	2	7	99.7	1863		0.63062	1
1	1	7	60.2			0.856805	
2	2	7	68.1	1101		1.491572	
3	3	7	71	1284	1619	2.134899	
4	1	7	65.5			2.951799	
5	2	7	100	1696		3.340384	
6	3	7	62.9	1603	1871	4.55713	
7	3	7	53.1	1523	1931	4.783589	
8	2	7	85.8	1016		5.559706	
9	3	7	68.1	1128	1104	6.398788	
10	3	7	82.1	1527	1847	6.784596	
11	2	7	50.7	1266		7.513437	
12	2	7	62.1	1973		8.453924	
13	1	7	73.7			8.860804	
14	1	7	67.9			9.423358	
15	2	7	94.1	1938		10.489845	
16	3	7	93.6	1631	1259	11.145296	
17	2	7	52.3	1974		11.760537	

Bin5 Statistics 16

Trial #	Pulse	Chirp (MHz)	Pulse Width (µS)	Pulse 1-2 spacing (µS)	Pulse 2-3 spacing (µS)	Pulse Start(S)	Detection (1:yes; 0:no)
0	3	9	50.6	1458	1838	0.581571	1
1	2	9	95.1	1656		1.509617	
2	2	9	61.3	1287		2.904596	
3	3	9	83.6	1606	1322	3.626584	
4	2	9	80.1	1121		5.2587	
5	1	9	51.6			5.889004	
6	2	9	59.4	1560		7.57134	
7	2	9	89.4	1614		7.882928	
8	2	9	66.5	1701		8.84574	
9	3	9	56.4	1426	1995	9.864207	
10	1	9	87.6			11.780322	

Bin5 Statistics 17

Trial #	Pulse	Chirp (MHz)	Pulse Width (µS)	Pulse 1-2 spacing (uS)	Pulse 2-3 spacing (uS)	Pulse Start(S)	Detection (1:yes; 0:no)
0	2	19	62.2	1138		0.649532	1
1	2	19	83.7	1165		1.126387	
2	2	19	95.9	1139		2.120316	
3	1	19	84.2			3.005389	
4	2	19	82.5	1556		3.401082	
5	2	19	50.8	1898		4.430344	
6	2	19	67.5	1216		5.110109	
7	2	19	81.7	1129		5.907917	
8	1	19	94.7			6.812491	
9	2	19	63	1279		7.38218	
10	1	19	76.9			8.348991	
11	2	19	72.4	1917		8.886757	
12	2	19	88.3	1296		10.320548	
13	1	19	68.6			11.047397	
14	2	19	52.7	1715		11.393804	

Bin5 Statistics 18

Trial #	Pulse	Chirp (MHz)	Pulse Width (µS)	Pulse 1-2 spacing (uS)	Pulse 2-3 spacing (uS)	Pulse Start(S)	Detection (1:yes; 0:no)
0	1	15	69.9			0.380969	1
1	3	15	84.4	1920	1902	0.714122	
2	2	15	66.8	1500		1.575805	
3	1	15	63.1			2.198887	
4	2	15	62.7	1637		2.668486	
5	2	15	89.7	1353		3.724084	
6	2	15	88	1942		4.366416	
7	2	15	56.2	1017		5.057791	
8	2	15	98.3	1895		5.890062	
9	3	15	81.2	1821	1703	6.427864	
10	2	15	54.1	1599		7.079524	
11	1	15	75.5			7.978882	
12	3	15	77	1701	1929	8.087556	
13	3	15	84.8	1814	1887	8.733541	
14	2	15	78.1	1980		9.570476	
15	2	15	87.7	1763		10.311878	
16	1	15	57			11.248394	
17	3	15	96.6	1557	1008	11.96136	

Bin5 Statistics 19

Trial #	Pulse	Chirp (MHz)	Pulse Width (µS)	Pulse 1-2 spacing (uS)	Pulse 2-3 spacing (uS)	Pulse Start(S)	Detection (1:yes; 0:no)
0	3	12	87.6	1562	1088	0.341243	1
1	1	12	86.3			1.387889	
2	2	12	90.8	1873		2.24014	
3	2	12	96.1	1914		2.574812	
4	3	12	59	1176	1412	3.538985	
5	1	12	86.3			4.638748	
6	1	12	53.3			5.447259	
7	2	12	75.7	1538		6.242255	
8	2	12	83.8	1316		7.66347	
9	3	12	58	1474	1957	7.866938	
10	1	12	86.7			9.334971	
11	3	12	80.5	1724	1017	9.602073	
12	2	12	71.7	1169		10.943274	
13	2	12	98.3	1956		11.182763	

Bin5 Statistics 20

Trial #	Pulse	Chirp (MHz)	Pulse Width (µS)	Pulse 1-2 spacing (uS)	Pulse 2-3 spacing (uS)	Pulse Start(S)	Detection (1:yes; 0:no)
0	2	6	64.4	1408		1.132745	1
1	1	6	83.4			2.624413	
2	2	6	56.2	1212		2.808619	
3	3	6	86.9	1649	1133	4.717214	
4	3	6	73.7	1240	1991	6.623354	
5	2	6	59.9	1806		7.37057	
6	3	6	70.6	1069	1257	9.140812	
7	3	6	97.7	1550	1419	9.70042	
8	2	6	63.7	1129		11.063302	

Bin5 Statistics 21

Trial #	Pulse	Chirp (MHz)	Pulse Width (µS)	Pulse 1-2 spacing (uS)	Pulse 2-3 spacing (uS)	Pulse Start(S)	Detection (1:yes; 0:no)
0	2	5	86.8	1719		0.086813	1
1	1	5	70.1			0.670795	
2	3	5	70.7	1189	1663	1.402095	
3	1	5	57.5			2.135168	
4	3	5	82.5	1154	1756	2.620422	
5	2	5	98.7	1005		3.377614	
6	2	5	61.8	1471		3.9928	
7	1	5	73.4			4.652393	
8	1	5	79.5			5.14781	
9	3	5	73.9	1633	1999	5.500383	
10	2	5	56.7	1693		6.335304	
11	2	5	86.5	1267		7.189437	
12	2	5	78.4	1423		7.699972	
13	2	5	78.6	1112		8.061748	
14	1	5	82			8.91044	
15	2	5	83.3	1192		9.577531	
16	1	5	80.6			9.645627	
17	3	5	73.4	1730	1019	10.419423	
18	3	5	97.9	1577	1819	11.128692	
19	1	5	75.5			11.730155	

Bin5 Statistics 22

Trial #	Pulse	Chirp (MHz)	Pulse Width (µS)	Pulse 1-2 spacing (uS)	Pulse 2-3 spacing (uS)	Pulse Start(S)	Detection (1:yes; 0:no)
0	2	13	72.7	1463		0.632823	1
1	1	13	65.9			1.567657	
2	2	13	78.2	1545		1.805513	
3	1	13	71.9			2.719118	
4	3	13	96.5	1816	1869	4.032641	
5	3	13	71.2	1581	1994	4.489984	
6	1	13	82.8			5.873083	
7	2	13	98.3	1958		6.031855	
8	1	13	92.2			7.473551	
9	2	13	93.4	1207		8.367691	
10	2	13	96.5	1094		8.790788	
11	2	13	79.9	1038		9.896045	
12	2	13	66.8	1685		11.074833	
13	2	13	78.7	1259		11.981473	

Bin5 Statistics 23

Trial #	Pulse	Chirp (MHz)	Pulse Width (µS)	Pulse 1-2 spacing (uS)	Pulse 2-3 spacing (uS)	Pulse Start(S)	Detection (1:yes; 0:no)
0	2	9	92.5	1252		0.030869	1
1	2	9	79.3	1796		1.354315	
2	2	9	99.5	1808		2.031662	
3	1	9	96.8			2.738247	
4	2	9	78.6	1370		3.617671	
5	1	9	64.5			4.153137	
6	3	9	53.7	1170	1629	4.88949	
7	2	9	71.3	1374		5.273171	
8	2	9	99.6	1408		6.373183	
9	1	9	54.3			6.753595	
10	2	9	72.6	1183		7.601098	
11	3	9	59.9	1130	1894	8.68649	
12	2	9	87.8	1341		9.266332	
13	3	9	89	1806	1959	10.482858	
14	2	9	60.3	1282		10.51146	
15	1	9	56			11.490735	

Bin5 Statistics 24

Trial #	Pulse	Chirp (MHz)	Pulse Width (µS)	Pulse 1-2 spacing (uS)	Pulse 2-3 spacing (uS)	Pulse Start(S)	Detection (1:yes; 0:no)
0	3	12	77.7	1499	1567	0.938398	1
1	2	12	79.6	1905		2.208825	
2	2	12	71	1729		3.384649	
3	2	12	86.9	1631		4.726072	
4	2	12	67.1	1660		5.912773	
5	2	12	75.7	1183		6.989014	
6	3	12	72.5	1231	1580	7.272284	
7	2	12	97	1471		9.139571	
8	2	12	55.1	1798		10.023012	
9	3	12	77.6	1371	1744	11.72236	

Bin5 Statistics 25

Trial #	Pulse	Chirp (MHz)	Pulse Width (µS)	Pulse 1-2 spacing (uS)	Pulse 2-3 spacing (uS)	Pulse Start(S)	Detection (1:yes; 0:no)
0	2	8	62.2	1519		0.633372	1
1	2	8	54.4	1251		1.331733	
2	1	8	72.6			2.375279	
3	2	8	79.8	1996		3.116238	
4	2	8	69.5	1097		4.504414	
5	1	8	52.2			5.231322	
6	2	8	98	1285		6.752016	
7	2	8	86.1	1960		7.904825	
8	1	8	89.9			8.960542	
9	1	8	84.3			9.944572	
10	2	8	62.6	1714		10.1453	
11	2	8	76.5	1364		11.740405	

Bin5 Statistics 26

Trial #	Pulse	Chirp (MHz)	Pulse Width (µS)	Pulse 1-2 spacing (uS)	Pulse 2-3 spacing (uS)	Pulse Start(S)	Detection (1:yes; 0:no)
0	2	11	62.9	1949		0.772418	1
1	2	11	90.3	1974		2.626604	
2	1	11	57.2			3.416198	
3	3	11	62.7	1767	1666	4.963141	
4	1	11	86.3			5.953918	
5	2	11	70.7	1056		6.688623	
6	2	11	53	1627		8.367372	
7	2	11	93.3	1319		10.003765	
8	1	11	91.9			11.450308	

Bin5 Statistics 27

Trial #	Pulse	Chirp (MHz)	Pulse Width (µS)	Pulse 1-2 spacing (uS)	Pulse 2-3 spacing (uS)	Pulse Start(S)	Detection (1:yes; 0:no)
0	1	9	77.2			0.466948	1
1	2	9	77.8	1831		1.764928	
2	3	9	92.8	1874	1757	2.220157	
3	2	9	88.8	1464		3.914292	
4	3	9	92.1	1098	1680	4.482766	
5	2	9	60.9	1442		6.307654	
6	1	9	51.8			6.742592	
7	2	9	51.2	1406		8.312815	
8	2	9	83.5	1672		9.331287	
9	2	9	93.3	1863		10.21304	
10	2	9	73.5	1963		11.070565	

Bin5 Statistics 28

Trial #	Pulse	Chirp (MHz)	Pulse Width (µS)	Pulse 1-2 spacing (uS)	Pulse 2-3 spacing (uS)	Pulse Start(S)	Detection (1:yes; 0:no)
0	2	6	78.2	1076		1.058485	1
1	2	6	96.7	1028		1.804064	
2	2	6	67.9	1647		2.422315	
3	2	6	97.9	1639		4.383083	
4	1	6	72.2			5.249387	
5	2	6	98.3	1824		6.345109	
6	3	6	87.7	1558	1370	8.372228	
7	2	6	59.9	1105		9.266718	
8	1	6	75.1			10.535162	
9	2	6	80.4	1516		11.336471	

Bin5 Statistics 29

Trial #	Pulse	Chirp (MHz)	Pulse Width (µS)	Pulse 1-2 spacing (uS)	Pulse 2-3 spacing (uS)	Pulse Start(S)	Detection (1:yes; 0:no)
0	2	14	65.9	1965		1.150657	1
1	2	14	79.6	1725		2.012484	
2	2	14	73.4	1810		3.109089	
3	2	14	66	1981		4.108555	
4	1	14	82.3			5.966315	
5	2	14	92.2	1440		7.329976	
6	2	14	97.6	1155		8.279016	
7	3	14	66.3	1259	1679	9.912545	
8	2	14	55	1091		10.890486	

Bin5 Statistics 30

Trial #	Pulse	Chirp (MHz)	Pulse Width (µS)	Pulse 1-2 spacing (µS)	Pulse 2-3 spacing (µS)	Pulse Start(S)	Detection (1:yes; 0:no)
0	2	6	73.4	1990		0.194101	1
1	2	6	99.7	1977		1.140683	
2	1	6	78.7			1.966978	
3	1	6	86			2.198874	
4	2	6	73.8	1760		3.236859	
5	2	6	69	1752		3.606369	
6	3	6	97.9	1943	1591	4.590179	
7	2	6	94.5	1219		5.42471	
8	2	6	98	1195		5.940186	
9	3	6	81.8	1992	1978	6.958188	
10	3	6	84.7	1403	1145	7.25817	
11	3	6	72.5	1123	1978	8.071538	
12	1	6	98.1			8.971061	
13	2	6	53.5	1144		9.236443	
14	1	6	68.1			10.443678	
15	2	6	74.7	1302		11.176035	
16	1	6	93.8			11.969297	

Table-6 Radar Type 6 Statistical Performance

Trial #	Fc (MHz)	Pulse /Burst	Pulse Width (µS)	PRI (µs)	Detection (1:yes; 0:no)	Hopping Sequence
1	5270	9	1	333	1	5344.0, 5397.0, 5398.0, 5462.0, 5531.0, 5508.0, 5667.0, 5529.0, 5313.0, 5584.0, 5536.0, 5616.0, 5337.0, 5419.0, 5579.0, 5519.0, 5449.0, 5310.0, 5649.0, 5386.0, 5566.0, 5681.0, 5702.0, 5511.0, 5522.0, 5674.0, 5411.0, 5391.0, 5400.0, 5465.0, 5624.0, 5659.0, 5609.0, 5710.0, 5534.0, 5296.0, 5539.0, 5350.0, 5298.0, 5295.0, 5393.0, 5282.0, 5656.0, 5336.0, 5596.0, 5582.0, 5494.0, 5638.0, 5332.0, 5645.0, 5252.0, 5712.0, 5507.0, 5470.0, 5490.0, 5717.0, 5489.0, 5451.0, 5424.0, 5293.0, 5615.0, 5403.0, 5602.0, 5401.0, 5704.0, 5590.0, 5402.0, 5583.0, 5472.0, 5454.0, 5524.0, 5506.0, 5355.0, 5482.0, 5396.0, 5357.0, 5581.0, 5325.0, 5586.0, 5305.0, 5346.0, 5598.0, 5661.0, 5591.0, 5600.0, 5456.0, 5444.0, 5319.0, 5714.0, 5491.0, 5567.0, 5644.0, 5433.0, 5430.0, 5525.0, 5653.0, 5469.0, 5480.0, 5632.0, 5303.0 (number of hits: 2)
2	5270	9	1	333	1	5258.0, 5268.0, 5687.0, 5688.0, 5709.0, 5402.0, 5543.0, 5318.0, 5307.0, 5615.0, 5323.0, 5679.0, 5720.0, 5721.0, 5544.0, 5573.0, 5271.0, 5532.0, 5564.0, 5419.0, 5640.0, 5644.0, 5482.0, 5586.0, 5530.0, 5693.0, 5522.0, 5462.0, 5274.0, 5598.0, 5523.0, 5350.0, 5634.0, 5535.0, 5485.0, 5383.0, 5401.0, 5497.0, 5551.0, 5680.0, 5393.0, 5304.0, 5524.0, 5572.0, 5412.0, 5596.0, 5723.0, 5451.0, 5492.0, 5571.0, 5339.0, 5711.0, 5603.0, 5563.0, 5642.0, 5453.0, 5691.0, 5503.0, 5252.0, 5367.0, 5514.0, 5305.0, 5431.0, 5372.0, 5713.0, 5508.0, 5312.0, 5341.0, 5273.0, 5560.0, 5469.0, 5483.0, 5295.0, 5702.0, 5427.0, 5461.0, 5338.0, 5389.0, 5474.0, 5351.0, 5705.0, 5512.0, 5426.0, 5379.0, 5471.0, 5324.0, 5308.0, 5668.0, 5515.0, 5557.0, 5602.0, 5404.0, 5531.0, 5622.0, 5396.0, 5361.0, 5382.0, 5381.0, 5597.0, 5585.0 (number of hits: 6)
3	5270	9	1	333	1	5503.0, 5302.0, 5441.0, 5259.0, 5542.0, 5708.0, 5400.0, 5700.0, 5437.0, 5346.0, 5337.0, 5677.0, 5340.0, 5256.0, 5516.0, 5587.0, 5311.0, 5600.0, 5425.0, 5653.0, 5455.0, 5692.0, 5452.0, 5355.0, 5617.0, 5694.0, 5413.0, 5395.0, 5686.0, 5329.0, 5616.0, 5415.0, 5382.0, 5339.0, 5630.0, 5636.0, 5569.0, 5360.0, 5294.0, 5490.0, 5277.0, 5276.0, 5411.0, 5698.0, 5404.0, 5430.0, 5659.0, 5478.0, 5582.0, 5405.0, 5649.0, 5559.0, 5366.0, 5419.0, 5426.0,

						5624.0, 5412.0, 5292.0, 5538.0, 5264.0, 5449.0, 5563.0, 5451.0, 5481.0, 5458.0, 5285.0, 5253.0, 5306.0, 5647.0, 5579.0, 5648.0, 5685.0, 5512.0, 5328.0, 5514.0, 5628.0, 5655.0, 5500.0, 5520.0, 5385.0, 5568.0, 5718.0, 5551.0, 5410.0, 5595.0, 5252.0, 5269.0, 5432.0, 5377.0, 5613.0, 5521.0, 5345.0, 5501.0, 5652.0, 5301.0, 5367.0, 5605.0, 5633.0, 5436.0, 5634.0 (number of hits: 9)
4	5270	9	1	333	1	5704.0, 5393.0, 5579.0, 5633.0, 5492.0, 5646.0, 5630.0, 5285.0, 5341.0, 5410.0, 5627.0, 5582.0, 5302.0, 5406.0, 5255.0, 5412.0, 5452.0, 5588.0, 5715.0, 5421.0, 5372.0, 5570.0, 5515.0, 5427.0, 5550.0, 5621.0, 5615.0, 5485.0, 5597.0, 5439.0, 5457.0, 5688.0, 5474.0, 5494.0, 5361.0, 5719.0, 5461.0, 5599.0, 5388.0, 5682.0, 5306.0, 5270.0, 5529.0, 5258.0, 5663.0, 5354.0, 5598.0, 5407.0, 5265.0, 5444.0, 5600.0, 5592.0, 5394.0, 5617.0, 5434.0, 5483.0, 5670.0, 5626.0, 5374.0, 5319.0, 5375.0, 5585.0, 5673.0, 5336.0, 5544.0, 5355.0, 5416.0, 5631.0, 5591.0, 5607.0, 5716.0, 5273.0, 5493.0, 5577.0, 5380.0, 5286.0, 5251.0, 5703.0, 5405.0, 5383.0, 5654.0, 5713.0, 5561.0, 5399.0, 5259.0, 5611.0, 5658.0, 5707.0, 5700.0, 5446.0, 5386.0, 5648.0, 5396.0, 5534.0, 5263.0, 5542.0, 5440.0, 5676.0, 5569.0, 5563.0 (number of hits: 10)
5	5270	9	1	333	1	5257.0, 5460.0, 5493.0, 5399.0, 5389.0, 5474.0, 5273.0, 5376.0, 5600.0, 5365.0, 5457.0, 5302.0, 5684.0, 5588.0, 5391.0, 5482.0, 5701.0, 5252.0, 5388.0, 5362.0, 5402.0, 5251.0, 5363.0, 5573.0, 5548.0, 5498.0, 5571.0, 5449.0, 5677.0, 5517.0, 5711.0, 5623.0, 5599.0, 5513.0, 5619.0, 5491.0, 5337.0, 5401.0, 5276.0, 5585.0, 5440.0, 5698.0, 5542.0, 5355.0, 5603.0, 5317.0, 5278.0, 5360.0, 5667.0, 5669.0, 5455.0, 5520.0, 5549.0, 5309.0, 5657.0, 5461.0, 5543.0, 5499.0, 5488.0, 5521.0, 5315.0, 5258.0, 5375.0, 5262.0, 5381.0, 5327.0, 5703.0, 5328.0, 5633.0, 5398.0, 5719.0, 5509.0, 5597.0, 5436.0, 5598.0, 5563.0, 5675.0, 5354.0, 5550.0, 5348.0, 5267.0, 5514.0, 5545.0, 5265.0, 5285.0, 5575.0, 5562.0, 5428.0, 5290.0, 5403.0, 5344.0, 5453.0, 5546.0, 5590.0, 5329.0, 5353.0, 5325.0, 5681.0, 5393.0, 5316.0 (number of hits: 11)
6	5270	9	1	333	1	5502.0, 5633.0, 5344.0, 5711.0, 5373.0, 5714.0, 5333.0, 5393.0, 5401.0, 5721.0, 5512.0, 5647.0, 5531.0, 5267.0, 5489.0, 5552.0, 5580.0, 5597.0, 5363.0, 5326.0, 5415.0, 5336.0, 5670.0, 5677.0, 5648.0, 5652.0, 5283.0, 5369.0, 5483.0, 5508.0, 5343.0, 5565.0, 5386.0, 5705.0, 5693.0,

						5651.0, 5270.0, 5321.0, 5606.0, 5573.0, 5281.0, 5686.0, 5529.0, 5364.0, 5492.0, 5487.0, 5419.0, 5537.0, 5557.0, 5478.0, 5399.0, 5673.0, 5324.0, 5609.0, 5427.0, 5697.0, 5301.0, 5467.0, 5643.0, 5382.0, 5253.0, 5626.0, 5448.0, 5460.0, 5519.0, 5262.0, 5603.0, 5712.0, 5426.0, 5550.0, 5302.0, 5378.0, 5280.0, 5383.0, 5536.0, 5611.0, 5700.0, 5713.0, 5680.0, 5720.0, 5549.0, 5353.0, 5451.0, 5583.0, 5347.0, 5654.0, 5367.0, 5315.0, 5699.0, 5586.0, 5286.0, 5625.0, 5435.0, 5692.0, 5441.0, 5323.0, 5663.0, 5665.0, 5526.0, 5561.0 (number of hits: 8)
7	5270	9	1	333	1	5679.0, 5636.0, 5416.0, 5403.0, 5409.0, 5535.0, 5400.0, 5402.0, 5500.0, 5695.0, 5523.0, 5648.0, 5320.0, 5681.0, 5703.0, 5414.0, 5688.0, 5262.0, 5381.0, 5304.0, 5558.0, 5475.0, 5611.0, 5457.0, 5529.0, 5360.0, 5705.0, 5565.0, 5598.0, 5654.0, 5401.0, 5570.0, 5588.0, 5625.0, 5521.0, 5609.0, 5487.0, 5405.0, 5435.0, 5257.0, 5511.0, 5584.0, 5545.0, 5701.0, 5312.0, 5637.0, 5537.0, 5436.0, 5530.0, 5501.0, 5498.0, 5473.0, 5429.0, 5492.0, 5315.0, 5687.0, 5481.0, 5480.0, 5574.0, 5579.0, 5702.0, 5390.0, 5673.0, 5313.0, 5425.0, 5447.0, 5297.0, 5690.0, 5586.0, 5697.0, 5489.0, 5513.0, 5254.0, 5507.0, 5421.0, 5721.0, 5708.0, 5440.0, 5655.0, 5293.0, 5548.0, 5319.0, 5711.0, 5283.0, 5506.0, 5624.0, 5439.0, 5271.0, 5342.0, 5366.0, 5364.0, 5651.0, 5706.0, 5367.0, 5383.0, 5362.0, 5665.0, 5539.0, 5441.0, 5645.0 (number of hits: 5)
8	5270	9	1	333	1	5311.0, 5282.0, 5394.0, 5461.0, 5309.0, 5550.0, 5402.0, 5403.0, 5560.0, 5474.0, 5471.0, 5289.0, 5649.0, 5570.0, 5400.0, 5673.0, 5342.0, 5710.0, 5679.0, 5527.0, 5437.0, 5714.0, 5270.0, 5470.0, 5250.0, 5439.0, 5392.0, 5356.0, 5545.0, 5417.0, 5338.0, 5580.0, 5458.0, 5292.0, 5603.0, 5278.0, 5343.0, 5296.0, 5277.0, 5711.0, 5472.0, 5307.0, 5533.0, 5418.0, 5273.0, 5511.0, 5523.0, 5634.0, 5589.0, 5328.0, 5262.0, 5652.0, 5619.0, 5433.0, 5434.0, 5510.0, 5303.0, 5707.0, 5540.0, 5361.0, 5304.0, 5697.0, 5659.0, 5576.0, 5401.0, 5612.0, 5700.0, 5367.0, 5454.0, 5357.0, 5579.0, 5473.0, 5276.0, 5382.0, 5672.0, 5337.0, 5556.0, 5479.0, 5310.0, 5512.0, 5359.0, 5543.0, 5429.0, 5670.0, 5348.0, 5363.0, 5555.0, 5541.0, 5658.0, 5281.0, 5681.0, 5406.0, 5252.0, 5607.0, 5463.0, 5647.0, 5272.0, 5601.0, 5564.0, 5583.0 (number of hits: 12)
9	5270	9	1	333	1	5465.0, 5329.0, 5392.0, 5574.0, 5558.0, 5539.0, 5665.0, 5347.0, 5331.0, 5279.0, 5326.0, 5361.0, 5591.0, 5677.0, 5422.0,

						5585.0, 5724.0, 5296.0, 5550.0, 5681.0, 5611.0, 5484.0, 5659.0, 5537.0, 5417.0, 5380.0, 5661.0, 5349.0, 5403.0, 5255.0, 5502.0, 5540.0, 5350.0, 5288.0, 5529.0, 5442.0, 5389.0, 5325.0, 5469.0, 5306.0, 5437.0, 5616.0, 5322.0, 5355.0, 5432.0, 5610.0, 5541.0, 5491.0, 5621.0, 5651.0, 5544.0, 5515.0, 5421.0, 5679.0, 5277.0, 5481.0, 5407.0, 5506.0, 5352.0, 5572.0, 5471.0, 5274.0, 5459.0, 5617.0, 5321.0, 5508.0, 5700.0, 5672.0, 5435.0, 5500.0, 5595.0, 5637.0, 5504.0, 5694.0, 5511.0, 5412.0, 5443.0, 5589.0, 5263.0, 5292.0, 5483.0, 5445.0, 5645.0, 5299.0, 5341.0, 5275.0, 5308.0, 5627.0, 5386.0, 5717.0, 5633.0, 5612.0, 5454.0, 5343.0, 5410.0, 5498.0, 5266.0, 5441.0, 5582.0, 5548.0 (number of hits: 8)
10	5270	9	1	333	1	5304.0, 5281.0, 5325.0, 5379.0, 5462.0, 5376.0, 5453.0, 5709.0, 5685.0, 5350.0, 5695.0, 5451.0, 5629.0, 5463.0, 5481.0, 5380.0, 5563.0, 5268.0, 5472.0, 5264.0, 5621.0, 5540.0, 5652.0, 5483.0, 5267.0, 5658.0, 5314.0, 5401.0, 5650.0, 5306.0, 5565.0, 5618.0, 5567.0, 5329.0, 5479.0, 5688.0, 5528.0, 5395.0, 5425.0, 5449.0, 5430.0, 5627.0, 5489.0, 5282.0, 5561.0, 5712.0, 5548.0, 5665.0, 5681.0, 5295.0, 5655.0, 5581.0, 5507.0, 5276.0, 5374.0, 5716.0, 5310.0, 5327.0, 5292.0, 5414.0, 5603.0, 5630.0, 5470.0, 5587.0, 5501.0, 5461.0, 5595.0, 5297.0, 5266.0, 5616.0, 5280.0, 5277.0, 5403.0, 5559.0, 5707.0, 5592.0, 5251.0, 5253.0, 5356.0, 5444.0, 5605.0, 5435.0, 5575.0, 5475.0, 5397.0, 5290.0, 5468.0, 5448.0, 5394.0, 5464.0, 5358.0, 5557.0, 5717.0, 5612.0, 5399.0, 5691.0, 5288.0, 5355.0, 5702.0, 5317.0 (number of hits: 12)
11	5270	9	1	333	1	5398.0, 5656.0, 5254.0, 5639.0, 5271.0, 5420.0, 5443.0, 5480.0, 5720.0, 5719.0, 5433.0, 5294.0, 5323.0, 5581.0, 5297.0, 5448.0, 5705.0, 5505.0, 5334.0, 5400.0, 5470.0, 5283.0, 5388.0, 5658.0, 5578.0, 5676.0, 5569.0, 5252.0, 5716.0, 5590.0, 5682.0, 5360.0, 5552.0, 5555.0, 5272.0, 5528.0, 5371.0, 5472.0, 5318.0, 5674.0, 5446.0, 5307.0, 5721.0, 5540.0, 5369.0, 5426.0, 5501.0, 5439.0, 5515.0, 5494.0, 5645.0, 5326.0, 5314.0, 5508.0, 5399.0, 5385.0, 5427.0, 5600.0, 5265.0, 5545.0, 5635.0, 5534.0, 5611.0, 5643.0, 5257.0, 5541.0, 5642.0, 5497.0, 5337.0, 5293.0, 5623.0, 5678.0, 5377.0, 5411.0, 5527.0, 5339.0, 5436.0, 5662.0, 5594.0, 5490.0, 5264.0, 5251.0, 5402.0, 5289.0, 5367.0, 5631.0, 5288.0, 5321.0, 5463.0, 5626.0, 5263.0, 5507.0, 5574.0, 5269.0, 5395.0, 5354.0, 5663.0, 5262.0, 5273.0, 5454.0

						(number of hits: 15)
12	5270	9	1	333	1	5477.0, 5263.0, 5344.0, 5465.0, 5539.0, 5475.0, 5366.0, 5290.0, 5330.0, 5493.0, 5671.0, 5683.0, 5601.0, 5349.0, 5634.0, 5716.0, 5554.0, 5270.0, 5258.0, 5707.0, 5603.0, 5706.0, 5449.0, 5491.0, 5666.0, 5677.0, 5639.0, 5533.0, 5580.0, 5443.0, 5450.0, 5721.0, 5661.0, 5416.0, 5378.0, 5522.0, 5382.0, 5339.0, 5351.0, 5318.0, 5281.0, 5502.0, 5535.0, 5470.0, 5350.0, 5372.0, 5530.0, 5602.0, 5395.0, 5630.0, 5597.0, 5558.0, 5600.0, 5286.0, 5315.0, 5471.0, 5578.0, 5323.0, 5575.0, 5387.0, 5524.0, 5396.0, 5658.0, 5476.0, 5432.0, 5643.0, 5368.0, 5386.0, 5684.0, 5337.0, 5590.0, 5302.0, 5717.0, 5565.0, 5365.0, 5367.0, 5274.0, 5406.0, 5654.0, 5511.0, 5664.0, 5361.0, 5392.0, 5547.0, 5295.0, 5422.0, 5611.0, 5347.0, 5621.0, 5615.0, 5679.0, 5271.0, 5289.0, 5685.0, 5501.0, 5407.0, 5576.0, 5426.0, 5618.0, 5297.0
						(number of hits: 8)
13	5270	9	1	333	1	5569.0, 5588.0, 5433.0, 5318.0, 5360.0, 5598.0, 5638.0, 5587.0, 5278.0, 5672.0, 5451.0, 5378.0, 5590.0, 5586.0, 5581.0, 5354.0, 5394.0, 5462.0, 5391.0, 5342.0, 5392.0, 5610.0, 5325.0, 5560.0, 5567.0, 5573.0, 5628.0, 5674.0, 5660.0, 5341.0, 5654.0, 5503.0, 5529.0, 5437.0, 5346.0, 5605.0, 5377.0, 5698.0, 5688.0, 5314.0, 5632.0, 5597.0, 5319.0, 5333.0, 5361.0, 5254.0, 5591.0, 5381.0, 5405.0, 5496.0, 5631.0, 5336.0, 5389.0, 5441.0, 5499.0, 5272.0, 5382.0, 5706.0, 5255.0, 5293.0, 5670.0, 5683.0, 5373.0, 5584.0, 5463.0, 5649.0, 5484.0, 5271.0, 5436.0, 5379.0, 5397.0, 5545.0, 5284.0, 5421.0, 5444.0, 5509.0, 5658.0, 5666.0, 5539.0, 5288.0, 5323.0, 5442.0, 5616.0, 5533.0, 5603.0, 5334.0, 5268.0, 5458.0, 5494.0, 5363.0, 5659.0, 5510.0, 5559.0, 5417.0, 5579.0, 5554.0, 5425.0, 5264.0, 5574.0, 5329.0
						(number of hits: 9)
14	5270	9	1	333	1	5353.0, 5370.0, 5356.0, 5715.0, 5406.0, 5499.0, 5714.0, 5615.0, 5349.0, 5269.0, 5319.0, 5434.0, 5311.0, 5385.0, 5474.0, 5424.0, 5276.0, 5566.0, 5389.0, 5592.0, 5463.0, 5626.0, 5518.0, 5288.0, 5524.0, 5361.0, 5450.0, 5554.0, 5320.0, 5280.0, 5422.0, 5661.0, 5417.0, 5493.0, 5535.0, 5544.0, 5700.0, 5657.0, 5294.0, 5549.0, 5347.0, 5362.0, 5509.0, 5388.0, 5642.0, 5261.0, 5632.0, 5620.0, 5318.0, 5274.0, 5298.0, 5563.0, 5339.0, 5291.0, 5637.0, 5624.0, 5510.0, 5690.0, 5367.0, 5281.0, 5567.0, 5621.0, 5285.0, 5409.0, 5397.0, 5627.0, 5584.0, 5682.0, 5449.0, 5696.0, 5286.0, 5531.0, 5445.0, 5268.0, 5664.0, 5350.0, 5458.0, 5533.0, 5492.0, 5597.0,

						5464.0, 5555.0, 5378.0, 5641.0, 5571.0, 5525.0, 5468.0, 5472.0, 5670.0, 5270.0, 5334.0, 5289.0, 5689.0, 5703.0, 5433.0, 5645.0, 5695.0, 5606.0, 5508.0, 5267.0 (number of hits: 13)
15	5270	9	1	333	1	5338.0, 5406.0, 5475.0, 5686.0, 5712.0, 5627.0, 5614.0, 5651.0, 5646.0, 5368.0, 5440.0, 5381.0, 5715.0, 5318.0, 5662.0, 5558.0, 5609.0, 5599.0, 5397.0, 5261.0, 5376.0, 5251.0, 5635.0, 5474.0, 5290.0, 5365.0, 5709.0, 5708.0, 5334.0, 5383.0, 5324.0, 5565.0, 5496.0, 5404.0, 5659.0, 5601.0, 5624.0, 5503.0, 5550.0, 5322.0, 5618.0, 5433.0, 5655.0, 5592.0, 5680.0, 5705.0, 5260.0, 5562.0, 5431.0, 5678.0, 5676.0, 5577.0, 5681.0, 5446.0, 5484.0, 5464.0, 5459.0, 5391.0, 5398.0, 5328.0, 5399.0, 5665.0, 5288.0, 5539.0, 5385.0, 5702.0, 5485.0, 5532.0, 5587.0, 5653.0, 5645.0, 5315.0, 5568.0, 5567.0, 5518.0, 5571.0, 5600.0, 5450.0, 5268.0, 5321.0, 5591.0, 5590.0, 5585.0, 5386.0, 5617.0, 5437.0, 5313.0, 5405.0, 5254.0, 5460.0, 5354.0, 5442.0, 5250.0, 5280.0, 5430.0, 5538.0, 5479.0, 5516.0, 5452.0, 5402.0 (number of hits: 8)
16	5270	9	1	333	1	5415.0, 5273.0, 5436.0, 5305.0, 5345.0, 5515.0, 5456.0, 5452.0, 5346.0, 5534.0, 5558.0, 5683.0, 5307.0, 5404.0, 5640.0, 5623.0, 5364.0, 5260.0, 5411.0, 5530.0, 5543.0, 5437.0, 5594.0, 5724.0, 5717.0, 5403.0, 5525.0, 5298.0, 5280.0, 5701.0, 5370.0, 5523.0, 5577.0, 5368.0, 5312.0, 5644.0, 5718.0, 5539.0, 5656.0, 5513.0, 5292.0, 5529.0, 5499.0, 5484.0, 5253.0, 5335.0, 5257.0, 5680.0, 5279.0, 5361.0, 5301.0, 5578.0, 5557.0, 5479.0, 5413.0, 5642.0, 5494.0, 5606.0, 5299.0, 5672.0, 5643.0, 5496.0, 5585.0, 5540.0, 5504.0, 5476.0, 5519.0, 5333.0, 5674.0, 5269.0, 5689.0, 5382.0, 5570.0, 5617.0, 5355.0, 5291.0, 5372.0, 5641.0, 5564.0, 5584.0, 5464.0, 5296.0, 5688.0, 5488.0, 5511.0, 5682.0, 5448.0, 5635.0, 5297.0, 5677.0, 5315.0, 5444.0, 5620.0, 5626.0, 5396.0, 5384.0, 5393.0, 5381.0, 5263.0, 5310.0 (number of hits: 8)
17	5270	9	1	333	1	5686.0, 5632.0, 5477.0, 5665.0, 5374.0, 5380.0, 5487.0, 5625.0, 5619.0, 5664.0, 5326.0, 5282.0, 5276.0, 5337.0, 5683.0, 5349.0, 5327.0, 5379.0, 5582.0, 5483.0, 5292.0, 5264.0, 5289.0, 5484.0, 5433.0, 5277.0, 5270.0, 5350.0, 5311.0, 5694.0, 5259.0, 5537.0, 5400.0, 5437.0, 5651.0, 5586.0, 5375.0, 5468.0, 5462.0, 5540.0, 5279.0, 5368.0, 5298.0, 5358.0, 5673.0, 5423.0, 5448.0, 5677.0, 5590.0, 5397.0, 5481.0, 5528.0, 5432.0, 5640.0, 5410.0, 5268.0, 5365.0, 5357.0, 5597.0, 5312.0,

						5523.0, 5638.0, 5543.0, 5370.0, 5362.0, 5660.0, 5413.0, 5558.0, 5347.0, 5431.0, 5302.0, 5622.0, 5584.0, 5295.0, 5610.0, 5588.0, 5538.0, 5530.0, 5583.0, 5353.0, 5402.0, 5388.0, 5346.0, 5507.0, 5609.0, 5674.0, 5426.0, 5383.0, 5309.0, 5267.0, 5594.0, 5485.0, 5273.0, 5576.0, 5283.0, 5614.0, 5254.0, 5641.0, 5517.0, 5600.0 (number of hits: 13)
18	5270	9	1	333	1	5687.0, 5312.0, 5716.0, 5583.0, 5388.0, 5607.0, 5617.0, 5446.0, 5660.0, 5657.0, 5522.0, 5370.0, 5474.0, 5447.0, 5671.0, 5285.0, 5442.0, 5434.0, 5393.0, 5531.0, 5629.0, 5324.0, 5516.0, 5335.0, 5513.0, 5639.0, 5387.0, 5691.0, 5499.0, 5276.0, 5719.0, 5724.0, 5405.0, 5706.0, 5647.0, 5582.0, 5541.0, 5571.0, 5669.0, 5323.0, 5696.0, 5564.0, 5641.0, 5554.0, 5332.0, 5337.0, 5302.0, 5271.0, 5321.0, 5683.0, 5450.0, 5601.0, 5701.0, 5402.0, 5675.0, 5545.0, 5655.0, 5385.0, 5680.0, 5277.0, 5400.0, 5342.0, 5407.0, 5380.0, 5394.0, 5299.0, 5452.0, 5661.0, 5396.0, 5576.0, 5320.0, 5537.0, 5591.0, 5581.0, 5521.0, 5460.0, 5628.0, 5681.0, 5510.0, 5613.0, 5580.0, 5508.0, 5642.0, 5682.0, 5713.0, 5631.0, 5317.0, 5618.0, 5692.0, 5426.0, 5653.0, 5676.0, 5664.0, 5283.0, 5720.0, 5549.0, 5383.0, 5379.0, 5484.0, 5722.0 (number of hits: 5)
19	5270	9	1	333	1	5671.0, 5618.0, 5723.0, 5497.0, 5585.0, 5298.0, 5592.0, 5711.0, 5531.0, 5550.0, 5551.0, 5306.0, 5426.0, 5546.0, 5384.0, 5270.0, 5623.0, 5482.0, 5519.0, 5416.0, 5331.0, 5293.0, 5516.0, 5670.0, 5323.0, 5523.0, 5308.0, 5649.0, 5464.0, 5485.0, 5402.0, 5471.0, 5593.0, 5373.0, 5525.0, 5566.0, 5554.0, 5336.0, 5440.0, 5673.0, 5363.0, 5661.0, 5577.0, 5534.0, 5486.0, 5362.0, 5277.0, 5484.0, 5596.0, 5692.0, 5507.0, 5630.0, 5707.0, 5501.0, 5536.0, 5710.0, 5500.0, 5267.0, 5398.0, 5724.0, 5435.0, 5608.0, 5289.0, 5527.0, 5511.0, 5541.0, 5299.0, 5495.0, 5370.0, 5328.0, 5688.0, 5549.0, 5396.0, 5607.0, 5327.0, 5481.0, 5260.0, 5457.0, 5262.0, 5612.0, 5258.0, 5403.0, 5601.0, 5520.0, 5359.0, 5600.0, 5698.0, 5700.0, 5319.0, 5595.0, 5647.0, 5345.0, 5694.0, 5411.0, 5410.0, 5615.0, 5456.0, 5286.0, 5680.0, 5341.0 (number of hits: 8)
20	5270	9	1	333	1	5431.0, 5505.0, 5672.0, 5447.0, 5638.0, 5539.0, 5689.0, 5709.0, 5610.0, 5462.0, 5363.0, 5692.0, 5410.0, 5388.0, 5664.0, 5552.0, 5307.0, 5657.0, 5700.0, 5278.0, 5378.0, 5251.0, 5385.0, 5609.0, 5595.0, 5266.0, 5333.0, 5662.0, 5655.0, 5427.0, 5599.0, 5508.0, 5616.0, 5644.0, 5620.0, 5425.0, 5711.0, 5534.0, 5507.0, 5317.0,

						5724.0, 5613.0, 5514.0, 5547.0, 5371.0, 5660.0, 5533.0, 5563.0, 5632.0, 5619.0, 5678.0, 5435.0, 5420.0, 5375.0, 5519.0, 5643.0, 5484.0, 5650.0, 5524.0, 5589.0, 5604.0, 5562.0, 5415.0, 5569.0, 5403.0, 5481.0, 5451.0, 5448.0, 5684.0, 5640.0, 5319.0, 5471.0, 5267.0, 5582.0, 5274.0, 5704.0, 5628.0, 5474.0, 5270.0, 5417.0, 5677.0, 5688.0, 5659.0, 5699.0, 5706.0, 5422.0, 5281.0, 5503.0, 5389.0, 5473.0, 5330.0, 5591.0, 5624.0, 5269.0, 5707.0, 5652.0, 5694.0, 5548.0, 5482.0, 5290.0 (number of hits: 8)
21	5270	9	1	333	1	5705.0, 5605.0, 5582.0, 5334.0, 5278.0, 5612.0, 5390.0, 5432.0, 5571.0, 5314.0, 5597.0, 5505.0, 5547.0, 5426.0, 5707.0, 5354.0, 5631.0, 5467.0, 5363.0, 5578.0, 5621.0, 5671.0, 5512.0, 5538.0, 5476.0, 5256.0, 5454.0, 5466.0, 5529.0, 5266.0, 5297.0, 5567.0, 5647.0, 5501.0, 5688.0, 5344.0, 5460.0, 5393.0, 5588.0, 5570.0, 5546.0, 5598.0, 5488.0, 5615.0, 5498.0, 5489.0, 5338.0, 5434.0, 5660.0, 5365.0, 5579.0, 5591.0, 5638.0, 5254.0, 5470.0, 5522.0, 5345.0, 5387.0, 5280.0, 5403.0, 5382.0, 5527.0, 5268.0, 5275.0, 5568.0, 5282.0, 5717.0, 5703.0, 5331.0, 5601.0, 5417.0, 5650.0, 5402.0, 5623.0, 5430.0, 5383.0, 5394.0, 5670.0, 5415.0, 5524.0, 5718.0, 5702.0, 5652.0, 5380.0, 5267.0, 5445.0, 5676.0, 5694.0, 5436.0, 5649.0, 5364.0, 5681.0, 5482.0, 5662.0, 5265.0, 5438.0, 5551.0, 5289.0, 5674.0, 5327.0 (number of hits: 11)
22	5270	9	1	333	1	5541.0, 5681.0, 5694.0, 5403.0, 5602.0, 5435.0, 5434.0, 5616.0, 5574.0, 5392.0, 5677.0, 5458.0, 5571.0, 5512.0, 5590.0, 5424.0, 5595.0, 5546.0, 5327.0, 5699.0, 5374.0, 5444.0, 5302.0, 5297.0, 5562.0, 5505.0, 5474.0, 5294.0, 5273.0, 5274.0, 5529.0, 5628.0, 5720.0, 5408.0, 5494.0, 5450.0, 5717.0, 5585.0, 5685.0, 5269.0, 5261.0, 5502.0, 5416.0, 5465.0, 5414.0, 5289.0, 5286.0, 5631.0, 5511.0, 5298.0, 5438.0, 5538.0, 5515.0, 5385.0, 5666.0, 5389.0, 5564.0, 5617.0, 5466.0, 5509.0, 5561.0, 5320.0, 5644.0, 5334.0, 5555.0, 5639.0, 5510.0, 5328.0, 5410.0, 5285.0, 5337.0, 5322.0, 5309.0, 5300.0, 5661.0, 5702.0, 5613.0, 5439.0, 5525.0, 5267.0, 5476.0, 5664.0, 5378.0, 5572.0, 5671.0, 5405.0, 5672.0, 5712.0, 5624.0, 5409.0, 5312.0, 5257.0, 5422.0, 5440.0, 5503.0, 5463.0, 5703.0, 5506.0, 5610.0, 5276.0 (number of hits: 10)
23	5270	9	1	333	1	5435.0, 5423.0, 5672.0, 5526.0, 5337.0, 5324.0, 5262.0, 5459.0, 5608.0, 5270.0, 5554.0, 5697.0, 5412.0, 5489.0, 5468.0, 5572.0, 5633.0, 5444.0, 5493.0, 5431.0,

						5338.0, 5511.0, 5256.0, 5643.0, 5566.0, 5401.0, 5579.0, 5611.0, 5508.0, 5630.0, 5372.0, 5283.0, 5478.0, 5375.0, 5492.0, 5419.0, 5364.0, 5696.0, 5271.0, 5467.0, 5379.0, 5580.0, 5567.0, 5306.0, 5439.0, 5466.0, 5413.0, 5297.0, 5442.0, 5593.0, 5632.0, 5267.0, 5545.0, 5521.0, 5497.0, 5294.0, 5664.0, 5512.0, 5685.0, 5454.0, 5474.0, 5570.0, 5616.0, 5691.0, 5513.0, 5400.0, 5473.0, 5465.0, 5628.0, 5547.0, 5530.0, 5609.0, 5418.0, 5288.0, 5703.0, 5449.0, 5583.0, 5515.0, 5302.0, 5482.0, 5615.0, 5282.0, 5527.0, 5441.0, 5334.0, 5709.0, 5280.0, 5715.0, 5596.0, 5417.0, 5562.0, 5712.0, 5693.0, 5421.0, 5415.0, 5414.0, 5425.0, 5377.0, 5640.0, 5507.0 (number of hits: 9)
24	5270	9	1	333	1	5371.0, 5710.0, 5705.0, 5355.0, 5315.0, 5625.0, 5515.0, 5589.0, 5347.0, 5346.0, 5715.0, 5604.0, 5386.0, 5649.0, 5612.0, 5472.0, 5358.0, 5454.0, 5490.0, 5354.0, 5331.0, 5573.0, 5345.0, 5437.0, 5291.0, 5712.0, 5608.0, 5640.0, 5523.0, 5285.0, 5259.0, 5266.0, 5252.0, 5626.0, 5408.0, 5551.0, 5435.0, 5463.0, 5564.0, 5464.0, 5670.0, 5611.0, 5562.0, 5273.0, 5594.0, 5711.0, 5425.0, 5672.0, 5598.0, 5653.0, 5567.0, 5356.0, 5410.0, 5373.0, 5327.0, 5309.0, 5512.0, 5510.0, 5387.0, 5593.0, 5527.0, 5671.0, 5390.0, 5714.0, 5474.0, 5456.0, 5287.0, 5665.0, 5446.0, 5645.0, 5706.0, 5384.0, 5278.0, 5481.0, 5469.0, 5416.0, 5621.0, 5404.0, 5678.0, 5545.0, 5623.0, 5307.0, 5682.0, 5572.0, 5529.0, 5303.0, 5535.0, 5703.0, 5378.0, 5409.0, 5440.0, 5615.0, 5701.0, 5352.0, 5458.0, 5575.0, 5362.0, 5388.0, 5351.0, 5556.0 (number of hits: 7)
25	5270	9	1	333	1	5611.0, 5670.0, 5387.0, 5385.0, 5277.0, 5493.0, 5315.0, 5382.0, 5583.0, 5612.0, 5666.0, 5283.0, 5427.0, 5270.0, 5450.0, 5603.0, 5638.0, 5470.0, 5594.0, 5544.0, 5318.0, 5600.0, 5620.0, 5618.0, 5677.0, 5260.0, 5345.0, 5584.0, 5703.0, 5404.0, 5464.0, 5543.0, 5645.0, 5711.0, 5403.0, 5628.0, 5384.0, 5303.0, 5327.0, 5716.0, 5261.0, 5469.0, 5370.0, 5651.0, 5325.0, 5698.0, 5656.0, 5672.0, 5305.0, 5591.0, 5444.0, 5562.0, 5289.0, 5596.0, 5536.0, 5290.0, 5448.0, 5494.0, 5321.0, 5424.0, 5426.0, 5477.0, 5291.0, 5344.0, 5712.0, 5710.0, 5480.0, 5486.0, 5602.0, 5721.0, 5266.0, 5515.0, 5316.0, 5573.0, 5714.0, 5446.0, 5275.0, 5407.0, 5722.0, 5664.0, 5601.0, 5399.0, 5585.0, 5637.0, 5613.0, 5478.0, 5462.0, 5354.0, 5520.0, 5377.0, 5542.0, 5320.0, 5312.0, 5356.0, 5349.0, 5718.0, 5660.0, 5554.0, 5659.0, 5549.0 (number of hits: 8)

26	5270	9	1	333	1	<p>5479.0, 5631.0, 5550.0, 5707.0, 5290.0, 5721.0, 5444.0, 5548.0, 5419.0, 5563.0, 5350.0, 5416.0, 5278.0, 5572.0, 5358.0, 5319.0, 5514.0, 5543.0, 5361.0, 5507.0, 5628.0, 5362.0, 5447.0, 5661.0, 5614.0, 5571.0, 5669.0, 5414.0, 5427.0, 5352.0, 5501.0, 5379.0, 5521.0, 5393.0, 5545.0, 5574.0, 5522.0, 5595.0, 5492.0, 5688.0, 5259.0, 5380.0, 5667.0, 5678.0, 5262.0, 5580.0, 5252.0, 5434.0, 5409.0, 5456.0, 5368.0, 5500.0, 5491.0, 5321.0, 5703.0, 5370.0, 5371.0, 5342.0, 5275.0, 5613.0, 5324.0, 5625.0, 5651.0, 5692.0, 5299.0, 5422.0, 5552.0, 5340.0, 5682.0, 5473.0, 5677.0, 5518.0, 5634.0, 5485.0, 5659.0, 5315.0, 5702.0, 5622.0, 5666.0, 5597.0, 5633.0, 5357.0, 5576.0, 5649.0, 5648.0, 5632.0, 5513.0, 5608.0, 5604.0, 5658.0, 5359.0, 5309.0, 5337.0, 5304.0, 5420.0, 5439.0, 5258.0, 5314.0, 5394.0, 5537.0 (number of hits: 6)</p>
27	5270	9	1	333	1	<p>5388.0, 5673.0, 5296.0, 5322.0, 5265.0, 5292.0, 5263.0, 5622.0, 5437.0, 5320.0, 5347.0, 5330.0, 5670.0, 5443.0, 5545.0, 5385.0, 5285.0, 5488.0, 5342.0, 5662.0, 5363.0, 5535.0, 5631.0, 5381.0, 5635.0, 5663.0, 5696.0, 5645.0, 5719.0, 5459.0, 5720.0, 5548.0, 5377.0, 5441.0, 5637.0, 5616.0, 5477.0, 5355.0, 5697.0, 5394.0, 5417.0, 5349.0, 5520.0, 5560.0, 5298.0, 5669.0, 5703.0, 5448.0, 5668.0, 5301.0, 5273.0, 5529.0, 5356.0, 5283.0, 5639.0, 5573.0, 5551.0, 5533.0, 5270.0, 5549.0, 5411.0, 5510.0, 5618.0, 5558.0, 5499.0, 5694.0, 5708.0, 5404.0, 5369.0, 5536.0, 5255.0, 5308.0, 5370.0, 5528.0, 5276.0, 5599.0, 5723.0, 5581.0, 5648.0, 5476.0, 5471.0, 5586.0, 5557.0, 5641.0, 5515.0, 5339.0, 5624.0, 5646.0, 5430.0, 5610.0, 5500.0, 5315.0, 5583.0, 5561.0, 5613.0, 5367.0, 5497.0, 5413.0, 5564.0, 5425.0 (number of hits: 8)</p>
28	5270	9	1	333	1	<p>5567.0, 5289.0, 5386.0, 5301.0, 5690.0, 5444.0, 5533.0, 5499.0, 5619.0, 5360.0, 5481.0, 5719.0, 5708.0, 5472.0, 5581.0, 5359.0, 5653.0, 5651.0, 5299.0, 5605.0, 5659.0, 5436.0, 5300.0, 5348.0, 5487.0, 5479.0, 5617.0, 5270.0, 5697.0, 5398.0, 5410.0, 5445.0, 5649.0, 5266.0, 5466.0, 5441.0, 5370.0, 5473.0, 5374.0, 5501.0, 5576.0, 5407.0, 5720.0, 5532.0, 5467.0, 5500.0, 5463.0, 5327.0, 5313.0, 5275.0, 5601.0, 5346.0, 5379.0, 5536.0, 5419.0, 5545.0, 5353.0, 5614.0, 5365.0, 5560.0, 5516.0, 5518.0, 5666.0, 5261.0, 5538.0, 5351.0, 5411.0, 5604.0, 5388.0, 5589.0, 5676.0, 5663.0, 5355.0, 5428.0, 5408.0, 5336.0, 5434.0, 5378.0, 5274.0, 5383.0, 5339.0, 5465.0, 5644.0, 5577.0, 5345.0</p>

						5492.0, 5699.0, 5373.0, 5324.0, 5526.0, 5315.0, 5294.0, 5484.0, 5507.0, 5319.0, 5375.0, 5688.0, 5557.0, 5262.0, 5668.0 (number of hits: 7)
29	5270	9	1	333	1	5343.0, 5328.0, 5278.0, 5372.0, 5453.0, 5351.0, 5430.0, 5565.0, 5530.0, 5639.0, 5665.0, 5266.0, 5385.0, 5700.0, 5531.0, 5444.0, 5395.0, 5518.0, 5699.0, 5519.0, 5377.0, 5368.0, 5417.0, 5575.0, 5318.0, 5431.0, 5437.0, 5555.0, 5662.0, 5503.0, 5566.0, 5681.0, 5308.0, 5289.0, 5584.0, 5352.0, 5695.0, 5415.0, 5466.0, 5705.0, 5326.0, 5371.0, 5433.0, 5329.0, 5540.0, 5552.0, 5283.0, 5319.0, 5459.0, 5499.0, 5260.0, 5605.0, 5564.0, 5480.0, 5549.0, 5717.0, 5520.0, 5590.0, 5713.0, 5273.0, 5270.0, 5614.0, 5464.0, 5375.0, 5554.0, 5424.0, 5583.0, 5461.0, 5455.0, 5611.0, 5711.0, 5608.0, 5456.0, 5688.0, 5439.0, 5429.0, 5690.0, 5570.0, 5435.0, 5250.0, 5365.0, 5635.0, 5458.0, 5587.0, 5621.0, 5546.0, 5607.0, 5423.0, 5335.0, 5588.0, 5487.0, 5447.0, 5655.0, 5630.0, 5703.0, 5535.0, 5300.0, 5678.0, 5398.0, 5297.0 (number of hits: 8)
30	5270	9	1	333	1	5713.0, 5595.0, 5679.0, 5475.0, 5571.0, 5287.0, 5715.0, 5445.0, 5607.0, 5531.0, 5643.0, 5548.0, 5551.0, 5270.0, 5481.0, 5408.0, 5273.0, 5615.0, 5416.0, 5419.0, 5395.0, 5616.0, 5655.0, 5491.0, 5347.0, 5506.0, 5714.0, 5670.0, 5336.0, 5343.0, 5390.0, 5657.0, 5570.0, 5439.0, 5396.0, 5418.0, 5681.0, 5446.0, 5644.0, 5482.0, 5597.0, 5574.0, 5293.0, 5623.0, 5635.0, 5541.0, 5447.0, 5484.0, 5424.0, 5257.0, 5546.0, 5594.0, 5376.0, 5537.0, 5411.0, 5649.0, 5585.0, 5427.0, 5284.0, 5540.0, 5399.0, 5690.0, 5267.0, 5253.0, 5640.0, 5368.0, 5707.0, 5458.0, 5403.0, 5387.0, 5723.0, 5665.0, 5530.0, 5367.0, 5685.0, 5314.0, 5361.0, 5717.0, 5260.0, 5671.0, 5527.0, 5444.0, 5688.0, 5288.0, 5263.0, 5410.0, 5648.0, 5425.0, 5360.0, 5307.0, 5357.0, 5600.0, 5389.0, 5580.0, 5310.0, 5348.0, 5497.0, 5391.0, 5281.0, 5420.0 (number of hits: 11)

5290 MHz, 80 MHz Bandwidth

Radar Signal Type	Waveform/Trial Number	Detection (%)	Limit (%)	Pass/Fail
Type 1A/1B	30	100 %	60%	Pass
Type 2	30	100 %	60%	Pass
Type 3	30	100 %	60%	Pass
Type 4	30	100 %	60%	Pass
Aggregate (Type1 to 4)	120	100 %	80%	Pass
Type 5	30	93.3 %	80%	Pass
Type 6	30	100 %	70%	Pass

Please refer to the following statistical tables:

5290 MHz, 80 MHz Bandwidth**Table-1A/1B Radar Type 1A/1B Statistical Performance**

Trial #	Fc (MHz)	Pulse/Burst	Pulse Width (μS)	PRI (μs)	Detection (1:yes; 0:no)
1	5290	72	1	738	1
2	5290	95	1	558	1
3	5290	70	1	758	1
4	5290	92	1	578	1
5	5290	67	1	798	1
6	5290	63	1	838	1
7	5290	57	1	938	1
8	5290	67	1	798	1
9	5290	68	1	778	1
10	5290	78	1	678	1
11	5290	83	1	638	1
12	5290	95	1	558	1
13	5290	62	1	858	1
14	5290	59	1	898	1
15	5290	68	1	778	1
16	5290	85	1	624	1
17	5290	38	1	1404	1
18	5290	64	1	829	1
19	5290	18	1	2994	1
20	5290	58	1	910	1
21	5290	46	1	1159	1
22	5290	35	1	1544	1
23	5290	42	1	1261	1
24	5290	18	1	2996	1
25	5290	20	1	2644	1
26	5290	20	1	2745	1
27	5290	26	1	2048	1
28	5290	35	1	1510	1
29	5290	30	1	1802	1
30	5290	28	1	1917	1
Detection Percentage: 100 % (>60%)					

Table-2 Radar Type 2 Statistical Performance

Trial #	Fc (MHz)	Pulse/Burst	Pulse Width (μS)	PRI (μs)	Detection (1:yes; 0:no)
1	5290	27	5	178	1
2	5290	23	4.2	214	1
3	5290	24	1.8	178	1
4	5290	24	4.1	184	1
5	5290	28	2.4	185	1
6	5290	29	1.1	215	1
7	5290	29	1.8	213	1
8	5290	23	2.3	179	1
9	5290	29	1.1	154	1
10	5290	28	4.3	155	1
11	5290	28	4.4	230	1
12	5290	27	1.6	177	1
13	5290	27	3.2	189	1
14	5290	27	4.3	160	1
15	5290	28	4.7	210	1
16	5290	27	2.5	229	1
17	5290	23	3.8	204	1
18	5290	26	3.5	179	1
19	5290	23	4	219	1
20	5290	27	3.3	158	1
21	5290	23	5	199	1
22	5290	27	4.2	194	1
23	5290	27	3.8	205	1
24	5290	29	3.2	183	1
25	5290	26	2.8	178	1
26	5290	24	1.9	189	1
27	5290	29	1.7	229	1
28	5290	27	1.1	189	1
29	5290	27	2.5	185	1
30	5290	25	4.3	174	1
Detection Percentage: 100 % (>60%)					

Table-3 Radar Type 3 Statistical Performance

Trial #	Fc (MHz)	Pulse/Burst	Pulse Width (μS)	PRI (μs)	Detection (1:yes; 0:no)
1	5290	17	8.3	385	1
2	5290	17	8.6	234	1
3	5290	18	6.9	308	1
4	5290	17	7.4	346	1
5	5290	18	9	386	1
6	5290	16	10	421	1
7	5290	18	8.1	208	1
8	5290	16	8.9	272	1
9	5290	16	9.9	244	1
10	5290	17	8.2	401	1
11	5290	16	6.9	392	1
12	5290	16	6.4	440	1
13	5290	16	8.4	338	1
14	5290	18	7.4	249	1
15	5290	17	7.3	463	1
16	5290	17	6.9	212	1
17	5290	16	9.1	317	1
18	5290	16	6.6	344	1
19	5290	17	7.9	380	1
20	5290	17	9.8	353	1
21	5290	16	6.6	497	1
22	5290	17	7.6	378	1
23	5290	17	7.7	340	1
24	5290	18	9.2	492	1
25	5290	16	8.6	326	1
26	5290	16	8.1	284	1
27	5290	18	8.4	335	1
28	5290	17	9.5	236	1
29	5290	18	8.2	455	1
30	5290	17	7.6	329	1
Detection Percentage: 100 % (>60%)					

Table-4 Radar Type 4 Statistical Performance

Trial #	Fc (MHz)	Pulse/Burst	Pulse Width (μS)	PRI (μs)	Detection (1:yes; 0:no)
1	5290	14	14.2	282	1
2	5290	16	13.4	293	1
3	5290	14	14.8	217	1
4	5290	15	15.7	276	1
5	5290	16	16.9	462	1
6	5290	14	19.5	471	1
7	5290	15	19.4	280	1
8	5290	14	13.4	482	1
9	5290	16	16.6	304	1
10	5290	13	19.4	223	1
11	5290	15	12.9	267	1
12	5290	16	14.5	201	1
13	5290	15	11.6	460	1
14	5290	12	11.1	473	1
15	5290	16	16.4	313	1
16	5290	13	11.8	207	1
17	5290	14	19.7	332	1
18	5290	14	12.9	471	1
19	5290	15	11.3	365	1
20	5290	15	11.5	415	1
21	5290	14	14.7	463	1
22	5290	14	14.7	200	1
23	5290	16	20	438	1
24	5290	16	11.8	311	1
25	5290	14	14.3	385	1
26	5290	13	19.6	234	1
27	5290	14	16.6	464	1
28	5290	12	11.3	416	1
29	5290	13	12.7	341	1
30	5290	12	16	267	1
Detection Percentage: 100 % (>60%)					

Table-5 Radar Type 5 Statistical Performance

Trial #	Fc (MHz)	Detection (1:yes; 0:no)
1	5290	1
2	5290	1
3	5290	1
4	5290	1
5	5290	1
6	5290	1
7	5290	1
8	5290	1
9	5290	1
10	5290	1
11	5255	1
12	5258.2	1
13	5255	1
14	5256.6	1
15	5255	1
16	5257.4	1
17	5254.6	0
18	5253.8	1
19	5257	1
20	5253.4	1
21	5321.4	1
22	5323.4	0
23	5325.4	1
24	5323.8	1
25	5321.4	1
26	5325.4	1
27	5321.8	1
28	5327	1
29	5324.2	1
30	5325	1
Detection Percentage: 93.3 % (>80%)		

Bin5 Statistics 1

Trial #	Pulse	Chirp (MHz)	Pulse Width (µS)	Pulse 1-2 spacing (µS)	Pulse 2-3 spacing (µS)	Pulse Start(S)	Detection (1:yes; 0:no)
0	2	10	72.8	1805		0.271672	1
1	1	10	53.1			1.083774	
2	1	10	80			1.859692	
3	1	10	93.1			2.386387	
4	1	10	82.4			2.889624	
5	1	10	97.5			3.446878	
6	2	10	81.2	1227		4.317701	
7	2	10	72.7	1085		4.49921	
8	3	10	68.2	1069	1784	5.319134	
9	2	10	59	1611		5.886101	
10	2	10	79.6	1452		6.356185	
11	3	10	95.2	1272	1950	7.455614	
12	3	10	65.9	1420	1708	7.601808	
13	2	10	53.6	1368		8.332328	
14	3	10	71.9	1202	1463	8.98168	
15	3	10	79	1920	1038	9.510759	
16	1	10	90.7			10.23298	
17	1	10	71.3			11.244588	
18	2	10	58.1	1796		11.962848	

Bin5 Statistics 2

Trial #	Pulse	Chirp (MHz)	Pulse Width (µS)	Pulse 1-2 spacing (µS)	Pulse 2-3 spacing (µS)	Pulse Start(S)	Detection (1:yes; 0:no)
0	1	6	74.4			0.368499	1
1	2	6	51	1214		1.271136	
2	3	6	92.6	1366	1208	1.761617	
3	2	6	58.5	1730		3.372422	
4	2	6	55.9	1580		3.558651	
5	3	6	72.2	1240	1014	4.752791	
6	1	6	75.7			5.494529	
7	1	6	75.7			6.480355	
8	1	6	56.5			7.656682	
9	1	6	65			7.807645	
10	3	6	88.9	1441	1948	9.192323	
11	2	6	83.7	1742		10.012558	
12	2	6	51.1	1573		10.448097	
13	1	6	53			11.910963	

Bin5 Statistics 3

Trial #	Pulse	Chirp (MHz)	Pulse Width (µS)	Pulse 1-2 spacing (µS)	Pulse 2-3 spacing (µS)	Pulse Start(S)	Detection (1:yes; 0:no)
0	3	20	58.8	1285	1593	0.010303	1
1	2	20	66.6	1434		0.982117	
2	3	20	99.5	1040	1512	1.735224	
3	2	20	55.3	1566		3.331203	
4	2	20	71.9	1855		3.740121	
5	2	20	55.4	1223		4.965941	
6	2	20	81.1	1584		5.489778	
7	2	20	72	1782		6.385649	
8	2	20	93.3	1915		7.279711	
9	3	20	96.1	1207	1470	8.085113	
10	2	20	65.3	1152		9.113616	
11	2	20	59.5	1326		10.276141	
12	3	20	86.5	1213	1147	10.311169	
13	2	20	99.3	1737		11.732834	

Bin5 Statistics 4

Trial #	Pulse	Chirp (MHz)	Pulse Width (µS)	Pulse 1-2 spacing (µS)	Pulse 2-3 spacing (µS)	Pulse Start(S)	Detection (1:yes; 0:no)
0	3	8	60.3	1264	1851	0.530962	1
1	2	8	98.6	1663		1.383919	
2	2	8	66.9	1664		1.626414	
3	2	8	50.6	1857		3.160198	
4	2	8	71.4	1783		3.311752	
5	2	8	65.4	1724		4.340802	
6	1	8	65.7			5.165007	
7	2	8	51.9	1126		5.832288	
8	1	8	58			6.742021	
9	3	8	51.8	1518	1165	7.85368	
10	2	8	55.8	1949		8.322937	
11	2	8	91.9	1962		9.529768	
12	2	8	62	1541		9.849571	
13	3	8	71	1287	1987	10.563895	
14	2	8	93.4	1764		11.60674	

Bin5 Statistics 5

Trial #	Pulse	Chirp (MHz)	Pulse Width (µS)	Pulse 1-2 spacing (uS)	Pulse 2-3 spacing (uS)	Pulse Start(S)	Detection (1:yes; 0:no)
0	2	15	81.9	1701		0.651427	1
1	2	15	68.5	1086		1.674473	
2	2	15	81.2	1828		2.551433	
3	1	15	78.5			2.816638	
4	2	15	95.6	1194		3.886744	
5	2	15	54.3	1993		4.765264	
6	3	15	60.7	1866	1528	5.713701	
7	2	15	54.1	1529		6.098236	
8	3	15	85.9	1176	1577	6.91785	
9	1	15	83.5			7.985836	
10	2	15	76	1419		8.610969	
11	2	15	57	1711		9.569278	
12	1	15	64.6			10.357956	
13	3	15	53	1703	1533	11.248541	

Bin5 Statistics 6

Trial #	Pulse	Chirp (MHz)	Pulse Width (µS)	Pulse 1-2 spacing (uS)	Pulse 2-3 spacing (uS)	Pulse Start(S)	Detection (1:yes; 0:no)
0	3	9	67.5	1750	1879	0.356736	1
1	1	9	90.6			1.136048	
2	2	9	73.4	1257		1.7207	
3	2	9	94.8	1252		2.078336	
4	2	9	98.5	1987		2.849209	
5	2	9	62.3	1163		3.925966	
6	2	9	71.1	1974		4.274803	
7	1	9	94.3			4.968827	
8	1	9	89.1			5.553249	
9	3	9	61.1	1981	1252	6.647473	
10	2	9	85.2	1966		6.914147	
11	3	9	63.5	1357	1071	7.972242	
12	3	9	63	1935	1099	8.029969	
13	2	9	54.9	1606		8.971181	
14	3	9	92.9	1634	1963	9.823853	
15	1	9	75.4			10.051604	
16	1	9	51.3			11.005666	
17	2	9	65.1	1607		11.589864	

Bin5 Statistics 7

Trial #	Pulse	Chirp (MHz)	Pulse Width (µS)	Pulse 1-2 spacing (µS)	Pulse 2-3 spacing (µS)	Pulse Start(S)	Detection (1:yes; 0:no)
0	2	7	98.3	1133		0.607411	1
1	3	7	71.4	1383	1222	1.283289	
2	2	7	88.9	1415		1.536213	
3	1	7	99.7			2.901905	
4	3	7	81.6	1201	1257	3.68545	
5	3	7	95.3	1058	1234	3.76265	
6	1	7	93			4.682738	
7	2	7	80	1990		5.292227	
8	2	7	88.1	1151		6.602537	
9	2	7	56.3	1489		7.40115	
10	2	7	94.7	1166		7.889347	
11	2	7	78.4	1165		8.566743	
12	1	7	78.7			9.228314	
13	2	7	70.6	1145		9.866901	
14	1	7	70.8			10.582507	
15	2	7	64.6	1527		11.398711	

Bin5 Statistics 8

Trial #	Pulse	Chirp (MHz)	Pulse Width (µS)	Pulse 1-2 spacing (µS)	Pulse 2-3 spacing (µS)	Pulse Start(S)	Detection (1:yes; 0:no)
0	2	14	77	1264		0.094879	1
1	1	14	68.9			0.911432	
2	2	14	72.1	1752		2.181233	
3	3	14	94.1	1362	1165	3.14056	
4	3	14	68.1	1799	1353	3.825756	
5	2	14	56.6	1508		4.788704	
6	3	14	84.4	1332	1353	5.144472	
7	2	14	60.5	1024		5.982903	
8	3	14	50.8	1422	1207	7.059179	
9	3	14	54.6	1547	1726	7.608103	
10	3	14	67.6	1355	1028	8.171669	
11	2	14	78.1	1145		9.024409	
12	3	14	83.2	1202	1278	10.193173	
13	1	14	56.5			10.653964	
14	3	14	71.6	1192	1175	11.697036	

Bin5 Statistics 9

Trial #	Pulse	Chirp (MHz)	Pulse Width (µS)	Pulse 1-2 spacing (uS)	Pulse 2-3 spacing (uS)	Pulse Start(S)	Detection (1:yes; 0:no)
0	2	14	88.9	1749		0.256188	1
1	2	14	73.3	1609		1.627126	
2	2	14	70.7	1039		2.202684	
3	1	14	51			3.152002	
4	3	14	57.3	1791	1040	4.549445	
5	2	14	90.5	1548		5.320046	
6	2	14	62.1	1436		6.356411	
7	1	14	61.3			7.021336	
8	3	14	68.7	1069	1279	8.194123	
9	2	14	75	1638		8.71612	
10	3	14	75.5	1730	1235	9.434654	
11	2	14	95.1	1506		10.746918	
12	3	14	88.9	1081	1389	11.649149	

Bin5 Statistics 10

Trial #	Pulse	Chirp (MHz)	Pulse Width (µS)	Pulse 1-2 spacing (uS)	Pulse 2-3 spacing (uS)	Pulse Start(S)	Detection (1:yes; 0:no)
0	3	16	86.5	1800	1134	0.624151	1
1	2	16	82.4	1862		1.917952	
2	2	16	72.5	1535		3.439528	
3	1	16	71.3			3.980188	
4	3	16	67.6	1309	1560	5.460602	
5	2	16	66.5	1910		6.765503	
6	2	16	93.4	1684		7.789983	
7	1	16	53.4			8.428168	
8	2	16	62.3	1668		10.229459	
9	2	16	58	1454		11.795432	

Bin5 Statistics 11

Trial #	Pulse	Chirp (MHz)	Pulse Width (µS)	Pulse 1-2 spacing (µS)	Pulse 2-3 spacing (µS)	Pulse Start(S)	Detection (1:yes; 0:no)
0	2	10	85.7	1053		0.131504	1
1	2	10	69.1	1376		1.175606	
2	2	10	81.3	1978		1.643453	
3	3	10	59.7	1114	1662	3.018051	
4	2	10	60.4	1297		3.298088	
5	2	10	62.2	1186		4.458143	
6	1	10	73.3			5.369144	
7	2	10	57.7	1476		6.368911	
8	3	10	66.5	1415	1435	7.04501	
9	1	10	50.8			7.839157	
10	1	10	93.3			8.321568	
11	2	10	54.4	1549		8.804385	
12	1	10	79.4			10.071927	
13	2	10	80.6	1654		10.569676	
14	3	10	58.9	1759	1708	11.304602	

Bin5 Statistics 12

Trial #	Pulse	Chirp (MHz)	Pulse Width (µS)	Pulse 1-2 spacing (µS)	Pulse 2-3 spacing (µS)	Pulse Start(S)	Detection (1:yes; 0:no)
0	2	18	53.4	1805		0.530958	1
1	2	18	79.9	1189		0.852355	
2	2	18	84.2	1694		1.662592	
3	1	18	95.6			2.63398	
4	2	18	84.9	1457		3.214143	
5	1	18	69.4			3.995693	
6	1	18	58.9			4.273505	
7	3	18	95.1	1104	1805	4.835799	
8	3	18	78.5	1888	1303	5.53955	
9	3	18	67	1494	1915	6.21601	
10	2	18	57	1337		7.282281	
11	1	18	66.1			7.853864	
12	2	18	65.4	1115		8.317169	
13	2	18	52.8	1267		8.979069	
14	3	18	74.3	1082	1360	9.489265	
15	2	18	65.9	1911		10.001336	
16	2	18	90.2	1222		10.779766	
17	2	18	59.3	1846		11.812502	

Bin5 Statistics 13

Trial #	Pulse	Chirp (MHz)	Pulse Width (µS)	Pulse 1-2 spacing (uS)	Pulse 2-3 spacing (uS)	Pulse Start(S)	Detection (1:yes; 0:no)
0	2	10	75.1	1275		0.510185	1
1	2	10	70	1705		1.928641	
2	1	10	73.2			3.071603	
3	3	10	84.7	1298	1744	4.632455	
4	2	10	92.7	1699		5.697634	
5	1	10	56.2			6.952961	
6	3	10	62.6	1261	1329	8.298893	
7	2	10	90.3	1013		9.411507	
8	2	10	83.7	1648		11.215346	

Bin5 Statistics 14

Trial #	Pulse	Chirp (MHz)	Pulse Width (µS)	Pulse 1-2 spacing (uS)	Pulse 2-3 spacing (uS)	Pulse Start(S)	Detection (1:yes; 0:no)
0	3	14	96.2	1352	1804	0.221082	1
1	2	14	70.1	1744		1.040904	
2	1	14	79.3			1.881075	
3	2	14	88.8	1469		1.940312	
4	1	14	68			2.688323	
5	1	14	67.3			3.699956	
6	2	14	89.3	1278		4.299167	
7	1	14	69.6			4.618517	
8	2	14	54.5	1989		5.462914	
9	2	14	75.6	1662		6.24284	
10	2	14	57.4	1812		6.640198	
11	2	14	66.2	1269		7.234902	
12	1	14	57.6			7.967686	
13	2	14	87.2	1800		8.337691	
14	2	14	57.3	1773		8.867887	
15	2	14	56	1117		9.83082	
16	2	14	61.7	1330		10.731155	
17	3	14	62.2	1619	1044	11.114987	
18	2	14	88.4	1684		11.46131	

Bin5 Statistics 15

Trial #	Pulse	Chirp (MHz)	Pulse Width (µS)	Pulse 1-2 spacing (uS)	Pulse 2-3 spacing (uS)	Pulse Start(S)	Detection (1:yes; 0:no)
0	2	10	74.1	1370		0.386272	1
1	3	10	87.9	1781	1928	1.412422	
2	1	10	71.1			2.549689	
3	1	10	55.1			3.099695	
4	2	10	67.6	1943		3.873155	
5	1	10	98			4.941977	
6	2	10	93.3	1103		5.231935	
7	2	10	85.1	1963		6.046897	
8	3	10	98	1215	1630	7.270941	
9	2	10	84.4	1633		7.876447	
10	2	10	86.3	1983		9.062835	
11	2	10	93.9	1341		9.880588	
12	2	10	97.3	1877		10.989299	
13	2	10	98.9	1669		11.637849	

Bin5 Statistics 16

Trial #	Pulse	Chirp (MHz)	Pulse Width (µS)	Pulse 1-2 spacing (uS)	Pulse 2-3 spacing (uS)	Pulse Start(S)	Detection (1:yes; 0:no)
0	2	16	68.5	1396		0.443318	1
1	2	16	77.5	1530		2.273971	
2	2	16	68.1	1217		2.885279	
3	2	16	63.7	1872		4.500382	
4	2	16	56.8	1039		6.370373	
5	2	16	77.7	1926		6.698188	
6	2	16	84.5	1043		9.262122	
7	2	16	86.2	1972		10.385284	
8	1	16	95.8			11.498587	

Bin5 Statistics 17

Trial #	Pulse	Chirp (MHz)	Pulse Width (µS)	Pulse 1-2 spacing (uS)	Pulse 2-3 spacing (uS)	Pulse Start(S)	Detection (1:yes; 0:no)
0	3	9	96.4	1344	1277	0.246815	0
1	3	9	57.4	1571	1651	1.672544	
2	3	9	59.7	1627	1101	1.866368	
3	2	9	65	1850		2.60542	
4	1	9	88.8			4.240242	
5	2	9	85.6	1200		4.788752	
6	1	9	52.3			5.839902	
7	3	9	98.7	1679	1564	6.33624	
8	2	9	54.2	1301		7.464454	
9	3	9	74.2	1733	1852	7.779293	
10	2	9	70.3	1461		9.342602	
11	2	9	55.7	1092		9.624189	
12	2	9	53.4	1132		10.6178	
13	1	9	96.1			11.71303	

Bin5 Statistics 18

Trial #	Pulse	Chirp (MHz)	Pulse Width (µS)	Pulse 1-2 spacing (uS)	Pulse 2-3 spacing (uS)	Pulse Start(S)	Detection (1:yes; 0:no)
0	2	7	96.6	1500		1.095558	1
1	1	7	63.2			1.380994	
2	1	7	85.8			3.680645	
3	2	7	50.2	1555		4.060106	
4	2	7	52.2	1681		5.911372	
5	3	7	87.2	1963	1316	6.718588	
6	2	7	76.4	1035		8.118485	
7	2	7	95.3	1839		10.126273	
8	2	7	70.3	1579		11.55007	

Bin5 Statistics 19

Trial #	Pulse	Chirp (MHz)	Pulse Width (µS)	Pulse 1-2 spacing (uS)	Pulse 2-3 spacing (uS)	Pulse Start(S)	Detection (1:yes; 0:no)
0	2	15	80.3	1005		0.152061	1
1	2	15	59.6	1494		0.94787	
2	1	15	97.9			2.259275	
3	2	15	91.8	1435		2.926722	
4	2	15	57.3	1989		3.766664	
5	2	15	74.5	1577		4.578903	
6	2	15	53.5	1918		5.942659	
7	3	15	75.7	1021	1704	6.149109	
8	2	15	81.5	1275		7.60066	
9	2	15	84.2	1712		8.342915	
10	3	15	54.4	1903	1413	9.027919	
11	2	15	92	1588		9.71685	
12	1	15	70			10.455695	
13	1	15	83.3			11.201644	

Bin5 Statistics 20

Trial #	Pulse	Chirp (MHz)	Pulse Width (µS)	Pulse 1-2 spacing (uS)	Pulse 2-3 spacing (uS)	Pulse Start(S)	Detection (1:yes; 0:no)
0	1	6	95.3			0.29008	1
1	2	6	56.5	1310		1.012658	
2	2	6	60.9	1173		2.989646	
3	3	6	91.2	1161	1434	3.811126	
4	1	6	96			4.22046	
5	3	6	81.8	1271	1803	5.670622	
6	2	6	69.5	1493		6.787577	
7	2	6	93.7	1856		7.65947	
8	2	6	99.9	1141		8.7582	
9	2	6	58.5	1763		9.574584	
10	2	6	83.3	1840		10.578369	
11	2	6	68	1813		11.278599	

Bin5 Statistics 21

Trial #	Pulse	Chirp (MHz)	Pulse Width (µS)	Pulse 1-2 spacing (µS)	Pulse 2-3 spacing (µS)	Pulse Start(S)	Detection (1:yes; 0:no)
0	2	19	68.4	1651		0.619038	1
1	3	19	54.9	1293	1164	0.835558	
2	2	19	88	1418		1.996126	
3	1	19	94.8			2.648801	
4	1	19	80.1			2.990918	
5	2	19	84.5	1002		4.147834	
6	2	19	70.1	1035		4.479495	
7	2	19	52.7	1842		5.293174	
8	3	19	68.8	1552	1756	5.69911	
9	2	19	98.3	1067		6.563854	
10	2	19	67.3	1990		7.15532	
11	3	19	67.4	1630	1533	8.35914	
12	2	19	90.2	1188		8.967905	
13	3	19	61	1168	1195	9.3429	
14	2	19	66	1269		9.937619	
15	3	19	81.9	1649	1836	11.042219	
16	1	19	89.3			11.993201	

Bin5 Statistics 22

Trial #	Pulse	Chirp (MHz)	Pulse Width (µS)	Pulse 1-2 spacing (µS)	Pulse 2-3 spacing (µS)	Pulse Start(S)	Detection (1:yes; 0:no)
0	2	14	60.6	1538		0.013513	0
1	2	14	62.9	1903		1.943573	
2	3	14	70.2	1736	1941	2.635702	
3	2	14	55.2	1157		3.30812	
4	2	14	58.4	1160		4.844052	
5	2	14	78.6	1146		5.6147	
6	3	14	70.7	1470	1998	6.958033	
7	1	14	65.9			8.595668	
8	3	14	70.8	1518	1027	8.737412	
9	3	14	73.8	1392	1879	10.540894	
10	3	14	93.9	1343	1226	11.360837	

Bin5 Statistics 23

Trial #	Pulse	Chirp (MHz)	Pulse Width (µS)	Pulse 1-2 spacing (uS)	Pulse 2-3 spacing (uS)	Pulse Start(S)	Detection (1:yes; 0:no)
0	3	9	57.4	1448	1052	0.700001	1
1	1	9	62.3			1.322644	
2	2	9	67.9	1193		1.725703	
3	2	9	88.4	1876		2.482508	
4	2	9	62.8	1542		3.276449	
5	3	9	84.8	1122	1118	3.677278	
6	3	9	58.5	1263	1652	4.523654	
7	2	9	72.6	1170		5.311805	
8	2	9	57.9	1495		5.878262	
9	2	9	51.4	1544		6.947441	
10	1	9	77.9			7.644841	
11	3	9	63.6	1861	1896	7.895021	
12	1	9	84.4			9.114865	
13	2	9	56.2	1672		9.343198	
14	2	9	81.9	1381		10.491843	
15	2	9	75.8	1474		11.016516	
16	2	9	78.9	1460		11.792142	

Bin5 Statistics 24

Trial #	Pulse	Chirp (MHz)	Pulse Width (µS)	Pulse 1-2 spacing (uS)	Pulse 2-3 spacing (uS)	Pulse Start(S)	Detection (1:yes; 0:no)
0	2	13	51.4	1317		0.601399	1
1	2	13	87.8	1162		0.948351	
2	2	13	87.9	1773		2.000377	
3	2	13	63.8	1009		2.916125	
4	2	13	73.2	1294		3.91047	
5	1	13	57			4.795889	
6	1	13	84.1			5.347275	
7	3	13	95.5	1734	1720	6.151019	
8	2	13	85.3	1870		7.157772	
9	2	13	71.6	1887		7.738541	
10	2	13	66.5	1571		8.913232	
11	2	13	80.7	1903		9.856344	
12	1	13	95.8			10.362529	
13	2	13	79.5	1788		11.237227	

Bin5 Statistics 25

Trial #	Pulse	Chirp (MHz)	Pulse Width (µS)	Pulse 1-2 spacing (uS)	Pulse 2-3 spacing (uS)	Pulse Start(S)	Detection (1:yes; 0:no)
0	1	19	82.6			0.221936	1
1	3	19	83.3	1597	1634	0.74957	
2	3	19	93.7	1797	1777	1.593758	
3	1	19	51			2.556401	
4	1	19	53.3			3.370373	
5	2	19	66.2	1018		4.001121	
6	1	19	64.7			4.807242	
7	2	19	68.1	1926		5.29127	
8	1	19	70.9			6.109663	
9	1	19	64.8			6.979385	
10	1	19	74.4			7.412276	
11	2	19	86.6	1101		7.806402	
12	1	19	77.1			8.858053	
13	2	19	69.1	1219		9.659025	
14	1	19	70.6			10.308758	
15	2	19	93	1598		10.952867	
16	1	19	57.8			11.427796	

Bin5 Statistics 26

Trial #	Pulse	Chirp (MHz)	Pulse Width (µS)	Pulse 1-2 spacing (uS)	Pulse 2-3 spacing (uS)	Pulse Start(S)	Detection (1:yes; 0:no)
0	2	9	68.1	1769		1.18337	1
1	2	9	95.6	1412		2.176228	
2	1	9	90.5			3.716347	
3	2	9	90.1	1194		5.117483	
4	2	9	96.8	1988		5.486417	
5	2	9	53.7	1488		7.203209	
6	2	9	79.9	1957		8.641437	
7	1	9	86			10.531506	
8	1	9	55.8			11.781405	

Bin5 Statistics 27

Trial #	Pulse	Chirp (MHz)	Pulse Width (µS)	Pulse 1-2 spacing (uS)	Pulse 2-3 spacing (uS)	Pulse Start(S)	Detection (1:yes; 0:no)
0	2	18	69.5	1195		0.103401	1
1	1	18	59.4			0.954792	
2	2	18	63.2	1940		1.883462	
3	1	18	84.5			2.774469	
4	3	18	83.6	1022	1805	3.873463	
5	2	18	59.7	1142		4.952583	
6	3	18	72.2	1287	1662	5.316469	
7	1	18	65.7			6.259653	
8	3	18	66.6	1059	1666	7.164529	
9	2	18	93.1	1996		8.004626	
10	2	18	69.9	1792		8.866003	
11	1	18	78.2			10.055336	
12	2	18	82.7	1011		10.650643	
13	3	18	67.7	1574	1958	11.710631	

Bin5 Statistics 28

Trial #	Pulse	Chirp (MHz)	Pulse Width (µS)	Pulse 1-2 spacing (uS)	Pulse 2-3 spacing (uS)	Pulse Start(S)	Detection (1:yes; 0:no)
0	3	5	57.9	1554	1071	0.214788	1
1	1	5	79.9			1.150268	
2	2	5	64.1	1218		2.32583	
3	2	5	68	1171		2.813023	
4	3	5	54.1	1165	1982	3.584702	
5	2	5	64.8	1494		4.409845	
6	3	5	66.6	1825	1720	5.432436	
7	2	5	73.5	1021		6.175991	
8	3	5	97.2	1498	1913	7.15236	
9	3	5	51.1	1225	1910	7.322203	
10	3	5	64	1499	1778	8.21907	
11	2	5	73.4	1841		8.846616	
12	1	5	56.3			10.379865	
13	2	5	97.4	1960		11.025693	
14	3	5	73.4	1670	1718	11.232606	

Bin5 Statistics 29

Trial #	Pulse	Chirp (MHz)	Pulse Width (µS)	Pulse 1-2 spacing (uS)	Pulse 2-3 spacing (uS)	Pulse Start(S)	Detection (1:yes; 0:no)
0	1	12	80.3			1.273656	1
1	1	12	81			1.805027	
2	2	12	95.9	1265		2.772237	
3	1	12	58.8			4.28381	
4	3	12	71.1	1637	1386	5.394907	
5	2	12	61.6	1384		7.670808	
6	3	12	94.4	1851	1234	8.002765	
7	3	12	87.9	1276	1188	10.01257	
8	1	12	78.9			11.193591	

Bin5 Statistics 30

Trial #	Pulse	Chirp (MHz)	Pulse Width (µS)	Pulse 1-2 spacing (uS)	Pulse 2-3 spacing (uS)	Pulse Start(S)	Detection (1:yes; 0:no)
0	2	10	81	1542		0.315683	1
1	3	10	70.6	1390	1766	1.384475	
2	2	10	56.4	1047		2.869475	
3	2	10	89.3	1208		3.688517	
4	2	10	79.6	1136		4.835975	
5	1	10	97.9			5.813274	
6	3	10	64.2	1035	1392	6.668411	
7	3	10	98.4	1715	1146	7.920597	
8	2	10	75.9	1960		8.258358	
9	3	10	80.4	1829	1924	9.746226	
10	3	10	91.1	1171	1432	10.305703	
11	2	10	67.7	1077		11.352167	

Table-6 Radar Type 6 Statistical Performance

Trial #	Fc (MHz)	Pulse /Burst	Pulse Width (µS)	PRI (µs)	Detection (1:yes; 0:no)	Hopping Sequence
1	5290	9	1	333	1	5383.0, 5625.0, 5338.0, 5600.0, 5511.0, 5359.0, 5339.0, 5480.0, 5603.0, 5301.0, 5405.0, 5340.0, 5506.0, 5605.0, 5717.0, 5474.0, 5458.0, 5661.0, 5276.0, 5509.0, 5639.0, 5516.0, 5601.0, 5470.0, 5607.0, 5261.0, 5390.0, 5486.0, 5262.0, 5533.0, 5325.0, 5368.0, 5534.0, 5377.0, 5708.0, 5618.0, 5422.0, 5322.0, 5385.0, 5345.0, 5573.0, 5369.0, 5412.0, 5495.0, 5668.0, 5445.0, 5646.0, 5660.0, 5258.0, 5571.0, 5513.0, 5440.0, 5497.0, 5395.0, 5581.0, 5373.0, 5669.0, 5686.0, 5715.0, 5436.0, 5617.0, 5304.0, 5718.0, 5333.0, 5324.0, 5535.0, 5577.0, 5687.0, 5450.0, 5315.0, 5648.0, 5297.0, 5283.0, 5598.0, 5515.0, 5402.0, 5433.0, 5494.0, 5256.0, 5574.0, 5680.0, 5503.0, 5467.0, 5437.0, 5525.0, 5675.0, 5381.0, 5674.0, 5380.0, 5656.0, 5465.0, 5471.0, 5411.0, 5371.0, 5306.0, 5529.0, 5346.0, 5709.0, 5320.0, 5431.0 (number of hits: 9)
2	5290	9	1	333	1	5569.0, 5617.0, 5703.0, 5267.0, 5564.0, 5470.0, 5625.0, 5476.0, 5303.0, 5464.0, 5644.0, 5357.0, 5701.0, 5482.0, 5332.0, 5277.0, 5546.0, 5567.0, 5405.0, 5344.0, 5459.0, 5675.0, 5337.0, 5635.0, 5638.0, 5608.0, 5501.0, 5704.0, 5614.0, 5436.0, 5272.0, 5378.0, 5623.0, 5410.0, 5603.0, 5677.0, 5409.0, 5648.0, 5425.0, 5719.0, 5491.0, 5502.0, 5408.0, 5315.0, 5363.0, 5264.0, 5586.0, 5645.0, 5646.0, 5354.0, 5463.0, 5437.0, 5494.0, 5523.0, 5356.0, 5285.0, 5676.0, 5404.0, 5273.0, 5572.0, 5396.0, 5438.0, 5706.0, 5345.0, 5585.0, 5518.0, 5334.0, 5573.0, 5324.0, 5508.0, 5721.0, 5689.0, 5304.0, 5579.0, 5401.0, 5346.0, 5299.0, 5562.0, 5557.0, 5445.0, 5683.0, 5413.0, 5377.0, 5416.0, 5596.0, 5615.0, 5577.0, 5664.0, 5253.0, 5358.0, 5561.0, 5574.0, 5610.0, 5453.0, 5271.0, 5316.0, 5480.0, 5320.0, 5468.0, 5531.0 (number of hits: 7)
3	5290	9	1	333	1	5506.0, 5315.0, 5274.0, 5697.0, 5636.0, 5600.0, 5306.0, 5562.0, 5627.0, 5614.0, 5287.0, 5349.0, 5677.0, 5421.0, 5721.0, 5376.0, 5671.0, 5360.0, 5646.0, 5344.0, 5535.0, 5517.0, 5427.0, 5288.0, 5552.0, 5323.0, 5269.0, 5668.0, 5648.0, 5660.0, 5615.0, 5641.0, 5707.0, 5495.0, 5432.0, 5460.0, 5572.0, 5527.0, 5290.0, 5559.0, 5704.0, 5303.0, 5347.0, 5416.0, 5679.0, 5436.0, 5438.0, 5560.0, 5357.0, 5472.0, 5455.0, 5596.0, 5461.0, 5529.0, 5515.0,

						5425.0, 5630.0, 5253.0, 5394.0, 5570.0, 5445.0, 5511.0, 5300.0, 5457.0, 5362.0, 5703.0, 5266.0, 5637.0, 5618.0, 5358.0, 5653.0, 5449.0, 5377.0, 5401.0, 5672.0, 5301.0, 5695.0, 5599.0, 5492.0, 5639.0, 5573.0, 5355.0, 5533.0, 5475.0, 5480.0, 5418.0, 5567.0, 5524.0, 5712.0, 5383.0, 5547.0, 5628.0, 5640.0, 5659.0, 5582.0, 5594.0, 5336.0, 5494.0, 5645.0, 5262.0 (number of hits: 7)
4	5290	9	1	333	1	5475.0, 5428.0, 5473.0, 5376.0, 5265.0, 5508.0, 5352.0, 5618.0, 5466.0, 5516.0, 5532.0, 5721.0, 5362.0, 5270.0, 5477.0, 5394.0, 5275.0, 5692.0, 5383.0, 5633.0, 5641.0, 5408.0, 5580.0, 5708.0, 5280.0, 5681.0, 5343.0, 5310.0, 5262.0, 5555.0, 5652.0, 5701.0, 5501.0, 5388.0, 5523.0, 5266.0, 5494.0, 5518.0, 5371.0, 5587.0, 5467.0, 5534.0, 5461.0, 5562.0, 5484.0, 5693.0, 5410.0, 5444.0, 5543.0, 5336.0, 5379.0, 5620.0, 5283.0, 5423.0, 5329.0, 5656.0, 5391.0, 5581.0, 5506.0, 5554.0, 5421.0, 5420.0, 5558.0, 5583.0, 5435.0, 5273.0, 5617.0, 5588.0, 5344.0, 5573.0, 5502.0, 5377.0, 5657.0, 5324.0, 5460.0, 5432.0, 5340.0, 5648.0, 5292.0, 5447.0, 5503.0, 5499.0, 5353.0, 5415.0, 5702.0, 5625.0, 5307.0, 5296.0, 5395.0, 5607.0, 5700.0, 5592.0, 5563.0, 5490.0, 5364.0, 5348.0, 5278.0, 5446.0, 5426.0, 5610.0 (number of hits: 6)
5	5290	9	1	333	1	5351.0, 5259.0, 5552.0, 5715.0, 5499.0, 5712.0, 5289.0, 5671.0, 5706.0, 5391.0, 5299.0, 5587.0, 5454.0, 5589.0, 5597.0, 5266.0, 5591.0, 5293.0, 5495.0, 5560.0, 5329.0, 5286.0, 5549.0, 5521.0, 5664.0, 5635.0, 5614.0, 5502.0, 5480.0, 5675.0, 5496.0, 5558.0, 5419.0, 5439.0, 5679.0, 5328.0, 5367.0, 5592.0, 5593.0, 5424.0, 5298.0, 5544.0, 5282.0, 5555.0, 5412.0, 5634.0, 5567.0, 5291.0, 5672.0, 5576.0, 5489.0, 5280.0, 5326.0, 5250.0, 5347.0, 5372.0, 5420.0, 5711.0, 5504.0, 5701.0, 5488.0, 5639.0, 5702.0, 5694.0, 5295.0, 5260.0, 5490.0, 5345.0, 5309.0, 5506.0, 5584.0, 5623.0, 5714.0, 5453.0, 5526.0, 5407.0, 5677.0, 5676.0, 5501.0, 5581.0, 5373.0, 5294.0, 5446.0, 5696.0, 5375.0, 5687.0, 5336.0, 5568.0, 5645.0, 5335.0, 5669.0, 5553.0, 5561.0, 5387.0, 5284.0, 5530.0, 5348.0, 5611.0, 5673.0, 5469.0 (number of hits: 10)
6	5290	9	1	333	1	5685.0, 5448.0, 5468.0, 5551.0, 5554.0, 5714.0, 5394.0, 5450.0, 5346.0, 5324.0, 5303.0, 5344.0, 5722.0, 5577.0, 5475.0, 5412.0, 5687.0, 5547.0, 5415.0, 5262.0, 5691.0, 5372.0, 5264.0, 5370.0, 5667.0, 5498.0, 5651.0, 5283.0, 5568.0, 5261.0, 5666.0, 5663.0, 5618.0, 5312.0, 5710.0,

						5676.0, 5273.0, 5390.0, 5572.0, 5408.0, 5674.0, 5451.0, 5333.0, 5439.0, 5569.0, 5692.0, 5604.0, 5325.0, 5619.0, 5592.0, 5256.0, 5458.0, 5367.0, 5715.0, 5271.0, 5393.0, 5512.0, 5621.0, 5281.0, 5340.0, 5661.0, 5469.0, 5360.0, 5348.0, 5331.0, 5576.0, 5420.0, 5411.0, 5434.0, 5614.0, 5426.0, 5291.0, 5515.0, 5364.0, 5675.0, 5349.0, 5487.0, 5268.0, 5533.0, 5254.0, 5584.0, 5414.0, 5537.0, 5558.0, 5622.0, 5492.0, 5296.0, 5557.0, 5620.0, 5379.0, 5319.0, 5493.0, 5562.0, 5538.0, 5424.0, 5396.0, 5251.0, 5389.0, 5549.0, 5306.0 (number of hits: 8)
7	5290	9	1	333	1	5681.0, 5291.0, 5438.0, 5329.0, 5331.0, 5411.0, 5675.0, 5251.0, 5272.0, 5648.0, 5679.0, 5430.0, 5593.0, 5604.0, 5353.0, 5381.0, 5267.0, 5435.0, 5539.0, 5512.0, 5324.0, 5680.0, 5654.0, 5532.0, 5600.0, 5334.0, 5397.0, 5401.0, 5258.0, 5260.0, 5522.0, 5400.0, 5318.0, 5546.0, 5275.0, 5682.0, 5621.0, 5565.0, 5285.0, 5671.0, 5525.0, 5700.0, 5596.0, 5426.0, 5444.0, 5315.0, 5445.0, 5646.0, 5280.0, 5338.0, 5322.0, 5269.0, 5271.0, 5536.0, 5299.0, 5351.0, 5496.0, 5424.0, 5350.0, 5614.0, 5570.0, 5336.0, 5388.0, 5476.0, 5667.0, 5602.0, 5524.0, 5715.0, 5500.0, 5374.0, 5518.0, 5591.0, 5652.0, 5633.0, 5387.0, 5429.0, 5651.0, 5366.0, 5691.0, 5490.0, 5548.0, 5427.0, 5692.0, 5413.0, 5581.0, 5557.0, 5514.0, 5533.0, 5576.0, 5594.0, 5612.0, 5516.0, 5405.0, 5703.0, 5394.0, 5441.0, 5639.0, 5443.0, 5421.0, 5603.0 (number of hits: 7)
8	5290	9	1	333	1	5452.0, 5704.0, 5571.0, 5457.0, 5419.0, 5496.0, 5404.0, 5574.0, 5358.0, 5488.0, 5357.0, 5301.0, 5408.0, 5588.0, 5690.0, 5568.0, 5430.0, 5333.0, 5667.0, 5644.0, 5625.0, 5450.0, 5406.0, 5672.0, 5443.0, 5611.0, 5562.0, 5279.0, 5504.0, 5349.0, 5470.0, 5484.0, 5411.0, 5338.0, 5505.0, 5403.0, 5699.0, 5441.0, 5577.0, 5494.0, 5648.0, 5714.0, 5433.0, 5678.0, 5499.0, 5520.0, 5650.0, 5384.0, 5717.0, 5427.0, 5435.0, 5297.0, 5436.0, 5337.0, 5585.0, 5640.0, 5370.0, 5705.0, 5587.0, 5368.0, 5621.0, 5555.0, 5709.0, 5367.0, 5474.0, 5405.0, 5483.0, 5600.0, 5327.0, 5696.0, 5422.0, 5257.0, 5565.0, 5527.0, 5335.0, 5604.0, 5351.0, 5440.0, 5609.0, 5635.0, 5537.0, 5557.0, 5344.0, 5651.0, 5275.0, 5324.0, 5393.0, 5434.0, 5407.0, 5353.0, 5622.0, 5277.0, 5645.0, 5509.0, 5380.0, 5688.0, 5522.0, 5586.0, 5531.0, 5623.0 (number of hits: 4)
9	5290	9	1	333	1	5582.0, 5670.0, 5305.0, 5578.0, 5267.0, 5361.0, 5522.0, 5516.0, 5462.0, 5709.0, 5412.0, 5268.0, 5581.0, 5463.0, 5507.0,

						5658.0, 5459.0, 5293.0, 5338.0, 5599.0, 5266.0, 5577.0, 5304.0, 5399.0, 5348.0, 5539.0, 5369.0, 5694.0, 5613.0, 5596.0, 5722.0, 5309.0, 5416.0, 5573.0, 5461.0, 5360.0, 5698.0, 5614.0, 5508.0, 5590.0, 5371.0, 5601.0, 5282.0, 5435.0, 5273.0, 5556.0, 5405.0, 5387.0, 5315.0, 5584.0, 5496.0, 5310.0, 5595.0, 5502.0, 5583.0, 5634.0, 5558.0, 5431.0, 5517.0, 5404.0, 5526.0, 5486.0, 5388.0, 5276.0, 5428.0, 5651.0, 5460.0, 5414.0, 5406.0, 5432.0, 5456.0, 5327.0, 5433.0, 5565.0, 5718.0, 5657.0, 5652.0, 5493.0, 5391.0, 5400.0, 5291.0, 5597.0, 5286.0, 5668.0, 5394.0, 5700.0, 5708.0, 5702.0, 5437.0, 5468.0, 5384.0, 5425.0, 5656.0, 5514.0, 5340.0, 5626.0, 5591.0, 5554.0, 5366.0, 5403.0 (number of hits: 8)
10	5290	9	1	333	1	5399.0, 5435.0, 5375.0, 5337.0, 5395.0, 5456.0, 5611.0, 5512.0, 5393.0, 5505.0, 5491.0, 5342.0, 5368.0, 5450.0, 5319.0, 5340.0, 5662.0, 5536.0, 5574.0, 5472.0, 5373.0, 5665.0, 5681.0, 5521.0, 5719.0, 5570.0, 5304.0, 5515.0, 5533.0, 5471.0, 5259.0, 5643.0, 5323.0, 5444.0, 5488.0, 5679.0, 5329.0, 5564.0, 5694.0, 5425.0, 5350.0, 5718.0, 5442.0, 5724.0, 5502.0, 5686.0, 5707.0, 5568.0, 5409.0, 5314.0, 5264.0, 5438.0, 5620.0, 5384.0, 5253.0, 5672.0, 5676.0, 5288.0, 5538.0, 5631.0, 5673.0, 5274.0, 5583.0, 5668.0, 5356.0, 5497.0, 5276.0, 5527.0, 5607.0, 5380.0, 5269.0, 5654.0, 5674.0, 5465.0, 5338.0, 5370.0, 5651.0, 5463.0, 5699.0, 5639.0, 5632.0, 5387.0, 5486.0, 5311.0, 5354.0, 5452.0, 5477.0, 5423.0, 5598.0, 5411.0, 5534.0, 5385.0, 5711.0, 5493.0, 5655.0, 5352.0, 5251.0, 5640.0, 5458.0, 5436.0 (number of hits: 6)
11	5290	9	1	333	1	5443.0, 5518.0, 5553.0, 5361.0, 5393.0, 5558.0, 5310.0, 5269.0, 5404.0, 5255.0, 5452.0, 5687.0, 5466.0, 5281.0, 5507.0, 5656.0, 5295.0, 5363.0, 5490.0, 5552.0, 5497.0, 5258.0, 5384.0, 5407.0, 5392.0, 5671.0, 5638.0, 5532.0, 5636.0, 5666.0, 5626.0, 5290.0, 5319.0, 5312.0, 5318.0, 5615.0, 5307.0, 5721.0, 5438.0, 5277.0, 5351.0, 5603.0, 5464.0, 5448.0, 5399.0, 5705.0, 5459.0, 5406.0, 5429.0, 5331.0, 5334.0, 5566.0, 5377.0, 5302.0, 5299.0, 5703.0, 5270.0, 5610.0, 5664.0, 5264.0, 5398.0, 5612.0, 5324.0, 5567.0, 5595.0, 5617.0, 5465.0, 5415.0, 5369.0, 5455.0, 5716.0, 5391.0, 5681.0, 5569.0, 5311.0, 5548.0, 5588.0, 5607.0, 5441.0, 5560.0, 5427.0, 5546.0, 5344.0, 5430.0, 5336.0, 5526.0, 5346.0, 5621.0, 5462.0, 5449.0, 5662.0, 5516.0, 5433.0, 5587.0, 5559.0, 5653.0, 5477.0, 5400.0, 5693.0, 5480.0

						(number of hits: 11)
12	5290	9	1	333	1	5345.0, 5565.0, 5363.0, 5462.0, 5395.0, 5273.0, 5595.0, 5440.0, 5319.0, 5620.0, 5394.0, 5642.0, 5348.0, 5453.0, 5267.0, 5437.0, 5503.0, 5648.0, 5709.0, 5561.0, 5564.0, 5695.0, 5607.0, 5589.0, 5572.0, 5420.0, 5703.0, 5630.0, 5307.0, 5463.0, 5251.0, 5511.0, 5516.0, 5713.0, 5310.0, 5614.0, 5318.0, 5665.0, 5574.0, 5309.0, 5723.0, 5616.0, 5288.0, 5289.0, 5391.0, 5653.0, 5456.0, 5587.0, 5551.0, 5672.0, 5543.0, 5553.0, 5570.0, 5275.0, 5361.0, 5673.0, 5635.0, 5299.0, 5393.0, 5263.0, 5575.0, 5569.0, 5499.0, 5664.0, 5256.0, 5685.0, 5526.0, 5504.0, 5276.0, 5529.0, 5317.0, 5563.0, 5518.0, 5374.0, 5459.0, 5624.0, 5567.0, 5270.0, 5688.0, 5714.0, 5272.0, 5435.0, 5611.0, 5501.0, 5719.0, 5562.0, 5528.0, 5340.0, 5663.0, 5254.0, 5495.0, 5416.0, 5519.0, 5534.0, 5581.0, 5701.0, 5284.0, 5293.0, 5720.0, 5497.0
						(number of hits: 8)
13	5290	9	1	333	1	5302.0, 5337.0, 5634.0, 5687.0, 5570.0, 5304.0, 5562.0, 5701.0, 5552.0, 5482.0, 5680.0, 5271.0, 5256.0, 5666.0, 5695.0, 5651.0, 5377.0, 5670.0, 5527.0, 5649.0, 5690.0, 5715.0, 5320.0, 5659.0, 5704.0, 5417.0, 5689.0, 5343.0, 5703.0, 5517.0, 5442.0, 5564.0, 5375.0, 5599.0, 5294.0, 5436.0, 5369.0, 5350.0, 5305.0, 5418.0, 5386.0, 5480.0, 5317.0, 5275.0, 5373.0, 5292.0, 5622.0, 5601.0, 5639.0, 5508.0, 5478.0, 5594.0, 5671.0, 5668.0, 5428.0, 5539.0, 5438.0, 5683.0, 5697.0, 5614.0, 5712.0, 5588.0, 5642.0, 5698.0, 5455.0, 5333.0, 5429.0, 5403.0, 5535.0, 5497.0, 5554.0, 5632.0, 5272.0, 5607.0, 5709.0, 5567.0, 5328.0, 5440.0, 5578.0, 5711.0, 5491.0, 5586.0, 5548.0, 5502.0, 5395.0, 5352.0, 5420.0, 5358.0, 5458.0, 5454.0, 5623.0, 5456.0, 5473.0, 5500.0, 5306.0, 5362.0, 5284.0, 5490.0, 5264.0, 5414.0
						(number of hits: 9)
14	5290	9	1	333	1	5272.0, 5428.0, 5389.0, 5478.0, 5538.0, 5545.0, 5425.0, 5629.0, 5328.0, 5397.0, 5544.0, 5415.0, 5502.0, 5611.0, 5519.0, 5385.0, 5574.0, 5712.0, 5290.0, 5291.0, 5654.0, 5305.0, 5615.0, 5656.0, 5317.0, 5688.0, 5491.0, 5311.0, 5640.0, 5318.0, 5309.0, 5633.0, 5453.0, 5626.0, 5395.0, 5405.0, 5482.0, 5414.0, 5697.0, 5566.0, 5550.0, 5658.0, 5680.0, 5721.0, 5413.0, 5594.0, 5333.0, 5543.0, 5369.0, 5341.0, 5288.0, 5652.0, 5501.0, 5452.0, 5526.0, 5434.0, 5392.0, 5472.0, 5706.0, 5349.0, 5605.0, 5645.0, 5520.0, 5473.0, 5353.0, 5407.0, 5598.0, 5647.0, 5504.0, 5584.0, 5490.0, 5264.0, 5361.0, 5363.0, 5406.0, 5525.0, 5690.0, 5437.0, 5469.0, 5356.0

						5669.0, 5576.0, 5484.0, 5510.0, 5416.0, 5409.0, 5711.0, 5450.0, 5601.0, 5505.0, 5620.0, 5421.0, 5495.0, 5342.0, 5673.0, 5534.0, 5569.0, 5643.0, 5702.0, 5267.0 (number of hits: 8)
15	5290	9	1	333	1	5457.0, 5295.0, 5427.0, 5553.0, 5280.0, 5625.0, 5675.0, 5603.0, 5714.0, 5465.0, 5681.0, 5509.0, 5719.0, 5301.0, 5718.0, 5440.0, 5456.0, 5671.0, 5660.0, 5381.0, 5252.0, 5447.0, 5633.0, 5253.0, 5446.0, 5491.0, 5362.0, 5329.0, 5686.0, 5266.0, 5255.0, 5391.0, 5687.0, 5659.0, 5559.0, 5495.0, 5717.0, 5715.0, 5397.0, 5614.0, 5401.0, 5615.0, 5623.0, 5696.0, 5656.0, 5589.0, 5543.0, 5475.0, 5355.0, 5627.0, 5303.0, 5550.0, 5448.0, 5383.0, 5651.0, 5428.0, 5674.0, 5563.0, 5720.0, 5284.0, 5309.0, 5319.0, 5513.0, 5400.0, 5713.0, 5551.0, 5586.0, 5668.0, 5594.0, 5292.0, 5324.0, 5592.0, 5591.0, 5607.0, 5409.0, 5297.0, 5548.0, 5646.0, 5269.0, 5367.0, 5649.0, 5283.0, 5637.0, 5494.0, 5308.0, 5407.0, 5390.0, 5415.0, 5632.0, 5573.0, 5609.0, 5405.0, 5282.0, 5343.0, 5612.0, 5458.0, 5533.0, 5290.0, 5711.0, 5598.0 (number of hits: 11)
16	5290	9	1	333	1	5266.0, 5538.0, 5409.0, 5637.0, 5430.0, 5691.0, 5383.0, 5543.0, 5350.0, 5294.0, 5454.0, 5302.0, 5653.0, 5673.0, 5676.0, 5684.0, 5481.0, 5503.0, 5573.0, 5497.0, 5307.0, 5268.0, 5524.0, 5582.0, 5530.0, 5471.0, 5341.0, 5599.0, 5636.0, 5527.0, 5351.0, 5700.0, 5425.0, 5597.0, 5317.0, 5631.0, 5693.0, 5253.0, 5623.0, 5555.0, 5309.0, 5344.0, 5557.0, 5270.0, 5633.0, 5272.0, 5572.0, 5467.0, 5313.0, 5679.0, 5523.0, 5400.0, 5315.0, 5448.0, 5638.0, 5381.0, 5698.0, 5360.0, 5604.0, 5348.0, 5418.0, 5432.0, 5678.0, 5461.0, 5611.0, 5656.0, 5551.0, 5692.0, 5703.0, 5287.0, 5675.0, 5553.0, 5369.0, 5297.0, 5470.0, 5649.0, 5505.0, 5281.0, 5380.0, 5452.0, 5689.0, 5707.0, 5326.0, 5614.0, 5440.0, 5456.0, 5305.0, 5522.0, 5518.0, 5513.0, 5619.0, 5263.0, 5548.0, 5303.0, 5542.0, 5376.0, 5571.0, 5318.0, 5306.0, 5560.0 (number of hits: 13)
17	5290	9	1	333	1	5590.0, 5549.0, 5597.0, 5654.0, 5509.0, 5645.0, 5687.0, 5273.0, 5718.0, 5587.0, 5519.0, 5377.0, 5419.0, 5301.0, 5613.0, 5630.0, 5320.0, 5656.0, 5304.0, 5405.0, 5624.0, 5640.0, 5546.0, 5255.0, 5459.0, 5658.0, 5286.0, 5495.0, 5582.0, 5359.0, 5719.0, 5433.0, 5466.0, 5399.0, 5649.0, 5436.0, 5331.0, 5554.0, 5384.0, 5659.0, 5712.0, 5696.0, 5313.0, 5715.0, 5602.0, 5375.0, 5280.0, 5352.0, 5682.0, 5307.0, 5360.0, 5406.0, 5551.0, 5564.0, 5391.0, 5497.0, 5292.0, 5583.0, 5489.0, 5500.0,

						5626.0, 5569.0, 5672.0, 5721.0, 5365.0, 5560.0, 5527.0, 5442.0, 5310.0, 5449.0, 5425.0, 5328.0, 5393.0, 5692.0, 5685.0, 5257.0, 5416.0, 5555.0, 5637.0, 5506.0, 5631.0, 5484.0, 5430.0, 5334.0, 5263.0, 5510.0, 5483.0, 5369.0, 5401.0, 5420.0, 5282.0, 5370.0, 5579.0, 5543.0, 5512.0, 5592.0, 5458.0, 5542.0, 5522.0, 5305.0 (number of hits: 9)
18	5290	9	1	333	1	5558.0, 5457.0, 5491.0, 5397.0, 5362.0, 5403.0, 5535.0, 5654.0, 5252.0, 5449.0, 5582.0, 5301.0, 5255.0, 5619.0, 5437.0, 5299.0, 5633.0, 5455.0, 5387.0, 5696.0, 5315.0, 5591.0, 5673.0, 5686.0, 5464.0, 5385.0, 5320.0, 5371.0, 5627.0, 5661.0, 5589.0, 5599.0, 5539.0, 5475.0, 5707.0, 5337.0, 5465.0, 5415.0, 5256.0, 5390.0, 5557.0, 5291.0, 5353.0, 5608.0, 5562.0, 5699.0, 5376.0, 5348.0, 5281.0, 5545.0, 5272.0, 5690.0, 5429.0, 5691.0, 5261.0, 5600.0, 5507.0, 5335.0, 5708.0, 5609.0, 5620.0, 5631.0, 5662.0, 5370.0, 5544.0, 5638.0, 5646.0, 5592.0, 5275.0, 5637.0, 5682.0, 5628.0, 5363.0, 5384.0, 5715.0, 5286.0, 5322.0, 5547.0, 5672.0, 5379.0, 5597.0, 5697.0, 5378.0, 5647.0, 5254.0, 5710.0, 5546.0, 5606.0, 5723.0, 5336.0, 5677.0, 5394.0, 5463.0, 5481.0, 5313.0, 5438.0, 5526.0, 5304.0, 5678.0, 5518.0 (number of hits: 8)
19	5290	9	1	333	1	5444.0, 5571.0, 5409.0, 5686.0, 5599.0, 5699.0, 5606.0, 5330.0, 5511.0, 5481.0, 5316.0, 5336.0, 5588.0, 5578.0, 5287.0, 5658.0, 5426.0, 5662.0, 5610.0, 5520.0, 5446.0, 5412.0, 5275.0, 5347.0, 5356.0, 5665.0, 5705.0, 5312.0, 5651.0, 5569.0, 5637.0, 5333.0, 5538.0, 5462.0, 5504.0, 5257.0, 5281.0, 5492.0, 5469.0, 5357.0, 5643.0, 5525.0, 5652.0, 5505.0, 5541.0, 5664.0, 5503.0, 5564.0, 5416.0, 5671.0, 5424.0, 5458.0, 5560.0, 5623.0, 5270.0, 5723.0, 5689.0, 5629.0, 5582.0, 5468.0, 5544.0, 5311.0, 5283.0, 5393.0, 5352.0, 5478.0, 5370.0, 5442.0, 5498.0, 5279.0, 5565.0, 5566.0, 5429.0, 5700.0, 5570.0, 5284.0, 5515.0, 5273.0, 5709.0, 5368.0, 5722.0, 5550.0, 5554.0, 5576.0, 5484.0, 5595.0, 5612.0, 5437.0, 5613.0, 5710.0, 5314.0, 5477.0, 5473.0, 5382.0, 5514.0, 5362.0, 5506.0, 5589.0, 5383.0, 5385.0 (number of hits: 4)
20	5290	9	1	333	1	5637.0, 5580.0, 5260.0, 5360.0, 5348.0, 5519.0, 5500.0, 5555.0, 5349.0, 5670.0, 5267.0, 5595.0, 5323.0, 5611.0, 5386.0, 5605.0, 5556.0, 5434.0, 5407.0, 5393.0, 5257.0, 5342.0, 5343.0, 5642.0, 5399.0, 5707.0, 5609.0, 5536.0, 5336.0, 5472.0, 5259.0, 5534.0, 5690.0, 5438.0, 5328.0, 5464.0, 5719.0, 5304.0, 5584.0, 5254.0

						5518.0, 5505.0, 5710.0, 5632.0, 5612.0, 5350.0, 5622.0, 5523.0, 5674.0, 5287.0, 5562.0, 5435.0, 5703.0, 5621.0, 5370.0, 5617.0, 5442.0, 5541.0, 5338.0, 5341.0, 5322.0, 5325.0, 5297.0, 5588.0, 5679.0, 5558.0, 5476.0, 5313.0, 5624.0, 5593.0, 5312.0, 5629.0, 5535.0, 5651.0, 5424.0, 5372.0, 5689.0, 5551.0, 5487.0, 5377.0, 5482.0, 5301.0, 5610.0, 5687.0, 5265.0, 5334.0, 5503.0, 5618.0, 5633.0, 5691.0, 5658.0, 5528.0, 5614.0, 5339.0, 5413.0, 5604.0, 5430.0, 5522.0, 5620.0, 5582.0 (number of hits: 9)
21	5290	9	1	333	1	5597.0, 5598.0, 5557.0, 5643.0, 5302.0, 5608.0, 5311.0, 5532.0, 5556.0, 5272.0, 5588.0, 5464.0, 5296.0, 5304.0, 5484.0, 5561.0, 5642.0, 5435.0, 5687.0, 5268.0, 5544.0, 5289.0, 5374.0, 5633.0, 5600.0, 5362.0, 5602.0, 5474.0, 5480.0, 5625.0, 5324.0, 5527.0, 5386.0, 5684.0, 5258.0, 5308.0, 5603.0, 5504.0, 5356.0, 5654.0, 5355.0, 5475.0, 5661.0, 5263.0, 5640.0, 5397.0, 5471.0, 5537.0, 5470.0, 5478.0, 5271.0, 5563.0, 5564.0, 5499.0, 5604.0, 5285.0, 5708.0, 5314.0, 5342.0, 5426.0, 5401.0, 5458.0, 5349.0, 5502.0, 5601.0, 5438.0, 5719.0, 5280.0, 5357.0, 5624.0, 5673.0, 5332.0, 5505.0, 5423.0, 5410.0, 5341.0, 5312.0, 5620.0, 5501.0, 5522.0, 5710.0, 5454.0, 5446.0, 5443.0, 5512.0, 5576.0, 5559.0, 5686.0, 5711.0, 5521.0, 5347.0, 5422.0, 5646.0, 5403.0, 5533.0, 5449.0, 5340.0, 5325.0, 5394.0, 5395.0 (number of hits: 9)
22	5290	9	1	333	1	5386.0, 5724.0, 5596.0, 5536.0, 5254.0, 5515.0, 5491.0, 5355.0, 5667.0, 5714.0, 5363.0, 5635.0, 5347.0, 5308.0, 5498.0, 5629.0, 5710.0, 5461.0, 5479.0, 5540.0, 5532.0, 5564.0, 5291.0, 5688.0, 5601.0, 5477.0, 5582.0, 5720.0, 5661.0, 5413.0, 5707.0, 5646.0, 5269.0, 5365.0, 5468.0, 5660.0, 5514.0, 5272.0, 5662.0, 5485.0, 5377.0, 5306.0, 5322.0, 5701.0, 5620.0, 5389.0, 5703.0, 5464.0, 5403.0, 5711.0, 5508.0, 5480.0, 5585.0, 5482.0, 5602.0, 5484.0, 5595.0, 5541.0, 5431.0, 5318.0, 5353.0, 5559.0, 5502.0, 5452.0, 5354.0, 5501.0, 5319.0, 5621.0, 5456.0, 5453.0, 5591.0, 5649.0, 5648.0, 5346.0, 5565.0, 5297.0, 5681.0, 5427.0, 5613.0, 5450.0, 5262.0, 5261.0, 5614.0, 5287.0, 5268.0, 5478.0, 5677.0, 5683.0, 5373.0, 5378.0, 5617.0, 5404.0, 5410.0, 5705.0, 5550.0, 5636.0, 5396.0, 5263.0, 5330.0, 5289.0 (number of hits: 7)
23	5290	9	1	333	1	5627.0, 5434.0, 5504.0, 5272.0, 5626.0, 5703.0, 5354.0, 5307.0, 5345.0, 5433.0, 5596.0, 5411.0, 5270.0, 5519.0, 5459.0, 5552.0, 5529.0, 5708.0, 5616.0, 5302.0,

						5577.0, 5326.0, 5715.0, 5358.0, 5281.0, 5617.0, 5479.0, 5437.0, 5568.0, 5304.0, 5545.0, 5465.0, 5366.0, 5615.0, 5620.0, 5505.0, 5430.0, 5602.0, 5572.0, 5512.0, 5334.0, 5481.0, 5475.0, 5636.0, 5698.0, 5655.0, 5268.0, 5590.0, 5484.0, 5712.0, 5258.0, 5530.0, 5537.0, 5373.0, 5449.0, 5282.0, 5496.0, 5466.0, 5558.0, 5349.0, 5632.0, 5560.0, 5375.0, 5467.0, 5634.0, 5446.0, 5428.0, 5359.0, 5508.0, 5579.0, 5604.0, 5419.0, 5721.0, 5472.0, 5517.0, 5341.0, 5276.0, 5399.0, 5271.0, 5487.0, 5581.0, 5300.0, 5429.0, 5477.0, 5360.0, 5584.0, 5460.0, 5424.0, 5507.0, 5651.0, 5421.0, 5327.0, 5261.0, 5252.0, 5410.0, 5534.0, 5400.0, 5696.0, 5597.0, 5680.0 (number of hits: 6)
24	5290	9	1	333	1	5266.0, 5412.0, 5536.0, 5291.0, 5531.0, 5379.0, 5717.0, 5564.0, 5467.0, 5362.0, 5313.0, 5351.0, 5593.0, 5338.0, 5428.0, 5569.0, 5672.0, 5689.0, 5318.0, 5289.0, 5392.0, 5697.0, 5300.0, 5444.0, 5622.0, 5498.0, 5415.0, 5315.0, 5443.0, 5567.0, 5654.0, 5457.0, 5594.0, 5560.0, 5684.0, 5314.0, 5311.0, 5668.0, 5322.0, 5680.0, 5699.0, 5520.0, 5515.0, 5493.0, 5568.0, 5528.0, 5585.0, 5710.0, 5466.0, 5562.0, 5502.0, 5601.0, 5553.0, 5473.0, 5620.0, 5702.0, 5626.0, 5425.0, 5713.0, 5613.0, 5703.0, 5360.0, 5718.0, 5714.0, 5490.0, 5524.0, 5426.0, 5653.0, 5649.0, 5299.0, 5544.0, 5410.0, 5587.0, 5326.0, 5287.0, 5404.0, 5507.0, 5327.0, 5465.0, 5439.0, 5550.0, 5483.0, 5671.0, 5707.0, 5260.0, 5496.0, 5346.0, 5674.0, 5295.0, 5345.0, 5546.0, 5643.0, 5330.0, 5308.0, 5454.0, 5614.0, 5570.0, 5432.0, 5696.0, 5462.0 (number of hits: 13)
25	5290	9	1	333	1	5260.0, 5445.0, 5499.0, 5305.0, 5317.0, 5404.0, 5411.0, 5589.0, 5548.0, 5690.0, 5631.0, 5670.0, 5366.0, 5685.0, 5675.0, 5432.0, 5592.0, 5339.0, 5473.0, 5344.0, 5348.0, 5325.0, 5423.0, 5704.0, 5678.0, 5428.0, 5396.0, 5461.0, 5475.0, 5440.0, 5626.0, 5705.0, 5543.0, 5456.0, 5327.0, 5492.0, 5664.0, 5307.0, 5568.0, 5367.0, 5599.0, 5370.0, 5574.0, 5613.0, 5384.0, 5385.0, 5639.0, 5352.0, 5452.0, 5530.0, 5264.0, 5308.0, 5571.0, 5282.0, 5546.0, 5272.0, 5417.0, 5516.0, 5437.0, 5371.0, 5598.0, 5564.0, 5476.0, 5624.0, 5699.0, 5372.0, 5719.0, 5555.0, 5283.0, 5275.0, 5612.0, 5587.0, 5443.0, 5251.0, 5691.0, 5380.0, 5401.0, 5323.0, 5519.0, 5291.0, 5393.0, 5324.0, 5621.0, 5659.0, 5717.0, 5638.0, 5559.0, 5681.0, 5556.0, 5676.0, 5331.0, 5400.0, 5596.0, 5486.0, 5426.0, 5386.0, 5419.0, 5252.0, 5341.0, 5281.0 (number of hits: 9)

26	5290	9	1	333	1	<p>5471.0, 5268.0, 5623.0, 5596.0, 5409.0, 5398.0, 5684.0, 5561.0, 5294.0, 5718.0, 5308.0, 5362.0, 5636.0, 5537.0, 5505.0, 5707.0, 5252.0, 5290.0, 5678.0, 5591.0, 5712.0, 5367.0, 5293.0, 5491.0, 5382.0, 5450.0, 5644.0, 5400.0, 5700.0, 5541.0, 5476.0, 5697.0, 5589.0, 5508.0, 5648.0, 5363.0, 5484.0, 5512.0, 5658.0, 5706.0, 5649.0, 5463.0, 5717.0, 5642.0, 5610.0, 5314.0, 5321.0, 5522.0, 5570.0, 5614.0, 5286.0, 5404.0, 5358.0, 5628.0, 5719.0, 5385.0, 5612.0, 5322.0, 5468.0, 5422.0, 5395.0, 5273.0, 5329.0, 5668.0, 5587.0, 5691.0, 5577.0, 5647.0, 5258.0, 5490.0, 5342.0, 5625.0, 5324.0, 5562.0, 5254.0, 5674.0, 5540.0, 5393.0, 5415.0, 5661.0, 5639.0, 5553.0, 5399.0, 5518.0, 5681.0, 5251.0, 5269.0, 5554.0, 5716.0, 5298.0, 5513.0, 5282.0, 5448.0, 5549.0, 5418.0, 5359.0, 5500.0, 5443.0, 5664.0, 5424.0 (number of hits: 10)</p>
27	5290	9	1	333	1	<p>5689.0, 5414.0, 5254.0, 5280.0, 5321.0, 5312.0, 5275.0, 5521.0, 5316.0, 5551.0, 5297.0, 5574.0, 5452.0, 5323.0, 5395.0, 5584.0, 5327.0, 5562.0, 5310.0, 5714.0, 5349.0, 5274.0, 5630.0, 5339.0, 5627.0, 5342.0, 5304.0, 5430.0, 5632.0, 5442.0, 5707.0, 5437.0, 5412.0, 5545.0, 5622.0, 5264.0, 5619.0, 5252.0, 5647.0, 5300.0, 5691.0, 5687.0, 5699.0, 5375.0, 5502.0, 5688.0, 5722.0, 5633.0, 5530.0, 5482.0, 5640.0, 5258.0, 5674.0, 5434.0, 5609.0, 5564.0, 5698.0, 5614.0, 5532.0, 5571.0, 5448.0, 5374.0, 5362.0, 5669.0, 5376.0, 5547.0, 5595.0, 5488.0, 5540.0, 5663.0, 5290.0, 5289.0, 5570.0, 5650.0, 5601.0, 5608.0, 5720.0, 5378.0, 5629.0, 5373.0, 5510.0, 5295.0, 5559.0, 5407.0, 5522.0, 5253.0, 5587.0, 5331.0, 5380.0, 5404.0, 5549.0, 5456.0, 5679.0, 5723.0, 5477.0, 5638.0, 5625.0, 5474.0, 5537.0, 5529.0 (number of hits: 11)</p>
28	5290	9	1	333	1	<p>5477.0, 5655.0, 5554.0, 5319.0, 5588.0, 5637.0, 5628.0, 5570.0, 5681.0, 5285.0, 5305.0, 5324.0, 5425.0, 5717.0, 5553.0, 5362.0, 5624.0, 5512.0, 5605.0, 5376.0, 5632.0, 5658.0, 5709.0, 5439.0, 5561.0, 5266.0, 5549.0, 5471.0, 5534.0, 5321.0, 5672.0, 5475.0, 5405.0, 5443.0, 5661.0, 5328.0, 5354.0, 5422.0, 5542.0, 5400.0, 5545.0, 5416.0, 5718.0, 5650.0, 5322.0, 5435.0, 5403.0, 5639.0, 5346.0, 5483.0, 5533.0, 5667.0, 5397.0, 5638.0, 5325.0, 5331.0, 5287.0, 5705.0, 5701.0, 5289.0, 5575.0, 5710.0, 5481.0, 5368.0, 5441.0, 5651.0, 5254.0, 5448.0, 5711.0, 5312.0, 5385.0, 5391.0, 5671.0, 5704.0, 5584.0, 5541.0, 5641.0, 5694.0, 5367.0, 5396.0, 5634.0, 5286.0, 5680.0, 5571.0, 5587.0,</p>

						5720.0, 5310.0, 5344.0, 5557.0, 5687.0, 5566.0, 5300.0, 5621.0, 5251.0, 5489.0, 5445.0, 5332.0, 5721.0, 5364.0, 5723.0 (number of hits: 10)
29	5290	9	1	333	1	5503.0, 5654.0, 5493.0, 5513.0, 5423.0, 5632.0, 5604.0, 5298.0, 5453.0, 5344.0, 5710.0, 5576.0, 5359.0, 5371.0, 5490.0, 5268.0, 5447.0, 5486.0, 5320.0, 5608.0, 5607.0, 5570.0, 5372.0, 5433.0, 5478.0, 5529.0, 5540.0, 5334.0, 5511.0, 5452.0, 5641.0, 5597.0, 5667.0, 5668.0, 5605.0, 5393.0, 5629.0, 5333.0, 5550.0, 5319.0, 5636.0, 5699.0, 5587.0, 5426.0, 5464.0, 5647.0, 5418.0, 5526.0, 5374.0, 5462.0, 5476.0, 5682.0, 5578.0, 5674.0, 5551.0, 5658.0, 5701.0, 5664.0, 5352.0, 5351.0, 5614.0, 5323.0, 5403.0, 5470.0, 5270.0, 5593.0, 5330.0, 5399.0, 5446.0, 5451.0, 5454.0, 5559.0, 5343.0, 5474.0, 5342.0, 5391.0, 5716.0, 5402.0, 5685.0, 5669.0, 5281.0, 5336.0, 5595.0, 5535.0, 5369.0, 5670.0, 5469.0, 5282.0, 5655.0, 5697.0, 5624.0, 5376.0, 5514.0, 5445.0, 5564.0, 5622.0, 5698.0, 5280.0, 5537.0, 5379.0 (number of hits: 4)
30	5290	9	1	333	1	5544.0, 5502.0, 5352.0, 5501.0, 5495.0, 5569.0, 5512.0, 5630.0, 5405.0, 5487.0, 5497.0, 5528.0, 5637.0, 5485.0, 5355.0, 5571.0, 5628.0, 5393.0, 5254.0, 5646.0, 5520.0, 5546.0, 5386.0, 5302.0, 5313.0, 5368.0, 5610.0, 5694.0, 5464.0, 5373.0, 5633.0, 5440.0, 5625.0, 5479.0, 5608.0, 5704.0, 5459.0, 5621.0, 5391.0, 5438.0, 5434.0, 5647.0, 5413.0, 5653.0, 5301.0, 5419.0, 5601.0, 5381.0, 5253.0, 5332.0, 5285.0, 5693.0, 5457.0, 5644.0, 5382.0, 5443.0, 5586.0, 5498.0, 5308.0, 5447.0, 5659.0, 5258.0, 5423.0, 5309.0, 5331.0, 5645.0, 5508.0, 5399.0, 5418.0, 5363.0, 5529.0, 5377.0, 5324.0, 5379.0, 5404.0, 5269.0, 5415.0, 5598.0, 5504.0, 5696.0, 5543.0, 5514.0, 5509.0, 5674.0, 5639.0, 5456.0, 5715.0, 5300.0, 5568.0, 5378.0, 5667.0, 5648.0, 5441.0, 5635.0, 5314.0, 5583.0, 5294.0, 5535.0, 5295.0, 5347.0 (number of hits: 10)

5540 MHz, 20 MHz Bandwidth

Radar Signal Type	Waveform/Trial Number	Detection (%)	Limit (%)	Pass/Fail
Type 1A/1B	30	100 %	60%	Pass
Type 2	30	100 %	60%	Pass
Type 3	30	100 %	60%	Pass
Type 4	30	100 %	60%	Pass
Aggregate (Type1 to 4)	120	100 %	80%	Pass
Type 5	30	93.3 %	80%	Pass
Type 6	30	100 %	70%	Pass

Please refer to the following statistical tables:

5540 MHz, 20 MHz Bandwidth**Table-1A/1B Radar Type 1A/1B Statistical Performance**

Trial #	Fc (MHz)	Pulse/Burst	Pulse Width (μS)	PRI (μs)	Detection (1:yes; 0:no)
1	5540	74	1	718	1
2	5540	92	1	578	1
3	5540	99	1	538	1
4	5540	89	1	598	1
5	5540	67	1	798	1
6	5540	61	1	878	1
7	5540	63	1	838	1
8	5540	61	1	878	1
9	5540	74	1	718	1
10	5540	99	1	538	1
11	5540	86	1	618	1
12	5540	59	1	898	1
13	5540	57	1	938	1
14	5540	59	1	898	1
15	5540	83	1	638	1
16	5540	23	1	2298	1
17	5540	91	1	585	1
18	5540	47	1	1145	1
19	5540	98	1	540	1
20	5540	23	1	2299	1
21	5540	20	1	2762	1
22	5540	29	1	1876	1
23	5540	20	1	2722	1
24	5540	25	1	2115	1
25	5540	32	1	1682	1
26	5540	23	1	2341	1
27	5540	54	1	994	1
28	5540	75	1	710	1
29	5540	32	1	1685	1
30	5540	57	1	931	1
Detection Percentage: 100 % (>60%)					

Table-2 Radar Type 2 Statistical Performance

Trial #	Fc (MHz)	Pulse/Burst	Pulse Width (μS)	PRI (μs)	Detection (1:yes; 0:no)
1	5540	23	1.2	167	1
2	5540	26	1	203	1
3	5540	27	2.8	154	1
4	5540	23	3.8	159	1
5	5540	27	2.5	151	1
6	5540	28	3.8	164	1
7	5540	29	3.8	166	1
8	5540	27	1.1	160	1
9	5540	29	1.6	177	1
10	5540	25	1.9	182	1
11	5540	26	4.5	159	1
12	5540	28	3.8	223	1
13	5540	26	3.2	169	1
14	5540	23	3.3	221	1
15	5540	24	4.5	195	1
16	5540	27	3.3	163	1
17	5540	24	5	190	1
18	5540	28	1.8	185	1
19	5540	27	3.8	150	1
20	5540	27	3.1	201	1
21	5540	25	3.5	225	1
22	5540	28	1.8	207	1
23	5540	23	3.5	175	1
24	5540	24	2.4	164	1
25	5540	24	4.9	210	1
26	5540	25	4.7	175	1
27	5540	23	1.9	190	1
28	5540	23	4.5	216	1
29	5540	24	2.5	155	1
30	5540	25	1.5	226	1
Detection Percentage: 100 % (>60%)					

Table-3 Radar Type 3 Statistical Performance

Trial #	Fc (MHz)	Pulse/Burst	Pulse Width (μS)	PRI (μs)	Detection (1:yes; 0:no)
1	5540	17	9	469	1
2	5540	18	8.4	342	1
3	5540	17	7.1	381	1
4	5540	16	7.8	357	1
5	5540	18	9.4	373	1
6	5540	16	9.9	458	1
7	5540	18	10	284	1
8	5540	17	7.5	345	1
9	5540	16	6	465	1
10	5540	18	7.6	351	1
11	5540	17	8.8	491	1
12	5540	17	9.4	331	1
13	5540	17	7.2	221	1
14	5540	17	8.7	421	1
15	5540	17	9.6	209	1
16	5540	17	8.9	299	1
17	5540	17	6.1	382	1
18	5540	17	9.2	285	1
19	5540	16	9.8	218	1
20	5540	17	6.1	455	1
21	5540	16	8.9	291	1
22	5540	18	6.2	497	1
23	5540	17	6.8	242	1
24	5540	16	6.8	263	1
25	5540	18	7.7	378	1
26	5540	17	6.1	416	1
27	5540	17	6.1	328	1
28	5540	18	9.1	428	1
29	5540	17	6	412	1
30	5540	16	6.5	387	1
Detection Percentage: 100 % (>60%)					

Table-4 Radar Type 4 Statistical Performance

Trial #	Fc (MHz)	Pulse/Burst	Pulse Width (μS)	PRI (μs)	Detection (1:yes; 0:no)
1	5540	16	19.6	421	1
2	5540	15	16.4	448	1
3	5540	12	20	498	1
4	5540	12	16.9	479	1
5	5540	16	15.2	203	1
6	5540	14	19.4	286	1
7	5540	13	17.3	447	1
8	5540	13	12.4	228	1
9	5540	16	12.8	349	1
10	5540	14	15.4	364	1
11	5540	14	15.4	457	1
12	5540	14	12.8	351	1
13	5540	12	16.8	223	1
14	5540	16	18.5	440	1
15	5540	16	14	435	1
16	5540	15	19.7	307	1
17	5540	14	18.4	456	1
18	5540	15	13.9	489	1
19	5540	16	11.7	261	1
20	5540	12	12.7	326	1
21	5540	12	18.3	228	1
22	5540	13	14.9	488	1
23	5540	12	17.6	301	1
24	5540	15	19.4	385	1
25	5540	14	14.3	359	1
26	5540	16	13.3	465	1
27	5540	13	16	323	1
28	5540	15	11.8	337	1
29	5540	13	15.1	485	1
30	5540	14	19.8	331	1
Detection Percentage: 100 % (>60%)					

Table-5 Radar Type 5 Statistical Performance

Trial #	Fc (MHz)	Detection (1:yes; 0:no)
1	5540	1
2	5540	1
3	5540	1
4	5540	1
5	5540	1
6	5540	1
7	5540	1
8	5540	1
9	5540	1
10	5540	1
11	5533.9	1
12	5536.7	0
13	5535.9	1
14	5538.3	1
15	5534.3	1
16	5535.1	0
17	5539.1	1
18	5537.5	1
19	5536.3	1
20	5533.9	1
21	5546.5	1
22	5543.3	1
23	5544.9	1
24	5543.7	1
25	5545.3	1
26	5544.1	1
27	5544.9	1
28	5546.1	1
29	5542.9	1
30	5545.3	1
Detection Percentage: 93.3 % (>80%)		

Bin5 Statistics 1

Trial #	Pulse	Chirp (MHz)	Pulse Width (µS)	Pulse 1-2 spacing (uS)	Pulse 2-3 spacing (uS)	Pulse Start(S)	Detection (1:yes; 0:no)
0	3	6	79.9	1651	1185	0.527891	1
1	1	6	80.5			1.21225	
2	2	6	68.9	1754		1.793349	
3	3	6	79.5	1242	1058	2.495955	
4	2	6	93	1354		2.663612	
5	2	6	63.1	1659		3.640071	
6	1	6	55.5			4.315569	
7	1	6	64			4.786924	
8	2	6	72.2	1624		5.211053	
9	3	6	77.8	1121	1198	6.193209	
10	1	6	59.1			6.935419	
11	2	6	64.5	1516		7.194355	
12	2	6	89.1	1812		7.901724	
13	2	6	81.8	1453		8.34278	
14	3	6	65.9	1447	1323	9.422494	
15	1	6	79			9.929338	
16	2	6	71.5	1489		10.323262	
17	2	6	66.9	1307		11.299295	
18	2	6	85.3	1335		11.750911	

Bin5 Statistics 2

Trial #	Pulse	Chirp (MHz)	Pulse Width (µS)	Pulse 1-2 spacing (uS)	Pulse 2-3 spacing (uS)	Pulse Start(S)	Detection (1:yes; 0:no)
0	2	11	63.4	1096		0.634071	1
1	2	11	81.7	1056		1.309625	
2	3	11	82.4	1379	1520	2.571747	
3	1	11	80.6			3.487131	
4	2	11	74.7	1404		5.036389	
5	2	11	68.4	1690		6.366915	
6	2	11	91.3	1706		7.225204	
7	2	11	74.3	1129		8.410009	
8	3	11	69	1909	1260	9.54144	
9	2	11	65.3	1414		10.794324	
10	3	11	80.3	1750	1295	11.518563	

Bin5 Statistics 3

Trial #	Pulse	Chirp (MHz)	Pulse Width (µS)	Pulse 1-2 spacing (µS)	Pulse 2-3 spacing (µS)	Pulse Start(S)	Detection (1:yes; 0:no)
0	2	5	51.9	1516		0.092063	1
1	3	5	66.3	1808	1975	1.169133	
2	2	5	89.5	1901		1.224538	
3	2	5	73.9	1380		2.005666	
4	1	5	85.3			2.802488	
5	1	5	50.7			3.032808	
6	2	5	61.7	1944		3.674667	
7	2	5	62.3	1859		4.264793	
8	2	5	65.9	1182		5.145014	
9	1	5	86.2			5.554667	
10	1	5	63.4			6.26852	
11	1	5	78			6.791147	
12	3	5	91.5	1635	1118	7.580244	
13	2	5	65.7	1070		8.122211	
14	2	5	78.5	1908		8.751273	
15	2	5	87.3	1451		9.495747	
16	3	5	67.4	1512	1530	10.007529	
17	2	5	57.5	1888		10.498419	
18	2	5	52.4	1094		11.166288	
19	2	5	53.5	1925		11.480453	

Bin5 Statistics 4

Trial #	Pulse	Chirp (MHz)	Pulse Width (µS)	Pulse 1-2 spacing (µS)	Pulse 2-3 spacing (µS)	Pulse Start(S)	Detection (1:yes; 0:no)
0	2	19	70	1670		0.344734	1
1	3	19	69.3	1069	1419	1.2771	
2	2	19	54.1	1922		3.089681	
3	1	19	65			3.39181	
4	1	19	90			4.775986	
5	2	19	92.3	1206		5.799097	
6	2	19	83	1388		7.149643	
7	3	19	78.2	1601	1063	7.93504	
8	2	19	54.5	1402		9.480652	
9	1	19	95.5			10.390822	
10	2	19	75.3	1059		11.776654	

Bin5 Statistics 5

Trial #	Pulse	Chirp (MHz)	Pulse Width (µS)	Pulse 1-2 spacing (µS)	Pulse 2-3 spacing (µS)	Pulse Start(S)	Detection (1:yes; 0:no)
0	1	8	54.7			0.186402	1
1	2	8	76.6	1997		1.243807	
2	2	8	66.2	1407		2.331871	
3	1	8	87.4			4.209633	
4	2	8	51.5	1954		4.800901	
5	2	8	53.4	1486		5.895227	
6	3	8	98.7	1820	1029	7.19904	
7	1	8	99.9			7.747421	
8	1	8	74			9.293396	
9	3	8	87.1	1292	1093	10.770018	
10	3	8	68.7	1215	1795	11.95605	

Bin5 Statistics 6

Trial #	Pulse	Chirp (MHz)	Pulse Width (µS)	Pulse 1-2 spacing (µS)	Pulse 2-3 spacing (µS)	Pulse Start(S)	Detection (1:yes; 0:no)
0	3	17	58.6	1759	1645	0.086394	1
1	1	17	67.7			0.780725	
2	2	17	88.3	1331		1.537272	
3	1	17	97			1.880124	
4	2	17	68.3	1982		2.833648	
5	2	17	86.7	1646		3.405279	
6	1	17	95.2			3.748538	
7	3	17	54	1600	1134	4.248468	
8	1	17	69.4			5.327301	
9	2	17	80.3	1023		5.82951	
10	3	17	96.5	1936	1537	6.136203	
11	2	17	77.5	1665		6.878448	
12	3	17	86.6	1805	1751	7.672233	
13	2	17	82	1020		7.832685	
14	2	17	83.3	1144		8.880449	
15	3	17	85.4	1950	1382	9.022482	
16	3	17	99.5	1202	1239	10.1071	
17	2	17	81.1	1968		10.778016	
18	3	17	97.7	1425	1707	11.051524	
19	2	17	66.5	1781		11.435382	

Bin5 Statistics 7

Trial #	Pulse	Chirp (MHz)	Pulse Width (µS)	Pulse 1-2 spacing (uS)	Pulse 2-3 spacing (uS)	Pulse Start(S)	Detection (1:yes; 0:no)
0	2	15	99.6	1307		0.073085	1
1	2	15	84	1785		1.490572	
2	3	15	54.5	1904	1246	1.88242	
3	2	15	97.4	1507		3.145587	
4	1	15	76.2			3.922114	
5	3	15	99	1439	1696	4.585708	
6	2	15	54.1	1433		5.530392	
7	2	15	70.4	1679		6.633114	
8	2	15	72.7	1666		7.586171	
9	1	15	80.5			7.82152	
10	2	15	76.5	1799		8.860177	
11	2	15	82	1505		10.026051	
12	2	15	87.7	1364		11.057812	
13	1	15	93.3			11.700877	

Bin5 Statistics 8

Trial #	Pulse	Chirp (MHz)	Pulse Width (µS)	Pulse 1-2 spacing (uS)	Pulse 2-3 spacing (uS)	Pulse Start(S)	Detection (1:yes; 0:no)
0	1	8	82			1.136731	1
1	1	8	84			2.269225	
2	2	8	85.5	1968		3.79804	
3	1	8	94.5			4.932031	
4	3	8	86	1614	1202	6.242985	
5	1	8	71.1			6.896547	
6	2	8	99.2	1004		9.105367	
7	2	8	96.4	1544		10.39191	
8	1	8	61			11.178249	

Bin5 Statistics 9

Trial #	Pulse	Chirp (MHz)	Pulse Width (µS)	Pulse 1-2 spacing (µS)	Pulse 2-3 spacing (µS)	Pulse Start(S)	Detection (1:yes; 0:no)
0	2	13	82.1	1563		0.089248	1
1	1	13	50.6			1.2015	
2	1	13	97.8			1.704648	
3	3	13	96.2	1782	1150	2.625875	
4	1	13	68.6			3.054862	
5	1	13	53			4.128203	
6	1	13	76.2			4.746111	
7	2	13	86.6	1635		5.283528	
8	2	13	86	1447		6.508622	
9	2	13	59.4	1406		7.325555	
10	2	13	68.8	1081		7.819234	
11	2	13	89	1862		8.482234	
12	1	13	74.3			9.47185	
13	2	13	90.6	1987		10.464824	
14	2	13	68.5	1818		10.930866	
15	3	13	51.3	1365	1952	11.505689	

Bin5 Statistics 10

Trial #	Pulse	Chirp (MHz)	Pulse Width (µS)	Pulse 1-2 spacing (µS)	Pulse 2-3 spacing (µS)	Pulse Start(S)	Detection (1:yes; 0:no)
0	2	18	60.9	1397		0.470489	1
1	2	18	83.2	1662		1.097143	
2	2	18	86.9	1213		2.619512	
3	1	18	91.7			3.044809	
4	3	18	79.3	1723	1267	3.970405	
5	1	18	80.8			5.329385	
6	3	18	91.8	1663	1882	5.640577	
7	2	18	88.4	1816		6.854432	
8	2	18	90.6	1962		7.505544	
9	2	18	51.9	1005		8.367151	
10	3	18	85.3	1739	1931	9.236141	
11	3	18	80	1697	1418	10.606374	
12	3	18	78.4	1850	1468	11.806772	

Bin5 Statistics 11

Trial #	Pulse	Chirp (MHz)	Pulse Width (µS)	Pulse 1-2 spacing (uS)	Pulse 2-3 spacing (uS)	Pulse Start(S)	Detection (1:yes; 0:no)
0	3	6	68.1	1211	1950	0.608162	1
1	3	6	66.5	1966	1328	2.181482	
2	3	6	57.6	1109	1155	3.516642	
3	1	6	88.6			5.084093	
4	3	6	66	1027	1794	7.460027	
5	2	6	62.7	1745		7.629564	
6	3	6	87.1	1018	1025	9.754435	
7	1	6	91			11.12342	

Bin5 Statistics 12

Trial #	Pulse	Chirp (MHz)	Pulse Width (µS)	Pulse 1-2 spacing (uS)	Pulse 2-3 spacing (uS)	Pulse Start(S)	Detection (1:yes; 0:no)
0	2	13	76.9	1226		0.121122	0
1	1	13	58.7			0.662208	
2	3	13	98.9	1001	1421	1.405699	
3	2	13	77.6	1334		2.426292	
4	3	13	65.8	1947	1698	2.912059	
5	3	13	92.8	1374	1612	3.330296	
6	3	13	55.5	1028	1782	4.313577	
7	3	13	95.6	1551	1556	4.54418	
8	2	13	96.5	1475		5.107616	
9	1	13	77.3			5.939652	
10	2	13	70.8	1363		6.839373	
11	2	13	89.4	1549		7.158211	
12	3	13	99	1420	1575	8.180618	
13	3	13	90.3	1786	1516	8.805491	
14	2	13	94.5	1240		9.216021	
15	2	13	80.2	1961		10.015044	
16	2	13	70	1882		10.68301	
17	2	13	86.4	1157		10.859649	
18	2	13	99	1947		11.437558	

Bin5 Statistics 13

Trial #	Pulse	Chirp (MHz)	Pulse Width (µS)	Pulse 1-2 spacing (uS)	Pulse 2-3 spacing (uS)	Pulse Start(S)	Detection (1:yes; 0:no)
0	2	11	78.1	1485		0.532637	1
1	2	11	98	1224		0.738738	
2	1	11	80.7			1.717602	
3	3	11	58.6	1071	1161	2.604741	
4	1	11	57.9			3.100421	
5	2	11	55.3	1960		4.225618	
6	2	11	74	1982		4.31281	
7	2	11	61.2	1283		5.081796	
8	2	11	99.5	1823		5.854868	
9	2	11	89.8	1728		7.039569	
10	2	11	82.7	1931		7.722637	
11	3	11	52.2	1870	1123	8.190345	
12	3	11	99.6	1669	1043	9.063447	
13	3	11	89.7	1560	1581	9.70673	
14	3	11	71.7	1637	1009	10.242686	
15	2	11	50.9	1579		10.878994	
16	3	11	68.3	1670	1172	11.409008	

Bin5 Statistics 14

Trial #	Pulse	Chirp (MHz)	Pulse Width (µS)	Pulse 1-2 spacing (uS)	Pulse 2-3 spacing (uS)	Pulse Start(S)	Detection (1:yes; 0:no)
0	3	17	69.3	1231	1325	0.639519	1
1	2	17	78.1	1339		0.814565	
2	1	17	54.7			2.3606	
3	2	17	59	1120		2.546392	
4	2	17	61.5	1577		3.338832	
5	2	17	71.3	1222		4.281168	
6	1	17	93.7			5.594919	
7	3	17	61.7	1390	1113	5.675448	
8	2	17	73.3	1728		6.972549	
9	2	17	83.5	1110		7.508482	
10	3	17	76.2	1899	1562	8.236758	
11	3	17	94.1	1134	1650	8.93735	
12	2	17	92.9	1523		9.665343	
13	1	17	60.3			10.788891	
14	2	17	99.1	1594		11.892932	

Bin5 Statistics 15

Trial #	Pulse	Chirp (MHz)	Pulse Width (µS)	Pulse 1-2 spacing (uS)	Pulse 2-3 spacing (uS)	Pulse Start(S)	Detection (1:yes; 0:no)
0	3	7	80.4	1521	1455	0.115099	1
1	2	7	71.8	1006		1.694354	
2	3	7	71.7	1684	1103	1.785938	
3	3	7	66.6	1730	1812	3.33509	
4	1	7	94.8			3.546142	
5	3	7	64.4	1039	1339	4.457583	
6	3	7	78.5	1704	1781	5.937521	
7	2	7	83.8	1409		6.650855	
8	2	7	93.6	1822		7.55225	
9	1	7	75.4			8.498136	
10	2	7	83	1778		9.040348	
11	2	7	84.1	1065		10.126226	
12	2	7	67.6	1838		10.575771	
13	1	7	94.4			11.835862	

Bin5 Statistics 16

Trial #	Pulse	Chirp (MHz)	Pulse Width (µS)	Pulse 1-2 spacing (uS)	Pulse 2-3 spacing (uS)	Pulse Start(S)	Detection (1:yes; 0:no)
0	1	9	80.5			0.668064	0
1	1	9	97.3			1.536674	
2	2	9	80.8	1993		2.473033	
3	2	9	93.4	1981		3.923273	
4	3	9	97.8	1827	1473	4.611252	
5	1	9	59.2			5.82583	
6	3	9	58.7	1504	1713	7.568044	
7	3	9	83.2	1120	1702	7.756606	
8	3	9	82.7	1433	1079	9.789483	
9	1	9	92.3			9.851358	
10	3	9	72.9	1367	1851	11.474245	

Bin5 Statistics 17

Trial #	Pulse	Chirp (MHz)	Pulse Width (µS)	Pulse 1-2 spacing (uS)	Pulse 2-3 spacing (uS)	Pulse Start(S)	Detection (1:yes; 0:no)
0	2	19	98	1737		1.022008	1
1	1	19	71.7			1.403988	
2	2	19	80.1	1874		2.27705	
3	1	19	63.8			3.313469	
4	2	19	82.3	1739		4.730316	
5	2	19	87.5	1800		5.974807	
6	3	19	82.6	1186	1090	6.737703	
7	2	19	90	1771		7.830309	
8	1	19	64			9.116309	
9	3	19	86.6	1711	1418	10.74527	
10	3	19	89.5	1942	1110	11.966834	

Bin5 Statistics 18

Trial #	Pulse	Chirp (MHz)	Pulse Width (µS)	Pulse 1-2 spacing (uS)	Pulse 2-3 spacing (uS)	Pulse Start(S)	Detection (1:yes; 0:no)
0	1	15	73.4			0.466037	1
1	2	15	61.9	1426		1.47668	
2	2	15	54.6	1937		1.983151	
3	1	15	85.2			3.019409	
4	2	15	62.4	1572		3.872359	
5	2	15	85.3	1526		4.163032	
6	3	15	66.8	1662	1571	5.239979	
7	2	15	50.4	1243		6.380839	
8	3	15	89.1	1894	1392	6.756259	
9	2	15	96.1	1375		7.232371	
10	1	15	81.7			8.330795	
11	1	15	65.4			9.437772	
12	2	15	53.8	1176		10.090414	
13	2	15	93.9	1326		10.753265	
14	2	15	74.1	1779		11.56376	

Bin5 Statistics 19

Trial #	Pulse	Chirp (MHz)	Pulse Width (µS)	Pulse 1-2 spacing (uS)	Pulse 2-3 spacing (uS)	Pulse Start(S)	Detection (1:yes; 0:no)
0	2	12	81.5	1210		0.185989	1
1	1	12	92.3			0.985588	
2	1	12	98.5			2.01716	
3	2	12	82.4	1586		2.695778	
4	1	12	79.7			3.404388	
5	1	12	93.4			4.200241	
6	2	12	63.2	1675		4.760285	
7	2	12	64.5	1866		5.030796	
8	2	12	82.8	1583		5.70366	
9	2	12	56	1695		7.035987	
10	3	12	96.2	1980	1861	7.221205	
11	2	12	64.9	1516		8.050403	
12	1	12	94.7			8.483499	
13	3	12	63.9	1770	1100	9.429867	
14	1	12	84.4			9.897755	
15	3	12	98.2	1409	1541	10.883653	
16	1	12	60.3			11.479724	

Bin5 Statistics 20

Trial #	Pulse	Chirp (MHz)	Pulse Width (µS)	Pulse 1-2 spacing (uS)	Pulse 2-3 spacing (uS)	Pulse Start(S)	Detection (1:yes; 0:no)
0	1	6	73			0.777919	1
1	2	6	74.8	1317		1.423944	
2	2	6	98.7	1054		2.036442	
3	3	6	56	1253	1244	2.400838	
4	2	6	82.2	1177		3.55147	
5	1	6	91			4.138065	
6	2	6	93.2	1823		5.301341	
7	2	6	62.5	1491		6.300863	
8	2	6	98.4	1702		6.460949	
9	2	6	88.3	1478		7.810168	
10	1	6	87.2			8.59147	
11	3	6	91.7	1050	1995	9.288902	
12	3	6	59.7	1804	1501	9.852987	
13	2	6	87.3	1596		10.532048	
14	3	6	73.4	1388	1748	11.653246	

Bin5 Statistics 21

Trial #	Pulse	Chirp (MHz)	Pulse Width (µS)	Pulse 1-2 spacing (uS)	Pulse 2-3 spacing (uS)	Pulse Start(S)	Detection (1:yes; 0:no)
0	2	5	92.2	1236		0.280894	1
1	1	5	95.7			1.208577	
2	2	5	55	1166		1.49521	
3	2	5	93.8	1116		1.937533	
4	3	5	82.8	1286	1803	3.008435	
5	2	5	64.3	1395		3.182258	
6	1	5	53.4			3.939859	
7	2	5	72.6	1256		5.01491	
8	3	5	51.7	1064	1539	5.266449	
9	1	5	73.8			5.906471	
10	2	5	96.6	1723		6.32332	
11	2	5	58.3	1638		7.073584	
12	3	5	98.8	1254	1736	7.752459	
13	1	5	89.4			8.222638	
14	2	5	59.7	1080		9.221794	
15	2	5	53.5	1478		10.026379	
16	2	5	92.8	1472		10.667182	
17	3	5	94.6	1214	1904	11.267163	
18	2	5	69.7	1745		11.524514	

Bin5 Statistics 22

Trial #	Pulse	Chirp (MHz)	Pulse Width (µS)	Pulse 1-2 spacing (uS)	Pulse 2-3 spacing (uS)	Pulse Start(S)	Detection (1:yes; 0:no)
0	2	13	51.7	1220		0.535407	1
1	2	13	51.6	1465		1.110924	
2	1	13	53.3			2.405498	
3	3	13	51.2	1184	1582	3.160345	
4	3	13	53.1	1485	1458	4.42849	
5	2	13	81.9	1036		4.880895	
6	1	13	74.5			6.324723	
7	1	13	58.4			7.116715	
8	2	13	74.1	1636		8.300348	
9	1	13	85			9.110988	
10	3	13	98	1432	1415	9.917227	
11	3	13	56.5	1636	1131	10.666829	
12	1	13	88.8			11.392415	

Bin5 Statistics 23

Trial #	Pulse	Chirp (MHz)	Pulse Width (µS)	Pulse 1-2 spacing (uS)	Pulse 2-3 spacing (uS)	Pulse Start(S)	Detection (1:yes; 0:no)
0	2	9	62.2	1138		0.649532	1
1	2	9	83.7	1165		1.126387	
2	2	9	95.9	1139		2.120316	
3	1	9	84.2			3.005389	
4	2	9	82.5	1556		3.401082	
5	2	9	50.8	1898		4.430344	
6	2	9	67.5	1216		5.110109	
7	2	9	81.7	1129		5.907917	
8	1	9	94.7			6.812491	
9	2	9	63	1279		7.38218	
10	1	9	76.9			8.348991	
11	2	9	72.4	1917		8.886757	
12	2	9	88.3	1296		10.320548	
13	1	9	68.6			11.047397	
14	2	9	52.7	1715		11.393804	

Bin5 Statistics 24

Trial #	Pulse	Chirp (MHz)	Pulse Width (µS)	Pulse 1-2 spacing (uS)	Pulse 2-3 spacing (uS)	Pulse Start(S)	Detection (1:yes; 0:no)
0	1	12	90.5			0.922622	1
1	3	12	91.3	1113	1958	1.386585	
2	2	12	82.1	1409		2.632759	
3	1	12	52			3.429987	
4	2	12	99.8	1418		5.436853	
5	2	12	83.5	1559		6.031371	
6	1	12	91.6			6.602128	
7	1	12	53.7			8.105699	
8	3	12	85.1	1249	1071	8.995615	
9	2	12	90.8	1783		10.740849	
10	3	12	98.1	1088	1425	11.416027	

Bin5 Statistics 25

Trial #	Pulse	Chirp (MHz)	Pulse Width (µS)	Pulse 1-2 spacing (µS)	Pulse 2-3 spacing (µS)	Pulse Start(S)	Detection (1:yes; 0:no)
0	1	8	54.5			0.675155	1
1	3	8	96.4	1609	1549	1.86062	
2	2	8	56.5	1872		3.221109	
3	1	8	89.7			4.195253	
4	2	8	74.6	1326		5.396643	
5	3	8	71.5	1695	1929	7.0739	
6	2	8	55.6	1449		8.29814	
7	1	8	77.4			8.567543	
8	3	8	82.4	1556	1681	9.723342	
9	2	8	77.9	1050		10.800929	

Bin5 Statistics 26

Trial #	Pulse	Chirp (MHz)	Pulse Width (µS)	Pulse 1-2 spacing (µS)	Pulse 2-3 spacing (µS)	Pulse Start(S)	Detection (1:yes; 0:no)
0	3	11	81.1	1463	1255	0.29741	1
1	2	11	80.3	1278		0.897541	
2	2	11	75.3	1451		1.304785	
3	2	11	50.4	1042		2.32386	
4	1	11	64.7			3.12157	
5	3	11	73	1971	1932	3.248824	
6	3	11	95.7	1939	1695	4.034765	
7	2	11	55.5	1717		4.489771	
8	2	11	82.8	1856		5.394073	
9	2	11	56.4	1902		5.848424	
10	2	11	68.2	1315		6.373397	
11	3	11	72.1	1663	1038	7.04726	
12	3	11	70.3	1028	1643	8.1437	
13	1	11	52.9			8.827859	
14	2	11	96.1	1979		9.149299	
15	2	11	93.7	1400		9.798276	
16	2	11	97	1133		10.162745	
17	1	11	69			11.040134	
18	2	11	59.9	1189		11.474805	

Bin5 Statistics 27

Trial #	Pulse	Chirp (MHz)	Pulse Width (µS)	Pulse 1-2 spacing (uS)	Pulse 2-3 spacing (uS)	Pulse Start(S)	Detection (1:yes; 0:no)
0	2	9	64.4	1408		1.132745	1
1	1	9	83.4			2.624413	
2	2	9	56.2	1212		2.808619	
3	3	9	86.9	1649	1133	4.717214	
4	3	9	73.7	1240	1991	6.623354	
5	2	9	59.9	1806		7.37057	
6	3	9	70.6	1069	1257	9.140812	
7	3	9	97.7	1550	1419	9.70042	
8	2	9	63.7	1129		11.063302	

Bin5 Statistics 28

Trial #	Pulse	Chirp (MHz)	Pulse Width (µS)	Pulse 1-2 spacing (uS)	Pulse 2-3 spacing (uS)	Pulse Start(S)	Detection (1:yes; 0:no)
0	3	6	80	1690	1624	1.314055	1
1	2	6	76	1157		2.553978	
2	3	6	94.2	1180	1830	3.986322	
3	2	6	84.1	1303		4.526566	
4	2	6	89.1	1879		6.02455	
5	2	6	86.1	1269		7.052887	
6	2	6	82.6	1675		9.12402	
7	2	6	52	1852		9.721942	
8	2	6	80	1186		11.200546	

Bin5 Statistics 29

Trial #	Pulse	Chirp (MHz)	Pulse Width (µS)	Pulse 1-2 spacing (uS)	Pulse 2-3 spacing (uS)	Pulse Start(S)	Detection (1:yes; 0:no)
0	2	14	99.6	1871		0.329906	1
1	3	14	75	1554	1077	1.200252	
2	1	14	76.7			3.022544	
3	2	14	72.8	1438		3.728221	
4	3	14	90.8	1943	1136	5.929877	
5	3	14	83.4	1972	1718	7.160283	
6	3	14	59.8	1795	1910	8.032651	
7	3	14	60	1058	1398	9.077596	
8	2	14	74.8	1456		9.708722	
9	2	14	87.7	1972		11.457262	

Bin5 Statistics 30

Trial #	Pulse	Chirp (MHz)	Pulse Width (µS)	Pulse 1-2 spacing (uS)	Pulse 2-3 spacing (uS)	Pulse Start(S)	Detection (1:yes; 0:no)
0	2	8	98.9	1286		0.785007	1
1	2	8	65.7	1560		1.458669	
2	3	8	97.3	1526	1774	2.046061	
3	2	8	55.9	1012		2.934914	
4	2	8	84.2	1157		3.395417	
5	2	8	92.1	1762		4.315668	
6	2	8	78.3	1406		5.199905	
7	3	8	67.1	1925	1063	6.070633	
8	2	8	88.4	1612		7.186982	
9	2	8	63	1739		7.220899	
10	1	8	75.1			8.445387	
11	2	8	56.1	1019		9.444655	
12	2	8	90.2	1429		10.065511	
13	1	8	71.5			10.961377	
14	2	8	89.1	1723		11.947887	

Table-6 Radar Type 6 Statistical Performance

Trial #	Fc (MHz)	Pulse /Burst	Pulse Width (µS)	PRI (µs)	Detection (1:yes; 0:no)	Hopping Sequence
1	5540	9	1	333	1	5337.0, 5365.0, 5557.0, 5637.0, 5254.0, 5633.0, 5354.0, 5623.0, 5424.0, 5287.0, 5721.0, 5289.0, 5419.0, 5332.0, 5404.0, 5548.0, 5550.0, 5252.0, 5385.0, 5679.0, 5324.0, 5322.0, 5395.0, 5431.0, 5399.0, 5491.0, 5670.0, 5302.0, 5616.0, 5480.0, 5416.0, 5495.0, 5250.0, 5596.0, 5407.0, 5565.0, 5592.0, 5366.0, 5377.0, 5709.0, 5434.0, 5293.0, 5556.0, 5507.0, 5283.0, 5560.0, 5428.0, 5617.0, 5604.0, 5506.0, 5410.0, 5668.0, 5613.0, 5568.0, 5341.0, 5326.0, 5253.0, 5471.0, 5542.0, 5691.0, 5546.0, 5715.0, 5265.0, 5482.0, 5631.0, 5549.0, 5444.0, 5512.0, 5701.0, 5672.0, 5277.0, 5251.0, 5285.0, 5411.0, 5561.0, 5671.0, 5257.0, 5402.0, 5296.0, 5388.0, 5597.0, 5711.0, 5712.0, 5300.0, 5291.0, 5417.0, 5510.0, 5598.0, 5462.0, 5403.0, 5567.0, 5378.0, 5502.0, 5461.0, 5422.0, 5578.0, 5438.0, 5394.0, 5618.0, 5504.0 (number of hits: 4)
2	5540	9	1	333	1	5343.0, 5685.0, 5564.0, 5602.0, 5533.0, 5322.0, 5674.0, 5653.0, 5308.0, 5373.0, 5452.0, 5571.0, 5565.0, 5457.0, 5531.0, 5281.0, 5384.0, 5370.0, 5469.0, 5527.0, 5514.0, 5525.0, 5391.0, 5358.0, 5327.0, 5712.0, 5378.0, 5487.0, 5596.0, 5369.0, 5290.0, 5320.0, 5673.0, 5702.0, 5598.0, 5517.0, 5721.0, 5395.0, 5341.0, 5499.0, 5642.0, 5676.0, 5609.0, 5588.0, 5346.0, 5376.0, 5572.0, 5271.0, 5280.0, 5719.0, 5424.0, 5717.0, 5439.0, 5438.0, 5254.0, 5486.0, 5282.0, 5264.0, 5619.0, 5359.0, 5326.0, 5420.0, 5539.0, 5645.0, 5407.0, 5440.0, 5454.0, 5466.0, 5512.0, 5375.0, 5367.0, 5385.0, 5411.0, 5581.0, 5548.0, 5279.0, 5334.0, 5711.0, 5579.0, 5382.0, 5310.0, 5665.0, 5574.0, 5657.0, 5634.0, 5319.0, 5511.0, 5708.0, 5675.0, 5398.0, 5585.0, 5374.0, 5323.0, 5357.0, 5534.0, 5631.0, 5425.0, 5616.0, 5670.0, 5583.0 (number of hits: 5)
3	5540	9	1	333	1	5427.0, 5455.0, 5357.0, 5545.0, 5376.0, 5275.0, 5613.0, 5383.0, 5451.0, 5572.0, 5354.0, 5396.0, 5434.0, 5386.0, 5274.0, 5459.0, 5307.0, 5300.0, 5702.0, 5414.0, 5333.0, 5329.0, 5548.0, 5493.0, 5649.0, 5700.0, 5581.0, 5467.0, 5252.0, 5541.0, 5494.0, 5465.0, 5554.0, 5540.0, 5609.0, 5419.0, 5474.0, 5332.0, 5362.0, 5437.0, 5344.0, 5659.0, 5542.0, 5610.0, 5399.0, 5634.0, 5499.0, 5447.0, 5453.0, 5478.0, 5410.0, 5664.0, 5458.0, 5438.0, 5721.0,

						5384.0, 5370.0, 5277.0, 5420.0, 5686.0, 5503.0, 5553.0, 5260.0, 5660.0, 5535.0, 5290.0, 5446.0, 5569.0, 5678.0, 5382.0, 5538.0, 5311.0, 5723.0, 5261.0, 5375.0, 5324.0, 5546.0, 5316.0, 5477.0, 5251.0, 5650.0, 5525.0, 5432.0, 5417.0, 5487.0, 5643.0, 5715.0, 5694.0, 5299.0, 5614.0, 5543.0, 5320.0, 5536.0, 5408.0, 5423.0, 5286.0, 5373.0, 5488.0, 5353.0, 5464.0 (number of hits: 10)
4	5540	9	1	333	1	5624.0, 5425.0, 5274.0, 5310.0, 5357.0, 5682.0, 5641.0, 5345.0, 5402.0, 5356.0, 5398.0, 5426.0, 5694.0, 5594.0, 5567.0, 5432.0, 5495.0, 5573.0, 5442.0, 5503.0, 5637.0, 5405.0, 5408.0, 5709.0, 5508.0, 5716.0, 5696.0, 5675.0, 5329.0, 5642.0, 5519.0, 5676.0, 5361.0, 5496.0, 5527.0, 5305.0, 5396.0, 5337.0, 5634.0, 5452.0, 5517.0, 5564.0, 5582.0, 5473.0, 5491.0, 5662.0, 5261.0, 5414.0, 5685.0, 5560.0, 5588.0, 5469.0, 5326.0, 5464.0, 5335.0, 5363.0, 5547.0, 5562.0, 5723.0, 5514.0, 5621.0, 5532.0, 5367.0, 5574.0, 5684.0, 5690.0, 5511.0, 5708.0, 5683.0, 5701.0, 5538.0, 5304.0, 5322.0, 5497.0, 5263.0, 5656.0, 5659.0, 5602.0, 5273.0, 5509.0, 5318.0, 5706.0, 5394.0, 5289.0, 5606.0, 5344.0, 5664.0, 5597.0, 5372.0, 5312.0, 5336.0, 5382.0, 5530.0, 5660.0, 5603.0, 5549.0, 5611.0, 5258.0, 5427.0, 5287.0 (number of hits: 5)
5	5540	9	1	333	1	5436.0, 5298.0, 5558.0, 5279.0, 5674.0, 5375.0, 5566.0, 5567.0, 5609.0, 5617.0, 5255.0, 5333.0, 5623.0, 5655.0, 5505.0, 5578.0, 5633.0, 5518.0, 5313.0, 5369.0, 5693.0, 5384.0, 5671.0, 5546.0, 5289.0, 5572.0, 5510.0, 5591.0, 5347.0, 5620.0, 5668.0, 5459.0, 5371.0, 5686.0, 5336.0, 5308.0, 5676.0, 5388.0, 5482.0, 5462.0, 5700.0, 5504.0, 5380.0, 5325.0, 5629.0, 5484.0, 5537.0, 5264.0, 5451.0, 5258.0, 5410.0, 5311.0, 5552.0, 5605.0, 5515.0, 5405.0, 5273.0, 5512.0, 5532.0, 5304.0, 5478.0, 5426.0, 5559.0, 5499.0, 5420.0, 5582.0, 5463.0, 5283.0, 5265.0, 5651.0, 5493.0, 5647.0, 5607.0, 5587.0, 5523.0, 5556.0, 5714.0, 5386.0, 5703.0, 5457.0, 5588.0, 5580.0, 5562.0, 5608.0, 5654.0, 5354.0, 5374.0, 5367.0, 5366.0, 5455.0, 5592.0, 5435.0, 5291.0, 5474.0, 5257.0, 5465.0, 5335.0, 5417.0, 5318.0, 5599.0 (number of hits: 3)
6	5540	9	1	333	1	5555.0, 5639.0, 5255.0, 5374.0, 5659.0, 5254.0, 5438.0, 5643.0, 5419.0, 5436.0, 5370.0, 5588.0, 5467.0, 5507.0, 5549.0, 5466.0, 5435.0, 5330.0, 5541.0, 5558.0, 5605.0, 5602.0, 5364.0, 5297.0, 5717.0, 5271.0, 5416.0, 5483.0, 5276.0, 5622.0, 5429.0, 5705.0, 5356.0, 5592.0, 5375.0,

						5619.0, 5476.0, 5545.0, 5294.0, 5251.0, 5320.0, 5722.0, 5578.0, 5413.0, 5571.0, 5718.0, 5494.0, 5264.0, 5409.0, 5666.0, 5647.0, 5252.0, 5455.0, 5335.0, 5553.0, 5431.0, 5486.0, 5383.0, 5321.0, 5590.0, 5665.0, 5275.0, 5703.0, 5257.0, 5450.0, 5344.0, 5535.0, 5353.0, 5350.0, 5644.0, 5343.0, 5663.0, 5406.0, 5580.0, 5474.0, 5724.0, 5523.0, 5581.0, 5497.0, 5388.0, 5707.0, 5341.0, 5608.0, 5503.0, 5371.0, 5408.0, 5645.0, 5296.0, 5286.0, 5262.0, 5310.0, 5689.0, 5566.0, 5460.0, 5564.0, 5672.0, 5681.0, 5615.0, 5505.0, 5524.0 (number of hits: 4)
7	5540	9	1	333	1	5643.0, 5450.0, 5252.0, 5650.0, 5657.0, 5489.0, 5324.0, 5626.0, 5261.0, 5589.0, 5335.0, 5389.0, 5622.0, 5349.0, 5294.0, 5454.0, 5623.0, 5337.0, 5405.0, 5304.0, 5364.0, 5280.0, 5707.0, 5411.0, 5690.0, 5469.0, 5645.0, 5633.0, 5491.0, 5425.0, 5548.0, 5418.0, 5619.0, 5431.0, 5415.0, 5639.0, 5368.0, 5553.0, 5704.0, 5295.0, 5254.0, 5712.0, 5293.0, 5320.0, 5395.0, 5549.0, 5703.0, 5565.0, 5328.0, 5627.0, 5649.0, 5384.0, 5641.0, 5609.0, 5386.0, 5383.0, 5675.0, 5608.0, 5721.0, 5541.0, 5302.0, 5616.0, 5354.0, 5423.0, 5310.0, 5625.0, 5605.0, 5435.0, 5484.0, 5594.0, 5706.0, 5564.0, 5511.0, 5319.0, 5269.0, 5360.0, 5502.0, 5543.0, 5455.0, 5366.0, 5677.0, 5642.0, 5575.0, 5480.0, 5651.0, 5451.0, 5278.0, 5697.0, 5614.0, 5598.0, 5408.0, 5251.0, 5668.0, 5525.0, 5573.0, 5724.0, 5566.0, 5550.0, 5482.0, 5353.0 (number of hits: 4)
8	5540	9	1	333	1	5414.0, 5715.0, 5477.0, 5536.0, 5682.0, 5712.0, 5624.0, 5697.0, 5539.0, 5422.0, 5495.0, 5602.0, 5723.0, 5598.0, 5537.0, 5316.0, 5411.0, 5413.0, 5501.0, 5471.0, 5589.0, 5286.0, 5492.0, 5680.0, 5677.0, 5703.0, 5529.0, 5611.0, 5559.0, 5334.0, 5591.0, 5387.0, 5415.0, 5385.0, 5376.0, 5635.0, 5511.0, 5706.0, 5339.0, 5405.0, 5671.0, 5542.0, 5296.0, 5649.0, 5325.0, 5653.0, 5373.0, 5409.0, 5618.0, 5496.0, 5478.0, 5342.0, 5596.0, 5595.0, 5254.0, 5583.0, 5651.0, 5366.0, 5361.0, 5534.0, 5586.0, 5453.0, 5305.0, 5332.0, 5483.0, 5340.0, 5693.0, 5275.0, 5439.0, 5326.0, 5674.0, 5673.0, 5640.0, 5290.0, 5494.0, 5650.0, 5691.0, 5287.0, 5560.0, 5683.0, 5601.0, 5467.0, 5724.0, 5573.0, 5578.0, 5331.0, 5687.0, 5549.0, 5303.0, 5401.0, 5379.0, 5636.0, 5419.0, 5540.0, 5584.0, 5397.0, 5575.0, 5486.0, 5514.0, 5442.0 (number of hits: 7)
9	5540	9	1	333	1	5592.0, 5487.0, 5325.0, 5535.0, 5264.0, 5710.0, 5274.0, 5431.0, 5537.0, 5648.0, 5339.0, 5630.0, 5312.0, 5481.0, 5291.0,

						5642.0, 5345.0, 5637.0, 5502.0, 5377.0, 5531.0, 5669.0, 5546.0, 5482.0, 5428.0, 5563.0, 5273.0, 5375.0, 5506.0, 5376.0, 5368.0, 5601.0, 5307.0, 5540.0, 5434.0, 5585.0, 5644.0, 5497.0, 5675.0, 5285.0, 5509.0, 5452.0, 5591.0, 5598.0, 5705.0, 5410.0, 5429.0, 5533.0, 5539.0, 5343.0, 5498.0, 5316.0, 5256.0, 5323.0, 5437.0, 5319.0, 5662.0, 5479.0, 5536.0, 5495.0, 5485.0, 5603.0, 5365.0, 5688.0, 5341.0, 5709.0, 5476.0, 5281.0, 5583.0, 5397.0, 5439.0, 5338.0, 5549.0, 5569.0, 5556.0, 5650.0, 5367.0, 5521.0, 5463.0, 5589.0, 5342.0, 5472.0, 5381.0, 5568.0, 5664.0, 5299.0, 5671.0, 5344.0, 5566.0, 5258.0, 5347.0, 5500.0, 5596.0, 5599.0, 5519.0, 5488.0, 5436.0, 5607.0, 5404.0, 5560.0 (number of hits: 9)
10	5540	9	1	333	1	5661.0, 5320.0, 5362.0, 5339.0, 5313.0, 5290.0, 5674.0, 5472.0, 5277.0, 5641.0, 5620.0, 5389.0, 5604.0, 5629.0, 5537.0, 5630.0, 5658.0, 5590.0, 5680.0, 5336.0, 5642.0, 5574.0, 5446.0, 5257.0, 5647.0, 5539.0, 5443.0, 5342.0, 5420.0, 5291.0, 5335.0, 5298.0, 5435.0, 5321.0, 5367.0, 5366.0, 5628.0, 5510.0, 5394.0, 5282.0, 5535.0, 5602.0, 5617.0, 5649.0, 5357.0, 5688.0, 5588.0, 5552.0, 5579.0, 5569.0, 5554.0, 5279.0, 5511.0, 5514.0, 5613.0, 5657.0, 5634.0, 5625.0, 5309.0, 5633.0, 5706.0, 5545.0, 5303.0, 5391.0, 5648.0, 5498.0, 5324.0, 5436.0, 5669.0, 5419.0, 5422.0, 5406.0, 5458.0, 5355.0, 5708.0, 5615.0, 5560.0, 5678.0, 5474.0, 5622.0, 5512.0, 5274.0, 5413.0, 5317.0, 5387.0, 5531.0, 5294.0, 5455.0, 5430.0, 5400.0, 5295.0, 5411.0, 5672.0, 5665.0, 5330.0, 5697.0, 5585.0, 5289.0, 5676.0, 5627.0 (number of hits: 5)
11	5540	9	1	333	1	5354.0, 5526.0, 5251.0, 5504.0, 5262.0, 5503.0, 5695.0, 5384.0, 5482.0, 5684.0, 5527.0, 5467.0, 5273.0, 5315.0, 5702.0, 5568.0, 5699.0, 5328.0, 5380.0, 5493.0, 5457.0, 5578.0, 5612.0, 5676.0, 5325.0, 5557.0, 5406.0, 5529.0, 5391.0, 5670.0, 5446.0, 5438.0, 5393.0, 5671.0, 5575.0, 5422.0, 5686.0, 5638.0, 5692.0, 5595.0, 5429.0, 5369.0, 5268.0, 5577.0, 5602.0, 5319.0, 5278.0, 5263.0, 5641.0, 5519.0, 5678.0, 5647.0, 5644.0, 5642.0, 5513.0, 5299.0, 5593.0, 5266.0, 5511.0, 5305.0, 5445.0, 5562.0, 5598.0, 5523.0, 5685.0, 5447.0, 5537.0, 5331.0, 5502.0, 5655.0, 5600.0, 5507.0, 5400.0, 5283.0, 5468.0, 5265.0, 5690.0, 5510.0, 5460.0, 5298.0, 5373.0, 5436.0, 5626.0, 5509.0, 5514.0, 5443.0, 5677.0, 5712.0, 5590.0, 5636.0, 5366.0, 5616.0, 5250.0, 5567.0, 5275.0, 5589.0, 5663.0, 5372.0, 5475.0, 5604.0

						(number of hits: 1)
12	5540	9	1	333	1	5551.0, 5668.0, 5553.0, 5258.0, 5533.0, 5254.0, 5615.0, 5363.0, 5721.0, 5545.0, 5483.0, 5420.0, 5360.0, 5466.0, 5638.0, 5619.0, 5706.0, 5508.0, 5257.0, 5670.0, 5500.0, 5647.0, 5250.0, 5688.0, 5311.0, 5334.0, 5256.0, 5384.0, 5686.0, 5569.0, 5278.0, 5276.0, 5574.0, 5714.0, 5639.0, 5649.0, 5456.0, 5361.0, 5644.0, 5355.0, 5400.0, 5397.0, 5549.0, 5504.0, 5528.0, 5503.0, 5369.0, 5317.0, 5285.0, 5606.0, 5342.0, 5375.0, 5337.0, 5478.0, 5259.0, 5685.0, 5298.0, 5611.0, 5678.0, 5689.0, 5530.0, 5653.0, 5604.0, 5556.0, 5633.0, 5591.0, 5723.0, 5628.0, 5448.0, 5590.0, 5656.0, 5715.0, 5402.0, 5338.0, 5535.0, 5589.0, 5540.0, 5345.0, 5449.0, 5550.0, 5457.0, 5357.0, 5634.0, 5390.0, 5275.0, 5637.0, 5711.0, 5272.0, 5501.0, 5346.0, 5362.0, 5584.0, 5297.0, 5554.0, 5511.0, 5490.0, 5316.0, 5705.0, 5565.0, 5690.0
						(number of hits: 6)
13	5540	9	1	333	1	5619.0, 5671.0, 5494.0, 5502.0, 5547.0, 5629.0, 5656.0, 5527.0, 5259.0, 5365.0, 5398.0, 5610.0, 5384.0, 5336.0, 5663.0, 5316.0, 5596.0, 5455.0, 5402.0, 5676.0, 5719.0, 5471.0, 5630.0, 5702.0, 5470.0, 5616.0, 5434.0, 5296.0, 5377.0, 5443.0, 5520.0, 5302.0, 5263.0, 5513.0, 5697.0, 5284.0, 5614.0, 5383.0, 5624.0, 5644.0, 5393.0, 5457.0, 5556.0, 5342.0, 5681.0, 5718.0, 5500.0, 5650.0, 5270.0, 5288.0, 5389.0, 5333.0, 5566.0, 5331.0, 5298.0, 5699.0, 5449.0, 5541.0, 5540.0, 5593.0, 5422.0, 5649.0, 5351.0, 5297.0, 5707.0, 5607.0, 5578.0, 5525.0, 5572.0, 5608.0, 5276.0, 5597.0, 5421.0, 5252.0, 5257.0, 5343.0, 5660.0, 5487.0, 5638.0, 5339.0, 5320.0, 5299.0, 5441.0, 5329.0, 5498.0, 5591.0, 5324.0, 5305.0, 5568.0, 5437.0, 5552.0, 5430.0, 5436.0, 5301.0, 5473.0, 5690.0, 5573.0, 5496.0, 5669.0, 5303.0
						(number of hits: 3)
14	5540	9	1	333	1	5568.0, 5291.0, 5309.0, 5357.0, 5610.0, 5345.0, 5674.0, 5418.0, 5529.0, 5372.0, 5396.0, 5506.0, 5266.0, 5275.0, 5523.0, 5482.0, 5387.0, 5598.0, 5712.0, 5327.0, 5550.0, 5444.0, 5286.0, 5555.0, 5526.0, 5536.0, 5285.0, 5311.0, 5711.0, 5716.0, 5468.0, 5365.0, 5464.0, 5620.0, 5413.0, 5564.0, 5337.0, 5622.0, 5271.0, 5604.0, 5362.0, 5359.0, 5450.0, 5704.0, 5535.0, 5699.0, 5289.0, 5706.0, 5505.0, 5442.0, 5594.0, 5713.0, 5461.0, 5557.0, 5502.0, 5635.0, 5350.0, 5626.0, 5433.0, 5697.0, 5458.0, 5409.0, 5515.0, 5389.0, 5534.0, 5281.0, 5380.0, 5511.0, 5300.0, 5510.0, 5307.0, 5541.0, 5570.0, 5412.0, 5410.0, 5294.0, 5264.0, 5691.0, 5643.0, 5301.0,

						5504.0, 5707.0, 5405.0, 5605.0, 5381.0, 5565.0, 5574.0, 5509.0, 5512.0, 5642.0, 5501.0, 5709.0, 5652.0, 5265.0, 5528.0, 5269.0, 5589.0, 5644.0, 5587.0, 5552.0 (number of hits: 4)
15	5540	9	1	333	1	5382.0, 5351.0, 5430.0, 5709.0, 5671.0, 5315.0, 5529.0, 5688.0, 5507.0, 5603.0, 5650.0, 5254.0, 5474.0, 5694.0, 5640.0, 5622.0, 5566.0, 5510.0, 5295.0, 5677.0, 5508.0, 5586.0, 5269.0, 5558.0, 5453.0, 5266.0, 5458.0, 5426.0, 5656.0, 5272.0, 5682.0, 5564.0, 5318.0, 5552.0, 5299.0, 5345.0, 5579.0, 5379.0, 5641.0, 5416.0, 5393.0, 5450.0, 5293.0, 5491.0, 5716.0, 5499.0, 5322.0, 5715.0, 5520.0, 5438.0, 5466.0, 5413.0, 5478.0, 5559.0, 5275.0, 5358.0, 5327.0, 5531.0, 5419.0, 5457.0, 5575.0, 5547.0, 5699.0, 5626.0, 5562.0, 5446.0, 5292.0, 5397.0, 5651.0, 5373.0, 5380.0, 5644.0, 5538.0, 5484.0, 5595.0, 5570.0, 5523.0, 5600.0, 5421.0, 5675.0, 5722.0, 5303.0, 5721.0, 5321.0, 5320.0, 5513.0, 5605.0, 5659.0, 5620.0, 5339.0, 5452.0, 5501.0, 5437.0, 5386.0, 5314.0, 5492.0, 5596.0, 5661.0, 5718.0, 5710.0 (number of hits: 3)
16	5540	9	1	333	1	5609.0, 5631.0, 5471.0, 5719.0, 5364.0, 5275.0, 5362.0, 5592.0, 5447.0, 5529.0, 5462.0, 5536.0, 5370.0, 5604.0, 5491.0, 5641.0, 5479.0, 5598.0, 5351.0, 5308.0, 5421.0, 5312.0, 5285.0, 5347.0, 5644.0, 5712.0, 5430.0, 5585.0, 5590.0, 5415.0, 5557.0, 5580.0, 5645.0, 5606.0, 5392.0, 5478.0, 5466.0, 5456.0, 5293.0, 5369.0, 5556.0, 5632.0, 5658.0, 5428.0, 5615.0, 5390.0, 5424.0, 5714.0, 5542.0, 5501.0, 5432.0, 5643.0, 5452.0, 5654.0, 5408.0, 5411.0, 5662.0, 5273.0, 5465.0, 5281.0, 5710.0, 5264.0, 5670.0, 5457.0, 5352.0, 5475.0, 5391.0, 5250.0, 5613.0, 5695.0, 5455.0, 5724.0, 5294.0, 5524.0, 5546.0, 5394.0, 5326.0, 5288.0, 5520.0, 5711.0, 5618.0, 5320.0, 5593.0, 5257.0, 5319.0, 5528.0, 5438.0, 5334.0, 5669.0, 5702.0, 5272.0, 5259.0, 5683.0, 5274.0, 5504.0, 5344.0, 5302.0, 5258.0, 5336.0, 5425.0 (number of hits: 3)
17	5540	9	1	333	1	5291.0, 5648.0, 5282.0, 5368.0, 5563.0, 5416.0, 5308.0, 5419.0, 5433.0, 5462.0, 5680.0, 5251.0, 5264.0, 5629.0, 5601.0, 5668.0, 5559.0, 5476.0, 5515.0, 5623.0, 5517.0, 5316.0, 5511.0, 5445.0, 5454.0, 5391.0, 5498.0, 5591.0, 5715.0, 5436.0, 5519.0, 5482.0, 5270.0, 5329.0, 5653.0, 5346.0, 5669.0, 5345.0, 5554.0, 5358.0, 5706.0, 5442.0, 5587.0, 5261.0, 5660.0, 5342.0, 5612.0, 5351.0, 5402.0, 5393.0, 5325.0, 5542.0, 5384.0, 5256.0, 5635.0, 5530.0, 5537.0, 5335.0, 5555.0, 5328.0,

						5296.0, 5632.0, 5578.0, 5473.0, 5676.0, 5497.0, 5440.0, 5413.0, 5640.0, 5575.0, 5369.0, 5330.0, 5657.0, 5656.0, 5665.0, 5376.0, 5271.0, 5350.0, 5352.0, 5569.0, 5521.0, 5719.0, 5432.0, 5572.0, 5487.0, 5250.0, 5460.0, 5674.0, 5468.0, 5363.0, 5357.0, 5424.0, 5257.0, 5589.0, 5496.0, 5684.0, 5359.0, 5532.0, 5437.0, 5598.0 (number of hits: 4)
18	5540	9	1	333	1	5715.0, 5582.0, 5667.0, 5506.0, 5482.0, 5514.0, 5577.0, 5263.0, 5537.0, 5439.0, 5303.0, 5616.0, 5256.0, 5663.0, 5257.0, 5671.0, 5379.0, 5612.0, 5685.0, 5280.0, 5419.0, 5548.0, 5609.0, 5561.0, 5632.0, 5712.0, 5714.0, 5513.0, 5370.0, 5438.0, 5384.0, 5372.0, 5260.0, 5284.0, 5325.0, 5281.0, 5501.0, 5614.0, 5530.0, 5634.0, 5400.0, 5487.0, 5415.0, 5290.0, 5308.0, 5385.0, 5649.0, 5580.0, 5724.0, 5518.0, 5495.0, 5398.0, 5416.0, 5595.0, 5458.0, 5328.0, 5389.0, 5549.0, 5594.0, 5571.0, 5532.0, 5507.0, 5333.0, 5373.0, 5699.0, 5306.0, 5664.0, 5421.0, 5366.0, 5633.0, 5556.0, 5623.0, 5515.0, 5683.0, 5711.0, 5407.0, 5563.0, 5270.0, 5539.0, 5309.0, 5562.0, 5364.0, 5472.0, 5707.0, 5559.0, 5347.0, 5669.0, 5693.0, 5397.0, 5689.0, 5296.0, 5431.0, 5278.0, 5552.0, 5619.0, 5489.0, 5261.0, 5298.0, 5720.0, 5587.0 (number of hits: 6)
19	5540	9	1	333	1	5276.0, 5706.0, 5301.0, 5639.0, 5258.0, 5341.0, 5447.0, 5378.0, 5344.0, 5654.0, 5290.0, 5462.0, 5535.0, 5365.0, 5695.0, 5473.0, 5506.0, 5665.0, 5637.0, 5600.0, 5584.0, 5436.0, 5670.0, 5364.0, 5598.0, 5395.0, 5714.0, 5496.0, 5325.0, 5539.0, 5649.0, 5483.0, 5261.0, 5468.0, 5282.0, 5720.0, 5677.0, 5542.0, 5455.0, 5354.0, 5663.0, 5562.0, 5510.0, 5272.0, 5485.0, 5435.0, 5556.0, 5629.0, 5633.0, 5322.0, 5458.0, 5336.0, 5406.0, 5434.0, 5644.0, 5505.0, 5572.0, 5383.0, 5446.0, 5449.0, 5537.0, 5474.0, 5527.0, 5386.0, 5285.0, 5278.0, 5315.0, 5311.0, 5529.0, 5309.0, 5400.0, 5623.0, 5613.0, 5583.0, 5419.0, 5347.0, 5321.0, 5647.0, 5318.0, 5661.0, 5326.0, 5371.0, 5604.0, 5577.0, 5342.0, 5675.0, 5651.0, 5353.0, 5512.0, 5361.0, 5716.0, 5427.0, 5373.0, 5426.0, 5374.0, 5516.0, 5479.0, 5279.0, 5273.0, 5538.0 (number of hits: 5)
20	5540	9	1	333	1	5714.0, 5472.0, 5638.0, 5437.0, 5497.0, 5480.0, 5566.0, 5360.0, 5287.0, 5431.0, 5567.0, 5615.0, 5546.0, 5521.0, 5583.0, 5501.0, 5291.0, 5313.0, 5709.0, 5534.0, 5295.0, 5588.0, 5435.0, 5665.0, 5354.0, 5453.0, 5624.0, 5412.0, 5664.0, 5628.0, 5500.0, 5395.0, 5434.0, 5260.0, 5681.0, 5483.0, 5319.0, 5366.0, 5258.0, 5656.0,

						5542.0, 5368.0, 5535.0, 5466.0, 5525.0, 5594.0, 5617.0, 5469.0, 5644.0, 5505.0, 5326.0, 5254.0, 5409.0, 5492.0, 5581.0, 5282.0, 5673.0, 5556.0, 5336.0, 5496.0, 5608.0, 5399.0, 5544.0, 5420.0, 5267.0, 5592.0, 5686.0, 5463.0, 5403.0, 5444.0, 5314.0, 5303.0, 5446.0, 5478.0, 5710.0, 5339.0, 5619.0, 5401.0, 5367.0, 5490.0, 5333.0, 5691.0, 5449.0, 5670.0, 5439.0, 5364.0, 5320.0, 5537.0, 5512.0, 5263.0, 5300.0, 5674.0, 5499.0, 5565.0, 5270.0, 5572.0, 5407.0, 5513.0, 5370.0, 5455.0 (number of hits: 6)
21	5540	9	1	333	1	5588.0, 5547.0, 5451.0, 5696.0, 5549.0, 5412.0, 5516.0, 5445.0, 5438.0, 5349.0, 5693.0, 5331.0, 5268.0, 5681.0, 5673.0, 5402.0, 5632.0, 5261.0, 5718.0, 5374.0, 5357.0, 5277.0, 5594.0, 5367.0, 5580.0, 5577.0, 5646.0, 5621.0, 5408.0, 5290.0, 5336.0, 5564.0, 5410.0, 5492.0, 5289.0, 5491.0, 5361.0, 5308.0, 5585.0, 5409.0, 5596.0, 5644.0, 5413.0, 5586.0, 5375.0, 5501.0, 5520.0, 5326.0, 5423.0, 5478.0, 5276.0, 5713.0, 5649.0, 5698.0, 5634.0, 5359.0, 5395.0, 5411.0, 5330.0, 5620.0, 5297.0, 5529.0, 5528.0, 5314.0, 5480.0, 5371.0, 5705.0, 5419.0, 5273.0, 5642.0, 5470.0, 5711.0, 5682.0, 5454.0, 5382.0, 5368.0, 5415.0, 5723.0, 5645.0, 5703.0, 5479.0, 5555.0, 5317.0, 5299.0, 5265.0, 5327.0, 5623.0, 5544.0, 5304.0, 5391.0, 5370.0, 5373.0, 5471.0, 5680.0, 5328.0, 5509.0, 5619.0, 5614.0, 5550.0, 5356.0 (number of hits: 3)
22	5540	9	1	333	1	5453.0, 5325.0, 5414.0, 5278.0, 5374.0, 5354.0, 5381.0, 5385.0, 5439.0, 5699.0, 5556.0, 5309.0, 5303.0, 5629.0, 5306.0, 5316.0, 5559.0, 5285.0, 5655.0, 5640.0, 5395.0, 5563.0, 5375.0, 5267.0, 5540.0, 5564.0, 5646.0, 5281.0, 5599.0, 5584.0, 5570.0, 5259.0, 5662.0, 5680.0, 5355.0, 5641.0, 5552.0, 5510.0, 5589.0, 5613.0, 5332.0, 5299.0, 5698.0, 5357.0, 5340.0, 5621.0, 5362.0, 5648.0, 5476.0, 5708.0, 5717.0, 5307.0, 5464.0, 5404.0, 5260.0, 5444.0, 5291.0, 5390.0, 5474.0, 5255.0, 5353.0, 5279.0, 5304.0, 5349.0, 5408.0, 5647.0, 5685.0, 5276.0, 5448.0, 5273.0, 5457.0, 5436.0, 5670.0, 5553.0, 5334.0, 5323.0, 5434.0, 5531.0, 5719.0, 5650.0, 5274.0, 5305.0, 5310.0, 5370.0, 5394.0, 5341.0, 5359.0, 5269.0, 5677.0, 5703.0, 5587.0, 5681.0, 5684.0, 5459.0, 5503.0, 5418.0, 5500.0, 5337.0, 5447.0, 5591.0 (number of hits: 2)
23	5540	9	1	333	1	5629.0, 5323.0, 5256.0, 5441.0, 5595.0, 5456.0, 5590.0, 5519.0, 5416.0, 5427.0, 5484.0, 5485.0, 5564.0, 5391.0, 5704.0, 5529.0, 5433.0, 5267.0, 5487.0, 5640.0,

						5698.0, 5699.0, 5403.0, 5615.0, 5606.0, 5558.0, 5326.0, 5294.0, 5486.0, 5491.0, 5496.0, 5293.0, 5443.0, 5692.0, 5291.0, 5641.0, 5673.0, 5594.0, 5373.0, 5349.0, 5300.0, 5621.0, 5310.0, 5723.0, 5689.0, 5495.0, 5466.0, 5261.0, 5341.0, 5656.0, 5603.0, 5409.0, 5509.0, 5577.0, 5584.0, 5260.0, 5666.0, 5344.0, 5434.0, 5678.0, 5278.0, 5408.0, 5390.0, 5587.0, 5645.0, 5334.0, 5350.0, 5283.0, 5710.0, 5644.0, 5682.0, 5524.0, 5685.0, 5399.0, 5538.0, 5553.0, 5503.0, 5449.0, 5514.0, 5560.0, 5610.0, 5322.0, 5274.0, 5417.0, 5383.0, 5511.0, 5691.0, 5574.0, 5429.0, 5355.0, 5657.0, 5556.0, 5395.0, 5292.0, 5282.0, 5289.0, 5662.0, 5490.0, 5528.0, 5701.0 (number of hits: 1)
24	5540	9	1	333	1	5318.0, 5302.0, 5578.0, 5617.0, 5516.0, 5322.0, 5641.0, 5337.0, 5395.0, 5408.0, 5705.0, 5581.0, 5427.0, 5266.0, 5396.0, 5444.0, 5275.0, 5299.0, 5357.0, 5417.0, 5267.0, 5309.0, 5504.0, 5460.0, 5256.0, 5459.0, 5693.0, 5426.0, 5575.0, 5480.0, 5547.0, 5425.0, 5380.0, 5506.0, 5437.0, 5661.0, 5281.0, 5512.0, 5603.0, 5447.0, 5535.0, 5543.0, 5484.0, 5635.0, 5629.0, 5672.0, 5491.0, 5418.0, 5361.0, 5614.0, 5261.0, 5553.0, 5431.0, 5669.0, 5651.0, 5409.0, 5539.0, 5628.0, 5647.0, 5638.0, 5622.0, 5276.0, 5608.0, 5695.0, 5407.0, 5271.0, 5367.0, 5519.0, 5479.0, 5257.0, 5713.0, 5551.0, 5676.0, 5404.0, 5467.0, 5474.0, 5685.0, 5457.0, 5601.0, 5440.0, 5675.0, 5708.0, 5410.0, 5665.0, 5285.0, 5597.0, 5694.0, 5350.0, 5365.0, 5653.0, 5530.0, 5449.0, 5291.0, 5458.0, 5660.0, 5422.0, 5526.0, 5378.0, 5624.0, 5542.0 (number of hits: 6)
25	5540	9	1	333	1	5458.0, 5411.0, 5364.0, 5661.0, 5684.0, 5450.0, 5340.0, 5570.0, 5524.0, 5596.0, 5402.0, 5392.0, 5407.0, 5321.0, 5631.0, 5680.0, 5331.0, 5634.0, 5420.0, 5525.0, 5425.0, 5573.0, 5265.0, 5572.0, 5529.0, 5649.0, 5293.0, 5394.0, 5284.0, 5608.0, 5516.0, 5663.0, 5360.0, 5561.0, 5717.0, 5648.0, 5517.0, 5277.0, 5410.0, 5255.0, 5567.0, 5588.0, 5616.0, 5387.0, 5356.0, 5349.0, 5466.0, 5670.0, 5473.0, 5555.0, 5270.0, 5622.0, 5538.0, 5307.0, 5481.0, 5395.0, 5359.0, 5614.0, 5578.0, 5269.0, 5274.0, 5591.0, 5259.0, 5515.0, 5390.0, 5566.0, 5601.0, 5257.0, 5553.0, 5598.0, 5612.0, 5322.0, 5521.0, 5297.0, 5363.0, 5280.0, 5501.0, 5337.0, 5353.0, 5556.0, 5453.0, 5357.0, 5370.0, 5701.0, 5264.0, 5702.0, 5550.0, 5676.0, 5306.0, 5594.0, 5530.0, 5499.0, 5417.0, 5432.0, 5474.0, 5267.0, 5722.0, 5488.0, 5304.0, 5397.0 (number of hits: 2)

26	5540	9	1	333	1	5276.0, 5305.0, 5431.0, 5472.0, 5558.0, 5277.0, 5449.0, 5662.0, 5641.0, 5701.0, 5389.0, 5499.0, 5545.0, 5456.0, 5259.0, 5718.0, 5709.0, 5441.0, 5571.0, 5684.0, 5648.0, 5517.0, 5479.0, 5500.0, 5536.0, 5279.0, 5670.0, 5692.0, 5325.0, 5344.0, 5468.0, 5385.0, 5628.0, 5272.0, 5383.0, 5629.0, 5486.0, 5623.0, 5724.0, 5362.0, 5349.0, 5676.0, 5507.0, 5320.0, 5551.0, 5354.0, 5656.0, 5491.0, 5333.0, 5318.0, 5335.0, 5269.0, 5657.0, 5581.0, 5439.0, 5619.0, 5370.0, 5445.0, 5633.0, 5377.0, 5707.0, 5338.0, 5367.0, 5677.0, 5550.0, 5695.0, 5575.0, 5447.0, 5622.0, 5589.0, 5304.0, 5660.0, 5321.0, 5374.0, 5702.0, 5401.0, 5532.0, 5457.0, 5679.0, 5357.0, 5615.0, 5361.0, 5434.0, 5270.0, 5359.0, 5366.0, 5380.0, 5264.0, 5315.0, 5626.0, 5653.0, 5658.0, 5381.0, 5608.0, 5506.0, 5440.0, 5384.0, 5630.0, 5526.0, 5712.0 (number of hits: 3)
27	5540	9	1	333	1	5623.0, 5546.0, 5474.0, 5420.0, 5639.0, 5627.0, 5477.0, 5527.0, 5699.0, 5517.0, 5662.0, 5445.0, 5336.0, 5541.0, 5616.0, 5613.0, 5486.0, 5516.0, 5681.0, 5505.0, 5697.0, 5399.0, 5463.0, 5363.0, 5638.0, 5410.0, 5400.0, 5347.0, 5588.0, 5272.0, 5698.0, 5322.0, 5379.0, 5643.0, 5405.0, 5288.0, 5496.0, 5469.0, 5393.0, 5407.0, 5273.0, 5651.0, 5406.0, 5264.0, 5418.0, 5713.0, 5633.0, 5354.0, 5360.0, 5392.0, 5693.0, 5555.0, 5708.0, 5297.0, 5536.0, 5453.0, 5263.0, 5512.0, 5333.0, 5556.0, 5459.0, 5634.0, 5625.0, 5601.0, 5428.0, 5692.0, 5572.0, 5599.0, 5682.0, 5703.0, 5331.0, 5695.0, 5417.0, 5375.0, 5676.0, 5619.0, 5573.0, 5559.0, 5614.0, 5521.0, 5503.0, 5437.0, 5352.0, 5378.0, 5488.0, 5298.0, 5279.0, 5543.0, 5368.0, 5579.0, 5586.0, 5493.0, 5576.0, 5315.0, 5723.0, 5687.0, 5433.0, 5350.0, 5276.0, 5275.0 (number of hits: 4)
28	5540	9	1	333	1	5326.0, 5284.0, 5439.0, 5402.0, 5301.0, 5571.0, 5336.0, 5386.0, 5716.0, 5535.0, 5432.0, 5468.0, 5259.0, 5610.0, 5403.0, 5626.0, 5265.0, 5322.0, 5410.0, 5648.0, 5710.0, 5476.0, 5368.0, 5486.0, 5313.0, 5618.0, 5564.0, 5521.0, 5433.0, 5623.0, 5357.0, 5273.0, 5669.0, 5296.0, 5474.0, 5619.0, 5545.0, 5384.0, 5444.0, 5483.0, 5305.0, 5700.0, 5508.0, 5645.0, 5549.0, 5497.0, 5559.0, 5532.0, 5282.0, 5546.0, 5472.0, 5507.0, 5450.0, 5435.0, 5653.0, 5659.0, 5574.0, 5691.0, 5552.0, 5506.0, 5657.0, 5650.0, 5401.0, 5699.0, 5548.0, 5527.0, 5605.0, 5470.0, 5633.0, 5582.0, 5719.0, 5297.0, 5697.0, 5456.0, 5569.0, 5279.0, 5306.0, 5707.0, 5430.0, 5501.0, 5711.0, 5680.0, 5425.0, 5541.0, 5361.0,

						5566.0, 5335.0, 5584.0, 5355.0, 5427.0, 5556.0, 5339.0, 5504.0, 5523.0, 5600.0, 5445.0, 5367.0, 5398.0, 5407.0, 5405.0 (number of hits: 7)
29	5540	9	1	333	1	5378.0, 5362.0, 5274.0, 5671.0, 5708.0, 5457.0, 5326.0, 5355.0, 5544.0, 5719.0, 5707.0, 5604.0, 5511.0, 5336.0, 5621.0, 5623.0, 5415.0, 5338.0, 5337.0, 5583.0, 5267.0, 5670.0, 5311.0, 5441.0, 5588.0, 5695.0, 5253.0, 5600.0, 5587.0, 5667.0, 5602.0, 5538.0, 5281.0, 5391.0, 5278.0, 5616.0, 5619.0, 5429.0, 5547.0, 5608.0, 5668.0, 5459.0, 5317.0, 5306.0, 5351.0, 5394.0, 5543.0, 5639.0, 5352.0, 5614.0, 5451.0, 5302.0, 5597.0, 5330.0, 5688.0, 5424.0, 5716.0, 5420.0, 5502.0, 5551.0, 5582.0, 5299.0, 5648.0, 5572.0, 5325.0, 5375.0, 5470.0, 5526.0, 5642.0, 5592.0, 5265.0, 5381.0, 5258.0, 5486.0, 5700.0, 5432.0, 5562.0, 5638.0, 5624.0, 5534.0, 5255.0, 5660.0, 5620.0, 5340.0, 5473.0, 5252.0, 5586.0, 5501.0, 5412.0, 5273.0, 5646.0, 5686.0, 5714.0, 5626.0, 5571.0, 5339.0, 5399.0, 5647.0, 5692.0, 5379.0 (number of hits: 5)
30	5540	9	1	333	1	5328.0, 5490.0, 5380.0, 5505.0, 5485.0, 5584.0, 5392.0, 5333.0, 5465.0, 5256.0, 5462.0, 5420.0, 5629.0, 5564.0, 5582.0, 5259.0, 5708.0, 5636.0, 5552.0, 5376.0, 5634.0, 5287.0, 5563.0, 5717.0, 5684.0, 5401.0, 5306.0, 5440.0, 5666.0, 5497.0, 5676.0, 5598.0, 5332.0, 5266.0, 5588.0, 5664.0, 5531.0, 5340.0, 5441.0, 5715.0, 5474.0, 5637.0, 5547.0, 5578.0, 5342.0, 5502.0, 5307.0, 5261.0, 5615.0, 5545.0, 5513.0, 5667.0, 5508.0, 5423.0, 5447.0, 5425.0, 5309.0, 5710.0, 5327.0, 5468.0, 5540.0, 5297.0, 5702.0, 5566.0, 5559.0, 5435.0, 5614.0, 5622.0, 5703.0, 5537.0, 5286.0, 5396.0, 5696.0, 5716.0, 5518.0, 5701.0, 5310.0, 5448.0, 5720.0, 5683.0, 5341.0, 5675.0, 5471.0, 5353.0, 5604.0, 5442.0, 5371.0, 5335.0, 5320.0, 5610.0, 5361.0, 5434.0, 5416.0, 5586.0, 5391.0, 5535.0, 5613.0, 5595.0, 5385.0, 5308.0 (number of hits: 6)

5550 MHz, 40 MHz Bandwidth

Radar Signal Type	Waveform/Trial Number	Detection (%)	Limit (%)	Pass/Fail
Type 1A/1B	30	100 %	60%	Pass
Type 2	30	100 %	60%	Pass
Type 3	30	100 %	60%	Pass
Type 4	30	100 %	60%	Pass
Aggregate (Type1 to 4)	120	100 %	80%	Pass
Type 5	30	90 %	80%	Pass
Type 6	30	100 %	70%	Pass

Please refer to the following statistical tables:

5550 MHz, 40 MHz Bandwidth**Table-1A/1B Radar Type 1A/1B Statistical Performance**

Trial #	Fc (MHz)	Pulse/Burst	Pulse Width (μS)	PRI (μs)	Detection (1:yes; 0:no)
1	5550	72	1	738	1
2	5550	74	1	718	1
3	5550	65	1	818	1
4	5550	95	1	558	1
5	5550	76	1	698	1
6	5550	58	1	918	1
7	5550	95	1	558	1
8	5550	78	1	678	1
9	5550	76	1	698	1
10	5550	102	1	518	1
11	5550	63	1	838	1
12	5550	89	1	598	1
13	5550	70	1	758	1
14	5550	58	1	918	1
15	5550	57	1	938	1
16	5550	35	1	1544	1
17	5550	24	1	2288	1
18	5550	19	1	2863	1
19	5550	24	1	2235	1
20	5550	35	1	1522	1
21	5550	19	1	2903	1
22	5550	32	1	1670	1
23	5550	77	1	689	1
24	5550	50	1	1059	1
25	5550	40	1	1320	1
26	5550	55	1	971	1
27	5550	43	1	1242	1
28	5550	84	1	634	1
29	5550	69	1	768	1
30	5550	81	1	656	1
Detection Percentage: 100 % (>60%)					

Table-2 Radar Type 2 Statistical Performance

Trial #	Fc (MHz)	Pulse/Burst	Pulse Width (μS)	PRI (μs)	Detection (1:yes; 0:no)
1	5550	28	3	185	1
2	5550	24	4.1	207	1
3	5550	28	3.3	155	1
4	5550	23	4.3	216	1
5	5550	24	3.5	178	1
6	5550	23	2.4	150	1
7	5550	28	4.5	170	1
8	5550	23	3.3	191	1
9	5550	24	3.8	224	1
10	5550	26	3.6	179	1
11	5550	26	4.8	185	1
12	5550	28	3.3	185	1
13	5550	25	3.8	207	1
14	5550	29	2.4	214	1
15	5550	27	3.9	170	1
16	5550	23	4	174	1
17	5550	24	3.4	194	1
18	5550	23	3.8	164	1
19	5550	27	4.6	224	1
20	5550	28	2.7	173	1
21	5550	24	3.1	199	1
22	5550	27	4.1	160	1
23	5550	28	2.2	159	1
24	5550	25	1.7	210	1
25	5550	27	1.6	207	1
26	5550	25	2	192	1
27	5550	28	2.2	184	1
28	5550	26	2.5	169	1
29	5550	24	2.6	189	1
30	5550	24	2.9	229	1
Detection Percentage: 100 % (>60%)					

Table-3 Radar Type 3 Statistical Performance

Trial #	Fc (MHz)	Pulse/Burst	Pulse Width (μS)	PRI (μs)	Detection (1:yes; 0:no)
1	5550	17	8.4	466	1
2	5550	17	6.3	235	1
3	5550	17	8.4	406	1
4	5550	18	9.6	284	1
5	5550	16	7.3	496	1
6	5550	18	7.6	446	1
7	5550	17	7.4	358	1
8	5550	18	9.1	424	1
9	5550	18	7.3	408	1
10	5550	16	6.5	410	1
11	5550	17	9	457	1
12	5550	18	9.7	250	1
13	5550	16	6.7	401	1
14	5550	16	9.1	462	1
15	5550	16	9.7	411	1
16	5550	18	9	265	1
17	5550	17	9.5	386	1
18	5550	18	8.8	478	1
19	5550	18	7.1	382	1
20	5550	16	6.2	433	1
21	5550	16	7.2	389	1
22	5550	16	7.2	420	1
23	5550	18	9.4	423	1
24	5550	17	6.5	443	1
25	5550	16	8.9	459	1
26	5550	18	9.2	246	1
27	5550	16	7.9	288	1
28	5550	17	8.1	325	1
29	5550	17	8.7	235	1
30	5550	16	7.4	374	1
Detection Percentage: 100 % (>60%)					

Table-4 Radar Type 4 Statistical Performance

Trial #	Fc (MHz)	Pulse/Burst	Pulse Width (μS)	PRI (μs)	Detection (1:yes; 0:no)
1	5550	13	16.2	481	1
2	5550	15	19.1	416	1
3	5550	16	19.6	493	1
4	5550	15	19.3	346	1
5	5550	13	11.1	443	1
6	5550	12	19.7	211	1
7	5550	12	12.3	496	1
8	5550	16	13.9	492	1
9	5550	14	18.4	241	1
10	5550	14	15.4	434	1
11	5550	14	18.1	320	1
12	5550	13	18.8	427	1
13	5550	14	16.1	444	1
14	5550	16	16.2	293	1
15	5550	12	14.4	255	1
16	5550	13	13.2	342	1
17	5550	13	11.8	467	1
18	5550	16	17.9	460	1
19	5550	13	13	207	1
20	5550	16	11.9	291	1
21	5550	13	15.1	219	1
22	5550	13	12.5	387	1
23	5550	14	12.2	379	1
24	5550	14	19.8	275	1
25	5550	15	14.3	450	1
26	5550	16	11.5	362	1
27	5550	15	19.2	443	1
28	5550	15	16.1	472	1
29	5550	15	19.2	325	1
30	5550	16	19.8	309	1
Detection Percentage: 100 % (>60%)					

Table-5 Radar Type 5 Statistical Performance

Trial #	Fc (MHz)	Detection (1:yes; 0:no)
1	5550	1
2	5550	1
3	5550	1
4	5550	1
5	5550	1
6	5550	1
7	5550	1
8	5550	1
9	5550	1
10	5550	1
11	5534.6	1
12	5537.4	1
13	5538.2	1
14	5534.2	1
15	5537	1
16	5533.4	1
17	5537.8	1
18	5538.2	1
19	5533.4	1
20	5535	1
21	5566.2	0
22	5565.4	1
23	5564.6	0
24	5562.2	0
25	5563	1
26	5565.8	1
27	5564.2	1
28	5565.4	1
29	5565	1
30	5564.6	1
Detection Percentage: 90 % (>80%)		

Bin5 Statistics 1

Trial #	Pulse	Chirp (MHz)	Pulse Width (µS)	Pulse 1-2 spacing (µS)	Pulse 2-3 spacing (µS)	Pulse Start(S)	Detection (1:yes; 0:no)
0	2	9	53.6	1381		0.342515	1
1	1	9	71.3			1.240459	
2	2	9	54.5	1761		1.798168	
3	2	9	67.6	1841		2.932425	
4	2	9	59.9	1282		3.375444	
5	3	9	82.7	1770	1068	3.923681	
6	3	9	75.5	1576	1484	4.986643	
7	2	9	73.3	1169		5.520291	
8	1	9	74.6			6.577304	
9	1	9	50			7.323336	
10	2	9	75.6	1400		7.645821	
11	2	9	94	1986		8.882991	
12	2	9	95.8	1412		9.277715	
13	2	9	70	1787		10.460147	
14	2	9	64.9	1420		10.705617	
15	1	9	60.6			11.470983	

Bin5 Statistics 2

Trial #	Pulse	Chirp (MHz)	Pulse Width (µS)	Pulse 1-2 spacing (µS)	Pulse 2-3 spacing (µS)	Pulse Start(S)	Detection (1:yes; 0:no)
0	2	17	75.2	1041		0.300143	1
1	2	17	75.6	1532		1.162636	
2	1	17	97.3			1.605683	
3	3	17	83.5	1701	1612	2.290135	
4	3	17	75	1674	1140	2.94864	
5	1	17	71.4			3.542421	
6	2	17	87.7	1819		4.312666	
7	3	17	72	1123	1535	4.737888	
8	1	17	77.1			5.689516	
9	2	17	77	1085		6.470597	
10	2	17	58.2	1516		6.906883	
11	2	17	53.1	1352		7.927524	
12	1	17	95.9			8.142155	
13	1	17	83.2			9.047176	
14	2	17	70.1	1060		9.761593	
15	3	17	67.9	1524	1822	10.391439	
16	1	17	50.8			11.278422	
17	2	17	69.6	1056		11.637599	

Bin5 Statistics 3

Trial #	Pulse	Chirp (MHz)	Pulse Width (µS)	Pulse 1-2 spacing (µS)	Pulse 2-3 spacing (µS)	Pulse Start(S)	Detection (1:yes; 0:no)
0	2	8	76.5	1090		0.633035	1
1	1	8	69.6			1.413765	
2	2	8	81.4	1773		1.67737	
3	2	8	77.8	1669		2.44792	
4	2	8	75.6	1332		3.237919	
5	3	8	57.5	1642	1860	4.185574	
6	2	8	53.8	1630		5.18368	
7	2	8	52.9	1117		5.68653	
8	2	8	59.4	1506		6.45955	
9	1	8	76.2			6.925132	
10	2	8	75.1	1316		7.824848	
11	2	8	77.3	1326		8.944273	
12	3	8	70.3	1407	1052	9.07454	
13	2	8	76.8	1289		10.387638	
14	2	8	63.4	1891		10.871857	
15	3	8	55.1	1704	1743	11.738438	

Bin5 Statistics 4

Trial #	Pulse	Chirp (MHz)	Pulse Width (µS)	Pulse 1-2 spacing (µS)	Pulse 2-3 spacing (µS)	Pulse Start(S)	Detection (1:yes; 0:no)
0	2	16	55.1	1054		0.044958	1
1	1	16	87.3			1.812455	
2	3	16	69	1522	1912	2.788415	
3	2	16	62.2	1150		4.239463	
4	2	16	84.6	1059		6.539323	
5	2	16	83	1033		7.816783	
6	3	16	55.9	1161	1795	8.630481	
7	3	16	62.9	1930	1431	9.971245	
8	2	16	81.8	1230		11.764935	

Bin5 Statistics 5

Trial #	Pulse	Chirp (MHz)	Pulse Width (µS)	Pulse 1-2 spacing (uS)	Pulse 2-3 spacing (uS)	Pulse Start(S)	Detection (1:yes; 0:no)
0	2	11	64.1	1512		0.133995	1
1	2	11	61.8	1423		1.183172	
2	1	11	96.5			2.123408	
3	3	11	77.7	1778	1134	3.529175	
4	2	11	54.6	1890		4.414148	
5	2	11	88.5	1928		5.051527	
6	3	11	56.4	1598	1322	6.165476	
7	2	11	56.8	1992		6.627208	
8	1	11	75.7			8.10147	
9	3	11	88.7	1896	1696	9.144669	
10	2	11	87.2	1116		9.799785	
11	1	11	79.3			10.665352	
12	3	11	64.6	1705	1252	11.291705	

Bin5 Statistics 6

Trial #	Pulse	Chirp (MHz)	Pulse Width (µS)	Pulse 1-2 spacing (uS)	Pulse 2-3 spacing (uS)	Pulse Start(S)	Detection (1:yes; 0:no)
0	2	19	91.8	1845		0.587258	1
1	3	19	80.6	1645	1058	0.953599	
2	1	19	93.2			1.651638	
3	2	19	86.7	1300		2.165705	
4	3	19	88.9	1559	1656	2.684999	
5	3	19	79.6	1573	1533	3.922745	
6	1	19	64.3			4.552593	
7	2	19	51.5	1465		4.78454	
8	2	19	93.6	1635		5.988169	
9	2	19	73.3	1423		6.565988	
10	2	19	66.7	1905		6.868667	
11	2	19	81	1857		7.640284	
12	3	19	86.7	1020	1045	8.29542	
13	2	19	66.1	1183		8.984643	
14	1	19	80.4			9.925667	
15	2	19	55.9	1779		10.192651	
16	1	19	98.4			11.196633	
17	1	19	83.5			11.500436	

Bin5 Statistics 7

Trial #	Pulse	Chirp (MHz)	Pulse Width (µS)	Pulse 1-2 spacing (uS)	Pulse 2-3 spacing (uS)	Pulse Start(S)	Detection (1:yes; 0:no)
0	3	20	63	1034	1936	0.874926	1
1	1	20	88.1			1.374904	
2	2	20	62.9	1845		3.750146	
3	3	20	63.8	1193	1969	4.386328	
4	2	20	93	1063		6.194963	
5	3	20	67.7	1588	1426	7.784192	
6	2	20	61.6	1634		8.729912	
7	2	20	55.4	1303		9.784211	
8	2	20	50.6	1274		11.276871	

Bin5 Statistics 8

Trial #	Pulse	Chirp (MHz)	Pulse Width (µS)	Pulse 1-2 spacing (uS)	Pulse 2-3 spacing (uS)	Pulse Start(S)	Detection (1:yes; 0:no)
0	3	14	55.8	1698	1565	0.54991	1
1	2	14	60.6	1005		0.877647	
2	2	14	71.4	1548		2.27398	
3	3	14	65	1703	1484	2.57097	
4	3	14	78.9	1098	1379	3.854922	
5	2	14	93.5	1928		4.033213	
6	1	14	72			4.872573	
7	2	14	54	1705		6.385029	
8	2	14	86	1746		6.651366	
9	2	14	87.2	1118		7.478358	
10	1	14	73			8.777377	
11	2	14	79.4	1679		9.394037	
12	2	14	86.5	1851		10.317391	
13	2	14	84.3	1203		11.173	
14	2	14	96.5	1729		11.947343	

Bin5 Statistics 9

Trial #	Pulse	Chirp (MHz)	Pulse Width (µS)	Pulse 1-2 spacing (uS)	Pulse 2-3 spacing (uS)	Pulse Start(S)	Detection (1:yes; 0:no)
0	2	5	53.1	1673		0.850978	1
1	2	5	70.2	1933		1.681986	
2	3	5	70.1	1566	1277	1.881243	
3	1	5	50.1			2.8436	
4	3	5	56.3	1229	1403	4.01259	
5	1	5	83.1			4.855179	
6	3	5	51.4	1400	1700	5.200271	
7	3	5	57.1	1098	1659	6.066964	
8	2	5	87.3	1712		7.584921	
9	2	5	72.9	1019		8.23856	
10	2	5	51.8	1642		8.663771	
11	3	5	75.8	1365	1130	9.794458	
12	2	5	79.8	1119		10.511052	
13	2	5	70.6	1545		11.208815	

Bin5 Statistics 10

Trial #	Pulse	Chirp (MHz)	Pulse Width (µS)	Pulse 1-2 spacing (uS)	Pulse 2-3 spacing (uS)	Pulse Start(S)	Detection (1:yes; 0:no)
0	3	8	79.2	1452	1365	0.651239	1
1	3	8	50.5	1512	1733	1.083254	
2	2	8	99.5	1910		1.910517	
3	1	8	94.8			2.79782	
4	1	8	77.2			3.727589	
5	3	8	75.6	1243	1315	4.755777	
6	2	8	92.9	1482		6.052603	
7	2	8	67	1709		7.069141	
8	1	8	94.9			7.404553	
9	3	8	92.5	1643	1426	8.759598	
10	2	8	55	1360		9.872044	
11	2	8	59.9	1864		10.432622	
12	3	8	90.5	1693	1192	11.416959	

Bin5 Statistics 11

Trial #	Pulse	Chirp (MHz)	Pulse Width (µS)	Pulse 1-2 spacing (uS)	Pulse 2-3 spacing (uS)	Pulse Start(S)	Detection (1:yes; 0:no)
0	2	9	80.3	1429		0.545178	1
1	1	9	67.1			0.843729	
2	2	9	98.8	1035		1.917992	
3	2	9	83	1198		2.308859	
4	2	9	96	1249		2.948935	
5	2	9	61.4	1424		3.686168	
6	2	9	74.7	1450		4.532585	
7	2	9	79.5	1565		4.773367	
8	3	9	84.9	1341	1235	5.558417	
9	3	9	64.4	1658	1758	6.491697	
10	3	9	64.1	1272	1910	6.674484	
11	2	9	57.3	1199		7.417994	
12	2	9	88.1	1193		8.255436	
13	1	9	59.1			9.013269	
14	2	9	95.5	1948		9.607089	
15	2	9	86	1023		10.43855	
16	2	9	71.3	1294		10.897028	
17	1	9	98.7			11.802671	

Bin5 Statistics 12

Trial #	Pulse	Chirp (MHz)	Pulse Width (µS)	Pulse 1-2 spacing (uS)	Pulse 2-3 spacing (uS)	Pulse Start(S)	Detection (1:yes; 0:no)
0	1	16	54			0.633065	1
1	1	16	89.1			1.479601	
2	3	16	91.1	1712	1025	1.788025	
3	2	16	67.5	1347		2.413572	
4	2	16	78.2	1525		3.152924	
5	2	16	90	1320		3.889831	
6	2	16	91.3	1347		5.030156	
7	2	16	94.8	1870		5.298213	
8	1	16	94.2			6.718047	
9	2	16	51.8	1857		7.30269	
10	3	16	83	1330	1552	8.197523	
11	3	16	78.1	1444	1195	8.397471	
12	1	16	73.1			9.598391	
13	1	16	98.5			10.103752	
14	1	16	88.9			10.928203	
15	1	16	83.5			11.502774	

Bin5 Statistics 13

Trial #	Pulse	Chirp (MHz)	Pulse Width (µS)	Pulse 1-2 spacing (µS)	Pulse 2-3 spacing (µS)	Pulse Start(S)	Detection (1:yes; 0:no)
0	3	18	86.7	1961	1804	0.798288	1
1	1	18	63.8			1.210389	
2	2	18	85.4	1597		1.990825	
3	2	18	64	1270		3.011546	
4	3	18	81.2	1605	1821	3.745567	
5	3	18	79.7	1105	1348	4.645529	
6	3	18	86.9	1171	1925	5.464025	
7	2	18	68.9	1865		6.765755	
8	1	18	92.2			7.155247	
9	1	18	55.9			8.182402	
10	2	18	96.6	1595		9.337966	
11	1	18	98.4			9.849133	
12	3	18	96.9	1489	1516	10.374003	
13	2	18	79.2	1350		11.891708	

Bin5 Statistics 14

Trial #	Pulse	Chirp (MHz)	Pulse Width (µS)	Pulse 1-2 spacing (µS)	Pulse 2-3 spacing (µS)	Pulse Start(S)	Detection (1:yes; 0:no)
0	2	8	52.6	1806		0.017622	1
1	2	8	73.6	1711		1.411032	
2	3	8	67.3	1346	1371	2.524417	
3	2	8	79.4	1703		2.71612	
4	2	8	73.8	1724		4.277998	
5	1	8	57.9			4.810292	
6	2	8	73.6	1191		5.156237	
7	2	8	74	1541		6.464125	
8	3	8	94.1	1917	1938	7.617415	
9	2	8	66	1957		7.754438	
10	2	8	98.1	1607		9.033038	
11	1	8	51.1			9.445425	
12	2	8	62.5	1253		10.965494	
13	2	8	85	1148		11.283605	

Bin5 Statistics 15

Trial #	Pulse	Chirp (MHz)	Pulse Width (µS)	Pulse 1-2 spacing (µS)	Pulse 2-3 spacing (µS)	Pulse Start(S)	Detection (1:yes; 0:no)
0	3	15	76.1	1768	1642	0.527787	1
1	2	15	82.9	1887		1.240889	
2	1	15	84.3			2.279132	
3	2	15	58.2	1470		3.342501	
4	1	15	85.8			3.937765	
5	2	15	66	1890		5.374346	
6	1	15	69.7			6.00393	
7	2	15	62	1831		7.161205	
8	2	15	62.2	1059		7.548595	
9	3	15	96.8	1584	1832	8.916271	
10	2	15	57.2	1472		9.446757	
11	1	15	77.6			10.386467	
12	1	15	87.2			11.300208	

Bin5 Statistics 16

Trial #	Pulse	Chirp (MHz)	Pulse Width (µS)	Pulse 1-2 spacing (µS)	Pulse 2-3 spacing (µS)	Pulse Start(S)	Detection (1:yes; 0:no)
0	2	6	57.2	1030		0.496237	1
1	2	6	77.7	1557		1.142471	
2	1	6	54.5			1.228862	
3	1	6	64.4			1.966057	
4	3	6	95.8	1624	1572	2.482686	
5	3	6	69.2	1356	1157	3.021518	
6	2	6	75.6	1344		3.95909	
7	3	6	96.2	1972	1851	4.643766	
8	3	6	90.1	1867	1817	5.145889	
9	2	6	89.6	1024		5.961628	
10	2	6	94.2	1550		6.294994	
11	2	6	54.8	1999		6.881335	
12	3	6	86.5	1687	1230	7.625675	
13	2	6	79.6	1162		8.009021	
14	2	6	93.6	1968		8.743829	
15	2	6	82.6	1106		9.128015	
16	1	6	96.8			9.840181	
17	3	6	62	1392	1883	10.276781	
18	3	6	65.5	1999	1226	11.227272	
19	2	6	70.1	1446		11.646596	

Bin5 Statistics 17

Trial #	Pulse	Chirp (MHz)	Pulse Width (µS)	Pulse 1-2 spacing (uS)	Pulse 2-3 spacing (uS)	Pulse Start(S)	Detection (1:yes; 0:no)
0	2	17	53.6	1207		0.669785	1
1	2	17	90.5	1737		1.694828	
2	2	17	81	1358		3.097318	
3	2	17	88.7	1259		4.150226	
4	1	17	66.3			4.587174	
5	2	17	86.9	1209		6.079184	
6	3	17	51.7	1007	1564	6.879708	
7	2	17	69.8	1845		7.859295	
8	3	17	51.1	1920	1491	9.069775	
9	3	17	68.3	1891	1634	10.468883	
10	3	17	53.1	1184	1717	11.68257	

Bin5 Statistics 18

Trial #	Pulse	Chirp (MHz)	Pulse Width (µS)	Pulse 1-2 spacing (uS)	Pulse 2-3 spacing (uS)	Pulse Start(S)	Detection (1:yes; 0:no)
0	3	18	86.7	1983	1162	0.376537	1
1	3	18	54.8	1484	1848	0.863587	
2	3	18	84.5	1803	1848	1.346909	
3	2	18	76.1	1573		1.852483	
4	2	18	70.6	1258		2.641603	
5	2	18	57.9	1930		3.27212	
6	2	18	85.7	1275		3.713709	
7	2	18	90.6	1274		4.630303	
8	2	18	57.3	1017		5.281261	
9	2	18	78.1	1801		5.618911	
10	1	18	83.9			6.458855	
11	2	18	82.2	1961		7.159586	
12	3	18	97.5	1488	1287	7.486436	
13	3	18	90.7	1012	1143	7.94885	
14	2	18	84.4	1850		8.74006	
15	1	18	91.4			9.30157	
16	2	18	94.5	1147		9.737601	
17	3	18	89	1493	1195	10.51609	
18	2	18	72.6	1274		11.023357	
19	1	18	92.6			11.611304	

Bin5 Statistics 19

Trial #	Pulse	Chirp (MHz)	Pulse Width (µS)	Pulse 1-2 spacing (µS)	Pulse 2-3 spacing (µS)	Pulse Start(S)	Detection (1:yes; 0:no)
0	1	6	51			0.074339	1
1	2	6	74.9	1327		1.449738	
2	3	6	69	1087	1781	2.121751	
3	2	6	64.2	1407		2.909436	
4	2	6	94.5	1752		3.222345	
5	2	6	88.5	1545		4.403166	
6	3	6	89.2	1185	1371	4.524598	
7	1	6	95.9			5.44619	
8	2	6	69.5	1559		6.273556	
9	2	6	82.7	1067		7.467411	
10	2	6	76.3	1923		8.115604	
11	2	6	68.5	1672		8.301895	
12	2	6	92.2	1006		9.55141	
13	3	6	69.8	1256	1158	9.933718	
14	1	6	98.2			10.816364	
15	2	6	83.4	1170		11.418269	

Bin5 Statistics 20

Trial #	Pulse	Chirp (MHz)	Pulse Width (µS)	Pulse 1-2 spacing (µS)	Pulse 2-3 spacing (µS)	Pulse Start(S)	Detection (1:yes; 0:no)
0	3	10	82.8	1362	1603	0.384382	1
1	2	10	75.8	1716		1.183969	
2	3	10	92.2	1978	1789	2.283273	
3	2	10	79.6	1979		3.367894	
4	1	10	82.8			4.555355	
5	2	10	85.8	1830		5.336529	
6	3	10	55.7	1725	1560	6.425818	
7	1	10	78.9			6.735372	
8	2	10	89.3	1281		8.166598	
9	2	10	62.7	1579		9.165968	
10	2	10	98.2	1497		10.096968	
11	2	10	52.4	1524		10.765202	
12	2	10	71.4	1556		11.751105	

Bin5 Statistics 21

Trial #	Pulse	Chirp (MHz)	Pulse Width (µS)	Pulse 1-2 spacing (uS)	Pulse 2-3 spacing (uS)	Pulse Start(S)	Detection (1:yes; 0:no)
0	2	7	97.4	1281		0.915849	0
1	1	7	80.3			1.18937	
2	1	7	97.8			1.993944	
3	1	7	61.5			3.39088	
4	3	7	95.7	1843	1209	3.752795	
5	1	7	66.4			4.65461	
6	1	7	64.6			5.779918	
7	1	7	50.8			7.070396	
8	3	7	66.3	1586	1712	7.597216	
9	2	7	91.3	1442		8.989864	
10	3	7	97.8	1388	1397	9.631341	
11	3	7	61.7	1868	1808	10.461006	
12	2	7	58.1	1667		11.709587	

Bin5 Statistics 22

Trial #	Pulse	Chirp (MHz)	Pulse Width (µS)	Pulse 1-2 spacing (uS)	Pulse 2-3 spacing (uS)	Pulse Start(S)	Detection (1:yes; 0:no)
0	2	9	86	1532		0.688885	1
1	1	9	62.3			1.49945	
2	1	9	56.1			1.621148	
3	1	9	56.8			2.448197	
4	3	9	91.8	1458	1786	3.555087	
5	1	9	72.6			4.700984	
6	2	9	81	1516		5.005183	
7	1	9	98.2			5.904082	
8	1	9	94			6.516521	
9	1	9	77.4			7.664452	
10	2	9	94	1932		8.2788	
11	3	9	57.3	1971	1585	9.584584	
12	3	9	61.9	1362	1917	9.915934	
13	3	9	70.4	1962	1182	11.164886	
14	3	9	92.3	1993	1689	11.957664	

Bin5 Statistics 23

Trial #	Pulse	Chirp (MHz)	Pulse Width (µS)	Pulse 1-2 spacing (µS)	Pulse 2-3 spacing (µS)	Pulse Start(S)	Detection (1:yes; 0:no)
0	1	11	64.6			0.311888	0
1	3	11	90	1435	1235	0.899813	
2	2	11	55.3	1723		1.836764	
3	2	11	67.8	1527		2.714245	
4	1	11	69.9			3.287159	
5	2	11	83.9	1704		4.677533	
6	1	11	77			5.009102	
7	3	11	67.9	1884	1123	6.055092	
8	2	11	61.9	1840		6.410064	
9	2	11	82.6	1221		7.280896	
10	2	11	76.8	1205		8.394139	
11	3	11	88.5	1788	1497	9.583781	
12	2	11	76.7	1934		9.775437	
13	2	11	72.2	1566		11.1785	
14	3	11	66	1944	1772	11.985736	

Bin5 Statistics 24

Trial #	Pulse	Chirp (MHz)	Pulse Width (µS)	Pulse 1-2 spacing (uS)	Pulse 2-3 spacing (uS)	Pulse Start(S)	Detection (1:yes; 0:no)
0	2	17	75.6	1608		0.379628	0
1	1	17	86.9			0.887477	
2	1	17	86.9			1.324415	
3	2	17	52.6	1737		2.185765	
4	1	17	57.3			2.613076	
5	3	17	50.9	1558	1073	3.472832	
6	2	17	88.6	1959		3.76486	
7	1	17	93.8			4.389602	
8	1	17	92.2			4.821724	
9	3	17	83	1115	1422	5.939374	
10	2	17	90.2	1327		6.034046	
11	3	17	90.4	1384	1289	6.945083	
12	2	17	93.3	1420		7.62775	
13	2	17	75.1	1747		7.938177	
14	2	17	56.3	1652		8.583576	
15	3	17	72	1981	1491	9.297223	
16	3	17	59.5	1576	1438	10.045921	
17	1	17	88.6			10.385614	
18	2	17	59.6	1299		10.814686	
19	1	17	62.4			11.920115	

Bin5 Statistics 25

Trial #	Pulse	Chirp (MHz)	Pulse Width (µS)	Pulse 1-2 spacing (uS)	Pulse 2-3 spacing (uS)	Pulse Start(S)	Detection (1:yes; 0:no)
0	1	15	86.9			0.372305	1
1	1	15	84.2			1.401388	
2	2	15	90.3	1070		3.650835	
3	3	15	62.1	1142	1895	4.196913	
4	1	15	61.9			6.245322	
5	2	15	90.6	1940		6.912914	
6	2	15	67.2	1430		8.181739	
7	2	15	85.4	1523		9.910585	
8	3	15	70.8	1909	1322	10.970354	

Bin5 Statistics 26

Trial #	Pulse	Chirp (MHz)	Pulse Width (µS)	Pulse 1-2 spacing (uS)	Pulse 2-3 spacing (uS)	Pulse Start(S)	Detection (1:yes; 0:no)
0	3	8	89.4	1518	1627	0.050817	1
1	2	8	54.1	1418		1.013417	
2	1	8	85.8			1.613699	
3	1	8	64.5			2.103949	
4	2	8	63.9	1356		2.776679	
5	2	8	68.6	1264		3.563045	
6	3	8	69.8	1243	1901	3.835909	
7	1	8	77			4.291401	
8	2	8	90.4	1363		5.334165	
9	3	8	81.2	1534	1754	5.500533	
10	3	8	91.6	1388	1746	6.548243	
11	1	8	87.4			6.706641	
12	1	8	80			7.528062	
13	1	8	67.4			8.032282	
14	1	8	83.1			8.870647	
15	2	8	93.4	1999		9.339507	
16	2	8	92.8	1840		9.703443	
17	2	8	98.2	1012		10.385552	
18	2	8	73.6	1496		10.888097	
19	2	8	68.7	1055		11.459815	

Bin5 Statistics 27

Trial #	Pulse	Chirp (MHz)	Pulse Width (µS)	Pulse 1-2 spacing (µS)	Pulse 2-3 spacing (µS)	Pulse Start(S)	Detection (1:yes; 0:no)
0	2	12	83.4	1986		0.901049	1
1	3	12	52.3	1806	1001	1.565993	
2	1	12	97.8			2.705762	
3	2	12	53.6	1102		4.514459	
4	1	12	55.5			6.354467	
5	2	12	52.6	1220		7.929073	
6	3	12	91.5	1879	1992	9.008209	
7	1	12	53.4			10.489063	
8	2	12	58.9	1647		11.63623	

Bin5 Statistics 28

Trial #	Pulse	Chirp (MHz)	Pulse Width (µS)	Pulse 1-2 spacing (µS)	Pulse 2-3 spacing (µS)	Pulse Start(S)	Detection (1:yes; 0:no)
0	1	9	80.6			0.348464	1
1	3	9	64.9	1678	1510	2.021047	
2	2	9	89.2	1890		2.991683	
3	2	9	71	1500		4.213038	
4	2	9	57.3	1189		6.227122	
5	2	9	87.7	1814		6.934045	
6	1	9	87			9.304515	
7	1	9	56.1			9.56563	
8	2	9	82.7	1670		11.808942	

Bin5 Statistics 29

Trial #	Pulse	Chirp (MHz)	Pulse Width (µS)	Pulse 1-2 spacing (uS)	Pulse 2-3 spacing (uS)	Pulse Start(S)	Detection (1:yes; 0:no)
0	3	10	72.8	1975	1859	0.597526	1
1	2	10	50.8	1851		1.741358	
2	2	10	59.1	1970		2.382241	
3	3	10	97.2	1094	1041	3.128802	
4	2	10	65.1	1047		4.309794	
5	3	10	54.2	1899	1995	4.915313	
6	2	10	68.3	1956		5.703815	
7	2	10	73.8	1275		6.707563	
8	2	10	50.3	1449		7.610909	
9	3	10	91.2	1118	1130	8.825975	
10	3	10	87.2	1809	1952	9.534938	
11	3	10	63.7	1191	1879	10.686291	
12	1	10	86.6			11.987729	

Bin5 Statistics 30

Trial #	Pulse	Chirp (MHz)	Pulse Width (µS)	Pulse 1-2 spacing (uS)	Pulse 2-3 spacing (uS)	Pulse Start(S)	Detection (1:yes; 0:no)
0	2	11	84.8	1430		1.089486	1
1	2	11	66.8	1154		1.879833	
2	1	11	98.3			2.962086	
3	2	11	75	1710		5.031555	
4	2	11	58.2	1438		6.641024	
5	1	11	89.4			7.918838	
6	1	11	98.5			8.442038	
7	2	11	55.9	1462		10.62041	
8	2	11	74.3	1467		11.731754	

Table-6 Radar Type 6 Statistical Performance

Trial #	Fc (MHz)	Pulse /Burst	Pulse Width (µS)	PRI (µs)	Detection (1:yes; 0:no)	Hopping Sequence
1	5550	9	1	333	1	5352.0, 5673.0, 5275.0, 5330.0, 5319.0, 5301.0, 5279.0, 5504.0, 5677.0, 5541.0, 5393.0, 5339.0, 5379.0, 5422.0, 5287.0, 5369.0, 5343.0, 5523.0, 5457.0, 5720.0, 5451.0, 5618.0, 5306.0, 5375.0, 5448.0, 5626.0, 5456.0, 5295.0, 5664.0, 5610.0, 5508.0, 5597.0, 5328.0, 5254.0, 5366.0, 5503.0, 5662.0, 5405.0, 5488.0, 5681.0, 5604.0, 5417.0, 5548.0, 5724.0, 5290.0, 5327.0, 5460.0, 5322.0, 5526.0, 5292.0, 5361.0, 5566.0, 5635.0, 5323.0, 5570.0, 5684.0, 5687.0, 5342.0, 5394.0, 5601.0, 5587.0, 5592.0, 5344.0, 5386.0, 5355.0, 5711.0, 5607.0, 5333.0, 5351.0, 5593.0, 5428.0, 5321.0, 5556.0, 5586.0, 5441.0, 5372.0, 5453.0, 5251.0, 5634.0, 5267.0, 5256.0, 5558.0, 5639.0, 5430.0, 5576.0, 5257.0, 5437.0, 5700.0, 5690.0, 5363.0, 5702.0, 5671.0, 5678.0, 5663.0, 5646.0, 5305.0, 5459.0, 5416.0, 5636.0, 5269.0 (number of hits: 3)
2	5550	9	1	333	1	5699.0, 5591.0, 5431.0, 5441.0, 5619.0, 5663.0, 5352.0, 5687.0, 5662.0, 5682.0, 5622.0, 5299.0, 5264.0, 5401.0, 5414.0, 5399.0, 5393.0, 5274.0, 5469.0, 5515.0, 5618.0, 5613.0, 5652.0, 5588.0, 5327.0, 5575.0, 5502.0, 5691.0, 5361.0, 5495.0, 5275.0, 5719.0, 5258.0, 5637.0, 5429.0, 5480.0, 5316.0, 5645.0, 5560.0, 5582.0, 5334.0, 5514.0, 5259.0, 5251.0, 5263.0, 5478.0, 5467.0, 5654.0, 5558.0, 5700.0, 5443.0, 5499.0, 5651.0, 5604.0, 5343.0, 5669.0, 5315.0, 5640.0, 5400.0, 5599.0, 5333.0, 5425.0, 5646.0, 5342.0, 5406.0, 5300.0, 5291.0, 5718.0, 5420.0, 5511.0, 5367.0, 5688.0, 5356.0, 5504.0, 5713.0, 5701.0, 5471.0, 5351.0, 5707.0, 5301.0, 5709.0, 5391.0, 5388.0, 5430.0, 5374.0, 5704.0, 5363.0, 5578.0, 5322.0, 5590.0, 5696.0, 5526.0, 5594.0, 5265.0, 5541.0, 5328.0, 5680.0, 5413.0, 5293.0, 5621.0 (number of hits: 5)
3	5550	9	1	333	1	5298.0, 5572.0, 5692.0, 5474.0, 5252.0, 5472.0, 5449.0, 5373.0, 5618.0, 5576.0, 5654.0, 5346.0, 5514.0, 5666.0, 5711.0, 5600.0, 5405.0, 5303.0, 5308.0, 5644.0, 5656.0, 5280.0, 5369.0, 5480.0, 5700.0, 5323.0, 5359.0, 5652.0, 5713.0, 5427.0, 5445.0, 5451.0, 5573.0, 5263.0, 5613.0, 5588.0, 5688.0, 5410.0, 5546.0, 5662.0, 5567.0, 5300.0, 5371.0, 5608.0, 5465.0, 5574.0, 5718.0, 5393.0, 5712.0, 5433.0, 5515.0, 5529.0, 5716.0, 5361.0, 5338.0

						5589.0, 5633.0, 5358.0, 5419.0, 5251.0, 5486.0, 5564.0, 5481.0, 5583.0, 5441.0, 5680.0, 5306.0, 5629.0, 5271.0, 5364.0, 5377.0, 5569.0, 5647.0, 5439.0, 5657.0, 5450.0, 5272.0, 5250.0, 5389.0, 5390.0, 5351.0, 5524.0, 5639.0, 5521.0, 5365.0, 5717.0, 5275.0, 5468.0, 5281.0, 5387.0, 5295.0, 5478.0, 5660.0, 5399.0, 5257.0, 5287.0, 5426.0, 5383.0, 5541.0, 5601.0 (number of hits: 2)
4	5550	9	1	333	1	5331.0, 5533.0, 5410.0, 5452.0, 5316.0, 5472.0, 5536.0, 5415.0, 5665.0, 5354.0, 5335.0, 5474.0, 5363.0, 5706.0, 5711.0, 5487.0, 5262.0, 5678.0, 5619.0, 5346.0, 5392.0, 5426.0, 5407.0, 5691.0, 5440.0, 5658.0, 5559.0, 5283.0, 5257.0, 5377.0, 5642.0, 5268.0, 5273.0, 5387.0, 5347.0, 5295.0, 5293.0, 5266.0, 5710.0, 5493.0, 5470.0, 5610.0, 5422.0, 5367.0, 5632.0, 5534.0, 5373.0, 5391.0, 5693.0, 5501.0, 5336.0, 5325.0, 5263.0, 5301.0, 5579.0, 5527.0, 5607.0, 5252.0, 5479.0, 5511.0, 5464.0, 5712.0, 5588.0, 5438.0, 5694.0, 5637.0, 5591.0, 5420.0, 5624.0, 5430.0, 5290.0, 5647.0, 5522.0, 5638.0, 5718.0, 5497.0, 5376.0, 5649.0, 5390.0, 5596.0, 5547.0, 5307.0, 5338.0, 5554.0, 5313.0, 5675.0, 5261.0, 5425.0, 5565.0, 5650.0, 5563.0, 5582.0, 5562.0, 5434.0, 5651.0, 5643.0, 5414.0, 5309.0, 5359.0, 5406.0 (number of hits: 2)
5	5550	9	1	333	1	5677.0, 5682.0, 5274.0, 5689.0, 5490.0, 5299.0, 5598.0, 5717.0, 5260.0, 5343.0, 5321.0, 5275.0, 5654.0, 5561.0, 5294.0, 5318.0, 5422.0, 5699.0, 5342.0, 5588.0, 5288.0, 5674.0, 5454.0, 5330.0, 5399.0, 5322.0, 5549.0, 5554.0, 5520.0, 5278.0, 5583.0, 5702.0, 5423.0, 5395.0, 5336.0, 5491.0, 5610.0, 5575.0, 5382.0, 5261.0, 5409.0, 5415.0, 5690.0, 5316.0, 5257.0, 5669.0, 5609.0, 5649.0, 5545.0, 5407.0, 5335.0, 5486.0, 5416.0, 5360.0, 5286.0, 5374.0, 5571.0, 5511.0, 5708.0, 5456.0, 5324.0, 5449.0, 5473.0, 5459.0, 5679.0, 5599.0, 5544.0, 5620.0, 5279.0, 5450.0, 5389.0, 5636.0, 5528.0, 5700.0, 5315.0, 5434.0, 5627.0, 5703.0, 5402.0, 5438.0, 5607.0, 5706.0, 5483.0, 5376.0, 5298.0, 5460.0, 5503.0, 5428.0, 5502.0, 5509.0, 5251.0, 5331.0, 5693.0, 5305.0, 5670.0, 5475.0, 5256.0, 5328.0, 5652.0, 5716.0 (number of hits: 4)
6	5550	9	1	333	1	5514.0, 5704.0, 5383.0, 5590.0, 5456.0, 5468.0, 5701.0, 5530.0, 5598.0, 5439.0, 5265.0, 5351.0, 5325.0, 5375.0, 5495.0, 5665.0, 5414.0, 5276.0, 5576.0, 5662.0, 5597.0, 5379.0, 5395.0, 5434.0, 5584.0, 5274.0, 5562.0, 5410.0, 5550.0, 5430.0, 5371.0, 5341.0, 5310.0, 5503.0, 5360.0,

						5661.0, 5337.0, 5455.0, 5608.0, 5680.0, 5624.0, 5491.0, 5289.0, 5364.0, 5688.0, 5558.0, 5627.0, 5380.0, 5673.0, 5457.0, 5518.0, 5581.0, 5626.0, 5441.0, 5540.0, 5717.0, 5442.0, 5545.0, 5350.0, 5389.0, 5413.0, 5525.0, 5543.0, 5577.0, 5664.0, 5396.0, 5567.0, 5713.0, 5479.0, 5269.0, 5542.0, 5466.0, 5622.0, 5563.0, 5405.0, 5534.0, 5263.0, 5498.0, 5378.0, 5454.0, 5641.0, 5642.0, 5648.0, 5697.0, 5470.0, 5614.0, 5523.0, 5445.0, 5492.0, 5319.0, 5361.0, 5615.0, 5450.0, 5526.0, 5619.0, 5476.0, 5285.0, 5292.0, 5397.0, 5336.0 (number of hits: 3)
7	5550	9	1	333	1	5705.0, 5686.0, 5324.0, 5720.0, 5550.0, 5501.0, 5597.0, 5567.0, 5619.0, 5360.0, 5317.0, 5466.0, 5696.0, 5570.0, 5657.0, 5314.0, 5706.0, 5507.0, 5699.0, 5261.0, 5537.0, 5286.0, 5524.0, 5598.0, 5405.0, 5603.0, 5345.0, 5609.0, 5513.0, 5377.0, 5509.0, 5658.0, 5504.0, 5516.0, 5431.0, 5689.0, 5530.0, 5285.0, 5682.0, 5505.0, 5411.0, 5517.0, 5586.0, 5389.0, 5384.0, 5477.0, 5677.0, 5626.0, 5419.0, 5420.0, 5672.0, 5288.0, 5628.0, 5691.0, 5331.0, 5683.0, 5719.0, 5313.0, 5711.0, 5464.0, 5455.0, 5463.0, 5531.0, 5278.0, 5375.0, 5553.0, 5676.0, 5572.0, 5616.0, 5367.0, 5661.0, 5543.0, 5593.0, 5391.0, 5568.0, 5722.0, 5556.0, 5269.0, 5640.0, 5653.0, 5435.0, 5358.0, 5694.0, 5476.0, 5421.0, 5257.0, 5398.0, 5580.0, 5579.0, 5606.0, 5511.0, 5361.0, 5291.0, 5418.0, 5551.0, 5333.0, 5491.0, 5610.0, 5352.0, 5307.0 (number of hits: 9)
8	5550	9	1	333	1	5278.0, 5378.0, 5580.0, 5505.0, 5401.0, 5500.0, 5585.0, 5560.0, 5602.0, 5351.0, 5556.0, 5557.0, 5578.0, 5471.0, 5374.0, 5508.0, 5454.0, 5259.0, 5546.0, 5267.0, 5443.0, 5319.0, 5548.0, 5576.0, 5694.0, 5572.0, 5425.0, 5535.0, 5485.0, 5458.0, 5658.0, 5705.0, 5315.0, 5614.0, 5664.0, 5275.0, 5283.0, 5445.0, 5597.0, 5331.0, 5627.0, 5712.0, 5287.0, 5716.0, 5574.0, 5718.0, 5512.0, 5484.0, 5579.0, 5592.0, 5429.0, 5591.0, 5502.0, 5503.0, 5344.0, 5252.0, 5541.0, 5669.0, 5295.0, 5682.0, 5539.0, 5685.0, 5281.0, 5433.0, 5297.0, 5286.0, 5550.0, 5544.0, 5675.0, 5372.0, 5260.0, 5326.0, 5395.0, 5608.0, 5543.0, 5652.0, 5588.0, 5568.0, 5255.0, 5270.0, 5435.0, 5343.0, 5634.0, 5290.0, 5455.0, 5288.0, 5673.0, 5515.0, 5663.0, 5656.0, 5552.0, 5470.0, 5708.0, 5446.0, 5606.0, 5427.0, 5466.0, 5651.0, 5370.0, 5659.0 (number of hits: 7)
9	5550	9	1	333	1	5482.0, 5673.0, 5431.0, 5421.0, 5670.0, 5323.0, 5405.0, 5265.0, 5686.0, 5344.0, 5410.0, 5429.0, 5327.0, 5275.0, 5436.0,

						5648.0, 5614.0, 5392.0, 5677.0, 5346.0, 5320.0, 5554.0, 5503.0, 5277.0, 5552.0, 5465.0, 5336.0, 5407.0, 5413.0, 5424.0, 5693.0, 5340.0, 5369.0, 5343.0, 5427.0, 5507.0, 5672.0, 5689.0, 5671.0, 5540.0, 5508.0, 5569.0, 5276.0, 5393.0, 5570.0, 5471.0, 5501.0, 5251.0, 5328.0, 5412.0, 5489.0, 5701.0, 5280.0, 5711.0, 5373.0, 5372.0, 5612.0, 5549.0, 5292.0, 5700.0, 5416.0, 5560.0, 5402.0, 5308.0, 5448.0, 5594.0, 5536.0, 5716.0, 5719.0, 5651.0, 5483.0, 5272.0, 5419.0, 5375.0, 5376.0, 5274.0, 5580.0, 5374.0, 5714.0, 5400.0, 5642.0, 5578.0, 5606.0, 5696.0, 5629.0, 5543.0, 5571.0, 5330.0, 5307.0, 5623.0, 5523.0, 5291.0, 5259.0, 5312.0, 5396.0, 5302.0, 5476.0, 5502.0, 5398.0, 5490.0 (number of hits: 5)
10	5550	9	1	333	1	5411.0, 5438.0, 5474.0, 5344.0, 5611.0, 5465.0, 5547.0, 5361.0, 5687.0, 5507.0, 5257.0, 5570.0, 5533.0, 5637.0, 5678.0, 5630.0, 5366.0, 5714.0, 5652.0, 5649.0, 5435.0, 5329.0, 5633.0, 5458.0, 5560.0, 5434.0, 5447.0, 5440.0, 5688.0, 5486.0, 5424.0, 5705.0, 5642.0, 5582.0, 5274.0, 5353.0, 5414.0, 5338.0, 5282.0, 5521.0, 5559.0, 5466.0, 5580.0, 5645.0, 5386.0, 5700.0, 5719.0, 5330.0, 5393.0, 5270.0, 5342.0, 5494.0, 5712.0, 5320.0, 5720.0, 5345.0, 5662.0, 5436.0, 5686.0, 5432.0, 5451.0, 5598.0, 5646.0, 5324.0, 5691.0, 5502.0, 5513.0, 5600.0, 5351.0, 5297.0, 5529.0, 5704.0, 5325.0, 5654.0, 5357.0, 5316.0, 5404.0, 5262.0, 5399.0, 5370.0, 5527.0, 5260.0, 5454.0, 5565.0, 5543.0, 5624.0, 5542.0, 5713.0, 5519.0, 5690.0, 5398.0, 5348.0, 5685.0, 5608.0, 5562.0, 5672.0, 5515.0, 5638.0, 5277.0, 5701.0 (number of hits: 5)
11	5550	9	1	333	1	5653.0, 5263.0, 5657.0, 5302.0, 5708.0, 5332.0, 5660.0, 5360.0, 5512.0, 5511.0, 5492.0, 5711.0, 5339.0, 5272.0, 5516.0, 5683.0, 5372.0, 5715.0, 5423.0, 5534.0, 5373.0, 5377.0, 5613.0, 5591.0, 5508.0, 5425.0, 5482.0, 5308.0, 5439.0, 5526.0, 5406.0, 5472.0, 5261.0, 5495.0, 5330.0, 5324.0, 5596.0, 5473.0, 5566.0, 5710.0, 5704.0, 5265.0, 5703.0, 5643.0, 5322.0, 5337.0, 5374.0, 5262.0, 5335.0, 5251.0, 5569.0, 5485.0, 5625.0, 5399.0, 5663.0, 5433.0, 5636.0, 5346.0, 5462.0, 5499.0, 5552.0, 5405.0, 5585.0, 5666.0, 5316.0, 5669.0, 5628.0, 5280.0, 5615.0, 5679.0, 5547.0, 5709.0, 5400.0, 5674.0, 5501.0, 5342.0, 5388.0, 5688.0, 5509.0, 5307.0, 5320.0, 5622.0, 5317.0, 5588.0, 5699.0, 5362.0, 5355.0, 5359.0, 5269.0, 5576.0, 5351.0, 5260.0, 5295.0, 5279.0, 5365.0, 5456.0, 5288.0, 5328.0, 5408.0, 5313.0

						(number of hits: 6)
12	5550	9	1	333	1	5445.0, 5655.0, 5409.0, 5665.0, 5658.0, 5699.0, 5534.0, 5511.0, 5635.0, 5612.0, 5630.0, 5420.0, 5697.0, 5679.0, 5686.0, 5336.0, 5258.0, 5466.0, 5287.0, 5666.0, 5588.0, 5419.0, 5326.0, 5408.0, 5433.0, 5639.0, 5601.0, 5526.0, 5340.0, 5589.0, 5629.0, 5507.0, 5552.0, 5361.0, 5405.0, 5454.0, 5643.0, 5300.0, 5713.0, 5715.0, 5314.0, 5632.0, 5492.0, 5410.0, 5678.0, 5400.0, 5668.0, 5343.0, 5620.0, 5590.0, 5463.0, 5567.0, 5393.0, 5346.0, 5451.0, 5303.0, 5614.0, 5484.0, 5593.0, 5532.0, 5513.0, 5608.0, 5518.0, 5253.0, 5660.0, 5719.0, 5712.0, 5359.0, 5273.0, 5296.0, 5704.0, 5256.0, 5294.0, 5683.0, 5662.0, 5367.0, 5613.0, 5535.0, 5722.0, 5385.0, 5541.0, 5675.0, 5271.0, 5426.0, 5351.0, 5664.0, 5617.0, 5681.0, 5436.0, 5448.0, 5479.0, 5452.0, 5505.0, 5437.0, 5496.0, 5406.0, 5509.0, 5283.0, 5353.0, 5542.0
						(number of hits: 6)
13	5550	9	1	333	1	5346.0, 5458.0, 5265.0, 5472.0, 5329.0, 5521.0, 5258.0, 5634.0, 5493.0, 5514.0, 5673.0, 5466.0, 5557.0, 5626.0, 5399.0, 5416.0, 5723.0, 5609.0, 5527.0, 5318.0, 5275.0, 5338.0, 5709.0, 5450.0, 5312.0, 5255.0, 5417.0, 5376.0, 5545.0, 5601.0, 5632.0, 5304.0, 5379.0, 5572.0, 5424.0, 5659.0, 5256.0, 5656.0, 5588.0, 5296.0, 5284.0, 5462.0, 5475.0, 5645.0, 5674.0, 5394.0, 5364.0, 5456.0, 5326.0, 5687.0, 5528.0, 5353.0, 5610.0, 5583.0, 5541.0, 5264.0, 5340.0, 5413.0, 5476.0, 5268.0, 5539.0, 5400.0, 5419.0, 5596.0, 5538.0, 5368.0, 5614.0, 5581.0, 5369.0, 5655.0, 5602.0, 5282.0, 5627.0, 5377.0, 5272.0, 5300.0, 5615.0, 5381.0, 5594.0, 5504.0, 5507.0, 5414.0, 5309.0, 5276.0, 5430.0, 5491.0, 5604.0, 5445.0, 5372.0, 5501.0, 5322.0, 5323.0, 5625.0, 5433.0, 5650.0, 5439.0, 5355.0, 5281.0, 5712.0, 5722.0
						(number of hits: 4)
14	5550	9	1	333	1	5435.0, 5360.0, 5423.0, 5625.0, 5332.0, 5564.0, 5516.0, 5250.0, 5266.0, 5511.0, 5502.0, 5285.0, 5648.0, 5551.0, 5438.0, 5267.0, 5470.0, 5458.0, 5637.0, 5584.0, 5316.0, 5364.0, 5419.0, 5358.0, 5556.0, 5497.0, 5604.0, 5615.0, 5565.0, 5622.0, 5638.0, 5696.0, 5589.0, 5384.0, 5488.0, 5591.0, 5397.0, 5477.0, 5447.0, 5367.0, 5475.0, 5451.0, 5369.0, 5649.0, 5611.0, 5553.0, 5427.0, 5366.0, 5647.0, 5383.0, 5321.0, 5632.0, 5406.0, 5331.0, 5336.0, 5614.0, 5518.0, 5500.0, 5505.0, 5540.0, 5550.0, 5708.0, 5535.0, 5720.0, 5308.0, 5503.0, 5467.0, 5562.0, 5329.0, 5428.0, 5362.0, 5411.0, 5478.0, 5270.0, 5699.0, 5389.0, 5359.0, 5298.0, 5319.0, 5377.0,

						5415.0, 5713.0, 5381.0, 5372.0, 5456.0, 5530.0, 5385.0, 5651.0, 5409.0, 5585.0, 5288.0, 5537.0, 5443.0, 5592.0, 5681.0, 5629.0, 5702.0, 5333.0, 5606.0, 5455.0 (number of hits: 7)
15	5550	9	1	333	1	5580.0, 5396.0, 5653.0, 5327.0, 5349.0, 5382.0, 5341.0, 5273.0, 5667.0, 5292.0, 5553.0, 5598.0, 5258.0, 5555.0, 5675.0, 5525.0, 5444.0, 5552.0, 5647.0, 5435.0, 5354.0, 5502.0, 5562.0, 5594.0, 5526.0, 5446.0, 5425.0, 5311.0, 5619.0, 5507.0, 5321.0, 5595.0, 5528.0, 5400.0, 5296.0, 5494.0, 5487.0, 5679.0, 5644.0, 5424.0, 5656.0, 5264.0, 5632.0, 5418.0, 5263.0, 5561.0, 5511.0, 5569.0, 5643.0, 5677.0, 5597.0, 5680.0, 5361.0, 5419.0, 5309.0, 5303.0, 5551.0, 5350.0, 5610.0, 5475.0, 5572.0, 5530.0, 5716.0, 5313.0, 5641.0, 5658.0, 5377.0, 5470.0, 5693.0, 5577.0, 5607.0, 5290.0, 5509.0, 5536.0, 5570.0, 5415.0, 5261.0, 5499.0, 5664.0, 5566.0, 5426.0, 5312.0, 5381.0, 5578.0, 5367.0, 5346.0, 5286.0, 5584.0, 5372.0, 5615.0, 5473.0, 5489.0, 5602.0, 5440.0, 5504.0, 5492.0, 5337.0, 5322.0, 5557.0, 5668.0 (number of hits: 5)
16	5550	9	1	333	1	5348.0, 5320.0, 5396.0, 5671.0, 5459.0, 5622.0, 5539.0, 5579.0, 5614.0, 5364.0, 5390.0, 5703.0, 5264.0, 5457.0, 5477.0, 5657.0, 5722.0, 5558.0, 5365.0, 5666.0, 5400.0, 5356.0, 5483.0, 5358.0, 5674.0, 5429.0, 5537.0, 5646.0, 5435.0, 5411.0, 5514.0, 5426.0, 5388.0, 5511.0, 5553.0, 5305.0, 5526.0, 5663.0, 5522.0, 5341.0, 5370.0, 5547.0, 5450.0, 5487.0, 5309.0, 5472.0, 5349.0, 5532.0, 5275.0, 5502.0, 5581.0, 5578.0, 5540.0, 5359.0, 5266.0, 5692.0, 5463.0, 5620.0, 5310.0, 5413.0, 5705.0, 5568.0, 5449.0, 5343.0, 5409.0, 5542.0, 5375.0, 5369.0, 5268.0, 5678.0, 5585.0, 5607.0, 5335.0, 5569.0, 5422.0, 5317.0, 5676.0, 5276.0, 5345.0, 5621.0, 5442.0, 5357.0, 5552.0, 5386.0, 5517.0, 5541.0, 5615.0, 5697.0, 5608.0, 5254.0, 5286.0, 5379.0, 5654.0, 5287.0, 5464.0, 5339.0, 5387.0, 5698.0, 5687.0, 5416.0 (number of hits: 4)
17	5550	9	1	333	1	5686.0, 5589.0, 5432.0, 5346.0, 5426.0, 5517.0, 5320.0, 5689.0, 5437.0, 5676.0, 5335.0, 5446.0, 5377.0, 5677.0, 5497.0, 5284.0, 5694.0, 5418.0, 5530.0, 5703.0, 5475.0, 5615.0, 5621.0, 5503.0, 5357.0, 5506.0, 5273.0, 5390.0, 5332.0, 5723.0, 5586.0, 5563.0, 5499.0, 5258.0, 5399.0, 5453.0, 5428.0, 5692.0, 5576.0, 5582.0, 5268.0, 5633.0, 5311.0, 5604.0, 5336.0, 5648.0, 5375.0, 5421.0, 5690.0, 5260.0, 5596.0, 5459.0, 5325.0, 5331.0, 5305.0, 5359.0, 5436.0, 5353.0, 5536.0, 5597.0,

						5280.0, 5319.0, 5634.0, 5420.0, 5355.0, 5682.0, 5666.0, 5342.0, 5343.0, 5337.0, 5608.0, 5704.0, 5448.0, 5298.0, 5379.0, 5272.0, 5415.0, 5347.0, 5281.0, 5631.0, 5613.0, 5650.0, 5630.0, 5358.0, 5581.0, 5658.0, 5622.0, 5322.0, 5623.0, 5447.0, 5392.0, 5326.0, 5304.0, 5384.0, 5700.0, 5467.0, 5461.0, 5371.0, 5639.0, 5315.0 (number of hits: 3)
18	5550	9	1	333	1	5258.0, 5607.0, 5417.0, 5559.0, 5326.0, 5711.0, 5484.0, 5624.0, 5386.0, 5343.0, 5592.0, 5669.0, 5716.0, 5447.0, 5391.0, 5418.0, 5388.0, 5649.0, 5622.0, 5521.0, 5398.0, 5281.0, 5516.0, 5431.0, 5615.0, 5471.0, 5678.0, 5362.0, 5608.0, 5456.0, 5373.0, 5262.0, 5306.0, 5587.0, 5347.0, 5323.0, 5688.0, 5680.0, 5501.0, 5421.0, 5658.0, 5309.0, 5252.0, 5666.0, 5546.0, 5696.0, 5705.0, 5298.0, 5426.0, 5570.0, 5515.0, 5340.0, 5480.0, 5364.0, 5357.0, 5261.0, 5338.0, 5401.0, 5645.0, 5567.0, 5265.0, 5360.0, 5251.0, 5420.0, 5582.0, 5605.0, 5543.0, 5502.0, 5483.0, 5407.0, 5479.0, 5296.0, 5438.0, 5548.0, 5709.0, 5630.0, 5650.0, 5435.0, 5519.0, 5722.0, 5700.0, 5674.0, 5464.0, 5458.0, 5687.0, 5512.0, 5569.0, 5452.0, 5708.0, 5639.0, 5625.0, 5371.0, 5499.0, 5473.0, 5657.0, 5703.0, 5367.0, 5619.0, 5445.0, 5717.0 (number of hits: 6)
19	5550	9	1	333	1	5304.0, 5350.0, 5684.0, 5460.0, 5540.0, 5437.0, 5562.0, 5708.0, 5669.0, 5396.0, 5267.0, 5388.0, 5352.0, 5295.0, 5331.0, 5431.0, 5658.0, 5254.0, 5262.0, 5342.0, 5546.0, 5418.0, 5559.0, 5534.0, 5626.0, 5519.0, 5650.0, 5681.0, 5368.0, 5494.0, 5515.0, 5616.0, 5537.0, 5457.0, 5283.0, 5362.0, 5489.0, 5595.0, 5634.0, 5306.0, 5293.0, 5568.0, 5265.0, 5390.0, 5578.0, 5552.0, 5613.0, 5429.0, 5611.0, 5477.0, 5649.0, 5447.0, 5314.0, 5503.0, 5335.0, 5270.0, 5252.0, 5473.0, 5334.0, 5607.0, 5397.0, 5449.0, 5566.0, 5343.0, 5271.0, 5290.0, 5600.0, 5284.0, 5312.0, 5439.0, 5469.0, 5648.0, 5375.0, 5591.0, 5428.0, 5268.0, 5508.0, 5309.0, 5367.0, 5652.0, 5382.0, 5324.0, 5464.0, 5413.0, 5629.0, 5377.0, 5674.0, 5459.0, 5509.0, 5395.0, 5376.0, 5701.0, 5462.0, 5572.0, 5253.0, 5484.0, 5604.0, 5565.0, 5257.0, 5441.0 (number of hits: 5)
20	5550	9	1	333	1	5463.0, 5401.0, 5353.0, 5658.0, 5292.0, 5311.0, 5536.0, 5313.0, 5589.0, 5668.0, 5686.0, 5711.0, 5639.0, 5314.0, 5571.0, 5651.0, 5454.0, 5384.0, 5721.0, 5349.0, 5412.0, 5601.0, 5596.0, 5310.0, 5331.0, 5638.0, 5650.0, 5450.0, 5342.0, 5448.0, 5364.0, 5284.0, 5449.0, 5495.0, 5490.0, 5620.0, 5570.0, 5617.0, 5251.0, 5703.0,

						5535.0, 5713.0, 5410.0, 5286.0, 5531.0, 5281.0, 5522.0, 5515.0, 5317.0, 5391.0, 5724.0, 5387.0, 5479.0, 5423.0, 5588.0, 5446.0, 5577.0, 5614.0, 5524.0, 5468.0, 5561.0, 5438.0, 5262.0, 5505.0, 5552.0, 5426.0, 5512.0, 5268.0, 5484.0, 5553.0, 5416.0, 5554.0, 5555.0, 5385.0, 5716.0, 5656.0, 5551.0, 5350.0, 5404.0, 5607.0, 5581.0, 5709.0, 5345.0, 5394.0, 5263.0, 5579.0, 5302.0, 5644.0, 5443.0, 5343.0, 5672.0, 5470.0, 5377.0, 5710.0, 5546.0, 5694.0, 5445.0, 5326.0, 5521.0, 5480.0 (number of hits: 3)
21	5550	9	1	333	1	5358.0, 5689.0, 5428.0, 5498.0, 5503.0, 5709.0, 5430.0, 5314.0, 5636.0, 5588.0, 5713.0, 5541.0, 5653.0, 5360.0, 5638.0, 5532.0, 5694.0, 5582.0, 5317.0, 5696.0, 5325.0, 5676.0, 5427.0, 5292.0, 5398.0, 5456.0, 5434.0, 5661.0, 5445.0, 5299.0, 5413.0, 5591.0, 5457.0, 5460.0, 5509.0, 5361.0, 5602.0, 5268.0, 5610.0, 5628.0, 5553.0, 5407.0, 5550.0, 5514.0, 5548.0, 5393.0, 5267.0, 5705.0, 5278.0, 5305.0, 5683.0, 5648.0, 5594.0, 5306.0, 5378.0, 5433.0, 5555.0, 5586.0, 5608.0, 5589.0, 5578.0, 5616.0, 5411.0, 5680.0, 5260.0, 5576.0, 5585.0, 5294.0, 5269.0, 5570.0, 5349.0, 5376.0, 5265.0, 5339.0, 5538.0, 5264.0, 5693.0, 5619.0, 5583.0, 5310.0, 5706.0, 5282.0, 5691.0, 5557.0, 5340.0, 5436.0, 5559.0, 5488.0, 5384.0, 5362.0, 5620.0, 5562.0, 5668.0, 5544.0, 5315.0, 5695.0, 5365.0, 5346.0, 5497.0, 5312.0 (number of hits: 3)
22	5550	9	1	333	1	5484.0, 5524.0, 5687.0, 5627.0, 5509.0, 5721.0, 5491.0, 5258.0, 5620.0, 5328.0, 5478.0, 5528.0, 5617.0, 5339.0, 5396.0, 5485.0, 5318.0, 5315.0, 5353.0, 5373.0, 5615.0, 5471.0, 5268.0, 5539.0, 5718.0, 5596.0, 5545.0, 5271.0, 5454.0, 5723.0, 5511.0, 5705.0, 5274.0, 5544.0, 5449.0, 5408.0, 5638.0, 5263.0, 5302.0, 5451.0, 5341.0, 5257.0, 5453.0, 5410.0, 5570.0, 5413.0, 5590.0, 5344.0, 5542.0, 5369.0, 5578.0, 5532.0, 5338.0, 5393.0, 5326.0, 5558.0, 5403.0, 5640.0, 5441.0, 5667.0, 5387.0, 5713.0, 5322.0, 5278.0, 5404.0, 5467.0, 5548.0, 5426.0, 5643.0, 5560.0, 5671.0, 5520.0, 5618.0, 5706.0, 5604.0, 5355.0, 5550.0, 5681.0, 5673.0, 5697.0, 5540.0, 5605.0, 5580.0, 5397.0, 5464.0, 5255.0, 5568.0, 5594.0, 5423.0, 5455.0, 5622.0, 5601.0, 5392.0, 5708.0, 5499.0, 5585.0, 5301.0, 5424.0, 5266.0, 5692.0 (number of hits: 2)
23	5550	9	1	333	1	5571.0, 5602.0, 5255.0, 5447.0, 5419.0, 5324.0, 5351.0, 5713.0, 5337.0, 5613.0, 5417.0, 5507.0, 5718.0, 5521.0, 5618.0, 5335.0, 5498.0, 5506.0, 5563.0, 5721.0,

						5712.0, 5276.0, 5699.0, 5520.0, 5509.0, 5605.0, 5448.0, 5625.0, 5386.0, 5355.0, 5523.0, 5272.0, 5270.0, 5645.0, 5640.0, 5446.0, 5648.0, 5630.0, 5627.0, 5510.0, 5594.0, 5288.0, 5456.0, 5349.0, 5407.0, 5268.0, 5489.0, 5492.0, 5464.0, 5660.0, 5657.0, 5421.0, 5256.0, 5566.0, 5370.0, 5279.0, 5577.0, 5692.0, 5398.0, 5409.0, 5716.0, 5484.0, 5403.0, 5603.0, 5343.0, 5318.0, 5314.0, 5688.0, 5292.0, 5479.0, 5429.0, 5555.0, 5424.0, 5667.0, 5508.0, 5466.0, 5570.0, 5400.0, 5327.0, 5284.0, 5595.0, 5317.0, 5619.0, 5435.0, 5295.0, 5278.0, 5588.0, 5451.0, 5457.0, 5344.0, 5452.0, 5616.0, 5708.0, 5412.0, 5545.0, 5374.0, 5254.0, 5267.0, 5558.0, 5582.0 (number of hits: 5)
24	5550	9	1	333	1	5408.0, 5507.0, 5264.0, 5324.0, 5402.0, 5465.0, 5657.0, 5335.0, 5571.0, 5310.0, 5453.0, 5541.0, 5472.0, 5495.0, 5605.0, 5720.0, 5516.0, 5553.0, 5493.0, 5555.0, 5263.0, 5301.0, 5706.0, 5293.0, 5474.0, 5290.0, 5405.0, 5530.0, 5549.0, 5438.0, 5390.0, 5649.0, 5712.0, 5544.0, 5582.0, 5624.0, 5546.0, 5483.0, 5316.0, 5380.0, 5594.0, 5590.0, 5410.0, 5406.0, 5632.0, 5709.0, 5684.0, 5450.0, 5387.0, 5576.0, 5689.0, 5411.0, 5550.0, 5676.0, 5716.0, 5505.0, 5519.0, 5442.0, 5482.0, 5586.0, 5273.0, 5434.0, 5454.0, 5269.0, 5357.0, 5573.0, 5475.0, 5523.0, 5315.0, 5522.0, 5270.0, 5593.0, 5527.0, 5429.0, 5282.0, 5583.0, 5308.0, 5370.0, 5691.0, 5280.0, 5386.0, 5346.0, 5318.0, 5426.0, 5705.0, 5456.0, 5612.0, 5296.0, 5578.0, 5302.0, 5653.0, 5560.0, 5542.0, 5311.0, 5665.0, 5255.0, 5366.0, 5440.0, 5398.0, 5699.0 (number of hits: 4)
25	5550	9	1	333	1	5624.0, 5260.0, 5340.0, 5516.0, 5505.0, 5540.0, 5413.0, 5478.0, 5534.0, 5393.0, 5445.0, 5434.0, 5659.0, 5567.0, 5631.0, 5625.0, 5335.0, 5633.0, 5314.0, 5369.0, 5603.0, 5255.0, 5496.0, 5605.0, 5675.0, 5552.0, 5692.0, 5632.0, 5542.0, 5258.0, 5284.0, 5689.0, 5500.0, 5686.0, 5391.0, 5324.0, 5615.0, 5678.0, 5469.0, 5529.0, 5459.0, 5669.0, 5271.0, 5397.0, 5336.0, 5358.0, 5286.0, 5611.0, 5364.0, 5574.0, 5345.0, 5651.0, 5702.0, 5352.0, 5502.0, 5488.0, 5600.0, 5607.0, 5328.0, 5708.0, 5517.0, 5411.0, 5303.0, 5476.0, 5620.0, 5339.0, 5290.0, 5683.0, 5562.0, 5679.0, 5285.0, 5425.0, 5415.0, 5252.0, 5270.0, 5309.0, 5670.0, 5282.0, 5685.0, 5508.0, 5481.0, 5310.0, 5483.0, 5666.0, 5390.0, 5560.0, 5654.0, 5684.0, 5474.0, 5713.0, 5299.0, 5370.0, 5495.0, 5330.0, 5525.0, 5346.0, 5360.0, 5591.0, 5262.0, 5428.0 (number of hits: 6)

26	5550	9	1	333	1	<p>5446.0, 5532.0, 5256.0, 5649.0, 5383.0, 5481.0, 5612.0, 5543.0, 5409.0, 5283.0, 5253.0, 5698.0, 5477.0, 5697.0, 5347.0, 5306.0, 5664.0, 5573.0, 5258.0, 5271.0, 5572.0, 5515.0, 5286.0, 5677.0, 5289.0, 5510.0, 5701.0, 5393.0, 5472.0, 5583.0, 5384.0, 5678.0, 5630.0, 5642.0, 5574.0, 5653.0, 5706.0, 5491.0, 5499.0, 5556.0, 5404.0, 5353.0, 5707.0, 5672.0, 5480.0, 5270.0, 5540.0, 5710.0, 5693.0, 5322.0, 5576.0, 5456.0, 5355.0, 5368.0, 5464.0, 5493.0, 5463.0, 5375.0, 5483.0, 5597.0, 5589.0, 5658.0, 5316.0, 5667.0, 5400.0, 5357.0, 5605.0, 5265.0, 5705.0, 5577.0, 5387.0, 5280.0, 5508.0, 5474.0, 5676.0, 5257.0, 5389.0, 5304.0, 5536.0, 5625.0, 5329.0, 5406.0, 5643.0, 5599.0, 5461.0, 5262.0, 5663.0, 5592.0, 5680.0, 5457.0, 5713.0, 5692.0, 5327.0, 5675.0, 5628.0, 5538.0, 5645.0, 5388.0, 5448.0, 5432.0 (number of hits: 3)</p>
27	5550	9	1	333	1	<p>5445.0, 5664.0, 5396.0, 5502.0, 5399.0, 5719.0, 5414.0, 5539.0, 5611.0, 5724.0, 5301.0, 5720.0, 5452.0, 5354.0, 5372.0, 5553.0, 5456.0, 5560.0, 5534.0, 5374.0, 5442.0, 5297.0, 5628.0, 5455.0, 5474.0, 5603.0, 5588.0, 5311.0, 5403.0, 5674.0, 5267.0, 5600.0, 5420.0, 5341.0, 5391.0, 5520.0, 5478.0, 5598.0, 5302.0, 5583.0, 5678.0, 5683.0, 5510.0, 5363.0, 5390.0, 5669.0, 5658.0, 5631.0, 5371.0, 5434.0, 5343.0, 5312.0, 5616.0, 5531.0, 5617.0, 5512.0, 5378.0, 5593.0, 5710.0, 5294.0, 5271.0, 5304.0, 5318.0, 5323.0, 5338.0, 5282.0, 5485.0, 5477.0, 5522.0, 5592.0, 5676.0, 5262.0, 5677.0, 5352.0, 5467.0, 5594.0, 5554.0, 5313.0, 5533.0, 5416.0, 5265.0, 5409.0, 5307.0, 5693.0, 5283.0, 5430.0, 5427.0, 5380.0, 5305.0, 5429.0, 5526.0, 5326.0, 5618.0, 5568.0, 5322.0, 5335.0, 5481.0, 5599.0, 5486.0, 5587.0 (number of hits: 3)</p>
28	5550	9	1	333	1	<p>5305.0, 5511.0, 5453.0, 5647.0, 5334.0, 5605.0, 5633.0, 5415.0, 5275.0, 5503.0, 5507.0, 5671.0, 5571.0, 5369.0, 5628.0, 5635.0, 5437.0, 5460.0, 5420.0, 5353.0, 5541.0, 5719.0, 5409.0, 5519.0, 5454.0, 5489.0, 5459.0, 5251.0, 5682.0, 5492.0, 5579.0, 5261.0, 5439.0, 5638.0, 5367.0, 5590.0, 5442.0, 5256.0, 5588.0, 5665.0, 5390.0, 5326.0, 5476.0, 5495.0, 5491.0, 5463.0, 5324.0, 5434.0, 5673.0, 5604.0, 5309.0, 5318.0, 5406.0, 5677.0, 5451.0, 5700.0, 5710.0, 5304.0, 5394.0, 5640.0, 5422.0, 5691.0, 5408.0, 5362.0, 5291.0, 5366.0, 5255.0, 5343.0, 5696.0, 5575.0, 5600.0, 5432.0, 5607.0, 5609.0, 5664.0, 5694.0, 5560.0, 5551.0, 5522.0, 5283.0, 5282.0, 5661.0, 5341.0, 5704.0, 5610.0,</p>

						5586.0, 5301.0, 5538.0, 5479.0, 5399.0, 5407.0, 5335.0, 5583.0, 5668.0, 5567.0, 5319.0, 5466.0, 5412.0, 5544.0, 5257.0 (number of hits: 4)
29	5550	9	1	333	1	5668.0, 5475.0, 5261.0, 5651.0, 5467.0, 5624.0, 5370.0, 5429.0, 5337.0, 5373.0, 5547.0, 5413.0, 5667.0, 5375.0, 5490.0, 5328.0, 5376.0, 5489.0, 5494.0, 5482.0, 5652.0, 5502.0, 5690.0, 5588.0, 5607.0, 5716.0, 5511.0, 5415.0, 5420.0, 5407.0, 5628.0, 5486.0, 5440.0, 5677.0, 5633.0, 5636.0, 5432.0, 5252.0, 5661.0, 5627.0, 5354.0, 5271.0, 5647.0, 5637.0, 5292.0, 5516.0, 5305.0, 5634.0, 5615.0, 5672.0, 5289.0, 5393.0, 5254.0, 5293.0, 5417.0, 5353.0, 5644.0, 5331.0, 5518.0, 5592.0, 5364.0, 5572.0, 5425.0, 5491.0, 5700.0, 5556.0, 5443.0, 5603.0, 5355.0, 5266.0, 5631.0, 5699.0, 5625.0, 5304.0, 5267.0, 5434.0, 5460.0, 5693.0, 5555.0, 5437.0, 5257.0, 5506.0, 5358.0, 5659.0, 5272.0, 5270.0, 5310.0, 5558.0, 5570.0, 5452.0, 5461.0, 5314.0, 5519.0, 5418.0, 5342.0, 5471.0, 5300.0, 5269.0, 5399.0, 5617.0 (number of hits: 6)
30	5550	9	1	333	1	5310.0, 5718.0, 5697.0, 5444.0, 5406.0, 5544.0, 5667.0, 5251.0, 5326.0, 5254.0, 5286.0, 5405.0, 5630.0, 5352.0, 5273.0, 5533.0, 5395.0, 5349.0, 5519.0, 5700.0, 5669.0, 5264.0, 5291.0, 5567.0, 5427.0, 5550.0, 5309.0, 5382.0, 5597.0, 5661.0, 5321.0, 5285.0, 5495.0, 5292.0, 5584.0, 5306.0, 5336.0, 5561.0, 5604.0, 5491.0, 5672.0, 5329.0, 5320.0, 5607.0, 5686.0, 5255.0, 5287.0, 5460.0, 5418.0, 5639.0, 5390.0, 5429.0, 5687.0, 5341.0, 5379.0, 5261.0, 5506.0, 5348.0, 5541.0, 5629.0, 5605.0, 5494.0, 5601.0, 5270.0, 5266.0, 5710.0, 5324.0, 5403.0, 5426.0, 5323.0, 5419.0, 5400.0, 5257.0, 5709.0, 5364.0, 5299.0, 5606.0, 5308.0, 5720.0, 5293.0, 5297.0, 5619.0, 5696.0, 5603.0, 5616.0, 5361.0, 5716.0, 5610.0, 5681.0, 5623.0, 5376.0, 5683.0, 5480.0, 5564.0, 5250.0, 5439.0, 5707.0, 5425.0, 5582.0, 5546.0 (number of hits: 2)

5530 MHz, 80 MHz Bandwidth

Radar Signal Type	Waveform/Trial Number	Detection (%)	Limit (%)	Pass/Fail
Type 1A/1B	30	100 %	60%	Pass
Type 2	30	100 %	60%	Pass
Type 3	30	100 %	60%	Pass
Type 4	30	100 %	60%	Pass
Aggregate (Type1 to 4)	120	100 %	80%	Pass
Type 5	30	90 %	80%	Pass
Type 6	30	100 %	70%	Pass

Please refer to the following statistical tables:

5290 MHz, 80 MHz Bandwidth

Table-1A/1B Radar Type 1A/1B Statistical Performance

Trial #	Fc (MHz)	Pulse/Burst	Pulse Width (μS)	PRI (μs)	Detection (1:yes; 0:no)
1	5530	63	1	838	1
2	5530	76	1	698	1
3	5530	78	1	678	1
4	5530	57	1	938	1
5	5530	59	1	898	1
6	5530	86	1	618	1
7	5530	95	1	558	1
8	5530	62	1	858	1
9	5530	68	1	778	1
10	5530	72	1	738	1
11	5530	99	1	538	1
12	5530	81	1	658	1
13	5530	67	1	798	1
14	5530	61	1	878	1
15	5530	70	1	758	1
16	5530	37	1	1432	1
17	5530	29	1	1876	1
18	5530	71	1	753	1
19	5530	73	1	727	1
20	5530	22	1	2400	1
21	5530	23	1	2349	1
22	5530	45	1	1175	1
23	5530	26	1	2086	1
24	5530	37	1	1466	1
25	5530	26	1	2107	1
26	5530	24	1	2232	1
27	5530	58	1	923	1
28	5530	27	1	1959	1
29	5530	23	1	2388	1
30	5530	46	1	1149	1
Detection Percentage: 100 % (>60%)					

Table-2 Radar Type 2 Statistical Performance

Trial #	Fc (MHz)	Pulse/Burst	Pulse Width (μS)	PRI (μs)	Detection (1:yes; 0:no)
1	5530	28	3.1	218	1
2	5530	26	3.2	217	1
3	5530	29	2.6	169	1
4	5530	23	3.1	228	1
5	5530	25	2.4	190	1
6	5530	27	4.1	205	1
7	5530	25	3.9	188	1
8	5530	23	4.8	188	1
9	5530	23	3.1	183	1
10	5530	25	5	152	1
11	5530	24	2	160	1
12	5530	23	2.8	222	1
13	5530	25	2.7	186	1
14	5530	29	1.3	225	1
15	5530	29	1.8	210	1
16	5530	29	3.4	214	1
17	5530	26	4	159	1
18	5530	28	4	217	1
19	5530	25	1.5	153	1
20	5530	23	1.9	152	1
21	5530	26	2.3	164	1
22	5530	26	3.2	160	1
23	5530	23	1.8	166	1
24	5530	24	4	212	1
25	5530	27	3.2	179	1
26	5530	28	1.8	162	1
27	5530	24	4	220	1
28	5530	27	3.8	179	1
29	5530	27	1.4	187	1
30	5530	27	1.9	201	1
Detection Percentage: 100 % (>60%)					

Table-3 Radar Type 3 Statistical Performance

Trial #	Fc (MHz)	Pulse/Burst	Pulse Width (μS)	PRI (μs)	Detection (1:yes; 0:no)
1	5530	16	9.4	391	1
2	5530	16	7.2	433	1
3	5530	18	8.6	414	1
4	5530	17	9.3	385	1
5	5530	18	9.6	205	1
6	5530	17	6	226	1
7	5530	17	7.3	471	1
8	5530	17	9.7	244	1
9	5530	18	8.3	351	1
10	5530	18	7.9	240	1
11	5530	18	6.8	316	1
12	5530	18	8.2	239	1
13	5530	17	7.6	393	1
14	5530	17	6	399	1
15	5530	16	9.9	355	1
16	5530	17	6.7	365	1
17	5530	18	7.3	234	1
18	5530	17	7.3	462	1
19	5530	16	7.9	434	1
20	5530	16	8.4	427	1
21	5530	16	7.3	297	1
22	5530	18	9.7	245	1
23	5530	18	7.2	427	1
24	5530	18	6.7	405	1
25	5530	16	6.9	279	1
26	5530	17	7.2	291	1
27	5530	16	10	340	1
28	5530	16	7.1	391	1
29	5530	17	9.1	472	1
30	5530	18	8.3	420	1
Detection Percentage: 100 % (>60%)					

Table-4 Radar Type 4 Statistical Performance

Trial #	Fc (MHz)	Pulse/Burst	Pulse Width (μS)	PRI (μs)	Detection (1:yes; 0:no)
1	5530	12	11.2	236	1
2	5530	13	19.4	438	1
3	5530	15	15.6	389	1
4	5530	12	19.6	226	1
5	5530	15	13.1	272	1
6	5530	16	16.3	428	1
7	5530	13	16.1	345	1
8	5530	16	12.7	496	1
9	5530	15	13.2	438	1
10	5530	14	18.9	464	1
11	5530	12	17.5	339	1
12	5530	15	12.2	307	1
13	5530	16	19.8	483	1
14	5530	15	12.1	317	1
15	5530	14	17.6	221	1
16	5530	13	17.1	330	1
17	5530	16	18.1	460	1
18	5530	16	12	470	1
19	5530	12	18.9	428	1
20	5530	15	13.3	258	1
21	5530	13	12	386	1
22	5530	15	14.2	312	1
23	5530	13	11.1	294	1
24	5530	13	18.4	464	1
25	5530	13	14.9	211	1
26	5530	15	16.7	268	1
27	5530	15	15.5	372	1
28	5530	12	16.4	336	1
29	5530	12	17.9	379	1
30	5530	14	19.2	304	1
Detection Percentage: 100 % (>60%)					

Table-5 Radar Type 5 Statistical Performance

Trial #	Fc (MHz)	Detection (1:yes; 0:no)
1	5530	1
2	5530	1
3	5530	1
4	5530	1
5	5530	1
6	5530	1
7	5530	1
8	5530	1
9	5530	1
10	5530	1
11	5497.8	1
12	5495	1
13	5494.6	0
14	5498.6	1
15	5495	1
16	5498.6	0
17	5495.4	1
18	5497.4	1
19	5496.2	1
20	5495	0
21	5561.4	1
22	5565.8	1
23	5563	1
24	5561.8	1
25	5562.6	1
26	5565	1
27	5567	1
28	5566.6	1
29	5563	1
30	5566.2	1
Detection Percentage: 90 % (>80%)		

Bin5 Statistics 1

Trial #	Pulse	Chirp (MHz)	Pulse Width (µS)	Pulse 1-2 spacing (µS)	Pulse 2-3 spacing (µS)	Pulse Start(S)	Detection (1:yes; 0:no)
0	1	17	79.6			1.020184	1
1	1	17	94.5			1.845772	
2	2	17	53.1	1964		3.264841	
3	2	17	69.4	1155		3.426382	
4	2	17	57.6	1198		4.851406	
5	2	17	60.4	1498		5.580431	
6	1	17	51.7			7.567503	
7	2	17	87.3	1319		8.037551	
8	1	17	51.7			9.645296	
9	1	17	51.5			9.876283	
10	1	17	90			11.013006	

Bin5 Statistics 2

Trial #	Pulse	Chirp (MHz)	Pulse Width (µS)	Pulse 1-2 spacing (µS)	Pulse 2-3 spacing (µS)	Pulse Start(S)	Detection (1:yes; 0:no)
0	3	8	84.7	1985	1305	0.488375	1
1	1	8	76.2			1.694275	
2	3	8	96.5	1795	1356	2.476762	
3	2	8	71.3	1493		3.025574	
4	2	8	78.5	1093		4.86564	
5	2	8	65.5	1935		5.11129	
6	3	8	99.7	1358	1127	6.948394	
7	2	8	63.1	1156		7.517997	
8	1	8	66.4			8.035677	
9	2	8	54.1	1397		9.017658	
10	2	8	94.9	1299		10.095209	
11	3	8	83.4	1565	1788	11.338909	

Bin5 Statistics 3

Trial #	Pulse	Chirp (MHz)	Pulse Width (µS)	Pulse 1-2 spacing (µS)	Pulse 2-3 spacing (µS)	Pulse Start(S)	Detection (1:yes; 0:no)
0	1	15	57.6			0.359881	1
1	1	15	87.8			0.904734	
2	2	15	79.9	1698		1.842393	
3	2	15	88.7	1661		1.905921	
4	2	15	83.8	1414		2.785915	
5	2	15	92.9	1167		3.450573	
6	3	15	81.9	1114	1260	3.872609	
7	1	15	58.4			4.995878	
8	2	15	76.7	1311		5.671099	
9	2	15	99.5	1226		6.128236	
10	2	15	76.2	1472		6.509182	
11	1	15	99.6			7.230841	
12	3	15	85	1561	1484	7.957833	
13	2	15	98.4	1324		8.474298	
14	1	15	54.7			8.895497	
15	2	15	91.5	1277		9.757574	
16	2	15	73.7	1370		10.280916	
17	3	15	92.5	1294	1164	11.271657	
18	2	15	50.6	1892		11.949799	

Bin5 Statistics 4

Trial #	Pulse	Chirp (MHz)	Pulse Width (µS)	Pulse 1-2 spacing (µS)	Pulse 2-3 spacing (µS)	Pulse Start(S)	Detection (1:yes; 0:no)
0	2	7	99.8	1251		0.173596	1
1	2	7	89	1300		1.71595	
2	2	7	82	1873		2.447074	
3	2	7	96.6	1131		3.570642	
4	3	7	54.6	1413	1099	4.843299	
5	2	7	71.7	1359		6.509343	
6	3	7	89.6	1403	1104	6.70345	
7	1	7	60.3			8.137694	
8	1	7	50.5			8.738692	
9	3	7	69.6	1315	1632	10.602937	
10	1	7	54.9			11.575135	

Bin5 Statistics 5

Trial #	Pulse	Chirp (MHz)	Pulse Width (µS)	Pulse 1-2 spacing (uS)	Pulse 2-3 spacing (uS)	Pulse Start(S)	Detection (1:yes; 0:no)
0	1	7	79.7			0.03617	1
1	2	7	94.7	1511		0.998508	
2	3	7	80.2	1468	1972	1.421083	
3	3	7	68.8	1285	1702	2.111372	
4	1	7	76.1			3.019805	
5	2	7	59.7	1857		3.647457	
6	2	7	84.3	1954		4.086272	
7	2	7	77.3	1106		4.852046	
8	3	7	86.3	1267	1812	5.128279	
9	3	7	72.4	1997	1357	6.205023	
10	1	7	69			6.867119	
11	3	7	82.2	1678	1556	7.191511	
12	2	7	66	1648		7.821291	
13	2	7	69.5	1800		8.663473	
14	1	7	78.8			9.403105	
15	3	7	96.6	1247	1804	10.087229	
16	1	7	71.8			10.303557	
17	2	7	57.7	1528		11.191822	
18	2	7	72.3	1458		11.903799	

Bin5 Statistics 6

Trial #	Pulse	Chirp (MHz)	Pulse Width (µS)	Pulse 1-2 spacing (uS)	Pulse 2-3 spacing (uS)	Pulse Start(S)	Detection (1:yes; 0:no)
0	2	16	54.4	1263		1.050512	1
1	2	16	80.2	1031		1.937957	
2	3	16	67.7	1596	1203	2.576231	
3	2	16	64.4	1436		4.389712	
4	3	16	76	1582	1687	5.161862	
5	3	16	96.8	1089	1935	6.425535	
6	1	16	80.6			7.798495	
7	2	16	95.3	1813		9.410891	
8	3	16	66.7	1472	1621	10.050183	
9	2	16	83.4	1247		10.992648	

Bin5 Statistics 7

Trial #	Pulse	Chirp (MHz)	Pulse Width (µS)	Pulse 1-2 spacing (uS)	Pulse 2-3 spacing (uS)	Pulse Start(S)	Detection (1:yes; 0:no)
0	2	12	86.5	1820		0.6602	1
1	1	12	57.5			0.879484	
2	1	12	88.9			1.896366	
3	2	12	86.8	1568		2.076242	
4	3	12	87.3	1279	1179	3.036293	
5	1	12	72			3.504359	
6	2	12	65.7	1212		4.095508	
7	1	12	62.3			4.817755	
8	2	12	83.9	1249		5.342644	
9	2	12	88.5	1368		6.090129	
10	1	12	65.6			7.226679	
11	2	12	70.4	1647		7.409518	
12	3	12	60.6	1235	1065	8.08666	
13	2	12	65.4	1488		9.20144	
14	1	12	84.2			9.542215	
15	1	12	99			10.141745	
16	3	12	65.3	1871	1673	10.888049	
17	2	12	54.3	1596		11.92996	

Bin5 Statistics 8

Trial #	Pulse	Chirp (MHz)	Pulse Width (µS)	Pulse 1-2 spacing (uS)	Pulse 2-3 spacing (uS)	Pulse Start(S)	Detection (1:yes; 0:no)
0	2	12	59.1	1082		1.246618	1
1	2	12	86.5	1784		1.364223	
2	3	12	96.3	1818	1240	3.02672	
3	3	12	54.3	1988	1490	4.789366	
4	3	12	88.6	1337	1334	5.688742	
5	2	12	97.8	1284		7.980758	
6	1	12	74.5			8.274964	
7	1	12	79.2			10.08333	
8	2	12	85.1	1247		11.536293	

Bin5 Statistics 9

Trial #	Pulse	Chirp (MHz)	Pulse Width (µS)	Pulse 1-2 spacing (µS)	Pulse 2-3 spacing (µS)	Pulse Start(S)	Detection (1:yes; 0:no)
0	2	16	66.8	1380		0.89481	1
1	1	16	57.4			1.627075	
2	3	16	82.6	1667	1008	2.545572	
3	3	16	77.2	1359	1885	3.679244	
4	1	16	88.7			4.92539	
5	2	16	74.3	1157		5.552081	
6	2	16	65.2	1526		6.003376	
7	2	16	98.8	1524		7.873946	
8	1	16	92.2			8.724357	
9	3	16	97.9	1884	1851	9.120305	
10	2	16	88.2	1738		10.870148	
11	2	16	95.5	1564		11.450218	

Bin5 Statistics 10

Trial #	Pulse	Chirp (MHz)	Pulse Width (µS)	Pulse 1-2 spacing (µS)	Pulse 2-3 spacing (µS)	Pulse Start(S)	Detection (1:yes; 0:no)
0	3	6	92.4	1195	1426	0.639314	1
1	2	6	55.5	1783		2.020185	
2	1	6	53.2			2.42885	
3	1	6	62.1			4.180449	
4	2	6	52.8	1700		5.125755	
5	2	6	58.6	1948		6.262347	
6	1	6	53			7.456889	
7	1	6	74			8.661363	
8	1	6	60			10.289032	
9	2	6	95.4	1388		11.283848	

Bin5 Statistics 11

Trial #	Pulse	Chirp (MHz)	Pulse Width (µS)	Pulse 1-2 spacing (µS)	Pulse 2-3 spacing (µS)	Pulse Start(S)	Detection (1:yes; 0:no)
0	3	17	89.1	1297	1798	0.615807	1
1	3	17	89.8	1485	1597	0.683431	
2	1	17	57			1.581258	
3	2	17	97.7	1136		2.639843	
4	2	17	66.8	1335		2.814106	
5	1	17	76.3			3.612381	
6	1	17	94.8			4.075632	
7	3	17	55.8	1565	1334	5.092475	
8	2	17	61.5	1261		5.470841	
9	2	17	67.4	1098		6.636908	
10	3	17	78.4	1246	1981	7.221672	
11	2	17	66.9	1172		7.393664	
12	2	17	64.1	1441		8.608534	
13	3	17	98.8	1184	1289	9.097363	
14	3	17	77.9	1950	1911	9.489552	
15	1	17	80.4			10.107848	
16	1	17	96.4			11.127371	
17	1	17	89.7			11.453604	

Bin5 Statistics 12

Trial #	Pulse	Chirp (MHz)	Pulse Width (µS)	Pulse 1-2 spacing (µS)	Pulse 2-3 spacing (µS)	Pulse Start(S)	Detection (1:yes; 0:no)
0	3	10	96.2	1799	1439	0.312016	1
1	2	10	69.6	1359		0.758177	
2	3	10	80.3	1485	1070	1.661513	
3	3	10	62.6	1343	1500	2.315579	
4	3	10	71.5	1702	1090	2.949217	
5	3	10	50.1	1665	1636	3.206723	
6	2	10	71.6	1466		3.966361	
7	2	10	50.9	1372		4.928158	
8	3	10	87.3	1430	1473	5.345698	
9	3	10	89.8	1636	1014	5.950832	
10	2	10	54.7	1904		6.760698	
11	3	10	67.1	1960	1798	7.434036	
12	3	10	72.1	1783	1251	7.92044	
13	2	10	78.9	1122		8.435221	
14	1	10	73.3			9.214902	
15	3	10	63.9	1371	1397	9.569608	
16	1	10	87			10.462631	
17	2	10	62.7	1324		10.860129	
18	2	10	73.9	1312		11.749689	

Bin5 Statistics 13

Trial #	Pulse	Chirp (MHz)	Pulse Width (µS)	Pulse 1-2 spacing (µS)	Pulse 2-3 spacing (µS)	Pulse Start(S)	Detection (1:yes; 0:no)
0	2	9	71	1324		0.328685	0
1	1	9	57.5			1.678693	
2	2	9	62.5	1120		2.227144	
3	2	9	51.7	1448		2.632954	
4	1	9	82			4.023695	
5	2	9	92.2	1290		4.546533	
6	2	9	50.4	1588		5.985057	
7	1	9	90.7			6.495666	
8	2	9	52.2	1552		7.042418	
9	1	9	91.6			8.142801	
10	2	9	93.7	1446		9.342238	
11	3	9	98.9	1665	1612	9.914395	
12	2	9	66.2	1660		10.92044	
13	2	9	69.5	1487		11.262119	

Bin5 Statistics 14

Trial #	Pulse	Chirp (MHz)	Pulse Width (µS)	Pulse 1-2 spacing (µS)	Pulse 2-3 spacing (µS)	Pulse Start(S)	Detection (1:yes; 0:no)
0	2	19	94.8	1375		0.234291	1
1	2	19	80.6	1839		1.383207	
2	1	19	61.7			1.966946	
3	1	19	96.5			2.825604	
4	3	19	96.4	1470	1820	3.249779	
5	1	19	57.8			3.751978	
6	1	19	76.5			5.05004	
7	2	19	74	1324		5.425569	
8	2	19	61.6	1931		6.376977	
9	1	19	89.6			6.770969	
10	2	19	76.1	1818		7.764396	
11	3	19	93	1537	1935	8.595244	
12	2	19	97.9	1926		9.505641	
13	3	19	50.7	1726	1191	10.057052	
14	2	19	61.5	1263		10.553723	
15	2	19	62.4	1846		11.783958	

Bin5 Statistics 15

Trial #	Pulse	Chirp (MHz)	Pulse Width (µS)	Pulse 1-2 spacing (µS)	Pulse 2-3 spacing (µS)	Pulse Start(S)	Detection (1:yes; 0:no)
0	2	10	81.2	1777		0.233766	1
1	2	10	98.6	1834		0.915963	
2	1	10	89.9			1.380344	
3	1	10	98.2			2.200486	
4	3	10	69	1381	1937	2.621695	
5	2	10	92.6	1012		3.48564	
6	3	10	87.3	1626	1154	4.154222	
7	3	10	54.5	1230	1559	4.98532	
8	3	10	65.9	1098	1314	5.610417	
9	1	10	83.6			6.119882	
10	2	10	87.9	1578		6.449118	
11	3	10	78.7	1439	1558	7.129372	
12	1	10	95.2			8.099635	
13	1	10	52.3			8.421073	
14	2	10	97	1706		9.405464	
15	1	10	60.5			10.00156	
16	1	10	55.4			10.35669	
17	3	10	56.3	1012	1352	10.90691	
18	2	10	77.2	1690		11.37701	

Bin5 Statistics 16

Trial #	Pulse	Chirp (MHz)	Pulse Width (µS)	Pulse 1-2 spacing (µS)	Pulse 2-3 spacing (µS)	Pulse Start(S)	Detection (1:yes; 0:no)
0	2	19	71.4	1194		0.594756	0
1	3	19	67.6	1696	1866	1.421483	
2	1	19	66			2.513142	
3	3	19	71.1	1679	1148	3.128479	
4	1	19	79.5			4.707014	
5	3	19	52	1570	1995	5.156734	
6	3	19	89.1	1391	1860	6.371311	
7	2	19	89.6	1828		7.54631	
8	2	19	76.9	1301		8.132432	
9	1	19	72.2			9.552767	
10	2	19	57.5	1579		10.977558	
11	3	19	74.6	1786	1691	11.526834	

Bin5 Statistics 17

Trial #	Pulse	Chirp (MHz)	Pulse Width (µS)	Pulse 1-2 spacing (µS)	Pulse 2-3 spacing (µS)	Pulse Start(S)	Detection (1:yes; 0:no)
0	2	11	64.6	1150		0.95814	1
1	1	11	52.7			1.730506	
2	2	11	71.1	1508		2.862579	
3	3	11	57.2	1854	1256	5.148728	
4	2	11	94	1416		5.92923	
5	1	11	93.5			6.693038	
6	2	11	54.9	1080		9.180562	
7	2	11	91.3	1068		10.62376	
8	2	11	90.4	1349		10.955	

Bin5 Statistics 18

Trial #	Pulse	Chirp (MHz)	Pulse Width (µS)	Pulse 1-2 spacing (µS)	Pulse 2-3 spacing (µS)	Pulse Start(S)	Detection (1:yes; 0:no)
0	1	16	84.7			0.448799	1
1	2	16	70	1950		1.14359	
2	2	16	98.9	1729		1.503607	
3	2	16	81.7	1184		2.412197	
4	1	16	74.8			3.444258	
5	1	16	51.6			3.87481	
6	2	16	83.6	1614		4.317252	
7	2	16	87	1615		5.220717	
8	2	16	53.8	1739		5.669916	
9	1	16	90.4			6.597717	
10	1	16	71.3			7.133294	
11	2	16	54.5	1160		8.140456	
12	1	16	74.6			8.609465	
13	2	16	70.3	1135		9.426282	
14	2	16	69.7	1391		9.902001	
15	1	16	70.1			10.743444	
16	1	16	98.7			11.747201	

Bin5 Statistics 19

Trial #	Pulse	Chirp (MHz)	Pulse Width (µS)	Pulse 1-2 spacing (µS)	Pulse 2-3 spacing (µS)	Pulse Start(S)	Detection (1:yes; 0:no)
0	1	13	79.6			0.025202	1
1	1	13	88.9			0.911448	
2	2	13	60.3	1233		1.6158	
3	3	13	94.3	1012	1683	2.646215	
4	3	13	99.9	1185	1800	3.447888	
5	3	13	75.3	1797	1842	3.72928	
6	2	13	66.6	1334		4.734487	
7	1	13	50.1			5.528944	
8	2	13	61.6	1970		5.731945	
9	2	13	86.1	1550		6.775081	
10	2	13	82.1	1010		7.462325	
11	2	13	83.2	1435		7.798441	
12	2	13	96.5	1638		9.0243	
13	3	13	71.2	1765	1076	9.532801	
14	2	13	60.5	1250		9.901829	
15	2	13	97.2	1794		11.00174	
16	1	13	51.1			11.88783	

Bin5 Statistics 20

Trial #	Pulse	Chirp (MHz)	Pulse Width (µS)	Pulse 1-2 spacing (µS)	Pulse 2-3 spacing (µS)	Pulse Start(S)	Detection (1:yes; 0:no)
0	3	10	71.6	1142	1585	0.598061	0
1	1	10	83			0.916062	
2	2	10	53.5	1186		1.950459	
3	2	10	97.8	1531		2.458038	
4	2	10	93.9	1296		3.141467	
5	2	10	72.6	1641		3.89782	
6	2	10	89.6	1070		5.111174	
7	1	10	69.3			5.918075	
8	3	10	57.1	1093	1587	6.544697	
9	3	10	76.2	1245	1540	7.042264	
10	3	10	71.4	1575	1955	7.862913	
11	1	10	98.5			8.723688	
12	3	10	57.1	1970	1862	9.562736	
13	2	10	91	1092		10.104828	
14	3	10	80.1	1588	1223	10.83951	
15	1	10	87.2			11.691811	

Bin5 Statistics 21

Trial #	Pulse	Chirp (MHz)	Pulse Width (µS)	Pulse 1-2 spacing (uS)	Pulse 2-3 spacing (uS)	Pulse Start(S)	Detection (1:yes; 0:no)
0	2	19	79	1910		0.227435	1
1	2	19	65.4	1393		0.868887	
2	2	19	80.5	1034		2.152113	
3	3	19	58.8	1086	1333	2.874592	
4	2	19	90.8	1727		3.729799	
5	1	19	87.3			4.325508	
6	3	19	95.7	1404	1443	5.052865	
7	2	19	81.3	1050		6.192137	
8	2	19	89.2	1348		6.762606	
9	1	19	74.6			7.838821	
10	3	19	90.9	1572	1358	8.039243	
11	2	19	52.7	1383		8.858931	
12	3	19	69.2	1429	1059	10.158218	
13	3	19	88.3	1136	1060	10.749719	
14	1	19	74.2			11.848535	

Bin5 Statistics 22

Trial #	Pulse	Chirp (MHz)	Pulse Width (µS)	Pulse 1-2 spacing (uS)	Pulse 2-3 spacing (uS)	Pulse Start(S)	Detection (1:yes; 0:no)
0	3	8	87.6	1646	1718	0.036329	1
1	2	8	83.4	2000		1.033625	
2	2	8	96.1	1706		1.675595	
3	1	8	69.7			2.162622	
4	2	8	83.6	1327		2.948534	
5	2	8	69	1679		3.710292	
6	3	8	97.7	1572	1039	4.852929	
7	2	8	86.3	1418		5.490379	
8	3	8	53.4	1504	1951	5.772876	
9	2	8	85.6	1731		6.539263	
10	1	8	72.5			7.187284	
11	1	8	72.8			7.861148	
12	2	8	86.4	1343		8.50278	
13	2	8	68.3	1118		9.805902	
14	2	8	93.8	1976		10.50068	
15	2	8	64.9	1722		11.10109	
16	1	8	66.7			11.68294	

Bin5 Statistics 23

Trial #	Pulse	Chirp (MHz)	Pulse Width (µS)	Pulse 1-2 spacing (uS)	Pulse 2-3 spacing (uS)	Pulse Start(S)	Detection (1:yes; 0:no)
0	1	15	61.3			0.534768	1
1	3	15	53.1	1047	1052	1.039545	
2	2	15	91.8	1249		2.661993	
3	1	15	90.6			3.770001	
4	2	15	91.1	1885		4.303693	
5	2	15	79.7	1410		5.519975	
6	2	15	66.4	1943		6.761859	
7	2	15	83.5	1998		7.837206	
8	1	15	84.9			8.85322	
9	2	15	99.4	1302		9.245699	
10	2	15	99.1	1609		10.36392	
11	2	15	56	1433		11.26309	

Bin5 Statistics 24

Trial #	Pulse	Chirp (MHz)	Pulse Width (µS)	Pulse 1-2 spacing (uS)	Pulse 2-3 spacing (uS)	Pulse Start(S)	Detection (1:yes; 0:no)
0	2	18	74.8	1771		0.144682	1
1	3	18	98.9	1146	1809	1.139033	
2	2	18	88.4	1072		1.936948	
3	3	18	78.6	1686	1647	2.498508	
4	2	18	50.7	1588		3.237682	
5	1	18	90			4.032158	
6	2	18	68.1	1645		5.170727	
7	2	18	81.5	1624		5.848895	
8	2	18	71.5	1154		6.765235	
9	2	18	73.2	1674		7.86923	
10	3	18	60.9	1229	1294	8.402038	
11	2	18	74	1808		9.359428	
12	3	18	96.1	1010	1636	10.198627	
13	2	18	69.5	1018		10.964481	
14	2	18	70.3	1104		11.38027	

Bin5 Statistics 25

Trial #	Pulse	Chirp (MHz)	Pulse Width (µS)	Pulse 1-2 spacing (uS)	Pulse 2-3 spacing (uS)	Pulse Start(S)	Detection (1:yes; 0:no)
0	1	16	50.3			1.307499	1
1	2	16	71.1	1547		2.482109	
2	2	16	96.4	1064		3.745915	
3	3	16	74.6	1045	1652	4.424683	
4	2	16	74.8	1325		5.451946	
5	2	16	51.2	1196		6.836395	
6	2	16	75	1392		8.617207	
7	2	16	77.1	1844		10.11466	
8	2	16	54.7	1019		11.98461	

Bin5 Statistics 26

Trial #	Pulse	Chirp (MHz)	Pulse Width (µS)	Pulse 1-2 spacing (uS)	Pulse 2-3 spacing (uS)	Pulse Start(S)	Detection (1:yes; 0:no)
0	1	10	89.4			0.405745	1
1	3	10	91.6	1041	1357	1.144938	
2	3	10	97.7	1192	1909	1.878834	
3	3	10	50.6	1719	1151	3.029102	
4	2	10	65	1537		3.833026	
5	2	10	52.7	1035		5.133634	
6	3	10	64.3	1206	1387	5.344495	
7	2	10	99.5	1227		6.591082	
8	3	10	95.5	1419	1034	7.043041	
9	3	10	68.3	1522	1802	7.934144	
10	3	10	85.8	1288	1815	9.076462	
11	1	10	99.8			9.611522	
12	3	10	80.9	1464	1744	11.03231	
13	2	10	68.9	1381		11.368	

Bin5 Statistics 27

Trial #	Pulse	Chirp (MHz)	Pulse Width (µS)	Pulse 1-2 spacing (uS)	Pulse 2-3 spacing (uS)	Pulse Start(S)	Detection (1:yes; 0:no)
0	2	5	71.3	1525		0.712141	1
1	2	5	78.1	1605		1.813376	
2	2	5	82.3	1012		3.493235	
3	3	5	51.7	1610	1932	4.464565	
4	3	5	73.5	1277	1500	5.493879	
5	2	5	61.2	1452		7.351178	
6	2	5	76	1532		8.855152	
7	2	5	50.3	1229		9.5692	
8	3	5	86.6	1545	1712	11.31207	

Bin5 Statistics 28

Trial #	Pulse	Chirp (MHz)	Pulse Width (µS)	Pulse 1-2 spacing (uS)	Pulse 2-3 spacing (uS)	Pulse Start(S)	Detection (1:yes; 0:no)
0	3	6	79	1660	1897	0.228137	1
1	2	6	86	1392		2.307946	
2	3	6	74.9	1805	1720	3.312712	
3	3	6	88.5	1598	1384	5.492077	
4	3	6	88.1	1094	1361	7.281535	
5	2	6	81.9	1475		7.825054	
6	3	6	70	1188	1114	9.286314	
7	2	6	77.8	1558		10.721985	

Bin5 Statistics 29

Trial #	Pulse	Chirp (MHz)	Pulse Width (µS)	Pulse 1-2 spacing (µS)	Pulse 2-3 spacing (µS)	Pulse Start(S)	Detection (1:yes; 0:no)
0	2	15	57.1	1640		0.045894	1
1	3	15	65	1306	1230	1.948847	
2	1	15	84.6			2.930772	
3	3	15	96.8	1602	1523	3.488318	
4	2	15	56.3	1983		4.741826	
5	1	15	76.7			6.135553	
6	3	15	69	1125	1289	6.76271	
7	2	15	53.6	1502		8.575691	
8	3	15	93.4	1593	1676	8.834857	
9	1	15	54			10.87113	
10	3	15	64.6	1489	1812	10.98707	

Bin5 Statistics 30

Trial #	Pulse	Chirp (MHz)	Pulse Width (µS)	Pulse 1-2 spacing (µS)	Pulse 2-3 spacing (µS)	Pulse Start(S)	Detection (1:yes; 0:no)
0	2	7	89.6	1536		0.744891	1
1	3	7	91.1	1255	1130	1.242632	
2	1	7	91.7			2.343806	
3	1	7	80.2			2.720216	
4	2	7	74.8	1114		3.769712	
5	2	7	87.4	1248		4.658853	
6	2	7	55.5	1335		5.63496	
7	3	7	88.6	1200	1217	6.031833	
8	1	7	50.8			6.93369	
9	2	7	90.1	1268		8.045439	
10	3	7	57.5	1604	1851	8.61266	
11	1	7	52.2			10.02782	
12	2	7	95.1	1044		11.08198	
13	3	7	80.9	1886	1681	11.5611	

Table-6 Radar Type 6 Statistical Performance

Trial #	Fc (MHz)	Pulse /Burst	Pulse Width (µS)	PRI (µs)	Detection (1:yes; 0:no)	Hopping Sequence
1	5530	9	1	333	1	5448.0, 5531.0, 5251.0, 5393.0, 5685.0, 5577.0, 5658.0, 5348.0, 5398.0, 5449.0, 5596.0, 5567.0, 5346.0, 5390.0, 5635.0, 5314.0, 5454.0, 5680.0, 5573.0, 5333.0, 5485.0, 5461.0, 5456.0, 5279.0, 5418.0, 5642.0, 5627.0, 5717.0, 5400.0, 5285.0, 5690.0, 5268.0, 5652.0, 5720.0, 5636.0, 5688.0, 5616.0, 5599.0, 5260.0, 5483.0, 5499.0, 5665.0, 5701.0, 5396.0, 5588.0, 5702.0, 5266.0, 5374.0, 5281.0, 5320.0, 5300.0, 5549.0, 5601.0, 5645.0, 5476.0, 5352.0, 5661.0, 5439.0, 5673.0, 5666.0, 5472.0, 5674.0, 5397.0, 5623.0, 5267.0, 5565.0, 5541.0, 5408.0, 5705.0, 5634.0, 5431.0, 5586.0, 5611.0, 5332.0, 5619.0, 5310.0, 5378.0, 5264.0, 5392.0, 5657.0, 5271.0, 5497.0, 5668.0, 5643.0, 5686.0, 5451.0, 5654.0, 5715.0, 5687.0, 5298.0, 5455.0, 5625.0, 5675.0, 5648.0, 5399.0, 5421.0, 5653.0, 5707.0, 5275.0, 5345.0 (number of hits: 5)
2	5530	9	1	333	1	5691.0, 5459.0, 5418.0, 5595.0, 5558.0, 5375.0, 5438.0, 5315.0, 5553.0, 5275.0, 5264.0, 5466.0, 5412.0, 5493.0, 5332.0, 5427.0, 5649.0, 5571.0, 5568.0, 5326.0, 5529.0, 5385.0, 5393.0, 5267.0, 5423.0, 5261.0, 5285.0, 5606.0, 5387.0, 5331.0, 5668.0, 5279.0, 5383.0, 5678.0, 5695.0, 5365.0, 5413.0, 5344.0, 5282.0, 5470.0, 5680.0, 5522.0, 5658.0, 5302.0, 5297.0, 5615.0, 5675.0, 5256.0, 5448.0, 5431.0, 5603.0, 5409.0, 5392.0, 5640.0, 5311.0, 5316.0, 5597.0, 5653.0, 5632.0, 5662.0, 5320.0, 5366.0, 5380.0, 5480.0, 5525.0, 5508.0, 5600.0, 5280.0, 5665.0, 5684.0, 5561.0, 5634.0, 5699.0, 5334.0, 5616.0, 5722.0, 5372.0, 5333.0, 5638.0, 5432.0, 5455.0, 5681.0, 5314.0, 5532.0, 5693.0, 5462.0, 5417.0, 5425.0, 5667.0, 5262.0, 5317.0, 5388.0, 5442.0, 5580.0, 5703.0, 5456.0, 5618.0, 5574.0, 5420.0, 5400.0 (number of hits: 5)
3	5530	9	1	333	1	5525.0, 5316.0, 5459.0, 5564.0, 5389.0, 5683.0, 5473.0, 5261.0, 5501.0, 5629.0, 5331.0, 5492.0, 5295.0, 5486.0, 5665.0, 5555.0, 5572.0, 5343.0, 5350.0, 5265.0, 5308.0, 5301.0, 5370.0, 5655.0, 5368.0, 5627.0, 5511.0, 5429.0, 5498.0, 5580.0, 5515.0, 5334.0, 5679.0, 5366.0, 5313.0, 5512.0, 5280.0, 5530.0, 5293.0, 5556.0, 5393.0, 5310.0, 5392.0, 5514.0, 5278.0, 5502.0, 5542.0, 5451.0, 5430.0, 5547.0, 5253.0, 5505.0, 5609.0, 5419.0, 5710.0

						5325.0, 5329.0, 5497.0, 5255.0, 5560.0, 5381.0, 5658.0, 5681.0, 5704.0, 5702.0, 5466.0, 5425.0, 5355.0, 5605.0, 5475.0, 5371.0, 5568.0, 5678.0, 5327.0, 5534.0, 5646.0, 5286.0, 5406.0, 5270.0, 5360.0, 5326.0, 5287.0, 5487.0, 5573.0, 5590.0, 5411.0, 5516.0, 5391.0, 5395.0, 5645.0, 5537.0, 5641.0, 5662.0, 5553.0, 5420.0, 5621.0, 5256.0, 5321.0, 5444.0, 5644.0 (number of hits: 8)
4	5530	9	1	333	1	5359.0, 5519.0, 5293.0, 5651.0, 5443.0, 5430.0, 5464.0, 5679.0, 5573.0, 5628.0, 5497.0, 5481.0, 5594.0, 5462.0, 5354.0, 5529.0, 5648.0, 5718.0, 5565.0, 5711.0, 5665.0, 5683.0, 5582.0, 5667.0, 5592.0, 5549.0, 5294.0, 5453.0, 5275.0, 5322.0, 5269.0, 5501.0, 5303.0, 5459.0, 5585.0, 5520.0, 5632.0, 5372.0, 5458.0, 5352.0, 5403.0, 5607.0, 5384.0, 5455.0, 5273.0, 5586.0, 5532.0, 5674.0, 5553.0, 5498.0, 5391.0, 5694.0, 5640.0, 5435.0, 5548.0, 5345.0, 5472.0, 5601.0, 5581.0, 5588.0, 5433.0, 5415.0, 5291.0, 5709.0, 5680.0, 5545.0, 5334.0, 5697.0, 5302.0, 5524.0, 5450.0, 5253.0, 5423.0, 5707.0, 5427.0, 5661.0, 5722.0, 5456.0, 5380.0, 5717.0, 5376.0, 5616.0, 5491.0, 5556.0, 5353.0, 5503.0, 5344.0, 5626.0, 5647.0, 5476.0, 5550.0, 5705.0, 5432.0, 5591.0, 5577.0, 5659.0, 5538.0, 5612.0, 5593.0, 5599.0 (number of hits: 5)
5	5530	9	1	333	1	5407.0, 5285.0, 5339.0, 5616.0, 5436.0, 5348.0, 5576.0, 5701.0, 5697.0, 5315.0, 5404.0, 5533.0, 5654.0, 5462.0, 5496.0, 5477.0, 5714.0, 5438.0, 5482.0, 5547.0, 5640.0, 5464.0, 5382.0, 5589.0, 5519.0, 5349.0, 5609.0, 5550.0, 5558.0, 5504.0, 5452.0, 5569.0, 5269.0, 5679.0, 5495.0, 5594.0, 5302.0, 5666.0, 5321.0, 5564.0, 5678.0, 5328.0, 5422.0, 5612.0, 5500.0, 5331.0, 5412.0, 5286.0, 5347.0, 5677.0, 5370.0, 5512.0, 5355.0, 5583.0, 5474.0, 5516.0, 5606.0, 5265.0, 5431.0, 5629.0, 5546.0, 5645.0, 5298.0, 5468.0, 5260.0, 5447.0, 5562.0, 5336.0, 5457.0, 5549.0, 5360.0, 5574.0, 5289.0, 5294.0, 5423.0, 5660.0, 5268.0, 5387.0, 5637.0, 5700.0, 5535.0, 5683.0, 5401.0, 5710.0, 5253.0, 5273.0, 5258.0, 5720.0, 5610.0, 5548.0, 5325.0, 5659.0, 5393.0, 5513.0, 5358.0, 5684.0, 5591.0, 5446.0, 5276.0, 5685.0 (number of hits: 6)
6	5530	9	1	333	1	5711.0, 5372.0, 5436.0, 5487.0, 5563.0, 5636.0, 5423.0, 5650.0, 5616.0, 5627.0, 5696.0, 5623.0, 5685.0, 5576.0, 5382.0, 5502.0, 5551.0, 5539.0, 5594.0, 5530.0, 5334.0, 5586.0, 5532.0, 5651.0, 5422.0, 5694.0, 5346.0, 5374.0, 5598.0, 5575.0, 5509.0, 5250.0, 5499.0, 5345.0, 5648.0,

						5452.0, 5479.0, 5570.0, 5621.0, 5548.0, 5702.0, 5451.0, 5463.0, 5438.0, 5583.0, 5407.0, 5471.0, 5626.0, 5272.0, 5468.0, 5429.0, 5557.0, 5533.0, 5402.0, 5252.0, 5309.0, 5254.0, 5641.0, 5337.0, 5628.0, 5348.0, 5492.0, 5562.0, 5359.0, 5585.0, 5370.0, 5649.0, 5295.0, 5448.0, 5363.0, 5443.0, 5351.0, 5644.0, 5475.0, 5512.0, 5264.0, 5693.0, 5298.0, 5661.0, 5698.0, 5305.0, 5459.0, 5484.0, 5308.0, 5703.0, 5592.0, 5489.0, 5324.0, 5349.0, 5569.0, 5516.0, 5333.0, 5329.0, 5381.0, 5715.0, 5646.0, 5257.0, 5520.0, 5535.0, 5300.0 (number of hits: 6)
7	5530	9	1	333	1	5596.0, 5625.0, 5341.0, 5478.0, 5502.0, 5342.0, 5493.0, 5348.0, 5293.0, 5586.0, 5665.0, 5544.0, 5352.0, 5708.0, 5572.0, 5278.0, 5433.0, 5343.0, 5371.0, 5410.0, 5345.0, 5347.0, 5456.0, 5398.0, 5524.0, 5337.0, 5279.0, 5686.0, 5365.0, 5678.0, 5669.0, 5445.0, 5364.0, 5295.0, 5658.0, 5284.0, 5590.0, 5600.0, 5672.0, 5712.0, 5459.0, 5593.0, 5311.0, 5575.0, 5559.0, 5369.0, 5253.0, 5716.0, 5670.0, 5385.0, 5422.0, 5332.0, 5679.0, 5707.0, 5487.0, 5346.0, 5325.0, 5718.0, 5635.0, 5618.0, 5723.0, 5601.0, 5396.0, 5378.0, 5693.0, 5565.0, 5643.0, 5488.0, 5498.0, 5539.0, 5547.0, 5614.0, 5660.0, 5701.0, 5258.0, 5616.0, 5355.0, 5402.0, 5379.0, 5585.0, 5450.0, 5497.0, 5441.0, 5505.0, 5291.0, 5334.0, 5282.0, 5628.0, 5714.0, 5504.0, 5467.0, 5602.0, 5542.0, 5517.0, 5477.0, 5359.0, 5395.0, 5675.0, 5319.0, 5349.0 (number of hits: 4)
8	5530	9	1	333	1	5578.0, 5328.0, 5610.0, 5719.0, 5416.0, 5438.0, 5640.0, 5723.0, 5393.0, 5339.0, 5351.0, 5685.0, 5556.0, 5367.0, 5410.0, 5636.0, 5513.0, 5309.0, 5604.0, 5531.0, 5630.0, 5650.0, 5552.0, 5284.0, 5267.0, 5631.0, 5435.0, 5269.0, 5579.0, 5422.0, 5532.0, 5392.0, 5526.0, 5461.0, 5666.0, 5436.0, 5709.0, 5430.0, 5585.0, 5293.0, 5616.0, 5601.0, 5642.0, 5447.0, 5527.0, 5696.0, 5487.0, 5550.0, 5279.0, 5483.0, 5457.0, 5482.0, 5700.0, 5611.0, 5542.0, 5632.0, 5549.0, 5477.0, 5386.0, 5287.0, 5266.0, 5595.0, 5597.0, 5544.0, 5454.0, 5280.0, 5374.0, 5303.0, 5485.0, 5390.0, 5546.0, 5663.0, 5676.0, 5625.0, 5591.0, 5677.0, 5270.0, 5633.0, 5686.0, 5437.0, 5389.0, 5353.0, 5695.0, 5715.0, 5708.0, 5523.0, 5711.0, 5606.0, 5619.0, 5268.0, 5668.0, 5693.0, 5404.0, 5469.0, 5674.0, 5627.0, 5417.0, 5273.0, 5662.0, 5285.0 (number of hits: 5)
9	5530	9	1	333	1	5261.0, 5552.0, 5344.0, 5648.0, 5500.0, 5488.0, 5654.0, 5556.0, 5507.0, 5440.0, 5290.0, 5336.0, 5270.0, 5527.0, 5446.0,

						5665.0, 5698.0, 5697.0, 5642.0, 5582.0, 5653.0, 5324.0, 5520.0, 5508.0, 5362.0, 5511.0, 5467.0, 5638.0, 5401.0, 5663.0, 5305.0, 5275.0, 5451.0, 5623.0, 5307.0, 5606.0, 5469.0, 5345.0, 5350.0, 5272.0, 5619.0, 5303.0, 5262.0, 5464.0, 5565.0, 5482.0, 5636.0, 5503.0, 5268.0, 5537.0, 5544.0, 5693.0, 5551.0, 5436.0, 5380.0, 5545.0, 5635.0, 5589.0, 5611.0, 5419.0, 5372.0, 5251.0, 5368.0, 5577.0, 5538.0, 5705.0, 5553.0, 5557.0, 5431.0, 5437.0, 5316.0, 5573.0, 5327.0, 5616.0, 5296.0, 5555.0, 5629.0, 5294.0, 5514.0, 5394.0, 5323.0, 5363.0, 5684.0, 5273.0, 5687.0, 5672.0, 5643.0, 5259.0, 5534.0, 5353.0, 5450.0, 5378.0, 5281.0, 5699.0, 5418.0, 5260.0, 5340.0, 5254.0, 5325.0, 5366.0 (number of hits: 6)
10	5530	9	1	333	1	5368.0, 5435.0, 5639.0, 5451.0, 5439.0, 5493.0, 5442.0, 5464.0, 5654.0, 5398.0, 5599.0, 5547.0, 5584.0, 5275.0, 5391.0, 5509.0, 5699.0, 5308.0, 5337.0, 5379.0, 5575.0, 5298.0, 5264.0, 5690.0, 5544.0, 5644.0, 5627.0, 5570.0, 5333.0, 5569.0, 5395.0, 5315.0, 5648.0, 5408.0, 5296.0, 5325.0, 5542.0, 5251.0, 5430.0, 5579.0, 5341.0, 5304.0, 5587.0, 5405.0, 5362.0, 5718.0, 5610.0, 5440.0, 5563.0, 5402.0, 5367.0, 5697.0, 5363.0, 5586.0, 5638.0, 5449.0, 5458.0, 5572.0, 5688.0, 5531.0, 5353.0, 5549.0, 5664.0, 5687.0, 5433.0, 5250.0, 5528.0, 5453.0, 5323.0, 5497.0, 5519.0, 5416.0, 5366.0, 5344.0, 5499.0, 5324.0, 5384.0, 5496.0, 5399.0, 5512.0, 5711.0, 5254.0, 5322.0, 5475.0, 5503.0, 5331.0, 5390.0, 5348.0, 5516.0, 5557.0, 5345.0, 5513.0, 5617.0, 5712.0, 5299.0, 5457.0, 5555.0, 5258.0, 5375.0, 5444.0 (number of hits: 5)
11	5530	9	1	333	1	5269.0, 5466.0, 5393.0, 5634.0, 5284.0, 5480.0, 5370.0, 5424.0, 5664.0, 5646.0, 5531.0, 5388.0, 5572.0, 5351.0, 5439.0, 5706.0, 5263.0, 5702.0, 5445.0, 5402.0, 5384.0, 5279.0, 5549.0, 5457.0, 5300.0, 5709.0, 5592.0, 5320.0, 5409.0, 5680.0, 5668.0, 5420.0, 5310.0, 5389.0, 5521.0, 5277.0, 5503.0, 5292.0, 5346.0, 5276.0, 5367.0, 5537.0, 5613.0, 5337.0, 5575.0, 5306.0, 5341.0, 5260.0, 5714.0, 5469.0, 5334.0, 5542.0, 5317.0, 5565.0, 5673.0, 5324.0, 5363.0, 5425.0, 5596.0, 5434.0, 5610.0, 5495.0, 5605.0, 5288.0, 5456.0, 5681.0, 5399.0, 5282.0, 5707.0, 5621.0, 5640.0, 5261.0, 5612.0, 5677.0, 5623.0, 5649.0, 5719.0, 5547.0, 5578.0, 5626.0, 5481.0, 5345.0, 5603.0, 5496.0, 5315.0, 5568.0, 5523.0, 5606.0, 5353.0, 5422.0, 5504.0, 5467.0, 5387.0, 5656.0, 5694.0, 5498.0, 5430.0, 5287.0, 5516.0, 5450.0

						(number of hits: 6)
12	5530	9	1	333	1	5712.0, 5274.0, 5543.0, 5575.0, 5655.0, 5577.0, 5614.0, 5278.0, 5426.0, 5323.0, 5304.0, 5722.0, 5448.0, 5689.0, 5652.0, 5435.0, 5717.0, 5645.0, 5723.0, 5432.0, 5477.0, 5505.0, 5288.0, 5556.0, 5446.0, 5475.0, 5567.0, 5703.0, 5669.0, 5372.0, 5682.0, 5609.0, 5421.0, 5499.0, 5377.0, 5656.0, 5314.0, 5250.0, 5295.0, 5440.0, 5535.0, 5558.0, 5686.0, 5569.0, 5620.0, 5268.0, 5564.0, 5375.0, 5306.0, 5497.0, 5376.0, 5612.0, 5257.0, 5632.0, 5413.0, 5439.0, 5514.0, 5702.0, 5479.0, 5568.0, 5561.0, 5275.0, 5654.0, 5300.0, 5693.0, 5457.0, 5534.0, 5269.0, 5487.0, 5688.0, 5523.0, 5378.0, 5496.0, 5590.0, 5601.0, 5373.0, 5681.0, 5366.0, 5576.0, 5606.0, 5486.0, 5332.0, 5589.0, 5538.0, 5462.0, 5276.0, 5615.0, 5355.0, 5532.0, 5671.0, 5417.0, 5367.0, 5573.0, 5481.0, 5407.0, 5525.0, 5647.0, 5396.0, 5489.0, 5333.0
						(number of hits: 6)
13	5530	9	1	333	1	5629.0, 5428.0, 5456.0, 5426.0, 5678.0, 5263.0, 5264.0, 5468.0, 5471.0, 5273.0, 5359.0, 5438.0, 5673.0, 5391.0, 5588.0, 5699.0, 5459.0, 5328.0, 5525.0, 5520.0, 5587.0, 5410.0, 5401.0, 5572.0, 5561.0, 5711.0, 5714.0, 5514.0, 5348.0, 5503.0, 5624.0, 5311.0, 5535.0, 5266.0, 5442.0, 5376.0, 5642.0, 5251.0, 5384.0, 5308.0, 5626.0, 5648.0, 5566.0, 5606.0, 5433.0, 5656.0, 5294.0, 5545.0, 5458.0, 5332.0, 5614.0, 5300.0, 5620.0, 5432.0, 5423.0, 5397.0, 5427.0, 5374.0, 5253.0, 5615.0, 5687.0, 5679.0, 5261.0, 5646.0, 5569.0, 5649.0, 5354.0, 5722.0, 5619.0, 5653.0, 5516.0, 5403.0, 5488.0, 5670.0, 5596.0, 5381.0, 5601.0, 5640.0, 5686.0, 5383.0, 5585.0, 5630.0, 5595.0, 5301.0, 5632.0, 5635.0, 5605.0, 5361.0, 5579.0, 5368.0, 5475.0, 5655.0, 5269.0, 5281.0, 5676.0, 5481.0, 5443.0, 5571.0, 5519.0, 5622.0
						(number of hits: 5)
14	5530	9	1	333	1	5558.0, 5354.0, 5661.0, 5411.0, 5430.0, 5455.0, 5671.0, 5318.0, 5680.0, 5632.0, 5713.0, 5458.0, 5382.0, 5286.0, 5581.0, 5326.0, 5591.0, 5703.0, 5712.0, 5282.0, 5340.0, 5544.0, 5552.0, 5701.0, 5356.0, 5644.0, 5368.0, 5401.0, 5659.0, 5454.0, 5492.0, 5450.0, 5442.0, 5507.0, 5267.0, 5513.0, 5460.0, 5357.0, 5263.0, 5572.0, 5699.0, 5708.0, 5652.0, 5664.0, 5268.0, 5331.0, 5434.0, 5505.0, 5294.0, 5653.0, 5257.0, 5362.0, 5538.0, 5299.0, 5439.0, 5641.0, 5688.0, 5542.0, 5484.0, 5274.0, 5497.0, 5269.0, 5590.0, 5316.0, 5327.0, 5367.0, 5502.0, 5609.0, 5570.0, 5635.0, 5474.0, 5494.0, 5694.0, 5706.0, 5381.0, 5503.0, 5612.0, 5283.0, 5426.0, 5514.0,

						5413.0, 5539.0, 5379.0, 5628.0, 5536.0, 5677.0, 5402.0, 5422.0, 5371.0, 5270.0, 5547.0, 5569.0, 5308.0, 5705.0, 5622.0, 5687.0, 5526.0, 5684.0, 5465.0, 5672.0 (number of hits: 4)
15	5530	9	1	333	1	5329.0, 5674.0, 5376.0, 5556.0, 5307.0, 5308.0, 5530.0, 5686.0, 5409.0, 5699.0, 5622.0, 5658.0, 5486.0, 5585.0, 5541.0, 5696.0, 5690.0, 5449.0, 5259.0, 5507.0, 5280.0, 5399.0, 5336.0, 5586.0, 5526.0, 5457.0, 5331.0, 5514.0, 5636.0, 5672.0, 5580.0, 5476.0, 5509.0, 5588.0, 5431.0, 5270.0, 5682.0, 5720.0, 5499.0, 5614.0, 5391.0, 5317.0, 5361.0, 5421.0, 5441.0, 5640.0, 5528.0, 5340.0, 5712.0, 5610.0, 5666.0, 5704.0, 5612.0, 5338.0, 5319.0, 5305.0, 5292.0, 5406.0, 5582.0, 5291.0, 5368.0, 5550.0, 5487.0, 5267.0, 5353.0, 5552.0, 5628.0, 5563.0, 5420.0, 5495.0, 5445.0, 5379.0, 5611.0, 5490.0, 5467.0, 5312.0, 5330.0, 5381.0, 5532.0, 5548.0, 5474.0, 5565.0, 5538.0, 5360.0, 5412.0, 5688.0, 5364.0, 5657.0, 5546.0, 5700.0, 5523.0, 5544.0, 5633.0, 5442.0, 5418.0, 5722.0, 5263.0, 5493.0, 5320.0, 5709.0 (number of hits: 6)
16	5530	9	1	333	1	5351.0, 5326.0, 5502.0, 5252.0, 5422.0, 5298.0, 5355.0, 5323.0, 5672.0, 5390.0, 5352.0, 5448.0, 5679.0, 5652.0, 5273.0, 5332.0, 5471.0, 5518.0, 5521.0, 5640.0, 5470.0, 5267.0, 5573.0, 5720.0, 5702.0, 5426.0, 5708.0, 5437.0, 5529.0, 5658.0, 5576.0, 5321.0, 5458.0, 5365.0, 5328.0, 5596.0, 5259.0, 5542.0, 5325.0, 5563.0, 5441.0, 5701.0, 5485.0, 5713.0, 5705.0, 5555.0, 5369.0, 5607.0, 5373.0, 5344.0, 5314.0, 5512.0, 5372.0, 5654.0, 5433.0, 5483.0, 5572.0, 5719.0, 5651.0, 5587.0, 5621.0, 5415.0, 5285.0, 5472.0, 5294.0, 5582.0, 5400.0, 5339.0, 5559.0, 5509.0, 5378.0, 5272.0, 5583.0, 5473.0, 5284.0, 5408.0, 5682.0, 5487.0, 5282.0, 5394.0, 5692.0, 5516.0, 5392.0, 5633.0, 5315.0, 5391.0, 5508.0, 5452.0, 5552.0, 5406.0, 5469.0, 5382.0, 5674.0, 5681.0, 5707.0, 5567.0, 5357.0, 5439.0, 5665.0, 5541.0 (number of hits: 4)
17	5530	9	1	333	1	5708.0, 5522.0, 5605.0, 5681.0, 5383.0, 5543.0, 5426.0, 5620.0, 5596.0, 5622.0, 5600.0, 5608.0, 5500.0, 5553.0, 5428.0, 5398.0, 5650.0, 5331.0, 5589.0, 5569.0, 5384.0, 5645.0, 5468.0, 5688.0, 5303.0, 5389.0, 5675.0, 5544.0, 5518.0, 5344.0, 5660.0, 5251.0, 5439.0, 5457.0, 5529.0, 5554.0, 5719.0, 5429.0, 5339.0, 5349.0, 5411.0, 5257.0, 5407.0, 5279.0, 5412.0, 5614.0, 5351.0, 5603.0, 5511.0, 5254.0, 5477.0, 5654.0, 5365.0, 5625.0, 5577.0, 5538.0, 5505.0, 5480.0, 5323.0, 5624.0,

						5691.0, 5353.0, 5578.0, 5452.0, 5435.0, 5487.0, 5694.0, 5319.0, 5634.0, 5557.0, 5255.0, 5378.0, 5484.0, 5661.0, 5713.0, 5324.0, 5593.0, 5612.0, 5462.0, 5515.0, 5431.0, 5320.0, 5427.0, 5350.0, 5402.0, 5655.0, 5549.0, 5636.0, 5641.0, 5637.0, 5445.0, 5693.0, 5302.0, 5458.0, 5568.0, 5555.0, 5459.0, 5310.0, 5470.0, 5701.0 (number of hits: 3)
18	5530	9	1	333	1	5638.0, 5546.0, 5507.0, 5490.0, 5423.0, 5636.0, 5685.0, 5466.0, 5430.0, 5599.0, 5625.0, 5523.0, 5374.0, 5690.0, 5565.0, 5634.0, 5429.0, 5445.0, 5649.0, 5604.0, 5480.0, 5411.0, 5528.0, 5702.0, 5459.0, 5298.0, 5494.0, 5410.0, 5296.0, 5595.0, 5284.0, 5646.0, 5336.0, 5476.0, 5375.0, 5619.0, 5687.0, 5400.0, 5647.0, 5710.0, 5442.0, 5340.0, 5542.0, 5327.0, 5697.0, 5331.0, 5311.0, 5659.0, 5271.0, 5250.0, 5489.0, 5582.0, 5711.0, 5452.0, 5387.0, 5291.0, 5591.0, 5385.0, 5346.0, 5628.0, 5665.0, 5434.0, 5700.0, 5344.0, 5335.0, 5319.0, 5524.0, 5497.0, 5302.0, 5485.0, 5288.0, 5424.0, 5676.0, 5337.0, 5396.0, 5723.0, 5683.0, 5597.0, 5556.0, 5471.0, 5703.0, 5538.0, 5437.0, 5467.0, 5295.0, 5478.0, 5630.0, 5262.0, 5552.0, 5403.0, 5562.0, 5415.0, 5719.0, 5496.0, 5577.0, 5460.0, 5275.0, 5571.0, 5280.0, 5506.0 (number of hits: 7)
19	5530	9	1	333	1	5511.0, 5703.0, 5397.0, 5679.0, 5583.0, 5610.0, 5627.0, 5622.0, 5353.0, 5492.0, 5642.0, 5410.0, 5432.0, 5563.0, 5635.0, 5665.0, 5289.0, 5413.0, 5611.0, 5570.0, 5387.0, 5348.0, 5332.0, 5317.0, 5555.0, 5261.0, 5539.0, 5264.0, 5430.0, 5373.0, 5647.0, 5581.0, 5644.0, 5470.0, 5620.0, 5459.0, 5661.0, 5312.0, 5524.0, 5309.0, 5285.0, 5716.0, 5513.0, 5369.0, 5532.0, 5681.0, 5304.0, 5637.0, 5613.0, 5425.0, 5402.0, 5568.0, 5713.0, 5455.0, 5263.0, 5552.0, 5253.0, 5496.0, 5519.0, 5590.0, 5381.0, 5293.0, 5435.0, 5427.0, 5322.0, 5573.0, 5721.0, 5439.0, 5386.0, 5670.0, 5650.0, 5370.0, 5504.0, 5385.0, 5281.0, 5445.0, 5468.0, 5482.0, 5699.0, 5724.0, 5277.0, 5421.0, 5688.0, 5389.0, 5720.0, 5265.0, 5259.0, 5330.0, 5422.0, 5475.0, 5301.0, 5379.0, 5618.0, 5494.0, 5390.0, 5399.0, 5257.0, 5327.0, 5501.0, 5367.0 (number of hits: 7)
20	5530	9	1	333	1	5366.0, 5349.0, 5703.0, 5641.0, 5299.0, 5531.0, 5602.0, 5529.0, 5569.0, 5325.0, 5546.0, 5697.0, 5437.0, 5311.0, 5681.0, 5537.0, 5286.0, 5485.0, 5673.0, 5395.0, 5289.0, 5563.0, 5499.0, 5319.0, 5432.0, 5592.0, 5479.0, 5684.0, 5512.0, 5701.0, 5369.0, 5487.0, 5455.0, 5553.0, 5654.0, 5534.0, 5640.0, 5310.0, 5708.0, 5448.0

						5296.0, 5620.0, 5278.0, 5591.0, 5642.0, 5273.0, 5587.0, 5542.0, 5495.0, 5330.0, 5470.0, 5373.0, 5689.0, 5686.0, 5431.0, 5318.0, 5387.0, 5500.0, 5605.0, 5651.0, 5515.0, 5538.0, 5484.0, 5365.0, 5612.0, 5386.0, 5705.0, 5549.0, 5715.0, 5316.0, 5457.0, 5494.0, 5417.0, 5340.0, 5545.0, 5604.0, 5382.0, 5699.0, 5516.0, 5337.0, 5581.0, 5619.0, 5672.0, 5565.0, 5454.0, 5685.0, 5308.0, 5547.0, 5562.0, 5288.0, 5302.0, 5509.0, 5506.0, 5560.0, 5389.0, 5698.0, 5721.0, 5561.0, 5348.0, 5328.0 (number of hits: 9)
21	5530	9	1	333	1	5686.0, 5401.0, 5699.0, 5296.0, 5386.0, 5575.0, 5705.0, 5305.0, 5458.0, 5297.0, 5573.0, 5449.0, 5568.0, 5327.0, 5256.0, 5514.0, 5342.0, 5332.0, 5470.0, 5681.0, 5532.0, 5495.0, 5610.0, 5309.0, 5258.0, 5703.0, 5625.0, 5537.0, 5668.0, 5443.0, 5382.0, 5722.0, 5518.0, 5430.0, 5497.0, 5717.0, 5476.0, 5291.0, 5643.0, 5277.0, 5488.0, 5419.0, 5483.0, 5721.0, 5338.0, 5698.0, 5596.0, 5570.0, 5468.0, 5406.0, 5261.0, 5527.0, 5471.0, 5398.0, 5611.0, 5517.0, 5285.0, 5255.0, 5655.0, 5678.0, 5701.0, 5674.0, 5320.0, 5252.0, 5613.0, 5352.0, 5455.0, 5496.0, 5581.0, 5374.0, 5259.0, 5491.0, 5710.0, 5472.0, 5475.0, 5300.0, 5307.0, 5312.0, 5545.0, 5459.0, 5494.0, 5314.0, 5687.0, 5466.0, 5329.0, 5650.0, 5385.0, 5547.0, 5469.0, 5682.0, 5586.0, 5541.0, 5719.0, 5646.0, 5672.0, 5571.0, 5281.0, 5323.0, 5394.0, 5409.0 (number of hits: 10)
22	5530	9	1	333	1	5593.0, 5399.0, 5594.0, 5291.0, 5684.0, 5705.0, 5685.0, 5524.0, 5671.0, 5446.0, 5616.0, 5437.0, 5462.0, 5689.0, 5465.0, 5339.0, 5712.0, 5699.0, 5319.0, 5693.0, 5463.0, 5274.0, 5458.0, 5661.0, 5286.0, 5368.0, 5639.0, 5688.0, 5324.0, 5571.0, 5503.0, 5261.0, 5642.0, 5327.0, 5657.0, 5255.0, 5526.0, 5342.0, 5370.0, 5656.0, 5691.0, 5486.0, 5710.0, 5328.0, 5680.0, 5455.0, 5470.0, 5515.0, 5422.0, 5427.0, 5386.0, 5478.0, 5288.0, 5406.0, 5349.0, 5711.0, 5556.0, 5435.0, 5643.0, 5335.0, 5394.0, 5722.0, 5634.0, 5473.0, 5605.0, 5631.0, 5424.0, 5611.0, 5608.0, 5269.0, 5591.0, 5417.0, 5551.0, 5574.0, 5297.0, 5265.0, 5402.0, 5431.0, 5615.0, 5651.0, 5652.0, 5461.0, 5409.0, 5333.0, 5296.0, 5352.0, 5362.0, 5531.0, 5702.0, 5579.0, 5377.0, 5581.0, 5273.0, 5412.0, 5281.0, 5445.0, 5414.0, 5418.0, 5629.0, 5701.0 (number of hits: 5)
23	5530	9	1	333	1	5623.0, 5279.0, 5371.0, 5267.0, 5393.0, 5459.0, 5255.0, 5721.0, 5583.0, 5320.0, 5663.0, 5582.0, 5648.0, 5567.0, 5318.0, 5461.0, 5422.0, 5295.0, 5359.0, 5599.0,

						5457.0, 5637.0, 5356.0, 5592.0, 5672.0, 5347.0, 5545.0, 5681.0, 5515.0, 5404.0, 5396.0, 5495.0, 5319.0, 5625.0, 5398.0, 5714.0, 5263.0, 5261.0, 5699.0, 5317.0, 5647.0, 5266.0, 5645.0, 5490.0, 5405.0, 5308.0, 5367.0, 5348.0, 5530.0, 5270.0, 5716.0, 5384.0, 5668.0, 5691.0, 5296.0, 5315.0, 5402.0, 5483.0, 5539.0, 5389.0, 5454.0, 5692.0, 5311.0, 5466.0, 5708.0, 5269.0, 5300.0, 5531.0, 5652.0, 5676.0, 5321.0, 5285.0, 5553.0, 5492.0, 5554.0, 5502.0, 5594.0, 5331.0, 5474.0, 5512.0, 5611.0, 5302.0, 5522.0, 5479.0, 5666.0, 5516.0, 5653.0, 5513.0, 5403.0, 5410.0, 5306.0, 5312.0, 5609.0, 5537.0, 5646.0, 5523.0, 5493.0, 5644.0, 5604.0, 5361.0 (number of hits: 9)
24	5530	9	1	333	1	5253.0, 5446.0, 5581.0, 5456.0, 5598.0, 5419.0, 5503.0, 5341.0, 5494.0, 5409.0, 5654.0, 5401.0, 5451.0, 5590.0, 5563.0, 5605.0, 5626.0, 5455.0, 5480.0, 5259.0, 5315.0, 5710.0, 5613.0, 5528.0, 5565.0, 5531.0, 5492.0, 5621.0, 5683.0, 5407.0, 5557.0, 5693.0, 5469.0, 5712.0, 5344.0, 5348.0, 5697.0, 5721.0, 5709.0, 5670.0, 5402.0, 5612.0, 5500.0, 5515.0, 5467.0, 5720.0, 5594.0, 5576.0, 5577.0, 5711.0, 5620.0, 5422.0, 5370.0, 5667.0, 5568.0, 5277.0, 5509.0, 5266.0, 5382.0, 5355.0, 5484.0, 5272.0, 5493.0, 5352.0, 5578.0, 5704.0, 5260.0, 5399.0, 5365.0, 5269.0, 5723.0, 5297.0, 5271.0, 5342.0, 5638.0, 5533.0, 5359.0, 5288.0, 5586.0, 5625.0, 5349.0, 5615.0, 5608.0, 5542.0, 5562.0, 5488.0, 5622.0, 5694.0, 5611.0, 5335.0, 5334.0, 5674.0, 5440.0, 5541.0, 5678.0, 5279.0, 5282.0, 5599.0, 5601.0, 5715.0 (number of hits: 2)
25	5530	9	1	333	1	5551.0, 5360.0, 5514.0, 5507.0, 5707.0, 5617.0, 5576.0, 5683.0, 5300.0, 5376.0, 5722.0, 5657.0, 5271.0, 5505.0, 5654.0, 5262.0, 5438.0, 5586.0, 5254.0, 5564.0, 5417.0, 5687.0, 5310.0, 5441.0, 5433.0, 5675.0, 5668.0, 5694.0, 5491.0, 5608.0, 5653.0, 5721.0, 5393.0, 5520.0, 5550.0, 5601.0, 5609.0, 5421.0, 5680.0, 5291.0, 5399.0, 5340.0, 5490.0, 5506.0, 5648.0, 5284.0, 5629.0, 5701.0, 5427.0, 5343.0, 5619.0, 5407.0, 5263.0, 5479.0, 5258.0, 5686.0, 5493.0, 5708.0, 5621.0, 5623.0, 5282.0, 5599.0, 5472.0, 5552.0, 5655.0, 5697.0, 5287.0, 5385.0, 5712.0, 5296.0, 5640.0, 5690.0, 5658.0, 5431.0, 5391.0, 5459.0, 5495.0, 5508.0, 5367.0, 5536.0, 5556.0, 5293.0, 5437.0, 5432.0, 5425.0, 5338.0, 5369.0, 5561.0, 5620.0, 5302.0, 5542.0, 5642.0, 5311.0, 5436.0, 5641.0, 5294.0, 5681.0, 5267.0, 5404.0, 5354.0 (number of hits: 9)

26	5530	9	1	333	1	<p>5665.0, 5269.0, 5330.0, 5424.0, 5304.0, 5594.0, 5309.0, 5360.0, 5333.0, 5489.0, 5327.0, 5618.0, 5490.0, 5703.0, 5494.0, 5679.0, 5720.0, 5647.0, 5450.0, 5464.0, 5455.0, 5586.0, 5668.0, 5454.0, 5372.0, 5559.0, 5340.0, 5483.0, 5470.0, 5306.0, 5283.0, 5313.0, 5651.0, 5673.0, 5654.0, 5411.0, 5575.0, 5567.0, 5361.0, 5709.0, 5391.0, 5565.0, 5451.0, 5605.0, 5364.0, 5642.0, 5723.0, 5406.0, 5262.0, 5430.0, 5271.0, 5322.0, 5579.0, 5480.0, 5496.0, 5417.0, 5288.0, 5631.0, 5711.0, 5447.0, 5521.0, 5550.0, 5615.0, 5603.0, 5541.0, 5478.0, 5525.0, 5588.0, 5264.0, 5716.0, 5387.0, 5643.0, 5267.0, 5321.0, 5538.0, 5472.0, 5292.0, 5607.0, 5492.0, 5415.0, 5632.0, 5611.0, 5659.0, 5453.0, 5598.0, 5452.0, 5385.0, 5449.0, 5544.0, 5572.0, 5561.0, 5587.0, 5695.0, 5425.0, 5574.0, 5600.0, 5347.0, 5589.0, 5326.0, 5721.0 (number of hits: 6)</p>
27	5530	9	1	333	1	<p>5538.0, 5428.0, 5602.0, 5590.0, 5396.0, 5380.0, 5575.0, 5364.0, 5393.0, 5661.0, 5510.0, 5282.0, 5392.0, 5543.0, 5432.0, 5336.0, 5685.0, 5721.0, 5714.0, 5331.0, 5506.0, 5589.0, 5513.0, 5595.0, 5338.0, 5366.0, 5660.0, 5377.0, 5697.0, 5502.0, 5571.0, 5276.0, 5305.0, 5529.0, 5535.0, 5354.0, 5578.0, 5352.0, 5294.0, 5414.0, 5416.0, 5254.0, 5278.0, 5286.0, 5487.0, 5609.0, 5287.0, 5488.0, 5623.0, 5273.0, 5464.0, 5266.0, 5265.0, 5389.0, 5279.0, 5634.0, 5412.0, 5498.0, 5312.0, 5559.0, 5585.0, 5612.0, 5441.0, 5526.0, 5600.0, 5643.0, 5425.0, 5486.0, 5553.0, 5635.0, 5496.0, 5413.0, 5666.0, 5627.0, 5290.0, 5689.0, 5410.0, 5532.0, 5325.0, 5650.0, 5610.0, 5631.0, 5327.0, 5508.0, 5622.0, 5398.0, 5478.0, 5552.0, 5656.0, 5447.0, 5558.0, 5301.0, 5403.0, 5645.0, 5490.0, 5636.0, 5335.0, 5262.0, 5374.0, 5676.0 (number of hits: 7)</p>
28	5530	9	1	333	1	<p>5327.0, 5255.0, 5388.0, 5463.0, 5448.0, 5698.0, 5412.0, 5408.0, 5373.0, 5535.0, 5435.0, 5687.0, 5355.0, 5641.0, 5436.0, 5628.0, 5617.0, 5488.0, 5485.0, 5499.0, 5414.0, 5377.0, 5723.0, 5577.0, 5433.0, 5671.0, 5302.0, 5294.0, 5330.0, 5721.0, 5646.0, 5362.0, 5262.0, 5649.0, 5424.0, 5661.0, 5283.0, 5276.0, 5347.0, 5304.0, 5715.0, 5459.0, 5701.0, 5357.0, 5407.0, 5543.0, 5611.0, 5514.0, 5494.0, 5364.0, 5380.0, 5513.0, 5366.0, 5601.0, 5318.0, 5599.0, 5654.0, 5612.0, 5370.0, 5524.0, 5648.0, 5676.0, 5476.0, 5593.0, 5409.0, 5281.0, 5251.0, 5668.0, 5403.0, 5663.0, 5704.0, 5395.0, 5351.0, 5385.0, 5383.0, 5679.0, 5420.0, 5531.0, 5480.0, 5311.0, 5719.0, 5483.0, 5422.0, 5427.0, 5450.0</p>

						5445.0, 5594.0, 5404.0, 5695.0, 5279.0, 5688.0, 5289.0, 5268.0, 5300.0, 5343.0, 5658.0, 5271.0, 5259.0, 5308.0, 5596.0 (number of hits: 7)
29	5530	9	1	333	1	5320.0, 5657.0, 5451.0, 5399.0, 5666.0, 5632.0, 5461.0, 5712.0, 5251.0, 5275.0, 5495.0, 5342.0, 5691.0, 5482.0, 5260.0, 5466.0, 5281.0, 5683.0, 5687.0, 5479.0, 5716.0, 5677.0, 5590.0, 5347.0, 5355.0, 5313.0, 5487.0, 5291.0, 5585.0, 5628.0, 5371.0, 5592.0, 5448.0, 5656.0, 5453.0, 5416.0, 5361.0, 5317.0, 5658.0, 5586.0, 5301.0, 5690.0, 5527.0, 5374.0, 5345.0, 5538.0, 5322.0, 5303.0, 5389.0, 5685.0, 5524.0, 5253.0, 5570.0, 5617.0, 5410.0, 5372.0, 5438.0, 5694.0, 5622.0, 5689.0, 5722.0, 5436.0, 5430.0, 5507.0, 5325.0, 5595.0, 5601.0, 5675.0, 5256.0, 5397.0, 5367.0, 5670.0, 5580.0, 5551.0, 5643.0, 5563.0, 5612.0, 5500.0, 5333.0, 5718.0, 5398.0, 5546.0, 5378.0, 5671.0, 5366.0, 5648.0, 5414.0, 5539.0, 5351.0, 5613.0, 5255.0, 5493.0, 5556.0, 5508.0, 5636.0, 5340.0, 5468.0, 5681.0, 5609.0, 5562.0 (number of hits: 4)
30	5530	9	1	333	1	5474.0, 5349.0, 5702.0, 5358.0, 5353.0, 5309.0, 5376.0, 5453.0, 5368.0, 5356.0, 5722.0, 5293.0, 5638.0, 5663.0, 5718.0, 5400.0, 5461.0, 5340.0, 5532.0, 5386.0, 5351.0, 5647.0, 5473.0, 5374.0, 5467.0, 5662.0, 5393.0, 5695.0, 5444.0, 5614.0, 5588.0, 5274.0, 5419.0, 5531.0, 5319.0, 5513.0, 5422.0, 5425.0, 5354.0, 5466.0, 5696.0, 5723.0, 5292.0, 5481.0, 5658.0, 5714.0, 5268.0, 5291.0, 5348.0, 5593.0, 5406.0, 5576.0, 5618.0, 5388.0, 5261.0, 5454.0, 5457.0, 5693.0, 5541.0, 5436.0, 5517.0, 5507.0, 5434.0, 5459.0, 5495.0, 5571.0, 5665.0, 5521.0, 5424.0, 5512.0, 5314.0, 5265.0, 5527.0, 5634.0, 5339.0, 5529.0, 5715.0, 5673.0, 5553.0, 5574.0, 5369.0, 5508.0, 5719.0, 5655.0, 5503.0, 5323.0, 5589.0, 5344.0, 5494.0, 5399.0, 5627.0, 5383.0, 5669.0, 5709.0, 5491.0, 5639.0, 5625.0, 5451.0, 5551.0, 5659.0 (number of hits: 5)

10 Bridge and/or MESH mode

10.1 Test standard

Networks Access Points with Bridge and/or MESH modes of operation are permitted to operate in the DFS bands but must employ a DFS function. The functionality of the Bridge mode as specified in §15.403(a) must be validated in the DFS test report. Devices operating as relays where they act as master and client must also employ DFS function for the master. The method used to validate the functionality must be documented and validation data must be documented. Bridge mode can be validated by performing a test statistical performance check (Section 7.8.4) on any one of the radar types. This is an abbreviated test to verify DFS functionality. MESH mode operational methodology must be submitted in the application for certification for evaluation by the FCC.

10.2 Test result

5280MHz

Trial #	Fc (MHz)	Pulse/Burst	Pulse Width (µS)	PRI (µs)	Detection (1:yes; 0:no)
1	5280	18	1	1428	1
2	5280	18	1	1428	1
3	5280	18	1	1428	1
4	5280	18	1	1428	1
5	5280	18	1	1428	1
6	5280	18	1	1428	1
7	5280	18	1	1428	1
8	5280	18	1	1428	1
9	5280	18	1	1428	1
10	5280	18	1	1428	1
11	5280	18	1	1428	1
12	5280	18	1	1428	1
13	5280	18	1	1428	1
14	5280	18	1	1428	1
15	5280	18	1	1428	1
16	5280	18	1	1428	1
17	5280	18	1	1428	1
18	5280	18	1	1428	1
19	5280	18	1	1428	1
20	5280	18	1	1428	1
21	5280	18	1	1428	1
22	5280	18	1	1428	1
23	5280	18	1	1428	1
24	5280	18	1	1428	1
25	5280	18	1	1428	1
26	5280	18	1	1428	1
27	5280	18	1	1428	1
28	5280	18	1	1428	1
29	5280	18	1	1428	1
30	5280	18	1	1428	1
Detection Percentage: 100 % (>60%)					

5540MHz

Trial #	Fc (MHz)	Pulse/Burst	Pulse Width (μS)	PRI (μs)	Detection (1:yes; 0:no)
1	5540	18	1	1428	1
2	5540	18	1	1428	1
3	5540	18	1	1428	1
4	5540	18	1	1428	1
5	5540	18	1	1428	1
6	5540	18	1	1428	1
7	5540	18	1	1428	1
8	5540	18	1	1428	1
9	5540	18	1	1428	1
10	5540	18	1	1428	1
11	5540	18	1	1428	1
12	5540	18	1	1428	1
13	5540	18	1	1428	1
14	5540	18	1	1428	1
15	5540	18	1	1428	1
16	5540	18	1	1428	1
17	5540	18	1	1428	1
18	5540	18	1	1428	1
19	5540	18	1	1428	1
20	5540	18	1	1428	1
21	5540	18	1	1428	1
22	5540	18	1	1428	1
23	5540	18	1	1428	1
24	5540	18	1	1428	1
25	5540	18	1	1428	1
26	5540	18	1	1428	1
27	5540	18	1	1428	1
28	5540	18	1	1428	1
29	5540	18	1	1428	1
30	5540	18	1	1428	1
Detection Percentage: 100 % (>60%)					