

FCC Test Report

Report No.: RF160224C19B

FCC ID: TVE-28166033

Test Model: FAP-S422E

Series Model: FortiAP S422Exxxxxx, FAP-S422Exxxxxx, FORTIAP-S422Exxxxxx (where "x" can be used as "A-Z" or "0-9" or "-" or blank for software changes or marketing purposes only)

Received Date: Oct. 19, 2016

Test Date: Nov. 04 ~ Dec. 19, 2016

Issued Date: Dec. 22, 2016

Applicant: Fortinet Inc.

Address: 899 Kifer Road Sunnyvale, CA 94086 USA

Issued By: Bureau Veritas Consumer Products Services (H.K.) Ltd., Taoyuan Branch

Lab Address: No. 47-2, 14th Ling, Chia Pau Vil., Lin Kou Dist., New Taipei City, Taiwan, R.O.C.

Test Location: No. 19, Hwa Ya 2nd Rd., Wen Hwa Vil., Kwei Shan Dist., Taoyuan City 33383, TAIWAN (R.O.C.)



This report is for your exclusive use. Any copying or replication of this report to or for any other person or entity, or use of our name or trademark, is permitted only with our prior written permission. This report sets forth our findings solely with respect to the test samples identified herein. The results set forth in this report are not indicative or representative of the quality or characteristics of the lot from which a test sample was taken or any similar or identical product unless specifically and expressly noted. Our report includes all of the tests requested by you and the results thereof based upon the information that you provided to us. You have 60 days from date of issuance of this report to notify us of any material error or omission caused by our negligence, provided, however, that such notice shall be in writing and shall specifically address the issue you wish to raise. A failure to raise such issue within the prescribed time shall constitute your unqualified acceptance of the completeness of this report, the tests conducted and the correctness of the report contents. Unless specific mention, the uncertainty of measurement has been explicitly taken into account to declare the compliance or non-compliance to the specification. The report must not be used by the client to claim product certification, approval, or endorsement by TAF or any government agencies.

Table of Contents

Release Control Record	4
1 Certificate of Conformity	5
2 Summary of Test Results	6
2.1 Measurement Uncertainty.....	6
2.2 Modification Record.....	6
3 General Information	7
3.1 General Description of EUT.....	7
3.2 Description of Test Modes.....	9
3.2.1 Test Mode Applicability and Tested Channel Detail.....	10
3.3 Duty Cycle of Test Signal.....	12
3.4 Description of Support Units.....	13
3.4.1 Configuration of System under Test.....	13
3.5 General Description of Applied Standards.....	14
4 Test Types and Results	15
4.1 Radiated Emission and Bandedge Measurement.....	15
4.1.1 Limits of Radiated Emission and Bandedge Measurement.....	15
4.1.2 Test Instruments.....	16
4.1.3 Test Procedures.....	17
4.1.4 Deviation from Test Standard.....	17
4.1.5 Test Setup.....	18
4.1.6 EUT Operating Conditions.....	19
4.1.7 Test Results.....	20
4.2 Conducted Emission Measurement.....	44
4.2.1 Limits of Conducted Emission Measurement.....	44
4.2.2 Test Instruments.....	44
4.2.3 Test Procedures.....	45
4.2.4 Deviation from Test Standard.....	45
4.2.5 Test Setup.....	45
4.2.6 EUT Operating Conditions.....	45
4.2.7 Test Results.....	46
4.3 Transmit Power Measurement.....	48
4.3.1 Limits of Transmit Power Measurement.....	48
4.3.2 Test Setup.....	48
4.3.3 Test Instruments.....	48
4.3.4 Test Procedure.....	49
4.3.5 Deviation from Test Standard.....	49
4.3.6 EUT Operating Conditions.....	49
4.3.7 Test Result.....	50
4.4 Peak Power Spectral Density Measurement.....	64
4.4.1 Limits of Peak Power Spectral Density Measurement.....	64
4.4.2 Test Setup.....	64
4.4.3 Test Instruments.....	64
4.4.4 Test Procedures.....	64
4.4.5 Deviation from Test Standard.....	64
4.4.6 EUT Operating Conditions.....	64
4.4.7 Test Results.....	65
4.5 Frequency Stability.....	68
4.5.1 Limits of Frequency Stability Measurement.....	68
4.5.2 Test Setup.....	68
4.5.3 Test Instruments.....	68
4.5.4 Test Procedure.....	68
4.5.5 Deviation from Test Standard.....	68
4.5.6 EUT Operating Condition.....	68

4.5.7 Test Results	69
5 Pictures of Test Arrangements.....	70
Appendix – Information on the Testing Laboratories	71

Release Control Record

Issue No.	Description	Date Issued
RF160224C19B	Original release.	Dec. 22, 2016

1 Certificate of Conformity

Product: Secured Wireless Access Point

Brand: Fortinet Inc.

Test Model: FAP-S422E

Series Model: FortiAP S422Exxxxxx, FAP-S422Exxxxxx, FORTIAP-S422Exxxxxx (where "x" can be used as "A-Z" or "0-9" or "-" or blank for software changes or marketing purposes only)

Sample Status: Engineering sample

Applicant: Fortinet Inc.

Test Date: Nov. 04 ~ Dec. 19, 2016

Standards: 47 CFR FCC Part 15, Subpart E (Section 15.407)
ANSI C63.10:2013

The above equipment has been tested by **Bureau Veritas Consumer Products Services (H.K.) Ltd., Taoyuan Branch**, and found compliance with the requirement of the above standards. The test record, data evaluation & Equipment Under Test (EUT) configurations represented herein are true and accurate accounts of the measurements of the sample's EMC characteristics under the conditions specified in this report.

Prepared by :  , **Date:** Dec. 22, 2016
Pettie Chen / Senior Specialist

Approved by :  , **Date:** Dec. 22, 2016
Ken Liu / Senior Manager

2 Summary of Test Results

47 CFR FCC Part 15, Subpart E (SECTION 15.407)			
FCC Clause	Test Item	Result	Remarks
15.407(b)(6)	AC Power Conducted Emissions	Pass	Meet the requirement of limit. Minimum passing margin is -9.24dB at 0.51856MHz.
15.407(b) (1/2/3/4(i/ii)/6)	Radiated Emissions & Band Edge Measurement	Pass	Meet the requirement of limit. Minimum passing margin is -1.3dB at 5350.00MHz.
15.407(a) (1/2/3)	Max Average Transmit Power	Pass	Meet the requirement of limit.
15.407(a)(1/2/3)	Peak Power Spectral Density	Pass	Meet the requirement of limit.
15.407(g)	Frequency Stability	Pass	Meet the requirement of limit.
15.203	Antenna Requirement	Pass	Antenna connector is N-Type. (The device is professionally installed)

2.1 Measurement Uncertainty

Where relevant, the following measurement uncertainty levels have been estimated for tests performed on the EUT as specified in CISPR 16-4-2:

Measurement	Frequency	Expanded Uncertainty (k=2) (±)
Conducted Emissions at mains ports	150kHz ~ 30MHz	2.44 dB
Radiated Emissions up to 1 GHz	30MHz ~ 200MHz	3.86 dB
	200MHz ~ 1000MHz	3.87 dB
Radiated Emissions above 1 GHz	1GHz ~ 18GHz	2.29 dB
	18GHz ~ 40GHz	2.29 dB

2.2 Modification Record

There were no modifications required for compliance.

3 General Information

3.1 General Description of EUT

Product	Secured Wireless Access Point
Brand	Fortinet Inc.
Test Model	FAP-S422E
Series Model	FortiAP S422Exxxxxx, FAP-S422Exxxxxx, FORTIAP-S422Exxxxxx (where "x" can be used as "A-Z" or "0-9" or "-" or blank for software changes or marketing purposes only)
Model Difference	Refer to Note
Status of EUT	Engineering sample
Power Supply Rating	48Vdc (POE)
Modulation Type	256QAM, 64QAM, 16QAM, QPSK, BPSK
Modulation Technology	OFDM
Transfer Rate	802.11a: 54/48/36/24/18/12/9/6Mbps 802.11n: up to 600Mbps 802.11ac: up to 1733Mbps
Operating Frequency	5260 ~ 5320MHz, 5500 ~ 5720MHz
Number of Channel	5260 ~ 5320MHz: 4 for 802.11a, 802.11n (HT20), 802.11ac (VHT20) 2 for 802.11n (HT40), 802.11ac (VHT40) 1 for 802.11ac (VHT80) 5500 ~ 5700MHz: 12 for 802.11a, 802.11n (HT20), 802.11ac (VHT20) 6 for 802.11n (HT40), 802.11ac (VHT40) 3 for 802.11ac (VHT80)
Output Power	CDD Mode: 5260 ~ 5320MHz: 134.348mW 5500 ~ 5700MHz: 219.365mW Beamforming Mode: 5260 ~ 5320MHz: 33.592mW 5500 ~ 5700MHz: 54.849mW
Antenna Type	Dipole antenna with 6.3dBi gain
Antenna Connector	N-Type (The device is professionally installed)
Accessory Device	POE, POE's adapter, surge protector
Data Cable Supplied	1.8m non-shielded grounding cable without core x3

Note:

1. This report is prepared for FCC class II permissive change. This report is issued as a supplementary report of the original report no.: RF160224C19-1. The difference compared with original report is adding 5.26GHz to 5.32GHz and 5.50GHz to 5.70GHz by software.

2. All models are listed as below. Model FAP-S422E is the representative for final test.

Brand	Model	Difference
Fortinet Inc.	FortiAP S422Exxxxxx	where "x" can be used as "A-Z" or "0-9" or "-" or blank for software changes or marketing purposes only
	FAP-S422Exxxxxx	
	FORTIAP-S422Exxxxxx	

3. The EUT incorporates a MIMO function. Physically, the EUT provides 4 completed transmitters and 4 receivers.

Band	Modulation Mode	CDD Mode	Beamforming Mode	TX Function
5GHz	802.11a	Support	Not Support	4TX
	802.11n (HT20)	Support	Not Support	4TX
	802.11n (HT40)	Support	Not Support	4TX
	802.11ac (VHT20)	Support	Support	4TX
	802.11ac (VHT40)	Support	Support	4TX
	802.11ac (VHT80)	Support	Support	4TX

* CDD Mode: The modulation and bandwidth are similar for 802.11n mode for HT20/HT40 and 802.11ac mode for HT20/HT40, therefore investigated worst case to representative mode in test report. (Final test mode refer section 3.2.1)

4. The EUT uses the following POE and POE's adapter.

POE	
Brand	EnGenius
Model	POE-48GP
Rating	48Vdc

POE's adapter	
Brand	Powertron Electronics Corp.
Model	PA1040-480IB080
Input Power	100-240Vac, 50-60Hz, 1.5A
Output Power	48Vdc, 0.8A, 38.4W Max
Power Line	1.55m cable with 1 core attached on adapter

5. The above EUT information is declared by manufacturer and for more detailed features description, please refer to the manufacturer's specifications or user's manual.

3.2 Description of Test Modes

FOR 5260 ~ 5320MHz:

4 channels are provided for 802.11a, 802.11n (HT20), 802.11ac (VHT20):

Channel	Frequency	Channel	Frequency
52	5260 MHz	60	5300 MHz
56	5280 MHz	64	5320 MHz

2 channels are provided for 802.11n (HT40), 802.11ac (VHT40):

Channel	Frequency	Channel	Frequency
54	5270 MHz	62	5310 MHz

1 channel is provided for 802.11ac (VHT80):

Channel	Frequency
58	5290 MHz

FOR 5500 ~ 5720MHz:

12 channels are provided for 802.11a, 802.11n (HT20), 802.11ac (VHT20):

Channel	Frequency	Channel	Frequency
100	5500 MHz	124	5620 MHz
104	5520 MHz	128	5640 MHz
108	5540 MHz	132	5660 MHz
112	5560 MHz	136	5680 MHz
116	5580 MHz	140	5700 MHz
120	5600 MHz	144	5720 MHz

6 channels are provided for 802.11n (HT40), 802.11ac (VHT40):

Channel	Frequency	Channel	Frequency
102	5510 MHz	126	5630 MHz
110	5550 MHz	134	5670 MHz
118	5590 MHz	142	5710 MHz

3 channels are provided for 802.11ac (VHT80):

Channel	Frequency	Channel	Frequency
106	5530 MHz	122	5610 MHz
138	5690 MHz		

3.2.1 Test Mode Applicability and Tested Channel Detail

EUT CONFIGURE MODE	APPLICABLE TO				DESCRIPTION
	RE \geq 1G	RE<1G	PLC	APCM	
-	√	√	√	√	-

Where **RE \geq 1G**: Radiated Emission above 1GHz & Bandedge Measurement
RE<1G: Radiated Emission below 1GHz
PLC: Power Line Conducted Emission
APCM: Antenna Port Conducted Measurement

Note: The EUT was positioned on the Y-plane during testing.

Radiated Emission Test (Above 1GHz):

Pre-Scan has been conducted to determine the worst-case mode from all possible combinations between available modulations, data rates and antenna ports (if EUT with antenna diversity architecture).

Following channel(s) was (were) selected for the final test as listed below.

EUT Configure Mode	Mode	Frequency Band (MHz)	Available Channel	Tested Channel	Modulation Technology	Data Rate (Mbps)
-	802.11a	5260-5320	52 to 64	52, 60, 64	OFDM	6.0
-	802.11n (HT20)		52 to 64	52, 60, 64	OFDM	6.5
-	802.11n (HT40)		54 to 62	54, 62	OFDM	13.5
-	802.11ac (VHT80)		58	58	OFDM	117.0
-	802.11a	5500-5720	100 to 144	100, 116, 140, 144	OFDM	6.0
-	802.11n (HT20)		100 to 144	100, 116, 140, 144	OFDM	6.5
-	802.11n (HT40)		102 to 142	102, 110, 134, 142	OFDM	13.5
-	802.11ac (VHT80)		106 to 138	106, 138	OFDM	117.0

Radiated Emission Test (Below 1GHz):

Pre-Scan has been conducted to determine the worst-case mode from all possible combinations between available modulations, data rates and antenna ports (if EUT with antenna diversity architecture).

Following channel(s) was (were) selected for the final test as listed below.

EUT Configure Mode	Mode	Frequency Band (MHz)	Available Channel	Tested Channel	Modulation Technology	Data Rate (Mbps)
-	802.11a	5260-5320	52 to 64	52	OFDM	6
	802.11a	5500-5720	100 to 144		OFDM	6

Power Line Conducted Emission Test:

- Pre-Scan has been conducted to determine the worst-case mode from all possible combinations between available modulations, data rates and antenna ports (if EUT with antenna diversity architecture).
- Following channel(s) was (were) selected for the final test as listed below.

EUT Configure Mode	Mode	Frequency Band (MHz)	Available Channel	Tested Channel	Modulation Technology	Data Rate (Mbps)
-	802.11a	5260-5320	52 to 64	52	OFDM	6
-	802.11a	5500-5720	100 to 144		OFDM	6

Antenna Port Conducted Measurement:

- This item includes all test value of each mode, but only includes spectrum plot of worst value of each mode.
- Pre-Scan has been conducted to determine the worst-case mode from all possible combinations between available modulations, data rates and antenna ports (if EUT with antenna diversity architecture).
- Following channel(s) was (were) selected for the final test as listed below.

EUT Configure Mode	Mode	Frequency Band (MHz)	Available Channel	Tested Channel	Modulation Technology	Data Rate (Mbps)
-	802.11a	5260-5320	52 to 64	52, 60, 64	OFDM	6.0
-	802.11n (HT20)		52 to 64	52, 60, 64	OFDM	6.5
-	802.11n (HT40)		54 to 62	54, 62	OFDM	13.5
-	802.11ac (VHT80)		58	58	OFDM	117.0
-	802.11a	5500-5720	100 to 144	100, 116, 140, 144	OFDM	6.0
-	802.11n (HT20)		100 to 144	100, 116, 140, 144	OFDM	6.5
-	802.11n (HT40)		102 to 142	102, 110, 134, 142	OFDM	13.5
-	802.11ac (VHT80)		106 to 138	106, 138	OFDM	117.0

Test Condition:

APPLICABLE TO	ENVIRONMENTAL CONDITIONS	INPUT POWER	TESTED BY
RE\geq1G	16deg. C, 70%RH	120Vac, 60Hz	Nick Hsu
RE$<$1G	16deg. C, 70%RH	120Vac, 60Hz	Nick Hsu
PLC	16deg. C, 70%RH	120Vac, 60Hz	Nick Hsu
APCM	25deg. C, 60%RH	120Vac, 60Hz	Ted Chand

3.3 Duty Cycle of Test Signal

Duty cycle of test signal is > 98%, duty factor is not required

Duty cycle of test signal is < 98 %, duty factor is required

802.11a: Duty cycle = $2.022/2.102 = 0.962$, Duty factor = $10 * \log(1/0.962) = 0.17$

802.11n (HT20): Duty cycle = $4.955/5.025 = 0.986$

802.11n (HT40): Duty cycle = $2.407/2.475 = 0.973$, Duty factor = $10 * \log(1/0.973) = 0.12$

802.11ac (VHT80): Duty cycle = $1.127/1.202 = 0.938$, Duty factor = $10 * \log(1/0.938) = 0.28$

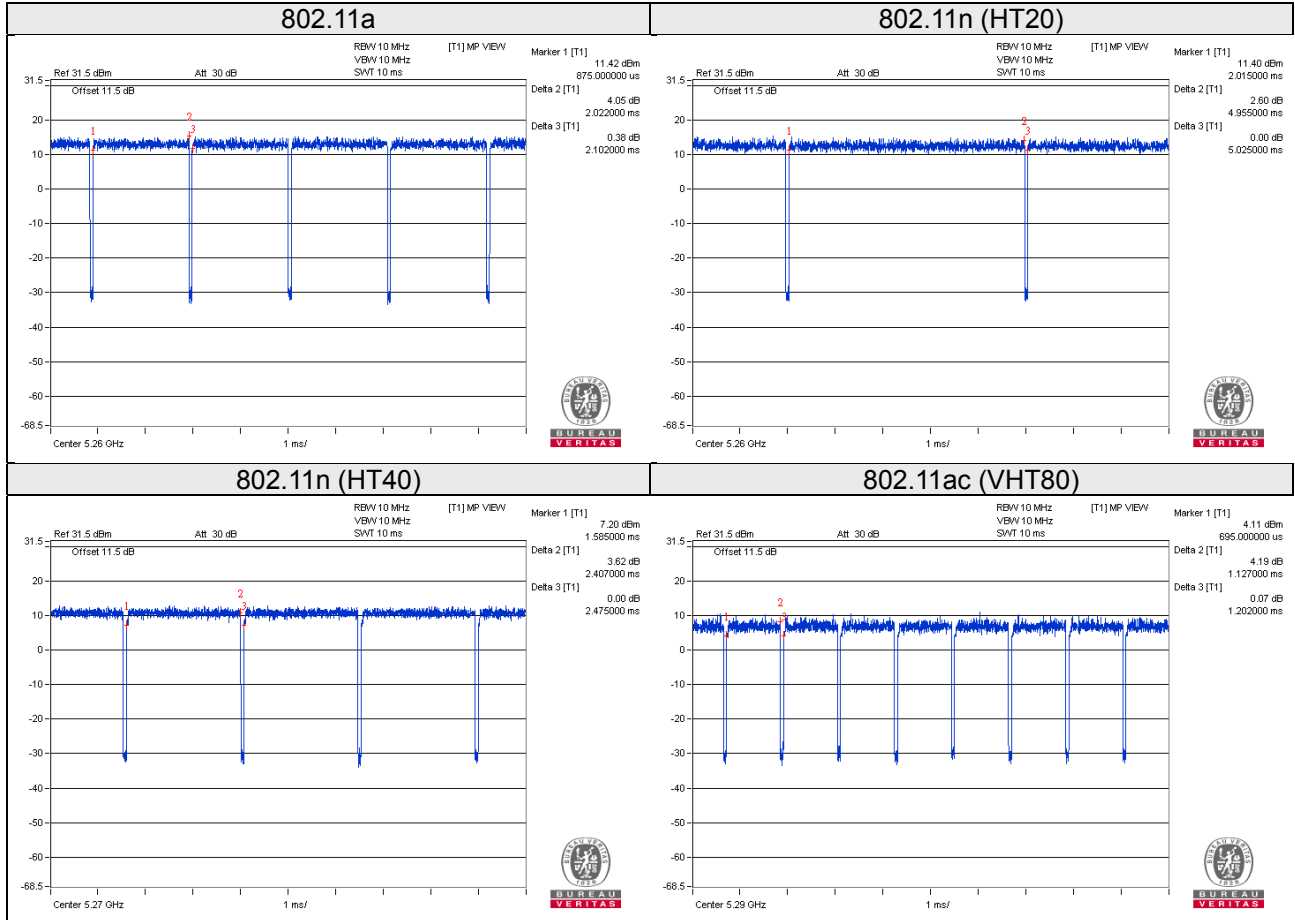

3.4 Description of Support Units

The EUT has been tested as an independent unit together with other necessary accessories or support units. The following support units or accessories were used to form a representative test configuration during the tests.

ID	Product	Brand	Model No.	Serial No.	FCC ID	Remarks
A.	Notebook	DELL	D531	CN-0XM006-48643-81 U-2973	QDS-BRCM1020	-
B.	Load	NA	NA	NA	NA	-

Note:

1. All power cords of the above support units are non-shielded (1.8m).
2. Item A acted as a communication partner to transfer data.

ID	Descriptions	Qty.	Length (m)	Shielding (Yes/No)	Cores (Qty.)	Remarks
1.	RJ45	1	1.0	N	0	-
2.	RJ45	1	1.8	N	0	-
3.	RJ45	1	10	N	0	-
4.	RJ45 to RS232	1	1.8	Y	0	-

3.4.1 Configuration of System under Test

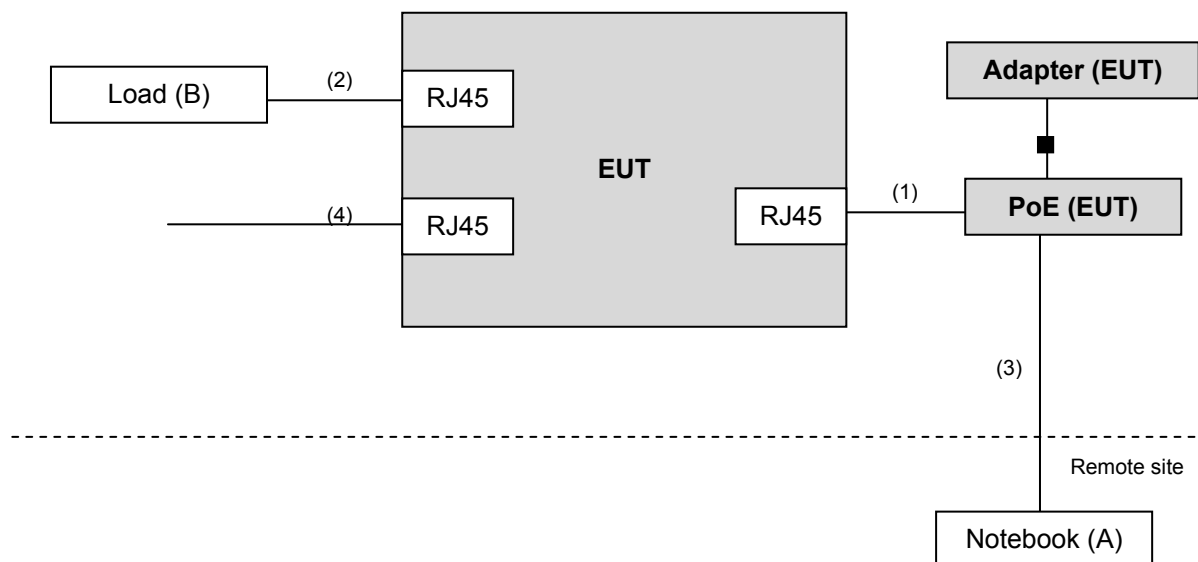

3.5 General Description of Applied Standards

The EUT is a RF Product. According to the specifications of the manufacturer, it must comply with the requirements of the following standards:

FCC Part 15, Subpart E (15.407)

KDB 789033 D02 General UNII Test Procedures New Rules v01r03

KDB 662911 D01 Multiple Transmitter Output v02r01

ANSI C63.10-2013

All test items have been performed and recorded as per the above standards.

Note: The EUT has been verified to comply with the requirements of FCC Part 15, Subpart B, Class B (DoC).
The test report has been issued separately.

4 Test Types and Results

4.1 Radiated Emission and Bandedge Measurement

4.1.1 Limits of Radiated Emission and Bandedge Measurement

Radiated emissions which fall in the restricted bands must comply with the radiated emission limits specified as below table. Other emissions shall be at least 20dB below the highest level of the desired power:

Frequencies (MHz)	Field Strength (microvolts/meter)	Measurement Distance (meters)
0.009 ~ 0.490	2400/F(kHz)	300
0.490 ~ 1.705	24000/F(kHz)	30
1.705 ~ 30.0	30	30
30 ~ 88	100	3
88 ~ 216	150	3
216 ~ 960	200	3
Above 960	500	3

NOTE:

1. The lower limit shall apply at the transition frequencies.
2. Emission level (dBuV/m) = 20 log Emission level (uV/m).
3. For frequencies above 1000MHz, the field strength limits are based on average detector, however, the peak field strength of any emission shall not exceed the maximum permitted average limits, specified above by more than 20dB under any condition of modulation.

Limits of Unwanted Emission Out of the Restricted Bands

Applicable To		Limit	
789033 D02 General UNII Test Procedure New Rules v01r03		Field Strength at 3m	
		PK:74 (dBµV/m)	AV:54 (dBµV/m)
Frequency Band	Applicable To	EIRP Limit	Equivalent Field Strength at 3m
5150~5250 MHz	15.407(b)(1)	PK:-27 (dBm/MHz)	PK:68.2(dBµV/m)
5250~5350 MHz	15.407(b)(2)		
5470~5725 MHz	15.407(b)(3)		
5725~5850 MHz	<input checked="" type="checkbox"/> 15.407(b)(4)(i)	PK:-27 (dBm/MHz) ^{*1} PK:10 (dBm/MHz) ^{*2} PK:15.6 (dBm/MHz) ^{*3} PK:27 (dBm/MHz) ^{*4}	PK: 68.2(dBµV/m) ^{*1} PK:105.2 (dBµV/m) ^{*2} PK: 110.8(dBµV/m) ^{*3} PK:122.2 (dBµV/m) ^{*4}
	<input type="checkbox"/> 15.407(b)(4)(ii)	Emission limits in section 15.247(d)	
^{*1} beyond 75 MHz or more above of the band edge.		^{*2} below the band edge increasing linearly to 10 dBm/MHz at 25 MHz above.	
^{*3} below the band edge increasing linearly to a level of 15.6 dBm/MHz at 5 MHz above.		^{*4} from 5 MHz above or below the band edge increasing linearly to a level of 27 dBm/MHz at the band edge.	

NOTE: The following formula is used to convert the equipment isotropic radiated power (eirp) to field strength:

$$E = \frac{1000000 \sqrt{30P}}{3} \mu\text{V/m, where } P \text{ is the eirp (Watts).}$$

4.1.2 Test Instruments

DESCRIPTION & MANUFACTURER	MODEL NO.	SERIAL NO.	DATE OF CALIBRATION	DUE DATE OF CALIBRATION
Test Receiver ROHDE & SCHWARZ	ESIB7	100187	Apr. 18, 2016	Apr. 17, 2017
Spectrum Analyzer ROHDE & SCHWARZ	FSP40	100041	Nov. 16, 2016	Nov. 15, 2017
BILOG Antenna SCHWARZBECK	VULB9168	9168-171	Jan. 07, 2016	Jan. 06, 2017
HORN Antenna SCHWARZBECK	9120D	209	Jan. 20, 2016	Jan. 19, 2017
HORN Antenna SCHWARZBECK	BBHA 9170	BBHA9170241	Jan. 18, 2016	Jan. 17, 2017
Loop Antenna	EM-6879	269	Aug. 11, 2016	Aug. 10, 2017
Preamplifier Agilent	8447D	2944A10738	Aug. 22, 2016	Aug. 21, 2017
Preamplifier Agilent	8449B	3008A01964	Aug. 22, 2016	Aug. 21, 2017
RF signal cable HUBER+SUHNER	SUCOFLEX 104	Cable-CH3-03 (214378)	Aug. 22, 2016	Aug. 21, 2017
RF signal cable HUBER+SUHNER	SUCOFLEX 106	Cable-CH3-03 (309224+12738)	Aug. 22, 2016	Aug. 21, 2017
Software BV ADT	ADT_Radiated_ V7.6.15.9.4	NA	NA	NA
Antenna Tower inn-co GmbH	MA 4000	013303	NA	NA
Antenna Tower Controller BV ADT	AT100	AT93021702	NA	NA
Turn Table BV ADT	TT100	TT93021702	NA	NA
Turn Table Controller BV ADT	SC100	SC93021702	NA	NA
26GHz ~ 40GHz Amplifier	EM26400	815221	Oct. 17, 2016	Oct. 16, 2017
High Speed Peak Power Meter	ML2495A	0842014	Apr. 28, 2016	Apr. 27, 2017
Power Sensor	MA2411B	0738171	Aug. 11, 2016	Aug. 10, 2017

Note: 1. The calibration interval of the above test instruments is 12 months and the calibrations are traceable to NML/ROC and NIST/USA.

2. The test was performed in HwaYa Chamber 3.

3. The horn antenna and preamplifier (model: 8449B) are used only for the measurement of emission frequency above 1GHz if tested.

4. The FCC Site Registration No. is 988962.

5. The IC Site Registration No. is IC 7450F-3.

4.1.3 Test Procedures

For Radiated emission below 30MHz

- a. The EUT was placed on the top of a rotating table 0.8 meters above the ground at a 3 meter chamber room. The table was rotated 360 degrees to determine the position of the highest radiation.
- b. The EUT was set 3 meters away from the interference-receiving antenna, which was mounted on the top of a variable-height antenna tower.
- c. Both X and Y axes of the antenna are set to make the measurement.
- d. For each suspected emission, the EUT was arranged to its worst case and the rotatable table was turned from 0 degrees to 360 degrees to find the maximum reading.
- e. The test-receiver system was set to Quasi-Peak Detect Function and Specified Bandwidth with Maximum Hold Mode.

NOTE:

1. The resolution bandwidth and video bandwidth of test receiver/spectrum analyzer is 9kHz at frequency below 30MHz.

For Radiated emission above 30MHz

- a. The EUT was placed on the top of a rotating table 0.8 meters (for 30MHz ~ 1GHz) / 1.5 meters (for above 1GHz) above the ground at 3 meter chamber room for test. The table was rotated 360 degrees to determine the position of the highest radiation.
- b. The EUT was set 3 meters away from the interference-receiving antenna, which was mounted on the top of a variable-height antenna tower.
- c. The height of antenna is varied from one meter to four meters above the ground to determine the maximum value of the field strength. Both horizontal and vertical polarizations of the antenna are set to make the measurement.
- d. For each suspected emission, the EUT was arranged to its worst case and then the antenna was tuned to heights from 1 meter to 4 meters and the rotatable table was turned from 0 degrees to 360 degrees to find the maximum reading.
- e. The test-receiver system was set to quasi-peak detect function and specified bandwidth with maximum hold mode when the test frequency is below 1 GHz.
- f. The test-receiver system was set to peak and average detect function and specified bandwidth with maximum hold mode when the test frequency is above 1 GHz. If the peak reading value also meets average limit, measurement with the average detector is unnecessary.

Note:

1. The resolution bandwidth and video bandwidth of test receiver/spectrum analyzer is 120kHz for Quasi-peak detection (QP) at frequency below 1GHz.
2. The resolution bandwidth of test receiver/spectrum analyzer is 1 MHz and the video bandwidth is 3 MHz for Peak detection (PK) at frequency above 1GHz.
3. The resolution bandwidth of test receiver/spectrum analyzer is 1MHz and the video bandwidth is $\geq 1/T$ (Duty cycle < 98%) or 10Hz (Duty cycle $\geq 98\%$) for Average detection (AV) at frequency above 1GHz.
4. All modes of operation were investigated and the worst-case emissions are reported.

4.1.4 Deviation from Test Standard

No deviation.

4.1.5 Test Setup

For Radiated emission below 30MHz

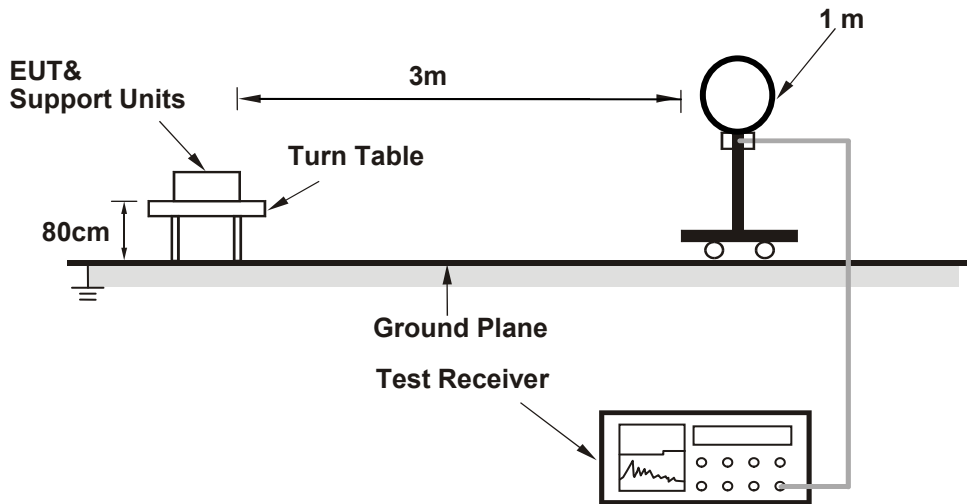

For Radiated emission 30MHz to 1GHz

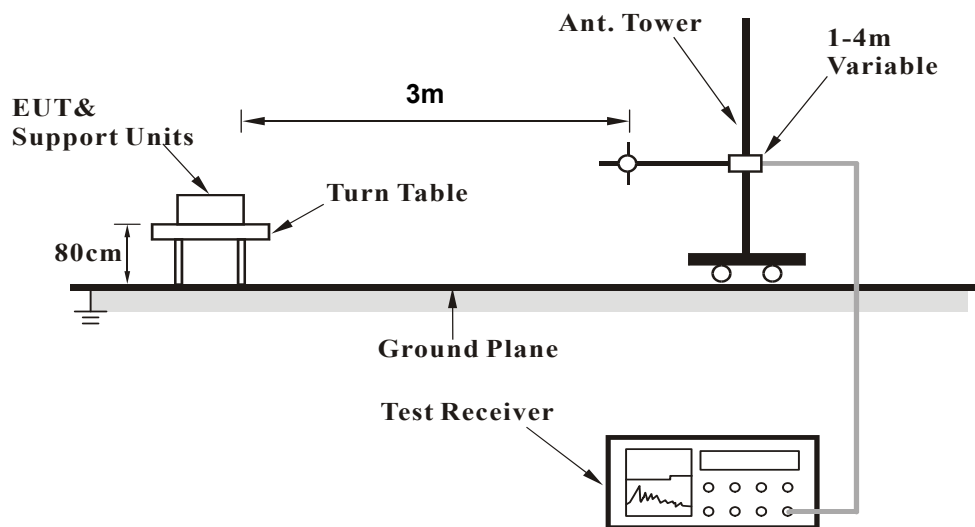

For Radiated emission above 1GHz

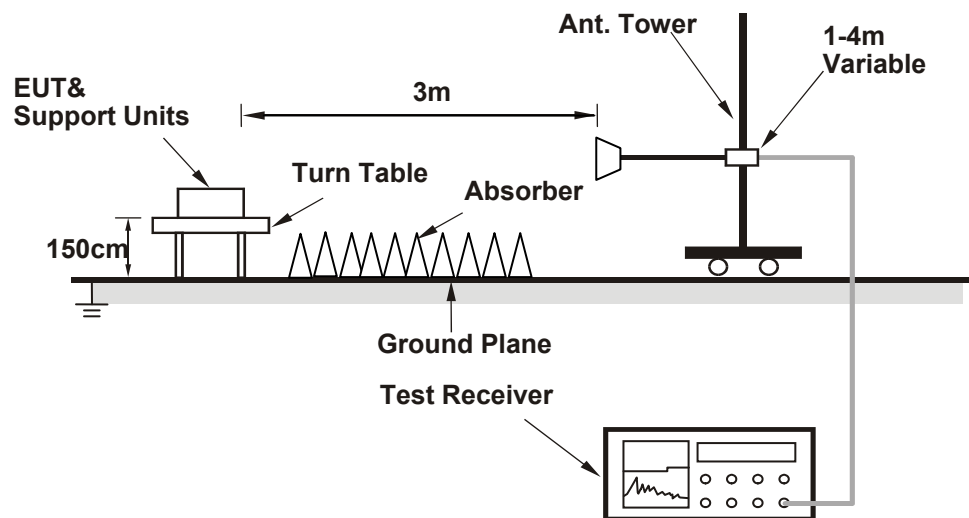

For the actual test configuration, please refer to the attached file (Test Setup Photo).

4.1.6 EUT Operating Conditions

- Placed the EUT on the testing table.
- Prepared a notebook to act as a communication partner and placed it outside of testing area.
- The communication partner connected with EUT via a RJ45 cable and ran a test program (provided by manufacturer) to enable EUT under transmission condition continuously at specific channel frequency.
- The communication partner sent data to EUT by command "PING".
- The necessary accessories enable the system in full functions.

4.1.7 Test Results

Above 1GHz data:

802.11a

CHANNEL	TX Channel 52	DETECTOR FUNCTION	Peak (PK)
FREQUENCY RANGE	1GHz ~ 40GHz		Average (AV)

ANTENNA POLARITY & TEST DISTANCE: HORIZONTAL AT 3 M

NO.	FREQ. (MHz)	EMISSION LEVEL (dBuV/m)	LIMIT (dBuV/m)	MARGIN (dB)	ANTENNA HEIGHT (m)	TABLE ANGLE (Degree)	RAW VALUE (dBuV)	CORRECTION FACTOR (dB/m)
1	5150.00	54.5 PK	74.0	-19.5	1.65 H	186	49.7	4.8
2	5150.00	42.2 AV	54.0	-11.8	1.65 H	186	37.4	4.8
3	*5260.00	102.4 PK			1.53 H	169	63.5	38.9
4	*5260.00	91.3 AV			1.53 H	169	52.4	38.9
5	#10520.00	59.4 PK	74.0	-14.6	3.06 H	320	40.8	18.6
6	#10520.00	46.6 AV	54.0	-7.4	3.06 H	320	28.0	18.6

ANTENNA POLARITY & TEST DISTANCE: VERTICAL AT 3 M

NO.	FREQ. (MHz)	EMISSION LEVEL (dBuV/m)	LIMIT (dBuV/m)	MARGIN (dB)	ANTENNA HEIGHT (m)	TABLE ANGLE (Degree)	RAW VALUE (dBuV)	CORRECTION FACTOR (dB/m)
1	5150.00	56.0 PK	74.0	-18.0	1.37 V	322	51.2	4.8
2	5150.00	42.8 AV	54.0	-11.2	1.37 V	322	38.0	4.8
3	*5260.00	122.7 PK			1.67 V	171	83.8	38.9
4	*5260.00	111.5 AV			1.67 V	171	72.6	38.9
5	#10520.00	64.3 PK	74.0	-9.7	1.52 V	351	45.7	18.6
6	#10520.00	51.2 AV	54.0	-2.8	1.52 V	351	32.6	18.6

REMARKS:

1. Emission Level(dBuV/m) = Raw Value(dBuV) + Correction Factor(dB/m)
2. Correction Factor(dB/m) = Antenna Factor(dB/m) + Cable Factor(dB) – Pre-Amplifier Factor(dB)
3. The other emission levels were very low against the limit.
4. Margin value = Emission Level – Limit value
5. " * ": Fundamental frequency.
6. " # ": The radiated frequency is out of the restricted band.

CHANNEL	TX Channel 60	DETECTOR FUNCTION	Peak (PK)
FREQUENCY RANGE	1GHz ~ 40GHz		Average (AV)

ANTENNA POLARITY & TEST DISTANCE: HORIZONTAL AT 3 M

NO.	FREQ. (MHz)	EMISSION LEVEL (dBuV/m)	LIMIT (dBuV/m)	MARGIN (dB)	ANTENNA HEIGHT (m)	TABLE ANGLE (Degree)	RAW VALUE (dBuV)	CORRECTION FACTOR (dB/m)
1	*5300.00	102.5 PK			1.50 H	141	63.4	39.1
2	*5300.00	92.0 AV			1.50 H	141	52.9	39.1
3	10600.00	59.2 PK	74.0	-14.8	3.02 H	316	40.7	18.5
4	10600.00	46.5 AV	54.0	-7.5	3.02 H	316	28.0	18.5

ANTENNA POLARITY & TEST DISTANCE: VERTICAL AT 3 M

NO.	FREQ. (MHz)	EMISSION LEVEL (dBuV/m)	LIMIT (dBuV/m)	MARGIN (dB)	ANTENNA HEIGHT (m)	TABLE ANGLE (Degree)	RAW VALUE (dBuV)	CORRECTION FACTOR (dB/m)
1	*5300.00	121.9 PK			1.51 V	174	82.8	39.1
2	*5300.00	110.9 AV			1.51 V	174	71.8	39.1
3	10600.00	62.8 PK	74.0	-11.2	1.66 V	353	44.3	18.5
4	10600.00	50.5 AV	54.0	-3.5	1.66 V	353	32.0	18.5

REMARKS:

1. Emission Level(dBuV/m) = Raw Value(dBuV) + Correction Factor(dB/m)
2. Correction Factor(dB/m) = Antenna Factor(dB/m) + Cable Factor(dB) – Pre-Amplifier Factor(dB)
3. The other emission levels were very low against the limit.
4. Margin value = Emission Level – Limit value
5. " * ": Fundamental frequency.
6. " # ": The radiated frequency is out of the restricted band.

CHANNEL	TX Channel 64	DETECTOR FUNCTION	Peak (PK)
FREQUENCY RANGE	1GHz ~ 40GHz		Average (AV)

ANTENNA POLARITY & TEST DISTANCE: HORIZONTAL AT 3 M

NO.	FREQ. (MHz)	EMISSION LEVEL (dBuV/m)	LIMIT (dBuV/m)	MARGIN (dB)	ANTENNA HEIGHT (m)	TABLE ANGLE (Degree)	RAW VALUE (dBuV)	CORRECTION FACTOR (dB/m)
1	*5320.00	102.8 PK			1.50 H	332	63.7	39.1
2	*5320.00	92.3 AV			1.50 H	332	53.2	39.1
3	5350.00	56.5 PK	74.0	-17.5	1.61 H	318	51.0	5.5
4	5350.00	44.0 AV	54.0	-10.0	1.61 H	318	38.5	5.5
5	10640.00	58.9 PK	74.0	-15.1	3.03 H	326	40.4	18.5
6	10640.00	46.2 AV	54.0	-7.8	3.03 H	326	27.7	18.5

ANTENNA POLARITY & TEST DISTANCE: VERTICAL AT 3 M

NO.	FREQ. (MHz)	EMISSION LEVEL (dBuV/m)	LIMIT (dBuV/m)	MARGIN (dB)	ANTENNA HEIGHT (m)	TABLE ANGLE (Degree)	RAW VALUE (dBuV)	CORRECTION FACTOR (dB/m)
1	*5320.00	122.4 PK			1.88 V	171	83.3	39.1
2	*5320.00	111.4 AV			1.88 V	171	72.3	39.1
3	5350.00	65.3 PK	74.0	-8.7	1.87 V	149	59.8	5.5
4	5350.00	52.2 AV	54.0	-1.8	1.87 V	149	46.7	5.5
5	10640.00	61.6 PK	74.0	-12.4	1.65 V	352	43.1	18.5
6	10640.00	48.9 AV	54.0	-5.1	1.65 V	352	30.4	18.5

REMARKS:

1. Emission Level(dBuV/m) = Raw Value(dBuV) + Correction Factor(dB/m)
2. Correction Factor(dB/m) = Antenna Factor(dB/m) + Cable Factor(dB) – Pre-Amplifier Factor(dB)
3. The other emission levels were very low against the limit.
4. Margin value = Emission Level – Limit value
5. " * ": Fundamental frequency.

CHANNEL	TX Channel 100	DETECTOR FUNCTION	Peak (PK)
FREQUENCY RANGE	1GHz ~ 40GHz		Average (AV)

ANTENNA POLARITY & TEST DISTANCE: HORIZONTAL AT 3 M

NO.	FREQ. (MHz)	EMISSION LEVEL (dBuV/m)	LIMIT (dBuV/m)	MARGIN (dB)	ANTENNA HEIGHT (m)	TABLE ANGLE (Degree)	RAW VALUE (dBuV)	CORRECTION FACTOR (dB/m)
1	5460.00	56.4 PK	74.0	-17.6	1.49 H	205	50.7	5.7
2	5460.00	44.1 AV	54.0	-9.9	1.49 H	205	38.4	5.7
3	#5470.00	57.7 PK	74.0	-16.3	1.52 H	190	52.0	5.7
4	#5470.00	44.0 AV	54.0	-10.0	1.52 H	190	38.3	5.7
5	*5500.00	103.2 PK			1.46 H	201	63.6	39.6
6	*5500.00	92.9 AV			1.46 H	201	53.3	39.6
7	11000.00	59.1 PK	74.0	-14.9	3.06 H	302	39.4	19.7
8	11000.00	46.8 AV	54.0	-7.2	3.06 H	302	27.1	19.7

ANTENNA POLARITY & TEST DISTANCE: VERTICAL AT 3 M

NO.	FREQ. (MHz)	EMISSION LEVEL (dBuV/m)	LIMIT (dBuV/m)	MARGIN (dB)	ANTENNA HEIGHT (m)	TABLE ANGLE (Degree)	RAW VALUE (dBuV)	CORRECTION FACTOR (dB/m)
1	5460.00	60.0 PK	74.0	-14.0	1.63 V	159	54.3	5.7
2	5460.00	47.8 AV	54.0	-6.2	1.63 V	159	42.1	5.7
3	#5470.00	66.5 PK	74.0	-7.5	1.52 V	151	60.8	5.7
4	#5470.00	52.6 AV	54.0	-1.4	1.52 V	151	46.9	5.7
5	*5500.00	120.4 PK			1.45 V	349	80.8	39.6
6	*5500.00	109.3 AV			1.45 V	349	69.7	39.6
7	11000.00	63.5 PK	74.0	-10.5	1.78 V	158	43.8	19.7
8	11000.00	50.4 AV	54.0	-3.6	1.78 V	158	30.7	19.7

REMARKS:

1. Emission Level(dBuV/m) = Raw Value(dBuV) + Correction Factor(dB/m)
2. Correction Factor(dB/m) = Antenna Factor(dB/m) + Cable Factor(dB) – Pre-Amplifier Factor(dB)
3. The other emission levels were very low against the limit.
4. Margin value = Emission Level – Limit value
5. " * ": Fundamental frequency.
6. " # ": The radiated frequency is out of the restricted band.

CHANNEL	TX Channel 116	DETECTOR FUNCTION	Peak (PK)
FREQUENCY RANGE	1GHz ~ 40GHz		Average (AV)

ANTENNA POLARITY & TEST DISTANCE: HORIZONTAL AT 3 M

NO.	FREQ. (MHz)	EMISSION LEVEL (dBuV/m)	LIMIT (dBuV/m)	MARGIN (dB)	ANTENNA HEIGHT (m)	TABLE ANGLE (Degree)	RAW VALUE (dBuV)	CORRECTION FACTOR (dB/m)
1	*5580.00	104.7 PK			1.68 H	191	64.9	39.8
2	*5580.00	94.7 AV			1.68 H	191	54.9	39.8
3	11160.00	59.9 PK	74.0	-14.1	3.01 H	313	40.4	19.5
4	11160.00	47.2 AV	54.0	-6.8	3.01 H	313	27.7	19.5

ANTENNA POLARITY & TEST DISTANCE: VERTICAL AT 3 M

NO.	FREQ. (MHz)	EMISSION LEVEL (dBuV/m)	LIMIT (dBuV/m)	MARGIN (dB)	ANTENNA HEIGHT (m)	TABLE ANGLE (Degree)	RAW VALUE (dBuV)	CORRECTION FACTOR (dB/m)
1	*5580.00	121.1 PK			1.50 V	349	81.3	39.8
2	*5580.00	110.5 AV			1.50 V	349	70.7	39.8
3	11160.00	63.3 PK	74.0	-10.7	1.68 V	174	43.8	19.5
4	11160.00	51.0 AV	54.0	-3.0	1.68 V	174	31.5	19.5

REMARKS:

1. Emission Level(dBuV/m) = Raw Value(dBuV) + Correction Factor(dB/m)
2. Correction Factor(dB/m) = Antenna Factor(dB/m) + Cable Factor(dB) – Pre-Amplifier Factor(dB)
3. The other emission levels were very low against the limit.
4. Margin value = Emission Level – Limit value
5. " * ": Fundamental frequency.

CHANNEL	TX Channel 140	DETECTOR FUNCTION	Peak (PK)
FREQUENCY RANGE	1GHz ~ 40GHz		Average (AV)

ANTENNA POLARITY & TEST DISTANCE: HORIZONTAL AT 3 M

NO.	FREQ. (MHz)	EMISSION LEVEL (dBuV/m)	LIMIT (dBuV/m)	MARGIN (dB)	ANTENNA HEIGHT (m)	TABLE ANGLE (Degree)	RAW VALUE (dBuV)	CORRECTION FACTOR (dB/m)
1	*5700.00	103.8 PK			1.71 H	338	63.9	39.9
2	*5700.00	93.0 AV			1.71 H	338	53.1	39.9
3	#5725.00	56.9 PK	74.0	-17.1	1.60 H	328	50.6	6.3
4	#5725.00	44.1 AV	54.0	-9.9	1.60 H	328	37.8	6.3
5	11400.00	60.9 PK	74.0	-13.1	2.97 H	308	41.6	19.3
6	11400.00	47.8 AV	54.0	-6.2	2.97 H	308	28.5	19.3

ANTENNA POLARITY & TEST DISTANCE: VERTICAL AT 3 M

NO.	FREQ. (MHz)	EMISSION LEVEL (dBuV/m)	LIMIT (dBuV/m)	MARGIN (dB)	ANTENNA HEIGHT (m)	TABLE ANGLE (Degree)	RAW VALUE (dBuV)	CORRECTION FACTOR (dB/m)
1	*5700.00	121.5 PK			1.48 V	351	81.6	39.9
2	*5700.00	110.4 AV			1.48 V	351	70.5	39.9
3	#5725.00	64.6 PK	74.0	-9.4	1.63 V	171	58.3	6.3
4	#5725.00	51.2 AV	54.0	-2.8	1.63 V	171	44.9	6.3
5	11400.00	60.7 PK	74.0	-13.3	1.61 V	162	41.4	19.3
6	11400.00	48.4 AV	54.0	-5.6	1.61 V	162	29.1	19.3

REMARKS:

1. Emission Level(dBuV/m) = Raw Value(dBuV) + Correction Factor(dB/m)
2. Correction Factor(dB/m) = Antenna Factor(dB/m) + Cable Factor(dB) – Pre-Amplifier Factor(dB)
3. The other emission levels were very low against the limit.
4. Margin value = Emission Level – Limit value
5. " * ": Fundamental frequency.
6. " # ": The radiated frequency is out of the restricted band.

CHANNEL	TX Channel 144	DETECTOR FUNCTION	Peak (PK)
FREQUENCY RANGE	1GHz ~ 40GHz		Average (AV)

ANTENNA POLARITY & TEST DISTANCE: HORIZONTAL AT 3 M

NO.	FREQ. (MHz)	EMISSION LEVEL (dBuV/m)	LIMIT (dBuV/m)	MARGIN (dB)	ANTENNA HEIGHT (m)	TABLE ANGLE (Degree)	RAW VALUE (dBuV)	CORRECTION FACTOR (dB/m)
1	#5470.00	58.6 PK	74.0	-15.4	1.34 H	77	52.9	5.7
2	#5470.00	47.5 AV	54.0	-6.5	1.34 H	77	41.8	5.7
3	*5720.00	107.3 PK			1.77 H	348	67.3	40.0
4	*5720.00	97.2 AV			1.77 H	348	57.2	40.0
5	#5850.00	58.8 PK	74.0	-15.2	2.20 H	322	52.3	6.5
6	#5850.00	47.7 AV	54.0	-6.3	2.20 H	322	41.2	6.5
7	11440.00	62.3 PK	74.0	-11.7	4.00 H	240	43.0	19.3
8	11440.00	49.8 AV	54.0	-4.2	4.00 H	240	30.5	19.3

ANTENNA POLARITY & TEST DISTANCE: VERTICAL AT 3 M

NO.	FREQ. (MHz)	EMISSION LEVEL (dBuV/m)	LIMIT (dBuV/m)	MARGIN (dB)	ANTENNA HEIGHT (m)	TABLE ANGLE (Degree)	RAW VALUE (dBuV)	CORRECTION FACTOR (dB/m)
1	#5470.00	59.4 PK	74.0	-14.6	1.70 V	212	53.7	5.7
2	#5470.00	47.3 AV	54.0	-6.7	1.70 V	212	41.6	5.7
3	*5720.00	125.6 PK			1.82 V	165	85.6	40.0
4	*5720.00	114.7 AV			1.82 V	165	74.7	40.0
5	#5850.00	61.9 PK	74.0	-12.1	1.68 V	63	55.4	6.5
6	#5850.00	50.2 AV	54.0	-3.8	1.68 V	63	43.7	6.5
7	11440.00	63.4 PK	74.0	-10.6	1.80 V	326	44.1	19.3
8	11440.00	50.7 AV	54.0	-3.3	1.80 V	326	31.4	19.3

REMARKS:

1. Emission Level(dBuV/m) = Raw Value(dBuV) + Correction Factor(dB/m)
2. Correction Factor(dB/m) = Antenna Factor(dB/m) + Cable Factor(dB) – Pre-Amplifier Factor(dB)
3. The other emission levels were very low against the limit.
4. Margin value = Emission Level – Limit value
5. " * " : Fundamental frequency.
6. " # " : The radiated frequency is out of the restricted band.

802.11n (HT20)

CHANNEL	TX Channel 52	DETECTOR FUNCTION	Peak (PK)
FREQUENCY RANGE	1GHz ~ 40GHz		Average (AV)

ANTENNA POLARITY & TEST DISTANCE: HORIZONTAL AT 3 M

NO.	FREQ. (MHz)	EMISSION LEVEL (dBuV/m)	LIMIT (dBuV/m)	MARGIN (dB)	ANTENNA HEIGHT (m)	TABLE ANGLE (Degree)	RAW VALUE (dBuV)	CORRECTION FACTOR (dB/m)
1	5150.00	54.9 PK	74.0	-19.1	1.46 H	317	50.1	4.8
2	5150.00	42.3 AV	54.0	-11.7	1.46 H	317	37.5	4.8
3	*5260.00	101.4 PK			1.38 H	327	62.5	38.9
4	*5260.00	91.1 AV			1.38 H	327	52.2	38.9
5	#10520.00	59.0 PK	74.0	-15.0	3.12 H	318	40.4	18.6
6	#10520.00	46.7 AV	54.0	-7.3	3.12 H	318	28.1	18.6

ANTENNA POLARITY & TEST DISTANCE: VERTICAL AT 3 M

NO.	FREQ. (MHz)	EMISSION LEVEL (dBuV/m)	LIMIT (dBuV/m)	MARGIN (dB)	ANTENNA HEIGHT (m)	TABLE ANGLE (Degree)	RAW VALUE (dBuV)	CORRECTION FACTOR (dB/m)
1	5150.00	55.4 PK	74.0	-18.6	1.59 V	154	50.6	4.8
2	5150.00	43.1 AV	54.0	-10.9	1.59 V	154	38.3	4.8
3	*5260.00	121.7 PK			1.48 V	173	82.8	38.9
4	*5260.00	110.6 AV			1.48 V	173	71.7	38.9
5	#10520.00	63.4 PK	74.0	-10.6	1.51 V	353	44.8	18.6
6	#10520.00	50.8 AV	54.0	-3.2	1.51 V	353	32.2	18.6

REMARKS:

1. Emission Level(dBuV/m) = Raw Value(dBuV) + Correction Factor(dB/m)
2. Correction Factor(dB/m) = Antenna Factor(dB/m) + Cable Factor(dB) – Pre-Amplifier Factor(dB)
3. The other emission levels were very low against the limit.
4. Margin value = Emission Level – Limit value
5. " * ": Fundamental frequency.
6. " # ": The radiated frequency is out of the restricted band.

CHANNEL	TX Channel 60	DETECTOR FUNCTION	Peak (PK)
FREQUENCY RANGE	1GHz ~ 40GHz		Average (AV)

ANTENNA POLARITY & TEST DISTANCE: HORIZONTAL AT 3 M

NO.	FREQ. (MHz)	EMISSION LEVEL (dBuV/m)	LIMIT (dBuV/m)	MARGIN (dB)	ANTENNA HEIGHT (m)	TABLE ANGLE (Degree)	RAW VALUE (dBuV)	CORRECTION FACTOR (dB/m)
1	*5300.00	103.2 PK			1.59 H	144	64.1	39.1
2	*5300.00	92.7 AV			1.59 H	144	53.6	39.1
3	10600.00	59.0 PK	74.0	-15.0	2.99 H	317	40.5	18.5
4	10600.00	46.5 AV	54.0	-7.5	2.99 H	317	28.0	18.5

ANTENNA POLARITY & TEST DISTANCE: VERTICAL AT 3 M

NO.	FREQ. (MHz)	EMISSION LEVEL (dBuV/m)	LIMIT (dBuV/m)	MARGIN (dB)	ANTENNA HEIGHT (m)	TABLE ANGLE (Degree)	RAW VALUE (dBuV)	CORRECTION FACTOR (dB/m)
1	*5300.00	121.3 PK			1.53 V	166	82.2	39.1
2	*5300.00	111.1 AV			1.53 V	166	72.0	39.1
3	10600.00	62.6 PK	74.0	-11.4	1.63 V	352	44.1	18.5
4	10600.00	49.9 AV	54.0	-4.1	1.63 V	352	31.4	18.5

REMARKS:

1. Emission Level(dBuV/m) = Raw Value(dBuV) + Correction Factor(dB/m)
2. Correction Factor(dB/m) = Antenna Factor(dB/m) + Cable Factor(dB) – Pre-Amplifier Factor(dB)
3. The other emission levels were very low against the limit.
4. Margin value = Emission Level – Limit value
5. " * ": Fundamental frequency.

CHANNEL	TX Channel 64	DETECTOR FUNCTION	Peak (PK)
FREQUENCY RANGE	1GHz ~ 40GHz		Average (AV)

ANTENNA POLARITY & TEST DISTANCE: HORIZONTAL AT 3 M

NO.	FREQ. (MHz)	EMISSION LEVEL (dBuV/m)	LIMIT (dBuV/m)	MARGIN (dB)	ANTENNA HEIGHT (m)	TABLE ANGLE (Degree)	RAW VALUE (dBuV)	CORRECTION FACTOR (dB/m)
1	*5320.00	102.5 PK			1.37 H	331	63.4	39.1
2	*5320.00	91.9 AV			1.37 H	331	52.8	39.1
3	5350.00	56.8 PK	74.0	-17.2	1.45 H	342	51.3	5.5
4	5350.00	44.0 AV	54.0	-10.0	1.45 H	342	38.5	5.5
5	10640.00	58.5 PK	74.0	-15.5	2.94 H	321	40.0	18.5
6	10640.00	46.0 AV	54.0	-8.0	2.94 H	321	27.5	18.5

ANTENNA POLARITY & TEST DISTANCE: VERTICAL AT 3 M

NO.	FREQ. (MHz)	EMISSION LEVEL (dBuV/m)	LIMIT (dBuV/m)	MARGIN (dB)	ANTENNA HEIGHT (m)	TABLE ANGLE (Degree)	RAW VALUE (dBuV)	CORRECTION FACTOR (dB/m)
1	*5320.00	122.1 PK			1.66 V	167	83.0	39.1
2	*5320.00	111.1 AV			1.66 V	167	72.0	39.1
3	5350.00	64.1 PK	74.0	-9.9	1.50 V	359	58.6	5.5
4	5350.00	51.1 AV	54.0	-2.9	1.50 V	359	45.6	5.5
5	10640.00	60.8 PK	74.0	-13.2	1.48 V	351	42.3	18.5
6	10640.00	48.4 AV	54.0	-5.6	1.48 V	351	29.9	18.5

REMARKS:

1. Emission Level(dBuV/m) = Raw Value(dBuV) + Correction Factor(dB/m)
2. Correction Factor(dB/m) = Antenna Factor(dB/m) + Cable Factor(dB) – Pre-Amplifier Factor(dB)
3. The other emission levels were very low against the limit.
4. Margin value = Emission Level – Limit value
5. " * ": Fundamental frequency.

CHANNEL	TX Channel 100	DETECTOR FUNCTION	Peak (PK)
FREQUENCY RANGE	1GHz ~ 40GHz		Average (AV)

ANTENNA POLARITY & TEST DISTANCE: HORIZONTAL AT 3 M

NO.	FREQ. (MHz)	EMISSION LEVEL (dBuV/m)	LIMIT (dBuV/m)	MARGIN (dB)	ANTENNA HEIGHT (m)	TABLE ANGLE (Degree)	RAW VALUE (dBuV)	CORRECTION FACTOR (dB/m)
1	5460.00	56.7 PK	74.0	-17.3	1.49 H	205	51.0	5.7
2	5460.00	44.1 AV	54.0	-9.9	1.49 H	205	38.4	5.7
3	#5470.00	56.8 PK	74.0	-17.2	1.54 H	219	51.1	5.7
4	#5470.00	43.9 AV	54.0	-10.1	1.54 H	219	38.2	5.7
5	*5500.00	102.7 PK			1.45 H	202	63.1	39.6
6	*5500.00	91.7 AV			1.45 H	202	52.1	39.6
7	11000.00	59.6 PK	74.0	-14.4	3.03 H	313	39.9	19.7
8	11000.00	47.0 AV	54.0	-7.0	3.03 H	313	27.3	19.7

ANTENNA POLARITY & TEST DISTANCE: VERTICAL AT 3 M

NO.	FREQ. (MHz)	EMISSION LEVEL (dBuV/m)	LIMIT (dBuV/m)	MARGIN (dB)	ANTENNA HEIGHT (m)	TABLE ANGLE (Degree)	RAW VALUE (dBuV)	CORRECTION FACTOR (dB/m)
1	5460.00	59.8 PK	74.0	-14.2	1.62 V	163	54.1	5.7
2	5460.00	47.1 AV	54.0	-6.9	1.62 V	163	41.4	5.7
3	#5470.00	65.9 PK	74.0	-8.1	1.54 V	158	60.2	5.7
4	#5470.00	52.2 AV	54.0	-1.8	1.54 V	158	46.5	5.7
5	*5500.00	119.8 PK			1.48 V	349	80.2	39.6
6	*5500.00	108.8 AV			1.48 V	349	69.2	39.6
7	11000.00	62.6 PK	74.0	-11.4	1.67 V	173	42.9	19.7
8	11000.00	49.8 AV	54.0	-4.2	1.67 V	173	30.1	19.7

REMARKS:

1. Emission Level(dBuV/m) = Raw Value(dBuV) + Correction Factor(dB/m)
2. Correction Factor(dB/m) = Antenna Factor(dB/m) + Cable Factor(dB) – Pre-Amplifier Factor(dB)
3. The other emission levels were very low against the limit.
4. Margin value = Emission Level – Limit value
5. " * ": Fundamental frequency.
6. " # ": The radiated frequency is out of the restricted band.

CHANNEL	TX Channel 116	DETECTOR FUNCTION	Peak (PK)
FREQUENCY RANGE	1GHz ~ 40GHz		Average (AV)

ANTENNA POLARITY & TEST DISTANCE: HORIZONTAL AT 3 M

NO.	FREQ. (MHz)	EMISSION LEVEL (dBuV/m)	LIMIT (dBuV/m)	MARGIN (dB)	ANTENNA HEIGHT (m)	TABLE ANGLE (Degree)	RAW VALUE (dBuV)	CORRECTION FACTOR (dB/m)
1	*5580.00	105.3 PK			1.67 H	192	65.5	39.8
2	*5580.00	93.8 AV			1.67 H	192	54.0	39.8
3	11160.00	59.8 PK	74.0	-14.2	3.05 H	312	40.3	19.5
4	11160.00	47.1 AV	54.0	-6.9	3.05 H	312	27.6	19.5

ANTENNA POLARITY & TEST DISTANCE: VERTICAL AT 3 M

NO.	FREQ. (MHz)	EMISSION LEVEL (dBuV/m)	LIMIT (dBuV/m)	MARGIN (dB)	ANTENNA HEIGHT (m)	TABLE ANGLE (Degree)	RAW VALUE (dBuV)	CORRECTION FACTOR (dB/m)
1	*5580.00	120.4 PK			1.49 V	348	80.6	39.8
2	*5580.00	109.6 AV			1.49 V	348	69.8	39.8
3	11160.00	63.7 PK	74.0	-10.3	1.62 V	169	44.2	19.5
4	11160.00	50.1 AV	54.0	-3.9	1.62 V	169	30.6	19.5

REMARKS:

1. Emission Level(dBuV/m) = Raw Value(dBuV) + Correction Factor(dB/m)
2. Correction Factor(dB/m) = Antenna Factor(dB/m) + Cable Factor(dB) – Pre-Amplifier Factor(dB)
3. The other emission levels were very low against the limit.
4. Margin value = Emission Level – Limit value
5. " * ": Fundamental frequency.

CHANNEL	TX Channel 140	DETECTOR FUNCTION	Peak (PK)
FREQUENCY RANGE	1GHz ~ 40GHz		Average (AV)

ANTENNA POLARITY & TEST DISTANCE: HORIZONTAL AT 3 M

NO.	FREQ. (MHz)	EMISSION LEVEL (dBuV/m)	LIMIT (dBuV/m)	MARGIN (dB)	ANTENNA HEIGHT (m)	TABLE ANGLE (Degree)	RAW VALUE (dBuV)	CORRECTION FACTOR (dB/m)
1	*5700.00	101.8 PK			1.71 H	190	61.9	39.9
2	*5700.00	90.4 AV			1.71 H	190	50.5	39.9
3	#5725.00	56.6 PK	74.0	-17.4	1.63 H	202	50.3	6.3
4	#5725.00	43.7 AV	54.0	-10.3	1.63 H	202	37.4	6.3
5	11400.00	60.1 PK	74.0	-13.9	3.03 H	309	40.8	19.3
6	11400.00	47.6 AV	54.0	-6.4	3.03 H	309	28.3	19.3

ANTENNA POLARITY & TEST DISTANCE: VERTICAL AT 3 M

NO.	FREQ. (MHz)	EMISSION LEVEL (dBuV/m)	LIMIT (dBuV/m)	MARGIN (dB)	ANTENNA HEIGHT (m)	TABLE ANGLE (Degree)	RAW VALUE (dBuV)	CORRECTION FACTOR (dB/m)
1	*5700.00	118.0 PK			1.49 V	351	78.1	39.9
2	*5700.00	107.0 AV			1.49 V	351	67.1	39.9
3	#5725.00	67.4 PK	74.0	-6.6	1.49 V	19	61.1	6.3
4	#5725.00	52.2 AV	54.0	-1.8	1.49 V	19	45.9	6.3
5	11400.00	60.0 PK	74.0	-14.0	1.82 V	177	40.7	19.3
6	11400.00	47.7 AV	54.0	-6.3	1.82 V	177	28.4	19.3

REMARKS:

1. Emission Level(dBuV/m) = Raw Value(dBuV) + Correction Factor(dB/m)
2. Correction Factor(dB/m) = Antenna Factor(dB/m) + Cable Factor(dB) – Pre-Amplifier Factor(dB)
3. The other emission levels were very low against the limit.
4. Margin value = Emission Level – Limit value
5. " * ": Fundamental frequency.
6. " # ": The radiated frequency is out of the restricted band.

CHANNEL	TX Channel 144	DETECTOR FUNCTION	Peak (PK)
FREQUENCY RANGE	1GHz ~ 40GHz		Average (AV)

ANTENNA POLARITY & TEST DISTANCE: HORIZONTAL AT 3 M

NO.	FREQ. (MHz)	EMISSION LEVEL (dBuV/m)	LIMIT (dBuV/m)	MARGIN (dB)	ANTENNA HEIGHT (m)	TABLE ANGLE (Degree)	RAW VALUE (dBuV)	CORRECTION FACTOR (dB/m)
1	#5470.00	56.2 PK	74.0	-17.8	1.77 H	264	50.5	5.7
2	#5470.00	45.6 AV	54.0	-8.4	1.77 H	264	39.9	5.7
3	*5720.00	103.6 PK			1.94 H	126	63.6	40.0
4	*5720.00	93.2 AV			1.94 H	126	53.2	40.0
5	#5850.00	57.3 PK	74.0	-16.7	1.90 H	300	50.8	6.5
6	#5850.00	46.8 AV	54.0	-7.2	1.90 H	300	40.3	6.5
7	11440.00	61.8 PK	74.0	-12.2	1.56 H	55	42.5	19.3
8	11440.00	48.7 AV	54.0	-5.3	1.56 H	55	29.4	19.3

ANTENNA POLARITY & TEST DISTANCE: VERTICAL AT 3 M

NO.	FREQ. (MHz)	EMISSION LEVEL (dBuV/m)	LIMIT (dBuV/m)	MARGIN (dB)	ANTENNA HEIGHT (m)	TABLE ANGLE (Degree)	RAW VALUE (dBuV)	CORRECTION FACTOR (dB/m)
1	#5470.00	57.3 PK	74.0	-16.7	1.77 V	312	51.6	5.7
2	#5470.00	46.2 AV	54.0	-7.8	1.77 V	312	40.5	5.7
3	*5720.00	125.1 PK			1.83 V	162	85.1	40.0
4	*5720.00	114.9 AV			1.83 V	162	74.9	40.0
5	#5850.00	59.9 PK	74.0	-14.1	1.92 V	271	53.4	6.5
6	#5850.00	48.0 AV	54.0	-6.0	1.92 V	271	41.5	6.5
7	11440.00	63.4 PK	74.0	-10.6	1.78 V	327	44.1	19.3
8	11440.00	50.3 AV	54.0	-3.7	1.78 V	327	31.0	19.3

REMARKS:

1. Emission Level(dBuV/m) = Raw Value(dBuV) + Correction Factor(dB/m)
2. Correction Factor(dB/m) = Antenna Factor(dB/m) + Cable Factor(dB) – Pre-Amplifier Factor(dB)
3. The other emission levels were very low against the limit.
4. Margin value = Emission Level – Limit value
5. " * " : Fundamental frequency.
6. " # " : The radiated frequency is out of the restricted band.

802.11n (HT40)

CHANNEL	TX Channel 54	DETECTOR FUNCTION	Peak (PK)
FREQUENCY RANGE	1GHz ~ 40GHz		Average (AV)

ANTENNA POLARITY & TEST DISTANCE: HORIZONTAL AT 3 M

NO.	FREQ. (MHz)	EMISSION LEVEL (dBuV/m)	LIMIT (dBuV/m)	MARGIN (dB)	ANTENNA HEIGHT (m)	TABLE ANGLE (Degree)	RAW VALUE (dBuV)	CORRECTION FACTOR (dB/m)
1	*5270.00	101.3 PK			1.40 H	328	62.3	39.0
2	*5270.00	90.9 AV			1.40 H	328	51.9	39.0
3	5350.00	56.5 PK	74.0	-17.5	1.52 H	315	51.0	5.5
4	5350.00	44.0 AV	54.0	-10.0	1.52 H	315	38.5	5.5
5	#10540.00	59.0 PK	74.0	-15.0	2.90 H	318	40.4	18.6
6	#10540.00	46.7 AV	54.0	-7.3	2.90 H	318	28.1	18.6

ANTENNA POLARITY & TEST DISTANCE: VERTICAL AT 3 M

NO.	FREQ. (MHz)	EMISSION LEVEL (dBuV/m)	LIMIT (dBuV/m)	MARGIN (dB)	ANTENNA HEIGHT (m)	TABLE ANGLE (Degree)	RAW VALUE (dBuV)	CORRECTION FACTOR (dB/m)
1	*5270.00	118.8 PK			1.67 V	169	79.8	39.0
2	*5270.00	108.8 AV			1.67 V	169	69.8	39.0
3	5350.00	60.0 PK	74.0	-14.0	1.64 V	148	54.5	5.5
4	5350.00	47.3 AV	54.0	-6.7	1.64 V	148	41.8	5.5
5	#10540.00	62.1 PK	74.0	-11.9	1.44 V	354	43.5	18.6
6	#10540.00	49.7 AV	54.0	-4.3	1.44 V	354	31.1	18.6

REMARKS:

1. Emission Level(dBuV/m) = Raw Value(dBuV) + Correction Factor(dB/m)
2. Correction Factor(dB/m) = Antenna Factor(dB/m) + Cable Factor(dB) – Pre-Amplifier Factor(dB)
3. The other emission levels were very low against the limit.
4. Margin value = Emission Level – Limit value
5. " * ": Fundamental frequency.
6. " # ": The radiated frequency is out of the restricted band.

CHANNEL	TX Channel 62	DETECTOR FUNCTION	Peak (PK)
FREQUENCY RANGE	1GHz ~ 40GHz		Average (AV)

ANTENNA POLARITY & TEST DISTANCE: HORIZONTAL AT 3 M

NO.	FREQ. (MHz)	EMISSION LEVEL (dBuV/m)	LIMIT (dBuV/m)	MARGIN (dB)	ANTENNA HEIGHT (m)	TABLE ANGLE (Degree)	RAW VALUE (dBuV)	CORRECTION FACTOR (dB/m)
1	*5310.00	95.1 PK			1.48 H	193	56.0	39.1
2	*5310.00	85.7 AV			1.48 H	193	46.6	39.1
3	5350.00	56.7 PK	74.0	-17.3	1.64 H	208	51.2	5.5
4	5350.00	43.8 AV	54.0	-10.2	1.64 H	208	38.3	5.5
5	10620.00	59.1 PK	74.0	-14.9	3.02 H	323	40.6	18.5
6	10620.00	46.4 AV	54.0	-7.6	3.02 H	323	27.9	18.5

ANTENNA POLARITY & TEST DISTANCE: VERTICAL AT 3 M

NO.	FREQ. (MHz)	EMISSION LEVEL (dBuV/m)	LIMIT (dBuV/m)	MARGIN (dB)	ANTENNA HEIGHT (m)	TABLE ANGLE (Degree)	RAW VALUE (dBuV)	CORRECTION FACTOR (dB/m)
1	*5310.00	113.8 PK			1.49 V	164	74.7	39.1
2	*5310.00	104.1 AV			1.49 V	164	65.0	39.1
3	5350.00	65.5 PK	74.0	-8.5	1.57 V	312	60.0	5.5
4	5350.00	52.4 AV	54.0	-1.6	1.57 V	312	46.9	5.5
5	10620.00	58.9 PK	74.0	-15.1	1.56 V	356	40.4	18.5
6	10620.00	46.7 AV	54.0	-7.3	1.56 V	356	28.2	18.5

REMARKS:

1. Emission Level(dBuV/m) = Raw Value(dBuV) + Correction Factor(dB/m)
2. Correction Factor(dB/m) = Antenna Factor(dB/m) + Cable Factor(dB) – Pre-Amplifier Factor(dB)
3. The other emission levels were very low against the limit.
4. Margin value = Emission Level – Limit value
5. " * ": Fundamental frequency.

CHANNEL	TX Channel 102	DETECTOR FUNCTION	Peak (PK)
FREQUENCY RANGE	1GHz ~ 40GHz		Average (AV)

ANTENNA POLARITY & TEST DISTANCE: HORIZONTAL AT 3 M

NO.	FREQ. (MHz)	EMISSION LEVEL (dBuV/m)	LIMIT (dBuV/m)	MARGIN (dB)	ANTENNA HEIGHT (m)	TABLE ANGLE (Degree)	RAW VALUE (dBuV)	CORRECTION FACTOR (dB/m)
1	5460.00	56.1 PK	74.0	-17.9	1.46 H	204	50.4	5.7
2	5460.00	43.8 AV	54.0	-10.2	1.46 H	204	38.1	5.7
3	#5470.00	56.5 PK	74.0	-17.5	1.55 H	217	50.8	5.7
4	#5470.00	43.8 AV	54.0	-10.2	1.55 H	217	38.1	5.7
5	*5510.00	97.4 PK			1.48 H	204	57.8	39.6
6	*5510.00	87.7 AV			1.48 H	204	48.1	39.6
7	11020.00	60.2 PK	74.0	-13.8	2.95 H	315	40.6	19.6
8	11020.00	47.3 AV	54.0	-6.7	2.95 H	315	27.7	19.6

ANTENNA POLARITY & TEST DISTANCE: VERTICAL AT 3 M

NO.	FREQ. (MHz)	EMISSION LEVEL (dBuV/m)	LIMIT (dBuV/m)	MARGIN (dB)	ANTENNA HEIGHT (m)	TABLE ANGLE (Degree)	RAW VALUE (dBuV)	CORRECTION FACTOR (dB/m)
1	5460.00	62.6 PK	74.0	-11.4	1.43 V	167	56.9	5.7
2	5460.00	49.8 AV	54.0	-4.2	1.43 V	167	44.1	5.7
3	#5470.00	66.8 PK	74.0	-7.2	1.44 V	162	61.1	5.7
4	#5470.00	52.3 AV	54.0	-1.7	1.44 V	162	46.6	5.7
5	*5510.00	114.6 PK			1.46 V	345	75.0	39.6
6	*5510.00	105.0 AV			1.46 V	345	65.4	39.6
7	11020.00	60.3 PK	74.0	-13.7	1.67 V	175	40.7	19.6
8	11020.00	48.1 AV	54.0	-5.9	1.67 V	175	28.5	19.6

REMARKS:

1. Emission Level(dBuV/m) = Raw Value(dBuV) + Correction Factor(dB/m)
2. Correction Factor(dB/m) = Antenna Factor(dB/m) + Cable Factor(dB) – Pre-Amplifier Factor(dB)
3. The other emission levels were very low against the limit.
4. Margin value = Emission Level – Limit value
5. " * ": Fundamental frequency.
6. " # ": The radiated frequency is out of the restricted band.

CHANNEL	TX Channel 110	DETECTOR FUNCTION	Peak (PK)
FREQUENCY RANGE	1GHz ~ 40GHz		Average (AV)

ANTENNA POLARITY & TEST DISTANCE: HORIZONTAL AT 3 M

NO.	FREQ. (MHz)	EMISSION LEVEL (dBuV/m)	LIMIT (dBuV/m)	MARGIN (dB)	ANTENNA HEIGHT (m)	TABLE ANGLE (Degree)	RAW VALUE (dBuV)	CORRECTION FACTOR (dB/m)
1	#5470.00	56.8 PK	74.0	-17.2	1.72 H	226	51.1	5.7
2	#5470.00	44.0 AV	54.0	-10.0	1.72 H	226	38.3	5.7
3	*5550.00	101.0 PK			1.85 H	199	61.4	39.6
4	*5550.00	91.2 AV			1.85 H	199	51.6	39.6
5	11100.00	59.9 PK	74.0	-14.1	2.94 H	311	40.7	19.2
6	11100.00	47.2 AV	54.0	-6.8	2.94 H	311	28.0	19.2

ANTENNA POLARITY & TEST DISTANCE: VERTICAL AT 3 M

NO.	FREQ. (MHz)	EMISSION LEVEL (dBuV/m)	LIMIT (dBuV/m)	MARGIN (dB)	ANTENNA HEIGHT (m)	TABLE ANGLE (Degree)	RAW VALUE (dBuV)	CORRECTION FACTOR (dB/m)
1	#5470.00	65.0 PK	74.0	-9.0	1.43 V	357	59.3	5.7
2	#5470.00	50.4 AV	54.0	-3.6	1.43 V	357	44.7	5.7
3	*5550.00	117.1 PK			1.48 V	347	77.5	39.6
4	*5550.00	107.1 AV			1.48 V	347	67.5	39.6
5	11100.00	61.9 PK	74.0	-12.1	1.72 V	178	42.7	19.2
6	11100.00	49.4 AV	54.0	-4.6	1.72 V	178	30.2	19.2

REMARKS:

1. Emission Level(dBuV/m) = Raw Value(dBuV) + Correction Factor(dB/m)
2. Correction Factor(dB/m) = Antenna Factor(dB/m) + Cable Factor(dB) – Pre-Amplifier Factor(dB)
3. The other emission levels were very low against the limit.
4. Margin value = Emission Level – Limit value
5. " * ": Fundamental frequency.

CHANNEL	TX Channel 134	DETECTOR FUNCTION	Peak (PK)
FREQUENCY RANGE	1GHz ~ 40GHz		Average (AV)

ANTENNA POLARITY & TEST DISTANCE: HORIZONTAL AT 3 M

NO.	FREQ. (MHz)	EMISSION LEVEL (dBuV/m)	LIMIT (dBuV/m)	MARGIN (dB)	ANTENNA HEIGHT (m)	TABLE ANGLE (Degree)	RAW VALUE (dBuV)	CORRECTION FACTOR (dB/m)
1	*5670.00	100.1 PK			1.77 H	191	60.3	39.8
2	*5670.00	89.9 AV			1.77 H	191	50.1	39.8
3	#5725.00	56.9 PK	74.0	-17.1	1.67 H	189	50.6	6.3
4	#5725.00	44.0 AV	54.0	-10.0	1.67 H	189	37.7	6.3
5	11340.00	60.4 PK	74.0	-13.6	2.86 H	309	40.9	19.5
6	11340.00	47.5 AV	54.0	-6.5	2.86 H	309	28.0	19.5

ANTENNA POLARITY & TEST DISTANCE: VERTICAL AT 3 M

NO.	FREQ. (MHz)	EMISSION LEVEL (dBuV/m)	LIMIT (dBuV/m)	MARGIN (dB)	ANTENNA HEIGHT (m)	TABLE ANGLE (Degree)	RAW VALUE (dBuV)	CORRECTION FACTOR (dB/m)
1	*5670.00	117.0 PK			1.47 V	342	77.2	39.8
2	*5670.00	106.8 AV			1.47 V	342	67.0	39.8
3	#5725.00	66.2 PK	74.0	-7.8	1.94 V	347	59.9	6.3
4	#5725.00	52.3 AV	54.0	-1.7	1.94 V	347	46.0	6.3
5	11340.00	60.7 PK	74.0	-13.3	1.82 V	166	41.2	19.5
6	11340.00	48.1 AV	54.0	-5.9	1.82 V	166	28.6	19.5

REMARKS:

1. Emission Level(dBuV/m) = Raw Value(dBuV) + Correction Factor(dB/m)
2. Correction Factor(dB/m) = Antenna Factor(dB/m) + Cable Factor(dB) – Pre-Amplifier Factor(dB)
3. The other emission levels were very low against the limit.
4. Margin value = Emission Level – Limit value
5. " * ": Fundamental frequency.
6. " # ": The radiated frequency is out of the restricted band.

CHANNEL	TX Channel 142	DETECTOR FUNCTION	Peak (PK)
FREQUENCY RANGE	1GHz ~ 40GHz		Average (AV)

ANTENNA POLARITY & TEST DISTANCE: HORIZONTAL AT 3 M

NO.	FREQ. (MHz)	EMISSION LEVEL (dBuV/m)	LIMIT (dBuV/m)	MARGIN (dB)	ANTENNA HEIGHT (m)	TABLE ANGLE (Degree)	RAW VALUE (dBuV)	CORRECTION FACTOR (dB/m)
1	#5470.00	57.8 PK	74.0	-16.2	1.83 H	0	52.1	5.7
2	#5470.00	45.9 AV	54.0	-8.1	1.83 H	0	40.2	5.7
3	*5710.00	102.9 PK			1.10 H	29	62.9	40.0
4	*5710.00	92.6 AV			1.10 H	29	52.6	40.0
5	#5850.00	59.8 PK	74.0	-14.2	1.42 H	226	53.3	6.5
6	#5850.00	47.5 AV	54.0	-6.5	1.42 H	226	41.0	6.5
7	11420.00	61.3 PK	74.0	-12.7	1.83 H	310	42.0	19.3
8	11420.00	48.4 AV	54.0	-5.6	1.83 H	310	29.1	19.3

ANTENNA POLARITY & TEST DISTANCE: VERTICAL AT 3 M

NO.	FREQ. (MHz)	EMISSION LEVEL (dBuV/m)	LIMIT (dBuV/m)	MARGIN (dB)	ANTENNA HEIGHT (m)	TABLE ANGLE (Degree)	RAW VALUE (dBuV)	CORRECTION FACTOR (dB/m)
1	#5470.00	57.5 PK	74.0	-16.5	1.90 V	288	51.8	5.7
2	#5470.00	46.3 AV	54.0	-7.7	1.90 V	288	40.6	5.7
3	*5710.00	122.7 PK			1.60 V	171	82.7	40.0
4	*5710.00	112.0 AV			1.60 V	171	72.0	40.0
5	#5850.00	66.5 PK	74.0	-7.5	1.80 V	347	60.0	6.5
6	#5850.00	50.5 AV	54.0	-3.5	1.80 V	347	44.0	6.5
7	11420.00	63.5 PK	74.0	-10.5	2.00 V	345	44.2	19.3
8	11420.00	50.7 AV	54.0	-3.3	2.00 V	345	31.4	19.3

REMARKS:

1. Emission Level(dBuV/m) = Raw Value(dBuV) + Correction Factor(dB/m)
2. Correction Factor(dB/m) = Antenna Factor(dB/m) + Cable Factor(dB) – Pre-Amplifier Factor(dB)
3. The other emission levels were very low against the limit.
4. Margin value = Emission Level – Limit value
5. " * " : Fundamental frequency.
6. " # " : The radiated frequency is out of the restricted band.

802.11ac (VHT80)

CHANNEL	TX Channel 58	DETECTOR FUNCTION	Peak (PK)
FREQUENCY RANGE	1GHz ~ 40GHz		Average (AV)

ANTENNA POLARITY & TEST DISTANCE: HORIZONTAL AT 3 M

NO.	FREQ. (MHz)	EMISSION LEVEL (dBuV/m)	LIMIT (dBuV/m)	MARGIN (dB)	ANTENNA HEIGHT (m)	TABLE ANGLE (Degree)	RAW VALUE (dBuV)	CORRECTION FACTOR (dB/m)
1	5150.00	54.6 PK	74.0	-19.4	1.78 H	201	49.8	4.8
2	5150.00	42.4 AV	54.0	-11.6	1.78 H	201	37.6	4.8
3	*5290.00	91.5 PK			1.79 H	197	52.4	39.1
4	*5290.00	81.4 AV			1.79 H	197	42.3	39.1
5	5350.00	56.8 PK	74.0	-17.2	1.69 H	183	51.3	5.5
6	5350.00	43.4 AV	54.0	-10.6	1.69 H	183	37.9	5.5
7	#10580.00	58.6 PK	74.0	-15.4	2.92 H	313	40.0	18.6
8	#10580.00	46.8 AV	54.0	-7.2	2.92 H	313	28.2	18.6

ANTENNA POLARITY & TEST DISTANCE: VERTICAL AT 3 M

NO.	FREQ. (MHz)	EMISSION LEVEL (dBuV/m)	LIMIT (dBuV/m)	MARGIN (dB)	ANTENNA HEIGHT (m)	TABLE ANGLE (Degree)	RAW VALUE (dBuV)	CORRECTION FACTOR (dB/m)
1	5150.00	55.5 PK	74.0	-18.5	1.80 V	160	50.7	4.8
2	5150.00	43.8 AV	54.0	-10.2	1.80 V	160	39.0	4.8
3	*5290.00	107.9 PK			1.70 V	166	68.8	39.1
4	*5290.00	98.2 AV			1.70 V	166	59.1	39.1
5	5350.00	67.5 PK	74.0	-6.5	1.54 V	164	62.0	5.5
6	5350.00	52.7 AV	54.0	-1.3	1.54 V	164	47.2	5.5
7	#10580.00	59.1 PK	74.0	-14.9	1.49 V	345	40.5	18.6
8	#10580.00	47.0 AV	54.0	-7.0	1.49 V	345	28.4	18.6

REMARKS:

1. Emission Level(dBuV/m) = Raw Value(dBuV) + Correction Factor(dB/m)
2. Correction Factor(dB/m) = Antenna Factor(dB/m) + Cable Factor(dB) – Pre-Amplifier Factor(dB)
3. The other emission levels were very low against the limit.
4. Margin value = Emission Level – Limit value
5. " * ": Fundamental frequency.
6. " # ": The radiated frequency is out of the restricted band.

CHANNEL	TX Channel 106	DETECTOR FUNCTION	Peak (PK)
FREQUENCY RANGE	1GHz ~ 40GHz		Average (AV)

ANTENNA POLARITY & TEST DISTANCE: HORIZONTAL AT 3 M

NO.	FREQ. (MHz)	EMISSION LEVEL (dBuV/m)	LIMIT (dBuV/m)	MARGIN (dB)	ANTENNA HEIGHT (m)	TABLE ANGLE (Degree)	RAW VALUE (dBuV)	CORRECTION FACTOR (dB/m)
1	5460.00	56.6 PK	74.0	-17.4	1.57 H	199	50.9	5.7
2	5460.00	43.9 AV	54.0	-10.1	1.57 H	199	38.2	5.7
3	#5470.00	56.3 PK	74.0	-17.7	1.50 H	190	50.6	5.7
4	#5470.00	43.8 AV	54.0	-10.2	1.50 H	190	38.1	5.7
5	*5530.00	89.6 PK			1.45 H	198	50.0	39.6
6	*5530.00	80.2 AV			1.45 H	198	40.6	39.6
7	#5725.00	57.5 PK	74.0	-16.5	1.49 H	185	51.2	6.3
8	#5725.00	44.0 AV	54.0	-10.0	1.49 H	185	37.7	6.3
9	11060.00	59.0 PK	74.0	-15.0	2.80 H	291	39.7	19.3
10	11060.00	46.9 AV	54.0	-7.1	2.80 H	291	27.6	19.3

ANTENNA POLARITY & TEST DISTANCE: VERTICAL AT 3 M

NO.	FREQ. (MHz)	EMISSION LEVEL (dBuV/m)	LIMIT (dBuV/m)	MARGIN (dB)	ANTENNA HEIGHT (m)	TABLE ANGLE (Degree)	RAW VALUE (dBuV)	CORRECTION FACTOR (dB/m)
1	5460.00	65.5 PK	74.0	-8.5	1.54 V	153	59.8	5.7
2	5460.00	51.9 AV	54.0	-2.1	1.54 V	153	46.2	5.7
3	#5470.00	67.4 PK	74.0	-6.6	1.50 V	147	61.7	5.7
4	#5470.00	52.6 AV	54.0	-1.4	1.50 V	147	46.9	5.7
5	*5530.00	106.6 PK			1.44 V	353	67.0	39.6
6	*5530.00	96.9 AV			1.44 V	353	57.3	39.6
7	#5725.00	56.9 PK	74.0	-17.1	1.52 V	343	50.6	6.3
8	#5725.00	44.2 AV	54.0	-9.8	1.52 V	343	37.9	6.3
9	11060.00	60.0 PK	74.0	-14.0	1.73 V	165	40.7	19.3
10	11060.00	47.4 AV	54.0	-6.6	1.73 V	165	28.1	19.3

REMARKS:

1. Emission Level(dBuV/m) = Raw Value(dBuV) + Correction Factor(dB/m)
2. Correction Factor(dB/m) = Antenna Factor(dB/m) + Cable Factor(dB) – Pre-Amplifier Factor(dB)
3. The other emission levels were very low against the limit.
4. Margin value = Emission Level – Limit value
5. " * ": Fundamental frequency.
6. " # ": The radiated frequency is out of the restricted band.

CHANNEL	TX Channel 138	DETECTOR FUNCTION	Peak (PK)
FREQUENCY RANGE	1GHz ~ 40GHz		Average (AV)

ANTENNA POLARITY & TEST DISTANCE: HORIZONTAL AT 3 M

NO.	FREQ. (MHz)	EMISSION LEVEL (dBuV/m)	LIMIT (dBuV/m)	MARGIN (dB)	ANTENNA HEIGHT (m)	TABLE ANGLE (Degree)	RAW VALUE (dBuV)	CORRECTION FACTOR (dB/m)
1	#5470.00	57.7 PK	74.0	-16.3	1.71 H	311	52.0	5.7
2	#5470.00	45.9 AV	54.0	-8.1	1.71 H	311	40.2	5.7
3	*5690.00	96.4 PK			1.09 H	122	56.5	39.9
4	*5690.00	86.7 AV			1.09 H	122	46.8	39.9
5	#5850.00	58.8 PK	74.0	-15.2	1.49 H	64	52.3	6.5
6	#5850.00	47.7 AV	54.0	-6.3	1.49 H	64	41.2	6.5
7	11380.00	61.7 PK	74.0	-12.3	2.21 H	345	42.4	19.3
8	11380.00	48.6 AV	54.0	-5.4	2.21 H	345	29.3	19.3

ANTENNA POLARITY & TEST DISTANCE: VERTICAL AT 3 M

NO.	FREQ. (MHz)	EMISSION LEVEL (dBuV/m)	LIMIT (dBuV/m)	MARGIN (dB)	ANTENNA HEIGHT (m)	TABLE ANGLE (Degree)	RAW VALUE (dBuV)	CORRECTION FACTOR (dB/m)
1	#5470.00	58.3 PK	74.0	-15.7	2.00 V	79	52.6	5.7
2	#5470.00	47.2 AV	54.0	-6.8	2.00 V	79	41.5	5.7
3	*5690.00	114.8 PK			1.82 V	168	74.9	39.9
4	*5690.00	104.9 AV			1.82 V	168	65.0	39.9
5	#5850.00	66.4 PK	74.0	-7.6	1.60 V	25	59.9	6.5
6	#5850.00	52.5 AV	54.0	-1.5	1.60 V	25	46.0	6.5
7	11380.00	62.4 PK	74.0	-11.6	1.56 V	279	43.1	19.3
8	11380.00	49.5 AV	54.0	-4.5	1.56 V	279	30.2	19.3

REMARKS:

1. Emission Level(dBuV/m) = Raw Value(dBuV) + Correction Factor(dB/m)
2. Correction Factor(dB/m) = Antenna Factor(dB/m) + Cable Factor(dB) – Pre-Amplifier Factor(dB)
3. The other emission levels were very low against the limit.
4. Margin value = Emission Level – Limit value
5. " * " : Fundamental frequency.
6. " # " : The radiated frequency is out of the restricted band.

Below 1GHz worst-case data:

802.11a

CHANNEL	TX Channel 52	DETECTOR FUNCTION	Quasi-Peak (QP)
FREQUENCY RANGE	30MHz ~ 1GHz		

ANTENNA POLARITY & TEST DISTANCE: HORIZONTAL AT 3 M								
NO.	FREQ. (MHz)	EMISSION LEVEL (dBuV/m)	LIMIT (dBuV/m)	MARGIN (dB)	ANTENNA HEIGHT (m)	TABLE ANGLE (Degree)	RAW VALUE (dBuV)	CORRECTION FACTOR (dB/m)
1	97.95	35.4 QP	43.5	-8.1	2.00 H	87	54.5	-19.1
2	134.89	36.2 QP	43.5	-7.3	2.00 H	260	51.2	-15.0
3	232.11	36.1 QP	46.0	-9.9	1.50 H	143	51.6	-15.5
4	290.43	33.3 QP	46.0	-12.7	1.00 H	172	45.6	-12.3
5	624.85	34.7 QP	46.0	-11.3	1.00 H	258	39.4	-4.7
6	751.23	34.0 QP	46.0	-12.0	1.50 H	5	36.2	-2.2
ANTENNA POLARITY & TEST DISTANCE: VERTICAL AT 3 M								
NO.	FREQ. (MHz)	EMISSION LEVEL (dBuV/m)	LIMIT (dBuV/m)	MARGIN (dB)	ANTENNA HEIGHT (m)	TABLE ANGLE (Degree)	RAW VALUE (dBuV)	CORRECTION FACTOR (dB/m)
1	31.84	34.2 QP	40.0	-5.8	1.50 V	151	50.6	-16.4
2	53.23	33.7 QP	40.0	-6.3	1.50 V	16	47.9	-14.2
3	94.06	32.9 QP	43.5	-10.6	1.00 V	140	52.5	-19.6
4	148.50	32.6 QP	43.5	-10.9	1.00 V	140	46.3	-13.7
5	228.22	32.1 QP	46.0	-13.9	1.00 V	162	48.0	-15.9
6	624.85	33.4 QP	46.0	-12.6	1.50 V	16	38.1	-4.7

REMARKS:

1. Emission Level(dBuV/m) = Raw Value(dBuV) + Correction Factor(dB/m)
2. Correction Factor(dB/m) = Antenna Factor(dB/m) + Cable Factor(dB)
3. The other emission levels were very low against the limit.
4. Margin value = Emission Level – Limit value

4.2 Conducted Emission Measurement

4.2.1 Limits of Conducted Emission Measurement

Frequency (MHz)	Conducted Limit (dBuV)	
	Quasi-peak	Average
0.15 - 0.5	66 - 56	56 - 46
0.50 - 5.0	56	46
5.0 - 30.0	60	50

- Note:** 1. The lower limit shall apply at the transition frequencies.
 2. The limit decreases in line with the logarithm of the frequency in the range of 0.15 to 0.50MHz.

4.2.2 Test Instruments

Description & Manufacturer	Model No.	Serial No.	Date Of Calibration	Due Date Of Calibration
Test Receiver ROHDE & SCHWARZ	ESCI	100424	Oct. 24, 2016	Oct. 23, 2017
RF signal cable (with 10dB PAD) Woken	5D-FB	Cable-cond1-01	Dec. 26, 2015	Dec. 25, 2016
LISN ROHDE & SCHWARZ (EUT)	ESH3-Z5	835239/001	Feb. 26, 2016	Feb. 25, 2017
LISN ROHDE & SCHWARZ (Peripheral)	ESH3-Z5	100311	Jul. 28, 2016	Jul. 27, 2017
Software ADT	BV ADT_Cond_ V7.3.7.3	NA	NA	NA

- Note:** 1. The calibration interval of the above test instruments is 12 months and the calibrations are traceable to NML/ROC and NIST/USA.
 2. The test was performed in HwaYa Shielded Room 1.
 3. The VCCI Site Registration No. is C-2040.

4.2.3 Test Procedures

- The EUT was placed 0.4 meters from the conducting wall of the shielded room with EUT being connected to the power mains through a line impedance stabilization network (LISN). Other support units were connected to the power mains through another LISN. The two LISNs provide 50 ohm/ 50uH of coupling impedance for the measuring instrument.
- Both lines of the power mains connected to the EUT were checked for maximum conducted interference.
- The frequency range from 150kHz to 30MHz was searched. Emission levels under (Limit - 20dB) was not recorded.

NOTE: The resolution bandwidth and video bandwidth of test receiver is 9kHz for quasi-peak detection (QP) and average detection (AV) at frequency 0.15MHz-30MHz.

4.2.4 Deviation from Test Standard

No deviation.

4.2.5 Test Setup

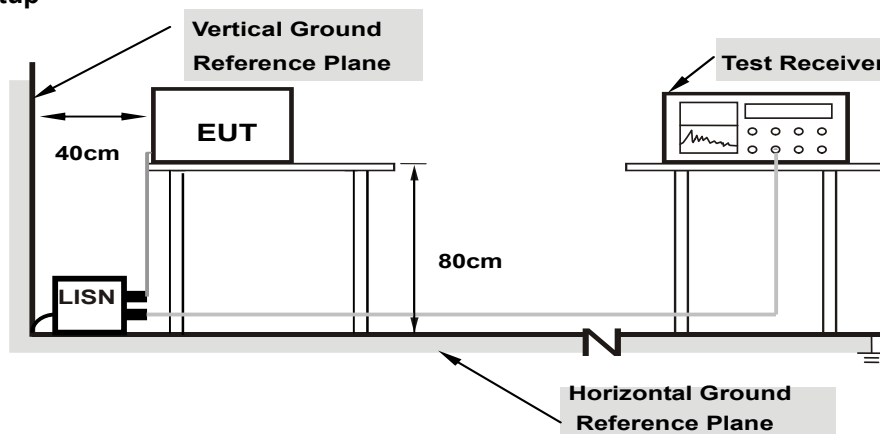

Note: 1.Support units were connected to second LISN.

For the actual test configuration, please refer to the attached file (Test Setup Photo).

4.2.6 EUT Operating Conditions

Same as 4.1.6.

4.2.7 Test Results

Phase	Line (L)	Detector Function	Quasi-Peak (QP) / Average (AV)
-------	----------	-------------------	--------------------------------

No	Freq. [MHz]	Corr. Factor (dB)	Reading Value [dB (uV)]		Emission Level [dB (uV)]		Limit [dB (uV)]		Margin (dB)	
			Q.P.	AV.	Q.P.	AV.	Q.P.	AV.	Q.P.	AV.
			1	0.16181	10.08	21.80	8.34	31.88	18.42	65.37
2	0.19305	10.08	18.84	7.15	28.92	17.23	63.90	53.90	-34.98	-36.67
3	0.52145	10.19	31.02	25.50	41.21	35.69	56.00	46.00	-14.79	-10.31
4	0.67785	10.23	17.72	11.54	27.95	21.77	56.00	46.00	-28.05	-24.23
5	1.50677	10.33	15.65	9.01	25.98	19.34	56.00	46.00	-30.02	-26.66
6	8.89667	10.71	14.24	8.46	24.95	19.17	60.00	50.00	-35.05	-30.83

REMARKS:

1. Q.P. and AV. are abbreviations of quasi-peak and average individually.
2. The emission levels of other frequencies were very low against the limit.
3. Margin value = Emission level - Limit value
4. Correction factor = Insertion loss + Cable loss
5. Emission Level = Correction Factor + Reading Value.

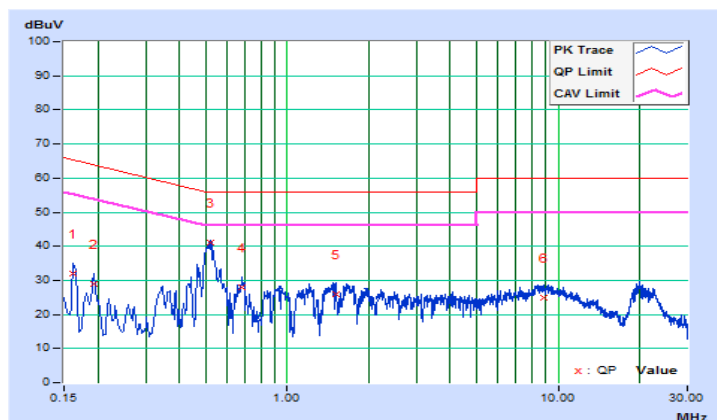

Phase	Neutral (N)	Detector Function	Quasi-Peak (QP) / Average (AV)
-------	-------------	-------------------	--------------------------------

No	Freq. [MHz]	Corr. Factor (dB)	Reading Value [dB (uV)]		Emission Level [dB (uV)]		Limit [dB (uV)]		Margin (dB)	
			Q.P.	AV.	Q.P.	AV.	Q.P.	AV.	Q.P.	AV.
			1	0.15782	10.08	22.63	9.66	32.71	19.74	65.58
2	0.36526	10.21	20.16	13.20	30.37	23.41	58.61	48.61	-28.24	-25.20
3	0.51856	10.25	30.91	26.51	41.16	36.76	56.00	46.00	-14.84	-9.24
4	0.65907	10.26	21.29	14.30	31.55	24.56	56.00	46.00	-24.45	-21.44
5	0.91245	10.28	19.56	13.13	29.84	23.41	56.00	46.00	-26.16	-22.59
6	18.95710	11.50	15.59	9.24	27.09	20.74	60.00	50.00	-32.91	-29.26

REMARKS:

1. Q.P. and AV. are abbreviations of quasi-peak and average individually.
2. The emission levels of other frequencies were very low against the limit.
3. Margin value = Emission level - Limit value
4. Correction factor = Insertion loss + Cable loss
5. Emission Level = Correction Factor + Reading Value.

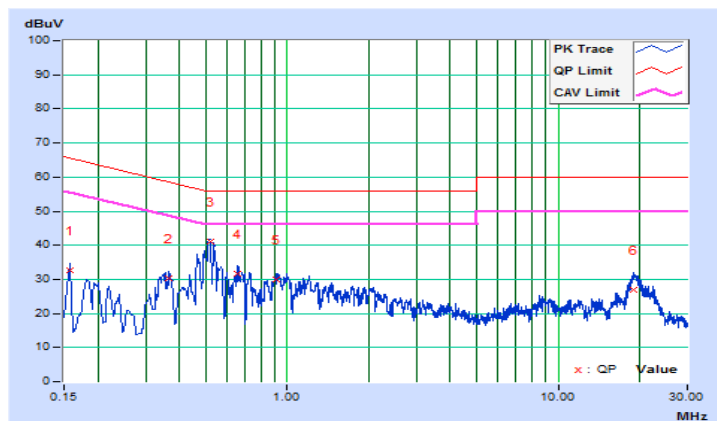

4.3 Transmit Power Measurement

4.3.1 Limits of Transmit Power Measurement

Operation Band	EUT Category		LIMIT
U-NII-1	-	Outdoor Access Point	1 Watt (30 dBm) (Max. e.i.r.p \leq 125mW(21 dBm) at any elevation angle above 30 degrees as measured from the horizon)
	-	Fixed point-to-point Access Point	1 Watt (30 dBm)
	-	Indoor Access Point	1 Watt (30 dBm)
	-	Mobile and Portable client device	250mW (24 dBm)
U-NII-2A	√		250mW (24 dBm) or 11 dBm+10 log B*
U-NII-2C	√		250mW (24 dBm) or 11 dBm+10 log B*
U-NII-3	-		1 Watt (30 dBm)

*B is the 26 dB emission bandwidth in megahertz

Per KDB 662911 Method of conducted output power measurement on IEEE 802.11 devices,

Array Gain = 0 dB (i.e., no array gain) for $N_{ANT} \leq 4$;

Array Gain = 0 dB (i.e., no array gain) for channel widths ≥ 40 MHz for any N_{ANT} ;

Array Gain = $5 \log(N_{ANT}/N_{SS})$ dB or 3 dB, whichever is less for 20-MHz channel widths with $N_{ANT} \geq 5$.

For power measurements on all other devices: Array Gain = $10 \log(N_{ANT}/N_{SS})$ dB.

4.3.2 Test Setup

For Power Output Measurement

For 802.11a, 802.11n (HT20), 802.11n (HT40)

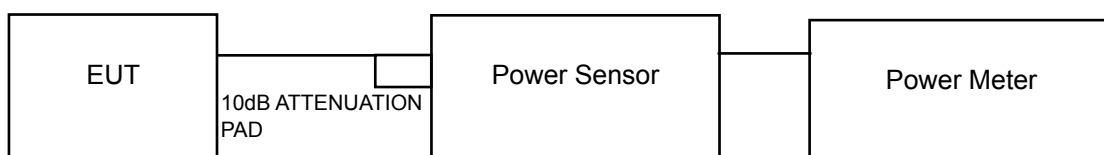

For 802.11ac (VHT80)

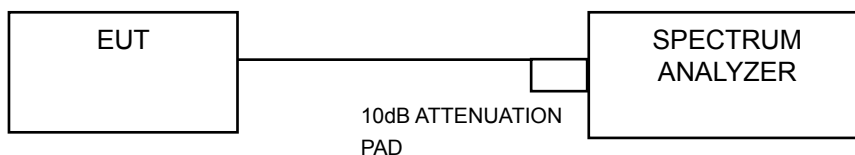

For 26dB and Occupied Bandwidth

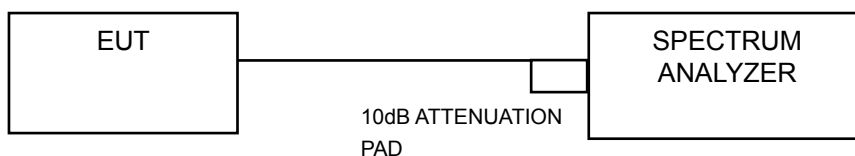

4.3.3 Test Instruments

Refer to section 4.1.2 to get information of above instrument.

4.3.4 Test Procedure

FOR AVERAGE POWER MEASUREMENT

For 802.11a, 802.11n (HT20), 802.11n (HT40)

Method PM is used to perform output power measurement, trigger and gating function of wide band power meter is enabled to measure max output power of TX on burst. Duty factor is not added to measured value.

For 802.11ac (VHT80)

- 1) Set span to encompass the entire 26 dB EBW (or, alternatively, the entire 99% occupied bandwidth) of the signal.
- 2) Set sweep trigger to "free run".
- 3) Set RBW = 1 MHz.
- 4) Set VBW \geq 3 MHz
- 5) Number of points in sweep \geq 2 Span / RBW.
- 6) Sweep time \leq (number of points in sweep) * T
- 7) Using emission bandwidth to determine the frequency span for integration the channel bandwidth.
- 8) Detector = RMS.
- 9) Trace mode = max hold.
- 10) Allow max hold to run for at least 60 seconds, or longer as needed to allow the trace to stabilize.

FOR 26dB BANDWIDTH

- 1) Set RBW = approximately 1% of the emission bandwidth.
- 2) Set the VBW > RBW.
- 3) Detector = Peak.
- 4) Trace mode = max hold.
- 5) Measure the maximum width of the emission that is 26 dB down from the peak of the emission. Compare this with the RBW setting of the analyzer. Readjust RBW and repeat measurement as needed until the RBW/EBW ratio is approximately 1%.

FOR OCCUPIED BANDWIDTH

The transmitter output was connected to the spectrum analyzer through an attenuator. The bandwidth of the fundamental frequency was measured by spectrum analyzer with resolution bandwidth in the range of 1% to 5% of the anticipated emission bandwidth, and a video bandwidth at least 3x the resolution bandwidth and set the detector to Sampling. The width of a frequency band such that, below the lower and above the upper frequency limits, the mean powers emitted are each equal to a specified percentage 0.5 % of the total mean power of a given emission.

4.3.5 Deviation from Test Standard

No deviation.

4.3.6 EUT Operating Conditions

The software provided by client to enable the EUT under transmission condition continuously at lowest, middle and highest channel frequencies individually.

4.3.7 Test Result

POWER OUTPUT:

CDD Mode

802.11a

Chan.	Freq. (MHz)	Maximum Conducted Power (dBm)				Total Power (mW)	Total Power (dBm)	Power Limit (dBm)	Pass / Fail
		Chain 0	Chain 1	Chain 2	Chain 3				
52	5260	11.97	12.14	12.07	12.74	67.007	18.26	23.60	Pass
60	5300	12.08	12.04	12.38	12.78	68.405	18.35	23.61	Pass
64	5320	12.11	12.41	12.38	12.69	69.549	18.42	23.62	Pass
100	5500	11.68	11.75	12.10	11.83	61.144	17.86	23.60	Pass
116	5580	11.89	11.98	12.19	11.35	61.433	17.88	23.65	Pass
140	5700	11.18	11.20	11.08	11.43	53.028	17.25	23.62	Pass
144	5720 For U-NII-2C	10.47	10.51	10.78	10.97	48.710	16.88	22.38	Pass
144	5720 For U-NII-3	5.53	5.75	5.81	6.09	15.807	11.99	29.70	Pass

- * For chan. 52: Gain = 6.30dBi > 6dBi, so the power limit shall be reduced to 23.90-(6.3-6) = 23.60dBm.
- * For chan. 60: Gain = 6.30dBi > 6dBi, so the power limit shall be reduced to 23.91-(6.3-6) = 23.61dBm.
- * For chan. 64: Gain = 6.30dBi > 6dBi, so the power limit shall be reduced to 23.92-(6.3-6) = 23.62dBm.
- * For chan. 100: Gain = 6.30dBi > 6dBi, so the power limit shall be reduced to 23.90-(6.3-6) = 23.60dBm.
- * For chan. 116: Gain = 6.30dBi > 6dBi, so the power limit shall be reduced to 23.95-(6.3-6) = 23.65dBm.
- * For chan. 140: Gain = 6.30dBi > 6dBi, so the power limit shall be reduced to 23.92-(6.3-6) = 23.62dBm.
- * For chan. 144(U-NII-2C): Gain = 6.30dBi > 6dBi, so the power limit shall be reduced to 22.68-(6.3-6) = 22.38dBm.
- * For chan. 144(U-NII-3): Gain = 6.30dBi > 6dBi, so the power limit shall be reduced to 30-(6.3-6) = 29.70dBm.

Note:

Chain 0

1. 11dBm + 10log(19.82) = 23.97 dBm < 24dBm.
2. 11dBm + 10log(20.17) = 24.05 dBm > 24dBm.
3. 11dBm + 10log(19.84) = 23.98 dBm < 24dBm.
4. 11dBm + 10log(20.14) = 24.04 dBm > 24dBm.
5. 11dBm + 10log(19.99) = 24.01 dBm > 24dBm.
6. 11dBm + 10log(19.85) = 23.98 dBm < 24dBm.
7. 11dBm + 10log(5725.00 - 5709.97) = 22.77 dBm < 24dBm.

Chain 1

1. 11dBm + 10log(19.87) = 23.98 dBm < 24dBm.
2. 11dBm + 10log(20.12) = 24.04 dBm > 24dBm.
3. 11dBm + 10log(20.03) = 24.02 dBm > 24dBm.
4. 11dBm + 10log(19.93) = 24.00 dBm = 24dBm.
5. 11dBm + 10log(19.74) = 23.95 dBm < 24dBm.
6. 11dBm + 10log(20.06) = 24.02 dBm > 24dBm.
7. 11dBm + 10log(5725.00 - 5710.04) = 22.75 dBm < 24dBm.



Chain 2

1. $11\text{dBm} + 10\log(19.80) = 23.97\text{ dBm} < 24\text{dBm}$.
2. $11\text{dBm} + 10\log(19.82) = 23.97\text{ dBm} < 24\text{dBm}$.
3. $11\text{dBm} + 10\log(20.11) = 24.03\text{ dBm} > 24\text{dBm}$.
4. $11\text{dBm} + 10\log(19.99) = 24.01\text{ dBm} > 24\text{dBm}$.
5. $11\text{dBm} + 10\log(19.74) = 23.95\text{ dBm} < 24\text{dBm}$.
6. $11\text{dBm} + 10\log(19.69) = 23.94\text{ dBm} < 24\text{dBm}$.
7. $11\text{dBm} + 10\log(5725.00 - 5710.27) = 22.68\text{ dBm} < 24\text{dBm}$.

Chain 3

1. $11\text{dBm} + 10\log(19.51) = 23.90\text{ dBm} < 24\text{dBm}$.
2. $11\text{dBm} + 10\log(19.57) = 23.91\text{ dBm} < 24\text{dBm}$.
3. $11\text{dBm} + 10\log(19.61) = 23.92\text{ dBm} < 24\text{dBm}$.
4. $11\text{dBm} + 10\log(19.53) = 23.90\text{ dBm} < 24\text{dBm}$.
5. $11\text{dBm} + 10\log(19.83) = 23.97\text{ dBm} < 24\text{dBm}$.
6. $11\text{dBm} + 10\log(19.63) = 23.92\text{ dBm} < 24\text{dBm}$.
7. $11\text{dBm} + 10\log(5725.00 - 5710.19) = 22.71\text{ dBm} < 24\text{dBm}$.

802.11n (HT20)

Chan.	Freq. (MHz)	Maximum Conducted Power (dBm)				Total Power (mW)	Total Power (dBm)	Power Limit (dBm)	Pass / Fail
		Chain 0	Chain 1	Chain 2	Chain 3				
52	5260	12.31	12.45	12.30	13.12	72.095	18.58	23.70	Pass
60	5300	12.32	12.67	12.58	12.82	72.810	18.62	23.70	Pass
64	5320	12.47	12.65	12.58	12.81	73.280	18.65	23.70	Pass
100	5500	11.95	11.93	12.31	12.14	64.654	18.11	23.70	Pass
116	5580	12.12	12.14	12.48	11.56	64.684	18.11	23.70	Pass
140	5700	11.98	11.91	12.14	12.27	64.534	18.10	23.70	Pass
144	5720 For U-NII-2C	10.56	10.73	10.88	11.00	48.041	16.82	22.53	Pass
144	5720 For U-NII-3	6.03	6.11	6.18	6.39	16.597	12.20	29.70	Pass

* For Chan. 52~140: Gain = 6.30dBi > 6dBi, so the power limit shall be reduced to 24-(6.3-6) = 23.70dBm.

* For chan. 144(U-NII-2C): Gain = 6.30dBi > 6dBi, so the power limit shall be reduced to 22.83-(6.3-6) = 22.53dBm.

* For chan. 144(U-NII-3): Gain = 6.30dBi > 6dBi, so the power limit shall be reduced to 30-(6.3-6) = 29.70dBm.

Note:

Chain 0

1. 11dBm + 10log(20.92) = 24.21 dBm > 24dBm.
2. 11dBm + 10log(20.81) = 24.18 dBm > 24dBm.
3. 11dBm + 10log(20.86) = 24.19 dBm > 24dBm.
4. 11dBm + 10log(20.43) = 24.10 dBm > 24dBm.
5. 11dBm + 10log(20.83) = 24.19 dBm > 24dBm.
6. 11dBm + 10log(20.93) = 24.21 dBm > 24dBm.
7. 11dBm + 10log(5725.00 - 5709.53) = 22.89 dBm < 24dBm.

Chain 1

1. 11dBm + 10log(20.84) = 24.19 dBm > 24dBm.
2. 11dBm + 10log(20.72) = 24.16 dBm > 24dBm.
3. 11dBm + 10log(20.62) = 24.14 dBm > 24dBm.
4. 11dBm + 10log(20.77) = 24.17 dBm > 24dBm.
5. 11dBm + 10log(20.63) = 24.14 dBm > 24dBm.
6. 11dBm + 10log(21.03) = 24.23 dBm > 24dBm.
7. 11dBm + 10log(5725.00 - 5709.61) = 22.87 dBm < 24dBm.

Chain 2

1. 11dBm + 10log(20.96) = 24.21 dBm > 24dBm.
2. 11dBm + 10log(20.94) = 24.21 dBm > 24dBm.
3. 11dBm + 10log(20.87) = 24.20 dBm > 24dBm.
4. 11dBm + 10log(20.96) = 24.21 dBm > 24dBm.
5. 11dBm + 10log(20.82) = 24.18 dBm > 24dBm.
6. 11dBm + 10log(20.69) = 24.16 dBm > 24dBm.
7. 11dBm + 10log(5725.00 - 5709.74) = 22.83 dBm < 24dBm.

Chain 3

1. $11\text{dBm} + 10\log(20.59) = 24.14\text{ dBm} > 24\text{dBm}$.
2. $11\text{dBm} + 10\log(20.44) = 24.10\text{ dBm} > 24\text{dBm}$.
3. $11\text{dBm} + 10\log(20.64) = 24.15\text{ dBm} > 24\text{dBm}$.
4. $11\text{dBm} + 10\log(20.35) = 24.09\text{ dBm} > 24\text{dBm}$.
5. $11\text{dBm} + 10\log(20.68) = 24.16\text{ dBm} > 24\text{dBm}$.
6. $11\text{dBm} + 10\log(20.78) = 24.18\text{ dBm} > 24\text{dBm}$.
7. $11\text{dBm} + 10\log(5725.00 - 5709.69) = 22.85\text{ dBm} < 24\text{dBm}$.

802.11n (HT40)

Chan.	Freq. (MHz)	Maximum Conducted Power (dBm)				Total Power (mW)	Total Power (dBm)	Power Limit (dBm)	Pass / Fail
		Chain 0	Chain 1	Chain 2	Chain 3				
54	5270	14.95	15.10	15.26	15.70	134.348	21.28	23.70	Pass
62	5310	12.64	13.32	13.09	13.35	81.840	19.13	23.70	Pass
102	5510	14.41	14.24	14.79	14.36	111.572	20.48	23.70	Pass
110	5550	14.46	14.36	14.91	14.08	111.775	20.48	23.70	Pass
134	5670	14.38	13.78	14.75	14.46	109.073	20.38	23.70	Pass
142	5710 For U-NII-2C	14.02	14.17	14.40	14.47	109.855	20.41	23.70	Pass
142	5710 For U-NII-3	5.82	5.86	6.15	6.18	16.387	12.14	29.70	Pass

* For U-NII-2A, U-NII-2C: Gain = 6.30dBi > 6dBi, so the power limit shall be reduced to $24 - (6.3 - 6) = 23.70\text{dBm}$.

* For U-NII-3: Gain = 6.30dBi > 6dBi, so the power limit shall be reduced to $30 - (6.3 - 6) = 29.70\text{dBm}$.

Note:

Chain 0

1. $11\text{dBm} + 10\log(40.54) = 27.08\text{ dBm} > 24\text{dBm}$.
2. $11\text{dBm} + 10\log(40.59) = 27.08\text{ dBm} > 24\text{dBm}$.
3. $11\text{dBm} + 10\log(40.71) = 27.10\text{ dBm} > 24\text{dBm}$.
4. $11\text{dBm} + 10\log(40.87) = 27.11\text{ dBm} > 24\text{dBm}$.
5. $11\text{dBm} + 10\log(40.75) = 27.10\text{ dBm} > 24\text{dBm}$.
6. $11\text{dBm} + 10\log(5725.00 - 5689.68) = 26.48\text{ dBm} > 24\text{dBm}$.

Chain 1

1. $11\text{dBm} + 10\log(40.62) = 27.09\text{ dBm} > 24\text{dBm}$.
2. $11\text{dBm} + 10\log(40.53) = 27.08\text{ dBm} > 24\text{dBm}$.
3. $11\text{dBm} + 10\log(40.69) = 27.09\text{ dBm} > 24\text{dBm}$.
4. $11\text{dBm} + 10\log(40.55) = 27.08\text{ dBm} > 24\text{dBm}$.
5. $11\text{dBm} + 10\log(40.39) = 27.06\text{ dBm} > 24\text{dBm}$.
6. $11\text{dBm} + 10\log(5725.00 - 5689.73) = 26.47\text{ dBm} > 24\text{dBm}$.

Chain 2

1. $11\text{dBm} + 10\log(40.76) = 27.10\text{ dBm} > 24\text{dBm}$.
2. $11\text{dBm} + 10\log(40.29) = 27.05\text{ dBm} > 24\text{dBm}$.
3. $11\text{dBm} + 10\log(40.56) = 27.08\text{ dBm} > 24\text{dBm}$.
4. $11\text{dBm} + 10\log(40.52) = 27.08\text{ dBm} > 24\text{dBm}$.
5. $11\text{dBm} + 10\log(40.54) = 27.08\text{ dBm} > 24\text{dBm}$.
6. $11\text{dBm} + 10\log(5725.00 - 5689.76) = 26.47\text{ dBm} > 24\text{dBm}$.

Chain 3

1. $11\text{dBm} + 10\log(40.56) = 27.08\text{ dBm} > 24\text{dBm}$.
2. $11\text{dBm} + 10\log(40.50) = 27.07\text{ dBm} > 24\text{dBm}$.
3. $11\text{dBm} + 10\log(40.62) = 27.09\text{ dBm} > 24\text{dBm}$.
4. $11\text{dBm} + 10\log(40.47) = 27.07\text{ dBm} > 24\text{dBm}$.
5. $11\text{dBm} + 10\log(40.53) = 27.08\text{ dBm} > 24\text{dBm}$.
6. $11\text{dBm} + 10\log(5725.00 - 5689.91) = 26.45\text{ dBm} > 24\text{dBm}$.

802.11ac (VHT80)

Chan.	Freq. (MHz)	Maximum Conducted Power (dBm)				Total Power (mW)	Total Power (dBm)	Power Limit (dBm)	Pass / Fail
		Chain 0	Chain 1	Chain 2	Chain 3				
58	5290	10.38	10.98	10.21	10.89	46.214	16.65	23.70	Pass
106	5530	10.29	10.47	10.33	10.14	42.951	16.33	23.70	Pass
138	5690 For U-NII-2C	16.96	16.84	17.23	17.40	219.365	23.41	23.70	Pass
138	5690 For U-NII-3	7.21	6.77	7.61	7.36	22.629	13.55	29.70	Pass

* For U-NII-2A, U-NII-2C: Gain = 6.30dBi > 6dBi, so the power limit shall be reduced to 24-(6.3-6) = 23.70dBm.

* For U-NII-3: Gain = 6.30dBi > 6dBi, so the power limit shall be reduced to 30-(6.3-6) = 29.70dBm.

Note:

Chain 0

1. 11dBm + 10log(86.00) = 30.34 dBm > 24dBm.
2. 11dBm + 10log(85.87) = 30.34 dBm > 24dBm.
3. 11dBm + 10log(5725.00 - 5647.01) = 29.92 dBm > 24dBm.

Chain 1

1. 11dBm + 10log(84.99) = 30.29 dBm > 24dBm.
2. 11dBm + 10log(85.16) = 30.30 dBm > 24dBm.
3. 11dBm + 10log(5725.00 - 5647.11) = 29.91 dBm > 24dBm.

Chain 2

1. 11dBm + 10log(84.73) = 30.28 dBm > 24dBm.
2. 11dBm + 10log(85.10) = 30.30 dBm > 24dBm.
3. 11dBm + 10log(5725.00 - 5646.72) = 29.94 dBm > 24dBm.

Chain 3

1. 11dBm + 10log(85.24) = 30.31 dBm > 24dBm.
2. 11dBm + 10log(84.73) = 30.28 dBm > 24dBm.
3. 11dBm + 10log(5725.00 - 5647.41) = 29.90 dBm > 24dBm.

Beamforming Mode

802.11n (HT20)

Chan.	Freq. (MHz)	Maximum Conducted Power (dBm)				Total Power (mW)	Total Power (dBm)	Power Limit (dBm)	Pass / Fail
		Chain 0	Chain 1	Chain 2	Chain 3				
52	5260	6.29	6.43	6.28	7.10	18.026	12.56	17.68	Pass
60	5300	6.30	6.65	6.56	6.80	18.205	12.60	17.68	Pass
64	5320	6.45	6.63	6.56	6.79	18.323	12.63	17.68	Pass
100	5500	5.93	5.91	6.29	6.12	16.165	12.09	17.68	Pass
116	5580	6.10	6.12	6.46	5.54	16.174	12.09	17.68	Pass
140	5700	5.96	5.89	6.12	6.25	16.137	12.08	17.68	Pass
144	5720 For U-NII-2C	4.54	4.71	4.86	4.98	12.012	10.80	16.83	Pass
144	5720 For U-NII-3	0.01	0.09	0.16	0.37	4.150	6.18	23.68	Pass

* For U-NII-2A, U-NII-2C: Directional gain = $6.30\text{dBi} + 10\log(4) = 12.32\text{dBi} > 6\text{dBi}$, so the power limit shall be reduced to $24 - (12.32 - 6) = 17.68\text{dBm}$.

* For chan. 144(U-NII-2C): Directional gain = $6.30\text{dBi} + 10\log(4) = 12.32\text{dBi} > 6\text{dBi}$, so the power limit shall be reduced to $22.83 - (12.32 - 6) = 16.83\text{dBm}$.

* For chan. 144(U-NII-3): Directional gain = $6.30\text{dBi} + 10\log(4) = 12.32\text{dBi} > 6\text{dBi}$, so the power limit shall be reduced to $30 - (12.32 - 6) = 23.68\text{dBm}$.

Note:

Chain 0

- $11\text{dBm} + 10\log(20.92) = 24.21\text{dBm} > 24\text{dBm}$.
- $11\text{dBm} + 10\log(20.81) = 24.18\text{dBm} > 24\text{dBm}$.
- $11\text{dBm} + 10\log(20.86) = 24.19\text{dBm} > 24\text{dBm}$.
- $11\text{dBm} + 10\log(20.43) = 24.10\text{dBm} > 24\text{dBm}$.
- $11\text{dBm} + 10\log(20.83) = 24.19\text{dBm} > 24\text{dBm}$.
- $11\text{dBm} + 10\log(20.93) = 24.21\text{dBm} > 24\text{dBm}$.
- $11\text{dBm} + 10\log(5725.00 - 5709.53) = 22.89\text{dBm} < 24\text{dBm}$.

Chain 1

- $11\text{dBm} + 10\log(20.84) = 24.19\text{dBm} > 24\text{dBm}$.
- $11\text{dBm} + 10\log(20.72) = 24.16\text{dBm} > 24\text{dBm}$.
- $11\text{dBm} + 10\log(20.62) = 24.14\text{dBm} > 24\text{dBm}$.
- $11\text{dBm} + 10\log(20.77) = 24.17\text{dBm} > 24\text{dBm}$.
- $11\text{dBm} + 10\log(20.63) = 24.14\text{dBm} > 24\text{dBm}$.
- $11\text{dBm} + 10\log(21.03) = 24.23\text{dBm} > 24\text{dBm}$.
- $11\text{dBm} + 10\log(5725.00 - 5709.61) = 22.87\text{dBm} < 24\text{dBm}$.

Chain 2

- $11\text{dBm} + 10\log(20.96) = 24.21\text{dBm} > 24\text{dBm}$.
- $11\text{dBm} + 10\log(20.94) = 24.21\text{dBm} > 24\text{dBm}$.
- $11\text{dBm} + 10\log(20.87) = 24.20\text{dBm} > 24\text{dBm}$.
- $11\text{dBm} + 10\log(20.96) = 24.21\text{dBm} > 24\text{dBm}$.
- $11\text{dBm} + 10\log(20.82) = 24.18\text{dBm} > 24\text{dBm}$.
- $11\text{dBm} + 10\log(20.69) = 24.16\text{dBm} > 24\text{dBm}$.
- $11\text{dBm} + 10\log(5725.00 - 5709.74) = 22.83\text{dBm} < 24\text{dBm}$.

Chain 3

1. $11\text{dBm} + 10\log(20.59) = 24.14\text{ dBm} > 24\text{dBm}$.
2. $11\text{dBm} + 10\log(20.44) = 24.10\text{ dBm} > 24\text{dBm}$.
3. $11\text{dBm} + 10\log(20.64) = 24.15\text{ dBm} > 24\text{dBm}$.
4. $11\text{dBm} + 10\log(20.35) = 24.09\text{ dBm} > 24\text{dBm}$.
5. $11\text{dBm} + 10\log(20.68) = 24.16\text{ dBm} > 24\text{dBm}$.
6. $11\text{dBm} + 10\log(20.78) = 24.18\text{ dBm} > 24\text{dBm}$.
7. $11\text{dBm} + 10\log(5725.00 - 5709.69) = 22.85\text{ dBm} < 24\text{dBm}$.

802.11n (HT40)

Chan.	Freq. (MHz)	Maximum Conducted Power (dBm)				Total Power (mW)	Total Power (dBm)	Power Limit (dBm)	Pass / Fail
		Chain 0	Chain 1	Chain 2	Chain 3				
54	5270	8.93	9.08	9.24	9.68	33.592	15.26	17.68	Pass
62	5310	6.62	7.30	7.07	7.33	20.463	13.11	17.68	Pass
102	5510	8.39	8.22	8.77	8.34	27.896	14.46	17.68	Pass
110	5550	8.44	8.34	8.89	8.06	27.947	14.46	17.68	Pass
134	5670	8.36	7.76	8.73	8.44	27.271	14.36	17.68	Pass
142	5710 For U-NII-2C	8.00	8.15	8.38	8.45	27.468	14.39	17.68	Pass
142	5710 For U-NII-3	-0.20	-0.16	0.13	0.16	4.097	6.12	23.68	Pass

* For U-NII-2A, U-NII-2C: Directional gain = $6.30\text{dBi} + 10\log(4) = 12.32\text{dBi} > 6\text{dBi}$, so the power limit shall be reduced to $24 - (12.32 - 6) = 17.68\text{dBm}$.

* For U-NII-3: Directional gain = $6.30\text{dBi} + 10\log(4) = 12.32\text{dBi} > 6\text{dBi}$, so the power limit shall be reduced to $30 - (12.32 - 6) = 23.68\text{dBm}$.

Note:

Chain 0

1. $11\text{dBm} + 10\log(40.54) = 27.08\text{ dBm} > 24\text{dBm}$.
2. $11\text{dBm} + 10\log(40.59) = 27.08\text{ dBm} > 24\text{dBm}$.
3. $11\text{dBm} + 10\log(40.71) = 27.10\text{ dBm} > 24\text{dBm}$.
4. $11\text{dBm} + 10\log(40.87) = 27.11\text{ dBm} > 24\text{dBm}$.
5. $11\text{dBm} + 10\log(40.75) = 27.10\text{ dBm} > 24\text{dBm}$.
6. $11\text{dBm} + 10\log(5725.00 - 5689.68) = 26.48\text{ dBm} > 24\text{dBm}$.

Chain 1

1. $11\text{dBm} + 10\log(40.62) = 27.09\text{ dBm} > 24\text{dBm}$.
2. $11\text{dBm} + 10\log(40.53) = 27.08\text{ dBm} > 24\text{dBm}$.
3. $11\text{dBm} + 10\log(40.69) = 27.09\text{ dBm} > 24\text{dBm}$.
4. $11\text{dBm} + 10\log(40.55) = 27.08\text{ dBm} > 24\text{dBm}$.
5. $11\text{dBm} + 10\log(40.39) = 27.06\text{ dBm} > 24\text{dBm}$.
6. $11\text{dBm} + 10\log(5725.00 - 5689.73) = 26.47\text{ dBm} > 24\text{dBm}$.

Chain 2

1. $11\text{dBm} + 10\log(40.76) = 27.10\text{ dBm} > 24\text{dBm}$.
2. $11\text{dBm} + 10\log(40.29) = 27.05\text{ dBm} > 24\text{dBm}$.
3. $11\text{dBm} + 10\log(40.56) = 27.08\text{ dBm} > 24\text{dBm}$.
4. $11\text{dBm} + 10\log(40.52) = 27.08\text{ dBm} > 24\text{dBm}$.
5. $11\text{dBm} + 10\log(40.54) = 27.08\text{ dBm} > 24\text{dBm}$.
6. $11\text{dBm} + 10\log(5725.00 - 5689.76) = 26.47\text{ dBm} > 24\text{dBm}$.

Chain 3

1. $11\text{dBm} + 10\log(40.56) = 27.08\text{ dBm} > 24\text{dBm}$.
2. $11\text{dBm} + 10\log(40.50) = 27.07\text{ dBm} > 24\text{dBm}$.
3. $11\text{dBm} + 10\log(40.62) = 27.09\text{ dBm} > 24\text{dBm}$.
4. $11\text{dBm} + 10\log(40.47) = 27.07\text{ dBm} > 24\text{dBm}$.
5. $11\text{dBm} + 10\log(40.53) = 27.08\text{ dBm} > 24\text{dBm}$.
6. $11\text{dBm} + 10\log(5725.00 - 5689.91) = 26.45\text{ dBm} > 24\text{dBm}$.

802.11ac (VHT80)

Chan.	Freq. (MHz)	Maximum Conducted Power (dBm)				Total Power (mW)	Total Power (dBm)	Power Limit (dBm)	Pass / Fail
		Chain 0	Chain 1	Chain 2	Chain 3				
58	5290	4.36	4.96	4.19	4.87	11.555	10.63	17.68	Pass
106	5530	4.27	4.45	4.31	4.12	10.739	10.31	17.68	Pass
138	5690 For U-NII-2C	10.94	10.82	11.21	11.38	54.849	17.39	17.68	Pass
138	5690 For U-NII-3	1.19	0.75	1.59	1.34	5.658	7.53	23.68	Pass

* For U-NII-2A, U-NII-2C: Directional gain = $6.30\text{dBi} + 10\log(4) = 12.32\text{dBi} > 6\text{dBi}$, so the power limit shall be reduced to $24 - (12.32 - 6) = 17.68\text{dBm}$.

* For U-NII-3: Directional gain = $6.30\text{dBi} + 10\log(4) = 12.32\text{dBi} > 6\text{dBi}$, so the power limit shall be reduced to $30 - (12.32 - 6) = 23.68\text{dBm}$.

Note:

Chain 0

1. $11\text{dBm} + 10\log(86.00) = 30.34\text{ dBm} > 24\text{dBm}$.
2. $11\text{dBm} + 10\log(85.87) = 30.34\text{ dBm} > 24\text{dBm}$.
3. $11\text{dBm} + 10\log(5725.00 - 5647.01) = 29.92\text{ dBm} > 24\text{dBm}$.

Chain 1

1. $11\text{dBm} + 10\log(84.99) = 30.29\text{ dBm} > 24\text{dBm}$.
2. $11\text{dBm} + 10\log(85.16) = 30.30\text{ dBm} > 24\text{dBm}$.
3. $11\text{dBm} + 10\log(5725.00 - 5647.11) = 29.91\text{ dBm} > 24\text{dBm}$.

Chain 2

1. $11\text{dBm} + 10\log(84.73) = 30.28\text{ dBm} > 24\text{dBm}$.
2. $11\text{dBm} + 10\log(85.10) = 30.30\text{ dBm} > 24\text{dBm}$.
3. $11\text{dBm} + 10\log(5725.00 - 5646.72) = 29.94\text{ dBm} > 24\text{dBm}$.

Chain 3

1. $11\text{dBm} + 10\log(85.24) = 30.31\text{ dBm} > 24\text{dBm}$.
2. $11\text{dBm} + 10\log(84.73) = 30.28\text{ dBm} > 24\text{dBm}$.
3. $11\text{dBm} + 10\log(5725.00 - 5647.41) = 29.90\text{ dBm} > 24\text{dBm}$.



26dB BANDWIDTH:

802.11a

Chan.	Freq. (MHz)	26dBc Bandwidth (MHz)				Pass / Fail
		Chain 0	Chain 1	Chain 2	Chain 3	
52	5260	19.82	19.87	19.80	19.51	Pass
60	5300	20.17	20.12	19.82	19.57	Pass
64	5320	19.84	20.03	20.11	19.61	Pass
100	5500	20.14	19.93	19.99	19.53	Pass
116	5580	19.99	19.74	19.74	19.83	Pass
140	5700	19.85	20.06	19.69	19.63	Pass
144	5720 For U-NII-2C	15.03	14.96	14.73	14.81	Pass

802.11n (HT20)

Chan.	Freq. (MHz)	26dBc Bandwidth (MHz)				Pass / Fail
		Chain 0	Chain 1	Chain 2	Chain 3	
52	5260	20.92	20.84	20.96	20.59	Pass
60	5300	20.81	20.72	20.94	20.44	Pass
64	5320	20.86	20.62	20.87	20.64	Pass
100	5500	20.43	20.77	20.96	20.35	Pass
116	5580	20.83	20.63	20.82	20.68	Pass
140	5700	20.93	21.03	20.69	20.78	Pass
144	5720 For U-NII-2C	15.47	15.39	15.26	15.31	Pass

802.11n (HT40)

Chan.	Freq. (MHz)	26dBc Bandwidth (MHz)				Pass / Fail
		Chain 0	Chain 1	Chain 2	Chain 3	
54	5270	40.54	40.62	40.76	40.56	Pass
62	5310	40.59	40.53	40.29	40.50	Pass
102	5510	40.71	40.69	40.56	40.62	Pass
110	5550	40.87	40.55	40.52	40.47	Pass
134	5670	40.75	40.39	40.54	40.53	Pass
142	5710 For U-NII-2C	35.32	35.27	35.24	35.09	Pass

802.11ac (VHT80)

Chan.	Freq. (MHz)	26dBc Bandwidth (MHz)				Pass / Fail
		Chain 0	Chain 1	Chain 2	Chain 3	
58	5290	86.00	84.99	84.73	85.24	Pass
106	5530	85.87	85.16	85.10	84.73	Pass
138	5690 For U-NII-2C	77.99	77.89	78.28	77.59	Pass



BUREAU
VERITAS

Spectrum Plot of Worst Value

802.11a

802.11n (HT20)

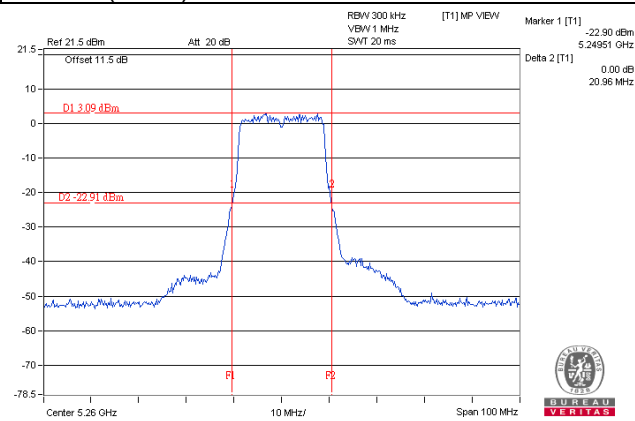
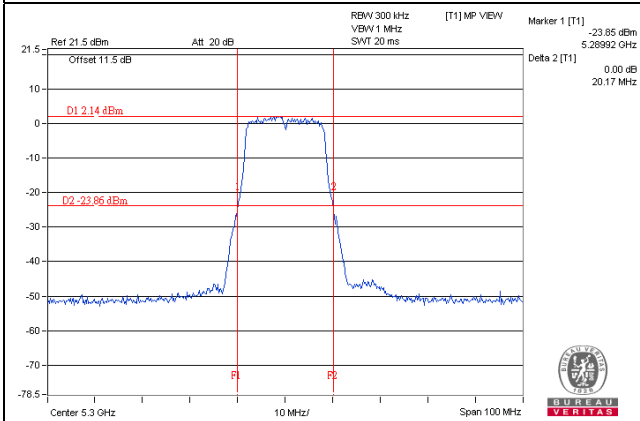

802.11n (HT40)

802.11ac (VHT80)

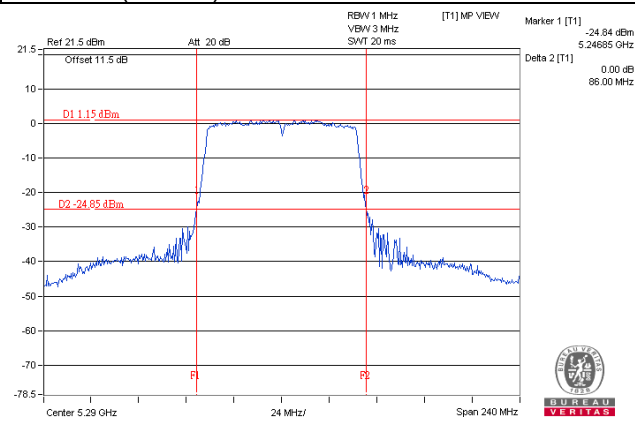
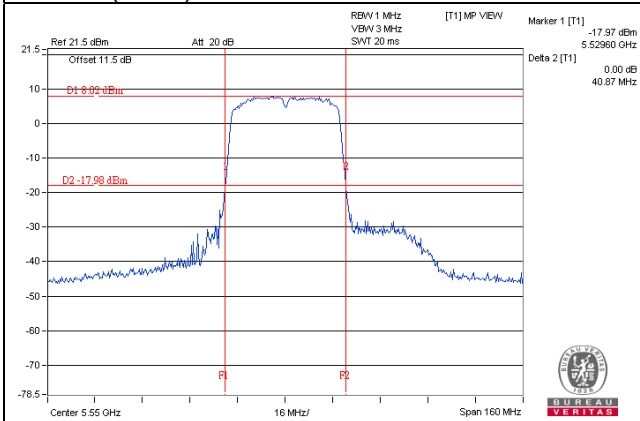

OCCUPIED BANDWIDTH:
802.11a

Chan.	Freq. (MHz)	Occupied Bandwidth (MHz)			
		Chain 0	Chain 1	Chain 2	Chain 3
52	5260	16.44	16.44	16.44	16.44
60	5300	16.44	16.44	16.44	16.44
64	5320	16.44	16.44	16.44	16.44
100	5500	16.44	16.44	16.44	16.44
116	5580	16.44	16.44	16.44	16.44
140	5700	16.44	16.44	16.44	16.44
144	5720 For U-NII-2C	13.28	13.28	13.28	13.28
144	5720 For U-NII-3	3.04	3.04	3.04	3.04

802.11n (HT20)

Chan.	Freq. (MHz)	Occupied Bandwidth (MHz)			
		Chain 0	Chain 1	Chain 2	Chain 3
52	5260	17.64	17.64	17.64	17.64
60	5300	17.64	17.64	17.64	17.64
64	5320	17.64	17.64	17.64	17.64
100	5500	17.64	17.64	17.64	17.64
116	5580	17.64	17.64	17.64	17.64
140	5700	17.64	17.64	17.64	17.64
144	5720 For U-NII-2C	13.88	13.88	13.88	13.88
144	5720 For U-NII-3	3.64	3.76	3.64	3.76

802.11n (HT40)

Chan.	Freq. (MHz)	Occupied Bandwidth (MHz)			
		Chain 0	Chain 1	Chain 2	Chain 3
54	5270	36.00	36.12	35.88	36.24
62	5310	36.00	36.12	36.00	36.24
102	5510	36.12	36.00	36.00	36.12
110	5550	36.00	36.00	36.12	36.12
134	5670	36.24	36.12	36.12	36.00
142	5710 For U-NII-2C	33.12	33.12	33.00	33.00
142	5710 For U-NII-3	3.00	3.00	3.00	3.00

802.11ac (VHT80)

Chan.	Freq. (MHz)	Occupied Bandwidth (MHz)			
		Chain 0	Chain 1	Chain 2	Chain 3
58	5290	75.88	75.88	75.60	75.88
106	5530	75.88	75.88	75.88	75.88
138	5690 For U-NII-2C	72.92	73.16	73.16	72.92
138	5690 For U-NII-3	2.92	2.92	2.92	2.92

Spectrum Plot of Worst Value

802.11a

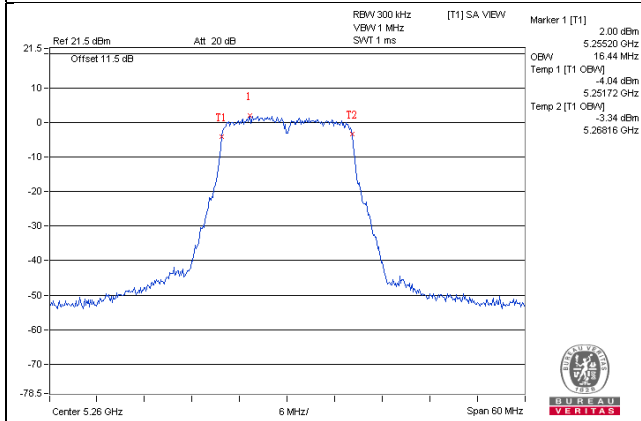

802.11n (HT20)

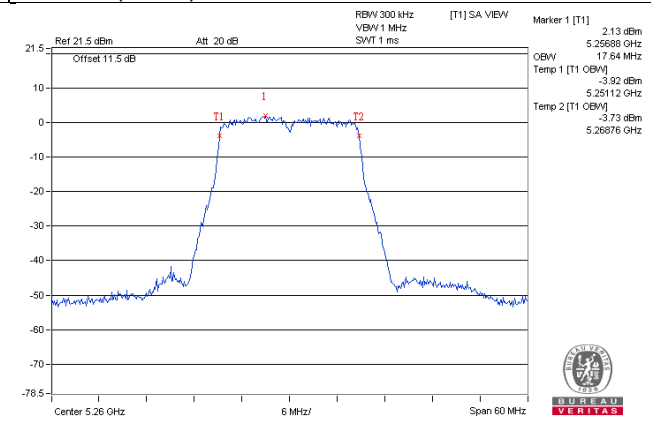

802.11n (HT40)

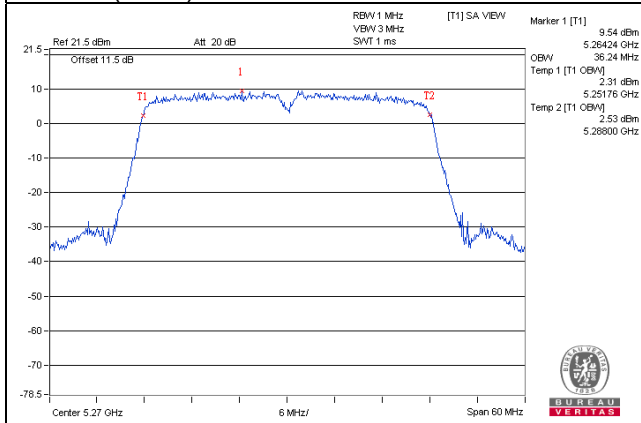

802.11ac (VHT80)

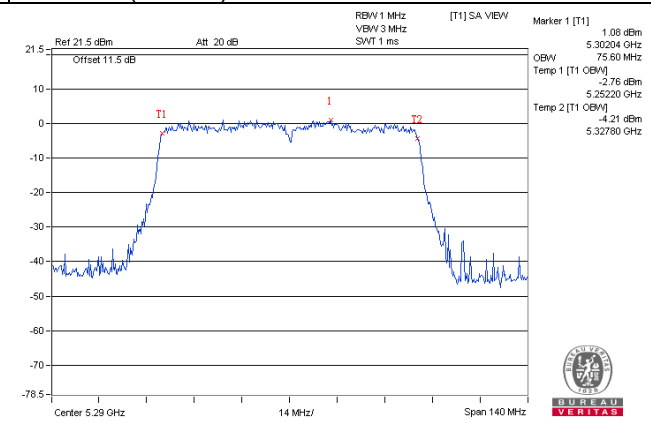

EUT MAXIMUM CONDUCTED POWER

CDD Mode

802.11a

Frequency Band (MHz)	Max. Power	
	Output Power (mW)	Output Power (dBm)
5250~5350	69.549	18.42
5470~5725	61.433	17.88

Note: Manufacturer provides Transmit Power Control description to meet this requirement.

802.11n (HT20)

Frequency Band (MHz)	Max. Power	
	Output Power (mW)	Output Power (dBm)
5250~5350	73.280	18.65
5470~5725	64.684	18.11

Note: Manufacturer provides Transmit Power Control description to meet this requirement.

802.11n (HT40)

Frequency Band (MHz)	Max. Power	
	Output Power (mW)	Output Power (dBm)
5250~5350	134.348	21.28
5470~5725	111.775	20.48

Note: Manufacturer provides Transmit Power Control description to meet this requirement.

802.11ac (VHT80)

Frequency Band (MHz)	Max. Power	
	Output Power (mW)	Output Power (dBm)
5250~5350	46.214	16.65
5470~5725	219.365	23.41

Note: Manufacturer provides Transmit Power Control description to meet this requirement.

Beamforming Mode

802.11n (HT20)

Frequency Band (MHz)	Max. Power	
	Output Power (mW)	Output Power (dBm)
5250~5350	18.323	12.63
5470~5725	16.174	12.09

Note: Manufacturer provides Transmit Power Control description to meet this requirement.

802.11n (HT40)

Frequency Band (MHz)	Max. Power	
	Output Power (mW)	Output Power (dBm)
5250~5350	33.592	15.26
5470~5725	27.947	14.46

Note: Manufacturer provides Transmit Power Control description to meet this requirement.

802.11ac (VHT80)

Frequency Band (MHz)	Max. Power	
	Output Power (mW)	Output Power (dBm)
5250~5350	11.555	10.63
5470~5725	54.849	17.39

Note: Manufacturer provides Transmit Power Control description to meet this requirement.

4.4 Peak Power Spectral Density Measurement

4.4.1 Limits of Peak Power Spectral Density Measurement

Operation Band	EUT Category		LIMIT
U-NII-1	-	Outdoor Access Point	17dBm/ MHz
	-	Fixed point-to-point Access Point	
	-	Indoor Access Point	11dBm/ MHz
	-	Mobile and Portable client device	
U-NII-2A	√		11dBm/ MHz
U-NII-2C	√		11dBm/ MHz
U-NII-3	-		30dBm/ 500kHz

4.4.2 Test Setup

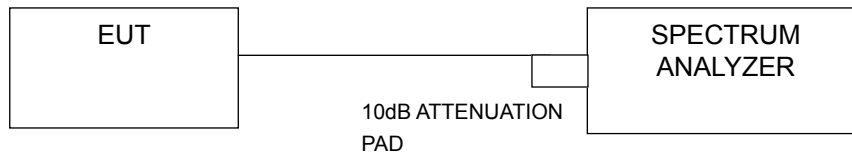

4.4.3 Test Instruments

Refer to section 4.1.2 to get information of above instrument.

4.4.4 Test Procedures

Without duty cycle (Using method SA-1):

- 1) Set span to encompass the entire emission bandwidth (EBW) of the signal.
- 2) Set RBW = 1MHz, Set VBW ≥ 3MHz, Detector = RMS
- 3) Set Channel power measure = 1MHz
- 4) Sweep time = auto, trigger set to “free run”.
- 5) Trace average at least 100 traces in power averaging mode.
- 6) Record the max value

With duty cycle (Using method SA-2):

- 1) Set span to encompass the entire emission bandwidth (EBW) of the signal.
- 2) Set RBW = 1MHz, Set VBW ≥ 3MHz, Detector = RMS
- 3) Set Channel power measure = 1MHz
- 4) Sweep time = auto, trigger set to “free run”.
- 5) Trace average at least 100 traces in power averaging mode.
- 6) Record the max value and add 10 log (1/duty cycle)

4.4.5 Deviation from Test Standard

No deviation.

4.4.6 EUT Operating Conditions

Same as Item 4.3.6.

4.4.7 Test Results

802.11a

Chan.	Freq. (MHz)	PSD (dBm)				Duty factor	Total PSD with duty factor (dBm)	Max. Limit (dBm)	Pass / Fail
		Chain 0	Chain 1	Chain 2	Chain 3				
52	5260	-2.12	-2.40	-2.18	-1.30	0.17	4.21	4.68	Pass
60	5300	-2.17	-2.14	-1.82	-1.25	0.17	4.36	4.68	Pass
64	5320	-2.04	-1.90	-1.75	-1.26	0.17	4.46	4.68	Pass
100	5500	-1.97	-1.84	-1.40	-1.33	0.17	4.56	4.68	Pass
116	5580	-1.86	-1.78	-1.45	-1.47	0.17	4.55	4.68	Pass
140	5700	-2.38	-2.12	-1.74	-1.58	0.17	4.25	4.68	Pass
144	5720 For U-NII-2C	-2.05	-1.57	-1.23	-1.42	0.17	4.63	4.68	Pass

Note:

1. Method 1 of power density measurement of KDB 662911 is using for calculating total power density. Total power density is summing entire spectra across corresponding frequency bins on the various outputs by computer.
2. Directional gain = $6.30\text{dBi} + 10\log(4) = 12.32\text{dBi} > 6\text{dBi}$, so the power density limit shall be reduced to $11 - (12.32 - 6) = 4.68\text{dBm}$.
3. Refer to section 3.3 for duty cycle spectrum plot.

802.11n (HT20)

Chan.	Freq. (MHz)	PSD (dBm)				Total PSD (dBm)	Max. Limit (dBm)	Pass / Fail
		Chain 0	Chain 1	Chain 2	Chain 3			
52	5260	-2.12	-2.49	-2.35	-1.31	3.98	4.68	Pass
60	5300	-1.99	-2.17	-1.83	-1.20	4.24	4.68	Pass
64	5320	-1.95	-1.92	-1.79	-1.33	4.28	4.68	Pass
100	5500	-1.88	-1.93	-1.52	-1.27	4.38	4.68	Pass
116	5580	-2.10	-1.72	-1.45	-1.54	4.33	4.68	Pass
140	5700	-2.20	-2.25	-1.81	-1.60	4.06	4.68	Pass
144	5720 For U-NII-2C	-1.53	-1.59	-1.49	-1.46	4.50	4.68	Pass

Note:

1. Method 1 of power density measurement of KDB 662911 is using for calculating total power density. Total power density is summing entire spectra across corresponding frequency bins on the various outputs by computer.
2. Directional gain = $6.30\text{dBi} + 10\log(4) = 12.32\text{dBi} > 6\text{dBi}$, so the power density limit shall be reduced to $11 - (12.32 - 6) = 4.68\text{dBm}$.
3. Refer to section 3.3 for duty cycle spectrum plot.

802.11n (HT40)

Chan.	Freq. (MHz)	PSD (dBm)				Duty factor	Total PSD with duty factor (dBm)	Max. Limit (dBm)	Pass / Fail
		Chain 0	Chain 1	Chain 2	Chain 3				
54	5270	-2.06	-2.23	-2.24	-1.21	0.12	4.23	4.68	Pass
62	5310	-3.49	-3.45	-3.55	-2.72	0.12	2.85	4.68	Pass
102	5510	-2.05	-2.03	-1.93	-1.99	0.12	4.14	4.68	Pass
110	5550	-1.92	-1.81	-1.65	-2.11	0.12	4.27	4.68	Pass
134	5670	-1.90	-2.41	-1.68	-2.04	0.12	4.14	4.68	Pass
142	5710 For U-NII-2C	-1.96	-1.77	-1.52	-1.52	0.12	4.45	4.68	Pass

Note:

1. Method 1 of power density measurement of KDB 662911 is using for calculating total power density. Total power density is summing entire spectra across corresponding frequency bins on the various outputs by computer.
2. Directional gain = 6.30dBi + 10log(4) = 12.32dBi > 6dBi, so the power density limit shall be reduced to 11-(12.32-6) = 4.68dBm.
3. Refer to section 3.3 for duty cycle spectrum plot.

802.11ac (VHT80)

Chan.	Freq. (MHz)	PSD (dBm)				Duty factor	Total PSD with duty factor (dBm)	Max. Limit (dBm)	Pass / Fail
		Chain 0	Chain 1	Chain 2	Chain 3				
58	5290	-9.94	-9.28	-9.45	-9.16	0.28	-3.15	4.68	Pass
106	5530	-9.45	-8.66	-9.12	-9.15	0.28	-2.79	4.68	Pass
138	5690 For U-NII-2C	-2.42	-1.91	-1.96	-1.73	0.28	4.30	4.68	Pass

Note:

1. Method 1 of power density measurement of KDB 662911 is using for calculating total power density. Total power density is summing entire spectra across corresponding frequency bins on the various outputs by computer.
2. Directional gain = 6.30dBi + 10log(4) = 12.32dBi > 6dBi, so the power density limit shall be reduced to 11-(12.32-6) = 4.68dBm.
3. Refer to section 3.3 for duty cycle spectrum plot.



BUREAU
VERITAS

Spectrum Plot of Worst Value

802.11a / Chain 3 / Ch 60

802.11n (HT20) / Chain 3 / Ch 60

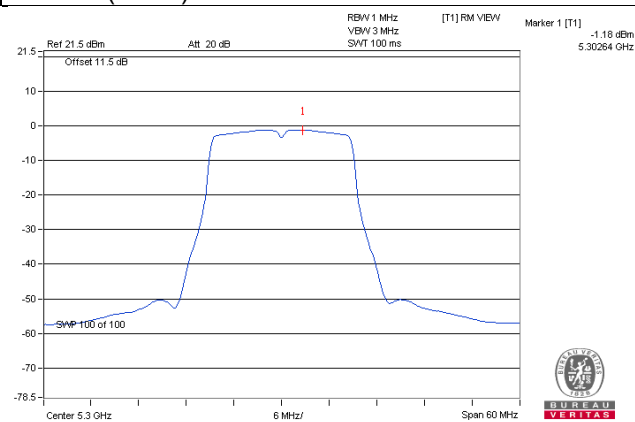
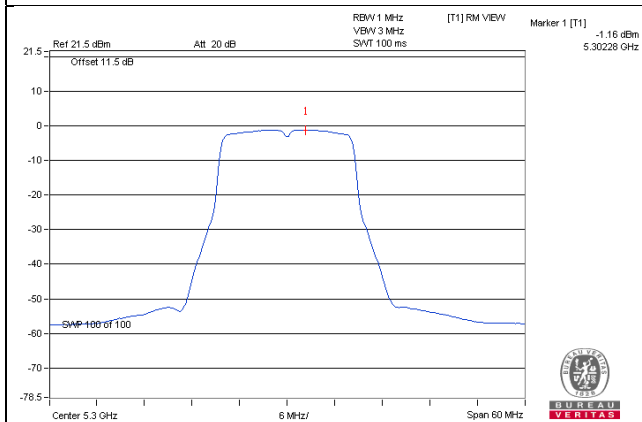

802.11n (HT40) / Chain 3 / Ch 54

802.11ac (VHT80) / Chain 3 / Ch 138

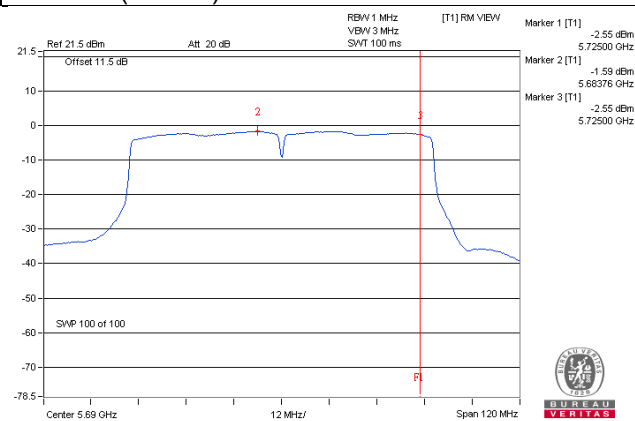
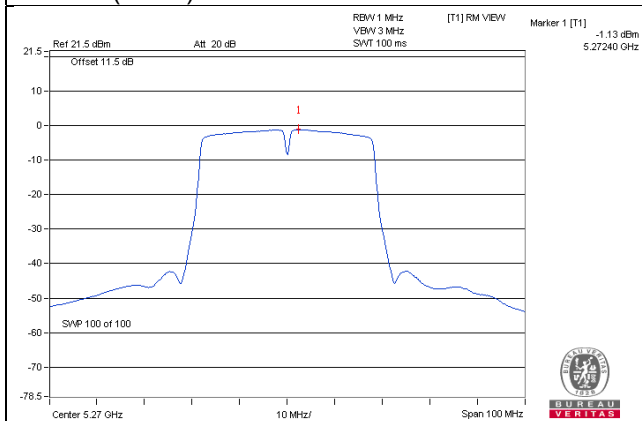

4.5 Frequency Stability

4.5.1 Limits of Frequency Stability Measurement

The frequency of the carrier signal shall be maintained within band of operation

4.5.2 Test Setup

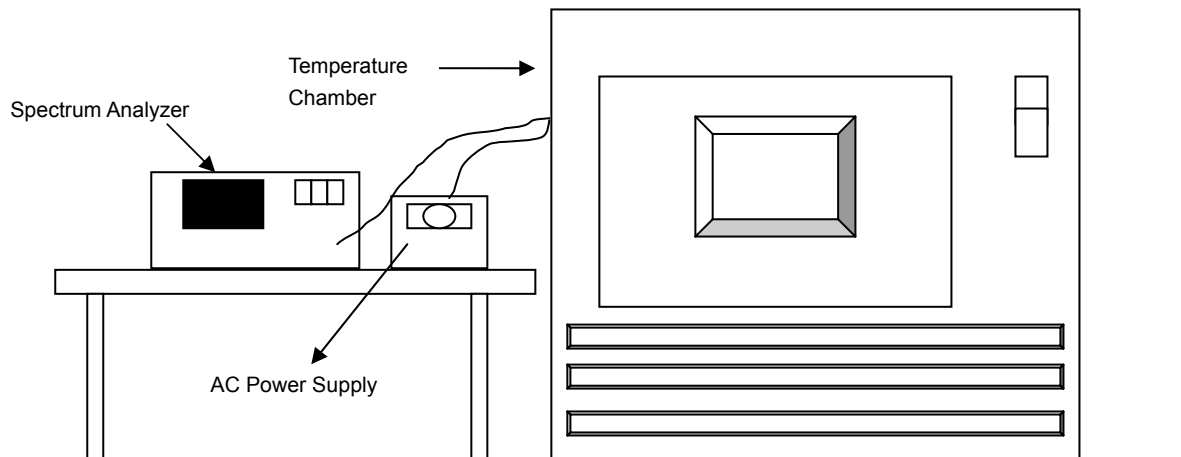

4.5.3 Test Instruments

Refer to section 4.1.2 to get information of above instrument.

4.5.4 Test Procedure

- The EUT was placed inside the environmental test chamber and powered by nominal AC voltage.
- Turn the EUT on and couple its output to a spectrum analyzer.
- Turn the EUT off and set the chamber to the highest temperature specified.
- Allow sufficient time (approximately 30 min) for the temperature of the chamber to stabilize, turn the EUT on and measure the operating frequency after 2, 5, and 10 minutes.
- Repeat step 2 and 3 with the temperature chamber set to the lowest temperature.
- The test chamber was allowed to stabilize at +20 degree C for a minimum of 30 minutes. The supply voltage was then adjusted on the EUT from 85% to 115% and the frequency record.

4.5.5 Deviation from Test Standard

No deviation.

4.5.6 EUT Operating Condition

Set the EUT transmit at un-modulation mode to test frequency stability.

4.5.7 Test Results

Frequency Stability Versus Temp.									
Operating Frequency: 5700MHz									
Temp. (°C)	Power Supply (Vac)	0 Minute		2 Minute		5 Minute		10 Minute	
		Measured Frequency (MHz)	Frequency Drift (%)	Measured Frequency (MHz)	Frequency Drift (%)	Measured Frequency (MHz)	Frequency Drift (%)	Measured Frequency (MHz)	Frequency Drift (%)
50	120	5699.9799	-0.00035	5699.9789	-0.00037	5699.9801	-0.00035	5699.9804	-0.00034
40	120	5699.9839	-0.00028	5699.9801	-0.00035	5699.9793	-0.00036	5699.9838	-0.00028
30	120	5700.0020	0.00004	5700.0019	0.00003	5699.9999	0.00000	5700.0028	0.00005
20	120	5699.9912	-0.00015	5699.9918	-0.00014	5699.9873	-0.00022	5699.9891	-0.00019
10	120	5699.9893	-0.00019	5699.9895	-0.00018	5699.9900	-0.00018	5699.9889	-0.00019
0	120	5700.0063	0.00011	5700.0075	0.00013	5700.0052	0.00009	5700.0075	0.00013
-10	120	5699.9781	-0.00038	5699.9780	-0.00039	5699.9783	-0.00038	5699.9784	-0.00038
-20	120	5699.9813	-0.00033	5699.9804	-0.00034	5699.9783	-0.00038	5699.9785	-0.00038
-30	120	5700.0239	0.00042	5700.0274	0.00048	5700.0235	0.00041	5700.0247	0.00043

Frequency Stability Versus Voltage									
Operating Frequency: 5700MHz									
Temp. (°C)	Power Supply (Vac)	0 Minute		2 Minute		5 Minute		10 Minute	
		Measured Frequency (MHz)	Frequency Drift (%)	Measured Frequency (MHz)	Frequency Drift (%)	Measured Frequency (MHz)	Frequency Drift (%)	Measured Frequency (MHz)	Frequency Drift (%)
20	138	5699.9905	-0.00017	5699.9917	-0.00015	5699.9875	-0.00022	5699.9891	-0.00019
	120	5699.9912	-0.00015	5699.9918	-0.00014	5699.9873	-0.00022	5699.9891	-0.00019
	102	5699.9908	-0.00016	5699.9911	-0.00016	5699.9884	-0.00020	5699.9894	-0.00019

5 Pictures of Test Arrangements

Please refer to the attached file (Test Setup Photo).

Appendix – Information on the Testing Laboratories

We, Bureau Veritas Consumer Products Services (H.K.) Ltd., Taoyuan Branch, were founded in 1988 to provide our best service in EMC, Radio, Telecom and Safety consultation. Our laboratories are accredited and approved according to ISO/IEC 17025.

If you have any comments, please feel free to contact us at the following:

Linko EMC/RF Lab

Tel: 886-2-26052180

Fax: 886-2-26051924

Hsin Chu EMC/RF/Telecom Lab

Tel: 886-3-6668565

Fax: 886-3-6668323

Hwa Ya EMC/RF/Safety

Tel: 886-3-3183232

Fax: 886-3-3270892

Email: service.adt@tw.bureauveritas.com

Web Site: www.bureauveritas-adt.com

The address and road map of all our labs can be found in our web site also.

--- END ---