

FCC Test Report

Report No.: RF160224C19-1

FCC ID: TVE-28166033

Test Model: FAP-S422E

Series Model: FortiAP S422Exxxxxx, FAP-S422Exxxxxx, FORTIAP-S422Exxxxxx (where "x" can be used as "A-Z" or "0-9" or "-" or blank for software changes or marketing purposes only)

Received Date: Feb. 24, 2016

Test Date: Mar. 09 ~ May 17, 2016

Issued Date: May 23, 2016

Applicant: Fortinet Inc.

Address: 899 Kifer Road Sunnyvale, CA 94086 USA

Issued By: Bureau Veritas Consumer Products Services (H.K.) Ltd., Taoyuan Branch

Lab Address: No. 47-2, 14th Ling, Chia Pau Vil., Lin Kou Dist., New Taipei City, Taiwan (R.O.C.)

Test Location: No.19, Hwa Ya 2nd Rd., Wen Hwa Vil., Kwei Shan Dist., Taoyuan City 33383, TAIWAN (R.O.C.)



This report is for your exclusive use. Any copying or replication of this report to or for any other person or entity, or use of our name or trademark, is permitted only with our prior written permission. This report sets forth our findings solely with respect to the test samples identified herein. The results set forth in this report are not indicative or representative of the quality or characteristics of the lot from which a test sample was taken or any similar or identical product unless specifically and expressly noted. Our report includes all of the tests requested by you and the results thereof based upon the information that you provided to us. You have 60 days from date of issuance of this report to notify us of any material error or omission caused by our negligence, provided, however, that such notice shall be in writing and shall specifically address the issue you wish to raise. A failure to raise such issue within the prescribed time shall constitute your unqualified acceptance of the completeness of this report, the tests conducted and the correctness of the report contents. Unless specific mention, the uncertainty of measurement has been explicitly taken into account to declare the compliance or non-compliance to the specification. The report must not be used by the client to claim product certification, approval, or endorsement by TAF or any government agencies.

Table of Contents

Release Control Record	4
1 Certificate of Conformity	5
2 Summary of Test Results	6
2.1 Measurement Uncertainty.....	6
2.2 Modification Record.....	6
3 General Information	7
3.1 General Description of EUT.....	7
3.2 Description of Test Modes.....	9
3.2.1 Test Mode Applicability and Tested Channel Detail.....	10
3.3 Duty Cycle of Test Signal.....	12
3.4 Description of Support Units.....	14
3.4.1 Configuration of System under Test.....	14
3.5 General Description of Applied Standard.....	15
4 Test Types and Results	16
4.1 Radiated Emission and Bandedge Measurement.....	16
4.1.1 Limits of Radiated Emission and Bandedge Measurement.....	16
4.1.2 Test Instruments.....	17
4.1.3 Test Procedure.....	18
4.1.4 Deviation from Test Standard.....	18
4.1.5 Test Setup.....	19
4.1.6 EUT Operating Conditions.....	19
4.1.7 Test Results.....	20
4.2 Conducted Emission Measurement.....	51
4.2.1 Limits of Conducted Emission Measurement.....	51
4.2.2 Test Instruments.....	51
4.2.3 Test Procedure.....	52
4.2.4 Deviation from Test Standard.....	52
4.2.5 Test Setup.....	52
4.2.6 EUT Operating Conditions.....	52
4.2.7 Test Results.....	53
4.3 Transmit Power Measurement.....	55
4.3.1 Limits of Transmit Power Measurement.....	55
4.3.2 Test Setup.....	55
4.3.3 Test Instruments.....	55
4.3.4 Test Procedure.....	56
4.3.5 Deviation from Test Standard.....	56
4.3.6 EUT Operating Conditions.....	56
4.3.7 Test Result.....	57
4.4 Peak Power Spectral Density Measurement.....	68
4.4.1 Limits of Peak Power Spectral Density Measurement.....	68
4.4.2 Test Setup.....	68
4.4.3 Test Instruments.....	68
4.4.4 Test Procedure.....	69
4.4.5 Deviation from Test Standard.....	69
4.4.6 EUT Operating Condition.....	69
4.4.7 Test Results.....	70
4.5 Frequency Stability.....	80
4.5.1 Limits of Frequency Stability Measurement.....	80
4.5.2 Test Setup.....	80
4.5.3 Test Instruments.....	80
4.5.4 Test Procedure.....	80
4.5.5 Deviation from Test Standard.....	80
4.5.6 EUT Operating Condition.....	80

4.5.7 Test Results	81
4.6 6dB Bandwidth Measurement.....	82
4.6.1 Limits of 6dB Bandwidth Measurement.....	82
4.6.2 Test Setup.....	82
4.6.3 Test Instruments	82
4.6.4 Test Procedure	82
4.6.5 Deviation from Test Standard	82
4.6.6 EUT Operating Condition	82
4.6.7 Test Results	83
5 Pictures of Test Arrangements.....	86
Appendix – Information on the Testing Laboratories	87

Release Control Record

Issue No.	Description	Date Issued
RF160224C19-1	Original release.	May 23, 2016

1 Certificate of Conformity

Product: Secured Wireless Access Point

Brand: Fortinet Inc.

Test Model: FAP-S422E

Series Model: FortiAP S422Exxxxxx, FAP-S422Exxxxxx, FORTIAP-S422Exxxxxx (where "x" can be used as "A-Z" or "0-9" or "-" or blank for software changes or marketing purposes only)

Sample Status: Engineering sample

Applicant: Fortinet Inc.

Test Date: Mar. 09 ~ Mar. 17, 2016

Standard: 47 CFR FCC Part 15, Subpart E (Section 15.407)
ANSI C63.10:2013

The above equipment has been tested by **Bureau Veritas Consumer Products Services (H.K.) Ltd., Taoyuan Branch**, and found compliance with the requirement of the above standards. The test record, data evaluation & Equipment Under Test (EUT) configurations represented herein are true and accurate accounts of the measurements of the sample's EMC characteristics under the Conditions specified in this report.

Prepared by :  , **Date:** May 23, 2016
Petlie Chen / Senior Specialist

Approved by :  , **Date:** May 23, 2016
Ken Liu / Senior Manager

2 Summary of Test Results

47 CFR FCC Part 15, Subpart E (Section 15.407)			
FCC Clause	Test Item	Result	Remarks
15.407(b)(6)	AC Power Conducted Emissions	Pass	Meet the requirement of limit. Minimum passing margin is -6.10dB at 0.52600MHz.
15.407(b)(1/2/3/4/6)	Radiated Emissions & Band Edge Measurement	Pass	Meet the requirement of limit. Minimum passing margin is -1.1dB at 5150.00MHz.
15.407(a)(1/2/3)	Max Average Transmit Power	Pass	Meet the requirement of limit.
15.407(a)(1/2/3)	Peak Power Spectral Density	Pass	Meet the requirement of limit.
15.407(e)	6dB bandwidth	Pass	Meet the requirement of limit. (U-NII-3 Band only)
15.407(g)	Frequency Stability	Pass	Meet the requirement of limit.
15.203	Antenna Requirement	Pass	Antenna connector is N-Type. (The device is professionally installed)

2.1 Measurement Uncertainty

Where relevant, the following measurement uncertainty levels have been estimated for tests performed on the EUT as specified in CISPR 16-4-2:

Measurement	Frequency	Expanded Uncertainty (k=2) (\pm)
Conducted Emissions at mains ports	150kHz ~ 30MHz	2.44 dB
Radiated Emissions up to 1 GHz	30MHz ~ 200MHz	3.86 dB
	200MHz ~ 1000MHz	3.87 dB
Radiated Emissions above 1 GHz	1GHz ~ 18GHz	2.29 dB
	18GHz ~ 40GHz	2.29 dB

2.2 Modification Record

There were no modifications required for compliance.

3 General Information

3.1 General Description of EUT

Product	Secured Wireless Access Point
Brand	Fortinet Inc.
Test Model	FAP-S422E
Series Model	FortiAP S422Exxxxxx, FAP-S422Exxxxxx, FORTIAP-S422Exxxxxx (where "x" can be used as "A-Z" or "0-9" or "-" or blank for software changes or marketing purposes only)
Model Difference	Refer to Note
Sample Status	Engineering sample
Power Supply Rating	48Vdc (POE)
Modulation Type	256QAM, 64QAM, 16QAM, QPSK, BPSK
Modulation Technology	OFDM
Transfer Rate	802.11a: 54/48/36/24/18/12/9/6Mbps 802.11n: up to 600Mbps 802.11ac: up to 1733Mbps
Operating Frequency	5180 ~ 5240MHz, 5745 ~ 5825MHz
Number of Channel	5180 ~ 5240MHz: 4 for 802.11a, 802.11n (HT20), 802.11ac (VHT20) 2 for 802.11n (HT40), 802.11ac (VHT40) 1 for 802.11ac (VHT80) 5745 ~ 5825MHz: 5 for 802.11a, 802.11n (HT20), 802.11ac (VHT20) 2 for 802.11n (HT40), 802.11ac (VHT40) 1 for 802.11ac (VHT80)
Output Power	CDD Mode: 5180 ~ 5240MHz: 255.910mW 5745 ~ 5825MHz: 526.023mW Beamforming Mode: 5180 ~ 5240MHz: 76.608mW 5745 ~ 5825MHz: 174.959mW
Antenna Type	Dipole antenna with 6.3dBi gain
Antenna Connector	N-Type (The device is professionally installed)
Accessory Device	POE, POE's adapter, surge protector
Data Cable Supplied	1.8m non-shielded grounding cable without core x3

Note:

1. All models are listed as below. Model FAP-S422E is the representative for final test.

Brand	Model	Difference
Fortinet Inc.	FortiAP S422Exxxxxx	where "x" can be used as "A-Z" or "0-9" or "-" or blank for software changes or marketing purposes only
	FAP-S422Exxxxxx	
	FORTIAP-S422Exxxxxx	

2. The EUT incorporates a MIMO function. Physically, the EUT provides 4 completed transmitters and 4 receivers.

Band	Modulation Mode	CDD Mode	Beamforming Mode	TX Function
5GHz	802.11a	Support	Not Support	4TX
	802.11n (HT20)	Support	Not Support	4TX
	802.11n (HT40)	Support	Not Support	4TX
	802.11ac (VHT20)	Support	Support	4TX
	802.11ac (VHT40)	Support	Support	4TX
	802.11ac (VHT80)	Support	Support	4TX

* CDD Mode: The modulation and bandwidth are similar for 802.11n mode for HT20/HT40 and 802.11ac mode for HT20/HT40, therefore investigated worst case to representative mode in test report. (Final test mode refer section 3.2.1)

3. The EUT uses the following POE and POE's adapter.

POE	
Brand	EnGenius
Model	POE-48GP
Rating	48Vdc

POE's adapter	
Brand	Powertron Electronics Corp.
Model	PA1040-480IB080
Input Power	100-240Vac, 50-60Hz, 1.5A
Output Power	48Vdc, 0.8A, 38.4W Max
Power Line	1.55m cable with 1 core attached on adapter

4. The EUT will install at outdoor area, the highest antenna gain from the horizon above 30 degrees as below, for more detail information please refer to antenna specification and user manual

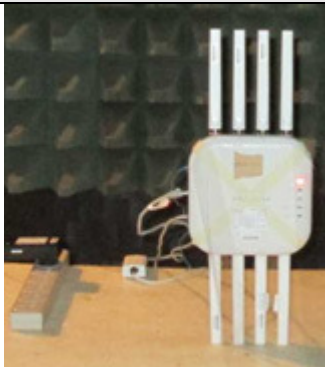
Antenna	Antenna gain	Antenna install degree
Dipole	-3.89 dBi	

5. The above EUT information is declared by manufacturer and for more detailed features description, please refer to the manufacturer's specifications or user's manual.

3.2 Description of Test Modes

FOR 5180 ~ 5240MHz:

4 channels are provided for 802.11a, 802.11n (HT20), 802.11ac (VHT20):

Channel	Frequency	Channel	Frequency
36	5180 MHz	44	5220 MHz
40	5200 MHz	48	5240 MHz

2 channels are provided for 802.11n (HT40), 802.11ac (VHT40):

Channel	Frequency	Channel	Frequency
38	5190 MHz	46	5230 MHz

1 channel is provided for 802.11ac (VHT80):

Channel	Frequency
42	5210MHz

FOR 5745 ~ 5825MHz:

5 channels are provided for 802.11a, 802.11n (HT20), 802.11ac (VHT20):

Channel	Frequency	Channel	Frequency
149	5745MHz	161	5805MHz
153	5765MHz	165	5825MHz
157	5785MHz		

2 channels are provided for 802.11n (HT40), 802.11ac (VHT40):

Channel	Frequency	Channel	Frequency
151	5755MHz	159	5795MHz

1 channel is provided for 802.11ac (VHT80):

Channel	Frequency
155	5775MHz

3.2.1 Test Mode Applicability and Tested Channel Detail

EUT Configure Mode	Applicable to				Description
	RE \geq 1G	RE<1G	PLC	APCM	
-	√	√	√	√	-

Where RE \geq 1G: Radiated Emission above 1GHz & Bandedge Measurement
 RE<1G: Radiated Emission below 1GHz
 PLC: Power Line Conducted Emission
 APCM: Antenna Port Conducted Measurement

Note: The EUT was positioned on the Y-plane during testing.

Radiated Emission Test (Above 1GHz):

- Pre-Scan has been conducted to determine the worst-case mode from all possible combinations between available modulations, data rates and antenna ports (if EUT with antenna diversity architecture).
- Following channel(s) was (were) selected for the final test as listed below.

EUT CONFIGURE MODE	MODE	FREQ. BAND (MHz)	AVAILABLE CHANNEL	TESTED CHANNEL	MODULATION TECHNOLOGY	MODULATION TYPE	DATA RATE (Mbps)
CDD Mode							
-	802.11a	5180-5240	36 to 48	36, 40, 48	OFDM	BPSK	6.0
-	802.11n (HT20)		36 to 48	36, 40, 48	OFDM	BPSK	6.5
-	802.11n (HT40)		38 to 46	38, 46	OFDM	BPSK	13.5
-	802.11ac (VHT80)		42	42	OFDM	BPSK	117.0
-	802.11a	5745-5825	149 to 165	149, 157, 165	OFDM	BPSK	6.0
-	802.11n (HT20)		149 to 165	149, 157, 165	OFDM	BPSK	6.5
-	802.11n (HT40)		151 to 159	151, 159	OFDM	BPSK	13.5
-	802.11ac (VHT80)		155	155	OFDM	BPSK	117.0
Beamforming Mode							
-	802.11ac (VHT20)	5180-5240	36 to 48	36, 40, 48	OFDM	BPSK	26.0
-	802.11ac (VHT40)		38 to 46	38, 46	OFDM	BPSK	54.0
-	802.11ac (VHT80)		42	42	OFDM	BPSK	117.0
-	802.11ac (VHT20)	5745-5825	149 to 165	149, 157, 165	OFDM	BPSK	26.0
-	802.11ac (VHT40)		151 to 159	151, 159	OFDM	BPSK	54.0
-	802.11ac (VHT80)		155	155	OFDM	BPSK	117.0

Radiated Emission Test (Below 1GHz):

- Pre-Scan has been conducted to determine the worst-case mode from all possible combinations between available modulations, data rates and antenna ports (if EUT with antenna diversity architecture).
- Following channel(s) was (were) selected for the final test as listed below.

EUT CONFIGURE MODE	MODE	FREQ. BAND (MHz)	AVAILABLE CHANNEL	TESTED CHANNEL	MODULATION TECHNOLOGY	MODULATION TYPE	DATA RATE (Mbps)
CDD Mode							
-	802.11a	5180-5240	36 to 48	149	OFDM	BPSK	6.0
	802.11a	5745-5825	149 to 165		OFDM	BPSK	6.0

Power Line Conducted Emission Test:

- Pre-Scan has been conducted to determine the worst-case mode from all possible combinations between available modulations, data rates and antenna ports (if EUT with antenna diversity architecture).
- Following channel(s) was (were) selected for the final test as listed below.

EUT CONFIGURE MODE	MODE	FREQ. BAND (MHz)	AVAILABLE CHANNEL	TESTED CHANNEL	MODULATION TECHNOLOGY	MODULATION TYPE	DATA RATE (Mbps)
CDD Mode							
-	802.11a	5180-5240	36 to 48	149	OFDM	BPSK	6.0
-	802.11a	5745-5825	149 to 165		OFDM	BPSK	6.0

Antenna Port Conducted Measurement:

- This item includes all test value of each mode, but only includes spectrum plot of worst value of each mode.
- Pre-Scan has been conducted to determine the worst-case mode from all possible combinations between available modulations, data rates and antenna ports (if EUT with antenna diversity architecture).
- Following channel(s) was (were) selected for the final test as listed below.

EUT CONFIGURE MODE	MODE	FREQ. BAND (MHz)	AVAILABLE CHANNEL	TESTED CHANNEL	MODULATION TECHNOLOGY	MODULATION TYPE	DATA RATE (Mbps)
CDD Mode							
-	802.11a	5180-5240	36 to 48	36, 40, 48	OFDM	BPSK	6.0
-	802.11n (HT20)		36 to 48	36, 40, 48	OFDM	BPSK	6.5
-	802.11n (HT40)		38 to 46	38, 46	OFDM	BPSK	13.5
-	802.11ac (VHT80)		42	42	OFDM	BPSK	117.0
-	802.11a	5745-5825	149 to 165	149, 157, 165	OFDM	BPSK	6.0
-	802.11n (HT20)		149 to 165	149, 157, 165	OFDM	BPSK	6.5
-	802.11n (HT40)		151 to 159	151, 159	OFDM	BPSK	13.5
-	802.11ac (VHT80)		155	155	OFDM	BPSK	117.0
Beamforming Mode							
-	802.11ac (VHT20)	5180-5240	36 to 48	36, 40, 48	OFDM	BPSK	26.0
-	802.11ac (VHT40)		38 to 46	38, 46	OFDM	BPSK	54.0
-	802.11ac (VHT80)		42	42	OFDM	BPSK	117.0
-	802.11ac (VHT20)	5745-5825	149 to 165	149, 157, 165	OFDM	BPSK	26.0
-	802.11ac (VHT40)		151 to 159	151, 159	OFDM	BPSK	54.0
-	802.11ac (VHT80)		155	155	OFDM	BPSK	117.0

Test Condition:

Applicable to	Environmental Conditions	Input Power	Tested by
RE≥1G	18 deg. C, 70% RH	120Vac, 60Hz	Nick Hsu
RE<1G	19 deg. C, 70% RH	120Vac, 60Hz	Jones Chang
PLC	20 deg. C, 70% RH	120Vac, 60Hz	Jones Chang
APCM	25 deg. C, 60% RH	120Vac, 60Hz	Leo Tsai

3.3 Duty Cycle of Test Signal

CDD Mode

Duty cycle of test signal is > 98%, duty factor is not required

Duty cycle of test signal is < 98 %, duty factor is required

802.11a: Duty cycle = $2.065/2.135 = 0.967$, Duty factor = $10 * \log(1/0.967) = 0.14$

802.11n (HT20): Duty cycle = $4.955/5.073 = 0.977$, Duty factor = $10 * \log(1/0.977) = 0.10$

802.11n (HT40): Duty cycle = $2.428/2.503 = 0.970$, Duty factor = $10 * \log(1/0.970) = 0.13$

802.11ac (VHT80): Duty cycle = $1.144/1.227 = 0.932$, Duty factor = $10 * \log(1/0.932) = 0.30$



Beamforming Mode

Duty cycle of test signal is > 98%, duty factor is not required

Duty cycle of test signal is < 98 %, duty factor is required

802.11ac (VHT20): Duty cycle = 4.997/5.082 = 0.983

802.11ac (VHT40): Duty cycle = 2.428/2.515 = 0.965, Duty factor = $10 * \log(1/0.965) = 0.15$

802.11ac (VHT80): Duty cycle = 1.143/1.223 = 0.935, Duty factor = $10 * \log(1/0.935) = 0.29$

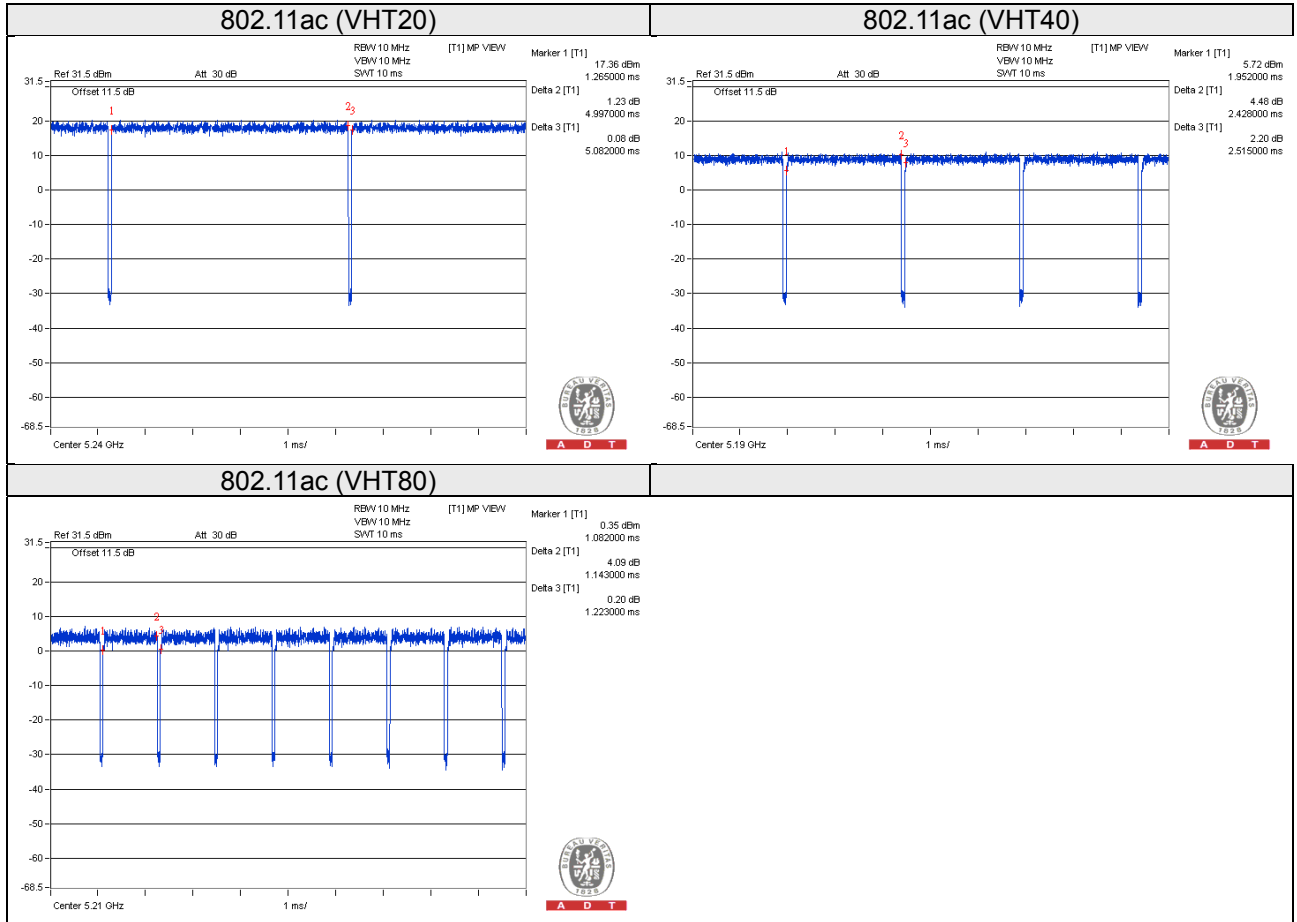

3.4 Description of Support Units

The EUT has been tested as an independent unit together with other necessary accessories or support units. The following support units or accessories were used to form a representative test configuration during the tests.

ID	Product	Brand	Model No.	Serial No.	FCC ID	Remarks
A.	Notebook	DELL	D531	CN-0XM006-48643-81 U-2973	QDS-BRCM1020	-
B.	Load	NA	NA	NA	NA	-

Note:

1. All power cords of the above support units are non-shielded (1.8m).
2. Item A acted as a communication partner to transfer data.

ID	Descriptions	Qty.	Length (m)	Shielding (Yes/No)	Cores (Qty.)	Remarks
1.	RJ45	1	1.0	N	0	-
2.	RJ45	1	1.8	N	0	-
3.	RJ45	1	10	N	0	-
4.	RJ45 to RS232	1	1.8	Y	0	-

3.4.1 Configuration of System under Test

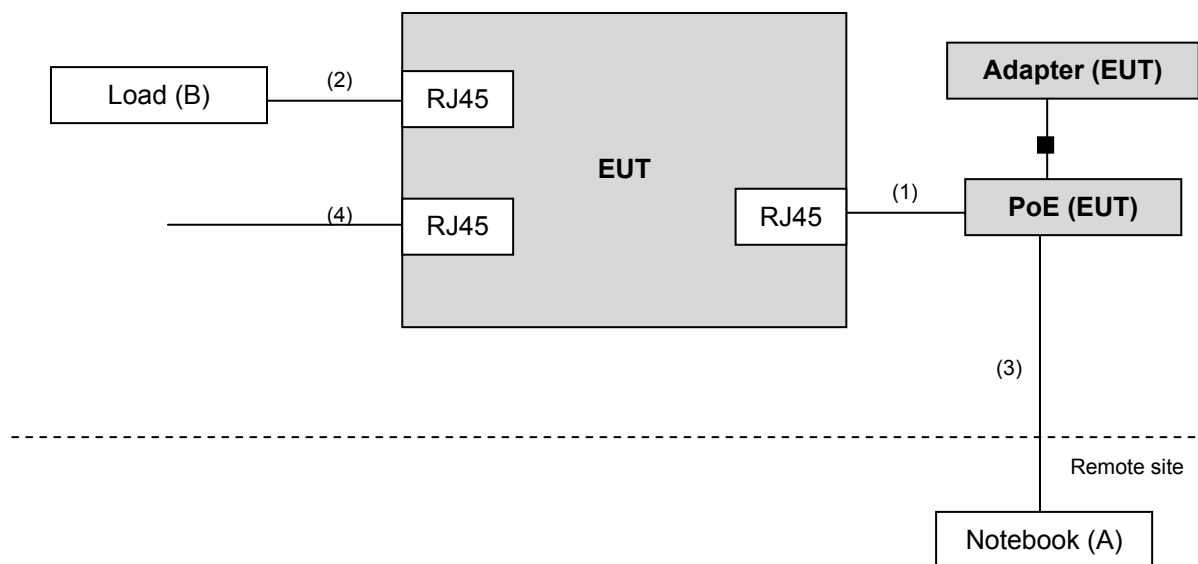

3.5 General Description of Applied Standard

The EUT is a RF Product. According to the specifications of the manufacturer, it must comply with the requirements of the following standards:

FCC Part 15, Subpart E (15.407)

KDB 789033 D02 General UNII Test Procedures New Rules v01r02

KDB 662911 D01 Multiple Transmitter Output v02r01

ANSI C63.10:2013

All test items have been performed and recorded as per the above standards.

Note: The EUT has been verified to comply with the requirements of FCC Part 15, Subpart B, Class B (DoC).
The test report has been issued separately.

4 Test Types and Results

4.1 Radiated Emission and Bandedge Measurement

4.1.1 Limits of Radiated Emission and Bandedge Measurement

Radiated emissions which fall in the restricted bands must comply with the radiated emission limits specified as below table.

Frequencies (MHz)	Field Strength (microvolts/meter)	Measurement Distance (meters)
0.009 ~ 0.490	2400/F(kHz)	300
0.490 ~ 1.705	24000/F(kHz)	30
1.705 ~ 30.0	30	30
30 ~ 88	100	3
88 ~ 216	150	3
216 ~ 960	200	3
Above 960	500	3

NOTE:

1. The lower limit shall apply at the transition frequencies.
2. Emission level (dBuV/m) = 20 log Emission level (uV/m).
3. For frequencies above 1000MHz, the field strength limits are based on average detector, however, the peak field strength of any emission shall not exceed the maximum permitted average limits, specified above by more than 20dB under any condition of modulation.

Limits of Unwanted Emission Out of The Restricted Bands

Applicable To	Limit	
789033 D02 General UNII Test Procedures New Rules v01r02	Field Strength at 3m	
	PK:74 (dBuV/m)	AV:54 (dBuV/m)
Applicable To	EIRP Limit	Equivalent Field Strength at 3m
15.407(b)(1)	PK: -27 (dBm/MHz)	PK: 68.2 (dBuV/m)
15.407(b)(2)		
15.407(b)(3)		
15.407(b)(4)	PK: -27 (dBm/MHz) ^{*1} PK: -17 (dBm/MHz) ^{*2}	PK: 68.2 (dBuV/m) ^{*1} PK: 78.2 (dBuV/m) ^{*2}

NOTE: ^{*1} beyond 10MHz of the band edge ^{*2} within 10 MHz of band edge

The following formula is used to convert the equipment isotropic radiated power (eirp) to field strength:

$$E = \frac{1000000 \sqrt{30P}}{3} \mu\text{V/m, where P is the eirp (Watts).}$$

4.1.2 Test Instruments

Description & Manufacturer	Model No.	Serial No.	Cal. Date	Cal. Due
Test Receiver ROHDE & SCHWARZ	ESIB7	100187	Apr. 18, 2016	Apr. 17, 2017
Spectrum Analyzer ROHDE & SCHWARZ	FSV40	100979	Feb. 19, 2016	Feb. 18, 2017
BILOG Antenna SCHWARZBECK	VULB9168	9168-171	Jan. 07, 2016	Jan. 06, 2017
HORN Antenna SCHWARZBECK	9120D	209	Jan. 20, 2016	Jan. 19, 2017
HORN Antenna SCHWARZBECK	BBHA 9170	BBHA9170241	Jan. 18, 2016	Jan. 17, 2017
Preamplifier Agilent	8447D	2944A10738	Oct. 18, 2015	Oct. 17, 2016
Preamplifier Agilent	8449B	3008A01964	Aug. 22, 2015	Aug. 21, 2016
RF signal cable HUBER+SUHNER	SUCOFLEX 104	Cable-CH3-03 (214378)	Aug. 22, 2015	Aug. 21, 2016
RF signal cable HUBER+SUHNER	SUCOFLEX 106	Cable-CH3-03 (309224+12738)	Aug. 22, 2015	Aug. 21, 2016
Software BV ADT	ADT_Radiated_ V7.6.15.9.4	NA	NA	NA
Antenna Tower inn-co GmbH	MA 4000	013303	NA	NA
Antenna Tower Controller BV ADT	AT100	AT93021702	NA	NA
Turn Table BV ADT	TT100	TT93021702	NA	NA
Turn Table Controller BV ADT	SC100	SC93021702	NA	NA
26GHz ~ 40GHz Amplifier	EM26400	815221	Oct. 18, 2015	Oct. 17, 2016
High Speed Peak Power Meter	ML2495A	0824011	Jul. 09, 2015	Jul. 08, 2016
Power Sensor	MA2411B	0738171	Jul. 09, 2015	Jul. 08, 2016

- Note:
1. The calibration interval of the above test instruments is 12 months and the calibrations are traceable to NML/ROC and NIST/USA.
 2. The test was performed in HwaYa Chamber 3.
 3. The horn antenna and preamplifier (model: 8449B) are used only for the measurement of emission frequency above 1GHz if tested.
 4. The FCC Site Registration No. is 988962.
 5. The IC Site Registration No. is IC 7450F-3.

4.1.3 Test Procedure

- a. The EUT was placed on the top of a rotating table 0.8 meters (for below 1GHz) / 1.5 meters (for above 1GHz) above the ground at 3 meter chamber room for test. The table was rotated 360 degrees to determine the position of the highest radiation.
- b. The EUT was set 3 meters away from the interference-receiving antenna, which was mounted on the top of a variable-height antenna tower.
- c. The height of antenna is varied from one meter to four meters above the ground to determine the maximum value of the field strength. Both horizontal and vertical polarizations of the antenna are set to make the measurement.
- d. For each suspected emission, the EUT was arranged to its worst case and then the antenna was tuned to heights from 1 meter to 4 meters and the rotatable table was turned from 0 degrees to 360 degrees to find the maximum reading.
- e. The test-receiver system was set to quasi-peak detect function and specified bandwidth with maximum hold mode when the test frequency is below 1 GHz.
- f. The test-receiver system was set to peak and average detect function and specified bandwidth with maximum hold mode when the test frequency is above 1 GHz. If the peak reading value also meets average limit, measurement with the average detector is unnecessary.

Note:

1. The resolution bandwidth and video bandwidth of test receiver/spectrum analyzer is 120kHz for Quasi-peak detection (QP) at frequency below 1GHz.
2. The resolution bandwidth of test receiver/spectrum analyzer is 1 MHz and the video bandwidth is 3 MHz for Peak detection (PK) at frequency above 1GHz.
3. The resolution bandwidth of test receiver/spectrum analyzer is 1MHz and the video bandwidth is 3MHz for RMS Average (Duty cycle < 98%) for Average detection (AV) at frequency above 1GHz, then the measurement results was added to a correction factor ($10 \log(1/\text{duty cycle})$).
4. The resolution bandwidth of test receiver/spectrum analyzer is 1MHz and the video bandwidth is 10Hz (Duty cycle $\geq 98\%$) for Average detection (AV) at frequency above 1GHz.
5. All modes of operation were investigated and the worst-case emissions are reported.

4.1.4 Deviation from Test Standard

No deviation.

4.1.5 Test Setup

<Frequency Range 30MHz~1GHz>

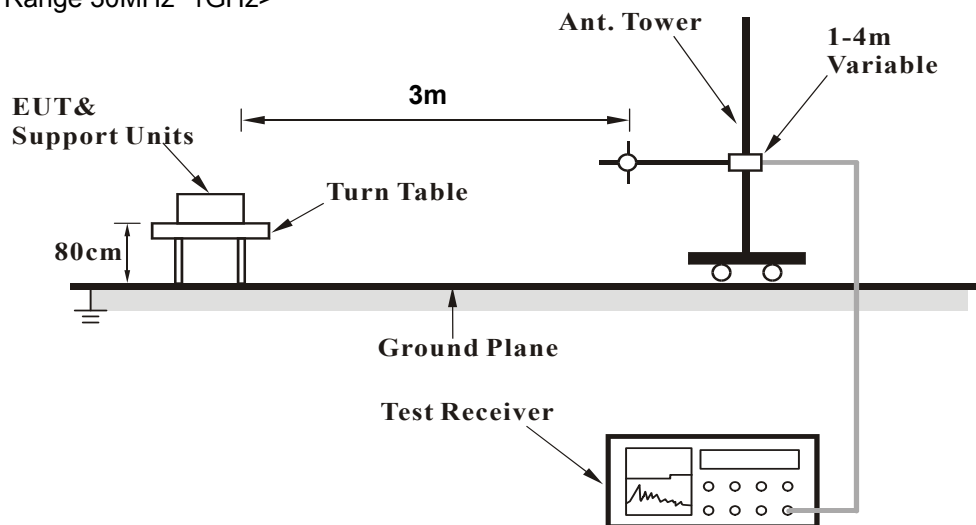

<Frequency Range above 1GHz>

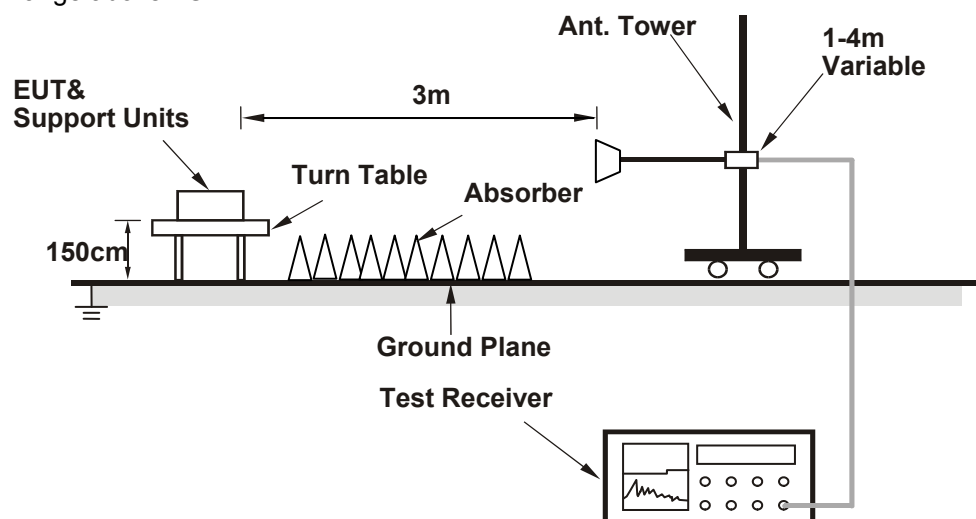

For the actual test configuration, please refer to the attached file (Test Setup Photo).

4.1.6 EUT Operating Conditions

- a. Placed the EUT on the testing table.
- b. Prepared a notebook to act as a communication partner and placed it outside of testing area.
- c. The communication partner connected with EUT via a RJ45 cable and ran a test program (provided by manufacturer) to enable EUT under transmission condition continuously at specific channel frequency.
- d. The communication partner sent data to EUT by command "PING".
- e. The necessary accessories enable the system in full functions.

4.1.7 Test Results

Above 1GHz Data:

CDD Mode

802.11a

CHANNEL	TX Channel 36	DETECTOR FUNCTION	Peak (PK)
FREQUENCY RANGE	1GHz ~ 40GHz		Average (AV)

ANTENNA POLARITY & TEST DISTANCE: HORIZONTAL AT 3 M

NO.	FREQ. (MHz)	EMISSION LEVEL (dBuV/m)	LIMIT (dBuV/m)	MARGIN (dB)	ANTENNA HEIGHT (m)	TABLE ANGLE (Degree)	RAW VALUE (dBuV)	CORRECTION FACTOR (dB/m)
1	5150.00	57.4 PK	74.0	-16.6	1.75 H	201	51.40	6.00
2	5150.00	44.5 AV	54.0	-9.5	1.75 H	201	38.50	6.00
3	*5180.00	102.6 PK			1.94 H	173	63.20	39.40
4	*5180.00	91.8 AV			1.94 H	173	52.40	39.40
5	#10360.00	59.6 PK	74.0	-14.4	1.49 H	330	41.80	17.80
6	#10360.00	46.4 AV	54.0	-7.6	1.49 H	330	28.60	17.80

ANTENNA POLARITY & TEST DISTANCE: VERTICAL AT 3 M

NO.	FREQ. (MHz)	EMISSION LEVEL (dBuV/m)	LIMIT (dBuV/m)	MARGIN (dB)	ANTENNA HEIGHT (m)	TABLE ANGLE (Degree)	RAW VALUE (dBuV)	CORRECTION FACTOR (dB/m)
1	5150.00	66.4 PK	74.0	-7.6	1.78 V	341	60.40	6.00
2	5150.00	52.2 AV	54.0	-1.8	1.78 V	341	46.20	6.00
3	*5180.00	123.2 PK			1.72 V	352	83.80	39.40
4	*5180.00	111.8 AV			1.72 V	352	72.40	39.40
5	#10360.00	61.0 PK	74.0	-13.0	1.74 V	349	43.20	17.80
6	#10360.00	47.5 AV	54.0	-6.5	1.74 V	349	29.70	17.80

REMARKS:

1. Emission Level(dBuV/m) = Raw Value(dBuV) + Correction Factor(dB/m)
2. Correction Factor(dB/m) = Antenna Factor(dB/m) + Cable Factor(dB)
3. The other emission levels were very low against the limit.
4. Margin value = Emission Level – Limit value
5. " * ": Fundamental frequency.
6. " # ": The radiated frequency is out of the restricted band.

CHANNEL	TX Channel 40	DETECTOR FUNCTION	Peak (PK)
FREQUENCY RANGE	1GHz ~ 40GHz		Average (AV)

ANTENNA POLARITY & TEST DISTANCE: HORIZONTAL AT 3 M

NO.	FREQ. (MHz)	EMISSION LEVEL (dBuV/m)	LIMIT (dBuV/m)	MARGIN (dB)	ANTENNA HEIGHT (m)	TABLE ANGLE (Degree)	RAW VALUE (dBuV)	CORRECTION FACTOR (dB/m)
1	5150.00	60.2 PK	74.0	-13.8	1.67 H	176	54.20	6.00
2	5150.00	47.8 AV	54.0	-6.2	1.67 H	176	41.80	6.00
3	*5200.00	124.4 PK			1.74 H	169	84.90	39.50
4	*5200.00	113.5 AV			1.74 H	169	74.00	39.50
5	#10400.00	59.0 PK	74.0	-15.0	1.46 H	134	41.30	17.70
6	#10400.00	46.8 AV	54.0	-7.2	1.46 H	134	29.10	17.70

ANTENNA POLARITY & TEST DISTANCE: VERTICAL AT 3 M

NO.	FREQ. (MHz)	EMISSION LEVEL (dBuV/m)	LIMIT (dBuV/m)	MARGIN (dB)	ANTENNA HEIGHT (m)	TABLE ANGLE (Degree)	RAW VALUE (dBuV)	CORRECTION FACTOR (dB/m)
1	5150.00	61.1 PK	74.0	-12.9	1.64 V	175	55.10	6.00
2	5150.00	48.8 AV	54.0	-5.2	1.64 V	175	42.80	6.00
3	*5200.00	126.7 PK			1.71 V	169	87.20	39.50
4	*5200.00	116.0 AV			1.71 V	169	76.50	39.50
5	#10400.00	59.7 PK	74.0	-14.3	1.87 V	345	42.00	17.70
6	#10400.00	47.4 AV	54.0	-6.6	1.87 V	345	29.70	17.70

REMARKS:

1. Emission Level(dBuV/m) = Raw Value(dBuV) + Correction Factor(dB/m)
2. Correction Factor(dB/m) = Antenna Factor(dB/m) + Cable Factor(dB)
3. The other emission levels were very low against the limit.
4. Margin value = Emission Level – Limit value
5. " * ": Fundamental frequency.
6. " # ": The radiated frequency is out of the restricted band.

CHANNEL	TX Channel 48	DETECTOR FUNCTION	Peak (PK)
FREQUENCY RANGE	1GHz ~ 40GHz		Average (AV)

ANTENNA POLARITY & TEST DISTANCE: HORIZONTAL AT 3 M

NO.	FREQ. (MHz)	EMISSION LEVEL (dBuV/m)	LIMIT (dBuV/m)	MARGIN (dB)	ANTENNA HEIGHT (m)	TABLE ANGLE (Degree)	RAW VALUE (dBuV)	CORRECTION FACTOR (dB/m)
1	*5240.00	124.2 PK			1.57 H	173	84.60	39.60
2	*5240.00	114.1 AV			1.57 H	173	74.50	39.60
3	5350.00	59.5 PK	74.0	-14.5	1.74 H	144	53.00	6.50
4	5350.00	46.8 AV	54.0	-7.2	1.74 H	144	40.30	6.50
5	#10480.00	61.7 PK	74.0	-12.3	1.68 H	346	43.00	18.70
6	#10480.00	49.2 AV	54.0	-4.8	1.68 H	346	30.50	18.70

ANTENNA POLARITY & TEST DISTANCE: VERTICAL AT 3 M

NO.	FREQ. (MHz)	EMISSION LEVEL (dBuV/m)	LIMIT (dBuV/m)	MARGIN (dB)	ANTENNA HEIGHT (m)	TABLE ANGLE (Degree)	RAW VALUE (dBuV)	CORRECTION FACTOR (dB/m)
1	*5240.00	126.9 PK			1.71 V	171	87.30	39.60
2	*5240.00	115.8 AV			1.71 V	171	76.20	39.60
3	5350.00	59.1 PK	74.0	-14.9	1.53 V	190	52.60	6.50
4	5350.00	47.3 AV	54.0	-6.7	1.53 V	190	40.80	6.50
5	#10480.00	62.6 PK	74.0	-11.4	1.76 V	163	43.90	18.70
6	#10480.00	50.0 AV	54.0	-4.0	1.76 V	163	31.30	18.70

REMARKS:

1. Emission Level(dBuV/m) = Raw Value(dBuV) + Correction Factor(dB/m)
2. Correction Factor(dB/m) = Antenna Factor(dB/m) + Cable Factor(dB)
3. The other emission levels were very low against the limit.
4. Margin value = Emission Level – Limit value
5. " * ": Fundamental frequency.
6. " # ": The radiated frequency is out of the restricted band.



CHANNEL	TX Channel 149	DETECTOR FUNCTION	Peak (PK)
FREQUENCY RANGE	1GHz ~ 40GHz		Average (AV)

ANTENNA POLARITY & TEST DISTANCE: HORIZONTAL AT 3 M

NO.	FREQ. (MHz)	EMISSION LEVEL (dBuV/m)	LIMIT (dBuV/m)	MARGIN (dB)	ANTENNA HEIGHT (m)	TABLE ANGLE (Degree)	RAW VALUE (dBuV)	CORRECTION FACTOR (dB/m)
1	#5714.90	58.8 PK	74.0	-15.2	2.84 H	103	51.40	7.40
2	#5714.90	45.6 AV	54.0	-8.4	2.84 H	103	38.20	7.40
3	#5722.90	59.4 PK	78.2	-18.8	2.55 H	130	52.00	7.40
4	#5725.00	48.5 PK	78.2	-29.7	2.55 H	126	41.10	7.40
5	*5745.00	103.3 PK			3.11 H	124	62.80	40.50
6	*5745.00	92.9 AV			3.11 H	124	52.40	40.50
7	11490.00	59.2 PK	74.0	-14.8	1.86 H	164	40.50	18.70
8	11490.00	46.4 AV	54.0	-7.6	1.86 H	164	27.70	18.70

ANTENNA POLARITY & TEST DISTANCE: VERTICAL AT 3 M

NO.	FREQ. (MHz)	EMISSION LEVEL (dBuV/m)	LIMIT (dBuV/m)	MARGIN (dB)	ANTENNA HEIGHT (m)	TABLE ANGLE (Degree)	RAW VALUE (dBuV)	CORRECTION FACTOR (dB/m)
1	#5714.90	66.7 PK	74.0	-7.3	1.63 V	146	59.30	7.40
2	#5714.90	52.6 AV	54.0	-1.4	1.63 V	146	45.20	7.40
3	#5722.90	74.3 PK	78.2	-3.9	2.03 V	169	66.90	7.40
4	#5725.00	63.3 PK	78.2	-14.9	2.07 V	176	55.90	7.40
5	*5745.00	124.1 PK			1.86 V	165	83.60	40.50
6	*5745.00	114.1 AV			1.86 V	165	73.60	40.50
7	11490.00	58.9 PK	74.0	-15.1	2.11 V	356	40.20	18.70
8	11490.00	46.4 AV	54.0	-7.6	2.11 V	356	27.70	18.70

REMARKS:

1. Emission Level(dBuV/m) = Raw Value(dBuV) + Correction Factor(dB/m)
2. Correction Factor(dB/m) = Antenna Factor(dB/m) + Cable Factor(dB)
3. The other emission levels were very low against the limit.
4. Margin value = Emission Level – Limit value
5. " * ": Fundamental frequency.
6. " # ": The radiated frequency is out of the restricted band.

CHANNEL	TX Channel 157	DETECTOR FUNCTION	Peak (PK)
FREQUENCY RANGE	1GHz ~ 40GHz		Average (AV)

ANTENNA POLARITY & TEST DISTANCE: HORIZONTAL AT 3 M

NO.	FREQ. (MHz)	EMISSION LEVEL (dBuV/m)	LIMIT (dBuV/m)	MARGIN (dB)	ANTENNA HEIGHT (m)	TABLE ANGLE (Degree)	RAW VALUE (dBuV)	CORRECTION FACTOR (dB/m)
1	#5714.90	58.9 PK	74.0	-15.1	2.58 H	165	51.50	7.40
2	#5714.90	45.6 AV	54.0	-8.4	2.58 H	165	38.20	7.40
3	*5785.00	108.5 PK			3.16 H	128	67.90	40.60
4	*5785.00	98.0 AV			3.16 H	128	57.40	40.60
5	11570.00	59.2 PK	74.0	-14.8	1.55 H	115	40.50	18.70
6	11570.00	47.1 AV	54.0	-6.9	1.55 H	115	28.40	18.70

ANTENNA POLARITY & TEST DISTANCE: VERTICAL AT 3 M

NO.	FREQ. (MHz)	EMISSION LEVEL (dBuV/m)	LIMIT (dBuV/m)	MARGIN (dB)	ANTENNA HEIGHT (m)	TABLE ANGLE (Degree)	RAW VALUE (dBuV)	CORRECTION FACTOR (dB/m)
1	#5714.90	67.2 PK	74.0	-6.8	1.58 V	9	59.80	7.40
2	#5714.90	52.3 AV	54.0	-1.7	1.58 V	9	44.90	7.40
3	*5785.00	128.6 PK			1.89 V	170	88.00	40.60
4	*5785.00	118.1 AV			1.89 V	170	77.50	40.60
5	11570.00	60.2 PK	74.0	-13.8	1.87 V	179	41.50	18.70
6	11570.00	48.0 AV	54.0	-6.0	1.87 V	179	29.30	18.70

REMARKS:

1. Emission Level(dBuV/m) = Raw Value(dBuV) + Correction Factor(dB/m)
2. Correction Factor(dB/m) = Antenna Factor(dB/m) + Cable Factor(dB)
3. The other emission levels were very low against the limit.
4. Margin value = Emission Level – Limit value
5. " * ": Fundamental frequency.
6. " # ": The radiated frequency is out of the restricted band.

CHANNEL	TX Channel 165	DETECTOR FUNCTION	Peak (PK)
FREQUENCY RANGE	1GHz ~ 40GHz		Average (AV)

ANTENNA POLARITY & TEST DISTANCE: HORIZONTAL AT 3 M

NO.	FREQ. (MHz)	EMISSION LEVEL (dBuV/m)	LIMIT (dBuV/m)	MARGIN (dB)	ANTENNA HEIGHT (m)	TABLE ANGLE (Degree)	RAW VALUE (dBuV)	CORRECTION FACTOR (dB/m)
1	*5825.00	105.8 PK			1.00 H	125	65.20	40.60
2	*5825.00	95.9 AV			1.00 H	125	55.30	40.60
3	#5850.00	47.0 PK	78.2	-31.2	1.26 H	148	39.40	7.60
4	#5852.10	59.5 PK	78.2	-18.7	1.57 H	174	51.80	7.70
5	#5860.10	58.9 PK	74.0	-15.1	1.67 H	174	51.20	7.70
6	#5860.10	46.4 AV	54.0	-7.6	1.67 H	174	38.70	7.70
7	11650.00	60.1 PK	74.0	-13.9	1.53 H	135	40.90	19.20
8	11650.00	47.7 AV	54.0	-6.3	1.53 H	135	28.50	19.20

ANTENNA POLARITY & TEST DISTANCE: VERTICAL AT 3 M

NO.	FREQ. (MHz)	EMISSION LEVEL (dBuV/m)	LIMIT (dBuV/m)	MARGIN (dB)	ANTENNA HEIGHT (m)	TABLE ANGLE (Degree)	RAW VALUE (dBuV)	CORRECTION FACTOR (dB/m)
1	*5825.00	125.1 PK			1.85 V	168	84.60	40.50
2	*5825.00	114.5 AV			1.85 V	168	74.00	40.50
3	#5850.00	59.5 PK	78.2	-18.7	1.95 V	179	51.90	7.60
4	#5852.10	70.6 PK	78.2	-7.6	2.04 V	168	62.90	7.70
5	#5860.10	67.8 PK	74.0	-6.2	1.80 V	202	60.10	7.70
6	#5860.10	52.6 AV	54.0	-1.4	1.80 V	202	44.90	7.70
7	11650.00	61.8 PK	74.0	-12.2	1.60 V	143	42.60	19.20
8	11650.00	48.2 AV	54.0	-5.8	1.60 V	143	29.00	19.20

REMARKS:

1. Emission Level(dBuV/m) = Raw Value(dBuV) + Correction Factor(dB/m)
2. Correction Factor(dB/m) = Antenna Factor(dB/m) + Cable Factor(dB)
3. The other emission levels were very low against the limit.
4. Margin value = Emission Level – Limit value
5. " * ": Fundamental frequency.
6. " # ": The radiated frequency is out of the restricted band.

802.11n (HT20)

CHANNEL	TX Channel 36	DETECTOR FUNCTION	Peak (PK)
FREQUENCY RANGE	1GHz ~ 40GHz		Average (AV)

ANTENNA POLARITY & TEST DISTANCE: HORIZONTAL AT 3 M								
NO.	FREQ. (MHz)	EMISSION LEVEL (dBuV/m)	LIMIT (dBuV/m)	MARGIN (dB)	ANTENNA HEIGHT (m)	TABLE ANGLE (Degree)	RAW VALUE (dBuV)	CORRECTION FACTOR (dB/m)
1	5150.00	56.6 PK	74.0	-17.4	1.26 H	200	50.60	6.00
2	5150.00	44.3 AV	54.0	-9.7	1.26 H	200	38.30	6.00
3	*5180.00	101.8 PK			1.04 H	197	62.40	39.40
4	*5180.00	91.1 AV			1.04 H	197	51.70	39.40
5	#10360.00	58.7 PK	74.0	-15.3	1.17 H	144	40.90	17.80
6	#10360.00	46.2 AV	54.0	-7.8	1.17 H	144	28.40	17.80

ANTENNA POLARITY & TEST DISTANCE: VERTICAL AT 3 M								
NO.	FREQ. (MHz)	EMISSION LEVEL (dBuV/m)	LIMIT (dBuV/m)	MARGIN (dB)	ANTENNA HEIGHT (m)	TABLE ANGLE (Degree)	RAW VALUE (dBuV)	CORRECTION FACTOR (dB/m)
1	5150.00	65.6 PK	74.0	-8.4	1.92 V	178	59.60	6.00
2	5150.00	52.2 AV	54.0	-1.8	1.92 V	178	46.20	6.00
3	*5180.00	122.3 PK			1.73 V	353	82.90	39.40
4	*5180.00	112.3 AV			1.73 V	353	72.90	39.40
5	#10360.00	59.3 PK	74.0	-14.7	1.88 V	180	41.50	17.80
6	#10360.00	46.9 AV	54.0	-7.1	1.88 V	180	29.10	17.80

REMARKS:

1. Emission Level(dBuV/m) = Raw Value(dBuV) + Correction Factor(dB/m)
2. Correction Factor(dB/m) = Antenna Factor(dB/m) + Cable Factor(dB)
3. The other emission levels were very low against the limit.
4. Margin value = Emission Level – Limit value
5. " * ": Fundamental frequency.
6. " # ": The radiated frequency is out of the restricted band.

CHANNEL	TX Channel 40	DETECTOR FUNCTION	Peak (PK)
FREQUENCY RANGE	1GHz ~ 40GHz		Average (AV)

ANTENNA POLARITY & TEST DISTANCE: HORIZONTAL AT 3 M

NO.	FREQ. (MHz)	EMISSION LEVEL (dBuV/m)	LIMIT (dBuV/m)	MARGIN (dB)	ANTENNA HEIGHT (m)	TABLE ANGLE (Degree)	RAW VALUE (dBuV)	CORRECTION FACTOR (dB/m)
1	5150.00	57.0 PK	74.0	-17.0	1.42 H	209	51.00	6.00
2	5150.00	44.3 AV	54.0	-9.7	1.42 H	209	38.30	6.00
3	*5200.00	104.7 PK			1.19 H	195	65.20	39.50
4	*5200.00	94.2 AV			1.19 H	195	54.70	39.50
5	#10400.00	59.1 PK	74.0	-14.9	1.26 H	271	41.40	17.70
6	#10400.00	45.9 AV	54.0	-8.1	1.26 H	271	28.20	17.70

ANTENNA POLARITY & TEST DISTANCE: VERTICAL AT 3 M

NO.	FREQ. (MHz)	EMISSION LEVEL (dBuV/m)	LIMIT (dBuV/m)	MARGIN (dB)	ANTENNA HEIGHT (m)	TABLE ANGLE (Degree)	RAW VALUE (dBuV)	CORRECTION FACTOR (dB/m)
1	5150.00	60.7 PK	74.0	-13.3	1.73 V	172	54.70	6.00
2	5150.00	48.5 AV	54.0	-5.5	1.73 V	172	42.50	6.00
3	*5200.00	126.0 PK			1.72 V	170	86.50	39.50
4	*5200.00	115.0 AV			1.72 V	170	75.50	39.50
5	#10400.00	59.2 PK	74.0	-14.8	1.86 V	343	41.50	17.70
6	#10400.00	47.2 AV	54.0	-6.8	1.86 V	343	29.50	17.70

REMARKS:

1. Emission Level(dBuV/m) = Raw Value(dBuV) + Correction Factor(dB/m)
2. Correction Factor(dB/m) = Antenna Factor(dB/m) + Cable Factor(dB)
3. The other emission levels were very low against the limit.
4. Margin value = Emission Level – Limit value
5. " * ": Fundamental frequency.
6. " # ": The radiated frequency is out of the restricted band.

CHANNEL	TX Channel 48	DETECTOR FUNCTION	Peak (PK)
FREQUENCY RANGE	1GHz ~ 40GHz		Average (AV)

ANTENNA POLARITY & TEST DISTANCE: HORIZONTAL AT 3 M

NO.	FREQ. (MHz)	EMISSION LEVEL (dBuV/m)	LIMIT (dBuV/m)	MARGIN (dB)	ANTENNA HEIGHT (m)	TABLE ANGLE (Degree)	RAW VALUE (dBuV)	CORRECTION FACTOR (dB/m)
1	*5240.00	105.6 PK			1.99 H	220	66.00	39.60
2	*5240.00	94.8 AV			1.99 H	220	55.20	39.60
3	5350.00	58.5 PK	74.0	-15.5	1.71 H	155	52.00	6.50
4	5350.00	45.8 AV	54.0	-8.2	1.71 H	155	39.30	6.50
5	#10480.00	59.0 PK	74.0	-15.0	1.51 H	142	40.30	18.70
6	#10480.00	46.9 AV	54.0	-7.1	1.51 H	142	28.20	18.70

ANTENNA POLARITY & TEST DISTANCE: VERTICAL AT 3 M

NO.	FREQ. (MHz)	EMISSION LEVEL (dBuV/m)	LIMIT (dBuV/m)	MARGIN (dB)	ANTENNA HEIGHT (m)	TABLE ANGLE (Degree)	RAW VALUE (dBuV)	CORRECTION FACTOR (dB/m)
1	*5240.00	126.3 PK			1.71 V	168	86.70	39.60
2	*5240.00	115.5 AV			1.71 V	168	75.90	39.60
3	5350.00	59.2 PK	74.0	-14.8	1.77 V	209	52.70	6.50
4	5350.00	47.4 AV	54.0	-6.6	1.77 V	209	40.90	6.50
5	#10480.00	63.1 PK	74.0	-10.9	1.64 V	343	44.40	18.70
6	#10480.00	50.0 AV	54.0	-4.0	1.64 V	343	31.30	18.70

REMARKS:

1. Emission Level(dBuV/m) = Raw Value(dBuV) + Correction Factor(dB/m)
2. Correction Factor(dB/m) = Antenna Factor(dB/m) + Cable Factor(dB)
3. The other emission levels were very low against the limit.
4. Margin value = Emission Level – Limit value
5. " * ": Fundamental frequency.
6. " # ": The radiated frequency is out of the restricted band.



CHANNEL	TX Channel 149	DETECTOR FUNCTION	Peak (PK)
FREQUENCY RANGE	1GHz ~ 40GHz		Average (AV)

ANTENNA POLARITY & TEST DISTANCE: HORIZONTAL AT 3 M

NO.	FREQ. (MHz)	EMISSION LEVEL (dBuV/m)	LIMIT (dBuV/m)	MARGIN (dB)	ANTENNA HEIGHT (m)	TABLE ANGLE (Degree)	RAW VALUE (dBuV)	CORRECTION FACTOR (dB/m)
1	#5714.90	58.4 PK	74.0	-15.6	1.26 H	44	51.00	7.40
2	#5714.90	45.5 AV	54.0	-8.5	1.26 H	44	38.10	7.40
3	#5722.90	59.1 PK	78.2	-19.1	1.88 H	73	51.70	7.40
4	#5725.00	47.9 PK	78.2	-30.3	1.79 H	64	40.50	7.40
5	*5745.00	104.3 PK			1.36 H	20	63.80	40.50
6	*5745.00	93.0 AV			1.36 H	20	52.50	40.50
7	11490.00	59.3 PK	74.0	-14.7	1.55 H	202	40.60	18.70
8	11490.00	46.2 AV	54.0	-7.8	1.55 H	202	27.50	18.70

ANTENNA POLARITY & TEST DISTANCE: VERTICAL AT 3 M

NO.	FREQ. (MHz)	EMISSION LEVEL (dBuV/m)	LIMIT (dBuV/m)	MARGIN (dB)	ANTENNA HEIGHT (m)	TABLE ANGLE (Degree)	RAW VALUE (dBuV)	CORRECTION FACTOR (dB/m)
1	#5714.90	66.8 PK	74.0	-7.2	1.70 V	175	59.40	7.40
2	#5714.90	52.5 AV	54.0	-1.5	1.70 V	175	45.10	7.40
3	#5722.90	75.5 PK	78.2	-2.7	2.06 V	171	68.10	7.40
4	#5725.00	63.4 PK	78.2	-14.8	2.15 V	167	56.00	7.40
5	*5745.00	123.9 PK			1.88 V	167	83.40	40.50
6	*5745.00	113.2 AV			1.88 V	167	72.70	40.50
7	11490.00	58.8 PK	74.0	-15.2	1.37 V	322	40.10	18.70
8	11490.00	46.3 AV	54.0	-7.7	1.37 V	322	27.60	18.70

REMARKS:

1. Emission Level(dBuV/m) = Raw Value(dBuV) + Correction Factor(dB/m)
2. Correction Factor(dB/m) = Antenna Factor(dB/m) + Cable Factor(dB)
3. The other emission levels were very low against the limit.
4. Margin value = Emission Level – Limit value
5. " * ": Fundamental frequency.
6. " # ": The radiated frequency is out of the restricted band.

CHANNEL	TX Channel 157	DETECTOR FUNCTION	Peak (PK)
FREQUENCY RANGE	1GHz ~ 40GHz		Average (AV)

ANTENNA POLARITY & TEST DISTANCE: HORIZONTAL AT 3 M

NO.	FREQ. (MHz)	EMISSION LEVEL (dBuV/m)	LIMIT (dBuV/m)	MARGIN (dB)	ANTENNA HEIGHT (m)	TABLE ANGLE (Degree)	RAW VALUE (dBuV)	CORRECTION FACTOR (dB/m)
1	#5714.90	58.7 PK	74.0	-15.3	2.20 H	161	51.30	7.40
2	#5714.90	45.6 AV	54.0	-8.4	2.20 H	161	38.20	7.40
3	*5785.00	107.8 PK			3.15 H	127	67.20	40.60
4	*5785.00	97.0 AV			3.15 H	127	56.40	40.60
5	11570.00	59.9 PK	74.0	-14.1	1.82 H	114	41.20	18.70
6	11570.00	47.0 AV	54.0	-7.0	1.82 H	114	28.30	18.70

ANTENNA POLARITY & TEST DISTANCE: VERTICAL AT 3 M

NO.	FREQ. (MHz)	EMISSION LEVEL (dBuV/m)	LIMIT (dBuV/m)	MARGIN (dB)	ANTENNA HEIGHT (m)	TABLE ANGLE (Degree)	RAW VALUE (dBuV)	CORRECTION FACTOR (dB/m)
1	#5714.90	66.9 PK	74.0	-7.1	1.52 V	17	59.50	7.40
2	#5714.90	52.5 AV	54.0	-1.5	1.52 V	17	45.10	7.40
3	*5785.00	126.7 PK			1.86 V	350	86.10	40.60
4	*5785.00	116.5 AV			1.86 V	350	75.90	40.60
5	11570.00	60.5 PK	74.0	-13.5	1.61 V	176	41.80	18.70
6	11570.00	47.7 AV	54.0	-6.3	1.61 V	176	29.00	18.70

REMARKS:

1. Emission Level(dBuV/m) = Raw Value(dBuV) + Correction Factor(dB/m)
2. Correction Factor(dB/m) = Antenna Factor(dB/m) + Cable Factor(dB)
3. The other emission levels were very low against the limit.
4. Margin value = Emission Level – Limit value
5. " * ": Fundamental frequency.
6. " # ": The radiated frequency is out of the restricted band.

CHANNEL	TX Channel 165	DETECTOR FUNCTION	Peak (PK)
FREQUENCY RANGE	1GHz ~ 40GHz		Average (AV)

ANTENNA POLARITY & TEST DISTANCE: HORIZONTAL AT 3 M

NO.	FREQ. (MHz)	EMISSION LEVEL (dBuV/m)	LIMIT (dBuV/m)	MARGIN (dB)	ANTENNA HEIGHT (m)	TABLE ANGLE (Degree)	RAW VALUE (dBuV)	CORRECTION FACTOR (dB/m)
1	*5825.00	103.4 PK			1.10 H	127	62.80	40.60
2	*5825.00	91.9 AV			1.10 H	127	51.30	40.60
3	#5850.00	47.6 PK	78.2	-30.6	1.38 H	141	40.00	7.60
4	#5852.10	59.6 PK	78.2	-18.6	1.55 H	141	51.90	7.70
5	#5860.10	59.5 PK	74.0	-14.5	1.32 H	101	51.80	7.70
6	#5860.10	46.1 AV	54.0	-7.9	1.32 H	101	38.40	7.70
7	11650.00	60.3 PK	74.0	-13.7	1.24 H	82	41.10	19.20
8	11650.00	47.2 AV	54.0	-6.8	1.24 H	82	28.00	19.20

ANTENNA POLARITY & TEST DISTANCE: VERTICAL AT 3 M

NO.	FREQ. (MHz)	EMISSION LEVEL (dBuV/m)	LIMIT (dBuV/m)	MARGIN (dB)	ANTENNA HEIGHT (m)	TABLE ANGLE (Degree)	RAW VALUE (dBuV)	CORRECTION FACTOR (dB/m)
1	*5825.00	124.2 PK			1.86 V	350	83.60	40.60
2	*5825.00	113.2 AV			1.86 V	350	72.60	40.60
3	#5850.00	62.3 PK	78.2	-15.9	1.78 V	148	54.70	7.60
4	#5852.10	69.9 PK	78.2	-8.3	1.78 V	152	62.20	7.70
5	#5860.10	67.4 PK	74.0	-6.6	1.84 V	199	59.70	7.70
6	#5860.10	52.5 AV	54.0	-1.5	1.84 V	199	44.80	7.70
7	11650.00	60.4 PK	74.0	-13.6	1.37 V	124	41.20	19.20
8	11650.00	47.3 AV	54.0	-6.7	1.37 V	124	28.10	19.20

REMARKS:

1. Emission Level(dBuV/m) = Raw Value(dBuV) + Correction Factor(dB/m)
2. Correction Factor(dB/m) = Antenna Factor(dB/m) + Cable Factor(dB)
3. The other emission levels were very low against the limit.
4. Margin value = Emission Level – Limit value
5. " * ": Fundamental frequency.
6. " # ": The radiated frequency is out of the restricted band.

802.11n (HT40)

CHANNEL	TX Channel 38	DETECTOR FUNCTION	Peak (PK)
FREQUENCY RANGE	1GHz ~ 40GHz		Average (AV)

ANTENNA POLARITY & TEST DISTANCE: HORIZONTAL AT 3 M								
NO.	FREQ. (MHz)	EMISSION LEVEL (dBuV/m)	LIMIT (dBuV/m)	MARGIN (dB)	ANTENNA HEIGHT (m)	TABLE ANGLE (Degree)	RAW VALUE (dBuV)	CORRECTION FACTOR (dB/m)
1	5150.00	57.1 PK	74.0	-16.9	1.18 H	183	51.10	6.00
2	5150.00	44.6 AV	54.0	-9.4	1.18 H	183	38.60	6.00
3	*5190.00	94.3 PK			1.00 H	194	54.90	39.40
4	*5190.00	84.6 AV			1.00 H	194	45.20	39.40
5	#10380.00	59.3 PK	74.0	-14.7	1.09 H	210	41.60	17.70
6	#10380.00	46.2 AV	54.0	-7.8	1.09 H	210	28.50	17.70

ANTENNA POLARITY & TEST DISTANCE: VERTICAL AT 3 M								
NO.	FREQ. (MHz)	EMISSION LEVEL (dBuV/m)	LIMIT (dBuV/m)	MARGIN (dB)	ANTENNA HEIGHT (m)	TABLE ANGLE (Degree)	RAW VALUE (dBuV)	CORRECTION FACTOR (dB/m)
1	5150.00	65.8 PK	74.0	-8.2	1.96 V	0	59.80	6.00
2	5150.00	52.9 AV	54.0	-1.1	1.96 V	0	46.90	6.00
3	*5190.00	119.2 PK			1.70 V	357	79.80	39.40
4	*5190.00	108.9 AV			1.70 V	357	69.50	39.40
5	#10380.00	59.6 PK	74.0	-14.4	1.42 V	245	41.90	17.70
6	#10380.00	47.0 AV	54.0	-7.0	1.42 V	245	29.30	17.70

REMARKS:

1. Emission Level(dBuV/m) = Raw Value(dBuV) + Correction Factor(dB/m)
2. Correction Factor(dB/m) = Antenna Factor(dB/m) + Cable Factor(dB)
3. The other emission levels were very low against the limit.
4. Margin value = Emission Level – Limit value
5. " * ": Fundamental frequency.
6. " # ": The radiated frequency is out of the restricted band.

CHANNEL	TX Channel 46	DETECTOR FUNCTION	Peak (PK)
FREQUENCY RANGE	1GHz ~ 40GHz		Average (AV)

ANTENNA POLARITY & TEST DISTANCE: HORIZONTAL AT 3 M

NO.	FREQ. (MHz)	EMISSION LEVEL (dBuV/m)	LIMIT (dBuV/m)	MARGIN (dB)	ANTENNA HEIGHT (m)	TABLE ANGLE (Degree)	RAW VALUE (dBuV)	CORRECTION FACTOR (dB/m)
1	5150.00	56.9 PK	74.0	-17.1	1.49 H	166	50.90	6.00
2	5150.00	44.6 AV	54.0	-9.4	1.49 H	166	38.60	6.00
3	*5230.00	100.2 PK			1.17 H	196	60.60	39.60
4	*5230.00	90.2 AV			1.17 H	196	50.60	39.60
5	#10460.00	60.0 PK	74.0	-14.0	1.31 H	104	41.50	18.50
6	#10460.00	46.9 AV	54.0	-7.1	1.31 H	104	28.40	18.50

ANTENNA POLARITY & TEST DISTANCE: VERTICAL AT 3 M

NO.	FREQ. (MHz)	EMISSION LEVEL (dBuV/m)	LIMIT (dBuV/m)	MARGIN (dB)	ANTENNA HEIGHT (m)	TABLE ANGLE (Degree)	RAW VALUE (dBuV)	CORRECTION FACTOR (dB/m)
1	5150.00	66.4 PK	74.0	-7.6	1.94 V	169	60.40	6.00
2	5150.00	52.2 AV	54.0	-1.8	1.94 V	169	46.20	6.00
3	*5230.00	123.3 PK			1.75 V	168	83.70	39.60
4	*5230.00	113.0 AV			1.75 V	168	73.40	39.60
5	#10460.00	60.4 PK	74.0	-13.6	1.72 V	348	41.90	18.50
6	#10460.00	48.2 AV	54.0	-5.8	1.72 V	348	29.70	18.50

REMARKS:

1. Emission Level(dBuV/m) = Raw Value(dBuV) + Correction Factor(dB/m)
2. Correction Factor(dB/m) = Antenna Factor(dB/m) + Cable Factor(dB)
3. The other emission levels were very low against the limit.
4. Margin value = Emission Level – Limit value
5. " * ": Fundamental frequency.
6. " # ": The radiated frequency is out of the restricted band.

CHANNEL	TX Channel 151	DETECTOR FUNCTION	Peak (PK)
FREQUENCY RANGE	1GHz ~ 40GHz		Average (AV)

ANTENNA POLARITY & TEST DISTANCE: HORIZONTAL AT 3 M

NO.	FREQ. (MHz)	EMISSION LEVEL (dBuV/m)	LIMIT (dBuV/m)	MARGIN (dB)	ANTENNA HEIGHT (m)	TABLE ANGLE (Degree)	RAW VALUE (dBuV)	CORRECTION FACTOR (dB/m)
1	#5714.90	58.5 PK	74.0	-15.5	1.13 H	229	51.10	7.40
2	#5714.90	45.5 AV	54.0	-8.5	1.13 H	229	38.10	7.40
3	#5722.90	58.9 PK	78.2	-19.3	1.29 H	244	51.50	7.40
4	#5725.00	46.7 PK	78.2	-31.5	1.52 H	267	39.30	7.40
5	*5755.00	98.8 PK			1.00 H	216	58.20	40.60
6	*5755.00	89.0 AV			1.00 H	216	48.40	40.60
7	11510.00	59.0 PK	74.0	-15.0	1.21 H	222	40.30	18.70
8	11510.00	46.0 AV	54.0	-8.0	1.21 H	222	27.30	18.70

ANTENNA POLARITY & TEST DISTANCE: VERTICAL AT 3 M

NO.	FREQ. (MHz)	EMISSION LEVEL (dBuV/m)	LIMIT (dBuV/m)	MARGIN (dB)	ANTENNA HEIGHT (m)	TABLE ANGLE (Degree)	RAW VALUE (dBuV)	CORRECTION FACTOR (dB/m)
1	#5714.90	67.0 PK	74.0	-7.0	1.85 V	326	59.60	7.40
2	#5714.90	52.7 AV	54.0	-1.3	1.85 V	326	45.30	7.40
3	#5722.90	71.8 PK	78.2	-6.4	1.78 V	342	64.40	7.40
4	#5725.00	57.0 PK	78.2	-21.2	1.80 V	340	49.60	7.40
5	*5755.00	117.6 PK			1.68 V	343	77.00	40.60
6	*5755.00	107.4 AV			1.68 V	343	66.80	40.60
7	11510.00	59.2 PK	74.0	-14.8	1.48 V	243	40.50	18.70
8	11510.00	46.3 AV	54.0	-7.7	1.48 V	243	27.60	18.70

REMARKS:

1. Emission Level(dBuV/m) = Raw Value(dBuV) + Correction Factor(dB/m)
2. Correction Factor(dB/m) = Antenna Factor(dB/m) + Cable Factor(dB)
3. The other emission levels were very low against the limit.
4. Margin value = Emission Level – Limit value
5. " * ": Fundamental frequency.
6. " # ": The radiated frequency is out of the restricted band.

CHANNEL	TX Channel 159	DETECTOR FUNCTION	Peak (PK)
FREQUENCY RANGE	1GHz ~ 40GHz		Average (AV)

ANTENNA POLARITY & TEST DISTANCE: HORIZONTAL AT 3 M

NO.	FREQ. (MHz)	EMISSION LEVEL (dBuV/m)	LIMIT (dBuV/m)	MARGIN (dB)	ANTENNA HEIGHT (m)	TABLE ANGLE (Degree)	RAW VALUE (dBuV)	CORRECTION FACTOR (dB/m)
1	*5795.00	99.8 PK			3.65 H	123	59.20	40.60
2	*5795.00	90.4 AV			3.65 H	123	49.80	40.60
3	#5850.00	46.8 PK	78.2	-31.4	3.38 H	128	39.20	7.60
4	#5852.10	59.6 PK	78.2	-18.6	2.43 H	139	51.90	7.70
5	#5860.10	59.3 PK	74.0	-14.7	1.78 H	180	51.60	7.70
6	#5860.10	46.2 AV	54.0	-7.8	1.78 H	180	38.50	7.70
7	11590.00	60.1 PK	74.0	-13.9	1.43 H	132	41.30	18.80
8	11590.00	46.7 AV	54.0	-7.3	1.43 H	132	27.90	18.80

ANTENNA POLARITY & TEST DISTANCE: VERTICAL AT 3 M

NO.	FREQ. (MHz)	EMISSION LEVEL (dBuV/m)	LIMIT (dBuV/m)	MARGIN (dB)	ANTENNA HEIGHT (m)	TABLE ANGLE (Degree)	RAW VALUE (dBuV)	CORRECTION FACTOR (dB/m)
1	*5795.00	120.9 PK			1.90 V	173	80.30	40.60
2	*5795.00	110.7 AV			1.90 V	173	70.10	40.60
3	#5850.00	54.9 PK	78.2	-23.3	1.74 V	141	47.30	7.60
4	#5852.10	67.8 PK	78.2	-10.4	1.76 V	147	60.10	7.70
5	#5860.10	66.7 PK	74.0	-7.3	1.82 V	150	59.00	7.70
6	#5860.10	52.2 AV	54.0	-1.8	1.82 V	150	44.50	7.70
7	11590.00	59.7 PK	74.0	-14.3	1.43 V	115	40.90	18.80
8	11590.00	47.3 AV	54.0	-6.7	1.43 V	115	28.50	18.80

REMARKS:

1. Emission Level(dBuV/m) = Raw Value(dBuV) + Correction Factor(dB/m)
2. Correction Factor(dB/m) = Antenna Factor(dB/m) + Cable Factor(dB)
3. The other emission levels were very low against the limit.
4. Margin value = Emission Level – Limit value
5. " * ": Fundamental frequency.
6. " # ": The radiated frequency is out of the restricted band.

802.11ac (VHT80)

CHANNEL	TX Channel 42	DETECTOR FUNCTION	Peak (PK)
FREQUENCY RANGE	1GHz ~ 40GHz		Average (AV)

ANTENNA POLARITY & TEST DISTANCE: HORIZONTAL AT 3 M								
NO.	FREQ. (MHz)	EMISSION LEVEL (dBuV/m)	LIMIT (dBuV/m)	MARGIN (dB)	ANTENNA HEIGHT (m)	TABLE ANGLE (Degree)	RAW VALUE (dBuV)	CORRECTION FACTOR (dB/m)
1	5150.00	57.4 PK	74.0	-16.6	1.19 H	193	51.40	6.00
2	5150.00	44.7 AV	54.0	-9.3	1.19 H	193	38.70	6.00
3	*5210.00	89.9 PK			1.38 H	197	50.40	39.50
4	*5210.00	80.0 AV			1.38 H	197	40.50	39.50
5	5350.00	56.7 PK	74.0	-17.3	1.39 H	201	50.20	6.50
6	5350.00	45.9 AV	54.0	-8.1	1.39 H	201	39.40	6.50
7	#10420.00	58.5 PK	74.0	-15.5	1.10 H	124	40.60	17.90
8	#10420.00	46.4 AV	54.0	-7.6	1.10 H	124	28.50	17.90
ANTENNA POLARITY & TEST DISTANCE: VERTICAL AT 3 M								
NO.	FREQ. (MHz)	EMISSION LEVEL (dBuV/m)	LIMIT (dBuV/m)	MARGIN (dB)	ANTENNA HEIGHT (m)	TABLE ANGLE (Degree)	RAW VALUE (dBuV)	CORRECTION FACTOR (dB/m)
1	5150.00	66.6 PK	74.0	-7.4	1.67 V	356	60.60	6.00
2	5150.00	52.9 AV	54.0	-1.1	1.67 V	356	46.90	6.00
3	*5210.00	110.8 PK			1.75 V	166	71.30	39.50
4	*5210.00	100.7 AV			1.75 V	166	61.20	39.50
5	5350.00	58.8 PK	74.0	-15.2	1.77 V	165	52.30	6.50
6	5350.00	46.5 AV	54.0	-7.5	1.77 V	165	40.00	6.50
7	#10420.00	60.4 PK	74.0	-13.6	1.56 V	103	42.50	17.90
8	#10420.00	46.7 AV	54.0	-7.3	1.56 V	103	28.80	17.90

REMARKS:

1. Emission Level(dBuV/m) = Raw Value(dBuV) + Correction Factor(dB/m)
2. Correction Factor(dB/m) = Antenna Factor(dB/m) + Cable Factor(dB)
3. The other emission levels were very low against the limit.
4. Margin value = Emission Level – Limit value
5. " * ": Fundamental frequency.
6. " # ": The radiated frequency is out of the restricted band.



CHANNEL	TX Channel 155	DETECTOR FUNCTION	Peak (PK)
FREQUENCY RANGE	1GHz ~ 40GHz		Average (AV)

ANTENNA POLARITY & TEST DISTANCE: HORIZONTAL AT 3 M

NO.	FREQ. (MHz)	EMISSION LEVEL (dBuV/m)	LIMIT (dBuV/m)	MARGIN (dB)	ANTENNA HEIGHT (m)	TABLE ANGLE (Degree)	RAW VALUE (dBuV)	CORRECTION FACTOR (dB/m)
1	#5714.90	59.3 PK	74.0	-14.7	1.64 H	169	51.90	7.40
2	#5714.90	47.3 AV	54.0	-6.7	1.64 H	169	39.90	7.40
3	#5722.00	59.5 PK	78.2	-18.7	1.59 H	176	52.10	7.40
4	#5725.00	49.9 PK	78.2	-28.3	1.59 H	176	42.50	7.40
5	*5775.00	99.1 PK			1.85 H	163	58.50	40.60
6	*5775.00	89.1 AV			1.85 H	163	48.50	40.60
7	#5850.00	49.2 PK	78.2	-29.0	1.50 H	222	41.60	7.60
8	#5853.00	59.8 PK	78.2	-18.4	1.50 H	222	52.10	7.70
9	#5861.00	59.4 PK	74.0	-14.6	1.44 H	217	51.70	7.70
10	#5861.00	46.7 AV	54.0	-7.3	1.44 H	217	39.00	7.70
11	11550.00	60.1 PK	74.0	-13.9	1.70 H	156	41.50	18.60
12	11550.00	47.0 AV	54.0	-7.0	1.70 H	156	28.40	18.60

ANTENNA POLARITY & TEST DISTANCE: VERTICAL AT 3 M

NO.	FREQ. (MHz)	EMISSION LEVEL (dBuV/m)	LIMIT (dBuV/m)	MARGIN (dB)	ANTENNA HEIGHT (m)	TABLE ANGLE (Degree)	RAW VALUE (dBuV)	CORRECTION FACTOR (dB/m)
1	#5700.00	68.6 PK	74.0	-5.4	1.49 V	354	61.30	7.30
2	#5700.00	52.6 AV	54.0	-1.4	1.49 V	354	45.30	7.30
3	#5722.00	72.1 PK	78.2	-6.1	1.66 V	351	64.70	7.40
4	#5725.00	58.9 PK	78.2	-19.3	1.66 V	351	51.50	7.40
5	*5775.00	111.0 PK			1.65 V	167	70.40	40.60
6	*5775.00	101.2 AV			1.65 V	167	60.60	40.60
7	#5850.00	63.6 PK	78.2	-14.6	1.63 V	168	56.00	7.60
8	#5856.00	67.4 PK	78.2	-10.8	1.63 V	168	59.70	7.70
9	#5861.00	65.6 PK	74.0	-8.4	1.69 V	124	57.90	7.70
10	#5861.00	52.1 AV	54.0	-1.9	1.67 V	124	44.40	7.70
11	11550.00	60.4 PK	74.0	-13.6	1.55 V	100	41.80	18.60
12	11550.00	47.6 AV	54.0	-6.4	1.55 V	100	29.00	18.60

REMARKS:

1. Emission Level(dBuV/m) = Raw Value(dBuV) + Correction Factor(dB/m)
2. Correction Factor(dB/m) = Antenna Factor(dB/m) + Cable Factor(dB)
3. The other emission levels were very low against the limit.
4. Margin value = Emission Level – Limit value
5. " * ": Fundamental frequency.
6. " # ": The radiated frequency is out of the restricted band.

Beamforming Mode

802.11ac (VHT20)

CHANNEL	TX Channel 36	DETECTOR FUNCTION	Peak (PK)
FREQUENCY RANGE	1GHz ~ 40GHz		Average (AV)

ANTENNA POLARITY & TEST DISTANCE: HORIZONTAL AT 3 M

NO.	FREQ. (MHz)	EMISSION LEVEL (dBuV/m)	LIMIT (dBuV/m)	MARGIN (dB)	ANTENNA HEIGHT (m)	TABLE ANGLE (Degree)	RAW VALUE (dBuV)	CORRECTION FACTOR (dB/m)
1	5150.00	57.2 PK	74.0	-16.8	1.31 H	227	51.20	6.00
2	5150.00	44.1 AV	54.0	-9.9	1.31 H	227	38.10	6.00
3	*5180.00	103.7 PK			1.08 H	207	64.30	39.40
4	*5180.00	90.6 AV			1.08 H	207	51.20	39.40
5	#10360.00	58.4 PK	74.0	-15.6	1.46 H	152	40.60	17.80
6	#10360.00	45.5 AV	54.0	-8.5	1.46 H	152	27.70	17.80

ANTENNA POLARITY & TEST DISTANCE: VERTICAL AT 3 M

NO.	FREQ. (MHz)	EMISSION LEVEL (dBuV/m)	LIMIT (dBuV/m)	MARGIN (dB)	ANTENNA HEIGHT (m)	TABLE ANGLE (Degree)	RAW VALUE (dBuV)	CORRECTION FACTOR (dB/m)
1	5150.00	71.1 PK	74.0	-2.9	1.64 V	163	65.10	6.00
2	5150.00	49.5 AV	54.0	-4.5	1.64 V	163	43.50	6.00
3	*5180.00	121.8 PK			1.74 V	255	82.40	39.40
4	*5180.00	109.6 AV			1.74 V	255	70.20	39.40
5	#10360.00	58.5 PK	74.0	-15.5	1.46 V	15	40.70	17.80
6	#10360.00	46.7 AV	54.0	-7.3	1.46 V	15	28.90	17.80

REMARKS:

1. Emission Level(dBuV/m) = Raw Value(dBuV) + Correction Factor(dB/m)
2. Correction Factor(dB/m) = Antenna Factor(dB/m) + Cable Factor(dB)
3. The other emission levels were very low against the limit.
4. Margin value = Emission Level – Limit value
5. " * ": Fundamental frequency.
6. " # ": The radiated frequency is out of the restricted band.

CHANNEL	TX Channel 40	DETECTOR FUNCTION	Peak (PK)
FREQUENCY RANGE	1GHz ~ 40GHz		Average (AV)

ANTENNA POLARITY & TEST DISTANCE: HORIZONTAL AT 3 M

NO.	FREQ. (MHz)	EMISSION LEVEL (dBuV/m)	LIMIT (dBuV/m)	MARGIN (dB)	ANTENNA HEIGHT (m)	TABLE ANGLE (Degree)	RAW VALUE (dBuV)	CORRECTION FACTOR (dB/m)
1	*5200.00	102.4 PK			1.19 H	219	62.90	39.50
2	*5200.00	91.2 AV			1.19 H	219	51.70	39.50
3	#10400.00	58.7 PK	74.0	-15.3	1.33 H	128	41.00	17.70
4	#10400.00	46.1 AV	54.0	-7.9	1.33 H	128	28.40	17.70

ANTENNA POLARITY & TEST DISTANCE: VERTICAL AT 3 M

NO.	FREQ. (MHz)	EMISSION LEVEL (dBuV/m)	LIMIT (dBuV/m)	MARGIN (dB)	ANTENNA HEIGHT (m)	TABLE ANGLE (Degree)	RAW VALUE (dBuV)	CORRECTION FACTOR (dB/m)
1	*5200.00	122.2 PK			1.75 V	265	82.70	39.50
2	*5200.00	110.0 AV			1.75 V	265	70.50	39.50
3	#10400.00	59.1 PK	74.0	-14.9	1.65 V	120	41.40	17.70
4	#10400.00	46.6 AV	54.0	-7.4	1.65 V	120	28.90	17.70

REMARKS:

1. Emission Level(dBuV/m) = Raw Value(dBuV) + Correction Factor(dB/m)
2. Correction Factor(dB/m) = Antenna Factor(dB/m) + Cable Factor(dB)
3. The other emission levels were very low against the limit.
4. Margin value = Emission Level – Limit value
5. " * ": Fundamental frequency.
6. " # ": The radiated frequency is out of the restricted band.

CHANNEL	TX Channel 48	DETECTOR FUNCTION	Peak (PK)
FREQUENCY RANGE	1GHz ~ 40GHz		Average (AV)

ANTENNA POLARITY & TEST DISTANCE: HORIZONTAL AT 3 M

NO.	FREQ. (MHz)	EMISSION LEVEL (dBuV/m)	LIMIT (dBuV/m)	MARGIN (dB)	ANTENNA HEIGHT (m)	TABLE ANGLE (Degree)	RAW VALUE (dBuV)	CORRECTION FACTOR (dB/m)
1	*5240.00	105.4 PK			1.15 H	192	65.80	39.60
2	*5240.00	92.8 AV			1.15 H	192	53.20	39.60
3	5350.00	57.8 PK	74.0	-16.2	1.30 H	155	51.30	6.50
4	5350.00	45.4 AV	54.0	-8.6	1.30 H	155	38.90	6.50
5	#10480.00	58.9 PK	74.0	-15.1	1.46 H	73	40.20	18.70
6	#10480.00	46.2 AV	54.0	-7.8	1.46 H	73	27.50	18.70

ANTENNA POLARITY & TEST DISTANCE: VERTICAL AT 3 M

NO.	FREQ. (MHz)	EMISSION LEVEL (dBuV/m)	LIMIT (dBuV/m)	MARGIN (dB)	ANTENNA HEIGHT (m)	TABLE ANGLE (Degree)	RAW VALUE (dBuV)	CORRECTION FACTOR (dB/m)
1	*5240.00	122.0 PK			1.65 V	262	82.40	39.60
2	*5240.00	109.1 AV			1.65 V	262	69.50	39.60
3	5350.00	58.1 PK	74.0	-15.9	1.45 V	294	51.60	6.50
4	5350.00	46.1 AV	54.0	-7.9	1.45 V	294	39.60	6.50
5	#10480.00	59.6 PK	74.0	-14.4	1.44 V	53	40.90	18.70
6	#10480.00	47.2 AV	54.0	-6.8	1.44 V	53	28.50	18.70

REMARKS:

1. Emission Level(dBuV/m) = Raw Value(dBuV) + Correction Factor(dB/m)
2. Correction Factor(dB/m) = Antenna Factor(dB/m) + Cable Factor(dB)
3. The other emission levels were very low against the limit.
4. Margin value = Emission Level – Limit value
5. " * ": Fundamental frequency.
6. " # ": The radiated frequency is out of the restricted band.

CHANNEL	TX Channel 149	DETECTOR FUNCTION	Peak (PK)
FREQUENCY RANGE	1GHz ~ 40GHz		Average (AV)

ANTENNA POLARITY & TEST DISTANCE: HORIZONTAL AT 3 M

NO.	FREQ. (MHz)	EMISSION LEVEL (dBuV/m)	LIMIT (dBuV/m)	MARGIN (dB)	ANTENNA HEIGHT (m)	TABLE ANGLE (Degree)	RAW VALUE (dBuV)	CORRECTION FACTOR (dB/m)
1	#5714.90	58.7 PK	74.0	-15.3	1.12 H	141	51.30	7.40
2	#5714.90	44.8 AV	54.0	-9.2	1.12 H	141	37.40	7.40
3	#5722.90	58.2 PK	78.2	-20.0	1.30 H	162	50.80	7.40
4	#5725.00	47.6 PK	78.2	-30.6	1.48 H	146	40.20	7.40
5	*5745.00	97.7 PK			1.00 H	124	57.20	40.50
6	*5745.00	86.7 AV			1.00 H	124	46.20	40.50
7	11490.00	59.3 PK	74.0	-14.7	1.26 H	85	40.60	18.70
8	11490.00	47.2 AV	54.0	-6.8	1.26 H	85	28.50	18.70

ANTENNA POLARITY & TEST DISTANCE: VERTICAL AT 3 M

NO.	FREQ. (MHz)	EMISSION LEVEL (dBuV/m)	LIMIT (dBuV/m)	MARGIN (dB)	ANTENNA HEIGHT (m)	TABLE ANGLE (Degree)	RAW VALUE (dBuV)	CORRECTION FACTOR (dB/m)
1	#5714.90	59.0 PK	74.0	-15.0	1.81 V	301	51.60	7.40
2	#5714.90	45.4 AV	54.0	-8.6	1.81 V	301	38.00	7.40
3	#5722.90	76.4 PK	78.2	-1.8	1.66 V	340	69.00	7.40
4	#5725.00	52.0 PK	78.2	-26.2	1.66 V	343	44.60	7.40
5	*5745.00	117.4 PK			1.66 V	319	76.90	40.50
6	*5745.00	103.2 AV			1.66 V	319	62.70	40.50
7	11490.00	60.0 PK	74.0	-14.0	1.52 V	72	41.30	18.70
8	11490.00	47.2 AV	54.0	-6.8	1.52 V	72	28.50	18.70

REMARKS:

1. Emission Level(dBuV/m) = Raw Value(dBuV) + Correction Factor(dB/m)
2. Correction Factor(dB/m) = Antenna Factor(dB/m) + Cable Factor(dB)
3. The other emission levels were very low against the limit.
4. Margin value = Emission Level – Limit value
5. " * ": Fundamental frequency.
6. " # ": The radiated frequency is out of the restricted band.

CHANNEL	TX Channel 157	DETECTOR FUNCTION	Peak (PK)
FREQUENCY RANGE	1GHz ~ 40GHz		Average (AV)

ANTENNA POLARITY & TEST DISTANCE: HORIZONTAL AT 3 M

NO.	FREQ. (MHz)	EMISSION LEVEL (dBuV/m)	LIMIT (dBuV/m)	MARGIN (dB)	ANTENNA HEIGHT (m)	TABLE ANGLE (Degree)	RAW VALUE (dBuV)	CORRECTION FACTOR (dB/m)
1	*5785.00	105.1 PK			1.97 H	214	64.50	40.60
2	*5785.00	92.6 AV			1.97 H	214	52.00	40.60
3	11570.00	60.3 PK	74.0	-13.7	1.66 H	119	41.60	18.70
4	11570.00	47.3 AV	54.0	-6.7	1.66 H	119	28.60	18.70

ANTENNA POLARITY & TEST DISTANCE: VERTICAL AT 3 M

NO.	FREQ. (MHz)	EMISSION LEVEL (dBuV/m)	LIMIT (dBuV/m)	MARGIN (dB)	ANTENNA HEIGHT (m)	TABLE ANGLE (Degree)	RAW VALUE (dBuV)	CORRECTION FACTOR (dB/m)
1	*5785.00	125.0 PK			1.62 V	352	84.40	40.60
2	*5785.00	112.8 AV			1.62 V	352	72.20	40.60
3	11570.00	60.2 PK	74.0	-13.8	1.46 V	33	41.50	18.70
4	11570.00	47.4 AV	54.0	-6.6	1.46 V	33	28.70	18.70

REMARKS:

1. Emission Level(dBuV/m) = Raw Value(dBuV) + Correction Factor(dB/m)
2. Correction Factor(dB/m) = Antenna Factor(dB/m) + Cable Factor(dB)
3. The other emission levels were very low against the limit.
4. Margin value = Emission Level – Limit value
5. " * ": Fundamental frequency.
6. " # ": The radiated frequency is out of the restricted band.

CHANNEL	TX Channel 165	DETECTOR FUNCTION	Peak (PK)
FREQUENCY RANGE	1GHz ~ 40GHz		Average (AV)

ANTENNA POLARITY & TEST DISTANCE: HORIZONTAL AT 3 M

NO.	FREQ. (MHz)	EMISSION LEVEL (dBuV/m)	LIMIT (dBuV/m)	MARGIN (dB)	ANTENNA HEIGHT (m)	TABLE ANGLE (Degree)	RAW VALUE (dBuV)	CORRECTION FACTOR (dB/m)
1	*5825.00	104.0 PK			1.99 H	131	63.40	40.60
2	*5825.00	92.2 AV			1.99 H	131	51.60	40.60
3	#5850.00	46.8 PK	78.2	-31.4	1.88 H	151	39.20	7.60
4	#5852.10	58.9 PK	78.2	-19.3	2.03 H	126	51.20	7.70
5	#5860.10	58.4 PK	74.0	-15.6	1.75 H	129	50.70	7.70
6	#5860.10	45.4 AV	54.0	-8.6	1.75 H	129	37.70	7.70
7	11650.00	59.9 PK	74.0	-14.1	1.51 H	82	40.70	19.20
8	11650.00	47.5 AV	54.0	-6.5	1.51 H	82	28.30	19.20

ANTENNA POLARITY & TEST DISTANCE: VERTICAL AT 3 M

NO.	FREQ. (MHz)	EMISSION LEVEL (dBuV/m)	LIMIT (dBuV/m)	MARGIN (dB)	ANTENNA HEIGHT (m)	TABLE ANGLE (Degree)	RAW VALUE (dBuV)	CORRECTION FACTOR (dB/m)
1	*5825.00	124.6 PK			1.65 V	347	84.00	40.60
2	*5825.00	112.6 AV			1.65 V	347	72.00	40.60
3	#5850.00	60.5 PK	78.2	-17.7	1.70 V	347	52.90	7.60
4	#5852.10	72.0 PK	78.2	-6.2	1.72 V	327	64.30	7.70
5	#5860.10	65.3 PK	74.0	-8.7	1.67 V	354	57.60	7.70
6	#5860.10	49.6 AV	54.0	-4.4	1.67 V	354	41.90	7.70
7	11650.00	60.6 PK	74.0	-13.4	1.38 V	215	41.40	19.20
8	11650.00	47.5 AV	54.0	-6.5	1.38 V	215	28.30	19.20

REMARKS:

1. Emission Level(dBuV/m) = Raw Value(dBuV) + Correction Factor(dB/m)
2. Correction Factor(dB/m) = Antenna Factor(dB/m) + Cable Factor(dB)
3. The other emission levels were very low against the limit.
4. Margin value = Emission Level – Limit value
5. " * ": Fundamental frequency.
6. " # ": The radiated frequency is out of the restricted band.

802.11ac (VHT40)

CHANNEL	TX Channel 38	DETECTOR FUNCTION	Peak (PK)
FREQUENCY RANGE	1GHz ~ 40GHz		Average (AV)

ANTENNA POLARITY & TEST DISTANCE: HORIZONTAL AT 3 M								
NO.	FREQ. (MHz)	EMISSION LEVEL (dBuV/m)	LIMIT (dBuV/m)	MARGIN (dB)	ANTENNA HEIGHT (m)	TABLE ANGLE (Degree)	RAW VALUE (dBuV)	CORRECTION FACTOR (dB/m)
1	5150.00	56.5 PK	74.0	-17.5	1.26 H	144	50.50	6.00
2	5150.00	44.0 AV	54.0	-10.0	1.26 H	144	38.00	6.00
3	*5190.00	97.7 PK			1.13 H	206	58.30	39.40
4	*5190.00	83.0 AV			1.13 H	206	43.60	39.40
5	#10380.00	58.7 PK	74.0	-15.3	1.26 H	77	41.00	17.70
6	#10380.00	45.8 AV	54.0	-8.2	1.26 H	77	28.10	17.70

ANTENNA POLARITY & TEST DISTANCE: VERTICAL AT 3 M								
NO.	FREQ. (MHz)	EMISSION LEVEL (dBuV/m)	LIMIT (dBuV/m)	MARGIN (dB)	ANTENNA HEIGHT (m)	TABLE ANGLE (Degree)	RAW VALUE (dBuV)	CORRECTION FACTOR (dB/m)
1	5150.00	72.4 PK	74.0	-1.6	1.67 V	224	66.40	6.00
2	5150.00	45.4 AV	54.0	-8.6	1.67 V	224	39.40	6.00
3	*5190.00	113.4 PK			1.69 V	282	74.00	39.40
4	*5190.00	98.4 AV			1.69 V	282	59.00	39.40
5	#10380.00	58.6 PK	74.0	-15.4	1.32 V	218	40.90	17.70
6	#10380.00	45.9 AV	54.0	-8.1	1.32 V	218	28.20	17.70

REMARKS:

1. Emission Level(dBuV/m) = Raw Value(dBuV) + Correction Factor(dB/m)
2. Correction Factor(dB/m) = Antenna Factor(dB/m) + Cable Factor(dB)
3. The other emission levels were very low against the limit.
4. Margin value = Emission Level – Limit value
5. " * ": Fundamental frequency.
6. " # ": The radiated frequency is out of the restricted band.



CHANNEL	TX Channel 46	DETECTOR FUNCTION	Peak (PK)
FREQUENCY RANGE	1GHz ~ 40GHz		Average (AV)

ANTENNA POLARITY & TEST DISTANCE: HORIZONTAL AT 3 M

NO.	FREQ. (MHz)	EMISSION LEVEL (dBuV/m)	LIMIT (dBuV/m)	MARGIN (dB)	ANTENNA HEIGHT (m)	TABLE ANGLE (Degree)	RAW VALUE (dBuV)	CORRECTION FACTOR (dB/m)
1	5150.00	56.3 PK	74.0	-17.7	1.31 H	211	50.30	6.00
2	5150.00	44.0 AV	54.0	-10.0	1.31 H	211	38.00	6.00
3	*5230.00	101.8 PK			1.17 H	204	62.20	39.60
4	*5230.00	90.7 AV			1.17 H	204	51.10	39.60
5	5350.00	55.8 PK	74.0	-18.2	1.17 H	211	49.30	6.50
6	5350.00	43.8 AV	54.0	-10.2	1.17 H	211	37.30	6.50
7	#10460.00	58.2 PK	74.0	-15.8	1.33 H	108	39.70	18.50
8	#10460.00	46.1 AV	54.0	-7.9	1.33 H	108	27.60	18.50

ANTENNA POLARITY & TEST DISTANCE: VERTICAL AT 3 M

NO.	FREQ. (MHz)	EMISSION LEVEL (dBuV/m)	LIMIT (dBuV/m)	MARGIN (dB)	ANTENNA HEIGHT (m)	TABLE ANGLE (Degree)	RAW VALUE (dBuV)	CORRECTION FACTOR (dB/m)
1	5150.00	66.7 PK	74.0	-7.3	1.54 V	343	60.70	6.00
2	5150.00	47.9 AV	54.0	-6.1	1.54 V	343	41.90	6.00
3	*5230.00	121.8 PK			1.72 V	348	82.20	39.60
4	*5230.00	110.0 AV			1.72 V	348	70.40	39.60
5	5350.00	56.7 PK	74.0	-17.3	1.73 V	336	50.20	6.50
6	5350.00	43.9 AV	54.0	-10.1	1.73 V	336	37.40	6.50
7	#10460.00	58.9 PK	74.0	-15.1	1.66 V	40	40.40	18.50
8	#10460.00	46.7 AV	54.0	-7.3	1.66 V	40	28.20	18.50

REMARKS:

1. Emission Level(dBuV/m) = Raw Value(dBuV) + Correction Factor(dB/m)
2. Correction Factor(dB/m) = Antenna Factor(dB/m) + Cable Factor(dB)
3. The other emission levels were very low against the limit.
4. Margin value = Emission Level – Limit value
5. " * ": Fundamental frequency.
6. " # ": The radiated frequency is out of the restricted band.

CHANNEL	TX Channel 151	DETECTOR FUNCTION	Peak (PK)
FREQUENCY RANGE	1GHz ~ 40GHz		Average (AV)

ANTENNA POLARITY & TEST DISTANCE: HORIZONTAL AT 3 M

NO.	FREQ. (MHz)	EMISSION LEVEL (dBuV/m)	LIMIT (dBuV/m)	MARGIN (dB)	ANTENNA HEIGHT (m)	TABLE ANGLE (Degree)	RAW VALUE (dBuV)	CORRECTION FACTOR (dB/m)
1	#5714.90	58.4 PK	74.0	-15.6	1.15 H	227	51.00	7.40
2	#5714.90	44.7 AV	54.0	-9.3	1.15 H	227	37.30	7.40
3	#5722.90	62.4 PK	78.2	-15.8	1.25 H	251	55.00	7.40
4	#5725.00	47.9 PK	78.2	-30.3	1.36 H	221	40.50	7.40
5	*5755.00	93.9 PK			1.00 H	201	53.30	40.60
6	*5755.00	83.4 AV			1.00 H	201	42.80	40.60
7	11510.00	59.8 PK	74.0	-14.2	1.29 H	70	41.10	18.70
8	11510.00	47.3 AV	54.0	-6.7	1.29 H	70	28.60	18.70

ANTENNA POLARITY & TEST DISTANCE: VERTICAL AT 3 M

NO.	FREQ. (MHz)	EMISSION LEVEL (dBuV/m)	LIMIT (dBuV/m)	MARGIN (dB)	ANTENNA HEIGHT (m)	TABLE ANGLE (Degree)	RAW VALUE (dBuV)	CORRECTION FACTOR (dB/m)
1	#5714.90	69.3 PK	74.0	-4.7	1.34 V	333	61.90	7.40
2	#5714.90	46.1 AV	54.0	-7.9	1.34 V	333	38.70	7.40
3	#5722.90	76.5 PK	78.2	-1.7	1.60 V	348	69.10	7.40
4	#5725.00	59.8 PK	78.2	-18.4	1.54 V	359	52.40	7.40
5	*5755.00	112.9 PK			1.72 V	337	72.30	40.60
6	*5755.00	100.9 AV			1.72 V	337	60.30	40.60
7	11510.00	61.0 PK	74.0	-13.0	1.46 V	221	42.30	18.70
8	11510.00	47.1 AV	54.0	-6.9	1.46 V	221	28.40	18.70

REMARKS:

1. Emission Level(dBuV/m) = Raw Value(dBuV) + Correction Factor(dB/m)
2. Correction Factor(dB/m) = Antenna Factor(dB/m) + Cable Factor(dB)
3. The other emission levels were very low against the limit.
4. Margin value = Emission Level – Limit value
5. " * ": Fundamental frequency.
6. " # ": The radiated frequency is out of the restricted band.

CHANNEL	TX Channel 159	DETECTOR FUNCTION	Peak (PK)
FREQUENCY RANGE	1GHz ~ 40GHz		Average (AV)

ANTENNA POLARITY & TEST DISTANCE: HORIZONTAL AT 3 M

NO.	FREQ. (MHz)	EMISSION LEVEL (dBuV/m)	LIMIT (dBuV/m)	MARGIN (dB)	ANTENNA HEIGHT (m)	TABLE ANGLE (Degree)	RAW VALUE (dBuV)	CORRECTION FACTOR (dB/m)
1	*5795.00	102.1 PK			1.67 H	123	61.50	40.60
2	*5795.00	90.9 AV			1.67 H	123	50.30	40.60
3	#5850.00	46.5 PK	78.2	-31.7	1.54 H	144	38.90	7.60
4	#5852.10	58.8 PK	78.2	-19.4	1.38 H	121	51.10	7.70
5	#5860.10	58.2 PK	74.0	-15.8	1.26 H	100	50.50	7.70
6	#5860.10	45.3 AV	54.0	-8.7	1.26 H	100	37.60	7.70
7	11590.00	60.5 PK	74.0	-13.5	1.21 H	65	41.70	18.80
8	11590.00	47.2 AV	54.0	-6.8	1.21 H	65	28.40	18.80

ANTENNA POLARITY & TEST DISTANCE: VERTICAL AT 3 M

NO.	FREQ. (MHz)	EMISSION LEVEL (dBuV/m)	LIMIT (dBuV/m)	MARGIN (dB)	ANTENNA HEIGHT (m)	TABLE ANGLE (Degree)	RAW VALUE (dBuV)	CORRECTION FACTOR (dB/m)
1	*5795.00	122.5 PK			1.63 V	181	81.90	40.60
2	*5795.00	111.0 AV			1.63 V	181	70.40	40.60
3	#5850.00	56.4 PK	78.2	-21.8	1.62 V	352	48.80	7.60
4	#5852.10	72.7 PK	78.2	-5.5	1.72 V	314	65.00	7.70
5	#5860.10	70.0 PK	74.0	-4.0	1.71 V	315	62.30	7.70
6	#5860.10	50.9 AV	54.0	-3.1	1.71 V	315	43.20	7.70
7	11590.00	60.2 PK	74.0	-13.8	1.51 V	19	41.40	18.80
8	11590.00	47.4 AV	54.0	-6.6	1.51 V	19	28.60	18.80

REMARKS:

1. Emission Level(dBuV/m) = Raw Value(dBuV) + Correction Factor(dB/m)
2. Correction Factor(dB/m) = Antenna Factor(dB/m) + Cable Factor(dB)
3. The other emission levels were very low against the limit.
4. Margin value = Emission Level – Limit value
5. " * ": Fundamental frequency.
6. " # ": The radiated frequency is out of the restricted band.

802.11ac (VHT80)

CHANNEL	TX Channel 42	DETECTOR FUNCTION	Peak (PK)
FREQUENCY RANGE	1GHz ~ 40GHz		Average (AV)

ANTENNA POLARITY & TEST DISTANCE: HORIZONTAL AT 3 M								
NO.	FREQ. (MHz)	EMISSION LEVEL (dBuV/m)	LIMIT (dBuV/m)	MARGIN (dB)	ANTENNA HEIGHT (m)	TABLE ANGLE (Degree)	RAW VALUE (dBuV)	CORRECTION FACTOR (dB/m)
1	5150.00	56.8 PK	74.0	-17.2	1.38 H	217	50.80	6.00
2	5150.00	45.0 AV	54.0	-9.0	1.38 H	217	39.00	6.00
3	*5210.00	91.3 PK			1.31 H	232	51.80	39.50
4	*5210.00	79.2 AV			1.31 H	232	39.70	39.50
5	5350.00	58.0 PK	74.0	-16.0	1.23 H	245	51.50	6.50
6	5350.00	47.4 AV	54.0	-6.6	1.23 H	245	40.90	6.50
7	#10420.00	58.4 PK	74.0	-15.6	1.16 H	128	40.50	17.90
8	#10420.00	46.0 AV	54.0	-8.0	1.16 H	128	28.10	17.90
ANTENNA POLARITY & TEST DISTANCE: VERTICAL AT 3 M								
NO.	FREQ. (MHz)	EMISSION LEVEL (dBuV/m)	LIMIT (dBuV/m)	MARGIN (dB)	ANTENNA HEIGHT (m)	TABLE ANGLE (Degree)	RAW VALUE (dBuV)	CORRECTION FACTOR (dB/m)
1	5150.00	72.3 PK	74.0	-1.7	1.72 V	249	66.30	6.00
2	5150.00	48.3 AV	54.0	-5.7	1.72 V	249	42.30	6.00
3	*5210.00	108.0 PK			1.68 V	260	68.50	39.50
4	*5210.00	94.1 AV			1.68 V	260	54.60	39.50
5	5350.00	62.1 PK	74.0	-11.9	1.69 V	266	55.60	6.50
6	5350.00	48.8 AV	54.0	-5.2	1.69 V	266	42.30	6.50
7	#10420.00	58.5 PK	74.0	-15.5	1.44 V	228	40.60	17.90
8	#10420.00	46.2 AV	54.0	-7.8	1.44 V	228	28.30	17.90

REMARKS:

1. Emission Level(dBuV/m) = Raw Value(dBuV) + Correction Factor(dB/m)
2. Correction Factor(dB/m) = Antenna Factor(dB/m) + Cable Factor(dB)
3. The other emission levels were very low against the limit.
4. Margin value = Emission Level – Limit value
5. " * ": Fundamental frequency.
6. " # ": The radiated frequency is out of the restricted band.



CHANNEL	TX Channel 155	DETECTOR FUNCTION	Peak (PK)
FREQUENCY RANGE	1GHz ~ 40GHz		Average (AV)

ANTENNA POLARITY & TEST DISTANCE: HORIZONTAL AT 3 M

NO.	FREQ. (MHz)	EMISSION LEVEL (dBuV/m)	LIMIT (dBuV/m)	MARGIN (dB)	ANTENNA HEIGHT (m)	TABLE ANGLE (Degree)	RAW VALUE (dBuV)	CORRECTION FACTOR (dB/m)
1	#5714.90	60.6 PK	74.0	-13.4	1.14 H	212	53.20	7.40
2	#5714.90	45.6 AV	54.0	-8.4	1.14 H	212	38.20	7.40
3	#5722.90	59.9 PK	78.2	-18.3	1.22 H	232	52.50	7.40
4	#5725.00	45.5 PK	78.2	-32.7	1.34 H	203	38.10	7.40
5	*5775.00	89.1 PK			1.28 H	196	48.50	40.60
6	*5775.00	80.5 AV			1.28 H	196	39.90	40.60
7	#5850.00	50.9 PK	78.2	-27.3	1.30 H	200	43.30	7.60
8	11550.00	59.4 PK	74.0	-14.6	1.05 H	113	40.80	18.60
9	11550.00	47.3 AV	54.0	-6.7	1.05 H	113	28.70	18.60

ANTENNA POLARITY & TEST DISTANCE: VERTICAL AT 3 M

NO.	FREQ. (MHz)	EMISSION LEVEL (dBuV/m)	LIMIT (dBuV/m)	MARGIN (dB)	ANTENNA HEIGHT (m)	TABLE ANGLE (Degree)	RAW VALUE (dBuV)	CORRECTION FACTOR (dB/m)
1	#5714.90	70.7 PK	74.0	-3.3	1.78 V	167	63.30	7.40
2	#5714.90	48.2 AV	54.0	-5.8	1.78 V	167	40.80	7.40
3	#5722.90	76.5 PK	78.2	-1.7	1.76 V	152	69.10	7.40
4	#5725.00	50.0 PK	78.2	-28.2	1.78 V	162	42.60	7.40
5	*5775.00	105.4 PK			1.63 V	308	64.80	40.60
6	*5775.00	94.1 AV			1.63 V	308	53.50	40.60
7	#5850.00	53.7 PK	78.2	-24.5	1.62 V	311	46.10	7.60
8	11550.00	60.5 PK	74.0	-13.5	1.46 V	193	41.90	18.60
9	11550.00	47.3 AV	54.0	-6.7	1.46 V	193	28.70	18.60

REMARKS:

1. Emission Level(dBuV/m) = Raw Value(dBuV) + Correction Factor(dB/m)
2. Correction Factor(dB/m) = Antenna Factor(dB/m) + Cable Factor(dB)
3. The other emission levels were very low against the limit.
4. Margin value = Emission Level – Limit value
5. " * ": Fundamental frequency.
6. " # ": The radiated frequency is out of the restricted band.

Below 1GHz Worst-Case Data: 802.11a

CHANNEL	TX Channel 149	DETECTOR FUNCTION	Quasi-Peak (QP)
FREQUENCY RANGE	9kHz ~ 1GHz		

ANTENNA POLARITY & TEST DISTANCE: HORIZONTAL AT 3 M								
NO.	FREQ. (MHz)	EMISSION LEVEL (dBuV/m)	LIMIT (dBuV/m)	MARGIN (dB)	ANTENNA HEIGHT (m)	TABLE ANGLE (Degree)	RAW VALUE (dBuV)	CORRECTION FACTOR (dB/m)
1	94.06	36.2 QP	43.5	-7.3	2.00 H	273	55.60	-19.40
2	148.50	36.3 QP	43.5	-7.2	2.00 H	268	50.10	-13.80
3	374.04	43.0 QP	46.0	-3.0	1.00 H	153	53.60	-10.60
4	624.85	40.7 QP	46.0	-5.3	1.00 H	13	45.80	-5.10
5	751.23	37.4 QP	46.0	-8.6	1.49 H	343	40.20	-2.80
6	875.67	35.7 QP	46.0	-10.3	2.00 H	114	36.60	-0.90

ANTENNA POLARITY & TEST DISTANCE: VERTICAL AT 3 M								
NO.	FREQ. (MHz)	EMISSION LEVEL (dBuV/m)	LIMIT (dBuV/m)	MARGIN (dB)	ANTENNA HEIGHT (m)	TABLE ANGLE (Degree)	RAW VALUE (dBuV)	CORRECTION FACTOR (dB/m)
1	49.34	36.7 QP	40.0	-3.3	1.00 V	332	51.00	-14.30
2	154.33	31.6 QP	43.5	-11.9	1.00 V	270	45.20	-13.60
3	218.50	30.7 QP	46.0	-15.3	1.00 V	200	46.70	-16.00
4	374.04	40.1 QP	46.0	-5.9	1.00 V	208	50.70	-10.60
5	624.85	36.9 QP	46.0	-9.1	1.00 V	16	42.00	-5.10
6	875.67	34.4 QP	46.0	-11.6	1.00 V	337	35.30	-0.90

REMARKS:

1. Emission Level(dBuV/m) = Raw Value(dBuV) + Correction Factor(dB/m)
2. Correction Factor(dB/m) = Antenna Factor(dB/m) + Cable Factor(dB)
3. The other emission levels were very low against the limit.
4. Margin value = Emission Level – Limit value

4.2 Conducted Emission Measurement

4.2.1 Limits of Conducted Emission Measurement

Frequency (MHz)	Conducted Limit (dBuV)	
	Quasi-peak	Average
0.15 - 0.5	66 - 56	56 - 46
0.50 - 5.0	56	46
5.0 - 30.0	60	50

Note: 1. The lower limit shall apply at the transition frequencies.

2. The limit decreases in line with the logarithm of the frequency in the range of 0.15 to 0.50MHz.

4.2.2 Test Instruments

Description & Manufacturer	Model No.	Serial No.	Cal. Date	Cal. Due
Test Receiver ROHDE & SCHWARZ	ESCI	100613	Nov. 16, 2015	Nov. 15, 2016
RF signal cable (with 10dB PAD) Woken	5D-FB	Cable-cond1-01	Dec. 26, 2015	Dec. 25, 2016
LISN ROHDE & SCHWARZ (EUT)	ESH3-Z5	835239/001	Feb. 26, 2016	Feb. 25, 2017
LISN ROHDE & SCHWARZ (Peripheral)	ESH3-Z5	100311	Jul. 24, 2015	Jul. 23, 2016
Software ADT	BV ADT_Cond_ V7.3.7.3	NA	NA	NA

Note: 1. The calibration interval of the above test instruments is 12 months and the calibrations are traceable to NML/ROC and NIST/USA.

2. The test was performed in HwaYa Shielded Room 1.

3. The VCCI Site Registration No. is C-2040.

4.2.3 Test Procedure

- The EUT was placed 0.4 meters from the conducting wall of the shielded room with EUT being connected to the power mains through a line impedance stabilization network (LISN). Other support units were connected to the power mains through another LISN. The two LISNs provide 50 ohm/ 50uH of coupling impedance for the measuring instrument.
- Both lines of the power mains connected to the EUT were checked for maximum conducted interference.
- The frequency range from 150kHz to 30MHz was searched. Emission levels under (Limit - 20dB) was not recorded.

NOTE: The resolution bandwidth and video bandwidth of test receiver is 9kHz for quasi-peak detection (QP) and average detection (AV) at frequency 0.15MHz-30MHz.

4.2.4 Deviation from Test Standard

No deviation.

4.2.5 Test Setup

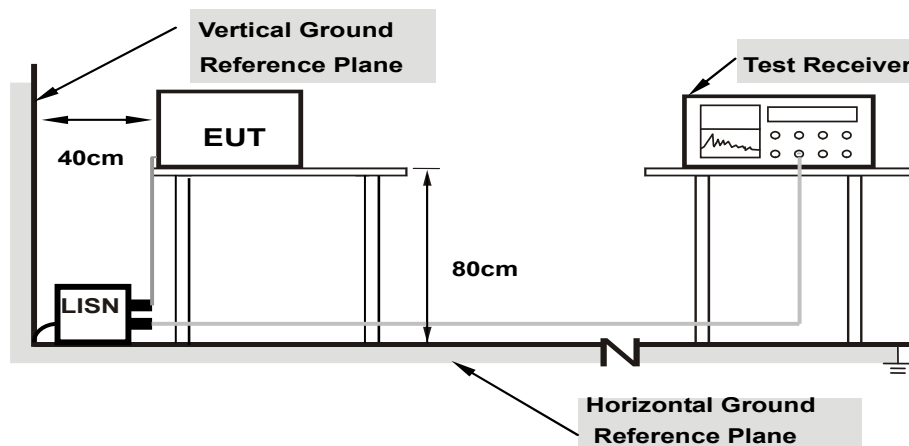

- Note:**
- Support units were connected to second LISN.
 - Both of LISNs (AMN) are 80 cm from EUT and at least 80 from other units and other metal planes

For the actual test configuration, please refer to the attached file (Test Setup Photo).

4.2.6 EUT Operating Conditions

Same as 4.1.6.

4.2.7 Test Results

Phase	Line (L)	Detector Function	Quasi-Peak (QP) / Average (AV)
-------	----------	-------------------	--------------------------------

No	Freq. [MHz]	Corr. Factor (dB)	Reading Value [dB (uV)]		Emission Level [dB (uV)]		Limit [dB (uV)]		Margin (dB)	
			Q.P.	AV.	Q.P.	AV.	Q.P.	AV.	Q.P.	AV.
			1	0.52153	10.19	35.67	29.62	45.86	39.81	56.00
2	1.02600	10.29	22.53	14.16	32.82	24.45	56.00	46.00	-23.18	-21.55
3	1.24200	10.31	24.16	17.17	34.47	27.48	56.00	46.00	-21.53	-18.52
4	1.52200	10.33	24.01	16.78	34.34	27.11	56.00	46.00	-21.66	-18.89
5	1.71000	10.35	22.01	14.27	32.36	24.62	56.00	46.00	-23.64	-21.38
6	22.00200	11.55	18.26	11.92	29.81	23.47	60.00	50.00	-30.19	-26.53

REMARKS:

1. Q.P. and AV. are abbreviations of quasi-peak and average individually.
2. The emission levels of other frequencies were very low against the limit.
3. Margin value = Emission level - Limit value
4. Correction factor = Insertion loss + Cable loss
5. Emission Level = Correction Factor + Reading Value.

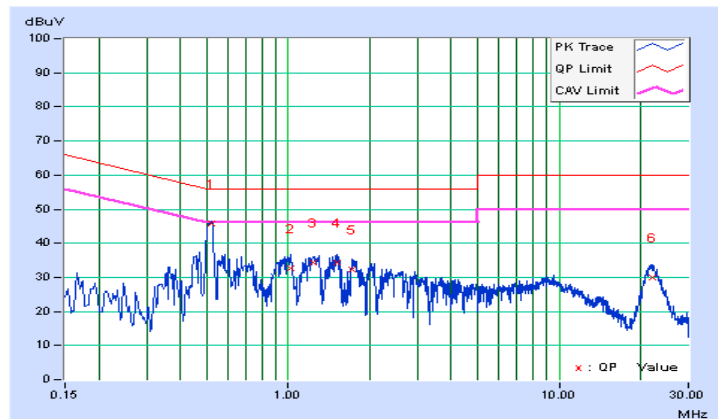

Phase	Neutral (N)	Detector Function	Quasi-Peak (QP) / Average (AV)
-------	-------------	-------------------	--------------------------------

No	Freq. [MHz]	Corr. Factor (dB)	Reading Value [dB (uV)]		Emission Level [dB (uV)]		Limit [dB (uV)]		Margin (dB)	
			Q.P.	AV.	Q.P.	AV.	Q.P.	AV.	Q.P.	AV.
			1	0.15000	10.08	25.76	15.66	35.84	25.74	66.00
2	0.52600	10.25	35.13	29.65	45.38	39.90	56.00	46.00	-10.62	-6.10
3	0.71734	10.27	25.23	17.25	35.50	27.52	56.00	46.00	-20.50	-18.48
4	0.95400	10.29	25.45	18.33	35.74	28.62	56.00	46.00	-20.26	-17.38
5	1.23432	10.31	25.14	17.97	35.45	28.28	56.00	46.00	-20.55	-17.72
6	22.08600	11.72	17.88	10.75	29.60	22.47	60.00	50.00	-30.40	-27.53

REMARKS:

1. Q.P. and AV. are abbreviations of quasi-peak and average individually.
2. The emission levels of other frequencies were very low against the limit.
3. Margin value = Emission level - Limit value
4. Correction factor = Insertion loss + Cable loss
5. Emission Level = Correction Factor + Reading Value.

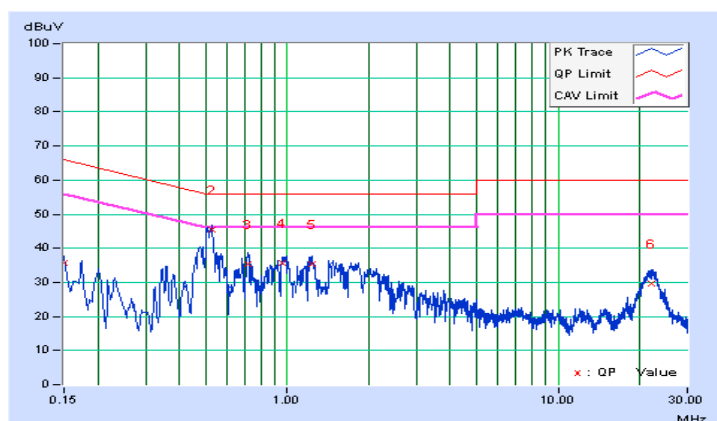

4.3 Transmit Power Measurement

4.3.1 Limits of Transmit Power Measurement

Operation Band	EUT Category		LIMIT
U-NII-1	√	Outdoor Access Point	1 Watt (30 dBm) (Max. e.i.r.p ≤ 125mW (21 dBm) at any elevation angle above 30 degrees as measured from the horizon)
		Fixed point-to-point Access Point	1 Watt (30 dBm)
		Indoor Access Point	1 Watt (30 dBm)
		Mobile and Portable client device	250mW (24 dBm)
U-NII-2A	---		250mW (24 dBm) or 11 dBm+10 log B*
U-NII-2C	---		250mW (24 dBm) or 11 dBm+10 log B*
U-NII-3	√		1 Watt (30 dBm)

*B is the 26 dB emission bandwidth in megahertz

Per KDB 662911 Method of conducted output power measurement on IEEE 802.11 devices,

Array Gain = 0 dB (i.e., no array gain) for $N_{ANT} \leq 4$;

Array Gain = 0 dB (i.e., no array gain) for channel widths ≥ 40 MHz for any N_{ANT} ;

Array Gain = $5 \log(N_{ANT}/N_{SS})$ dB or 3 dB, whichever is less for 20-MHz channel widths with $N_{ANT} \geq 5$.

For power measurements on all other devices: Array Gain = $10 \log(N_{ANT}/N_{SS})$ dB.

4.3.2 Test Setup

For Power Output Measurement

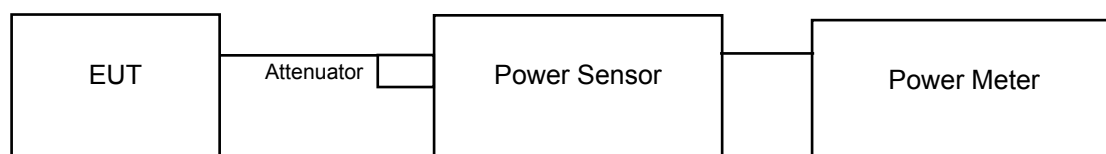

For 26dB and Occupied Bandwidth

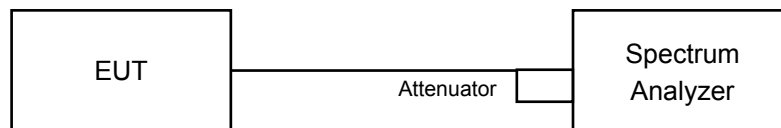

4.3.3 Test Instruments

Refer to section 4.1.2 to get information of above instrument.

4.3.4 Test Procedure

For Average Power Measurement

For 802.11a, 802.11n (HT20), 802.11n (HT40), 802.11ac (VHT20), 802.11ac (VHT40)

Method PM is used to perform output power measurement, trigger and gating function of wide band power meter is enabled to measure max output power of TX on burst and set the detector to AVERAGE. Duty factor is not added to measured value.

For 802.11ac (VHT80)

- a. Set span to encompass the entire 26 dB EBW (or, alternatively, the entire 99% occupied bandwidth) of the signal.
- b. Set sweep trigger to "free run".
- c. Set RBW = 1 MHz
- d. Set VBW \geq 3 MHz
- e. Number of points in sweep \geq 2 Span / RBW
- f. Sweep time \leq (number of points in sweep) * T
- g. Using emission bandwidth to determine the frequency span for integration the channel bandwidth.
- h. Detector = RMS
- i. Trace mode = max hold
- j. Allow max hold to run for at least 60 seconds, or longer as needed to allow the trace to stabilize.

For Occupied Bandwidth

The transmitter output was connected to the spectrum analyzer through an attenuator. The bandwidth of the fundamental frequency was measured by spectrum analyzer with resolution bandwidth in the range of 1% to 5% of the anticipated emission bandwidth, and a video bandwidth at least 3x the resolution bandwidth and set the detector to Sampling. The width of a frequency band such that, below the lower and above the upper frequency limits, the mean powers emitted are each equal to a specified percentage 0.5 %of the total mean power of a given emission.

4.3.5 Deviation from Test Standard

No deviation.

4.3.6 EUT Operating Conditions

The software provided by client to enable the EUT under transmission Condition continuously at lowest, middle and highest channel frequencies individually.

4.3.7 Test Result

Power Output:

CDD Mode

For U-NII-1 Band (Outdoor Access Point)

802.11a

Chan.	Freq. (MHz)	Conducted Power (dBm)				Total Power (mW)	Total Power (dBm)	Power Limit (dBm)	Gain (dBi)	EIRP (dBm)	EIRP limit (dBm)	Pass / Fail
		Chain 0	Chain 1	Chain 2	Chain 3							
36	5180	16.34	17.12	17.01	17.03	195.276	22.91	29.70	-3.89	19.02	21.00	Pass
40	5200	16.91	17.06	17.11	16.84	199.617	23.00	29.70	-3.89	19.11	21.00	Pass
48	5240	16.72	17.03	17.15	16.92	198.539	22.98	29.70	-3.89	19.09	21.00	Pass

Gain = 6.30 dBi > 6dBi, so the power limit shall be reduced to 30-(6.3-6) = 29.70dBm.

Gain = -3.89dBi (above 30 degrees from the horizon),

EIRP = conducted power +(-3.89dBi) + array gain = (0 dB (i.e., no array gain) for $N_{ANT} \leq 4$).

802.11n (HT20)

Chan.	Freq. (MHz)	Conducted Power (dBm)				Total Power (mW)	Total Power (dBm)	Power Limit (dBm)	Gain (dBi)	EIRP (dBm)	EIRP limit (dBm)	Pass / Fail
		Chain 0	Chain 1	Chain 2	Chain 3							
36	5180	16.20	16.63	16.87	16.66	182.699	22.62	29.70	-3.89	18.73	21.00	Pass
40	5200	16.37	16.89	16.85	16.66	186.978	22.72	29.70	-3.89	18.83	21.00	Pass
48	5240	16.33	17.02	16.81	16.78	188.920	22.76	29.70	-3.89	18.87	21.00	Pass

Gain = 6.30 dBi > 6dBi, so the power limit shall be reduced to 30-(6.3-6) = 29.70dBm.

Gain = -3.89dBi (above 30 degrees from the horizon),

EIRP = conducted power +(-3.89dBi) + array gain = (0 dB (i.e., no array gain) for $N_{ANT} \leq 4$).

802.11n (HT40)

Chan.	Freq. (MHz)	Conducted Power (dBm)				Total Power (mW)	Total Power (dBm)	Power Limit (dBm)	Gain (dBi)	EIRP (dBm)	EIRP limit (dBm)	Pass / Fail
		Chain 0	Chain 1	Chain 2	Chain 3							
38	5190	14.56	15.05	15.14	15.04	125.139	20.97	29.70	-3.89	17.08	21.00	Pass
46	5230	17.71	18.05	18.28	18.18	255.910	24.08	29.70	-3.89	20.19	21.00	Pass

Gain = 6.30 dBi > 6dBi, so the power limit shall be reduced to 30-(6.3-6) = 29.70dBm.

Gain = -3.89dBi (above 30 degrees from the horizon),

EIRP = conducted power +(-3.89dBi) + array gain = (0 dB (i.e., no array gain) for $N_{ANT} \leq 4$).

802.11ac (VHT80)

Chan.	Freq. (MHz)	Conducted Power (dBm)				Total Power (mW)	Total Power (dBm)	Power Limit (dBm)	Gain (dBi)	EIRP (dBm)	EIRP limit (dBm)	Pass / Fail
		Chain 0	Chain 1	Chain 2	Chain 3							
42	5210	8.77	9.52	9.57	9.52	34.499	15.38	29.70	-3.89	11.49	21.00	Pass

Gain = 6.30 dBi > 6dBi, so the power limit shall be reduced to 30-(6.3-6) = 29.70dBm.

Gain = -3.89dBi (above 30 degrees from the horizon),

EIRP = conducted power +(-3.89dBi) + array gain = (0 dB (i.e., no array gain) for $N_{ANT} \leq 4$).

For U-NII-3 Band

802.11a

Channel	Frequency (MHz)	Maximum Conducted Power (dBm)				Total Power (mW)	Total Power (dBm)	Power Limit (dBm)	Pass / Fail
		Chain 0	Chain 1	Chain 2	Chain 3				
149	5745	16.97	17.34	17.25	17.02	207.412	23.17	29.70	Pass
157	5785	20.97	21.31	21.26	21.21	526.023	27.21	29.70	Pass
165	5825	18.13	18.21	18.57	18.19	269.097	24.30	29.70	Pass

Gain = 6.30 dBi > 6dBi, so the power limit shall be reduced to $30-(6.3-6) = 29.70\text{dBm}$.

802.11n (HT20)

Channel	Frequency (MHz)	Maximum Conducted Power (dBm)				Total Power (mW)	Total Power (dBm)	Power Limit (dBm)	Pass / Fail
		Chain 0	Chain 1	Chain 2	Chain 3				
149	5745	16.51	16.25	17.10	16.52	183.102	22.63	29.70	Pass
157	5785	20.52	20.71	21.23	21.04	490.277	26.90	29.70	Pass
165	5825	17.32	18.67	18.04	17.96	253.769	24.04	29.70	Pass

Gain = 6.30 dBi > 6dBi, so the power limit shall be reduced to $30-(6.3-6) = 29.70\text{dBm}$.

802.11n (HT40)

Channel	Frequency (MHz)	Maximum Conducted Power (dBm)				Total Power (mW)	Total Power (dBm)	Power Limit (dBm)	Pass / Fail
		Chain 0	Chain 1	Chain 2	Chain 3				
151	5755	13.86	14.01	14.17	13.89	100.112	20.00	29.70	Pass
159	5795	16.81	16.85	17.11	16.86	196.323	22.93	29.70	Pass

Gain = 6.30 dBi > 6dBi, so the power limit shall be reduced to $30-(6.3-6) = 29.70\text{dBm}$.

802.11ac (VHT80)

Channel	Frequency (MHz)	Maximum Conducted Power (dBm)				Total Power (mW)	Total Power (dBm)	Power Limit (dBm)	Pass / Fail
		Chain 0	Chain 1	Chain 2	Chain 3				
155	5775	9.80	9.76	10.23	10.07	39.718	15.99	29.70	Pass

Gain = 6.30 dBi > 6dBi, so the power limit shall be reduced to $30-(6.3-6) = 29.70\text{dBm}$.

Beamforming Mode

For U-NII-1 Band (Outdoor Access Point)

802.11ac (VHT20)

Chan.	Freq. (MHz)	Conducted Power (dBm)				Total Power (mW)	Total Power (dBm)	Power Limit (dBm)	Gain (dBi)	EIRP (dBm)	EIRP limit (dBm)	Pass / Fail
		Chain 0	Chain 1	Chain 2	Chain 3							
36	5180	12.31	13.02	12.88	12.71	75.140	18.76	29.70	2.13	20.89	21.00	Pass
40	5200	12.35	13.01	12.91	12.75	75.557	18.78	29.70	2.13	20.91	21.00	Pass
48	5240	12.47	12.99	12.90	12.91	76.608	18.84	29.70	2.13	20.97	21.00	Pass

Gain = 6.30 dBi > 6dBi, so the power limit shall be reduced to $30-(6.3-6) = 29.70\text{dBm}$.

Gain = -3.89dBi (above 30 degrees from the horizon),

EIRP = conducted power + Directional gain

Directional gain = $-3.89\text{dBi} + 10\log(4) = 2.13$

802.11ac (VHT40)

Chan.	Freq. (MHz)	Conducted Power (dBm)				Total Power (mW)	Total Power (dBm)	Power Limit (dBm)	Gain (dBi)	EIRP (dBm)	EIRP limit (dBm)	Pass / Fail
		Chain 0	Chain 1	Chain 2	Chain 3							
38	5190	7.62	8.35	7.96	7.96	25.124	14.00	29.70	2.13	16.13	21.00	Pass
46	5230	12.33	12.85	12.88	12.71	74.448	18.72	29.70	2.13	20.85	21.00	Pass

Gain = 6.30 dBi > 6dBi, so the power limit shall be reduced to $30-(6.3-6) = 29.70\text{dBm}$.

Gain = -3.89dBi (above 30 degrees from the horizon),

EIRP = conducted power + Directional gain

Directional gain = $-3.89\text{dBi} + 10\log(4) = 2.13$

802.11ac (VHT80)

Chan.	Freq. (MHz)	Conducted Power (dBm)				Total Power (mW)	Total Power (dBm)	Power Limit (dBm)	Gain (dBi)	EIRP (dBm)	EIRP limit (dBm)	Pass / Fail
		Chain 0	Chain 1	Chain 2	Chain 3							
42	5210	5.42	6.05	5.58	5.81	14.935	11.74	29.70	2.13	13.87	21.00	Pass

Gain = 6.30 dBi > 6dBi, so the power limit shall be reduced to $30-(6.3-6) = 29.70\text{dBm}$.

Gain = -3.89dBi (above 30 degrees from the horizon),

EIRP = conducted power + Directional gain

Directional gain = $-3.89\text{dBi} + 10\log(4) = 2.13$

For U-NII-3 Band

802.11ac (VHT20)

Chan.	Freq. (MHz)	Conducted Power (dBm)				Total Power (mW)	Total Power (dBm)	Power Limit (dBm)	Pass / Fail
		Chain 0	Chain 1	Chain 2	Chain 3				
149	5745	6.34	6.62	6.48	6.68	17.999	12.55	23.68	Pass
157	5785	15.40	15.77	15.66	15.53	144.971	21.61	23.68	Pass
165	5825	15.30	15.81	15.36	15.67	143.245	21.56	23.68	Pass

Directional gain = $6.30\text{dBi} + 10\log(4) = 12.32\text{dBi} > 6\text{dBi}$, so the power limit shall be reduced to $30 - (12.32 - 6) = 23.68\text{dBm}$.

802.11ac (VHT40)

Chan.	Freq. (MHz)	Conducted Power (dBm)				Total Power (mW)	Total Power (dBm)	Power Limit (dBm)	Pass / Fail
		Chain 0	Chain 1	Chain 2	Chain 3				
151	5755	6.07	6.42	6.00	6.42	16.797	12.25	23.68	Pass
159	5795	16.20	16.68	16.30	16.44	174.959	22.43	23.68	Pass

Directional gain = $6.30\text{dBi} + 10\log(4) = 12.32\text{dBi} > 6\text{dBi}$, so the power limit shall be reduced to $30 - (12.32 - 6) = 23.68\text{dBm}$.

802.11ac (VHT80)

Chan.	Freq. (MHz)	Conducted Power (dBm)				Total Power (mW)	Total Power (dBm)	Power Limit (dBm)	Pass / Fail
		Chain 0	Chain 1	Chain 2	Chain 3				
155	5775	3.54	3.80	3.61	3.56	9.224	9.65	23.68	Pass

Directional gain = $6.30\text{dBi} + 10\log(4) = 12.32\text{dBi} > 6\text{dBi}$, so the power limit shall be reduced to $30 - (12.32 - 6) = 23.68\text{dBm}$.

26dB Bandwidth:

CDD Mode

802.11a

Channel	Frequency (MHz)	26dBc Bandwidth (MHz)				Pass / Fail
		Chain 0	Chain 1	Chain 2	Chain 3	
36	5180	22.84	23.91	24.32	21.54	Pass
40	5200	24.67	23.82	28.36	21.43	Pass
48	5240	23.19	24.16	28.24	21.43	Pass

802.11n (HT20)

Channel	Frequency (MHz)	26dBc Bandwidth (MHz)				Pass / Fail
		Chain 0	Chain 1	Chain 2	Chain 3	
36	5180	22.34	23.29	26.59	22.49	Pass
40	5200	26.14	26.08	27.86	22.29	Pass
48	5240	23.13	26.27	28.29	22.22	Pass

802.11n (HT40)

Channel	Frequency (MHz)	26dBc Bandwidth (MHz)				Pass / Fail
		Chain 0	Chain 1	Chain 2	Chain 3	
38	5190	41.26	40.91	45.21	40.74	Pass
46	5230	53.73	62.50	66.17	45.30	Pass

802.11ac (VHT80)

Channel	Frequency (MHz)	26dBc Bandwidth (MHz)				Pass / Fail
		Chain 0	Chain 1	Chain 2	Chain 3	
42	5210	116.68	84.76	84.88	86.09	Pass



Spectrum Plot of Worst Value

802.11a

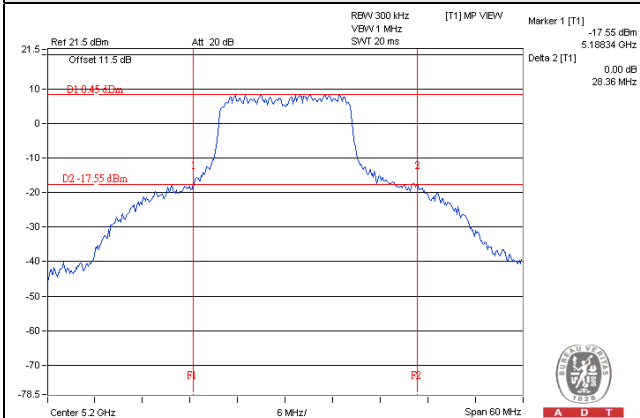

802.11n (HT20)

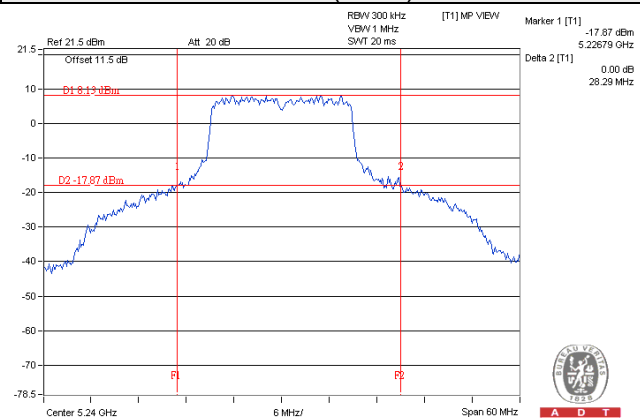

802.11n (HT40)

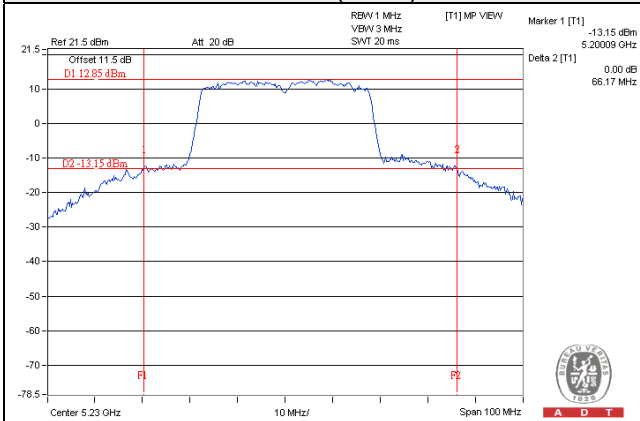

802.11ac (VHT80)

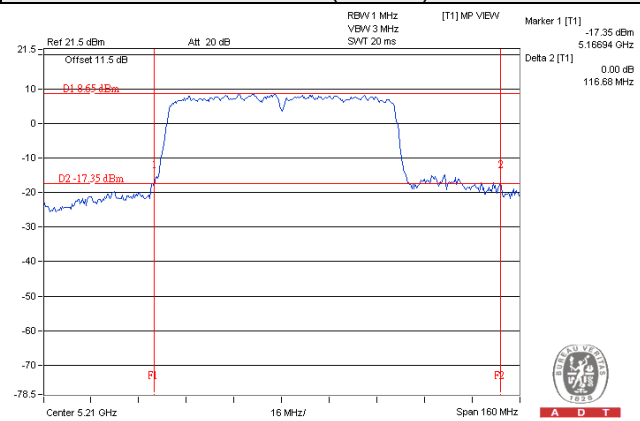

Beamforming Mode

802.11ac (VHT20)

Channel	Frequency (MHz)	26dBc Bandwidth (MHz)				Pass / Fail
		Chain 0	Chain 1	Chain 2	Chain 3	
36	5180	22.29	23.13	24.74	22.31	Pass
40	5200	22.48	22.55	26.11	22.31	Pass
48	5240	22.58	26.04	27.93	22.04	Pass

802.11ac (VHT40)

Channel	Frequency (MHz)	26dBc Bandwidth (MHz)				Pass / Fail
		Chain 0	Chain 1	Chain 2	Chain 3	
38	5190	40.85	40.63	40.54	40.48	Pass
46	5230	46.91	46.91	53.37	41.05	Pass

802.11ac (VHT80)

Channel	Frequency (MHz)	26dBc Bandwidth (MHz)				Pass / Fail
		Chain 0	Chain 1	Chain 2	Chain 3	
42	5210	85.17	97.69	85.15	86.19	Pass

Spectrum Plot of Worst Value

802.11ac (VHT20)

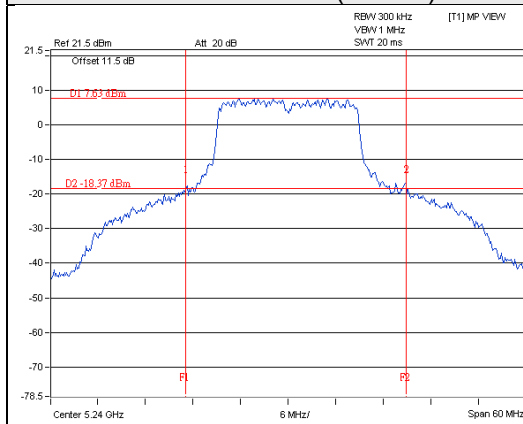

802.11ac (VHT40)

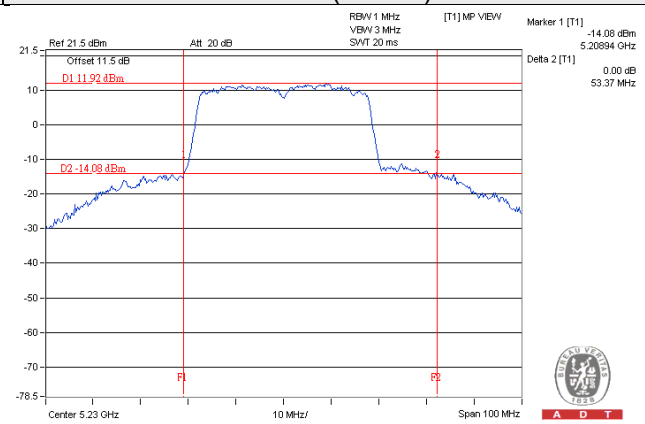

802.11ac (VHT80)

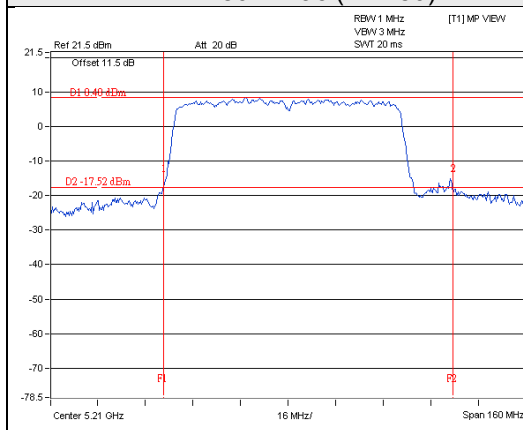

Occupied Bandwidth:

CDD Mode

802.11a

Channel	Frequency (MHz)	Occupied Bandwidth (MHz)			
		Chain 0	Chain 1	Chain 2	Chain 3
36	5180	16.56	16.68	16.80	16.56
40	5200	16.56	16.80	16.80	16.44
48	5240	16.80	16.68	16.80	16.44
149	5745	16.78	16.87	17.13	16.70
157	5785	26.16	23.76	28.20	26.76
165	5825	18.24	16.80	16.92	16.68

802.11n (HT20)

Channel	Frequency (MHz)	Occupied Bandwidth (MHz)			
		Chain 0	Chain 1	Chain 2	Chain 3
36	5180	17.76	17.76	17.76	17.64
40	5200	17.76	17.88	18.00	17.64
48	5240	17.76	17.76	18.00	17.64
149	5745	17.76	17.88	18.24	17.88
157	5785	27.00	24.00	28.68	26.64
165	5825	18.60	17.88	17.88	17.88

802.11n (HT40)

Channel	Frequency (MHz)	Occupied Bandwidth (MHz)			
		Chain 0	Chain 1	Chain 2	Chain 3
38	5190	36.24	36.12	36.24	36.24
46	5230	36.36	36.36	36.48	36.24
151	5755	36.24	36.24	36.12	36.12
159	5795	36.36	36.36	36.36	36.12

802.11ac (VHT80)

Channel	Frequency (MHz)	Occupied Bandwidth (MHz)			
		Chain 0	Chain 1	Chain 2	Chain 3
42	5210	76.16	75.88	76.16	75.88
155	5775	75.88	75.88	75.88	75.88



Spectrum Plot of Worst Value

802.11a

802.11n (HT20)

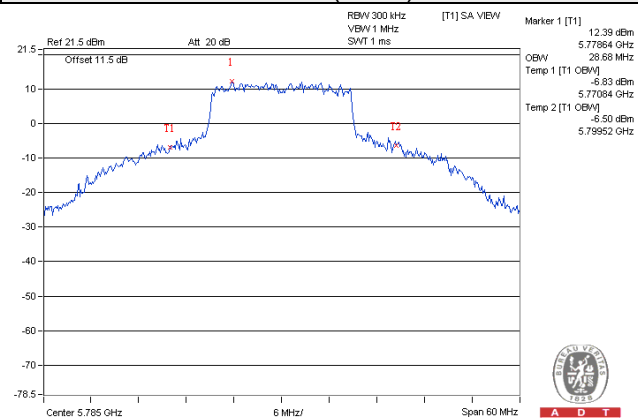
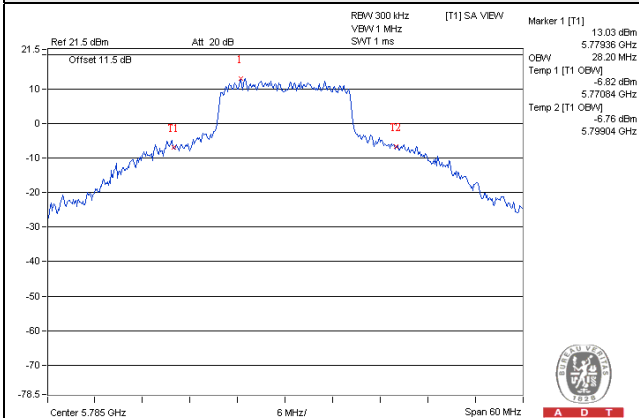

802.11n (HT40)

802.11ac (VHT80)

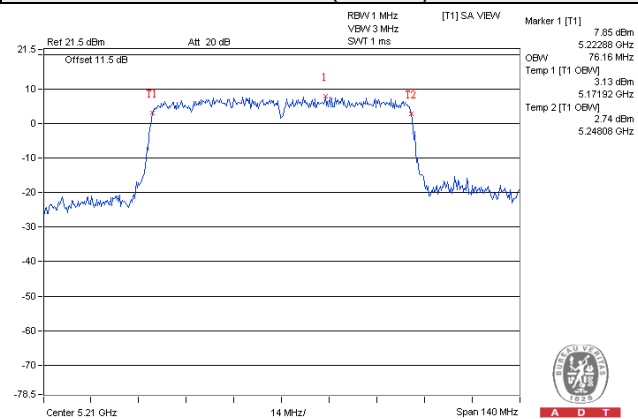
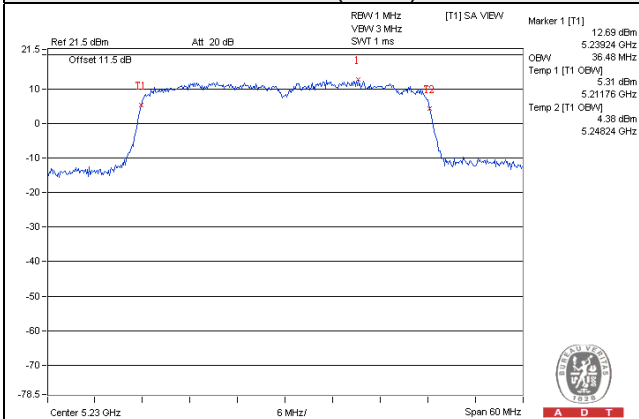

Beamforming Mode

802.11ac (VHT20)

Channel	Frequency (MHz)	Occupied Bandwidth (MHz)			
		Chain 0	Chain 1	Chain 2	Chain 3
36	5180	17.76	17.64	17.76	17.64
40	5200	17.76	17.88	17.88	17.64
48	5240	17.76	17.64	17.88	17.64
149	5745	17.65	17.65	17.65	17.65
157	5785	17.88	17.76	17.88	17.76
165	5825	17.88	17.64	17.88	18.00

802.11ac (VHT40)

Channel	Frequency (MHz)	Occupied Bandwidth (MHz)			
		Chain 0	Chain 1	Chain 2	Chain 3
38	5190	36.12	36.12	36.00	36.12
46	5230	36.24	36.24	36.24	36.24
151	5755	36.00	36.12	36.00	36.12
159	5795	36.12	36.36	36.36	36.48

802.11ac (VHT80)

Channel	Frequency (MHz)	Occupied Bandwidth (MHz)			
		Chain 0	Chain 1	Chain 2	Chain 3
42	5210	76.16	76.16	75.88	75.88
155	5775	75.88	75.88	76.16	75.88



Spectrum Plot of Worst Value

802.11ac (VHT20)

802.11ac (VHT40)

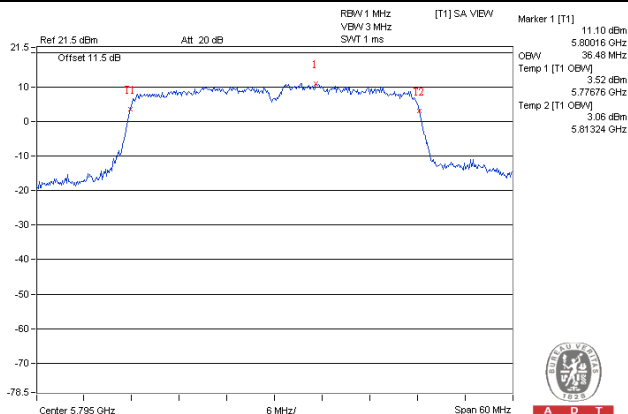
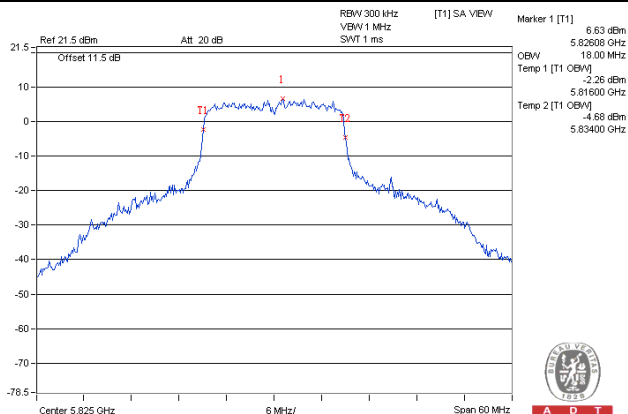

802.11ac (VHT80)

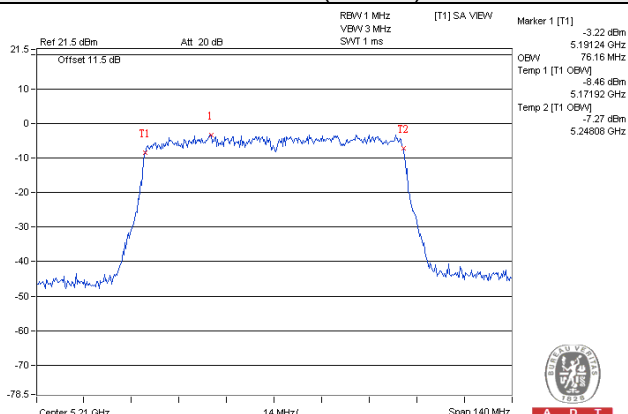

4.4 Peak Power Spectral Density Measurement

4.4.1 Limits of Peak Power Spectral Density Measurement

Operation Band	EUT Category		LIMIT
U-NII-1	√	Outdoor Access Point	17dBm/ MHz
		Fixed point-to-point Access Point	
		Indoor Access Point	
		Mobile and Portable client device	11dBm/ MHz
U-NII-2A	---		11dBm/ MHz
U-NII-2C	---		11dBm/ MHz
U-NII-3	√		30dBm/ 500kHz

4.4.2 Test Setup

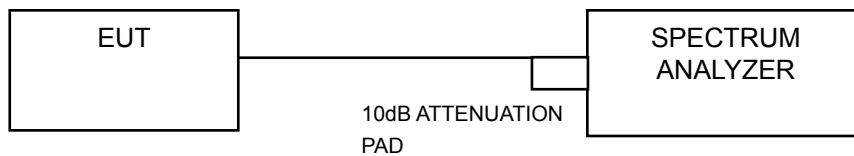

4.4.3 Test Instruments

Refer to section 4.1.2 to get information of above instrument.

4.4.4 Test Procedure

For U-NII-1 band:

Using method SA-1

- 1) Set span to encompass the entire emission bandwidth (EBW) of the signal.
- 2) Set RBW = 30 kHz, Set VBW \geq 1 MHz, Detector = RMS
- 3) Set Channel power measure = 1MHz
- 4) Sweep time = auto, trigger set to "free run".
- 5) Trace average at least 100 traces in power averaging mode.
- 6) Record the max value

Using method SA-2

- 1) Set span to encompass the entire emission bandwidth (EBW) of the signal.
- 2) Set RBW = 30 kHz, Set VBW \geq 1 MHz, Detector = RMS
- 3) Set Channel power measure = 1MHz
- 4) Sweep time = auto, trigger set to "free run".
- 5) Trace average at least 100 traces in power averaging mode.
- 6) Record the max value and add $10 \log (1/\text{duty cycle})$

For U-NII-3 band:

- 1) Set span to encompass the entire emission bandwidth (EBW) of the signal.
- 2) Set RBW = 500 kHz, Set VBW \geq 3 RBW, Detector = RMS
- 3) Sweep time = auto, trigger set to "free run".
- 4) Trace average at least 100 traces in power averaging mode.
- 5) Record the max value and add $10 \log (1/\text{duty cycle})$
- 6) Scale the observed power level to an equivalent value in 500 kHz by adjusting (reducing) the measured power by a bandwidth correction factor (BWCF) where $\text{BWCF} = 10 \log(500 \text{ kHz}/300 \text{ kHz})$

4.4.5 Deviation from Test Standard

No deviation.

4.4.6 EUT Operating Condition

Same as Item 4.3.6.

4.4.7 Test Results

For U-NII-1 Band

CDD Mode

802.11a

Chan.	Freq. (MHz)	PSD (dBm)				Total PSD w/o duty factor (dBm)	Duty factor	Total PSD with duty factor (dBm)	Max. Limit (dBm)	Pass / Fail
		Chain 0	Chain 1	Chain 2	Chain 3					
36	5180	2.93	3.71	3.46	3.82	9.52	0.14	9.66	10.68	Pass
40	5200	2.85	3.67	3.42	3.73	9.46	0.14	9.60	10.68	Pass
48	5240	3.20	3.52	3.26	3.55	9.41	0.14	9.55	10.68	Pass

Note:

1. Method 1 of power density measurement of KDB 662911 is using for calculating total power density. Total power density is summing entire spectra across corresponding frequency bins on the various outputs by computer.
2. Directional gain = $6.30\text{dBi} + 10\log(4) = 12.32\text{dBi} > 6\text{dBi}$, so the power density limit shall be reduced to $17 - (12.32 - 6) = 10.68\text{dBm}$.
3. Refer to section 3.3 for duty cycle spectrum plot.

802.11n (HT20)

Chan.	Freq. (MHz)	PSD (dBm)				Total PSD w/o duty factor (dBm)	Duty factor	Total PSD with duty factor (dBm)	Max. Limit (dBm)	Pass / Fail
		Chain 0	Chain 1	Chain 2	Chain 3					
36	5180	2.62	3.27	2.97	3.36	9.09	0.10	9.19	10.68	Pass
40	5200	2.84	3.67	3.02	3.30	9.24	0.10	9.34	10.68	Pass
48	5240	3.34	3.19	2.96	3.25	9.21	0.10	9.31	10.68	Pass

Note:

1. Method 1 of power density measurement of KDB 662911 is using for calculating total power density. Total power density is summing entire spectra across corresponding frequency bins on the various outputs by computer.
2. Directional gain = $6.30\text{dBi} + 10\log(4) = 12.32\text{dBi} > 6\text{dBi}$, so the power density limit shall be reduced to $17 - (12.32 - 6) = 10.68\text{dBm}$.
3. Refer to section 3.3 for duty cycle spectrum plot.

802.11n (HT40)

Chan.	Freq. (MHz)	PSD (dBm)				Total PSD w/o duty factor (dBm)	Duty factor	Total PSD with duty factor (dBm)	Max. Limit (dBm)	Pass / Fail
		Chain 0	Chain 1	Chain 2	Chain 3					
38	5190	-2.02	-1.15	-1.35	-1.02	4.65	0.13	4.78	10.68	Pass
46	5230	1.07	1.76	1.61	1.69	7.56	0.13	7.69	10.68	Pass

Note:

1. Method 1 of power density measurement of KDB 662911 is using for calculating total power density. Total power density is summing entire spectra across corresponding frequency bins on the various outputs by computer.
2. Directional gain = $6.30\text{dBi} + 10\log(4) = 12.32\text{dBi} > 6\text{dBi}$, so the power density limit shall be reduced to $17 - (12.32 - 6) = 10.68\text{dBm}$.
3. Refer to section 3.3 for duty cycle spectrum plot.

802.11ac (VHT80)

Chan.	Freq. (MHz)	PSD (dBm)				Total PSD w/o duty factor (dBm)	Duty factor	Total PSD with duty factor (dBm)	Max. Limit (dBm)	Pass / Fail
		Chain 0	Chain 1	Chain 2	Chain 3					
42	5210	-2.34	-10.15	-9.88	-10.06	-0.54	0.30	-0.24	10.68	Pass

Note:

1. Method 1 of power density measurement of KDB 662911 is using for calculating total power density. Total power density is summing entire spectra across corresponding frequency bins on the various outputs by computer.
2. Directional gain = $6.30\text{dBi} + 10\log(4) = 12.32\text{dBi} > 6\text{dBi}$, so the power density limit shall be reduced to $17 - (12.32 - 6) = 10.68\text{dBm}$.
3. Refer to section 3.3 for duty cycle spectrum plot.



Spectrum Plot of Worst Value

802.11a / Ch 36 / Chain 3

802.11n (HT20) / Ch 40 / Chain 1

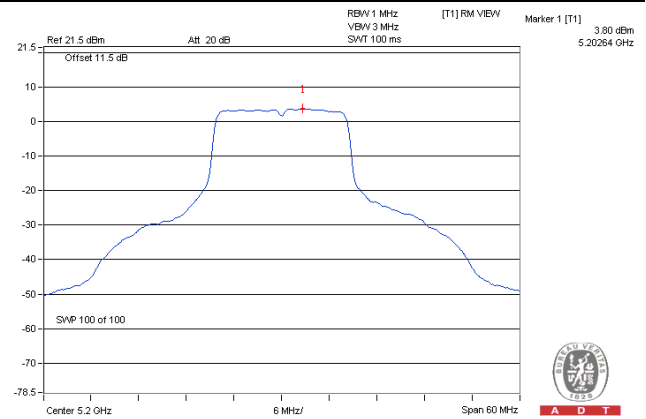
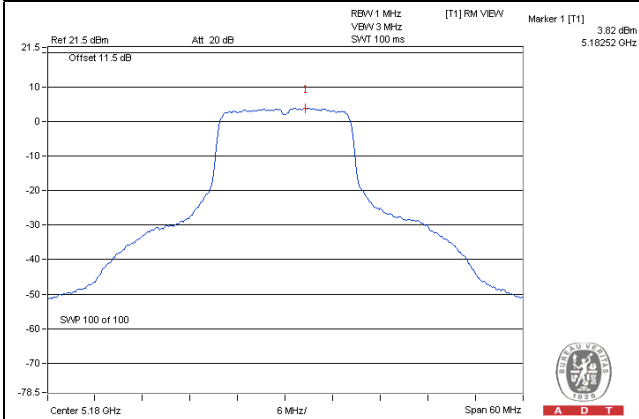

802.11n (HT40) / Ch 46 / Chain 1

802.11ac (VHT80) / Ch 42 / Chain 0

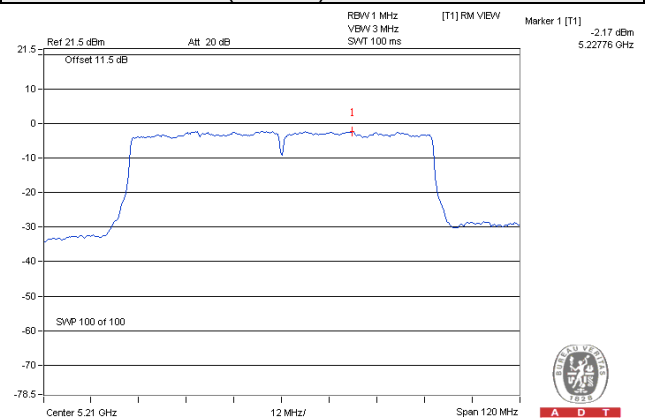
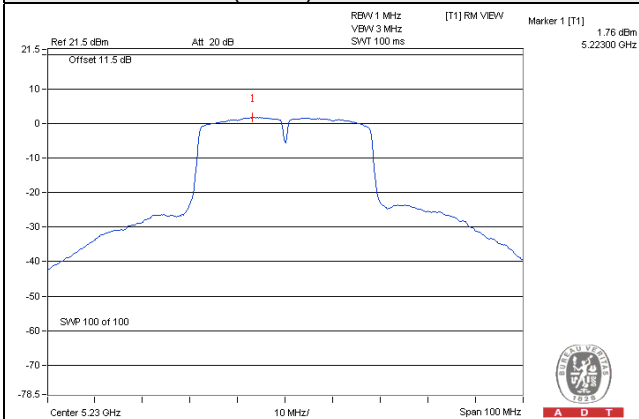

Beamforming Mode

802.11ac (VHT20)

Chan.	Freq. (MHz)	PSD (dBm)				Total PSD (dBm)	Max. Limit (dBm)	Pass / Fail
		Chain 0	Chain 1	Chain 2	Chain 3			
36	5180	0.09	1.03	0.68	1.17	6.78	10.68	Pass
40	5200	0.09	0.97	0.77	1.13	6.78	10.68	Pass
48	5240	0.61	0.90	0.64	1.11	6.84	10.68	Pass

Note:

- Method 1 of power density measurement of KDB 662911 is using for calculating total power density. Total power density is summing entire spectra across corresponding frequency bins on the various outputs by computer.
- Directional gain = $6.30\text{dBi} + 10\log(4) = 12.32\text{dBi} > 6\text{dBi}$, so the power density limit shall be reduced to $17 - (12.32 - 6) = 10.68\text{dBm}$.

802.11ac (VHT40)

Chan.	Freq. (MHz)	PSD (dBm)				Total PSD w/o duty factor (dBm)	Duty factor	Total PSD with duty factor (dBm)	Max. Limit (dBm)	Pass / Fail
		Chain 0	Chain 1	Chain 2	Chain 3					
38	5190	-7.17	-7.06	-7.39	-6.99	-1.12	0.15	-0.97	10.68	Pass
46	5230	-2.66	-2.23	-1.93	-2.28	3.76	0.15	3.91	10.68	Pass

Note:

- Method 1 of power density measurement of KDB 662911 is using for calculating total power density. Total power density is summing entire spectra across corresponding frequency bins on the various outputs by computer.
- Directional gain = $6.30\text{dBi} + 10\log(4) = 12.32\text{dBi} > 6\text{dBi}$, so the power density limit shall be reduced to $17 - (12.32 - 6) = 10.68\text{dBm}$.
- Refer to section 3.3 for duty cycle spectrum plot.

802.11ac (VHT80)

Chan.	Freq. (MHz)	PSD (dBm)				Total PSD w/o duty factor (dBm)	Duty factor	Total PSD with duty factor (dBm)	Max. Limit (dBm)	Pass / Fail
		Chain 0	Chain 1	Chain 2	Chain 3					
42	5210	-13.59	-2.64	-13.73	-13.27	-1.69	0.29	-1.40	10.68	Pass

Note:

- Method 1 of power density measurement of KDB 662911 is using for calculating total power density. Total power density is summing entire spectra across corresponding frequency bins on the various outputs by computer.
- Directional gain = $6.30\text{dBi} + 10\log(4) = 12.32\text{dBi} > 6\text{dBi}$, so the power density limit shall be reduced to $17 - (12.32 - 6) = 10.68\text{dBm}$.
- Refer to section 3.3 for duty cycle spectrum plot.



BUREAU
VERITAS

Spectrum Plot of Worst Value

802.11ac (VHT20) / Ch 36 / Chain 3

802.11ac (VHT40) / Ch 46 / Chain 2

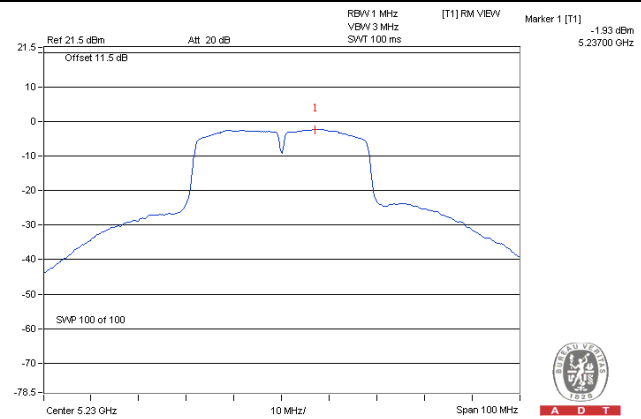
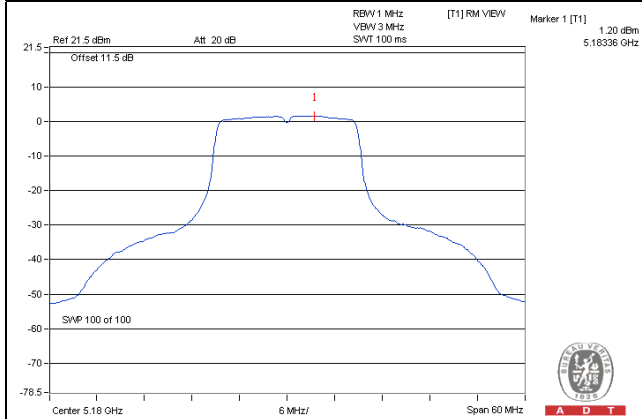

802.11ac (VHT80) / Ch 42 / Chain 1

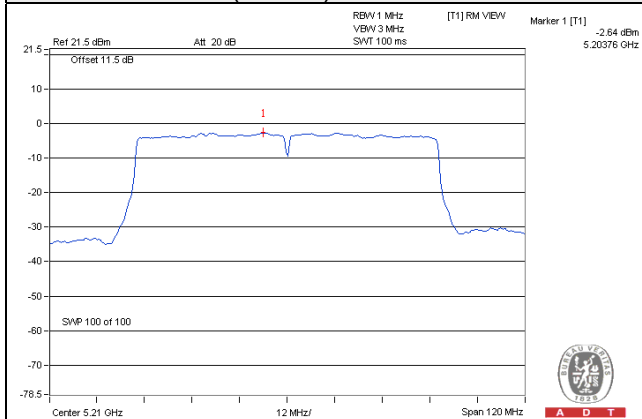

For U-NII-3 Band

CDD Mode

802.11a

TX chain	Channel	Freq. (MHz)	PSD (dBm/300kHz)	PSD (dBm/500kHz)	10 log (N=4) dB	Duty factor	Total PSD (dBm/500kHz)	Limit (dBm/500kHz)	Pass / Fail
0	149	5745	-4.94	-2.72	6.02	0.14	3.44	23.68	Pass
	157	5785	-0.78	1.44	6.02	0.14	7.60	23.68	Pass
	165	5825	-3.85	-1.63	6.02	0.14	4.53	23.68	Pass
1	149	5745	-5.00	-2.78	6.02	0.14	3.38	23.68	Pass
	157	5785	-0.59	1.63	6.02	0.14	7.79	23.68	Pass
	165	5825	-3.52	-1.30	6.02	0.14	4.86	23.68	Pass
2	149	5745	-4.91	-2.69	6.02	0.14	3.47	23.68	Pass
	157	5785	-0.51	1.71	6.02	0.14	7.87	23.68	Pass
	165	5825	-3.18	-0.96	6.02	0.14	5.20	23.68	Pass
3	149	5745	-5.07	-2.85	6.02	0.14	3.31	23.68	Pass
	157	5785	-0.39	1.83	6.02	0.14	7.99	23.68	Pass
	165	5825	-3.93	-1.71	6.02	0.14	4.45	23.68	Pass

Note:

1. Method 1 of power density measurement of KDB 662911 is using for calculating total power density. Total power density is summing entire spectra across corresponding frequency bins on the various outputs by computer.
2. Directional gain = 6.30dBi + 10log(4) = 12.32dBi > 6dBi, so the limit shall be reduced to 30-(12.32-6) = 23.68dBm.
3. Refer to section 3.3 for duty cycle spectrum plot.

802.11n (HT20)

TX chain	Channel	Freq. (MHz)	PSD (dBm/300kHz)	PSD (dBm/500kHz)	10 log (N=4) dB	Duty factor	Total PSD (dBm/500kHz)	Limit (dBm/500kHz)	Pass / Fail
0	149	5745	-5.51	-3.29	6.02	0.10	2.83	23.68	Pass
	157	5785	-1.38	0.84	6.02	0.10	6.96	23.68	Pass
	165	5825	-4.49	-2.27	6.02	0.10	3.85	23.68	Pass
1	149	5745	-5.08	-2.86	6.02	0.10	3.26	23.68	Pass
	157	5785	-1.02	1.20	6.02	0.10	7.32	23.68	Pass
	165	5825	-4.02	-1.80	6.02	0.10	4.32	23.68	Pass
2	149	5745	-5.21	-2.99	6.02	0.10	3.13	23.68	Pass
	157	5785	-0.82	1.40	6.02	0.10	7.52	23.68	Pass
	165	5825	-3.53	-1.31	6.02	0.10	4.81	23.68	Pass
3	149	5745	-5.32	-3.10	6.02	0.10	3.02	23.68	Pass
	157	5785	-0.79	1.43	6.02	0.10	7.55	23.68	Pass
	165	5825	-4.06	-1.84	6.02	0.10	4.28	23.68	Pass

Note:

1. Method 1 of power density measurement of KDB 662911 is using for calculating total power density. Total power density is summing entire spectra across corresponding frequency bins on the various outputs by computer.
2. Directional gain = 6.30dBi + 10log(4) = 12.32dBi > 6dBi, so the limit shall be reduced to 30-(12.32-6) = 23.68dBm.
3. Refer to section 3.3 for duty cycle spectrum plot.

802.11n (HT40)

TX chain	Channel	Freq. (MHz)	PSD (dBm/300kHz)	PSD (dBm/500kHz)	10 log (N=4) dB	Duty factor	Total PSD (dBm/500kHz)	Limit (dBm/500kHz)	Pass / Fail
0	151	5755	-11.42	-9.20	6.02	0.13	-3.05	23.68	Pass
	159	5795	-8.26	-6.04	6.02	0.13	0.11	23.68	Pass
1	151	5755	-11.41	-9.19	6.02	0.13	-3.04	23.68	Pass
	159	5795	-8.42	-6.20	6.02	0.13	-0.05	23.68	Pass
2	151	5755	-11.24	-9.02	6.02	0.13	-2.87	23.68	Pass
	159	5795	-8.16	-5.94	6.02	0.13	0.21	23.68	Pass
3	151	5755	-11.15	-8.93	6.02	0.13	-2.78	23.68	Pass
	159	5795	-8.12	-5.90	6.02	0.13	0.25	23.68	Pass

Note:

1. Method 1 of power density measurement of KDB 662911 is using for calculating total power density. Total power density is summing entire spectra across corresponding frequency bins on the various outputs by computer.
2. Directional gain = 6.30dBi + 10log(4) = 12.32dBi > 6dBi, so the limit shall be reduced to 30-(12.32-6) = 23.68dBm.
3. Refer to section 3.3 for duty cycle spectrum plot.

802.11ac (VHT80)

TX chain	Channel	Freq. (MHz)	PSD (dBm/300kHz)	PSD (dBm/500kHz)	10 log (N=4) dB	Duty factor	Total PSD (dBm/500kHz)	Limit (dBm/500kHz)	Pass / Fail
0	155	5775	-18.48	-16.26	6.02	0.30	-9.94	23.68	Pass
1	155	5775	-18.43	-16.21	6.02	0.30	-9.89	23.68	Pass
2	155	5775	-18.44	-16.22	6.02	0.30	-9.90	23.68	Pass
3	155	5775	-18.72	-16.50	6.02	0.30	-10.18	23.68	Pass

Note:

- Method 1 of power density measurement of KDB 662911 is using for calculating total power density. Total power density is summing entire spectra across corresponding frequency bins on the various outputs by computer.
- Directional gain = 6.30dBi + 10log(4) = 12.32dBi > 6dBi, so the limit shall be reduced to 30-(12.32-6) = 23.68dBm.
- Refer to section 3.3 for duty cycle spectrum plot.

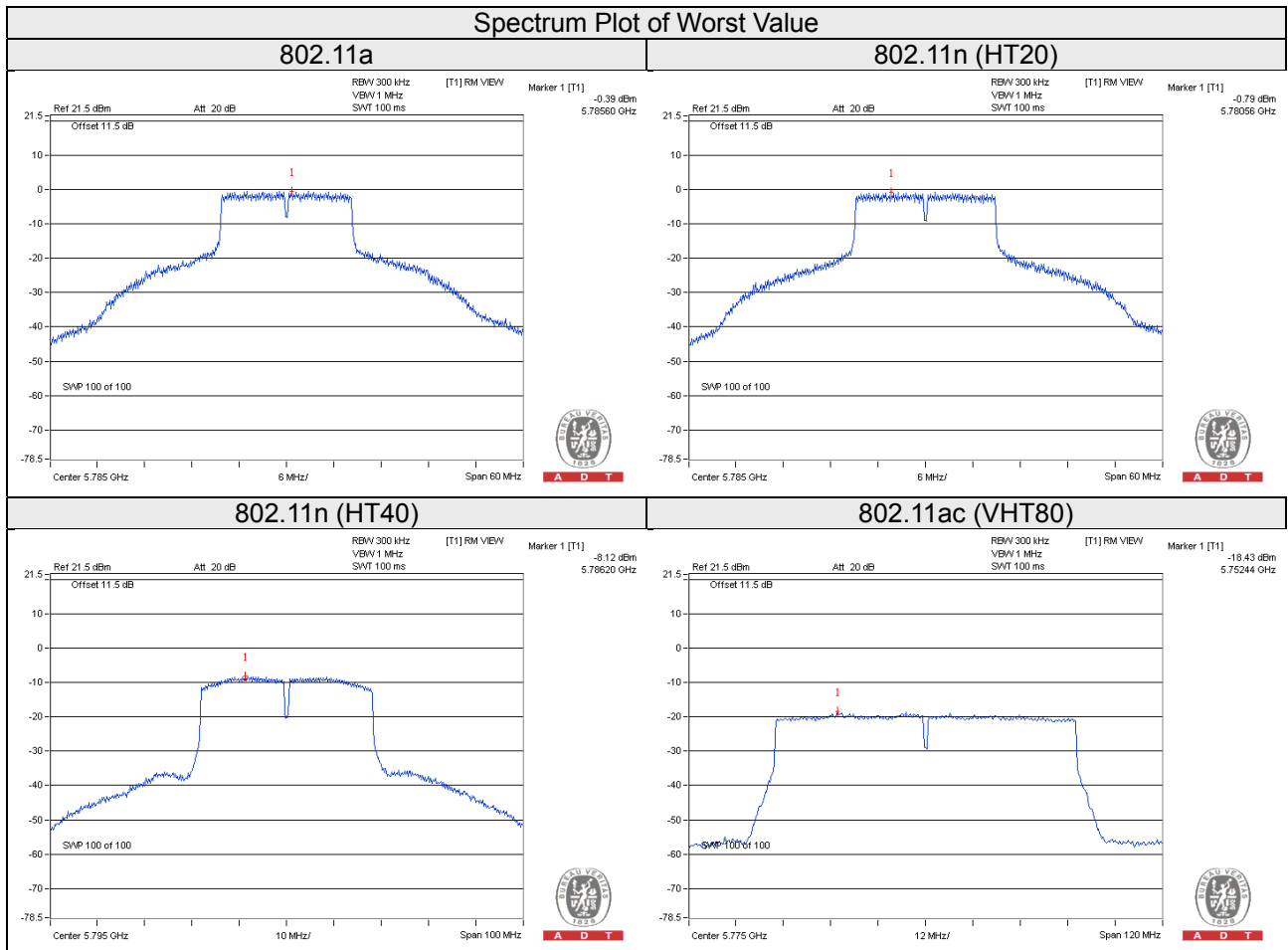

Beamforming Mode

802.11ac (VHT20)

TX chain	Channel	Freq. (MHz)	PSD (dBm/300kHz)	PSD (dBm/500kHz)	10 log (N=4) dB	Total PSD (dBm/500kHz)	Limit (dBm/500kHz)	Pass / Fail
0	149	5745	-14.55	-12.33	6.02	-6.24	23.68	Pass
	157	5785	-5.77	-3.55	6.02	2.54	23.68	Pass
	165	5825	-5.97	-3.75	6.02	2.34	23.68	Pass
1	149	5745	-14.75	-12.53	6.02	-6.44	23.68	Pass
	157	5785	-5.82	-3.60	6.02	2.49	23.68	Pass
	165	5825	-5.90	-3.68	6.02	2.41	23.68	Pass
2	149	5745	-14.89	-12.67	6.02	-6.58	23.68	Pass
	157	5785	-5.63	-3.41	6.02	2.68	23.68	Pass
	165	5825	-5.42	-3.20	6.02	2.89	23.68	Pass
3	149	5745	-14.81	-12.59	6.02	-6.50	23.68	Pass
	157	5785	-5.91	-3.69	6.02	2.40	23.68	Pass
	165	5825	-6.10	-3.88	6.02	2.21	23.68	Pass

Note:

- Method 1 of power density measurement of KDB 662911 is using for calculating total power density. Total power density is summing entire spectra across corresponding frequency bins on the various outputs by computer.
- Directional gain = 6.30dBi + 10log(4) = 12.32dBi > 6dBi, so the limit shall be reduced to 30-(12.32-6) = 23.68dBm.

802.11ac (VHT40)

TX chain	Channel	Freq. (MHz)	PSD (dBm/300kHz)	PSD (dBm/500kHz)	10 log (N=4) dB	Duty factor	Total PSD (dBm/500kHz)	Limit (dBm/500kHz)	Pass / Fail
0	151	5755	-18.05	-15.83	6.02	0.15	-9.66	23.68	Pass
	159	5795	-7.97	-5.75	6.02	0.15	0.42	23.68	Pass
1	151	5755	-18.32	-16.10	6.02	0.15	-9.93	23.68	Pass
	159	5795	-8.38	-6.16	6.02	0.15	0.01	23.68	Pass
2	151	5755	-18.61	-16.39	6.02	0.15	-10.22	23.68	Pass
	159	5795	-8.24	-6.02	6.02	0.15	0.15	23.68	Pass
3	151	5755	-18.62	-16.40	6.02	0.15	-10.23	23.68	Pass
	159	5795	-8.27	-6.05	6.02	0.15	0.12	23.68	Pass

Note:

- Method 1 of power density measurement of KDB 662911 is using for calculating total power density. Total power density is summing entire spectra across corresponding frequency bins on the various outputs by computer.
- Directional gain = 6.30dBi + 10log(4) = 12.32dBi > 6dBi, so the limit shall be reduced to 30-(12.32-6) = 23.68dBm.
- Refer to section 3.3 for duty cycle spectrum plot.

802.11ac (VHT80)

TX chain	Channel	Freq. (MHz)	PSD (dBm/300kHz)	PSD (dBm/500kHz)	10 log (N=4) dB	Duty factor	Total PSD (dBm/500kHz)	Limit (dBm/500kHz)	Pass / Fail
0	155	5775	-24.19	-21.97	6.02	0.29	-15.66	23.68	Pass
1	155	5775	-23.88	-21.66	6.02	0.29	-15.35	23.68	Pass
2	155	5775	-24.25	-22.03	6.02	0.29	-15.72	23.68	Pass
3	155	5775	-24.18	-21.96	6.02	0.29	-15.65	23.68	Pass

Note:

- Method 1 of power density measurement of KDB 662911 is using for calculating total power density. Total power density is summing entire spectra across corresponding frequency bins on the various outputs by computer.
- Directional gain = 6.30dBi + 10log(4) = 12.32dBi > 6dBi, so the limit shall be reduced to 30-(12.32-6) = 23.68dBm.
- Refer to section 3.3 for duty cycle spectrum plot.

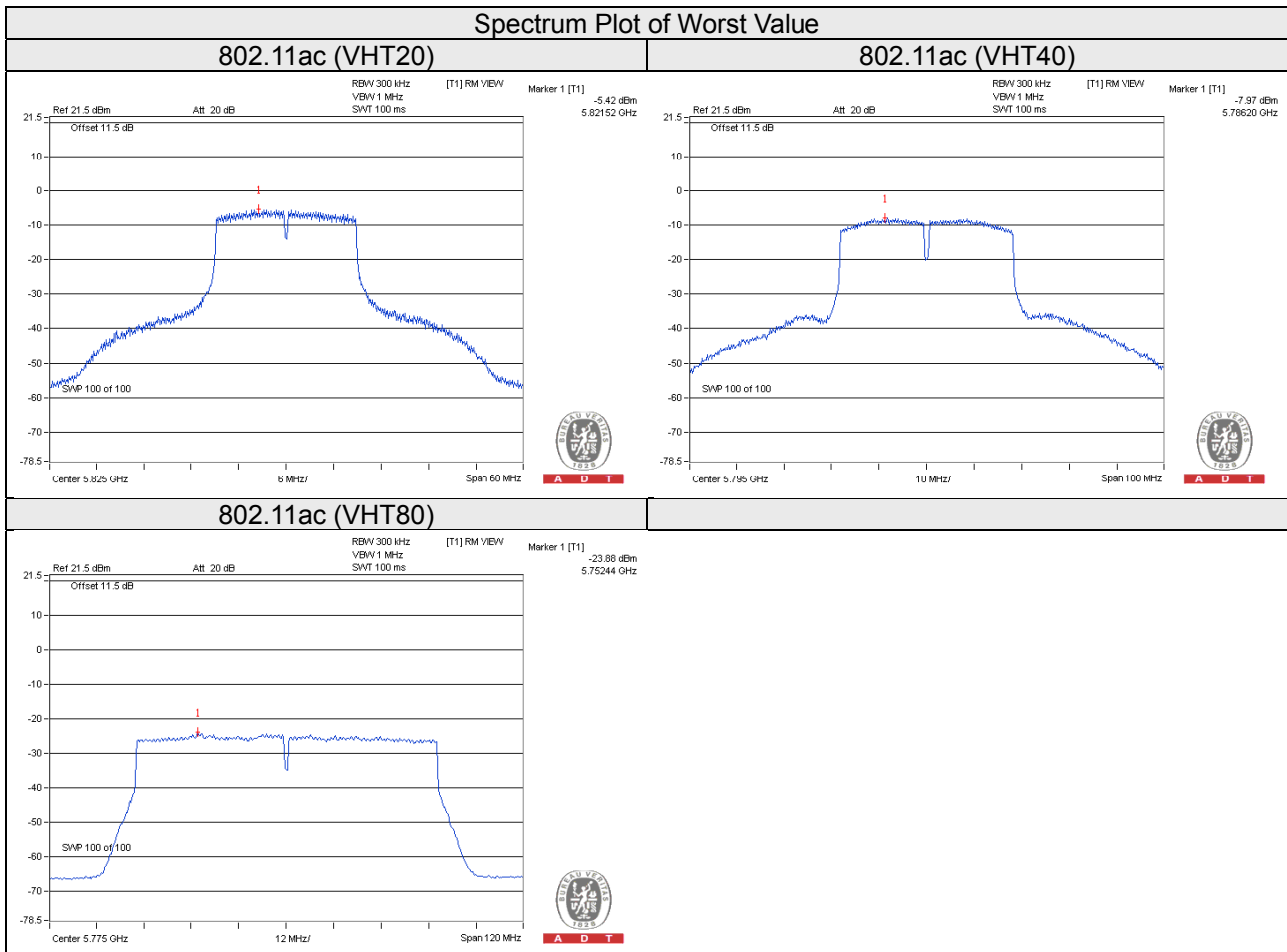

4.5 Frequency Stability

4.5.1 Limits of Frequency Stability Measurement

The frequency of the carrier signal shall be maintained within band of operation

4.5.2 Test Setup

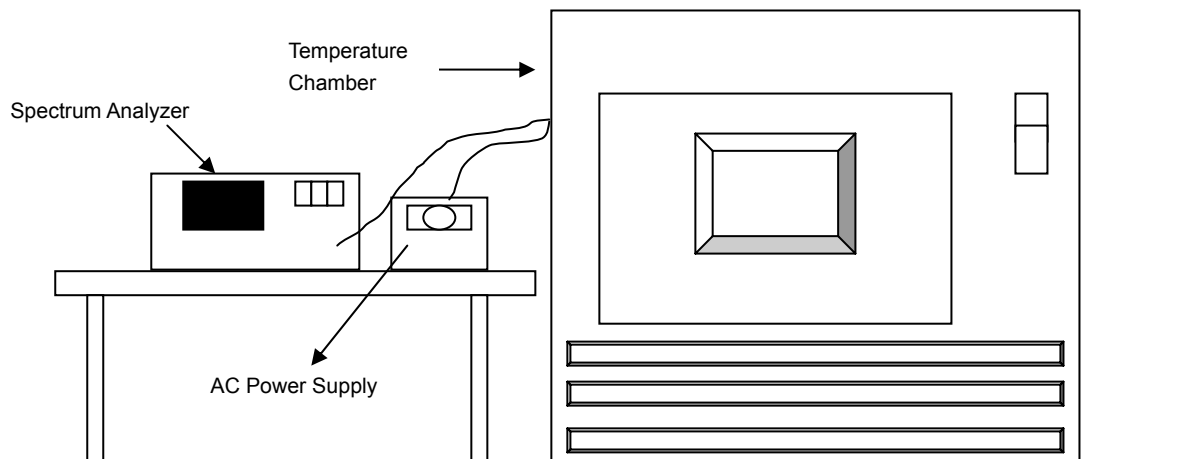

4.5.3 Test Instruments

Refer to section 4.1.2 to get information of above instrument.

4.5.4 Test Procedure

- The EUT was placed inside the environmental test chamber and powered by nominal AC voltage.
- Turn the EUT on and couple its output to a spectrum analyzer.
- Turn the EUT off and set the chamber to the highest temperature specified.
- Allow sufficient time (approximately 30 min) for the temperature of the chamber to stabilize, turn the EUT on and measure the operating frequency after 2, 5, and 10 minutes.
- Repeat step 2 and 3 with the temperature chamber set to the lowest temperature.
- The test chamber was allowed to stabilize at +20 degree C for a minimum of 30 minutes. The supply voltage was then adjusted on the EUT from 85% to 115% and the frequency record.

4.5.5 Deviation from Test Standard

No deviation.

4.5.6 EUT Operating Condition

Set the EUT transmit at un-modulation mode to test frequency stability.

4.5.7 Test Results

Frequency Stability Versus Temp.									
Operating Frequency: 5240MHz									
Temp. (°C)	Power Supply (Vac)	0 Minute		2 Minute		5 Minute		10 Minute	
		Measured Frequency (MHz)	Frequency Drift (%)	Measured Frequency (MHz)	Frequency Drift (%)	Measured Frequency (MHz)	Frequency Drift (%)	Measured Frequency (MHz)	Frequency Drift (%)
50	120	5239.9886	-0.00022	5239.9886	-0.00022	5239.9891	-0.00021	5239.9843	-0.00030
40	120	5240.0041	0.00008	5240.0018	0.00003	5240.0010	0.00002	5239.9998	0.00000
30	120	5239.9792	-0.00040	5239.9781	-0.00042	5239.9791	-0.00040	5239.9793	-0.00040
20	120	5239.9866	-0.00026	5239.9835	-0.00031	5239.9860	-0.00027	5239.9854	-0.00028
10	120	5240.0042	0.00008	5240.0059	0.00011	5240.0042	0.00008	5240.0026	0.00005
0	120	5240.0183	0.00035	5240.0231	0.00044	5240.0190	0.00036	5240.0215	0.00041
-10	120	5239.9757	-0.00046	5239.9755	-0.00047	5239.9759	-0.00046	5239.9767	-0.00044
-20	120	5240.0147	0.00028	5240.0132	0.00025	5240.0142	0.00027	5240.013	0.00025
-30	120	5240.0211	0.00040	5240.0191	0.00036	5240.0233	0.00044	5240.0202	0.00039

Frequency Stability Versus Voltage									
Operating Frequency: 5240MHz									
Temp. (°C)	Power Supply (Vac)	0 Minute		2 Minute		5 Minute		10 Minute	
		Measured Frequency (MHz)	Frequency Drift (%)	Measured Frequency (MHz)	Frequency Drift (%)	Measured Frequency (MHz)	Frequency Drift (%)	Measured Frequency (MHz)	Frequency Drift (%)
20	138	5239.9868	-0.00025	5239.9825	-0.00033	5239.9852	-0.00028	5239.9864	-0.00026
	120	5239.9866	-0.00026	5239.9835	-0.00031	5239.9860	-0.00027	5239.9854	-0.00028
	102	5239.9873	-0.00024	5239.9829	-0.00033	5239.9855	-0.00028	5239.9849	-0.00029

4.6 6dB Bandwidth Measurement

4.6.1 Limits of 6dB Bandwidth Measurement

The minimum of 6dB Bandwidth Measurement is 0.5MHz.

4.6.2 Test Setup

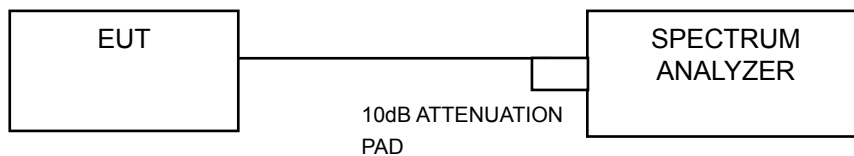

4.6.3 Test Instruments

Refer to section 4.1.2 to get information of above instrument.

4.6.4 Test Procedure

- Set resolution bandwidth (RBW) = 100kHz
- Set the video bandwidth (VBW) $\geq 3 \times$ RBW, Detector = Peak
- Trace mode = max hold
- Sweep = auto couple
- Measure the maximum width of the emission that is constrained by the frequencies associated with the two amplitude points (upper and lower) that are attenuated by 6 dB relative to the maximum level measured in the fundamental emission

4.6.5 Deviation from Test Standard

No deviation.

4.6.6 EUT Operating Condition

The software provided by client to enable the EUT under transmission Condition continuously at lowest, middle and highest channel frequencies individually.

4.6.7 Test Results

CDD Mode

802.11a

Channel	Frequency (MHz)	6dB Bandwidth (MHz)				Minimum Limit (MHz)	Pass / Fail
		Chain 0	Chain 1	Chain 2	Chain 3		
149	5745	16.05	16.09	16.03	16.34	0.5	Pass
157	5785	15.96	16.36	15.96	16.35	0.5	Pass
165	5825	15.81	15.71	16.05	16.35	0.5	Pass

802.11n (HT20)

Channel	Frequency (MHz)	6dB Bandwidth (MHz)				Minimum Limit (MHz)	Pass / Fail
		Chain 0	Chain 1	Chain 2	Chain 3		
149	5745	16.59	16.62	16.58	17.33	0.5	Pass
157	5785	16.58	16.94	16.01	17.28	0.5	Pass
165	5825	16.94	16.60	16.58	17.61	0.5	Pass

802.11n (HT40)

Channel	Frequency (MHz)	6dB Bandwidth (MHz)				Minimum Limit (MHz)	Pass / Fail
		Chain 0	Chain 1	Chain 2	Chain 3		
151	5755	35.25	35.17	35.16	35.17	0.5	Pass
159	5795	35.19	33.99	35.15	35.16	0.5	Pass

802.11ac (VHT80)

Channel	Frequency (MHz)	6dB Bandwidth (MHz)				Minimum Limit (MHz)	Pass / Fail
		Chain 0	Chain 1	Chain 2	Chain 3		
155	5775	75.28	75.40	75.42	75.34	0.5	Pass



Spectrum Plot of Worst Value

802.11a

802.11n (HT20)

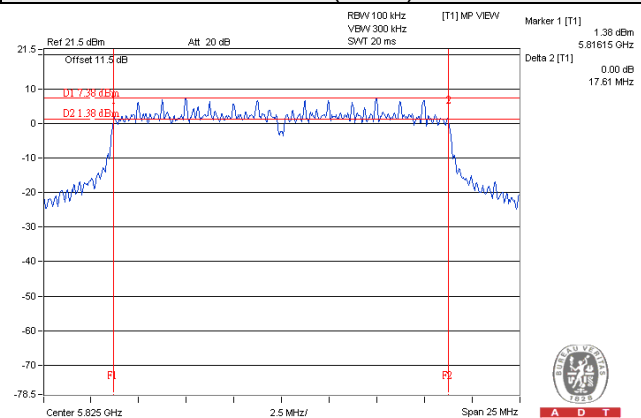
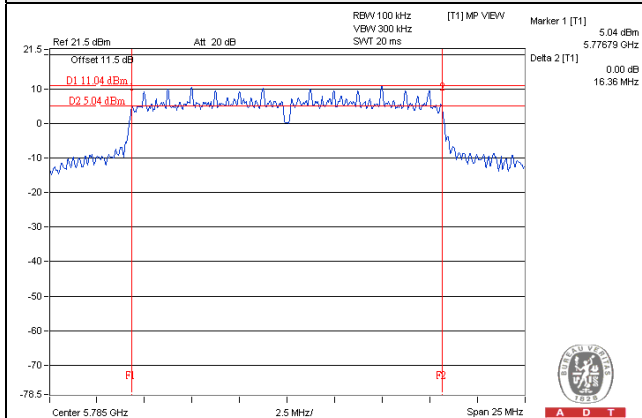

802.11n (HT40)

802.11ac (VHT80)

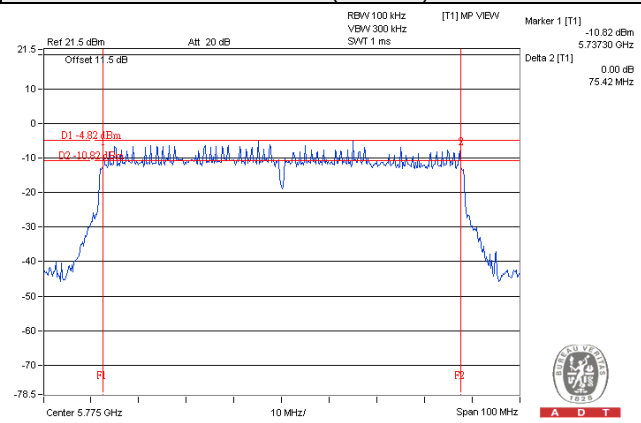
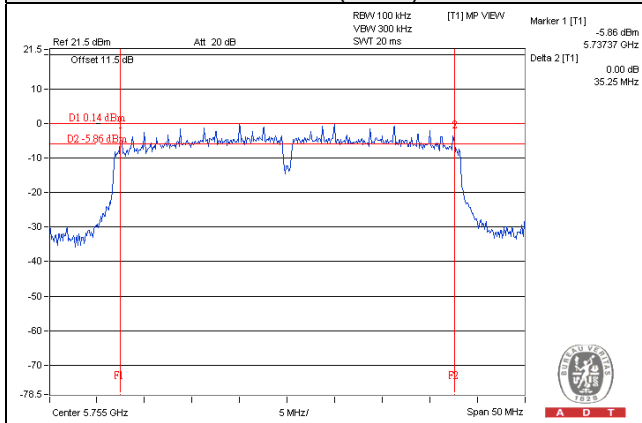

Beamforming Mode

802.11ac (VHT20)

Channel	Frequency (MHz)	6dB Bandwidth (MHz)				Minimum Limit (MHz)	Pass / Fail
		Chain 0	Chain 1	Chain 2	Chain 3		
149	5745	17.17	16.56	16.83	16.57	0.5	Pass
157	5785	16.84	16.61	16.59	16.62	0.5	Pass
165	5825	17.55	16.60	16.59	16.57	0.5	Pass

802.11ac (VHT40)

Channel	Frequency (MHz)	6dB Bandwidth (MHz)				Minimum Limit (MHz)	Pass / Fail
		Chain 0	Chain 1	Chain 2	Chain 3		
151	5755	35.14	35.14	35.16	35.17	0.5	Pass
159	5795	35.16	35.15	35.18	35.20	0.5	Pass

802.11ac (VHT80)

Channel	Frequency (MHz)	6dB Bandwidth (MHz)				Minimum Limit (MHz)	Pass / Fail
		Chain 0	Chain 1	Chain 2	Chain 3		
155	5775	75.35	75.42	75.43	75.45	0.5	Pass

Spectrum Plot of Worst Value

802.11ac (VHT20)

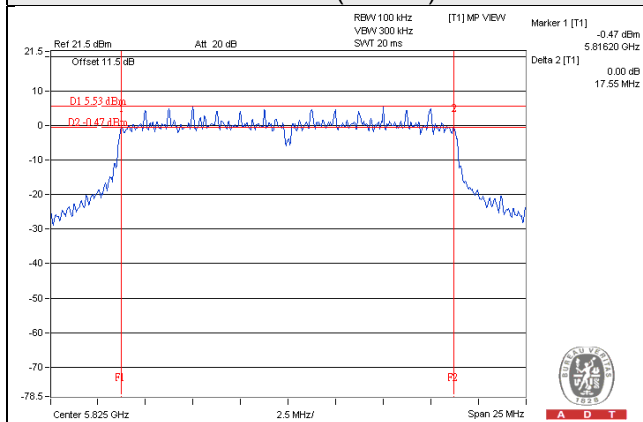

802.11ac (VHT40)

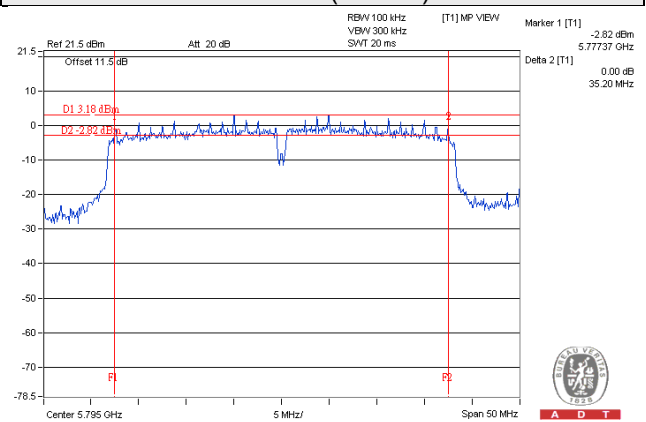

802.11ac (VHT80)

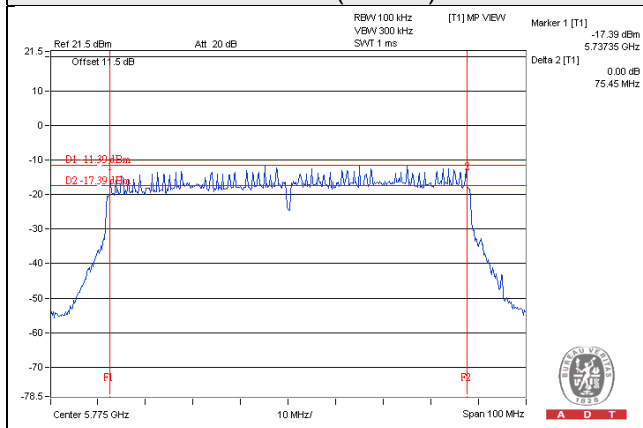

5 Pictures of Test Arrangements

Please refer to the attached file (Test Setup Photo).

Appendix – Information on the Testing Laboratories

We, Bureau Veritas Consumer Products Services (H.K.) Ltd., Taoyuan Branch, were founded in 1988 to provide our best service in EMC, Radio, Telecom and Safety consultation. Our laboratories are accredited and approved according to ISO/IEC 17025.

If you have any comments, please feel free to contact us at the following:

Linko EMC/RF Lab

Tel: 886-2-26052180

Fax: 886-2-26051924

Hsin Chu EMC/RF/Telecom Lab

Tel: 886-3-6668565

Fax: 886-3-6668323

Hwa Ya EMC/RF/Safety Lab

Tel: 886-3-3183232

Fax: 886-3-3270892

Email: service.adt@tw.bureauveritas.com

Web Site: www.bureauveritas-adt.com

The address and road map of all our labs can be found in our web site also.

--- END ---