

FCC Test Report

Report No.: RF160224C19

FCC ID: TVE-28166033

Test Model: FAP-S422E

Series Model: FortiAP S422Exxxxxx, FAP-S422Exxxxxx, FORTIAP-S422Exxxxxx (where "x" can be used as "A-Z" or "0-9" or "-" or blank for software changes or marketing purposes only)

Received Date: Feb. 24, 2016

Test Date: Mar. 09 ~ May 17, 2016

Issued Date: May 23, 2016

Applicant: Fortinet Inc.

Address: 899 Kifer Road Sunnyvale, CA 94086 USA

Issued By: Bureau Veritas Consumer Products Services (H.K.) Ltd., Taoyuan Branch

Lab Address: No. 47-2, 14th Ling, Chia Pau Vil., Lin Kou Dist., New Taipei City, Taiwan (R.O.C.)

Test Location: No.19, Hwa Ya 2nd Rd., Wen Hwa Vil., Kwei Shan Dist., Taoyuan City 33383, TAIWAN (R.O.C.)



This report is for your exclusive use. Any copying or replication of this report to or for any other person or entity, or use of our name or trademark, is permitted only with our prior written permission. This report sets forth our findings solely with respect to the test samples identified herein. The results set forth in this report are not indicative or representative of the quality or characteristics of the lot from which a test sample was taken or any similar or identical product unless specifically and expressly noted. Our report includes all of the tests requested by you and the results thereof based upon the information that you provided to us. You have 60 days from date of issuance of this report to notify us of any material error or omission caused by our negligence, provided, however, that such notice shall be in writing and shall specifically address the issue you wish to raise. A failure to raise such issue within the prescribed time shall constitute your unqualified acceptance of the completeness of this report, the tests conducted and the correctness of the report contents. Unless specific mention, the uncertainty of measurement has been explicitly taken into account to declare the compliance or non-compliance to the specification. The report must not be used by the client to claim product certification, approval, or endorsement by TAF or any government agencies.

Table of Contents

Release Control Record	4
1 Certificate of Conformity	5
2 Summary of Test Results	6
2.1 Measurement Uncertainty.....	6
2.2 Modification Record.....	6
3 General Information	7
3.1 General Description of EUT.....	7
3.2 Description of Test Modes.....	9
3.2.1 Test Mode Applicability and Tested Channel Detail.....	10
3.3 Duty Cycle of Test Signal.....	12
3.4 Description of Support Units.....	14
3.4.1 Configuration of System under Test.....	14
3.5 General Description of Applied Standards.....	14
4 Test Types and Results	15
4.1 Radiated Emission and Bandedge Measurement.....	15
4.1.1 Limits of Radiated Emission and Bandedge Measurement.....	15
4.1.2 Test Instruments.....	16
4.1.3 Test Procedures.....	17
4.1.4 Deviation from Test Standard.....	17
4.1.5 Test Setup.....	18
4.1.6 EUT Operating Conditions.....	18
4.1.7 Test Results.....	19
4.2 Conducted Emission Measurement.....	38
4.2.1 Limits of Conducted Emission Measurement.....	38
4.2.2 Test Instruments.....	38
4.2.3 Test Procedures.....	39
4.2.4 Deviation from Test Standard.....	39
4.2.5 Test Setup.....	39
4.2.6 EUT Operating Conditions.....	39
4.2.7 Test Results.....	40
4.3 6dB Bandwidth Measurement.....	42
4.3.1 Limits of 6dB Bandwidth Measurement.....	42
4.3.2 Test Setup.....	42
4.3.3 Test Instruments.....	42
4.3.4 Test Procedure.....	42
4.3.5 Deviation from Test Standard.....	42
4.3.6 EUT Operating Conditions.....	42
4.3.7 Test Result.....	43
4.4 Conducted Output Power Measurement.....	46
4.4.1 Limits of Conducted Output Power Measurement.....	46
4.4.2 Test Setup.....	46
4.4.3 Test Instruments.....	46
4.4.4 Test Procedures.....	46
4.4.5 Deviation from Test Standard.....	46
4.4.6 EUT Operating Conditions.....	46
4.4.7 Test Results.....	47
4.5 Power Spectral Density Measurement.....	49
4.5.1 Limits of Power Spectral Density Measurement.....	49
4.5.2 Test Setup.....	49
4.5.3 Test Instruments.....	49
4.5.4 Test Procedure.....	49
4.5.5 Deviation from Test Standard.....	49

4.5.6 EUT Operating Condition	49
4.5.7 Test Results	50
4.6 Conducted Out of Band Emission Measurement.....	57
4.6.1 Limits of Conducted Out of Band Emission Measurement	57
4.6.2 Test Setup.....	57
4.6.3 Test Instruments	57
4.6.4 Test Procedure	57
4.6.5 Deviation from Test Standard	57
4.6.6 EUT Operating Condition	57
4.6.7 Test Results	57
5 Pictures of Test Arrangements.....	82
Appendix – Information on the Testing Laboratories	83

Release Control Record

Issue No.	Description	Date Issued
RF160224C19	Original release.	May 23, 2016

1 Certificate of Conformity

Product: Secured Wireless Access Point

Brand: Fortinet Inc.

Test Model: FAP-S422E

Series Model: FortiAP S422Exxxxxx, FAP-S422Exxxxxx, FORTIAP-S422Exxxxxx (where "x" can be used as "A-Z" or "0-9" or "-" or blank for software changes or marketing purposes only)

Sample Status: Engineering sample

Applicant: Fortinet Inc.

Test Date: Mar. 09 ~ Mar. 17, 2016

Standards: 47 CFR FCC Part 15, Subpart C (Section 15.247)
ANSI C63.10:2013

The above equipment has been tested by **Bureau Veritas Consumer Products Services (H.K.) Ltd., Taoyuan Branch**, and found compliance with the requirement of the above standards. The test record, data evaluation & Equipment Under Test (EUT) configurations represented herein are true and accurate accounts of the measurements of the sample's EMC characteristics under the conditions specified in this report.

Prepared by :  , **Date:** May 23, 2016
Pettie Chen / Senior Specialist

Approved by :  , **Date:** May 23, 2016
Ken Liu / Senior Manager

2 Summary of Test Results

47 CFR FCC Part 15, Subpart C (Section 15.247)			
FCC Clause	Test Item	Result	Remarks
15.207	AC Power Conducted Emission	Pass	Meet the requirement of limit. Minimum passing margin is -8.51dB at 0.51606MHz.
15.205 / 15.209 / 15.247(d)	Radiated Emissions and Band Edge Measurement	Pass	Meet the requirement of limit. Minimum passing margin is -1.1dB at 2390.0, 2483.50MHz.
15.247(d)	Antenna Port Emission	Pass	Meet the requirement of limit.
15.247(a)(2)	6dB bandwidth	Pass	Meet the requirement of limit.
15.247(b)	Conducted power	Pass	Meet the requirement of limit.
15.247(e)	Power Spectral Density	Pass	Meet the requirement of limit.
15.203	Antenna Requirement	Pass	Antenna connector is N-Type. (The device is professionally installed)

2.1 Measurement Uncertainty

Where relevant, the following measurement uncertainty levels have been estimated for tests performed on the EUT as specified in CISPR 16-4-2:

Measurement	Frequency	Expanded Uncertainty (k=2) (\pm)
Conducted Emissions at mains ports	150kHz ~ 30MHz	2.44 dB
Radiated Emissions up to 1 GHz	30MHz ~ 200MHz	3.86 dB
	200MHz ~ 1000MHz	3.87 dB
Radiated Emissions above 1 GHz	1GHz ~ 18GHz	2.29 dB
	18GHz ~ 40GHz	2.29 dB

2.2 Modification Record

There were no modifications required for compliance.

3 General Information

3.1 General Description of EUT

Product	Secured Wireless Access Point
Brand	Fortinet Inc.
Test Model	FAP-S422E
Series Model	FortiAP S422Exxxxxx, FAP-S422Exxxxxx, FORTIAP-S422Exxxxxx (where “x” can be used as “A-Z” or “0-9” or “-” or blank for software changes or marketing purposes only)
Model Difference	Refer to Note
Sample Status	Engineering sample
Power Supply Rating	48Vdc (POE)
Modulation Type	CCK, DQPSK, DBPSK for DSSS 64QAM, 16QAM, QPSK, BPSK for OFDM
Modulation Technology	DSSS, OFDM
Transfer Rate	802.11b: 11/5.5/2/1Mbps 802.11g: 54/48/36/24/18/12/9/6Mbps 802.11n: up to 600Mbps
Operating Frequency	2412 ~ 2462MHz
Number of Channel	11 for 802.11b, 802.11g, 802.11n (HT20), 802.11n (VHT20) 7 for 802.11n (HT40), 802.11n (VHT40)
Output Power	CDD Mode:371.962mW Beamforming Mode: 224.971mW
Antenna Type	Dipole antenna with 4.5dBi gain
Antenna Connector	N-Type (The device is professionally installed)
Accessory Device	POE, POE’s adapter, surge protector
Cable Supplied	1.8m non-shielded grounding cable without core x3

Note:

1. All models are listed as below. Model FAP-S422E is the representative for final test.

Brand	Model	Difference
Fortinet Inc.	FortiAP S422Exxxxxx	where “x” can be used as “A-Z” or “0-9” or “-” or blank for software changes or marketing purposes only
	FAP-S422Exxxxxx	
	FORTIAP-S422Exxxxxx	

2. The EUT incorporates a MIMO function. Physically, the EUT provides 4 completed transmitters and 4 receivers.

Band	Modulation Mode	CDD Mode	Beamforming Mode	TX Function
2.4GHz	802.11b	Support	Not Support	4TX
	802.11g	Support	Not Support	4TX
	802.11n (HT20)	Support	Not Support	4TX
	802.11n (HT40)	Support	Not Support	4TX
	802.11n (VHT20)	Support	Support	4TX
	802.11n (VHT40)	Support	Support	4TX

* CDD Mode: The modulation and bandwidth are similar for 802.11n mode for HT20/HT40 and 802.11n mode for VHT20/ VHT40, therefore investigated worst case to representative mode in test report. (Final test mode refer section 3.2.1)

3. The EUT uses the following POE and POE's adapter.

POE	
Brand	EnGenius
Model	POE-48GP
Rating	48Vdc

POE's adapter	
Brand	Powertron Electronics Corp.
Model	PA1040-480IB080
Input Power	100-240Vac, 50-60Hz, 1.5A
Output Power	48Vdc, 0.8A, 38.4W Max
Power Line	1.55m cable with 1 core attached on adapter

3.2 Description of Test Modes

11 channels are provided for 802.11b, 802.11g and 802.11n (HT20), 802.11n (VHT20):

Channel	Frequency	Channel	Frequency
1	2412MHz	7	2442MHz
2	2417MHz	8	2447MHz
3	2422MHz	9	2452MHz
4	2427MHz	10	2457MHz
5	2432MHz	11	2462MHz
6	2437MHz		

7 channels are provided for 802.11n (HT40), 802.11n (VHT40):

Channel	Frequency	Channel	Frequency
3	2422MHz	7	2442MHz
4	2427MHz	8	2447MHz
5	2432MHz	9	2452MHz
6	2437MHz		

3.2.1 Test Mode Applicability and Tested Channel Detail

EUT Configure Mode	Applicable to				Description
	RE \geq 1G	RE<1G	PLC	APCM	
-	√	√	√	√	-

Where RE \geq 1G: Radiated Emission above 1GHz & Bandedge Measurement
 RE<1G: Radiated Emission below 1GHz
 PLC: Power Line Conducted Emission
 APCM: Antenna Port Conducted Measurement

Note: The EUT was positioned on the Y-plane during testing.

Radiated Emission Test (Above 1GHz):

- Pre-Scan has been conducted to determine the worst-case mode from all possible combinations between available modulations, data rates and antenna ports (if EUT with antenna diversity architecture).
- Following channel(s) was (were) selected for the final test as listed below.

EUT Configure Mode	Mode	Available Channel	Tested Channel	Modulation Technology	Modulation Type	Date Rate (Mbps)
CDD Mode						
-	802.11b	1 to 11	1, 6, 11	DSSS	DBPSK	1.0
-	802.11g	1 to 11	1, 6, 11	OFDM	BPSK	6.0
-	802.11n (HT20)	1 to 11	1, 6, 11	OFDM	BPSK	6.5
-	802.11n (HT40)	3 to 9	3, 6, 9	OFDM	BPSK	13.5
Beamforming Mode						
-	802.11n (VHT20)	1 to 11	1, 6, 11	OFDM	BPSK	6.5
-	802.11n (VHT40)	3 to 9	3, 6, 9	OFDM	BPSK	13.5

Radiated Emission Test (Below 1GHz):

- Pre-Scan has been conducted to determine the worst-case mode from all possible combinations between available modulations, data rates and antenna ports (if EUT with antenna diversity architecture).
- Following channel(s) was (were) selected for the final test as listed below.

EUT Configure Mode	Mode	Available Channel	Tested Channel	Modulation Technology	Modulation Type	Date Rate (Mbps)
CDD Mode						
-	802.11b	1 to 13	1	DSSS	DBPSK	1

Power Line Conducted Emission Test:

- Pre-Scan has been conducted to determine the worst-case mode from all possible combinations between available modulations, data rates and antenna ports (if EUT with antenna diversity architecture).
- Following channel(s) was (were) selected for the final test as listed below.

EUT Configure Mode	Mode	Available Channel	Tested Channel	Modulation Technology	Modulation Type	Date Rate (Mbps)
CDD Mode						
-	802.11b	1 to 13	1	DSSS	DBPSK	1

Antenna Port Conducted Measurement:

- This item includes all test value of each mode, but only includes spectrum plot of worst value of each mode.
- Pre-Scan has been conducted to determine the worst-case mode from all possible combinations between available modulations, data rates and antenna ports (if EUT with antenna diversity architecture).
- Following channel(s) was (were) selected for the final test as listed below.

EUT Configure Mode	Mode	Available Channel	Tested Channel	Modulation Technology	Modulation Type	Date Rate (Mbps)
CDD Mode						
-	802.11b	1 to 11	1, 6, 11	DSSS	DBPSK	1.0
-	802.11g	1 to 11	1, 6, 11	OFDM	BPSK	6.0
-	802.11n (HT20)	1 to 11	1, 6, 11	OFDM	BPSK	6.5
-	802.11n (HT40)	3 to 9	3, 6, 9	OFDM	BPSK	13.5
Beamforming Mode						
-	802.11n (VHT20)	1 to 11	1, 6, 11	OFDM	BPSK	6.5
-	802.11n (VHT40)	3 to 9	3, 6, 9	OFDM	BPSK	13.5

Test Condition:

Applicable to	Environmental Conditions	Input Power	Tested by
RE \geq 1G	18 deg. C, 70% RH	120Vac, 60Hz	Nick Hsu
RE $<$ 1G	19 deg. C, 70% RH	120Vac, 60Hz	Jones Chang
PLC	20 deg. C, 70% RH	120Vac, 60Hz	Jones Chang
APCM	25 deg. C, 60% RH	120Vac, 60Hz	Leo Tsai

3.3 Duty Cycle of Test Signal

CDD Mode

Duty cycle of test signal is > 98%, duty factor is not required

Duty cycle of test signal is < 98 %, duty factor is required

802.11b: Duty cycle = 12.43/12.505 = 0.994

802.11g: Duty cycle = 2.063/2.144 = 0.962, Duty factor = $10 * \log(1/0.962) = 0.17$

802.11n (HT20): Duty cycle = 4.998/5.098 = 0.98

802.11n (HT40): Duty cycle = 2.426/2.496 = 0.972, Duty factor = $10 * \log(1/0.972) = 0.12$

802.11b

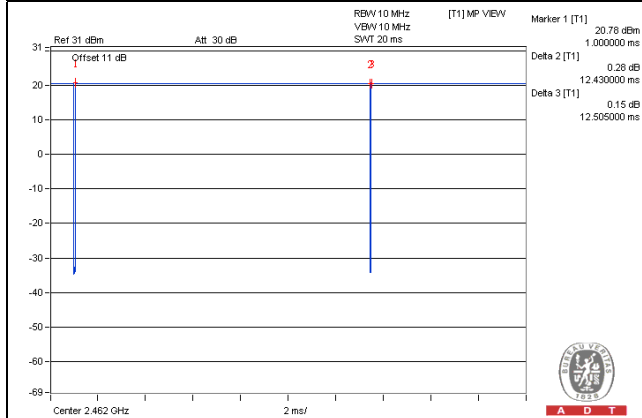

802.11g

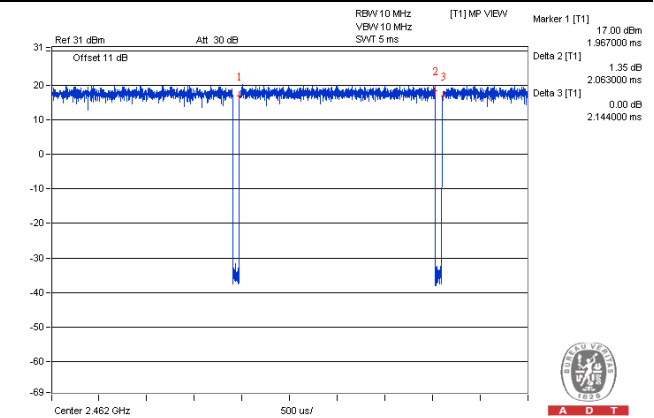

802.11n (HT20)

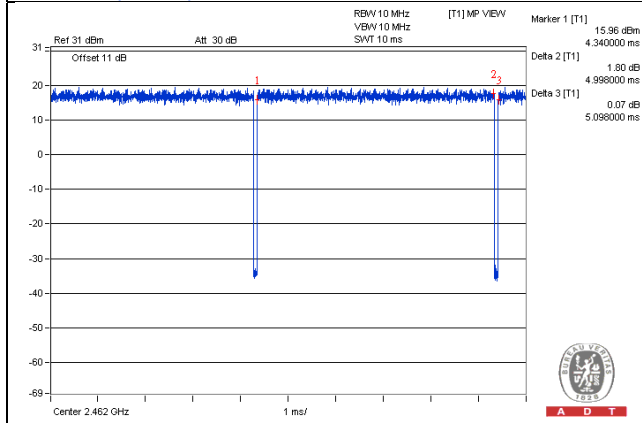

802.11n (HT40)

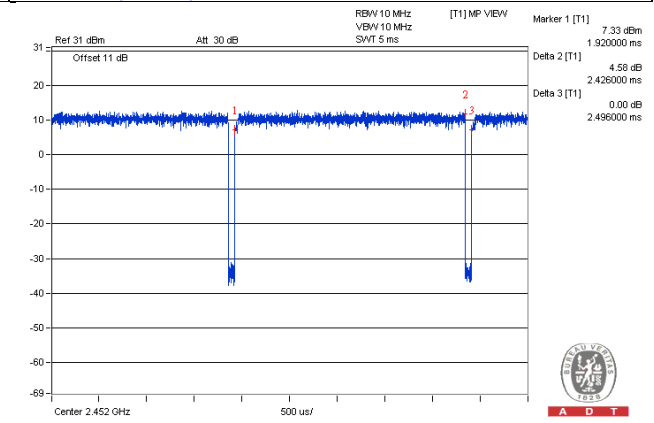

Beamforming Mode

Duty cycle of test signal is > 98%, duty factor is not required

Duty cycle of test signal is < 98 %, duty factor is required

802.11n (VHT20): Duty cycle = $4.995/5.08 = 0.983$

802.11n (VHT40): Duty cycle = $2.059/2.147 = 0.959$, Duty factor = $10 * \log(1/0.959) = 0.18$

802.11n (VHT20)

802.11n (VHT40)

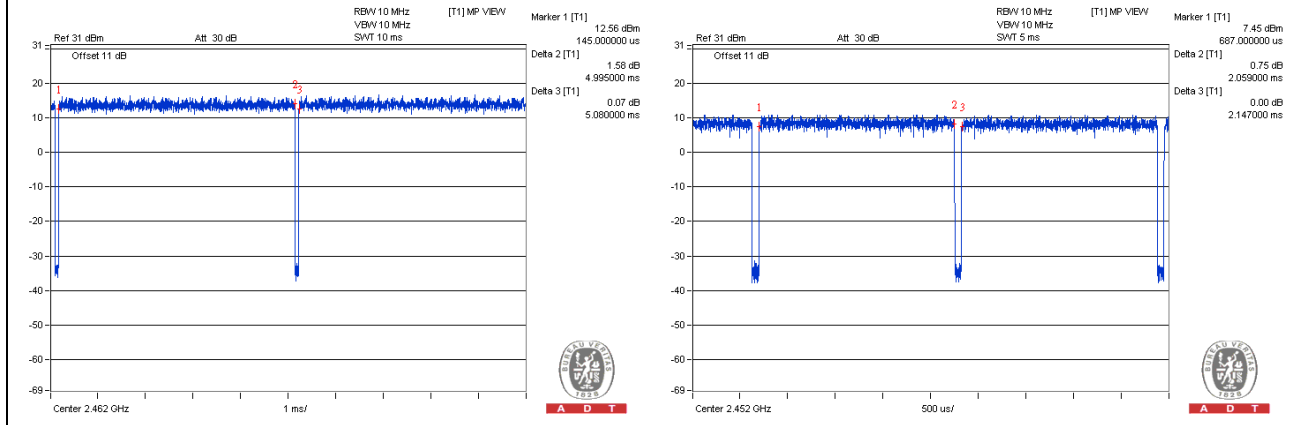

3.4 Description of Support Units

The EUT has been tested as an independent unit together with other necessary accessories or support units. The following support units or accessories were used to form a representative test configuration during the tests.

ID	Product	Brand	Model No.	Serial No.	FCC ID	Remarks
A.	Notebook	DELL	D531	CN-0XM006-48643-81 U-2973	QDS-BRCM1020	-
B.	Load	NA	NA	NA	NA	-

Note:

1. All power cords of the above support units are non-shielded (1.8m).
2. Item A acted as a communication partner to transfer data.

ID	Descriptions	Qty.	Length (m)	Shielding (Yes/No)	Cores (Qty.)	Remarks
1.	RJ45	1	1.0	N	0	-
2.	RJ45	1	1.8	N	0	-
3.	RJ45	1	10	N	0	-
4.	RJ45 to RS232	1	1.8	Y	0	-

3.4.1 Configuration of System under Test

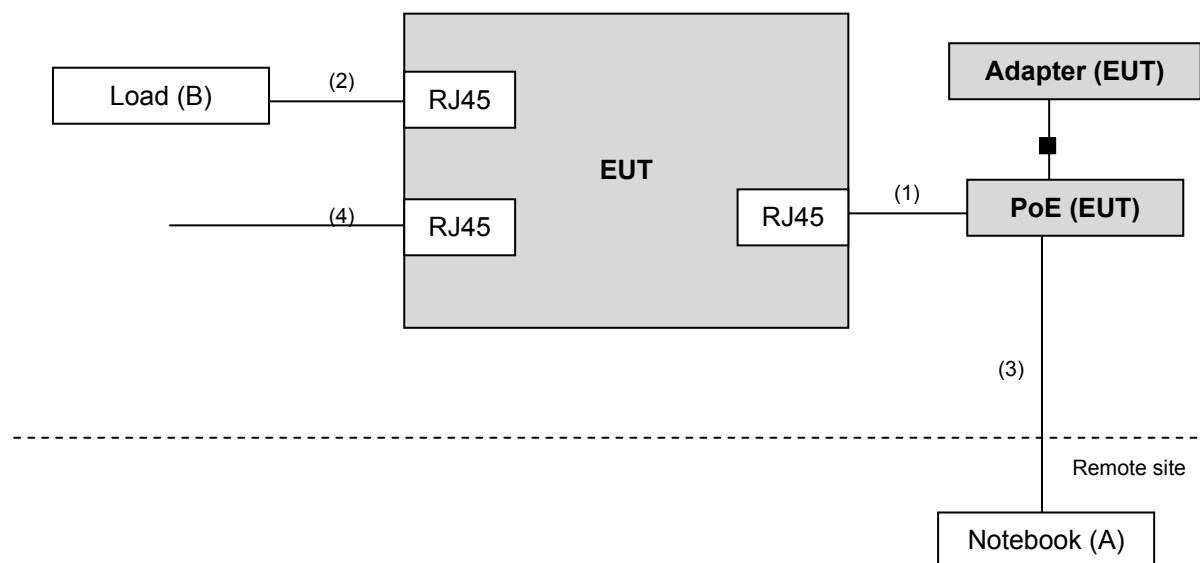

3.5 General Description of Applied Standards

The EUT is a RF Product. According to the specification of the EUT declared by the manufacturer, it must comply with the requirements of the following standards:

FCC Part 15, Subpart C (15.247)
KDB 558074 D01 DTS Meas Guidance v03r05
KDB 662911 D01 Multiple Transmitter Output v02r01
 ANSI C63.10-2013

All test items have been performed and recorded as per the above standards.

Note: The EUT has been verified to comply with the requirements of FCC Part 15, Subpart B, Class B (DoC). The test report has been issued separately.

4 Test Types and Results

4.1 Radiated Emission and Bandedge Measurement

4.1.1 Limits of Radiated Emission and Bandedge Measurement

Radiated emissions which fall in the restricted bands must comply with the radiated emission limits specified as below table. Other emissions shall be at least 30dB below the highest level of the desired power:

Frequencies (MHz)	Field Strength (microvolts/meter)	Measurement Distance (meters)
0.009 ~ 0.490	2400/F(kHz)	300
0.490 ~ 1.705	24000/F(kHz)	30
1.705 ~ 30.0	30	30
30 ~ 88	100	3
88 ~ 216	150	3
216 ~ 960	200	3
Above 960	500	3

NOTE:

1. The lower limit shall apply at the transition frequencies.
2. Emission level (dBuV/m) = 20 log Emission level (uV/m).
3. For frequencies above 1000MHz, the field strength limits are based on average detector, however, the peak field strength of any emission shall not exceed the maximum permitted average limits, specified above by more than 30dB under any condition of modulation.

4.1.2 Test Instruments

Description & Manufacturer	Model No.	Serial No.	Cal. Date	Cal. Due
Test Receiver ROHDE & SCHWARZ	ESIB7	100187	Apr. 18, 2016	Apr. 17, 2017
Spectrum Analyzer ROHDE & SCHWARZ	FSV40	100979	Feb. 19, 2016	Feb. 18, 2017
BILOG Antenna SCHWARZBECK	VULB9168	9168-171	Jan. 07, 2016	Jan. 06, 2017
HORN Antenna SCHWARZBECK	9120D	209	Jan. 20, 2016	Jan. 19, 2017
HORN Antenna SCHWARZBECK	BBHA 9170	BBHA9170241	Jan. 18, 2016	Jan. 17, 2017
Preamplifier Agilent	8447D	2944A10738	Oct. 18, 2015	Oct. 17, 2016
Preamplifier Agilent	8449B	3008A01964	Aug. 22, 2015	Aug. 21, 2016
RF signal cable HUBER+SUHNER	SUCOFLEX 104	Cable-CH3-03 (214378)	Aug. 22, 2015	Aug. 21, 2016
RF signal cable HUBER+SUHNER	SUCOFLEX 106	Cable-CH3-03 (309224+12738)	Aug. 22, 2015	Aug. 21, 2016
Software BV ADT	ADT_Radiated_ V7.6.15.9.4	NA	NA	NA
Antenna Tower inn-co GmbH	MA 4000	013303	NA	NA
Antenna Tower Controller BV ADT	AT100	AT93021702	NA	NA
Turn Table BV ADT	TT100	TT93021702	NA	NA
Turn Table Controller BV ADT	SC100	SC93021702	NA	NA
26GHz ~ 40GHz Amplifier	EM26400	815221	Oct. 18, 2015	Oct. 17, 2016
High Speed Peak Power Meter	ML2495A	0824011	Jul. 09, 2015	Jul. 08, 2016
Power Sensor	MA2411B	0738171	Jul. 09, 2015	Jul. 08, 2016

- Note:
1. The calibration interval of the above test instruments is 12 months and the calibrations are traceable to NML/ROC and NIST/USA.
 2. The test was performed in HwaYa Chamber 3.
 3. The horn antenna and preamplifier (model: 8449B) are used only for the measurement of emission frequency above 1GHz if tested.
 4. The FCC Site Registration No. is 988962.
 5. The IC Site Registration No. is IC 7450F-3.

4.1.3 Test Procedures

- a. The EUT was placed on the top of a rotating table 0.8 meters (for below 1GHz) / 1.5 meters (for above 1GHz) above the ground at 3 meter chamber room for test. The table was rotated 360 degrees to determine the position of the highest radiation.
- b. The EUT was set 3 meters away from the interference-receiving antenna, which was mounted on the top of a variable-height antenna tower.
- c. The height of antenna is varied from one meter to four meters above the ground to determine the maximum value of the field strength. Both horizontal and vertical polarizations of the antenna are set to make the measurement.
- d. For each suspected emission, the EUT was arranged to its worst case and then the antenna was tuned to heights from 1 meter to 4 meters and the rotatable table was turned from 0 degrees to 360 degrees to find the maximum reading.
- e. The test-receiver system was set to quasi-peak detect function and specified bandwidth with maximum hold mode when the test frequency is below 1 GHz.
- f. The test-receiver system was set to peak and average detect function and specified bandwidth with maximum hold mode when the test frequency is above 1 GHz. If the peak reading value also meets average limit, measurement with the average detector is unnecessary.

Note:

1. The resolution bandwidth and video bandwidth of test receiver/spectrum analyzer is 120kHz for Quasi-peak detection (QP) at frequency below 1GHz.
2. The resolution bandwidth of test receiver/spectrum analyzer is 1 MHz and the video bandwidth is 3 MHz for Peak detection (PK) at frequency above 1GHz.
3. The resolution bandwidth of test receiver/spectrum analyzer is 1MHz and the video bandwidth is 3MHz for RMS Average (Duty cycle < 98%) for Average detection (AV) at frequency above 1GHz, then the measurement results was added to a correction factor ($10 \log(1/\text{duty cycle})$).
4. The resolution bandwidth of test receiver/spectrum analyzer is 1MHz and the video bandwidth is 10Hz (Duty cycle $\geq 98\%$) for Average detection (AV) at frequency above 1GHz.
5. All modes of operation were investigated and the worst-case emissions are reported.

4.1.4 Deviation from Test Standard

No deviation.

4.1.5 Test Setup

<Frequency Range 30MHz~1GHz>

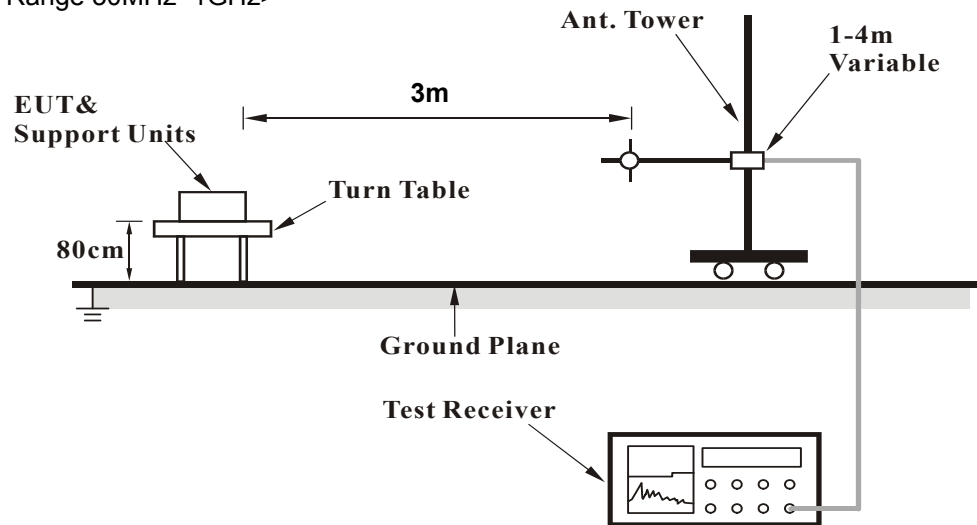

<Frequency Range above 1GHz>

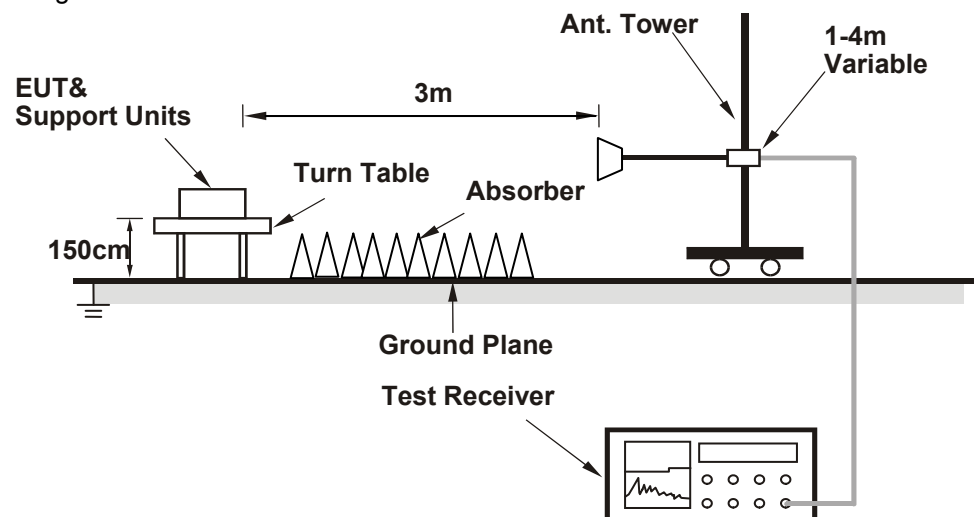

For the actual test configuration, please refer to the attached file (Test Setup Photo).

4.1.6 EUT Operating Conditions

- Placed the EUT on the testing table.
- Prepared a notebook to act as a communication partner and placed it outside of testing area.
- The communication partner connected with EUT via a RJ45 cable and ran a test program (provided by manufacturer) to enable EUT under transmission condition continuously at specific channel frequency.
- The communication partner sent data to EUT by command "PING".
- The necessary accessories enable the system in full functions.

4.1.7 Test Results

Above 1GHz Data :

CDD Mode

802.11b

CHANNEL	TX Channel 1	DETECTOR FUNCTION	Peak (PK)
FREQUENCY RANGE	1GHz ~ 25GHz		Average (AV)

ANTENNA POLARITY & TEST DISTANCE: HORIZONTAL AT 3 M

NO.	FREQ. (MHz)	EMISSION LEVEL (dBuV/m)	LIMIT (dBuV/m)	MARGIN (dB)	ANTENNA HEIGHT (m)	TABLE ANGLE (Degree)	RAW VALUE (dBuV)	CORRECTION FACTOR (dB/m)
1	2390.00	57.2 PK	74.0	-16.8	1.96 H	210	24.40	32.80
2	2390.00	45.3 AV	54.0	-8.7	1.96 H	210	12.50	32.80
3	*2412.00	102.9 PK			1.78 H	187	70.00	32.90
4	*2412.00	99.5 AV			1.78 H	187	66.60	32.90
5	2492.00	56.9 PK	74.0	-17.1	1.93 H	268	23.90	33.00
6	2492.00	45.2 AV	54.0	-8.8	1.93 H	268	12.20	33.00
7	#3216.00	48.1 PK	72.9	-24.8	1.76 H	157	46.30	1.80
8	#3216.00	40.6 AV	69.5	-28.9	1.76 H	157	38.80	1.80
9	4824.00	52.6 PK	74.0	-21.4	2.11 H	54	46.70	5.90
10	4824.00	47.5 AV	54.0	-6.5	2.11 H	54	41.60	5.90

ANTENNA POLARITY & TEST DISTANCE: VERTICAL AT 3 M

NO.	FREQ. (MHz)	EMISSION LEVEL (dBuV/m)	LIMIT (dBuV/m)	MARGIN (dB)	ANTENNA HEIGHT (m)	TABLE ANGLE (Degree)	RAW VALUE (dBuV)	CORRECTION FACTOR (dB/m)
1	2390.00	59.6 PK	74.0	-14.4	1.66 V	182	26.80	32.80
2	2390.00	50.1 AV	54.0	-3.9	1.66 V	182	17.30	32.80
3	*2412.00	118.3 PK			1.76 V	332	85.40	32.90
4	*2412.00	114.4 AV			1.76 V	332	81.50	32.90
5	2492.00	61.0 PK	74.0	-13.0	1.77 V	163	28.00	33.00
6	2492.00	52.6 AV	54.0	-1.4	1.77 V	163	19.60	33.00
7	#3216.00	57.2 PK	88.3	-31.1	1.75 V	157	55.40	1.80
8	#3216.00	55.2 AV	84.4	-29.2	1.75 V	157	53.40	1.80
9	4824.00	49.7 PK	74.0	-24.3	1.91 V	177	43.80	5.90
10	4824.00	41.5 AV	54.0	-12.5	1.91 V	177	35.60	5.90

REMARKS:

1. Emission Level(dBuV/m) = Raw Value(dBuV) + Correction Factor(dB/m)
2. Correction Factor(dB/m) = Antenna Factor(dB/m) + Cable Factor(dB)
3. The other emission levels were very low against the limit.
4. Margin value = Emission Level – Limit value
5. " * ": Fundamental frequency.
6. " # ": The radiated frequency is out of the restricted band.

CHANNEL	TX Channel 6	DETECTOR FUNCTION	Peak (PK)
FREQUENCY RANGE	1GHz ~ 25GHz		Average (AV)

ANTENNA POLARITY & TEST DISTANCE: HORIZONTAL AT 3 M

NO.	FREQ. (MHz)	EMISSION LEVEL (dBuV/m)	LIMIT (dBuV/m)	MARGIN (dB)	ANTENNA HEIGHT (m)	TABLE ANGLE (Degree)	RAW VALUE (dBuV)	CORRECTION FACTOR (dB/m)
1	2365.00	56.3 PK	74.0	-17.7	1.75 H	181	23.60	32.70
2	2365.00	45.5 AV	54.0	-8.5	1.75 H	181	12.80	32.70
3	*2437.00	106.1 PK			1.77 H	182	73.20	32.90
4	*2437.00	102.0 AV			1.77 H	182	69.10	32.90
5	2495.00	56.8 PK	74.0	-17.2	1.59 H	219	23.80	33.00
6	2495.00	45.2 AV	54.0	-8.8	1.59 H	219	12.20	33.00
7	#3249.00	46.1 PK	76.1	-30.0	1.72 H	162	44.20	1.90
8	#3249.00	34.4 AV	72.0	-37.6	1.72 H	162	32.50	1.90
9	4874.00	51.8 PK	74.0	-22.2	1.88 H	51	45.80	6.00
10	4874.00	45.8 AV	54.0	-8.2	1.88 H	51	39.80	6.00

ANTENNA POLARITY & TEST DISTANCE: VERTICAL AT 3 M

NO.	FREQ. (MHz)	EMISSION LEVEL (dBuV/m)	LIMIT (dBuV/m)	MARGIN (dB)	ANTENNA HEIGHT (m)	TABLE ANGLE (Degree)	RAW VALUE (dBuV)	CORRECTION FACTOR (dB/m)
1	2365.00	60.4 PK	74.0	-13.6	2.21 V	174	27.70	32.70
2	2365.00	51.9 AV	54.0	-2.1	2.21 V	174	19.20	32.70
3	*2437.00	117.3 PK			1.95 V	251	84.40	32.90
4	*2437.00	113.5 AV			1.95 V	251	80.60	32.90
5	2495.00	65.6 PK	74.0	-8.4	1.50 V	172	32.60	33.00
6	2495.00	52.4 AV	54.0	-1.6	1.50 V	172	19.40	33.00
7	#3249.00	53.2 PK	87.3	-34.1	1.74 V	160	51.30	1.90
8	#3249.00	49.5 AV	83.5	-34.0	1.74 V	160	47.60	1.90
9	4874.00	50.3 PK	74.0	-23.7	1.50 V	176	44.30	6.00
10	4874.00	40.5 AV	54.0	-13.5	1.50 V	176	34.50	6.00

REMARKS:

1. Emission Level(dBuV/m) = Raw Value(dBuV) + Correction Factor(dB/m)
2. Correction Factor(dB/m) = Antenna Factor(dB/m) + Cable Factor(dB)
3. The other emission levels were very low against the limit.
4. Margin value = Emission Level – Limit value
5. " * ": Fundamental frequency.
6. " # ": The radiated frequency is out of the restricted band.

CHANNEL	TX Channel 11	DETECTOR FUNCTION	Peak (PK)
FREQUENCY RANGE	1GHz ~ 25GHz		Average (AV)

ANTENNA POLARITY & TEST DISTANCE: HORIZONTAL AT 3 M

NO.	FREQ. (MHz)	EMISSION LEVEL (dBuV/m)	LIMIT (dBuV/m)	MARGIN (dB)	ANTENNA HEIGHT (m)	TABLE ANGLE (Degree)	RAW VALUE (dBuV)	CORRECTION FACTOR (dB/m)
1	2380.00	56.2 PK	74.0	-17.8	1.68 H	228	23.40	32.80
2	2380.00	45.2 AV	54.0	-8.8	1.68 H	228	12.40	32.80
3	*2462.00	99.1 PK			1.95 H	203	66.20	32.90
4	*2462.00	95.6 AV			1.95 H	203	62.70	32.90
5	2483.50	56.6 PK	74.0	-17.4	1.88 H	278	23.60	33.00
6	2483.50	45.2 AV	54.0	-8.8	1.88 H	278	12.20	33.00
7	#3282.00	45.9 PK	69.1	-23.2	1.96 H	293	44.10	1.80
8	#3282.00	33.0 AV	65.6	-32.6	1.96 H	293	31.20	1.80
9	4924.00	51.4 PK	74.0	-22.6	1.75 H	19	45.40	6.00
10	4924.00	44.0 AV	54.0	-10.0	1.75 H	19	38.00	6.00

ANTENNA POLARITY & TEST DISTANCE: VERTICAL AT 3 M

NO.	FREQ. (MHz)	EMISSION LEVEL (dBuV/m)	LIMIT (dBuV/m)	MARGIN (dB)	ANTENNA HEIGHT (m)	TABLE ANGLE (Degree)	RAW VALUE (dBuV)	CORRECTION FACTOR (dB/m)
1	2380.00	61.3 PK	74.0	-12.7	1.64 V	188	28.50	32.80
2	2380.00	52.2 AV	54.0	-1.8	1.64 V	188	19.40	32.80
3	*2462.00	119.6 PK			1.72 V	333	86.70	32.90
4	*2462.00	115.6 AV			1.72 V	333	82.70	32.90
5	2483.50	68.3 PK	74.0	-5.7	1.54 V	168	35.30	33.00
6	2483.50	49.5 AV	54.0	-4.5	1.54 V	168	16.50	33.00
7	#3282.00	49.7 PK	89.6	-39.9	1.80 V	162	47.90	1.80
8	#3282.00	44.2 AV	85.6	-41.4	1.80 V	162	42.40	1.80
9	4924.00	49.1 PK	74.0	-24.9	1.05 V	38	43.10	6.00
10	4924.00	37.9 AV	54.0	-16.1	1.05 V	38	31.90	6.00

REMARKS:

1. Emission Level(dBuV/m) = Raw Value(dBuV) + Correction Factor(dB/m)
2. Correction Factor(dB/m) = Antenna Factor(dB/m) + Cable Factor(dB)
3. The other emission levels were very low against the limit.
4. Margin value = Emission Level – Limit value
5. " * ": Fundamental frequency.
6. " # ": The radiated frequency is out of the restricted band.

802.11g

CHANNEL	TX Channel 1	DETECTOR FUNCTION	Peak (PK)
FREQUENCY RANGE	1GHz ~ 25GHz		Average (AV)

ANTENNA POLARITY & TEST DISTANCE: HORIZONTAL AT 3 M								
NO.	FREQ. (MHz)	EMISSION LEVEL (dBuV/m)	LIMIT (dBuV/m)	MARGIN (dB)	ANTENNA HEIGHT (m)	TABLE ANGLE (Degree)	RAW VALUE (dBuV)	CORRECTION FACTOR (dB/m)
1	2390.00	56.3 PK	74.0	-17.7	1.42 H	220	23.50	32.80
2	2390.00	45.3 AV	54.0	-8.7	1.42 H	220	12.50	32.80
3	*2412.00	102.7 PK			1.28 H	204	69.80	32.90
4	*2412.00	91.6 AV			1.28 H	204	58.70	32.90
5	#3216.00	47.2 PK	72.7	-25.5	1.04 H	148	45.40	1.80
6	#3216.00	37.8 AV	61.6	-23.8	1.04 H	148	36.00	1.80
7	4824.00	47.9 PK	74.0	-26.1	1.87 H	0	42.00	5.90
8	4824.00	36.4 AV	54.0	-17.6	1.87 H	0	30.50	5.90

ANTENNA POLARITY & TEST DISTANCE: VERTICAL AT 3 M								
NO.	FREQ. (MHz)	EMISSION LEVEL (dBuV/m)	LIMIT (dBuV/m)	MARGIN (dB)	ANTENNA HEIGHT (m)	TABLE ANGLE (Degree)	RAW VALUE (dBuV)	CORRECTION FACTOR (dB/m)
1	2390.00	67.2 PK	74.0	-6.8	2.24 V	338	34.40	32.80
2	2390.00	52.5 AV	54.0	-1.5	2.24 V	338	19.70	32.80
3	*2412.00	119.3 PK			1.85 V	181	86.40	32.90
4	*2412.00	108.9 AV			1.85 V	181	76.00	32.90
5	#3216.00	57.4 PK	89.3	-31.9	1.75 V	160	55.60	1.80
6	#3216.00	55.7 AV	78.9	-23.2	1.75 V	160	53.90	1.80
7	4824.00	47.5 PK	74.0	-26.5	1.69 V	186	41.60	5.90
8	4824.00	34.6 AV	54.0	-19.4	1.69 V	186	28.70	5.90

REMARKS:

1. Emission Level(dBuV/m) = Raw Value(dBuV) + Correction Factor(dB/m)
2. Correction Factor(dB/m) = Antenna Factor(dB/m) + Cable Factor(dB)
3. The other emission levels were very low against the limit.
4. Margin value = Emission Level – Limit value
5. " * ": Fundamental frequency.
6. " # ": The radiated frequency is out of the restricted band.

CHANNEL	TX Channel 6	DETECTOR FUNCTION	Peak (PK)
FREQUENCY RANGE	1GHz ~ 25GHz		Average (AV)

ANTENNA POLARITY & TEST DISTANCE: HORIZONTAL AT 3 M

NO.	FREQ. (MHz)	EMISSION LEVEL (dBuV/m)	LIMIT (dBuV/m)	MARGIN (dB)	ANTENNA HEIGHT (m)	TABLE ANGLE (Degree)	RAW VALUE (dBuV)	CORRECTION FACTOR (dB/m)
1	*2437.00	107.1 PK			2.03 H	200	74.20	32.90
2	*2437.00	95.9 AV			2.03 H	200	63.00	32.90
3	2483.50	56.2 PK	74.0	-17.8	2.15 H	229	23.20	33.00
4	2483.50	45.3 AV	54.0	-8.7	2.15 H	229	12.30	33.00
5	#3249.00	46.4 PK	77.1	-30.7	1.57 H	21	44.50	1.90
6	#3249.00	32.9 AV	65.9	-33.0	1.57 H	21	31.00	1.90
7	4874.00	50.5 PK	74.0	-23.5	1.67 H	53	44.50	6.00
8	4874.00	38.1 AV	54.0	-15.9	1.67 H	53	32.10	6.00

ANTENNA POLARITY & TEST DISTANCE: VERTICAL AT 3 M

NO.	FREQ. (MHz)	EMISSION LEVEL (dBuV/m)	LIMIT (dBuV/m)	MARGIN (dB)	ANTENNA HEIGHT (m)	TABLE ANGLE (Degree)	RAW VALUE (dBuV)	CORRECTION FACTOR (dB/m)
1	*2437.00	121.2 PK			2.45 V	343	88.30	32.90
2	*2437.00	110.8 AV			2.45 V	343	77.90	32.90
3	2483.50	65.8 PK	74.0	-8.2	1.42 V	173	32.80	33.00
4	2483.50	52.4 AV	54.0	-1.6	1.42 V	173	19.40	33.00
5	#3249.00	53.6 PK	91.2	-37.6	1.79 V	157	51.70	1.90
6	#3249.00	49.6 AV	80.8	-31.2	1.79 V	157	47.70	1.90
7	4874.00	47.6 PK	74.0	-26.4	1.90 V	263	41.60	6.00
8	4874.00	35.0 AV	54.0	-19.0	1.90 V	263	29.00	6.00

REMARKS:

1. Emission Level(dBuV/m) = Raw Value(dBuV) + Correction Factor(dB/m)
2. Correction Factor(dB/m) = Antenna Factor(dB/m) + Cable Factor(dB)
3. The other emission levels were very low against the limit.
4. Margin value = Emission Level – Limit value
5. " * ": Fundamental frequency.
6. " # ": The radiated frequency is out of the restricted band.

CHANNEL	TX Channel 11	DETECTOR FUNCTION	Peak (PK)
FREQUENCY RANGE	1GHz ~ 25GHz		Average (AV)

ANTENNA POLARITY & TEST DISTANCE: HORIZONTAL AT 3 M

NO.	FREQ. (MHz)	EMISSION LEVEL (dBuV/m)	LIMIT (dBuV/m)	MARGIN (dB)	ANTENNA HEIGHT (m)	TABLE ANGLE (Degree)	RAW VALUE (dBuV)	CORRECTION FACTOR (dB/m)
1	*2462.00	102.2 PK			1.63 H	148	69.30	32.90
2	*2462.00	92.1 AV			1.63 H	148	59.20	32.90
3	2483.50	57.5 PK	74.0	-16.5	1.74 H	163	24.50	33.00
4	2483.50	45.9 AV	54.0	-8.1	1.74 H	163	12.90	33.00
5	#3282.00	47.8 PK	72.2	-24.4	2.10 H	131	46.00	1.80
6	#3282.00	36.2 AV	62.1	-25.9	2.10 H	131	34.40	1.80
7	4924.00	49.1 PK	74.0	-24.9	1.69 H	51	43.10	6.00
8	4924.00	36.8 AV	54.0	-17.2	1.69 H	51	30.80	6.00

ANTENNA POLARITY & TEST DISTANCE: VERTICAL AT 3 M

NO.	FREQ. (MHz)	EMISSION LEVEL (dBuV/m)	LIMIT (dBuV/m)	MARGIN (dB)	ANTENNA HEIGHT (m)	TABLE ANGLE (Degree)	RAW VALUE (dBuV)	CORRECTION FACTOR (dB/m)
1	*2462.00	119.7 PK			1.48 V	167	86.80	32.90
2	*2462.00	107.9 AV			1.48 V	167	75.00	32.90
3	2483.50	66.0 PK	74.0	-8.0	1.88 V	252	33.00	33.00
4	2483.50	52.8 AV	54.0	-1.2	1.88 V	252	19.80	33.00
5	#3282.00	50.2 PK	89.7	-69.5	1.82 V	160	48.40	1.80
6	#3282.00	45.1 AV	77.9	-32.8	1.82 V	160	43.30	1.80
7	4924.00	47.7 PK	74.0	-26.3	1.36 V	93	41.70	6.00
8	4924.00	35.1 AV	54.0	-18.9	1.36 V	93	29.10	6.00

REMARKS:

1. Emission Level(dBuV/m) = Raw Value(dBuV) + Correction Factor(dB/m)
2. Correction Factor(dB/m) = Antenna Factor(dB/m) + Cable Factor(dB)
3. The other emission levels were very low against the limit.
4. Margin value = Emission Level – Limit value
5. " * ": Fundamental frequency.
6. " # ": The radiated frequency is out of the restricted band.

802.11n (HT20)

CHANNEL	TX Channel 1	DETECTOR FUNCTION	Peak (PK)
FREQUENCY RANGE	1GHz ~ 25GHz		Average (AV)

ANTENNA POLARITY & TEST DISTANCE: HORIZONTAL AT 3 M

NO.	FREQ. (MHz)	EMISSION LEVEL (dBuV/m)	LIMIT (dBuV/m)	MARGIN (dB)	ANTENNA HEIGHT (m)	TABLE ANGLE (Degree)	RAW VALUE (dBuV)	CORRECTION FACTOR (dB/m)
1	2390.00	56.5 PK	74.0	-17.5	1.22 H	181	23.70	32.80
2	2390.00	45.0 AV	54.0	-9.0	1.22 H	181	12.20	32.80
3	*2412.00	101.0 PK			1.06 H	208	68.10	32.90
4	*2412.00	90.0 AV			1.06 H	208	57.10	32.90
5	#3216.00	46.6 PK	71.0	-24.4	1.75 H	155	44.80	1.80
6	#3216.00	37.2 AV	60.0	-22.8	1.75 H	155	35.40	1.80
7	4824.00	47.3 PK	74.0	-26.7	1.43 H	161	41.40	5.90
8	4824.00	34.4 AV	54.0	-19.6	1.43 H	161	28.50	5.90

ANTENNA POLARITY & TEST DISTANCE: VERTICAL AT 3 M

NO.	FREQ. (MHz)	EMISSION LEVEL (dBuV/m)	LIMIT (dBuV/m)	MARGIN (dB)	ANTENNA HEIGHT (m)	TABLE ANGLE (Degree)	RAW VALUE (dBuV)	CORRECTION FACTOR (dB/m)
1	2390.00	63.8 PK	74.0	-10.2	2.34 V	173	31.00	32.80
2	2390.00	52.2 AV	54.0	-1.8	2.34 V	173	19.40	32.80
3	*2412.00	114.9 PK			1.82 V	333	82.00	32.90
4	*2412.00	104.2 AV			1.82 V	333	71.30	32.90
5	#3216.00	56.7 PK	84.9	-28.2	1.76 V	157	54.90	1.80
6	#3216.00	54.6 AV	74.2	-19.6	1.76 V	157	52.80	1.80
7	4824.00	47.7 PK	74.0	-26.3	1.34 V	96	41.80	5.90
8	4824.00	34.6 AV	54.0	-19.4	1.34 V	96	28.70	5.90

REMARKS:

1. Emission Level(dBuV/m) = Raw Value(dBuV) + Correction Factor(dB/m)
2. Correction Factor(dB/m) = Antenna Factor(dB/m) + Cable Factor(dB)
3. The other emission levels were very low against the limit.
4. Margin value = Emission Level – Limit value
5. " * ": Fundamental frequency.
6. " # ": The radiated frequency is out of the restricted band.

CHANNEL	TX Channel 6	DETECTOR FUNCTION	Peak (PK)
FREQUENCY RANGE	1GHz ~ 25GHz		Average (AV)

ANTENNA POLARITY & TEST DISTANCE: HORIZONTAL AT 3 M

NO.	FREQ. (MHz)	EMISSION LEVEL (dBuV/m)	LIMIT (dBuV/m)	MARGIN (dB)	ANTENNA HEIGHT (m)	TABLE ANGLE (Degree)	RAW VALUE (dBuV)	CORRECTION FACTOR (dB/m)
1	*2437.00	104.3 PK			1.00 H	203	71.40	32.90
2	*2437.00	93.5 AV			1.00 H	203	60.60	32.90
3	2483.50	56.2 PK	74.0	-17.8	1.50 H	193	23.20	33.00
4	2483.50	45.3 AV	54.0	-8.7	1.50 H	193	12.30	33.00
5	#3249.00	45.8 PK	74.3	-28.5	1.54 H	152	43.90	1.90
6	#3249.00	33.6 AV	63.5	-29.9	1.54 H	152	31.70	1.90
7	4874.00	47.9 PK	74.0	-26.1	1.33 H	218	41.90	6.00
8	4874.00	34.3 AV	54.0	-19.7	1.33 H	218	28.30	6.00

ANTENNA POLARITY & TEST DISTANCE: VERTICAL AT 3 M

NO.	FREQ. (MHz)	EMISSION LEVEL (dBuV/m)	LIMIT (dBuV/m)	MARGIN (dB)	ANTENNA HEIGHT (m)	TABLE ANGLE (Degree)	RAW VALUE (dBuV)	CORRECTION FACTOR (dB/m)
1	*2437.00	122.2 PK			1.42 V	172	89.30	32.90
2	*2437.00	111.5 AV			1.42 V	172	78.60	32.90
3	2483.50	65.9 PK	74.0	-8.1	1.40 V	172	32.90	33.00
4	2483.50	52.2 AV	54.0	-1.8	1.40 V	172	19.20	33.00
5	#3249.00	53.8 PK	92.2	-38.4	1.68 V	163	51.90	1.90
6	#3249.00	50.1 AV	81.5	-31.4	1.68 V	163	48.20	1.90
7	4874.00	47.4 PK	74.0	-26.6	1.29 V	124	41.40	6.00
8	4874.00	34.8 AV	54.0	-19.2	1.29 V	124	28.80	6.00

REMARKS:

1. Emission Level(dBuV/m) = Raw Value(dBuV) + Correction Factor(dB/m)
2. Correction Factor(dB/m) = Antenna Factor(dB/m) + Cable Factor(dB)
3. The other emission levels were very low against the limit.
4. Margin value = Emission Level – Limit value
5. " * ": Fundamental frequency.
6. " # ": The radiated frequency is out of the restricted band.

CHANNEL	TX Channel 11	DETECTOR FUNCTION	Peak (PK)
FREQUENCY RANGE	1GHz ~ 25GHz		Average (AV)

ANTENNA POLARITY & TEST DISTANCE: HORIZONTAL AT 3 M

NO.	FREQ. (MHz)	EMISSION LEVEL (dBuV/m)	LIMIT (dBuV/m)	MARGIN (dB)	ANTENNA HEIGHT (m)	TABLE ANGLE (Degree)	RAW VALUE (dBuV)	CORRECTION FACTOR (dB/m)
1	*2462.00	96.9 PK			2.01 H	144	64.00	32.90
2	*2462.00	86.5 AV			2.01 H	144	53.60	32.90
3	2483.50	56.3 PK	74.0	-17.7	1.71 H	192	23.30	33.00
4	2483.50	45.3 AV	54.0	-8.7	1.71 H	192	12.30	33.00
5	#3282.00	45.1 PK	66.9	-21.8	1.46 H	127	43.30	1.80
6	#3282.00	33.5 AV	56.5	-23.0	1.46 H	127	31.70	1.80
7	4924.00	47.7 PK	74.0	-26.3	1.52 H	159	41.70	6.00
8	4924.00	34.4 AV	54.0	-19.6	1.52 H	159	28.40	6.00

ANTENNA POLARITY & TEST DISTANCE: VERTICAL AT 3 M

NO.	FREQ. (MHz)	EMISSION LEVEL (dBuV/m)	LIMIT (dBuV/m)	MARGIN (dB)	ANTENNA HEIGHT (m)	TABLE ANGLE (Degree)	RAW VALUE (dBuV)	CORRECTION FACTOR (dB/m)
1	*2462.00	118.0 PK			1.46 V	171	85.10	32.90
2	*2462.00	107.4 AV			1.46 V	171	74.50	32.90
3	2483.50	65.9 PK	74.0	-8.1	1.34 V	166	32.90	33.00
4	2483.50	52.6 AV	54.0	-1.4	1.34 V	166	19.60	33.00
5	#3282.00	47.8 PK	88.0	-40.2	1.49 V	83	46.00	1.80
6	#3282.00	40.1 AV	77.4	-37.3	1.49 V	83	38.30	1.80
7	4924.00	47.5 PK	74.0	-26.5	1.36 V	115	41.50	6.00
8	4924.00	34.3 AV	54.0	-19.7	1.36 V	115	28.30	6.00

REMARKS:

1. Emission Level(dBuV/m) = Raw Value(dBuV) + Correction Factor(dB/m)
2. Correction Factor(dB/m) = Antenna Factor(dB/m) + Cable Factor(dB)
3. The other emission levels were very low against the limit.
4. Margin value = Emission Level – Limit value
5. " * ": Fundamental frequency.
6. " # ": The radiated frequency is out of the restricted band.

802.11n (HT40)

CHANNEL	TX Channel 3	DETECTOR FUNCTION	Peak (PK)
FREQUENCY RANGE	1GHz ~ 25GHz		Average (AV)

ANTENNA POLARITY & TEST DISTANCE: HORIZONTAL AT 3 M

NO.	FREQ. (MHz)	EMISSION LEVEL (dBuV/m)	LIMIT (dBuV/m)	MARGIN (dB)	ANTENNA HEIGHT (m)	TABLE ANGLE (Degree)	RAW VALUE (dBuV)	CORRECTION FACTOR (dB/m)
1	2390.00	56.2 PK	74.0	-17.8	1.33 H	187	23.40	32.80
2	2390.00	45.1 AV	54.0	-8.9	1.33 H	187	12.30	32.80
3	*2422.00	92.8 PK			1.21 H	203	59.90	32.90
4	*2422.00	82.9 AV			1.21 H	203	50.00	32.90
5	#3229.00	47.4 PK	62.8	-15.4	1.62 H	139	45.60	1.80
6	#3229.00	36.4 AV	52.9	-16.5	1.62 H	139	34.60	1.80
7	4844.00	46.8 PK	74.0	-27.2	1.32 H	290	41.00	5.80
8	4844.00	34.5 AV	54.0	-19.5	1.32 H	290	28.70	5.80

ANTENNA POLARITY & TEST DISTANCE: VERTICAL AT 3 M

NO.	FREQ. (MHz)	EMISSION LEVEL (dBuV/m)	LIMIT (dBuV/m)	MARGIN (dB)	ANTENNA HEIGHT (m)	TABLE ANGLE (Degree)	RAW VALUE (dBuV)	CORRECTION FACTOR (dB/m)
1	2390.00	71.2 PK	74.0	-2.8	1.81 V	170	38.40	32.80
2	2390.00	52.2 AV	54.0	-1.8	1.81 V	170	19.40	32.80
3	*2422.00	110.5 PK			1.84 V	172	77.60	32.90
4	*2422.00	100.6 AV			1.84 V	172	67.70	32.90
5	#3229.00	54.3 PK	80.5	-26.2	1.74 V	162	52.50	1.80
6	#3229.00	51.7 AV	70.6	-18.9	1.74 V	162	49.90	1.80
7	4844.00	46.8 PK	74.0	-27.2	1.47 V	96	41.00	5.80
8	4844.00	34.5 AV	54.0	-19.5	1.47 V	96	28.70	5.80

REMARKS:

1. Emission Level(dBuV/m) = Raw Value(dBuV) + Correction Factor(dB/m)
2. Correction Factor(dB/m) = Antenna Factor(dB/m) + Cable Factor(dB)
3. The other emission levels were very low against the limit.
4. Margin value = Emission Level – Limit value
5. " * ": Fundamental frequency.
6. " # ": The radiated frequency is out of the restricted band.

CHANNEL	TX Channel 6	DETECTOR FUNCTION	Peak (PK)
FREQUENCY RANGE	1GHz ~ 25GHz		Average (AV)

ANTENNA POLARITY & TEST DISTANCE: HORIZONTAL AT 3 M

NO.	FREQ. (MHz)	EMISSION LEVEL (dBuV/m)	LIMIT (dBuV/m)	MARGIN (dB)	ANTENNA HEIGHT (m)	TABLE ANGLE (Degree)	RAW VALUE (dBuV)	CORRECTION FACTOR (dB/m)
1	*2437.00	94.1 PK			1.77 H	204	61.20	32.90
2	*2437.00	84.2 AV			1.77 H	204	51.30	32.90
3	2483.50	56.1 PK	74.0	-17.9	1.93 H	177	23.10	33.00
4	2483.50	45.3 AV	54.0	-8.7	1.93 H	177	12.30	33.00
5	#3249.00	45.2 PK	64.1	-18.9	1.53 H	207	43.30	1.90
6	#3249.00	33.5 AV	54.2	-20.7	1.53 H	207	31.60	1.90
7	4874.00	47.2 PK	74.0	-26.8	1.55 H	138	41.20	6.00
8	4874.00	34.8 AV	54.0	-19.2	1.55 H	138	28.80	6.00

ANTENNA POLARITY & TEST DISTANCE: VERTICAL AT 3 M

NO.	FREQ. (MHz)	EMISSION LEVEL (dBuV/m)	LIMIT (dBuV/m)	MARGIN (dB)	ANTENNA HEIGHT (m)	TABLE ANGLE (Degree)	RAW VALUE (dBuV)	CORRECTION FACTOR (dB/m)
1	*2437.00	110.7 PK			1.88 V	343	77.80	32.90
2	*2437.00	100.6 AV			1.88 V	343	67.70	32.90
3	2483.50	66.2 PK	74.0	-7.8	1.47 V	172	33.20	33.00
4	2483.50	52.4 AV	54.0	-1.6	1.47 V	172	19.40	33.00
5	#3249.00	51.3 PK	80.7	-29.4	2.10 V	242	49.40	1.90
6	#3249.00	45.6 AV	70.6	-25.0	2.10 V	242	43.70	1.90
7	4874.00	47.8 PK	74.0	-26.2	1.86 V	206	41.80	6.00
8	4874.00	34.2 AV	54.0	-19.8	1.86 V	206	28.20	6.00

REMARKS:

1. Emission Level(dBuV/m) = Raw Value(dBuV) + Correction Factor(dB/m)
2. Correction Factor(dB/m) = Antenna Factor(dB/m) + Cable Factor(dB)
3. The other emission levels were very low against the limit.
4. Margin value = Emission Level – Limit value
5. " * ": Fundamental frequency.
6. " # ": The radiated frequency is out of the restricted band.

CHANNEL	TX Channel 9	DETECTOR FUNCTION	Peak (PK)
FREQUENCY RANGE	1GHz ~ 25GHz		Average (AV)

ANTENNA POLARITY & TEST DISTANCE: HORIZONTAL AT 3 M

NO.	FREQ. (MHz)	EMISSION LEVEL (dBuV/m)	LIMIT (dBuV/m)	MARGIN (dB)	ANTENNA HEIGHT (m)	TABLE ANGLE (Degree)	RAW VALUE (dBuV)	CORRECTION FACTOR (dB/m)
1	*2452.00	91.7 PK			1.00 H	133	58.70	33.00
2	*2452.00	81.9 AV			1.00 H	133	48.90	33.00
3	2483.50	56.4 PK	74.0	-17.6	1.12 H	149	23.40	33.00
4	2483.50	45.2 AV	54.0	-8.8	1.12 H	149	12.20	33.00
5	#3282.00	44.4 PK	61.7	-17.3	1.23 H	66	42.60	1.80
6	#3282.00	32.3 AV	51.9	-19.6	1.23 H	66	30.50	1.80
7	4904.00	47.0 PK	74.0	-27.0	1.27 H	162	41.10	5.90
8	4904.00	34.0 AV	54.0	-20.0	1.27 H	162	28.10	5.90

ANTENNA POLARITY & TEST DISTANCE: VERTICAL AT 3 M

NO.	FREQ. (MHz)	EMISSION LEVEL (dBuV/m)	LIMIT (dBuV/m)	MARGIN (dB)	ANTENNA HEIGHT (m)	TABLE ANGLE (Degree)	RAW VALUE (dBuV)	CORRECTION FACTOR (dB/m)
1	*2452.00	111.3 PK			1.47 V	169	78.30	33.00
2	*2452.00	101.5 AV			1.47 V	169	68.50	33.00
3	2483.50	64.2 PK	74.0	-9.8	1.56 V	149	31.20	33.00
4	2483.50	52.8 AV	54.0	-1.2	1.56 V	149	19.80	33.00
5	3262.00	50.6 PK	74.0	-23.4	1.82 V	359	48.80	1.80
6	3262.00	46.3 AV	54.0	-7.7	1.82 V	359	44.50	1.80
7	4904.00	47.3 PK	74.0	-26.7	1.53 V	286	41.40	5.90
8	4904.00	34.1 AV	54.0	-19.9	1.53 V	286	28.20	5.90

REMARKS:

1. Emission Level(dBuV/m) = Raw Value(dBuV) + Correction Factor(dB/m)
2. Correction Factor(dB/m) = Antenna Factor(dB/m) + Cable Factor(dB)
3. The other emission levels were very low against the limit.
4. Margin value = Emission Level – Limit value
5. " * ": Fundamental frequency.
6. " # ": The radiated frequency is out of the restricted band.

Beamforming Mode

802.11n (VHT20)

CHANNEL	TX Channel 1	DETECTOR FUNCTION	Peak (PK)
FREQUENCY RANGE	1GHz ~ 25GHz		Average (AV)

ANTENNA POLARITY & TEST DISTANCE: HORIZONTAL AT 3 M

NO.	FREQ. (MHz)	EMISSION LEVEL (dBuV/m)	LIMIT (dBuV/m)	MARGIN (dB)	ANTENNA HEIGHT (m)	TABLE ANGLE (Degree)	RAW VALUE (dBuV)	CORRECTION FACTOR (dB/m)
1	2390.00	56.6 PK	74.0	-17.4	1.59 H	136	23.80	32.80
2	2390.00	44.9 AV	54.0	-9.1	1.59 H	136	12.10	32.80
3	*2412.00	97.8 PK			1.45 H	152	64.90	32.90
4	*2412.00	90.2 AV			1.45 H	152	57.30	32.90
5	4824.00	46.6 PK	74.0	-27.4	1.32 H	76	40.70	5.90
6	4824.00	34.4 AV	54.0	-19.6	1.32 H	76	28.50	5.90

ANTENNA POLARITY & TEST DISTANCE: VERTICAL AT 3 M

NO.	FREQ. (MHz)	EMISSION LEVEL (dBuV/m)	LIMIT (dBuV/m)	MARGIN (dB)	ANTENNA HEIGHT (m)	TABLE ANGLE (Degree)	RAW VALUE (dBuV)	CORRECTION FACTOR (dB/m)
1	2390.00	64.1 PK	74.0	-9.9	1.99 V	157	31.30	32.80
2	2390.00	52.2 AV	54.0	-1.8	1.99 V	157	19.40	32.80
3	*2412.00	114.1 PK			2.16 V	5	81.20	32.90
4	*2412.00	105.6 AV			2.16 V	5	72.70	32.90
5	4824.00	47.7 PK	74.0	-26.3	1.71 V	103	41.80	5.90
6	4824.00	34.5 AV	54.0	-19.5	1.71 V	103	28.60	5.90

REMARKS:

1. Emission Level(dBuV/m) = Raw Value(dBuV) + Correction Factor(dB/m)
2. Correction Factor(dB/m) = Antenna Factor(dB/m) + Cable Factor(dB)
3. The other emission levels were very low against the limit.
4. Margin value = Emission Level – Limit value
5. " * ": Fundamental frequency.

CHANNEL	TX Channel 6	DETECTOR FUNCTION	Peak (PK)
FREQUENCY RANGE	1GHz ~ 25GHz		Average (AV)

ANTENNA POLARITY & TEST DISTANCE: HORIZONTAL AT 3 M

NO.	FREQ. (MHz)	EMISSION LEVEL (dBuV/m)	LIMIT (dBuV/m)	MARGIN (dB)	ANTENNA HEIGHT (m)	TABLE ANGLE (Degree)	RAW VALUE (dBuV)	CORRECTION FACTOR (dB/m)
1	*2437.00	100.8 PK			1.48 H	144	67.90	32.90
2	*2437.00	95.7 AV			1.48 H	144	62.80	32.90
3	2483.50	56.7 PK	74.0	-17.3	1.27 H	135	23.70	33.00
4	2483.50	45.1 AV	54.0	-8.9	1.27 H	135	12.10	33.00
5	#3249.00	45.8 PK	70.8	-25.0	1.24 H	286	43.90	1.90
6	#3249.00	35.5 AV	65.7	-30.2	1.24 H	286	33.60	1.90
7	4874.00	47.4 PK	74.0	-26.6	1.30 H	192	41.40	6.00
8	4874.00	35.0 AV	54.0	-19.0	1.30 H	192	29.00	6.00

ANTENNA POLARITY & TEST DISTANCE: VERTICAL AT 3 M

NO.	FREQ. (MHz)	EMISSION LEVEL (dBuV/m)	LIMIT (dBuV/m)	MARGIN (dB)	ANTENNA HEIGHT (m)	TABLE ANGLE (Degree)	RAW VALUE (dBuV)	CORRECTION FACTOR (dB/m)
1	*2437.00	118.0 PK			1.80 V	353	85.10	32.90
2	*2437.00	110.7 AV			1.80 V	353	77.80	32.90
3	2483.50	59.2 PK	74.0	-14.8	2.04 V	182	26.20	33.00
4	2483.50	46.6 AV	54.0	-7.4	2.04 V	182	13.60	33.00
5	#3249.00	49.2 PK	88.0	-38.8	1.89 V	169	47.30	1.90
6	#3249.00	44.1 AV	80.7	-36.6	1.89 V	169	42.20	1.90
7	4874.00	48.7 PK	74.0	-25.3	1.61 V	86	42.70	6.00
8	4874.00	34.9 AV	54.0	-19.1	1.61 V	86	28.90	6.00

REMARKS:

1. Emission Level(dBuV/m) = Raw Value(dBuV) + Correction Factor(dB/m)
2. Correction Factor(dB/m) = Antenna Factor(dB/m) + Cable Factor(dB)
3. The other emission levels were very low against the limit.
4. Margin value = Emission Level – Limit value
5. " * ": Fundamental frequency.
6. " # ": The radiated frequency is out of the restricted band.

CHANNEL	TX Channel 11	DETECTOR FUNCTION	Peak (PK)
FREQUENCY RANGE	1GHz ~ 25GHz		Average (AV)

ANTENNA POLARITY & TEST DISTANCE: HORIZONTAL AT 3 M

NO.	FREQ. (MHz)	EMISSION LEVEL (dBuV/m)	LIMIT (dBuV/m)	MARGIN (dB)	ANTENNA HEIGHT (m)	TABLE ANGLE (Degree)	RAW VALUE (dBuV)	CORRECTION FACTOR (dB/m)
1	*2462.00	100.0 PK			1.09 H	148	67.10	32.90
2	*2462.00	92.8 AV			1.09 H	148	59.90	32.90
3	2483.50	61.9 PK	74.0	-12.1	1.05 H	166	28.90	33.00
4	2483.50	46.0 AV	54.0	-8.0	1.05 H	166	13.00	33.00
5	4924.00	47.4 PK	74.0	-26.6	1.17 H	82	41.40	6.00
6	4924.00	34.9 AV	54.0	-19.1	1.17 H	82	28.90	6.00

ANTENNA POLARITY & TEST DISTANCE: VERTICAL AT 3 M

NO.	FREQ. (MHz)	EMISSION LEVEL (dBuV/m)	LIMIT (dBuV/m)	MARGIN (dB)	ANTENNA HEIGHT (m)	TABLE ANGLE (Degree)	RAW VALUE (dBuV)	CORRECTION FACTOR (dB/m)
1	*2462.00	114.6 PK			2.27 V	353	81.70	32.90
2	*2462.00	107.7 AV			2.27 V	353	74.80	32.90
3	2483.50	67.4 PK	74.0	-6.6	1.91 V	166	34.40	33.00
4	2483.50	52.5 AV	54.0	-1.5	1.91 V	166	19.50	33.00
5	4924.00	48.0 PK	74.0	-26.0	1.95 V	252	42.00	6.00
6	4924.00	35.1 AV	54.0	-18.9	1.95 V	252	29.10	6.00

REMARKS:

1. Emission Level(dBuV/m) = Raw Value(dBuV) + Correction Factor(dB/m)
2. Correction Factor(dB/m) = Antenna Factor(dB/m) + Cable Factor(dB)
3. The other emission levels were very low against the limit.
4. Margin value = Emission Level – Limit value
5. " * ": Fundamental frequency.

802.11n (VHT40)

CHANNEL	TX Channel 3	DETECTOR FUNCTION	Peak (PK)
FREQUENCY RANGE	1GHz ~ 25GHz		Average (AV)

ANTENNA POLARITY & TEST DISTANCE: HORIZONTAL AT 3 M								
NO.	FREQ. (MHz)	EMISSION LEVEL (dBuV/m)	LIMIT (dBuV/m)	MARGIN (dB)	ANTENNA HEIGHT (m)	TABLE ANGLE (Degree)	RAW VALUE (dBuV)	CORRECTION FACTOR (dB/m)
1	2390.00	59.2 PK	74.0	-14.8	1.62 H	214	26.40	32.80
2	2390.00	46.0 AV	54.0	-8.0	1.62 H	214	13.20	32.80
3	*2422.00	94.8 PK			1.00 H	222	61.90	32.90
4	*2422.00	84.9 AV			1.00 H	222	52.00	32.90
5	4844.00	47.1 PK	74.0	-26.9	1.23 H	152	41.30	5.80
6	4844.00	34.5 AV	54.0	-19.5	1.23 H	152	28.70	5.80

ANTENNA POLARITY & TEST DISTANCE: VERTICAL AT 3 M								
NO.	FREQ. (MHz)	EMISSION LEVEL (dBuV/m)	LIMIT (dBuV/m)	MARGIN (dB)	ANTENNA HEIGHT (m)	TABLE ANGLE (Degree)	RAW VALUE (dBuV)	CORRECTION FACTOR (dB/m)
1	2390.00	72.9 PK	74.0	-1.1	1.56 V	154	40.10	32.80
2	2390.00	52.1 AV	54.0	-1.9	1.56 V	154	19.30	32.80
3	*2422.00	108.4 PK			2.36 V	2	75.50	32.90
4	*2422.00	103.7 AV			2.36 V	2	70.80	32.90
5	4844.00	47.7 PK	74.0	-26.3	1.54 V	182	41.90	5.80
6	4844.00	34.4 AV	54.0	-19.6	1.54 V	182	28.60	5.80

REMARKS:

1. Emission Level(dBuV/m) = Raw Value(dBuV) + Correction Factor(dB/m)
2. Correction Factor(dB/m) = Antenna Factor(dB/m) + Cable Factor(dB)
3. The other emission levels were very low against the limit.
4. Margin value = Emission Level – Limit value
5. " * ": Fundamental frequency.

CHANNEL	TX Channel 6	DETECTOR FUNCTION	Peak (PK)
FREQUENCY RANGE	1GHz ~ 25GHz		Average (AV)

ANTENNA POLARITY & TEST DISTANCE: HORIZONTAL AT 3 M

NO.	FREQ. (MHz)	EMISSION LEVEL (dBuV/m)	LIMIT (dBuV/m)	MARGIN (dB)	ANTENNA HEIGHT (m)	TABLE ANGLE (Degree)	RAW VALUE (dBuV)	CORRECTION FACTOR (dB/m)
1	*2437.00	94.2 PK			1.24 H	216	61.30	32.90
2	*2437.00	83.5 AV			1.24 H	216	50.60	32.90
3	2483.50	56.9 PK	74.0	-17.1	1.35 H	196	23.90	33.00
4	2483.50	44.9 AV	54.0	-9.1	1.35 H	196	11.90	33.00
5	#3249.00	45.6 PK	64.2	-18.6	1.20 H	139	43.70	1.90
6	#3249.00	34.3 AV	53.5	-19.2	1.20 H	139	32.40	1.90
7	4874.00	48.3 PK	74.0	-25.7	1.06 H	86	42.30	6.00
8	4874.00	34.5 AV	54.0	-19.5	1.06 H	86	28.50	6.00

ANTENNA POLARITY & TEST DISTANCE: VERTICAL AT 3 M

NO.	FREQ. (MHz)	EMISSION LEVEL (dBuV/m)	LIMIT (dBuV/m)	MARGIN (dB)	ANTENNA HEIGHT (m)	TABLE ANGLE (Degree)	RAW VALUE (dBuV)	CORRECTION FACTOR (dB/m)
1	*2437.00	109.7 PK			1.22 V	184	76.80	32.90
2	*2437.00	100.2 AV			1.22 V	184	67.30	32.90
3	2483.50	72.9 PK	74.0	-1.1	1.07 V	177	39.90	33.00
4	2483.50	49.5 AV	54.0	-4.5	1.07 V	177	16.50	33.00
5	#3249.00	52.9 PK	79.7	-26.8	1.73 V	155	51.00	1.90
6	#3249.00	47.5 AV	70.2	-22.7	1.73 V	155	45.60	1.90
7	4874.00	47.2 PK	74.0	-26.8	1.48 V	63	41.20	6.00
8	4874.00	35.2 AV	54.0	-18.8	1.48 V	63	29.20	6.00

REMARKS:

1. Emission Level(dBuV/m) = Raw Value(dBuV) + Correction Factor(dB/m)
2. Correction Factor(dB/m) = Antenna Factor(dB/m) + Cable Factor(dB)
3. The other emission levels were very low against the limit.
4. Margin value = Emission Level – Limit value
5. " * ": Fundamental frequency.
6. " # ": The radiated frequency is out of the restricted band.

CHANNEL	TX Channel 9	DETECTOR FUNCTION	Peak (PK)
FREQUENCY RANGE	1GHz ~ 25GHz		Average (AV)

ANTENNA POLARITY & TEST DISTANCE: HORIZONTAL AT 3 M

NO.	FREQ. (MHz)	EMISSION LEVEL (dBuV/m)	LIMIT (dBuV/m)	MARGIN (dB)	ANTENNA HEIGHT (m)	TABLE ANGLE (Degree)	RAW VALUE (dBuV)	CORRECTION FACTOR (dB/m)
1	*2452.00	90.7 PK			1.00 H	106	57.70	33.00
2	*2452.00	85.1 AV			1.00 H	106	52.10	33.00
3	2483.50	56.5 PK	74.0	-17.5	1.98 H	3	23.50	33.00
4	2483.50	45.0 AV	54.0	-9.0	1.98 H	3	12.00	33.00
5	4904.00	47.8 PK	74.0	-26.2	1.32 H	241	41.90	5.90
6	4904.00	35.0 AV	54.0	-19.0	1.32 H	241	29.10	5.90

ANTENNA POLARITY & TEST DISTANCE: VERTICAL AT 3 M

NO.	FREQ. (MHz)	EMISSION LEVEL (dBuV/m)	LIMIT (dBuV/m)	MARGIN (dB)	ANTENNA HEIGHT (m)	TABLE ANGLE (Degree)	RAW VALUE (dBuV)	CORRECTION FACTOR (dB/m)
1	*2452.00	113.6 PK			1.38 V	169	80.60	33.00
2	*2452.00	102.6 AV			1.38 V	169	69.60	33.00
3	2483.50	72.2 PK	74.0	-1.8	2.78 V	290	39.20	33.00
4	2483.50	48.4 AV	54.0	-5.6	2.78 V	290	15.40	33.00
5	4904.00	47.6 PK	74.0	-26.4	1.08 V	76	41.70	5.90
6	4904.00	35.3 AV	54.0	-18.7	1.08 V	76	29.40	5.90

REMARKS:

1. Emission Level(dBuV/m) = Raw Value(dBuV) + Correction Factor(dB/m)
2. Correction Factor(dB/m) = Antenna Factor(dB/m) + Cable Factor(dB)
3. The other emission levels were very low against the limit.
4. Margin value = Emission Level – Limit value
5. " * ": Fundamental frequency.

Below 1GHz Worst-Case Data: 802.11b

CHANNEL	TX Channel 1	DETECTOR FUNCTION	Quasi-Peak (QP)
FREQUENCY RANGE	9kHz ~ 1GHz		

ANTENNA POLARITY & TEST DISTANCE: HORIZONTAL AT 3 M

NO.	FREQ. (MHz)	EMISSION LEVEL (dBuV/m)	LIMIT (dBuV/m)	MARGIN (dB)	ANTENNA HEIGHT (m)	TABLE ANGLE (Degree)	RAW VALUE (dBuV)	CORRECTION FACTOR (dB/m)
1	57.12	30.8 QP	40.0	-9.2	2.00 H	96	45.30	-14.50
2	90.17	36.3 QP	43.5	-7.2	2.00 H	288	55.90	-19.60
3	150.45	35.9 QP	43.5	-7.6	1.51 H	247	49.70	-13.80
4	374.04	43.0 QP	46.0	-3.0	1.01 H	152	53.60	-10.60
5	624.85	40.8 QP	46.0	-5.2	1.01 H	280	45.90	-5.10
6	751.23	37.0 QP	46.0	-9.0	1.51 H	338	39.80	-2.80

ANTENNA POLARITY & TEST DISTANCE: VERTICAL AT 3 M

NO.	FREQ. (MHz)	EMISSION LEVEL (dBuV/m)	LIMIT (dBuV/m)	MARGIN (dB)	ANTENNA HEIGHT (m)	TABLE ANGLE (Degree)	RAW VALUE (dBuV)	CORRECTION FACTOR (dB/m)
1	49.34	35.5 QP	40.0	-4.5	1.00 V	290	49.80	-14.30
2	76.56	34.7 QP	40.0	-5.3	1.99 V	234	52.40	-17.70
3	374.04	41.6 QP	46.0	-4.4	1.00 V	187	52.20	-10.60
4	624.85	36.7 QP	46.0	-9.3	1.50 V	15	41.80	-5.10
5	714.29	41.8 QP	46.0	-4.2	1.50 V	15	45.60	-3.80
6	875.67	35.4 QP	46.0	-10.6	1.50 V	337	36.30	-0.90

REMARKS:

1. Emission Level(dBuV/m) = Raw Value(dBuV) + Correction Factor(dB/m)
2. Correction Factor(dB/m) = Antenna Factor(dB/m) + Cable Factor(dB)
3. The other emission levels were very low against the limit.
4. Margin value = Emission Level – Limit value

4.2 Conducted Emission Measurement

4.2.1 Limits of Conducted Emission Measurement

Frequency (MHz)	Conducted Limit (dBuV)	
	Quasi-peak	Average
0.15 - 0.5	66 - 56	56 - 46
0.50 - 5.0	56	46
5.0 - 30.0	60	50

- Note: 1. The lower limit shall apply at the transition frequencies.
 2. The limit decreases in line with the logarithm of the frequency in the range of 0.15 to 0.50MHz.

4.2.2 Test Instruments

Description & Manufacturer	Model No.	Serial No.	Cal. Date	Cal. Due
Test Receiver ROHDE & SCHWARZ	ESCI	100613	Nov. 16, 2015	Nov. 15, 2016
RF signal cable (with 10dB PAD) Woken	5D-FB	Cable-cond1-01	Dec. 26, 2015	Dec. 25, 2016
LISN ROHDE & SCHWARZ (EUT)	ESH3-Z5	835239/001	Feb. 26, 2016	Feb. 25, 2017
LISN ROHDE & SCHWARZ (Peripheral)	ESH3-Z5	100311	Jul. 24, 2015	Jul. 23, 2016
Software ADT	BV ADT_Cond_ V7.3.7.3	NA	NA	NA

- Note: 1. The calibration interval of the above test instruments is 12 months and the calibrations are traceable to NML/ROC and NIST/USA.
 2. The test was performed in HwaYa Shielded Room 1.
 3. The VCCI Site Registration No. is C-2040.

4.2.3 Test Procedures

- The EUT was placed 0.4 meters from the conducting wall of the shielded room with EUT being connected to the power mains through a line impedance stabilization network (LISN). Other support units were connected to the power mains through another LISN. The two LISNs provide 50 ohm/ 50uH of coupling impedance for the measuring instrument.
- Both lines of the power mains connected to the EUT were checked for maximum conducted interference.
- The frequency range from 150kHz to 30MHz was searched. Emission levels under (Limit - 20dB) were not recorded.

NOTE: The resolution bandwidth and video bandwidth of test receiver is 9kHz for quasi-peak detection (QP) and average detection (AV) at frequency 0.15MHz-30MHz.

4.2.4 Deviation from Test Standard

No deviation.

4.2.5 Test Setup

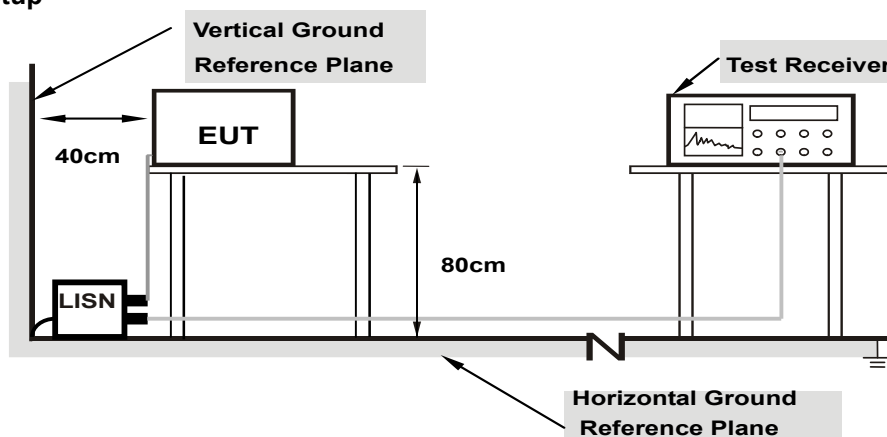

Note: 1.Support units were connected to second LISN.

For the actual test configuration, please refer to the attached file (Test Setup Photo).

4.2.6 EUT Operating Conditions

Same as 4.1.6.

4.2.7 Test Results

Phase	Line (L)	Detector Function	Quasi-Peak (QP) / Average (AV)
-------	----------	-------------------	--------------------------------

No	Freq. [MHz]	Corr. Factor (dB)	Reading Value [dB (uV)]		Emission Level [dB (uV)]		Limit [dB (uV)]		Margin (dB)	
			Q.P.	AV.	Q.P.	AV.	Q.P.	AV.	Q.P.	AV.
			1	0.16600	10.08	22.53	10.72	32.61	20.80	65.16
2	0.46690	10.18	27.35	19.81	37.53	29.99	56.57	46.57	-19.04	-16.58
3	0.51606	10.19	35.45	27.30	45.64	37.49	56.00	46.00	-10.36	-8.51
4	0.57342	10.20	25.13	18.69	35.33	28.89	56.00	46.00	-20.67	-17.11
5	1.21400	10.31	23.83	16.40	34.14	26.71	56.00	46.00	-21.86	-19.29
6	21.65000	11.52	18.13	12.12	29.65	23.64	60.00	50.00	-30.35	-26.36

REMARKS:

1. Q.P. and AV. are abbreviations of quasi-peak and average individually.
2. The emission levels of other frequencies were very low against the limit.
3. Margin value = Emission level - Limit value
4. Correction factor = Insertion loss + Cable loss
5. Emission Level = Correction Factor + Reading Value.

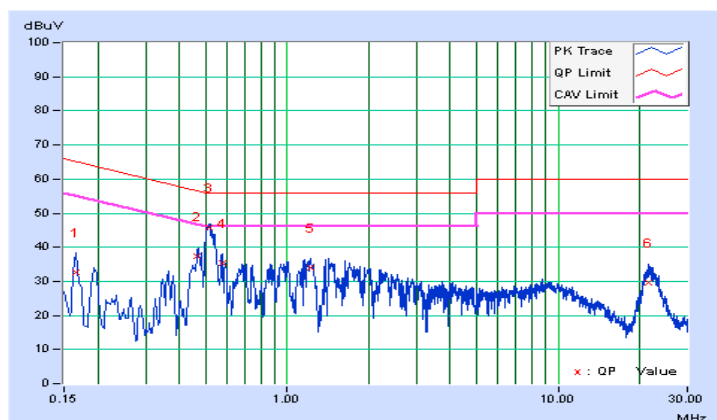

Phase	Neutral (N)	Detector Function	Quasi-Peak (QP) / Average (AV)
-------	-------------	-------------------	--------------------------------

No	Freq. [MHz]	Corr. Factor (dB)	Reading Value [dB (uV)]		Emission Level [dB (uV)]		Limit [dB (uV)]		Margin (dB)	
			Q.P.	AV.	Q.P.	AV.	Q.P.	AV.	Q.P.	AV.
			1	0.18180	10.08	23.24	13.64	33.32	23.72	64.40
2	0.50931	10.25	33.63	22.63	43.88	32.88	56.00	46.00	-12.12	-13.12
3	0.52984	10.25	34.18	26.93	44.43	37.18	56.00	46.00	-11.57	-8.82
4	0.69000	10.26	25.19	18.02	35.45	28.28	56.00	46.00	-20.55	-17.72
5	1.18649	10.31	24.79	17.42	35.10	27.73	56.00	46.00	-20.90	-18.27
6	21.87000	11.71	17.82	10.69	29.53	22.40	60.00	50.00	-30.47	-27.60

REMARKS:

1. Q.P. and AV. are abbreviations of quasi-peak and average individually.
2. The emission levels of other frequencies were very low against the limit.
3. Margin value = Emission level - Limit value
4. Correction factor = Insertion loss + Cable loss
5. Emission Level = Correction Factor + Reading Value.

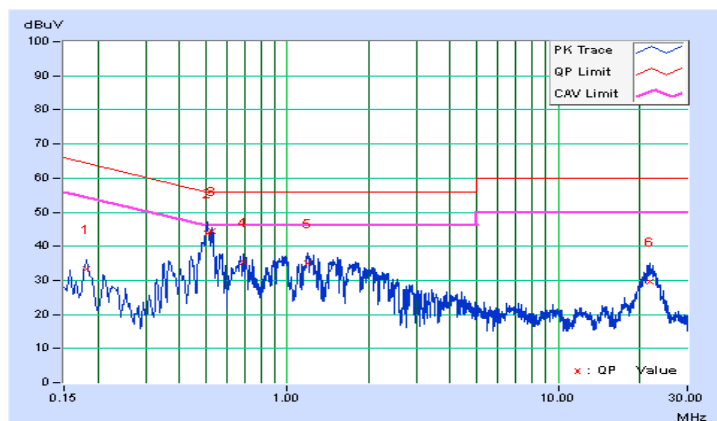

4.3 6dB Bandwidth Measurement

4.3.1 Limits of 6dB Bandwidth Measurement

The minimum of 6dB Bandwidth Measurement is 0.5 MHz.

4.3.2 Test Setup

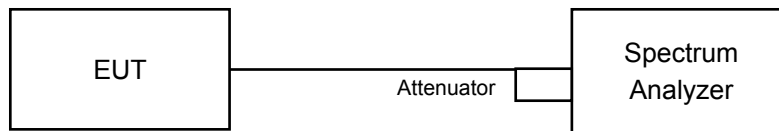

4.3.3 Test Instruments

Refer to section 4.1.2 to get information of above instrument.

4.3.4 Test Procedure

- Set resolution bandwidth (RBW) = 100kHz
- Set the video bandwidth (VBW) $\geq 3 \times$ RBW, Detector = Peak.
- Trace mode = max hold.
- Sweep = auto couple.
- Measure the maximum width of the emission that is constrained by the frequencies associated with the two amplitude points (upper and lower) that are attenuated by 6 dB relative to the maximum level measured in the fundamental emission

4.3.5 Deviation from Test Standard

No deviation.

4.3.6 EUT Operating Conditions

The software provided by client to enable the EUT under transmission condition continuously at lowest, middle and highest channel frequencies individually.

4.3.7 Test Result

CDD Mode

802.11b

Channel	Frequency (MHz)	6dB Bandwidth (MHz)				Minimum Limit (MHz)	Pass / Fail
		Chain 0	Chain 1	Chain 2	Chain 3		
1	2412	8.11	8.10	7.58	8.11	0.5	Pass
6	2437	8.12	8.09	7.14	9.10	0.5	Pass
11	2462	8.11	7.14	9.09	9.11	0.5	Pass

802.11g

Channel	Frequency (MHz)	6dB Bandwidth (MHz)				Minimum Limit (MHz)	Pass / Fail
		Chain 0	Chain 1	Chain 2	Chain 3		
1	2412	16.34	16.07	15.78	15.74	0.5	Pass
6	2437	16.07	15.75	15.50	15.36	0.5	Pass
11	2462	16.30	15.75	15.49	15.74	0.5	Pass

802.11n (HT20)

Channel	Frequency (MHz)	6dB Bandwidth (MHz)				Minimum Limit (MHz)	Pass / Fail
		Chain 0	Chain 1	Chain 2	Chain 3		
1	2412	16.84	17.19	15.78	15.16	0.5	Pass
6	2437	16.84	16.02	15.73	15.36	0.5	Pass
11	2462	16.80	16.00	15.70	15.71	0.5	Pass

802.11n (HT40)

Channel	Frequency (MHz)	6dB Bandwidth (MHz)				Minimum Limit (MHz)	Pass / Fail
		Chain 0	Chain 1	Chain 2	Chain 3		
3	2422	35.19	35.10	35.18	35.23	0.5	Pass
6	2437	35.21	35.20	35.11	35.19	0.5	Pass
9	2452	35.22	35.19	35.13	35.21	0.5	Pass



Spectrum Plot of Worst Value

802.11b

802.11g

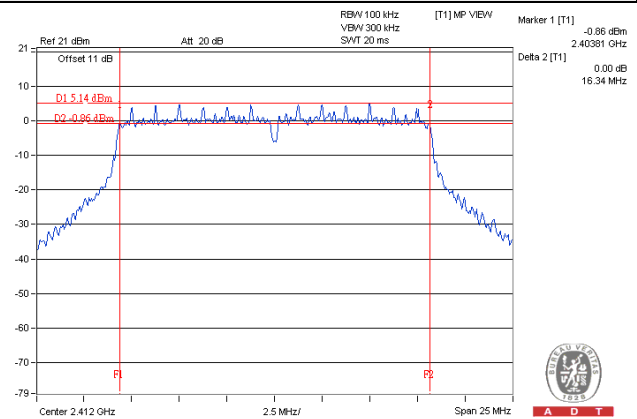
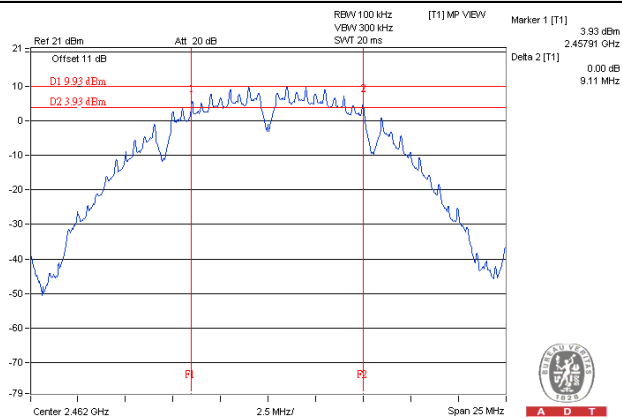

802.11n (HT20)

802.11n (HT40)

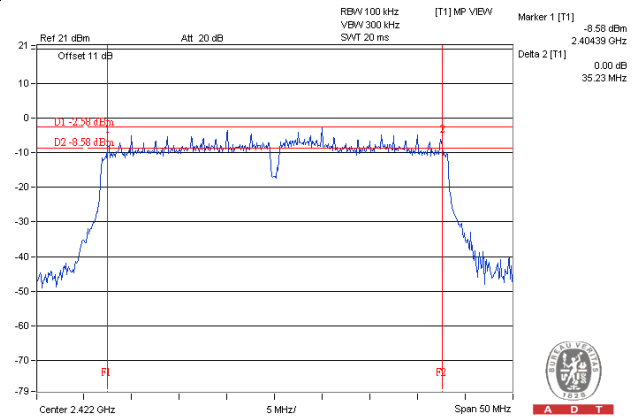
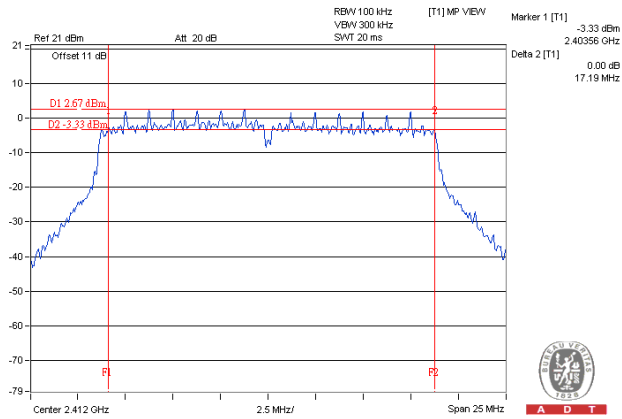

Beamforming Mode

802.11n (VHT20)

Channel	Frequency (MHz)	6dB Bandwidth (MHz)				Minimum Limit (MHz)	Pass / Fail
		Chain 0	Chain 1	Chain 2	Chain 3		
1	2412	16.86	16.58	16.62	15.13	0.5	Pass
6	2437	16.82	16.95	15.76	15.37	0.5	Pass
11	2462	16.58	16.57	16.33	15.35	0.5	Pass

802.11n (VHT40)

Channel	Frequency (MHz)	6dB Bandwidth (MHz)				Minimum Limit (MHz)	Pass / Fail
		Chain 0	Chain 1	Chain 2	Chain 3		
3	2422	35.16	35.20	35.18	35.15	0.5	Pass
6	2437	35.23	35.15	35.14	35.17	0.5	Pass
9	2452	35.18	35.14	31.37	35.23	0.5	Pass

Spectrum Plot of Worst Value

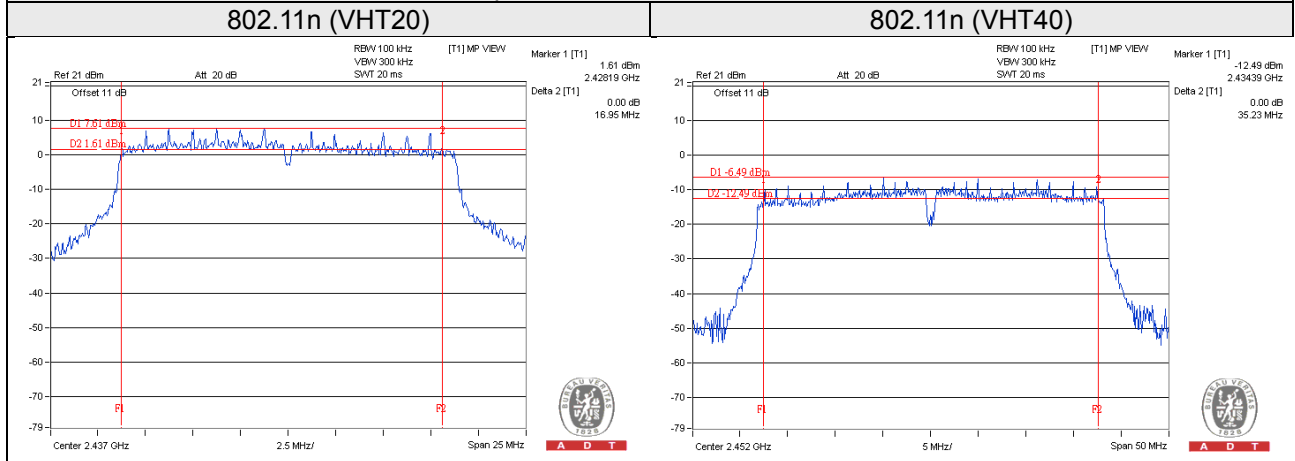

4.4 Conducted Output Power Measurement

4.4.1 Limits of Conducted Output Power Measurement

For systems using digital modulation in the 2400–2483.5 MHz bands: 1 Watt (30dBm)
Per KDB 662911 D01 Multiple Transmitter Output Method of conducted output power measurement on IEEE 802.11 devices,

Array Gain = 0 dB (i.e., no array gain) for $N_{ANT} \leq 4$;

Array Gain = 0 dB (i.e., no array gain) for channel widths ≥ 40 MHz for any N_{ANT} ;

Array Gain = $5 \log(N_{ANT}/N_{SS})$ dB or 3 dB, whichever is less for 20-MHz channel widths with $N_{ANT} \geq 5$.

For power measurements on all other devices: Array Gain = $10 \log(N_{ANT}/N_{SS})$ dB.

4.4.2 Test Setup

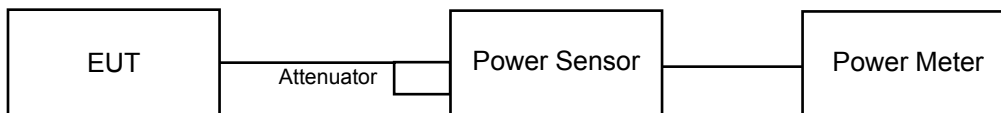

4.4.3 Test Instruments

Refer to section 4.1.2 to get information of above instrument.

4.4.4 Test Procedures

An average power sensor was used on the output port of the EUT. A power meter was used to read the response of the average power sensor. Record the power level.

4.4.5 Deviation from Test Standard

No deviation.

4.4.6 EUT Operating Conditions

Same as item 4.3.6.

4.4.7 Test Results

For Average Power
 CDD Mode

802.11b

Chan.	Freq. (MHz)	Average Power (dBm)				Total Power (mW)	Total Power (dBm)	Limit (dBm)	Pass / Fail
		Chain 0	Chain 1	Chain 2	Chain 3				
1	2412	16.93	16.59	16.72	16.70	188.684	22.76	30	Pass
6	2437	19.95	19.29	19.66	19.81	371.962	25.70	30	Pass
11	2462	17.81	18.63	17.91	18.21	261.365	24.17	30	Pass

802.11g

Chan.	Freq. (MHz)	Average Power (dBm)				Total Power (mW)	Total Power (dBm)	Limit (dBm)	Pass / Fail
		Chain 0	Chain 1	Chain 2	Chain 3				
1	2412	15.31	15.04	14.91	15.27	130.503	21.16	30	Pass
6	2437	18.64	18.06	18.27	18.71	278.532	24.45	30	Pass
11	2462	15.09	15.02	14.78	15.08	126.326	21.01	30	Pass

802.11n (HT20)

Chan.	Freq. (MHz)	Average Power (dBm)				Total Power (mW)	Total Power (dBm)	Limit (dBm)	Pass / Fail
		Chain 0	Chain 1	Chain 2	Chain 3				
1	2412	12.94	12.78	12.59	12.89	76.255	18.82	30	Pass
6	2437	18.35	17.81	17.85	18.43	259.403	24.14	30	Pass
11	2462	13.81	13.67	13.66	13.79	94.485	19.75	30	Pass

802.11n (HT40)

Chan.	Freq. (MHz)	Average Power (dBm)				Total Power (mW)	Total Power (dBm)	Limit (dBm)	Pass / Fail
		Chain 0	Chain 1	Chain 2	Chain 3				
3	2422	9.65	9.61	9.44	9.62	36.319	15.60	30	Pass
6	2437	11.07	11.21	11.44	11.85	55.250	17.42	30	Pass
9	2452	10.77	10.81	10.66	11.20	48.814	16.89	30	Pass

Beamforming Mode

802.11n (VHT20)

Chan.	Freq. (MHz)	Average Power (dBm)				Total Power (mW)	Total Power (dBm)	Limit (dBm)	Pass / Fail
		Chain 0	Chain 1	Chain 2	Chain 3				
1	2412	9.83	9.21	9.49	9.40	35.555	15.51	25.48	Pass
6	2437	17.70	17.15	17.32	17.80	224.971	23.52	25.48	Pass
11	2462	10.34	10.11	10.64	10.39	43.599	16.39	25.48	Pass

*Directional gain = $4.5\text{dBi} + 10\log(4) = 10.52 > 6\text{dBi}$, so the power limit shall be reduced to $30 - (10.52 - 6) = 25.48\text{dBm}$.

802.11n (VHT40)

Chan.	Freq. (MHz)	Average Power (dBm)				Total Power (mW)	Total Power (dBm)	Limit (dBm)	Pass / Fail
		Chain 0	Chain 1	Chain 2	Chain 3				
3	2422	7.31	7.22	7.40	7.15	21.338	13.29	25.48	Pass
6	2437	6.75	7.05	7.02	7.12	19.989	13.01	25.48	Pass
9	2452	5.61	6.04	5.97	6.08	15.666	11.95	25.48	Pass

*Directional gain = $4.5\text{dBi} + 10\log(4) = 10.52 > 6\text{dBi}$, so the power limit shall be reduced to $30 - (10.52 - 6) = 25.48\text{dBm}$.

4.5 Power Spectral Density Measurement

4.5.1 Limits of Power Spectral Density Measurement

The Maximum of Power Spectral Density Measurement is 8dBm.

4.5.2 Test Setup

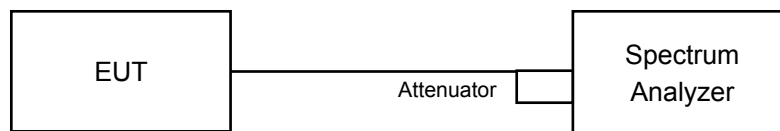

4.5.3 Test Instruments

Refer to section 4.1.2 to get information of above instrument.

4.5.4 Test Procedure

For AVG. power (duty cycle $\geq 98\%$)

- a) Set instrument center frequency to DTS channel center frequency.
- b) Set span to at least 1.5 times the OBW.
- c) Set RBW to: $3 \text{ kHz} \leq \text{RBW} \leq 100 \text{ kHz}$.
- d) Set VBW $\geq 3 \times \text{RBW}$.
- e) Detector = power averaging (RMS) or sample detector (when RMS not available).
- f) Ensure that the number of measurement points in the sweep $\geq 2 \times \text{span}/\text{RBW}$.
- g) Sweep time = auto couple.
- h) Employ trace averaging (RMS) mode over a minimum of 100 traces.
- i) Use the peak marker function to determine the maximum amplitude level.

For AVG. power (duty cycle $< 98\%$)

- a) Measure the duty cycle (x).
- b) Set instrument center frequency to DTS channel center frequency.
- c) Set span to at least 1.5 times the OBW.
- d) Set RBW to: $3 \text{ kHz} \leq \text{RBW} \leq 100 \text{ kHz}$.
- e) Set VBW $\geq 3 \times \text{RBW}$.
- f) Detector = power averaging (RMS) or sample detector (when RMS not available).
- g) Ensure that the number of measurement points in the sweep $\geq 2 \times \text{span}/\text{RBW}$.
- h) Sweep time = auto couple.
- i) Do not use sweep triggering. Allow sweep to "free run".
- j) Employ trace averaging (RMS) mode over a minimum of 100 traces.
- k) Use the peak marker function to determine the maximum amplitude level.
- l) Add $10 \log(1/x)$, where x is the duty cycle measured in step (a), to the measured PSD to compute the average PSD during the actual transmission time.

4.5.5 Deviation from Test Standard

No deviation.

4.5.6 EUT Operating Condition

Same as item 4.3.6

4.5.7 Test Results

CDD Mode

802.11b

TX chain	Chan.	Freq. (MHz)	PSD (dBm/10kHz)	10 log (N=4) dB	Total PSD (dBm/10kHz)	Limit (dBm/3kHz)	Pass / Fail
0	1	2412	-10.55	6.02	-4.53	3.48	Pass
	6	2437	-6.38	6.02	-0.36	3.48	Pass
	11	2462	-9.69	6.02	-3.67	3.48	Pass
1	1	2412	-10.81	6.02	-4.79	3.48	Pass
	6	2437	-8.46	6.02	-2.44	3.48	Pass
	11	2462	-9.03	6.02	-3.01	3.48	Pass
2	1	2412	-10.64	6.02	-4.62	3.48	Pass
	6	2437	-6.78	6.02	-0.76	3.48	Pass
	11	2462	-8.82	6.02	-2.80	3.48	Pass
3	1	2412	-10.51	6.02	-4.49	3.48	Pass
	6	2437	-7.47	6.02	-1.45	3.48	Pass
	11	2462	-9.01	6.02	-2.99	3.48	Pass

Note:

1. Method 1 of power density measurement of KDB 662911 is using for calculating total power density. Total power density is summing entire spectra across corresponding frequency bins on the various outputs by computer.
2. Directional gain = $4.5\text{dBi} + 10\log(4) = 10.52\text{dBi} > 6\text{dBi}$, so the power density limit shall be reduced to $8 - (10.52 - 6) = 3.48\text{dBm}$.

802.11g

TX chain	Chan.	Freq. (MHz)	PSD (dBm/10kHz)	10 log (N=4) dB	Duty Factor	Total PSD with Duty Factor (dBm/10kHz)	Limit (dBm/3kHz)	Pass / Fail
0	1	2412	-14.83	6.02	0.17	-8.64	3.48	Pass
	6	2437	-11.39	6.02	0.17	-5.20	3.48	Pass
	11	2462	-15.11	6.02	0.17	-8.92	3.48	Pass
1	1	2412	-14.67	6.02	0.17	-8.48	3.48	Pass
	6	2437	-11.38	6.02	0.17	-5.19	3.48	Pass
	11	2462	-14.68	6.02	0.17	-8.49	3.48	Pass
2	1	2412	-14.74	6.02	0.17	-8.55	3.48	Pass
	6	2437	-11.24	6.02	0.17	-5.05	3.48	Pass
	11	2462	-14.13	6.02	0.17	-7.94	3.48	Pass
3	1	2412	-14.17	6.02	0.17	-7.98	3.48	Pass
	6	2437	-10.13	6.02	0.17	-3.94	3.48	Pass
	11	2462	-13.74	6.02	0.17	-7.55	3.48	Pass

Note:

1. Method 1 of power density measurement of KDB 662911 is using for calculating total power density. Total power density is summing entire spectra across corresponding frequency bins on the various outputs by computer.
2. Directional gain = $4.5\text{dBi} + 10\log(4) = 10.52\text{dBi} > 6\text{dBi}$, so the power density limit shall be reduced to $8 - (10.52 - 6) = 3.48\text{dBm}$.
3. Refer to section 3.3 for duty cycle spectrum plot.

802.11n (HT20)

TX chain	Chan.	Freq. (MHz)	PSD (dBm/10kHz)	10 log (N=4) dB	Total PSD (dBm/10kHz)	Limit (dBm/3kHz)	Pass / Fail
0	1	2412	-16.47	6.02	-10.45	3.48	Pass
	6	2437	-11.25	6.02	-5.23	3.48	Pass
	11	2462	-15.70	6.02	-9.68	3.48	Pass
1	1	2412	-16.65	6.02	-10.63	3.48	Pass
	6	2437	-10.71	6.02	-4.69	3.48	Pass
	11	2462	-15.23	6.02	-9.21	3.48	Pass
2	1	2412	-16.88	6.02	-10.86	3.48	Pass
	6	2437	-11.03	6.02	-5.01	3.48	Pass
	11	2462	-10.61	6.02	-4.59	3.48	Pass
3	1	2412	-16.15	6.02	-10.13	3.48	Pass
	6	2437	-10.63	6.02	-4.61	3.48	Pass
	11	2462	-14.78	6.02	-8.76	3.48	Pass

Note:

- Method 1 of power density measurement of KDB 662911 is using for calculating total power density. Total power density is summing entire spectra across corresponding frequency bins on the various outputs by computer.
- Directional gain = $4.5\text{dBi} + 10\log(4) = 10.52\text{dBi} > 6\text{dBi}$, so the power density limit shall be reduced to $8 - (10.52 - 6) = 3.48\text{dBm}$.

802.11n (HT40)

TX chain	Chan.	Freq. (MHz)	PSD (dBm/10kHz)	10 log (N=4) dB	Duty Factor	Total PSD with Duty Factor (dBm/10kHz)	Limit (dBm/3kHz)	Pass / Fail
0	3	2422	-22.94	6.02	0.12	-16.80	3.48	Pass
	6	2437	-21.28	6.02	0.12	-15.14	3.48	Pass
	9	2452	-22.61	6.02	0.12	-16.47	3.48	Pass
1	3	2422	-22.98	6.02	0.12	-16.84	3.48	Pass
	6	2437	-20.84	6.02	0.12	-14.70	3.48	Pass
	9	2452	-21.60	6.02	0.12	-15.46	3.48	Pass
2	3	2422	-22.47	6.02	0.12	-16.33	3.48	Pass
	6	2437	-20.59	6.02	0.12	-14.45	3.48	Pass
	9	2452	-21.12	6.02	0.12	-14.98	3.48	Pass
3	3	2422	-23.06	6.02	0.12	-16.92	3.48	Pass
	6	2437	-19.78	6.02	0.12	-13.64	3.48	Pass
	9	2452	-20.63	6.02	0.12	-14.49	3.48	Pass

Note:

1. Method 1 of power density measurement of KDB 662911 is using for calculating total power density. Total power density is summing entire spectra across corresponding frequency bins on the various outputs by computer.
2. Directional gain = $4.5\text{dBi} + 10\log(4) = 10.52\text{dBi} > 6\text{dBi}$, so the power density limit shall be reduced to $8 - (10.52 - 6) = 3.48\text{dBm}$.
3. Refer to section 3.3 for duty cycle spectrum plot.

Spectrum Plot of Worst Value

802.11b

802.11g

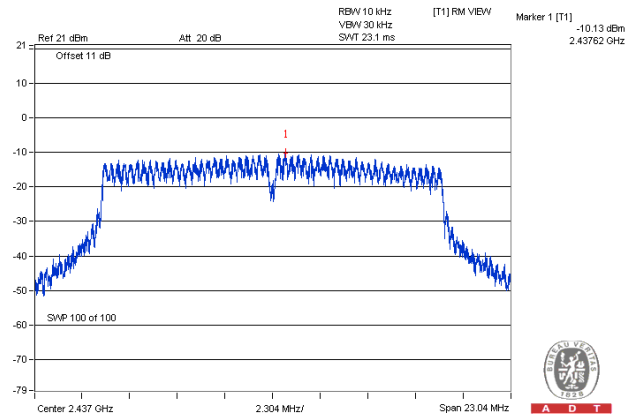
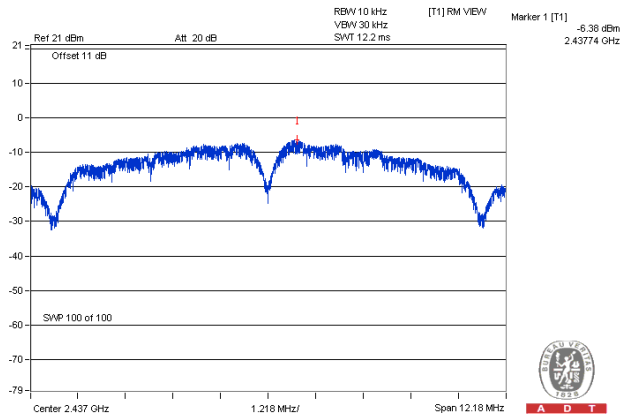

802.11n (HT20)

802.11n (HT40)

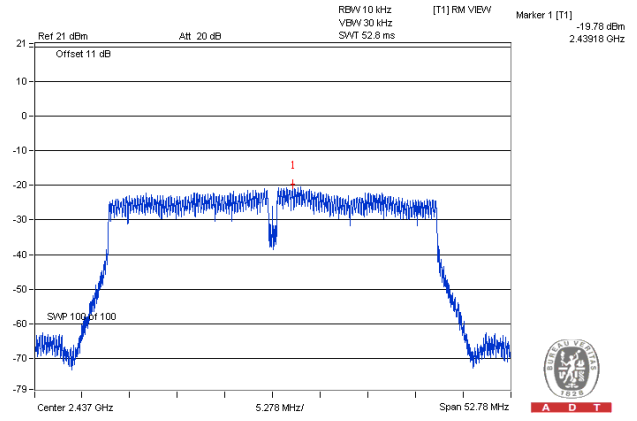
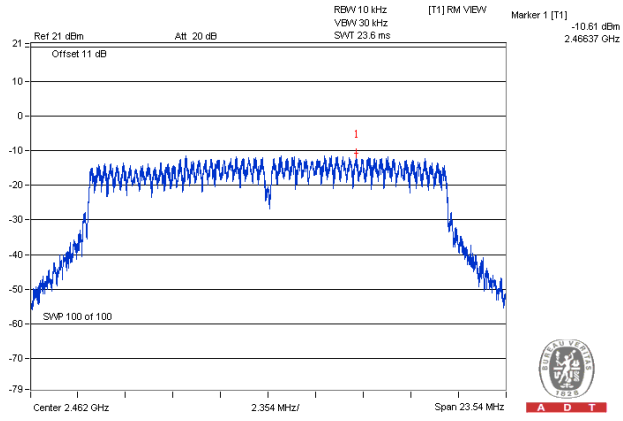

Beamforming Mode

802.11n (VHT20)

TX chain	Chan.	Freq. (MHz)	PSD (dBm/10kHz)	10 log (N=4) dB	Total PSD (dBm/10kHz)	Limit (dBm/3kHz)	Pass / Fail
0	1	2412	-13.50	6.02	-7.48	3.48	Pass
	6	2437	-11.45	6.02	-5.43	3.48	Pass
	11	2462	-18.90	6.02	-12.88	3.48	Pass
1	1	2412	-13.68	6.02	-7.66	3.48	Pass
	6	2437	-12.14	6.02	-6.12	3.48	Pass
	11	2462	-18.53	6.02	-12.51	3.48	Pass
2	1	2412	-13.42	6.02	-7.40	3.48	Pass
	6	2437	-11.31	6.02	-5.29	3.48	Pass
	11	2462	-18.09	6.02	-12.07	3.48	Pass
3	1	2412	-12.43	6.02	-6.41	3.48	Pass
	6	2437	-10.32	6.02	-4.30	3.48	Pass
	11	2462	-18.09	6.02	-12.07	3.48	Pass

Note:

- Method 1 of power density measurement of KDB 662911 is using for calculating total power density. Total power density is summing entire spectra across corresponding frequency bins on the various outputs by computer.
- Directional gain = $4.5\text{dBi} + 10\log(4) = 10.52\text{dBi} > 6\text{dBi}$, so the power density limit shall be reduced to $8 - (10.52 - 6) = 3.48\text{dBm}$.

802.11n (VHT40)

TX chain	Chan.	Freq. (MHz)	PSD (dBm/10kHz)	10 log (N=4) dB	Duty Factor	Total PSD with Duty Factor (dBm/10kHz)	Limit (dBm/3kHz)	Pass / Fail
0	3	2422	-24.66	6.02	0.18	-18.46	3.48	Pass
	6	2437	-25.14	6.02	0.18	-18.94	3.48	Pass
	9	2452	-24.11	6.02	0.18	-17.91	3.48	Pass
1	3	2422	-25.19	6.02	0.18	-18.99	3.48	Pass
	6	2437	-25.00	6.02	0.18	-18.80	3.48	Pass
	9	2452	-25.90	6.02	0.18	-19.70	3.48	Pass
2	3	2422	-24.42	6.02	0.18	-18.22	3.48	Pass
	6	2437	-24.49	6.02	0.18	-18.29	3.48	Pass
	9	2452	-26.14	6.02	0.18	-19.94	3.48	Pass
3	3	2422	-24.01	6.02	0.18	-17.81	3.48	Pass
	6	2437	-24.32	6.02	0.18	-18.12	3.48	Pass
	9	2452	-25.58	6.02	0.18	-19.38	3.48	Pass

Note:

- Method 1 of power density measurement of KDB 662911 is using for calculating total power density. Total power density is summing entire spectra across corresponding frequency bins on the various outputs by computer.
- Directional gain = $4.5\text{dBi} + 10\log(4) = 10.52\text{dBi} > 6\text{dBi}$, so the power density limit shall be reduced to $8 - (10.52 - 6) = 3.48\text{dBm}$.
- Refer to section 3.3 for duty cycle spectrum plot.

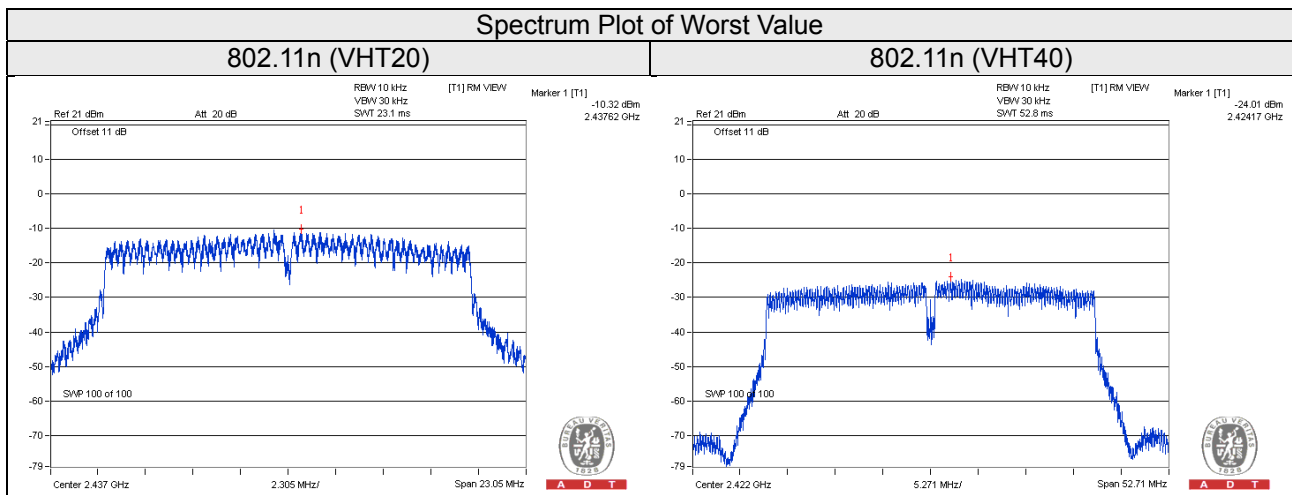

4.6 Conducted Out of Band Emission Measurement

4.6.1 Limits of Conducted Out of Band Emission Measurement

Below 30dB of the highest emission level of operating band (in 100kHz Resolution Bandwidth).

4.6.2 Test Setup

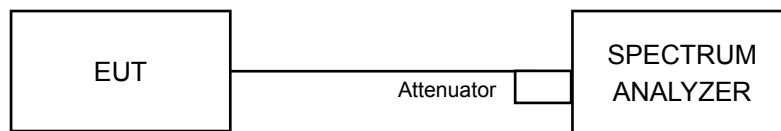

4.6.3 Test Instruments

Refer to section 4.1.2 to get information of above instrument.

4.6.4 Test Procedure

MEASUREMENT PROCEDURE REF

1. Set the RBW = 100 kHz.
2. Set the VBW \geq 300 kHz.
3. Detector = peak.
4. Sweep time = auto couple.
5. Trace mode = max hold.
6. Allow trace to fully stabilize.
7. Use the peak marker function to determine the maximum power level in any 100 kHz band segment within the fundamental EBW.

MEASUREMENT PROCEDURE OOBE

1. Set RBW = 100 kHz.
2. Set VBW \geq 300 kHz.
3. Detector = peak.
4. Sweep = auto couple.
5. Trace Mode = max hold.
6. Allow trace to fully stabilize.
7. Use the peak marker function to determine the maximum amplitude level.

4.6.5 Deviation from Test Standard

No deviation.

4.6.6 EUT Operating Condition

Same as item 4.3.6

4.6.7 Test Results

The conducted emission test is performed on each TX port of operating mode without summing or adding $10\log(N)$ since the limit is relative emission limit.

The spectrum plots are attached on the following pages. D1 line indicates the highest level, and D2 line indicates the 30dB offset below D1. It shows compliance with the requirement.

CDD Mode
802.11b_CHAIN 0

CH 1

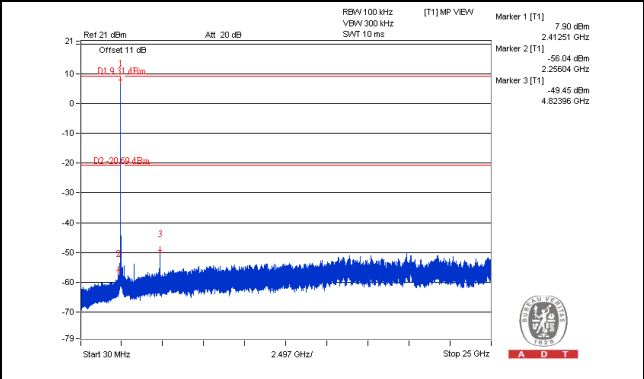
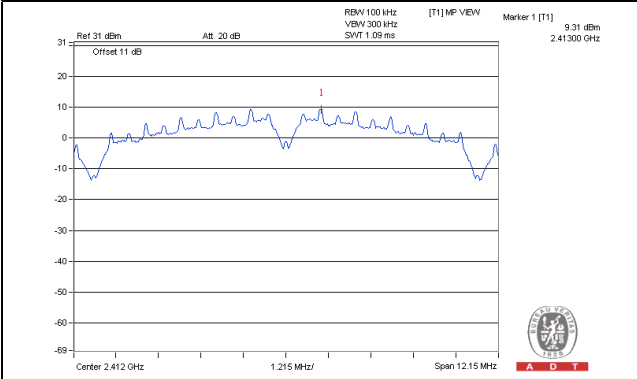

CH 6

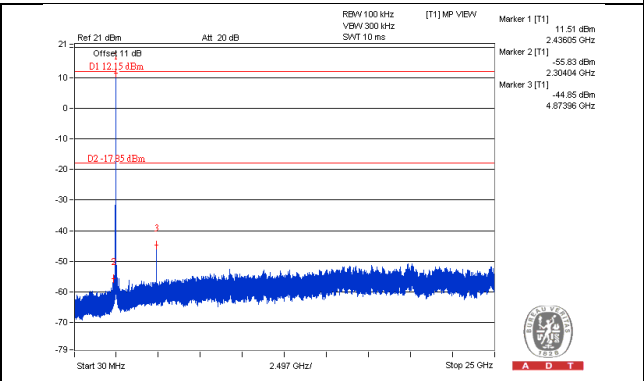
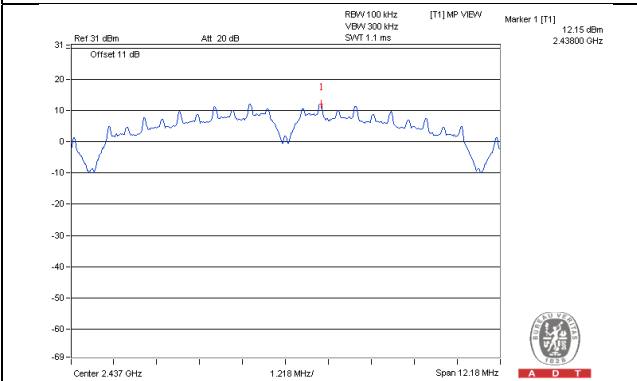

CH 11

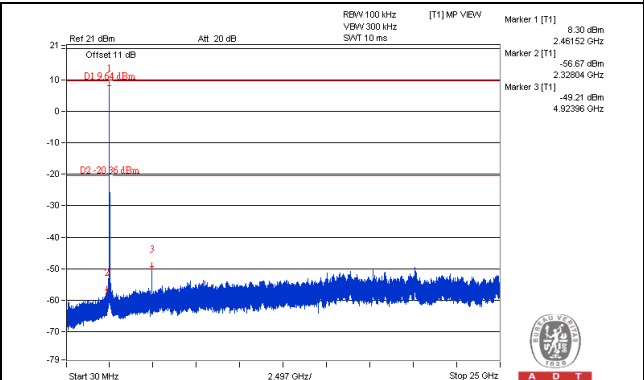
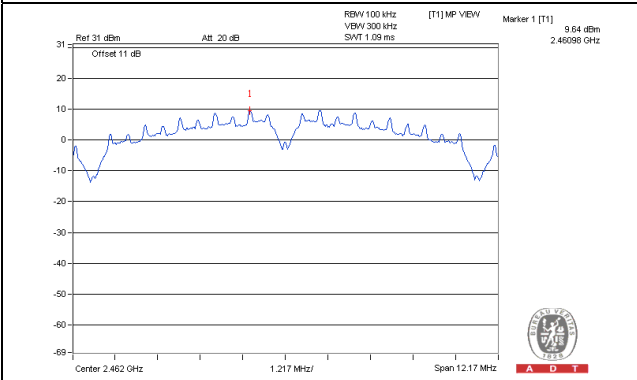

CH 1 Band edge

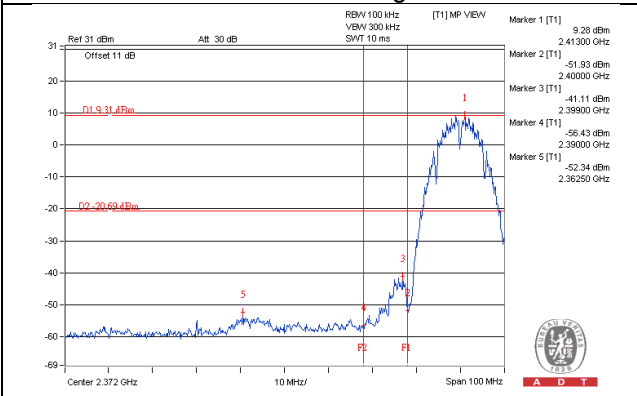

CH 11 Band edge

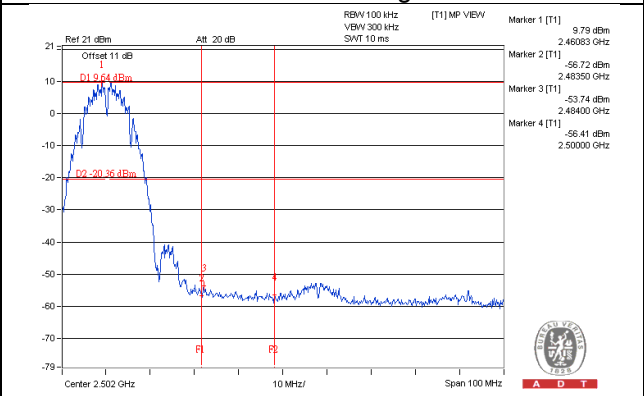

802.11b_CHAIN 1

CH 1

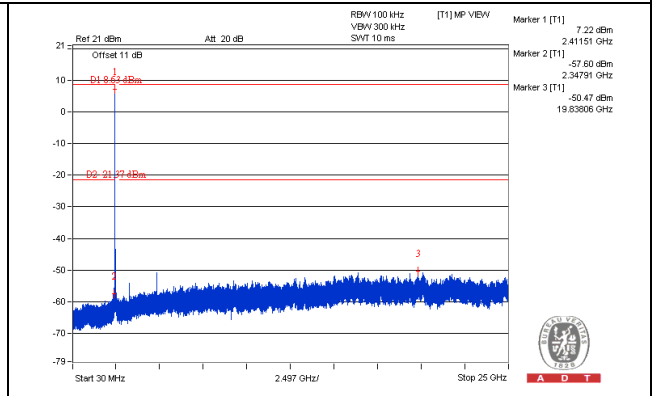
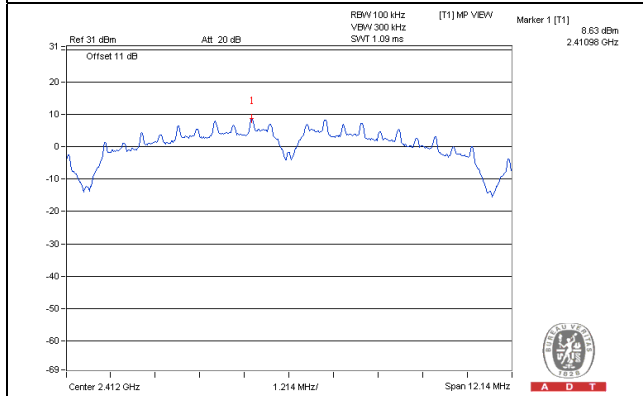

CH 6

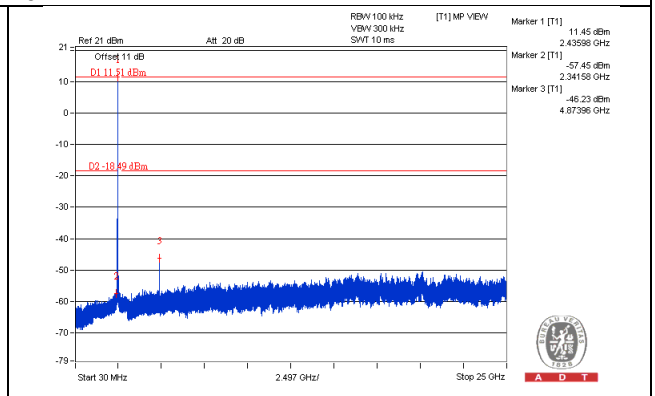
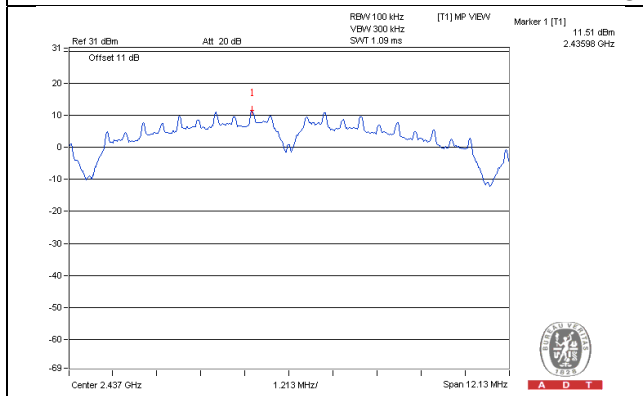

CH 11

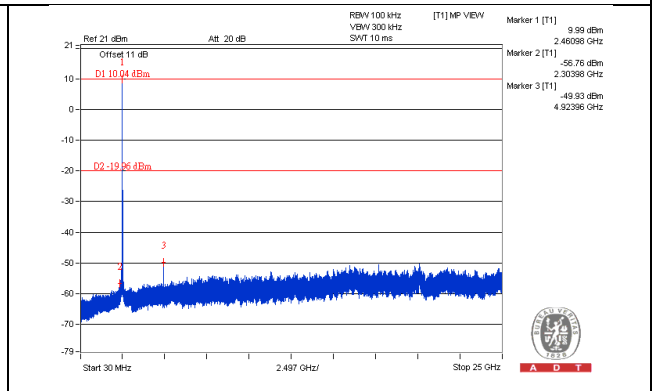
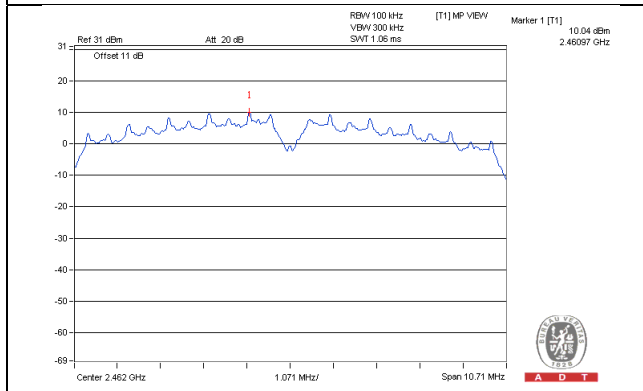

CH 1 Band edge

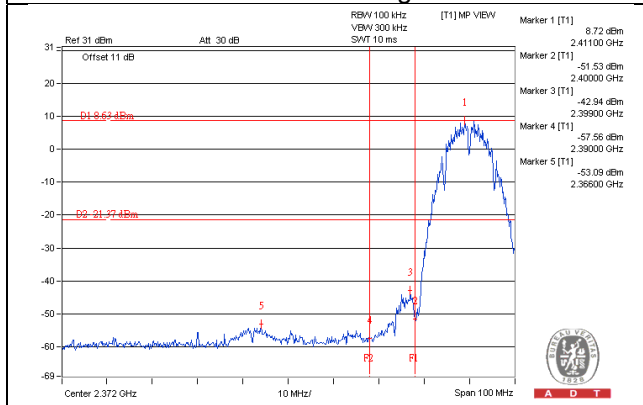

CH 11 Band edge

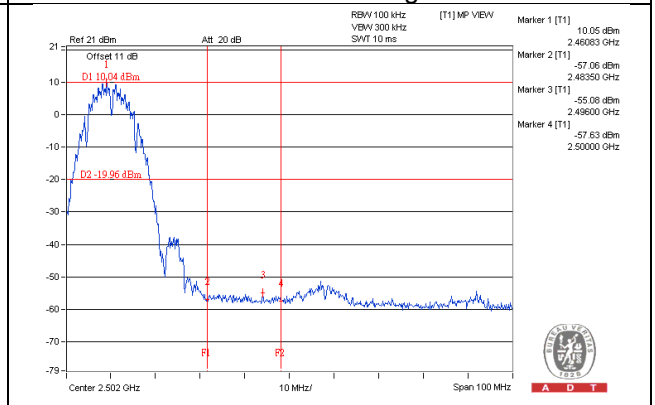



802.11b_CHAIN 2

CH 1

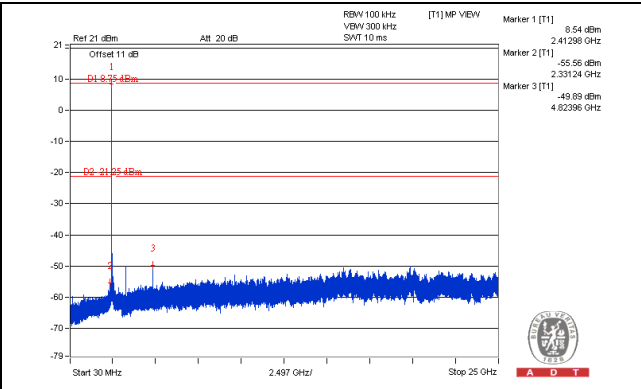
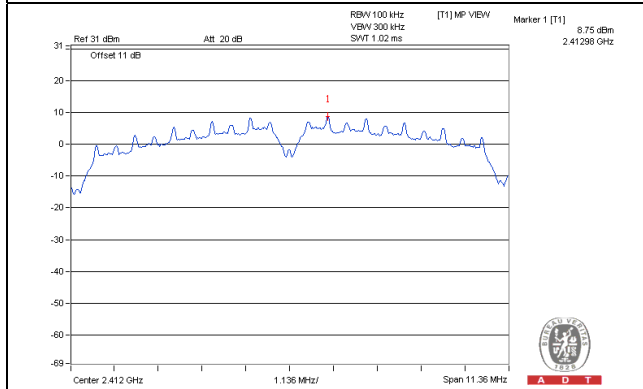

CH 6

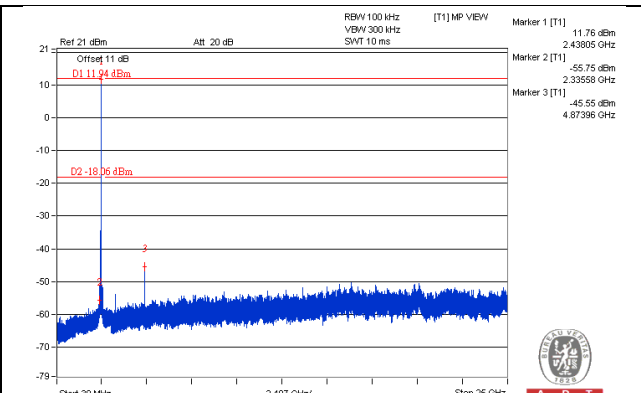
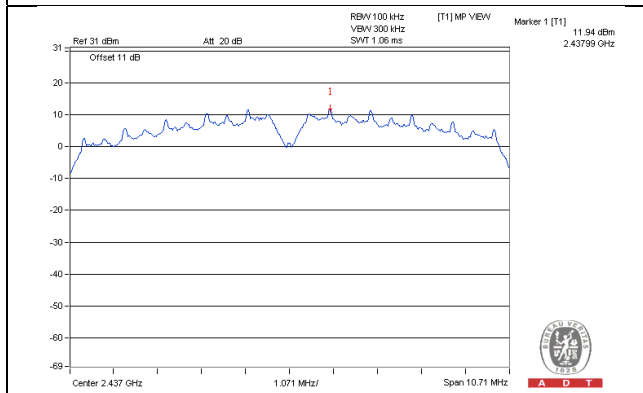

CH 11

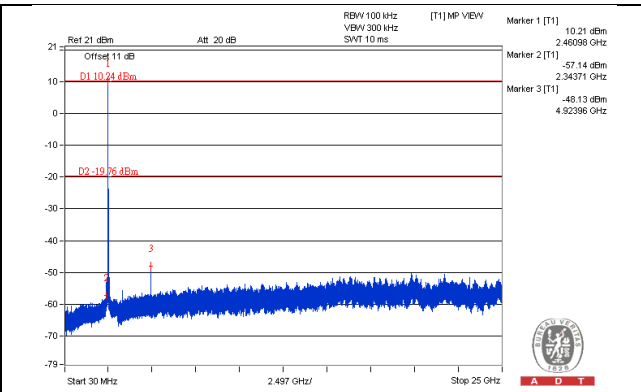
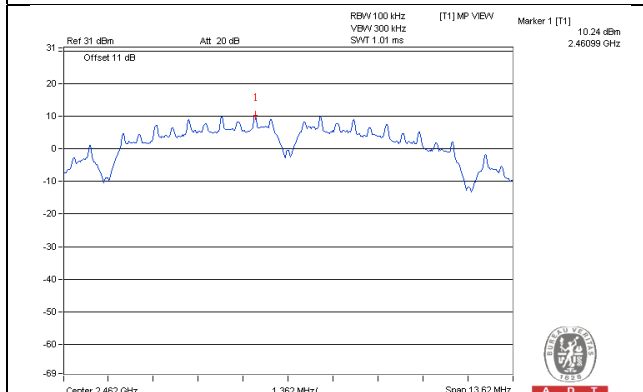

CH 1 Band edge

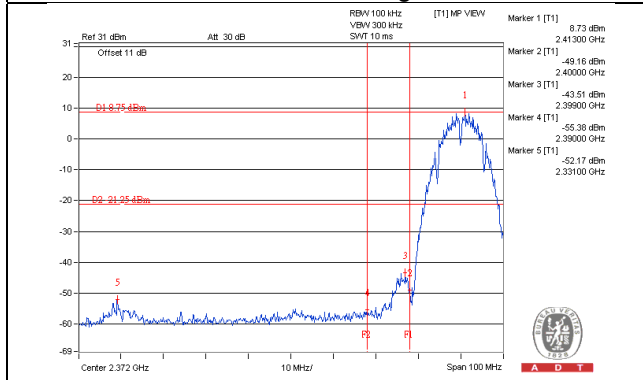

CH 11 Band edge

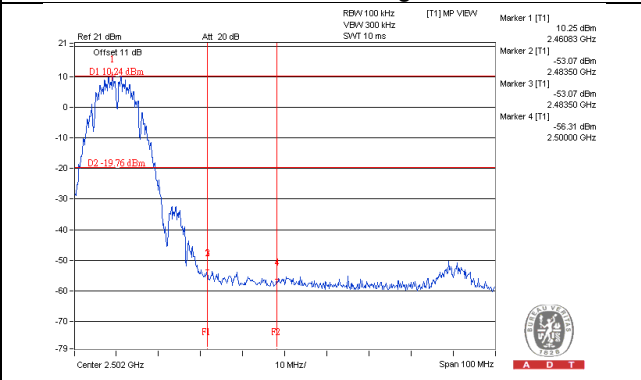



BUREAU VERITAS

802.11b_CHAIN 3

CH 1

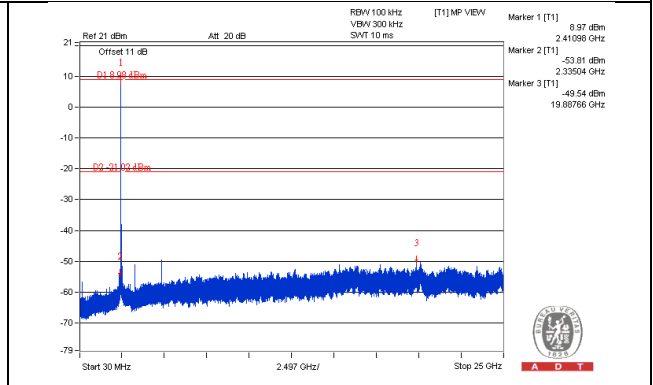
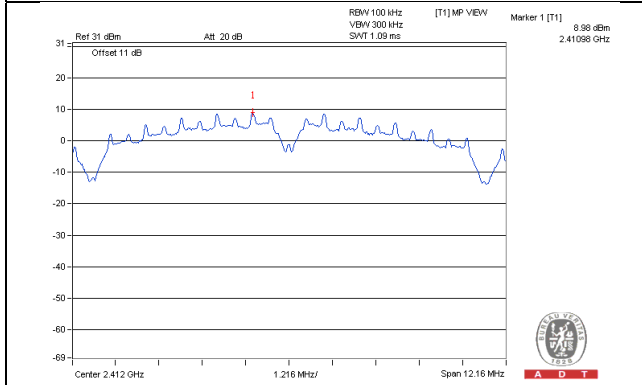

CH 6

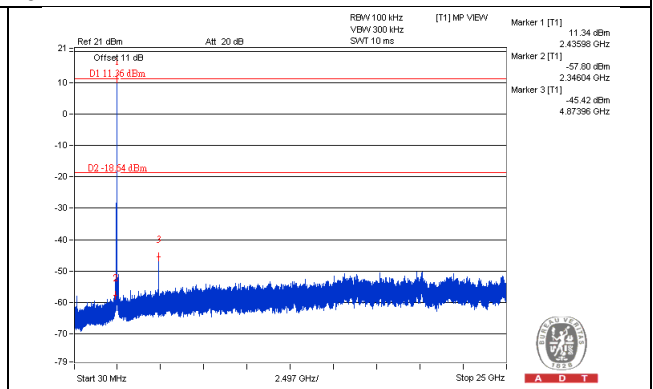
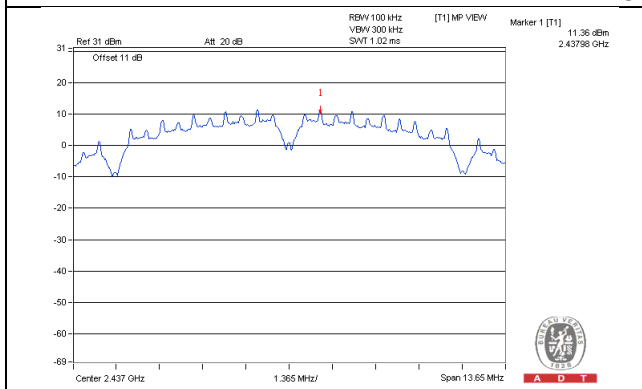

CH 11

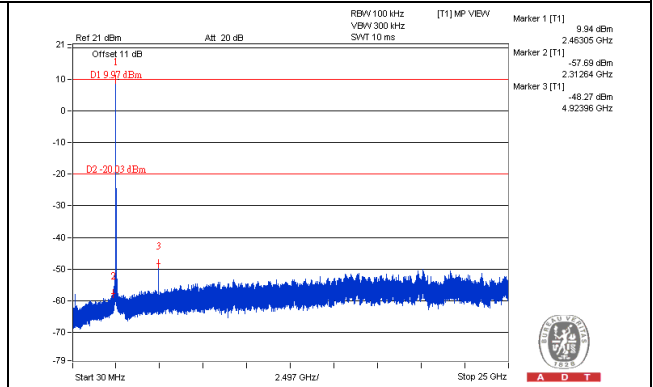
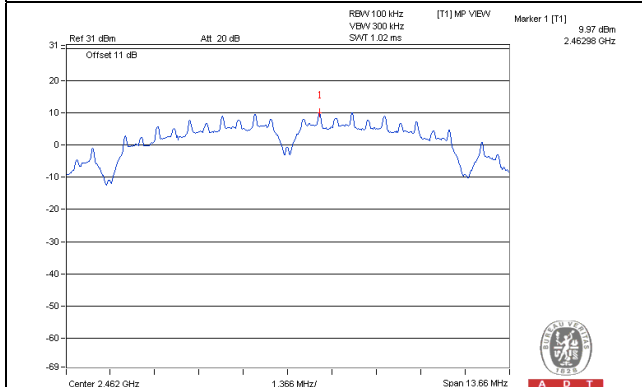

CH 1 Band edge

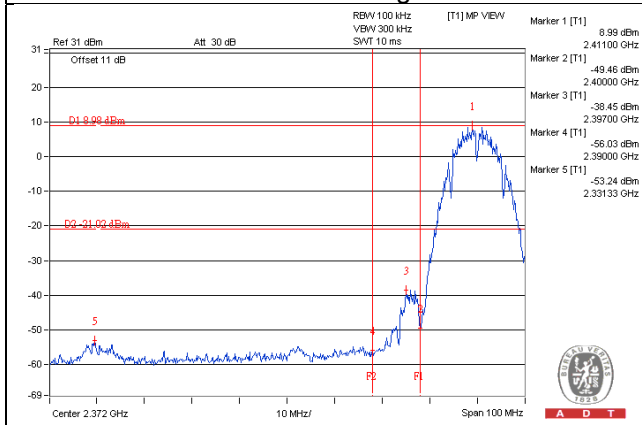

CH 11 Band edge

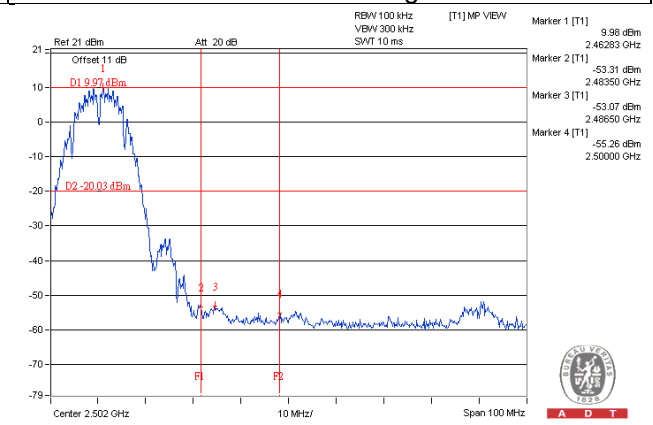



802.11g_CHAIN 0

CH 1

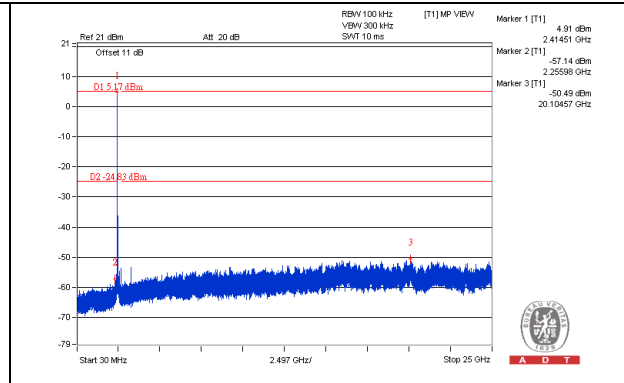
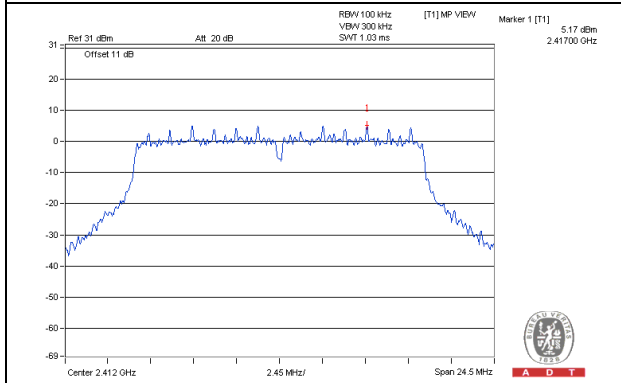

CH 6

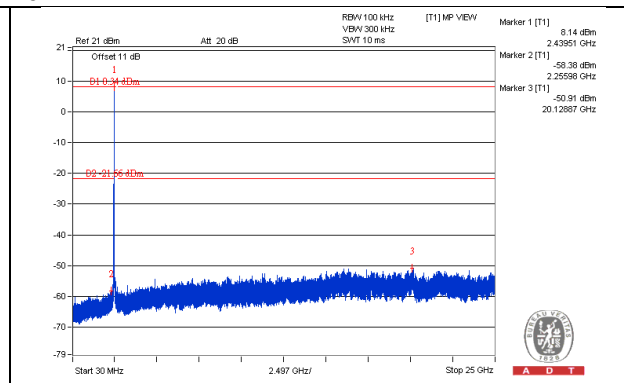
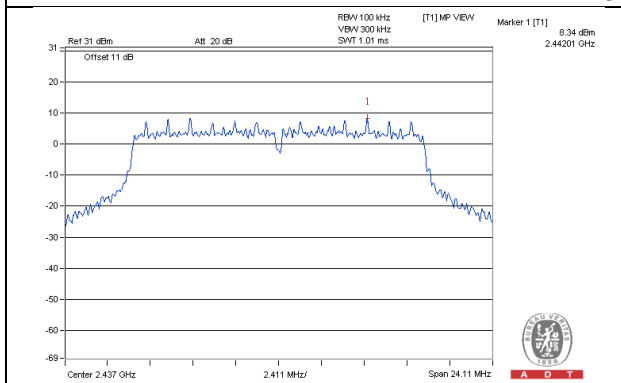

CH 11

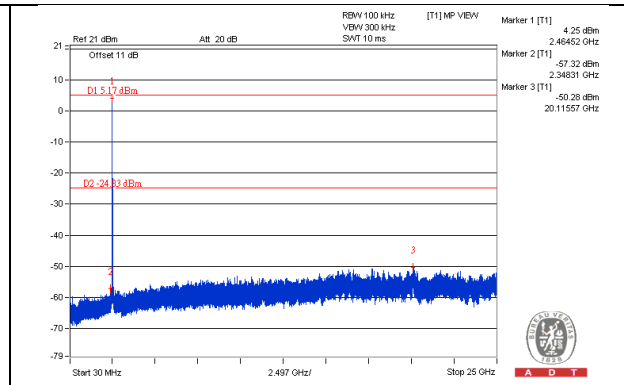
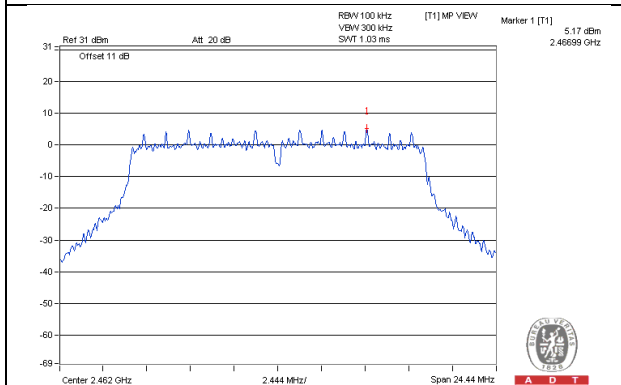

CH 1 Band edge

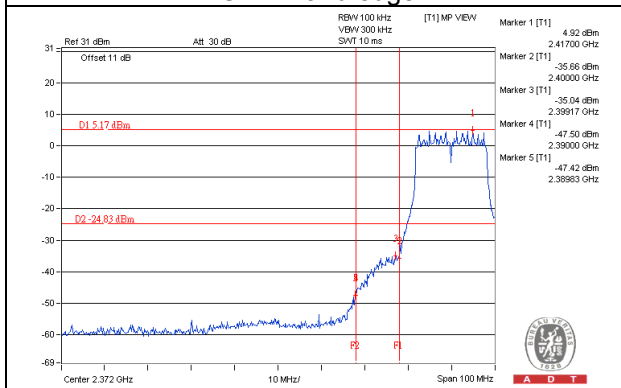

CH 11 Band edge

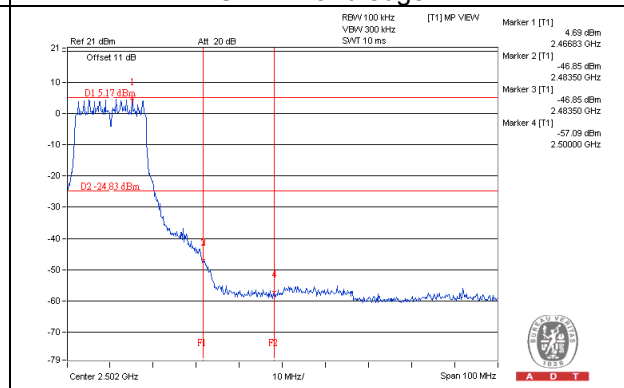



BUREAU VERITAS

802.11g_CHAIN 1

CH 1

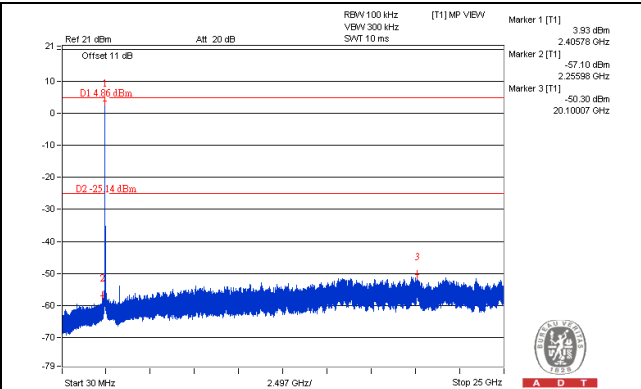
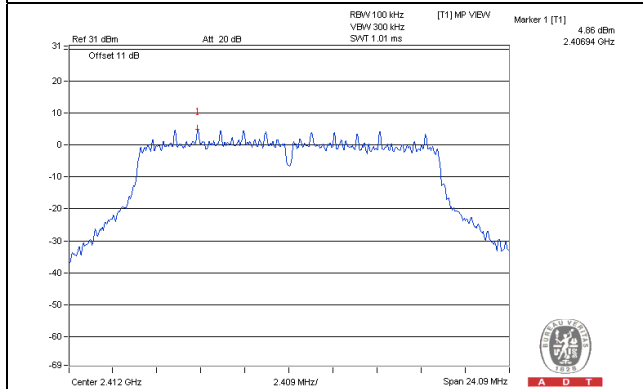

CH 6

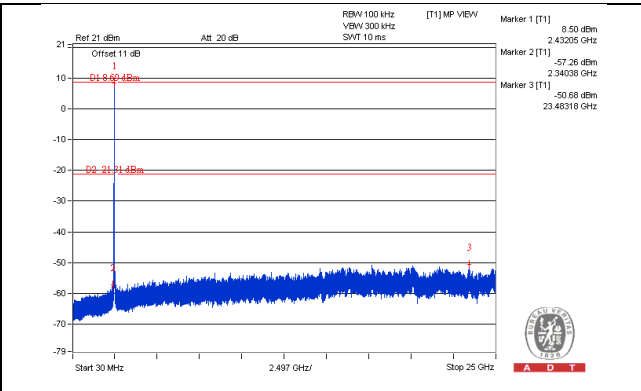
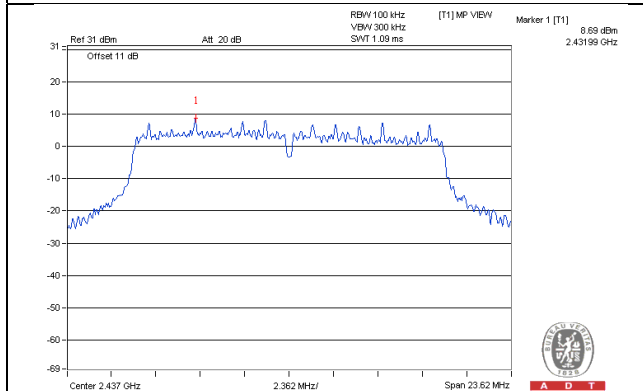

CH 11

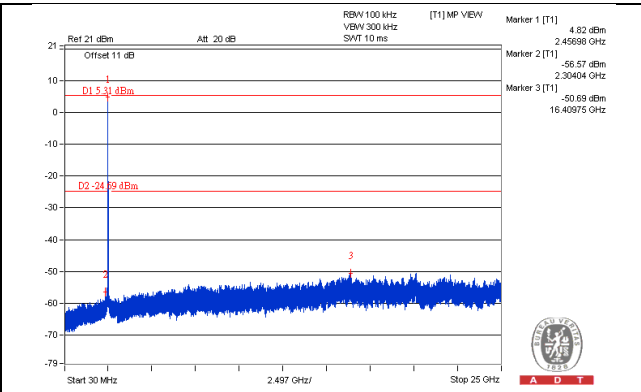
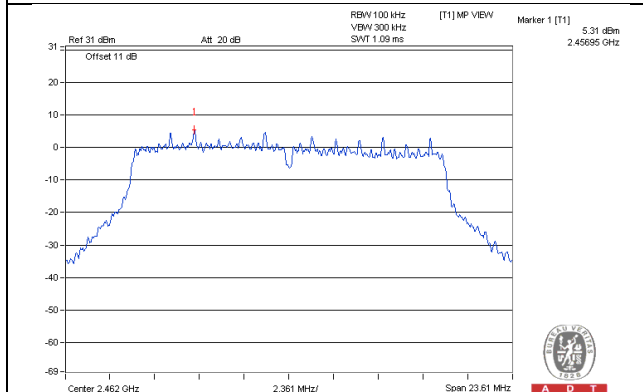

CH 1 Band edge

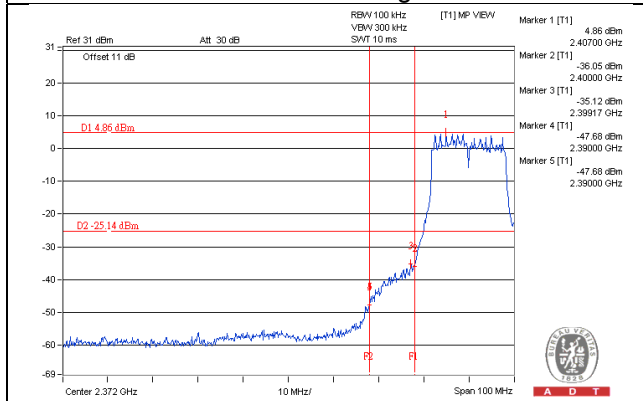

CH 11 Band edge

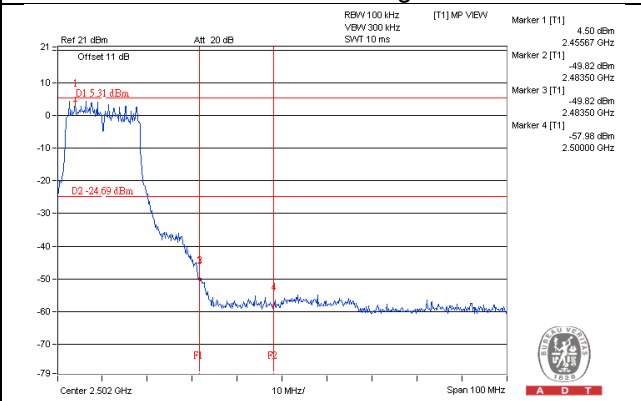



802.11g_CHAIN 2

CH 1

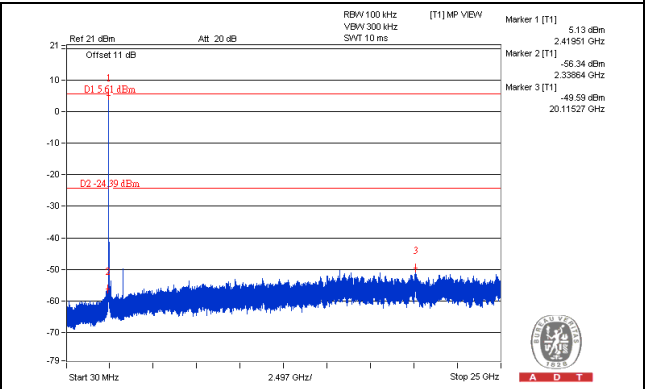
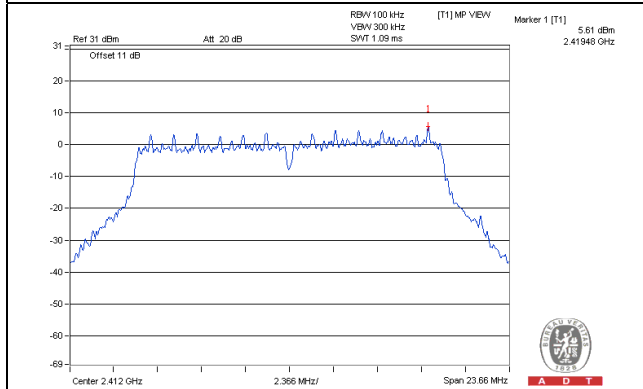

CH 6

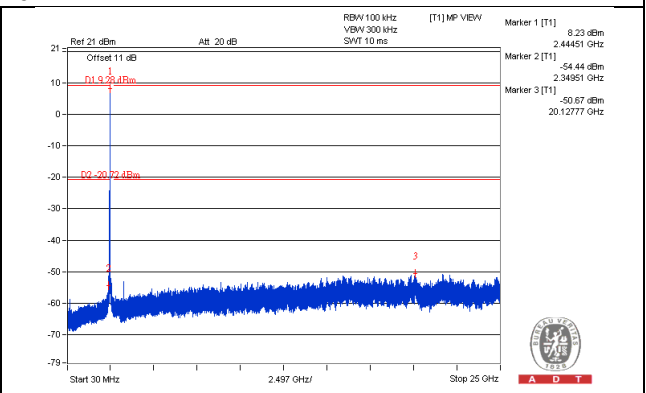
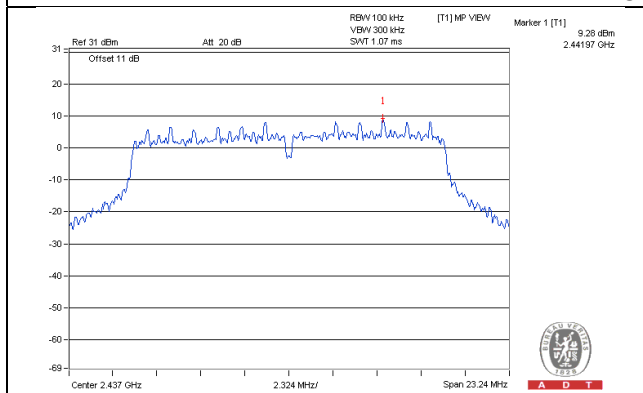

CH 11

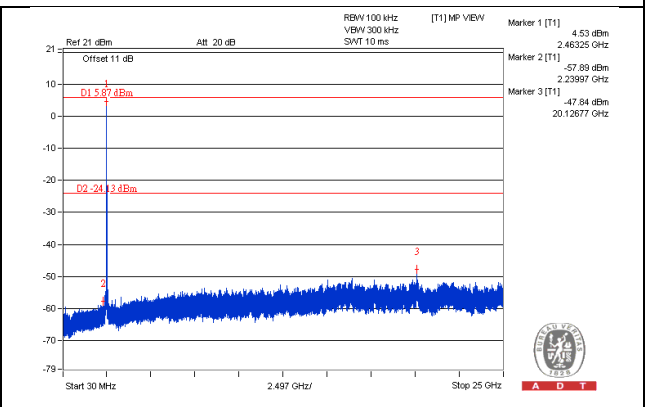
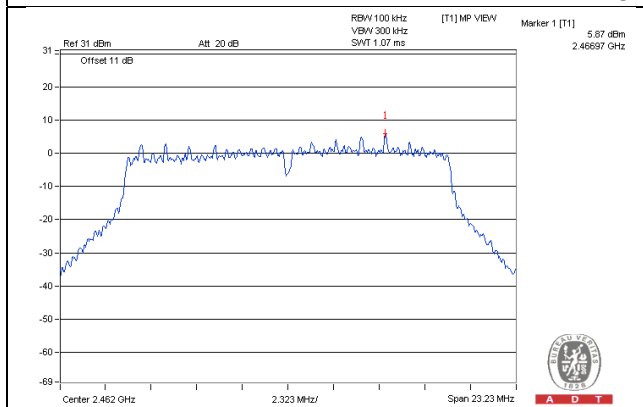

CH 1 Band edge

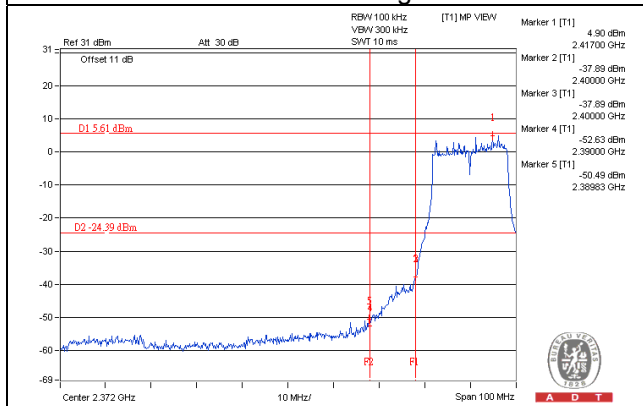

CH 11 Band edge

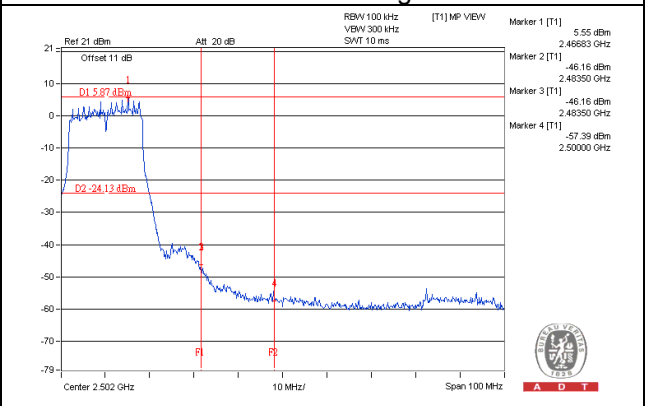



802.11g_CHAIN 3

CH 1

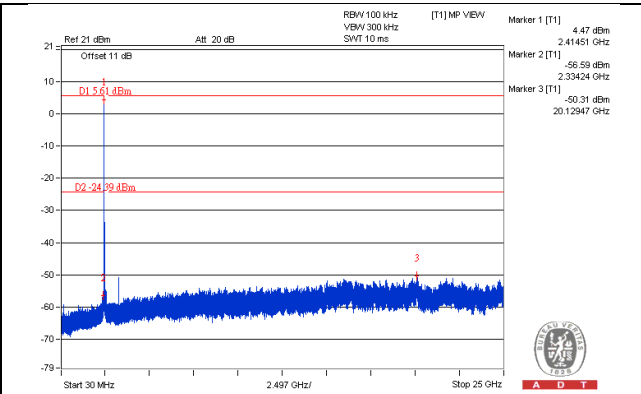
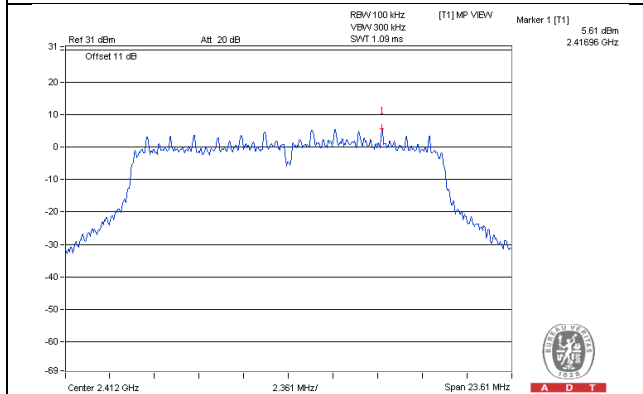

CH 6

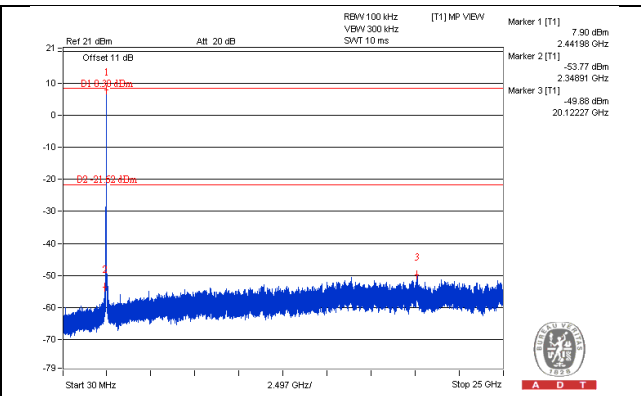
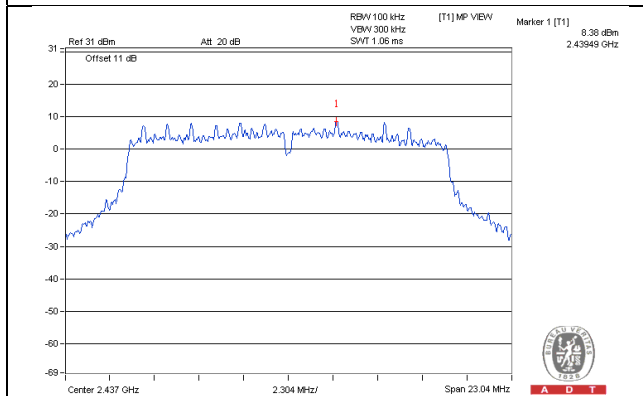

CH 11

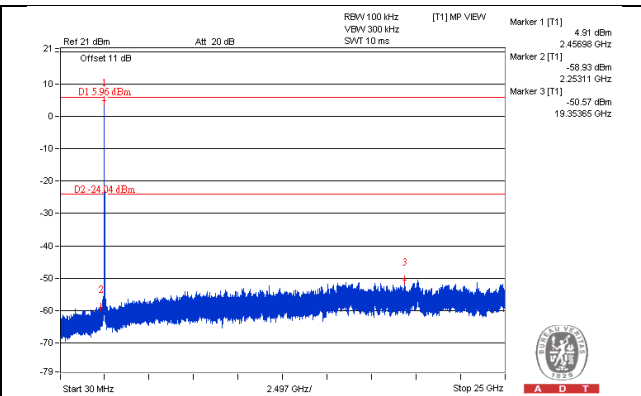
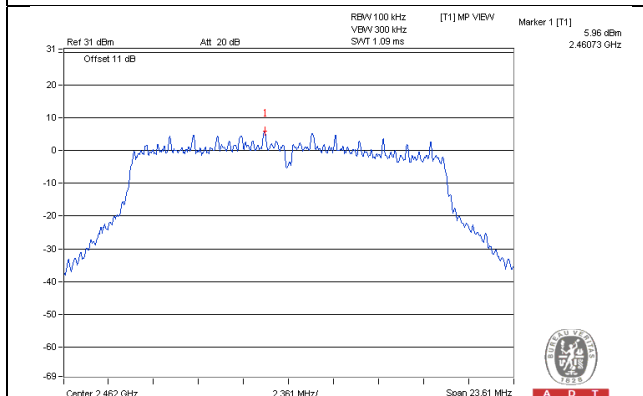

CH 1 Band edge

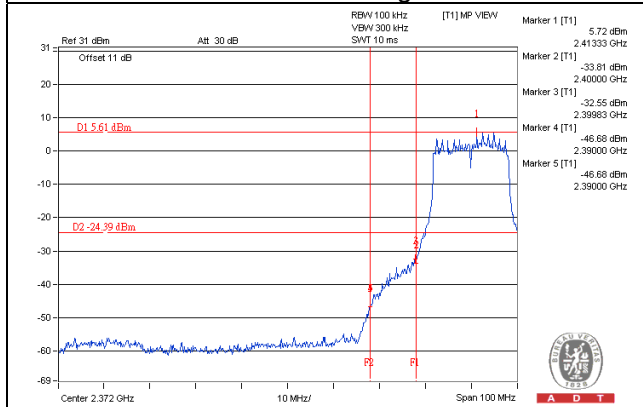

CH 11 Band edge

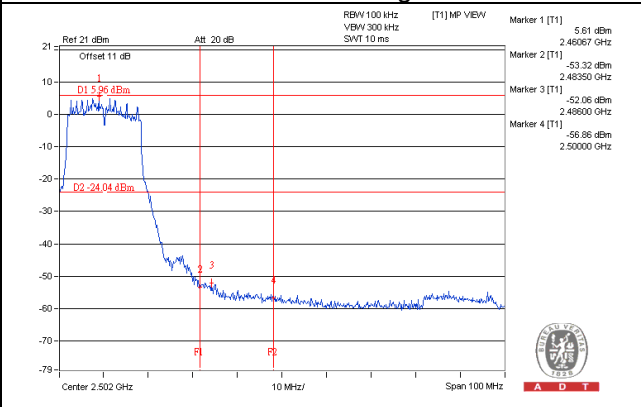

802.11n (HT20)_CHAIN 0

CH 1

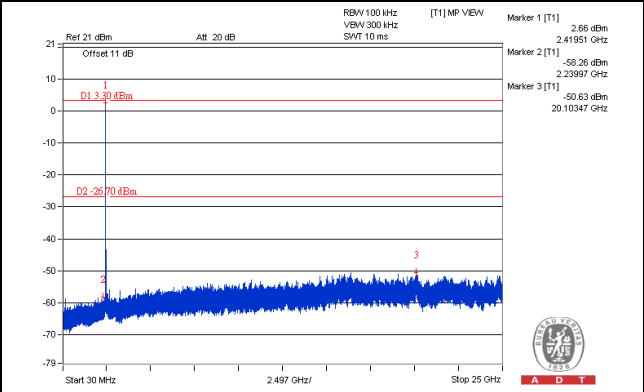
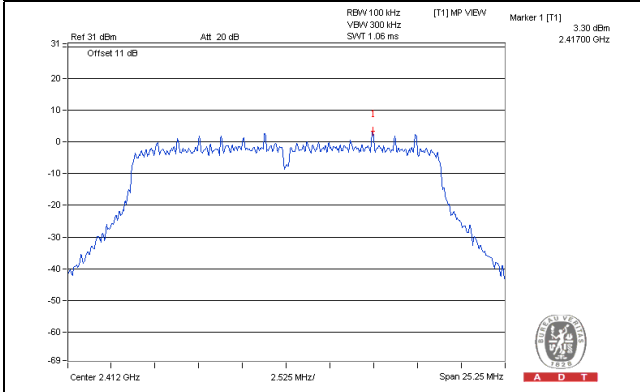

CH 6

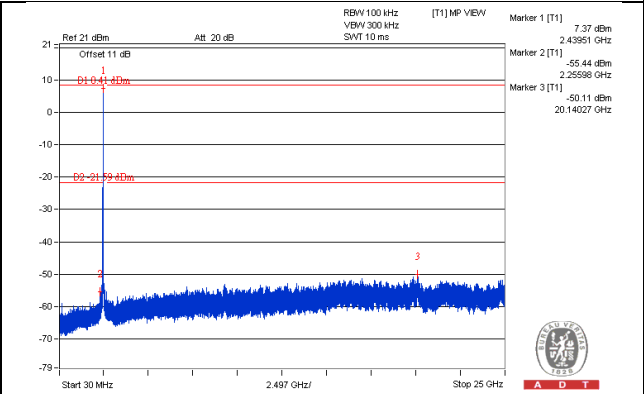
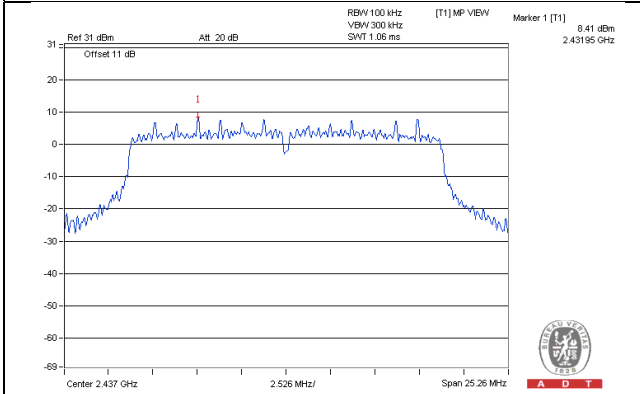

CH 11

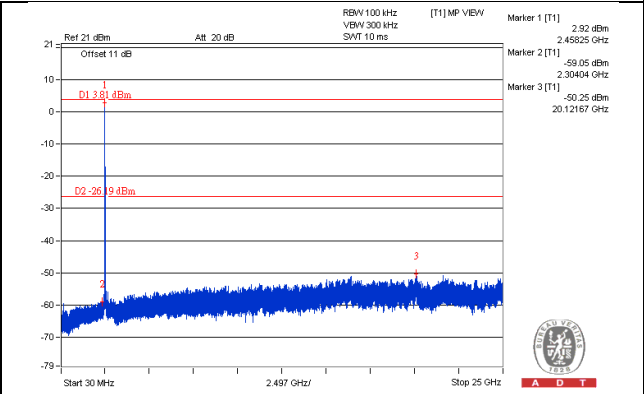
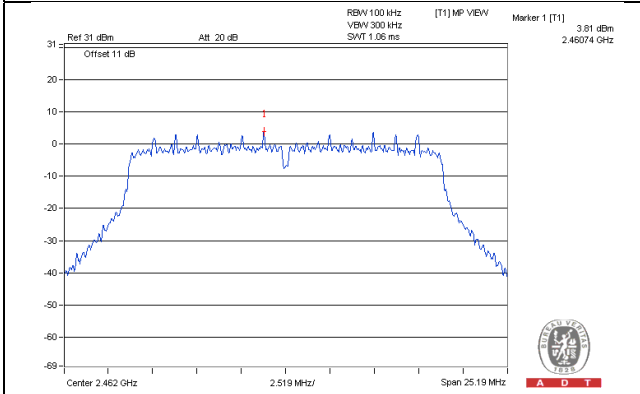

CH 1 Band edge

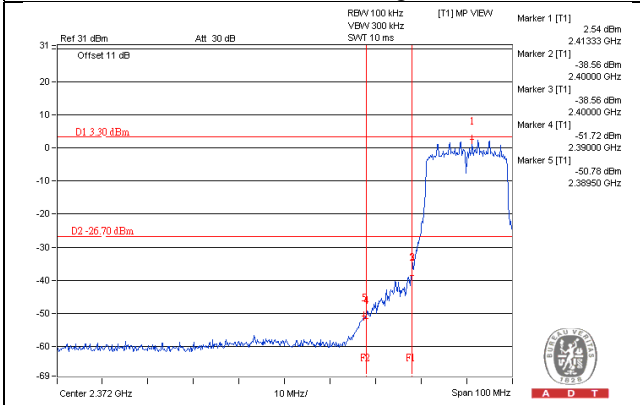

CH 11 Band edge

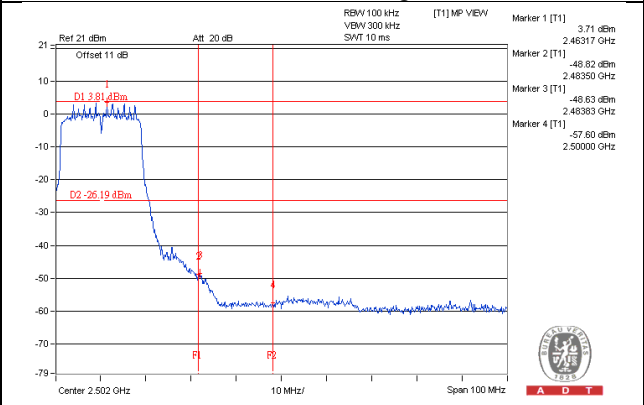

802.11n (HT20)_CHAIN 1

CH 1

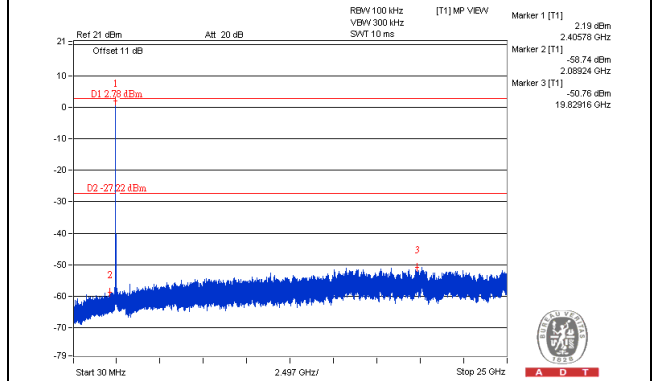
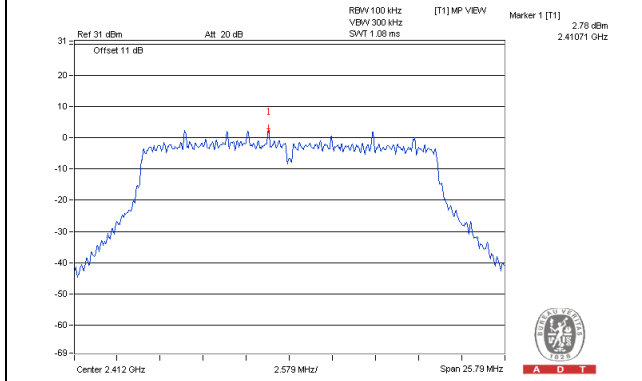

CH 6

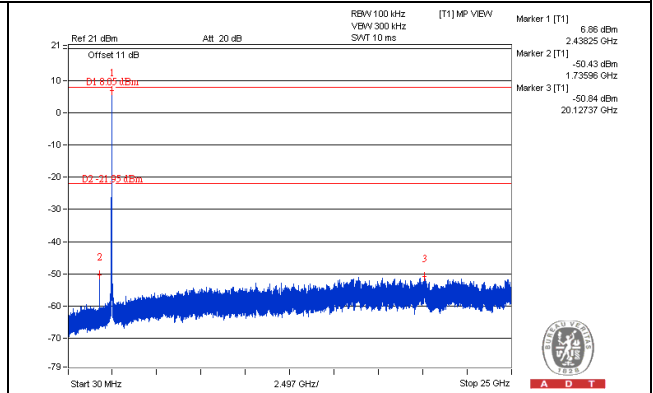
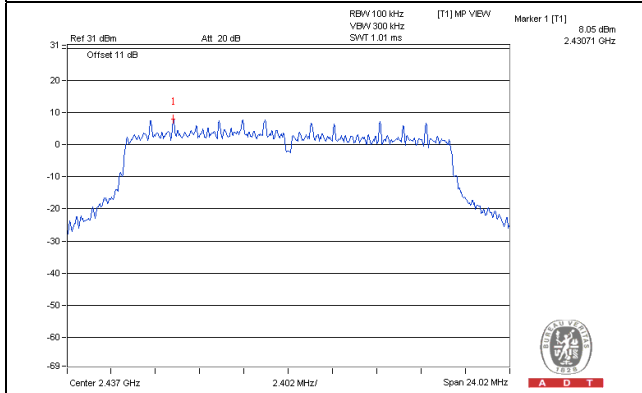

CH 11

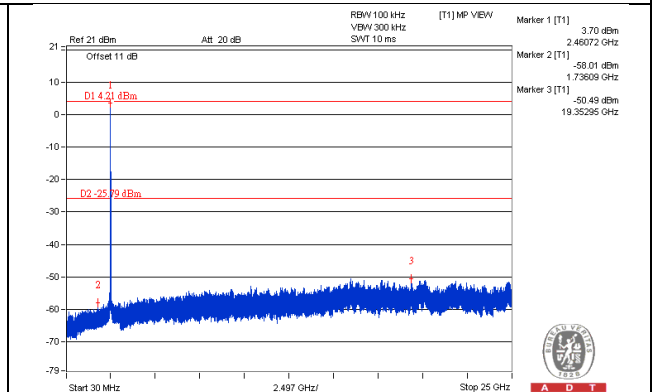
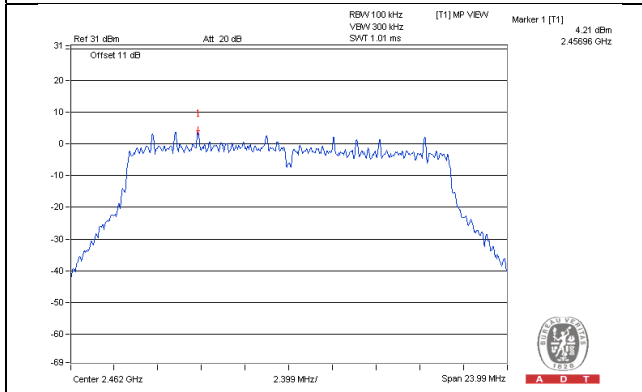

CH 1 Band edge

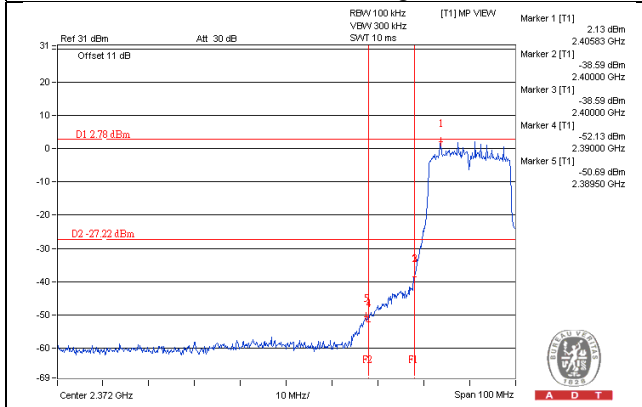

CH 11 Band edge

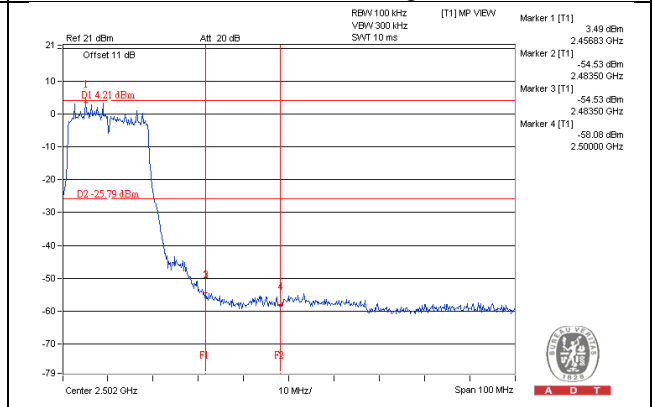

802.11n (HT20)_CHAIN 2

CH 1

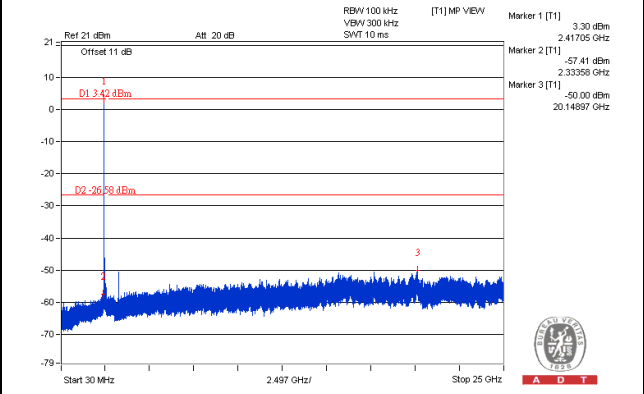
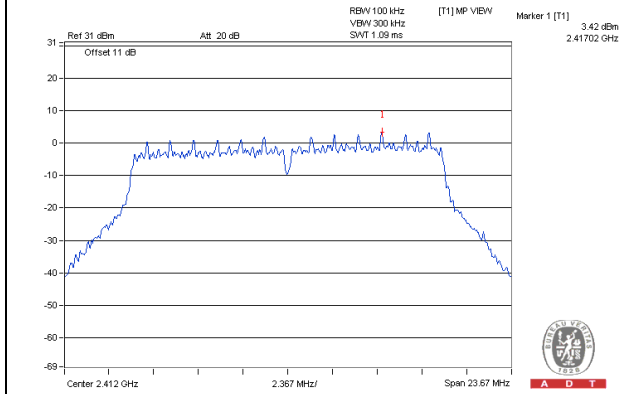

CH 6

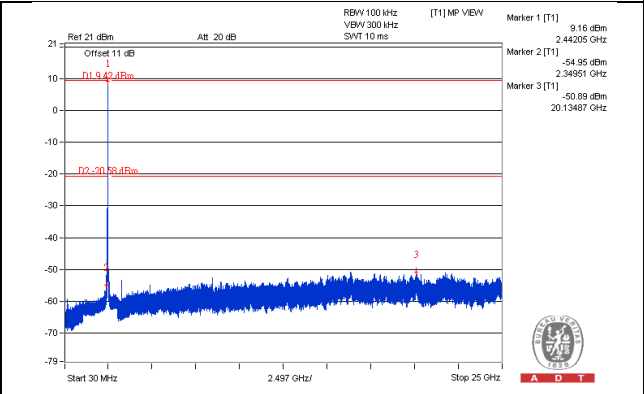
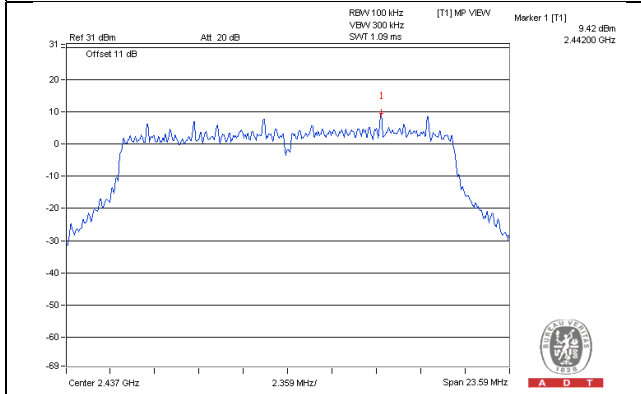

CH 11

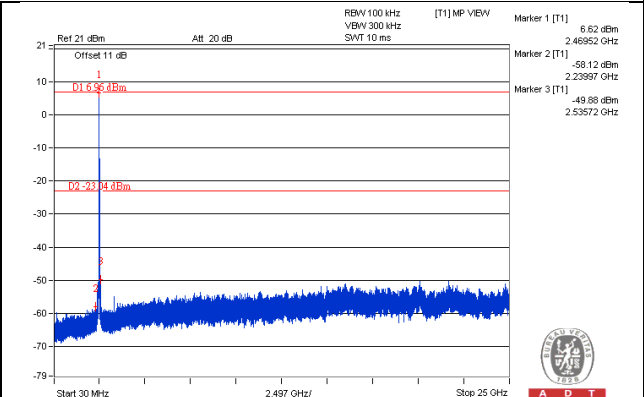
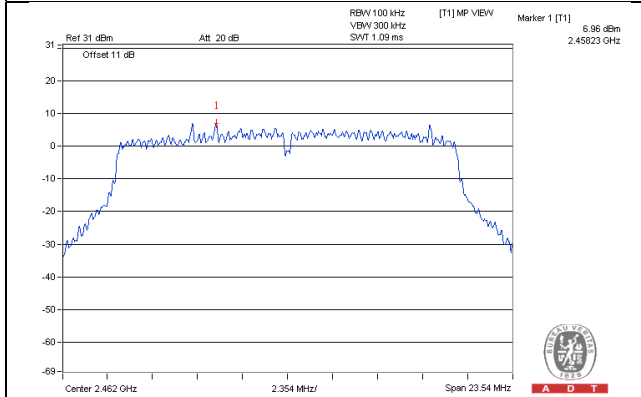

CH 1 Band edge

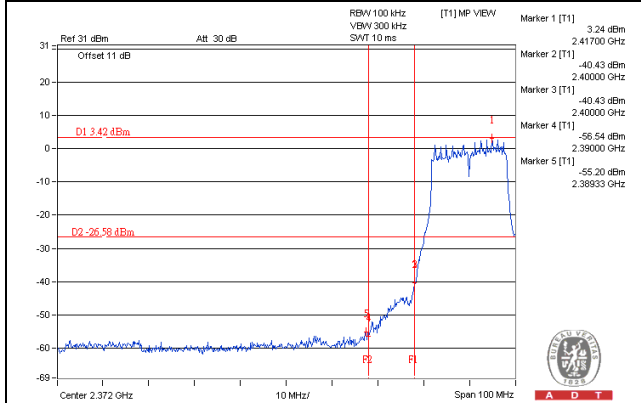

CH 11 Band edge

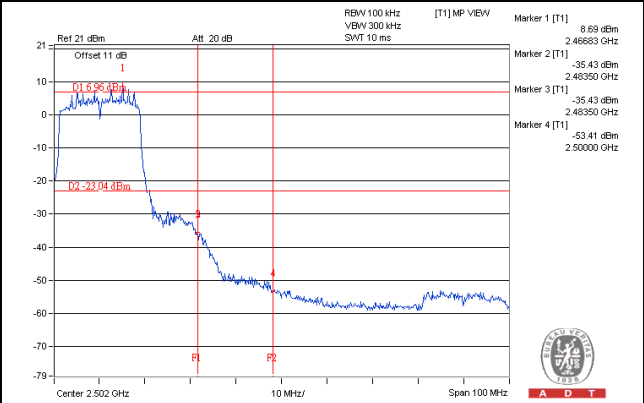



BUREAU VERITAS

802.11n (HT20)_CHAIN 3

CH 1

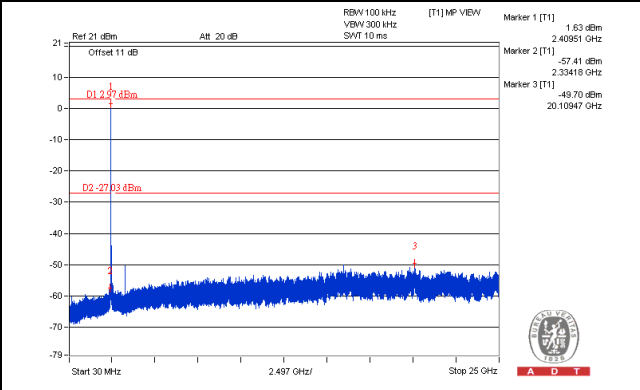
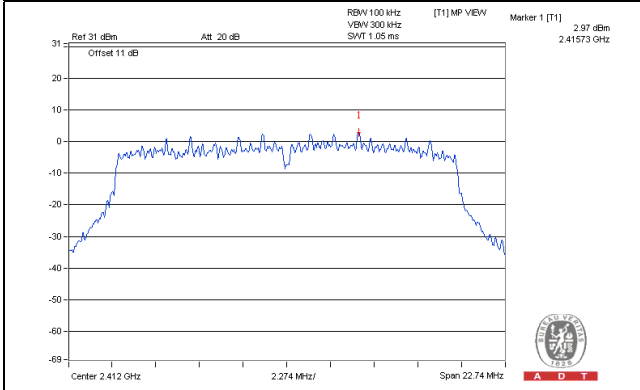

CH 6

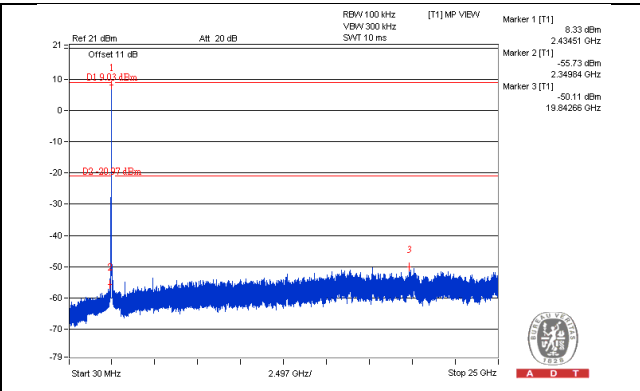
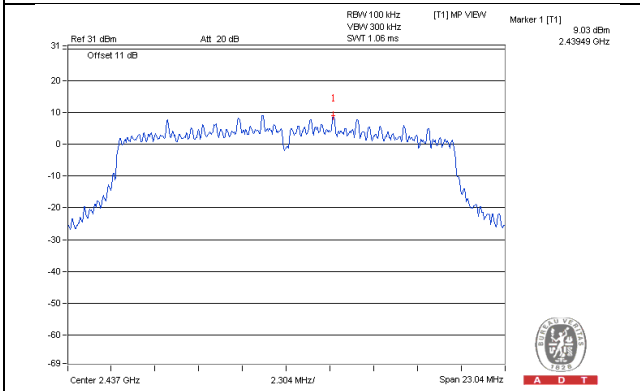

CH 11

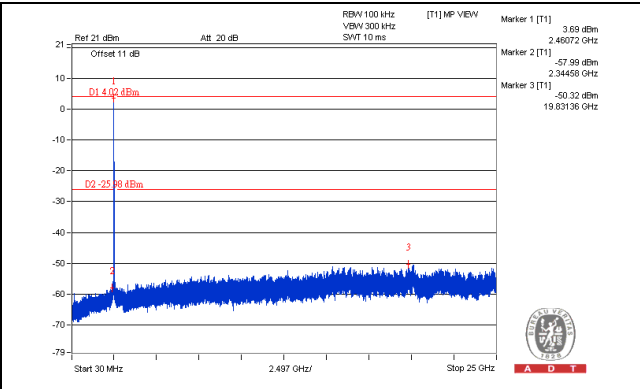
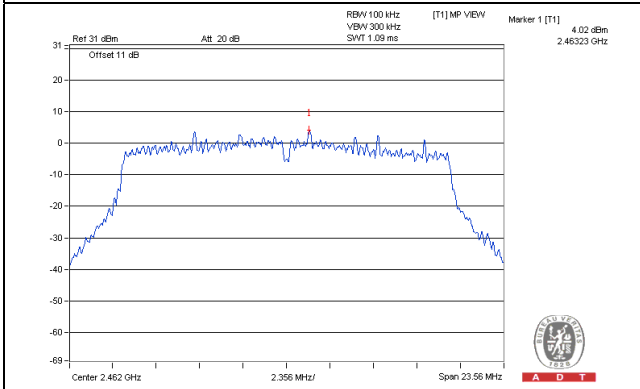

CH 1 Band edge

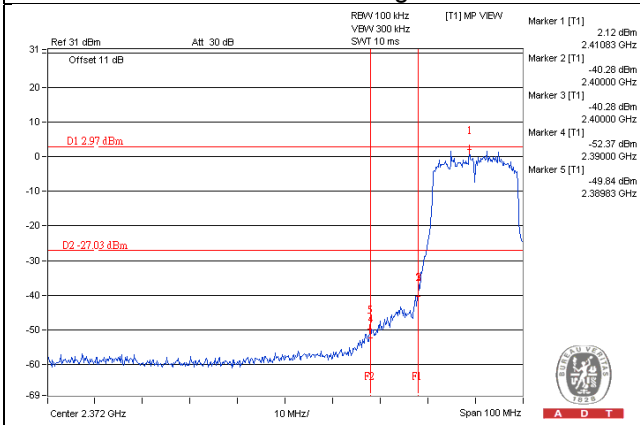

CH 11 Band edge

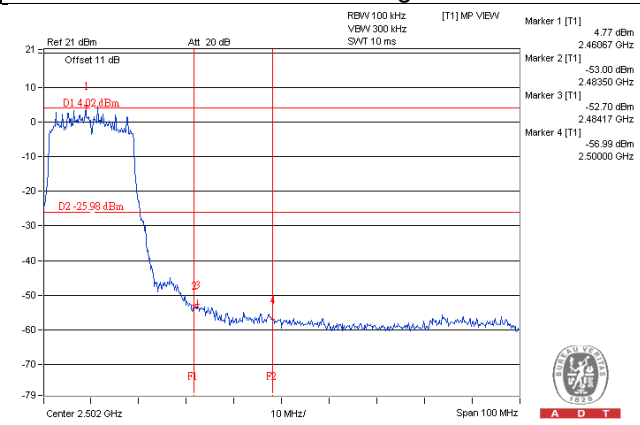

802.11n (HT40)_CHAIN 0

CH 3

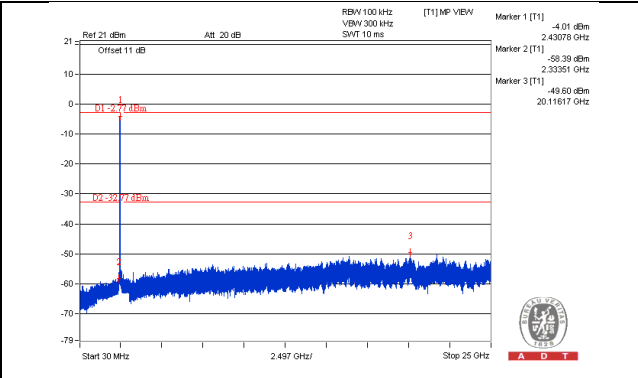
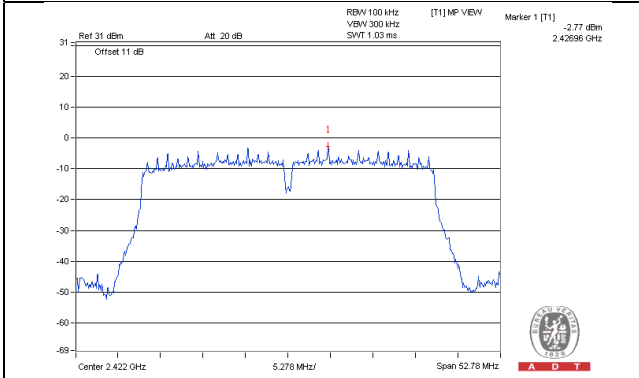

CH 6

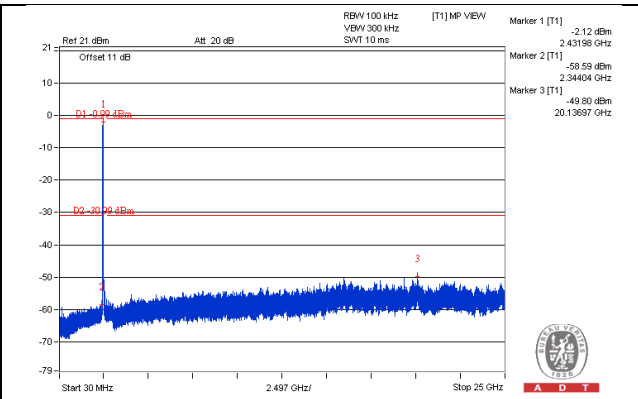
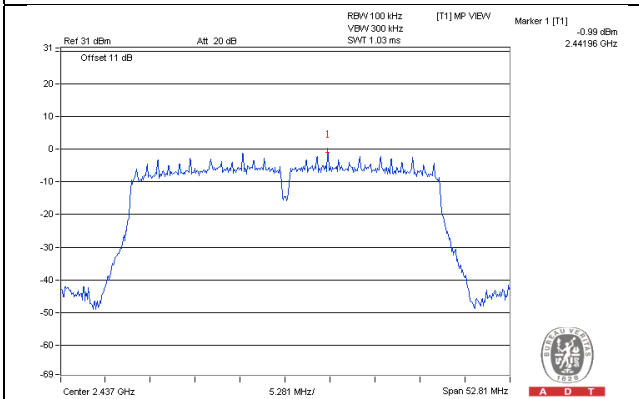

CH 9

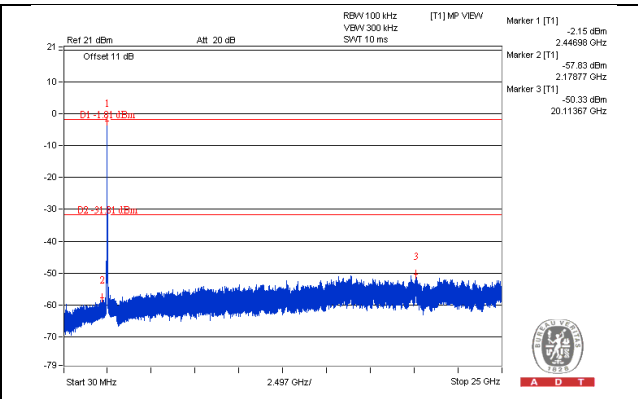
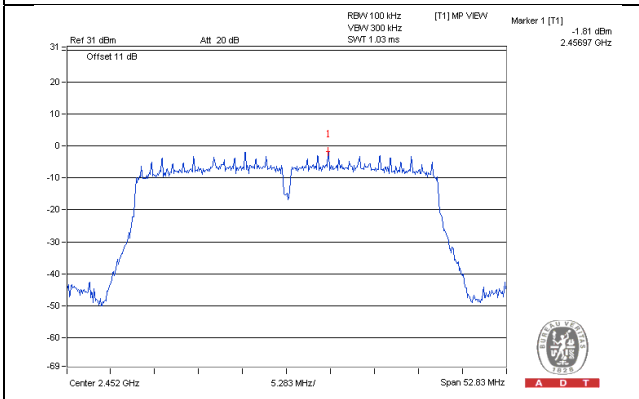

CH 3 Band edge

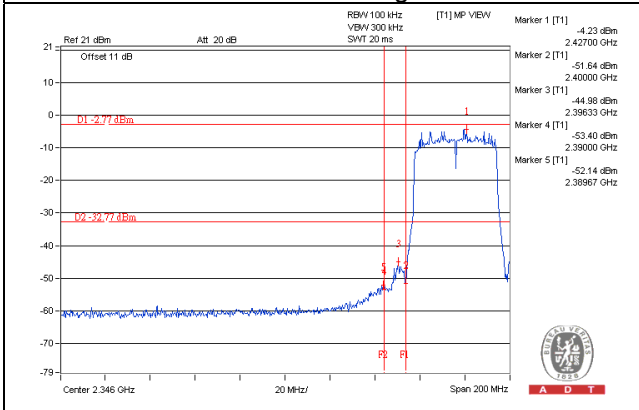

CH 9 Band edge

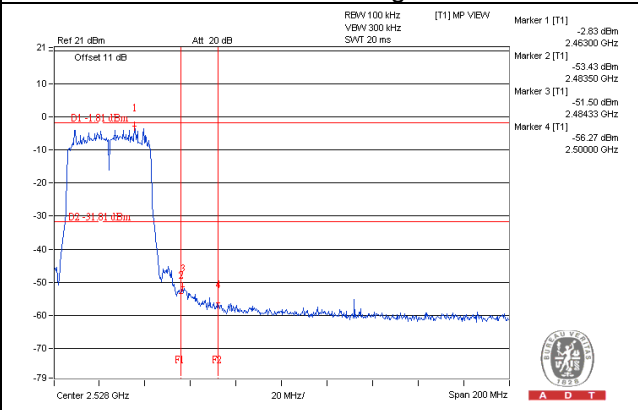



802.11n (HT40)_CHAIN 1

CH 3

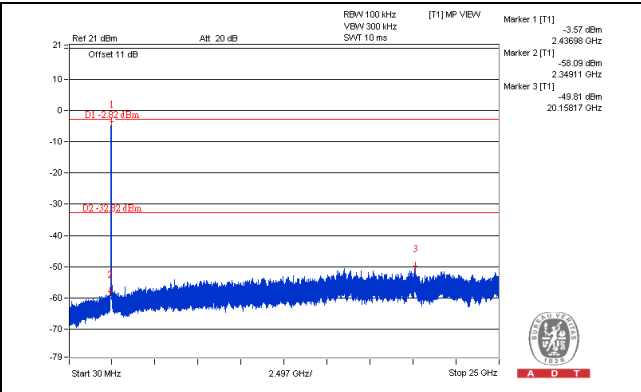
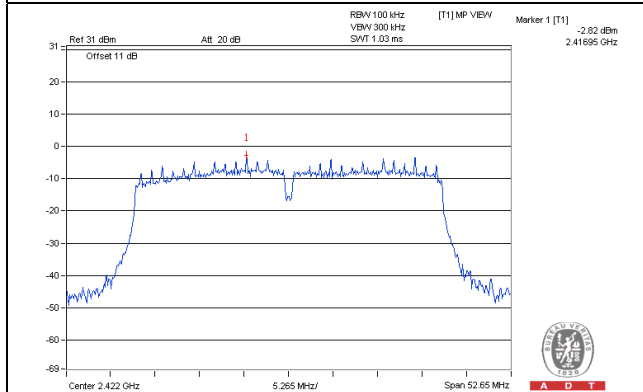

CH 6

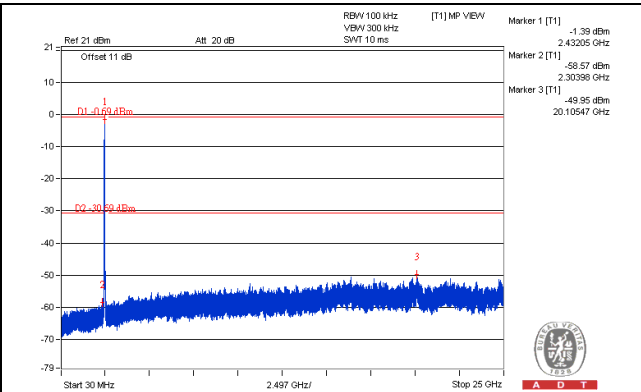
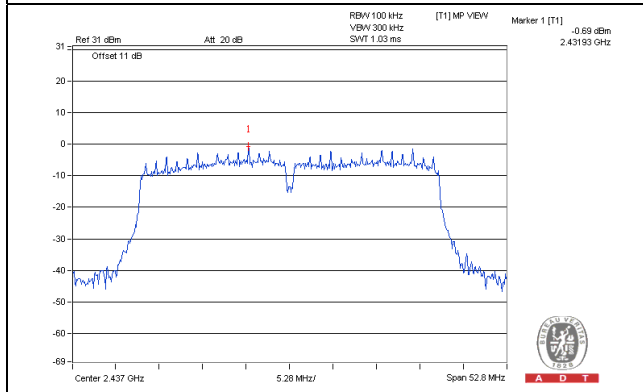

CH 9

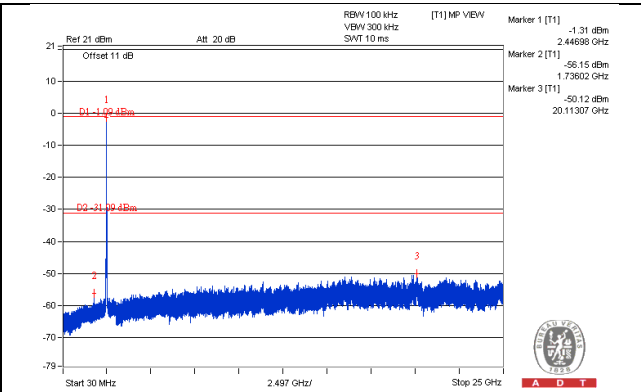
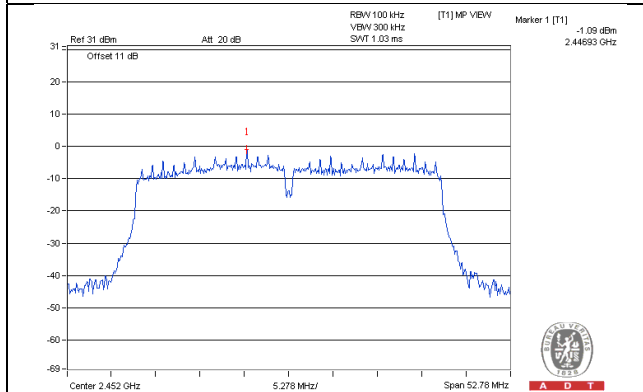

CH 3 Band edge

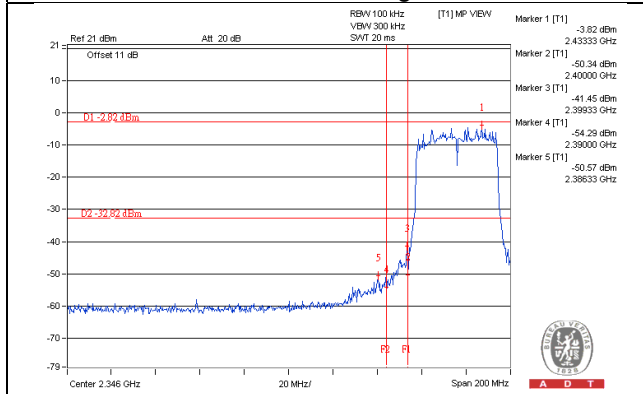

CH 9 Band edge

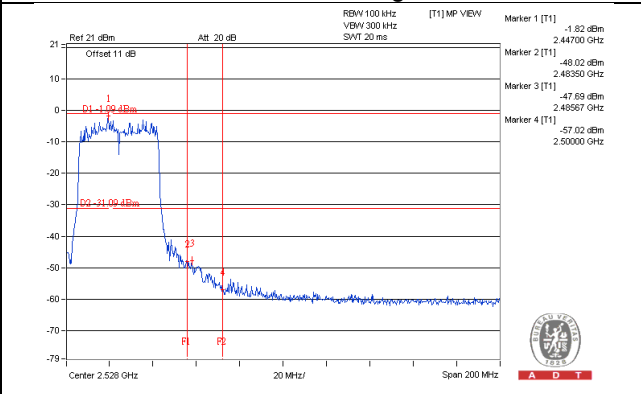



BUREAU VERITAS

802.11n (HT40)_CHAIN 2

CH 3

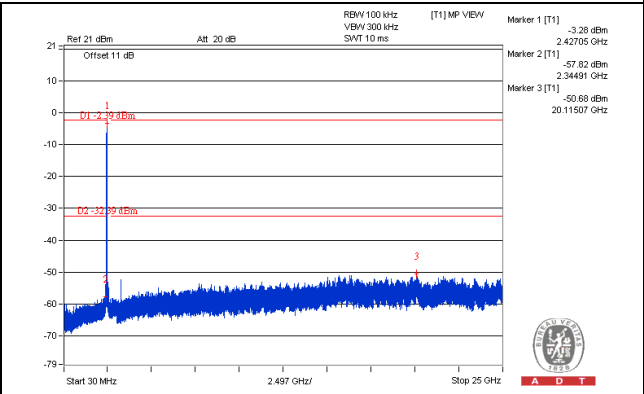
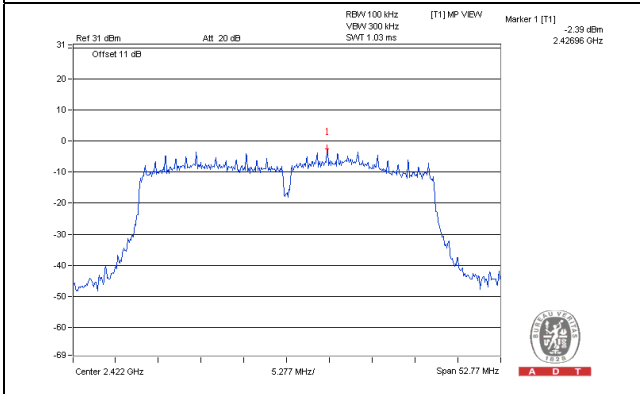

CH 6

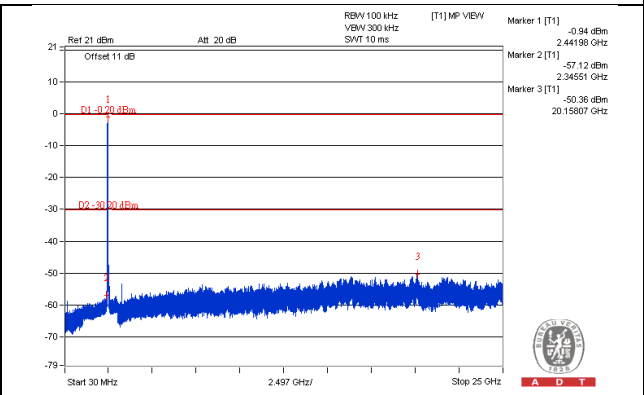
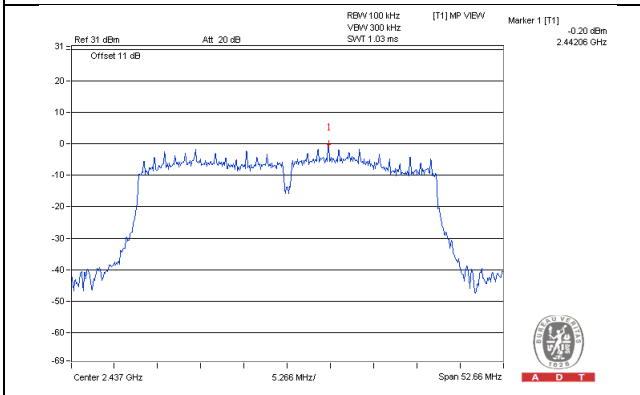

CH 9

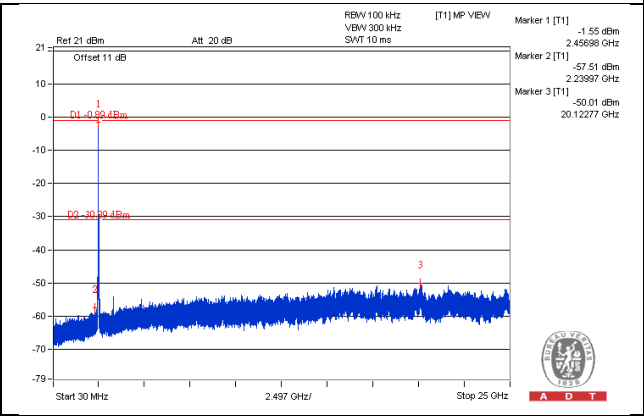
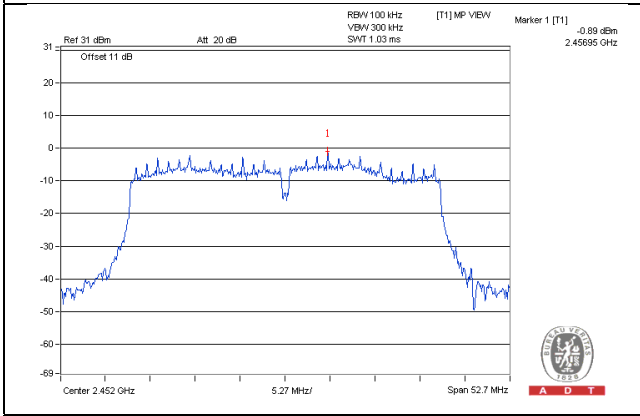

CH 3 Band edge

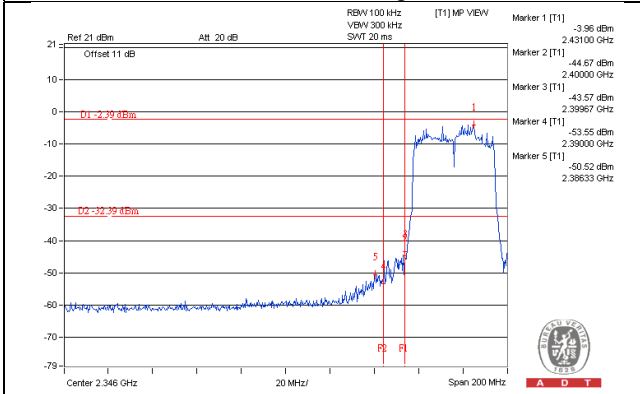

CH 9 Band edge

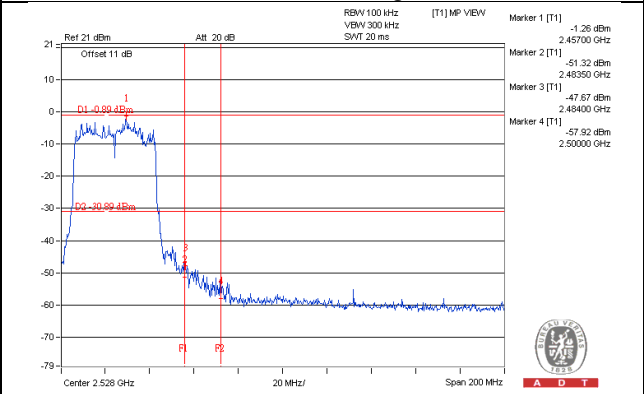

802.11n (HT40)_CHAIN 3

CH 3

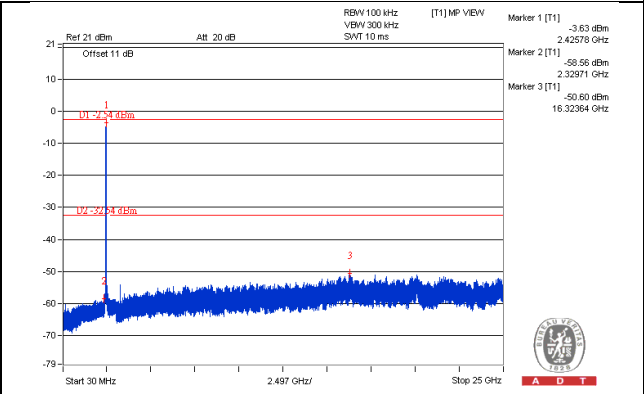
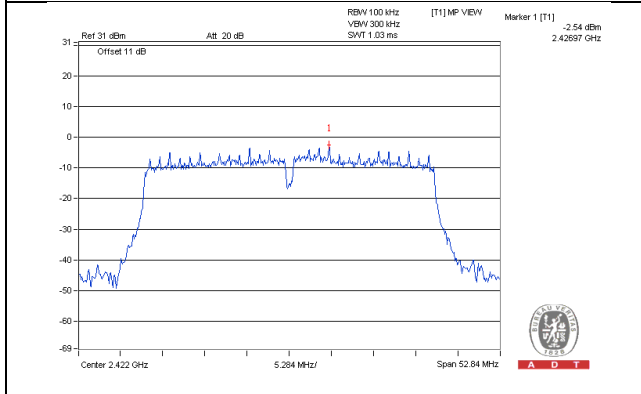

CH 6

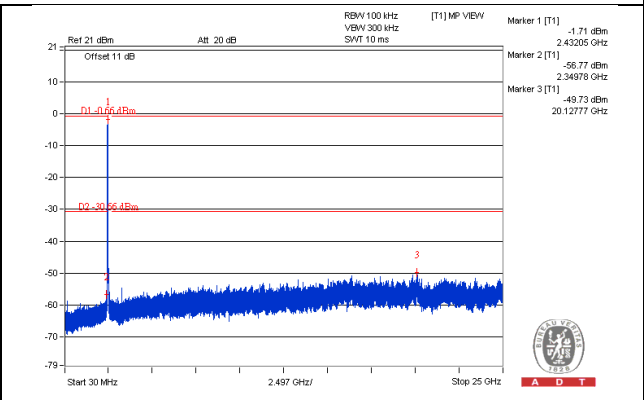
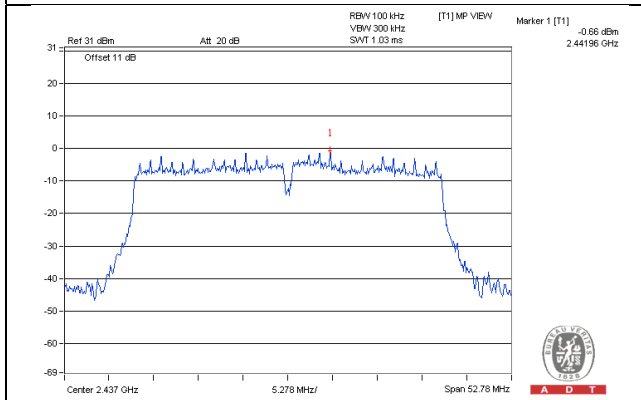

CH 9

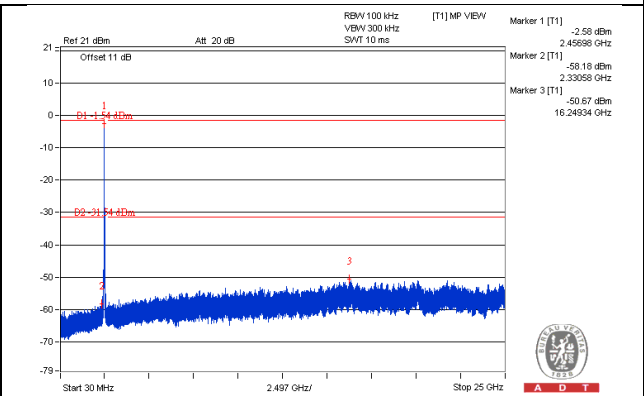
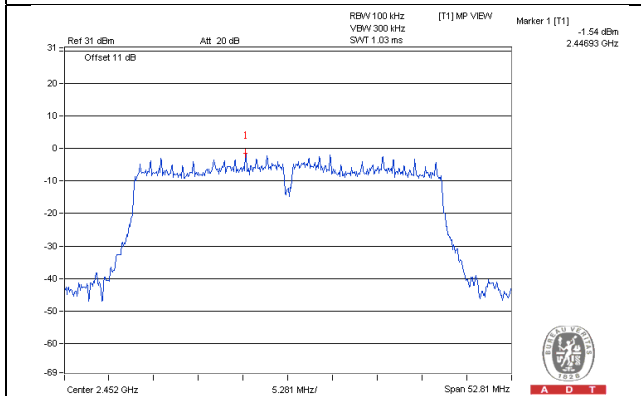

CH 3 Band edge

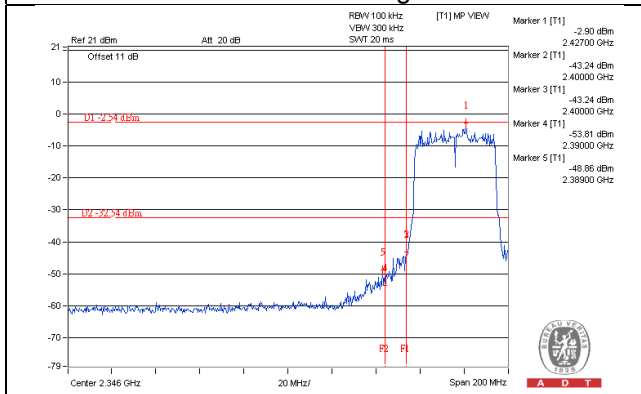

CH 9 Band edge

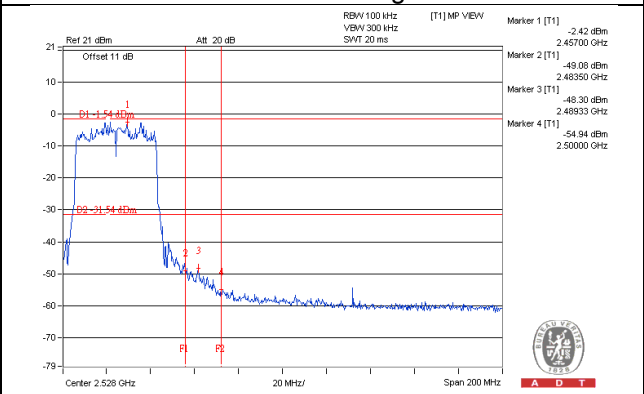

Beamforming Mode
802.11n (VHT20)_CHAIN 0

CH 1

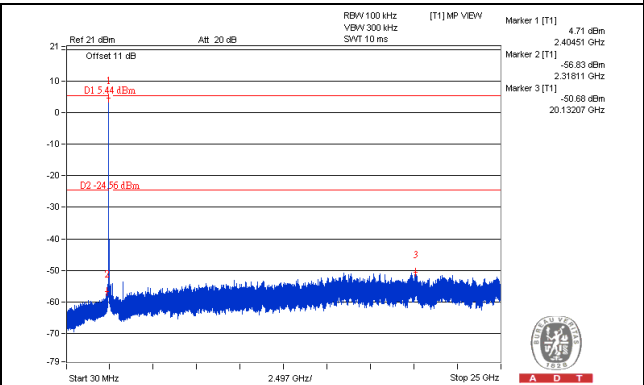
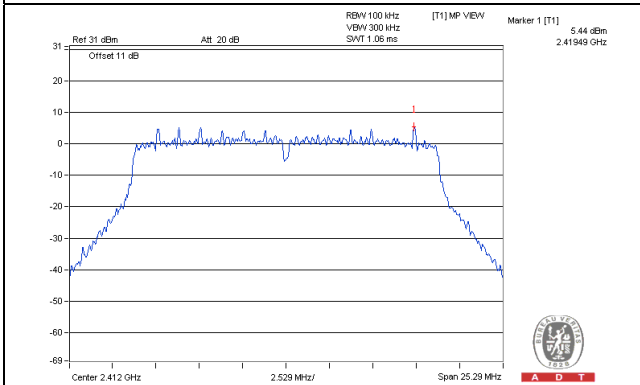

CH 6

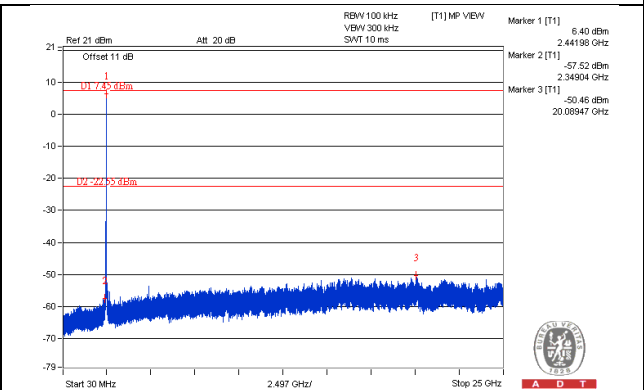
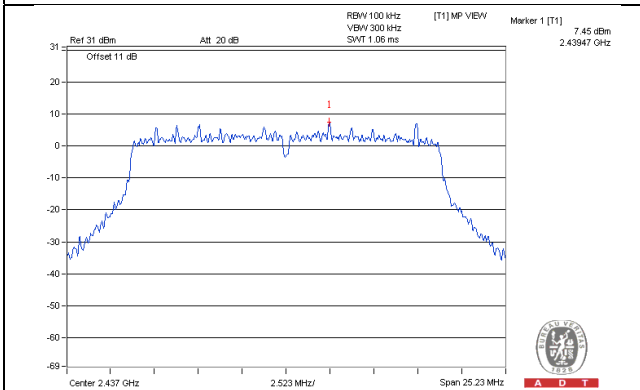

CH 11

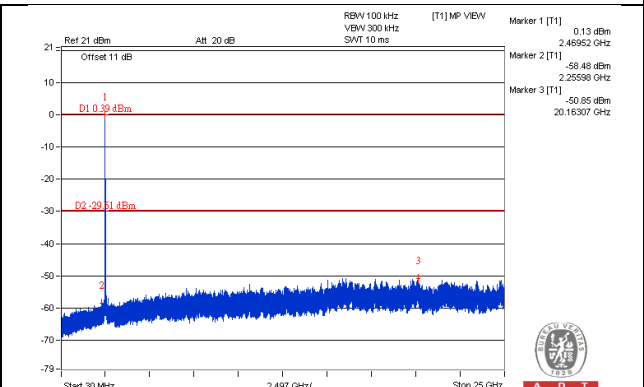
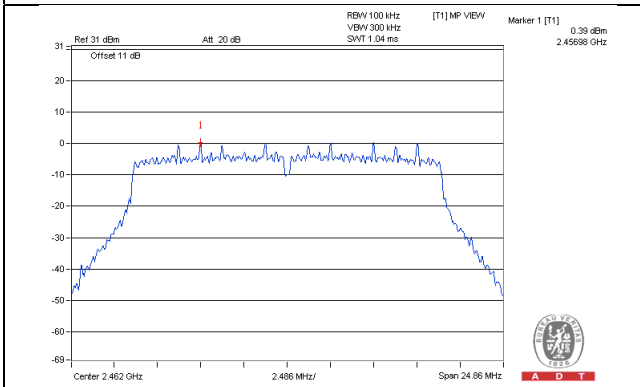

CH 1 Band edge

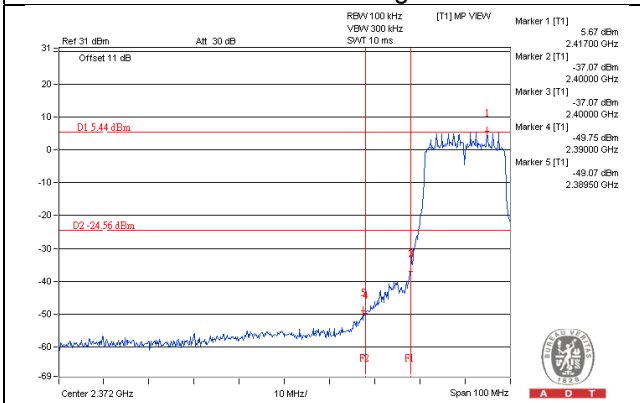

CH 11 Band edge

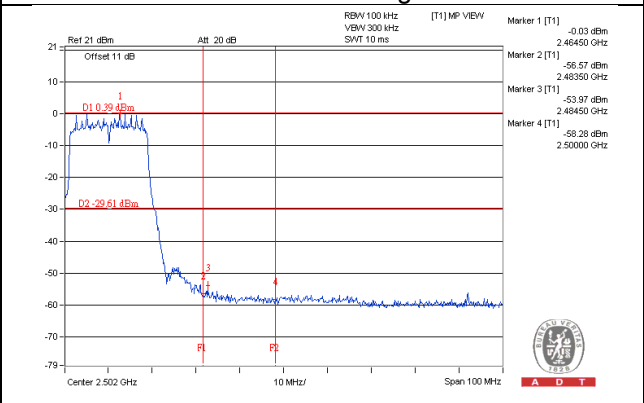

802.11n (VHT20)_CHAIN 1

CH 1

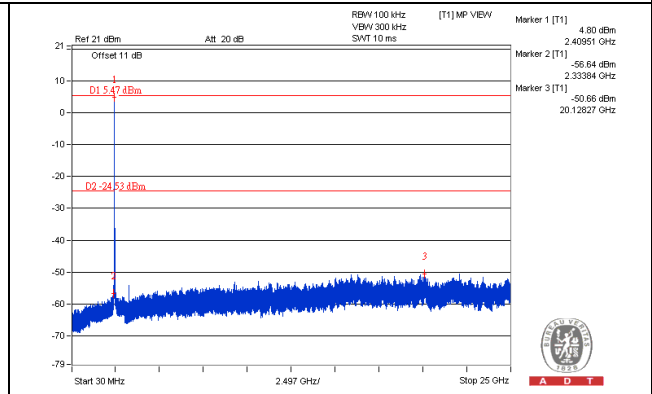
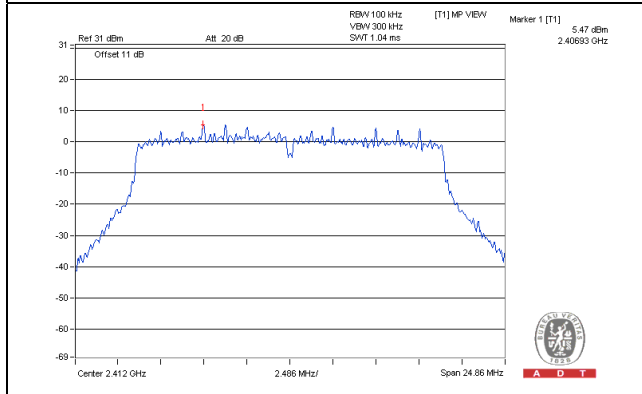

CH 6

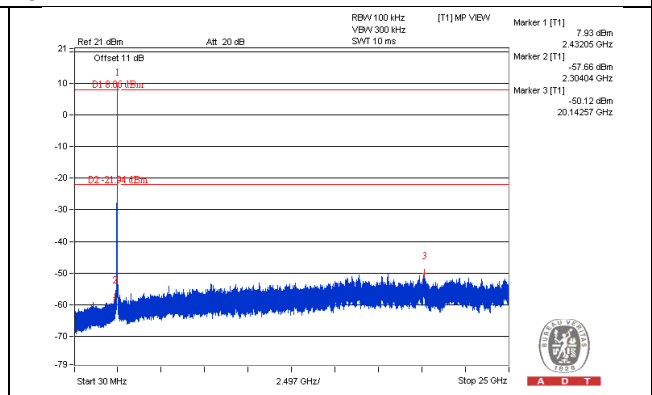
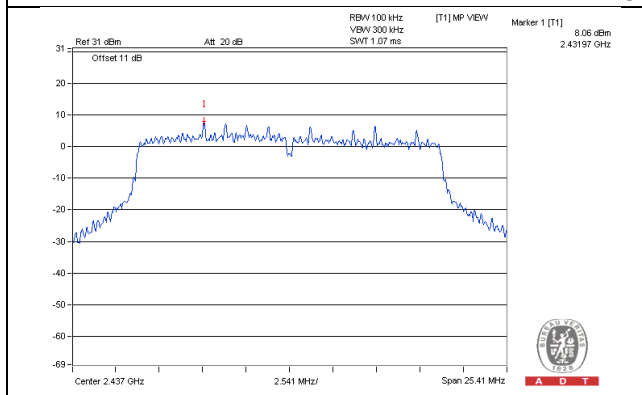

CH 11

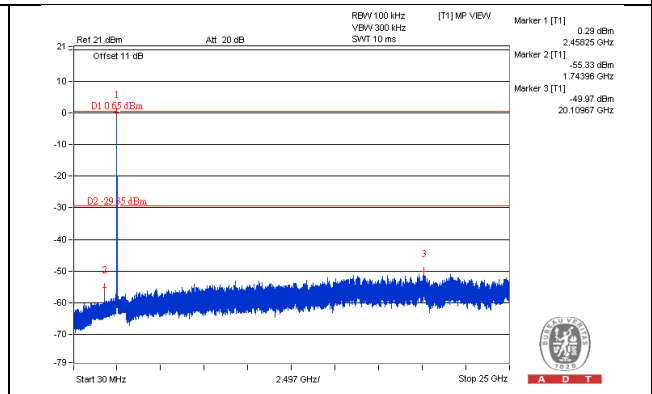
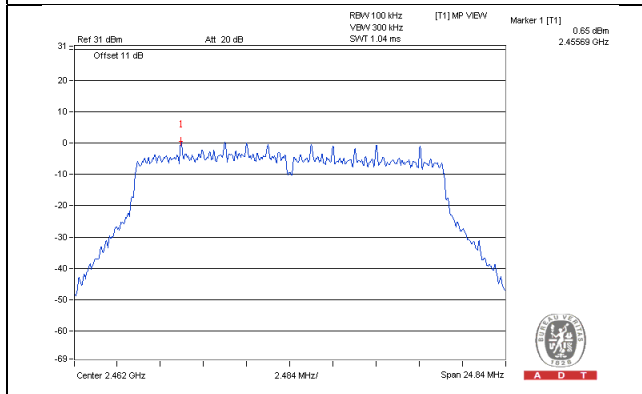

CH 1 Band edge

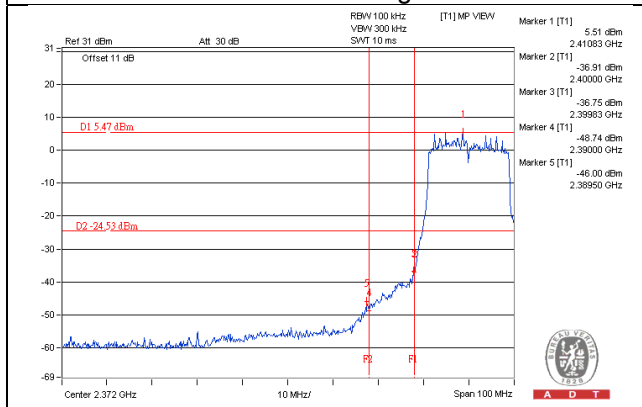

CH 11 Band edge

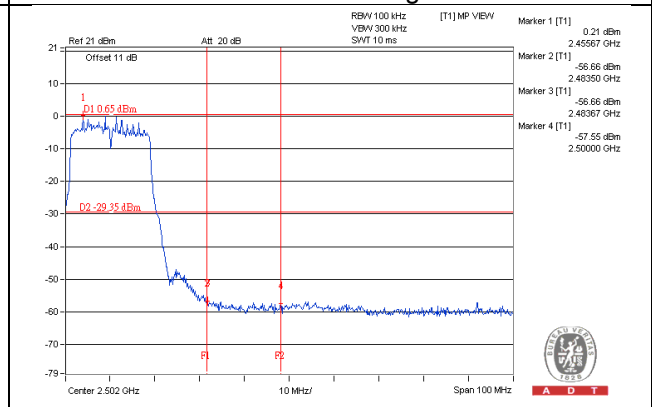

802.11n (VHT20)_CHAIN 2

CH 1

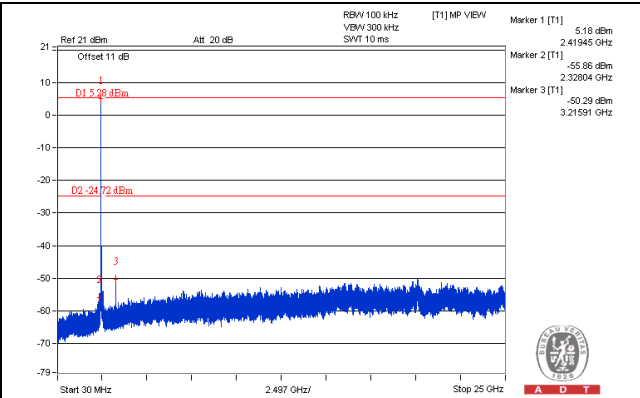
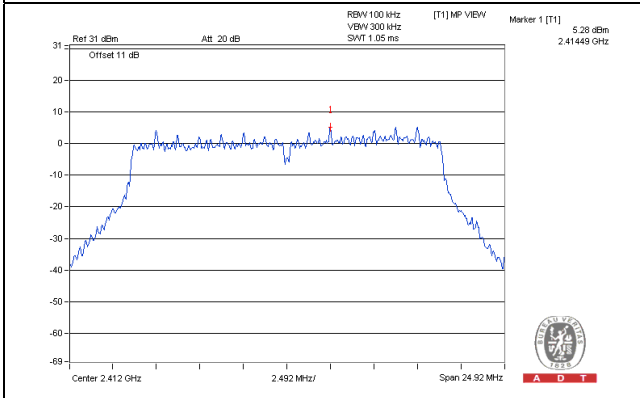

CH 6

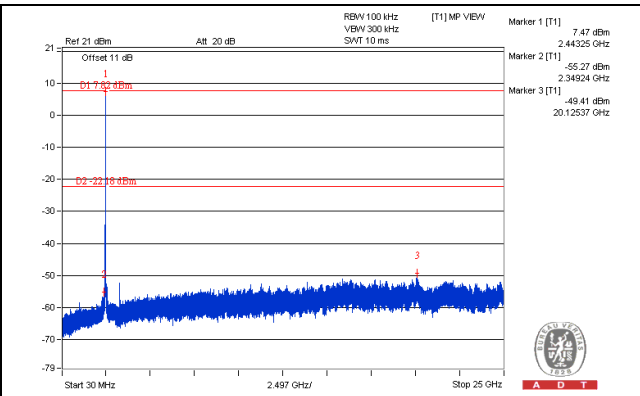
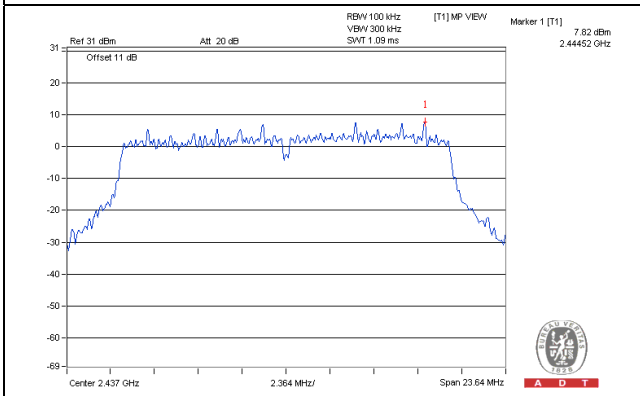

CH 11

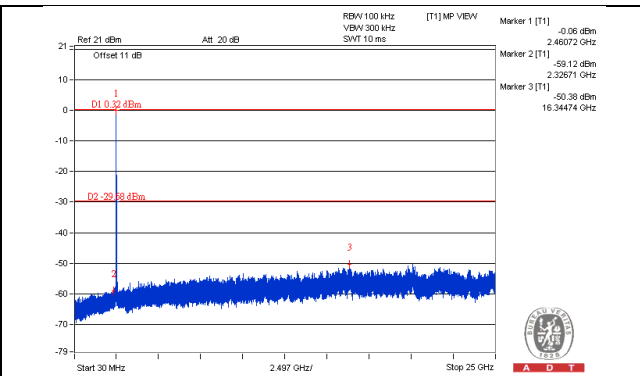
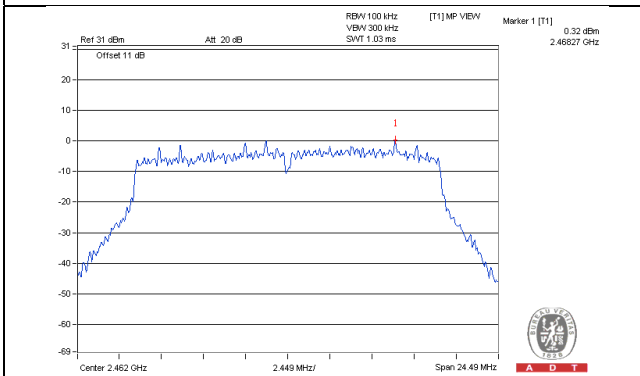

CH 1 Band edge

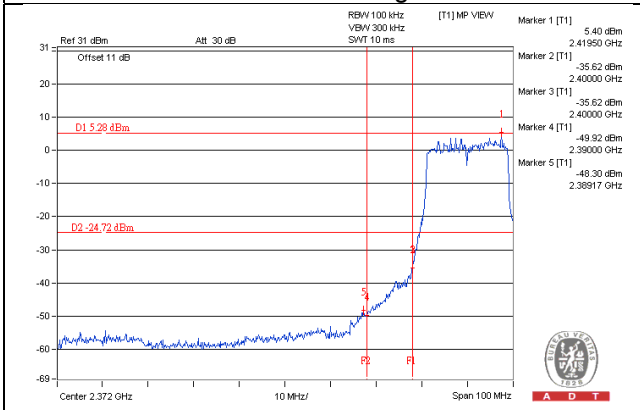

CH 11 Band edge

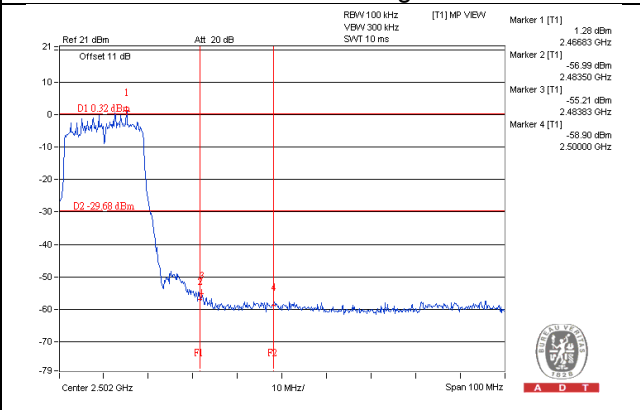



BUREAU
VERITAS

802.11n (VHT20)_CHAIN 3

CH 1

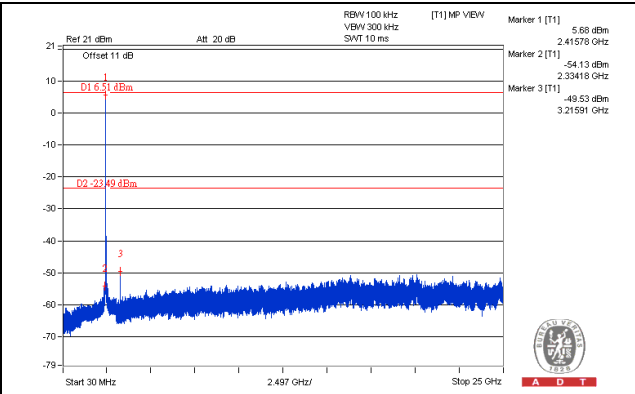
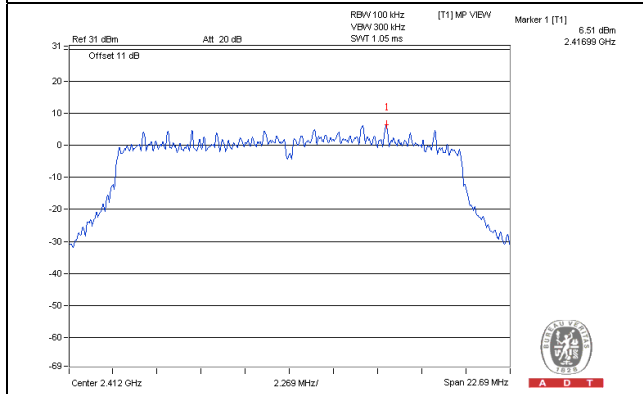

CH 6

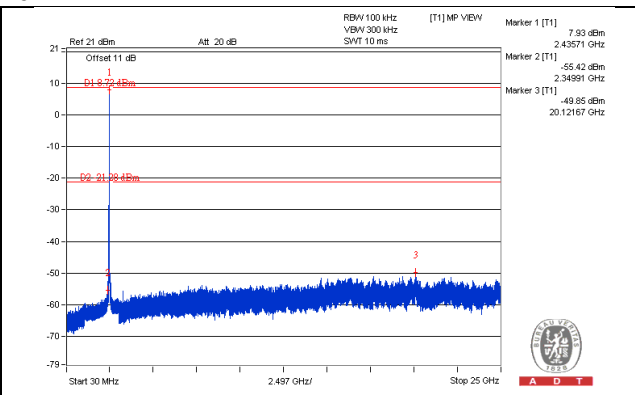
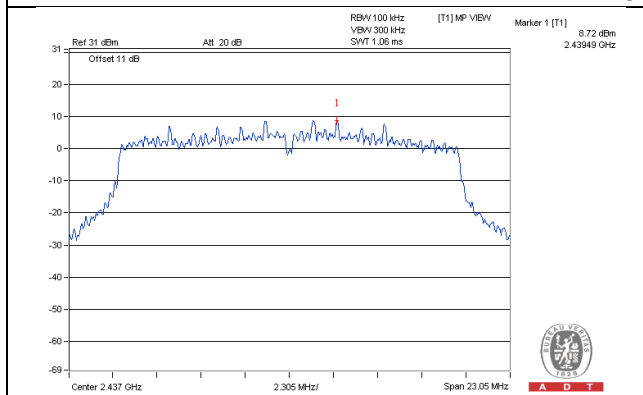

CH 11

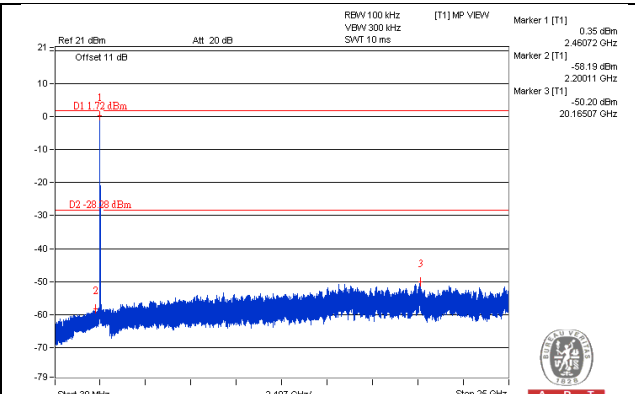
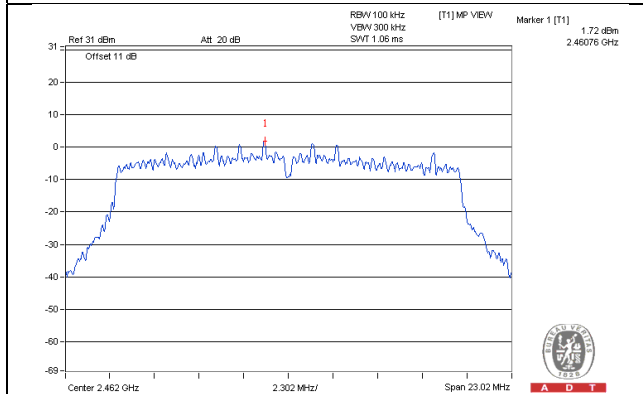

CH 1 Band edge

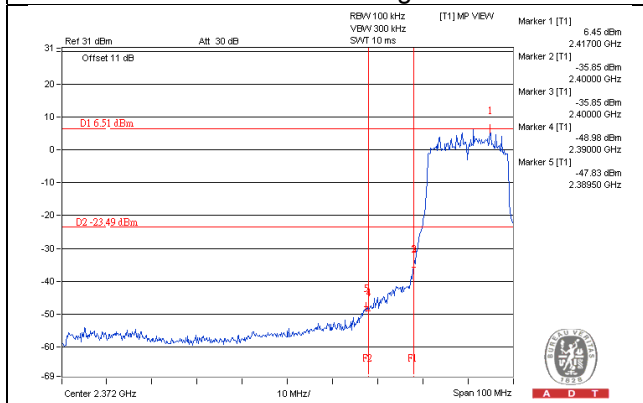

CH 11 Band edge

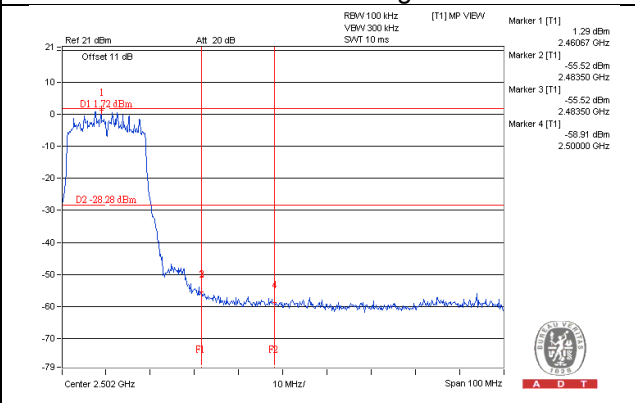



802.11n (VHT40)_CHAIN 0

CH 3

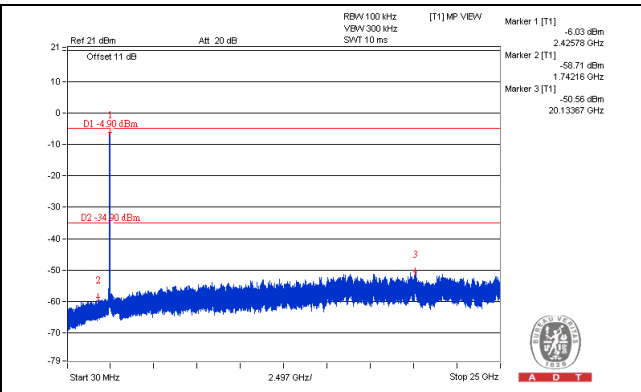
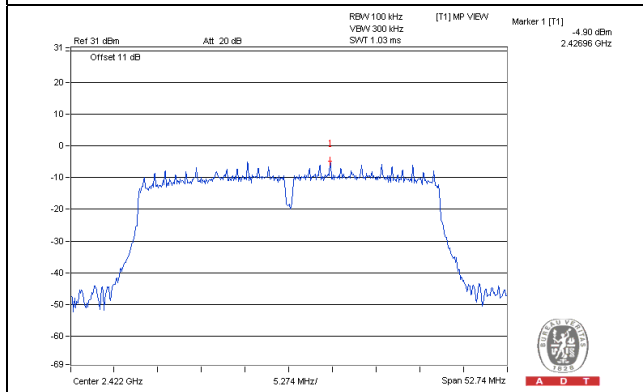

CH 6

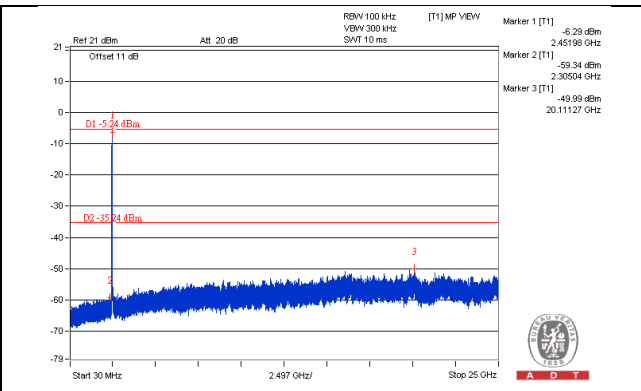
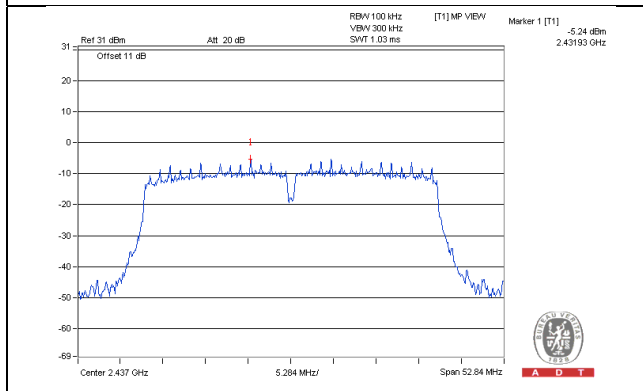

CH 9

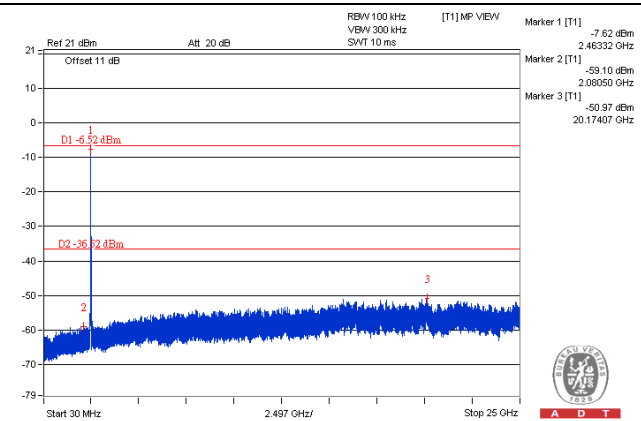
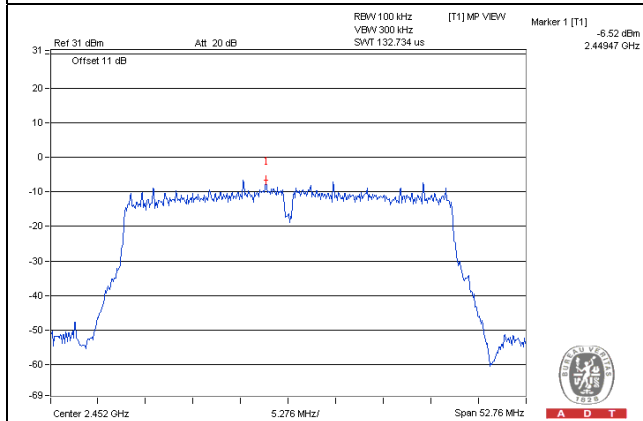

CH 3 Band edge

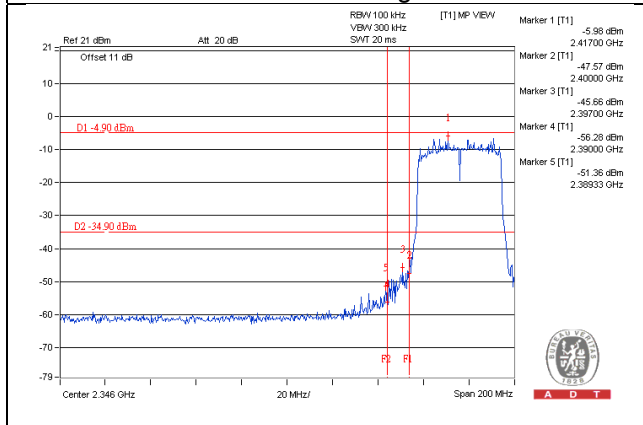

CH 9 Band edge

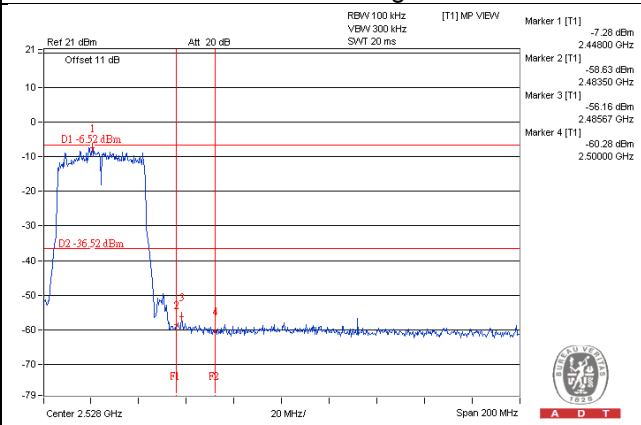



BUREAU VERITAS

802.11n (VHT40)_CHAIN 1

CH 3

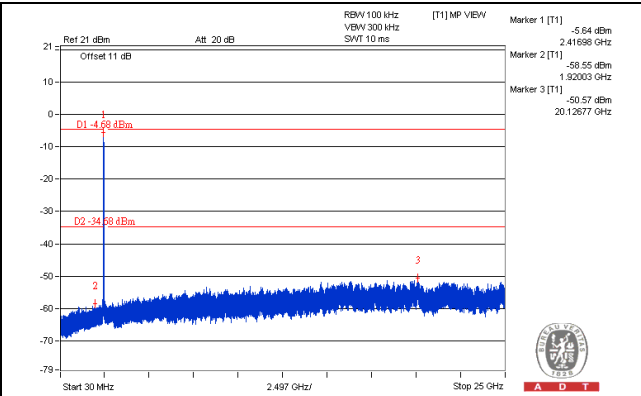
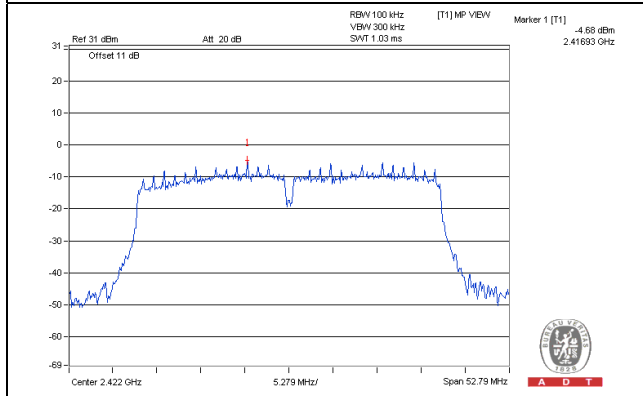

CH 6

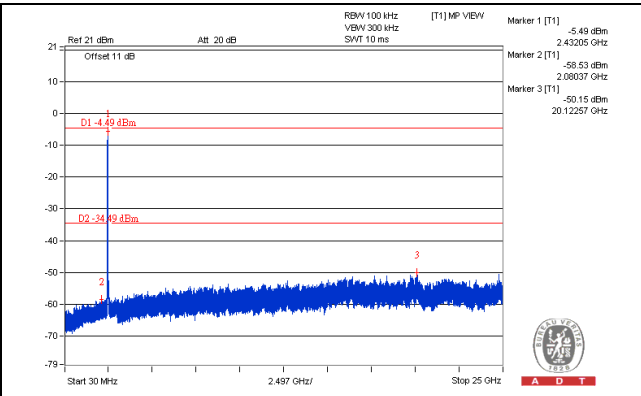
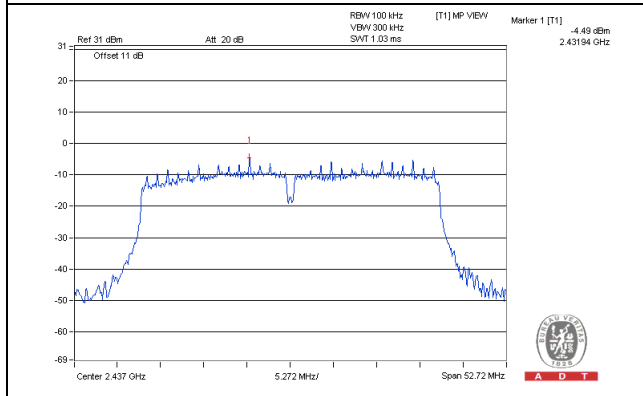

CH 9

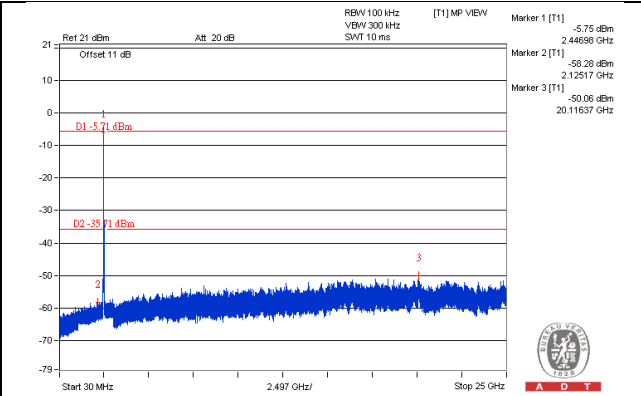
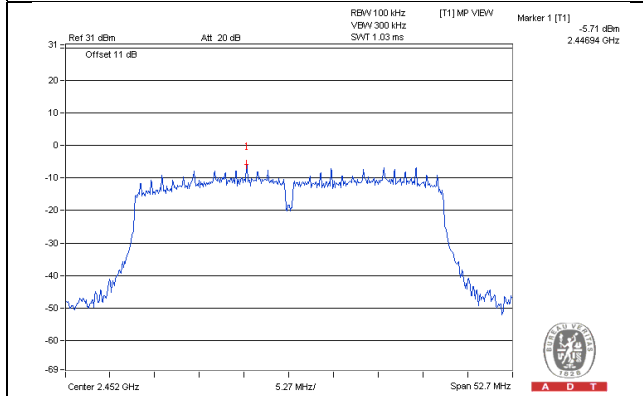

CH 3 Band edge

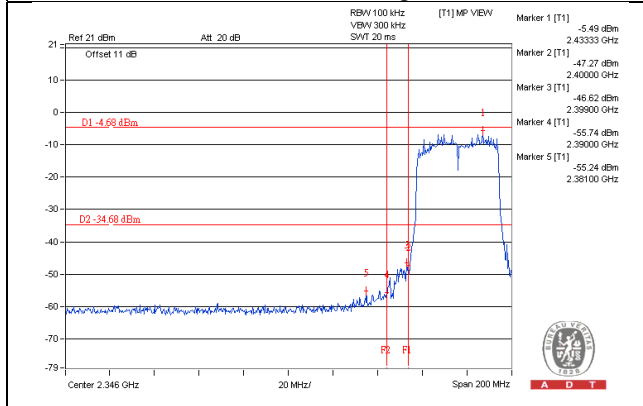

CH 9 Band edge

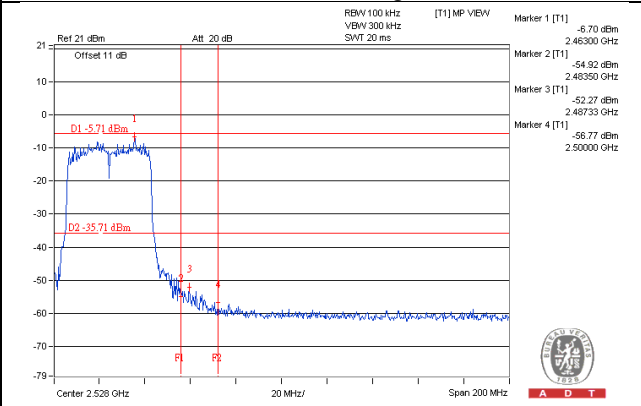



BUREAU VERITAS

802.11n (VHT40)_CHAIN 2

CH 3

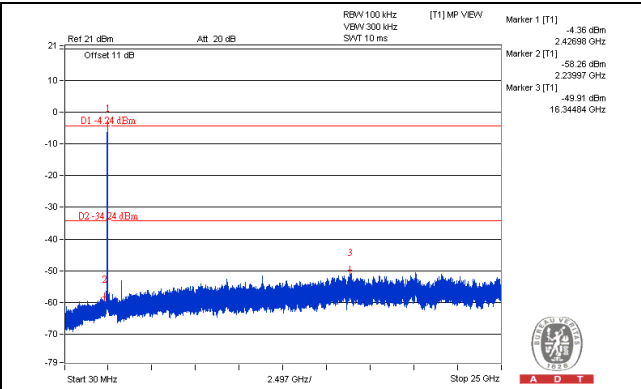
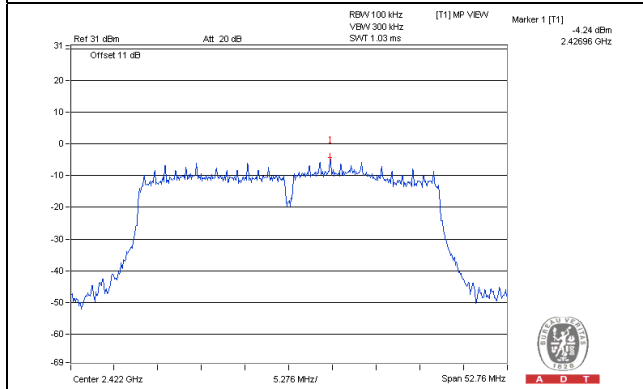

CH 6

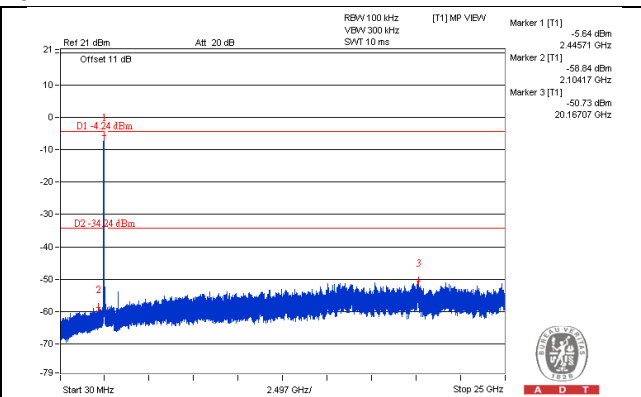
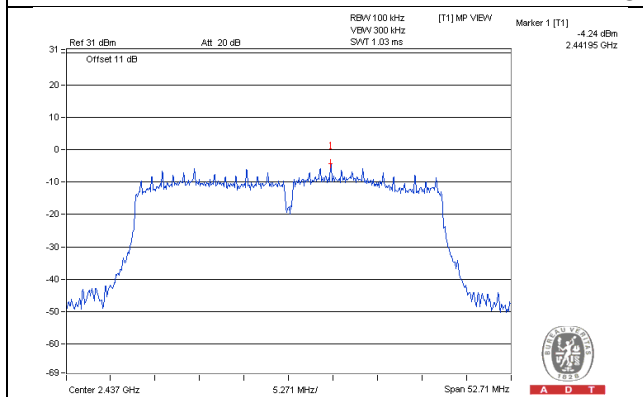

CH 9

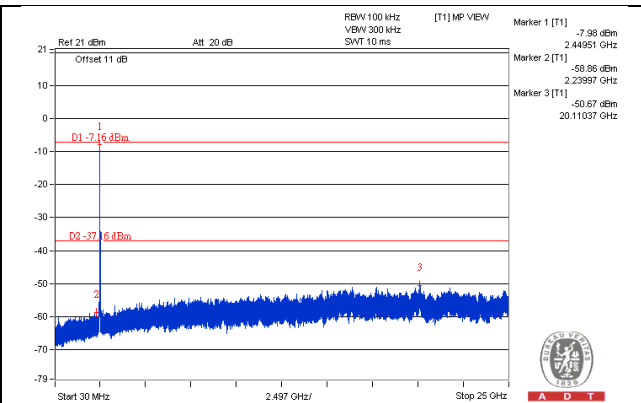
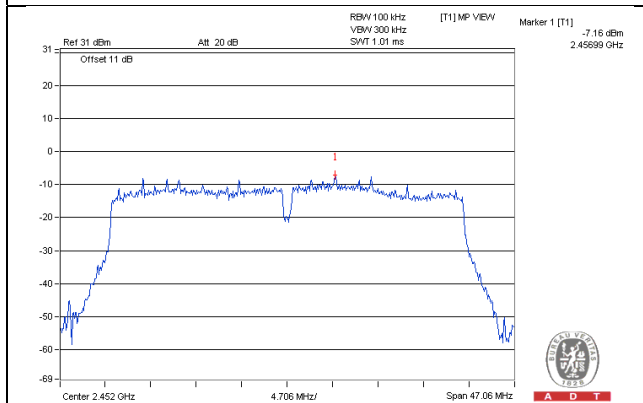

CH 3 Band edge

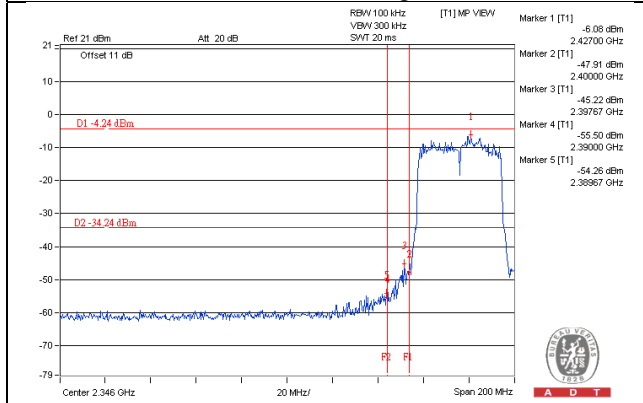

CH 9 Band edge

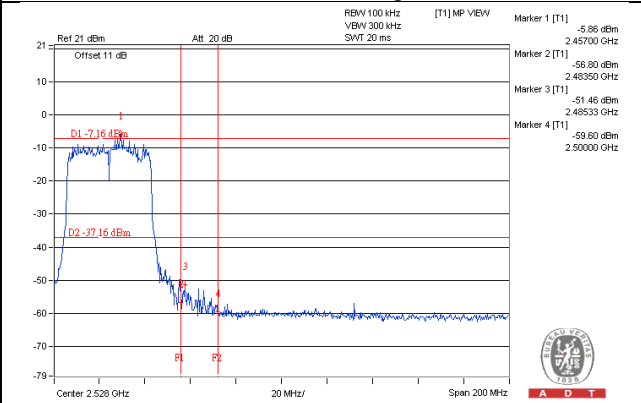



BUREAU VERITAS

802.11n (VHT40)_CHAIN 3

CH 3

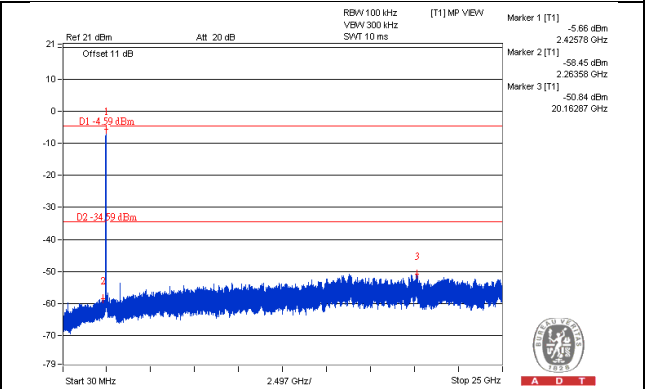
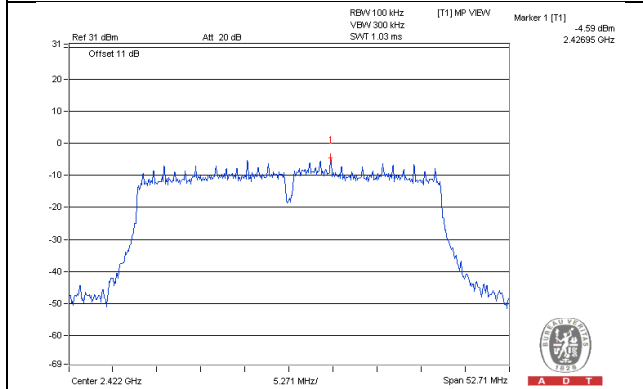

CH 6

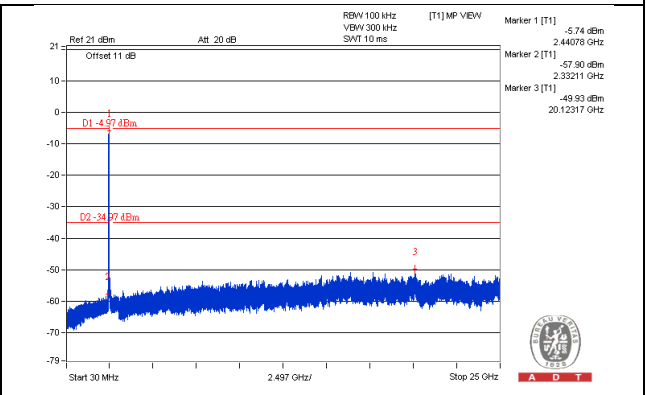
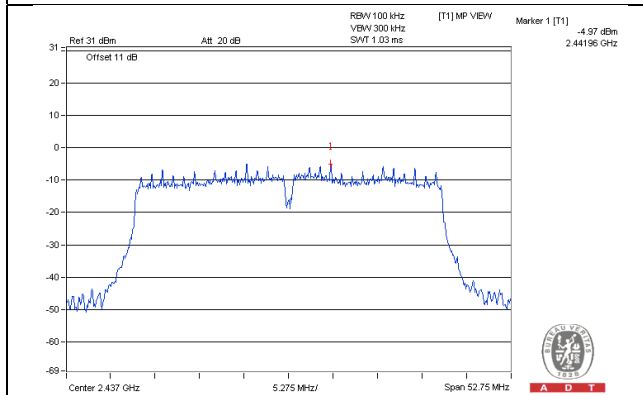

CH 9

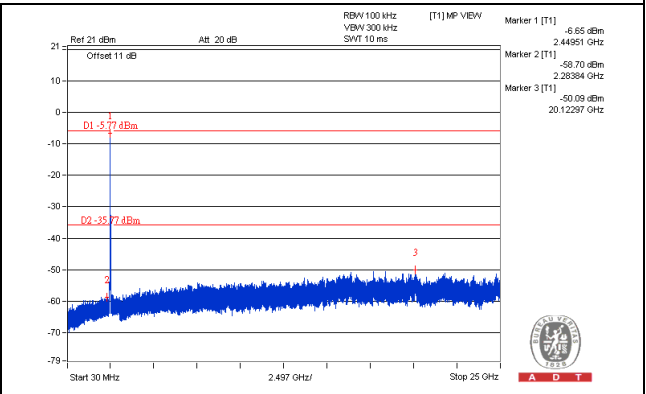
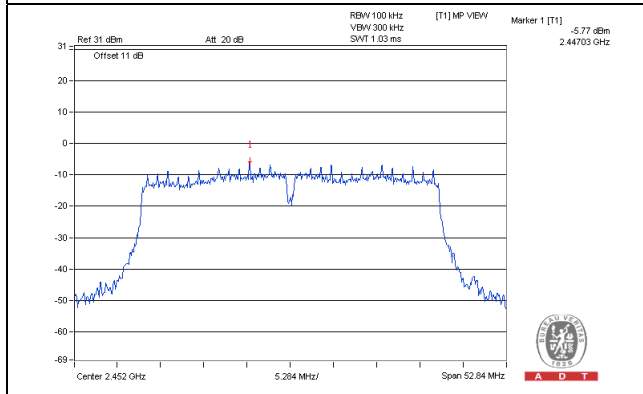

CH 3 Band edge

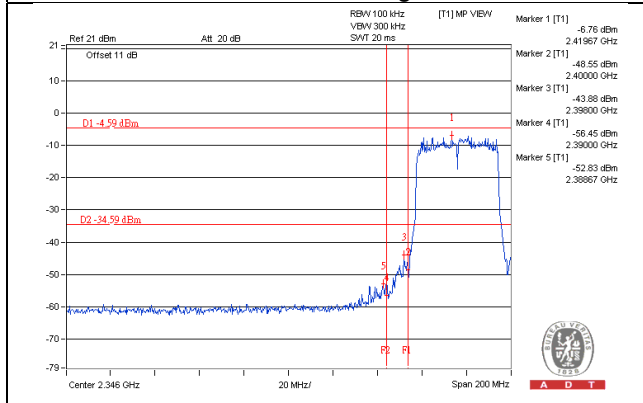

CH 9 Band edge

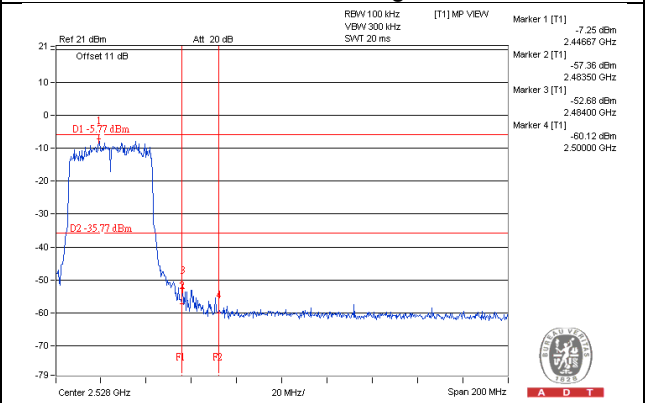

5 Pictures of Test Arrangements

Please refer to the attached file (Test Setup Photo).

Appendix – Information on the Testing Laboratories

We, Bureau Veritas Consumer Products Services (H.K.) Ltd., Taoyuan Branch, were founded in 1988 to provide our best service in EMC, Radio, Telecom and Safety consultation. Our laboratories are accredited and approved according to ISO/IEC 17025.

If you have any comments, please feel free to contact us at the following:

Linko EMC/RF Lab

Tel: 886-2-26052180

Fax: 886-2-26051924

Hsin Chu EMC/RF/Telecom Lab

Tel: 886-3-6668565

Fax: 886-3-6668323

Hwa Ya EMC/RF/Safety Lab

Tel: 886-3-3183232

Fax: 886-3-3270892

Email: service.adt@tw.bureauveritas.com

Web Site: www.bureauveritas-adt.com

The address and road map of all our labs can be found in our web site also.

--- END ---