



FCC PART 15.407
 IC RSS-247, ISSUE 1, MAY 2015
 DYNAMIC FREQUENCY SELECTION
 TEST AND MEASUREMENT REPORT



For

Fortinet, Inc.

899 Kifer Road

Sunnyvale, CA 94086, USA

FCC ID: TVE-28166022
IC: 7280B-28166022

Report Type: Original Report	Product Type: Secured Wireless Access Point
Prepared By: Xiao Lin Test Engineer	
Report Number: R1610072-DFS	
Report Date: 2016-11-28	
Reviewed By: Bo Li RF Supervisor	
Bay Area Compliance Laboratories Corporation (BACL) 1274 Anvilwood Avenue, Sunnyvale, CA 94089, USA Tel: 1 (408) 732-9162 Fax: 1 (408) 732-9164	

Note: This test report is prepared for the customer shown above and for the device described herein. It may not be duplicated or used in part without prior written consent from Bay Area Compliance Laboratories Corp. This report **must not** be used by the customer to claim product certification, approval, or endorsement by A2LA* or any agency of the Federal Government.

* This report may contain data that are not covered by the A2LA accreditation and are marked with an asterisk “*”

TABLE OF CONTENTS

1	GENERAL DESCRIPTION.....	4
1.1	PRODUCT DESCRIPTION FOR EQUIPMENT UNDER TEST (EUT).....	4
1.2	MECHANICAL DESCRIPTION OF EUT.....	4
1.3	OBJECTIVE.....	4
1.4	RELATED SUBMITTAL(S)/GRANT(S).....	4
1.5	TEST METHODOLOGY.....	4
1.6	TEST FACILITY REGISTRATIONS.....	5
1.7	TEST FACILITY ACCREDITATIONS.....	5
2	EUT TEST CONFIGURATION.....	8
2.1	JUSTIFICATION.....	8
2.2	EUT EXERCISE SOFTWARE.....	8
2.3	EQUIPMENT MODIFICATIONS.....	8
2.4	LOCAL SUPPORT EQUIPMENT.....	8
2.5	INTERFACE PORTS AND CABLES.....	8
2.6	POWER SUPPLY AND LINE FILTERS.....	8
3	SUMMARY OF TEST RESULTS.....	9
4	APPLICABLE STANDARDS.....	10
4.1	DFS REQUIREMENT.....	10
4.2	DFS MEASUREMENT SYSTEM.....	13
4.3	SYSTEM BLOCK DIAGRAM.....	13
4.4	CONDUCTED METHOD.....	13
4.5	RADIATED METHOD.....	15
4.6	TEST PROCEDURE.....	15
5	TEST RESULTS.....	16
5.1	DESCRIPTION OF EUT.....	16
5.2	ANTENNA DESCRIPTION.....	16
5.3	TEST EQUIPMENT LIST AND DETAILS.....	16
5.4	RADAR WAVEFORM CALIBRATION.....	17
5.5	TEST ENVIRONMENTAL CONDITIONS.....	17
6	CHANNEL AVAILABILITY CHECK TIME (CAC).....	42
6.1	TEST PROCEDURE.....	42
7	CHANNEL MOVE TIME AND CHANNEL CLOSING TRANSMISSION TIME.....	49
7.1	TEST PROCEDURE.....	49
7.2	TEST RESULTS.....	49
8	NON-OCCUPANCY PERIOD.....	52
8.1	TEST PROCEDURE.....	52
8.2	TEST RESULTS.....	52
9	RADAR DETECTION BANDWIDTH & RADAR DETECTION PERFORMANCE CHECK.....	54
9.1	DETECTION BANDWIDTH.....	54
9.2	RADAR DETECTION PERFORMANCE CHECK.....	59
10	BRIDGE AND/OR MESH MODE.....	261
10.1	TEST STANDARD.....	261
10.2	TEST RESULT.....	261

DOCUMENT REVISION HISTORY

Revision Number	Report Number	Description of Revision	Date of Revision
0	R1610072-DFS	Original	2016-11-28

1 General Description

1.1 Product Description for Equipment under Test (EUT)

This test and measurement report has been compiled on behalf of *Fortinet, Inc.* and their product Model: FORTIAP-S421E, FortiAP S421E, FAP-S421E, FORTIAP-S423E, FortiAP S423E, FAP-S423E which will henceforth be referred to as the EUT (Equipment under Test). The EUT is an Secured Wireless Access Point.

1.2 Mechanical Description of EUT

The EUT measures approximately 21.6cm (Diameter) x 3.5cm (Height) and weighs approximately 500 g

The data gathered are from production sample provided by the manufacturer, serial number: R1610072-1, assigned by BACL.

1.3 Objective

This report is prepared on behalf of *Fortinet, Inc.* in accordance with FCC CFR47 §15.407 (h) & RSS 247 §6.3 and KDB: 905462 D02 UNII DFS Compliance Procedures New Rules v02.

The objective is to determine compliance with FCC rules for DFS Detection Threshold, Channel Availability Check Time, Uniform Spreading U-NII Detection Bandwidth, Channel Closing Transmission Time, and Channel Move time in Master Mode.

1.4 Related Submittal(s)/Grant(s)

N/A

1.5 Test Methodology

FCC CFR 47 Part2, Part15.407 (h)

RSS 247 §6.3

KDB: 905462 D02 UNII DFS Compliance Procedures New Rules v02.

COMPLIANCE MEASUREMENT PROCEDURES FOR UNLICENSED-NATIONAL INFORMATION INFRASTRUCTURE DEVICES OPERATING IN THE 5250-5350 MHz AND 5470-5725 MHz BANDS INCORPORATING DYNAMIC FREQUENCY SELECTION

1.6 Test Facility Registrations

BACLs test facilities that are used to perform Radiated and Conducted Emissions tests are currently recognized by the Federal Communications Commission as Accredited with NIST Designation Number US1129.

BACL's test facilities that are used to perform Radiated and Conducted Emissions tests are currently registered with Industry Canada under Registration Numbers: 3062A-1, 3062A-2, and 3062A-3.

BACL is a Chinese Taipei Bureau of Standards Metrology and Inspection (BSMI) validated Conformity Assessment Body (CAB), under Annex B, Phase I Procedures of the APEC Mutual Recognition Arrangement (MRA). BACL's BSMI Lab Code Number is: SL2-IN-E-1002R

BACL's test facilities that are used to perform AC Line Conducted Emissions, Telecommunications Line Conducted Emissions, Radiated Emissions from 30 MHz to 1 GHz, and Radiated Emissions from 1 GHz to 6 GHz are currently recognized as Accredited in accordance with the Voluntary Control Council for Interference [VCCI] Article 15 procedures under Registration Number A-0027.

1.7 Test Facility Accreditations

Bay Area Compliance Laboratories Corp. (BACL) is:

A- An independent, 3rd-Party, Commercial Test Laboratory accredited to ISO/IEC 17025:2005 by A2LA (Test Laboratory Accreditation Certificate Number 3297.02), in the fields of: Electromagnetic Compatibility and Telecommunications. Unless noted by an Asterisk (*) in the Compliance Matrix (See Section 3 of this Test Report), BACL's ISO/IEC 17025:2005 Scope of Accreditation includes all of the Test Method Standards and/or the Product Family Standards detailed in this Test Report..

BACL's ISO/IEC 17025:2005 Scope of Accreditation includes a comprehensive suite of EMC Emissions, EMC Immunity, Radio, RF Exposure, Safety and wireline Telecommunications test methods applicable to a wide range of product categories. These product categories include Central Office Telecommunications Equipment [including NEBS - Network Equipment Building Systems], Unlicensed and Licensed Wireless and RF devices, Information Technology Equipment (ITE); Telecommunications Terminal Equipment (TTE); Medical Electrical Equipment; Industrial, Scientific and Medical Test Equipment; Professional Audio and Video Equipment; Industrial and Scientific Instruments and Laboratory Apparatus; Cable Distribution Systems, and Energy Efficient Lighting.

B- A Product Certification Body accredited to ISO/IEC 17065:2012 by A2LA (Product Certification Body Accreditation Certificate Number 3297.03) to certify

- For the USA (Federal Communications Commission):
 - 1- All Unlicensed radio frequency devices within FCC Scopes A1, A2, A3, and A4;
 - 2- All Licensed radio frequency devices within FCC Scopes B1, B2, B3, and B4;
 - 3- All Telephone Terminal Equipment within FCC Scope C.
- For the Canada (Industry Canada):
 - 1 All Scope 1-Licence-Exempt Radio Frequency Devices;
 - 2 All Scope 2-Licensed Personal Mobile Radio Services;
 - 3 All Scope 3-Licensed General Mobile & Fixed Radio Services;
 - 4 All Scope 4-Licensed Maritime & Aviation Radio Services;
 - 5 All Scope 5-Licensed Fixed Microwave Radio Services
 - 6 All Broadcasting Technical Standards (BETS) in the Category I Equipment Standards List.
- For Singapore (Info-Communications Development Authority (IDA)):
 - 1 All Line Terminal Equipment: All Technical Specifications for Line Terminal Equipment – Table 1 of IDA MRA Recognition Scheme: 2011, Annex 2
 2. All Radio-Communication Equipment: All Technical Specifications for Radio-Communication Equipment – Table 2 of IDA MRA Recognition Scheme: 2011, Annex 2
- For the Hong Kong Special Administrative Region:
 - 1 All Radio Equipment, per KHCA 10XX-series Specifications;
 - 2 All GMDSS Marine Radio Equipment, per HKCA 12XX-series Specifications;
 - 3 All Fixed Network Equipment, per HKCA 20XX-series Specifications.
- For Japan:
 - 1 MIC Telecommunication Business Law (Terminal Equipment):
 - All Scope A1 - Terminal Equipment for the Purpose of Calls;
 - All Scope A2 - Other Terminal Equipment
 - 2 Radio Law (Radio Equipment):
 - All Scope B1 - Specified Radio Equipment specified in Article 38-2-2, paragraph 1, item 1 of the Radio Law
 - All Scope B2 - Specified Radio Equipment specified in Article 38-2-2, paragraph 1, item 2 of the Radio Law
 - All Scope B3 - Specified Radio Equipment specified in Article 38-2-2, paragraph 1, item 3 of the Radio Law

C- A Product Certification Body accredited to ISO/IEC 17065:2012 by A2LA (Product Certification Body Accreditation Certificate Number 3297.01) to certify Products to USA's Environmental Protection Agency (EPA) ENERGY STAR Product Specifications for:

- 1 Electronics and Office Equipment:
 - for Telephony (ver. 3.0)
 - for Audio/Video (ver. 3.0)
 - for Battery Charging Systems (ver. 1.1)
 - for Set-top Boxes & Cable Boxes (ver. 4.1)
 - for Televisions (ver. 6.1)
 - for Computers (ver. 6.0)
 - for Displays (ver. 6.0)
 - for Imaging Equipment (ver. 2.0)
 - for Computer Servers (ver. 2.0)
- 2 Commercial Food Service Equipment
 - for Commercial Dishwashers (ver. 2.0)
 - for Commercial Ice Machines (ver. 2.0)
 - for Commercial Ovens (ver. 2.1)
 - for Commercial Refrigerators and Freezers
- 3 Lighting Products
 - For Decorative Light Strings (ver. 1.5)
 - For Luminaires (including sub-components) and Lamps (ver. 1.2)
 - For Compact Fluorescent Lamps (CFLs) (ver. 4.3)
 - For Integral LED Lamps (ver. 1.4)
- 4 Heating, Ventilation, and AC Products
 - for Residential Ceiling Fans (ver. 3.0)
 - for Residential Ventilating Fans (ver. 3.2)
- 5 Other
 - For Water Coolers (ver. 3.0)

D. A NIST Designated Phase-I and Phase-II Conformity Assessment Body (CAB) for the following economies and regulatory authorities under the terms of the stated MRAs/Treaties:

- Australia: ACMA (Australian Communication and Media Authority) – APEC Tel MRA -Phase I;
- Canada: (Industry Canada - IC) Foreign Certification Body – FCB – APEC Tel MRA -Phase I & Phase II;
- Chinese Taipei (Republic of China – Taiwan):
 - o BSMI (Bureau of Standards, Metrology and Inspection) APEC Tel MRA -Phase I;
 - o NCC (National Communications Commission) APEC Tel MRA -Phase I;
- European Union:
 - o EMC Directive 2014/30/EC US-EU EMC & Telecom MRA CAB
 - o Radio & Teleterminal Equipment (R&TTE) Directive 1995/5/EC
US -EU EMC & Telecom MRA CAB
- Hong Kong Special Administrative Region: (Office of the Telecommunications Authority – OFTA)
APEC Tel MRA -Phase I & Phase II
- Israel – US-Israel MRA Phase I
- Republic of Korea (Ministry of Communications - Radio Research Laboratory) APEC Tel MRA -Phase I
- Singapore: (Infocomm Development Authority - IDA) APEC Tel MRA -Phase I & Phase II;
- Japan: VCCI - Voluntary Control Council for Interference US-Japan Telecom Treaty VCCI Side Letter-
- USA:
 - o ENERGY STAR Recognized Test Laboratory – US EPA
 - o Telecommunications Certification Body (TCB) – US FCC;

Vietnam: APEC Tel MRA -Phase I;

2 EUT Test Configuration

2.1 Justification

The EUT was configured for testing according to FCC CFR47 §15.407 (h) & RSS 247 §6.3, and KDB: 905462 D02 UNII DFS Compliance Procedures New Rules v02.

2.2 EUT Exercise Software

The test software used was FortiWiFi 60D GUI web and Tera Term, they were been used to change the WiFi mode and channel to control the radio.

2.3 Equipment Modifications

N/A

2.4 Local Support Equipment

Manufacturer	Description	Model
Dell	Laptop	Latitude D630
Fortinet	Controller	FortiWiFi 60D

2.5 Interface Ports and Cables

Cable Description	Length (M)	From	To
RJ 45 (CAT 5)	< 3	Controller	POE
RJ 45 (CAT 5)	<3	Supporting Laptop	Controller
RJ 45 (CAT 5)	<3	AP	POE
Serial Cable	<3	AP	Supporting Laptop

2.6 Power Supply and Line Filters

Manufacturer	Description	Model	Part Number
N/A	POE injector	N/A	N/A

3 Summary of Test Results

The following result table represents the list of measurements required under the FCC CFR47 §15.407 (h) & RSS 247 §6.3, and KDB: 905462 D02 UNII DFS Compliance Procedures New Rules v02. This report is to update from KDB: 905462 D02 UNII DFS Compliance Procedures Old rules v01 to KDB: 905462 D02 UNII DFS Compliance Procedures New Rules v02.

Items	Description of Test	Results
Detection Bandwidth	UNII Detection Bandwidth	Compliant
Performance Requirements Check	Initial Channel Availability Check Time (CAC)	Compliant
	Radar Burst at the Beginning of the CAC	Compliant
	Radar Burst at the End of the CAC	Compliant
In-Service Monitoring	Channel Move Time	Compliant
	Channel Closing Transmission Time	Compliant
	Non-Occupancy Period	Compliant
Radar Detection	Statistical Performance Check	Compliant

4 Applicable Standards

4.1 DFS Requirement

FCC CFR47 §15.407 (h) & RSS 247 §6.3, and KDB: 905462 D02 UNII DFS Compliance Procedures New Rules v02.

Table 1: Applicability of DFS requirements prior to use of a channel

Requirement	Operational Mode		
	Master	Client (Without radar detection)	Client (With radar detection)
Non-Occupancy Period	Yes	Not Required	Yes
DFS Detection Threshold	Yes	Not Required	Yes
Channel Availability Check Time	Yes	Not Required	Not Required
U-NII Detection Bandwidth	Yes	Not Required	Yes

Table 2: Applicability of DFS requirements during normal operation

Requirement	Operational Mode	
	Master Device or Client with Radar Detection	Client Without Radar Detection
DFS Detection Threshold	Yes	Not Required
Channel Closing Transmission Time	Yes	Yes
Channel Move Time	Yes	Yes
U-NII Detection Bandwidth	Yes	Not Required

Additional requirements for devices with multiple bandwidth modes	Master Device or Client with Radar Detection	Client Without Radar Detection
U-NII Detection Bandwidth and Statistical Performance Check	All BW modes must be tested	Not required
Channel Move Time and Channel Closing Transmission Time	Test using widest BW mode available	Test using the widest BW mode available for the link
All other tests	Any single BW mode	Not required

Note: Frequencies selected for statistical performance check (Section 7.8.4) should include several frequencies within the radar detection bandwidth and frequencies near the edge of the radar detection bandwidth. For 802.11 devices it is suggested to select frequencies in each of the bonded 20 MHz channels and the channel center frequency.

Table 3: Interference Threshold for Master and Client with Radar Detection

Maximum Transmit Power	Value (See Notes 1, 2 and 3)
EIRP \geq 200 milliwatt	-64 dBm
EIRP $<$ 200 milliwatt and power spectral density $<$ 10dBm/MHz	-62 dBm
EIRP $<$ 200 milliwatt that do not meet the power spectral density requirement	-64 dBm

Note 1: This is the level at the input of the receiver assuming a 0 dBi receive antenna.
Note 2: Throughout these test procedures an additional 1 dB has been added to the amplitude of the test transmission waveforms to account for variations in measurement equipment. This will ensure that the test signal is at or above the detection threshold level to trigger a DFS response.
Note 3: EIRP is based on the highest antenna gain. For MIMO devices refer to KDB Publication 662911 D01.

Table 4: DFS Response Requirement Values

Parameter	Value
Non-occupancy period	Minimum 30 minutes
Channel Availability Check Time	60 seconds
Channel Move Time	10 seconds <i>See Note 1.</i>
Channel Closing Transmission Time	200 milliseconds + an aggregate of 60 milliseconds over remaining 10 second period. <i>See Notes 1 and 2.</i>
U-NII Detection Bandwidth	Minimum 100% of the UNII 99% transmission power bandwidth. <i>See Note 3.</i>

Note 1: Channel Move Time and the Channel Closing Transmission Time should be performed with Radar Type 0. The measurement timing begins at the end of the Radar Type 0 burst.

Note 2: The Channel Closing Transmission Time is comprised of 200 milliseconds starting at the beginning of the Channel Move Time plus any additional intermittent control signals required to facilitate a Channel move (an aggregate of 60 milliseconds) during the remainder of the 10 second period. The aggregate duration of control signals will not count quiet periods in between transmissions.

Note 3: During the U-NII Detection Bandwidth detection test, radar type 0 should be used. For each frequency step the minimum percentage of detection is 90 percent. Measurements are performed with no data traffic.

Table 5: Short Pulse Radar Test Waveforms

Radar Type	Pulse Width (Microseconds)	PRI (Microseconds)	Pulses	Minimum Percentage of Successful Detection	Minimum Number of Trials
0	1	1428	18	See Note 1	See Note 1
1	1	Test A: 15 unique PRI values randomly selected from the list of 23 PRI values in Table 5a Test B: 15 unique PRI values randomly selected within the range of 518-3066 μsec, with a minimum increment of 1 μsec, excluding PRI values selected in Test A	$\text{Roundup} \left\{ \begin{matrix} \left(\frac{1}{360} \right) \\ \left(\frac{19 \cdot 10^6}{\text{PRI}_{\mu\text{sec}}} \right) \end{matrix} \right.$	60%	30
2	1-5	150-230	23-29	60%	30
3	6-10	200-500	16-18	60%	30
4	11-20	200-500	12-16	60%	30
Aggregate (Radar Types 1-4)				80%	120
Note 1: Short Pulse Radar Type 0 should be used for the detection bandwidth test, channel move time, and channel closing time tests.					

Table 6: Long Pulse Radar Test Signal

Radar Type	Bursts	Chirp Width (MHz)	PRI (usec)	Number of Pulses per Burst	Number of Bursts	Minimum Percentage of Successful Detection	Minimum Number of Trials
5	50-100	5-20	1000-2000	1-3	8-20	80%	30

Table 7: Frequency Hopping Radar Test Signal

Radar Type	Pulse Width (usec)	PRI (usec)	Pulses per Hop	Hopping Rate (kHz)	Hopping Sequence Length (msec)	Minimum Percentage of Successful Detection	Minimum Number of Trials
6	1	333	9	0.333	300	70%	30

4.2 DFS Measurement System

BACL DFS measurement system consists of two subsystems: (1) The radar signal generating subsystem and (2) the traffic monitoring subsystem.

4.3 System Block Diagram

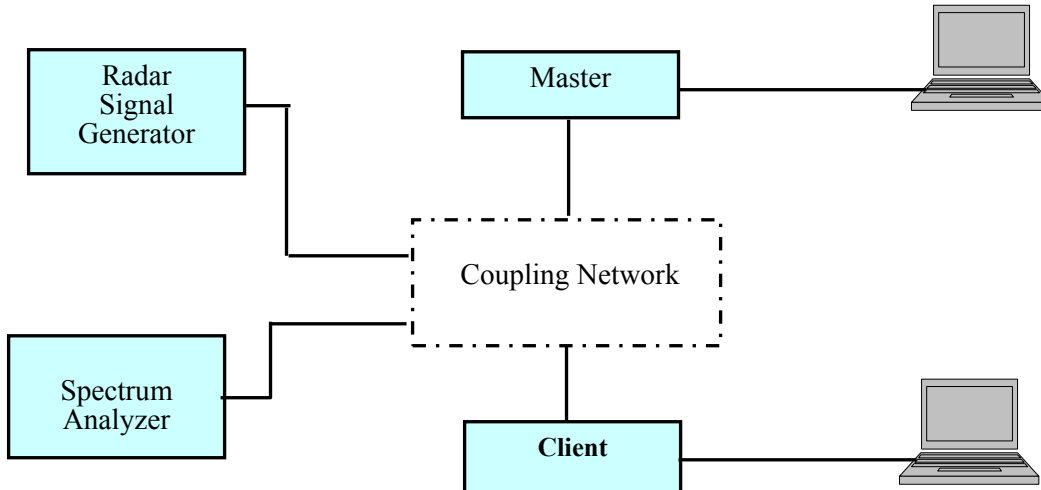

4.4 Conducted Method

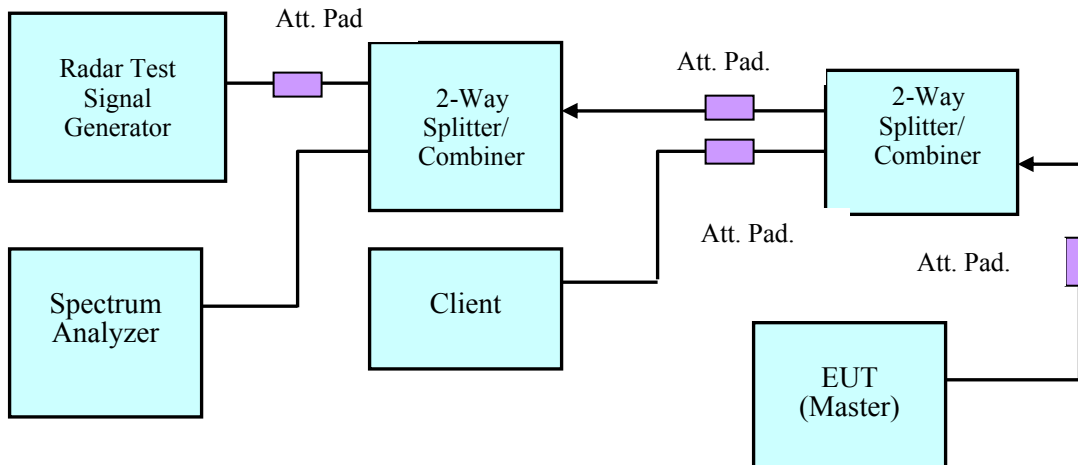

Setup for Master with injection at the Master

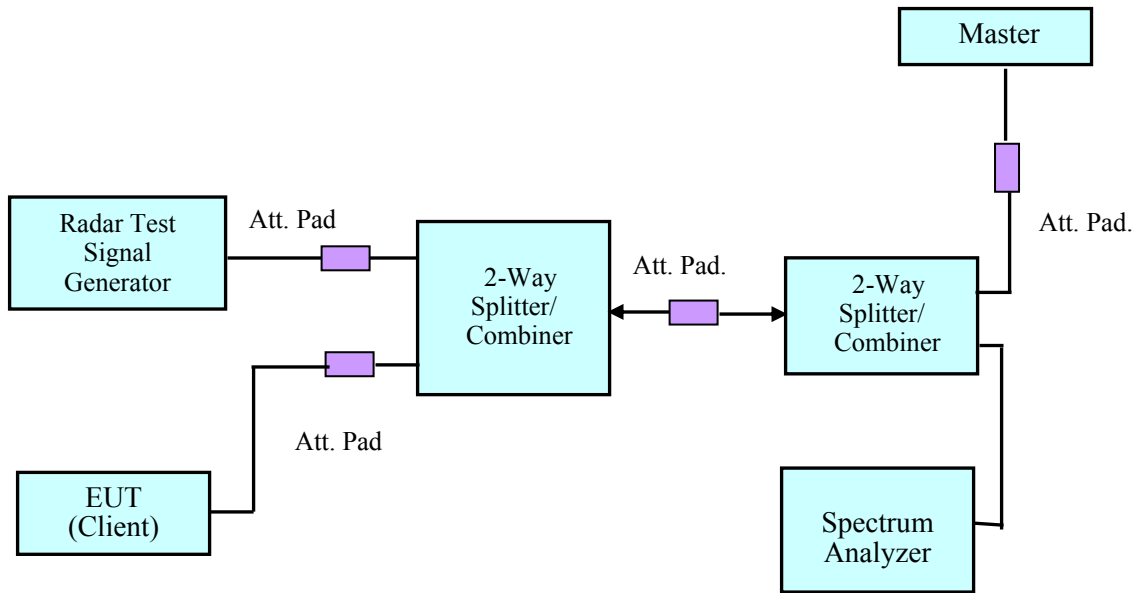

Setup for Client with injection at the Master

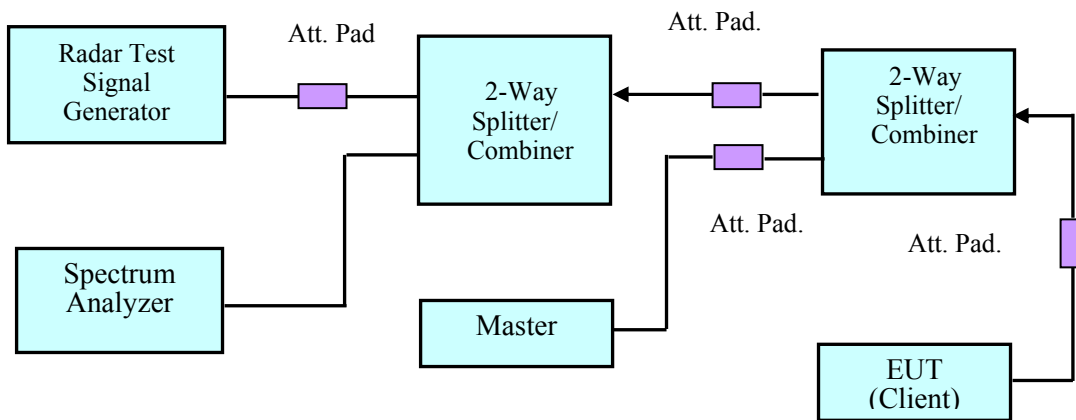

Setup for Client with injection at the Client

4.5 Radiated Method

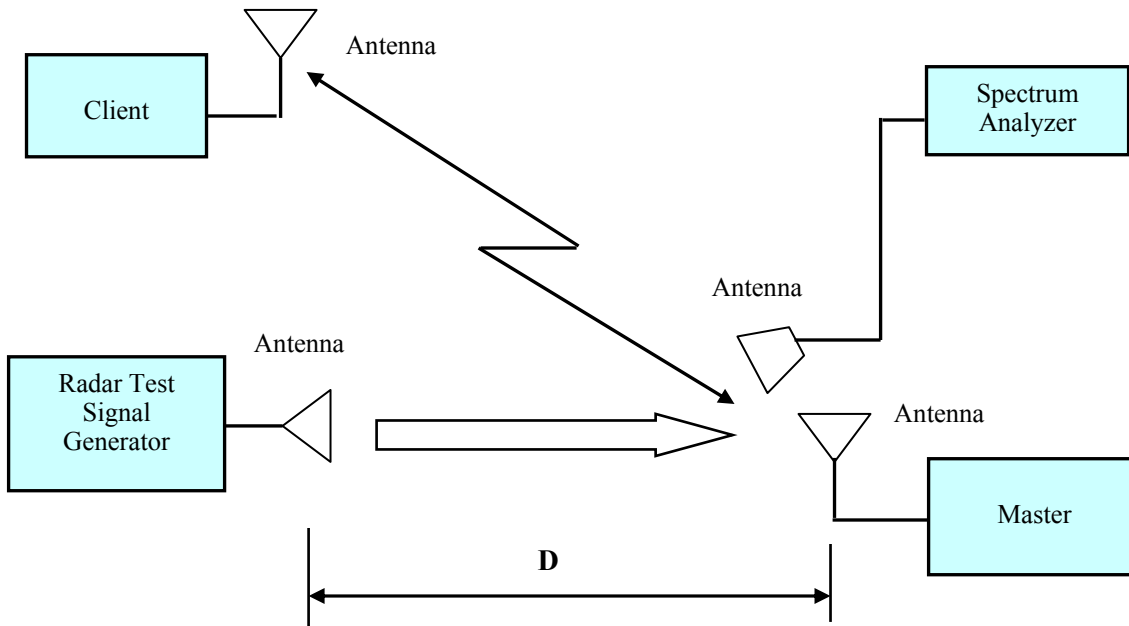

4.6 Test Procedure

A spectrum analyzer is used as a monitor that verifies the EUT's status, which includes the Channel Closing Transmission Time and the Channel Move Time. The Spectrum analyzer is used to monitor the equipment under test (EUT) does not transmit on the same channel during the Non-Occupied Period after the radar detection. It is also used to monitor EUT transmissions during the Channel Availability Check Time.

5 Test Results

5.1 Description of EUT

The EUT operates in 5230-5350 MHz and 5470-5725 MHz range in Master Mode.

The rated output power of EUT is > 23 dBm (EIRP), Therefore the required interference threshold level is -64 dBm, the required radiated threshold at antenna port is -64 dBm.

The calibrated radiated DFS detection threshold level is set to -64 dBm.

WLAN traffic is generated by streaming the video file TestFile.mpg, this file is used by IP and Frame based systems for loading the test channel during the In-service compliance testing of the U-NII device. The file is streamed from the Access Point to the Client in full motion video mode using the media player with the V2.61 Codec package.

S423E was selected for DFS testing

5.2 Antenna Description

Antenna Type	Antenna Gain (dBi) @ 5 GHz
Internal (S421E)	4.78
External (S423E)	3.18

5.3 Test Equipment List and Details

Manufacturer	Equipment Description	Model	S/N	Calibration Date	Calibration Interval
National Instruments	NI PXI-1042 8-Slot chassis	PXI-1042	V08X01EE1	N/A	N/A
National Instruments	Arbitrary Waveform Generator	PXI-5421	N/A	N/A	N/A
National Instruments	RF Upconverter	PXI-5610	N/A	N/A	N/A
ASCOR	Upconverter	AS-7206	N/A	N/A	N/A
Agilent	Analyzer, Spectrum	E4440A	US45303156	2016-01-19	1 year
A.R.A.	Antenna Horn	DRG-118/A	1132	2016-01-29	2 years
EMCO	Antenna Horn	3115	9511-4627	2015-10-17	2 years
Mini-Circuits	Splitter/Combiner	2FSC-2-10G	0349	N/A	N/A
Narda	Splitter/Combiner	4326B-2	03514	N/A	N/A
Midwest	Attenuator	290-30	N/A	N/A	N/A
Mini-Circuits	Attenuator	BW-S30W2	N/A	N/A	N/A

Statement of Traceability: **BACL Corp.** attests that all calibrations have been performed per the A2LA requirements, traceable to the NIST.

5.4 Radar Waveform Calibration

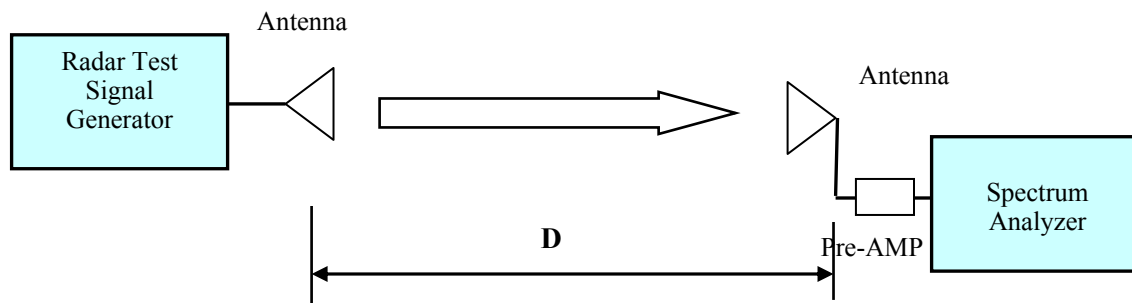

Radiated Calibration Setup Block Diagram

5.5 Test Environmental Conditions

Temperature:	23-25° C
Relative Humidity:	37-42 %
ATM Pressure:	101.5 kPa

Testing performed by Xiao Lin from 2016-10-17 to 2016-10-19 at DFS testing site.

Plots of Radar Waveforms

5280 MHz

Radar Type 0

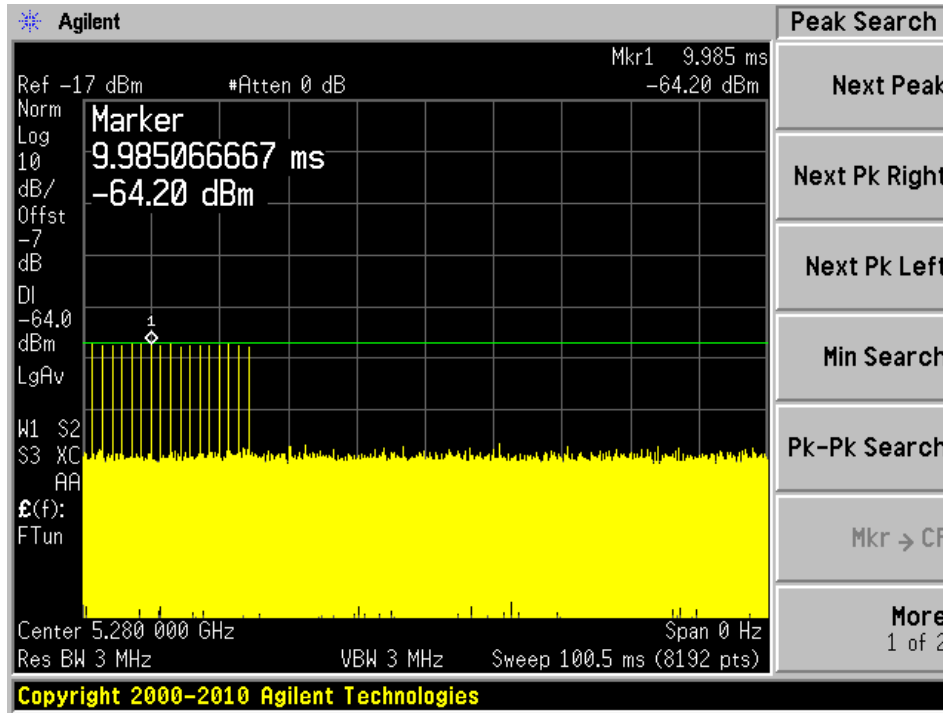

Radar Type 1A

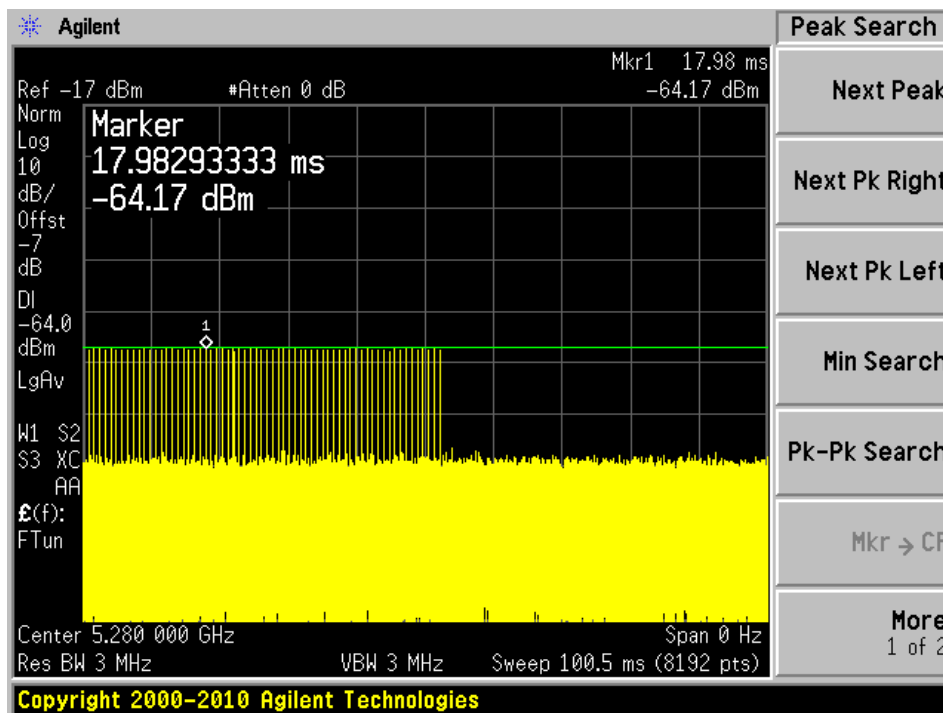

Radar Type 1B

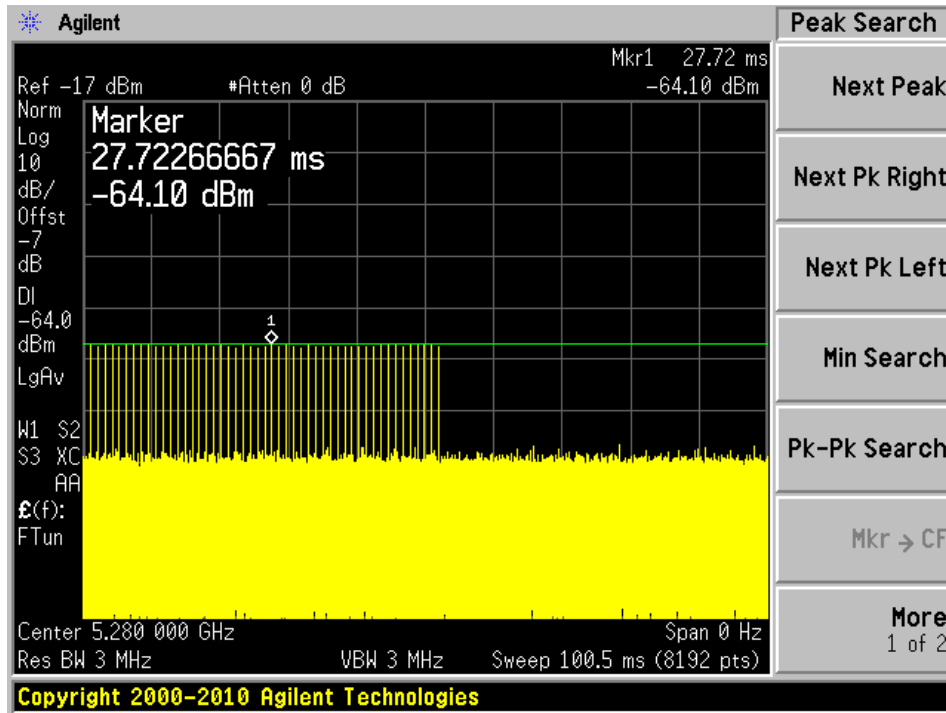

Radar Type 2

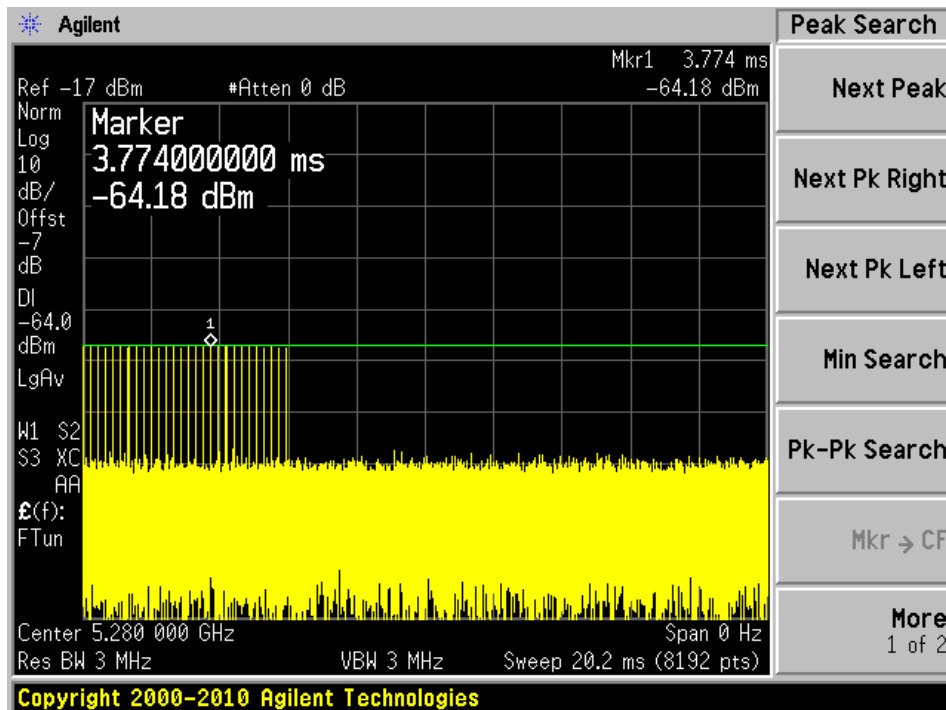

Radar Type 3

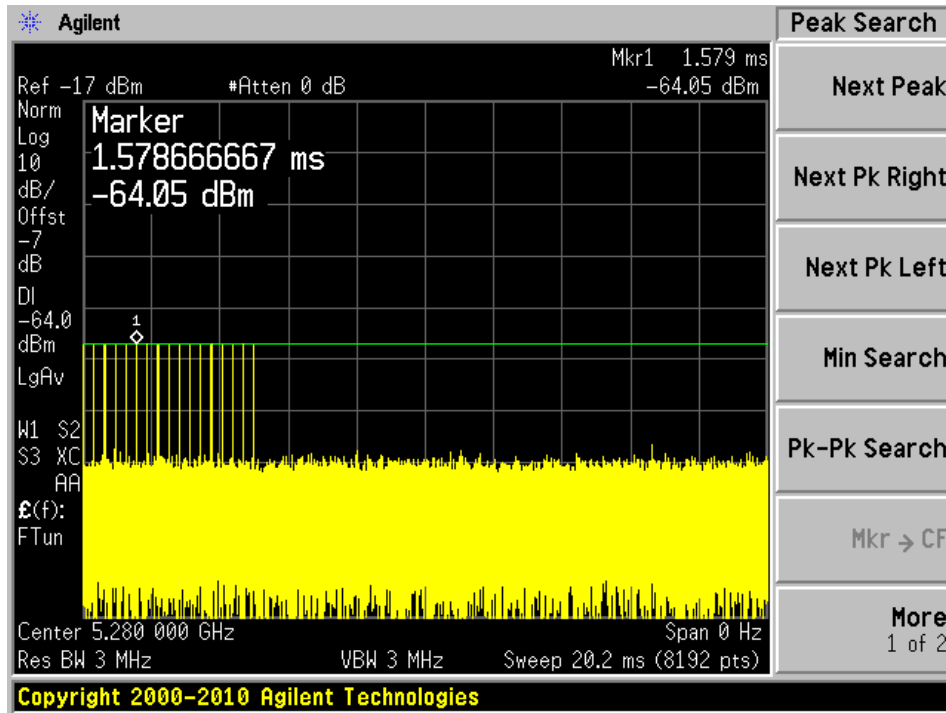

Radar Type 4

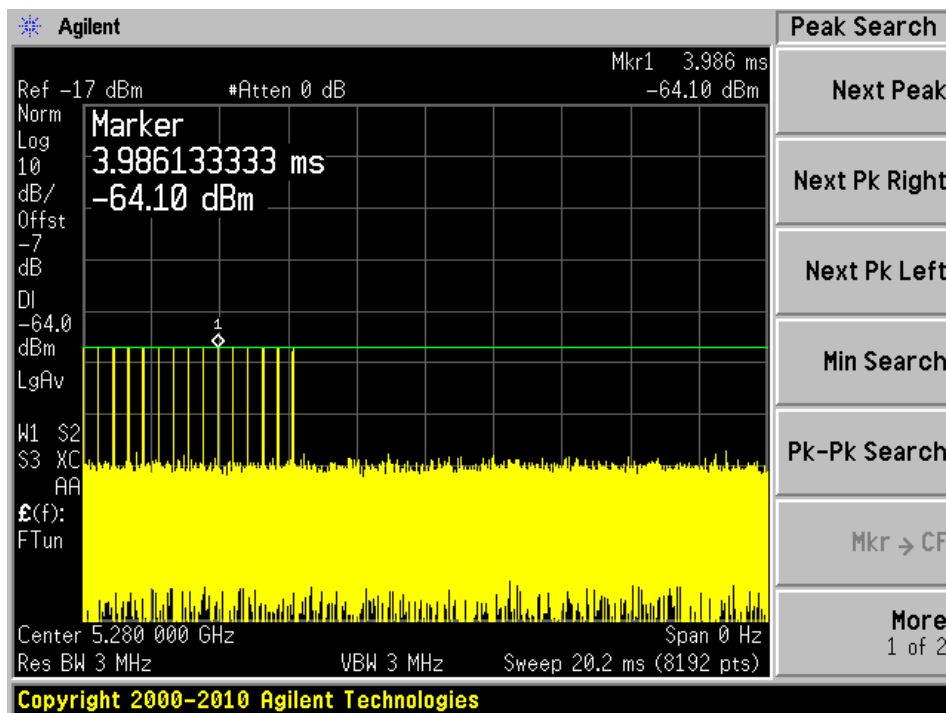

Radar Type 5

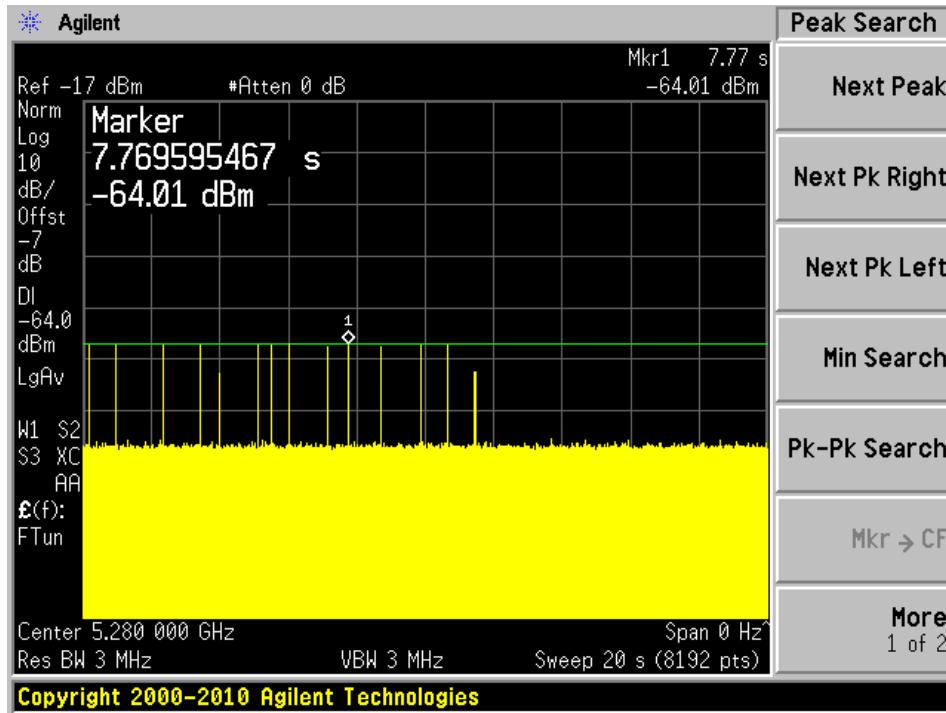

Radar Type 6

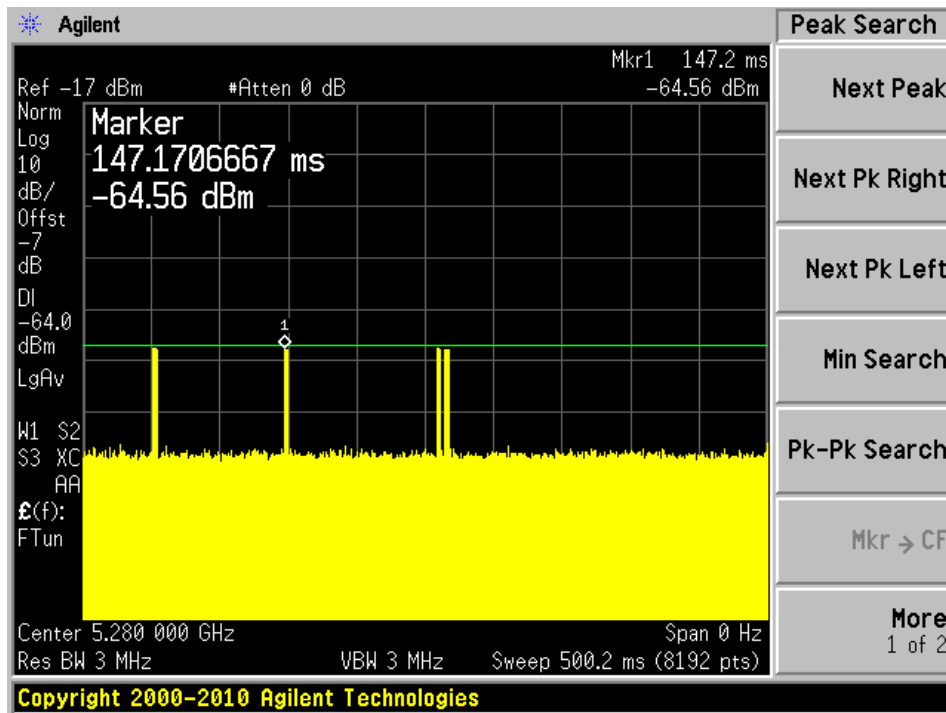

5540 MHz

Radar Type 0

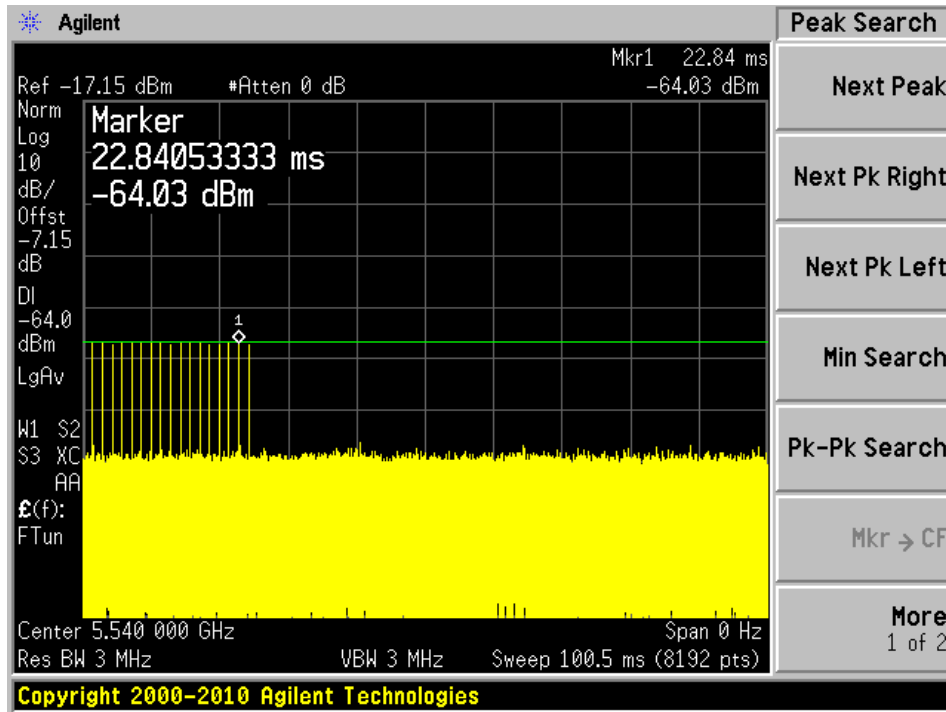

Radar Type 1A

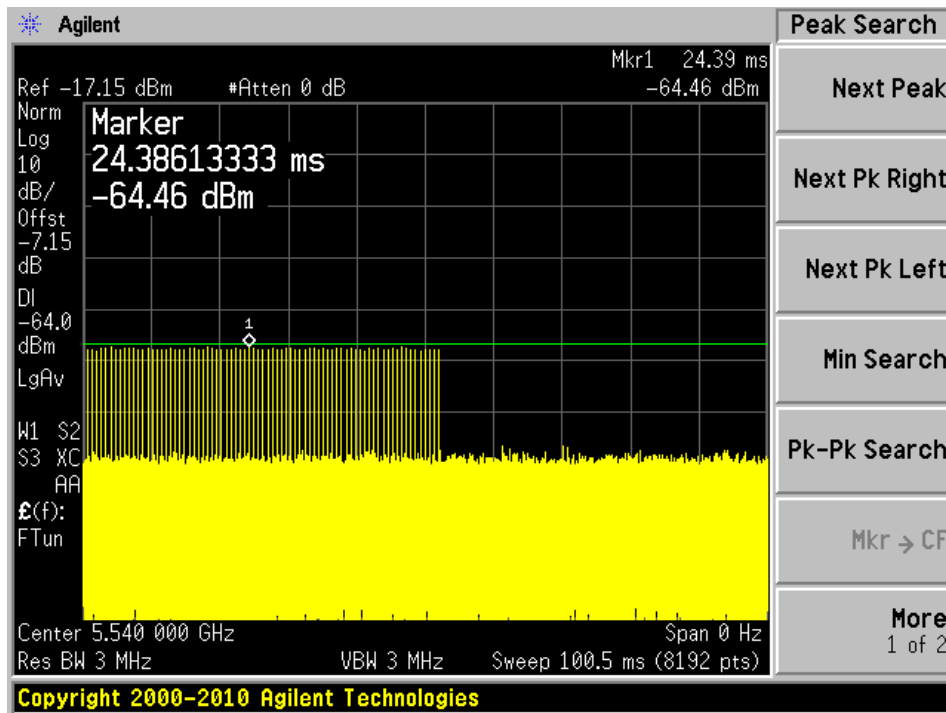

Radar Type 1B

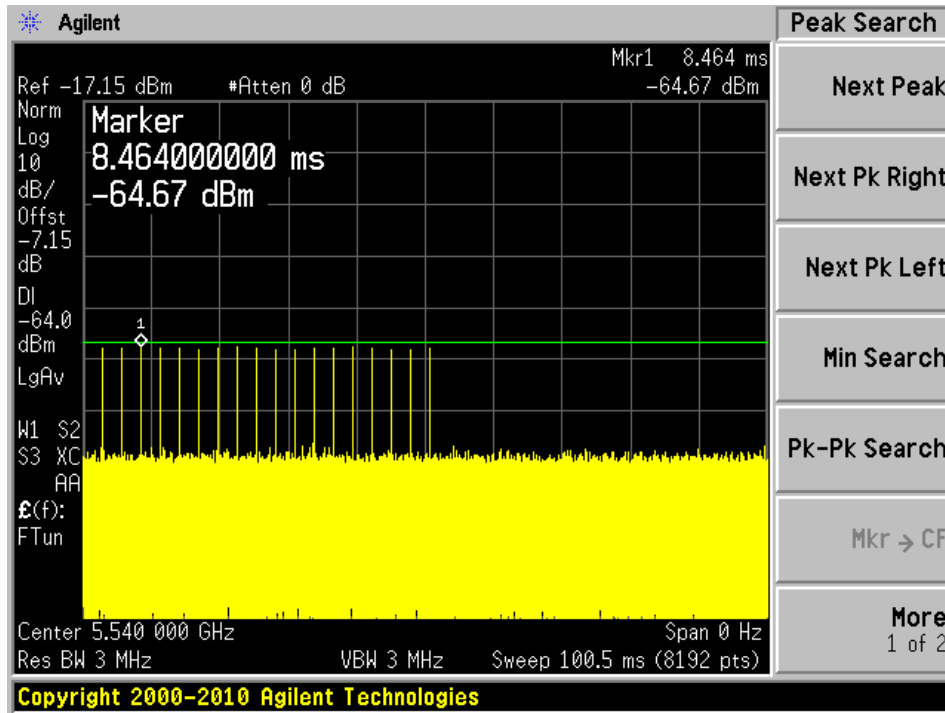

Radar Type 2

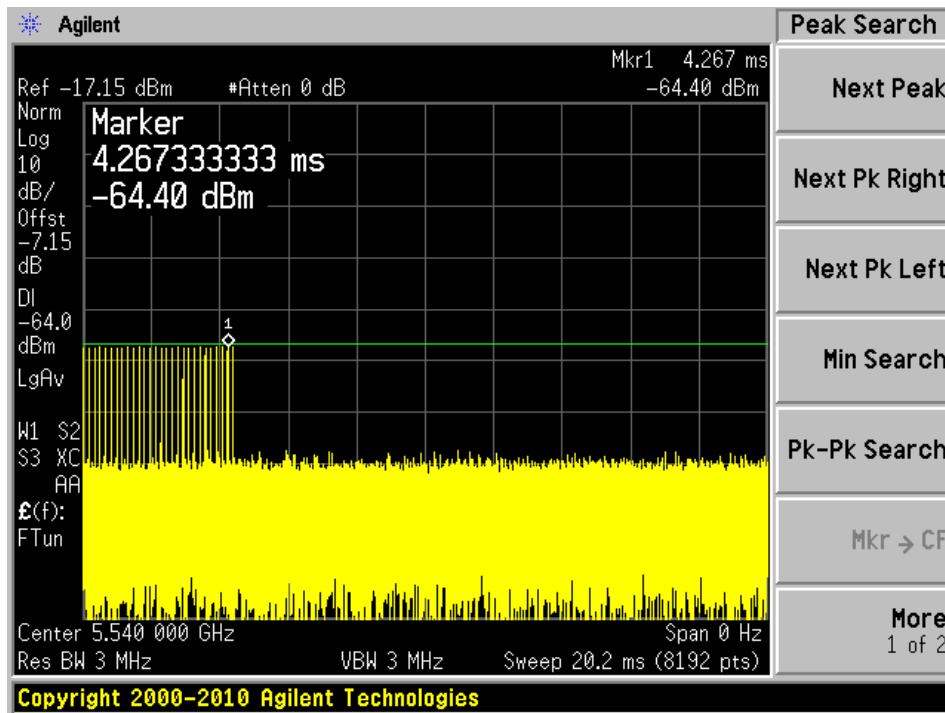

Radar Type 3

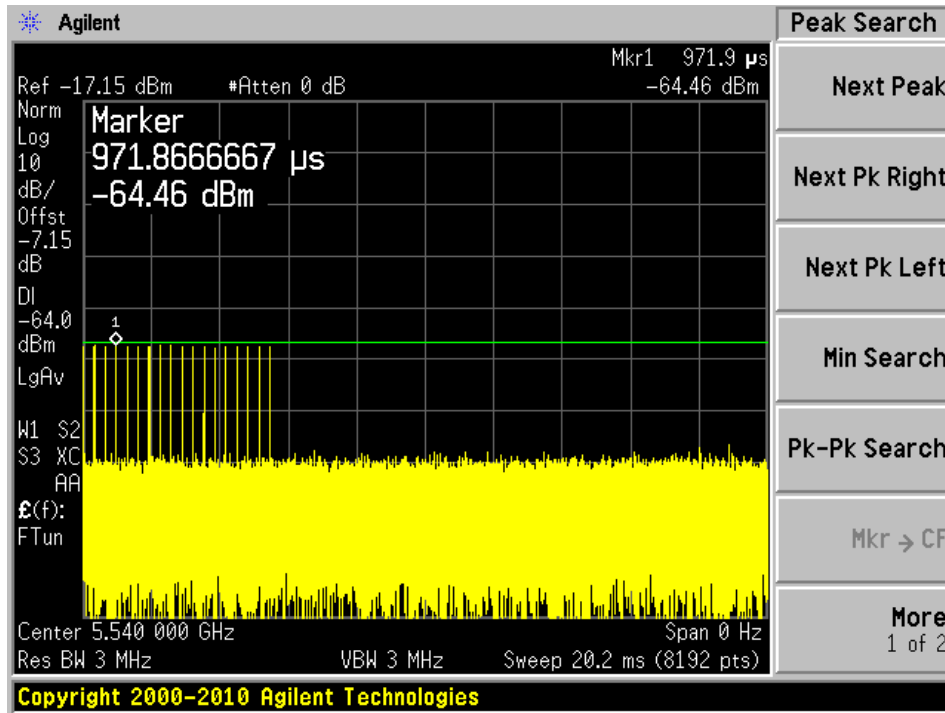

Radar Type 4

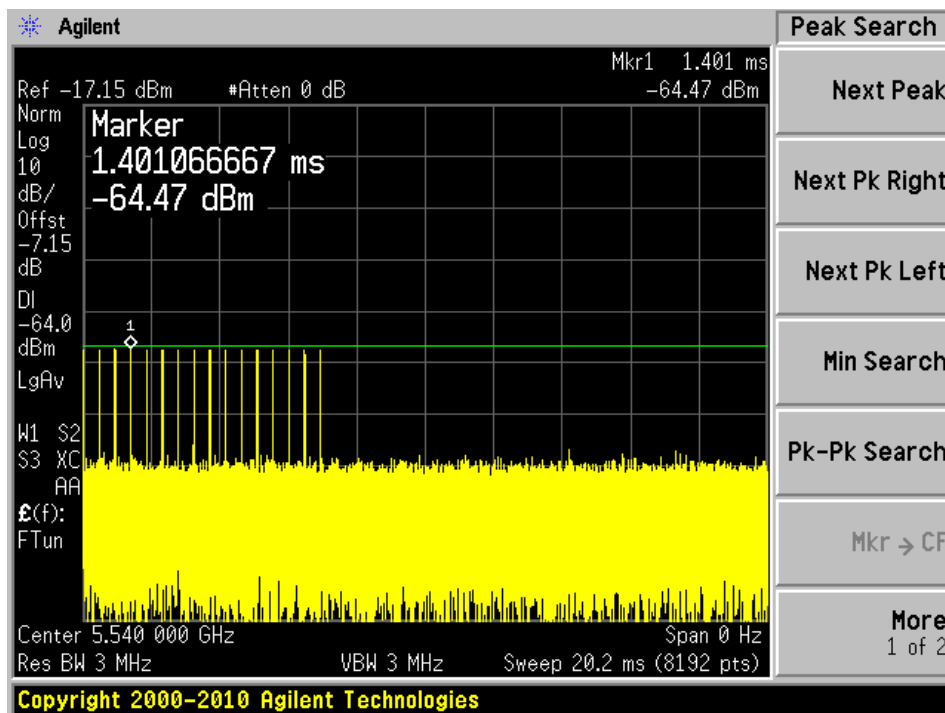

Radar Type 5

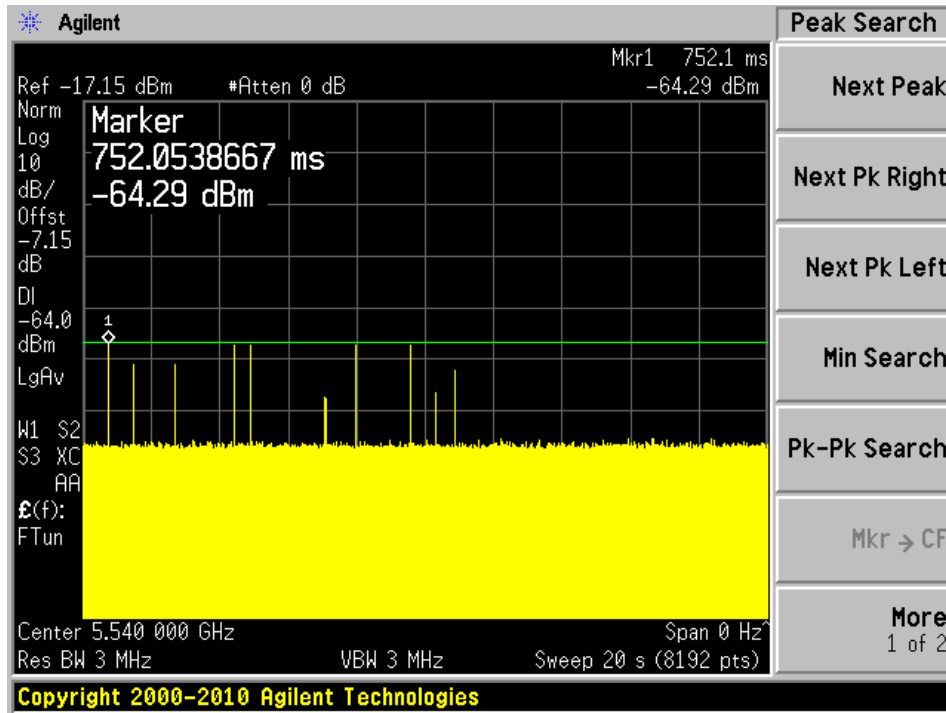

Radar Type 6

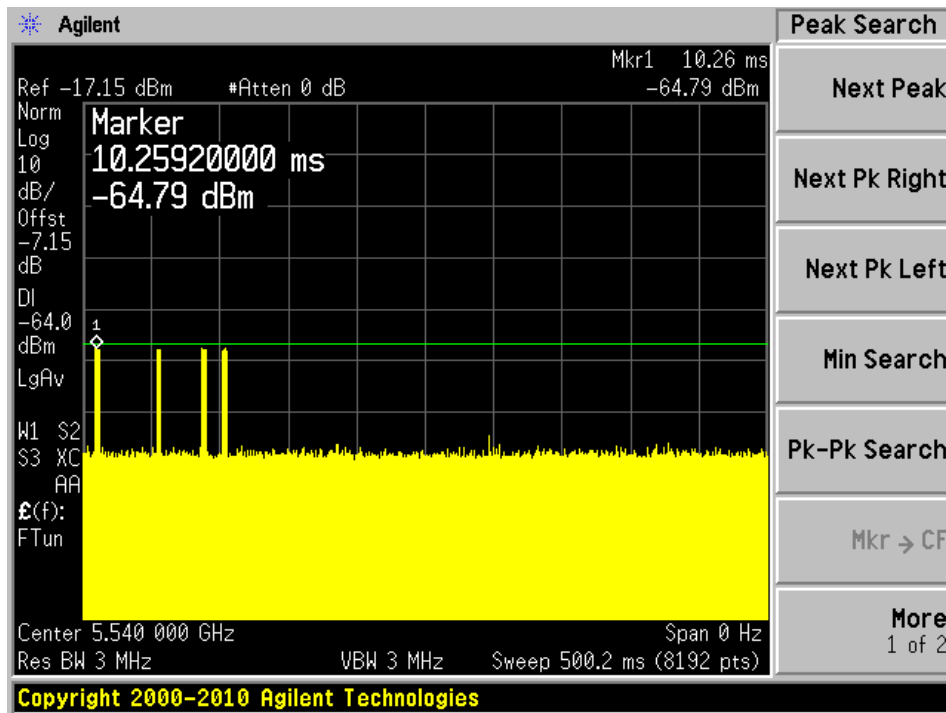

5270 MHz

Radar Type 0

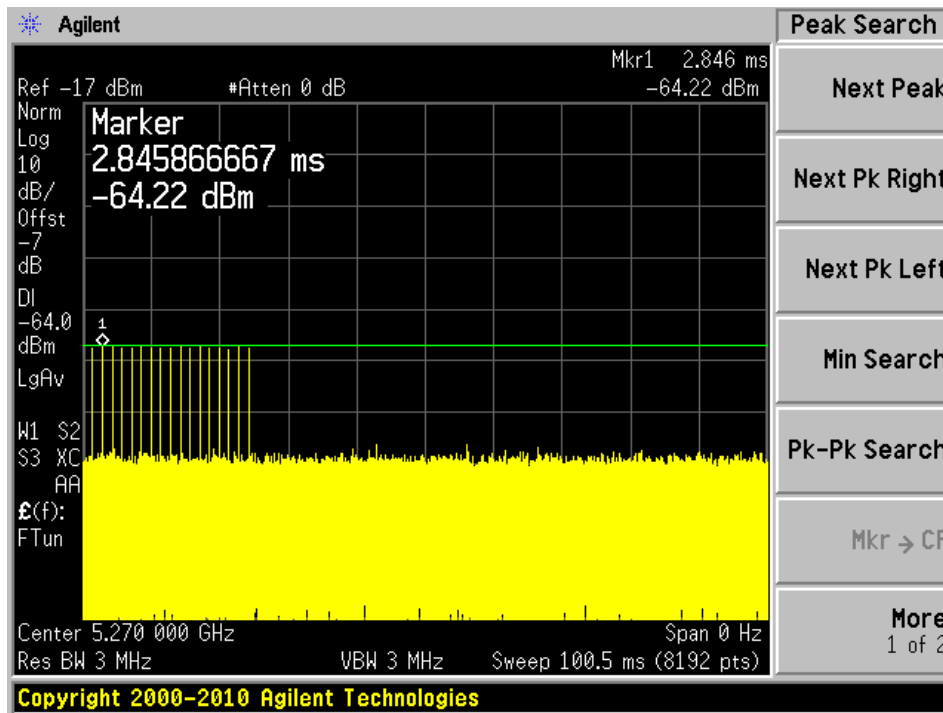

Radar Type 1A

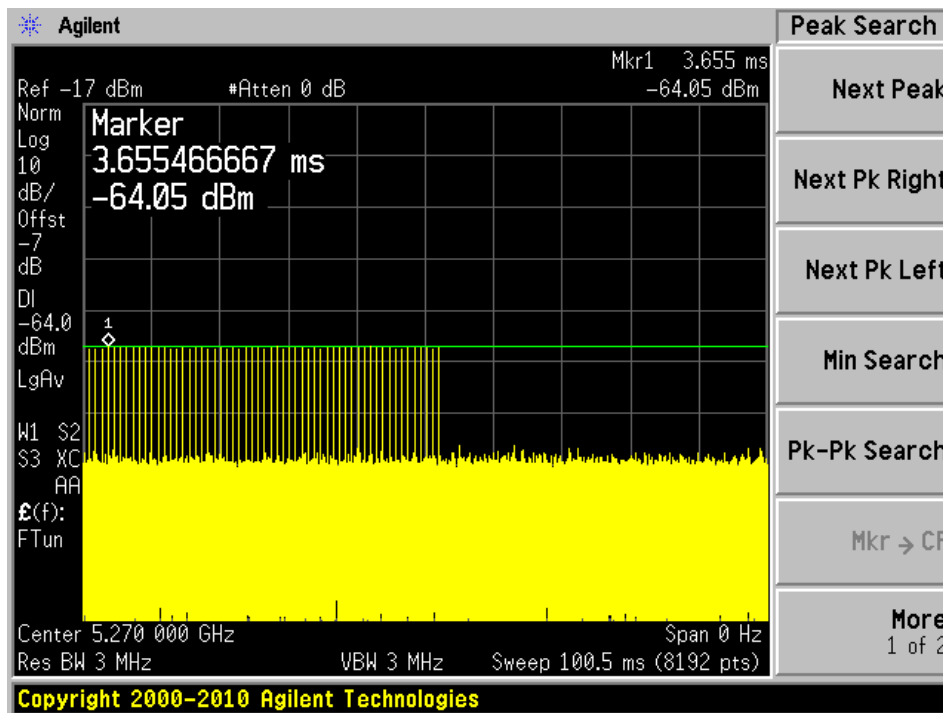

Radar Type 1B

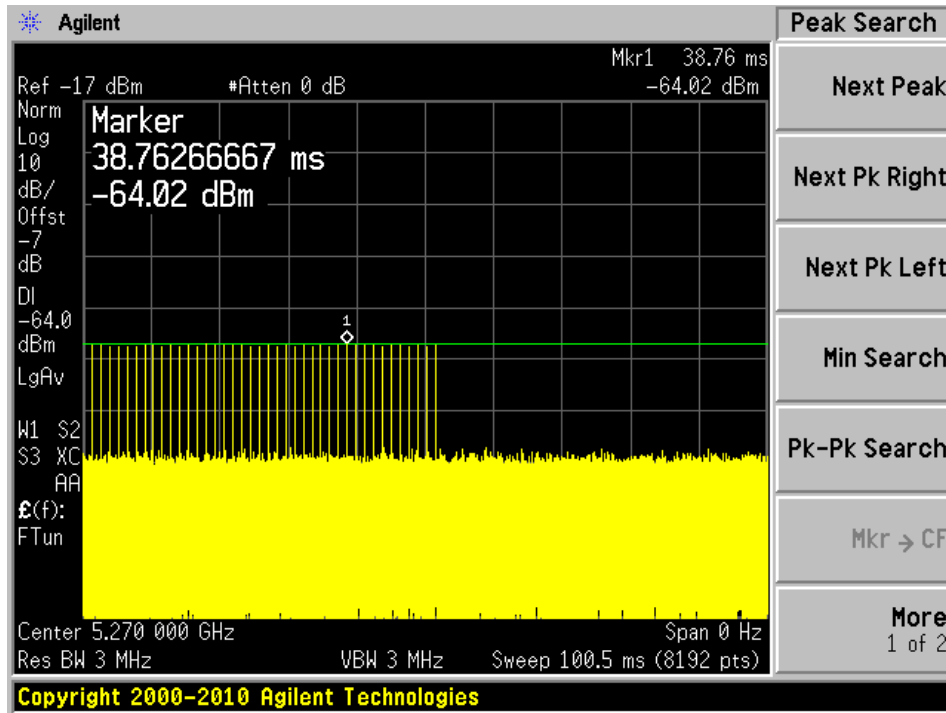

Radar Type 2

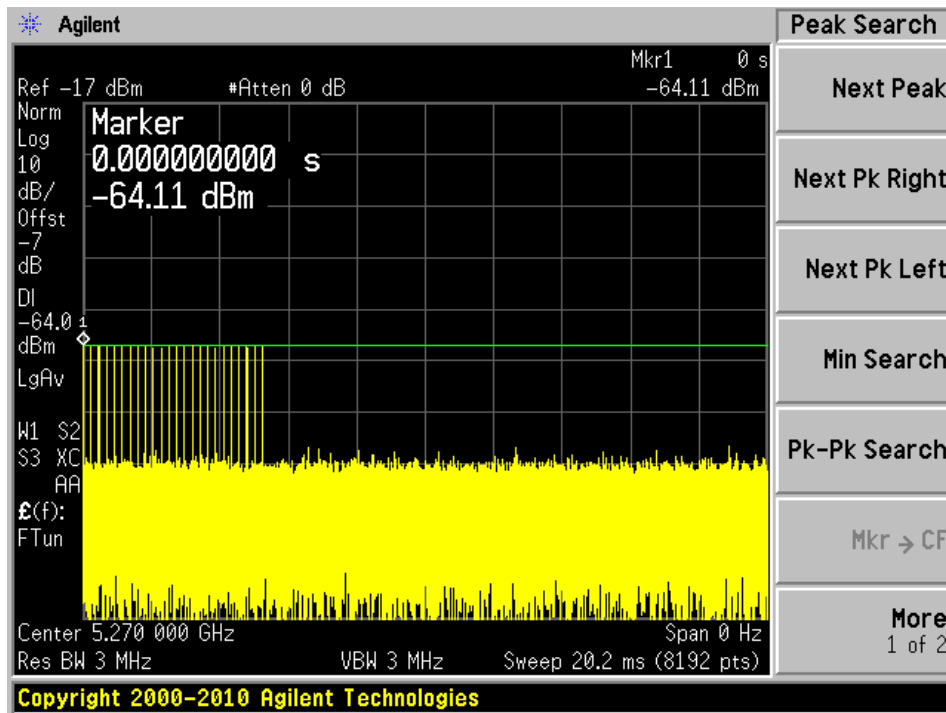

Radar Type 3

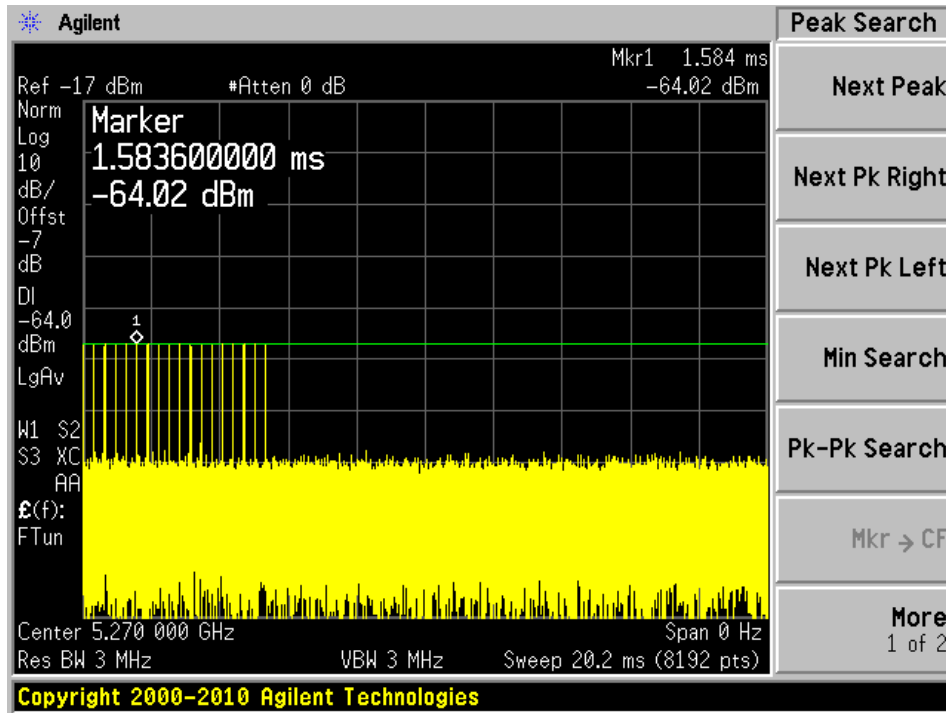

Radar Type 4

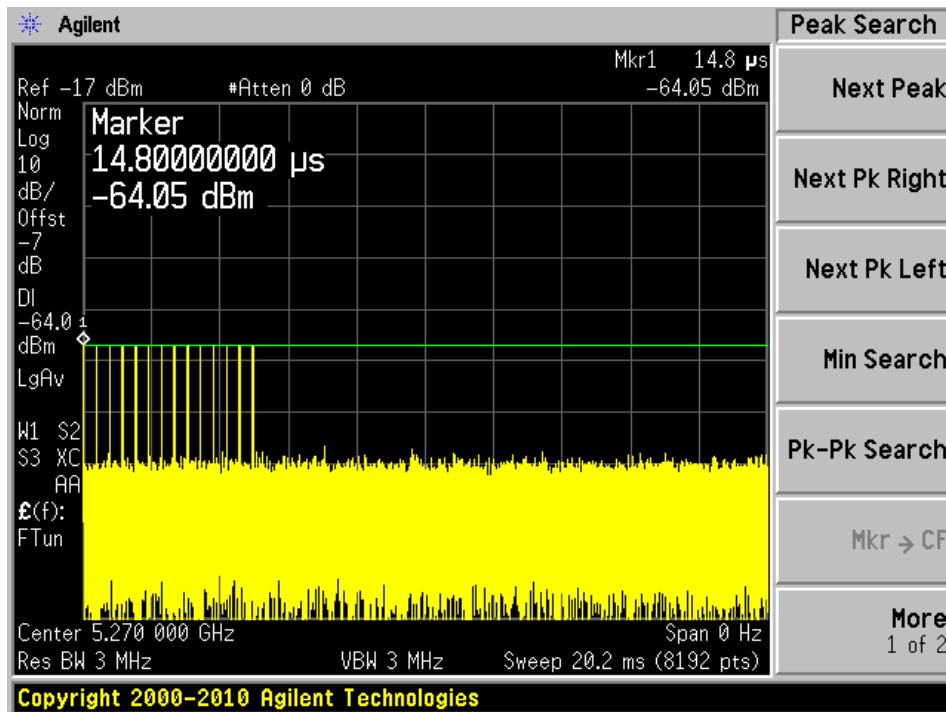

Radar Type 5

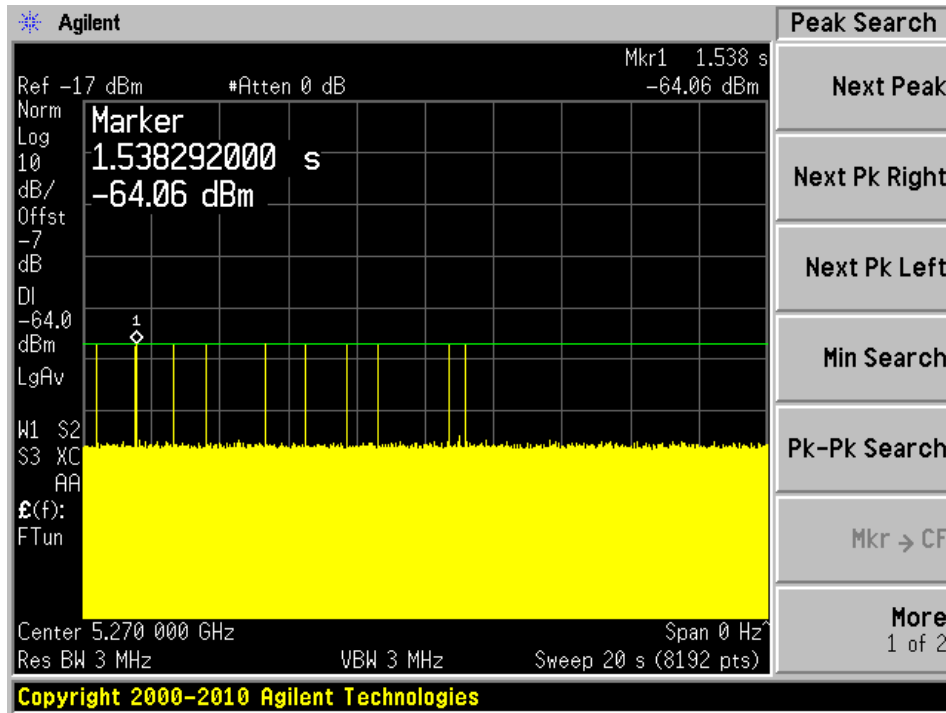

Radar Type 6

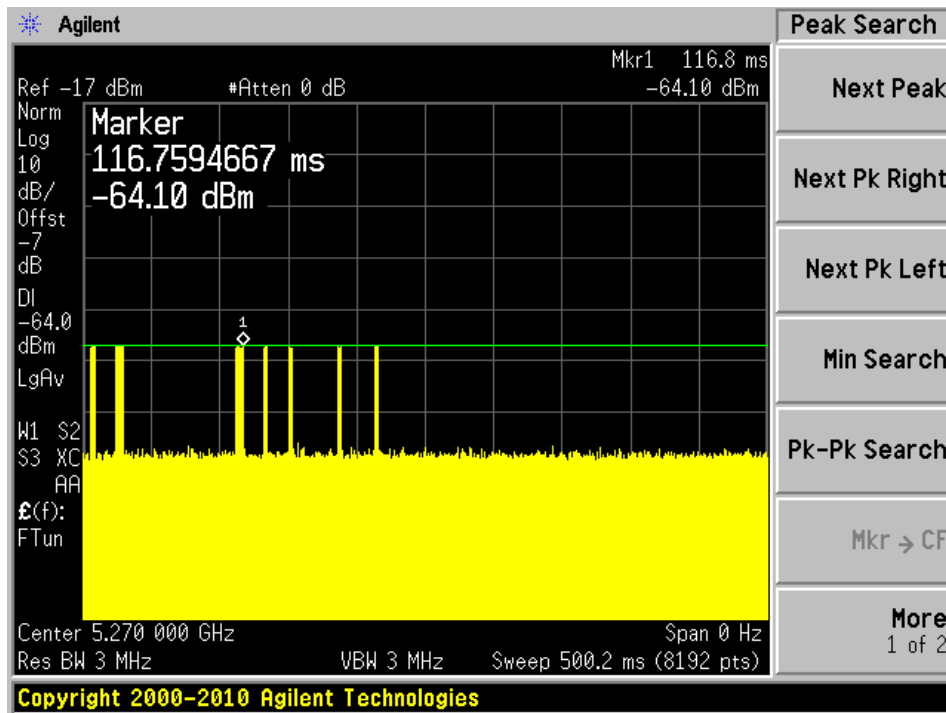

5550 MHz

Radar Type 0

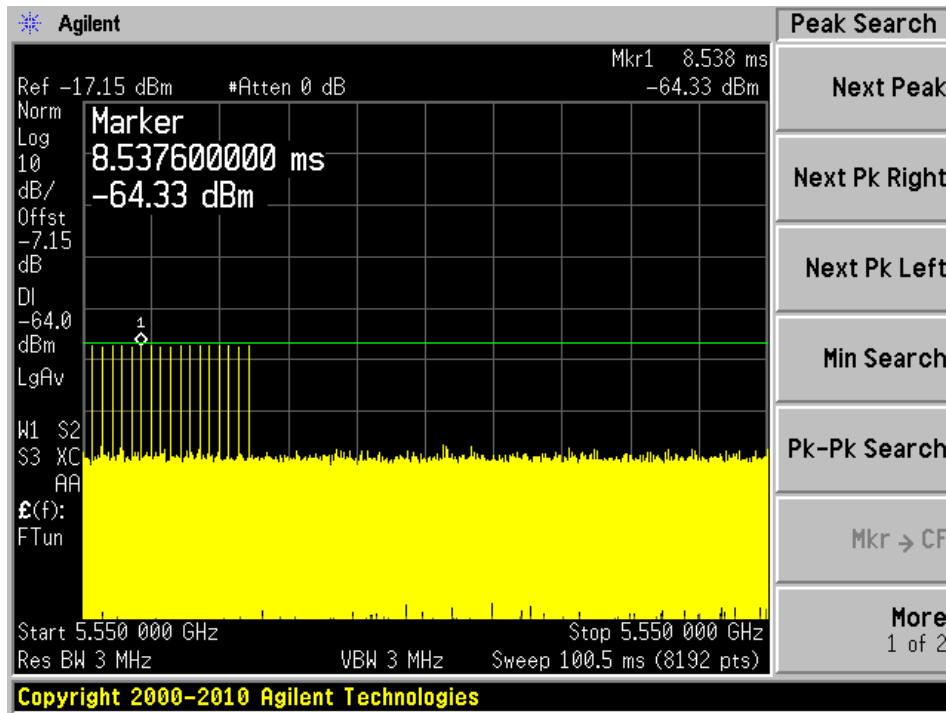

Radar Type 1A

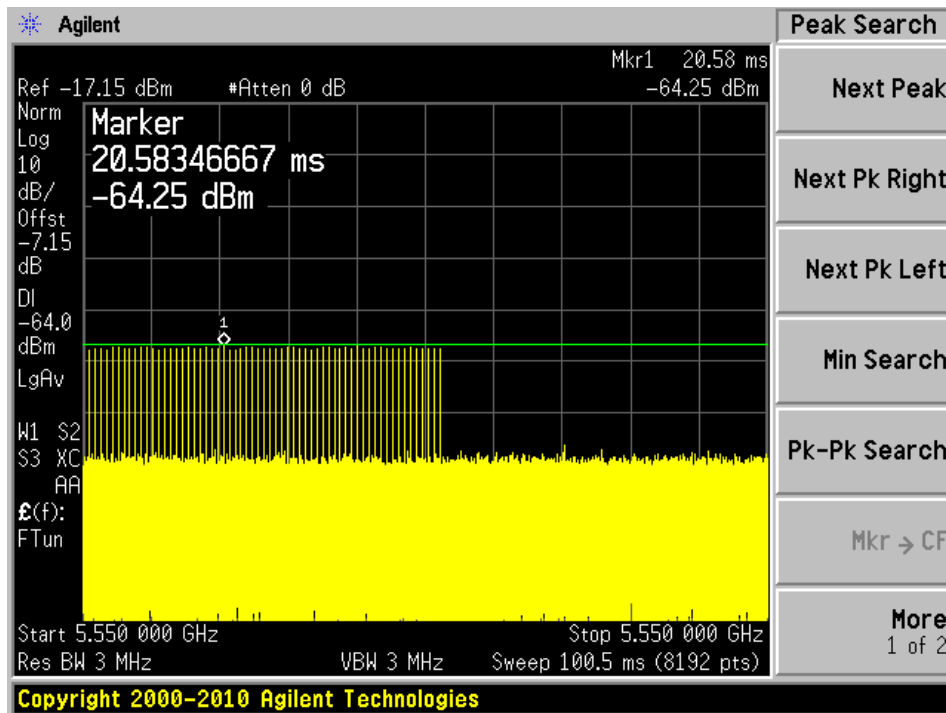

Radar Type 1B

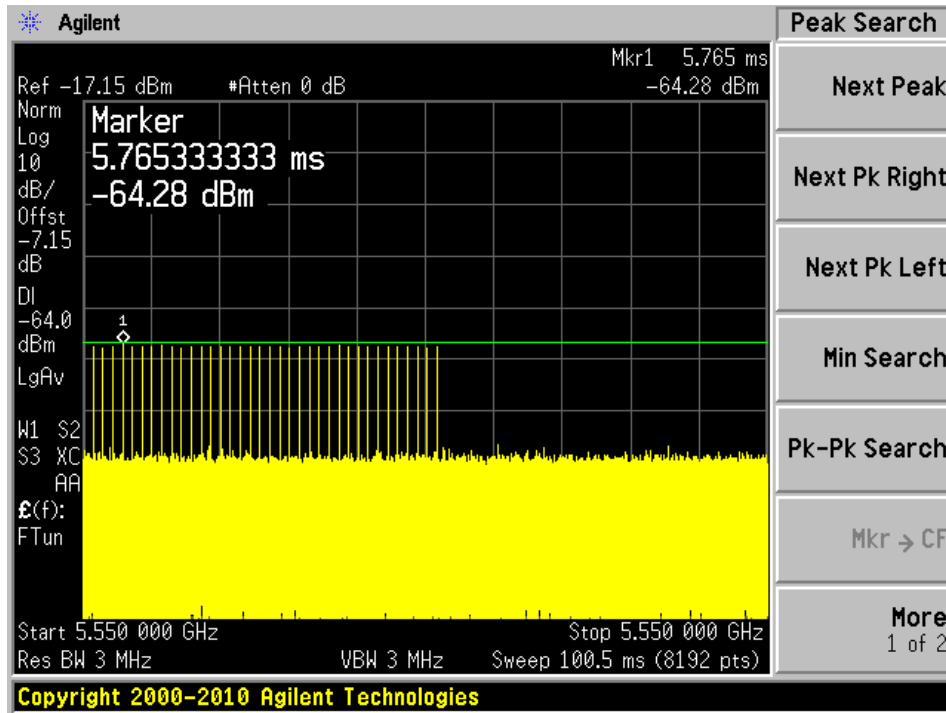

Radar Type 2

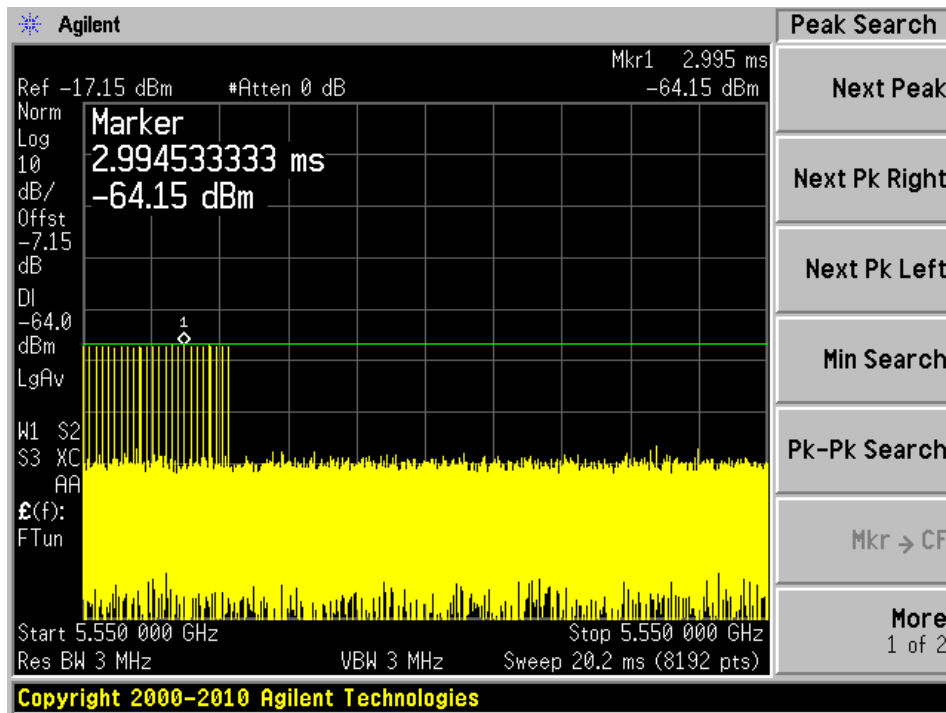

Radar Type 3

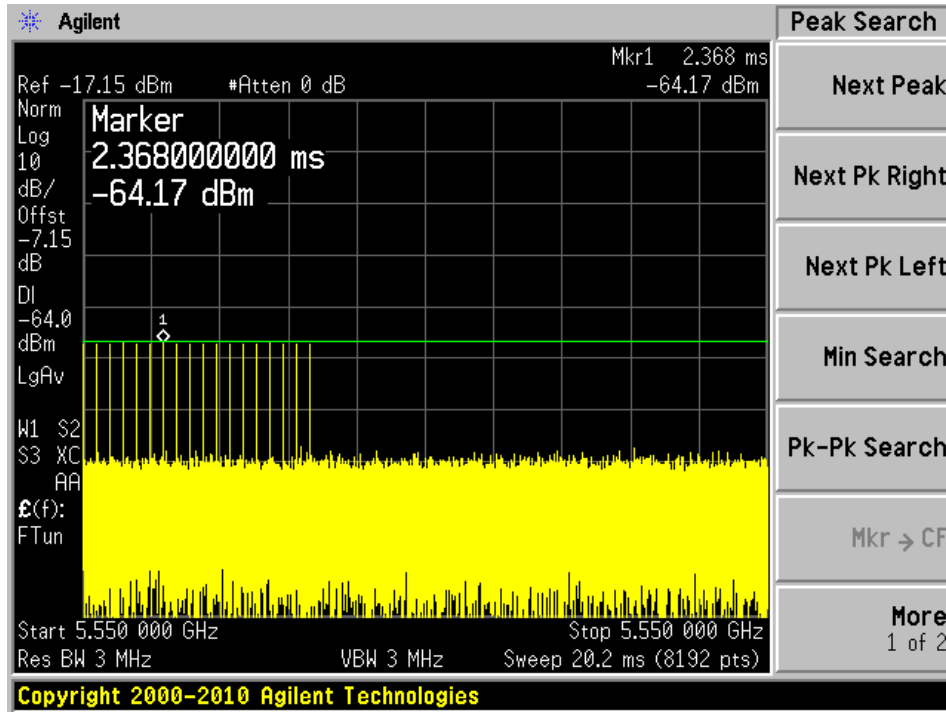

Radar Type 4

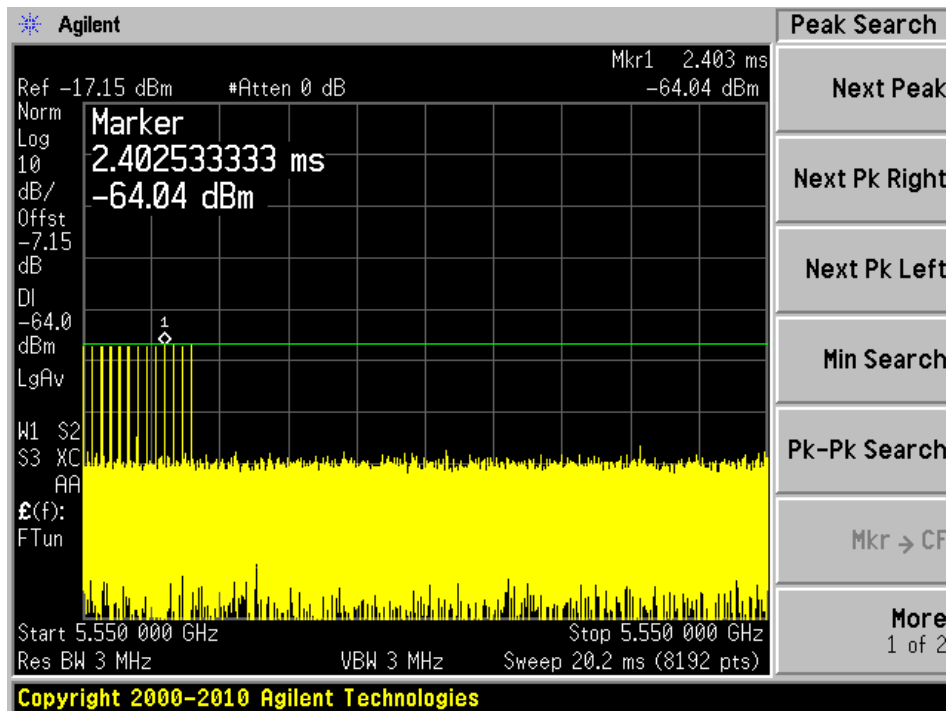

Radar Type 5

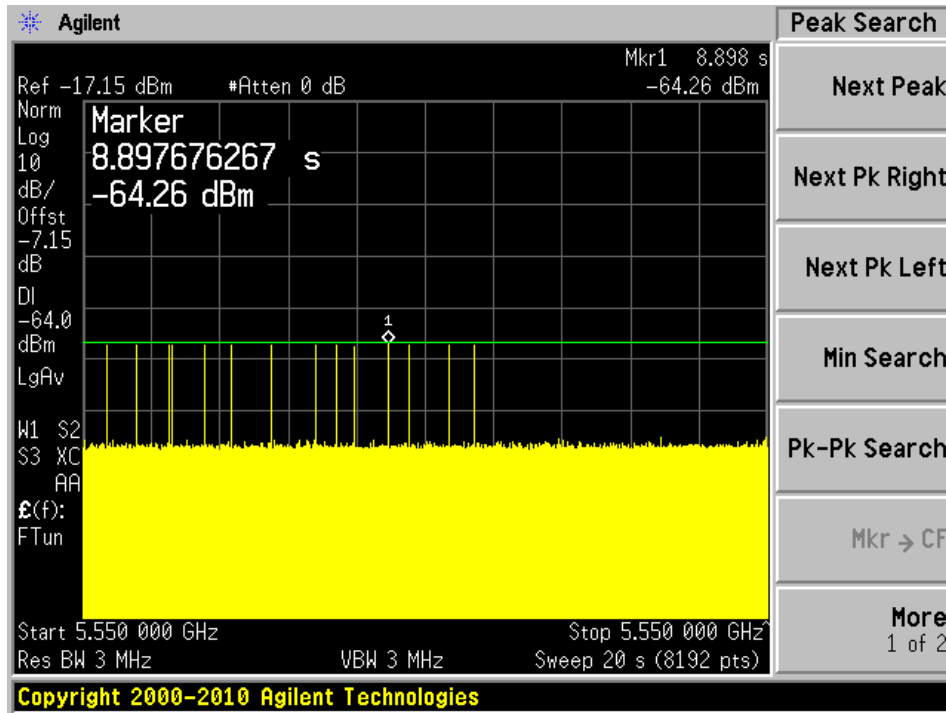

Radar Type 6

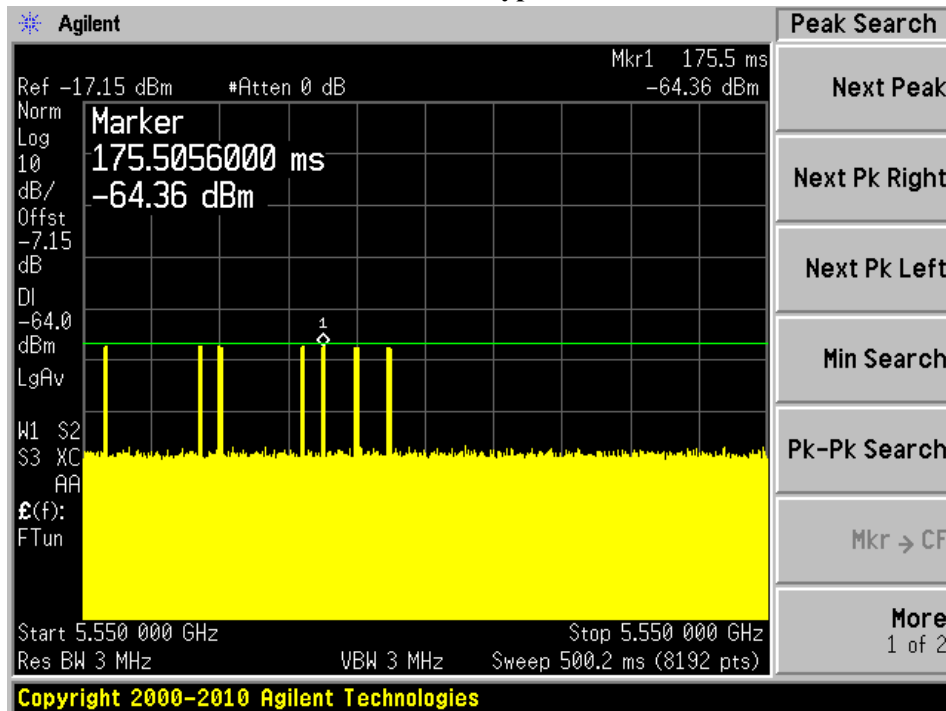

5290 MHz

Radar Type 0

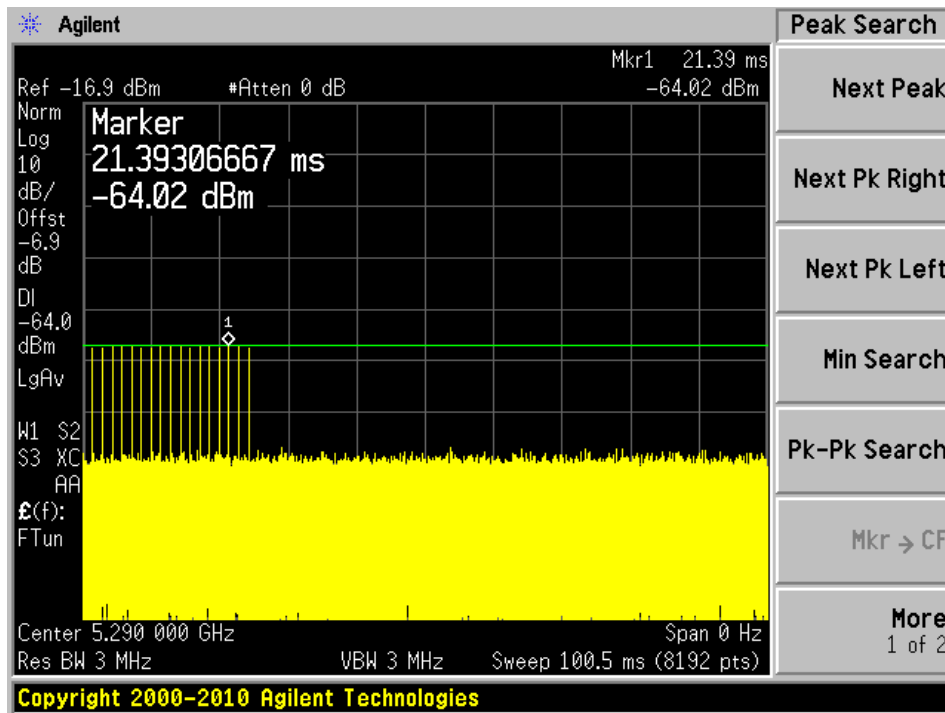

Radar Type 1A

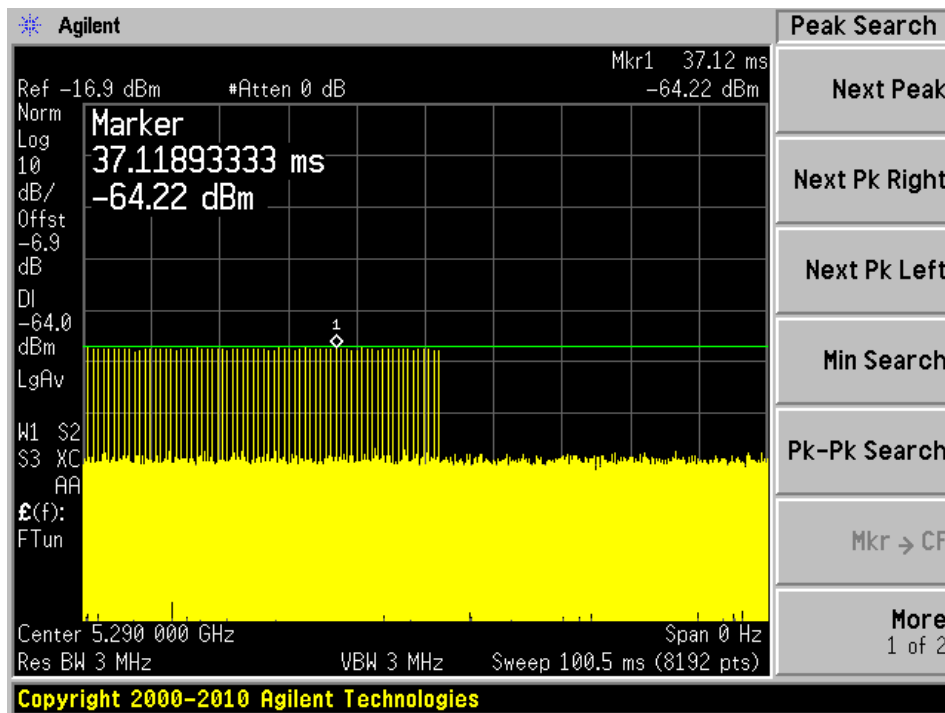

Radar Type 1B

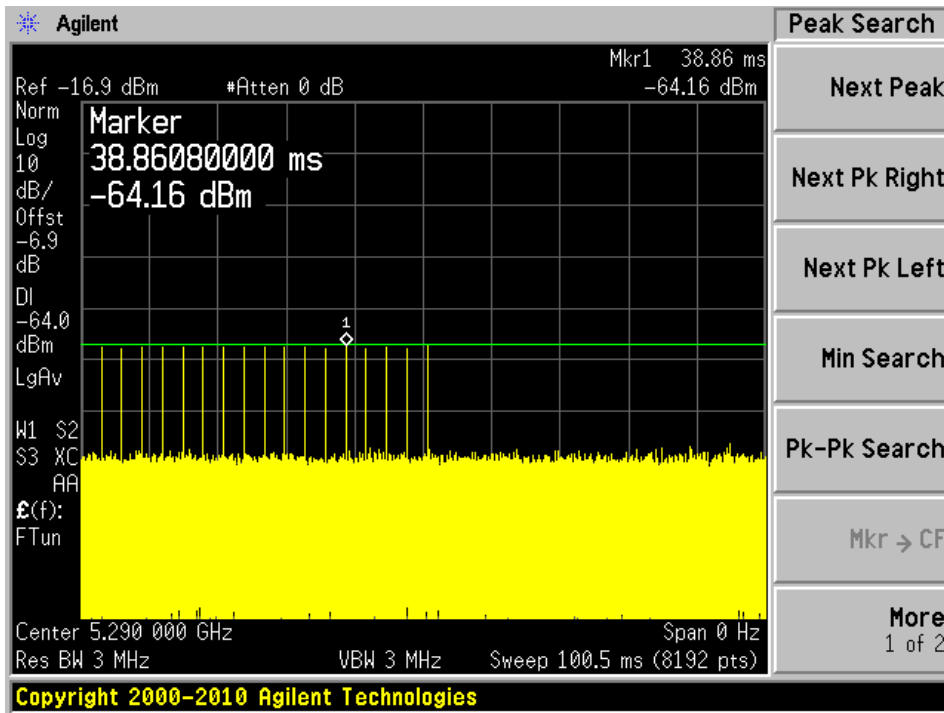

Radar Type 2

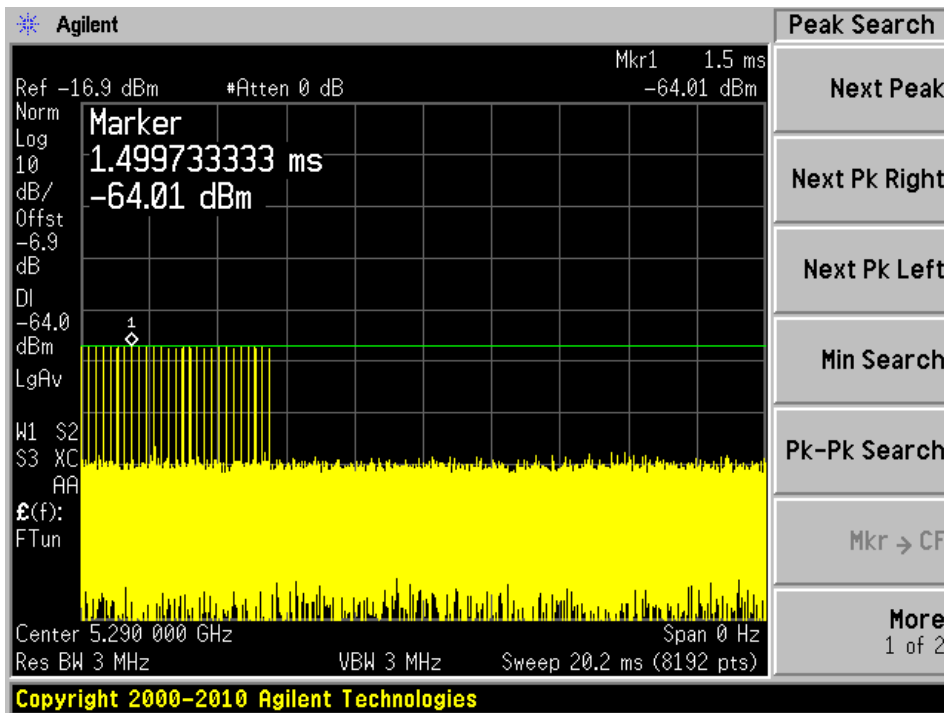

Radar Type 3

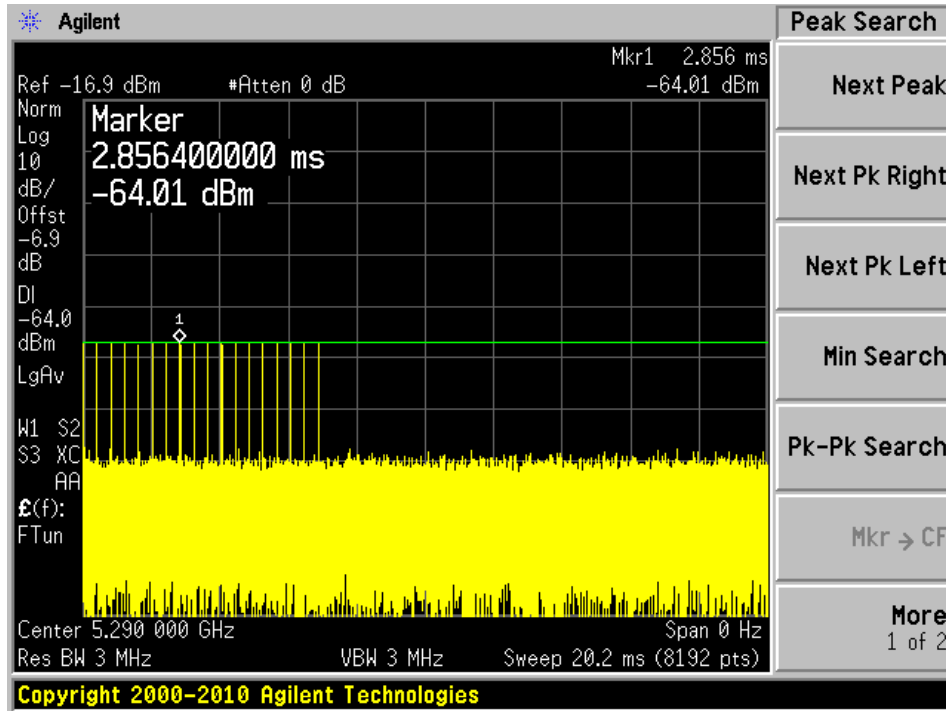

Radar Type 4

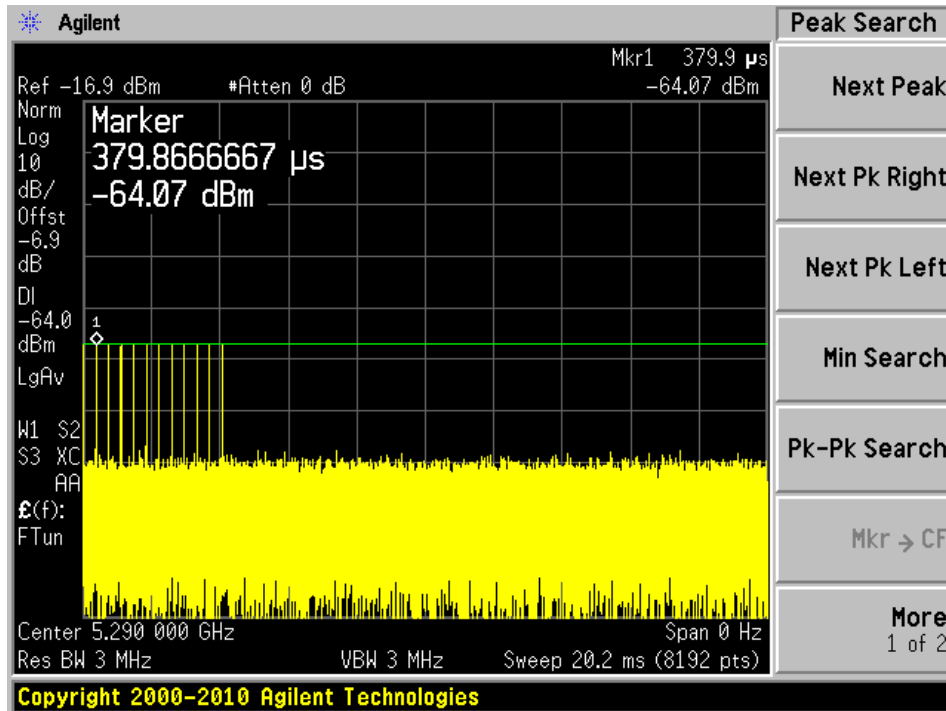

Radar Type 5

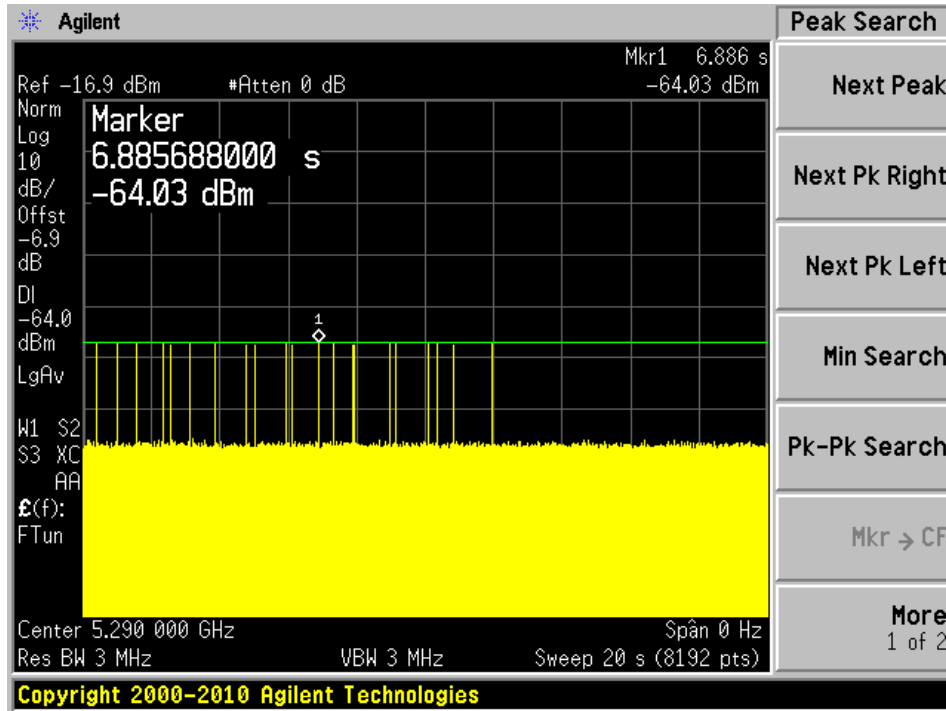

Radar Type 6

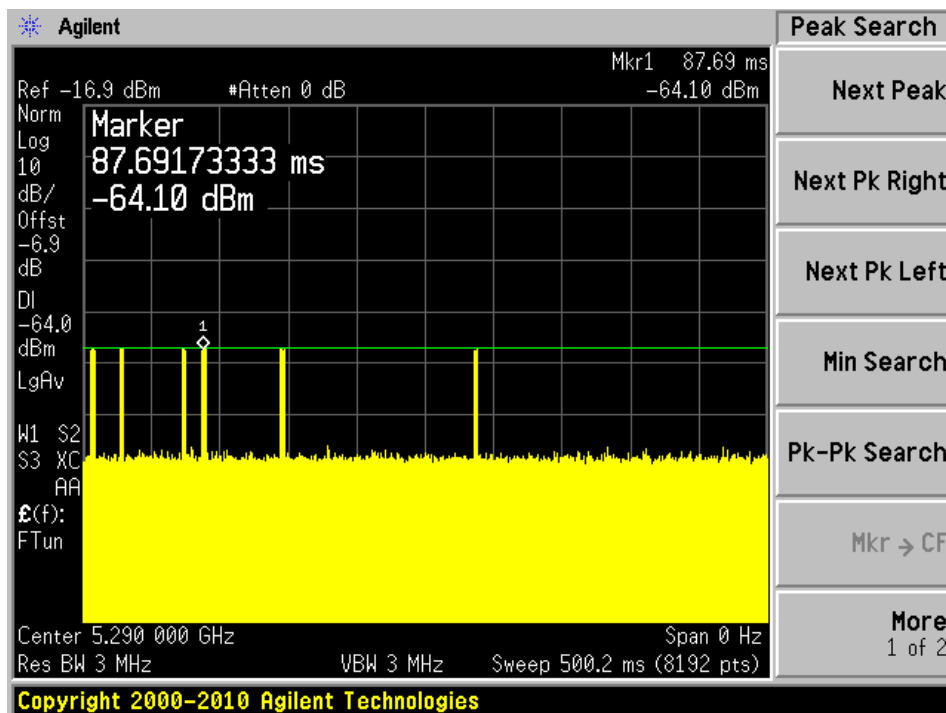

5530 MHz

Radar Type 0

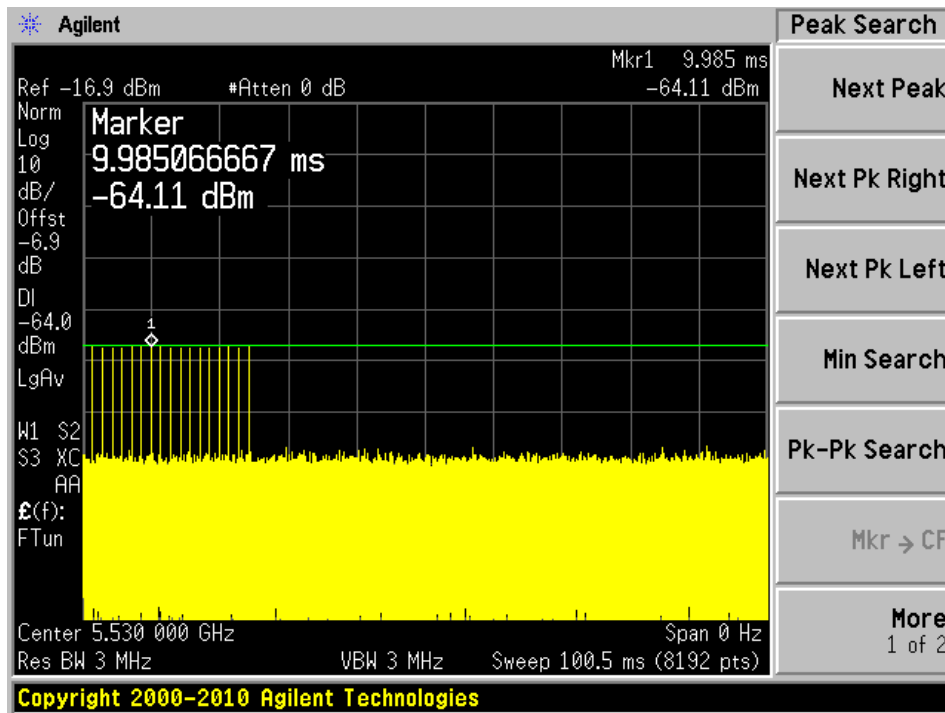

Radar Type 1A

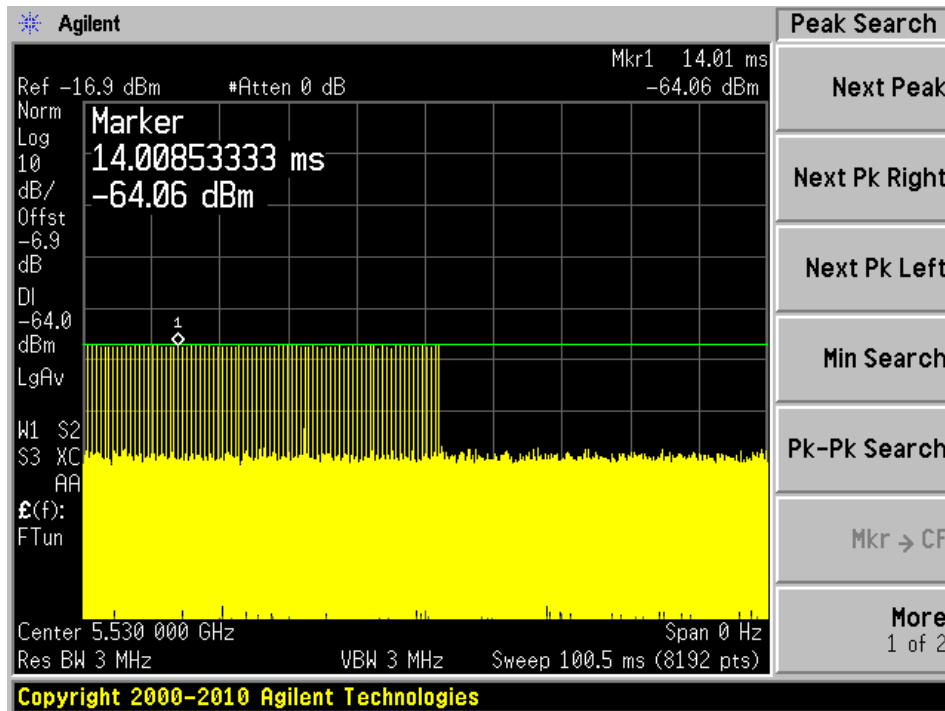

Radar Type 1B

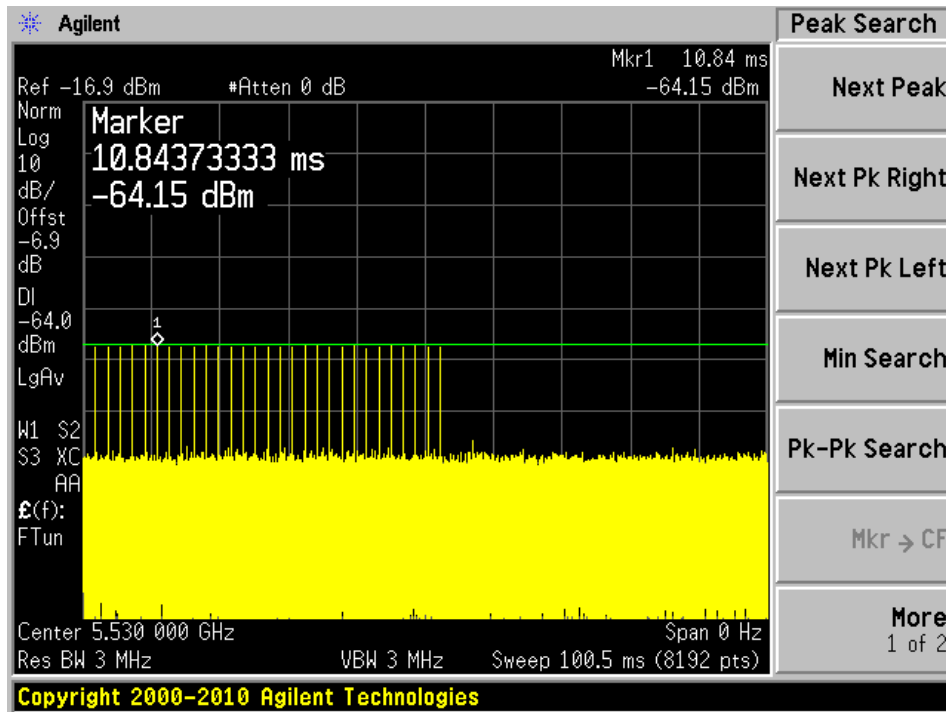

Radar Type 2

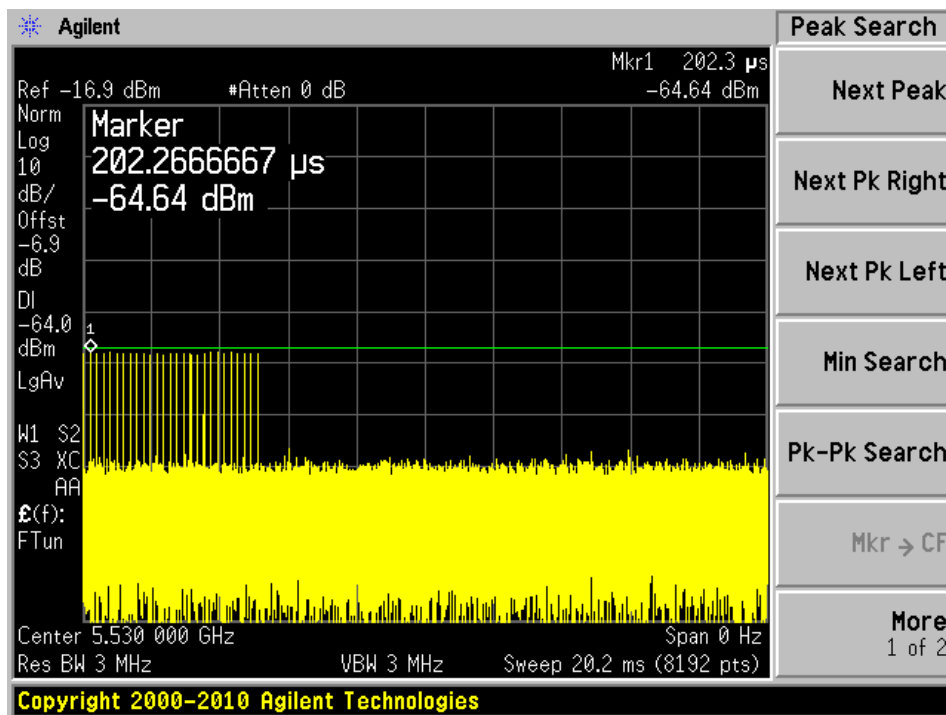

Radar Type 3

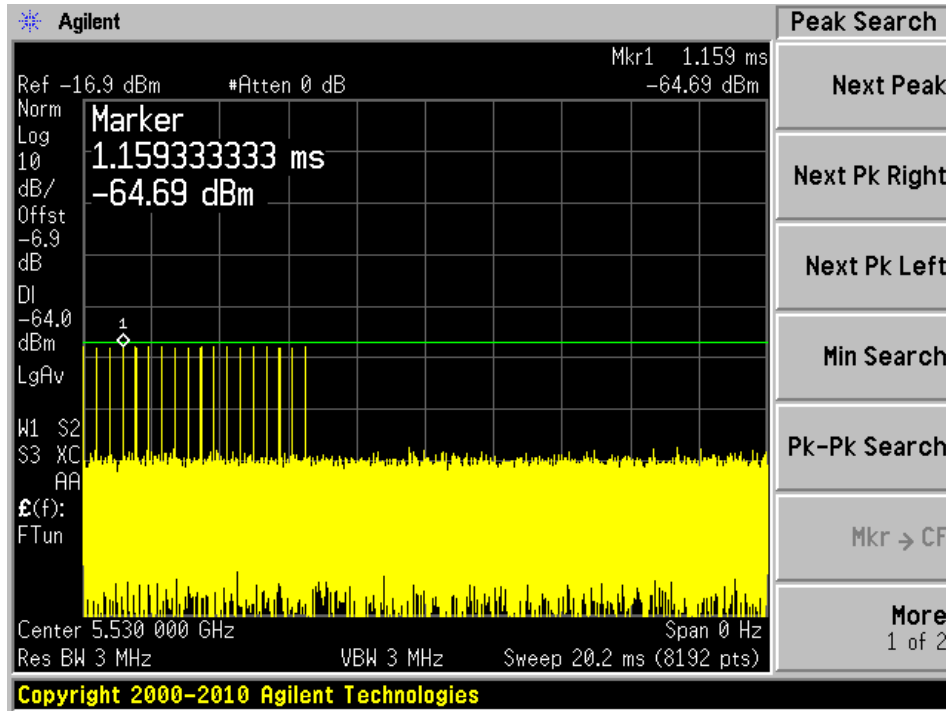

Radar Type 4

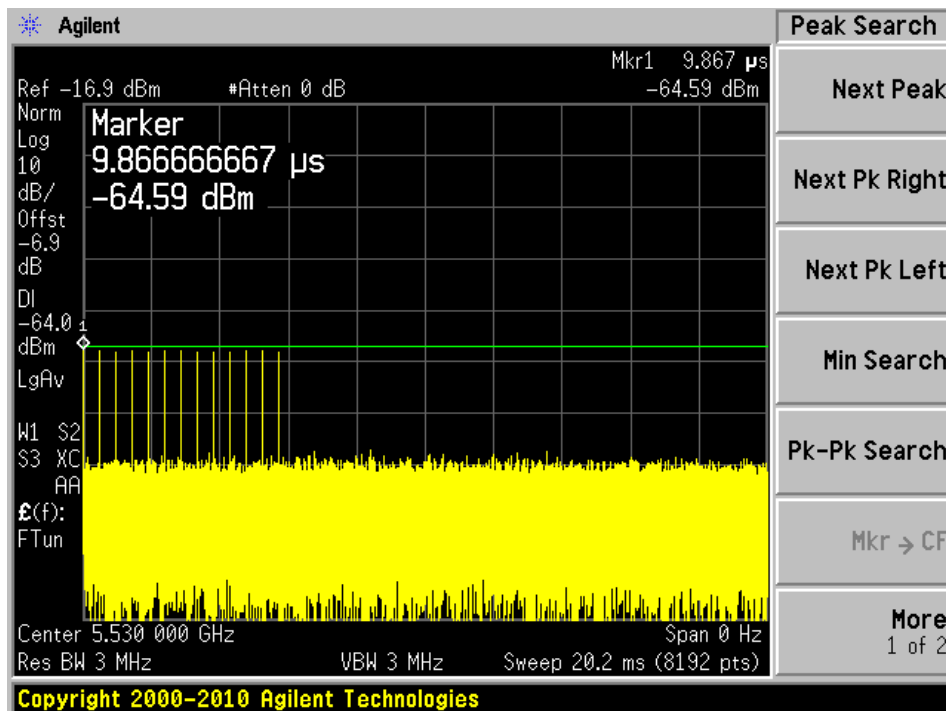

Radar Type 5

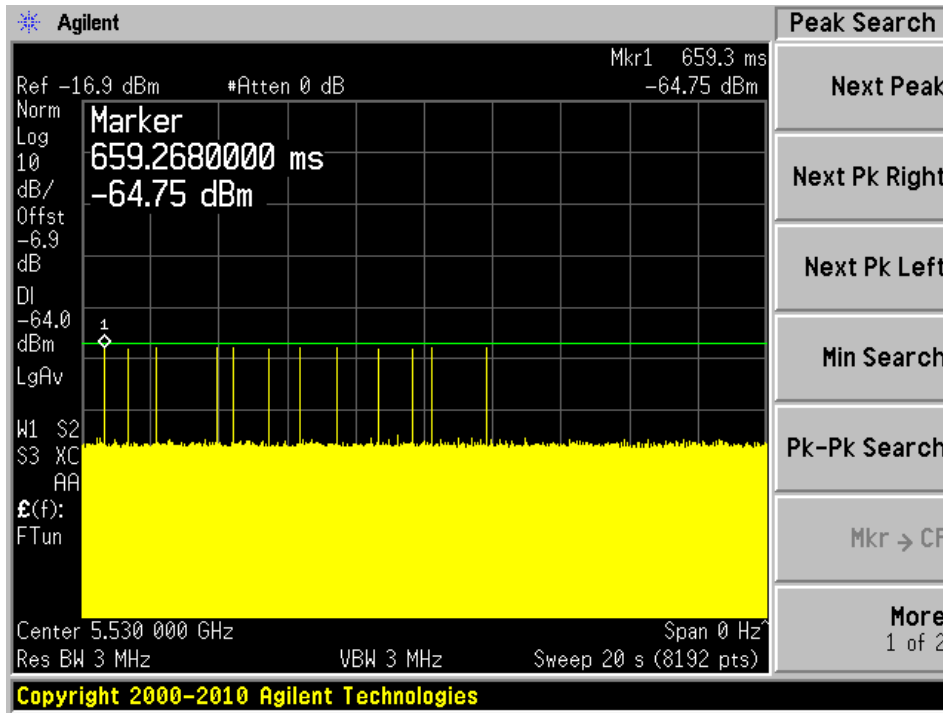

Radar Type 6

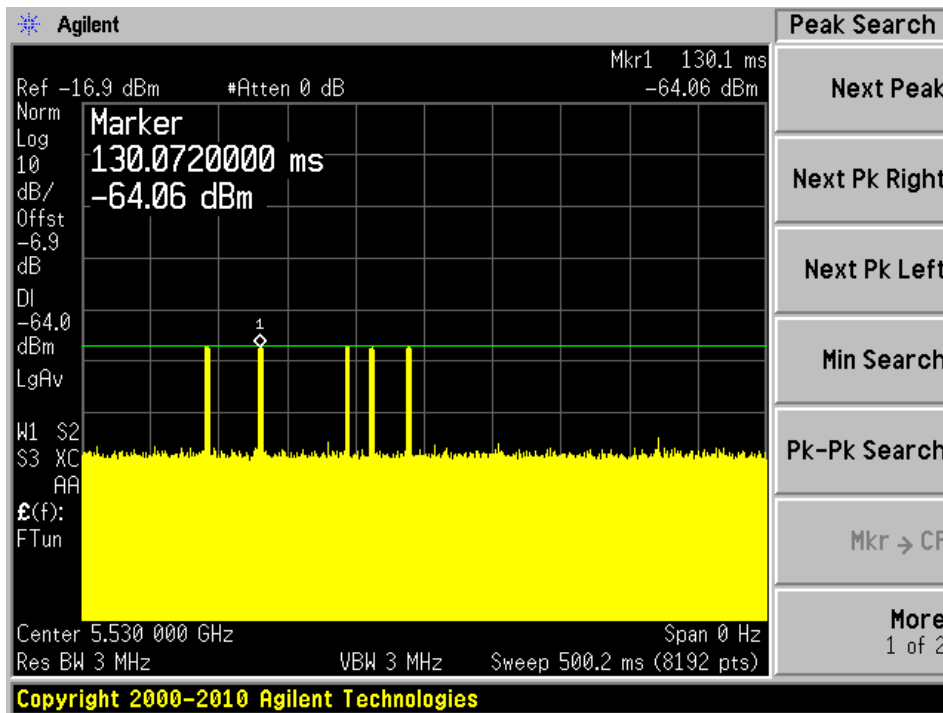

6 Channel Availability Check Time (CAC)

6.1 Test Procedure

- 1) Measure the initial power-up time of EUT.
- 2) With link established on channel, apply a radar signal within 0~6 seconds after the initial power-up period; monitor the transmissions on channel from the spectrum analyzer.
- 3) Reboot EUT, with a link established on channel, apply a radar signal within 54~60 seconds after the initial power-up period, and monitor the transmission on channel from the spectrum analyzer.

EUT Initial power-up Cycle Time

Note: EUT initial Power-up cycle is vary, this testing was performed with software monitor function that shows the start time of CAC, once the monitor shows the CAC start time, we used the stop watch to keep the accuracy of the testing.

Results:

Timing of Radar Burst	Spectrum Analyzer Display	Result
No Radar Triggered	Transmission begin after power-up cycle +62 seconds CAC	Pass
Within 6 seconds of the CAC starting	No transmission	Pass
Within the last 6 seconds of the CAC	No transmission	Pass

Note: The CAC test is with the Radar type 0.

5290 MHz

Plot of without Radar signal applied

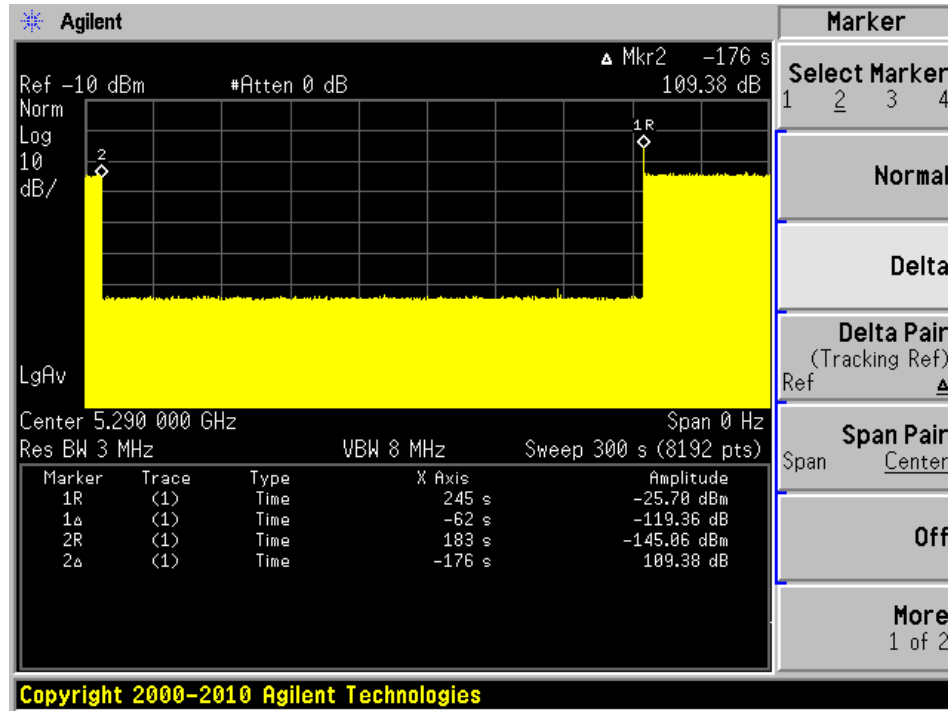

Plot of Radar signal applied within 6 seconds of start of CAC

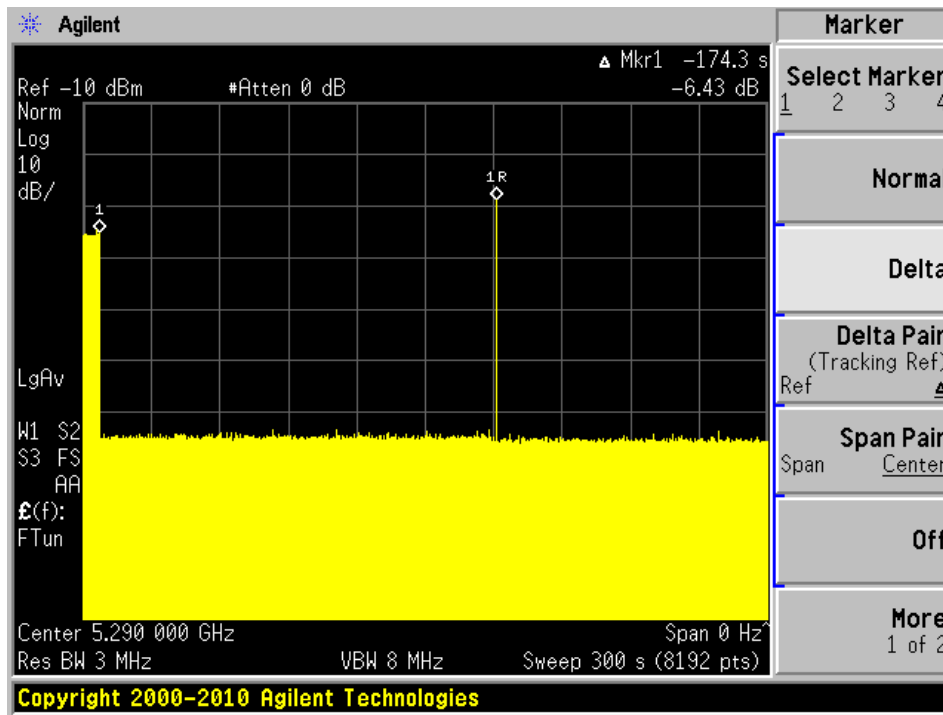

No transmissions found after radar signal applied.

Plot of Radar signal applied at the end of 6 seconds of CAC

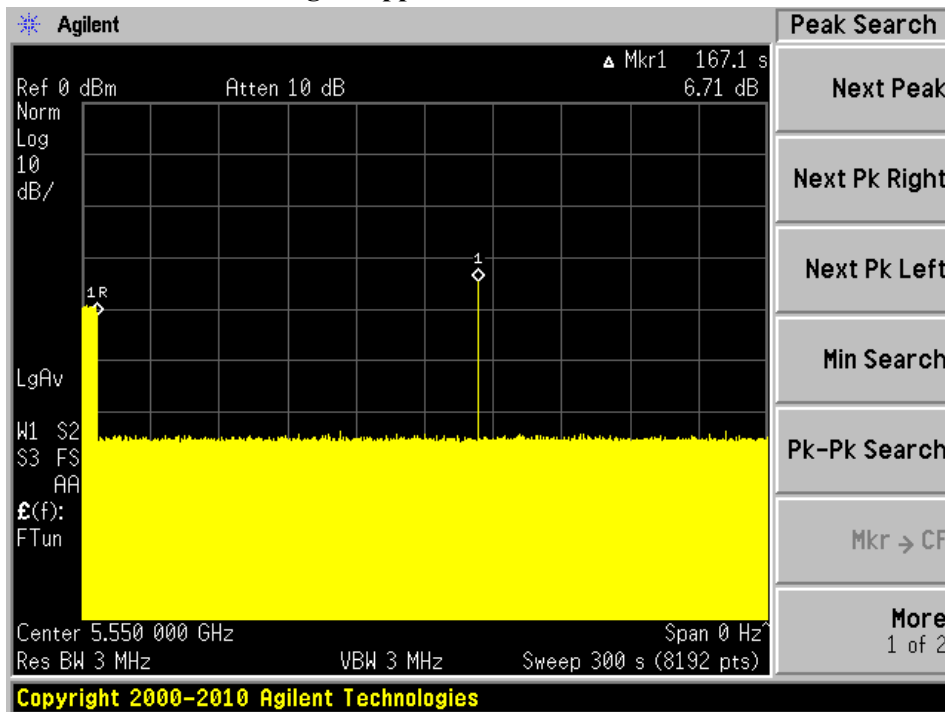

No transmissions found after radar signal applied.

5530 MHz

Plot of without Radar signal applied

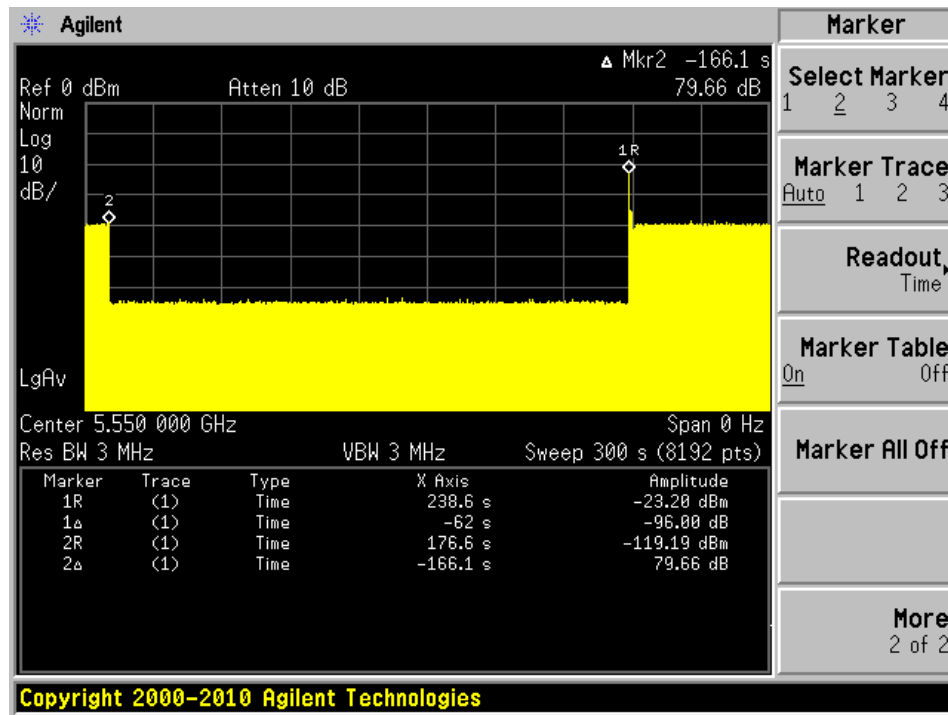

Plot of Radar signal applied within 6 seconds of start of CAC

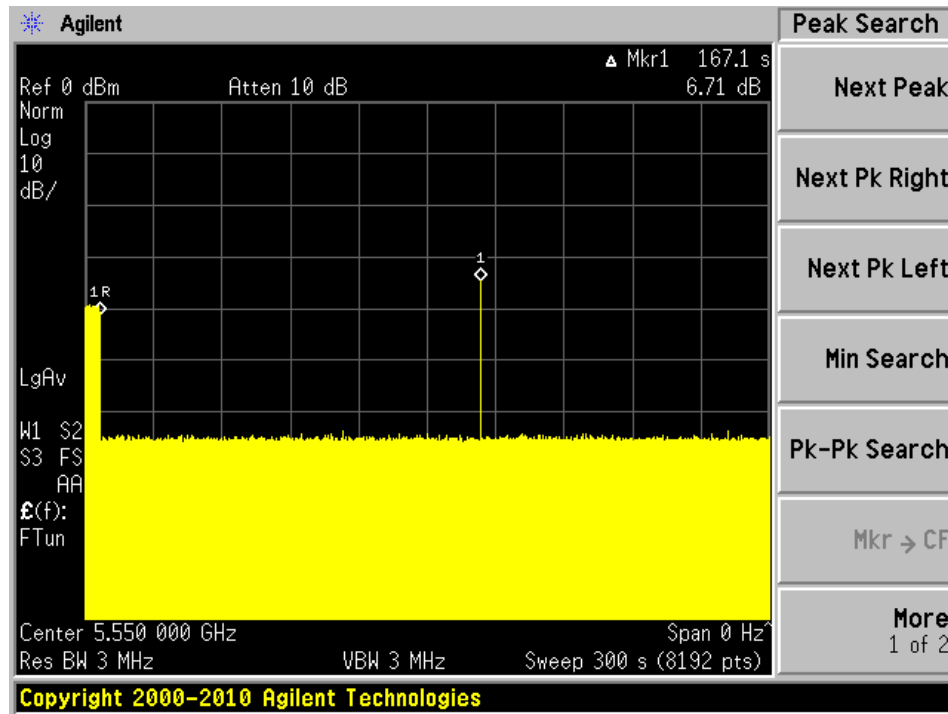

No transmissions found after radar signal applied.

Plot of Radar signal applied at the end of 6 seconds of CAC

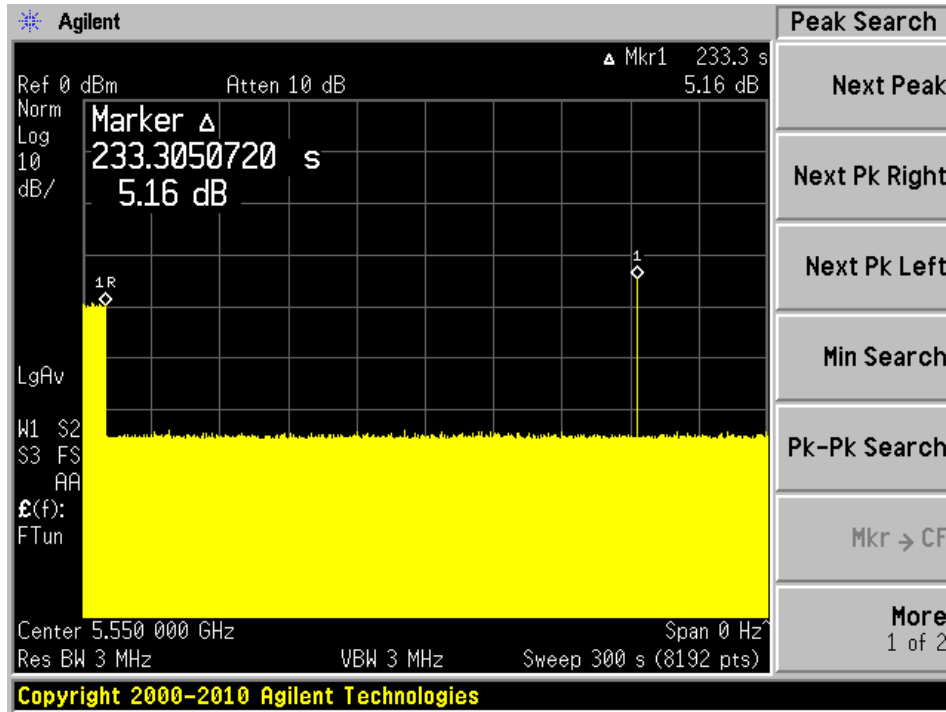

No transmissions found after radar signal applied.

7 Channel Move Time and Channel Closing Transmission Time

7.1 Test Procedure

BACL use type 0 radar signal to test the channel move time and channel closing transmission time.

The aggregate channel closing transmission time is calculated as follows:

Aggregate Transmission Time = N * Dwell Time

N is the number of spectrum analyzer bins showing a device transmission

Dwell Time is the dwell time per bin (i.e. Dwell Time = S/B, S is the sweep time and B is the number of bin, i.e. 8192)

7.2 Test Results

Frequency (MHz)	Bandwidth (MHz)	Radar Type	Results
5290	80	Type 0	Compliant
5530	80	Type 0	Compliant

Please refer to the following tables and plots.

5290 MHz, Bandwidth 80 MHz

Type 0 radar channel move time and channel closing transmission time result:

Channel closing transmitting time (ms)	Limit (ms)	Result
26.26	200	Pass

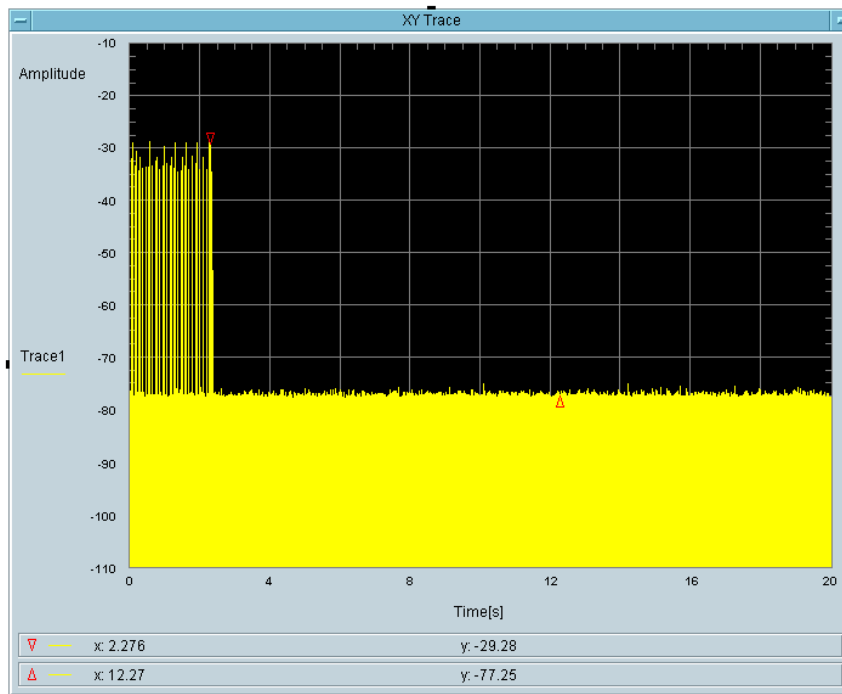

Total On Time [s]
26.26m

5530 MHz, Bandwidth 80 MHz

Type 0 radar channel move time and channel closing transmission time result:

Channel closing transmitting time (ms)	Limit (ms)	Result
41.64	200	Pass

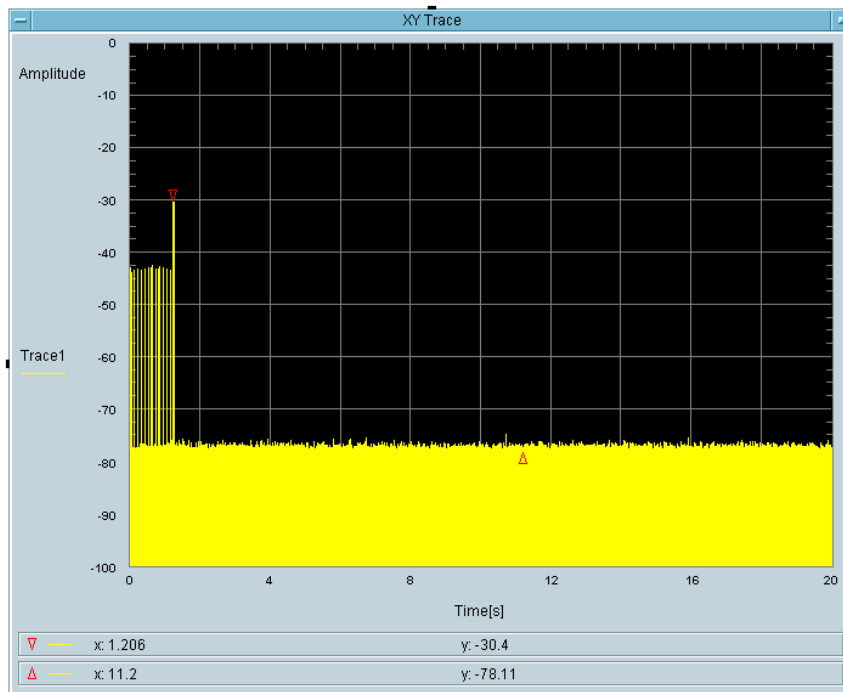

Total On Time [s]
41.64m

8 Non-Occupancy Period

8.1 Test Procedure

Measure the EUT for more than 30 minutes following the channel close/move time to verify that the EUT does not resume any transmissions on this channel. Provide one plot to demonstrate no transmission on the channel for the non-occupancy period (30 minutes observation time)

8.2 Test Results

Frequency (MHz)	Bandwidth (MHz)	Spectrum Analyzer Display
5290	80	No transmission within 30 minutes
5530	80	No transmission within 30 minutes

Please refer to the following plots.

5290 MHz, Bandwidth 80 MHz

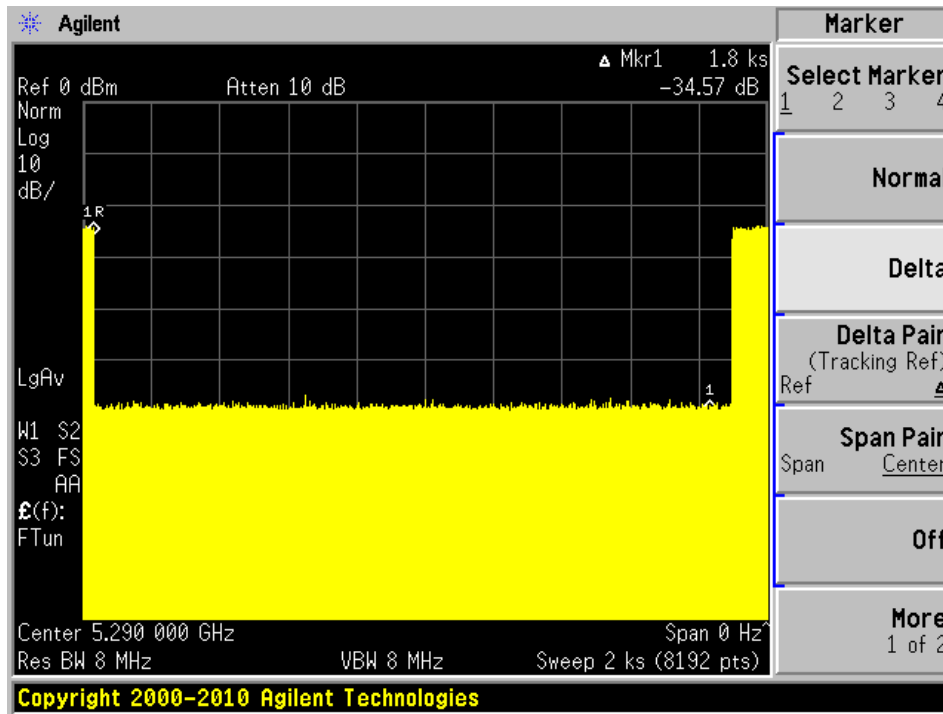

5530 MHz, Bandwidth 80 MHz

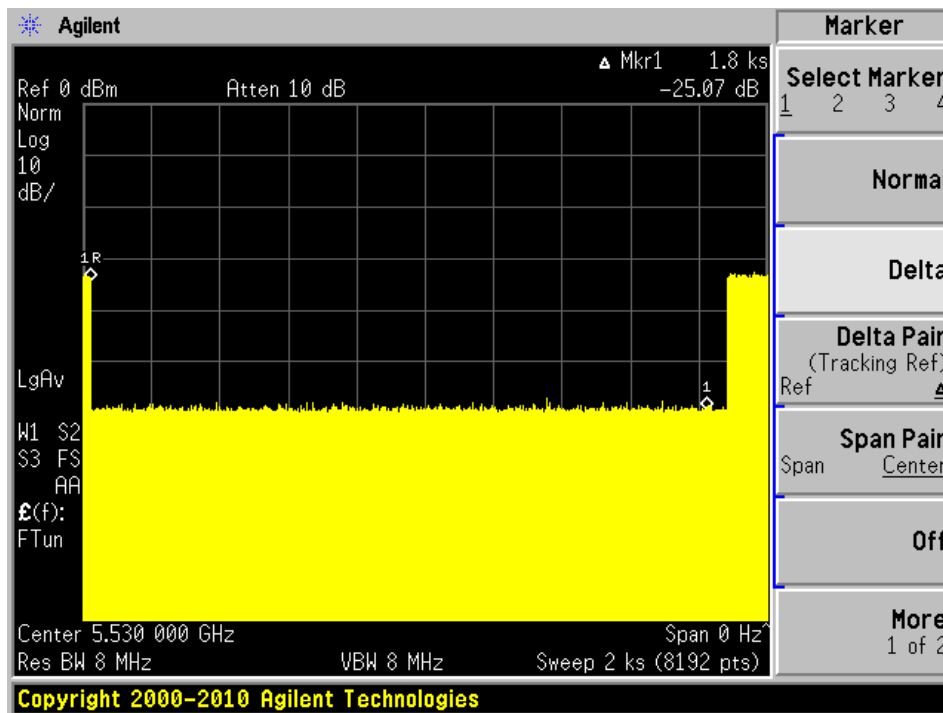

9 Radar Detection Bandwidth & Radar Detection Performance Check

9.1 Detection Bandwidth

Procedure:

Performed with any one of the short pulse radar waveforms type 0

Starting at the center frequency of the UUT operating Channel, increase the radar frequency in 5 MHz steps, repeating the above test sequence, until the detection rate falls below the U-NII Detection Bandwidth criterion specified in Table 4. Repeat this measurement in 1MHz steps at frequencies 5 MHz below where the detection rate begins to fall. Record the highest frequency (denote as FH) at which detection is greater than or equal to the U-NII Detection Bandwidth criterion. Recording the detection rate at frequencies above FH is not required to demonstrate compliance.

Starting at the center frequency of the UUT operating Channel, decrease the radar frequency in 5 MHz steps, repeating the above test sequence, until the detection rate falls below the U-NII Detection Bandwidth criterion specified in Table 4. Repeat this measurement in 1MHz steps at frequencies 5 MHz above where the detection rate begins to fall. Record the lowest frequency (denote as FL) at which detection is greater than or equal to the U-NII Detection Bandwidth criterion. Recording the detection rate at frequencies below FL is not required to demonstrate compliance.

The U-NII Detection Bandwidth is calculated as follows: U-NII Detection Bandwidth = FH – FL

Test Results

Frequency (MHz)	F _L (MHz)	F _H (MHz)	Detection Bandwidth (MHz)	Minimum Limit	Result
5270	5250	5290	40	100%	Compliance
5280	5270	5290	20	100%	Compliance
5290	5250	5330	80	100%	Compliance
5530	5490	5570	80	100%	Compliance
5540	5530	5550	20	100%	Compliance
5550	5530	5570	40	100%	Compliance

Please refer to the following tables.

Results of Detection Bandwidth:

EUT Frequency = 5280 MHz											
DFS Detection Trials (1 = Detected, 0 = No Detected)											
Radar Frequency (MHz)	1	2	3	4	5	6	7	8	9	10	Detection Rate (%)
5269	0	0	0	0	0	0	0	0	0	0	0 %
5270(F_L)	1	1	1	1	1	1	1	1	1	1	100 %
5275	1	1	1	1	1	1	1	1	1	1	100 %
5280(F _c)	1	1	1	1	1	1	1	1	1	1	100 %
5285	1	1	1	1	1	1	1	1	1	1	100 %
5290(F_H)	1	1	1	1	1	1	1	1	1	1	100 %
5291	0	0	0	0	0	0	0	0	0	0	0 %
Detection Bandwidth = F_H - F_L=5290-5270=20 MHz											
EUT 99% OBW = 17.6 MHz; 17.6 x 100% = 17.6 MHz Result: Pass											

EUT Frequency = 5540 MHz											
DFS Detection Trials (1 = Detected, 0 = No Detected)											
Radar Frequency (MHz)	1	2	3	4	5	6	7	8	9	10	Detection Rate (%)
5529	0	0	0	0	0	0	0	0	0	0	0 %
5530(F_L)	1	1	1	1	1	1	1	1	1	1	100 %
5535	1	1	1	1	1	1	1	1	1	1	100 %
5540(F _c)	1	1	1	1	1	1	1	1	1	1	100 %
5545	1	1	1	1	1	1	1	1	1	1	100 %
5550(F_H)	1	1	1	1	1	1	1	1	1	1	100 %
5551	0	0	0	0	0	0	0	0	0	0	0 %
Detection Bandwidth = F_H - F_L=5550-5530=20 MHz											
EUT 99% OBW = 17.6 MHz; 17.6 x 100% = 17.6 MHz Result: Pass											

Results of Detection Bandwidth:

EUT Frequency = 5270 MHz											
DFS Detection Trials (1 = Detected, 0 = No Detected)											
Radar Frequency (MHz)	1	2	3	4	5	6	7	8	9	10	Detection Rate (%)
5249	0	0	0	0	0	0	0	0	0	0	0 %
5250(F_L)	1	1	1	1	1	1	1	1	1	1	100 %
5255	1	1	1	1	1	1	1	1	1	1	100 %
5260	1	1	1	1	1	1	1	1	1	1	100 %
5265	1	1	1	1	1	1	1	1	1	1	100 %
5270(F _c)	1	1	1	1	1	1	1	1	1	1	100 %
5275	1	1	1	1	1	1	1	1	1	1	100 %
5280	1	1	1	1	1	1	1	1	1	1	100 %
5285	1	1	1	1	1	1	1	1	1	1	100 %
5290(F_H)	1	1	1	1	1	1	1	1	1	1	100 %
5291	0	0	0	0	0	0	0	0	0	0	0 %
Detection Bandwidth = F_H - F_L=5290-5250=40 MHz											
EUT 99% OBW = 36.01 MHz; 36.01 x 100% = 36.01 MHz						Result:		Pass			

EUT Frequency = 5550 MHz											
DFS Detection Trials (1 = Detected, 0 = No Detected)											
Radar Frequency (MHz)	1	2	3	4	5	6	7	8	9	10	Detection Rate (%)
5529	0	0	0	0	0	0	0	0	0	0	0 %
5530(F_L)	1	1	1	1	1	1	1	1	1	1	100 %
5535	1	1	1	1	1	1	1	1	1	1	100 %
5540	1	1	1	1	1	1	1	1	1	1	100 %
5545	1	1	1	1	1	1	1	1	1	1	100 %
5550(F _c)	1	1	1	1	1	1	1	1	1	1	100 %
5555	1	1	1	1	1	1	1	1	1	1	100 %
5560	1	1	1	1	1	1	1	1	1	1	100 %
5565	1	1	1	1	1	1	1	1	1	1	100 %
5570(F_H)	1	1	1	1	1	1	1	1	1	1	100 %
5571	0	0	0	0	0	0	0	0	0	0	0 %
Detection Bandwidth = F_H - F_L=5570-5530=40 MHz											
EUT 99% OBW = 35.89 MHz; 35.89 x 100% = 35.89 MHz						Result:		Pass			

Results of Detection Bandwidth:

EUT Frequency = 5290 MHz											
DFS Detection Trials (1 = Detected, 0 = No Detected)											
Radar Frequency (MHz)	1	2	3	4	5	6	7	8	9	10	Detection Rate (%)
5249	0	0	0	0	0	0	0	0	0	0	0 %
5250(F_L)	1	1	1	1	1	1	1	1	1	1	100 %
5255	1	1	1	1	1	1	1	1	1	1	100 %
5260	1	1	1	1	1	1	1	1	1	1	100 %
5265	1	1	1	1	1	1	1	1	1	1	100 %
5270	1	1	1	1	1	1	1	1	1	1	100 %
5275	1	1	1	1	1	1	1	1	1	1	100 %
5280	1	1	1	1	1	1	1	1	1	1	100 %
5285	1	1	1	1	1	1	1	1	1	1	100 %
5290(F _C)	1	1	1	1	1	1	1	1	1	1	100 %
5295	1	1	1	1	1	1	1	1	1	1	100 %
5300	1	1	1	1	1	1	1	1	1	1	100 %
5305	1	1	1	1	1	1	1	1	1	1	100 %
5310	1	1	1	1	1	1	1	1	1	1	100 %
5315	1	1	1	1	1	1	1	1	1	1	100 %
5320	1	1	1	1	1	1	1	1	1	1	100 %
5325	1	1	1	1	1	1	1	1	1	1	100 %
5330(F_H)	1	1	1	1	1	1	1	1	1	1	100 %
5291	0	0	0	0	0	0	0	0	0	0	0 %
Detection Bandwidth = F_H - F_L=5330-5250=80 MHz											
EUT 99% OBW = 75.48 MHz; 75.48 x 100% = 75.48 MHz Result: Pass											

EUT Frequency = 5530 MHz											
DFS Detection Trials (1 = Detected, 0 = No Detected)											
Radar Frequency (MHz)	1	2	3	4	5	6	7	8	9	10	Detection Rate (%)
5489	0	0	0	0	0	0	0	0	0	0	0 %
5490(F_L)	1	1	1	1	1	1	1	1	1	1	100 %
5495	1	1	1	1	1	1	1	1	1	1	100 %
5500	1	1	1	1	1	1	1	1	1	1	100 %
5505	1	1	1	1	1	1	1	1	1	1	100 %
5510	1	1	1	1	1	1	1	1	1	1	100 %
5515	1	1	1	1	1	1	1	1	1	1	100 %
5520	1	1	1	1	1	1	1	1	1	1	100 %
5525	1	1	1	1	1	1	1	1	1	1	100 %
5530(F _C)	1	1	1	1	1	1	1	1	1	1	100 %
5535	1	1	1	1	1	1	1	1	1	1	100 %
5540	1	1	1	1	1	1	1	1	1	1	100 %
5545	1	1	1	1	1	1	1	1	1	1	100 %
5550	1	1	1	1	1	1	1	1	1	1	100 %
5555	1	1	1	1	1	1	1	1	1	1	100 %
5560	1	1	1	1	1	1	1	1	1	1	100 %
5565	1	1	1	1	1	1	1	1	1	1	100 %
5570(F_H)	1	1	1	1	1	1	1	1	1	1	100 %
5571	0	0	0	0	0	0	0	0	0	0	0 %
Detection Bandwidth = F_H - F_L=5570-5490=80 MHz											
EUT 99% OBW = 75.72 MHz; 75.72 x 100% = 75.72 MHz Result: Pass											

9.2 Radar Detection Performance Check

Procedure:

Stream MPEG file from master to slave

Generate radar waveform

Record whether or not the waveform was detected

At least 30 trials are applied for each radar type

For radar types with randomized parameters, each trial uses a unique waveform

Perform with each of the radar types 1-6

Confirm that the detection rate for each radar type meets the minimum requirement

Type 1A&1B, 2, 3, 4: 60% each

Type 5: 80%

Type 6: 70%

Confirm that the mean of the rates for radar types 1 through 4 meets the requirement of 80%

$$\text{Detection Ratio} = \frac{\text{Total Waveform Detections}}{\text{Total Waveform Trials}} \times 100$$

Test Results:

5280 MHz, 20 MHz Bandwidth

Radar Signal Type	Waveform/Trial Number	Detection (%)	Limit (%)	Pass/Fail
Type 1A/1B	30	100 %	60%	Pass
Type 2	30	100 %	60%	Pass
Type 3	30	100 %	60%	Pass
Type 4	30	100 %	60%	Pass
Aggregate (Type1 to 4)	120	100 %	80%	Pass
Type 5	30	96.7 %	80%	Pass
Type 6	30	100 %	70%	Pass

Please refer to the following statistical tables:

5280 MHz, 20 MHz Bandwidth**Table-1A/1B Radar Type 1A/1B Statistical Performance**

Trial #	Fc (MHz)	Pulse/Burst	Pulse Width (μS)	PRI (μs)	Detection (1:yes; 0:no)
1	5280	62	1	858	1
2	5280	76	1	698	1
3	5280	81	1	658	1
4	5280	89	1	598	1
5	5280	59	1	898	1
6	5280	72	1	738	1
7	5280	57	1	938	1
8	5280	63	1	838	1
9	5280	74	1	718	1
10	5280	70	1	758	1
11	5280	61	1	878	1
12	5280	18	1	3066	1
13	5280	65	1	818	1
14	5280	86	1	618	1
15	5280	92	1	578	1
16	5280	34	1	1597	1
17	5280	35	1	1524	1
18	5280	25	1	2181	1
19	5280	19	1	2854	1
20	5280	35	1	1536	1
21	5280	79	1	670	1
22	5280	38	1	1390	1
23	5280	28	1	1927	1
24	5280	93	1	568	1
25	5280	20	1	2729	1
26	5280	18	1	2961	1
27	5280	69	1	766	1
28	5280	32	1	1670	1
29	5280	42	1	1273	1
30	5280	19	1	2900	1
Detection Percentage: 100 % (>60%)					

Table-2 Radar Type 2 Statistical Performance

Trial #	Fc (MHz)	Pulse/Burst	Pulse Width (µS)	PRI (µs)	Detection (1:yes; 0:no)
1	5280	25	4.1	212	1
2	5280	28	3.5	180	1
3	5280	24	1.4	152	1
4	5280	28	2.2	168	1
5	5280	26	1.6	224	1
6	5280	26	1.3	152	1
7	5280	26	1.3	163	1
8	5280	24	4.3	174	1
9	5280	26	1.4	173	1
10	5280	28	2.5	168	1
11	5280	27	2.3	213	1
12	5280	28	5	215	1
13	5280	29	1	196	1
14	5280	26	1.8	178	1
15	5280	24	3.8	189	1
16	5280	24	3.9	218	1
17	5280	28	2.8	201	1
18	5280	27	1.1	150	1
19	5280	24	3.1	210	1
20	5280	29	5	153	1
21	5280	27	4.8	189	1
22	5280	29	1.6	170	1
23	5280	23	1.6	161	1
24	5280	28	3.4	228	1
25	5280	26	2	215	1
26	5280	25	3.7	199	1
27	5280	29	1	155	1
28	5280	25	1.4	195	1
29	5280	28	2.3	193	1
30	5280	27	1.7	206	1
Detection Percentage: 100 % (>60%)					

Table-3 Radar Type 3 Statistical Performance

Trial #	Fc (MHz)	Pulse/Burst	Pulse Width (μS)	PRI (μs)	Detection (1:yes; 0:no)
1	5280	18	6.6	461	1
2	5280	18	8.5	246	1
3	5280	18	10	221	1
4	5280	17	9.7	356	1
5	5280	18	7.2	399	1
6	5280	18	6.8	380	1
7	5280	18	9.1	406	1
8	5280	16	7.1	303	1
9	5280	17	7.7	305	1
10	5280	17	8.9	458	1
11	5280	17	6.2	303	1
12	5280	18	7.1	493	1
13	5280	16	7.6	355	1
14	5280	17	9.9	259	1
15	5280	17	8.2	485	1
16	5280	17	8.4	297	1
17	5280	18	7.2	281	1
18	5280	17	9	477	1
19	5280	16	6.2	489	1
20	5280	17	6.1	488	1
21	5280	17	6	435	1
22	5280	16	7	454	1
23	5280	17	7.9	357	1
24	5280	16	8.4	380	1
25	5280	17	8.2	409	1
26	5280	18	6.1	398	1
27	5280	18	6.3	271	1
28	5280	18	7.8	424	1
29	5280	18	8.5	425	1
30	5280	17	6.7	397	1
Detection Percentage: 100 % (>60%)					

Table-4 Radar Type 4 Statistical Performance

Trial #	Fc (MHz)	Pulse/Burst	Pulse Width (µS)	PRI (µs)	Detection (1:yes; 0:no)
1	5280	12	17.3	393	1
2	5280	13	18	273	1
3	5280	12	18.9	382	1
4	5280	16	15.2	445	1
5	5280	13	11.3	472	1
6	5280	13	11.2	389	1
7	5280	15	16.9	470	1
8	5280	13	19.2	349	1
9	5280	16	16.4	328	1
10	5280	14	12.1	329	1
11	5280	16	18	270	1
12	5280	13	17.9	404	1
13	5280	15	14	295	1
14	5280	13	16.3	343	1
15	5280	15	12.4	290	1
16	5280	13	12.2	248	1
17	5280	14	18.4	289	1
18	5280	12	16	483	1
19	5280	13	15.1	376	1
20	5280	16	20	271	1
21	5280	14	14.1	425	1
22	5280	15	15.3	224	1
23	5280	16	18.6	500	1
24	5280	15	13.3	370	1
25	5280	14	17.3	218	1
26	5280	12	18.1	375	1
27	5280	15	18.7	313	1
28	5280	13	16.4	236	1
29	5280	12	12.9	279	1
30	5280	13	13.1	327	1
Detection Percentage: 100% (>60%)					

Table-5 Radar Type 5 Statistical Performance

Trial #	Fc (MHz)	Detection (1:yes; 0:no)
1	5280	1
2	5280	1
3	5280	1
4	5280	1
5	5280	0
6	5280	1
7	5280	1
8	5280	1
9	5280	1
10	5280	1
11	5276.3	1
12	5275.9	1
13	5279.1	1
14	5276.7	1
15	5277.5	1
16	5275.5	1
17	5279.5	1
18	5278.3	1
19	5277.9	1
20	5274.7	1
21	5280.9	1
22	5284.1	1
23	5285.3	1
24	5284.5	1
25	5286.5	1
26	5283.3	1
27	5285.3	1
28	5284.9	1
29	5283.3	1
30	5281.7	1
Detection Percentage: 96.7 % (>80%)		

Bin5 Statistics 1

Trial #	Pulse	Chirp (MHz)	Pulse Width (µS)	Pulse 1-2 spacing (µS)	Pulse 2-3 spacing (µS)	Pulse Start(S)	Detection (1:yes; 0:no)
0	2	5	57	1716		0.702604	1
1	3	5	70.4	1127	1458	1.218954	
2	2	5	80.5	1358		2.28647	
3	3	5	86.5	1326	1668	2.502596	
4	1	5	59			3.469993	
5	2	5	82.8	1244		4.656926	
6	2	5	95.1	1679		4.980051	
7	2	5	76.7	1866		5.837426	
8	2	5	71.4	1784		6.532982	
9	3	5	53.3	1465	1528	7.887894	
10	1	5	55.9			8.520196	
11	3	5	54.7	1809	1466	9.490908	
12	1	5	55			9.768736	
13	2	5	64.3	1368		10.462991	
14	2	5	72.8	1254		11.325288	

Bin5 Statistics 2

Trial #	Pulse	Chirp (MHz)	Pulse Width (µS)	Pulse 1-2 spacing (uS)	Pulse 2-3 spacing (uS)	Pulse Start(S)	Detection (1:yes; 0:no)
0	1	12	70			0.502078	1
1	2	12	62.4	1685		1.114357	
2	2	12	77.4	1830		1.784439	
3	3	12	78.7	1647	1346	2.516956	
4	3	12	54.8	1997	1826	3.19078	
5	3	12	81.5	1519	1098	3.6754	
6	1	12	89			4.916936	
7	3	12	80.7	1655	1203	5.542596	
8	3	12	99	1371	1270	6.17849	
9	1	12	83.2			6.438893	
10	2	12	91.1	1914		7.661897	
11	1	12	61.2			8.347741	
12	1	12	86.2			8.471533	
13	3	12	87.5	1910	1152	9.758325	
14	2	12	60.5	1467		9.905799	
15	3	12	65.6	1099	1933	10.851847	
16	1	12	99.2			11.650042	

Bin5 Statistics 3

Trial #	Pulse	Chirp (MHz)	Pulse Width (µS)	Pulse 1-2 spacing (uS)	Pulse 2-3 spacing (uS)	Pulse Start(S)	Detection (1:yes; 0:no)
0	2	12	70.5	1331		0.383622	1
1	2	12	78.3	1538		1.111103	
2	3	12	69.6	1948	1760	1.699238	
3	2	12	71.5	1488		2.713782	
4	2	12	63.4	1915		3.117042	
5	2	12	74.2	1482		4.367427	
6	2	12	64.1	1241		5.166931	
7	1	12	70.9			5.541258	
8	1	12	96.1			6.207824	
9	2	12	91.6	1619		6.957715	
10	3	12	76.1	1588	1700	8.017031	
11	2	12	97.9	1721		8.271453	
12	3	12	98.8	1081	1621	9.509259	
13	2	12	53.1	1591		10.108117	
14	2	12	86	1107		10.755611	
15	3	12	98.3	1913	1001	11.774382	

Bin5 Statistics 4

Trial #	Pulse	Chirp (MHz)	Pulse Width (µS)	Pulse 1-2 spacing (µS)	Pulse 2-3 spacing (µS)	Pulse Start(S)	Detection (1:yes; 0:no)
0	1	19	94.5			0.269323	1
1	2	19	55.3	1968		1.059712	
2	1	19	80.6			1.719416	
3	2	19	85.5	1319		2.08747	
4	3	19	86	1435	1421	2.614273	
5	2	19	81.9	1092		3.293557	
6	2	19	81.4	1273		4.045078	
7	1	19	85.6			4.5129	
8	3	19	90.6	1928	1754	4.998772	
9	2	19	68.6	1812		5.565756	
10	1	19	56.2			6.578533	
11	2	19	95.3	1559		7.080304	
12	2	19	55.5	1940		7.483655	
13	2	19	94.4	1762		8.062697	
14	2	19	99.7	1011		8.920416	
15	2	19	66.2	1506		9.455291	
16	3	19	90.5	1333	1994	10.025583	
17	2	19	58.5	1399		10.360443	
18	2	19	67.3	1448		11.100539	
19	2	19	96.7	1081		11.581598	

Bin5 Statistics 5

Trial #	Pulse	Chirp (MHz)	Pulse Width (µS)	Pulse 1-2 spacing (µS)	Pulse 2-3 spacing (µS)	Pulse Start(S)	Detection (1:yes; 0:no)
0	2	16	68.5	1483		0.617538	0
1	2	16	74.3	1782		1.661073	
2	1	16	91.1			2.911068	
3	2	16	62.2	1969		4.364316	
4	2	16	98.2	1346		4.822202	
5	3	16	51.7	1182	1329	6.775896	
6	3	16	81.2	1429	1575	7.742777	
7	1	16	81.2			9.328421	
8	3	16	95.2	1612	1371	10.383914	
9	3	16	69.1	1155	1656	11.519697	

Bin5 Statistics 6

Trial #	Pulse	Chirp (MHz)	Pulse Width (µS)	Pulse 1-2 spacing (µS)	Pulse 2-3 spacing (µS)	Pulse Start(S)	Detection (1:yes; 0:no)
0	3	12	78.3	1108	1507	0.363201	1
1	2	12	60.7	1330		2.390668	
2	2	12	70.8	1908		2.426012	
3	2	12	74.4	1726		4.539077	
4	3	12	96.1	1527	1645	5.111015	
5	3	12	85	1822	1254	6.436135	
6	2	12	94.2	1684		7.711113	
7	2	12	65.5	1204		9.083761	
8	2	12	82.3	1095		10.355319	
9	1	12	77.6			11.748119	

Bin5 Statistics 7

Trial #	Pulse	Chirp (MHz)	Pulse Width (µS)	Pulse 1-2 spacing (µS)	Pulse 2-3 spacing (µS)	Pulse Start(S)	Detection (1:yes; 0:no)
0	1	15	82.4			0.404317	0
1	1	15	63.9			1.801701	
2	1	15	86.3			1.847209	
3	2	15	91.1	1939		3.086451	
4	1	15	82.5			4.430012	
5	1	15	92.4			5.252092	
6	3	15	82.5	1697	1814	5.734927	
7	2	15	82.1	1889		7.15479	
8	2	15	79.4	1841		7.844041	
9	2	15	87.1	1370		8.774121	
10	2	15	77	1162		9.840147	
11	3	15	99.2	1337	1769	10.388025	
12	2	15	62.6	1511		11.207966	

Bin5 Statistics 8

Trial #	Pulse	Chirp (MHz)	Pulse Width (µS)	Pulse 1-2 spacing (µS)	Pulse 2-3 spacing (µS)	Pulse Start(S)	Detection (1:yes; 0:no)
0	1	18	89.5			0.024853	1
1	2	18	54.7	1757		0.92183	
2	2	18	60.5	1885		1.275534	
3	1	18	77.9			1.801569	
4	2	18	75.8	1356		2.53157	
5	2	18	54.6	1563		3.591772	
6	2	18	83.6	1468		3.830029	
7	3	18	59.1	1257	1750	4.727654	
8	3	18	96.7	1880	1818	5.050198	
9	3	18	94.1	1488	1766	5.419412	
10	2	18	76.1	1428		6.572658	
11	3	18	64.6	1613	1949	6.958626	
12	3	18	81.4	1459	1625	7.667003	
13	2	18	72	1790		7.830312	
14	2	18	81.3	1855		8.631111	
15	2	18	99.7	1678		9.480685	
16	1	18	65.8			10.11073	
17	3	18	61.6	1328	1838	10.788005	
18	2	18	61	1487		10.849601	
19	2	18	90	1765		11.673278	

Bin5 Statistics 9

Trial #	Pulse	Chirp (MHz)	Pulse Width (µS)	Pulse 1-2 spacing (µS)	Pulse 2-3 spacing (µS)	Pulse Start(S)	Detection (1:yes; 0:no)
0	2	15	83.4	1826		0.07823	1
1	1	15	95.5			1.699174	
2	2	15	51.7	1905		3.03237	
3	1	15	72.2			3.592615	
4	2	15	58.5	1421		4.366247	
5	2	15	81.6	1915		6.284665	
6	1	15	61.9			7.48739	
7	3	15	78.9	1306	1656	8.509379	
8	3	15	59.7	1911	1951	9.542523	
9	3	15	53.6	1268	1917	10.425086	
10	3	15	79.7	1924	1797	11.041924	

Bin5 Statistics 10

Trial #	Pulse	Chirp (MHz)	Pulse Width (µS)	Pulse 1-2 spacing (µS)	Pulse 2-3 spacing (µS)	Pulse Start(S)	Detection (1:yes; 0:no)
0	1	17	86.1			1.129	1
1	1	17	62			2.709441	
2	3	17	73.6	1313	1085	3.404572	
3	2	17	52.2	1581		5.343642	
4	2	17	97.4	1108		6.057897	
5	2	17	83	1715		7.963596	
6	2	17	64.3	1503		10.045383	
7	2	17	65.4	1500		11.460941	

Bin5 Statistics 11

Trial #	Pulse	Chirp (MHz)	Pulse Width (µS)	Pulse 1-2 spacing (uS)	Pulse 2-3 spacing (uS)	Pulse Start(S)	Detection (1:yes; 0:no)
0	2	12	75.4	1822		0.077071	1
1	2	12	87.5	1995		1.368626	
2	2	12	71.5	1366		2.278688	
3	3	12	93.2	1964	1050	3.063384	
4	3	12	52.4	1747	1243	3.463367	
5	2	12	74	1870		4.005608	
6	1	12	68.3			5.167837	
7	1	12	79.5			6.055414	
8	1	12	74.5			6.576489	
9	3	12	81.7	1222	1173	7.9045	
10	2	12	90.3	1553		8.358158	
11	2	12	55.3	1316		9.584686	
12	1	12	87.2			10.060758	
13	1	12	53			10.967143	
14	2	12	73.3	1434		11.615236	

Bin5 Statistics 12

Trial #	Pulse	Chirp (MHz)	Pulse Width (µS)	Pulse 1-2 spacing (uS)	Pulse 2-3 spacing (uS)	Pulse Start(S)	Detection (1:yes; 0:no)
0	2	11	65.5	1832		0.976058	0
1	1	11	73			1.648577	
2	1	11	82.5			4.493866	
3	2	11	84.6	1822		5.504631	
4	1	11	67.7			6.062301	
5	1	11	84.9			7.816407	
6	1	11	68.2			9.712545	
7	1	11	80			10.640833	

Bin5 Statistics 13

Trial #	Pulse	Chirp (MHz)	Pulse Width (µS)	Pulse 1-2 spacing (µS)	Pulse 2-3 spacing (µS)	Pulse Start(S)	Detection (1:yes; 0:no)
0	2	19	51.4	1310		0.786563	1
1	3	19	60.1	1874	1538	1.567922	
2	2	19	65.9	1772		2.54377	
3	2	19	97.6	1720		3.355332	
4	1	19	98.1			4.268669	
5	2	19	88.2	1262		4.789419	
6	3	19	98.7	1645	1240	5.478885	
7	2	19	94.4	1466		6.098429	
8	1	19	75.3			7.654272	
9	2	19	77.9	1424		8.214632	
10	3	19	68.8	1836	1253	8.596097	
11	2	19	61.7	1061		9.579051	
12	1	19	71.7			10.733663	
13	2	19	90.6	1025		11.901345	

Bin5 Statistics 14

Trial #	Pulse	Chirp (MHz)	Pulse Width (µS)	Pulse 1-2 spacing (µS)	Pulse 2-3 spacing (µS)	Pulse Start(S)	Detection (1:yes; 0:no)
0	3	13	70.5	1577	1863	0.138297	1
1	3	13	72.9	1564	1687	0.720316	
2	3	13	62.6	1605	1471	1.294338	
3	2	13	81.4	1662		1.996523	
4	3	13	55.1	1422	1678	2.639286	
5	3	13	92.7	1844	1501	3.213238	
6	3	13	69.7	1360	1246	3.898071	
7	2	13	84.1	1709		4.864915	
8	2	13	88.2	1643		5.440878	
9	2	13	87.5	1578		5.79027	
10	1	13	89.6			6.514589	
11	3	13	58.6	1749	1834	7.518562	
12	3	13	59.2	1185	1844	7.968877	
13	3	13	75.6	1313	1946	8.542473	
14	1	13	97.8			9.108337	
15	2	13	91.7	1542		9.530831	
16	2	13	91	1063		10.710275	
17	2	13	57.7	1952		11.330776	
18	1	13	77.7			11.743561	

Bin5 Statistics 15

Trial #	Pulse	Chirp (MHz)	Pulse Width (µS)	Pulse 1-2 spacing (µS)	Pulse 2-3 spacing (µS)	Pulse Start(S)	Detection (1:yes; 0:no)
0	3	15	65.4	1081	1490	0.675337	1
1	2	15	82	1897		1.103694	
2	2	15	75.8	1429		1.986315	
3	3	15	58.7	1952	1761	2.984148	
4	3	15	95.3	1117	1326	3.387401	
5	3	15	93.5	1150	1660	4.460845	
6	3	15	61.5	1926	1335	4.986537	
7	1	15	92.7			6.21411	
8	1	15	90.3			6.745619	
9	1	15	92.7			7.311814	
10	1	15	53.7			8.072662	
11	3	15	82.6	1919	1941	9.248324	
12	1	15	64.3			9.686382	
13	2	15	72.9	1038		10.835991	
14	1	15	53			11.234539	
15	2	15	91.7	1542		9.530831	

Bin5 Statistics 16

Trial #	Pulse	Chirp (MHz)	Pulse Width (µS)	Pulse 1-2 spacing (µS)	Pulse 2-3 spacing (µS)	Pulse Start(S)	Detection (1:yes; 0:no)
0	3	10	54	1562	1356	0.547025	1
1	1	10	53.7			1.006497	
2	1	10	54.5			1.865805	
3	2	10	85	1801		2.15236	
4	2	10	54	1934		3.158315	
5	2	10	83.7	1194		3.954297	
6	1	10	73.3			4.344864	
7	1	10	73.7			4.941958	
8	3	10	68.6	1182	1386	5.742615	
9	1	10	70.1			6.266371	
10	2	10	53.4	1900		7.114442	
11	3	10	63.2	1480	1942	7.61452	
12	1	10	73.9			8.530211	
13	1	10	78.4			9.192226	
14	2	10	56.6	1350		9.391706	
15	2	10	94.1	1340		10.331886	
16	3	10	58.6	1768	1781	10.856918	
17	3	10	85.4	1103	1522	11.935103	

Bin5 Statistics 17

Trial #	Pulse	Chirp (MHz)	Pulse Width (µS)	Pulse 1-2 spacing (µS)	Pulse 2-3 spacing (µS)	Pulse Start(S)	Detection (1:yes; 0:no)
0	3	20	84.2	1945	1965	0.216099	1
1	3	20	92.1	1554	1310	1.517531	
2	1	20	98.4			2.358821	
3	1	20	69.6			2.487741	
4	1	20	93			3.852393	
5	1	20	64.5			4.728787	
6	2	20	58.6	1443		5.254989	
7	1	20	65.8			6.249153	
8	2	20	84.5	1626		6.781704	
9	2	20	91	1374		7.757859	
10	3	20	92.6	1753	1101	8.068524	
11	2	20	68.3	1400		9.130985	
12	2	20	81.7	1019		10.045393	
13	2	20	70.6	1300		10.658747	
14	2	20	69.9	1415		11.695238	

Bin5 Statistics 18

Trial #	Pulse	Chirp (MHz)	Pulse Width (µS)	Pulse 1-2 spacing (µS)	Pulse 2-3 spacing (µS)	Pulse Start(S)	Detection (1:yes; 0:no)
0	3	17	78.2	1801	1204	0.487197	1
1	1	17	72.1			0.960516	
2	3	17	98.5	1111	1805	1.811192	
3	1	17	87			2.192527	
4	1	17	50.6			2.992535	
5	2	17	95.8	1382		3.829302	
6	1	17	80.7			4.367273	
7	2	17	68	1727		5.191368	
8	2	17	51.4	1802		5.464076	
9	3	17	68.9	1923	1609	6.637433	
10	3	17	89.5	1381	1711	6.741497	
11	1	17	96.8			7.985243	
12	3	17	83.9	1280	1410	8.306895	
13	1	17	52.3			8.769455	
14	2	17	90.9	1994		9.911719	
15	1	17	96			10.269733	
16	2	17	66.4	1526		11.29355	
17	3	17	76.6	1940	1092	11.670517	

Bin5 Statistics 19

Trial #	Pulse	Chirp (MHz)	Pulse Width (µS)	Pulse 1-2 spacing (µS)	Pulse 2-3 spacing (µS)	Pulse Start(S)	Detection (1:yes; 0:no)
0	2	16	51.7	1042		0.627602	1
1	1	16	56.2			0.930809	
2	1	16	54.5			2.227159	
3	2	16	81.1	1364		2.656645	
4	1	16	57.4			4.125554	
5	3	16	84.3	1605	1505	4.857972	
6	2	16	79.1	1008		5.766263	
7	3	16	72	1001	1035	6.557914	
8	3	16	50.6	1156	1259	7.420276	
9	2	16	88.7	1225		8.022028	
10	2	16	96.6	1769		9.355463	
11	2	16	60.3	1561		10.150097	
12	2	16	78.8	1976		10.524497	
13	2	16	67.2	1907		11.766497	

Bin5 Statistics 20

Trial #	Pulse	Chirp (MHz)	Pulse Width (µS)	Pulse 1-2 spacing (µS)	Pulse 2-3 spacing (µS)	Pulse Start(S)	Detection (1:yes; 0:no)
0	2	8	77.2	1209		0.394356	1
1	3	8	88.9	1661	1565	1.752261	
2	2	8	53	1812		2.316217	
3	2	8	85.3	1598		3.131818	
4	2	8	95.8	1738		4.412074	
5	2	8	86	1312		5.539173	
6	1	8	63.2			6.252506	
7	2	8	66.8	1885		7.125177	
8	1	8	52.9			8.098898	
9	1	8	68.3			9.837245	
10	2	8	83.5	1614		10.593379	
11	1	8	87.4			11.85881	

Bin5 Statistics 21

Trial #	Pulse	Chirp (MHz)	Pulse Width (µS)	Pulse 1-2 spacing (uS)	Pulse 2-3 spacing (uS)	Pulse Start(S)	Detection (1:yes; 0:no)
0	2	19	71	1401		1.132881	1
1	2	19	96.4	1472		2.342721	
2	2	19	81.9	1768		2.506153	
3	1	19	68.5			3.810179	
4	2	19	81.4	1957		5.177535	
5	3	19	50.2	1425	1678	6.253158	
6	3	19	54.3	1693	1810	7.467217	
7	3	19	94.4	1059	1922	9.383595	
8	2	19	60.8	1341		9.604438	
9	1	19	85.6			10.816307	

Bin5 Statistics 22

Trial #	Pulse	Chirp (MHz)	Pulse Width (µS)	Pulse 1-2 spacing (uS)	Pulse 2-3 spacing (uS)	Pulse Start(S)	Detection (1:yes; 0:no)
0	3	11	60.9	1452	1246	0.207523	1
1	2	11	55.8	1028		1.206402	
2	2	11	76.9	1267		3.021506	
3	1	11	74.1			3.467954	
4	1	11	99.7			4.738909	
5	2	11	59	1080		6.053457	
6	2	11	98.5	1007		6.948897	
7	3	11	78.5	1365	1741	7.686747	
8	1	11	65.8			9.280861	
9	1	11	74.1			10.348857	
10	2	11	50.7	1738		11.962618	

Bin5 Statistics 23

Trial #	Pulse	Chirp (MHz)	Pulse Width (µS)	Pulse 1-2 spacing (µS)	Pulse 2-3 spacing (µS)	Pulse Start(S)	Detection (1:yes; 0:no)
0	3	8	92.6	1865	1010	0.60409	1
1	1	8	50.1			1.495494	
2	1	8	59.5			2.275348	
3	2	8	95.1	1590		2.735347	
4	3	8	65.6	1625	1364	3.610465	
5	3	8	99.5	1285	1689	4.535978	
6	2	8	88.1	1749		5.12151	
7	3	8	87.5	1102	1675	6.193291	
8	1	8	95.1			6.908766	
9	1	8	65.4			7.727564	
10	1	8	74			8.050011	
11	2	8	99.8	1226		9.526956	
12	3	8	86.2	1130	1646	9.798669	
13	2	8	89.5	1525		10.805203	
14	1	8	62.2			11.870715	

Bin5 Statistics 24

Trial #	Pulse	Chirp (MHz)	Pulse Width (µS)	Pulse 1-2 spacing (µS)	Pulse 2-3 spacing (µS)	Pulse Start(S)	Detection (1:yes; 0:no)
0	1	10	82.1			0.862036	1
1	1	10	96.2			1.171341	
2	1	10	99.9			2.518447	
3	1	10	98			3.627895	
4	2	10	56	1594		4.674791	
5	2	10	95.9	1240		5.54664	
6	2	10	56.4	1235		6.558034	
7	3	10	79.2	1078	1942	7.039749	
8	1	10	50.6			8.703327	
9	3	10	84.3	1403	1181	9.80658	
10	3	10	80.6	1528	1923	10.451684	
11	3	10	64.4	1928	1110	11.266774	

Bin5 Statistics 25

Trial #	Pulse	Chirp (MHz)	Pulse Width (µS)	Pulse 1-2 spacing (µS)	Pulse 2-3 spacing (µS)	Pulse Start(S)	Detection (1:yes; 0:no)
0	2	5	65	1150		0.420173	1
1	3	5	50.3	1845	1794	0.829665	
2	2	5	81.9	1842		2.197873	
3	2	5	75.6	1404		2.431313	
4	2	5	77.9	1984		3.363633	
5	2	5	91	1752		4.012244	
6	2	5	71.1	1769		5.162011	
7	2	5	72	1127		5.799702	
8	3	5	58.7	1667	1979	6.011935	
9	3	5	79.2	1388	1752	6.932978	
10	1	5	56.4			7.852116	
11	3	5	56	1172	1962	8.740333	
12	2	5	52.9	1461		9.625443	
13	3	5	68.2	1201	1397	10.067759	
14	1	5	92.4			10.851649	
15	3	5	75	1940	1137	11.505128	

Bin5 Statistics 26

Trial #	Pulse	Chirp (MHz)	Pulse Width (µS)	Pulse 1-2 spacing (µS)	Pulse 2-3 spacing (µS)	Pulse Start(S)	Detection (1:yes; 0:no)
0	2	13	99.8	1967		0.004605	1
1	1	13	67.2			0.949461	
2	3	13	60.7	1471	1283	1.68017	
3	2	13	85.6	1759		2.650502	
4	1	13	86.7			3.593302	
5	1	13	66.3			4.47304	
6	2	13	78.7	1919		5.084089	
7	2	13	99.2	1902		5.943501	
8	1	13	62.5			6.675524	
9	2	13	65.6	1458		7.457088	
10	1	13	58.4			8.4596	
11	2	13	78.1	1706		9.202267	
12	2	13	89.5	1677		9.697879	
13	2	13	62.4	1885		10.538834	
14	2	13	52.3	1460		11.862629	

Bin5 Statistics 27

Trial #	Pulse	Chirp (MHz)	Pulse Width (µS)	Pulse 1-2 spacing (µS)	Pulse 2-3 spacing (µS)	Pulse Start(S)	Detection (1:yes; 0:no)
0	1	8	53.8			0.107392	1
1	2	8	54.9	1106		1.468551	
2	3	8	65	1938	1853	1.939149	
3	2	8	70.4	1085		3.596603	
4	2	8	91.7	1750		4.303564	
5	1	8	75.6			5.121824	
6	2	8	62.4	1909		6.33079	
7	3	8	61.4	1251	1558	6.68049	
8	1	8	55.6			7.520791	
9	1	8	93.8			8.320027	
10	1	8	62.5			10.042159	
11	2	8	73.4	1784		10.701445	
12	2	8	51.5	1321		11.583965	

Bin5 Statistics 28

Trial #	Pulse	Chirp (MHz)	Pulse Width (µS)	Pulse 1-2 spacing (µS)	Pulse 2-3 spacing (µS)	Pulse Start(S)	Detection (1:yes; 0:no)
0	3	9	57.2	1873	1874	0.559187	1
1	3	9	67.1	1748	1975	1.077021	
2	3	9	51.3	1651	1395	1.629008	
3	2	9	92.4	1166		2.132069	
4	1	9	97.2			2.739272	
5	3	9	80.2	1106	1366	3.584029	
6	2	9	99.2	1027		3.897144	
7	3	9	57	1762	1992	4.827687	
8	2	9	71.1	1932		5.224599	
9	1	9	84.3			5.978731	
10	2	9	63.6	1546		6.321812	
11	1	9	86			7.110434	
12	3	9	81	1188	1468	7.842894	
13	2	9	71.4	1359		8.230293	
14	2	9	91.5	1210		9.305358	
15	3	9	84.6	1753	1994	10.059607	
16	3	9	77.2	1777	1846	10.164822	
17	2	9	84.2	1779		11.27163	
18	1	9	53.4			11.944501	

Bin5 Statistics 29

Trial #	Pulse	Chirp (MHz)	Pulse Width (µS)	Pulse 1-2 spacing (µS)	Pulse 2-3 spacing (µS)	Pulse Start(S)	Detection (1:yes; 0:no)
0	1	13	61.7			0.897388	1
1	1	13	90			2.042326	
2	2	13	59.6	1130		2.911633	
3	1	13	87.7			4.079906	
4	2	13	81.8	1281		4.439571	
5	2	13	95.1	1232		5.938653	
6	3	13	56.3	1852	1206	7.563897	
7	2	13	79.9	1347		7.7986	
8	2	13	77	1352		9.722727	
9	3	13	81.4	1275	1794	10.701318	
10	3	13	57.4	1905	1682	11.90434	

Bin5 Statistics 30

Trial #	Pulse	Chirp (MHz)	Pulse Width (µS)	Pulse 1-2 spacing (µS)	Pulse 2-3 spacing (µS)	Pulse Start(S)	Detection (1:yes; 0:no)
0	2	17	90.7	1914		0.241381	1
1	1	17	68			1.4561	
2	2	17	54.6	1282		1.591632	
3	2	17	67.3	1487		2.843801	
4	1	17	67.8			3.087295	
5	2	17	86.3	1015		4.289908	
6	2	17	51.4	1849		4.583405	
7	1	17	95.9			5.484367	
8	2	17	63.2	1789		6.213836	
9	3	17	67	1704	1431	6.888842	
10	3	17	92.9	1358	1761	7.739991	
11	3	17	50.2	1146	1570	8.795149	
12	1	17	90			9.20765	
13	1	17	97.4			10.370012	
14	2	17	79.1	1415		11.004222	
15	1	17	99.6			11.497082	

Table-6 Radar Type 6 Statistical Performance

Trial #	Fc (MHz)	Pulse /Burst	Pulse Width (µS)	PRI (µs)	Detection (1:yes; 0:no)	Hopping Sequence
1	5280	9	1	333	1	5596.0, 5582.0, 5716.0, 5711.0, 5682.0, 5515.0, 5322.0, 5272.0, 5352.0, 5474.0, 5513.0, 5522.0, 5288.0, 5686.0, 5270.0, 5258.0, 5551.0, 5448.0, 5670.0, 5269.0, 5674.0, 5608.0, 5612.0, 5507.0, 5698.0, 5298.0, 5586.0, 5719.0, 5299.0, 5323.0, 5293.0, 5536.0, 5399.0, 5660.0, 5571.0, 5335.0, 5662.0, 5696.0, 5493.0, 5645.0, 5468.0, 5671.0, 5555.0, 5402.0, 5254.0, 5541.0, 5569.0, 5624.0, 5285.0, 5426.0, 5690.0, 5339.0, 5314.0, 5301.0, 5406.0, 5629.0, 5342.0, 5591.0, 5502.0, 5365.0, 5306.0, 5385.0, 5431.0, 5404.0, 5443.0, 5435.0, 5251.0, 5563.0, 5701.0, 5684.0, 5702.0, 5279.0, 5723.0, 5312.0, 5494.0, 5453.0, 5318.0, 5373.0, 5486.0, 5626.0, 5429.0, 5391.0, 5565.0, 5618.0, 5481.0, 5592.0, 5488.0, 5381.0, 5648.0, 5403.0, 5326.0, 5651.0, 5421.0, 5616.0, 5685.0, 5611.0, 5644.0, 5309.0, 5585.0, 5338.0 (number of hits: 5)
2	5280	9	1	333	1	5287.0, 5707.0, 5320.0, 5482.0, 5313.0, 5572.0, 5673.0, 5581.0, 5505.0, 5264.0, 5266.0, 5584.0, 5573.0, 5372.0, 5696.0, 5568.0, 5674.0, 5413.0, 5370.0, 5649.0, 5268.0, 5723.0, 5396.0, 5364.0, 5468.0, 5610.0, 5340.0, 5333.0, 5609.0, 5598.0, 5338.0, 5548.0, 5321.0, 5502.0, 5481.0, 5259.0, 5472.0, 5550.0, 5492.0, 5473.0, 5262.0, 5484.0, 5356.0, 5624.0, 5508.0, 5597.0, 5281.0, 5494.0, 5711.0, 5316.0, 5651.0, 5477.0, 5718.0, 5374.0, 5485.0, 5486.0, 5303.0, 5633.0, 5677.0, 5579.0, 5719.0, 5662.0, 5480.0, 5475.0, 5302.0, 5622.0, 5255.0, 5307.0, 5410.0, 5571.0, 5546.0, 5384.0, 5683.0, 5580.0, 5690.0, 5383.0, 5629.0, 5678.0, 5529.0, 5464.0, 5594.0, 5476.0, 5326.0, 5695.0, 5543.0, 5567.0, 5318.0, 5387.0, 5411.0, 5422.0, 5524.0, 5680.0, 5538.0, 5712.0, 5664.0, 5721.0, 5603.0, 5667.0, 5520.0, 5616.0 (number of hits: 2)
3	5280	9	1	333	1	5288.0, 5704.0, 5324.0, 5499.0, 5419.0, 5655.0, 5378.0, 5411.0, 5255.0, 5364.0, 5536.0, 5624.0, 5616.0, 5356.0, 5547.0, 5298.0, 5280.0, 5251.0, 5550.0, 5578.0, 5691.0, 5305.0, 5557.0, 5443.0, 5697.0, 5353.0, 5678.0, 5263.0, 5275.0, 5648.0, 5530.0, 5537.0, 5327.0, 5440.0, 5470.0, 5581.0, 5519.0, 5404.0, 5439.0, 5680.0, 5575.0, 5639.0, 5270.0, 5297.0, 5589.0, 5562.0, 5696.0, 5313.0, 5549.0, 5254.0, 5336.0, 5407.0, 5256.0, 5343.0, 5415.0,

						5687.0, 5403.0, 5659.0, 5572.0, 5492.0, 5385.0, 5294.0, 5645.0, 5349.0, 5563.0, 5693.0, 5561.0, 5475.0, 5686.0, 5513.0, 5374.0, 5724.0, 5338.0, 5489.0, 5282.0, 5626.0, 5683.0, 5695.0, 5450.0, 5506.0, 5375.0, 5521.0, 5315.0, 5504.0, 5688.0, 5460.0, 5301.0, 5417.0, 5527.0, 5584.0, 5662.0, 5560.0, 5357.0, 5265.0, 5323.0, 5508.0, 5541.0, 5528.0, 5512.0, 5307.0 (number of hits: 5)
4	5280	9	1	333	1	5609.0, 5506.0, 5536.0, 5690.0, 5548.0, 5664.0, 5507.0, 5670.0, 5409.0, 5557.0, 5516.0, 5532.0, 5611.0, 5461.0, 5465.0, 5309.0, 5368.0, 5512.0, 5336.0, 5646.0, 5410.0, 5537.0, 5280.0, 5321.0, 5443.0, 5442.0, 5278.0, 5334.0, 5389.0, 5477.0, 5260.0, 5615.0, 5716.0, 5706.0, 5335.0, 5631.0, 5337.0, 5568.0, 5654.0, 5692.0, 5262.0, 5297.0, 5319.0, 5583.0, 5457.0, 5550.0, 5648.0, 5474.0, 5572.0, 5562.0, 5605.0, 5495.0, 5429.0, 5551.0, 5430.0, 5521.0, 5377.0, 5686.0, 5701.0, 5338.0, 5359.0, 5314.0, 5402.0, 5519.0, 5380.0, 5652.0, 5576.0, 5721.0, 5574.0, 5447.0, 5433.0, 5423.0, 5346.0, 5265.0, 5412.0, 5340.0, 5316.0, 5612.0, 5498.0, 5305.0, 5613.0, 5466.0, 5274.0, 5711.0, 5584.0, 5308.0, 5524.0, 5320.0, 5328.0, 5413.0, 5391.0, 5397.0, 5708.0, 5468.0, 5513.0, 5318.0, 5324.0, 5675.0, 5597.0, 5558.0 (number of hits: 3)
5	5280	9	1	333	1	5524.0, 5499.0, 5491.0, 5417.0, 5307.0, 5418.0, 5481.0, 5336.0, 5385.0, 5578.0, 5400.0, 5383.0, 5716.0, 5403.0, 5668.0, 5296.0, 5303.0, 5473.0, 5480.0, 5278.0, 5435.0, 5666.0, 5395.0, 5314.0, 5438.0, 5388.0, 5671.0, 5594.0, 5332.0, 5676.0, 5350.0, 5287.0, 5337.0, 5469.0, 5691.0, 5628.0, 5384.0, 5560.0, 5443.0, 5610.0, 5291.0, 5394.0, 5531.0, 5613.0, 5549.0, 5619.0, 5312.0, 5488.0, 5552.0, 5370.0, 5261.0, 5436.0, 5358.0, 5582.0, 5466.0, 5377.0, 5694.0, 5456.0, 5585.0, 5348.0, 5704.0, 5283.0, 5717.0, 5382.0, 5647.0, 5512.0, 5448.0, 5684.0, 5471.0, 5372.0, 5361.0, 5265.0, 5611.0, 5557.0, 5553.0, 5622.0, 5692.0, 5478.0, 5614.0, 5262.0, 5342.0, 5508.0, 5474.0, 5279.0, 5277.0, 5308.0, 5275.0, 5642.0, 5424.0, 5648.0, 5593.0, 5368.0, 5455.0, 5562.0, 5527.0, 5701.0, 5685.0, 5708.0, 5470.0, 5465.0 (number of hits: 6)
6	5280	9	1	333	1	5355.0, 5611.0, 5429.0, 5624.0, 5559.0, 5508.0, 5471.0, 5305.0, 5375.0, 5591.0, 5712.0, 5481.0, 5443.0, 5668.0, 5537.0, 5586.0, 5685.0, 5701.0, 5252.0, 5411.0, 5382.0, 5603.0, 5501.0, 5329.0, 5250.0, 5390.0, 5708.0, 5418.0, 5717.0, 5696.0, 5448.0, 5622.0, 5519.0, 5592.0, 5302.0,

						5368.0, 5525.0, 5652.0, 5621.0, 5277.0, 5533.0, 5510.0, 5560.0, 5456.0, 5553.0, 5279.0, 5328.0, 5440.0, 5635.0, 5459.0, 5661.0, 5594.0, 5502.0, 5498.0, 5452.0, 5430.0, 5290.0, 5389.0, 5544.0, 5667.0, 5643.0, 5638.0, 5281.0, 5499.0, 5721.0, 5256.0, 5656.0, 5398.0, 5641.0, 5584.0, 5434.0, 5663.0, 5400.0, 5455.0, 5720.0, 5488.0, 5535.0, 5694.0, 5552.0, 5531.0, 5571.0, 5500.0, 5693.0, 5718.0, 5716.0, 5640.0, 5323.0, 5645.0, 5325.0, 5415.0, 5580.0, 5627.0, 5709.0, 5258.0, 5576.0, 5416.0, 5597.0, 5300.0, 5514.0, 5549.0 (number of hits: 3)
7	5280	9	1	333	1	5549.0, 5598.0, 5605.0, 5585.0, 5501.0, 5324.0, 5399.0, 5299.0, 5492.0, 5540.0, 5535.0, 5626.0, 5471.0, 5409.0, 5382.0, 5481.0, 5457.0, 5436.0, 5413.0, 5454.0, 5677.0, 5267.0, 5511.0, 5531.0, 5260.0, 5717.0, 5464.0, 5284.0, 5702.0, 5657.0, 5453.0, 5572.0, 5521.0, 5681.0, 5304.0, 5629.0, 5263.0, 5573.0, 5276.0, 5294.0, 5313.0, 5336.0, 5480.0, 5318.0, 5552.0, 5265.0, 5395.0, 5642.0, 5683.0, 5483.0, 5475.0, 5576.0, 5542.0, 5386.0, 5539.0, 5645.0, 5706.0, 5325.0, 5659.0, 5300.0, 5713.0, 5469.0, 5490.0, 5651.0, 5634.0, 5599.0, 5333.0, 5489.0, 5342.0, 5269.0, 5364.0, 5646.0, 5384.0, 5558.0, 5696.0, 5670.0, 5358.0, 5562.0, 5485.0, 5641.0, 5557.0, 5288.0, 5609.0, 5487.0, 5385.0, 5338.0, 5564.0, 5297.0, 5673.0, 5316.0, 5716.0, 5467.0, 5380.0, 5679.0, 5522.0, 5514.0, 5628.0, 5517.0, 5282.0, 5352.0 (number of hits: 4)
8	5280	9	1	333	1	5583.0, 5416.0, 5512.0, 5307.0, 5660.0, 5514.0, 5562.0, 5257.0, 5533.0, 5318.0, 5390.0, 5426.0, 5652.0, 5424.0, 5431.0, 5469.0, 5640.0, 5328.0, 5723.0, 5541.0, 5428.0, 5508.0, 5408.0, 5430.0, 5299.0, 5604.0, 5275.0, 5566.0, 5450.0, 5605.0, 5362.0, 5325.0, 5331.0, 5394.0, 5405.0, 5507.0, 5264.0, 5688.0, 5341.0, 5284.0, 5588.0, 5581.0, 5427.0, 5509.0, 5708.0, 5418.0, 5585.0, 5382.0, 5274.0, 5543.0, 5271.0, 5659.0, 5369.0, 5350.0, 5656.0, 5609.0, 5521.0, 5404.0, 5386.0, 5622.0, 5528.0, 5674.0, 5276.0, 5403.0, 5698.0, 5491.0, 5347.0, 5412.0, 5569.0, 5383.0, 5651.0, 5576.0, 5548.0, 5657.0, 5579.0, 5391.0, 5532.0, 5612.0, 5616.0, 5494.0, 5269.0, 5650.0, 5595.0, 5414.0, 5620.0, 5691.0, 5334.0, 5476.0, 5572.0, 5480.0, 5360.0, 5388.0, 5267.0, 5493.0, 5687.0, 5374.0, 5702.0, 5499.0, 5352.0, 5482.0 (number of hits: 5)
9	5280	9	1	333	1	5624.0, 5295.0, 5526.0, 5410.0, 5550.0, 5277.0, 5687.0, 5261.0, 5545.0, 5708.0, 5422.0, 5656.0, 5423.0, 5326.0, 5421.0,

						5393.0, 5630.0, 5672.0, 5476.0, 5716.0, 5461.0, 5604.0, 5301.0, 5348.0, 5453.0, 5592.0, 5634.0, 5669.0, 5570.0, 5353.0, 5554.0, 5679.0, 5658.0, 5607.0, 5411.0, 5654.0, 5262.0, 5567.0, 5420.0, 5588.0, 5495.0, 5328.0, 5296.0, 5540.0, 5306.0, 5379.0, 5625.0, 5286.0, 5302.0, 5496.0, 5559.0, 5480.0, 5442.0, 5259.0, 5456.0, 5455.0, 5641.0, 5505.0, 5432.0, 5267.0, 5468.0, 5596.0, 5636.0, 5651.0, 5646.0, 5622.0, 5605.0, 5305.0, 5395.0, 5440.0, 5578.0, 5700.0, 5436.0, 5609.0, 5251.0, 5289.0, 5321.0, 5562.0, 5486.0, 5483.0, 5340.0, 5680.0, 5475.0, 5537.0, 5452.0, 5522.0, 5631.0, 5268.0, 5695.0, 5618.0, 5386.0, 5419.0, 5501.0, 5577.0, 5417.0, 5503.0, 5374.0, 5568.0, 5610.0, 5303.0 (number of hits: 3)
10	5280	9	1	333	1	5289.0, 5368.0, 5265.0, 5718.0, 5477.0, 5481.0, 5430.0, 5513.0, 5689.0, 5377.0, 5392.0, 5483.0, 5460.0, 5320.0, 5297.0, 5332.0, 5357.0, 5683.0, 5256.0, 5393.0, 5418.0, 5300.0, 5275.0, 5661.0, 5403.0, 5446.0, 5644.0, 5425.0, 5714.0, 5257.0, 5272.0, 5585.0, 5672.0, 5525.0, 5399.0, 5631.0, 5327.0, 5582.0, 5573.0, 5615.0, 5402.0, 5649.0, 5421.0, 5501.0, 5364.0, 5404.0, 5669.0, 5373.0, 5638.0, 5679.0, 5648.0, 5609.0, 5276.0, 5458.0, 5556.0, 5577.0, 5537.0, 5346.0, 5375.0, 5654.0, 5381.0, 5671.0, 5371.0, 5535.0, 5479.0, 5288.0, 5397.0, 5663.0, 5491.0, 5427.0, 5471.0, 5639.0, 5329.0, 5554.0, 5572.0, 5569.0, 5350.0, 5659.0, 5475.0, 5717.0, 5457.0, 5283.0, 5422.0, 5587.0, 5650.0, 5542.0, 5523.0, 5629.0, 5622.0, 5646.0, 5409.0, 5708.0, 5361.0, 5444.0, 5454.0, 5625.0, 5372.0, 5677.0, 5337.0, 5570.0 (number of hits: 6)
11	5280	9	1	333	1	5673.0, 5363.0, 5555.0, 5436.0, 5268.0, 5631.0, 5267.0, 5639.0, 5266.0, 5257.0, 5475.0, 5714.0, 5613.0, 5416.0, 5604.0, 5496.0, 5509.0, 5412.0, 5717.0, 5552.0, 5403.0, 5522.0, 5663.0, 5269.0, 5311.0, 5514.0, 5681.0, 5638.0, 5336.0, 5410.0, 5387.0, 5581.0, 5470.0, 5680.0, 5447.0, 5586.0, 5289.0, 5385.0, 5627.0, 5585.0, 5288.0, 5372.0, 5464.0, 5655.0, 5296.0, 5337.0, 5339.0, 5557.0, 5628.0, 5633.0, 5279.0, 5667.0, 5654.0, 5532.0, 5572.0, 5607.0, 5466.0, 5432.0, 5399.0, 5362.0, 5414.0, 5434.0, 5316.0, 5701.0, 5529.0, 5458.0, 5259.0, 5277.0, 5677.0, 5721.0, 5291.0, 5449.0, 5494.0, 5498.0, 5507.0, 5601.0, 5430.0, 5314.0, 5580.0, 5562.0, 5312.0, 5600.0, 5411.0, 5465.0, 5365.0, 5565.0, 5548.0, 5284.0, 5274.0, 5499.0, 5278.0, 5584.0, 5618.0, 5272.0, 5352.0, 5451.0, 5282.0, 5536.0, 5533.0, 5437.0

						(number of hits: 9)
12	5280	9	1	333	1	5694.0, 5508.0, 5490.0, 5575.0, 5577.0, 5562.0, 5451.0, 5633.0, 5683.0, 5578.0, 5472.0, 5718.0, 5335.0, 5527.0, 5412.0, 5491.0, 5613.0, 5673.0, 5474.0, 5328.0, 5670.0, 5500.0, 5303.0, 5702.0, 5629.0, 5466.0, 5666.0, 5584.0, 5258.0, 5319.0, 5357.0, 5441.0, 5721.0, 5430.0, 5692.0, 5715.0, 5709.0, 5310.0, 5425.0, 5269.0, 5434.0, 5409.0, 5640.0, 5376.0, 5325.0, 5717.0, 5524.0, 5424.0, 5459.0, 5690.0, 5582.0, 5586.0, 5400.0, 5456.0, 5427.0, 5647.0, 5349.0, 5346.0, 5436.0, 5637.0, 5483.0, 5539.0, 5532.0, 5285.0, 5693.0, 5461.0, 5519.0, 5554.0, 5695.0, 5540.0, 5331.0, 5520.0, 5501.0, 5551.0, 5471.0, 5259.0, 5463.0, 5298.0, 5568.0, 5311.0, 5417.0, 5301.0, 5309.0, 5391.0, 5687.0, 5410.0, 5564.0, 5590.0, 5426.0, 5393.0, 5606.0, 5458.0, 5263.0, 5293.0, 5691.0, 5361.0, 5277.0, 5516.0, 5589.0, 5608.0
						(number of hits: 2)
13	5280	9	1	333	1	5482.0, 5280.0, 5488.0, 5655.0, 5357.0, 5609.0, 5380.0, 5525.0, 5689.0, 5483.0, 5345.0, 5611.0, 5592.0, 5520.0, 5565.0, 5355.0, 5330.0, 5701.0, 5660.0, 5413.0, 5553.0, 5629.0, 5485.0, 5554.0, 5622.0, 5574.0, 5317.0, 5255.0, 5372.0, 5663.0, 5514.0, 5395.0, 5290.0, 5351.0, 5495.0, 5708.0, 5657.0, 5536.0, 5631.0, 5291.0, 5604.0, 5289.0, 5502.0, 5580.0, 5696.0, 5464.0, 5396.0, 5607.0, 5711.0, 5270.0, 5571.0, 5677.0, 5448.0, 5378.0, 5687.0, 5426.0, 5524.0, 5420.0, 5645.0, 5676.0, 5713.0, 5588.0, 5385.0, 5570.0, 5440.0, 5652.0, 5674.0, 5654.0, 5326.0, 5535.0, 5569.0, 5494.0, 5692.0, 5703.0, 5299.0, 5305.0, 5484.0, 5584.0, 5653.0, 5582.0, 5374.0, 5430.0, 5546.0, 5408.0, 5296.0, 5427.0, 5391.0, 5470.0, 5722.0, 5459.0, 5293.0, 5278.0, 5285.0, 5618.0, 5719.0, 5612.0, 5519.0, 5412.0, 5496.0, 5411.0
						(number of hits: 5)
14	5280	9	1	333	1	5268.0, 5462.0, 5388.0, 5571.0, 5641.0, 5692.0, 5280.0, 5705.0, 5681.0, 5448.0, 5378.0, 5719.0, 5324.0, 5339.0, 5425.0, 5307.0, 5558.0, 5664.0, 5712.0, 5493.0, 5259.0, 5407.0, 5698.0, 5304.0, 5599.0, 5416.0, 5267.0, 5590.0, 5465.0, 5342.0, 5530.0, 5505.0, 5314.0, 5702.0, 5302.0, 5689.0, 5381.0, 5547.0, 5582.0, 5317.0, 5428.0, 5683.0, 5499.0, 5517.0, 5562.0, 5700.0, 5676.0, 5415.0, 5261.0, 5722.0, 5476.0, 5518.0, 5666.0, 5346.0, 5523.0, 5459.0, 5491.0, 5537.0, 5318.0, 5510.0, 5568.0, 5374.0, 5436.0, 5675.0, 5252.0, 5419.0, 5602.0, 5418.0, 5331.0, 5278.0, 5457.0, 5464.0, 5253.0, 5515.0, 5257.0, 5309.0, 5328.0, 5292.0, 5535.0, 5653.0,

						5633.0, 5413.0, 5351.0, 5352.0, 5579.0, 5710.0, 5552.0, 5636.0, 5691.0, 5372.0, 5453.0, 5338.0, 5376.0, 5706.0, 5400.0, 5369.0, 5723.0, 5409.0, 5427.0, 5574.0 (number of hits: 2)
15	5280	9	1	333	1	5386.0, 5652.0, 5476.0, 5708.0, 5466.0, 5473.0, 5374.0, 5385.0, 5328.0, 5518.0, 5409.0, 5283.0, 5593.0, 5659.0, 5470.0, 5465.0, 5541.0, 5332.0, 5717.0, 5634.0, 5492.0, 5257.0, 5306.0, 5715.0, 5618.0, 5325.0, 5534.0, 5572.0, 5258.0, 5699.0, 5340.0, 5535.0, 5703.0, 5709.0, 5448.0, 5398.0, 5376.0, 5538.0, 5561.0, 5439.0, 5406.0, 5295.0, 5255.0, 5502.0, 5449.0, 5345.0, 5309.0, 5303.0, 5569.0, 5596.0, 5356.0, 5354.0, 5292.0, 5349.0, 5639.0, 5305.0, 5698.0, 5480.0, 5653.0, 5677.0, 5334.0, 5392.0, 5404.0, 5441.0, 5604.0, 5399.0, 5537.0, 5282.0, 5595.0, 5630.0, 5507.0, 5592.0, 5490.0, 5649.0, 5588.0, 5284.0, 5544.0, 5528.0, 5358.0, 5468.0, 5322.0, 5658.0, 5559.0, 5584.0, 5644.0, 5384.0, 5553.0, 5627.0, 5519.0, 5469.0, 5445.0, 5685.0, 5643.0, 5300.0, 5408.0, 5501.0, 5462.0, 5252.0, 5610.0, 5368.0 (number of hits: 3)
16	5280	9	1	333	1	5553.0, 5413.0, 5355.0, 5704.0, 5393.0, 5364.0, 5510.0, 5433.0, 5681.0, 5640.0, 5719.0, 5526.0, 5292.0, 5703.0, 5419.0, 5614.0, 5266.0, 5341.0, 5599.0, 5535.0, 5689.0, 5549.0, 5399.0, 5572.0, 5285.0, 5655.0, 5352.0, 5672.0, 5334.0, 5263.0, 5368.0, 5699.0, 5439.0, 5711.0, 5390.0, 5369.0, 5574.0, 5360.0, 5320.0, 5724.0, 5610.0, 5347.0, 5446.0, 5321.0, 5645.0, 5626.0, 5519.0, 5340.0, 5492.0, 5377.0, 5643.0, 5485.0, 5590.0, 5641.0, 5664.0, 5659.0, 5363.0, 5376.0, 5315.0, 5516.0, 5472.0, 5462.0, 5403.0, 5427.0, 5504.0, 5354.0, 5282.0, 5339.0, 5589.0, 5286.0, 5512.0, 5607.0, 5593.0, 5264.0, 5693.0, 5303.0, 5308.0, 5543.0, 5696.0, 5520.0, 5586.0, 5442.0, 5295.0, 5650.0, 5374.0, 5253.0, 5482.0, 5702.0, 5314.0, 5503.0, 5371.0, 5345.0, 5310.0, 5560.0, 5386.0, 5665.0, 5632.0, 5576.0, 5691.0, 5406.0 (number of hits: 3)
17	5280	9	1	333	1	5260.0, 5333.0, 5269.0, 5600.0, 5709.0, 5398.0, 5357.0, 5622.0, 5557.0, 5424.0, 5472.0, 5264.0, 5335.0, 5353.0, 5266.0, 5302.0, 5653.0, 5331.0, 5649.0, 5690.0, 5583.0, 5722.0, 5349.0, 5259.0, 5626.0, 5682.0, 5675.0, 5273.0, 5356.0, 5444.0, 5391.0, 5629.0, 5347.0, 5405.0, 5407.0, 5482.0, 5627.0, 5458.0, 5528.0, 5592.0, 5559.0, 5296.0, 5400.0, 5720.0, 5340.0, 5312.0, 5465.0, 5346.0, 5278.0, 5525.0, 5563.0, 5462.0, 5710.0, 5674.0, 5587.0, 5280.0, 5419.0, 5378.0, 5430.0, 5267.0,

						5386.0, 5669.0, 5439.0, 5252.0, 5538.0, 5416.0, 5496.0, 5478.0, 5270.0, 5401.0, 5683.0, 5612.0, 5436.0, 5442.0, 5345.0, 5531.0, 5705.0, 5620.0, 5679.0, 5678.0, 5342.0, 5606.0, 5449.0, 5373.0, 5614.0, 5666.0, 5508.0, 5415.0, 5586.0, 5537.0, 5589.0, 5704.0, 5292.0, 5523.0, 5677.0, 5708.0, 5580.0, 5680.0, 5691.0, 5566.0 (number of hits: 4)
18	5280	9	1	333	1	5400.0, 5431.0, 5437.0, 5315.0, 5685.0, 5267.0, 5613.0, 5564.0, 5552.0, 5546.0, 5403.0, 5587.0, 5291.0, 5502.0, 5328.0, 5607.0, 5675.0, 5276.0, 5457.0, 5395.0, 5418.0, 5618.0, 5360.0, 5279.0, 5307.0, 5419.0, 5298.0, 5673.0, 5581.0, 5345.0, 5684.0, 5453.0, 5399.0, 5378.0, 5622.0, 5483.0, 5668.0, 5636.0, 5416.0, 5263.0, 5290.0, 5588.0, 5579.0, 5463.0, 5541.0, 5310.0, 5397.0, 5401.0, 5601.0, 5527.0, 5364.0, 5604.0, 5344.0, 5487.0, 5402.0, 5408.0, 5642.0, 5356.0, 5417.0, 5393.0, 5573.0, 5391.0, 5271.0, 5521.0, 5724.0, 5700.0, 5583.0, 5351.0, 5699.0, 5495.0, 5375.0, 5407.0, 5679.0, 5582.0, 5471.0, 5492.0, 5479.0, 5522.0, 5288.0, 5341.0, 5696.0, 5615.0, 5646.0, 5327.0, 5475.0, 5710.0, 5434.0, 5343.0, 5421.0, 5485.0, 5602.0, 5508.0, 5302.0, 5513.0, 5695.0, 5703.0, 5498.0, 5574.0, 5713.0, 5592.0 (number of hits: 4)
19	5280	9	1	333	1	5642.0, 5611.0, 5310.0, 5578.0, 5635.0, 5410.0, 5710.0, 5581.0, 5676.0, 5304.0, 5306.0, 5349.0, 5644.0, 5708.0, 5661.0, 5509.0, 5424.0, 5323.0, 5543.0, 5531.0, 5432.0, 5539.0, 5493.0, 5698.0, 5656.0, 5308.0, 5569.0, 5566.0, 5693.0, 5503.0, 5416.0, 5540.0, 5386.0, 5483.0, 5305.0, 5474.0, 5541.0, 5348.0, 5443.0, 5307.0, 5447.0, 5363.0, 5672.0, 5262.0, 5717.0, 5337.0, 5314.0, 5670.0, 5449.0, 5354.0, 5572.0, 5458.0, 5471.0, 5368.0, 5550.0, 5325.0, 5461.0, 5508.0, 5409.0, 5466.0, 5560.0, 5568.0, 5289.0, 5680.0, 5260.0, 5329.0, 5439.0, 5718.0, 5623.0, 5630.0, 5528.0, 5532.0, 5520.0, 5380.0, 5519.0, 5369.0, 5300.0, 5648.0, 5619.0, 5721.0, 5301.0, 5647.0, 5428.0, 5285.0, 5622.0, 5319.0, 5313.0, 5279.0, 5371.0, 5486.0, 5537.0, 5291.0, 5400.0, 5479.0, 5632.0, 5476.0, 5501.0, 5507.0, 5592.0, 5478.0 (number of hits: 3)
20	5280	9	1	333	1	5530.0, 5438.0, 5702.0, 5455.0, 5454.0, 5596.0, 5307.0, 5456.0, 5600.0, 5599.0, 5620.0, 5338.0, 5693.0, 5422.0, 5434.0, 5683.0, 5318.0, 5547.0, 5328.0, 5278.0, 5351.0, 5660.0, 5495.0, 5545.0, 5492.0, 5395.0, 5641.0, 5634.0, 5459.0, 5578.0, 5652.0, 5450.0, 5513.0, 5357.0, 5533.0, 5532.0, 5592.0, 5296.0, 5631.0, 5302.0,

						5466.0, 5493.0, 5475.0, 5698.0, 5529.0, 5463.0, 5722.0, 5391.0, 5550.0, 5468.0, 5669.0, 5717.0, 5668.0, 5436.0, 5340.0, 5622.0, 5474.0, 5462.0, 5644.0, 5367.0, 5526.0, 5586.0, 5409.0, 5287.0, 5369.0, 5482.0, 5366.0, 5564.0, 5623.0, 5626.0, 5461.0, 5595.0, 5437.0, 5603.0, 5383.0, 5266.0, 5588.0, 5258.0, 5527.0, 5449.0, 5697.0, 5261.0, 5447.0, 5543.0, 5453.0, 5552.0, 5597.0, 5294.0, 5442.0, 5610.0, 5525.0, 5489.0, 5344.0, 5710.0, 5458.0, 5283.0, 5572.0, 5277.0, 5444.0, 5311.0 (number of hits: 4)
21	5280	9	1	333	1	5307.0, 5557.0, 5415.0, 5619.0, 5655.0, 5586.0, 5339.0, 5266.0, 5276.0, 5589.0, 5697.0, 5704.0, 5599.0, 5433.0, 5275.0, 5337.0, 5602.0, 5325.0, 5462.0, 5693.0, 5678.0, 5660.0, 5529.0, 5580.0, 5637.0, 5471.0, 5559.0, 5720.0, 5494.0, 5723.0, 5340.0, 5491.0, 5592.0, 5280.0, 5512.0, 5394.0, 5521.0, 5584.0, 5291.0, 5386.0, 5493.0, 5715.0, 5329.0, 5448.0, 5404.0, 5401.0, 5708.0, 5409.0, 5670.0, 5309.0, 5298.0, 5501.0, 5518.0, 5451.0, 5496.0, 5332.0, 5350.0, 5510.0, 5534.0, 5539.0, 5474.0, 5403.0, 5317.0, 5412.0, 5279.0, 5363.0, 5392.0, 5460.0, 5564.0, 5405.0, 5430.0, 5370.0, 5645.0, 5271.0, 5625.0, 5476.0, 5587.0, 5341.0, 5391.0, 5596.0, 5365.0, 5295.0, 5385.0, 5558.0, 5322.0, 5319.0, 5506.0, 5698.0, 5575.0, 5463.0, 5606.0, 5642.0, 5345.0, 5540.0, 5372.0, 5359.0, 5435.0, 5445.0, 5374.0, 5458.0 (number of hits: 5)
22	5280	9	1	333	1	5540.0, 5580.0, 5490.0, 5367.0, 5541.0, 5319.0, 5705.0, 5529.0, 5394.0, 5531.0, 5348.0, 5279.0, 5271.0, 5457.0, 5607.0, 5352.0, 5518.0, 5567.0, 5538.0, 5359.0, 5375.0, 5554.0, 5447.0, 5583.0, 5289.0, 5522.0, 5494.0, 5338.0, 5381.0, 5376.0, 5273.0, 5373.0, 5703.0, 5663.0, 5594.0, 5485.0, 5491.0, 5374.0, 5574.0, 5605.0, 5630.0, 5719.0, 5292.0, 5694.0, 5436.0, 5262.0, 5355.0, 5456.0, 5408.0, 5452.0, 5573.0, 5385.0, 5582.0, 5460.0, 5318.0, 5481.0, 5632.0, 5475.0, 5657.0, 5428.0, 5488.0, 5419.0, 5552.0, 5326.0, 5571.0, 5370.0, 5495.0, 5379.0, 5349.0, 5634.0, 5397.0, 5542.0, 5256.0, 5648.0, 5589.0, 5502.0, 5399.0, 5484.0, 5514.0, 5345.0, 5300.0, 5608.0, 5575.0, 5276.0, 5371.0, 5468.0, 5311.0, 5340.0, 5511.0, 5287.0, 5710.0, 5661.0, 5517.0, 5592.0, 5524.0, 5356.0, 5284.0, 5620.0, 5533.0, 5335.0 (number of hits: 7)
23	5280	9	1	333	1	5473.0, 5576.0, 5458.0, 5578.0, 5257.0, 5358.0, 5685.0, 5454.0, 5686.0, 5396.0, 5355.0, 5356.0, 5630.0, 5673.0, 5403.0, 5466.0, 5669.0, 5650.0, 5441.0, 5712.0,

						5551.0, 5328.0, 5540.0, 5254.0, 5698.0, 5719.0, 5277.0, 5664.0, 5464.0, 5315.0, 5279.0, 5342.0, 5582.0, 5428.0, 5416.0, 5369.0, 5490.0, 5504.0, 5448.0, 5296.0, 5429.0, 5325.0, 5537.0, 5522.0, 5704.0, 5417.0, 5353.0, 5453.0, 5447.0, 5337.0, 5658.0, 5676.0, 5425.0, 5640.0, 5667.0, 5616.0, 5552.0, 5322.0, 5258.0, 5528.0, 5364.0, 5500.0, 5567.0, 5596.0, 5635.0, 5360.0, 5479.0, 5557.0, 5487.0, 5708.0, 5412.0, 5484.0, 5603.0, 5709.0, 5323.0, 5382.0, 5663.0, 5284.0, 5285.0, 5301.0, 5573.0, 5351.0, 5642.0, 5690.0, 5406.0, 5598.0, 5268.0, 5362.0, 5434.0, 5538.0, 5493.0, 5563.0, 5431.0, 5438.0, 5386.0, 5518.0, 5496.0, 5407.0, 5682.0, 5717.0 (number of hits: 4)
24	5280	9	1	333	1	5513.0, 5314.0, 5445.0, 5419.0, 5432.0, 5705.0, 5491.0, 5287.0, 5693.0, 5422.0, 5494.0, 5684.0, 5634.0, 5501.0, 5400.0, 5703.0, 5516.0, 5541.0, 5417.0, 5519.0, 5694.0, 5391.0, 5713.0, 5644.0, 5312.0, 5584.0, 5717.0, 5441.0, 5341.0, 5380.0, 5481.0, 5591.0, 5463.0, 5401.0, 5251.0, 5656.0, 5297.0, 5330.0, 5690.0, 5437.0, 5474.0, 5464.0, 5421.0, 5264.0, 5490.0, 5585.0, 5292.0, 5426.0, 5493.0, 5689.0, 5409.0, 5476.0, 5257.0, 5603.0, 5276.0, 5324.0, 5479.0, 5452.0, 5254.0, 5652.0, 5687.0, 5307.0, 5699.0, 5544.0, 5581.0, 5478.0, 5635.0, 5486.0, 5647.0, 5475.0, 5310.0, 5524.0, 5326.0, 5306.0, 5563.0, 5592.0, 5654.0, 5596.0, 5625.0, 5538.0, 5318.0, 5706.0, 5620.0, 5456.0, 5709.0, 5663.0, 5497.0, 5404.0, 5438.0, 5551.0, 5593.0, 5529.0, 5285.0, 5685.0, 5616.0, 5453.0, 5259.0, 5526.0, 5353.0, 5357.0 (number of hits: 3)
25	5280	9	1	333	1	5708.0, 5629.0, 5437.0, 5663.0, 5667.0, 5425.0, 5641.0, 5403.0, 5478.0, 5558.0, 5257.0, 5607.0, 5347.0, 5392.0, 5305.0, 5264.0, 5591.0, 5674.0, 5361.0, 5573.0, 5349.0, 5618.0, 5564.0, 5261.0, 5288.0, 5444.0, 5721.0, 5590.0, 5356.0, 5651.0, 5589.0, 5408.0, 5649.0, 5283.0, 5346.0, 5410.0, 5556.0, 5276.0, 5449.0, 5390.0, 5465.0, 5678.0, 5664.0, 5579.0, 5562.0, 5387.0, 5595.0, 5421.0, 5319.0, 5586.0, 5256.0, 5464.0, 5453.0, 5694.0, 5454.0, 5599.0, 5517.0, 5550.0, 5588.0, 5363.0, 5462.0, 5341.0, 5300.0, 5603.0, 5476.0, 5297.0, 5555.0, 5376.0, 5679.0, 5520.0, 5280.0, 5324.0, 5434.0, 5302.0, 5291.0, 5513.0, 5447.0, 5375.0, 5675.0, 5699.0, 5485.0, 5696.0, 5294.0, 5620.0, 5503.0, 5306.0, 5473.0, 5531.0, 5647.0, 5482.0, 5571.0, 5560.0, 5377.0, 5568.0, 5637.0, 5705.0, 5493.0, 5686.0, 5497.0, 5489.0 (number of hits: 4)

26	5280	9	1	333	1	<p>5290.0, 5567.0, 5611.0, 5672.0, 5448.0, 5310.0, 5308.0, 5572.0, 5577.0, 5360.0, 5678.0, 5333.0, 5286.0, 5556.0, 5279.0, 5291.0, 5257.0, 5252.0, 5503.0, 5457.0, 5667.0, 5581.0, 5295.0, 5465.0, 5655.0, 5442.0, 5359.0, 5589.0, 5374.0, 5551.0, 5387.0, 5677.0, 5423.0, 5537.0, 5541.0, 5397.0, 5368.0, 5658.0, 5679.0, 5375.0, 5362.0, 5272.0, 5386.0, 5364.0, 5383.0, 5312.0, 5595.0, 5644.0, 5455.0, 5300.0, 5542.0, 5379.0, 5366.0, 5297.0, 5490.0, 5674.0, 5626.0, 5508.0, 5522.0, 5696.0, 5628.0, 5485.0, 5261.0, 5562.0, 5306.0, 5700.0, 5715.0, 5477.0, 5720.0, 5640.0, 5703.0, 5472.0, 5559.0, 5466.0, 5342.0, 5709.0, 5510.0, 5694.0, 5439.0, 5685.0, 5546.0, 5417.0, 5592.0, 5393.0, 5280.0, 5619.0, 5707.0, 5440.0, 5513.0, 5414.0, 5506.0, 5363.0, 5536.0, 5435.0, 5301.0, 5449.0, 5647.0, 5618.0, 5600.0, 5643.0 (number of hits: 4)</p>
27	5280	9	1	333	1	<p>5486.0, 5490.0, 5443.0, 5537.0, 5351.0, 5588.0, 5359.0, 5524.0, 5476.0, 5387.0, 5334.0, 5630.0, 5721.0, 5436.0, 5500.0, 5410.0, 5541.0, 5479.0, 5637.0, 5667.0, 5678.0, 5547.0, 5574.0, 5290.0, 5471.0, 5459.0, 5489.0, 5702.0, 5253.0, 5676.0, 5338.0, 5516.0, 5699.0, 5579.0, 5390.0, 5662.0, 5617.0, 5549.0, 5425.0, 5679.0, 5350.0, 5306.0, 5273.0, 5291.0, 5482.0, 5534.0, 5281.0, 5316.0, 5448.0, 5509.0, 5381.0, 5557.0, 5520.0, 5470.0, 5274.0, 5283.0, 5508.0, 5424.0, 5419.0, 5488.0, 5624.0, 5545.0, 5457.0, 5548.0, 5264.0, 5717.0, 5611.0, 5619.0, 5543.0, 5451.0, 5660.0, 5555.0, 5708.0, 5303.0, 5452.0, 5257.0, 5584.0, 5352.0, 5444.0, 5466.0, 5704.0, 5333.0, 5330.0, 5398.0, 5686.0, 5369.0, 5712.0, 5539.0, 5565.0, 5307.0, 5320.0, 5683.0, 5615.0, 5533.0, 5536.0, 5373.0, 5293.0, 5655.0, 5684.0, 5672.0 (number of hits: 4)</p>
28	5280	9	1	333	1	<p>5312.0, 5422.0, 5377.0, 5279.0, 5292.0, 5327.0, 5507.0, 5375.0, 5656.0, 5434.0, 5536.0, 5634.0, 5527.0, 5606.0, 5362.0, 5424.0, 5461.0, 5325.0, 5398.0, 5714.0, 5543.0, 5290.0, 5373.0, 5288.0, 5699.0, 5615.0, 5693.0, 5542.0, 5621.0, 5546.0, 5484.0, 5702.0, 5567.0, 5291.0, 5705.0, 5525.0, 5468.0, 5584.0, 5454.0, 5478.0, 5603.0, 5360.0, 5432.0, 5642.0, 5580.0, 5413.0, 5382.0, 5637.0, 5260.0, 5610.0, 5531.0, 5491.0, 5506.0, 5423.0, 5427.0, 5385.0, 5599.0, 5641.0, 5485.0, 5608.0, 5573.0, 5409.0, 5388.0, 5628.0, 5696.0, 5655.0, 5571.0, 5270.0, 5394.0, 5367.0, 5370.0, 5282.0, 5583.0, 5661.0, 5523.0, 5718.0, 5453.0, 5328.0, 5254.0, 5597.0, 5361.0, 5508.0, 5660.0, 5337.0, 5499.0</p>

						5495.0, 5450.0, 5280.0, 5659.0, 5403.0, 5316.0, 5604.0, 5498.0, 5555.0, 5444.0, 5673.0, 5301.0, 5294.0, 5389.0, 5465.0 (number of hits: 5)
29	5280	9	1	333	1	5372.0, 5410.0, 5678.0, 5440.0, 5355.0, 5469.0, 5528.0, 5275.0, 5441.0, 5667.0, 5631.0, 5682.0, 5347.0, 5604.0, 5684.0, 5645.0, 5334.0, 5681.0, 5317.0, 5514.0, 5647.0, 5446.0, 5665.0, 5637.0, 5489.0, 5521.0, 5692.0, 5455.0, 5526.0, 5625.0, 5509.0, 5381.0, 5720.0, 5616.0, 5533.0, 5579.0, 5370.0, 5634.0, 5559.0, 5651.0, 5646.0, 5575.0, 5623.0, 5555.0, 5358.0, 5328.0, 5415.0, 5361.0, 5336.0, 5602.0, 5617.0, 5329.0, 5280.0, 5676.0, 5622.0, 5479.0, 5271.0, 5662.0, 5359.0, 5516.0, 5373.0, 5660.0, 5363.0, 5615.0, 5303.0, 5545.0, 5672.0, 5588.0, 5488.0, 5315.0, 5352.0, 5583.0, 5350.0, 5577.0, 5502.0, 5321.0, 5536.0, 5710.0, 5531.0, 5655.0, 5520.0, 5724.0, 5302.0, 5633.0, 5396.0, 5580.0, 5560.0, 5260.0, 5309.0, 5450.0, 5685.0, 5473.0, 5299.0, 5548.0, 5688.0, 5649.0, 5453.0, 5293.0, 5572.0, 5694.0 (number of hits: 3)
30	5280	9	1	333	1	5418.0, 5574.0, 5686.0, 5558.0, 5707.0, 5458.0, 5412.0, 5482.0, 5662.0, 5298.0, 5656.0, 5442.0, 5660.0, 5338.0, 5263.0, 5552.0, 5367.0, 5581.0, 5651.0, 5289.0, 5714.0, 5400.0, 5692.0, 5456.0, 5405.0, 5272.0, 5448.0, 5555.0, 5640.0, 5371.0, 5469.0, 5404.0, 5288.0, 5691.0, 5416.0, 5658.0, 5327.0, 5347.0, 5431.0, 5314.0, 5548.0, 5646.0, 5395.0, 5398.0, 5716.0, 5563.0, 5422.0, 5410.0, 5311.0, 5252.0, 5267.0, 5687.0, 5383.0, 5336.0, 5578.0, 5615.0, 5484.0, 5661.0, 5633.0, 5526.0, 5522.0, 5362.0, 5414.0, 5690.0, 5364.0, 5616.0, 5540.0, 5587.0, 5318.0, 5677.0, 5485.0, 5312.0, 5659.0, 5702.0, 5516.0, 5396.0, 5287.0, 5282.0, 5366.0, 5670.0, 5622.0, 5262.0, 5457.0, 5251.0, 5593.0, 5294.0, 5475.0, 5254.0, 5679.0, 5613.0, 5508.0, 5380.0, 5377.0, 5435.0, 5269.0, 5449.0, 5472.0, 5607.0, 5545.0, 5683.0 (number of hits: 5)

5270 MHz, 40 MHz Bandwidth

Radar Signal Type	Waveform/Trial Number	Detection (%)	Limit (%)	Pass/Fail
Type 1A/1B	30	100 %	60%	Pass
Type 2	30	100 %	60%	Pass
Type 3	30	100 %	60%	Pass
Type 4	30	100 %	60%	Pass
Aggregate (Type1 to 4)	120	100 %	80%	Pass
Type 5	30	96.7 %	80%	Pass
Type 6	30	100 %	70%	Pass

Please refer to the following statistical tables:

5270 MHz, 40 MHz Bandwidth

Table-1A/1B Radar Type 1A/1B Statistical Performance

Trial #	Fc (MHz)	Pulse/Burst	Pulse Width (μS)	PRI (μs)	Detection (1:yes; 0:no)
1	5270	83	1	638	1
2	5270	72	1	738	1
3	5270	61	1	878	1
4	5270	74	1	718	1
5	5270	95	1	558	1
6	5270	86	1	618	1
7	5270	67	1	798	1
8	5270	68	1	778	1
9	5270	76	1	698	1
10	5270	89	1	598	1
11	5270	92	1	578	1
12	5270	63	1	838	1
13	5270	70	1	758	1
14	5270	58	1	918	1
15	5270	57	1	938	1
16	5270	35	1	1526	1
17	5270	36	1	1486	1
18	5270	57	1	931	1
19	5270	78	1	679	1
20	5270	22	1	2419	1
21	5270	19	1	2855	1
22	5270	19	1	2797	1
23	5270	64	1	826	1
24	5270	32	1	1670	1
25	5270	66	1	805	1
26	5270	47	1	1134	1
27	5270	41	1	1289	1
28	5270	76	1	701	1
29	5270	28	1	1936	1
30	5270	43	1	1237	1
Detection Percentage: 100 % (>60%)					

Table-2 Radar Type 2 Statistical Performance

Trial #	Fc (MHz)	Pulse/Burst	Pulse Width (µS)	PRI (µs)	Detection (1:yes; 0:no)
1	5270	24	1.6	229	1
2	5270	27	3.1	200	1
3	5270	29	1.2	158	1
4	5270	26	4.8	205	1
5	5270	25	1.8	213	1
6	5270	28	1.7	211	1
7	5270	28	3.1	178	1
8	5270	23	3.1	204	1
9	5270	28	3.5	216	1
10	5270	27	1.3	215	1
11	5270	27	3.6	220	1
12	5270	28	3.1	157	1
13	5270	29	3.7	194	1
14	5270	28	2.6	207	1
15	5270	24	3.3	168	1
16	5270	28	2.8	197	1
17	5270	28	4.5	186	1
18	5270	26	3	152	1
19	5270	28	3.6	229	1
20	5270	26	2.5	177	1
21	5270	26	2.6	156	1
22	5270	26	4.5	197	1
23	5270	29	1.1	186	1
24	5270	24	1.6	161	1
25	5270	24	1.6	199	1
26	5270	24	3.7	174	1
27	5270	28	2.4	213	1
28	5270	29	4.6	192	1
29	5270	29	1.5	216	1
30	5270	23	2.2	228	1
Detection Percentage: 100 % (>60%)					

Table-3 Radar Type 3 Statistical Performance

Trial #	Fc (MHz)	Pulse/Burst	Pulse Width (μS)	PRI (μs)	Detection (1:yes; 0:no)
1	5270	17	10	380	1
2	5270	18	7.8	264	1
3	5270	16	6.2	443	1
4	5270	18	7.5	212	1
5	5270	18	6.5	252	1
6	5270	18	8.5	255	1
7	5270	16	6.3	404	1
8	5270	17	8.9	430	1
9	5270	17	8.6	230	1
10	5270	16	8.9	207	1
11	5270	18	7	412	1
12	5270	17	8.4	222	1
13	5270	17	8.8	478	1
14	5270	17	7.1	221	1
15	5270	17	8.8	218	1
16	5270	18	9.9	275	1
17	5270	16	8.1	368	1
18	5270	16	9.4	485	1
19	5270	17	7.9	370	1
20	5270	18	9.1	220	1
21	5270	17	7.7	500	1
22	5270	17	8.6	243	1
23	5270	18	6	294	1
24	5270	18	7.8	341	1
25	5270	16	8.2	442	1
26	5270	17	9.1	498	1
27	5270	17	8.1	437	1
28	5270	18	6.6	281	1
29	5270	16	7.1	445	1
30	5270	18	8.2	279	1
Detection Percentage: 100 % (>60%)					

Table-4 Radar Type 4 Statistical Performance

Trial #	Fc (MHz)	Pulse/Burst	Pulse Width (μS)	PRI (μs)	Detection (1:yes; 0:no)
1	5270	12	16.4	248	1
2	5270	15	18.1	222	1
3	5270	12	19.4	269	1
4	5270	15	19.1	303	1
5	5270	13	17.9	265	1
6	5270	16	18.3	473	1
7	5270	13	19.2	289	1
8	5270	16	11.7	213	1
9	5270	12	17.4	224	1
10	5270	15	19.4	412	1
11	5270	12	11	262	1
12	5270	12	14.2	480	1
13	5270	16	16.6	404	1
14	5270	13	17.6	481	1
15	5270	14	14.3	390	1
16	5270	14	15.4	462	1
17	5270	12	15.5	221	1
18	5270	12	20	497	1
19	5270	15	11.3	485	1
20	5270	12	19.1	282	1
21	5270	16	17.4	319	1
22	5270	13	15.2	359	1
23	5270	12	13.2	495	1
24	5270	13	15.6	294	1
25	5270	12	16.1	487	1
26	5270	14	18.4	483	1
27	5270	16	13	360	1
28	5270	16	18.6	478	1
29	5270	15	18.6	468	1
30	5270	15	14.1	377	1
Detection Percentage: 100 % (>60%)					

Table-5 Radar Type 5 Statistical Performance

Trial #	Fc (MHz)	Detection (1:yes; 0:no)
1	5270	1
2	5270	1
3	5270	1
4	5270	1
5	5270	1
6	5270	1
7	5270	1
8	5270	0
9	5270	1
10	5270	1
11	5255.8	1
12	5253.8	1
13	5255.4	1
14	5253.8	1
15	5257	1
16	5253	1
17	5255.8	1
18	5259	1
19	5253.4	1
20	5255	1
21	5282.6	1
22	5284.6	1
23	5284.2	1
24	5281.8	1
25	5284.6	1
26	5281	1
27	5282.6	1
28	5283.4	1
29	5285.8	1
30	5282.2	1
Detection Percentage: 96.7 % (>80%)		

Bin5 Statistics 1

Trial #	Pulse	Chirp (MHz)	Pulse Width (μS)	Pulse 1-2 spacing (uS)	Pulse 2-3 spacing (uS)	Pulse Start(S)	Detection (1:yes; 0:no)
0	2	18	73.6	1549		0.203828	1
1	3	18	87.6	1126	1067	1.220171	
2	3	18	83.9	1876	1872	1.479976	
3	2	18	99.9	1861		2.363394	
4	2	18	74.8	1347		3.346752	
5	2	18	72.2	1811		4.228195	
6	2	18	56.8	1848		4.62896	
7	2	18	52	1016		5.233825	
8	2	18	73.1	1550		5.663608	
9	2	18	69.5	1778		6.626237	
10	1	18	59.8			7.322427	
11	3	18	65.4	1055	1470	7.973767	
12	1	18	57.3			8.92383	
13	2	18	63.3	1415		9.617247	
14	2	18	78.5	1065		10.338332	
15	1	18	63.2			10.708147	
16	2	18	68.7	1864		11.951783	

Bin5 Statistics 2

Trial #	Pulse	Chirp (MHz)	Pulse Width (µS)	Pulse 1-2 spacing (uS)	Pulse 2-3 spacing (uS)	Pulse Start(S)	Detection (1:yes; 0:no)
0	3	12	51.8	1003	1432	0.049284	1
1	3	12	92.6	1347	1462	0.726798	
2	2	12	52.8	1515		1.859266	
3	2	12	83.6	1363		2.168739	
4	1	12	56.8			3.233578	
5	2	12	82.5	1055		3.893193	
6	1	12	53.6			4.815172	
7	2	12	94.7	1429		5.005382	
8	3	12	53.5	1634	1226	6.159531	
9	3	12	93.4	1019	1017	6.956	
10	1	12	99.5			7.651468	
11	2	12	67.2	1605		8.358092	
12	1	12	88.7			8.603844	
13	2	12	63.9	1018		9.614628	
14	3	12	98.1	1434	1811	10.101863	
15	1	12	82.6			11.038892	
16	1	12	72.3			11.777864	

Bin5 Statistics 3

Trial #	Pulse	Chirp (MHz)	Pulse Width (µS)	Pulse 1-2 spacing (uS)	Pulse 2-3 spacing (uS)	Pulse Start(S)	Detection (1:yes; 0:no)
0	1	8	57.8			0.535465	1
1	2	8	89.8	1261		1.15044	
2	3	8	90.7	1022	1012	2.134972	
3	2	8	69.6	1522		2.756796	
4	2	8	96	1431		3.496027	
5	3	8	67.9	1008	1564	4.50097	
6	2	8	81.8	1746		5.045066	
7	2	8	70.8	1725		6.385528	
8	2	8	88.9	1471		6.943054	
9	2	8	60.4	1010		7.956112	
10	2	8	92.2	1326		8.201637	
11	1	8	89.3			9.185411	
12	3	8	50.7	1839	1809	10.297703	
13	2	8	60.1	1850		10.995028	
14	3	8	88.3	1728	1147	11.520238	

Bin5 Statistics 4

Trial #	Pulse	Chirp (MHz)	Pulse Width (μS)	Pulse 1-2 spacing (uS)	Pulse 2-3 spacing (uS)	Pulse Start(S)	Detection (1:yes; 0:no)
0	2	6	61.4	1182		0.45376	1
1	2	6	75	1044		0.704167	
2	1	6	59.9			1.856275	
3	2	6	86.3	1306		2.648207	
4	2	6	79.4	1367		2.670336	
5	3	6	92.8	1078	1680	3.379927	
6	3	6	62.6	1173	1284	4.316862	
7	3	6	66.8	1186	1035	5.175936	
8	3	6	63	1499	1969	5.387672	
9	1	6	92.7			6.024901	
10	2	6	67.9	1518		6.937087	
11	2	6	60.2	1760		7.410968	
12	2	6	63.4	1308		8.4733	
13	3	6	88.6	1617	1799	9.094566	
14	3	6	93.7	1191	1971	9.625559	
15	2	6	80.8	1335		10.006473	
16	1	6	51.4			10.91164	
17	1	6	50.6			11.768708	

Bin5 Statistics 5

Trial #	Pulse	Chirp (MHz)	Pulse Width (µS)	Pulse 1-2 spacing (uS)	Pulse 2-3 spacing (uS)	Pulse Start(S)	Detection (1:yes; 0:no)
0	2	12	97.3	1210		0.564828	1
1	3	12	80.4	1096	1399	1.50568	
2	1	12	73			1.884117	
3	2	12	95.2	1999		3.316999	
4	2	12	93.1	1861		3.928615	
5	1	12	51.6			4.91947	
6	1	12	56.5			6.246189	
7	3	12	78.6	1148	1774	6.848196	
8	3	12	99.9	1241	1481	8.197838	
9	2	12	60	1863		8.346273	
10	2	12	60.9	1861		9.573305	
11	2	12	91.7	1289		10.315202	
12	2	12	62.9	1928		11.431637	

Bin5 Statistics 6

Trial #	Pulse	Chirp (MHz)	Pulse Width (µS)	Pulse 1-2 spacing (uS)	Pulse 2-3 spacing (uS)	Pulse Start(S)	Detection (1:yes; 0:no)
0	3	15	71.4	1783	1186	0.35209	1
1	2	15	94	1853		1.750315	
2	1	15	51.3			2.138155	
3	3	15	59.7	1362	1336	3.322669	
4	1	15	69.9			4.66583	
5	2	15	63.5	1206		5.486731	
6	2	15	97.4	1040		6.099083	
7	2	15	57.9	1719		7.330832	
8	1	15	57.4			8.283982	
9	3	15	85.6	1094	1235	9.75417	
10	3	15	72.2	1652	1556	10.828687	
11	2	15	98.2	1570		11.282725	

Bin5 Statistics 7

Trial #	Pulse	Chirp (MHz)	Pulse Width (µS)	Pulse 1-2 spacing (µS)	Pulse 2-3 spacing (µS)	Pulse Start(S)	Detection (1:yes; 0:no)
0	3	12	96.1	1299	1265	0.129717	1
1	3	12	54.9	1028	1731	1.524252	
2	2	12	67.7	1948		2.209185	
3	2	12	84	1584		2.763151	
4	3	12	73.7	1825	1584	3.272731	
5	2	12	69.1	1516		4.705892	
6	3	12	73.3	1282	1221	5.253122	
7	2	12	54.5	1518		5.731467	
8	3	12	71	1270	1407	6.846425	
9	3	12	93.1	1131	1039	7.511093	
10	1	12	69			8.059741	
11	2	12	98.2	1201		9.173779	
12	3	12	54.8	1297	1812	9.741627	
13	2	12	72.6	1399		11.087343	
14	3	12	68.1	1214	1091	11.594366	

Bin5 Statistics 8

Trial #	Pulse	Chirp (MHz)	Pulse Width (µS)	Pulse 1-2 spacing (µS)	Pulse 2-3 spacing (µS)	Pulse Start(S)	Detection (1:yes; 0:no)
0	2	8	76.6	1588		0.208116	0
1	2	8	91.7	1405		0.712819	
2	1	8	78.3			1.719072	
3	1	8	58.5			1.96249	
4	1	8	97			2.987001	
5	2	8	66.8	1572		3.199603	
6	2	8	50	1848		4.219188	
7	1	8	67.9			4.626877	
8	2	8	88.5	1986		5.365802	
9	1	8	75.8			6.140706	
10	1	8	74.6			6.789884	
11	2	8	73.9	1375		7.309401	
12	2	8	92.4	1272		7.80664	
13	2	8	97.6	1348		8.245141	
14	3	8	89.2	1488	1762	9.180399	
15	3	8	59.9	1914	1034	9.905377	
16	3	8	90.7	1627	1284	10.264632	
17	2	8	64.5	1002		11.106732	
18	2	8	99.5	1413		11.438769	

Bin5 Statistics 9

Trial #	Pulse	Chirp (MHz)	Pulse Width (µS)	Pulse 1-2 spacing (µS)	Pulse 2-3 spacing (µS)	Pulse Start(S)	Detection (1:yes; 0:no)
0	1	7	60.9			0.4121	1
1	2	7	65.3	1478		1.798645	
2	1	7	70.3			2.08431	
3	2	7	60.9	1994		3.140909	
4	1	7	82.1			3.974677	
5	2	7	57.5	1124		5.053309	
6	3	7	91	1283	1596	6.199419	
7	2	7	66.9	1585		6.475905	
8	2	7	92.9	1946		7.735581	
9	1	7	75.5			8.736007	
10	2	7	95.8	1372		9.497168	
11	1	7	95			10.697543	
12	2	7	59.1	1685		11.469145	

Bin5 Statistics 10

Trial #	Pulse	Chirp (MHz)	Pulse Width (µS)	Pulse 1-2 spacing (µS)	Pulse 2-3 spacing (µS)	Pulse Start(S)	Detection (1:yes; 0:no)
0	2	9	57.3	1281		0.275068	1
1	1	9	99.7			0.858397	
2	2	9	55.1	1275		1.59695	
3	2	9	58.3	1605		2.17686	
4	2	9	91.3	1467		2.731521	
5	3	9	58.5	1846	1854	3.325897	
6	3	9	94.8	1210	1605	3.678629	
7	2	9	68.5	1571		4.269879	
8	2	9	64.6	1258		5.184538	
9	2	9	83.1	1356		5.534912	
10	2	9	76.7	1183		6.385302	
11	3	9	56.4	1236	1553	7.052078	
12	1	9	99.2			7.602391	
13	3	9	65.5	1991	1016	8.23376	
14	2	9	91.2	1460		8.469942	
15	2	9	63.9	1324		9.244941	
16	2	9	67.5	1464		9.975683	
17	1	9	59.8			10.685428	
18	2	9	94.4	1632		11.164799	
19	2	9	87.7	1483		11.714732	

Bin5 Statistics 11

Trial #	Pulse	Chirp (MHz)	Pulse Width (µS)	Pulse 1-2 spacing (µS)	Pulse 2-3 spacing (µS)	Pulse Start(S)	Detection (1:yes; 0:no)
0	1	12	89.1			0.474023	1
1	2	12	60.8	1895		1.740756	
2	2	12	91.7	1777		3.586711	
3	1	12	66.1			3.748243	
4	2	12	57.6	1855		5.850698	
5	2	12	76.1	1621		6.466847	
6	2	12	59.1	1281		8.391693	
7	3	12	64	1541	1487	8.465551	
8	3	12	53.1	1250	1330	9.908368	
9	2	12	69.4	1173		10.937268	

Bin5 Statistics 12

Trial #	Pulse	Chirp (MHz)	Pulse Width (µS)	Pulse 1-2 spacing (uS)	Pulse 2-3 spacing (uS)	Pulse Start(S)	Detection (1:yes; 0:no)
0	2	7	76	1527		0.552474	1
1	3	7	86.3	1900	1051	2.761209	
2	2	7	98.5	1457		4.02386	
3	2	7	50.4	1108		5.429036	
4	2	7	50.9	1257		6.376983	
5	2	7	63.8	1599		8.655941	
6	2	7	99.6	1049		9.915712	
7	2	7	76.4	1549		10.915505	

Bin5 Statistics 13

Trial #	Pulse	Chirp (MHz)	Pulse Width (µS)	Pulse 1-2 spacing (uS)	Pulse 2-3 spacing (uS)	Pulse Start(S)	Detection (1:yes; 0:no)
0	2	11	85.4	1211		0.588376	1
1	2	11	98.9	1126		1.796506	
2	2	11	64.7	1785		2.960675	
3	2	11	65.9	1938		3.111664	
4	1	11	63.2			4.058743	
5	2	11	79.2	1261		5.893137	
6	1	11	71			6.721063	
7	2	11	61.1	1449		7.147527	
8	3	11	99.5	1567	1073	8.019342	
9	1	11	81.6			9.438638	
10	3	11	92.9	1014	1453	10.797373	
11	2	11	56	1325		11.401814	

Bin5 Statistics 14

Trial #	Pulse	Chirp (MHz)	Pulse Width (µS)	Pulse 1-2 spacing (uS)	Pulse 2-3 spacing (uS)	Pulse Start(S)	Detection (1:yes; 0:no)
0	2	7	58.5	1445		0.32409	1
1	1	7	87.7			1.348418	
2	2	7	57.4	1967		2.400531	
3	2	7	98.5	1105		3.456815	
4	2	7	54	1991		5.20964	
5	1	7	91			5.886242	
6	2	7	79.3	1919		7.411663	
7	3	7	64.1	1446	1378	8.118303	
8	2	7	73.5	1452		9.791519	
9	2	7	59.1	1357		10.68169	
10	3	7	85.9	1124	1467	11.041224	

Bin5 Statistics 15

Trial #	Pulse	Chirp (MHz)	Pulse Width (µS)	Pulse 1-2 spacing (uS)	Pulse 2-3 spacing (uS)	Pulse Start(S)	Detection (1:yes; 0:no)
0	2	15	52	1172		0.352514	1
1	2	15	50.6	1337		1.191073	
2	1	15	83.1			2.474538	
3	2	15	65.9	1195		3.110969	
4	1	15	81.1			3.862727	
5	1	15	70.8			4.927682	
6	1	15	52.3			5.742653	
7	3	15	80.7	1265	1939	6.662137	
8	1	15	55.6			7.285139	
9	3	15	92.5	1848	1634	7.820183	
10	2	15	76	1189		9.395729	
11	3	15	57.7	1857	1604	9.923119	
12	3	15	59.1	1143	1743	10.707565	
13	1	15	67.1			11.874367	

Bin5 Statistics 16

Trial #	Pulse	Chirp (MHz)	Pulse Width (µS)	Pulse 1-2 spacing (µS)	Pulse 2-3 spacing (µS)	Pulse Start(S)	Detection (1:yes; 0:no)
0	1	5	76.3			0.481952	1
1	1	5	58.5			1.161497	
2	3	5	67.8	1657	1065	1.854798	
3	2	5	67.8	1838		1.963852	
4	2	5	85.5	1641		2.826617	
5	1	5	61.6			3.584581	
6	2	5	67.6	1183		3.980648	
7	1	5	84.3			4.874425	
8	2	5	79.7	1437		5.489258	
9	3	5	52	1250	1920	6.23922	
10	2	5	74.7	1788		6.430552	
11	1	5	56.6			7.483922	
12	2	5	67.3	1869		8.13122	
13	2	5	76.2	1360		8.688825	
14	3	5	63.3	1014	1214	8.856089	
15	3	5	60.5	1499	1604	9.683744	
16	2	5	59.3	1546		10.285918	

Bin5 Statistics 17

Trial #	Pulse	Chirp (MHz)	Pulse Width (µS)	Pulse 1-2 spacing (µS)	Pulse 2-3 spacing (µS)	Pulse Start(S)	Detection (1:yes; 0:no)
0	3	12	51.7	1686	1222	0.769864	1
1	2	12	70.6	1833		1.374715	
2	2	12	86.2	1120		2.143492	
3	2	12	56.2	1979		3.381797	
4	2	12	95.4	1712		3.613934	
5	2	12	78.5	1232		4.794398	
6	2	12	67.7	1087		5.15331	
7	2	12	99.9	1699		6.202091	
8	1	12	74.1			7.317193	
9	2	12	95.8	1287		8.448683	
10	1	12	62.7			8.648794	
11	2	12	60.1	1335		10.065454	
12	2	12	99.8	1089		10.524646	
13	2	12	52.9	1612		11.144761	

Bin5 Statistics 18

Trial #	Pulse	Chirp (MHz)	Pulse Width (µS)	Pulse 1-2 spacing (uS)	Pulse 2-3 spacing (uS)	Pulse Start(S)	Detection (1:yes; 0:no)
0	2	20	75.1	1575		1.264737	1
1	3	20	51.1	1511	1377	1.813525	
2	1	20	55.8			3.671225	
3	3	20	56.9	1443	1744	5.04713	
4	2	20	52.1	1413		6.142406	
5	1	20	84.7			7.813576	
6	3	20	80.5	1245	1329	8.555418	
7	2	20	80	1934		9.524325	
8	2	20	68.7	1411		11.528058	

Bin5 Statistics 19

Trial #	Pulse	Chirp (MHz)	Pulse Width (µS)	Pulse 1-2 spacing (uS)	Pulse 2-3 spacing (uS)	Pulse Start(S)	Detection (1:yes; 0:no)
0	3	6	53.1	1784	1459	0.397888	1
1	3	6	89.3	1745	1188	1.477282	
2	2	6	72.6	1502		3.053241	
3	2	6	90	1770		3.836873	
4	1	6	94.8			5.16715	
5	3	6	55	1343	1267	6.313154	
6	1	6	72			7.298271	
7	2	6	72.2	1699		8.518669	
8	2	6	85.7	1281		9.447132	
9	2	6	95.8	1944		9.903898	
10	1	6	93.3			11.826576	

Bin5 Statistics 20

Trial #	Pulse	Chirp (MHz)	Pulse Width (µS)	Pulse 1-2 spacing (µS)	Pulse 2-3 spacing (µS)	Pulse Start(S)	Detection (1:yes; 0:no)
0	2	10	68.1	1974		0.081541	1
1	3	10	55.6	1006	1858	0.983168	
2	2	10	57.1	1513		1.30157	
3	3	10	52.9	1643	1676	1.965776	
4	3	10	75.2	1435	1878	2.481279	
5	3	10	95.5	1133	1903	3.209096	
6	2	10	96.1	1962		4.032914	
7	2	10	96.6	1822		4.767716	
8	1	10	90.2			5.34669	
9	1	10	93.1			5.871224	
10	3	10	61.4	1021	1273	6.559459	
11	2	10	58.8	1644		6.765421	
12	2	10	88.8	1357		7.516863	
13	1	10	62.9			7.829561	
14	1	10	89.7			8.731174	
15	2	10	77.5	1326		9.182351	
16	1	10	95.4			9.793967	
17	2	10	79.6	1449		10.752735	
18	2	10	85.3	1436		11.251339	
19	2	10	54.8	1405		11.774909	

Bin5 Statistics 21

Trial #	Pulse	Chirp (MHz)	Pulse Width (µS)	Pulse 1-2 spacing (µS)	Pulse 2-3 spacing (µS)	Pulse Start(S)	Detection (1:yes; 0:no)
0	1	16	68.8			0.355782	1
1	2	16	63.8	1140		1.573277	
2	2	16	60.5	1971		2.650802	
3	2	16	61.2	1793		3.8399	
4	3	16	74.1	1480	1277	4.142099	
5	3	16	63.6	1184	1581	5.711445	
6	2	16	97.2	1523		6.133452	
7	3	16	61.8	1523	1104	7.857079	
8	2	16	78.3	1590		8.0982	
9	2	16	82.9	1289		9.431536	
10	2	16	90.7	1143		10.318722	
11	2	16	65.9	1466		11.289762	

Bin5 Statistics 22

Trial #	Pulse	Chirp (MHz)	Pulse Width (µS)	Pulse 1-2 spacing (µS)	Pulse 2-3 spacing (µS)	Pulse Start(S)	Detection (1:yes; 0:no)
0	1	11	87.3			0.110782	1
1	1	11	72.9			1.488641	
2	2	11	95	1677		1.752463	
3	2	11	88.5	1840		2.496797	
4	3	11	71.5	1180	1711	3.385845	
5	2	11	50.8	1510		4.158762	
6	1	11	73.5			4.91929	
7	2	11	55.7	1991		5.710254	
8	2	11	71.4	1150		6.656173	
9	2	11	86.5	1024		7.270551	
10	1	11	54.5			8.028767	
11	1	11	87.2			8.908549	
12	2	11	99.3	1262		9.517751	
13	2	11	83.6	1788		9.799676	
14	3	11	98.5	1500	1644	10.932214	
15	2	11	62.5	1342		11.647798	

Bin5 Statistics 23

Trial #	Pulse	Chirp (MHz)	Pulse Width (µS)	Pulse 1-2 spacing (µS)	Pulse 2-3 spacing (µS)	Pulse Start(S)	Detection (1:yes; 0:no)
0	2	12	91.4	1555		0.175442	1
1	2	12	62.7	1034		1.053883	
2	2	12	75.5	1532		1.695684	
3	2	12	69.7	1846		3.153122	
4	3	12	63.5	1740	1242	3.84344	
5	2	12	79.6	1740		4.225027	
6	3	12	65.9	1038	1147	4.913988	
7	2	12	52.3	1808		6.197195	
8	2	12	73.7	1277		7.113447	
9	1	12	97.4			7.648172	
10	1	12	60.1			8.315129	
11	2	12	95.4	1961		8.946853	
12	2	12	98.1	1699		9.694949	
13	2	12	66	1114		10.747781	
14	1	12	53.8			11.619498	

Bin5 Statistics 24

Trial #	Pulse	Chirp (MHz)	Pulse Width (µS)	Pulse 1-2 spacing (µS)	Pulse 2-3 spacing (µS)	Pulse Start(S)	Detection (1:yes; 0:no)
0	1	18	94.6			0.102722	1
1	2	18	95.9	1779		1.021156	
2	3	18	87.4	1663	1357	1.556829	
3	1	18	87.5			2.325019	
4	3	18	92	1728	1047	2.903624	
5	1	18	75.8			3.361174	
6	1	18	69.7			4.324598	
7	3	18	93.5	1510	1726	4.766101	
8	2	18	99.5	1495		5.671848	
9	3	18	58.7	1941	1034	6.04413	
10	3	18	73.6	1350	1971	6.829966	
11	3	18	89.4	1779	1352	7.716906	
12	1	18	68.3			8.534109	
13	1	18	65.3			8.97857	
14	2	18	61.2	1800		9.711896	
15	2	18	62.3	1242		10.196784	
16	2	18	93.1	1876		10.696311	
17	2	18	59.3	1489		11.578785	

Bin5 Statistics 25

Trial #	Pulse	Chirp (MHz)	Pulse Width (µS)	Pulse 1-2 spacing (µS)	Pulse 2-3 spacing (µS)	Pulse Start(S)	Detection (1:yes; 0:no)
0	3	11	63.2	1085	1784	0.125297	1
1	3	11	69.3	1008	1544	0.819962	
2	3	11	53.5	1661	1237	1.591347	
3	1	11	78.4			1.996364	
4	1	11	94.5			2.734197	
5	1	11	61.8			3.523549	
6	3	11	74.7	1517	1542	4.129092	
7	2	11	74.2	1544		4.326409	
8	3	11	66.4	1828	1858	5.043005	
9	1	11	72.2			5.948644	
10	3	11	57.9	1911	1402	6.583491	
11	2	11	66.7	1793		6.855845	
12	2	11	99.9	1034		7.669782	
13	2	11	55.1	1476		8.181626	
14	2	11	74.8	1922		8.480749	
15	3	11	65.4	1702	1789	9.411153	
16	1	11	66.6			9.625762	
17	3	11	73.4	1437	1576	10.391036	
18	2	11	91.2	1027		11.151402	
19	3	11	99	1260	1999	11.734845	

Bin5 Statistics 26

Trial #	Pulse	Chirp (MHz)	Pulse Width (µS)	Pulse 1-2 spacing (µS)	Pulse 2-3 spacing (µS)	Pulse Start(S)	Detection (1:yes; 0:no)
0	2	20	91.3	1790		0.057664	1
1	2	20	76.3	1562		1.443179	
2	1	20	69.8			2.320123	
3	1	20	86.4			4.242387	
4	2	20	96.2	1371		4.425698	
5	3	20	95.4	1475	1725	5.964798	
6	2	20	56.6	1186		7.329745	
7	1	20	56.9			8.267612	
8	2	20	62.1	1762		9.124446	
9	2	20	70.7	1330		10.492184	
10	1	20	59.3			10.983893	

Bin5 Statistics 27

Trial #	Pulse	Chirp (MHz)	Pulse Width (µS)	Pulse 1-2 spacing (µS)	Pulse 2-3 spacing (µS)	Pulse Start(S)	Detection (1:yes; 0:no)
0	2	16	90.3	1260		0.364483	1
1	1	16	50.3			1.213461	
2	2	16	67.3	1816		2.019474	
3	2	16	76.8	1620		3.308585	
4	2	16	64.9	1440		3.722623	
5	1	16	69.9			4.373839	
6	3	16	96.9	1834	1229	5.441114	
7	2	16	72	1722		6.499732	
8	1	16	73.3			7.55053	
9	2	16	55.5	1880		8.128176	
10	2	16	98.7	1535		8.674633	
11	3	16	94.1	1234	1766	10.191456	
12	1	16	84.6			10.728916	
13	2	16	64.8	1748		11.778163	

Bin5 Statistics 28

Trial #	Pulse	Chirp (MHz)	Pulse Width (µS)	Pulse 1-2 spacing (µS)	Pulse 2-3 spacing (µS)	Pulse Start(S)	Detection (1:yes; 0:no)
0	2	14	66.2	1379		0.583483	1
1	2	14	88	1393		0.910045	
2	3	14	78.3	1682	1892	2.102544	
3	3	14	58	1921	1584	2.351351	
4	2	14	60.3	1088		3.237889	
5	2	14	63.1	1093		4.06605	
6	2	14	58.8	1615		4.594507	
7	1	14	50.5			5.516224	
8	1	14	54.6			5.900401	
9	2	14	52.3	1811		6.564154	
10	3	14	70.3	1100	1300	7.498481	
11	2	14	69.7	1072		7.965924	
12	2	14	80.9	1831		8.68206	
13	2	14	69.2	1679		9.857738	
14	2	14	53.7	1630		10.398366	
15	2	14	88.9	1009		11.05177	
16	1	14	70.7			11.744321	

Bin5 Statistics 29

Trial #	Pulse	Chirp (MHz)	Pulse Width (µS)	Pulse 1-2 spacing (µS)	Pulse 2-3 spacing (µS)	Pulse Start(S)	Detection (1:yes; 0:no)
0	3	8	52	1210	1653	0.573433	1
1	3	8	54.1	1276	1942	1.512038	
2	2	8	60.6	1887		1.800613	
3	1	8	73.7			2.844293	
4	3	8	97.9	1426	1838	3.879873	
5	1	8	52.8			4.230911	
6	2	8	50.1	1325		5.260119	
7	3	8	64.3	1071	1017	6.325323	
8	2	8	68.3	1951		6.757965	
9	1	8	95.7			7.295756	
10	2	8	59.6	1450		8.548928	
11	1	8	82.2			9.127638	
12	2	8	61.6	1049		10.274639	
13	2	8	99.4	1674		11.117107	
14	1	8	59.6			11.793391	

Bin5 Statistics 30

Trial #	Pulse	Chirp (MHz)	Pulse Width (µS)	Pulse 1-2 spacing (µS)	Pulse 2-3 spacing (µS)	Pulse Start(S)	Detection (1:yes; 0:no)
0	3	17	85.1	1350	1605	0.433578	1
1	2	17	71.7	1209		1.080026	
2	3	17	87.9	1966	1225	2.653855	
3	1	17	80.6			3.430019	
4	3	17	96	1973	1413	4.112926	
5	1	17	56			5.968997	
6	3	17	58.2	1415	1101	6.120183	
7	2	17	51.9	1156		7.922962	
8	2	17	63.7	1196		8.712253	
9	3	17	95.1	1731	1447	9.197146	
10	3	17	84.8	1278	1945	10.204076	
11	1	17	53.4			11.228788	

Table-6 Radar Type 6 Statistical Performance

Trial #	Fc (MHz)	Pulse /Burst	Pulse Width (µS)	PRI (µs)	Detection (1:yes; 0:no)	Hopping Sequence
1	5270	9	1	333	1	5682.0, 5547.0, 5570.0, 5556.0, 5575.0, 5538.0, 5484.0, 5410.0, 5398.0, 5261.0, 5448.0, 5707.0, 5572.0, 5299.0, 5668.0, 5444.0, 5655.0, 5542.0, 5528.0, 5468.0, 5253.0, 5388.0, 5475.0, 5367.0, 5482.0, 5716.0, 5591.0, 5365.0, 5688.0, 5634.0, 5624.0, 5613.0, 5285.0, 5355.0, 5418.0, 5487.0, 5381.0, 5549.0, 5348.0, 5568.0, 5399.0, 5499.0, 5309.0, 5466.0, 5544.0, 5433.0, 5446.0, 5532.0, 5625.0, 5396.0, 5667.0, 5358.0, 5375.0, 5304.0, 5518.0, 5604.0, 5316.0, 5409.0, 5506.0, 5455.0, 5259.0, 5276.0, 5496.0, 5390.0, 5454.0, 5699.0, 5405.0, 5363.0, 5288.0, 5594.0, 5623.0, 5609.0, 5463.0, 5322.0, 5503.0, 5335.0, 5614.0, 5595.0, 5491.0, 5598.0, 5392.0, 5657.0, 5302.0, 5329.0, 5539.0, 5550.0, 5254.0, 5672.0, 5294.0, 5603.0, 5360.0, 5520.0, 5674.0, 5406.0, 5441.0, 5529.0, 5495.0, 5523.0, 5440.0, 5687.0 (number of hits: 7)
2	5270	9	1	333	1	5460.0, 5561.0, 5299.0, 5251.0, 5553.0, 5692.0, 5667.0, 5323.0, 5697.0, 5371.0, 5288.0, 5535.0, 5653.0, 5524.0, 5641.0, 5399.0, 5682.0, 5508.0, 5304.0, 5600.0, 5585.0, 5609.0, 5503.0, 5521.0, 5523.0, 5537.0, 5483.0, 5437.0, 5487.0, 5306.0, 5429.0, 5567.0, 5484.0, 5430.0, 5688.0, 5411.0, 5547.0, 5396.0, 5290.0, 5636.0, 5541.0, 5406.0, 5545.0, 5634.0, 5351.0, 5422.0, 5254.0, 5342.0, 5448.0, 5384.0, 5383.0, 5435.0, 5506.0, 5620.0, 5434.0, 5544.0, 5294.0, 5562.0, 5374.0, 5657.0, 5603.0, 5350.0, 5703.0, 5565.0, 5719.0, 5488.0, 5324.0, 5496.0, 5515.0, 5607.0, 5566.0, 5628.0, 5392.0, 5519.0, 5617.0, 5663.0, 5555.0, 5470.0, 5632.0, 5405.0, 5694.0, 5676.0, 5505.0, 5331.0, 5618.0, 5475.0, 5601.0, 5675.0, 5363.0, 5646.0, 5681.0, 5322.0, 5451.0, 5588.0, 5276.0, 5307.0, 5410.0, 5534.0, 5513.0, 5334.0 (number of hits: 4)
3	5270	9	1	333	1	5464.0, 5544.0, 5565.0, 5703.0, 5607.0, 5661.0, 5341.0, 5274.0, 5409.0, 5620.0, 5511.0, 5636.0, 5689.0, 5454.0, 5419.0, 5374.0, 5533.0, 5505.0, 5445.0, 5362.0, 5264.0, 5334.0, 5524.0, 5448.0, 5569.0, 5553.0, 5621.0, 5387.0, 5693.0, 5335.0, 5572.0, 5495.0, 5391.0, 5602.0, 5384.0, 5288.0, 5670.0, 5640.0, 5380.0, 5469.0, 5543.0, 5599.0, 5484.0, 5577.0, 5570.0, 5317.0, 5623.0, 5385.0, 5549.0, 5632.0, 5529.0, 5440.0, 5294.0, 5683.0, 5615.0,

						5474.0, 5541.0, 5575.0, 5643.0, 5411.0, 5684.0, 5332.0, 5476.0, 5283.0, 5597.0, 5508.0, 5627.0, 5722.0, 5292.0, 5301.0, 5299.0, 5702.0, 5314.0, 5631.0, 5690.0, 5491.0, 5369.0, 5438.0, 5426.0, 5465.0, 5486.0, 5443.0, 5415.0, 5451.0, 5675.0, 5677.0, 5436.0, 5323.0, 5477.0, 5296.0, 5349.0, 5416.0, 5652.0, 5430.0, 5717.0, 5557.0, 5526.0, 5648.0, 5450.0, 5498.0 (number of hits: 4)
4	5270	9	1	333	1	5344.0, 5254.0, 5386.0, 5398.0, 5562.0, 5655.0, 5672.0, 5373.0, 5657.0, 5598.0, 5591.0, 5621.0, 5321.0, 5507.0, 5482.0, 5683.0, 5320.0, 5592.0, 5504.0, 5397.0, 5330.0, 5668.0, 5698.0, 5644.0, 5435.0, 5266.0, 5347.0, 5674.0, 5494.0, 5409.0, 5279.0, 5538.0, 5604.0, 5580.0, 5381.0, 5612.0, 5632.0, 5365.0, 5462.0, 5654.0, 5665.0, 5335.0, 5603.0, 5659.0, 5394.0, 5322.0, 5596.0, 5708.0, 5252.0, 5638.0, 5594.0, 5669.0, 5570.0, 5646.0, 5377.0, 5307.0, 5446.0, 5495.0, 5336.0, 5291.0, 5500.0, 5680.0, 5484.0, 5583.0, 5545.0, 5599.0, 5558.0, 5688.0, 5473.0, 5565.0, 5457.0, 5295.0, 5278.0, 5436.0, 5696.0, 5519.0, 5395.0, 5478.0, 5505.0, 5312.0, 5693.0, 5626.0, 5355.0, 5299.0, 5325.0, 5384.0, 5653.0, 5613.0, 5684.0, 5323.0, 5714.0, 5552.0, 5403.0, 5662.0, 5276.0, 5275.0, 5369.0, 5695.0, 5477.0, 5593.0 (number of hits: 7)
5	5270	9	1	333	1	5655.0, 5517.0, 5624.0, 5296.0, 5341.0, 5721.0, 5274.0, 5690.0, 5673.0, 5273.0, 5529.0, 5449.0, 5340.0, 5393.0, 5617.0, 5503.0, 5724.0, 5539.0, 5535.0, 5664.0, 5706.0, 5493.0, 5633.0, 5532.0, 5572.0, 5320.0, 5498.0, 5571.0, 5566.0, 5437.0, 5354.0, 5286.0, 5692.0, 5697.0, 5265.0, 5316.0, 5305.0, 5461.0, 5593.0, 5366.0, 5426.0, 5631.0, 5678.0, 5300.0, 5257.0, 5430.0, 5413.0, 5653.0, 5482.0, 5584.0, 5267.0, 5591.0, 5602.0, 5660.0, 5670.0, 5630.0, 5416.0, 5699.0, 5362.0, 5486.0, 5279.0, 5328.0, 5654.0, 5400.0, 5688.0, 5278.0, 5409.0, 5635.0, 5377.0, 5404.0, 5623.0, 5592.0, 5283.0, 5578.0, 5648.0, 5447.0, 5516.0, 5365.0, 5332.0, 5585.0, 5266.0, 5459.0, 5634.0, 5683.0, 5276.0, 5540.0, 5562.0, 5383.0, 5298.0, 5424.0, 5715.0, 5666.0, 5329.0, 5433.0, 5501.0, 5391.0, 5370.0, 5314.0, 5583.0, 5439.0 (number of hits: 11)
6	5270	9	1	333	1	5500.0, 5644.0, 5672.0, 5588.0, 5435.0, 5687.0, 5314.0, 5393.0, 5436.0, 5382.0, 5380.0, 5569.0, 5262.0, 5674.0, 5425.0, 5623.0, 5663.0, 5297.0, 5548.0, 5449.0, 5526.0, 5543.0, 5509.0, 5399.0, 5643.0, 5342.0, 5439.0, 5360.0, 5660.0, 5343.0, 5566.0, 5305.0, 5652.0, 5420.0, 5388.0

						5549.0, 5483.0, 5707.0, 5363.0, 5567.0, 5346.0, 5287.0, 5448.0, 5481.0, 5635.0, 5279.0, 5628.0, 5615.0, 5559.0, 5721.0, 5536.0, 5630.0, 5369.0, 5458.0, 5351.0, 5486.0, 5295.0, 5414.0, 5491.0, 5461.0, 5474.0, 5433.0, 5442.0, 5368.0, 5558.0, 5609.0, 5550.0, 5556.0, 5675.0, 5516.0, 5665.0, 5593.0, 5605.0, 5466.0, 5715.0, 5697.0, 5590.0, 5646.0, 5294.0, 5441.0, 5417.0, 5599.0, 5568.0, 5682.0, 5584.0, 5386.0, 5269.0, 5580.0, 5654.0, 5723.0, 5350.0, 5470.0, 5267.0, 5650.0, 5714.0, 5524.0, 5478.0, 5664.0, 5462.0, 5327.0 (number of hits: 5)
7	5270	9	1	333	1	5480.0, 5472.0, 5539.0, 5629.0, 5599.0, 5404.0, 5356.0, 5641.0, 5723.0, 5703.0, 5702.0, 5569.0, 5601.0, 5311.0, 5343.0, 5620.0, 5619.0, 5387.0, 5469.0, 5521.0, 5654.0, 5418.0, 5663.0, 5647.0, 5398.0, 5670.0, 5545.0, 5669.0, 5327.0, 5517.0, 5384.0, 5447.0, 5697.0, 5667.0, 5444.0, 5491.0, 5513.0, 5421.0, 5718.0, 5335.0, 5389.0, 5367.0, 5402.0, 5428.0, 5542.0, 5609.0, 5383.0, 5467.0, 5694.0, 5379.0, 5354.0, 5508.0, 5660.0, 5272.0, 5639.0, 5325.0, 5410.0, 5490.0, 5717.0, 5333.0, 5675.0, 5616.0, 5488.0, 5463.0, 5645.0, 5680.0, 5535.0, 5275.0, 5456.0, 5299.0, 5664.0, 5615.0, 5621.0, 5525.0, 5308.0, 5346.0, 5633.0, 5344.0, 5400.0, 5297.0, 5622.0, 5347.0, 5695.0, 5353.0, 5692.0, 5624.0, 5665.0, 5254.0, 5303.0, 5464.0, 5451.0, 5431.0, 5388.0, 5567.0, 5341.0, 5524.0, 5534.0, 5643.0, 5331.0, 5606.0 (number of hits: 3)
8	5270	9	1	333	1	5552.0, 5450.0, 5328.0, 5651.0, 5586.0, 5287.0, 5352.0, 5413.0, 5575.0, 5393.0, 5615.0, 5323.0, 5373.0, 5648.0, 5386.0, 5690.0, 5417.0, 5613.0, 5529.0, 5569.0, 5437.0, 5484.0, 5279.0, 5544.0, 5403.0, 5414.0, 5256.0, 5521.0, 5340.0, 5300.0, 5473.0, 5680.0, 5266.0, 5511.0, 5388.0, 5536.0, 5550.0, 5253.0, 5695.0, 5461.0, 5295.0, 5296.0, 5594.0, 5476.0, 5551.0, 5554.0, 5724.0, 5274.0, 5459.0, 5505.0, 5430.0, 5367.0, 5494.0, 5495.0, 5375.0, 5462.0, 5259.0, 5548.0, 5664.0, 5337.0, 5655.0, 5321.0, 5653.0, 5590.0, 5636.0, 5697.0, 5662.0, 5359.0, 5685.0, 5714.0, 5540.0, 5589.0, 5496.0, 5445.0, 5260.0, 5546.0, 5713.0, 5408.0, 5499.0, 5456.0, 5405.0, 5314.0, 5491.0, 5361.0, 5624.0, 5429.0, 5421.0, 5286.0, 5639.0, 5338.0, 5285.0, 5656.0, 5474.0, 5325.0, 5378.0, 5384.0, 5582.0, 5444.0, 5434.0, 5315.0 (number of hits: 10)
9	5270	9	1	333	1	5414.0, 5708.0, 5645.0, 5535.0, 5618.0, 5440.0, 5580.0, 5470.0, 5415.0, 5298.0, 5327.0, 5300.0, 5691.0, 5285.0, 5666.0,

						5329.0, 5384.0, 5686.0, 5350.0, 5313.0, 5577.0, 5292.0, 5396.0, 5705.0, 5539.0, 5358.0, 5342.0, 5391.0, 5450.0, 5323.0, 5629.0, 5571.0, 5409.0, 5605.0, 5314.0, 5284.0, 5402.0, 5423.0, 5376.0, 5378.0, 5392.0, 5692.0, 5689.0, 5707.0, 5706.0, 5449.0, 5372.0, 5603.0, 5527.0, 5430.0, 5297.0, 5269.0, 5383.0, 5677.0, 5310.0, 5427.0, 5715.0, 5259.0, 5589.0, 5335.0, 5521.0, 5683.0, 5322.0, 5688.0, 5511.0, 5607.0, 5486.0, 5393.0, 5380.0, 5615.0, 5311.0, 5462.0, 5567.0, 5564.0, 5452.0, 5421.0, 5693.0, 5600.0, 5525.0, 5595.0, 5516.0, 5630.0, 5723.0, 5655.0, 5367.0, 5653.0, 5401.0, 5671.0, 5388.0, 5413.0, 5410.0, 5554.0, 5281.0, 5685.0, 5373.0, 5387.0, 5424.0, 5560.0, 5680.0, 5623.0 (number of hits: 5)
10	5270	9	1	333	1	5623.0, 5549.0, 5470.0, 5258.0, 5607.0, 5341.0, 5692.0, 5659.0, 5380.0, 5445.0, 5648.0, 5279.0, 5436.0, 5414.0, 5582.0, 5458.0, 5296.0, 5472.0, 5672.0, 5717.0, 5403.0, 5371.0, 5374.0, 5669.0, 5372.0, 5462.0, 5542.0, 5494.0, 5465.0, 5459.0, 5572.0, 5491.0, 5464.0, 5712.0, 5280.0, 5707.0, 5400.0, 5264.0, 5698.0, 5592.0, 5662.0, 5394.0, 5370.0, 5537.0, 5473.0, 5275.0, 5507.0, 5423.0, 5328.0, 5427.0, 5277.0, 5525.0, 5415.0, 5500.0, 5273.0, 5268.0, 5312.0, 5322.0, 5287.0, 5605.0, 5556.0, 5310.0, 5402.0, 5373.0, 5442.0, 5340.0, 5718.0, 5526.0, 5429.0, 5483.0, 5361.0, 5305.0, 5497.0, 5480.0, 5274.0, 5635.0, 5471.0, 5699.0, 5668.0, 5626.0, 5278.0, 5552.0, 5680.0, 5628.0, 5416.0, 5567.0, 5600.0, 5656.0, 5587.0, 5260.0, 5364.0, 5314.0, 5444.0, 5685.0, 5406.0, 5702.0, 5705.0, 5383.0, 5559.0, 5359.0 (number of hits: 12)
11	5270	9	1	333	1	5576.0, 5529.0, 5457.0, 5365.0, 5495.0, 5305.0, 5313.0, 5624.0, 5309.0, 5444.0, 5258.0, 5450.0, 5547.0, 5709.0, 5559.0, 5452.0, 5322.0, 5687.0, 5373.0, 5433.0, 5387.0, 5702.0, 5563.0, 5471.0, 5705.0, 5291.0, 5275.0, 5514.0, 5647.0, 5482.0, 5369.0, 5424.0, 5367.0, 5288.0, 5650.0, 5531.0, 5385.0, 5665.0, 5562.0, 5321.0, 5637.0, 5323.0, 5499.0, 5543.0, 5550.0, 5325.0, 5386.0, 5612.0, 5377.0, 5551.0, 5346.0, 5696.0, 5574.0, 5507.0, 5629.0, 5683.0, 5695.0, 5668.0, 5664.0, 5718.0, 5260.0, 5524.0, 5349.0, 5618.0, 5684.0, 5630.0, 5371.0, 5394.0, 5409.0, 5342.0, 5437.0, 5468.0, 5338.0, 5417.0, 5593.0, 5678.0, 5717.0, 5415.0, 5397.0, 5269.0, 5509.0, 5721.0, 5591.0, 5707.0, 5660.0, 5640.0, 5430.0, 5330.0, 5527.0, 5573.0, 5522.0, 5475.0, 5610.0, 5400.0, 5708.0, 5600.0, 5382.0, 5525.0, 5314.0, 5510.0

						(number of hits: 5)
12	5270	9	1	333	1	5267.0, 5561.0, 5452.0, 5263.0, 5333.0, 5339.0, 5405.0, 5465.0, 5343.0, 5591.0, 5442.0, 5613.0, 5681.0, 5670.0, 5671.0, 5320.0, 5607.0, 5606.0, 5694.0, 5469.0, 5275.0, 5345.0, 5673.0, 5501.0, 5387.0, 5632.0, 5584.0, 5327.0, 5679.0, 5709.0, 5666.0, 5626.0, 5644.0, 5408.0, 5401.0, 5478.0, 5654.0, 5427.0, 5716.0, 5271.0, 5657.0, 5290.0, 5493.0, 5384.0, 5419.0, 5349.0, 5329.0, 5564.0, 5562.0, 5375.0, 5400.0, 5526.0, 5722.0, 5279.0, 5634.0, 5633.0, 5270.0, 5402.0, 5348.0, 5457.0, 5705.0, 5508.0, 5477.0, 5266.0, 5338.0, 5577.0, 5664.0, 5647.0, 5683.0, 5398.0, 5593.0, 5356.0, 5686.0, 5389.0, 5367.0, 5507.0, 5303.0, 5429.0, 5486.0, 5355.0, 5675.0, 5611.0, 5578.0, 5520.0, 5406.0, 5515.0, 5495.0, 5351.0, 5252.0, 5337.0, 5455.0, 5659.0, 5668.0, 5701.0, 5278.0, 5479.0, 5575.0, 5594.0, 5563.0, 5397.0
						(number of hits: 9)
13	5270	9	1	333	1	5656.0, 5443.0, 5492.0, 5418.0, 5317.0, 5279.0, 5478.0, 5598.0, 5371.0, 5400.0, 5346.0, 5540.0, 5570.0, 5660.0, 5319.0, 5575.0, 5555.0, 5709.0, 5391.0, 5491.0, 5366.0, 5594.0, 5617.0, 5564.0, 5292.0, 5458.0, 5345.0, 5376.0, 5714.0, 5383.0, 5595.0, 5581.0, 5374.0, 5310.0, 5394.0, 5653.0, 5347.0, 5440.0, 5550.0, 5684.0, 5442.0, 5659.0, 5365.0, 5593.0, 5642.0, 5637.0, 5352.0, 5661.0, 5615.0, 5260.0, 5565.0, 5511.0, 5450.0, 5695.0, 5460.0, 5444.0, 5605.0, 5648.0, 5341.0, 5272.0, 5423.0, 5628.0, 5627.0, 5410.0, 5267.0, 5321.0, 5358.0, 5630.0, 5572.0, 5705.0, 5466.0, 5338.0, 5529.0, 5256.0, 5493.0, 5288.0, 5447.0, 5664.0, 5270.0, 5449.0, 5675.0, 5285.0, 5281.0, 5699.0, 5501.0, 5413.0, 5479.0, 5419.0, 5669.0, 5484.0, 5351.0, 5588.0, 5542.0, 5481.0, 5624.0, 5280.0, 5517.0, 5355.0, 5509.0, 5601.0
						(number of hits: 10)
14	5270	9	1	333	1	5283.0, 5345.0, 5647.0, 5451.0, 5705.0, 5509.0, 5644.0, 5332.0, 5397.0, 5542.0, 5341.0, 5253.0, 5587.0, 5290.0, 5484.0, 5697.0, 5436.0, 5281.0, 5708.0, 5525.0, 5467.0, 5475.0, 5611.0, 5390.0, 5704.0, 5661.0, 5629.0, 5524.0, 5323.0, 5582.0, 5352.0, 5471.0, 5513.0, 5568.0, 5311.0, 5643.0, 5388.0, 5427.0, 5310.0, 5387.0, 5548.0, 5363.0, 5481.0, 5384.0, 5651.0, 5257.0, 5490.0, 5378.0, 5691.0, 5584.0, 5464.0, 5537.0, 5567.0, 5417.0, 5535.0, 5306.0, 5469.0, 5512.0, 5720.0, 5554.0, 5683.0, 5696.0, 5620.0, 5447.0, 5466.0, 5579.0, 5646.0, 5700.0, 5561.0, 5286.0, 5348.0, 5520.0, 5486.0, 5589.0, 5578.0, 5291.0, 5615.0, 5716.0, 5433.0, 5592.0

						5530.0, 5437.0, 5443.0, 5650.0, 5476.0, 5721.0, 5468.0, 5485.0, 5382.0, 5463.0, 5724.0, 5265.0, 5383.0, 5353.0, 5465.0, 5319.0, 5722.0, 5292.0, 5559.0, 5601.0 (number of hits: 6)
15	5270	9	1	333	1	5436.0, 5644.0, 5510.0, 5414.0, 5473.0, 5596.0, 5360.0, 5388.0, 5649.0, 5309.0, 5497.0, 5656.0, 5632.0, 5261.0, 5698.0, 5651.0, 5448.0, 5679.0, 5432.0, 5426.0, 5562.0, 5353.0, 5689.0, 5294.0, 5369.0, 5694.0, 5564.0, 5684.0, 5395.0, 5586.0, 5469.0, 5404.0, 5269.0, 5290.0, 5503.0, 5490.0, 5548.0, 5568.0, 5582.0, 5676.0, 5631.0, 5553.0, 5254.0, 5477.0, 5323.0, 5597.0, 5430.0, 5354.0, 5550.0, 5349.0, 5483.0, 5673.0, 5409.0, 5380.0, 5506.0, 5567.0, 5259.0, 5402.0, 5336.0, 5435.0, 5352.0, 5412.0, 5348.0, 5310.0, 5423.0, 5507.0, 5486.0, 5640.0, 5561.0, 5361.0, 5379.0, 5316.0, 5324.0, 5253.0, 5318.0, 5641.0, 5500.0, 5701.0, 5487.0, 5267.0, 5529.0, 5327.0, 5400.0, 5635.0, 5421.0, 5485.0, 5408.0, 5350.0, 5447.0, 5620.0, 5351.0, 5383.0, 5499.0, 5546.0, 5498.0, 5607.0, 5304.0, 5419.0, 5308.0, 5622.0 (number of hits: 6)
16	5270	9	1	333	1	5707.0, 5297.0, 5655.0, 5333.0, 5629.0, 5400.0, 5527.0, 5462.0, 5680.0, 5711.0, 5606.0, 5427.0, 5288.0, 5710.0, 5511.0, 5582.0, 5359.0, 5664.0, 5703.0, 5632.0, 5586.0, 5472.0, 5534.0, 5309.0, 5318.0, 5608.0, 5662.0, 5691.0, 5482.0, 5296.0, 5376.0, 5587.0, 5600.0, 5366.0, 5452.0, 5510.0, 5532.0, 5488.0, 5528.0, 5264.0, 5575.0, 5630.0, 5686.0, 5487.0, 5401.0, 5299.0, 5628.0, 5342.0, 5301.0, 5723.0, 5392.0, 5615.0, 5648.0, 5554.0, 5355.0, 5323.0, 5336.0, 5693.0, 5610.0, 5396.0, 5486.0, 5285.0, 5478.0, 5558.0, 5566.0, 5408.0, 5294.0, 5583.0, 5547.0, 5263.0, 5573.0, 5690.0, 5645.0, 5557.0, 5620.0, 5481.0, 5665.0, 5529.0, 5708.0, 5284.0, 5358.0, 5491.0, 5523.0, 5409.0, 5695.0, 5445.0, 5652.0, 5437.0, 5458.0, 5475.0, 5370.0, 5524.0, 5334.0, 5700.0, 5436.0, 5407.0, 5560.0, 5382.0, 5365.0, 5257.0 (number of hits: 6)
17	5270	9	1	333	1	5303.0, 5316.0, 5582.0, 5670.0, 5558.0, 5274.0, 5270.0, 5264.0, 5306.0, 5539.0, 5323.0, 5386.0, 5508.0, 5456.0, 5445.0, 5286.0, 5322.0, 5492.0, 5572.0, 5568.0, 5611.0, 5377.0, 5425.0, 5329.0, 5634.0, 5276.0, 5629.0, 5541.0, 5658.0, 5268.0, 5553.0, 5442.0, 5583.0, 5341.0, 5317.0, 5520.0, 5440.0, 5348.0, 5575.0, 5623.0, 5532.0, 5540.0, 5332.0, 5280.0, 5396.0, 5443.0, 5673.0, 5436.0, 5675.0, 5544.0, 5665.0, 5522.0, 5589.0, 5364.0, 5484.0, 5324.0, 5563.0, 5616.0, 5311.0, 5652.0,

						5550.0, 5667.0, 5318.0, 5314.0, 5371.0, 5661.0, 5536.0, 5564.0, 5411.0, 5512.0, 5293.0, 5651.0, 5368.0, 5354.0, 5421.0, 5480.0, 5716.0, 5636.0, 5253.0, 5282.0, 5358.0, 5418.0, 5291.0, 5434.0, 5571.0, 5533.0, 5686.0, 5715.0, 5320.0, 5605.0, 5592.0, 5612.0, 5681.0, 5557.0, 5707.0, 5705.0, 5406.0, 5721.0, 5599.0, 5709.0 (number of hits: 9)
18	5270	9	1	333	1	5487.0, 5651.0, 5442.0, 5537.0, 5468.0, 5678.0, 5612.0, 5614.0, 5401.0, 5521.0, 5573.0, 5544.0, 5461.0, 5303.0, 5714.0, 5517.0, 5719.0, 5506.0, 5427.0, 5335.0, 5393.0, 5257.0, 5593.0, 5601.0, 5567.0, 5538.0, 5648.0, 5471.0, 5572.0, 5659.0, 5424.0, 5645.0, 5265.0, 5545.0, 5503.0, 5352.0, 5607.0, 5385.0, 5309.0, 5272.0, 5582.0, 5688.0, 5549.0, 5654.0, 5330.0, 5453.0, 5384.0, 5398.0, 5507.0, 5276.0, 5269.0, 5382.0, 5611.0, 5288.0, 5325.0, 5561.0, 5596.0, 5644.0, 5380.0, 5405.0, 5409.0, 5433.0, 5536.0, 5649.0, 5671.0, 5685.0, 5589.0, 5554.0, 5527.0, 5259.0, 5412.0, 5399.0, 5504.0, 5610.0, 5512.0, 5558.0, 5680.0, 5262.0, 5620.0, 5371.0, 5311.0, 5588.0, 5435.0, 5585.0, 5339.0, 5676.0, 5404.0, 5479.0, 5451.0, 5320.0, 5306.0, 5470.0, 5274.0, 5647.0, 5574.0, 5548.0, 5532.0, 5723.0, 5443.0, 5634.0 (number of hits: 9)
19	5270	9	1	333	1	5539.0, 5683.0, 5464.0, 5419.0, 5432.0, 5710.0, 5689.0, 5488.0, 5663.0, 5360.0, 5716.0, 5416.0, 5593.0, 5511.0, 5439.0, 5580.0, 5492.0, 5623.0, 5640.0, 5403.0, 5356.0, 5518.0, 5515.0, 5657.0, 5555.0, 5343.0, 5717.0, 5723.0, 5336.0, 5545.0, 5333.0, 5597.0, 5430.0, 5664.0, 5459.0, 5622.0, 5379.0, 5261.0, 5406.0, 5571.0, 5582.0, 5411.0, 5478.0, 5363.0, 5656.0, 5712.0, 5431.0, 5345.0, 5669.0, 5612.0, 5521.0, 5448.0, 5585.0, 5498.0, 5338.0, 5294.0, 5357.0, 5415.0, 5626.0, 5370.0, 5641.0, 5604.0, 5546.0, 5491.0, 5509.0, 5654.0, 5516.0, 5291.0, 5443.0, 5450.0, 5647.0, 5665.0, 5620.0, 5694.0, 5598.0, 5260.0, 5385.0, 5680.0, 5693.0, 5684.0, 5646.0, 5606.0, 5500.0, 5572.0, 5335.0, 5391.0, 5720.0, 5704.0, 5410.0, 5326.0, 5628.0, 5399.0, 5566.0, 5603.0, 5627.0, 5401.0, 5278.0, 5651.0, 5691.0, 5698.0 (number of hits: 3)
20	5270	9	1	333	1	5353.0, 5566.0, 5610.0, 5687.0, 5470.0, 5293.0, 5313.0, 5698.0, 5281.0, 5683.0, 5304.0, 5342.0, 5282.0, 5501.0, 5463.0, 5721.0, 5316.0, 5475.0, 5633.0, 5710.0, 5684.0, 5688.0, 5695.0, 5452.0, 5528.0, 5489.0, 5590.0, 5697.0, 5369.0, 5604.0, 5557.0, 5258.0, 5545.0, 5661.0, 5655.0, 5423.0, 5417.0, 5307.0, 5435.0, 5644.0

						5500.0, 5494.0, 5642.0, 5662.0, 5453.0, 5678.0, 5332.0, 5483.0, 5437.0, 5570.0, 5722.0, 5663.0, 5629.0, 5375.0, 5372.0, 5492.0, 5686.0, 5334.0, 5273.0, 5531.0, 5351.0, 5414.0, 5320.0, 5410.0, 5605.0, 5666.0, 5679.0, 5675.0, 5529.0, 5712.0, 5690.0, 5670.0, 5433.0, 5513.0, 5404.0, 5382.0, 5402.0, 5499.0, 5385.0, 5339.0, 5327.0, 5348.0, 5442.0, 5699.0, 5345.0, 5556.0, 5251.0, 5696.0, 5260.0, 5637.0, 5276.0, 5301.0, 5376.0, 5581.0, 5265.0, 5622.0, 5546.0, 5525.0, 5527.0, 5711.0 (number of hits: 8)
21	5270	9	1	333	1	5432.0, 5709.0, 5545.0, 5504.0, 5719.0, 5409.0, 5489.0, 5454.0, 5284.0, 5550.0, 5566.0, 5361.0, 5636.0, 5379.0, 5434.0, 5519.0, 5685.0, 5253.0, 5672.0, 5511.0, 5480.0, 5439.0, 5274.0, 5256.0, 5606.0, 5683.0, 5444.0, 5619.0, 5518.0, 5289.0, 5506.0, 5599.0, 5581.0, 5443.0, 5304.0, 5349.0, 5417.0, 5455.0, 5622.0, 5324.0, 5563.0, 5460.0, 5442.0, 5669.0, 5399.0, 5611.0, 5699.0, 5509.0, 5523.0, 5495.0, 5577.0, 5496.0, 5436.0, 5613.0, 5332.0, 5710.0, 5415.0, 5318.0, 5713.0, 5516.0, 5411.0, 5513.0, 5602.0, 5694.0, 5384.0, 5582.0, 5491.0, 5469.0, 5704.0, 5406.0, 5531.0, 5500.0, 5329.0, 5575.0, 5290.0, 5716.0, 5684.0, 5628.0, 5594.0, 5362.0, 5308.0, 5280.0, 5269.0, 5689.0, 5522.0, 5422.0, 5497.0, 5316.0, 5597.0, 5311.0, 5428.0, 5558.0, 5378.0, 5393.0, 5314.0, 5390.0, 5263.0, 5292.0, 5650.0, 5346.0 (number of hits: 8)
22	5270	9	1	333	1	5406.0, 5482.0, 5270.0, 5466.0, 5373.0, 5433.0, 5589.0, 5710.0, 5512.0, 5366.0, 5633.0, 5327.0, 5415.0, 5584.0, 5642.0, 5699.0, 5336.0, 5408.0, 5625.0, 5308.0, 5590.0, 5695.0, 5426.0, 5576.0, 5284.0, 5508.0, 5629.0, 5703.0, 5711.0, 5318.0, 5614.0, 5566.0, 5310.0, 5331.0, 5315.0, 5346.0, 5259.0, 5362.0, 5719.0, 5648.0, 5618.0, 5665.0, 5622.0, 5281.0, 5681.0, 5500.0, 5657.0, 5562.0, 5453.0, 5686.0, 5697.0, 5667.0, 5347.0, 5471.0, 5722.0, 5702.0, 5352.0, 5607.0, 5530.0, 5513.0, 5598.0, 5492.0, 5577.0, 5624.0, 5609.0, 5675.0, 5503.0, 5449.0, 5620.0, 5521.0, 5563.0, 5480.0, 5684.0, 5556.0, 5337.0, 5285.0, 5486.0, 5628.0, 5356.0, 5479.0, 5320.0, 5385.0, 5278.0, 5377.0, 5516.0, 5333.0, 5494.0, 5368.0, 5581.0, 5636.0, 5450.0, 5300.0, 5430.0, 5446.0, 5545.0, 5265.0, 5413.0, 5350.0, 5335.0, 5398.0 (number of hits: 7)
23	5270	9	1	333	1	5336.0, 5368.0, 5461.0, 5414.0, 5407.0, 5553.0, 5267.0, 5522.0, 5538.0, 5342.0, 5285.0, 5291.0, 5526.0, 5534.0, 5341.0, 5493.0, 5374.0, 5567.0, 5412.0, 5705.0,

						5590.0, 5489.0, 5409.0, 5689.0, 5513.0, 5440.0, 5565.0, 5618.0, 5685.0, 5325.0, 5398.0, 5344.0, 5377.0, 5708.0, 5258.0, 5380.0, 5260.0, 5675.0, 5297.0, 5384.0, 5642.0, 5433.0, 5406.0, 5346.0, 5253.0, 5682.0, 5454.0, 5459.0, 5545.0, 5304.0, 5358.0, 5394.0, 5348.0, 5482.0, 5447.0, 5283.0, 5631.0, 5310.0, 5457.0, 5624.0, 5391.0, 5436.0, 5637.0, 5663.0, 5601.0, 5452.0, 5694.0, 5255.0, 5608.0, 5652.0, 5367.0, 5280.0, 5458.0, 5562.0, 5519.0, 5716.0, 5646.0, 5548.0, 5627.0, 5724.0, 5446.0, 5319.0, 5252.0, 5632.0, 5629.0, 5309.0, 5480.0, 5488.0, 5586.0, 5470.0, 5667.0, 5610.0, 5264.0, 5576.0, 5540.0, 5516.0, 5616.0, 5660.0, 5481.0, 5259.0 (number of hits: 11)
24	5270	9	1	333	1	5715.0, 5594.0, 5299.0, 5643.0, 5650.0, 5364.0, 5679.0, 5613.0, 5712.0, 5451.0, 5435.0, 5474.0, 5673.0, 5485.0, 5438.0, 5529.0, 5509.0, 5360.0, 5524.0, 5281.0, 5472.0, 5540.0, 5487.0, 5427.0, 5470.0, 5260.0, 5516.0, 5590.0, 5259.0, 5522.0, 5502.0, 5292.0, 5657.0, 5662.0, 5533.0, 5479.0, 5626.0, 5362.0, 5265.0, 5286.0, 5363.0, 5697.0, 5619.0, 5526.0, 5681.0, 5320.0, 5423.0, 5629.0, 5374.0, 5354.0, 5521.0, 5680.0, 5277.0, 5389.0, 5406.0, 5542.0, 5317.0, 5264.0, 5600.0, 5440.0, 5263.0, 5452.0, 5467.0, 5611.0, 5434.0, 5571.0, 5561.0, 5572.0, 5419.0, 5254.0, 5379.0, 5696.0, 5257.0, 5498.0, 5636.0, 5329.0, 5514.0, 5513.0, 5308.0, 5537.0, 5463.0, 5462.0, 5461.0, 5253.0, 5655.0, 5465.0, 5606.0, 5429.0, 5273.0, 5689.0, 5321.0, 5630.0, 5615.0, 5671.0, 5699.0, 5501.0, 5708.0, 5297.0, 5255.0, 5475.0 (number of hits: 13)
25	5270	9	1	333	1	5665.0, 5404.0, 5261.0, 5502.0, 5340.0, 5463.0, 5543.0, 5548.0, 5388.0, 5432.0, 5407.0, 5508.0, 5483.0, 5668.0, 5596.0, 5647.0, 5382.0, 5576.0, 5310.0, 5403.0, 5256.0, 5569.0, 5410.0, 5409.0, 5272.0, 5254.0, 5489.0, 5572.0, 5555.0, 5524.0, 5491.0, 5490.0, 5477.0, 5652.0, 5406.0, 5653.0, 5478.0, 5581.0, 5515.0, 5550.0, 5494.0, 5251.0, 5405.0, 5455.0, 5385.0, 5398.0, 5287.0, 5437.0, 5641.0, 5472.0, 5428.0, 5296.0, 5336.0, 5377.0, 5475.0, 5339.0, 5553.0, 5701.0, 5676.0, 5539.0, 5427.0, 5436.0, 5700.0, 5412.0, 5350.0, 5654.0, 5467.0, 5681.0, 5583.0, 5618.0, 5485.0, 5363.0, 5556.0, 5292.0, 5715.0, 5253.0, 5252.0, 5443.0, 5672.0, 5264.0, 5664.0, 5582.0, 5305.0, 5476.0, 5435.0, 5387.0, 5566.0, 5694.0, 5660.0, 5419.0, 5423.0, 5717.0, 5712.0, 5615.0, 5512.0, 5471.0, 5277.0, 5495.0, 5610.0, 5623.0 (number of hits: 10)

26	5270	9	1	333	1	<p>5608.0, 5261.0, 5527.0, 5453.0, 5517.0, 5344.0, 5478.0, 5633.0, 5316.0, 5685.0, 5606.0, 5332.0, 5504.0, 5610.0, 5277.0, 5427.0, 5429.0, 5562.0, 5474.0, 5409.0, 5544.0, 5389.0, 5670.0, 5625.0, 5505.0, 5695.0, 5382.0, 5472.0, 5406.0, 5297.0, 5515.0, 5469.0, 5719.0, 5293.0, 5607.0, 5546.0, 5296.0, 5586.0, 5322.0, 5352.0, 5668.0, 5310.0, 5499.0, 5691.0, 5488.0, 5468.0, 5498.0, 5694.0, 5531.0, 5363.0, 5580.0, 5345.0, 5617.0, 5286.0, 5624.0, 5271.0, 5282.0, 5401.0, 5432.0, 5521.0, 5356.0, 5582.0, 5400.0, 5451.0, 5288.0, 5473.0, 5276.0, 5269.0, 5381.0, 5268.0, 5587.0, 5413.0, 5337.0, 5508.0, 5535.0, 5444.0, 5568.0, 5679.0, 5476.0, 5579.0, 5349.0, 5577.0, 5548.0, 5357.0, 5649.0, 5354.0, 5383.0, 5711.0, 5275.0, 5644.0, 5272.0, 5672.0, 5583.0, 5661.0, 5497.0, 5556.0, 5700.0, 5589.0, 5709.0, 5639.0 (number of hits: 11)</p>
27	5270	9	1	333	1	<p>5302.0, 5601.0, 5503.0, 5588.0, 5284.0, 5401.0, 5303.0, 5308.0, 5344.0, 5650.0, 5322.0, 5413.0, 5596.0, 5617.0, 5675.0, 5356.0, 5330.0, 5527.0, 5719.0, 5389.0, 5585.0, 5518.0, 5252.0, 5661.0, 5631.0, 5561.0, 5531.0, 5283.0, 5576.0, 5698.0, 5678.0, 5694.0, 5565.0, 5337.0, 5486.0, 5333.0, 5335.0, 5473.0, 5378.0, 5269.0, 5365.0, 5633.0, 5407.0, 5592.0, 5559.0, 5579.0, 5384.0, 5702.0, 5438.0, 5541.0, 5580.0, 5345.0, 5460.0, 5500.0, 5724.0, 5602.0, 5449.0, 5571.0, 5309.0, 5444.0, 5256.0, 5279.0, 5517.0, 5478.0, 5516.0, 5641.0, 5442.0, 5673.0, 5507.0, 5583.0, 5668.0, 5715.0, 5336.0, 5493.0, 5647.0, 5343.0, 5394.0, 5459.0, 5450.0, 5546.0, 5528.0, 5424.0, 5717.0, 5348.0, 5297.0, 5328.0, 5293.0, 5430.0, 5696.0, 5451.0, 5703.0, 5574.0, 5321.0, 5613.0, 5458.0, 5261.0, 5469.0, 5639.0, 5300.0, 5455.0 (number of hits: 7)</p>
28	5270	9	1	333	1	<p>5366.0, 5407.0, 5339.0, 5571.0, 5553.0, 5509.0, 5315.0, 5606.0, 5250.0, 5617.0, 5459.0, 5280.0, 5558.0, 5551.0, 5574.0, 5442.0, 5604.0, 5506.0, 5536.0, 5461.0, 5364.0, 5588.0, 5503.0, 5680.0, 5478.0, 5401.0, 5610.0, 5554.0, 5453.0, 5586.0, 5286.0, 5426.0, 5479.0, 5383.0, 5684.0, 5525.0, 5419.0, 5405.0, 5658.0, 5547.0, 5655.0, 5414.0, 5575.0, 5290.0, 5689.0, 5289.0, 5417.0, 5367.0, 5266.0, 5682.0, 5481.0, 5343.0, 5471.0, 5601.0, 5499.0, 5609.0, 5628.0, 5587.0, 5378.0, 5641.0, 5402.0, 5567.0, 5271.0, 5379.0, 5513.0, 5278.0, 5664.0, 5469.0, 5424.0, 5391.0, 5347.0, 5415.0, 5473.0, 5317.0, 5720.0, 5387.0, 5721.0, 5370.0, 5427.0, 5524.0, 5324.0, 5623.0, 5563.0, 5356.0, 5263.0,</p>

						5683.0, 5431.0, 5714.0, 5539.0, 5296.0, 5397.0, 5256.0, 5550.0, 5325.0, 5373.0, 5346.0, 5350.0, 5268.0, 5275.0, 5337.0 (number of hits: 11)
29	5270	9	1	333	1	5533.0, 5398.0, 5530.0, 5430.0, 5589.0, 5425.0, 5471.0, 5442.0, 5721.0, 5258.0, 5364.0, 5631.0, 5706.0, 5645.0, 5548.0, 5666.0, 5412.0, 5447.0, 5278.0, 5474.0, 5640.0, 5550.0, 5354.0, 5668.0, 5291.0, 5619.0, 5511.0, 5710.0, 5483.0, 5279.0, 5394.0, 5458.0, 5707.0, 5552.0, 5469.0, 5648.0, 5381.0, 5335.0, 5519.0, 5310.0, 5326.0, 5378.0, 5656.0, 5535.0, 5251.0, 5392.0, 5543.0, 5461.0, 5421.0, 5353.0, 5393.0, 5575.0, 5350.0, 5563.0, 5562.0, 5316.0, 5343.0, 5440.0, 5498.0, 5560.0, 5261.0, 5561.0, 5646.0, 5438.0, 5502.0, 5418.0, 5273.0, 5456.0, 5476.0, 5518.0, 5453.0, 5444.0, 5641.0, 5323.0, 5523.0, 5718.0, 5334.0, 5399.0, 5457.0, 5263.0, 5713.0, 5580.0, 5678.0, 5553.0, 5318.0, 5577.0, 5609.0, 5620.0, 5685.0, 5411.0, 5515.0, 5360.0, 5684.0, 5389.0, 5272.0, 5615.0, 5654.0, 5322.0, 5700.0, 5544.0 (number of hits: 8)
30	5270	9	1	333	1	5712.0, 5279.0, 5723.0, 5564.0, 5628.0, 5467.0, 5541.0, 5663.0, 5580.0, 5661.0, 5709.0, 5692.0, 5523.0, 5662.0, 5532.0, 5252.0, 5606.0, 5687.0, 5328.0, 5688.0, 5335.0, 5332.0, 5355.0, 5322.0, 5251.0, 5681.0, 5556.0, 5385.0, 5405.0, 5643.0, 5283.0, 5428.0, 5528.0, 5637.0, 5307.0, 5447.0, 5684.0, 5585.0, 5569.0, 5468.0, 5483.0, 5586.0, 5581.0, 5677.0, 5364.0, 5658.0, 5557.0, 5549.0, 5522.0, 5682.0, 5538.0, 5653.0, 5409.0, 5498.0, 5636.0, 5679.0, 5666.0, 5351.0, 5324.0, 5312.0, 5516.0, 5638.0, 5407.0, 5652.0, 5360.0, 5594.0, 5570.0, 5698.0, 5369.0, 5411.0, 5302.0, 5689.0, 5697.0, 5366.0, 5597.0, 5673.0, 5560.0, 5261.0, 5543.0, 5298.0, 5644.0, 5457.0, 5584.0, 5657.0, 5502.0, 5694.0, 5529.0, 5424.0, 5275.0, 5440.0, 5509.0, 5550.0, 5268.0, 5591.0, 5616.0, 5722.0, 5423.0, 5707.0, 5515.0, 5266.0 (number of hits: 8)

5290 MHz, 80 MHz Bandwidth

Radar Signal Type	Waveform/Trial Number	Detection (%)	Limit (%)	Pass/Fail
Type 1A/1B	30	100 %	60%	Pass
Type 2	30	100 %	60%	Pass
Type 3	30	100 %	60%	Pass
Type 4	30	100 %	60%	Pass
Aggregate (Type1 to 4)	120	100 %	80%	Pass
Type 5	30	93.3 %	80%	Pass
Type 6	30	100 %	70%	Pass

Please refer to the following statistical tables:

5290 MHz, 80 MHz Bandwidth

Table-1A/1B Radar Type 1A/1B Statistical Performance

Trial #	Fc (MHz)	Pulse/Burst	Pulse Width (μS)	PRI (μs)	Detection (1:yes; 0:no)
1	5290	67	1	798	1
2	5290	76	1	698	1
3	5290	61	1	878	1
4	5290	86	1	618	1
5	5290	89	1	598	1
6	5290	70	1	758	1
7	5290	59	1	898	1
8	5290	18	1	3066	1
9	5290	63	1	838	1
10	5290	95	1	558	1
11	5290	83	1	638	1
12	5290	102	1	518	1
13	5290	62	1	858	1
14	5290	65	1	818	1
15	5290	92	1	578	1
16	5290	31	1	1757	1
17	5290	21	1	2607	1
18	5290	19	1	2794	1
19	5290	26	1	2063	1
20	5290	19	1	2822	1
21	5290	27	1	1997	1
22	5290	41	1	1302	1
23	5290	40	1	1349	1
24	5290	33	1	1601	1
25	5290	26	1	2078	1
26	5290	58	1	911	1
27	5290	26	1	2048	1
28	5290	35	1	1510	1
29	5290	49	1	1093	1
30	5290	27	1	1968	1
Detection Percentage: 100 % (>60%)					

Table-2 Radar Type 2 Statistical Performance

Trial #	Fc (MHz)	Pulse/Burst	Pulse Width (µS)	PRI (µs)	Detection (1:yes; 0:no)
1	5290	28	3.7	227	1
2	5290	24	1.8	175	1
3	5290	27	3.7	152	1
4	5290	24	1.9	192	1
5	5290	29	1.6	155	1
6	5290	23	2.9	184	1
7	5290	24	4.1	184	1
8	5290	28	2.4	185	1
9	5290	29	1.1	215	1
10	5290	28	4.3	155	1
11	5290	28	4.4	230	1
12	5290	27	1.6	177	1
13	5290	27	4.7	152	1
14	5290	27	2.9	215	1
15	5290	26	1.9	174	1
16	5290	24	4.3	161	1
17	5290	23	1.4	210	1
18	5290	29	3.8	200	1
19	5290	26	3.5	173	1
20	5290	25	3.6	203	1
21	5290	26	4.7	165	1
22	5290	23	2.3	175	1
23	5290	28	3.8	169	1
24	5290	28	3.5	179	1
25	5290	25	4.3	202	1
26	5290	23	1.6	163	1
27	5290	25	1.2	209	1
28	5290	24	2	220	1
29	5290	25	1.1	187	1
30	5290	24	1.6	160	1
Detection Percentage: 100 % (>60%)					

Table-3 Radar Type 3 Statistical Performance

Trial #	Fc (MHz)	Pulse/Burst	Pulse Width (µS)	PRI (µs)	Detection (1:yes; 0:no)
1	5290	16	9.5	336	1
2	5290	18	6.1	418	1
3	5290	16	7.2	305	1
4	5290	16	6.8	356	1
5	5290	16	6.8	462	1
6	5290	18	7.4	290	1
7	5290	18	9.8	407	1
8	5290	18	8	455	1
9	5290	17	7.7	464	1
10	5290	17	6.6	289	1
11	5290	16	7.7	458	1
12	5290	16	9	478	1
13	5290	18	9.2	290	1
14	5290	18	6.2	493	1
15	5290	18	6.6	220	1
16	5290	16	9	213	1
17	5290	17	6.5	270	1
18	5290	18	7.4	430	1
19	5290	18	6.9	258	1
20	5290	18	8.7	431	1
21	5290	18	9.5	415	1
22	5290	17	8.4	457	1
23	5290	17	7.7	470	1
24	5290	17	8.7	498	1
25	5290	18	6.2	347	1
26	5290	18	8.6	400	1
27	5290	16	9.9	202	1
28	5290	17	9.5	236	1
29	5290	17	8.5	258	1
30	5290	17	9	267	1
Detection Percentage: 100 % (>60%)					

Table-4 Radar Type 4 Statistical Performance

Trial #	Fc (MHz)	Pulse/Burst	Pulse Width (µS)	PRI (µs)	Detection (1:yes; 0:no)
1	5290	15	14.1	404	1
2	5290	16	14.2	229	1
3	5290	15	14	208	1
4	5290	15	14	219	1
5	5290	12	12.5	341	1
6	5290	14	13	230	1
7	5290	13	19.4	404	1
8	5290	14	16.7	487	1
9	5290	13	12.1	281	1
10	5290	16	12.8	325	1
11	5290	13	11.6	429	1
12	5290	15	19.2	492	1
13	5290	15	14.7	239	1
14	5290	14	15.5	292	1
15	5290	15	11.6	409	1
16	5290	14	13.5	285	1
17	5290	12	19.2	309	1
18	5290	13	13.2	427	1
19	5290	16	17.4	279	1
20	5290	15	19.2	255	1
21	5290	13	17.4	480	1
22	5290	14	14.7	200	1
23	5290	16	20	438	1
24	5290	14	17.1	248	1
25	5290	13	19.5	311	1
26	5290	14	11.7	365	1
27	5290	14	17.2	342	1
28	5290	14	16.6	310	1
29	5290	12	20	357	1
30	5290	14	16.5	462	1
Detection Percentage: 100 % (>60%)					

Table-5 Radar Type 5 Statistical Performance

Trial #	Fc (MHz)	Detection (1:yes; 0:no)
1	5290	1
2	5290	1
3	5290	1
4	5290	1
5	5290	1
6	5290	1
7	5290	1
8	5290	1
9	5290	1
10	5290	1
11	5256.2	1
12	5256.6	1
13	5258.2	0
14	5253.4	1
15	5255	1
16	5258.6	1
17	5257.8	1
18	5254.6	1
19	5256.2	1
20	5254.2	0
21	5326.2	1
22	5324.6	1
23	5326.2	1
24	5323	1
25	5326.6	1
26	5324.2	1
27	5327	1
28	5322.6	1
29	5325	1
30	5325	1
Detection Percentage: 93.3 % (>80%)		

Bin5 Statistics 1

Trial #	Pulse	Chirp (MHz)	Pulse Width (μS)	Pulse 1-2 spacing (uS)	Pulse 2-3 spacing (uS)	Pulse Start(S)	Detection (1:yes; 0:no)
0	3	19	76.1	1606	1336	0.250314	1
1	2	19	73.7	1883		1.331762	
2	1	19	85.9			2.256613	
3	2	19	63.1	1582		2.648976	
4	1	19	96.1			3.449479	
5	1	19	77.2			4.461345	
6	2	19	91.8	1994		5.534837	
7	3	19	96.7	1914	1923	6.005011	
8	2	19	68.3	1215		7.111983	
9	1	19	70.1			7.56273	
10	1	19	56.9			8.15617	
11	1	19	64.8			8.943607	
12	3	19	77.2	1023	1070	10.208245	
13	1	19	74.7			10.612596	
14	1	19	97.8			11.593871	

Bin5 Statistics 2

Trial #	Pulse	Chirp (MHz)	Pulse Width (μS)	Pulse 1-2 spacing (uS)	Pulse 2-3 spacing (uS)	Pulse Start(S)	Detection (1:yes; 0:no)
0	2	11	75.4	1203		0.229802	1
1	2	11	85.7	1931		0.66969	
2	1	11	80.7			1.58766	
3	2	11	50.6	1990		2.492816	
4	2	11	88.8	1396		2.584927	
5	1	11	95.4			3.755235	
6	2	11	60	1319		4.064496	
7	3	11	62.5	1893	1282	5.025029	
8	2	11	50	1217		5.628265	
9	1	11	67.3			6.293363	
10	2	11	60.6	1926		6.558754	
11	2	11	96	1673		7.547571	
12	2	11	63.7	1091		8.015753	
13	1	11	90.2			8.566656	
14	2	11	92.5	1284		8.946805	
15	3	11	57.7	1144	1442	9.808227	
16	3	11	94.5	1530	1824	10.618536	
17	3	11	74	1165	1714	11.015644	
18	2	11	86.6	1627		11.729755	

Bin5 Statistics 3

Trial #	Pulse	Chirp (MHz)	Pulse Width (µS)	Pulse 1-2 spacing (uS)	Pulse 2-3 spacing (uS)	Pulse Start(S)	Detection (1:yes; 0:no)
0	2	14	82.7	1368		0.634166	1
1	3	14	60.1	1211	1424	1.618002	
2	2	14	81	1920		2.502828	
3	1	14	89.2			3.116244	
4	1	14	91.2			4.280449	
5	2	14	67.5	1280		4.996652	
6	1	14	52.3			5.445591	
7	3	14	85.7	1364	1281	6.139522	
8	2	14	78.7	1420		7.196913	
9	3	14	71.4	1407	1083	8.500243	
10	2	14	93.7	1850		8.946812	
11	2	14	54.7	1291		9.868261	
12	2	14	70.1	1438		10.997435	
13	2	14	79.3	1249		11.640669	

Bin5 Statistics 4

Trial #	Pulse	Chirp (MHz)	Pulse Width (µS)	Pulse 1-2 spacing (uS)	Pulse 2-3 spacing (uS)	Pulse Start(S)	Detection (1:yes; 0:no)
0	1	15	61.6			0.223505	1
1	1	15	94.4			0.891289	
2	2	15	60	1335		1.773863	
3	1	15	84.9			2.414277	
4	2	15	71.2	1208		3.401583	
5	3	15	55.5	1179	1432	3.775672	
6	3	15	59.2	1315	1927	4.854197	
7	3	15	88.3	1604	1925	5.575392	
8	2	15	50.1	1866		5.837536	
9	3	15	96.8	1280	1785	6.893424	
10	1	15	62.2			7.119035	
11	2	15	69.6	1819		7.945526	
12	2	15	77	1438		8.587645	
13	1	15	62.5			9.30525	
14	1	15	90.4			10.061023	
15	2	15	89	1544		11.158194	
16	3	15	66.3	1115	1539	11.879771	

Bin5 Statistics 5

Trial #	Pulse	Chirp (MHz)	Pulse Width (µS)	Pulse 1-2 spacing (uS)	Pulse 2-3 spacing (uS)	Pulse Start(S)	Detection (1:yes; 0:no)
0	3	6	79.4	1381	1805	0.865182	1
1	1	6	83.8			1.704666	
2	2	6	71.3	1118		2.252931	
3	3	6	74	1954	1671	3.064198	
4	1	6	80.5			4.707472	
5	2	6	57.5	1998		5.744877	
6	2	6	73.1	1147		6.836459	
7	1	6	52			7.020483	
8	1	6	84.7			8.88407	
9	3	6	89.5	1288	1297	9.870374	
10	2	6	51.4	1509		10.881622	
11	3	6	61.2	1255	1933	11.355097	

Bin5 Statistics 6

Trial #	Pulse	Chirp (MHz)	Pulse Width (µS)	Pulse 1-2 spacing (uS)	Pulse 2-3 spacing (uS)	Pulse Start(S)	Detection (1:yes; 0:no)
0	2	9	94.5	1969		0.61547	1
1	1	9	91			1.936288	
2	3	9	94.5	1476	1359	2.388455	
3	2	9	53.6	1616		3.785832	
4	2	9	90.3	1966		4.223328	
5	3	9	64	1554	1999	5.967843	
6	1	9	57.9			6.937801	
7	1	9	95.3			7.185104	
8	1	9	67.1			8.525029	
9	2	9	65.3	1133		9.489618	
10	2	9	64.2	1872		10.994712	
11	3	9	86.2	1934	1720	11.719267	

Bin5 Statistics 7

Trial #	Pulse	Chirp (MHz)	Pulse Width (µS)	Pulse 1-2 spacing (uS)	Pulse 2-3 spacing (uS)	Pulse Start(S)	Detection (1:yes; 0:no)
0	2	8	73.2	1948		0.071442	1
1	2	8	70.7	1007		1.751901	
2	1	8	74.6			2.122577	
3	3	8	77.3	1632	1186	2.780931	
4	2	8	55.1	1554		3.80535	
5	2	8	85.6	1581		5.145177	
6	2	8	81.3	1349		5.688133	
7	2	8	77.6	1121		7.010834	
8	3	8	74.2	1798	1700	7.920283	
9	3	8	95.9	1233	1944	9.067988	
10	2	8	95	1648		10.085502	
11	3	8	76.3	1111	1786	10.954681	
12	1	8	80			11.134204	

Bin5 Statistics 8

Trial #	Pulse	Chirp (MHz)	Pulse Width (µS)	Pulse 1-2 spacing (uS)	Pulse 2-3 spacing (uS)	Pulse Start(S)	Detection (1:yes; 0:no)
0	3	12	57.6	1465	1522	0.444571	1
1	1	12	66.8			1.037625	
2	2	12	98.5	1745		1.71623	
3	2	12	58.5	1203		2.047515	
4	2	12	50.2	1284		2.884196	
5	3	12	53.3	1663	1425	3.218102	
6	1	12	78.3			3.961109	
7	2	12	86	1483		4.723625	
8	3	12	96.7	1785	1861	5.52948	
9	2	12	85.4	1542		6.119813	
10	2	12	62.7	1504		6.805013	
11	3	12	65.3	1474	1231	6.962252	
12	2	12	77.6	1688		7.833757	
13	2	12	53.6	1834		8.771939	
14	3	12	83	1144	1368	9.199052	
15	3	12	67.4	1896	1561	9.962856	
16	1	12	56.3			10.123676	
17	2	12	80.4	1843		11.100888	
18	3	12	74.1	1782	1232	11.909533	

Bin5 Statistics 9

Trial #	Pulse	Chirp (MHz)	Pulse Width (µS)	Pulse 1-2 spacing (uS)	Pulse 2-3 spacing (uS)	Pulse Start(S)	Detection (1:yes; 0:no)
0	2	18	80.4	1080		0.168087	1
1	2	18	92.6	1896		0.983826	
2	3	18	99.6	1337	1353	1.63456	
3	1	18	50.5			2.290823	
4	2	18	81	1996		3.066214	
5	2	18	69.9	1297		3.275431	
6	2	18	75.7	1272		3.908458	
7	2	18	68.7	1304		4.90975	
8	3	18	95.3	1858	1788	5.507914	
9	1	18	82.9			5.849382	
10	2	18	58.9	1168		6.347227	
11	2	18	96	1323		7.175956	
12	2	18	93.5	1213		8.196506	
13	1	18	63.5			8.381033	
14	3	18	97.9	1895	1705	9.299031	
15	2	18	64.8	1201		9.876224	
16	2	18	68.2	1954		10.539156	
17	2	18	68	1799		10.757041	
18	1	18	98.9			11.466114	

Bin5 Statistics 10

Trial #	Pulse	Chirp (MHz)	Pulse Width (µS)	Pulse 1-2 spacing (uS)	Pulse 2-3 spacing (uS)	Pulse Start(S)	Detection (1:yes; 0:no)
0	2	14	52.4	1162		0.451832	1
1	2	14	76	1331		1.196016	
2	2	14	58.3	1162		2.145431	
3	3	14	98.6	1947	1294	3.065712	
4	3	14	82.3	1413	1348	4.056573	
5	3	14	75.3	1026	1414	4.77675	
6	2	14	63.9	1748		5.422276	
7	3	14	70.4	1566	1821	6.776631	
8	2	14	58.2	1117		7.315705	
9	2	14	79.8	1244		7.982586	
10	1	14	92.4			8.85132	
11	3	14	67.4	1347	1880	9.511312	
12	2	14	89.1	1054		11.000772	
13	2	14	51.6	1853		11.175969	

Bin5 Statistics 11

Trial #	Pulse	Chirp (MHz)	Pulse Width (µS)	Pulse 1-2 spacing (uS)	Pulse 2-3 spacing (uS)	Pulse Start(S)	Detection (1:yes; 0:no)
0	1	13	79.7			1.044794	1
1	3	13	60.6	1117	1288	1.787586	
2	3	13	99.5	1381	1176	2.857727	
3	3	13	86.9	1761	1666	4.440679	
4	2	13	78	1031		5.720316	
5	2	13	96.7	1592		7.064844	
6	1	13	67.3			8.895875	
7	2	13	51.4	1274		10.003289	
8	1	13	70.1			10.775649	

Bin5 Statistics 12

Trial #	Pulse	Chirp (MHz)	Pulse Width (µS)	Pulse 1-2 spacing (uS)	Pulse 2-3 spacing (uS)	Pulse Start(S)	Detection (1:yes; 0:no)
0	3	14	94	1924	1646	0.11249	1
1	3	14	50.7	1691	1137	0.8461	
2	3	14	87.2	1362	1743	1.356976	
3	2	14	93.6	1860		2.247176	
4	1	14	59.1			2.794914	
5	2	14	78.9	1230		3.626196	
6	1	14	97.7			4.567618	
7	2	14	76	1032		5.101907	
8	3	14	63	1261	1434	5.662745	
9	2	14	61.1	1088		6.154782	
10	2	14	65.2	1700		7.281916	
11	1	14	88.5			7.476436	
12	3	14	60.2	1024	1927	8.487012	
13	2	14	86.8	1271		9.237005	
14	2	14	74.8	1554		9.972668	
15	3	14	79.5	1663	1812	10.658419	
16	1	14	87.7			10.969451	
17	2	14	91.3	1477		11.843972	

Bin5 Statistics 13

Trial #	Pulse	Chirp (MHz)	Pulse Width (µS)	Pulse 1-2 spacing (µS)	Pulse 2-3 spacing (µS)	Pulse Start(S)	Detection (1:yes; 0:no)
0	2	18	65.3	1612		0.647932	0
1	1	18	66			1.590934	
2	2	18	67.5	1111		1.624934	
3	1	18	97.4			2.608508	
4	1	18	87.4			3.966615	
5	1	18	77.5			4.148306	
6	3	18	50.8	1590	1456	4.928253	
7	1	18	65.7			6.067561	
8	3	18	78	1415	1458	6.408952	
9	2	18	82.3	1719		7.523078	
10	3	18	77.8	1885	1352	8.17352	
11	2	18	87.9	1919		9.555305	
12	2	18	60.3	1669		9.635818	
13	3	18	96	1413	1380	10.73009	
14	2	18	93.5	1128		11.976511	

Bin5 Statistics 14

Trial #	Pulse	Chirp (MHz)	Pulse Width (µS)	Pulse 1-2 spacing (µS)	Pulse 2-3 spacing (µS)	Pulse Start(S)	Detection (1:yes; 0:no)
0	3	6	95.3	1663	1864	0.560237	1
1	2	6	81.9	1924		1.084478	
2	2	6	71.8	1915		1.823563	
3	2	6	91.3	1398		2.246904	
4	1	6	70.1			2.999003	
5	2	6	65.6	1311		3.595594	
6	3	6	60.2	1283	1513	4.29994	
7	3	6	78.1	1733	1745	5.610635	
8	1	6	88.2			5.706202	
9	2	6	50.4	1132		6.61624	
10	2	6	99.3	1911		7.328733	
11	2	6	96.5	1103		7.950656	
12	2	6	80.6	1565		9.015196	
13	2	6	50.7	1705		9.65673	
14	2	6	54.3	1550		10.182699	
15	3	6	76.1	1242	1412	11.102118	
16	3	6	67.5	1102	1291	11.849762	

Bin5 Statistics 15

Trial #	Pulse	Chirp (MHz)	Pulse Width (µS)	Pulse 1-2 spacing (µS)	Pulse 2-3 spacing (µS)	Pulse Start(S)	Detection (1:yes; 0:no)
0	3	10	86.5	1557	1996	0.363075	1
1	2	10	75.6	1702		1.157835	
2	2	10	66.9	1468		1.520863	
3	2	10	94.4	1535		2.120926	
4	2	10	93	1508		2.734912	
5	2	10	76	1373		3.749561	
6	2	10	61.3	1552		4.383391	
7	2	10	62.7	1341		5.257146	
8	1	10	52.5			5.741215	
9	2	10	88.4	1172		6.408723	
10	1	10	99.8			6.745569	
11	2	10	73.8	1198		7.54513	
12	2	10	84.9	1204		8.164814	
13	1	10	97			9.032862	
14	3	10	69.7	1322	1432	9.894935	
15	2	10	94.4	1491		10.341	
16	2	10	85.3	1531		11.320308	
17	3	10	90.8	1932	1786	11.510312	

Bin5 Statistics 16

Trial #	Pulse	Chirp (MHz)	Pulse Width (µS)	Pulse 1-2 spacing (µS)	Pulse 2-3 spacing (µS)	Pulse Start(S)	Detection (1:yes; 0:no)
0	1	19	95.8			0.096405	1
1	1	19	70.2			1.264489	
2	2	19	59.3	1688		1.654432	
3	2	19	54.7	1133		2.692005	
4	3	19	93.6	1185	1238	3.242059	
5	2	19	96.4	1818		4.169366	
6	2	19	62.9	1499		4.532086	
7	2	19	81.8	1228		5.187457	
8	2	19	88.4	1722		6.11393	
9	3	19	93.4	1954	1628	6.925304	
10	2	19	96.8	1505		7.629244	
11	1	19	89.8			8.337753	
12	1	19	94			9.135869	
13	2	19	62.7	1814		9.787842	
14	3	19	74.6	1740	1347	9.978772	
15	2	19	93.6	1051		10.689307	
16	2	19	89.2	1859		11.626313	

Bin5 Statistics 17

Trial #	Pulse	Chirp (MHz)	Pulse Width (µS)	Pulse 1-2 spacing (uS)	Pulse 2-3 spacing (uS)	Pulse Start(S)	Detection (1:yes; 0:no)
0	2	17	66.7	1412		0.065355	1
1	3	17	75	1378	1326	1.032445	
2	1	17	63.8			1.798228	
3	2	17	92.4	1808		2.391751	
4	1	17	50.9			2.794294	
5	1	17	94			3.427489	
6	2	17	59.4	1163		4.164634	
7	2	17	50.1	1152		4.947689	
8	2	17	57.7	1672		5.555829	
9	3	17	94.5	1072	1623	6.648355	
10	2	17	67.8	1483		7.161151	
11	2	17	73.6	1927		7.458614	
12	3	17	91.7	1523	1954	8.113521	
13	3	17	57.8	1259	1814	9.174837	
14	2	17	78.2	1045		9.370367	
15	2	17	58.5	1998		10.007553	
16	2	17	96.3	1505		11.16599	
17	1	17	93			11.969508	

Bin5 Statistics 18

Trial #	Pulse	Chirp (MHz)	Pulse Width (µS)	Pulse 1-2 spacing (uS)	Pulse 2-3 spacing (uS)	Pulse Start(S)	Detection (1:yes; 0:no)
0	1	9	80.3			0.042469	1
1	1	9	71.4			1.416846	
2	1	9	88			2.148386	
3	2	9	71.8	1029		2.653109	
4	3	9	73.4	1151	1496	3.722816	
5	3	9	74.1	1296	1143	4.596844	
6	2	9	85.1	1860		5.496216	
7	1	9	66.2			6.218875	
8	1	9	73.5			6.921192	
9	1	9	61.3			7.633106	
10	1	9	85.7			8.01454	
11	2	9	67.6	1361		9.581283	
12	3	9	81.5	1803	1340	9.87853	
13	3	9	50.6	1613	1455	10.521486	
14	2	9	78	1023		11.937617	

Bin5 Statistics 19

Trial #	Pulse	Chirp (MHz)	Pulse Width (µS)	Pulse 1-2 spacing (uS)	Pulse 2-3 spacing (uS)	Pulse Start(S)	Detection (1:yes; 0:no)
0	2	13	82.6	1862		0.780583	1
1	3	13	75.4	1403	1292	1.629875	
2	2	13	97	1929		2.501464	
3	1	13	82			3.869665	
4	3	13	95.6	1334	1607	4.917601	
5	2	13	90.7	1795		5.497249	
6	1	13	82.1			7.292494	
7	2	13	66.8	1409		8.255882	
8	1	13	71.4			9.507203	
9	3	13	52.8	1956	1080	10.022101	
10	2	13	83.1	1923		11.733795	

Bin5 Statistics 20

Trial #	Pulse	Chirp (MHz)	Pulse Width (µS)	Pulse 1-2 spacing (uS)	Pulse 2-3 spacing (uS)	Pulse Start(S)	Detection (1:yes; 0:no)
0	2	8	72.1	1961		0.0785	1
1	2	8	70.5	1013		1.27063	
2	2	8	55.6	1769		2.184103	
3	3	8	78.9	1051	1059	2.99031	
4	2	8	69.4	1041		4.366382	
5	3	8	98.1	1464	1690	5.242252	
6	3	8	50.3	1778	1165	5.986357	
7	2	8	60.9	1056		6.696592	
8	1	8	56.2			7.416864	
9	2	8	76	1438		8.969148	
10	2	8	54.4	1554		9.698262	
11	2	8	71.6	1257		10.462724	
12	3	8	88.1	1019	1672	11.523951	

Bin5 Statistics 21

Trial #	Pulse	Chirp (MHz)	Pulse Width (µS)	Pulse 1-2 spacing (µS)	Pulse 2-3 spacing (µS)	Pulse Start(S)	Detection (1:yes; 0:no)
0	2	7	72.8	1068		0.264835	1
1	2	7	66.2	1514		1.033595	
2	2	7	99.6	1609		2.164276	
3	3	7	52.6	1083	1765	3.409745	
4	1	7	86.3			3.665917	
5	2	7	99.1	1238		4.480509	
6	1	7	90.9			5.920962	
7	1	7	65.8			6.82566	
8	2	7	86.6	1406		7.232156	
9	2	7	71.3	1785		7.932239	
10	2	7	67.6	1625		9.25312	
11	3	7	54.1	1876	1561	10.06785	
12	3	7	78.3	1040	1469	10.719095	
13	3	7	76.3	1257	1407	11.832165	

Bin5 Statistics 22

Trial #	Pulse	Chirp (MHz)	Pulse Width (µS)	Pulse 1-2 spacing (µS)	Pulse 2-3 spacing (µS)	Pulse Start(S)	Detection (1:yes; 0:no)
0	2	11	84	1115		0.730393	1
1	3	11	67.5	1225	1224	1.95882	
2	2	11	95.7	1633		2.287079	
3	2	11	67.3	1897		3.182164	
4	2	11	99.2	1237		4.474291	
5	2	11	96.9	1561		5.016286	
6	1	11	69.7			6.71888	
7	3	11	51	1076	1956	7.116108	
8	2	11	81.8	1031		8.192098	
9	1	11	68.8			9.315586	
10	3	11	68.8	1791	1160	10.167316	
11	1	11	71.6			11.204984	

Bin5 Statistics 23

Trial #	Pulse	Chirp (MHz)	Pulse Width (µS)	Pulse 1-2 spacing (µS)	Pulse 2-3 spacing (µS)	Pulse Start(S)	Detection (1:yes; 0:no)
0	3	7	63.6	1032	1792	0.481371	1
1	1	7	78.3			1.062665	
2	3	7	99.4	1592	1702	1.504076	
3	2	7	77.4	1942		2.317539	
4	2	7	59.5	1372		3.323713	
5	2	7	64	1514		4.09185	
6	2	7	54.1	1378		5.118381	
7	2	7	93.7	1735		5.771632	
8	1	7	56			6.15143	
9	1	7	59.9			7.398121	
10	3	7	73.6	1154	1589	7.709003	
11	2	7	53.9	1845		8.527758	
12	3	7	80.9	1045	1536	9.41457	
13	2	7	80.7	1686		10.285031	
14	3	7	95.4	1752	1944	10.809882	
15	3	7	68.5	1066	1946	11.524313	

Bin5 Statistics 24

Trial #	Pulse	Chirp (MHz)	Pulse Width (µS)	Pulse 1-2 spacing (µS)	Pulse 2-3 spacing (µS)	Pulse Start(S)	Detection (1:yes; 0:no)
0	1	15	66.3			0.1014	1
1	3	15	61.3	1393	1405	1.568577	
2	3	15	76.8	1480	1083	3.894633	
3	2	15	95.2	1130		4.849966	
4	1	15	74.3			6.648217	
5	2	15	68.4	1508		7.721864	
6	3	15	59.6	1401	1663	9.178829	
7	2	15	79.2	1468		10.647175	
8	1	15	79.5			11.846174	

Bin5 Statistics 25

Trial #	Pulse	Chirp (MHz)	Pulse Width (µS)	Pulse 1-2 spacing (uS)	Pulse 2-3 spacing (uS)	Pulse Start(S)	Detection (1:yes; 0:no)
0	2	6	56.4	1495		1.16092	1
1	2	6	95.2	1480		1.520956	
2	2	6	91.7	1098		2.603201	
3	3	6	73.6	1043	1998	4.420167	
4	2	6	100	1043		5.418026	
5	2	6	51.9	1088		7.013039	
6	3	6	57.8	1813	1108	8.226703	
7	2	6	99.2	1325		8.82262	
8	3	6	73.8	1741	1698	10.433735	
9	2	6	61.4	1269		10.879919	

Bin5 Statistics 26

Trial #	Pulse	Chirp (MHz)	Pulse Width (µS)	Pulse 1-2 spacing (uS)	Pulse 2-3 spacing (uS)	Pulse Start(S)	Detection (1:yes; 0:no)
0	2	12	90.4	1292		0.602153	1
1	1	12	81.6			0.968378	
2	2	12	95.1	1706		2.218252	
3	2	12	50.9	1150		2.896109	
4	2	12	50.7	1022		3.240967	
5	3	12	64.2	1318	1581	4.651672	
6	2	12	89.6	1261		5.068557	
7	2	12	61.6	1857		5.672571	
8	3	12	96.4	1778	1608	6.53985	
9	2	12	73.9	1964		7.819774	
10	2	12	84.5	1358		8.424204	
11	2	12	65.8	1361		9.160248	
12	3	12	55.9	1370	1976	9.773686	
13	2	12	53.6	1355		10.62071	
14	3	12	74.1	1121	1378	11.227865	

Bin5 Statistics 27

Trial #	Pulse	Chirp (MHz)	Pulse Width (µS)	Pulse 1-2 spacing (µS)	Pulse 2-3 spacing (µS)	Pulse Start(S)	Detection (1:yes; 0:no)
0	2	5	97.7	1180		0.742517	1
1	1	5	66.2			0.945731	
2	3	5	71.9	1723	1510	1.741266	
3	1	5	80.6			2.591444	
4	3	5	61.9	1158	1591	3.523647	
5	2	5	95.6	1019		4.57365	
6	1	5	90.2			5.135148	
7	2	5	73.7	1276		5.758299	
8	3	5	68	1386	1349	6.785999	
9	2	5	60	1593		7.386802	
10	1	5	97.2			8.206897	
11	2	5	78	1183		8.944825	
12	2	5	99.1	1008		10.358067	
13	2	5	82.4	1629		11.163391	
14	2	5	84.6	1220		11.641153	

Bin5 Statistics 28

Trial #	Pulse	Chirp (MHz)	Pulse Width (µS)	Pulse 1-2 spacing (µS)	Pulse 2-3 spacing (µS)	Pulse Start(S)	Detection (1:yes; 0:no)
0	2	16	68	1294		0.648219	1
1	3	16	89.6	1627	1057	0.808777	
2	1	16	62			1.453093	
3	2	16	91	1628		2.252052	
4	2	16	58.3	1070		3.110047	
5	2	16	53.5	1530		3.954587	
6	1	16	92.1			4.202977	
7	2	16	70.1	1447		4.71002	
8	2	16	57.3	1818		5.611896	
9	2	16	89.5	1740		6.312085	
10	1	16	97.4			6.988016	
11	1	16	50.3			7.395038	
12	1	16	57.5			8.505676	
13	2	16	76.8	1058		8.800654	
14	1	16	99.9			9.684549	
15	2	16	69.9	1523		10.525541	
16	2	16	74.8	1967		10.861108	
17	2	16	52.3	1542		11.966471	

Bin5 Statistics 29

Trial #	Pulse	Chirp (MHz)	Pulse Width (µS)	Pulse 1-2 spacing (µS)	Pulse 2-3 spacing (µS)	Pulse Start(S)	Detection (1:yes; 0:no)
0	1	10	90.6			0.738248	1
1	3	10	98.2	1426	1983	1.099737	
2	2	10	88.6	1553		2.759811	
3	2	10	96.6	1649		3.531716	
4	2	10	70.4	1860		5.02836	
5	1	10	94.2			5.652066	
6	2	10	94.2	1374		7.371316	
7	1	10	61.9			8.513513	
8	1	10	89.6			9.474756	
9	3	10	74.9	1849	1792	10.511989	
10	1	10	63.4			11.355879	

Bin5 Statistics 30

Trial #	Pulse	Chirp (MHz)	Pulse Width (µS)	Pulse 1-2 spacing (µS)	Pulse 2-3 spacing (µS)	Pulse Start(S)	Detection (1:yes; 0:no)
0	2	10	99.4	1717		0.073205	0
1	1	10	73.6			2.034823	
2	2	10	97.5	1951		2.518163	
3	1	10	67			4.058685	
4	3	10	91.1	1085	1321	5.096473	
5	3	10	69.6	1397	1837	6.882854	
6	3	10	75.7	1920	1054	7.886812	
7	2	10	96.9	1572		8.893924	
8	1	10	54.7			10.167313	
9	2	10	55.8	1853		11.064648	

Table-6 Radar Type 6 Statistical Performance

Trial #	Fc (MHz)	Pulse /Burst	Pulse Width (µS)	PRI (µs)	Detection (1:yes; 0:no)	Hopping Sequence
1	5290	9	1	333	1	5410.0, 5266.0, 5353.0, 5470.0, 5724.0, 5586.0, 5569.0, 5403.0, 5406.0, 5607.0, 5264.0, 5565.0, 5265.0, 5381.0, 5464.0, 5507.0, 5623.0, 5356.0, 5428.0, 5698.0, 5517.0, 5295.0, 5337.0, 5425.0, 5632.0, 5305.0, 5657.0, 5546.0, 5315.0, 5364.0, 5397.0, 5454.0, 5559.0, 5462.0, 5671.0, 5394.0, 5471.0, 5665.0, 5624.0, 5257.0, 5326.0, 5313.0, 5273.0, 5475.0, 5615.0, 5481.0, 5707.0, 5426.0, 5556.0, 5677.0, 5483.0, 5584.0, 5424.0, 5630.0, 5358.0, 5588.0, 5639.0, 5552.0, 5479.0, 5287.0, 5523.0, 5609.0, 5487.0, 5675.0, 5549.0, 5256.0, 5383.0, 5686.0, 5502.0, 5678.0, 5527.0, 5591.0, 5526.0, 5627.0, 5322.0, 5640.0, 5647.0, 5476.0, 5450.0, 5457.0, 5645.0, 5359.0, 5343.0, 5560.0, 5498.0, 5362.0, 5505.0, 5692.0, 5659.0, 5272.0, 5339.0, 5566.0, 5330.0, 5377.0, 5697.0, 5718.0, 5534.0, 5723.0, 5373.0 (number of hits: 0)
2	5290	9	1	333	1	5500.0, 5400.0, 5649.0, 5510.0, 5421.0, 5316.0, 5389.0, 5625.0, 5703.0, 5488.0, 5491.0, 5513.0, 5270.0, 5564.0, 5719.0, 5599.0, 5630.0, 5608.0, 5490.0, 5631.0, 5284.0, 5506.0, 5258.0, 5632.0, 5494.0, 5622.0, 5356.0, 5662.0, 5593.0, 5501.0, 5687.0, 5254.0, 5562.0, 5557.0, 5575.0, 5482.0, 5431.0, 5382.0, 5331.0, 5299.0, 5486.0, 5446.0, 5397.0, 5337.0, 5332.0, 5503.0, 5520.0, 5430.0, 5548.0, 5268.0, 5441.0, 5317.0, 5550.0, 5668.0, 5485.0, 5336.0, 5353.0, 5723.0, 5426.0, 5635.0, 5448.0, 5394.0, 5527.0, 5443.0, 5252.0, 5606.0, 5370.0, 5367.0, 5341.0, 5661.0, 5395.0, 5714.0, 5712.0, 5405.0, 5684.0, 5390.0, 5716.0, 5695.0, 5371.0, 5310.0, 5278.0, 5614.0, 5365.0, 5451.0, 5387.0, 5300.0, 5361.0, 5496.0, 5563.0, 5721.0, 5366.0, 5484.0, 5515.0, 5402.0, 5565.0, 5291.0, 5724.0, 5318.0, 5523.0 (number of hits: 0)
3	5290	9	1	333	1	5634.0, 5583.0, 5533.0, 5453.0, 5632.0, 5658.0, 5314.0, 5573.0, 5372.0, 5487.0, 5457.0, 5597.0, 5395.0, 5407.0, 5692.0, 5515.0, 5469.0, 5320.0, 5295.0, 5661.0, 5537.0, 5274.0, 5449.0, 5704.0, 5326.0, 5552.0, 5397.0, 5504.0, 5265.0, 5442.0, 5445.0, 5307.0, 5414.0, 5641.0, 5678.0, 5405.0, 5505.0, 5366.0, 5452.0, 5439.0, 5424.0, 5571.0, 5475.0, 5502.0, 5520.0, 5662.0, 5292.0, 5383.0, 5371.0, 5344.0, 5361.0, 5723.0, 5418.0, 5599.0, 5438.0,

						5620.0, 5346.0, 5664.0, 5303.0, 5724.0, 5341.0, 5624.0, 5338.0, 5382.0, 5468.0, 5306.0, 5478.0, 5551.0, 5645.0, 5612.0, 5428.0, 5508.0, 5363.0, 5610.0, 5476.0, 5378.0, 5536.0, 5364.0, 5481.0, 5448.0, 5297.0, 5554.0, 5464.0, 5466.0, 5368.0, 5514.0, 5390.0, 5592.0, 5484.0, 5548.0, 5252.0, 5654.0, 5473.0, 5310.0, 5293.0, 5639.0, 5488.0, 5406.0, 5722.0 (number of hits: 0)
4	5290	9	1	333	1	5439.0, 5509.0, 5601.0, 5532.0, 5415.0, 5703.0, 5333.0, 5712.0, 5420.0, 5318.0, 5599.0, 5553.0, 5433.0, 5581.0, 5317.0, 5631.0, 5682.0, 5351.0, 5258.0, 5604.0, 5301.0, 5449.0, 5362.0, 5488.0, 5502.0, 5322.0, 5329.0, 5272.0, 5716.0, 5287.0, 5290.0, 5591.0, 5370.0, 5286.0, 5395.0, 5623.0, 5487.0, 5404.0, 5440.0, 5562.0, 5398.0, 5622.0, 5451.0, 5596.0, 5303.0, 5714.0, 5413.0, 5569.0, 5257.0, 5518.0, 5582.0, 5707.0, 5263.0, 5401.0, 5265.0, 5349.0, 5446.0, 5321.0, 5424.0, 5337.0, 5704.0, 5594.0, 5478.0, 5711.0, 5458.0, 5643.0, 5486.0, 5430.0, 5548.0, 5461.0, 5510.0, 5305.0, 5706.0, 5344.0, 5640.0, 5358.0, 5280.0, 5323.0, 5555.0, 5719.0, 5288.0, 5662.0, 5366.0, 5477.0, 5674.0, 5340.0, 5580.0, 5603.0, 5394.0, 5334.0, 5577.0, 5282.0, 5560.0, 5283.0, 5456.0, 5498.0, 5460.0, 5680.0, 5250.0 (number of hits: 0)
5	5290	9	1	333	1	5419.0, 5455.0, 5380.0, 5704.0, 5558.0, 5594.0, 5724.0, 5678.0, 5490.0, 5507.0, 5691.0, 5719.0, 5696.0, 5616.0, 5431.0, 5388.0, 5511.0, 5310.0, 5480.0, 5392.0, 5499.0, 5689.0, 5637.0, 5586.0, 5699.0, 5591.0, 5277.0, 5265.0, 5387.0, 5530.0, 5690.0, 5536.0, 5592.0, 5627.0, 5500.0, 5298.0, 5424.0, 5460.0, 5585.0, 5651.0, 5462.0, 5459.0, 5306.0, 5659.0, 5273.0, 5539.0, 5381.0, 5553.0, 5506.0, 5697.0, 5390.0, 5671.0, 5262.0, 5565.0, 5465.0, 5425.0, 5291.0, 5545.0, 5413.0, 5403.0, 5575.0, 5636.0, 5264.0, 5343.0, 5615.0, 5494.0, 5259.0, 5328.0, 5700.0, 5285.0, 5466.0, 5303.0, 5638.0, 5515.0, 5446.0, 5525.0, 5505.0, 5589.0, 5450.0, 5323.0, 5280.0, 5464.0, 5688.0, 5473.0, 5603.0, 5252.0, 5555.0, 5407.0, 5599.0, 5695.0, 5329.0, 5423.0, 5293.0, 5714.0, 5509.0, 5286.0, 5331.0, 5476.0, 5559.0 (number of hits: 0)
6	5290	9	1	333	1	5274.0, 5437.0, 5564.0, 5421.0, 5665.0, 5495.0, 5546.0, 5279.0, 5659.0, 5589.0, 5538.0, 5539.0, 5451.0, 5426.0, 5320.0, 5535.0, 5621.0, 5627.0, 5545.0, 5302.0, 5694.0, 5667.0, 5622.0, 5332.0, 5507.0, 5313.0, 5457.0, 5285.0, 5501.0, 5410.0, 5456.0, 5611.0, 5411.0, 5528.0, 5651.0,

						5474.0, 5567.0, 5481.0, 5711.0, 5461.0, 5337.0, 5260.0, 5296.0, 5695.0, 5414.0, 5505.0, 5333.0, 5568.0, 5543.0, 5650.0, 5269.0, 5344.0, 5334.0, 5341.0, 5687.0, 5266.0, 5396.0, 5579.0, 5559.0, 5720.0, 5480.0, 5436.0, 5253.0, 5312.0, 5288.0, 5319.0, 5681.0, 5419.0, 5598.0, 5514.0, 5606.0, 5724.0, 5577.0, 5624.0, 5578.0, 5561.0, 5403.0, 5716.0, 5298.0, 5379.0, 5450.0, 5475.0, 5417.0, 5530.0, 5585.0, 5389.0, 5673.0, 5278.0, 5641.0, 5649.0, 5601.0, 5717.0, 5494.0, 5383.0, 5662.0, 5380.0, 5478.0, 5444.0, 5273.0 (number of hits: 0)
7	5290	9	1	333	1	5409.0, 5421.0, 5450.0, 5275.0, 5408.0, 5363.0, 5438.0, 5453.0, 5435.0, 5312.0, 5273.0, 5340.0, 5626.0, 5294.0, 5361.0, 5583.0, 5664.0, 5514.0, 5349.0, 5303.0, 5633.0, 5255.0, 5284.0, 5329.0, 5454.0, 5644.0, 5412.0, 5559.0, 5565.0, 5261.0, 5446.0, 5257.0, 5401.0, 5606.0, 5693.0, 5419.0, 5561.0, 5487.0, 5718.0, 5660.0, 5622.0, 5455.0, 5630.0, 5333.0, 5483.0, 5525.0, 5673.0, 5320.0, 5690.0, 5512.0, 5688.0, 5362.0, 5680.0, 5621.0, 5613.0, 5291.0, 5637.0, 5721.0, 5627.0, 5429.0, 5632.0, 5292.0, 5519.0, 5602.0, 5286.0, 5574.0, 5549.0, 5667.0, 5407.0, 5416.0, 5418.0, 5529.0, 5720.0, 5259.0, 5507.0, 5678.0, 5694.0, 5375.0, 5591.0, 5716.0, 5488.0, 5712.0, 5289.0, 5347.0, 5524.0, 5568.0, 5649.0, 5691.0, 5674.0, 5287.0, 5338.0, 5343.0, 5315.0, 5616.0, 5451.0, 5611.0, 5672.0, 5671.0, 5297.0, 5544.0 (number of hits: 13)
8	5290	9	1	333	1	5708.0, 5678.0, 5697.0, 5580.0, 5367.0, 5441.0, 5288.0, 5520.0, 5721.0, 5625.0, 5587.0, 5577.0, 5502.0, 5464.0, 5558.0, 5614.0, 5278.0, 5680.0, 5396.0, 5437.0, 5545.0, 5427.0, 5375.0, 5634.0, 5377.0, 5531.0, 5682.0, 5256.0, 5659.0, 5575.0, 5576.0, 5650.0, 5641.0, 5649.0, 5507.0, 5499.0, 5419.0, 5261.0, 5699.0, 5439.0, 5276.0, 5264.0, 5333.0, 5484.0, 5429.0, 5304.0, 5371.0, 5569.0, 5257.0, 5345.0, 5269.0, 5404.0, 5694.0, 5628.0, 5302.0, 5326.0, 5479.0, 5592.0, 5459.0, 5683.0, 5658.0, 5610.0, 5425.0, 5402.0, 5595.0, 5512.0, 5519.0, 5647.0, 5510.0, 5266.0, 5475.0, 5316.0, 5543.0, 5274.0, 5593.0, 5476.0, 5285.0, 5612.0, 5485.0, 5517.0, 5373.0, 5303.0, 5453.0, 5291.0, 5664.0, 5349.0, 5674.0, 5518.0, 5466.0, 5258.0, 5656.0, 5495.0, 5267.0, 5559.0, 5710.0, 5488.0, 5470.0, 5605.0, 5509.0, 5386.0 (number of hits: 10)
9	5290	9	1	333	1	5335.0, 5628.0, 5287.0, 5593.0, 5667.0, 5341.0, 5476.0, 5404.0, 5598.0, 5407.0, 5428.0, 5257.0, 5330.0, 5321.0, 5716.0,

						5545.0, 5579.0, 5379.0, 5279.0, 5274.0, 5482.0, 5385.0, 5709.0, 5645.0, 5391.0, 5520.0, 5613.0, 5528.0, 5556.0, 5559.0, 5676.0, 5276.0, 5403.0, 5266.0, 5349.0, 5288.0, 5717.0, 5514.0, 5460.0, 5505.0, 5634.0, 5653.0, 5329.0, 5491.0, 5626.0, 5603.0, 5362.0, 5382.0, 5296.0, 5400.0, 5325.0, 5360.0, 5591.0, 5509.0, 5507.0, 5535.0, 5277.0, 5549.0, 5666.0, 5702.0, 5632.0, 5452.0, 5519.0, 5566.0, 5707.0, 5483.0, 5576.0, 5561.0, 5540.0, 5302.0, 5309.0, 5596.0, 5271.0, 5284.0, 5265.0, 5471.0, 5297.0, 5344.0, 5304.0, 5601.0, 5590.0, 5447.0, 5394.0, 5357.0, 5665.0, 5374.0, 5345.0, 5465.0, 5473.0, 5381.0, 5712.0, 5422.0, 5415.0, 5630.0, 5421.0, 5484.0, 5530.0, 5278.0, 5440.0, 5552.0 (number of hits: 14)
10	5290	9	1	333	1	5275.0, 5438.0, 5338.0, 5436.0, 5688.0, 5567.0, 5479.0, 5696.0, 5323.0, 5316.0, 5504.0, 5652.0, 5423.0, 5302.0, 5261.0, 5380.0, 5609.0, 5287.0, 5551.0, 5686.0, 5409.0, 5452.0, 5490.0, 5324.0, 5575.0, 5298.0, 5675.0, 5290.0, 5557.0, 5592.0, 5307.0, 5362.0, 5694.0, 5286.0, 5258.0, 5321.0, 5300.0, 5522.0, 5560.0, 5429.0, 5502.0, 5339.0, 5716.0, 5622.0, 5588.0, 5700.0, 5470.0, 5356.0, 5642.0, 5413.0, 5516.0, 5571.0, 5532.0, 5389.0, 5639.0, 5670.0, 5707.0, 5605.0, 5455.0, 5494.0, 5476.0, 5495.0, 5552.0, 5426.0, 5687.0, 5702.0, 5384.0, 5368.0, 5671.0, 5576.0, 5706.0, 5541.0, 5699.0, 5566.0, 5343.0, 5512.0, 5378.0, 5381.0, 5322.0, 5715.0, 5539.0, 5283.0, 5375.0, 5606.0, 5477.0, 5689.0, 5273.0, 5493.0, 5385.0, 5723.0, 5593.0, 5658.0, 5643.0, 5407.0, 5648.0, 5418.0, 5640.0, 5294.0, 5519.0, 5474.0 (number of hits: 12)
11	5290	9	1	333	1	5622.0, 5295.0, 5301.0, 5293.0, 5477.0, 5535.0, 5360.0, 5380.0, 5470.0, 5488.0, 5642.0, 5385.0, 5710.0, 5522.0, 5714.0, 5351.0, 5533.0, 5316.0, 5656.0, 5258.0, 5296.0, 5672.0, 5490.0, 5404.0, 5348.0, 5530.0, 5713.0, 5451.0, 5619.0, 5612.0, 5299.0, 5280.0, 5422.0, 5327.0, 5428.0, 5379.0, 5275.0, 5564.0, 5722.0, 5610.0, 5633.0, 5353.0, 5480.0, 5640.0, 5478.0, 5325.0, 5505.0, 5281.0, 5373.0, 5694.0, 5635.0, 5605.0, 5696.0, 5534.0, 5311.0, 5349.0, 5358.0, 5609.0, 5439.0, 5297.0, 5430.0, 5268.0, 5531.0, 5401.0, 5719.0, 5504.0, 5337.0, 5524.0, 5576.0, 5441.0, 5693.0, 5256.0, 5548.0, 5261.0, 5330.0, 5440.0, 5688.0, 5525.0, 5677.0, 5593.0, 5641.0, 5365.0, 5443.0, 5457.0, 5350.0, 5269.0, 5454.0, 5447.0, 5549.0, 5508.0, 5375.0, 5606.0, 5328.0, 5520.0, 5403.0, 5627.0, 5597.0, 5371.0, 5712.0, 5345.0

						(number of hits: 11)
12	5290	9	1	333	1	5293.0, 5655.0, 5572.0, 5501.0, 5289.0, 5472.0, 5281.0, 5602.0, 5691.0, 5560.0, 5608.0, 5558.0, 5544.0, 5274.0, 5433.0, 5491.0, 5290.0, 5592.0, 5385.0, 5460.0, 5421.0, 5669.0, 5259.0, 5667.0, 5712.0, 5622.0, 5352.0, 5660.0, 5360.0, 5582.0, 5395.0, 5455.0, 5619.0, 5332.0, 5586.0, 5668.0, 5382.0, 5611.0, 5413.0, 5294.0, 5309.0, 5432.0, 5425.0, 5672.0, 5546.0, 5428.0, 5556.0, 5596.0, 5536.0, 5359.0, 5528.0, 5492.0, 5380.0, 5448.0, 5258.0, 5357.0, 5477.0, 5321.0, 5427.0, 5456.0, 5393.0, 5657.0, 5406.0, 5601.0, 5262.0, 5495.0, 5659.0, 5301.0, 5351.0, 5537.0, 5531.0, 5377.0, 5632.0, 5284.0, 5580.0, 5521.0, 5715.0, 5664.0, 5418.0, 5590.0, 5620.0, 5416.0, 5532.0, 5551.0, 5464.0, 5511.0, 5384.0, 5534.0, 5704.0, 5363.0, 5597.0, 5539.0, 5559.0, 5441.0, 5251.0, 5703.0, 5269.0, 5291.0, 5453.0, 5519.0
						(number of hits: 10)
13	5290	9	1	333	1	5477.0, 5683.0, 5429.0, 5438.0, 5581.0, 5654.0, 5680.0, 5598.0, 5614.0, 5424.0, 5698.0, 5501.0, 5459.0, 5340.0, 5317.0, 5638.0, 5380.0, 5580.0, 5576.0, 5567.0, 5526.0, 5301.0, 5675.0, 5489.0, 5386.0, 5442.0, 5349.0, 5596.0, 5407.0, 5402.0, 5457.0, 5422.0, 5607.0, 5721.0, 5594.0, 5445.0, 5642.0, 5701.0, 5430.0, 5696.0, 5265.0, 5643.0, 5558.0, 5636.0, 5473.0, 5323.0, 5335.0, 5306.0, 5605.0, 5545.0, 5658.0, 5579.0, 5646.0, 5629.0, 5252.0, 5332.0, 5673.0, 5565.0, 5595.0, 5502.0, 5305.0, 5546.0, 5677.0, 5600.0, 5436.0, 5697.0, 5292.0, 5678.0, 5686.0, 5343.0, 5669.0, 5413.0, 5304.0, 5366.0, 5498.0, 5553.0, 5264.0, 5651.0, 5359.0, 5612.0, 5507.0, 5374.0, 5555.0, 5631.0, 5536.0, 5684.0, 5708.0, 5635.0, 5666.0, 5647.0, 5294.0, 5624.0, 5259.0, 5641.0, 5408.0, 5715.0, 5328.0, 5513.0, 5645.0, 5375.0
						(number of hits: 7)
14	5290	9	1	333	1	5482.0, 5423.0, 5313.0, 5664.0, 5688.0, 5663.0, 5436.0, 5265.0, 5319.0, 5508.0, 5595.0, 5337.0, 5307.0, 5607.0, 5549.0, 5380.0, 5623.0, 5384.0, 5416.0, 5430.0, 5321.0, 5383.0, 5531.0, 5662.0, 5312.0, 5703.0, 5714.0, 5696.0, 5512.0, 5410.0, 5673.0, 5561.0, 5474.0, 5636.0, 5534.0, 5695.0, 5503.0, 5429.0, 5253.0, 5400.0, 5671.0, 5251.0, 5270.0, 5435.0, 5567.0, 5687.0, 5495.0, 5546.0, 5668.0, 5452.0, 5331.0, 5378.0, 5669.0, 5545.0, 5605.0, 5591.0, 5643.0, 5715.0, 5417.0, 5332.0, 5256.0, 5260.0, 5428.0, 5516.0, 5346.0, 5523.0, 5694.0, 5368.0, 5447.0, 5325.0, 5501.0, 5391.0, 5338.0, 5286.0, 5614.0, 5320.0, 5301.0, 5254.0, 5691.0, 5420.0

						5496.0, 5455.0, 5258.0, 5411.0, 5720.0, 5533.0, 5689.0, 5629.0, 5692.0, 5413.0, 5404.0, 5280.0, 5401.0, 5630.0, 5723.0, 5367.0, 5375.0, 5494.0, 5425.0, 5318.0 (number of hits: 9)
15	5290	9	1	333	1	5538.0, 5309.0, 5599.0, 5644.0, 5315.0, 5342.0, 5693.0, 5532.0, 5404.0, 5663.0, 5597.0, 5338.0, 5569.0, 5544.0, 5652.0, 5438.0, 5433.0, 5526.0, 5539.0, 5522.0, 5321.0, 5376.0, 5674.0, 5614.0, 5310.0, 5719.0, 5603.0, 5681.0, 5641.0, 5471.0, 5702.0, 5571.0, 5316.0, 5274.0, 5360.0, 5632.0, 5473.0, 5287.0, 5578.0, 5320.0, 5412.0, 5484.0, 5621.0, 5534.0, 5694.0, 5457.0, 5587.0, 5400.0, 5699.0, 5265.0, 5264.0, 5254.0, 5668.0, 5420.0, 5292.0, 5615.0, 5611.0, 5591.0, 5374.0, 5267.0, 5256.0, 5255.0, 5598.0, 5560.0, 5618.0, 5585.0, 5307.0, 5432.0, 5545.0, 5426.0, 5528.0, 5373.0, 5649.0, 5252.0, 5510.0, 5445.0, 5392.0, 5689.0, 5593.0, 5547.0, 5704.0, 5261.0, 5430.0, 5576.0, 5713.0, 5503.0, 5633.0, 5327.0, 5500.0, 5425.0, 5643.0, 5443.0, 5285.0, 5251.0, 5325.0, 5399.0, 5671.0, 5363.0, 5361.0, 5282.0 (number of hits: 10)
16	5290	9	1	333	1	5301.0, 5335.0, 5371.0, 5659.0, 5309.0, 5465.0, 5438.0, 5614.0, 5417.0, 5697.0, 5557.0, 5643.0, 5694.0, 5351.0, 5385.0, 5254.0, 5270.0, 5655.0, 5428.0, 5444.0, 5350.0, 5372.0, 5490.0, 5541.0, 5320.0, 5572.0, 5628.0, 5288.0, 5629.0, 5443.0, 5504.0, 5401.0, 5354.0, 5680.0, 5278.0, 5324.0, 5576.0, 5704.0, 5277.0, 5308.0, 5325.0, 5373.0, 5458.0, 5653.0, 5376.0, 5462.0, 5453.0, 5312.0, 5627.0, 5644.0, 5681.0, 5499.0, 5634.0, 5437.0, 5540.0, 5283.0, 5666.0, 5422.0, 5594.0, 5341.0, 5563.0, 5705.0, 5392.0, 5375.0, 5382.0, 5331.0, 5282.0, 5533.0, 5709.0, 5602.0, 5591.0, 5406.0, 5547.0, 5427.0, 5618.0, 5529.0, 5257.0, 5703.0, 5398.0, 5414.0, 5607.0, 5256.0, 5329.0, 5723.0, 5555.0, 5522.0, 5715.0, 5339.0, 5261.0, 5575.0, 5258.0, 5528.0, 5701.0, 5408.0, 5571.0, 5495.0, 5471.0, 5450.0, 5574.0, 5492.0 (number of hits: 10)
17	5290	9	1	333	1	5445.0, 5509.0, 5507.0, 5532.0, 5640.0, 5615.0, 5506.0, 5607.0, 5598.0, 5352.0, 5495.0, 5336.0, 5719.0, 5676.0, 5533.0, 5621.0, 5678.0, 5324.0, 5498.0, 5264.0, 5424.0, 5487.0, 5700.0, 5660.0, 5713.0, 5557.0, 5250.0, 5644.0, 5634.0, 5415.0, 5603.0, 5396.0, 5389.0, 5404.0, 5362.0, 5639.0, 5304.0, 5540.0, 5434.0, 5501.0, 5294.0, 5652.0, 5688.0, 5261.0, 5599.0, 5620.0, 5375.0, 5567.0, 5637.0, 5473.0, 5523.0, 5702.0, 5257.0, 5443.0, 5494.0, 5697.0, 5309.0, 5671.0, 5403.0, 5605.0

						5280.0, 5390.0, 5646.0, 5266.0, 5269.0, 5305.0, 5383.0, 5395.0, 5366.0, 5297.0, 5683.0, 5541.0, 5359.0, 5425.0, 5277.0, 5281.0, 5295.0, 5560.0, 5291.0, 5378.0, 5288.0, 5682.0, 5496.0, 5411.0, 5444.0, 5548.0, 5562.0, 5701.0, 5553.0, 5454.0, 5382.0, 5276.0, 5552.0, 5312.0, 5594.0, 5360.0, 5604.0, 5595.0, 5673.0, 5606.0 (number of hits: 13)
18	5290	9	1	333	1	5346.0, 5530.0, 5654.0, 5716.0, 5678.0, 5714.0, 5663.0, 5416.0, 5492.0, 5402.0, 5627.0, 5316.0, 5441.0, 5670.0, 5320.0, 5371.0, 5683.0, 5398.0, 5367.0, 5514.0, 5598.0, 5348.0, 5702.0, 5266.0, 5656.0, 5295.0, 5553.0, 5624.0, 5474.0, 5511.0, 5360.0, 5599.0, 5567.0, 5704.0, 5337.0, 5390.0, 5528.0, 5452.0, 5433.0, 5617.0, 5253.0, 5285.0, 5467.0, 5358.0, 5455.0, 5342.0, 5675.0, 5531.0, 5589.0, 5407.0, 5308.0, 5480.0, 5256.0, 5350.0, 5498.0, 5292.0, 5349.0, 5315.0, 5719.0, 5483.0, 5602.0, 5603.0, 5655.0, 5626.0, 5577.0, 5712.0, 5403.0, 5687.0, 5491.0, 5522.0, 5721.0, 5301.0, 5445.0, 5540.0, 5279.0, 5676.0, 5450.0, 5516.0, 5347.0, 5634.0, 5428.0, 5282.0, 5505.0, 5435.0, 5404.0, 5429.0, 5682.0, 5648.0, 5494.0, 5268.0, 5328.0, 5558.0, 5517.0, 5688.0, 5630.0, 5510.0, 5257.0, 5651.0, 5430.0, 5267.0 (number of hits: 9)
19	5290	9	1	333	1	5493.0, 5634.0, 5419.0, 5533.0, 5519.0, 5707.0, 5615.0, 5573.0, 5329.0, 5701.0, 5578.0, 5656.0, 5483.0, 5641.0, 5724.0, 5459.0, 5502.0, 5267.0, 5611.0, 5340.0, 5299.0, 5678.0, 5350.0, 5392.0, 5606.0, 5683.0, 5529.0, 5480.0, 5658.0, 5277.0, 5489.0, 5597.0, 5471.0, 5377.0, 5383.0, 5638.0, 5577.0, 5264.0, 5390.0, 5526.0, 5289.0, 5406.0, 5376.0, 5355.0, 5304.0, 5595.0, 5719.0, 5604.0, 5589.0, 5682.0, 5342.0, 5568.0, 5523.0, 5607.0, 5453.0, 5599.0, 5303.0, 5444.0, 5609.0, 5664.0, 5293.0, 5635.0, 5665.0, 5521.0, 5331.0, 5258.0, 5672.0, 5300.0, 5436.0, 5689.0, 5268.0, 5661.0, 5685.0, 5513.0, 5381.0, 5371.0, 5468.0, 5470.0, 5256.0, 5624.0, 5648.0, 5306.0, 5402.0, 5399.0, 5709.0, 5723.0, 5353.0, 5369.0, 5274.0, 5538.0, 5356.0, 5327.0, 5557.0, 5457.0, 5418.0, 5524.0, 5368.0, 5265.0, 5532.0, 5694.0 (number of hits: 9)
20	5290	9	1	333	1	5411.0, 5446.0, 5704.0, 5555.0, 5634.0, 5622.0, 5712.0, 5391.0, 5596.0, 5274.0, 5369.0, 5499.0, 5345.0, 5353.0, 5495.0, 5396.0, 5545.0, 5410.0, 5449.0, 5553.0, 5307.0, 5323.0, 5613.0, 5593.0, 5584.0, 5549.0, 5692.0, 5655.0, 5457.0, 5588.0, 5602.0, 5261.0, 5653.0, 5464.0, 5518.0, 5530.0, 5321.0, 5544.0, 5448.0, 5631.0

						5507.0, 5299.0, 5591.0, 5701.0, 5362.0, 5346.0, 5660.0, 5677.0, 5697.0, 5434.0, 5606.0, 5368.0, 5398.0, 5380.0, 5599.0, 5389.0, 5546.0, 5394.0, 5635.0, 5333.0, 5392.0, 5531.0, 5458.0, 5407.0, 5468.0, 5275.0, 5676.0, 5603.0, 5706.0, 5256.0, 5510.0, 5402.0, 5571.0, 5255.0, 5296.0, 5253.0, 5364.0, 5463.0, 5344.0, 5431.0, 5379.0, 5717.0, 5720.0, 5472.0, 5685.0, 5283.0, 5626.0, 5470.0, 5540.0, 5375.0, 5367.0, 5708.0, 5485.0, 5290.0, 5579.0, 5371.0, 5528.0, 5441.0, 5686.0, 5695.0 (number of hits: 7)
21	5290	9	1	333	1	5336.0, 5357.0, 5391.0, 5661.0, 5409.0, 5495.0, 5554.0, 5678.0, 5665.0, 5350.0, 5683.0, 5565.0, 5387.0, 5585.0, 5302.0, 5616.0, 5628.0, 5329.0, 5401.0, 5686.0, 5581.0, 5635.0, 5292.0, 5664.0, 5539.0, 5717.0, 5466.0, 5533.0, 5511.0, 5279.0, 5370.0, 5407.0, 5422.0, 5349.0, 5572.0, 5300.0, 5614.0, 5402.0, 5514.0, 5404.0, 5311.0, 5563.0, 5693.0, 5494.0, 5679.0, 5277.0, 5299.0, 5692.0, 5390.0, 5352.0, 5712.0, 5630.0, 5576.0, 5400.0, 5322.0, 5335.0, 5606.0, 5551.0, 5472.0, 5425.0, 5537.0, 5341.0, 5603.0, 5703.0, 5553.0, 5607.0, 5448.0, 5431.0, 5449.0, 5645.0, 5549.0, 5318.0, 5625.0, 5416.0, 5304.0, 5371.0, 5469.0, 5532.0, 5262.0, 5309.0, 5718.0, 5315.0, 5526.0, 5334.0, 5488.0, 5531.0, 5722.0, 5632.0, 5291.0, 5562.0, 5649.0, 5591.0, 5437.0, 5646.0, 5271.0, 5598.0, 5339.0, 5676.0, 5522.0, 5577.0 (number of hits: 13)
22	5290	9	1	333	1	5591.0, 5283.0, 5270.0, 5535.0, 5611.0, 5546.0, 5515.0, 5533.0, 5378.0, 5498.0, 5706.0, 5659.0, 5702.0, 5348.0, 5502.0, 5684.0, 5474.0, 5392.0, 5715.0, 5620.0, 5323.0, 5473.0, 5479.0, 5288.0, 5541.0, 5312.0, 5489.0, 5696.0, 5441.0, 5407.0, 5414.0, 5396.0, 5664.0, 5625.0, 5549.0, 5478.0, 5448.0, 5359.0, 5680.0, 5364.0, 5717.0, 5349.0, 5700.0, 5274.0, 5627.0, 5305.0, 5709.0, 5440.0, 5583.0, 5406.0, 5574.0, 5310.0, 5651.0, 5429.0, 5678.0, 5550.0, 5534.0, 5271.0, 5281.0, 5569.0, 5630.0, 5619.0, 5402.0, 5463.0, 5669.0, 5464.0, 5400.0, 5578.0, 5524.0, 5501.0, 5261.0, 5376.0, 5373.0, 5272.0, 5686.0, 5718.0, 5268.0, 5405.0, 5530.0, 5490.0, 5488.0, 5615.0, 5575.0, 5410.0, 5536.0, 5496.0, 5428.0, 5542.0, 5367.0, 5597.0, 5438.0, 5673.0, 5450.0, 5451.0, 5688.0, 5467.0, 5276.0, 5404.0, 5605.0, 5292.0 (number of hits: 12)
23	5290	9	1	333	1	5469.0, 5490.0, 5679.0, 5473.0, 5426.0, 5341.0, 5254.0, 5713.0, 5277.0, 5619.0, 5508.0, 5721.0, 5497.0, 5475.0, 5652.0, 5603.0, 5384.0, 5373.0, 5359.0, 5651.0,

						5484.0, 5690.0, 5583.0, 5285.0, 5686.0, 5406.0, 5404.0, 5536.0, 5711.0, 5712.0, 5596.0, 5587.0, 5278.0, 5615.0, 5332.0, 5693.0, 5466.0, 5501.0, 5696.0, 5707.0, 5627.0, 5632.0, 5719.0, 5324.0, 5287.0, 5263.0, 5281.0, 5390.0, 5356.0, 5468.0, 5293.0, 5271.0, 5451.0, 5267.0, 5251.0, 5328.0, 5581.0, 5454.0, 5622.0, 5634.0, 5282.0, 5401.0, 5465.0, 5585.0, 5692.0, 5718.0, 5520.0, 5542.0, 5650.0, 5594.0, 5699.0, 5365.0, 5457.0, 5670.0, 5655.0, 5612.0, 5636.0, 5662.0, 5515.0, 5400.0, 5464.0, 5532.0, 5261.0, 5307.0, 5675.0, 5534.0, 5723.0, 5273.0, 5681.0, 5382.0, 5331.0, 5624.0, 5505.0, 5645.0, 5378.0, 5461.0, 5262.0, 5667.0, 5269.0, 5665.0 (number of hits: 10)
24	5290	9	1	333	1	5473.0, 5559.0, 5675.0, 5624.0, 5520.0, 5643.0, 5355.0, 5722.0, 5276.0, 5543.0, 5563.0, 5492.0, 5261.0, 5649.0, 5557.0, 5352.0, 5573.0, 5426.0, 5693.0, 5479.0, 5665.0, 5462.0, 5682.0, 5542.0, 5291.0, 5293.0, 5653.0, 5378.0, 5622.0, 5387.0, 5494.0, 5320.0, 5697.0, 5475.0, 5359.0, 5659.0, 5568.0, 5361.0, 5358.0, 5676.0, 5550.0, 5578.0, 5667.0, 5346.0, 5398.0, 5560.0, 5547.0, 5273.0, 5290.0, 5318.0, 5471.0, 5436.0, 5294.0, 5681.0, 5442.0, 5628.0, 5541.0, 5583.0, 5709.0, 5620.0, 5647.0, 5713.0, 5523.0, 5354.0, 5341.0, 5515.0, 5437.0, 5500.0, 5537.0, 5466.0, 5570.0, 5495.0, 5576.0, 5600.0, 5610.0, 5253.0, 5446.0, 5252.0, 5350.0, 5317.0, 5401.0, 5257.0, 5687.0, 5565.0, 5403.0, 5388.0, 5699.0, 5348.0, 5512.0, 5374.0, 5470.0, 5700.0, 5453.0, 5694.0, 5577.0, 5302.0, 5691.0, 5377.0, 5708.0, 5496.0 (number of hits: 9)
25	5290	9	1	333	1	5670.0, 5716.0, 5485.0, 5327.0, 5708.0, 5685.0, 5604.0, 5442.0, 5372.0, 5539.0, 5686.0, 5290.0, 5532.0, 5488.0, 5663.0, 5499.0, 5461.0, 5608.0, 5276.0, 5390.0, 5495.0, 5370.0, 5394.0, 5628.0, 5553.0, 5272.0, 5387.0, 5517.0, 5563.0, 5661.0, 5637.0, 5492.0, 5398.0, 5677.0, 5367.0, 5433.0, 5543.0, 5388.0, 5665.0, 5501.0, 5266.0, 5297.0, 5281.0, 5376.0, 5446.0, 5627.0, 5607.0, 5554.0, 5701.0, 5582.0, 5334.0, 5426.0, 5473.0, 5348.0, 5550.0, 5256.0, 5360.0, 5402.0, 5600.0, 5624.0, 5254.0, 5464.0, 5292.0, 5542.0, 5434.0, 5401.0, 5275.0, 5295.0, 5502.0, 5318.0, 5375.0, 5709.0, 5477.0, 5713.0, 5528.0, 5455.0, 5269.0, 5647.0, 5439.0, 5466.0, 5385.0, 5698.0, 5489.0, 5425.0, 5305.0, 5595.0, 5427.0, 5610.0, 5253.0, 5478.0, 5683.0, 5340.0, 5282.0, 5615.0, 5585.0, 5711.0, 5530.0, 5490.0, 5650.0, 5435.0 (number of hits: 11)

26	5290	9	1	333	1	<p>5373.0, 5663.0, 5440.0, 5354.0, 5722.0, 5357.0, 5670.0, 5271.0, 5504.0, 5674.0, 5410.0, 5654.0, 5482.0, 5306.0, 5676.0, 5419.0, 5340.0, 5546.0, 5277.0, 5375.0, 5631.0, 5678.0, 5702.0, 5531.0, 5251.0, 5693.0, 5552.0, 5351.0, 5327.0, 5481.0, 5673.0, 5355.0, 5358.0, 5368.0, 5303.0, 5473.0, 5669.0, 5595.0, 5659.0, 5370.0, 5526.0, 5422.0, 5468.0, 5528.0, 5376.0, 5408.0, 5497.0, 5542.0, 5301.0, 5495.0, 5647.0, 5660.0, 5467.0, 5688.0, 5578.0, 5320.0, 5612.0, 5255.0, 5260.0, 5463.0, 5474.0, 5279.0, 5600.0, 5690.0, 5391.0, 5417.0, 5464.0, 5258.0, 5459.0, 5540.0, 5470.0, 5590.0, 5681.0, 5691.0, 5622.0, 5533.0, 5579.0, 5378.0, 5423.0, 5627.0, 5692.0, 5428.0, 5489.0, 5283.0, 5604.0, 5350.0, 5537.0, 5347.0, 5426.0, 5657.0, 5359.0, 5292.0, 5543.0, 5720.0, 5645.0, 5610.0, 5322.0, 5253.0, 5704.0, 5312.0 (number of hits: 9)</p>
27	5290	9	1	333	1	<p>5322.0, 5425.0, 5390.0, 5291.0, 5265.0, 5560.0, 5489.0, 5559.0, 5446.0, 5400.0, 5428.0, 5587.0, 5571.0, 5535.0, 5452.0, 5510.0, 5702.0, 5525.0, 5371.0, 5440.0, 5541.0, 5562.0, 5257.0, 5561.0, 5353.0, 5536.0, 5523.0, 5653.0, 5437.0, 5642.0, 5380.0, 5465.0, 5598.0, 5443.0, 5471.0, 5664.0, 5632.0, 5459.0, 5530.0, 5701.0, 5507.0, 5417.0, 5711.0, 5570.0, 5412.0, 5586.0, 5556.0, 5502.0, 5697.0, 5303.0, 5644.0, 5590.0, 5624.0, 5413.0, 5620.0, 5438.0, 5476.0, 5421.0, 5422.0, 5608.0, 5410.0, 5258.0, 5659.0, 5683.0, 5447.0, 5392.0, 5582.0, 5255.0, 5550.0, 5478.0, 5272.0, 5493.0, 5558.0, 5551.0, 5540.0, 5276.0, 5296.0, 5406.0, 5679.0, 5614.0, 5621.0, 5442.0, 5436.0, 5301.0, 5475.0, 5656.0, 5253.0, 5369.0, 5514.0, 5497.0, 5508.0, 5688.0, 5548.0, 5564.0, 5704.0, 5312.0, 5492.0, 5552.0, 5458.0, 5720.0 (number of hits: 7)</p>
28	5290	9	1	333	1	<p>5439.0, 5422.0, 5409.0, 5483.0, 5298.0, 5584.0, 5517.0, 5376.0, 5429.0, 5447.0, 5700.0, 5513.0, 5560.0, 5397.0, 5305.0, 5421.0, 5511.0, 5279.0, 5383.0, 5257.0, 5575.0, 5345.0, 5392.0, 5531.0, 5588.0, 5688.0, 5697.0, 5374.0, 5275.0, 5294.0, 5653.0, 5507.0, 5420.0, 5675.0, 5577.0, 5693.0, 5625.0, 5723.0, 5522.0, 5292.0, 5331.0, 5715.0, 5692.0, 5637.0, 5465.0, 5319.0, 5349.0, 5290.0, 5387.0, 5647.0, 5472.0, 5565.0, 5293.0, 5482.0, 5543.0, 5503.0, 5706.0, 5444.0, 5460.0, 5662.0, 5456.0, 5518.0, 5615.0, 5459.0, 5474.0, 5659.0, 5638.0, 5661.0, 5286.0, 5476.0, 5561.0, 5477.0, 5710.0, 5657.0, 5441.0, 5390.0, 5696.0, 5690.0, 5309.0, 5318.0, 5271.0, 5347.0, 5515.0, 5548.0, 5644.0</p>

						5280.0, 5401.0, 5402.0, 5491.0, 5413.0, 5624.0, 5377.0, 5406.0, 5622.0, 5428.0, 5283.0, 5358.0, 5479.0, 5389.0, 5654.0 (number of hits: 15)
29	5290	9	1	333	1	5646.0, 5369.0, 5434.0, 5339.0, 5722.0, 5579.0, 5525.0, 5651.0, 5319.0, 5428.0, 5487.0, 5492.0, 5682.0, 5540.0, 5437.0, 5411.0, 5580.0, 5699.0, 5634.0, 5302.0, 5676.0, 5318.0, 5352.0, 5289.0, 5308.0, 5594.0, 5271.0, 5482.0, 5567.0, 5450.0, 5641.0, 5612.0, 5509.0, 5373.0, 5709.0, 5424.0, 5455.0, 5427.0, 5628.0, 5305.0, 5447.0, 5392.0, 5286.0, 5668.0, 5324.0, 5680.0, 5530.0, 5306.0, 5586.0, 5616.0, 5254.0, 5354.0, 5400.0, 5527.0, 5542.0, 5277.0, 5627.0, 5705.0, 5397.0, 5326.0, 5284.0, 5423.0, 5410.0, 5574.0, 5368.0, 5356.0, 5315.0, 5467.0, 5690.0, 5697.0, 5264.0, 5331.0, 5649.0, 5678.0, 5290.0, 5657.0, 5711.0, 5488.0, 5715.0, 5345.0, 5483.0, 5442.0, 5528.0, 5478.0, 5310.0, 5570.0, 5493.0, 5473.0, 5311.0, 5376.0, 5451.0, 5557.0, 5452.0, 5703.0, 5611.0, 5719.0, 5405.0, 5693.0, 5633.0, 5578.0 (number of hits: 15)
30	5290	9	1	333	1	5682.0, 5251.0, 5252.0, 5503.0, 5628.0, 5258.0, 5354.0, 5508.0, 5623.0, 5720.0, 5438.0, 5622.0, 5455.0, 5255.0, 5692.0, 5324.0, 5707.0, 5487.0, 5555.0, 5689.0, 5595.0, 5611.0, 5495.0, 5276.0, 5307.0, 5445.0, 5390.0, 5560.0, 5533.0, 5264.0, 5288.0, 5534.0, 5596.0, 5704.0, 5548.0, 5475.0, 5706.0, 5680.0, 5544.0, 5651.0, 5711.0, 5642.0, 5428.0, 5383.0, 5279.0, 5522.0, 5497.0, 5515.0, 5532.0, 5285.0, 5362.0, 5282.0, 5287.0, 5281.0, 5666.0, 5339.0, 5333.0, 5269.0, 5385.0, 5579.0, 5259.0, 5536.0, 5290.0, 5412.0, 5283.0, 5485.0, 5673.0, 5360.0, 5543.0, 5504.0, 5669.0, 5722.0, 5400.0, 5650.0, 5677.0, 5443.0, 5608.0, 5513.0, 5303.0, 5592.0, 5526.0, 5674.0, 5315.0, 5654.0, 5357.0, 5257.0, 5294.0, 5422.0, 5293.0, 5261.0, 5349.0, 5469.0, 5486.0, 5292.0, 5618.0, 5439.0, 5625.0, 5575.0, 5309.0, 5670.0 (number of hits: 16)

5540 MHz, 20 MHz Bandwidth

Radar Signal Type	Waveform/Trial Number	Detection (%)	Limit (%)	Pass/Fail
Type 1A/1B	30	100 %	60%	Pass
Type 2	30	100 %	60%	Pass
Type 3	30	100 %	60%	Pass
Type 4	30	100 %	60%	Pass
Aggregate (Type1 to 4)	120	100 %	80%	Pass
Type 5	30	100 %	80%	Pass
Type 6	30	100 %	70%	Pass

Please refer to the following statistical tables:

5540 MHz, 20 MHz Bandwidth**Table-1A/1B Radar Type 1A/1B Statistical Performance**

Trial #	Fc (MHz)	Pulse/Burst	Pulse Width (μS)	PRI (μs)	Detection (1:yes; 0:no)
1	5540	57	1	938	1
2	5540	67	1	798	1
3	5540	76	1	698	1
4	5540	78	1	678	1
5	5540	86	1	618	1
6	5540	61	1	878	1
7	5540	95	1	558	1
8	5540	102	1	518	1
9	5540	70	1	758	1
10	5540	92	1	578	1
11	5540	81	1	658	1
12	5540	58	1	918	1
13	5540	72	1	738	1
14	5540	59	1	898	1
15	5540	83	1	638	1
16	5540	20	1	2696	1
17	5540	23	1	2302	1
18	5540	18	1	2942	1
19	5540	21	1	2554	1
20	5540	40	1	1350	1
21	5540	70	1	764	1
22	5540	41	1	1306	1
23	5540	40	1	1322	1
24	5540	86	1	616	1
25	5540	47	1	1139	1
26	5540	32	1	1694	1
27	5540	80	1	667	1
28	5540	23	1	2369	1
29	5540	30	1	1783	1
30	5540	26	1	2088	1
Detection Percentage: 100 % (>60%)					

Table-2 Radar Type 2 Statistical Performance

Trial #	Fc (MHz)	Pulse/Burst	Pulse Width (μS)	PRI (μs)	Detection (1:yes; 0:no)
1	5540	23	1.2	167	1
2	5540	25	1.2	208	1
3	5540	23	4.5	230	1
4	5540	25	2	176	1
5	5540	24	1	153	1
6	5540	26	2.7	157	1
7	5540	25	3.9	184	1
8	5540	26	4.8	207	1
9	5540	23	2	211	1
10	5540	25	1	162	1
11	5540	24	2.1	180	1
12	5540	27	3.7	169	1
13	5540	25	3.9	155	1
14	5540	29	1.3	221	1
15	5540	27	4.2	173	1
16	5540	28	2.7	191	1
17	5540	23	4.5	178	1
18	5540	26	1.6	177	1
19	5540	23	3.4	212	1
20	5540	24	3.5	217	1
21	5540	27	4.4	205	1
22	5540	24	3	176	1
23	5540	27	2.1	209	1
24	5540	27	4.1	191	1
25	5540	28	1.7	205	1
26	5540	25	4.7	175	1
27	5540	26	4.5	201	1
28	5540	23	2.9	165	1
29	5540	27	2.3	177	1
30	5540	24	2.6	159	1
Detection Percentage: 100 % (>60%)					

Table-3 Radar Type 3 Statistical Performance

Trial #	Fc (MHz)	Pulse/Burst	Pulse Width (μS)	PRI (μs)	Detection (1:yes; 0:no)
1	5540	17	8	229	1
2	5540	18	9	242	1
3	5540	16	8.1	253	1
4	5540	18	6.1	362	1
5	5540	16	8.8	277	1
6	5540	16	6.5	471	1
7	5540	16	7.1	365	1
8	5540	18	6.6	315	1
9	5540	17	9	481	1
10	5540	17	7.3	268	1
11	5540	17	9.1	360	1
12	5540	16	10	311	1
13	5540	18	9.1	341	1
14	5540	17	9.6	357	1
15	5540	18	6.3	257	1
16	5540	16	6.3	327	1
17	5540	18	8	205	1
18	5540	17	9.2	285	1
19	5540	18	9.8	476	1
20	5540	17	8.2	290	1
21	5540	18	7.1	364	1
22	5540	16	9.5	436	1
23	5540	18	9.1	288	1
24	5540	17	8.4	442	1
25	5540	18	8.5	406	1
26	5540	18	9.9	266	1
27	5540	17	6.1	427	1
28	5540	18	7.8	210	1
29	5540	17	7.7	212	1
30	5540	16	7.4	367	1
Detection Percentage: 100 % (>60%)					

Table-4 Radar Type 4 Statistical Performance

Trial #	Fc (MHz)	Pulse/Burst	Pulse Width (µS)	PRI (µs)	Detection (1:yes; 0:no)
1	5540	16	15.5	228	1
2	5540	16	16.1	202	1
3	5540	16	11.3	278	1
4	5540	14	11.5	254	1
5	5540	15	13.2	386	1
6	5540	15	17.8	485	1
7	5540	13	19.6	395	1
8	5540	15	18.3	276	1
9	5540	14	12.1	301	1
10	5540	13	13.2	210	1
11	5540	14	18.8	297	1
12	5540	14	19.7	233	1
13	5540	12	13.5	219	1
14	5540	12	15.5	269	1
15	5540	13	17.1	238	1
16	5540	12	17.3	250	1
17	5540	14	16.4	348	1
18	5540	16	13.7	239	1
19	5540	14	11.6	229	1
20	5540	14	16.1	273	1
21	5540	13	19.1	465	1
22	5540	12	18.9	334	1
23	5540	12	17.6	301	1
24	5540	14	15.3	254	1
25	5540	13	15.3	333	1
26	5540	15	18.6	350	1
27	5540	15	14.8	231	1
28	5540	15	16.5	474	1
29	5540	16	18.1	284	1
30	5540	12	15.5	486	1
Detection Percentage: 100 % (>60%)					

Table-5 Radar Type 5 Statistical Performance

Trial #	Fc (MHz)	Detection (1:yes; 0:no)
1	5540	1
2	5540	1
3	5540	1
4	5540	1
5	5540	1
6	5540	1
7	5540	1
8	5540	1
9	5540	1
10	5540	1
11	5535.5	1
12	5537.9	1
13	5537.1	1
14	5535.9	1
15	5537.5	1
16	5535.9	1
17	5537.9	1
18	5537.9	1
19	5536.3	1
20	5537.5	1
21	5541.3	1
22	5545.3	1
23	5541.3	1
24	5545.7	1
25	5543.3	1
26	5544.9	1
27	5543.7	1
28	5543.3	1
29	5545.3	1
30	5542.5	1
Detection Percentage: 100 % (>80%)		

Bin5 Statistics 1

Trial #	Pulse	Chirp (MHz)	Pulse Width (µS)	Pulse 1-2 spacing (uS)	Pulse 2-3 spacing (uS)	Pulse Start(S)	Detection (1:yes; 0:no)
0	1	10	57.1			0.219081	1
1	2	10	74.4	1471		2.294481	
2	2	10	59.7	1241		3.036967	
3	3	10	67	1350	1942	4.378322	
4	1	10	51.4			5.724339	
5	3	10	58	1672	1421	6.867772	
6	2	10	50	1190		9.19154	
7	1	10	99.4			10.605152	
8	1	10	91.9			11.870414	

Bin5 Statistics 2

Trial #	Pulse	Chirp (MHz)	Pulse Width (µS)	Pulse 1-2 spacing (uS)	Pulse 2-3 spacing (uS)	Pulse Start(S)	Detection (1:yes; 0:no)
0	1	14	79.9			0.237071	1
1	2	14	87.6	1309		1.116149	
2	2	14	96.1	1013		1.772733	
3	2	14	89.9	1078		2.509793	
4	1	14	80.2			2.729396	
5	2	14	82.2	1520		3.716552	
6	3	14	71.4	1836	1422	3.789824	
7	2	14	81.4	1387		4.431216	
8	1	14	66.2			5.366592	
9	1	14	56.9			5.716308	
10	2	14	75.1	1466		6.692967	
11	2	14	67.2	1403		7.56865	
12	1	14	82.3			8.174202	
13	1	14	82			8.272823	
14	1	14	98.8			9.224465	
15	1	14	74.7			9.946892	
16	2	14	55.2	1564		10.411164	
17	3	14	60.5	1335	1513	10.882978	
18	3	14	62.3	1458	1168	11.872269	

Bin5 Statistics 3

Trial #	Pulse	Chirp (MHz)	Pulse Width (µS)	Pulse 1-2 spacing (uS)	Pulse 2-3 spacing (uS)	Pulse Start(S)	Detection (1:yes; 0:no)
0	2	8	60.2	1266		0.217725	1
1	3	8	57.2	1425	1213	1.740728	
2	1	8	97.9			3.738133	
3	1	8	89.2			4.757255	
4	2	8	70.3	1502		5.519782	
5	3	8	95.5	1325	1986	7.843816	
6	2	8	87.4	1315		9.05553	
7	1	8	83.5			10.015512	
8	2	8	74.3	1620		11.783529	

Bin5 Statistics 4

Trial #	Pulse	Chirp (MHz)	Pulse Width (µS)	Pulse 1-2 spacing (uS)	Pulse 2-3 spacing (uS)	Pulse Start(S)	Detection (1:yes; 0:no)
0	3	19	87.7	1027	1650	0.216193	1
1	2	19	64.9	1008		1.170241	
2	2	19	99.7	1905		1.507195	
3	3	19	97.8	1551	1441	2.026939	
4	2	19	92.1	1389		3.171556	
5	3	19	73.2	1712	1319	3.499462	
6	2	19	64.4	1980		4.237462	
7	2	19	61	1899		4.728899	
8	2	19	51.3	1645		5.759113	
9	2	19	87.5	1462		6.069226	
10	3	19	93.4	1663	1959	7.139922	
11	2	19	52.5	1554		7.580881	
12	1	19	67.2			8.081154	
13	2	19	81.9	1146		9.252024	
14	1	19	71.5			9.4221	
15	2	19	98.2	1211		10.077137	
16	2	19	68.5	1421		11.314312	
17	2	19	72.3	1312		11.347417	

Bin5 Statistics 5

Trial #	Pulse	Chirp (MHz)	Pulse Width (μS)	Pulse 1-2 spacing (uS)	Pulse 2-3 spacing (uS)	Pulse Start(S)	Detection (1:yes; 0:no)
0	3	14	62.9	1366	1557	0.569195	1
1	2	14	51.5	1786		1.471427	
2	2	14	92.7	1443		2.639606	
3	3	14	67.5	1882	1688	3.810624	
4	2	14	68	1616		5.903306	
5	2	14	87.6	1672		7.106734	
6	2	14	97.3	1780		7.701874	
7	1	14	79.9			8.427125	
8	3	14	71.5	1711	1992	10.162688	
9	3	14	89	1151	1814	11.798508	

Bin5 Statistics 6

Trial #	Pulse	Chirp (MHz)	Pulse Width (μS)	Pulse 1-2 spacing (uS)	Pulse 2-3 spacing (uS)	Pulse Start(S)	Detection (1:yes; 0:no)
0	2	8	68.1	1049		0.82481	1
1	2	8	86.3	1805		1.51172	
2	3	8	94.5	1389	1601	2.04371	
3	2	8	64	1290		3.324159	
4	2	8	82.1	1545		4.168095	
5	2	8	69.8	1998		4.767689	
6	1	8	66.7			5.695126	
7	2	8	92.7	1933		6.730132	
8	1	8	80.8			7.483317	
9	3	8	66.3	1692	1962	9.201528	
10	2	8	75.4	1585		10.143242	
11	2	8	60.5	1711		10.210459	
12	3	8	68	1460	1494	11.807061	

Bin5 Statistics 7

Trial #	Pulse	Chirp (MHz)	Pulse Width (µS)	Pulse 1-2 spacing (uS)	Pulse 2-3 spacing (uS)	Pulse Start(S)	Detection (1:yes; 0:no)
0	1	9	79.9			0.629424	1
1	1	9	81.4			1.166935	
2	2	9	84.4	1994		2.233535	
3	1	9	95.1			2.70071	
4	2	9	55.6	1165		3.169421	
5	2	9	86	1618		3.97094	
6	2	9	90.8	1703		4.956708	
7	1	9	65.1			5.815306	
8	2	9	88.3	1944		6.377703	
9	3	9	76.2	1884	1035	6.929678	
10	1	9	96.7			7.788946	
11	3	9	81.9	1395	1110	8.397965	
12	3	9	71.2	1220	1569	9.312421	
13	1	9	63.9			9.969542	
14	1	9	67.9			11.095979	
15	3	9	99.8	1654	1504	11.325579	

Bin5 Statistics 8

Trial #	Pulse	Chirp (MHz)	Pulse Width (µS)	Pulse 1-2 spacing (µS)	Pulse 2-3 spacing (µS)	Pulse Start(S)	Detection (1:yes; 0:no)
0	2	16	95.5	1061		0.495901	1
1	1	16	95.5			0.893154	
2	2	16	92.7	1005		1.639637	
3	3	16	76.2	1720	1939	2.138399	
4	1	16	62.7			2.654059	
5	1	16	83.5			3.270676	
6	3	16	83.2	1809	1638	4.290133	
7	2	16	89.4	1687		4.721547	
8	2	16	89.1	1265		5.305517	
9	2	16	99.7	1384		6.082281	
10	2	16	84.1	1128		6.827374	
11	1	16	74.6			7.037999	
12	2	16	84.7	1956		8.126501	
13	1	16	51.9			8.386791	
14	3	16	64.8	1557	1518	9.344638	
15	3	16	76.1	1798	1220	10.083331	
16	1	16	76.2			10.647527	
17	2	16	81.6	1129		11.066258	
18	1	16	70.1			11.909005	

Bin5 Statistics 9

Trial #	Pulse	Chirp (MHz)	Pulse Width (µS)	Pulse 1-2 spacing (µS)	Pulse 2-3 spacing (µS)	Pulse Start(S)	Detection (1:yes; 0:no)
0	2	8	62	1582		0.312235	1
1	2	8	74.1	1774		1.973514	
2	1	8	67.5			3.203894	
3	3	8	60	1433	1665	3.884403	
4	1	8	96.8			5.474584	
5	2	8	82.1	1909		6.086172	
6	2	8	58.8	1058		8.106425	
7	3	8	64.1	1503	1861	8.437988	
8	2	8	51.6	1928		10.2015	
9	1	8	63			11.137953	

Bin5 Statistics 10

Trial #	Pulse	Chirp (MHz)	Pulse Width (µS)	Pulse 1-2 spacing (µS)	Pulse 2-3 spacing (µS)	Pulse Start(S)	Detection (1:yes; 0:no)
0	2	8	76.2	1675		1.042049	1
1	2	8	85.1	1091		2.020416	
2	1	8	77.5			3.176179	
3	1	8	81.7			3.694387	
4	3	8	76.3	1512	1694	4.949799	
5	2	8	57.1	1709		6.462749	
6	3	8	83.9	1920	1536	7.427779	
7	2	8	67	1322		9.081027	
8	2	8	86.2	1704		10.727886	
9	2	8	95.5	1587		11.269597	

Bin5 Statistics 11

Trial #	Pulse	Chirp (MHz)	Pulse Width (µS)	Pulse 1-2 spacing (µS)	Pulse 2-3 spacing (µS)	Pulse Start(S)	Detection (1:yes; 0:no)
0	3	10	84.1	1263	1154	0.036879	1
1	3	10	95	1780	1255	1.526736	
2	2	10	69.1	1136		2.835987	
3	3	10	84.1	1974	1455	3.563427	
4	2	10	78.8	1753		4.725727	
5	3	10	80.8	1524	1719	5.579874	
6	2	10	68.4	1132		7.10851	
7	3	10	74.5	1629	1106	8.353345	
8	3	10	72.5	1932	1988	9.200146	
9	2	10	82.7	1441		9.938878	
10	3	10	60.1	1419	1742	11.529115	

Bin5 Statistics 12

Trial #	Pulse	Chirp (MHz)	Pulse Width (µS)	Pulse 1-2 spacing (uS)	Pulse 2-3 spacing (uS)	Pulse Start(S)	Detection (1:yes; 0:no)
0	3	16	93.5	1965	1335	0.327767	1
1	2	16	71.1	1214		1.656543	
2	3	16	79.3	1375	1911	2.551878	
3	3	16	57.3	1841	1438	2.943746	
4	3	16	51.2	1609	1978	3.918272	
5	2	16	86	1238		4.941298	
6	1	16	83.3			5.756774	
7	2	16	71.6	1462		6.684487	
8	1	16	79.3			7.531761	
9	2	16	90.3	1578		8.095441	
10	3	16	93.8	1441	1010	8.723711	
11	1	16	55.4			10.210716	
12	2	16	93	1041		10.974018	
13	3	16	61.1	1329	1205	11.93162	

Bin5 Statistics 13

Trial #	Pulse	Chirp (MHz)	Pulse Width (µS)	Pulse 1-2 spacing (uS)	Pulse 2-3 spacing (uS)	Pulse Start(S)	Detection (1:yes; 0:no)
0	2	14	97.3	1526		1.133969	1
1	2	14	74.1	1547		2.283489	
2	2	14	69.2	1482		4.094995	
3	2	14	52.5	1162		4.832758	
4	3	14	87.6	1360	1318	6.291851	
5	2	14	70.8	1253		7.530498	
6	2	14	73.1	1810		9.957257	
7	3	14	70.5	1428	1734	10.503685	

Bin5 Statistics 14

Trial #	Pulse	Chirp (MHz)	Pulse Width (μ S)	Pulse 1-2 spacing (μ S)	Pulse 2-3 spacing (μ S)	Pulse Start(S)	Detection (1:yes; 0:no)
0	3	11	85.6	1459	1494	0.564781	1
1	1	11	78.4			1.932517	
2	1	11	70.8			2.225675	
3	1	11	50.9			4.079401	
4	2	11	62.3	1267		5.336523	
5	1	11	58.6			6.374834	
6	2	11	52.1	1807		7.355372	
7	1	11	54.8			8.629414	
8	2	11	88.6	1520		9.304008	
9	2	11	83.4	1512		10.499156	
10	2	11	67.5	1141		11.368963	

Bin5 Statistics 15

Trial #	Pulse	Chirp (MHz)	Pulse Width (μ S)	Pulse 1-2 spacing (μ S)	Pulse 2-3 spacing (μ S)	Pulse Start(S)	Detection (1:yes; 0:no)
0	1	15	76.1			0.647725	1
1	3	15	75.7	1675	1214	2.058778	
2	2	15	79	1142		2.688025	
3	3	15	74.2	1112	1471	3.978656	
4	2	15	51.2	1534		5.281931	
5	2	15	69.6	1893		7.082157	
6	3	15	87.1	1381	1779	7.325469	
7	2	15	57	1948		9.113034	
8	2	15	52.5	1781		9.716958	
9	2	15	56.1	1468		11.776002	

Bin5 Statistics 16

Trial #	Pulse	Chirp (MHz)	Pulse Width (µS)	Pulse 1-2 spacing (µS)	Pulse 2-3 spacing (µS)	Pulse Start(S)	Detection (1:yes; 0:no)
0	3	11	71.7	1532	1535	0.48028	1
1	2	11	67	1895		0.836351	
2	2	11	97.8	1777		1.60908	
3	3	11	84.2	1726	1443	2.393615	
4	2	11	57.6	1769		2.678991	
5	2	11	99.9	1209		3.664055	
6	1	11	71.7			4.159919	
7	1	11	95			5.318315	
8	2	11	95.5	1295		5.369812	
9	2	11	86.3	1706		6.315458	
10	2	11	62.3	1284		6.840703	
11	1	11	57.9			7.584381	
12	2	11	59.4	1899		8.598997	
13	2	11	60.4	1360		9.264396	
14	2	11	83	1426		9.687875	
15	3	11	60.2	1404	1452	10.6121	
16	2	11	65	1635		10.997775	
17	2	11	71.2	1925		11.453162	

Bin5 Statistics 17

Trial #	Pulse	Chirp (MHz)	Pulse Width (µS)	Pulse 1-2 spacing (µS)	Pulse 2-3 spacing (µS)	Pulse Start(S)	Detection (1:yes; 0:no)
0	3	16	97.3	1343	1419	0.780802	1
1	2	16	76.1	1161		0.962984	
2	2	16	63.1	1170		1.71758	
3	2	16	71.8	1092		2.908605	
4	2	16	66.9	1644		3.543337	
5	3	16	87.7	1881	1436	5.061384	
6	3	16	98.7	1520	1956	5.787473	
7	2	16	80.4	1090		6.454027	
8	3	16	77.1	1062	1187	6.958777	
9	3	16	79.4	1920	1673	8.283441	
10	3	16	61.8	1699	1339	9.033584	
11	2	16	62	1340		10.032726	
12	2	16	63.4	1421		10.545764	
13	3	16	53.8	1200	1849	11.183037	

Bin5 Statistics 18

Trial #	Pulse	Chirp (MHz)	Pulse Width (μS)	Pulse 1-2 spacing (uS)	Pulse 2-3 spacing (uS)	Pulse Start(S)	Detection (1:yes; 0:no)
0	2	16	64.3	1588		0.067301	1
1	2	16	90.8	1293		0.727936	
2	3	16	61.3	1076	1690	1.610975	
3	2	16	78.6	1710		2.043909	
4	2	16	81.4	1818		2.807465	
5	2	16	50	1743		3.559854	
6	2	16	63.8	1362		4.020536	
7	2	16	69.8	1624		5.031519	
8	1	16	72.9			5.65715	
9	2	16	61.4	1745		5.813774	
10	1	16	71.2			6.535252	
11	2	16	93.3	1890		7.281058	
12	2	16	93.6	1090		7.930828	
13	2	16	95.4	1487		8.567986	
14	2	16	53.9	1462		8.847813	
15	2	16	96.6	1015		9.612565	
16	2	16	86.2	1576		10.142879	
17	3	16	76.9	1057	1093	11.138905	
18	2	16	74.6	1540		11.931983	

Bin5 Statistics 19

Trial #	Pulse	Chirp (MHz)	Pulse Width (µS)	Pulse 1-2 spacing (µS)	Pulse 2-3 spacing (µS)	Pulse Start(S)	Detection (1:yes; 0:no)
0	2	12	88.1	1462		0.554335	1
1	2	12	73.8	1433		1.106779	
2	1	12	70.8			1.794273	
3	2	12	51.9	1880		2.48644	
4	1	12	91			2.769481	
5	3	12	54.8	1242	1319	3.67386	
6	2	12	62.6	1260		3.796876	
7	1	12	82.7			4.577262	
8	2	12	97.3	1332		5.646456	
9	2	12	83.9	1892		6.037001	
10	2	12	89.8	1665		6.643735	
11	3	12	80.7	1822	1342	7.552522	
12	1	12	91.3			7.630443	
13	1	12	74.5			8.71999	
14	1	12	87.8			9.130657	
15	3	12	88.3	1912	1408	9.91824	
16	2	12	87.2	1428		10.228797	
17	3	12	54.2	1438	1809	11.352925	
18	3	12	60.6	1818	1750	11.972787	

Bin5 Statistics 20

Trial #	Pulse	Chirp (MHz)	Pulse Width (µS)	Pulse 1-2 spacing (uS)	Pulse 2-3 spacing (uS)	Pulse Start(S)	Detection (1:yes; 0:no)
0	2	15	57.1	1854		0.056792	1
1	3	15	66.9	1098	1093	1.15908	
2	3	15	71.6	1810	1662	2.088292	
3	2	15	82.1	1765		2.457507	
4	2	15	96.8	1558		2.858358	
5	2	15	75.7	1228		3.638335	
6	1	15	84.1			4.806916	
7	1	15	78			5.255112	
8	2	15	96.8	1008		6.158057	
9	1	15	61.1			6.498402	
10	3	15	80.6	1829	1459	7.596681	
11	2	15	76.9	1930		8.274114	
12	2	15	87.5	1982		8.982686	
13	3	15	59.6	1526	1512	9.429452	
14	1	15	75.4			10.351742	
15	1	15	96.9			10.966141	
16	2	15	82.8	1609		11.327967	

Bin5 Statistics 21

Trial #	Pulse	Chirp (MHz)	Pulse Width (µS)	Pulse 1-2 spacing (uS)	Pulse 2-3 spacing (uS)	Pulse Start(S)	Detection (1:yes; 0:no)
0	2	18	88	1062		0.133921	1
1	3	18	87	1469	1771	1.181402	
2	1	18	87.2			1.374292	
3	1	18	75.8			2.445049	
4	2	18	52.1	1288		2.802229	
5	2	18	75.8	1544		3.741413	
6	2	18	94	1862		4.313675	
7	1	18	56.6			4.446402	
8	3	18	76.7	1233	1698	5.528212	
9	2	18	53.8	1633		6.170335	
10	3	18	86.5	1250	1127	6.655713	
11	2	18	59.1	1587		7.021807	
12	2	18	90.5	1949		7.700093	
13	2	18	84.6	1512		8.83101	
14	3	18	56	1143	1749	8.937129	
15	1	18	50.3			10.049497	
16	2	18	94.5	1332		10.503572	
17	3	18	85.4	1309	1311	11.267104	
18	2	18	83.9	1158		11.688037	

Bin5 Statistics 22

Trial #	Pulse	Chirp (MHz)	Pulse Width (µS)	Pulse 1-2 spacing (µS)	Pulse 2-3 spacing (µS)	Pulse Start(S)	Detection (1:yes; 0:no)
0	2	8	58.7	1653		0.213091	1
1	1	8	89.6			0.939919	
2	2	8	93.7	1914		1.525247	
3	1	8	93.5			2.18087	
4	3	8	50.3	1919	1390	3.051885	
5	3	8	50.3	1734	1723	4.132398	
6	3	8	95.5	1908	1374	4.883941	
7	2	8	63.9	1705		5.386075	
8	3	8	87.2	1546	1346	5.973151	
9	2	8	98.4	1749		6.6374	
10	1	8	84.4			7.3961	
11	2	8	69	1393		8.170512	
12	1	8	59.7			8.748522	
13	2	8	95.5	1918		9.777137	
14	2	8	58.9	1990		9.895894	
15	2	8	74.7	1941		10.922371	
16	2	8	74.6	1774		11.974328	

Bin5 Statistics 23

Trial #	Pulse	Chirp (MHz)	Pulse Width (µS)	Pulse 1-2 spacing (µS)	Pulse 2-3 spacing (µS)	Pulse Start(S)	Detection (1:yes; 0:no)
0	2	18	86.3	1335		0.434661	1
1	2	18	82	1591		0.767891	
2	3	18	80.7	1792	1800	1.752566	
3	2	18	73.1	1826		2.281302	
4	2	18	74.6	1873		2.688841	
5	2	18	63.8	1111		3.514396	
6	3	18	74.6	1872	1425	3.884335	
7	3	18	56.7	1107	1315	4.905503	
8	2	18	94.5	1973		5.18433	
9	3	18	70.9	1702	1385	6.1596	
10	3	18	82.7	1937	1287	6.621723	
11	2	18	68.7	1000		7.433495	
12	2	18	84.6	1548		7.723328	
13	2	18	52.9	1399		8.454145	
14	3	18	91.1	1363	1217	9.27402	
15	2	18	79.5	1911		9.895352	
16	1	18	95.3			10.568775	
17	2	18	55	1322		11.075065	
18	3	18	56.1	1361	1558	11.586864	

Bin5 Statistics 24

Trial #	Pulse	Chirp (MHz)	Pulse Width (µS)	Pulse 1-2 spacing (µS)	Pulse 2-3 spacing (µS)	Pulse Start(S)	Detection (1:yes; 0:no)
0	2	7	57.8	1038		0.896561	1
1	2	7	60.3	1113		1.724824	
2	2	7	78	1448		2.636451	
3	3	7	89.6	1256	1604	3.460181	
4	3	7	74.8	1883	1022	4.221113	
5	1	7	70.6			5.335811	
6	2	7	96.5	1327		6.955795	
7	1	7	55.3			7.308387	
8	2	7	69.1	1549		8.891981	
9	1	7	82.3			9.033748	
10	1	7	75.6			10.103089	
11	3	7	84.3	1197	1972	11.236576	

Bin5 Statistics 25

Trial #	Pulse	Chirp (MHz)	Pulse Width (µS)	Pulse 1-2 spacing (µS)	Pulse 2-3 spacing (µS)	Pulse Start(S)	Detection (1:yes; 0:no)
0	1	13	62			0.247819	1
1	1	13	74.8			0.882328	
2	2	13	52.2	1254		1.569724	
3	2	13	81.1	1659		2.38691	
4	1	13	57.5			3.642009	
5	2	13	66.3	1663		4.267459	
6	3	13	84.2	1533	1857	4.938972	
7	2	13	95.3	1612		5.556593	
8	1	13	72.5			6.684269	
9	2	13	72.1	1158		7.02408	
10	1	13	96.4			7.572948	
11	2	13	51.1	1915		8.597642	
12	1	13	93.6			9.348376	
13	2	13	54.5	1081		10.039306	
14	2	13	78.5	1717		10.776215	
15	2	13	93.3	1048		11.610121	

Bin5 Statistics 26

Trial #	Pulse	Chirp (MHz)	Pulse Width (µS)	Pulse 1-2 spacing (µS)	Pulse 2-3 spacing (µS)	Pulse Start(S)	Detection (1:yes; 0:no)
0	1	9	67.3			0.051115	1
1	2	9	98.2	1608		1.934682	
2	3	9	64.3	1230	1135	3.435019	
3	2	9	86.4	1319		4.364403	
4	2	9	69.8	1513		5.551095	
5	1	9	55.3			7.106883	
6	2	9	92.5	1560		7.589914	
7	2	9	64.6	1935		8.601817	
8	2	9	58.2	1296		9.862914	
9	2	9	70.7	1259		10.925787	

Bin5 Statistics 27

Trial #	Pulse	Chirp (MHz)	Pulse Width (µS)	Pulse 1-2 spacing (µS)	Pulse 2-3 spacing (µS)	Pulse Start(S)	Detection (1:yes; 0:no)
0	1	12	64.6			0.312694	1
1	1	12	71.2			1.086341	
2	2	12	71.1	1516		2.1923	
3	3	12	58.5	1475	1288	2.74705	
4	2	12	75.9	1495		3.365424	
5	2	12	81	1977		4.370948	
6	2	12	81.1	1630		5.069242	
7	2	12	90.6	1368		5.816279	
8	2	12	88.5	1990		6.48945	
9	1	12	98.7			7.090426	
10	2	12	53.5	1228		7.675761	
11	1	12	95.8			8.488834	
12	1	12	68.7			9.467287	
13	2	12	79.4	1615		9.75733	
14	3	12	69.4	1906	1231	10.697219	
15	2	12	78.3	1261		11.379619	

Bin5 Statistics 28

Trial #	Pulse	Chirp (MHz)	Pulse Width (µS)	Pulse 1-2 spacing (µS)	Pulse 2-3 spacing (µS)	Pulse Start(S)	Detection (1:yes; 0:no)
0	1	13	53.9			0.891668	1
1	2	13	68	1459		2.011009	
2	2	13	93.6	1965		3.045756	
3	3	13	64.7	1325	1502	4.739616	
4	2	13	64.8	1131		4.899344	
5	2	13	63.6	1479		6.670414	
6	2	13	75.5	1761		8.351674	
7	3	13	78.8	1018	1698	8.832592	
8	2	13	67	1078		10.055665	
9	2	13	55.2	1363		11.647438	

Bin5 Statistics 29

Trial #	Pulse	Chirp (MHz)	Pulse Width (µS)	Pulse 1-2 spacing (µS)	Pulse 2-3 spacing (µS)	Pulse Start(S)	Detection (1:yes; 0:no)
0	2	8	87.6	1064		0.78884	1
1	1	8	59.7			2.077185	
2	2	8	75.4	1287		2.785061	
3	2	8	87	1807		3.640455	
4	2	8	90.8	1999		5.031159	
5	2	8	89.6	1539		6.012243	
6	2	8	74.4	1599		6.761344	
7	1	8	63			8.353895	
8	2	8	83.2	1877		8.746588	
9	1	8	85.2			10.096348	
10	3	8	55.8	1125	1391	11.714077	

Bin5 Statistics 30

Trial #	Pulse	Chirp (MHz)	Pulse Width (µS)	Pulse 1-2 spacing (µS)	Pulse 2-3 spacing (µS)	Pulse Start(S)	Detection (1:yes; 0:no)
0	3	15	64	1446	1838	0.379381	1
1	2	15	85.3	1877		1.329245	
2	1	15	90.1			2.177381	
3	2	15	77	1091		3.397929	
4	3	15	83.9	1461	1095	3.82818	
5	1	15	93.7			5.160132	
6	3	15	85.6	1234	1603	6.390232	
7	2	15	89.6	1546		6.932972	
8	1	15	66.7			7.461539	
9	2	15	80.1	1970		8.850053	
10	1	15	80.1			9.610488	
11	2	15	54.8	1302		10.66555	
12	2	15	67.7	1039		11.596107	

Table-6 Radar Type 6 Statistical Performance

Trial #	Fc (MHz)	Pulse /Burst	Pulse Width (µS)	PRI (µs)	Detection (1:yes; 0:no)	Hopping Sequence
1	5540	9	1	333	1	5337.0, 5365.0, 5557.0, 5637.0, 5254.0, 5633.0, 5354.0, 5623.0, 5424.0, 5287.0, 5721.0, 5289.0, 5419.0, 5332.0, 5404.0, 5548.0, 5550.0, 5252.0, 5385.0, 5679.0, 5324.0, 5322.0, 5395.0, 5431.0, 5399.0, 5491.0, 5670.0, 5302.0, 5616.0, 5480.0, 5416.0, 5495.0, 5250.0, 5596.0, 5407.0, 5565.0, 5592.0, 5366.0, 5377.0, 5709.0, 5434.0, 5293.0, 5556.0, 5507.0, 5283.0, 5560.0, 5428.0, 5617.0, 5604.0, 5506.0, 5410.0, 5668.0, 5613.0, 5568.0, 5341.0, 5326.0, 5253.0, 5471.0, 5542.0, 5691.0, 5546.0, 5715.0, 5265.0, 5482.0, 5631.0, 5549.0, 5444.0, 5512.0, 5701.0, 5672.0, 5277.0, 5251.0, 5285.0, 5411.0, 5561.0, 5671.0, 5257.0, 5402.0, 5296.0, 5388.0, 5597.0, 5711.0, 5712.0, 5300.0, 5291.0, 5417.0, 5510.0, 5598.0, 5462.0, 5403.0, 5567.0, 5378.0, 5502.0, 5461.0, 5422.0, 5578.0, 5438.0, 5394.0, 5618.0, 5504.0 (number of hits: 4)
2	5540	9	1	333	1	5343.0, 5685.0, 5564.0, 5602.0, 5533.0, 5322.0, 5674.0, 5653.0, 5308.0, 5373.0, 5452.0, 5571.0, 5565.0, 5457.0, 5531.0, 5281.0, 5384.0, 5370.0, 5469.0, 5527.0, 5514.0, 5525.0, 5391.0, 5358.0, 5327.0, 5712.0, 5378.0, 5487.0, 5596.0, 5369.0, 5290.0, 5320.0, 5673.0, 5702.0, 5598.0, 5517.0, 5721.0, 5395.0, 5341.0, 5499.0, 5642.0, 5676.0, 5609.0, 5588.0, 5346.0, 5376.0, 5572.0, 5271.0, 5280.0, 5719.0, 5424.0, 5717.0, 5439.0, 5438.0, 5254.0, 5486.0, 5282.0, 5264.0, 5619.0, 5359.0, 5326.0, 5420.0, 5539.0, 5645.0, 5407.0, 5440.0, 5454.0, 5466.0, 5512.0, 5375.0, 5367.0, 5385.0, 5411.0, 5581.0, 5548.0, 5279.0, 5334.0, 5711.0, 5579.0, 5382.0, 5310.0, 5665.0, 5574.0, 5657.0, 5634.0, 5319.0, 5511.0, 5708.0, 5675.0, 5398.0, 5585.0, 5374.0, 5323.0, 5357.0, 5534.0, 5631.0, 5425.0, 5616.0, 5670.0, 5583.0 (number of hits: 5)
3	5540	9	1	333	1	5427.0, 5455.0, 5357.0, 5545.0, 5376.0, 5275.0, 5613.0, 5383.0, 5451.0, 5572.0, 5354.0, 5396.0, 5434.0, 5386.0, 5274.0, 5459.0, 5307.0, 5300.0, 5702.0, 5414.0, 5333.0, 5329.0, 5548.0, 5493.0, 5649.0, 5700.0, 5581.0, 5467.0, 5252.0, 5541.0, 5494.0, 5465.0, 5554.0, 5540.0, 5609.0, 5419.0, 5474.0, 5332.0, 5362.0, 5437.0, 5344.0, 5659.0, 5542.0, 5610.0, 5399.0, 5634.0, 5499.0, 5447.0, 5453.0, 5478.0, 5410.0, 5664.0, 5458.0, 5438.0, 5721.0,

						5384.0, 5370.0, 5277.0, 5420.0, 5686.0, 5503.0, 5553.0, 5260.0, 5660.0, 5535.0, 5290.0, 5446.0, 5569.0, 5678.0, 5382.0, 5538.0, 5311.0, 5723.0, 5261.0, 5375.0, 5324.0, 5546.0, 5316.0, 5477.0, 5251.0, 5650.0, 5525.0, 5432.0, 5417.0, 5487.0, 5643.0, 5715.0, 5694.0, 5299.0, 5614.0, 5543.0, 5320.0, 5536.0, 5408.0, 5423.0, 5286.0, 5373.0, 5488.0, 5353.0, 5464.0 (number of hits: 10)
4	5540	9	1	333	1	5624.0, 5425.0, 5274.0, 5310.0, 5357.0, 5682.0, 5641.0, 5345.0, 5402.0, 5356.0, 5398.0, 5426.0, 5694.0, 5594.0, 5567.0, 5432.0, 5495.0, 5573.0, 5442.0, 5503.0, 5637.0, 5405.0, 5408.0, 5709.0, 5508.0, 5716.0, 5696.0, 5675.0, 5329.0, 5642.0, 5519.0, 5676.0, 5361.0, 5496.0, 5527.0, 5305.0, 5396.0, 5337.0, 5634.0, 5452.0, 5517.0, 5564.0, 5582.0, 5473.0, 5491.0, 5662.0, 5261.0, 5414.0, 5685.0, 5560.0, 5588.0, 5469.0, 5326.0, 5464.0, 5335.0, 5363.0, 5547.0, 5562.0, 5723.0, 5514.0, 5621.0, 5532.0, 5367.0, 5574.0, 5684.0, 5690.0, 5511.0, 5708.0, 5683.0, 5701.0, 5538.0, 5304.0, 5322.0, 5497.0, 5263.0, 5656.0, 5659.0, 5602.0, 5273.0, 5509.0, 5318.0, 5706.0, 5394.0, 5289.0, 5606.0, 5344.0, 5664.0, 5597.0, 5372.0, 5312.0, 5336.0, 5382.0, 5530.0, 5660.0, 5603.0, 5549.0, 5611.0, 5258.0, 5427.0, 5287.0 (number of hits: 5)
5	5540	9	1	333	1	5436.0, 5298.0, 5558.0, 5279.0, 5674.0, 5375.0, 5566.0, 5567.0, 5609.0, 5617.0, 5255.0, 5333.0, 5623.0, 5655.0, 5505.0, 5578.0, 5633.0, 5518.0, 5313.0, 5369.0, 5693.0, 5384.0, 5671.0, 5546.0, 5289.0, 5572.0, 5510.0, 5591.0, 5347.0, 5620.0, 5668.0, 5459.0, 5371.0, 5686.0, 5336.0, 5308.0, 5676.0, 5388.0, 5482.0, 5462.0, 5700.0, 5504.0, 5380.0, 5325.0, 5629.0, 5484.0, 5537.0, 5264.0, 5451.0, 5258.0, 5410.0, 5311.0, 5552.0, 5605.0, 5515.0, 5405.0, 5273.0, 5512.0, 5532.0, 5304.0, 5478.0, 5426.0, 5559.0, 5499.0, 5420.0, 5582.0, 5463.0, 5283.0, 5265.0, 5651.0, 5493.0, 5647.0, 5607.0, 5587.0, 5523.0, 5556.0, 5714.0, 5386.0, 5703.0, 5457.0, 5588.0, 5580.0, 5562.0, 5608.0, 5654.0, 5354.0, 5374.0, 5367.0, 5366.0, 5455.0, 5592.0, 5435.0, 5291.0, 5474.0, 5257.0, 5465.0, 5335.0, 5417.0, 5318.0, 5599.0 (number of hits: 3)
6	5540	9	1	333	1	5555.0, 5639.0, 5255.0, 5374.0, 5659.0, 5254.0, 5438.0, 5643.0, 5419.0, 5436.0, 5370.0, 5588.0, 5467.0, 5507.0, 5549.0, 5466.0, 5435.0, 5330.0, 5541.0, 5558.0, 5605.0, 5602.0, 5364.0, 5297.0, 5717.0, 5271.0, 5416.0, 5483.0, 5276.0, 5622.0, 5429.0, 5705.0, 5356.0, 5592.0, 5375.0,

						5619.0, 5476.0, 5545.0, 5294.0, 5251.0, 5320.0, 5722.0, 5578.0, 5413.0, 5571.0, 5718.0, 5494.0, 5264.0, 5409.0, 5666.0, 5647.0, 5252.0, 5455.0, 5335.0, 5553.0, 5431.0, 5486.0, 5383.0, 5321.0, 5590.0, 5665.0, 5275.0, 5703.0, 5257.0, 5450.0, 5344.0, 5535.0, 5353.0, 5350.0, 5644.0, 5343.0, 5663.0, 5406.0, 5580.0, 5474.0, 5724.0, 5523.0, 5581.0, 5497.0, 5388.0, 5707.0, 5341.0, 5608.0, 5503.0, 5371.0, 5408.0, 5645.0, 5296.0, 5286.0, 5262.0, 5310.0, 5689.0, 5566.0, 5460.0, 5564.0, 5672.0, 5681.0, 5615.0, 5505.0, 5524.0 (number of hits: 4)
7	5540	9	1	333	1	5643.0, 5450.0, 5252.0, 5650.0, 5657.0, 5489.0, 5324.0, 5626.0, 5261.0, 5589.0, 5335.0, 5389.0, 5622.0, 5349.0, 5294.0, 5454.0, 5623.0, 5337.0, 5405.0, 5304.0, 5364.0, 5280.0, 5707.0, 5411.0, 5690.0, 5469.0, 5645.0, 5633.0, 5491.0, 5425.0, 5548.0, 5418.0, 5619.0, 5431.0, 5415.0, 5639.0, 5368.0, 5553.0, 5704.0, 5295.0, 5254.0, 5712.0, 5293.0, 5320.0, 5395.0, 5549.0, 5703.0, 5565.0, 5328.0, 5627.0, 5649.0, 5384.0, 5641.0, 5609.0, 5386.0, 5383.0, 5675.0, 5608.0, 5721.0, 5541.0, 5302.0, 5616.0, 5354.0, 5423.0, 5310.0, 5625.0, 5605.0, 5435.0, 5484.0, 5594.0, 5706.0, 5564.0, 5511.0, 5319.0, 5269.0, 5360.0, 5502.0, 5543.0, 5455.0, 5366.0, 5677.0, 5642.0, 5575.0, 5480.0, 5651.0, 5451.0, 5278.0, 5697.0, 5614.0, 5598.0, 5408.0, 5251.0, 5668.0, 5525.0, 5573.0, 5724.0, 5566.0, 5550.0, 5482.0, 5353.0 (number of hits: 4)
8	5540	9	1	333	1	5414.0, 5715.0, 5477.0, 5536.0, 5682.0, 5712.0, 5624.0, 5697.0, 5539.0, 5422.0, 5495.0, 5602.0, 5723.0, 5598.0, 5537.0, 5316.0, 5411.0, 5413.0, 5501.0, 5471.0, 5589.0, 5286.0, 5492.0, 5680.0, 5677.0, 5703.0, 5529.0, 5611.0, 5559.0, 5334.0, 5591.0, 5387.0, 5415.0, 5385.0, 5376.0, 5635.0, 5511.0, 5706.0, 5339.0, 5405.0, 5671.0, 5542.0, 5296.0, 5649.0, 5325.0, 5653.0, 5373.0, 5409.0, 5618.0, 5496.0, 5478.0, 5342.0, 5596.0, 5595.0, 5254.0, 5583.0, 5651.0, 5366.0, 5361.0, 5534.0, 5586.0, 5453.0, 5305.0, 5332.0, 5483.0, 5340.0, 5693.0, 5275.0, 5439.0, 5326.0, 5674.0, 5673.0, 5640.0, 5290.0, 5494.0, 5650.0, 5691.0, 5287.0, 5560.0, 5683.0, 5601.0, 5467.0, 5724.0, 5573.0, 5578.0, 5331.0, 5687.0, 5549.0, 5303.0, 5401.0, 5379.0, 5636.0, 5419.0, 5540.0, 5584.0, 5397.0, 5575.0, 5486.0, 5514.0, 5442.0 (number of hits: 7)
9	5540	9	1	333	1	5592.0, 5487.0, 5325.0, 5535.0, 5264.0, 5710.0, 5274.0, 5431.0, 5537.0, 5648.0, 5339.0, 5630.0, 5312.0, 5481.0, 5291.0,

						5642.0, 5345.0, 5637.0, 5502.0, 5377.0, 5531.0, 5669.0, 5546.0, 5482.0, 5428.0, 5563.0, 5273.0, 5375.0, 5506.0, 5376.0, 5368.0, 5601.0, 5307.0, 5540.0, 5434.0, 5585.0, 5644.0, 5497.0, 5675.0, 5285.0, 5509.0, 5452.0, 5591.0, 5598.0, 5705.0, 5410.0, 5429.0, 5533.0, 5539.0, 5343.0, 5498.0, 5316.0, 5256.0, 5323.0, 5437.0, 5319.0, 5662.0, 5479.0, 5536.0, 5495.0, 5485.0, 5603.0, 5365.0, 5688.0, 5341.0, 5709.0, 5476.0, 5281.0, 5583.0, 5397.0, 5439.0, 5338.0, 5549.0, 5569.0, 5556.0, 5650.0, 5367.0, 5521.0, 5463.0, 5589.0, 5342.0, 5472.0, 5381.0, 5568.0, 5664.0, 5299.0, 5671.0, 5344.0, 5566.0, 5258.0, 5347.0, 5500.0, 5596.0, 5599.0, 5519.0, 5488.0, 5436.0, 5607.0, 5404.0, 5560.0 (number of hits: 9)
10	5540	9	1	333	1	5661.0, 5320.0, 5362.0, 5339.0, 5313.0, 5290.0, 5674.0, 5472.0, 5277.0, 5641.0, 5620.0, 5389.0, 5604.0, 5629.0, 5537.0, 5630.0, 5658.0, 5590.0, 5680.0, 5336.0, 5642.0, 5574.0, 5446.0, 5257.0, 5647.0, 5539.0, 5443.0, 5342.0, 5420.0, 5291.0, 5335.0, 5298.0, 5435.0, 5321.0, 5367.0, 5366.0, 5628.0, 5510.0, 5394.0, 5282.0, 5535.0, 5602.0, 5617.0, 5649.0, 5357.0, 5688.0, 5588.0, 5552.0, 5579.0, 5569.0, 5554.0, 5279.0, 5511.0, 5514.0, 5613.0, 5657.0, 5634.0, 5625.0, 5309.0, 5633.0, 5706.0, 5545.0, 5303.0, 5391.0, 5648.0, 5498.0, 5324.0, 5436.0, 5669.0, 5419.0, 5422.0, 5406.0, 5458.0, 5355.0, 5708.0, 5615.0, 5560.0, 5678.0, 5474.0, 5622.0, 5512.0, 5274.0, 5413.0, 5317.0, 5387.0, 5531.0, 5294.0, 5455.0, 5430.0, 5400.0, 5295.0, 5411.0, 5672.0, 5665.0, 5330.0, 5697.0, 5585.0, 5289.0, 5676.0, 5627.0 (number of hits: 5)
11	5540	9	1	333	1	5354.0, 5526.0, 5251.0, 5504.0, 5262.0, 5503.0, 5695.0, 5384.0, 5482.0, 5684.0, 5527.0, 5467.0, 5273.0, 5315.0, 5702.0, 5568.0, 5699.0, 5328.0, 5380.0, 5493.0, 5457.0, 5578.0, 5612.0, 5676.0, 5325.0, 5557.0, 5406.0, 5529.0, 5391.0, 5670.0, 5446.0, 5438.0, 5393.0, 5671.0, 5575.0, 5422.0, 5686.0, 5638.0, 5692.0, 5595.0, 5429.0, 5369.0, 5268.0, 5577.0, 5602.0, 5319.0, 5278.0, 5263.0, 5641.0, 5519.0, 5678.0, 5647.0, 5644.0, 5642.0, 5513.0, 5299.0, 5593.0, 5266.0, 5511.0, 5305.0, 5445.0, 5562.0, 5598.0, 5523.0, 5685.0, 5447.0, 5537.0, 5331.0, 5502.0, 5655.0, 5600.0, 5507.0, 5400.0, 5283.0, 5468.0, 5265.0, 5690.0, 5510.0, 5460.0, 5298.0, 5373.0, 5436.0, 5626.0, 5509.0, 5514.0, 5443.0, 5677.0, 5712.0, 5590.0, 5636.0, 5366.0, 5616.0, 5250.0, 5567.0, 5275.0, 5589.0, 5663.0, 5372.0, 5475.0, 5604.0

						(number of hits: 1)
12	5540	9	1	333	1	5551.0, 5668.0, 5553.0, 5258.0, 5533.0, 5254.0, 5615.0, 5363.0, 5721.0, 5545.0, 5483.0, 5420.0, 5360.0, 5466.0, 5638.0, 5619.0, 5706.0, 5508.0, 5257.0, 5670.0, 5500.0, 5647.0, 5250.0, 5688.0, 5311.0, 5334.0, 5256.0, 5384.0, 5686.0, 5569.0, 5278.0, 5276.0, 5574.0, 5714.0, 5639.0, 5649.0, 5456.0, 5361.0, 5644.0, 5355.0, 5400.0, 5397.0, 5549.0, 5504.0, 5528.0, 5503.0, 5369.0, 5317.0, 5285.0, 5606.0, 5342.0, 5375.0, 5337.0, 5478.0, 5259.0, 5685.0, 5298.0, 5611.0, 5678.0, 5689.0, 5530.0, 5653.0, 5604.0, 5556.0, 5633.0, 5591.0, 5723.0, 5628.0, 5448.0, 5590.0, 5656.0, 5715.0, 5402.0, 5338.0, 5535.0, 5589.0, 5540.0, 5345.0, 5449.0, 5550.0, 5457.0, 5357.0, 5634.0, 5390.0, 5275.0, 5637.0, 5711.0, 5272.0, 5501.0, 5346.0, 5362.0, 5584.0, 5297.0, 5554.0, 5511.0, 5490.0, 5316.0, 5705.0, 5565.0, 5690.0
						(number of hits: 6)
13	5540	9	1	333	1	5619.0, 5671.0, 5494.0, 5502.0, 5547.0, 5629.0, 5656.0, 5527.0, 5259.0, 5365.0, 5398.0, 5610.0, 5384.0, 5336.0, 5663.0, 5316.0, 5596.0, 5455.0, 5402.0, 5676.0, 5719.0, 5471.0, 5630.0, 5702.0, 5470.0, 5616.0, 5434.0, 5296.0, 5377.0, 5443.0, 5520.0, 5302.0, 5263.0, 5513.0, 5697.0, 5284.0, 5614.0, 5383.0, 5624.0, 5644.0, 5393.0, 5457.0, 5556.0, 5342.0, 5681.0, 5718.0, 5500.0, 5650.0, 5270.0, 5288.0, 5389.0, 5333.0, 5566.0, 5331.0, 5298.0, 5699.0, 5449.0, 5541.0, 5540.0, 5593.0, 5422.0, 5649.0, 5351.0, 5297.0, 5707.0, 5607.0, 5578.0, 5525.0, 5572.0, 5608.0, 5276.0, 5597.0, 5421.0, 5252.0, 5257.0, 5343.0, 5660.0, 5487.0, 5638.0, 5339.0, 5320.0, 5299.0, 5441.0, 5329.0, 5498.0, 5591.0, 5324.0, 5305.0, 5568.0, 5437.0, 5552.0, 5430.0, 5436.0, 5301.0, 5473.0, 5690.0, 5573.0, 5496.0, 5669.0, 5303.0
						(number of hits: 3)
14	5540	9	1	333	1	5568.0, 5291.0, 5309.0, 5357.0, 5610.0, 5345.0, 5674.0, 5418.0, 5529.0, 5372.0, 5396.0, 5506.0, 5266.0, 5275.0, 5523.0, 5482.0, 5387.0, 5598.0, 5712.0, 5327.0, 5550.0, 5444.0, 5286.0, 5555.0, 5526.0, 5536.0, 5285.0, 5311.0, 5711.0, 5716.0, 5468.0, 5365.0, 5464.0, 5620.0, 5413.0, 5564.0, 5337.0, 5622.0, 5271.0, 5604.0, 5362.0, 5359.0, 5450.0, 5704.0, 5535.0, 5699.0, 5289.0, 5706.0, 5505.0, 5442.0, 5594.0, 5713.0, 5461.0, 5557.0, 5502.0, 5635.0, 5350.0, 5626.0, 5433.0, 5697.0, 5458.0, 5409.0, 5515.0, 5389.0, 5534.0, 5281.0, 5380.0, 5511.0, 5300.0, 5510.0, 5307.0, 5541.0, 5570.0, 5412.0, 5410.0, 5294.0, 5264.0, 5691.0, 5643.0, 5301.0,

						5504.0, 5707.0, 5405.0, 5605.0, 5381.0, 5565.0, 5574.0, 5509.0, 5512.0, 5642.0, 5501.0, 5709.0, 5652.0, 5265.0, 5528.0, 5269.0, 5589.0, 5644.0, 5587.0, 5552.0 (number of hits: 4)
15	5540	9	1	333	1	5382.0, 5351.0, 5430.0, 5709.0, 5671.0, 5315.0, 5529.0, 5688.0, 5507.0, 5603.0, 5650.0, 5254.0, 5474.0, 5694.0, 5640.0, 5622.0, 5566.0, 5510.0, 5295.0, 5677.0, 5508.0, 5586.0, 5269.0, 5558.0, 5453.0, 5266.0, 5458.0, 5426.0, 5656.0, 5272.0, 5682.0, 5564.0, 5318.0, 5552.0, 5299.0, 5345.0, 5579.0, 5379.0, 5641.0, 5416.0, 5393.0, 5450.0, 5293.0, 5491.0, 5716.0, 5499.0, 5322.0, 5715.0, 5520.0, 5438.0, 5466.0, 5413.0, 5478.0, 5559.0, 5275.0, 5358.0, 5327.0, 5531.0, 5419.0, 5457.0, 5575.0, 5547.0, 5699.0, 5626.0, 5562.0, 5446.0, 5292.0, 5397.0, 5651.0, 5373.0, 5380.0, 5644.0, 5538.0, 5484.0, 5595.0, 5570.0, 5523.0, 5600.0, 5421.0, 5675.0, 5722.0, 5303.0, 5721.0, 5321.0, 5320.0, 5513.0, 5605.0, 5659.0, 5620.0, 5339.0, 5452.0, 5501.0, 5437.0, 5386.0, 5314.0, 5492.0, 5596.0, 5661.0, 5718.0, 5710.0 (number of hits: 3)
16	5540	9	1	333	1	5609.0, 5631.0, 5471.0, 5719.0, 5364.0, 5275.0, 5362.0, 5592.0, 5447.0, 5529.0, 5462.0, 5536.0, 5370.0, 5604.0, 5491.0, 5641.0, 5479.0, 5598.0, 5351.0, 5308.0, 5421.0, 5312.0, 5285.0, 5347.0, 5644.0, 5712.0, 5430.0, 5585.0, 5590.0, 5415.0, 5557.0, 5580.0, 5645.0, 5606.0, 5392.0, 5478.0, 5466.0, 5456.0, 5293.0, 5369.0, 5556.0, 5632.0, 5658.0, 5428.0, 5615.0, 5390.0, 5424.0, 5714.0, 5542.0, 5501.0, 5432.0, 5643.0, 5452.0, 5654.0, 5408.0, 5411.0, 5662.0, 5273.0, 5465.0, 5281.0, 5710.0, 5264.0, 5670.0, 5457.0, 5352.0, 5475.0, 5391.0, 5250.0, 5613.0, 5695.0, 5455.0, 5724.0, 5294.0, 5524.0, 5546.0, 5394.0, 5326.0, 5288.0, 5520.0, 5711.0, 5618.0, 5320.0, 5593.0, 5257.0, 5319.0, 5528.0, 5438.0, 5334.0, 5669.0, 5702.0, 5272.0, 5259.0, 5683.0, 5274.0, 5504.0, 5344.0, 5302.0, 5258.0, 5336.0, 5425.0 (number of hits: 3)
17	5540	9	1	333	1	5291.0, 5648.0, 5282.0, 5368.0, 5563.0, 5416.0, 5308.0, 5419.0, 5433.0, 5462.0, 5680.0, 5251.0, 5264.0, 5629.0, 5601.0, 5668.0, 5559.0, 5476.0, 5515.0, 5623.0, 5517.0, 5316.0, 5511.0, 5445.0, 5454.0, 5391.0, 5498.0, 5591.0, 5715.0, 5436.0, 5519.0, 5482.0, 5270.0, 5329.0, 5653.0, 5346.0, 5669.0, 5345.0, 5554.0, 5358.0, 5706.0, 5442.0, 5587.0, 5261.0, 5660.0, 5342.0, 5612.0, 5351.0, 5402.0, 5393.0, 5325.0, 5542.0, 5384.0, 5256.0, 5635.0, 5530.0, 5537.0, 5335.0, 5555.0, 5328.0,

						5296.0, 5632.0, 5578.0, 5473.0, 5676.0, 5497.0, 5440.0, 5413.0, 5640.0, 5575.0, 5369.0, 5330.0, 5657.0, 5656.0, 5665.0, 5376.0, 5271.0, 5350.0, 5352.0, 5569.0, 5521.0, 5719.0, 5432.0, 5572.0, 5487.0, 5250.0, 5460.0, 5674.0, 5468.0, 5363.0, 5357.0, 5424.0, 5257.0, 5589.0, 5496.0, 5684.0, 5359.0, 5532.0, 5437.0, 5598.0 (number of hits: 4)
18	5540	9	1	333	1	5715.0, 5582.0, 5667.0, 5506.0, 5482.0, 5514.0, 5577.0, 5263.0, 5537.0, 5439.0, 5303.0, 5616.0, 5256.0, 5663.0, 5257.0, 5671.0, 5379.0, 5612.0, 5685.0, 5280.0, 5419.0, 5548.0, 5609.0, 5561.0, 5632.0, 5712.0, 5714.0, 5513.0, 5370.0, 5438.0, 5384.0, 5372.0, 5260.0, 5284.0, 5325.0, 5281.0, 5501.0, 5614.0, 5530.0, 5634.0, 5400.0, 5487.0, 5415.0, 5290.0, 5308.0, 5385.0, 5649.0, 5580.0, 5724.0, 5518.0, 5495.0, 5398.0, 5416.0, 5595.0, 5458.0, 5328.0, 5389.0, 5549.0, 5594.0, 5571.0, 5532.0, 5507.0, 5333.0, 5373.0, 5699.0, 5306.0, 5664.0, 5421.0, 5366.0, 5633.0, 5556.0, 5623.0, 5515.0, 5683.0, 5711.0, 5407.0, 5563.0, 5270.0, 5539.0, 5309.0, 5562.0, 5364.0, 5472.0, 5707.0, 5559.0, 5347.0, 5669.0, 5693.0, 5397.0, 5689.0, 5296.0, 5431.0, 5278.0, 5552.0, 5619.0, 5489.0, 5261.0, 5298.0, 5720.0, 5587.0 (number of hits: 6)
19	5540	9	1	333	1	5276.0, 5706.0, 5301.0, 5639.0, 5258.0, 5341.0, 5447.0, 5378.0, 5344.0, 5654.0, 5290.0, 5462.0, 5535.0, 5365.0, 5695.0, 5473.0, 5506.0, 5665.0, 5637.0, 5600.0, 5584.0, 5436.0, 5670.0, 5364.0, 5598.0, 5395.0, 5714.0, 5496.0, 5325.0, 5539.0, 5649.0, 5483.0, 5261.0, 5468.0, 5282.0, 5720.0, 5677.0, 5542.0, 5455.0, 5354.0, 5663.0, 5562.0, 5510.0, 5272.0, 5485.0, 5435.0, 5556.0, 5629.0, 5633.0, 5322.0, 5458.0, 5336.0, 5406.0, 5434.0, 5644.0, 5505.0, 5572.0, 5383.0, 5446.0, 5449.0, 5537.0, 5474.0, 5527.0, 5386.0, 5285.0, 5278.0, 5315.0, 5311.0, 5529.0, 5309.0, 5400.0, 5623.0, 5613.0, 5583.0, 5419.0, 5347.0, 5321.0, 5647.0, 5318.0, 5661.0, 5326.0, 5371.0, 5604.0, 5577.0, 5342.0, 5675.0, 5651.0, 5353.0, 5512.0, 5361.0, 5716.0, 5427.0, 5373.0, 5426.0, 5374.0, 5516.0, 5479.0, 5279.0, 5273.0, 5538.0 (number of hits: 5)
20	5540	9	1	333	1	5714.0, 5472.0, 5638.0, 5437.0, 5497.0, 5480.0, 5566.0, 5360.0, 5287.0, 5431.0, 5567.0, 5615.0, 5546.0, 5521.0, 5583.0, 5501.0, 5291.0, 5313.0, 5709.0, 5534.0, 5295.0, 5588.0, 5435.0, 5665.0, 5354.0, 5453.0, 5624.0, 5412.0, 5664.0, 5628.0, 5500.0, 5395.0, 5434.0, 5260.0, 5681.0, 5483.0, 5319.0, 5366.0, 5258.0, 5656.0,

						5542.0, 5368.0, 5535.0, 5466.0, 5525.0, 5594.0, 5617.0, 5469.0, 5644.0, 5505.0, 5326.0, 5254.0, 5409.0, 5492.0, 5581.0, 5282.0, 5673.0, 5556.0, 5336.0, 5496.0, 5608.0, 5399.0, 5544.0, 5420.0, 5267.0, 5592.0, 5686.0, 5463.0, 5403.0, 5444.0, 5314.0, 5303.0, 5446.0, 5478.0, 5710.0, 5339.0, 5619.0, 5401.0, 5367.0, 5490.0, 5333.0, 5691.0, 5449.0, 5670.0, 5439.0, 5364.0, 5320.0, 5537.0, 5512.0, 5263.0, 5300.0, 5674.0, 5499.0, 5565.0, 5270.0, 5572.0, 5407.0, 5513.0, 5370.0, 5455.0 (number of hits: 6)
21	5540	9	1	333	1	5588.0, 5547.0, 5451.0, 5696.0, 5549.0, 5412.0, 5516.0, 5445.0, 5438.0, 5349.0, 5693.0, 5331.0, 5268.0, 5681.0, 5673.0, 5402.0, 5632.0, 5261.0, 5718.0, 5374.0, 5357.0, 5277.0, 5594.0, 5367.0, 5580.0, 5577.0, 5646.0, 5621.0, 5408.0, 5290.0, 5336.0, 5564.0, 5410.0, 5492.0, 5289.0, 5491.0, 5361.0, 5308.0, 5585.0, 5409.0, 5596.0, 5644.0, 5413.0, 5586.0, 5375.0, 5501.0, 5520.0, 5326.0, 5423.0, 5478.0, 5276.0, 5713.0, 5649.0, 5698.0, 5634.0, 5359.0, 5395.0, 5411.0, 5330.0, 5620.0, 5297.0, 5529.0, 5528.0, 5314.0, 5480.0, 5371.0, 5705.0, 5419.0, 5273.0, 5642.0, 5470.0, 5711.0, 5682.0, 5454.0, 5382.0, 5368.0, 5415.0, 5723.0, 5645.0, 5703.0, 5479.0, 5555.0, 5317.0, 5299.0, 5265.0, 5327.0, 5623.0, 5544.0, 5304.0, 5391.0, 5370.0, 5373.0, 5471.0, 5680.0, 5328.0, 5509.0, 5619.0, 5614.0, 5550.0, 5356.0 (number of hits: 3)
22	5540	9	1	333	1	5453.0, 5325.0, 5414.0, 5278.0, 5374.0, 5354.0, 5381.0, 5385.0, 5439.0, 5699.0, 5556.0, 5309.0, 5303.0, 5629.0, 5306.0, 5316.0, 5559.0, 5285.0, 5655.0, 5640.0, 5395.0, 5563.0, 5375.0, 5267.0, 5540.0, 5564.0, 5646.0, 5281.0, 5599.0, 5584.0, 5570.0, 5259.0, 5662.0, 5680.0, 5355.0, 5641.0, 5552.0, 5510.0, 5589.0, 5613.0, 5332.0, 5299.0, 5698.0, 5357.0, 5340.0, 5621.0, 5362.0, 5648.0, 5476.0, 5708.0, 5717.0, 5307.0, 5464.0, 5404.0, 5260.0, 5444.0, 5291.0, 5390.0, 5474.0, 5255.0, 5353.0, 5279.0, 5304.0, 5349.0, 5408.0, 5647.0, 5685.0, 5276.0, 5448.0, 5273.0, 5457.0, 5436.0, 5670.0, 5553.0, 5334.0, 5323.0, 5434.0, 5531.0, 5719.0, 5650.0, 5274.0, 5305.0, 5310.0, 5370.0, 5394.0, 5341.0, 5359.0, 5269.0, 5677.0, 5703.0, 5587.0, 5681.0, 5684.0, 5459.0, 5503.0, 5418.0, 5500.0, 5337.0, 5447.0, 5591.0 (number of hits: 2)
23	5540	9	1	333	1	5629.0, 5323.0, 5256.0, 5441.0, 5595.0, 5456.0, 5590.0, 5519.0, 5416.0, 5427.0, 5484.0, 5485.0, 5564.0, 5391.0, 5704.0, 5529.0, 5433.0, 5267.0, 5487.0, 5640.0,

						5698.0, 5699.0, 5403.0, 5615.0, 5606.0, 5558.0, 5326.0, 5294.0, 5486.0, 5491.0, 5496.0, 5293.0, 5443.0, 5692.0, 5291.0, 5641.0, 5673.0, 5594.0, 5373.0, 5349.0, 5300.0, 5621.0, 5310.0, 5723.0, 5689.0, 5495.0, 5466.0, 5261.0, 5341.0, 5656.0, 5603.0, 5409.0, 5509.0, 5577.0, 5584.0, 5260.0, 5666.0, 5344.0, 5434.0, 5678.0, 5278.0, 5408.0, 5390.0, 5587.0, 5645.0, 5334.0, 5350.0, 5283.0, 5710.0, 5644.0, 5682.0, 5524.0, 5685.0, 5399.0, 5538.0, 5553.0, 5503.0, 5449.0, 5514.0, 5560.0, 5610.0, 5322.0, 5274.0, 5417.0, 5383.0, 5511.0, 5691.0, 5574.0, 5429.0, 5355.0, 5657.0, 5556.0, 5395.0, 5292.0, 5282.0, 5289.0, 5662.0, 5490.0, 5528.0, 5701.0 (number of hits: 1)
24	5540	9	1	333	1	5318.0, 5302.0, 5578.0, 5617.0, 5516.0, 5322.0, 5641.0, 5337.0, 5395.0, 5408.0, 5705.0, 5581.0, 5427.0, 5266.0, 5396.0, 5444.0, 5275.0, 5299.0, 5357.0, 5417.0, 5267.0, 5309.0, 5504.0, 5460.0, 5256.0, 5459.0, 5693.0, 5426.0, 5575.0, 5480.0, 5547.0, 5425.0, 5380.0, 5506.0, 5437.0, 5661.0, 5281.0, 5512.0, 5603.0, 5447.0, 5535.0, 5543.0, 5484.0, 5635.0, 5629.0, 5672.0, 5491.0, 5418.0, 5361.0, 5614.0, 5261.0, 5553.0, 5431.0, 5669.0, 5651.0, 5409.0, 5539.0, 5628.0, 5647.0, 5638.0, 5622.0, 5276.0, 5608.0, 5695.0, 5407.0, 5271.0, 5367.0, 5519.0, 5479.0, 5257.0, 5713.0, 5551.0, 5676.0, 5404.0, 5467.0, 5474.0, 5685.0, 5457.0, 5601.0, 5440.0, 5675.0, 5708.0, 5410.0, 5665.0, 5285.0, 5597.0, 5694.0, 5350.0, 5365.0, 5653.0, 5530.0, 5449.0, 5291.0, 5458.0, 5660.0, 5422.0, 5526.0, 5378.0, 5624.0, 5542.0 (number of hits: 6)
25	5540	9	1	333	1	5458.0, 5411.0, 5364.0, 5661.0, 5684.0, 5450.0, 5340.0, 5570.0, 5524.0, 5596.0, 5402.0, 5392.0, 5407.0, 5321.0, 5631.0, 5680.0, 5331.0, 5634.0, 5420.0, 5525.0, 5425.0, 5573.0, 5265.0, 5572.0, 5529.0, 5649.0, 5293.0, 5394.0, 5284.0, 5608.0, 5516.0, 5663.0, 5360.0, 5561.0, 5717.0, 5648.0, 5517.0, 5277.0, 5410.0, 5255.0, 5567.0, 5588.0, 5616.0, 5387.0, 5356.0, 5349.0, 5466.0, 5670.0, 5473.0, 5555.0, 5270.0, 5622.0, 5538.0, 5307.0, 5481.0, 5395.0, 5359.0, 5614.0, 5578.0, 5269.0, 5274.0, 5591.0, 5259.0, 5515.0, 5390.0, 5566.0, 5601.0, 5257.0, 5553.0, 5598.0, 5612.0, 5322.0, 5521.0, 5297.0, 5363.0, 5280.0, 5501.0, 5337.0, 5353.0, 5556.0, 5453.0, 5357.0, 5370.0, 5701.0, 5264.0, 5702.0, 5550.0, 5676.0, 5306.0, 5594.0, 5530.0, 5499.0, 5417.0, 5432.0, 5474.0, 5267.0, 5722.0, 5488.0, 5304.0, 5397.0 (number of hits: 2)

26	5540	9	1	333	1	<p>5276.0, 5305.0, 5431.0, 5472.0, 5558.0, 5277.0, 5449.0, 5662.0, 5641.0, 5701.0, 5389.0, 5499.0, 5545.0, 5456.0, 5259.0, 5718.0, 5709.0, 5441.0, 5571.0, 5684.0, 5648.0, 5517.0, 5479.0, 5500.0, 5536.0, 5279.0, 5670.0, 5692.0, 5325.0, 5344.0, 5468.0, 5385.0, 5628.0, 5272.0, 5383.0, 5629.0, 5486.0, 5623.0, 5724.0, 5362.0, 5349.0, 5676.0, 5507.0, 5320.0, 5551.0, 5354.0, 5656.0, 5491.0, 5333.0, 5318.0, 5335.0, 5269.0, 5657.0, 5581.0, 5439.0, 5619.0, 5370.0, 5445.0, 5633.0, 5377.0, 5707.0, 5338.0, 5367.0, 5677.0, 5550.0, 5695.0, 5575.0, 5447.0, 5622.0, 5589.0, 5304.0, 5660.0, 5321.0, 5374.0, 5702.0, 5401.0, 5532.0, 5457.0, 5679.0, 5357.0, 5615.0, 5361.0, 5434.0, 5270.0, 5359.0, 5366.0, 5380.0, 5264.0, 5315.0, 5626.0, 5653.0, 5658.0, 5381.0, 5608.0, 5506.0, 5440.0, 5384.0, 5630.0, 5526.0, 5712.0</p> <p>(number of hits: 3)</p>
27	5540	9	1	333	1	<p>5623.0, 5546.0, 5474.0, 5420.0, 5639.0, 5627.0, 5477.0, 5527.0, 5699.0, 5517.0, 5662.0, 5445.0, 5336.0, 5541.0, 5616.0, 5613.0, 5486.0, 5516.0, 5681.0, 5505.0, 5697.0, 5399.0, 5463.0, 5363.0, 5638.0, 5410.0, 5400.0, 5347.0, 5588.0, 5272.0, 5698.0, 5322.0, 5379.0, 5643.0, 5405.0, 5288.0, 5496.0, 5469.0, 5393.0, 5407.0, 5273.0, 5651.0, 5406.0, 5264.0, 5418.0, 5713.0, 5633.0, 5354.0, 5360.0, 5392.0, 5693.0, 5555.0, 5708.0, 5297.0, 5536.0, 5453.0, 5263.0, 5512.0, 5333.0, 5556.0, 5459.0, 5634.0, 5625.0, 5601.0, 5428.0, 5692.0, 5572.0, 5599.0, 5682.0, 5703.0, 5331.0, 5695.0, 5417.0, 5375.0, 5676.0, 5619.0, 5573.0, 5559.0, 5614.0, 5521.0, 5503.0, 5437.0, 5352.0, 5378.0, 5488.0, 5298.0, 5279.0, 5543.0, 5368.0, 5579.0, 5586.0, 5493.0, 5576.0, 5315.0, 5723.0, 5687.0, 5433.0, 5350.0, 5276.0, 5275.0</p> <p>(number of hits: 4)</p>
28	5540	9	1	333	1	<p>5326.0, 5284.0, 5439.0, 5402.0, 5301.0, 5571.0, 5336.0, 5386.0, 5716.0, 5535.0, 5432.0, 5468.0, 5259.0, 5610.0, 5403.0, 5626.0, 5265.0, 5322.0, 5410.0, 5648.0, 5710.0, 5476.0, 5368.0, 5486.0, 5313.0, 5618.0, 5564.0, 5521.0, 5433.0, 5623.0, 5357.0, 5273.0, 5669.0, 5296.0, 5474.0, 5619.0, 5545.0, 5384.0, 5444.0, 5483.0, 5305.0, 5700.0, 5508.0, 5645.0, 5549.0, 5497.0, 5559.0, 5532.0, 5282.0, 5546.0, 5472.0, 5507.0, 5450.0, 5435.0, 5653.0, 5659.0, 5574.0, 5691.0, 5552.0, 5506.0, 5657.0, 5650.0, 5401.0, 5699.0, 5548.0, 5527.0, 5605.0, 5470.0, 5633.0, 5582.0, 5719.0, 5297.0, 5697.0, 5456.0, 5569.0, 5279.0, 5306.0, 5707.0, 5430.0, 5501.0, 5711.0, 5680.0, 5425.0, 5541.0, 5361.0,</p>

						5566.0, 5335.0, 5584.0, 5355.0, 5427.0, 5556.0, 5339.0, 5504.0, 5523.0, 5600.0, 5445.0, 5367.0, 5398.0, 5407.0, 5405.0 (number of hits: 7)
29	5540	9	1	333	1	5378.0, 5362.0, 5274.0, 5671.0, 5708.0, 5457.0, 5326.0, 5355.0, 5544.0, 5719.0, 5707.0, 5604.0, 5511.0, 5336.0, 5621.0, 5623.0, 5415.0, 5338.0, 5337.0, 5583.0, 5267.0, 5670.0, 5311.0, 5441.0, 5588.0, 5695.0, 5253.0, 5600.0, 5587.0, 5667.0, 5602.0, 5538.0, 5281.0, 5391.0, 5278.0, 5616.0, 5619.0, 5429.0, 5547.0, 5608.0, 5668.0, 5459.0, 5317.0, 5306.0, 5351.0, 5394.0, 5543.0, 5639.0, 5352.0, 5614.0, 5451.0, 5302.0, 5597.0, 5330.0, 5688.0, 5424.0, 5716.0, 5420.0, 5502.0, 5551.0, 5582.0, 5299.0, 5648.0, 5572.0, 5325.0, 5375.0, 5470.0, 5526.0, 5642.0, 5592.0, 5265.0, 5381.0, 5258.0, 5486.0, 5700.0, 5432.0, 5562.0, 5638.0, 5624.0, 5534.0, 5255.0, 5660.0, 5620.0, 5340.0, 5473.0, 5252.0, 5586.0, 5501.0, 5412.0, 5273.0, 5646.0, 5686.0, 5714.0, 5626.0, 5571.0, 5339.0, 5399.0, 5647.0, 5692.0, 5379.0 (number of hits: 5)
30	5540	9	1	333	1	5328.0, 5490.0, 5380.0, 5505.0, 5485.0, 5584.0, 5392.0, 5333.0, 5465.0, 5256.0, 5462.0, 5420.0, 5629.0, 5564.0, 5582.0, 5259.0, 5708.0, 5636.0, 5552.0, 5376.0, 5634.0, 5287.0, 5563.0, 5717.0, 5684.0, 5401.0, 5306.0, 5440.0, 5666.0, 5497.0, 5676.0, 5598.0, 5332.0, 5266.0, 5588.0, 5664.0, 5531.0, 5340.0, 5441.0, 5715.0, 5474.0, 5637.0, 5547.0, 5578.0, 5342.0, 5502.0, 5307.0, 5261.0, 5615.0, 5545.0, 5513.0, 5667.0, 5508.0, 5423.0, 5447.0, 5425.0, 5309.0, 5710.0, 5327.0, 5468.0, 5540.0, 5297.0, 5702.0, 5566.0, 5559.0, 5435.0, 5614.0, 5622.0, 5703.0, 5537.0, 5286.0, 5396.0, 5696.0, 5716.0, 5518.0, 5701.0, 5310.0, 5448.0, 5720.0, 5683.0, 5341.0, 5675.0, 5471.0, 5353.0, 5604.0, 5442.0, 5371.0, 5335.0, 5320.0, 5610.0, 5361.0, 5434.0, 5416.0, 5586.0, 5391.0, 5535.0, 5613.0, 5595.0, 5385.0, 5308.0 (number of hits: 6)

5550 MHz, 40 MHz Bandwidth

Radar Signal Type	Waveform/Trial Number	Detection (%)	Limit (%)	Pass/Fail
Type 1A/1B	30	100 %	60%	Pass
Type 2	30	100 %	60%	Pass
Type 3	30	100 %	60%	Pass
Type 4	30	100 %	60%	Pass
Aggregate (Type1 to 4)	120	100 %	80%	Pass
Type 5	30	96.7 %	80%	Pass
Type 6	30	100 %	70%	Pass

Please refer to the following statistical tables:

5550 MHz, 40 MHz Bandwidth**Table-1A/1B Radar Type 1A/1B Statistical Performance**

Trial #	Fc (MHz)	Pulse/Burst	Pulse Width (μS)	PRI (μs)	Detection (1:yes; 0:no)
1	5550	70	1	758	1
2	5550	86	1	618	1
3	5550	61	1	878	1
4	5550	92	1	578	1
5	5550	76	1	698	1
6	5550	58	1	918	1
7	5550	89	1	598	1
8	5550	83	1	638	1
9	5550	67	1	798	1
10	5550	102	1	518	1
11	5550	65	1	818	1
12	5550	72	1	738	1
13	5550	68	1	778	1
14	5550	99	1	538	1
15	5550	57	1	938	1
16	5550	56	1	946	1
17	5550	19	1	2813	1
18	5550	34	1	1574	1
19	5550	19	1	2865	1
20	5550	35	1	1522	1
21	5550	18	1	3035	1
22	5550	25	1	2182	1
23	5550	22	1	2426	1
24	5550	21	1	2606	1
25	5550	31	1	1725	1
26	5550	27	1	1971	1
27	5550	43	1	1235	1
28	5550	64	1	826	1
29	5550	19	1	2892	1
30	5550	66	1	801	1
Detection Percentage: 100 % (>60%)					

Table-2 Radar Type 2 Statistical Performance

Trial #	Fc (MHz)	Pulse/Burst	Pulse Width (μS)	PRI (μs)	Detection (1:yes; 0:no)
1	5550	24	1.8	229	1
2	5550	24	4.5	187	1
3	5550	27	2.6	203	1
4	5550	29	2.5	177	1
5	5550	25	1.8	198	1
6	5550	23	2.4	150	1
7	5550	28	4.5	170	1
8	5550	23	3.3	191	1
9	5550	24	3.8	224	1
10	5550	26	3.6	179	1
11	5550	26	4.8	185	1
12	5550	28	3.3	185	1
13	5550	26	3.3	199	1
14	5550	24	4.1	195	1
15	5550	27	3.9	192	1
16	5550	24	2.2	191	1
17	5550	23	2.7	220	1
18	5550	23	2.1	198	1
19	5550	24	3.4	157	1
20	5550	26	4.6	151	1
21	5550	24	1.7	185	1
22	5550	26	3.3	205	1
23	5550	28	1.8	165	1
24	5550	29	2.1	172	1
25	5550	27	5	166	1
26	5550	26	3.3	189	1
27	5550	28	2.2	184	1
28	5550	26	2.5	169	1
29	5550	24	2.6	189	1
30	5550	24	2.9	229	1
Detection Percentage: 100 % (>60%)					

Table-3 Radar Type 3 Statistical Performance

Trial #	Fc (MHz)	Pulse/Burst	Pulse Width (μS)	PRI (μs)	Detection (1:yes; 0:no)
1	5550	18	8.4	233	1
2	5550	16	7.3	301	1
3	5550	16	6.5	479	1
4	5550	16	6.9	444	1
5	5550	18	8.6	406	1
6	5550	16	6.5	305	1
7	5550	16	7.7	251	1
8	5550	18	8.7	358	1
9	5550	18	7.8	217	1
10	5550	18	9.2	448	1
11	5550	18	8.1	426	1
12	5550	17	9.8	322	1
13	5550	17	8.9	452	1
14	5550	18	9.2	400	1
15	5550	16	6.2	328	1
16	5550	17	7.3	433	1
17	5550	17	9.8	373	1
18	5550	18	9.3	276	1
19	5550	18	9.1	487	1
20	5550	18	7.5	427	1
21	5550	18	7.2	371	1
22	5550	18	9.6	416	1
23	5550	16	9.1	320	1
24	5550	17	6.5	443	1
25	5550	17	8.5	484	1
26	5550	18	7.9	267	1
27	5550	17	10	311	1
28	5550	16	6.6	371	1
29	5550	16	7.4	367	1
30	5550	16	7.9	361	1
Detection Percentage: 100 % (>60%)					

Table-4 Radar Type 4 Statistical Performance

Trial #	Fc (MHz)	Pulse/Burst	Pulse Width (μS)	PRI (μs)	Detection (1:yes; 0:no)
1	5550	16	19.5	240	1
2	5550	14	18.1	374	1
3	5550	12	15.7	305	1
4	5550	14	15.7	291	1
5	5550	15	19	453	1
6	5550	16	19.1	366	1
7	5550	15	12.9	265	1
8	5550	16	13.9	492	1
9	5550	14	18.4	241	1
10	5550	12	19.9	274	1
11	5550	15	11.9	499	1
12	5550	16	11.6	472	1
13	5550	16	16	338	1
14	5550	15	16.9	471	1
15	5550	14	17.8	210	1
16	5550	13	18.5	435	1
17	5550	12	17.5	390	1
18	5550	12	13	329	1
19	5550	14	18.3	214	1
20	5550	16	11.9	291	1
21	5550	13	15.1	219	1
22	5550	14	14.5	357	1
23	5550	16	15	455	1
24	5550	12	14.3	223	1
25	5550	16	16.6	356	1
26	5550	13	11.3	295	1
27	5550	15	12.8	284	1
28	5550	16	14.3	364	1
29	5550	12	14.9	486	1
30	5550	16	18.8	225	1
Detection Percentage: 100 % (>60%)					

Table-5 Radar Type 5 Statistical Performance

Trial #	Fc (MHz)	Detection (1:yes; 0:no)
1	5550	1
2	5550	1
3	5550	1
4	5550	1
5	5550	1
6	5550	1
7	5550	1
8	5550	1
9	5550	1
10	5550	1
11	5536.6	1
12	5533.4	1
13	5534.2	1
14	5539	1
15	5537	1
16	5535.4	1
17	5537.4	0
18	5534.2	1
19	5536.6	1
20	5534.6	1
21	5561.4	1
22	5565	1
23	5563.4	1
24	5562.6	1
25	5565	1
26	5562.2	1
27	5565.4	1
28	5565	1
29	5566.2	1
30	5567	1
Detection Percentage: 96.7 % (>80%)		

Bin5 Statistics 1

Trial #	Pulse	Chirp (MHz)	Pulse Width (μS)	Pulse 1-2 spacing (uS)	Pulse 2-3 spacing (uS)	Pulse Start(S)	Detection (1:yes; 0:no)
0	2	14	50.6	1490		0.367676	1
1	2	14	75.6	1005		0.91715	
2	2	14	92.4	1171		1.414921	
3	2	14	84	1111		2.077066	
4	3	14	95.2	1114	1255	2.744035	
5	3	14	78.6	1304	1745	3.64803	
6	3	14	61.2	1916	1144	4.477598	
7	2	14	88.4	1821		5.066201	
8	2	14	61.8	1517		5.983677	
9	1	14	96.7			6.60601	
10	1	14	76.1			7.254765	
11	2	14	82.6	1765		7.590871	
12	2	14	52.1	1231		8.009613	
13	1	14	55.5			9.310249	
14	2	14	78	1117		9.794011	
15	2	14	72.4	1472		10.293903	
16	2	14	52.7	1085		11.184571	
17	2	14	64.1	1770		11.718227	

Bin5 Statistics 2

Trial #	Pulse	Chirp (MHz)	Pulse Width (μS)	Pulse 1-2 spacing (uS)	Pulse 2-3 spacing (uS)	Pulse Start(S)	Detection (1:yes; 0:no)
0	1	15	66.3			0.291035	1
1	3	15	72.6	1736	1067	0.756781	
2	2	15	81.9	1725		1.889488	
3	1	15	53.4			2.580597	
4	3	15	92	1802	1517	3.453511	
5	2	15	60.3	1885		3.99137	
6	2	15	62.6	1988		4.839334	
7	3	15	96.3	1433	1548	5.285223	
8	1	15	67.3			6.234923	
9	3	15	98.9	1416	1471	6.590092	
10	3	15	70.8	1582	1479	7.149949	
11	1	15	71			8.291858	
12	1	15	71.2			8.811657	
13	3	15	61.4	1116	1492	9.524409	
14	2	15	97.6	1337		10.18417	
15	2	15	66.2	1157		11.142267	
16	2	15	67.1	1720		11.861024	

Bin5 Statistics 3

Trial #	Pulse	Chirp (MHz)	Pulse Width (μS)	Pulse 1-2 spacing (uS)	Pulse 2-3 spacing (uS)	Pulse Start(S)	Detection (1:yes; 0:no)
0	2	14	74.4	1600		0.168078	1
1	1	14	84			1.018095	
2	3	14	96.6	1372	1563	2.794782	
3	3	14	68.9	1993	1065	3.831119	
4	1	14	77.4			4.808592	
5	3	14	64.5	1876	1388	5.224057	
6	2	14	88.8	1569		6.563367	
7	1	14	91.7			7.709782	
8	1	14	53.1			8.9482	
9	3	14	88.9	1148	1668	9.161649	
10	2	14	67.5	1469		10.861747	
11	2	14	57.5	1577		11.317561	

Bin5 Statistics 4

Trial #	Pulse	Chirp (MHz)	Pulse Width (μS)	Pulse 1-2 spacing (uS)	Pulse 2-3 spacing (uS)	Pulse Start(S)	Detection (1:yes; 0:no)
0	2	8	73	1263		1.101687	1
1	1	8	98.8			1.969109	
2	2	8	76.5	1873		2.862169	
3	2	8	69.8	1128		4.700552	
4	3	8	59.7	1170	1866	6.36801	
5	2	8	61.1	1227		6.769771	
6	1	8	78.6			8.920998	
7	2	8	63.4	1896		9.875618	
8	2	8	69.1	1788		11.493575	

Bin5 Statistics 5

Trial #	Pulse	Chirp (MHz)	Pulse Width (μS)	Pulse 1-2 spacing (uS)	Pulse 2-3 spacing (uS)	Pulse Start(S)	Detection (1:yes; 0:no)
0	2	9	89.6	1603		0.595115	1
1	1	9	89.9			1.288278	
2	2	9	75.7	1812		1.722044	
3	2	9	96.2	1148		2.549436	
4	1	9	65.6			3.63535	
5	1	9	60			4.270969	
6	2	9	71.8	1995		5.223902	
7	2	9	65.2	1655		5.45651	
8	1	9	52.8			6.383056	
9	1	9	74.4			6.753826	
10	2	9	51	1231		7.927591	
11	2	9	69.4	1194		8.719382	
12	2	9	51.4	1936		9.034278	
13	2	9	95.5	1097		9.99017	
14	1	9	60.5			11.010662	
15	1	9	93.9			11.588202	

Bin5 Statistics 6

Trial #	Pulse	Chirp (MHz)	Pulse Width (µS)	Pulse 1-2 spacing (uS)	Pulse 2-3 spacing (uS)	Pulse Start(S)	Detection (1:yes; 0:no)
0	3	12	87.8	1931	1180	0.077096	1
1	2	12	68.1	1037		1.223115	
2	2	12	88.9	1463		1.411193	
3	2	12	61.6	1090		2.067378	
4	2	12	55.2	1238		2.813427	
5	2	12	67.3	1661		3.635309	
6	3	12	50.2	1289	1537	4.146342	
7	3	12	72.3	1650	1867	4.69257	
8	2	12	51.8	1430		5.547889	
9	2	12	74.3	1910		5.70129	
10	2	12	88.1	1504		6.512189	
11	2	12	82.9	1503		7.479251	
12	2	12	84.4	1576		8.07989	
13	2	12	84.8	1583		8.464823	
14	2	12	69.8	1842		9.127417	
15	1	12	77.9			10.08433	
16	1	12	54.9			10.381511	
17	1	12	82.4			10.831332	
18	3	12	56.3	1620	1904	11.95264	

Bin5 Statistics 7

Trial #	Pulse	Chirp (MHz)	Pulse Width (µS)	Pulse 1-2 spacing (uS)	Pulse 2-3 spacing (uS)	Pulse Start(S)	Detection (1:yes; 0:no)
0	2	15	60.4	1524		0.284064	1
1	1	15	52.5			0.851601	
2	2	15	89.7	1576		1.942777	
3	2	15	79.9	1031		2.262071	
4	1	15	68.8			3.199066	
5	2	15	81	1293		4.095742	
6	1	15	87.5			4.721712	
7	1	15	60.7			5.608464	
8	2	15	89.1	1841		5.725823	
9	1	15	61.2			6.560188	
10	2	15	79.3	1506		7.624184	
11	1	15	61.6			7.96686	
12	3	15	59.8	1442	1754	8.609549	
13	3	15	83.2	1068	1096	9.432623	
14	2	15	61	1352		10.488365	
15	3	15	50.6	1515	1862	11.057003	
16	1	15	72.3			11.656654	

Bin5 Statistics 8

Trial #	Pulse	Chirp (MHz)	Pulse Width (µS)	Pulse 1-2 spacing (uS)	Pulse 2-3 spacing (uS)	Pulse Start(S)	Detection (1:yes; 0:no)
0	2	16	74.5	1267		0.177914	1
1	3	16	57.4	1107	1297	1.890814	
2	1	16	79.3			2.263275	
3	1	16	55.2			3.881777	
4	3	16	59.2	1467	1626	4.466901	
5	1	16	67.5			5.941578	
6	2	16	72.6	1743		6.762871	
7	3	16	88.9	1449	1196	7.169058	
8	2	16	67.6	1866		8.585352	
9	1	16	90.7			9.365539	
10	3	16	92.7	1409	1169	10.371429	
11	2	16	81.1	1234		11.975688	

Bin5 Statistics 9

Trial #	Pulse	Chirp (MHz)	Pulse Width (µS)	Pulse 1-2 spacing (uS)	Pulse 2-3 spacing (uS)	Pulse Start(S)	Detection (1:yes; 0:no)
0	3	5	91.5	1935	1361	0.158943	1
1	2	5	62.5	1691		1.05197	
2	2	5	88.3	1930		1.974941	
3	2	5	68.1	1616		2.297491	
4	3	5	63.6	1463	1584	3.290091	
5	3	5	62.6	1053	1833	3.373879	
6	2	5	54.2	1988		4.635603	
7	2	5	52.1	1180		4.840739	
8	2	5	63.7	1856		5.526594	
9	1	5	99.7			6.080748	
10	2	5	52	1903		6.748772	
11	3	5	72.2	1039	1729	7.767456	
12	1	5	96.8			8.491117	
13	2	5	82.1	1775		8.854895	
14	1	5	58.4			9.979593	
15	2	5	92.5	1390		10.017322	
16	2	5	79.4	1119		10.816875	
17	3	5	86.5	1674	1006	11.889046	

Bin5 Statistics 10

Trial #	Pulse	Chirp (MHz)	Pulse Width (µS)	Pulse 1-2 spacing (uS)	Pulse 2-3 spacing (uS)	Pulse Start(S)	Detection (1:yes; 0:no)
0	1	7	70.2			0.410347	1
1	1	7	83.8			1.380704	
2	2	7	100	1209		1.9062	
3	2	7	83.3	1557		2.251857	
4	3	7	52.6	1643	1739	3.491939	
5	1	7	86.6			4.449085	
6	2	7	96.9	1240		4.716481	
7	2	7	77.8	1831		5.63766	
8	3	7	53.3	1206	1241	6.590866	
9	3	7	95	1369	1047	7.333737	
10	3	7	97.9	1332	1686	7.680074	
11	3	7	82.1	1020	1218	8.806357	
12	2	7	71.2	1232		9.131606	
13	2	7	77.8	1561		10.061569	
14	1	7	51.9			11.238047	
15	2	7	79.4	1038		11.840045	

Bin5 Statistics 11

Trial #	Pulse	Chirp (MHz)	Pulse Width (µS)	Pulse 1-2 spacing (uS)	Pulse 2-3 spacing (uS)	Pulse Start(S)	Detection (1:yes; 0:no)
0	2	14	70.7	1059		0.182979	1
1	2	14	68	1308		1.329311	
2	1	14	74.4			2.211858	
3	1	14	93.4			2.487197	
4	3	14	89.6	1474	1048	3.798889	
5	1	14	90.3			4.506298	
6	2	14	69.1	1660		5.390143	
7	2	14	98	1361		6.374488	
8	1	14	62.1			6.847143	
9	2	14	59.4	1921		7.795039	
10	2	14	72.1	1682		8.090239	
11	3	14	85.7	1501	1039	9.507548	
12	3	14	64.6	1501	1883	9.64005	
13	2	14	67	1439		10.611831	
14	3	14	61	1031	1381	11.318881	

Bin5 Statistics 12

Trial #	Pulse	Chirp (MHz)	Pulse Width (µS)	Pulse 1-2 spacing (uS)	Pulse 2-3 spacing (uS)	Pulse Start(S)	Detection (1:yes; 0:no)
0	3	6	60.7	1699	1890	0.328335	1
1	2	6	90.5	1069		1.442245	
2	3	6	68.4	1603	1520	2.385903	
3	1	6	71.3			3.087558	
4	2	6	60.8	1614		4.865001	
5	3	6	64.4	1480	1732	5.928009	
6	2	6	76.8	1976		6.315194	
7	2	6	71.9	1423		7.050901	
8	1	6	88.2			8.102603	
9	1	6	51.4			9.446631	
10	2	6	56.9	1403		10.197384	
11	3	6	50.1	1340	1998	11.302269	

Bin5 Statistics 13

Trial #	Pulse	Chirp (MHz)	Pulse Width (µS)	Pulse 1-2 spacing (uS)	Pulse 2-3 spacing (uS)	Pulse Start(S)	Detection (1:yes; 0:no)
0	3	8	86.7	1961	1804	0.798288	1
1	1	8	63.8			1.210389	
2	2	8	85.4	1597		1.990825	
3	2	8	64	1270		3.011546	
4	3	8	81.2	1605	1821	3.745567	
5	3	8	79.7	1105	1348	4.645529	
6	3	8	86.9	1171	1925	5.464025	
7	2	8	68.9	1865		6.765755	
8	1	8	92.2			7.155247	
9	1	8	55.9			8.182402	
10	2	8	96.6	1595		9.337966	
11	1	8	98.4			9.849133	
12	3	8	96.9	1489	1516	10.374003	
13	2	8	79.2	1350		11.891708	

Bin5 Statistics 14

Trial #	Pulse	Chirp (MHz)	Pulse Width (µS)	Pulse 1-2 spacing (uS)	Pulse 2-3 spacing (uS)	Pulse Start(S)	Detection (1:yes; 0:no)
0	2	20	87.7	1047		0.143281	1
1	1	20	84.2			1.128517	
2	1	20	85.8			2.079275	
3	2	20	68.7	1350		2.688825	
4	2	20	57.7	1041		3.022986	
5	2	20	90.5	1945		3.707741	
6	2	20	81.2	1926		4.856289	
7	3	20	53.3	1802	1050	5.567443	
8	2	20	88.3	1153		6.313112	
9	1	20	82.2			6.414089	
10	3	20	87.5	1382	1575	7.590206	
11	2	20	59.5	1600		7.84298	
12	1	20	78.5			8.498038	
13	2	20	63.5	1387		9.849469	
14	3	20	93.4	1964	1054	9.937094	
15	2	20	70.5	1188		11.194126	
16	2	20	79.1	1904		11.720123	

Bin5 Statistics 15

Trial #	Pulse	Chirp (MHz)	Pulse Width (µS)	Pulse 1-2 spacing (µS)	Pulse 2-3 spacing (µS)	Pulse Start(S)	Detection (1:yes; 0:no)
0	1	15	77.1			0.709096	1
1	3	15	69.9	1801	1659	1.188608	
2	2	15	83.3	1092		2.097368	
3	1	15	63.7			3.178055	
4	3	15	71.7	1136	1398	3.958181	
5	3	15	73.4	1008	1880	4.584308	
6	2	15	95.6	1387		5.391767	
7	2	15	87.1	1349		6.647219	
8	1	15	71.6			7.572243	
9	2	15	84	1874		7.910797	
10	3	15	95.1	1522	1048	9.167869	
11	2	15	61.2	1133		9.730656	
12	1	15	83.2			10.456564	
13	2	15	99.8	1557		11.990448	

Bin5 Statistics 16

Trial #	Pulse	Chirp (MHz)	Pulse Width (µS)	Pulse 1-2 spacing (µS)	Pulse 2-3 spacing (µS)	Pulse Start(S)	Detection (1:yes; 0:no)
0	2	11	82.3	1124		0.690123	1
1	3	11	76.7	1100	1201	1.285156	
2	2	11	98.8	1156		2.985849	
3	2	11	79.5	1825		3.420142	
4	3	11	68.7	1271	1076	4.686675	
5	2	11	69.1	1383		5.312401	
6	3	11	59.7	1888	1968	6.969504	
7	3	11	65.9	1221	1574	7.170555	
8	2	11	89.5	1667		8.308847	
9	2	11	71.6	1475		9.942556	
10	3	11	69.1	1095	1873	10.781468	
11	3	11	58.5	1749	1574	11.053935	

Bin5 Statistics 17

Trial #	Pulse	Chirp (MHz)	Pulse Width (µS)	Pulse 1-2 spacing (µS)	Pulse 2-3 spacing (µS)	Pulse Start(S)	Detection (1:yes; 0:no)
0	1	16	93.9			0.220551	0
1	2	16	98.2	1095		1.576842	
2	1	16	70.2			2.454195	
3	2	16	78.7	1222		3.001005	
4	2	16	63.8	1124		4.26396	
5	2	16	63.5	1416		5.532094	
6	2	16	92.2	1173		6.176929	
7	2	16	70.5	1707		7.882082	
8	2	16	50.5	1564		8.540422	
9	1	16	87			9.05205	
10	1	16	76.7			10.116434	
11	2	16	81.3	1230		11.243873	

Bin5 Statistics 18

Trial #	Pulse	Chirp (MHz)	Pulse Width (µS)	Pulse 1-2 spacing (µS)	Pulse 2-3 spacing (µS)	Pulse Start(S)	Detection (1:yes; 0:no)
0	3	8	83	1371	1779	0.218805	1
1	3	8	84.7	1705	1323	0.721734	
2	2	8	80.1	1761		1.54466	
3	3	8	63	1712	1793	2.159475	
4	2	8	82.3	1426		2.797395	
5	3	8	85.4	1974	1064	3.489296	
6	2	8	77.3	1832		4.328605	
7	2	8	50.8	1061		4.940456	
8	1	8	56.4			5.651779	
9	2	8	74	1127		5.889609	
10	2	8	98.9	1337		6.620627	
11	2	8	79.1	1720		7.387186	
12	2	8	56.4	1581		7.656619	
13	2	8	74.2	1564		8.753752	
14	3	8	59.9	1736	1811	9.453464	
15	2	8	82.2	1276		9.887383	
16	2	8	57.2	1546		10.260979	
17	3	8	53	1376	1686	10.86721	
18	3	8	56.4	1353	1320	11.631756	

Bin5 Statistics 19

Trial #	Pulse	Chirp (MHz)	Pulse Width (µS)	Pulse 1-2 spacing (uS)	Pulse 2-3 spacing (uS)	Pulse Start(S)	Detection (1:yes; 0:no)
0	1	14	87.7			0.63073	1
1	3	14	88.3	1880	1891	1.981467	
2	1	14	50.1			2.624303	
3	1	14	79.1			4.177666	
4	2	14	51.5	1786		5.10582	
5	1	14	54			6.445451	
6	3	14	88.7	1080	1752	6.556806	
7	2	14	75.4	1865		7.961099	
8	2	14	84	1545		9.472101	
9	2	14	91.5	1849		10.168591	
10	2	14	89	1769		11.555319	

Bin5 Statistics 20

Trial #	Pulse	Chirp (MHz)	Pulse Width (µS)	Pulse 1-2 spacing (uS)	Pulse 2-3 spacing (uS)	Pulse Start(S)	Detection (1:yes; 0:no)
0	1	9	68.1			0.343682	1
1	3	9	87.6	1854	1958	1.18849	
2	2	v	91.9	1029		1.369629	
3	3	10	70.4	1220	1599	2.297467	
4	3	6	90.5	1180	1427	3.272117	
5	1	18	81.9			3.467549	
6	2	19	62.5	1833		4.363289	
7	3	15	98.8	1197	1703	4.816784	
8	2	18	61.7	1814		5.807354	
9	1	5	85.1			6.078085	
10	2	16	73.1	1380		7.08063	
11	3	16	95.4	1515	1541	7.871568	
12	2	9	52.2	1198		8.476011	
13	1	10	65.5			8.845441	
14	3	17	71.4	1224	1798	9.79176	
15	3	7	88.7	1680	1191	10.641621	
16	1	7	57.6			11.20585	
17	3	17	93.3	1962	1924	11.930722	

Bin5 Statistics 21

Trial #	Pulse	Chirp (MHz)	Pulse Width (µS)	Pulse 1-2 spacing (µS)	Pulse 2-3 spacing (µS)	Pulse Start(S)	Detection (1:yes; 0:no)
0	1	19	80.3			0.264467	1
1	2	19	62.6	1357		0.873179	
2	2	19	74	1730		1.943405	
3	2	19	94	1473		3.109561	
4	1	19	55.7			3.505959	
5	2	19	50.2	1526		4.286524	
6	2	19	96.1	1121		5.297555	
7	3	19	54.1	1961	1858	6.007877	
8	2	19	64.6	1342		7.061125	
9	3	19	67.6	1681	1239	8.389224	
10	2	19	75.2	1596		9.028324	
11	3	19	50.1	1600	1318	9.665303	
12	2	19	92.9	1754		10.854111	
13	2	19	54.1	1833		11.639072	

Bin5 Statistics 22

Trial #	Pulse	Chirp (MHz)	Pulse Width (µS)	Pulse 1-2 spacing (µS)	Pulse 2-3 spacing (µS)	Pulse Start(S)	Detection (1:yes; 0:no)
0	2	10	72.2	1088		0.705397	1
1	3	10	86.6	1205	1085	1.593177	
2	1	10	72.6			1.746683	
3	2	10	77.4	1576		2.41599	
4	3	10	63.3	1974	1598	3.23039	
5	3	10	79.1	1659	1867	4.068424	
6	1	10	75.2			5.103639	
7	2	10	52.8	1773		5.688175	
8	3	10	74.4	1475	1732	7.104511	
9	2	10	58.2	1467		7.969555	
10	1	10	93			8.43215	
11	2	10	74.5	1519		9.269885	
12	2	10	73	1863		10.280128	
13	2	10	50.6	1835		10.808318	
14	3	10	70.7	1540	1418	11.504577	

Bin5 Statistics 23

Trial #	Pulse	Chirp (MHz)	Pulse Width (µS)	Pulse 1-2 spacing (µS)	Pulse 2-3 spacing (µS)	Pulse Start(S)	Detection (1:yes; 0:no)
0	2	14	55.7	1398		0.199056	1
1	1	14	55.1			1.91144	
2	2	14	75.2	1746		3.569001	
3	1	14	89.9			4.725934	
4	2	14	69.1	1289		4.979559	
5	2	14	72	1964		6.838931	
6	3	14	95.2	1829	1728	7.311913	
7	3	14	73.2	1154	1491	9.277936	
8	2	14	75.5	1326		9.856482	
9	2	14	96.6	1459		11.532123	

Bin5 Statistics 24

Trial #	Pulse	Chirp (MHz)	Pulse Width (µS)	Pulse 1-2 spacing (µS)	Pulse 2-3 spacing (µS)	Pulse Start(S)	Detection (1:yes; 0:no)
0	2	16	62	1524		0.61034	1
1	2	16	95.9	1334		0.748117	
2	2	16	88.9	1705		2.008744	
3	1	16	89.3			2.469975	
4	3	16	97.4	1057	1050	3.231469	
5	1	16	60.5			3.756829	
6	1	16	61.8			4.617315	
7	1	16	98.7			5.061473	
8	2	16	75.4	1136		5.994653	
9	3	16	51.1	1611	1184	6.794956	
10	2	16	71.1	1152		7.229288	
11	1	16	61.8			7.791122	
12	2	16	86.8	1636		8.473039	
13	1	16	50.7			9.522123	
14	3	16	96.9	1078	1362	10.218309	
15	3	16	66.7	1331	1546	11.051342	
16	2	16	96.4	1040		11.340899	

Bin5 Statistics 25

Trial #	Pulse	Chirp (MHz)	Pulse Width (µS)	Pulse 1-2 spacing (uS)	Pulse 2-3 spacing (uS)	Pulse Start(S)	Detection (1:yes; 0:no)
0	2	10	54	1220		0.449613	1
1	2	10	96.7	1695		1.523267	
2	2	10	64.5	1254		2.853606	
3	2	10	54.3	1859		3.923908	
4	2	10	74.3	1130		5.17715	
5	2	10	59.4	1168		6.115483	
6	2	10	91.2	1771		7.030779	
7	3	10	99.2	1085	1601	7.989	
8	2	10	70.3	1825		9.156053	
9	2	10	72.8	1096		10.223636	
10	2	10	66.9	1640		11.739577	

Bin5 Statistics 26

Trial #	Pulse	Chirp (MHz)	Pulse Width (µS)	Pulse 1-2 spacing (uS)	Pulse 2-3 spacing (uS)	Pulse Start(S)	Detection (1:yes; 0:no)
0	2	17	95.7	1147		0.234008	1
1	1	17	69.3			1.82023	
2	1	17	82			2.45379	
3	2	17	75.3	1424		3.245974	
4	2	17	68.8	1320		4.368407	
5	1	17	58.9			4.864175	
6	3	17	86.7	1436	1037	6.054064	
7	3	17	63.3	1937	1647	7.251582	
8	3	17	99.9	1076	1982	7.556421	
9	2	17	87.1	1863		8.641712	
10	1	17	67.3			9.984094	
11	2	17	67.7	1581		10.534182	
12	3	17	74.1	1767	1737	11.798178	

Bin5 Statistics 27

Trial #	Pulse	Chirp (MHz)	Pulse Width (µS)	Pulse 1-2 spacing (µS)	Pulse 2-3 spacing (µS)	Pulse Start(S)	Detection (1:yes; 0:no)
0	2	9	76.8	1161		0.97805	1
1	3	9	50.1	1505	1060	1.815982	
2	1	9	56.8			2.218963	
3	2	9	98.6	1413		3.921995	
4	2	9	84.5	1007		4.510744	
5	3	9	79.4	1710	1565	5.647392	
6	2	9	92.5	1844		7.36433	
7	2	9	59	1390		7.752984	
8	3	9	90.5	1505	1263	9.249687	
9	1	9	61.2			9.920362	
10	2	9	71.8	1644		11.449875	

Bin5 Statistics 28

Trial #	Pulse	Chirp (MHz)	Pulse Width (µS)	Pulse 1-2 spacing (µS)	Pulse 2-3 spacing (µS)	Pulse Start(S)	Detection (1:yes; 0:no)
0	3	10	67.9	1758	1902	0.288775	1
1	2	10	59	1630		2.577813	
2	1	10	86			3.807037	
3	2	10	75.3	1824		4.749343	
4	3	10	93.8	1020	1898	6.294955	
5	2	10	93.4	1499		8.936611	
6	1	10	62.1			9.915579	
7	2	10	52	1430		11.211759	

Bin5 Statistics 29

Trial #	Pulse	Chirp (MHz)	Pulse Width (µS)	Pulse 1-2 spacing (µS)	Pulse 2-3 spacing (µS)	Pulse Start(S)	Detection (1:yes; 0:no)
0	3	7	63.2	1133	1573	0.407699	1
1	2	7	55.7	1396		1.161985	
2	2	7	96.4	1945		1.547193	
3	2	7	61	1121		2.196157	
4	2	7	78.8	1005		2.759252	
5	2	7	99.5	1777		3.302847	
6	1	7	88.7			3.728574	
7	2	7	98.3	1316		4.427917	
8	1	7	67.3			4.826143	
9	2	7	62.4	1141		5.969161	
10	3	7	58.4	1987	1653	6.057495	
11	3	7	97.8	1445	1885	7.067131	
12	1	7	95.2			7.207396	
13	2	7	66.3	1179		8.13089	
14	3	7	72	1116	1125	8.510771	
15	2	7	53.5	1641		9.164072	
16	1	7	68.2			10.115176	
17	2	7	65.6	1096		10.609512	
18	2	7	96.7	1388		11.356414	
19	2	7	60.9	1192		11.473365	

Bin5 Statistics 30

Trial #	Pulse	Chirp (MHz)	Pulse Width (µS)	Pulse 1-2 spacing (µS)	Pulse 2-3 spacing (µS)	Pulse Start(S)	Detection (1:yes; 0:no)
0	2	5	83.4	1076		0.435703	1
1	2	5	59.1	1629		1.328162	
2	2	5	75.3	1576		2.8008	
3	3	5	70.8	1455	1502	4.001464	
4	1	5	96.7			5.388536	
5	2	5	99.1	1940		5.511164	
6	3	5	58.2	1398	1802	6.573489	
7	3	5	85	1105	1944	8.354117	
8	3	5	75.7	1949	1590	9.663475	
9	1	5	58.6			9.892232	
10	3	5	67	1625	1940	11.553215	

Table-6 Radar Type 6 Statistical Performance

Trial #	Fc (MHz)	Pulse /Burst	Pulse Width (µS)	PRI (µs)	Detection (1:yes; 0:no)	Hopping Sequence
1	5550	9	1	333	1	5558.0, 5523.0, 5292.0, 5277.0, 5382.0, 5602.0, 5653.0, 5335.0, 5298.0, 5531.0, 5601.0, 5425.0, 5410.0, 5376.0, 5569.0, 5584.0, 5262.0, 5448.0, 5260.0, 5497.0, 5586.0, 5568.0, 5668.0, 5654.0, 5515.0, 5390.0, 5334.0, 5544.0, 5447.0, 5327.0, 5424.0, 5713.0, 5315.0, 5490.0, 5318.0, 5391.0, 5525.0, 5613.0, 5295.0, 5532.0, 5631.0, 5547.0, 5697.0, 5371.0, 5608.0, 5708.0, 5374.0, 5517.0, 5564.0, 5617.0, 5393.0, 5415.0, 5266.0, 5518.0, 5363.0, 5607.0, 5567.0, 5563.0, 5571.0, 5721.0, 5678.0, 5331.0, 5348.0, 5598.0, 5579.0, 5283.0, 5663.0, 5387.0, 5338.0, 5320.0, 5539.0, 5366.0, 5325.0, 5546.0, 5702.0, 5486.0, 5480.0, 5658.0, 5365.0, 5511.0, 5577.0, 5537.0, 5493.0, 5581.0, 5270.0, 5423.0, 5594.0, 5695.0, 5615.0, 5258.0, 5638.0, 5342.0, 5268.0, 5350.0, 5439.0, 5520.0, 5524.0, 5468.0, 5576.0, 5489.0 (number of hits: 13)
2	5550	9	1	333	1	5544.0, 5697.0, 5289.0, 5577.0, 5388.0, 5274.0, 5409.0, 5332.0, 5512.0, 5427.0, 5578.0, 5501.0, 5507.0, 5573.0, 5389.0, 5718.0, 5429.0, 5641.0, 5355.0, 5272.0, 5584.0, 5316.0, 5423.0, 5529.0, 5306.0, 5668.0, 5407.0, 5587.0, 5632.0, 5337.0, 5505.0, 5294.0, 5390.0, 5385.0, 5509.0, 5609.0, 5656.0, 5463.0, 5371.0, 5547.0, 5650.0, 5324.0, 5250.0, 5392.0, 5434.0, 5666.0, 5604.0, 5468.0, 5662.0, 5345.0, 5521.0, 5603.0, 5405.0, 5608.0, 5410.0, 5424.0, 5552.0, 5358.0, 5504.0, 5683.0, 5669.0, 5251.0, 5703.0, 5379.0, 5637.0, 5328.0, 5601.0, 5554.0, 5264.0, 5365.0, 5327.0, 5455.0, 5464.0, 5362.0, 5721.0, 5562.0, 5709.0, 5472.0, 5477.0, 5701.0, 5279.0, 5368.0, 5581.0, 5336.0, 5519.0, 5676.0, 5635.0, 5583.0, 5490.0, 5538.0, 5267.0, 5288.0, 5326.0, 5586.0, 5695.0, 5499.0, 5514.0, 5639.0, 5524.0, 5473.0 (number of hits: 6)
3	5550	9	1	333	1	5462.0, 5335.0, 5442.0, 5548.0, 5347.0, 5536.0, 5646.0, 5543.0, 5404.0, 5368.0, 5523.0, 5420.0, 5721.0, 5634.0, 5579.0, 5362.0, 5641.0, 5459.0, 5605.0, 5432.0, 5275.0, 5294.0, 5684.0, 5716.0, 5270.0, 5710.0, 5276.0, 5444.0, 5680.0, 5274.0, 5490.0, 5683.0, 5636.0, 5494.0, 5289.0, 5383.0, 5656.0, 5373.0, 5544.0, 5561.0, 5512.0, 5452.0, 5678.0, 5424.0, 5417.0, 5493.0, 5671.0, 5722.0, 5457.0, 5670.0, 5474.0, 5592.0, 5353.0, 5366.0, 5709.0,

						5257.0, 5564.0, 5659.0, 5451.0, 5649.0, 5502.0, 5485.0, 5317.0, 5455.0, 5593.0, 5284.0, 5460.0, 5632.0, 5500.0, 5596.0, 5262.0, 5472.0, 5613.0, 5542.0, 5267.0, 5625.0, 5336.0, 5489.0, 5456.0, 5650.0, 5576.0, 5667.0, 5389.0, 5503.0, 5312.0, 5416.0, 5637.0, 5370.0, 5251.0, 5364.0, 5621.0, 5392.0, 5361.0, 5582.0, 5606.0, 5719.0, 5639.0, 5585.0, 5601.0, 5293.0 (number of hits: 7)
4	5550	9	1	333	1	5697.0, 5425.0, 5336.0, 5339.0, 5527.0, 5383.0, 5282.0, 5602.0, 5305.0, 5389.0, 5460.0, 5409.0, 5544.0, 5557.0, 5418.0, 5266.0, 5328.0, 5278.0, 5318.0, 5446.0, 5499.0, 5667.0, 5316.0, 5334.0, 5283.0, 5405.0, 5413.0, 5594.0, 5440.0, 5379.0, 5474.0, 5515.0, 5717.0, 5349.0, 5352.0, 5327.0, 5642.0, 5656.0, 5359.0, 5311.0, 5709.0, 5532.0, 5302.0, 5600.0, 5459.0, 5502.0, 5607.0, 5552.0, 5586.0, 5458.0, 5483.0, 5562.0, 5433.0, 5632.0, 5331.0, 5507.0, 5330.0, 5422.0, 5643.0, 5624.0, 5259.0, 5415.0, 5529.0, 5503.0, 5714.0, 5583.0, 5254.0, 5464.0, 5478.0, 5323.0, 5701.0, 5711.0, 5538.0, 5427.0, 5300.0, 5623.0, 5721.0, 5584.0, 5541.0, 5257.0, 5569.0, 5719.0, 5357.0, 5420.0, 5597.0, 5718.0, 5472.0, 5381.0, 5630.0, 5645.0, 5294.0, 5710.0, 5577.0, 5635.0, 5620.0, 5338.0, 5716.0, 5384.0, 5437.0, 5666.0 (number of hits: 8)
5	5550	9	1	333	1	5561.0, 5686.0, 5601.0, 5493.0, 5379.0, 5696.0, 5483.0, 5526.0, 5394.0, 5434.0, 5417.0, 5408.0, 5592.0, 5678.0, 5539.0, 5615.0, 5617.0, 5424.0, 5275.0, 5397.0, 5580.0, 5605.0, 5648.0, 5277.0, 5435.0, 5422.0, 5312.0, 5585.0, 5324.0, 5459.0, 5687.0, 5396.0, 5712.0, 5418.0, 5323.0, 5375.0, 5673.0, 5456.0, 5528.0, 5505.0, 5356.0, 5557.0, 5450.0, 5572.0, 5362.0, 5431.0, 5385.0, 5661.0, 5684.0, 5464.0, 5504.0, 5518.0, 5640.0, 5718.0, 5313.0, 5552.0, 5440.0, 5517.0, 5371.0, 5471.0, 5274.0, 5529.0, 5419.0, 5576.0, 5558.0, 5480.0, 5260.0, 5683.0, 5488.0, 5664.0, 5512.0, 5497.0, 5330.0, 5454.0, 5515.0, 5354.0, 5331.0, 5647.0, 5281.0, 5662.0, 5591.0, 5635.0, 5658.0, 5705.0, 5314.0, 5679.0, 5607.0, 5595.0, 5270.0, 5347.0, 5432.0, 5597.0, 5355.0, 5641.0, 5343.0, 5722.0, 5669.0, 5709.0, 5573.0, 5296.0 (number of hits: 5)
6	5550	9	1	333	1	5537.0, 5488.0, 5256.0, 5721.0, 5252.0, 5477.0, 5504.0, 5314.0, 5574.0, 5667.0, 5704.0, 5304.0, 5255.0, 5381.0, 5540.0, 5600.0, 5315.0, 5308.0, 5630.0, 5299.0, 5445.0, 5508.0, 5387.0, 5532.0, 5581.0, 5266.0, 5722.0, 5434.0, 5364.0, 5492.0, 5714.0, 5292.0, 5269.0, 5397.0, 5438.0

						5583.0, 5524.0, 5511.0, 5384.0, 5484.0, 5642.0, 5426.0, 5512.0, 5557.0, 5359.0, 5340.0, 5690.0, 5526.0, 5553.0, 5565.0, 5669.0, 5435.0, 5294.0, 5716.0, 5432.0, 5251.0, 5586.0, 5343.0, 5495.0, 5328.0, 5530.0, 5591.0, 5519.0, 5527.0, 5665.0, 5625.0, 5584.0, 5416.0, 5385.0, 5463.0, 5270.0, 5403.0, 5567.0, 5558.0, 5326.0, 5353.0, 5719.0, 5502.0, 5311.0, 5505.0, 5253.0, 5592.0, 5281.0, 5417.0, 5656.0, 5325.0, 5621.0, 5362.0, 5520.0, 5261.0, 5713.0, 5715.0, 5506.0, 5664.0, 5408.0, 5475.0, 5286.0, 5369.0, 5273.0, 5655.0 (number of hits: 9)
7	5550	9	1	333	1	5296.0, 5394.0, 5421.0, 5341.0, 5386.0, 5268.0, 5274.0, 5335.0, 5586.0, 5340.0, 5689.0, 5712.0, 5498.0, 5491.0, 5460.0, 5632.0, 5602.0, 5606.0, 5522.0, 5497.0, 5668.0, 5643.0, 5380.0, 5661.0, 5370.0, 5287.0, 5493.0, 5699.0, 5322.0, 5559.0, 5313.0, 5424.0, 5383.0, 5587.0, 5442.0, 5334.0, 5715.0, 5701.0, 5477.0, 5682.0, 5470.0, 5505.0, 5377.0, 5299.0, 5400.0, 5653.0, 5343.0, 5482.0, 5533.0, 5321.0, 5393.0, 5253.0, 5401.0, 5569.0, 5489.0, 5724.0, 5625.0, 5355.0, 5526.0, 5267.0, 5379.0, 5344.0, 5601.0, 5698.0, 5306.0, 5615.0, 5269.0, 5348.0, 5298.0, 5548.0, 5641.0, 5282.0, 5293.0, 5292.0, 5382.0, 5614.0, 5354.0, 5440.0, 5633.0, 5607.0, 5597.0, 5582.0, 5619.0, 5500.0, 5665.0, 5659.0, 5457.0, 5403.0, 5455.0, 5381.0, 5520.0, 5537.0, 5469.0, 5435.0, 5511.0, 5311.0, 5681.0, 5295.0, 5499.0, 5362.0 (number of hits: 5)
8	5550	9	1	333	1	5501.0, 5401.0, 5449.0, 5462.0, 5421.0, 5435.0, 5616.0, 5448.0, 5424.0, 5551.0, 5708.0, 5429.0, 5320.0, 5499.0, 5374.0, 5627.0, 5523.0, 5624.0, 5458.0, 5573.0, 5351.0, 5282.0, 5438.0, 5702.0, 5602.0, 5344.0, 5385.0, 5322.0, 5315.0, 5409.0, 5287.0, 5334.0, 5589.0, 5440.0, 5590.0, 5465.0, 5379.0, 5629.0, 5431.0, 5538.0, 5455.0, 5684.0, 5317.0, 5466.0, 5428.0, 5723.0, 5486.0, 5700.0, 5445.0, 5265.0, 5290.0, 5638.0, 5470.0, 5301.0, 5628.0, 5291.0, 5614.0, 5701.0, 5475.0, 5377.0, 5564.0, 5284.0, 5507.0, 5311.0, 5688.0, 5495.0, 5703.0, 5400.0, 5670.0, 5430.0, 5655.0, 5460.0, 5267.0, 5609.0, 5541.0, 5722.0, 5637.0, 5575.0, 5604.0, 5276.0, 5561.0, 5522.0, 5504.0, 5381.0, 5286.0, 5498.0, 5714.0, 5572.0, 5323.0, 5568.0, 5527.0, 5365.0, 5457.0, 5459.0, 5410.0, 5671.0, 5710.0, 5349.0, 5353.0, 5625.0 (number of hits: 6)
9	5550	9	1	333	1	5714.0, 5344.0, 5333.0, 5584.0, 5308.0, 5292.0, 5573.0, 5678.0, 5293.0, 5611.0, 5500.0, 5426.0, 5444.0, 5665.0, 5664.0,

						5399.0, 5642.0, 5321.0, 5591.0, 5617.0, 5575.0, 5683.0, 5544.0, 5478.0, 5384.0, 5680.0, 5663.0, 5534.0, 5416.0, 5307.0, 5369.0, 5508.0, 5563.0, 5390.0, 5331.0, 5700.0, 5483.0, 5467.0, 5410.0, 5494.0, 5314.0, 5475.0, 5527.0, 5349.0, 5630.0, 5257.0, 5632.0, 5413.0, 5613.0, 5297.0, 5316.0, 5395.0, 5495.0, 5594.0, 5385.0, 5636.0, 5411.0, 5356.0, 5606.0, 5493.0, 5430.0, 5511.0, 5579.0, 5549.0, 5561.0, 5354.0, 5619.0, 5595.0, 5716.0, 5398.0, 5334.0, 5355.0, 5482.0, 5612.0, 5347.0, 5443.0, 5568.0, 5253.0, 5614.0, 5562.0, 5572.0, 5648.0, 5322.0, 5676.0, 5626.0, 5419.0, 5564.0, 5270.0, 5659.0, 5280.0, 5332.0, 5496.0, 5320.0, 5273.0, 5266.0, 5338.0, 5359.0, 5254.0, 5458.0, 5638.0 (number of hits: 8)
10	5550	9	1	333	1	5465.0, 5656.0, 5678.0, 5411.0, 5374.0, 5467.0, 5673.0, 5297.0, 5579.0, 5254.0, 5334.0, 5677.0, 5313.0, 5586.0, 5448.0, 5539.0, 5576.0, 5550.0, 5692.0, 5451.0, 5391.0, 5259.0, 5320.0, 5478.0, 5521.0, 5615.0, 5454.0, 5518.0, 5614.0, 5591.0, 5622.0, 5585.0, 5722.0, 5497.0, 5340.0, 5336.0, 5635.0, 5723.0, 5721.0, 5508.0, 5584.0, 5565.0, 5682.0, 5496.0, 5506.0, 5665.0, 5637.0, 5567.0, 5582.0, 5383.0, 5396.0, 5680.0, 5296.0, 5621.0, 5349.0, 5406.0, 5420.0, 5344.0, 5620.0, 5592.0, 5704.0, 5376.0, 5717.0, 5547.0, 5362.0, 5440.0, 5720.0, 5427.0, 5714.0, 5699.0, 5515.0, 5477.0, 5281.0, 5551.0, 5583.0, 5538.0, 5288.0, 5633.0, 5389.0, 5700.0, 5263.0, 5489.0, 5274.0, 5469.0, 5625.0, 5531.0, 5634.0, 5597.0, 5323.0, 5379.0, 5294.0, 5609.0, 5647.0, 5460.0, 5470.0, 5430.0, 5681.0, 5646.0, 5435.0, 5546.0 (number of hits: 9)
11	5550	9	1	333	1	5415.0, 5594.0, 5641.0, 5584.0, 5676.0, 5416.0, 5624.0, 5703.0, 5569.0, 5596.0, 5349.0, 5360.0, 5484.0, 5372.0, 5437.0, 5350.0, 5387.0, 5460.0, 5485.0, 5718.0, 5505.0, 5648.0, 5250.0, 5353.0, 5301.0, 5622.0, 5331.0, 5300.0, 5330.0, 5692.0, 5400.0, 5550.0, 5316.0, 5284.0, 5265.0, 5473.0, 5478.0, 5435.0, 5474.0, 5352.0, 5295.0, 5660.0, 5470.0, 5556.0, 5561.0, 5358.0, 5405.0, 5579.0, 5682.0, 5724.0, 5385.0, 5714.0, 5255.0, 5356.0, 5447.0, 5662.0, 5577.0, 5656.0, 5527.0, 5502.0, 5528.0, 5611.0, 5340.0, 5339.0, 5328.0, 5406.0, 5332.0, 5453.0, 5677.0, 5452.0, 5652.0, 5506.0, 5562.0, 5362.0, 5427.0, 5589.0, 5702.0, 5369.0, 5381.0, 5466.0, 5277.0, 5380.0, 5531.0, 5252.0, 5436.0, 5638.0, 5420.0, 5361.0, 5585.0, 5645.0, 5401.0, 5623.0, 5602.0, 5375.0, 5467.0, 5582.0, 5443.0, 5270.0, 5280.0, 5607.0

						(number of hits: 6)
12	5550	9	1	333	1	5474.0, 5697.0, 5447.0, 5598.0, 5615.0, 5355.0, 5460.0, 5637.0, 5699.0, 5667.0, 5538.0, 5391.0, 5606.0, 5648.0, 5417.0, 5325.0, 5705.0, 5550.0, 5516.0, 5334.0, 5630.0, 5651.0, 5466.0, 5477.0, 5694.0, 5256.0, 5588.0, 5468.0, 5533.0, 5493.0, 5263.0, 5655.0, 5461.0, 5489.0, 5690.0, 5708.0, 5462.0, 5295.0, 5566.0, 5639.0, 5642.0, 5607.0, 5289.0, 5663.0, 5593.0, 5322.0, 5658.0, 5300.0, 5465.0, 5422.0, 5601.0, 5718.0, 5315.0, 5570.0, 5537.0, 5392.0, 5618.0, 5358.0, 5368.0, 5276.0, 5720.0, 5681.0, 5632.0, 5375.0, 5430.0, 5656.0, 5567.0, 5584.0, 5490.0, 5264.0, 5599.0, 5290.0, 5394.0, 5666.0, 5411.0, 5427.0, 5721.0, 5452.0, 5650.0, 5711.0, 5515.0, 5641.0, 5401.0, 5645.0, 5301.0, 5259.0, 5616.0, 5396.0, 5347.0, 5437.0, 5557.0, 5627.0, 5467.0, 5687.0, 5250.0, 5558.0, 5698.0, 5432.0, 5397.0, 5564.0
						(number of hits: 9)
13	5550	9	1	333	1	5676.0, 5554.0, 5599.0, 5460.0, 5636.0, 5453.0, 5701.0, 5524.0, 5632.0, 5373.0, 5330.0, 5616.0, 5297.0, 5424.0, 5711.0, 5672.0, 5479.0, 5547.0, 5251.0, 5398.0, 5281.0, 5498.0, 5429.0, 5580.0, 5501.0, 5287.0, 5313.0, 5349.0, 5495.0, 5540.0, 5716.0, 5601.0, 5262.0, 5358.0, 5691.0, 5379.0, 5426.0, 5370.0, 5621.0, 5421.0, 5505.0, 5697.0, 5320.0, 5275.0, 5351.0, 5660.0, 5699.0, 5392.0, 5573.0, 5425.0, 5276.0, 5416.0, 5391.0, 5305.0, 5261.0, 5428.0, 5365.0, 5385.0, 5465.0, 5654.0, 5600.0, 5603.0, 5458.0, 5641.0, 5434.0, 5283.0, 5684.0, 5516.0, 5647.0, 5529.0, 5403.0, 5437.0, 5369.0, 5309.0, 5409.0, 5545.0, 5534.0, 5652.0, 5342.0, 5670.0, 5646.0, 5644.0, 5532.0, 5720.0, 5471.0, 5267.0, 5578.0, 5695.0, 5586.0, 5702.0, 5557.0, 5469.0, 5477.0, 5690.0, 5352.0, 5500.0, 5264.0, 5481.0, 5354.0, 5588.0
						(number of hits: 7)
14	5550	9	1	333	1	5440.0, 5542.0, 5431.0, 5277.0, 5539.0, 5471.0, 5630.0, 5342.0, 5339.0, 5354.0, 5657.0, 5604.0, 5564.0, 5311.0, 5334.0, 5478.0, 5436.0, 5469.0, 5338.0, 5451.0, 5401.0, 5468.0, 5601.0, 5549.0, 5321.0, 5389.0, 5668.0, 5379.0, 5625.0, 5556.0, 5663.0, 5260.0, 5427.0, 5642.0, 5646.0, 5508.0, 5484.0, 5460.0, 5644.0, 5555.0, 5631.0, 5298.0, 5287.0, 5459.0, 5382.0, 5485.0, 5661.0, 5702.0, 5365.0, 5390.0, 5621.0, 5477.0, 5432.0, 5652.0, 5600.0, 5673.0, 5312.0, 5550.0, 5698.0, 5634.0, 5293.0, 5719.0, 5422.0, 5284.0, 5653.0, 5659.0, 5707.0, 5250.0, 5596.0, 5493.0, 5333.0, 5480.0, 5362.0, 5723.0, 5363.0, 5328.0, 5445.0, 5647.0, 5437.0, 5497.0

						5343.0, 5528.0, 5455.0, 5597.0, 5446.0, 5385.0, 5373.0, 5462.0, 5255.0, 5350.0, 5517.0, 5581.0, 5648.0, 5665.0, 5256.0, 5685.0, 5476.0, 5530.0, 5300.0, 5326.0 (number of hits: 8)
15	5550	9	1	333	1	5591.0, 5275.0, 5462.0, 5510.0, 5552.0, 5441.0, 5415.0, 5341.0, 5394.0, 5253.0, 5512.0, 5563.0, 5526.0, 5663.0, 5585.0, 5382.0, 5479.0, 5298.0, 5410.0, 5584.0, 5336.0, 5423.0, 5267.0, 5440.0, 5697.0, 5273.0, 5380.0, 5628.0, 5387.0, 5544.0, 5378.0, 5281.0, 5572.0, 5351.0, 5407.0, 5590.0, 5465.0, 5315.0, 5723.0, 5483.0, 5436.0, 5571.0, 5518.0, 5286.0, 5428.0, 5313.0, 5546.0, 5343.0, 5710.0, 5692.0, 5274.0, 5649.0, 5567.0, 5559.0, 5345.0, 5388.0, 5562.0, 5502.0, 5369.0, 5412.0, 5256.0, 5370.0, 5488.0, 5303.0, 5685.0, 5678.0, 5470.0, 5416.0, 5696.0, 5720.0, 5519.0, 5521.0, 5398.0, 5660.0, 5262.0, 5405.0, 5498.0, 5443.0, 5686.0, 5527.0, 5403.0, 5473.0, 5568.0, 5474.0, 5707.0, 5700.0, 5658.0, 5291.0, 5340.0, 5283.0, 5269.0, 5548.0, 5447.0, 5513.0, 5541.0, 5717.0, 5446.0, 5284.0, 5680.0, 5356.0 (number of hits: 10)
16	5550	9	1	333	1	5315.0, 5521.0, 5328.0, 5555.0, 5688.0, 5251.0, 5304.0, 5423.0, 5375.0, 5531.0, 5321.0, 5422.0, 5448.0, 5271.0, 5508.0, 5680.0, 5368.0, 5369.0, 5613.0, 5635.0, 5653.0, 5349.0, 5593.0, 5539.0, 5517.0, 5721.0, 5540.0, 5412.0, 5562.0, 5331.0, 5565.0, 5370.0, 5468.0, 5260.0, 5608.0, 5362.0, 5250.0, 5355.0, 5473.0, 5303.0, 5322.0, 5457.0, 5657.0, 5407.0, 5484.0, 5258.0, 5290.0, 5594.0, 5524.0, 5573.0, 5430.0, 5310.0, 5300.0, 5373.0, 5436.0, 5280.0, 5309.0, 5397.0, 5357.0, 5716.0, 5625.0, 5561.0, 5444.0, 5697.0, 5676.0, 5313.0, 5670.0, 5600.0, 5480.0, 5402.0, 5411.0, 5519.0, 5589.0, 5292.0, 5438.0, 5337.0, 5460.0, 5496.0, 5714.0, 5269.0, 5421.0, 5479.0, 5302.0, 5381.0, 5549.0, 5276.0, 5638.0, 5656.0, 5491.0, 5693.0, 5301.0, 5699.0, 5277.0, 5408.0, 5487.0, 5325.0, 5564.0, 5261.0, 5459.0, 5481.0 (number of hits: 9)
17	5550	9	1	333	1	5463.0, 5480.0, 5608.0, 5373.0, 5471.0, 5681.0, 5684.0, 5484.0, 5680.0, 5624.0, 5721.0, 5602.0, 5574.0, 5393.0, 5670.0, 5616.0, 5455.0, 5556.0, 5497.0, 5675.0, 5358.0, 5478.0, 5390.0, 5335.0, 5465.0, 5315.0, 5658.0, 5555.0, 5313.0, 5372.0, 5491.0, 5661.0, 5379.0, 5261.0, 5409.0, 5709.0, 5377.0, 5336.0, 5383.0, 5641.0, 5422.0, 5331.0, 5639.0, 5284.0, 5551.0, 5410.0, 5542.0, 5686.0, 5366.0, 5460.0, 5371.0, 5558.0, 5318.0, 5696.0, 5544.0, 5626.0, 5345.0, 5569.0, 5575.0, 5386.0

						5357.0, 5703.0, 5265.0, 5629.0, 5623.0, 5546.0, 5698.0, 5391.0, 5504.0, 5334.0, 5600.0, 5695.0, 5612.0, 5522.0, 5297.0, 5296.0, 5295.0, 5437.0, 5685.0, 5342.0, 5285.0, 5479.0, 5529.0, 5473.0, 5453.0, 5701.0, 5500.0, 5711.0, 5541.0, 5493.0, 5528.0, 5408.0, 5303.0, 5513.0, 5338.0, 5396.0, 5723.0, 5385.0, 5332.0, 5280.0 (number of hits: 9)
18	5550	9	1	333	1	5543.0, 5619.0, 5649.0, 5509.0, 5348.0, 5454.0, 5661.0, 5710.0, 5672.0, 5552.0, 5658.0, 5298.0, 5338.0, 5303.0, 5512.0, 5651.0, 5397.0, 5357.0, 5692.0, 5411.0, 5302.0, 5339.0, 5379.0, 5475.0, 5336.0, 5321.0, 5406.0, 5287.0, 5611.0, 5676.0, 5455.0, 5722.0, 5294.0, 5433.0, 5360.0, 5255.0, 5707.0, 5533.0, 5568.0, 5314.0, 5532.0, 5548.0, 5557.0, 5399.0, 5599.0, 5270.0, 5584.0, 5464.0, 5601.0, 5719.0, 5398.0, 5264.0, 5559.0, 5446.0, 5386.0, 5698.0, 5633.0, 5665.0, 5435.0, 5618.0, 5724.0, 5309.0, 5516.0, 5349.0, 5508.0, 5432.0, 5354.0, 5560.0, 5517.0, 5705.0, 5259.0, 5591.0, 5425.0, 5261.0, 5499.0, 5528.0, 5334.0, 5391.0, 5331.0, 5684.0, 5470.0, 5681.0, 5272.0, 5563.0, 5491.0, 5723.0, 5444.0, 5486.0, 5645.0, 5285.0, 5711.0, 5268.0, 5631.0, 5447.0, 5714.0, 5477.0, 5300.0, 5308.0, 5697.0, 5450.0 (number of hits: 10)
19	5550	9	1	333	1	5530.0, 5606.0, 5465.0, 5642.0, 5599.0, 5516.0, 5617.0, 5389.0, 5694.0, 5419.0, 5349.0, 5461.0, 5313.0, 5668.0, 5714.0, 5511.0, 5444.0, 5339.0, 5372.0, 5647.0, 5332.0, 5717.0, 5574.0, 5365.0, 5590.0, 5538.0, 5375.0, 5410.0, 5635.0, 5580.0, 5624.0, 5301.0, 5296.0, 5304.0, 5409.0, 5711.0, 5442.0, 5618.0, 5446.0, 5345.0, 5604.0, 5309.0, 5537.0, 5598.0, 5376.0, 5276.0, 5640.0, 5596.0, 5326.0, 5595.0, 5710.0, 5575.0, 5561.0, 5616.0, 5696.0, 5475.0, 5358.0, 5535.0, 5602.0, 5368.0, 5432.0, 5398.0, 5364.0, 5390.0, 5510.0, 5528.0, 5341.0, 5512.0, 5344.0, 5440.0, 5629.0, 5434.0, 5545.0, 5609.0, 5382.0, 5363.0, 5689.0, 5486.0, 5250.0, 5266.0, 5340.0, 5453.0, 5692.0, 5261.0, 5269.0, 5484.0, 5379.0, 5661.0, 5582.0, 5589.0, 5260.0, 5637.0, 5315.0, 5706.0, 5671.0, 5547.0, 5532.0, 5611.0, 5272.0, 5251.0 (number of hits: 8)
20	5550	9	1	333	1	5483.0, 5547.0, 5396.0, 5383.0, 5253.0, 5280.0, 5295.0, 5404.0, 5503.0, 5572.0, 5281.0, 5287.0, 5559.0, 5319.0, 5431.0, 5520.0, 5585.0, 5298.0, 5430.0, 5307.0, 5515.0, 5401.0, 5372.0, 5591.0, 5616.0, 5371.0, 5288.0, 5635.0, 5395.0, 5600.0, 5649.0, 5397.0, 5375.0, 5429.0, 5356.0, 5344.0, 5664.0, 5354.0, 5365.0, 5414.0

						5292.0, 5461.0, 5359.0, 5644.0, 5724.0, 5619.0, 5433.0, 5450.0, 5525.0, 5466.0, 5420.0, 5504.0, 5522.0, 5711.0, 5565.0, 5453.0, 5322.0, 5454.0, 5255.0, 5541.0, 5537.0, 5573.0, 5353.0, 5446.0, 5688.0, 5675.0, 5445.0, 5410.0, 5631.0, 5593.0, 5545.0, 5309.0, 5492.0, 5551.0, 5670.0, 5324.0, 5346.0, 5662.0, 5262.0, 5260.0, 5316.0, 5341.0, 5641.0, 5603.0, 5651.0, 5539.0, 5672.0, 5707.0, 5659.0, 5710.0, 5576.0, 5318.0, 5312.0, 5605.0, 5465.0, 5456.0, 5470.0, 5676.0, 5721.0, 5497.0 (number of hits: 8)
21	5550	9	1	333	1	5465.0, 5293.0, 5461.0, 5456.0, 5563.0, 5386.0, 5261.0, 5714.0, 5450.0, 5683.0, 5490.0, 5269.0, 5365.0, 5651.0, 5379.0, 5693.0, 5299.0, 5449.0, 5689.0, 5561.0, 5548.0, 5311.0, 5265.0, 5644.0, 5625.0, 5716.0, 5481.0, 5650.0, 5468.0, 5708.0, 5720.0, 5353.0, 5336.0, 5588.0, 5436.0, 5358.0, 5516.0, 5578.0, 5366.0, 5485.0, 5653.0, 5512.0, 5312.0, 5500.0, 5273.0, 5704.0, 5384.0, 5717.0, 5662.0, 5287.0, 5685.0, 5595.0, 5466.0, 5507.0, 5527.0, 5376.0, 5499.0, 5497.0, 5281.0, 5646.0, 5264.0, 5590.0, 5645.0, 5491.0, 5533.0, 5532.0, 5567.0, 5458.0, 5309.0, 5318.0, 5495.0, 5505.0, 5566.0, 5272.0, 5510.0, 5549.0, 5473.0, 5608.0, 5573.0, 5503.0, 5256.0, 5628.0, 5550.0, 5375.0, 5713.0, 5408.0, 5448.0, 5462.0, 5519.0, 5398.0, 5547.0, 5641.0, 5298.0, 5364.0, 5599.0, 5342.0, 5686.0, 5382.0, 5679.0, 5337.0 (number of hits: 10)
22	5550	9	1	333	1	5493.0, 5301.0, 5313.0, 5445.0, 5638.0, 5722.0, 5550.0, 5446.0, 5487.0, 5439.0, 5261.0, 5684.0, 5423.0, 5293.0, 5502.0, 5268.0, 5303.0, 5517.0, 5256.0, 5579.0, 5305.0, 5470.0, 5530.0, 5410.0, 5667.0, 5557.0, 5392.0, 5420.0, 5625.0, 5582.0, 5412.0, 5655.0, 5598.0, 5603.0, 5700.0, 5516.0, 5431.0, 5285.0, 5390.0, 5604.0, 5612.0, 5584.0, 5455.0, 5315.0, 5592.0, 5414.0, 5425.0, 5362.0, 5344.0, 5364.0, 5461.0, 5489.0, 5656.0, 5602.0, 5648.0, 5480.0, 5280.0, 5535.0, 5424.0, 5459.0, 5615.0, 5663.0, 5605.0, 5437.0, 5531.0, 5397.0, 5607.0, 5697.0, 5650.0, 5291.0, 5521.0, 5500.0, 5275.0, 5322.0, 5520.0, 5448.0, 5309.0, 5556.0, 5642.0, 5456.0, 5366.0, 5332.0, 5622.0, 5379.0, 5374.0, 5720.0, 5662.0, 5342.0, 5421.0, 5691.0, 5696.0, 5277.0, 5254.0, 5519.0, 5583.0, 5298.0, 5653.0, 5539.0, 5679.0, 5716.0 (number of hits: 7)
23	5550	9	1	333	1	5338.0, 5437.0, 5286.0, 5497.0, 5440.0, 5486.0, 5291.0, 5348.0, 5418.0, 5455.0, 5335.0, 5517.0, 5519.0, 5695.0, 5633.0, 5277.0, 5571.0, 5479.0, 5611.0, 5549.0

						5674.0, 5396.0, 5373.0, 5436.0, 5669.0, 5412.0, 5427.0, 5416.0, 5478.0, 5577.0, 5528.0, 5520.0, 5522.0, 5663.0, 5306.0, 5706.0, 5331.0, 5493.0, 5301.0, 5404.0, 5290.0, 5666.0, 5513.0, 5271.0, 5314.0, 5452.0, 5573.0, 5710.0, 5512.0, 5576.0, 5364.0, 5349.0, 5542.0, 5336.0, 5406.0, 5433.0, 5680.0, 5461.0, 5593.0, 5532.0, 5303.0, 5626.0, 5361.0, 5574.0, 5557.0, 5386.0, 5367.0, 5309.0, 5640.0, 5556.0, 5371.0, 5438.0, 5602.0, 5265.0, 5521.0, 5442.0, 5527.0, 5449.0, 5481.0, 5322.0, 5341.0, 5555.0, 5675.0, 5334.0, 5453.0, 5378.0, 5443.0, 5359.0, 5464.0, 5690.0, 5394.0, 5589.0, 5358.0, 5677.0, 5490.0, 5720.0, 5509.0, 5278.0, 5658.0, 5722.0 (number of hits: 6)
24	5550	9	1	333	1	5287.0, 5604.0, 5662.0, 5651.0, 5642.0, 5450.0, 5323.0, 5550.0, 5308.0, 5548.0, 5597.0, 5445.0, 5593.0, 5264.0, 5404.0, 5467.0, 5538.0, 5711.0, 5393.0, 5402.0, 5518.0, 5644.0, 5474.0, 5371.0, 5568.0, 5439.0, 5469.0, 5555.0, 5635.0, 5682.0, 5556.0, 5715.0, 5674.0, 5470.0, 5588.0, 5270.0, 5551.0, 5284.0, 5273.0, 5553.0, 5721.0, 5392.0, 5459.0, 5583.0, 5329.0, 5491.0, 5479.0, 5506.0, 5377.0, 5687.0, 5543.0, 5630.0, 5416.0, 5390.0, 5510.0, 5288.0, 5706.0, 5575.0, 5422.0, 5299.0, 5547.0, 5464.0, 5353.0, 5462.0, 5418.0, 5406.0, 5437.0, 5354.0, 5522.0, 5572.0, 5546.0, 5577.0, 5261.0, 5306.0, 5545.0, 5686.0, 5309.0, 5295.0, 5684.0, 5665.0, 5399.0, 5594.0, 5508.0, 5370.0, 5452.0, 5320.0, 5714.0, 5342.0, 5387.0, 5549.0, 5380.0, 5516.0, 5285.0, 5515.0, 5520.0, 5363.0, 5681.0, 5527.0, 5509.0, 5266.0 (number of hits: 13)
25	5550	9	1	333	1	5515.0, 5325.0, 5276.0, 5644.0, 5708.0, 5718.0, 5293.0, 5638.0, 5342.0, 5652.0, 5512.0, 5523.0, 5359.0, 5605.0, 5510.0, 5641.0, 5634.0, 5253.0, 5503.0, 5356.0, 5505.0, 5493.0, 5254.0, 5476.0, 5619.0, 5291.0, 5326.0, 5418.0, 5655.0, 5371.0, 5450.0, 5308.0, 5688.0, 5411.0, 5539.0, 5582.0, 5284.0, 5281.0, 5385.0, 5587.0, 5676.0, 5716.0, 5689.0, 5416.0, 5315.0, 5720.0, 5445.0, 5355.0, 5432.0, 5658.0, 5374.0, 5673.0, 5399.0, 5334.0, 5317.0, 5471.0, 5441.0, 5556.0, 5413.0, 5525.0, 5302.0, 5314.0, 5682.0, 5664.0, 5502.0, 5443.0, 5404.0, 5401.0, 5491.0, 5379.0, 5283.0, 5466.0, 5690.0, 5540.0, 5573.0, 5713.0, 5279.0, 5419.0, 5574.0, 5480.0, 5537.0, 5669.0, 5532.0, 5691.0, 5598.0, 5723.0, 5470.0, 5427.0, 5495.0, 5534.0, 5544.0, 5464.0, 5559.0, 5345.0, 5451.0, 5486.0, 5312.0, 5446.0, 5319.0, 5636.0 (number of hits: 8)

26	5550	9	1	333	1	<p>5472.0, 5655.0, 5480.0, 5539.0, 5355.0, 5638.0, 5570.0, 5396.0, 5457.0, 5363.0, 5586.0, 5618.0, 5666.0, 5392.0, 5372.0, 5641.0, 5684.0, 5691.0, 5580.0, 5577.0, 5455.0, 5361.0, 5491.0, 5556.0, 5330.0, 5291.0, 5614.0, 5507.0, 5675.0, 5583.0, 5707.0, 5683.0, 5307.0, 5511.0, 5657.0, 5509.0, 5403.0, 5629.0, 5469.0, 5254.0, 5342.0, 5424.0, 5453.0, 5665.0, 5565.0, 5395.0, 5686.0, 5722.0, 5519.0, 5671.0, 5485.0, 5353.0, 5463.0, 5282.0, 5394.0, 5439.0, 5321.0, 5438.0, 5448.0, 5566.0, 5656.0, 5520.0, 5672.0, 5552.0, 5435.0, 5640.0, 5636.0, 5634.0, 5531.0, 5466.0, 5661.0, 5271.0, 5458.0, 5434.0, 5592.0, 5505.0, 5454.0, 5704.0, 5447.0, 5275.0, 5515.0, 5305.0, 5484.0, 5590.0, 5521.0, 5381.0, 5663.0, 5415.0, 5382.0, 5612.0, 5417.0, 5513.0, 5518.0, 5315.0, 5385.0, 5560.0, 5496.0, 5669.0, 5720.0, 5535.0 (number of hits: 8)</p>
27	5550	9	1	333	1	<p>5677.0, 5346.0, 5304.0, 5633.0, 5361.0, 5569.0, 5255.0, 5354.0, 5448.0, 5442.0, 5283.0, 5386.0, 5586.0, 5489.0, 5433.0, 5639.0, 5614.0, 5493.0, 5585.0, 5284.0, 5287.0, 5632.0, 5562.0, 5380.0, 5371.0, 5370.0, 5539.0, 5387.0, 5477.0, 5547.0, 5467.0, 5401.0, 5384.0, 5635.0, 5254.0, 5649.0, 5566.0, 5623.0, 5527.0, 5281.0, 5505.0, 5418.0, 5516.0, 5374.0, 5397.0, 5499.0, 5285.0, 5326.0, 5459.0, 5657.0, 5369.0, 5313.0, 5257.0, 5385.0, 5400.0, 5268.0, 5503.0, 5571.0, 5511.0, 5683.0, 5339.0, 5513.0, 5558.0, 5563.0, 5686.0, 5272.0, 5289.0, 5476.0, 5360.0, 5425.0, 5408.0, 5375.0, 5250.0, 5597.0, 5469.0, 5628.0, 5629.0, 5328.0, 5673.0, 5631.0, 5565.0, 5465.0, 5681.0, 5584.0, 5479.0, 5309.0, 5579.0, 5460.0, 5359.0, 5390.0, 5426.0, 5427.0, 5342.0, 5266.0, 5462.0, 5588.0, 5589.0, 5676.0, 5377.0, 5670.0 (number of hits: 8)</p>
28	5550	9	1	333	1	<p>5339.0, 5437.0, 5435.0, 5607.0, 5417.0, 5354.0, 5616.0, 5278.0, 5506.0, 5274.0, 5556.0, 5641.0, 5639.0, 5622.0, 5404.0, 5389.0, 5649.0, 5364.0, 5487.0, 5322.0, 5580.0, 5656.0, 5584.0, 5653.0, 5619.0, 5427.0, 5585.0, 5723.0, 5617.0, 5672.0, 5425.0, 5306.0, 5270.0, 5333.0, 5704.0, 5574.0, 5516.0, 5294.0, 5721.0, 5325.0, 5663.0, 5409.0, 5373.0, 5606.0, 5685.0, 5495.0, 5292.0, 5261.0, 5596.0, 5519.0, 5507.0, 5586.0, 5613.0, 5465.0, 5547.0, 5412.0, 5492.0, 5554.0, 5402.0, 5699.0, 5321.0, 5601.0, 5587.0, 5388.0, 5443.0, 5341.0, 5293.0, 5502.0, 5416.0, 5439.0, 5565.0, 5291.0, 5305.0, 5331.0, 5676.0, 5441.0, 5460.0, 5469.0, 5560.0, 5540.0, 5557.0, 5463.0, 5351.0, 5522.0, 5544.0</p>

						5323.0, 5489.0, 5459.0, 5258.0, 5625.0, 5552.0, 5529.0, 5257.0, 5289.0, 5320.0, 5658.0, 5636.0, 5360.0, 5677.0, 5633.0 (number of hits: 9)
29	5550	9	1	333	1	5644.0, 5290.0, 5700.0, 5324.0, 5332.0, 5507.0, 5271.0, 5406.0, 5627.0, 5495.0, 5550.0, 5433.0, 5342.0, 5452.0, 5556.0, 5624.0, 5575.0, 5445.0, 5276.0, 5629.0, 5415.0, 5620.0, 5355.0, 5458.0, 5621.0, 5412.0, 5633.0, 5351.0, 5407.0, 5558.0, 5492.0, 5684.0, 5264.0, 5472.0, 5514.0, 5532.0, 5559.0, 5305.0, 5321.0, 5420.0, 5656.0, 5256.0, 5607.0, 5496.0, 5371.0, 5596.0, 5694.0, 5660.0, 5500.0, 5398.0, 5714.0, 5692.0, 5719.0, 5723.0, 5337.0, 5479.0, 5417.0, 5313.0, 5494.0, 5634.0, 5364.0, 5545.0, 5643.0, 5549.0, 5432.0, 5462.0, 5604.0, 5573.0, 5391.0, 5284.0, 5601.0, 5299.0, 5338.0, 5322.0, 5653.0, 5609.0, 5333.0, 5317.0, 5679.0, 5286.0, 5552.0, 5475.0, 5360.0, 5251.0, 5657.0, 5650.0, 5353.0, 5443.0, 5691.0, 5384.0, 5261.0, 5401.0, 5285.0, 5718.0, 5347.0, 5444.0, 5280.0, 5504.0, 5503.0, 5361.0 (number of hits: 8)
30	5550	9	1	333	1	5618.0, 5426.0, 5261.0, 5677.0, 5633.0, 5382.0, 5639.0, 5675.0, 5428.0, 5358.0, 5543.0, 5508.0, 5579.0, 5361.0, 5495.0, 5312.0, 5270.0, 5362.0, 5265.0, 5556.0, 5603.0, 5280.0, 5558.0, 5473.0, 5304.0, 5643.0, 5461.0, 5604.0, 5578.0, 5454.0, 5447.0, 5504.0, 5510.0, 5451.0, 5277.0, 5397.0, 5313.0, 5570.0, 5616.0, 5560.0, 5336.0, 5511.0, 5481.0, 5551.0, 5490.0, 5492.0, 5254.0, 5617.0, 5537.0, 5667.0, 5311.0, 5704.0, 5530.0, 5592.0, 5501.0, 5721.0, 5283.0, 5390.0, 5444.0, 5494.0, 5676.0, 5720.0, 5263.0, 5276.0, 5334.0, 5493.0, 5569.0, 5387.0, 5706.0, 5703.0, 5423.0, 5469.0, 5497.0, 5299.0, 5303.0, 5290.0, 5601.0, 5379.0, 5665.0, 5664.0, 5635.0, 5275.0, 5253.0, 5305.0, 5484.0, 5396.0, 5609.0, 5448.0, 5450.0, 5512.0, 5531.0, 5460.0, 5282.0, 5328.0, 5705.0, 5272.0, 5465.0, 5446.0, 5325.0, 5719.0 (number of hits: 9)

5530 MHz, 80 MHz Bandwidth

Radar Signal Type	Waveform/Trial Number	Detection (%)	Limit (%)	Pass/Fail
Type 1A/1B	30	100 %	60%	Pass
Type 2	30	100 %	60%	Pass
Type 3	30	100 %	60%	Pass
Type 4	30	100 %	60%	Pass
Aggregate (Type1 to 4)	120	100 %	80%	Pass
Type 5	30	100 %	80%	Pass
Type 6	30	100 %	70%	Pass

Please refer to the following statistical tables:

5530 MHz, 80 MHz Bandwidth**Table-1A/1B Radar Type 1A/1B Statistical Performance**

Trial #	Fc (MHz)	Pulse/Burst	Pulse Width (µS)	PRI (µs)	Detection (1:yes; 0:no)
1	5530	63	1	838	1
2	5530	76	1	698	1
3	5530	78	1	678	1
4	5530	57	1	938	1
5	5530	59	1	898	1
6	5530	86	1	618	1
7	5530	95	1	558	1
8	5530	62	1	858	1
9	5530	68	1	778	1
10	5530	72	1	738	1
11	5530	99	1	538	1
12	5530	81	1	658	1
13	5530	67	1	798	1
14	5530	61	1	878	1
15	5530	70	1	758	1
16	5530	37	1	1432	1
17	5530	29	1	1876	1
18	5530	71	1	753	1
19	5530	73	1	727	1
20	5530	22	1	2400	1
21	5530	23	1	2349	1
22	5530	45	1	1175	1
23	5530	26	1	2086	1
24	5530	37	1	1466	1
25	5530	26	1	2107	1
26	5530	24	1	2232	1
27	5530	58	1	923	1
28	5530	27	1	1959	1
29	5530	23	1	2388	1
30	5530	46	1	1149	1
Detection Percentage: 100 % (>60%)					

Table-2 Radar Type 2 Statistical Performance

Trial #	Fc (MHz)	Pulse/Burst	Pulse Width (µS)	PRI (µs)	Detection (1:yes; 0:no)
1	5530	27	3.1	183	1
2	5530	26	3.9	200	1
3	5530	24	5	194	1
4	5530	28	3.9	211	1
5	5530	28	4.2	175	1
6	5530	25	2.4	192	1
7	5530	28	4.9	179	1
8	5530	24	1.6	226	1
9	5530	29	2.9	154	1
10	5530	26	3.6	229	1
11	5530	25	2	161	1
12	5530	24	2.2	228	1
13	5530	25	2.6	154	1
14	5530	25	3	210	1
15	5530	25	3.2	180	1
16	5530	29	5	187	1
17	5530	27	4.4	229	1
18	5530	24	3.3	228	1
19	5530	25	4.1	166	1
20	5530	27	1.3	213	1
21	5530	25	2.3	200	1
22	5530	26	4.5	173	1
23	5530	28	2	215	1
24	5530	23	2.9	170	1
25	5530	28	3.6	188	1
26	5530	24	4.6	182	1
27	5530	25	1.3	217	1
28	5530	23	1.7	173	1
29	5530	28	1	212	1
30	5530	27	1.1	226	1
Detection Percentage: 100 % (>60%)					

Table-3 Radar Type 3 Statistical Performance

Trial #	Fc (MHz)	Pulse/Burst	Pulse Width (μS)	PRI (μs)	Detection (1:yes; 0:no)
1	5530	18	7.7	356	1
2	5530	18	6.8	233	1
3	5530	17	6.1	207	1
4	5530	18	9.4	236	1
5	5530	18	8	274	1
6	5530	18	6.3	393	1
7	5530	18	8.3	316	1
8	5530	17	10	496	1
9	5530	16	9.1	452	1
10	5530	17	7	302	1
11	5530	18	6.1	408	1
12	5530	18	6.7	248	1
13	5530	18	6.6	276	1
14	5530	16	7.6	309	1
15	5530	17	7.4	364	1
16	5530	16	6.1	408	1
17	5530	17	7.3	465	1
18	5530	18	9.1	414	1
19	5530	16	8.4	279	1
20	5530	18	8.5	436	1
21	5530	17	9.4	422	1
22	5530	17	9.6	333	1
23	5530	16	8.6	363	1
24	5530	18	9	289	1
25	5530	18	9.3	457	1
26	5530	18	8.2	380	1
27	5530	17	9.7	230	1
28	5530	18	9.3	218	1
29	5530	17	8.1	483	1
30	5530	27	1.1	226	1
Detection Percentage: 100 % (>60%)					

Table-4 Radar Type 4 Statistical Performance

Trial #	Fc (MHz)	Pulse/Burst	Pulse Width (µS)	PRI (µs)	Detection (1:yes; 0:no)
1	5530	12	19.1	280	1
2	5530	13	15.4	428	1
3	5530	14	14.4	482	1
4	5530	12	19.6	204	1
5	5530	16	13.3	276	1
6	5530	14	18.7	454	1
7	5530	15	18.1	222	1
8	5530	13	17.6	347	1
9	5530	13	19.1	481	1
10	5530	12	15.8	472	1
11	5530	12	11.5	254	1
12	5530	13	19.1	392	1
13	5530	12	11.3	279	1
14	5530	14	17.5	223	1
15	5530	14	17.1	248	1
16	5530	16	14.2	486	1
17	5530	13	13.6	325	1
18	5530	13	13.6	247	1
19	5530	15	18.1	310	1
20	5530	14	15.4	201	1
21	5530	13	16.3	248	1
22	5530	16	14.4	332	1
23	5530	13	13.4	344	1
24	5530	12	18.1	417	1
25	5530	12	15.3	234	1
26	5530	13	11.6	247	1
27	5530	16	18.5	282	1
28	5530	13	12.9	392	1
29	5530	13	15.9	200	1
30	5530	13	14.1	350	1
Detection Percentage: 100 % (>60%)					

Table-5 Radar Type 5 Statistical Performance

Trial #	Fc (MHz)	Detection (1:yes; 0:no)
1	5530	1
2	5530	1
3	5530	1
4	5530	1
5	5530	1
6	5530	1
7	5530	1
8	5530	1
9	5530	1
10	5530	1
11	5498.2	1
12	5493.4	1
13	5494.6	1
14	5493.8	1
15	5495	1
16	5495	1
17	5498.6	1
18	5495.8	1
19	5493.8	1
20	5498.2	1
21	5565.4	1
22	5565	1
23	5563	1
24	5564.2	1
25	5563	1
26	5561.8	1
27	5563.4	1
28	5566.6	1
29	5563.4	1
30	5565.4	1
Detection Percentage: 100 % (>80%)		

Bin5 Statistics 1

Trial #	Pulse	Chirp (MHz)	Pulse Width (μS)	Pulse 1-2 spacing (uS)	Pulse 2-3 spacing (uS)	Pulse Start(S)	Detection (1:yes; 0:no)
0	2	6	72.6	1915		0.546842	1
1	3	6	86.8	1162	1036	1.461839	
2	3	6	69.3	1284	1688	1.514717	
3	1	6	66.8			2.923269	
4	2	6	50.1	1376		3.449395	
5	2	6	90.7	1996		3.935847	
6	2	6	98.8	1180		5.133748	
7	2	6	72.7	1109		5.311103	
8	1	6	62.3			6.084505	
9	1	6	78.9			6.79304	
10	2	6	60.6	1510		7.771525	
11	2	6	63.9	1806		8.605124	
12	2	6	58.5	1425		9.217942	
13	2	6	90.9	1312		10.28819	
14	2	6	82.5	1553		10.719853	
15	2	6	89.7	1513		11.358581	

Bin5 Statistics 2

Trial #	Pulse	Chirp (MHz)	Pulse Width (μS)	Pulse 1-2 spacing (uS)	Pulse 2-3 spacing (uS)	Pulse Start(S)	Detection (1:yes; 0:no)
0	3	8	84.7	1985	1305	0.488375	1
1	1	8	76.2			1.694275	
2	3	8	96.5	1795	1356	2.476762	
3	2	8	71.3	1493		3.025574	
4	2	8	78.5	1093		4.86564	
5	2	8	65.5	1935		5.11129	
6	3	8	99.7	1358	1127	6.948394	
7	2	8	63.1	1156		7.517997	
8	1	8	66.4			8.035677	
9	2	8	54.1	1397		9.017658	
10	2	8	94.9	1299		10.095209	
11	3	8	83.4	1565	1788	11.338909	

Bin5 Statistics 3

Trial #	Pulse	Chirp (MHz)	Pulse Width (μS)	Pulse 1-2 spacing (uS)	Pulse 2-3 spacing (uS)	Pulse Start(S)	Detection (1:yes; 0:no)
0	3	18	54	1356	1143	0.883848	1
1	2	18	60.5	1101		1.767559	
2	3	18	80.5	1352	1051	2.361823	
3	2	18	59.6	1855		3.844396	
4	2	18	65.9	1922		4.151057	
5	3	18	66.7	1258	1409	5.933389	
6	2	18	99.3	1191		6.140065	
7	2	18	79.5	1415		7.224713	
8	3	18	76.8	1617	1591	8.54094	
9	2	18	66.3	1988		9.440799	
10	3	18	96.4	1212	1761	10.858015	
11	1	18	87.1			11.744069	

Bin5 Statistics 4

Trial #	Pulse	Chirp (MHz)	Pulse Width (μS)	Pulse 1-2 spacing (uS)	Pulse 2-3 spacing (uS)	Pulse Start(S)	Detection (1:yes; 0:no)
0	3	15	91.6	1209	1868	0.965462	1
1	2	15	53.5	1014		1.786324	
2	2	15	96.9	1487		3.234812	
3	2	15	90.1	1008		4.03757	
4	3	15	73.7	1827	1367	4.524799	
5	1	15	85.7			6.475178	
6	3	15	71.8	1017	1451	6.963136	
7	2	15	86.9	1115		8.639014	
8	2	15	72.3	1264		9.005106	
9	2	15	60.4	1306		9.85101	
10	2	15	76.2	1256		11.397943	

Bin5 Statistics 5

Trial #	Pulse	Chirp (MHz)	Pulse Width (µS)	Pulse 1-2 spacing (uS)	Pulse 2-3 spacing (uS)	Pulse Start(S)	Detection (1:yes; 0:no)
0	2	9	55.6	1390		0.359364	1
1	2	9	91.2	1764		1.613206	
2	2	9	84.6	1549		3.927045	
3	2	9	67.1	1517		4.806561	
4	3	9	80.8	1958	1142	5.466885	
5	3	9	75.8	1874	1104	7.250283	
6	3	9	60.2	1509	1647	9.07358	
7	3	9	96	1686	1920	9.838439	
8	3	9	79.2	1492	1949	11.992675	

Bin5 Statistics 6

Trial #	Pulse	Chirp (MHz)	Pulse Width (µS)	Pulse 1-2 spacing (uS)	Pulse 2-3 spacing (uS)	Pulse Start(S)	Detection (1:yes; 0:no)
0	2	16	54.4	1263		1.050512	1
1	2	16	80.2	1031		1.937957	
2	3	16	67.7	1596	1203	2.576231	
3	2	16	64.4	1436		4.389712	
4	3	16	76	1582	1687	5.161862	
5	3	16	96.8	1089	1935	6.425535	
6	1	16	80.6			7.798495	
7	2	16	95.3	1813		9.410891	
8	3	16	66.7	1472	1621	10.050183	
9	2	16	83.4	1247		10.992648	

Bin5 Statistics 7

Trial #	Pulse	Chirp (MHz)	Pulse Width (µS)	Pulse 1-2 spacing (uS)	Pulse 2-3 spacing (uS)	Pulse Start(S)	Detection (1:yes; 0:no)
0	2	10	64.1	1316		0.890222	1
1	2	10	67.2	1488		1.813535	
2	2	10	56.5	1139		3.53826	
3	2	10	92.6	1781		5.925767	
4	2	10	54.4	1934		7.44982	
5	1	10	73.7			8.722257	
6	1	10	64.4			10.240401	
7	2	10	50.6	1081		10.517283	

Bin5 Statistics 8

Trial #	Pulse	Chirp (MHz)	Pulse Width (µS)	Pulse 1-2 spacing (uS)	Pulse 2-3 spacing (uS)	Pulse Start(S)	Detection (1:yes; 0:no)
0	3	19	96.1	1449	1921	0.182607	1
1	2	19	64.1	1797		0.629895	
2	3	19	75.4	1523	1001	1.236098	
3	1	19	70.9			1.853719	
4	3	19	91.8	1390	1593	2.797714	
5	2	19	56.3	1243		3.338907	
6	2	19	52.6	1184		4.051341	
7	2	19	74.4	1260		4.783135	
8	2	19	94.2	1867		5.204034	
9	3	19	79.3	1628	1570	5.671591	
10	1	19	87			6.175522	
11	2	19	72.8	1159		6.873186	
12	1	19	75.3			7.725468	
13	1	19	77.3			8.346265	
14	2	19	65.8	1946		8.877212	
15	1	19	54.9			9.390115	
16	3	19	96.8	1860	1085	10.070887	
17	2	19	68.5	1795		10.564194	
18	3	19	76	1244	1600	11.109906	
19	3	19	73.4	1643	1693	11.733741	

Bin5 Statistics 9

Trial #	Pulse	Chirp (MHz)	Pulse Width (µS)	Pulse 1-2 spacing (uS)	Pulse 2-3 spacing (uS)	Pulse Start(S)	Detection (1:yes; 0:no)
0	3	16	84.8	1313	1852	0.397237	1
1	3	16	80.5	1019	1385	1.847961	
2	2	16	53.4	1911		2.596251	
3	2	16	75.1	1238		3.945668	
4	2	16	84.4	1140		5.421457	
5	1	16	73.6			6.458244	
6	2	16	50.4	1207		7.771714	
7	3	16	68.3	1047	1069	8.892726	
8	3	16	84.4	1356	1635	9.654423	
9	2	16	57.8	1722		11.692686	

Bin5 Statistics 10

Trial #	Pulse	Chirp (MHz)	Pulse Width (µS)	Pulse 1-2 spacing (uS)	Pulse 2-3 spacing (uS)	Pulse Start(S)	Detection (1:yes; 0:no)
0	3	6	92.4	1195	1426	0.639314	1
1	2	6	55.5	1783		2.020185	
2	1	6	53.2			2.42885	
3	1	6	62.1			4.180449	
4	2	6	52.8	1700		5.125755	
5	2	6	58.6	1948		6.262347	
6	1	6	53			7.456889	
7	1	6	74			8.661363	
8	1	6	60			10.289032	
9	2	6	95.4	1388		11.283848	

Bin5 Statistics 11

Trial #	Pulse	Chirp (MHz)	Pulse Width (µS)	Pulse 1-2 spacing (uS)	Pulse 2-3 spacing (uS)	Pulse Start(S)	Detection (1:yes; 0:no)
0	1	18	78.4			0.681335	1
1	1	18	53.7			1.819164	
2	2	18	99.4	1747		2.579437	
3	1	18	89			3.604725	
4	2	18	73.1	1632		4.585778	
5	2	18	74.8	1510		5.270702	
6	2	18	56.8	1760		5.722115	
7	2	18	95.7	1104		6.649079	
8	1	18	96.6			7.793939	
9	2	18	88.9	1012		9.033168	
10	2	18	57.9	1449		10.105556	
11	2	18	50.5	1480		10.649029	
12	2	18	82.8	1614		11.177684	

Bin5 Statistics 12

Trial #	Pulse	Chirp (MHz)	Pulse Width (µS)	Pulse 1-2 spacing (uS)	Pulse 2-3 spacing (uS)	Pulse Start(S)	Detection (1:yes; 0:no)
0	1	6	94.7			0.175966	1
1	3	6	81.4	1500	1889	1.710235	
2	3	6	63.6	1648	1305	2.182643	
3	2	6	63.6	1521		3.144823	
4	3	6	81	1029	1410	3.762068	
5	3	6	97.2	1389	1796	5.337487	
6	1	6	94.5			5.687405	
7	1	6	64			6.463504	
8	3	6	91.2	1484	1594	7.722984	
9	3	6	68.8	1891	1716	8.456409	
10	2	6	74.1	1100		9.305091	
11	2	6	72.1	1375		10.637884	
12	2	6	70	1896		11.27183	

Bin5 Statistics 13

Trial #	Pulse	Chirp (MHz)	Pulse Width (µS)	Pulse 1-2 spacing (µS)	Pulse 2-3 spacing (µS)	Pulse Start(S)	Detection (1:yes; 0:no)
0	2	9	74.4	1813		0.06179	1
1	3	9	62.6	1618	1493	1.469825	
2	2	9	90.4	1396		2.048501	
3	2	9	85.2	1333		2.785751	
4	3	9	66.9	1165	1500	3.057243	
5	2	9	78.9	1373		4.331172	
6	3	9	59.7	1798	1495	4.947128	
7	3	9	94.5	1933	1615	5.669092	
8	2	9	86.1	1443		6.652915	
9	1	9	83.4			6.966872	
10	2	9	79.9	1961		8.074321	
11	3	9	77.7	1312	1374	8.898394	
12	2	9	88	1093		9.063482	
13	1	9	55.9			10.104432	
14	3	9	82.3	1059	1923	11.115862	
15	2	9	83.9	1618		11.285808	

Bin5 Statistics 14

Trial #	Pulse	Chirp (MHz)	Pulse Width (µS)	Pulse 1-2 spacing (µS)	Pulse 2-3 spacing (µS)	Pulse Start(S)	Detection (1:yes; 0:no)
0	2	7	94.8	1375		0.234291	1
1	2	7	80.6	1839		1.383207	
2	1	7	61.7			1.966946	
3	1	7	96.5			2.825604	
4	3	7	96.4	1470	1820	3.249779	
5	1	7	57.8			3.751978	
6	1	7	76.5			5.05004	
7	2	7	74	1324		5.425569	
8	2	7	61.6	1931		6.376977	
9	1	7	89.6			6.770969	
10	2	7	76.1	1818		7.764396	
11	3	7	93	1537	1935	8.595244	
12	2	7	97.9	1926		9.505641	
13	3	7	50.7	1726	1191	10.057052	
14	2	7	61.5	1263		10.553723	
15	2	7	62.4	1846		11.783958	

Bin5 Statistics 15

Trial #	Pulse	Chirp (MHz)	Pulse Width (µS)	Pulse 1-2 spacing (uS)	Pulse 2-3 spacing (uS)	Pulse Start(S)	Detection (1:yes; 0:no)
0	2	10	78	1789		0.434421	1
1	1	10	87.3			0.608223	
2	2	10	65.3	1289		1.239085	
3	2	10	94.3	1436		2.044609	
4	2	10	50.5	1499		2.915721	
5	2	10	79.3	1094		3.077865	
6	2	10	57.3	1669		3.914251	
7	3	10	78.2	1573	1115	4.74218	
8	2	10	84.6	1172		5.364782	
9	2	10	57.2	1398		5.649715	
10	2	10	55	1668		6.570041	
11	2	10	79.7	1741		6.884133	
12	1	10	65			7.691575	
13	1	10	75.7			8.268431	
14	1	10	71.2			8.843779	
15	2	10	63.7	1083		9.159607	
16	2	10	63.2	1525		9.955423	
17	3	10	89.5	1083	1774	10.409246	
18	3	10	82.3	1179	1255	11.314909	
19	3	10	62.5	1446	1490	11.712356	

Bin5 Statistics 16

Trial #	Pulse	Chirp (MHz)	Pulse Width (µS)	Pulse 1-2 spacing (uS)	Pulse 2-3 spacing (uS)	Pulse Start(S)	Detection (1:yes; 0:no)
0	3	10	62.7	1980	1452	1.057277	1
1	2	10	76.3	1244		2.161306	
2	2	10	90	1335		3.083106	
3	1	10	74.7			4.802302	
4	1	10	74.8			6.134871	
5	3	10	94.3	1525	1451	6.909785	
6	1	10	84.8			8.901592	
7	3	10	95.9	1981	1671	9.399026	
8	2	10	90.2	1816		10.834963	

Bin5 Statistics 17

Trial #	Pulse	Chirp (MHz)	Pulse Width (µS)	Pulse 1-2 spacing (uS)	Pulse 2-3 spacing (uS)	Pulse Start(S)	Detection (1:yes; 0:no)
0	2	19	55.8	1906		0.14964	1
1	3	19	59.9	1064	1810	1.244832	
2	1	19	81.8			2.096234	
3	2	19	95.3	1234		2.79087	
4	3	19	65.2	1914	1413	4.421878	
5	2	19	62.8	1868		4.805535	
6	3	19	94.9	1196	1767	6.44407	
7	3	19	69.6	1157	1259	7.239121	
8	2	19	71.3	1356		7.402627	
9	1	19	66.9			8.891363	
10	1	19	96.1			9.71594	
11	1	19	81.7			10.27641	
12	2	19	53.9	1293		11.49744	

Bin5 Statistics 18

Trial #	Pulse	Chirp (MHz)	Pulse Width (µS)	Pulse 1-2 spacing (uS)	Pulse 2-3 spacing (uS)	Pulse Start(S)	Detection (1:yes; 0:no)
0	2	12	73.8	1979		0.61846	1
1	2	12	76.3	1679		1.408514	
2	3	12	92	1585	1855	1.946488	
3	1	12	63.3			2.57553	
4	2	12	89.5	1861		3.392378	
5	2	12	92.3	1249		4.109381	
6	1	12	86.4			5.05407	
7	2	12	85.4	1497		5.994048	
8	2	12	96.4	1605		6.962664	
9	3	12	91.3	1021	1495	7.577182	
10	1	12	71.3			8.28933	
11	2	12	75	1818		9.432146	
12	2	12	64.3	1461		9.912398	
13	1	12	59.4			10.689846	
14	3	12	97.8	1454	1348	11.695914	

Bin5 Statistics 19

Trial #	Pulse	Chirp (MHz)	Pulse Width (µS)	Pulse 1-2 spacing (µS)	Pulse 2-3 spacing (µS)	Pulse Start(S)	Detection (1:yes; 0:no)
0	2	7	82.6	1503		0.221912	1
1	1	7	93.2			0.660011	
2	1	7	99.9			1.202246	
3	2	7	52.8	1458		2.03168	
4	2	7	96.6	1772		2.854866	
5	2	7	80.4	1756		3.513614	
6	2	7	59	1091		4.184616	
7	2	7	97.1	1623		4.672651	
8	2	7	56.2	1497		5.00423	
9	2	7	59.5	1059		5.686895	
10	1	7	96.2			6.447213	
11	3	7	53.3	1486	1457	6.638238	
12	1	7	79.7			7.503219	
13	2	7	59.5	1314		8.375622	
14	3	7	59.9	1240	1473	8.47266	
15	3	7	58.4	1309	1969	9.422438	
16	2	7	62.6	1686		9.654129	
17	1	7	72.5			10.66504	
18	2	7	91.8	1618		11.05676	
19	1	7	70			11.414756	

Bin5 Statistics 20

Trial #	Pulse	Chirp (MHz)	Pulse Width (µS)	Pulse 1-2 spacing (uS)	Pulse 2-3 spacing (uS)	Pulse Start(S)	Detection (1:yes; 0:no)
0	3	18	65.5	1797	1072	0.230334	1
1	2	18	66.1	1321		1.170652	
2	2	18	68.2	1027		2.105489	
3	3	18	81.5	1768	1001	2.789399	
4	2	18	74.3	1445		3.665662	
5	3	18	65	1561	1506	4.145974	
6	2	18	89.2	1139		5.034186	
7	2	18	58.7	1304		5.362939	
8	3	18	59.6	1171	1867	6.422423	
9	2	18	80.2	1390		6.820931	
10	2	18	60.7	1549		7.991481	
11	2	18	99.2	1084		8.912058	
12	2	18	67.7	1054		9.589241	
13	3	18	61.5	1241	1845	10.428725	
14	1	18	97			10.914216	
15	3	18	67.9	1187	1696	11.759773	

Bin5 Statistics 21

Trial #	Pulse	Chirp (MHz)	Pulse Width (µS)	Pulse 1-2 spacing (uS)	Pulse 2-3 spacing (uS)	Pulse Start(S)	Detection (1:yes; 0:no)
0	3	9	57.2	1732	1761	0.517558	1
1	2	9	50.3	1514		1.78632	
2	2	9	59.4	1516		2.749194	
3	1	9	63.8			3.32315	
4	1	9	69.6			4.138622	
5	2	9	51.1	1083		4.761303	
6	3	9	75	1146	1019	6.319635	
7	3	9	91.5	1064	1364	6.750038	
8	1	9	54.3			7.626169	
9	2	9	57.2	1168		8.771161	
10	2	9	58.7	1153		9.747651	
11	2	9	68.6	1691		10.385655	
12	2	9	91.8	1438		11.478344	

Bin5 Statistics 22

Trial #	Pulse	Chirp (MHz)	Pulse Width (µS)	Pulse 1-2 spacing (µS)	Pulse 2-3 spacing (µS)	Pulse Start(S)	Detection (1:yes; 0:no)
0	2	10	60	1830		0.201248	1
1	2	10	94.7	1184		1.233833	
2	1	10	87.9			1.431021	
3	2	10	70.9	1650		2.400002	
4	2	10	67.8	1085		2.917922	
5	3	10	54	1936	1008	3.979164	
6	2	10	58.4	1340		4.177547	
7	3	10	83.8	1248	1540	4.876817	
8	2	10	52.3	1245		5.808346	
9	3	10	91.5	1985	1976	6.401485	
10	2	10	98.7	1482		6.703115	
11	1	10	89.4			7.526676	
12	1	10	72.6			8.645229	
13	2	10	81.1	1282		8.94899	
14	3	10	84.1	1591	1903	9.581858	
15	1	10	68.1			10.380236	
16	3	10	76.2	1558	1860	10.847297	
17	3	10	81.8	1706	1160	11.601535	

Bin5 Statistics 23

Trial #	Pulse	Chirp (MHz)	Pulse Width (µS)	Pulse 1-2 spacing (µS)	Pulse 2-3 spacing (µS)	Pulse Start(S)	Detection (1:yes; 0:no)
0	1	15	84.9			0.083585	1
1	3	15	69.7	1739	1767	2.487811	
2	2	15	79.1	1651		3.62208	
3	1	15	86.8			4.848281	
4	3	15	72.8	1185	1466	6.569077	
5	3	15	87.9	1658	1902	7.568273	
6	3	15	71.5	1047	1048	8.045618	
7	2	15	98	1543		9.883187	
8	2	15	78.6	1518		11.359189	

Bin5 Statistics 24

Trial #	Pulse	Chirp (MHz)	Pulse Width (µS)	Pulse 1-2 spacing (uS)	Pulse 2-3 spacing (uS)	Pulse Start(S)	Detection (1:yes; 0:no)
0	1	12	80.3			0.524498	1
1	2	12	84.5	1309		1.117578	
2	1	12	71.3			1.739226	
3	2	12	84.5	1351		2.515724	
4	2	12	83.7	1104		3.353886	
5	1	12	61.4			3.785872	
6	2	12	68	1120		4.730581	
7	1	12	60			5.28095	
8	1	12	51			6.149245	
9	3	12	86.8	1978	1791	6.624744	
10	1	12	71			7.670861	
11	3	12	86.1	1121	1112	8.094806	
12	1	12	94.9			9.081395	
13	2	12	61.7	1942		9.408156	
14	1	12	62.8			10.088709	
15	1	12	61			11.08358	
16	2	12	60.9	1492		11.369224	

Bin5 Statistics 25

Trial #	Pulse	Chirp (MHz)	Pulse Width (µS)	Pulse 1-2 spacing (uS)	Pulse 2-3 spacing (uS)	Pulse Start(S)	Detection (1:yes; 0:no)
0	2	15	67.9	1350		0.146257	1
1	2	15	98.6	1733		1.487965	
2	2	15	70.5	1069		2.298147	
3	2	15	91.2	1223		2.597918	
4	1	15	70.1			3.763538	
5	2	15	62.9	1926		4.004929	
6	2	15	95.2	1126		5.583902	
7	2	15	85.7	1577		6.00427	
8	3	15	57.6	1046	1409	6.747499	
9	2	15	95.8	1711		7.503364	
10	2	15	82.7	1752		8.746672	
11	2	15	87.1	1870		9.269096	
12	2	15	73.4	1202		9.782854	
13	2	15	79.7	1970		10.911718	
14	2	15	67.4	1813		11.240573	

Bin5 Statistics 26

Trial #	Pulse	Chirp (MHz)	Pulse Width (µS)	Pulse 1-2 spacing (µS)	Pulse 2-3 spacing (µS)	Pulse Start(S)	Detection (1:yes; 0:no)
0	2	18	91.7	1380		0.610947	1
1	2	18	99.8	1916		0.926528	
2	2	18	59.9	1436		2.103317	
3	2	18	78.1	1588		2.783987	
4	2	18	98.3	1903		3.16273	
5	3	18	70.1	1463	1102	4.196699	
6	3	18	96.9	1604	1915	4.847989	
7	2	18	65.5	1635		4.982784	
8	3	18	95.1	1213	1215	6.307248	
9	2	18	74.3	1519		6.782421	
10	3	18	95.3	1410	1992	7.661585	
11	3	18	81.6	1475	1264	8.016282	
12	2	18	82.2	1313		8.90014	
13	2	18	75.4	1485		9.825242	
14	2	18	98.4	1831		10.473271	
15	2	18	77.7	1361		10.737028	
16	2	18	75.2	1350		11.785748	

Bin5 Statistics 27

Trial #	Pulse	Chirp (MHz)	Pulse Width (µS)	Pulse 1-2 spacing (µS)	Pulse 2-3 spacing (µS)	Pulse Start(S)	Detection (1:yes; 0:no)
0	1	14	81.4			0.330023	1
1	1	14	50.6			1.970164	
2	3	14	94.7	1264	1246	2.767804	
3	2	14	91.2	1551		3.59253	
4	1	14	56.6			4.26944	
5	1	14	80.3			5.840326	
6	2	14	70.6	1005		6.563849	
7	2	14	98.5	1850		7.161851	
8	2	14	97.6	1575		8.632251	
9	1	14	78.7			9.660098	
10	2	14	94.2	1003		10.840234	
11	3	14	58.8	1575	1094	11.586452	

Bin5 Statistics 28

Trial #	Pulse	Chirp (MHz)	Pulse Width (µS)	Pulse 1-2 spacing (µS)	Pulse 2-3 spacing (µS)	Pulse Start(S)	Detection (1:yes; 0:no)
0	1	6	54.2			0.610933	1
1	2	6	72.1	1514		1.149074	
2	1	6	61.8			1.933249	
3	2	6	93.7	1247		2.945763	
4	2	6	81.1	1268		3.441401	
5	2	6	98.1	1605		4.639468	
6	2	6	60.2	1353		5.533039	
7	3	6	90.4	1646	1363	6.185919	
8	2	6	64	1083		6.687792	
9	3	6	65.8	1533	1882	7.564114	
10	1	6	63			8.00592	
11	2	6	71	1588		9.012147	
12	2	6	54.3	1655		9.892425	
13	2	6	77.5	1533		11.12903	
14	2	6	73.3	1049		11.656488	

Bin5 Statistics 29

Trial #	Pulse	Chirp (MHz)	Pulse Width (µS)	Pulse 1-2 spacing (µS)	Pulse 2-3 spacing (µS)	Pulse Start(S)	Detection (1:yes; 0:no)
0	1	14	86.1			0.337648	1
1	2	14	93.1	1295		0.695822	
2	2	14	67	1653		1.255996	
3	2	14	81.5	1757		2.015938	
4	3	14	60.4	1138	1806	2.583704	
5	1	14	75			3.302759	
6	3	14	92.4	1335	1980	4.015662	
7	2	14	98.1	1360		4.380205	
8	2	14	80.9	1675		5.085462	
9	2	14	86.6	1490		5.759279	
10	2	14	75.6	1195		6.53868	
11	3	14	73.6	1521	1906	6.815374	
12	3	14	80.1	1602	1549	7.342269	
13	2	14	99.2	1476		8.081487	
14	2	14	59.9	1448		8.734504	
15	2	14	65.3	1802		9.18579	
16	3	14	80.3	1085	1538	9.872914	
17	2	14	54.6	1953		10.333832	
18	2	14	96	1280		11.378838	
19	3	14	88.9	1825	1976	11.766565	

Bin5 Statistics 30

Trial #	Pulse	Chirp (MHz)	Pulse Width (µS)	Pulse 1-2 spacing (µS)	Pulse 2-3 spacing (µS)	Pulse Start(S)	Detection (1:yes; 0:no)
0	1	9	58			0.348485	1
1	2	9	72.5	1080		1.1009	
2	2	9	97.6	1999		1.654729	
3	2	9	64.2	1721		2.67702	
4	2	9	67.4	1215		3.029272	
5	2	9	93.7	1836		3.760513	
6	2	9	63.8	1493		4.622702	
7	2	9	84.6	1364		5.79992	
8	2	9	84.5	1110		6.409727	
9	1	9	65.6			6.895165	
10	2	9	55.9	1372		8.062434	
11	1	9	78.7			8.738423	
12	2	9	62.3	1129		9.584923	
13	1	9	79.3			10.092972	
14	1	9	56.9			11.140428	
15	1	9	92.6			11.77781	

Table-6 Radar Type 6 Statistical Performance

Trial #	Fc (MHz)	Pulse /Burst	Pulse Width (µS)	PRI (µs)	Detection (1:yes; 0:no)	Hopping Sequence
1	5530	9	1	333	1	5355.0, 5541.0, 5437.0, 5369.0, 5454.0, 5520.0, 5542.0, 5405.0, 5263.0, 5630.0, 5296.0, 5531.0, 5685.0, 5581.0, 5359.0, 5303.0, 5493.0, 5260.0, 5346.0, 5420.0, 5617.0, 5505.0, 5475.0, 5699.0, 5701.0, 5614.0, 5470.0, 5363.0, 5409.0, 5639.0, 5653.0, 5339.0, 5388.0, 5540.0, 5349.0, 5665.0, 5555.0, 5432.0, 5417.0, 5716.0, 5387.0, 5386.0, 5577.0, 5476.0, 5485.0, 5515.0, 5490.0, 5640.0, 5352.0, 5273.0, 5425.0, 5495.0, 5284.0, 5523.0, 5585.0, 5286.0, 5547.0, 5252.0, 5397.0, 5379.0, 5491.0, 5353.0, 5264.0, 5633.0, 5552.0, 5626.0, 5423.0, 5688.0, 5255.0, 5545.0, 5439.0, 5508.0, 5392.0, 5378.0, 5375.0, 5278.0, 5587.0, 5671.0, 5253.0, 5318.0, 5282.0, 5350.0, 5461.0, 5281.0, 5658.0, 5462.0, 5612.0, 5258.0, 5435.0, 5538.0, 5647.0, 5565.0, 5629.0, 5358.0, 5551.0, 5362.0, 5450.0, 5687.0, 5628.0, 5503.0 (number of hits: 11)
2	5530	9	1	333	1	5710.0, 5611.0, 5488.0, 5295.0, 5519.0, 5261.0, 5499.0, 5453.0, 5495.0, 5465.0, 5723.0, 5531.0, 5287.0, 5644.0, 5640.0, 5432.0, 5408.0, 5352.0, 5254.0, 5283.0, 5285.0, 5639.0, 5555.0, 5309.0, 5548.0, 5360.0, 5498.0, 5395.0, 5721.0, 5308.0, 5515.0, 5641.0, 5604.0, 5421.0, 5452.0, 5434.0, 5312.0, 5372.0, 5623.0, 5621.0, 5599.0, 5344.0, 5517.0, 5265.0, 5577.0, 5430.0, 5407.0, 5483.0, 5387.0, 5299.0, 5346.0, 5460.0, 5473.0, 5521.0, 5687.0, 5676.0, 5612.0, 5461.0, 5598.0, 5355.0, 5631.0, 5428.0, 5353.0, 5550.0, 5549.0, 5590.0, 5470.0, 5527.0, 5468.0, 5632.0, 5695.0, 5358.0, 5417.0, 5702.0, 5540.0, 5318.0, 5572.0, 5423.0, 5689.0, 5719.0, 5264.0, 5411.0, 5650.0, 5701.0, 5718.0, 5373.0, 5661.0, 5277.0, 5669.0, 5281.0, 5400.0, 5554.0, 5415.0, 5705.0, 5685.0, 5263.0, 5427.0, 5662.0, 5565.0, 5666.0 (number of hits: 8)
3	5530	9	1	333	1	5442.0, 5609.0, 5269.0, 5316.0, 5621.0, 5512.0, 5255.0, 5613.0, 5696.0, 5399.0, 5602.0, 5372.0, 5395.0, 5400.0, 5624.0, 5582.0, 5653.0, 5341.0, 5540.0, 5669.0, 5430.0, 5614.0, 5479.0, 5605.0, 5651.0, 5284.0, 5368.0, 5661.0, 5351.0, 5577.0, 5498.0, 5566.0, 5607.0, 5716.0, 5325.0, 5575.0, 5295.0, 5682.0, 5503.0, 5397.0, 5272.0, 5453.0, 5693.0, 5544.0, 5720.0, 5508.0, 5685.0, 5450.0, 5439.0, 5547.0, 5631.0, 5435.0, 5715.0, 5645.0, 5705.0,

						5658.0, 5650.0, 5389.0, 5428.0, 5282.0, 5440.0, 5366.0, 5417.0, 5704.0, 5560.0, 5377.0, 5369.0, 5497.0, 5412.0, 5626.0, 5383.0, 5588.0, 5491.0, 5346.0, 5451.0, 5641.0, 5710.0, 5365.0, 5490.0, 5388.0, 5253.0, 5309.0, 5297.0, 5356.0, 5500.0, 5308.0, 5441.0, 5530.0, 5360.0, 5676.0, 5413.0, 5465.0, 5495.0, 5303.0, 5639.0, 5301.0, 5552.0, 5354.0, 5357.0, 5488.0 (number of hits: 7)
4	5530	9	1	333	1	5430.0, 5432.0, 5669.0, 5622.0, 5501.0, 5692.0, 5552.0, 5416.0, 5590.0, 5452.0, 5546.0, 5346.0, 5715.0, 5362.0, 5631.0, 5352.0, 5578.0, 5511.0, 5307.0, 5488.0, 5323.0, 5703.0, 5524.0, 5608.0, 5440.0, 5402.0, 5585.0, 5314.0, 5364.0, 5536.0, 5648.0, 5671.0, 5269.0, 5271.0, 5407.0, 5429.0, 5517.0, 5544.0, 5565.0, 5338.0, 5290.0, 5461.0, 5399.0, 5638.0, 5647.0, 5654.0, 5490.0, 5649.0, 5548.0, 5391.0, 5531.0, 5345.0, 5723.0, 5434.0, 5316.0, 5258.0, 5267.0, 5693.0, 5435.0, 5336.0, 5334.0, 5555.0, 5441.0, 5509.0, 5619.0, 5333.0, 5513.0, 5384.0, 5319.0, 5370.0, 5521.0, 5350.0, 5683.0, 5583.0, 5257.0, 5324.0, 5625.0, 5597.0, 5519.0, 5657.0, 5424.0, 5266.0, 5634.0, 5274.0, 5383.0, 5270.0, 5472.0, 5439.0, 5406.0, 5264.0, 5616.0, 5381.0, 5479.0, 5568.0, 5598.0, 5594.0, 5443.0, 5262.0, 5360.0, 5662.0 (number of hits: 9)
5	5530	9	1	333	1	5470.0, 5313.0, 5320.0, 5355.0, 5264.0, 5365.0, 5330.0, 5474.0, 5315.0, 5573.0, 5253.0, 5698.0, 5301.0, 5335.0, 5564.0, 5399.0, 5547.0, 5718.0, 5672.0, 5250.0, 5468.0, 5674.0, 5440.0, 5388.0, 5567.0, 5575.0, 5382.0, 5589.0, 5316.0, 5670.0, 5704.0, 5692.0, 5646.0, 5675.0, 5441.0, 5446.0, 5266.0, 5631.0, 5524.0, 5598.0, 5677.0, 5617.0, 5695.0, 5461.0, 5654.0, 5443.0, 5709.0, 5390.0, 5578.0, 5513.0, 5525.0, 5691.0, 5684.0, 5472.0, 5276.0, 5596.0, 5487.0, 5519.0, 5421.0, 5592.0, 5632.0, 5317.0, 5405.0, 5607.0, 5647.0, 5546.0, 5511.0, 5652.0, 5449.0, 5667.0, 5328.0, 5657.0, 5406.0, 5333.0, 5273.0, 5323.0, 5475.0, 5282.0, 5298.0, 5329.0, 5581.0, 5354.0, 5668.0, 5605.0, 5454.0, 5520.0, 5305.0, 5410.0, 5591.0, 5553.0, 5373.0, 5448.0, 5311.0, 5418.0, 5694.0, 5539.0, 5618.0, 5378.0, 5562.0, 5723.0 (number of hits: 7)
6	5530	9	1	333	1	5449.0, 5477.0, 5430.0, 5486.0, 5276.0, 5617.0, 5442.0, 5660.0, 5337.0, 5356.0, 5519.0, 5301.0, 5367.0, 5629.0, 5372.0, 5433.0, 5373.0, 5606.0, 5423.0, 5645.0, 5414.0, 5263.0, 5334.0, 5513.0, 5282.0, 5294.0, 5646.0, 5285.0, 5310.0, 5720.0, 5438.0, 5551.0, 5672.0, 5306.0, 5431.0,

						5581.0, 5339.0, 5687.0, 5695.0, 5701.0, 5325.0, 5512.0, 5676.0, 5443.0, 5280.0, 5633.0, 5410.0, 5670.0, 5521.0, 5420.0, 5321.0, 5463.0, 5253.0, 5461.0, 5257.0, 5546.0, 5359.0, 5450.0, 5471.0, 5345.0, 5622.0, 5319.0, 5378.0, 5252.0, 5264.0, 5312.0, 5705.0, 5358.0, 5274.0, 5717.0, 5329.0, 5653.0, 5376.0, 5620.0, 5402.0, 5628.0, 5535.0, 5488.0, 5448.0, 5453.0, 5665.0, 5291.0, 5444.0, 5621.0, 5445.0, 5651.0, 5563.0, 5635.0, 5277.0, 5315.0, 5479.0, 5567.0, 5503.0, 5555.0, 5569.0, 5706.0, 5346.0, 5530.0, 5636.0, 5302.0 (number of hits: 8)
7	5530	9	1	333	1	5305.0, 5287.0, 5315.0, 5708.0, 5474.0, 5549.0, 5453.0, 5525.0, 5565.0, 5611.0, 5258.0, 5513.0, 5552.0, 5595.0, 5378.0, 5499.0, 5510.0, 5626.0, 5351.0, 5661.0, 5399.0, 5538.0, 5279.0, 5488.0, 5539.0, 5679.0, 5620.0, 5483.0, 5293.0, 5543.0, 5479.0, 5436.0, 5469.0, 5515.0, 5637.0, 5269.0, 5368.0, 5381.0, 5498.0, 5588.0, 5701.0, 5657.0, 5478.0, 5281.0, 5519.0, 5331.0, 5559.0, 5363.0, 5303.0, 5678.0, 5590.0, 5507.0, 5297.0, 5263.0, 5550.0, 5355.0, 5389.0, 5349.0, 5522.0, 5629.0, 5617.0, 5684.0, 5555.0, 5295.0, 5393.0, 5692.0, 5318.0, 5470.0, 5460.0, 5493.0, 5497.0, 5702.0, 5376.0, 5449.0, 5487.0, 5273.0, 5333.0, 5415.0, 5682.0, 5530.0, 5551.0, 5253.0, 5502.0, 5443.0, 5313.0, 5598.0, 5395.0, 5614.0, 5639.0, 5597.0, 5664.0, 5271.0, 5455.0, 5379.0, 5533.0, 5300.0, 5575.0, 5529.0, 5492.0, 5712.0 (number of hits: 12)
8	5530	9	1	333	1	5363.0, 5484.0, 5668.0, 5471.0, 5700.0, 5538.0, 5390.0, 5529.0, 5621.0, 5579.0, 5475.0, 5275.0, 5465.0, 5709.0, 5663.0, 5258.0, 5331.0, 5364.0, 5717.0, 5393.0, 5473.0, 5690.0, 5382.0, 5287.0, 5479.0, 5577.0, 5507.0, 5512.0, 5304.0, 5530.0, 5544.0, 5510.0, 5575.0, 5520.0, 5429.0, 5367.0, 5366.0, 5652.0, 5437.0, 5541.0, 5477.0, 5522.0, 5565.0, 5293.0, 5654.0, 5705.0, 5433.0, 5666.0, 5573.0, 5650.0, 5683.0, 5531.0, 5277.0, 5547.0, 5591.0, 5676.0, 5704.0, 5697.0, 5546.0, 5656.0, 5476.0, 5570.0, 5370.0, 5415.0, 5430.0, 5691.0, 5288.0, 5486.0, 5571.0, 5623.0, 5632.0, 5714.0, 5517.0, 5439.0, 5712.0, 5641.0, 5385.0, 5562.0, 5455.0, 5616.0, 5695.0, 5467.0, 5685.0, 5369.0, 5648.0, 5470.0, 5584.0, 5420.0, 5449.0, 5481.0, 5723.0, 5633.0, 5448.0, 5642.0, 5368.0, 5386.0, 5284.0, 5611.0, 5397.0, 5413.0 (number of hits: 9)
9	5530	9	1	333	1	5445.0, 5291.0, 5575.0, 5535.0, 5462.0, 5583.0, 5594.0, 5375.0, 5382.0, 5411.0, 5481.0, 5282.0, 5329.0, 5519.0, 5716.0,

						5369.0, 5529.0, 5345.0, 5336.0, 5521.0, 5320.0, 5426.0, 5719.0, 5315.0, 5589.0, 5615.0, 5254.0, 5359.0, 5622.0, 5444.0, 5504.0, 5514.0, 5616.0, 5710.0, 5609.0, 5262.0, 5317.0, 5687.0, 5267.0, 5431.0, 5251.0, 5614.0, 5483.0, 5415.0, 5515.0, 5316.0, 5526.0, 5471.0, 5373.0, 5446.0, 5574.0, 5275.0, 5636.0, 5346.0, 5600.0, 5387.0, 5311.0, 5542.0, 5492.0, 5578.0, 5697.0, 5303.0, 5427.0, 5271.0, 5580.0, 5333.0, 5268.0, 5602.0, 5564.0, 5645.0, 5285.0, 5680.0, 5401.0, 5584.0, 5421.0, 5454.0, 5418.0, 5546.0, 5560.0, 5295.0, 5524.0, 5541.0, 5558.0, 5561.0, 5549.0, 5721.0, 5413.0, 5464.0, 5253.0, 5391.0, 5655.0, 5634.0, 5512.0, 5582.0, 5649.0, 5499.0, 5416.0, 5491.0, 5652.0, 5676.0 (number of hits: 9)
10	5530	9	1	333	1	5632.0, 5697.0, 5597.0, 5693.0, 5365.0, 5498.0, 5295.0, 5252.0, 5723.0, 5671.0, 5488.0, 5568.0, 5716.0, 5609.0, 5517.0, 5297.0, 5548.0, 5515.0, 5591.0, 5648.0, 5321.0, 5696.0, 5660.0, 5379.0, 5386.0, 5469.0, 5497.0, 5306.0, 5631.0, 5332.0, 5264.0, 5722.0, 5439.0, 5448.0, 5316.0, 5502.0, 5585.0, 5712.0, 5432.0, 5676.0, 5582.0, 5346.0, 5275.0, 5462.0, 5331.0, 5471.0, 5549.0, 5605.0, 5572.0, 5460.0, 5614.0, 5450.0, 5255.0, 5406.0, 5590.0, 5434.0, 5378.0, 5715.0, 5387.0, 5710.0, 5606.0, 5380.0, 5665.0, 5280.0, 5368.0, 5480.0, 5633.0, 5612.0, 5309.0, 5289.0, 5531.0, 5294.0, 5427.0, 5334.0, 5677.0, 5253.0, 5496.0, 5358.0, 5354.0, 5424.0, 5509.0, 5449.0, 5673.0, 5319.0, 5397.0, 5670.0, 5486.0, 5542.0, 5522.0, 5505.0, 5584.0, 5528.0, 5579.0, 5419.0, 5325.0, 5327.0, 5652.0, 5719.0, 5366.0, 5663.0 (number of hits: 5)
11	5530	9	1	333	1	5592.0, 5370.0, 5674.0, 5658.0, 5278.0, 5521.0, 5698.0, 5372.0, 5681.0, 5509.0, 5511.0, 5451.0, 5611.0, 5487.0, 5691.0, 5366.0, 5567.0, 5499.0, 5330.0, 5650.0, 5479.0, 5539.0, 5317.0, 5684.0, 5265.0, 5318.0, 5339.0, 5450.0, 5662.0, 5672.0, 5456.0, 5533.0, 5422.0, 5378.0, 5472.0, 5389.0, 5351.0, 5473.0, 5707.0, 5344.0, 5604.0, 5680.0, 5458.0, 5264.0, 5715.0, 5331.0, 5297.0, 5463.0, 5531.0, 5393.0, 5306.0, 5613.0, 5444.0, 5322.0, 5598.0, 5676.0, 5256.0, 5309.0, 5702.0, 5495.0, 5686.0, 5336.0, 5615.0, 5559.0, 5412.0, 5403.0, 5655.0, 5721.0, 5666.0, 5621.0, 5480.0, 5407.0, 5510.0, 5589.0, 5382.0, 5527.0, 5583.0, 5620.0, 5599.0, 5289.0, 5461.0, 5513.0, 5585.0, 5562.0, 5575.0, 5268.0, 5639.0, 5387.0, 5565.0, 5624.0, 5303.0, 5622.0, 5305.0, 5299.0, 5257.0, 5435.0, 5542.0, 5292.0, 5656.0, 5649.0

						(number of hits: 8)
12	5530	9	1	333	1	5612.0, 5394.0, 5395.0, 5476.0, 5445.0, 5678.0, 5309.0, 5569.0, 5651.0, 5514.0, 5610.0, 5397.0, 5681.0, 5292.0, 5555.0, 5305.0, 5399.0, 5535.0, 5448.0, 5545.0, 5486.0, 5552.0, 5320.0, 5375.0, 5365.0, 5449.0, 5498.0, 5352.0, 5628.0, 5392.0, 5470.0, 5718.0, 5621.0, 5306.0, 5567.0, 5497.0, 5635.0, 5266.0, 5299.0, 5589.0, 5367.0, 5324.0, 5463.0, 5267.0, 5600.0, 5425.0, 5340.0, 5362.0, 5500.0, 5679.0, 5593.0, 5704.0, 5507.0, 5441.0, 5684.0, 5712.0, 5272.0, 5570.0, 5551.0, 5652.0, 5288.0, 5723.0, 5541.0, 5294.0, 5605.0, 5336.0, 5721.0, 5671.0, 5587.0, 5389.0, 5620.0, 5680.0, 5338.0, 5559.0, 5688.0, 5689.0, 5609.0, 5658.0, 5573.0, 5515.0, 5604.0, 5390.0, 5516.0, 5459.0, 5580.0, 5619.0, 5647.0, 5304.0, 5583.0, 5554.0, 5501.0, 5608.0, 5318.0, 5322.0, 5656.0, 5343.0, 5602.0, 5437.0, 5694.0, 5419.0
						(number of hits: 10)
13	5530	9	1	333	1	5519.0, 5526.0, 5349.0, 5516.0, 5600.0, 5616.0, 5633.0, 5595.0, 5446.0, 5618.0, 5707.0, 5607.0, 5528.0, 5484.0, 5320.0, 5509.0, 5687.0, 5667.0, 5415.0, 5510.0, 5386.0, 5277.0, 5673.0, 5364.0, 5537.0, 5374.0, 5281.0, 5371.0, 5460.0, 5588.0, 5613.0, 5562.0, 5385.0, 5253.0, 5437.0, 5536.0, 5502.0, 5469.0, 5547.0, 5363.0, 5257.0, 5514.0, 5366.0, 5608.0, 5656.0, 5410.0, 5615.0, 5449.0, 5675.0, 5402.0, 5432.0, 5375.0, 5359.0, 5271.0, 5428.0, 5702.0, 5646.0, 5661.0, 5337.0, 5256.0, 5442.0, 5512.0, 5660.0, 5378.0, 5605.0, 5317.0, 5597.0, 5648.0, 5479.0, 5435.0, 5522.0, 5654.0, 5327.0, 5582.0, 5645.0, 5628.0, 5461.0, 5720.0, 5575.0, 5497.0, 5265.0, 5498.0, 5676.0, 5278.0, 5689.0, 5574.0, 5266.0, 5254.0, 5275.0, 5383.0, 5408.0, 5639.0, 5508.0, 5697.0, 5506.0, 5587.0, 5653.0, 5298.0, 5580.0, 5358.0
						(number of hits: 4)
14	5530	9	1	333	1	5338.0, 5715.0, 5604.0, 5343.0, 5590.0, 5559.0, 5508.0, 5385.0, 5453.0, 5256.0, 5460.0, 5422.0, 5293.0, 5270.0, 5406.0, 5263.0, 5607.0, 5639.0, 5681.0, 5359.0, 5426.0, 5280.0, 5340.0, 5417.0, 5542.0, 5392.0, 5300.0, 5294.0, 5331.0, 5402.0, 5474.0, 5576.0, 5427.0, 5602.0, 5380.0, 5633.0, 5357.0, 5368.0, 5382.0, 5324.0, 5497.0, 5403.0, 5653.0, 5272.0, 5292.0, 5641.0, 5558.0, 5306.0, 5454.0, 5513.0, 5378.0, 5295.0, 5600.0, 5563.0, 5724.0, 5708.0, 5484.0, 5536.0, 5476.0, 5487.0, 5635.0, 5362.0, 5302.0, 5515.0, 5366.0, 5360.0, 5512.0, 5363.0, 5652.0, 5520.0, 5489.0, 5625.0, 5500.0, 5673.0, 5697.0, 5257.0, 5299.0, 5582.0, 5678.0, 5493.0

						5337.0, 5346.0, 5486.0, 5410.0, 5327.0, 5569.0, 5668.0, 5276.0, 5320.0, 5347.0, 5606.0, 5425.0, 5328.0, 5683.0, 5712.0, 5440.0, 5409.0, 5330.0, 5432.0, 5530.0 (number of hits: 7)
15	5530	9	1	333	1	5650.0, 5518.0, 5542.0, 5578.0, 5359.0, 5502.0, 5322.0, 5620.0, 5525.0, 5386.0, 5551.0, 5496.0, 5667.0, 5330.0, 5662.0, 5350.0, 5532.0, 5411.0, 5622.0, 5600.0, 5435.0, 5406.0, 5260.0, 5369.0, 5374.0, 5460.0, 5385.0, 5396.0, 5365.0, 5360.0, 5473.0, 5455.0, 5467.0, 5507.0, 5546.0, 5716.0, 5515.0, 5493.0, 5587.0, 5286.0, 5638.0, 5598.0, 5441.0, 5417.0, 5660.0, 5304.0, 5494.0, 5512.0, 5503.0, 5644.0, 5583.0, 5581.0, 5498.0, 5394.0, 5636.0, 5710.0, 5621.0, 5613.0, 5594.0, 5590.0, 5347.0, 5378.0, 5333.0, 5423.0, 5298.0, 5677.0, 5593.0, 5634.0, 5290.0, 5393.0, 5291.0, 5553.0, 5451.0, 5380.0, 5533.0, 5465.0, 5434.0, 5606.0, 5724.0, 5499.0, 5699.0, 5399.0, 5577.0, 5295.0, 5373.0, 5516.0, 5283.0, 5256.0, 5364.0, 5309.0, 5354.0, 5408.0, 5293.0, 5274.0, 5320.0, 5397.0, 5584.0, 5254.0, 5305.0, 5505.0 (number of hits: 6)
16	5530	9	1	333	1	5256.0, 5273.0, 5513.0, 5685.0, 5347.0, 5505.0, 5406.0, 5394.0, 5550.0, 5446.0, 5438.0, 5565.0, 5696.0, 5674.0, 5516.0, 5643.0, 5667.0, 5555.0, 5612.0, 5489.0, 5294.0, 5615.0, 5494.0, 5309.0, 5465.0, 5282.0, 5388.0, 5504.0, 5408.0, 5291.0, 5377.0, 5605.0, 5461.0, 5580.0, 5385.0, 5374.0, 5601.0, 5519.0, 5307.0, 5483.0, 5586.0, 5305.0, 5670.0, 5400.0, 5380.0, 5435.0, 5260.0, 5339.0, 5558.0, 5692.0, 5532.0, 5663.0, 5705.0, 5678.0, 5255.0, 5539.0, 5425.0, 5393.0, 5658.0, 5378.0, 5447.0, 5510.0, 5592.0, 5283.0, 5607.0, 5497.0, 5448.0, 5441.0, 5426.0, 5352.0, 5423.0, 5496.0, 5412.0, 5299.0, 5296.0, 5660.0, 5265.0, 5556.0, 5336.0, 5503.0, 5551.0, 5693.0, 5585.0, 5535.0, 5311.0, 5680.0, 5359.0, 5707.0, 5427.0, 5572.0, 5337.0, 5381.0, 5428.0, 5334.0, 5286.0, 5432.0, 5570.0, 5414.0, 5251.0, 5303.0 (number of hits: 9)
17	5530	9	1	333	1	5534.0, 5520.0, 5703.0, 5599.0, 5354.0, 5585.0, 5517.0, 5455.0, 5496.0, 5428.0, 5330.0, 5368.0, 5306.0, 5612.0, 5691.0, 5449.0, 5596.0, 5589.0, 5283.0, 5310.0, 5269.0, 5487.0, 5356.0, 5416.0, 5315.0, 5452.0, 5549.0, 5261.0, 5323.0, 5569.0, 5486.0, 5607.0, 5717.0, 5563.0, 5437.0, 5488.0, 5508.0, 5657.0, 5701.0, 5384.0, 5652.0, 5291.0, 5478.0, 5721.0, 5295.0, 5362.0, 5377.0, 5542.0, 5627.0, 5661.0, 5654.0, 5326.0, 5572.0, 5645.0, 5548.0, 5299.0, 5427.0, 5260.0, 5328.0, 5429.0

						5344.0, 5579.0, 5408.0, 5576.0, 5494.0, 5501.0, 5413.0, 5276.0, 5490.0, 5312.0, 5620.0, 5629.0, 5551.0, 5303.0, 5642.0, 5289.0, 5349.0, 5439.0, 5590.0, 5351.0, 5451.0, 5480.0, 5464.0, 5304.0, 5722.0, 5527.0, 5317.0, 5626.0, 5361.0, 5581.0, 5274.0, 5373.0, 5504.0, 5525.0, 5365.0, 5404.0, 5697.0, 5506.0, 5567.0, 5538.0 (number of hits: 9)
18	5530	9	1	333	1	5408.0, 5589.0, 5721.0, 5487.0, 5685.0, 5382.0, 5415.0, 5336.0, 5301.0, 5600.0, 5342.0, 5670.0, 5713.0, 5635.0, 5270.0, 5586.0, 5364.0, 5314.0, 5307.0, 5389.0, 5672.0, 5316.0, 5632.0, 5483.0, 5259.0, 5351.0, 5290.0, 5417.0, 5631.0, 5671.0, 5463.0, 5528.0, 5281.0, 5639.0, 5684.0, 5363.0, 5295.0, 5630.0, 5695.0, 5401.0, 5477.0, 5697.0, 5343.0, 5505.0, 5266.0, 5346.0, 5476.0, 5593.0, 5411.0, 5390.0, 5557.0, 5344.0, 5345.0, 5577.0, 5349.0, 5394.0, 5431.0, 5592.0, 5452.0, 5481.0, 5375.0, 5296.0, 5500.0, 5542.0, 5698.0, 5423.0, 5520.0, 5332.0, 5473.0, 5465.0, 5298.0, 5385.0, 5285.0, 5499.0, 5337.0, 5621.0, 5466.0, 5575.0, 5494.0, 5325.0, 5564.0, 5696.0, 5547.0, 5649.0, 5560.0, 5398.0, 5503.0, 5617.0, 5439.0, 5488.0, 5647.0, 5537.0, 5304.0, 5441.0, 5377.0, 5562.0, 5256.0, 5471.0, 5339.0, 5595.0 (number of hits: 7)
19	5530	9	1	333	1	5306.0, 5632.0, 5568.0, 5528.0, 5618.0, 5707.0, 5643.0, 5478.0, 5383.0, 5408.0, 5683.0, 5296.0, 5275.0, 5563.0, 5349.0, 5657.0, 5678.0, 5373.0, 5574.0, 5433.0, 5697.0, 5641.0, 5267.0, 5327.0, 5668.0, 5613.0, 5427.0, 5432.0, 5599.0, 5308.0, 5562.0, 5452.0, 5688.0, 5602.0, 5633.0, 5706.0, 5611.0, 5548.0, 5601.0, 5425.0, 5476.0, 5660.0, 5586.0, 5367.0, 5721.0, 5639.0, 5506.0, 5567.0, 5559.0, 5295.0, 5526.0, 5635.0, 5364.0, 5251.0, 5404.0, 5377.0, 5273.0, 5419.0, 5357.0, 5555.0, 5624.0, 5553.0, 5333.0, 5352.0, 5454.0, 5575.0, 5395.0, 5304.0, 5577.0, 5719.0, 5560.0, 5485.0, 5292.0, 5385.0, 5512.0, 5673.0, 5516.0, 5449.0, 5634.0, 5280.0, 5589.0, 5437.0, 5606.0, 5453.0, 5347.0, 5330.0, 5488.0, 5353.0, 5662.0, 5309.0, 5651.0, 5716.0, 5497.0, 5346.0, 5447.0, 5481.0, 5285.0, 5622.0, 5620.0, 5299.0 (number of hits: 9)
20	5530	9	1	333	1	5575.0, 5274.0, 5360.0, 5690.0, 5463.0, 5584.0, 5478.0, 5349.0, 5507.0, 5693.0, 5262.0, 5546.0, 5362.0, 5312.0, 5275.0, 5420.0, 5377.0, 5513.0, 5352.0, 5659.0, 5509.0, 5325.0, 5439.0, 5361.0, 5668.0, 5350.0, 5592.0, 5636.0, 5698.0, 5272.0, 5667.0, 5585.0, 5616.0, 5613.0, 5683.0, 5701.0, 5517.0, 5468.0, 5580.0, 5458.0

						5269.0, 5526.0, 5300.0, 5670.0, 5669.0, 5324.0, 5385.0, 5303.0, 5357.0, 5721.0, 5405.0, 5713.0, 5431.0, 5661.0, 5314.0, 5602.0, 5676.0, 5264.0, 5389.0, 5489.0, 5594.0, 5282.0, 5434.0, 5537.0, 5518.0, 5261.0, 5484.0, 5479.0, 5373.0, 5387.0, 5679.0, 5267.0, 5382.0, 5364.0, 5560.0, 5682.0, 5328.0, 5687.0, 5703.0, 5673.0, 5492.0, 5577.0, 5438.0, 5363.0, 5645.0, 5664.0, 5623.0, 5400.0, 5494.0, 5298.0, 5634.0, 5417.0, 5578.0, 5586.0, 5383.0, 5606.0, 5700.0, 5699.0, 5547.0, 5367.0 (number of hits: 4)
21	5530	9	1	333	1	5363.0, 5549.0, 5453.0, 5676.0, 5679.0, 5529.0, 5655.0, 5395.0, 5482.0, 5253.0, 5526.0, 5322.0, 5293.0, 5552.0, 5416.0, 5508.0, 5436.0, 5584.0, 5263.0, 5466.0, 5377.0, 5262.0, 5522.0, 5353.0, 5442.0, 5333.0, 5602.0, 5430.0, 5446.0, 5294.0, 5384.0, 5718.0, 5260.0, 5425.0, 5352.0, 5634.0, 5587.0, 5358.0, 5403.0, 5320.0, 5652.0, 5451.0, 5278.0, 5573.0, 5279.0, 5657.0, 5567.0, 5284.0, 5582.0, 5447.0, 5604.0, 5575.0, 5420.0, 5507.0, 5360.0, 5723.0, 5721.0, 5441.0, 5400.0, 5368.0, 5387.0, 5624.0, 5502.0, 5475.0, 5520.0, 5518.0, 5495.0, 5557.0, 5598.0, 5267.0, 5433.0, 5707.0, 5599.0, 5577.0, 5700.0, 5621.0, 5645.0, 5470.0, 5350.0, 5406.0, 5374.0, 5314.0, 5398.0, 5286.0, 5424.0, 5673.0, 5479.0, 5521.0, 5534.0, 5381.0, 5383.0, 5489.0, 5257.0, 5359.0, 5547.0, 5635.0, 5596.0, 5601.0, 5326.0, 5578.0 (number of hits: 6)
22	5530	9	1	333	1	5363.0, 5292.0, 5430.0, 5442.0, 5307.0, 5435.0, 5705.0, 5286.0, 5478.0, 5578.0, 5373.0, 5580.0, 5347.0, 5559.0, 5707.0, 5421.0, 5393.0, 5453.0, 5688.0, 5468.0, 5654.0, 5476.0, 5494.0, 5719.0, 5639.0, 5428.0, 5609.0, 5356.0, 5549.0, 5623.0, 5316.0, 5620.0, 5576.0, 5722.0, 5685.0, 5527.0, 5546.0, 5313.0, 5269.0, 5554.0, 5573.0, 5518.0, 5378.0, 5343.0, 5560.0, 5314.0, 5344.0, 5449.0, 5577.0, 5492.0, 5469.0, 5555.0, 5277.0, 5496.0, 5257.0, 5718.0, 5650.0, 5663.0, 5287.0, 5458.0, 5538.0, 5690.0, 5414.0, 5634.0, 5381.0, 5339.0, 5467.0, 5434.0, 5320.0, 5545.0, 5724.0, 5625.0, 5270.0, 5667.0, 5574.0, 5401.0, 5345.0, 5680.0, 5487.0, 5431.0, 5386.0, 5463.0, 5308.0, 5561.0, 5534.0, 5318.0, 5642.0, 5285.0, 5535.0, 5708.0, 5391.0, 5459.0, 5603.0, 5375.0, 5557.0, 5326.0, 5410.0, 5524.0, 5655.0, 5338.0 (number of hits: 12)
23	5530	9	1	333	1	5529.0, 5325.0, 5437.0, 5598.0, 5538.0, 5623.0, 5302.0, 5600.0, 5658.0, 5522.0, 5560.0, 5439.0, 5723.0, 5689.0, 5373.0, 5536.0, 5704.0, 5696.0, 5527.0, 5280.0,

						5578.0, 5720.0, 5479.0, 5633.0, 5581.0, 5493.0, 5663.0, 5311.0, 5418.0, 5472.0, 5256.0, 5481.0, 5619.0, 5343.0, 5487.0, 5307.0, 5362.0, 5420.0, 5528.0, 5567.0, 5513.0, 5391.0, 5547.0, 5285.0, 5494.0, 5546.0, 5460.0, 5286.0, 5647.0, 5475.0, 5710.0, 5331.0, 5621.0, 5505.0, 5470.0, 5617.0, 5537.0, 5706.0, 5582.0, 5422.0, 5692.0, 5341.0, 5441.0, 5447.0, 5709.0, 5313.0, 5327.0, 5612.0, 5322.0, 5642.0, 5595.0, 5614.0, 5438.0, 5488.0, 5406.0, 5366.0, 5666.0, 5615.0, 5608.0, 5415.0, 5550.0, 5467.0, 5622.0, 5466.0, 5526.0, 5346.0, 5388.0, 5627.0, 5562.0, 5448.0, 5586.0, 5349.0, 5548.0, 5624.0, 5629.0, 5715.0, 5372.0, 5667.0, 5573.0, 5329.0 (number of hits: 10)
24	5530	9	1	333	1	5624.0, 5672.0, 5327.0, 5632.0, 5660.0, 5265.0, 5465.0, 5467.0, 5395.0, 5602.0, 5286.0, 5390.0, 5663.0, 5333.0, 5561.0, 5466.0, 5545.0, 5368.0, 5721.0, 5280.0, 5618.0, 5679.0, 5714.0, 5470.0, 5703.0, 5509.0, 5316.0, 5352.0, 5720.0, 5274.0, 5526.0, 5535.0, 5601.0, 5444.0, 5335.0, 5716.0, 5314.0, 5315.0, 5362.0, 5341.0, 5356.0, 5349.0, 5287.0, 5410.0, 5667.0, 5258.0, 5253.0, 5481.0, 5557.0, 5686.0, 5707.0, 5508.0, 5268.0, 5523.0, 5537.0, 5461.0, 5675.0, 5488.0, 5713.0, 5704.0, 5680.0, 5514.0, 5494.0, 5524.0, 5412.0, 5337.0, 5504.0, 5647.0, 5530.0, 5426.0, 5385.0, 5304.0, 5706.0, 5522.0, 5638.0, 5531.0, 5365.0, 5544.0, 5645.0, 5360.0, 5503.0, 5301.0, 5676.0, 5339.0, 5407.0, 5562.0, 5540.0, 5251.0, 5250.0, 5262.0, 5387.0, 5591.0, 5669.0, 5697.0, 5691.0, 5496.0, 5322.0, 5505.0, 5658.0, 5648.0 (number of hits: 10)
25	5530	9	1	333	1	5320.0, 5361.0, 5498.0, 5433.0, 5534.0, 5489.0, 5522.0, 5574.0, 5458.0, 5448.0, 5272.0, 5608.0, 5637.0, 5390.0, 5711.0, 5487.0, 5362.0, 5480.0, 5501.0, 5405.0, 5511.0, 5375.0, 5353.0, 5562.0, 5605.0, 5499.0, 5641.0, 5342.0, 5470.0, 5524.0, 5545.0, 5617.0, 5502.0, 5609.0, 5593.0, 5274.0, 5430.0, 5380.0, 5397.0, 5486.0, 5332.0, 5687.0, 5451.0, 5255.0, 5406.0, 5628.0, 5330.0, 5377.0, 5423.0, 5614.0, 5434.0, 5356.0, 5265.0, 5507.0, 5372.0, 5559.0, 5381.0, 5334.0, 5263.0, 5517.0, 5528.0, 5598.0, 5427.0, 5343.0, 5575.0, 5636.0, 5296.0, 5629.0, 5388.0, 5416.0, 5648.0, 5443.0, 5660.0, 5717.0, 5310.0, 5317.0, 5535.0, 5689.0, 5386.0, 5404.0, 5479.0, 5645.0, 5293.0, 5437.0, 5638.0, 5449.0, 5429.0, 5616.0, 5538.0, 5400.0, 5398.0, 5266.0, 5526.0, 5604.0, 5576.0, 5713.0, 5344.0, 5606.0, 5384.0, 5715.0 (number of hits: 6)

26	5530	9	1	333	1	<p>5509.0, 5555.0, 5663.0, 5347.0, 5338.0, 5408.0, 5530.0, 5479.0, 5654.0, 5644.0, 5622.0, 5329.0, 5634.0, 5512.0, 5431.0, 5268.0, 5276.0, 5507.0, 5317.0, 5381.0, 5388.0, 5390.0, 5559.0, 5438.0, 5563.0, 5402.0, 5566.0, 5510.0, 5684.0, 5676.0, 5655.0, 5572.0, 5648.0, 5511.0, 5316.0, 5595.0, 5286.0, 5489.0, 5675.0, 5504.0, 5678.0, 5620.0, 5375.0, 5715.0, 5298.0, 5352.0, 5650.0, 5455.0, 5456.0, 5296.0, 5608.0, 5659.0, 5255.0, 5653.0, 5574.0, 5567.0, 5478.0, 5423.0, 5275.0, 5547.0, 5429.0, 5708.0, 5515.0, 5373.0, 5481.0, 5614.0, 5611.0, 5391.0, 5575.0, 5378.0, 5495.0, 5424.0, 5468.0, 5348.0, 5313.0, 5425.0, 5669.0, 5365.0, 5380.0, 5356.0, 5401.0, 5263.0, 5288.0, 5494.0, 5432.0, 5709.0, 5333.0, 5612.0, 5482.0, 5522.0, 5279.0, 5343.0, 5490.0, 5692.0, 5607.0, 5680.0, 5319.0, 5415.0, 5590.0, 5387.0</p> <p>(number of hits: 7)</p>
27	5530	9	1	333	1	<p>5664.0, 5365.0, 5428.0, 5703.0, 5565.0, 5468.0, 5558.0, 5320.0, 5716.0, 5454.0, 5503.0, 5403.0, 5449.0, 5459.0, 5589.0, 5254.0, 5625.0, 5713.0, 5523.0, 5252.0, 5516.0, 5628.0, 5375.0, 5420.0, 5672.0, 5423.0, 5567.0, 5291.0, 5264.0, 5348.0, 5385.0, 5467.0, 5410.0, 5306.0, 5484.0, 5623.0, 5455.0, 5571.0, 5339.0, 5480.0, 5554.0, 5694.0, 5688.0, 5538.0, 5440.0, 5604.0, 5597.0, 5721.0, 5663.0, 5330.0, 5298.0, 5326.0, 5315.0, 5323.0, 5406.0, 5416.0, 5438.0, 5479.0, 5602.0, 5461.0, 5337.0, 5435.0, 5426.0, 5275.0, 5644.0, 5270.0, 5318.0, 5615.0, 5657.0, 5584.0, 5395.0, 5684.0, 5399.0, 5510.0, 5619.0, 5682.0, 5670.0, 5343.0, 5616.0, 5261.0, 5701.0, 5494.0, 5398.0, 5624.0, 5697.0, 5358.0, 5514.0, 5691.0, 5622.0, 5331.0, 5413.0, 5288.0, 5400.0, 5540.0, 5427.0, 5504.0, 5568.0, 5641.0, 5635.0, 5683.0</p> <p>(number of hits: 7)</p>
28	5530	9	1	333	1	<p>5404.0, 5687.0, 5565.0, 5630.0, 5557.0, 5508.0, 5301.0, 5345.0, 5545.0, 5459.0, 5441.0, 5274.0, 5293.0, 5428.0, 5398.0, 5262.0, 5420.0, 5329.0, 5473.0, 5405.0, 5616.0, 5702.0, 5276.0, 5691.0, 5555.0, 5457.0, 5538.0, 5669.0, 5664.0, 5393.0, 5269.0, 5372.0, 5324.0, 5482.0, 5446.0, 5655.0, 5481.0, 5537.0, 5498.0, 5412.0, 5680.0, 5627.0, 5369.0, 5523.0, 5712.0, 5681.0, 5636.0, 5678.0, 5518.0, 5703.0, 5322.0, 5426.0, 5704.0, 5556.0, 5258.0, 5278.0, 5521.0, 5350.0, 5515.0, 5551.0, 5683.0, 5593.0, 5445.0, 5253.0, 5456.0, 5256.0, 5602.0, 5653.0, 5284.0, 5643.0, 5342.0, 5357.0, 5472.0, 5541.0, 5470.0, 5659.0, 5598.0, 5539.0, 5351.0, 5361.0, 5392.0, 5490.0, 5634.0, 5525.0, 5713.0,</p>

						5673.0, 5308.0, 5480.0, 5530.0, 5415.0, 5595.0, 5414.0, 5331.0, 5591.0, 5672.0, 5367.0, 5476.0, 5667.0, 5618.0, 5526.0 (number of hits: 11)
29	5530	9	1	333	1	5699.0, 5472.0, 5658.0, 5264.0, 5435.0, 5483.0, 5702.0, 5668.0, 5468.0, 5667.0, 5522.0, 5294.0, 5536.0, 5515.0, 5704.0, 5544.0, 5484.0, 5273.0, 5419.0, 5348.0, 5496.0, 5384.0, 5285.0, 5546.0, 5566.0, 5665.0, 5642.0, 5291.0, 5705.0, 5410.0, 5571.0, 5677.0, 5255.0, 5537.0, 5613.0, 5692.0, 5452.0, 5411.0, 5393.0, 5495.0, 5416.0, 5475.0, 5453.0, 5559.0, 5531.0, 5345.0, 5311.0, 5591.0, 5375.0, 5431.0, 5396.0, 5412.0, 5575.0, 5420.0, 5577.0, 5707.0, 5628.0, 5362.0, 5601.0, 5282.0, 5343.0, 5712.0, 5690.0, 5424.0, 5464.0, 5275.0, 5308.0, 5657.0, 5626.0, 5646.0, 5364.0, 5661.0, 5502.0, 5437.0, 5279.0, 5254.0, 5627.0, 5286.0, 5506.0, 5260.0, 5714.0, 5387.0, 5290.0, 5724.0, 5624.0, 5592.0, 5429.0, 5621.0, 5250.0, 5593.0, 5316.0, 5547.0, 5320.0, 5332.0, 5474.0, 5480.0, 5697.0, 5265.0, 5403.0, 5681.0 (number of hits: 8)
30	5530	9	1	333	1	5534.0, 5548.0, 5439.0, 5520.0, 5331.0, 5629.0, 5350.0, 5496.0, 5673.0, 5489.0, 5513.0, 5527.0, 5658.0, 5536.0, 5517.0, 5276.0, 5627.0, 5357.0, 5414.0, 5611.0, 5613.0, 5668.0, 5680.0, 5482.0, 5470.0, 5330.0, 5299.0, 5369.0, 5657.0, 5655.0, 5700.0, 5328.0, 5298.0, 5495.0, 5352.0, 5277.0, 5696.0, 5364.0, 5679.0, 5528.0, 5619.0, 5605.0, 5659.0, 5456.0, 5663.0, 5250.0, 5581.0, 5530.0, 5466.0, 5532.0, 5522.0, 5449.0, 5625.0, 5459.0, 5317.0, 5303.0, 5387.0, 5401.0, 5562.0, 5570.0, 5616.0, 5602.0, 5618.0, 5280.0, 5647.0, 5557.0, 5720.0, 5272.0, 5372.0, 5429.0, 5380.0, 5716.0, 5430.0, 5682.0, 5628.0, 5265.0, 5451.0, 5639.0, 5714.0, 5301.0, 5359.0, 5576.0, 5692.0, 5262.0, 5719.0, 5586.0, 5436.0, 5396.0, 5338.0, 5623.0, 5410.0, 5448.0, 5428.0, 5358.0, 5271.0, 5497.0, 5551.0, 5374.0, 5457.0, 5708.0 (number of hits: 8)

10 Bridge and/or MESH mode

10.1 Test standard

Networks Access Points with Bridge and/or MESH modes of operation are permitted to operate in the DFS bands but must employ a DFS function. The functionality of the Bridge mode as specified in §15.403(a) must be validated in the DFS test report. Devices operating as relays where they act as master and client must also employ DFS function for the master. The method used to validate the functionality must be documented and validation data must be documented. Bridge mode can be validated by performing a test statistical performance check (Section 7.8.4) on any one of the radar types. This is an abbreviated test to verify DFS functionality. MESH mode operational methodology must be submitted in the application for certification for evaluation by the FCC.

10.2 Test result

5280MHz

Trial #	Fc (MHz)	Pulse/Burst	Pulse Width (µS)	PRI (µs)	Detection (1:yes; 0:no)
1	5280	18	1	1428	1
2	5280	18	1	1428	1
3	5280	18	1	1428	1
4	5280	18	1	1428	1
5	5280	18	1	1428	1
6	5280	18	1	1428	1
7	5280	18	1	1428	1
8	5280	18	1	1428	1
9	5280	18	1	1428	1
10	5280	18	1	1428	1
11	5280	18	1	1428	1
12	5280	18	1	1428	1
13	5280	18	1	1428	1
14	5280	18	1	1428	1
15	5280	18	1	1428	1
16	5280	18	1	1428	1
17	5280	18	1	1428	1
18	5280	18	1	1428	1
19	5280	18	1	1428	1
20	5280	18	1	1428	1
21	5280	18	1	1428	1
22	5280	18	1	1428	1
23	5280	18	1	1428	1
24	5280	18	1	1428	1
25	5280	18	1	1428	1
26	5280	18	1	1428	1
27	5280	18	1	1428	1
28	5280	18	1	1428	1
29	5280	18	1	1428	1
30	5280	18	1	1428	1
Detection Percentage: 100 % (>60%)					

5540MHz

Trial #	Fc (MHz)	Pulse/Burst	Pulse Width (µS)	PRI (µs)	Detection (1:yes; 0:no)
1	5540	18	1	1428	1
2	5540	18	1	1428	1
3	5540	18	1	1428	1
4	5540	18	1	1428	1
5	5540	18	1	1428	1
6	5540	18	1	1428	1
7	5540	18	1	1428	1
8	5540	18	1	1428	1
9	5540	18	1	1428	1
10	5540	18	1	1428	1
11	5540	18	1	1428	1
12	5540	18	1	1428	1
13	5540	18	1	1428	1
14	5540	18	1	1428	1
15	5540	18	1	1428	1
16	5540	18	1	1428	1
17	5540	18	1	1428	1
18	5540	18	1	1428	1
19	5540	18	1	1428	1
20	5540	18	1	1428	1
21	5540	18	1	1428	1
22	5540	18	1	1428	1
23	5540	18	1	1428	1
24	5540	18	1	1428	1
25	5540	18	1	1428	1
26	5540	18	1	1428	1
27	5540	18	1	1428	1
28	5540	18	1	1428	1
29	5540	18	1	1428	1
30	5540	18	1	1428	1
Detection Percentage: 100 % (>60%)					