

FCC Test Report

Report No.: RF160219C14B

FCC ID: TVE-28166011

Test Model: FAP-421E, FAP-423E

Series Model: FortiAP 421Exxxxxx, FAP-421Exxxxxx, FORTIAP-421Exxxxxx, FortiAP 423Exxxxxx, FAP-423Exxxxxx, FORTIAP-423Exxxxxx (where "x" can be used as "A-Z", or "0-9", or "-", or blank for software changes or marketing purposes only) (refer to item 3.1 for more details)

Received Date: Oct. 19, 2016

Test Date: Oct. 26 ~ Dec. 16, 2016

Issued Date: Dec .23, 2016

Applicant: Fortinet Inc.

Address: 899 Kifer Road Sunnyvale, CA 94086 USA

Issued By: Bureau Veritas Consumer Products Services (H.K.) Ltd., Taoyuan Branch

Lab Address: No. 47-2, 14th Ling, Chia Pau Vil., Lin Kou Dist., New Taipei City, Taiwan, R.O.C.

Test Location: No. 19, Hwa Ya 2nd Rd., Wen Hwa Vil., Kwei Shan Dist., Taoyuan City 33383, TAIWAN (R.O.C.)



This report is for your exclusive use. Any copying or replication of this report to or for any other person or entity, or use of our name or trademark, is permitted only with our prior written permission. This report sets forth our findings solely with respect to the test samples identified herein. The results set forth in this report are not indicative or representative of the quality or characteristics of the lot from which a test sample was taken or any similar or identical product specifically and expressly noted. Our report includes all of the tests requested by you and the results thereof based upon the information that you provided to us. You have 60 days from date of issuance of this report to notify us of any material error or omission caused by our negligence, provided, however, that such notice shall be in writing and shall specifically address the issue you wish to raise. A failure to raise such issue within the prescribed time shall constitute your unqualified acceptance of the completeness of this report, the tests conducted and the correctness of the report contents. Unless specific mention, the uncertainty of measurement has been explicitly taken into account to declare the compliance or non-compliance to the specification. The report must not be used by the client to claim product certification, approval, or endorsement by TAF or any government agencies.

Table of Contents

Release Control Record	4
1 Certificate of Conformity	5
2 Summary of Test Results	6
2.1 Measurement Uncertainty.....	6
2.2 Modification Record.....	6
3 General Information	7
3.1 General Description of EUT.....	7
3.2 Description of Test Modes.....	10
3.2.1 Test Mode Applicability and Tested Channel Detail.....	11
3.3 Duty Cycle of Test Signal.....	13
3.4 Description of Support Units.....	14
3.4.1 Configuration of System under Test.....	14
3.5 General Description of Applied Standards.....	15
4 Test Types and Results	16
4.1 Radiated Emission and Bandedge Measurement.....	16
4.1.1 Limits of Radiated Emission and Bandedge Measurement.....	16
4.1.2 Test Instruments.....	17
4.1.3 Test Procedures.....	18
4.1.4 Deviation from Test Standard.....	18
4.1.5 Test Setup.....	19
4.1.6 EUT Operating Conditions.....	20
4.1.7 Test Results.....	21
4.2 Conducted Emission Measurement.....	71
4.2.1 Limits of Conducted Emission Measurement.....	71
4.2.2 Test Instruments.....	71
4.2.3 Test Procedures.....	72
4.2.4 Deviation from Test Standard.....	72
4.2.5 Test Setup.....	72
4.2.6 EUT Operating Conditions.....	72
4.2.7 Test Results.....	73
4.3 Transmit Power Measurement.....	81
4.3.1 Limits of Transmit Power Measurement.....	81
4.3.2 Test Setup.....	81
4.3.3 Test Instruments.....	81
4.3.4 Test Procedure.....	82
4.3.5 Deviation from Test Standard.....	82
4.3.6 EUT Operating Conditions.....	82
4.3.7 Test Result.....	83
4.4 Peak Power Spectral Density Measurement.....	96
4.4.1 Limits of Peak Power Spectral Density Measurement.....	96
4.4.2 Test Setup.....	96
4.4.3 Test Instruments.....	96
4.4.4 Test Procedures.....	96
4.4.5 Deviation from Test Standard.....	96
4.4.6 EUT Operating Conditions.....	96
4.4.7 Test Results.....	97
4.5 Frequency Stability.....	100
4.5.1 Limits of Frequency Stability Measurement.....	100
4.5.2 Test Setup.....	100
4.5.3 Test Instruments.....	100
4.5.4 Test Procedure.....	100
4.5.5 Deviation from Test Standard.....	100
4.5.6 EUT Operating Condition.....	100

4.5.7 Test Results	101
5 Pictures of Test Arrangements.....	102
Appendix – Information on the Testing Laboratories	103



Release Control Record

Issue No.	Description	Date Issued
RF160219C14B	Original release.	Dec. 23, 2016

1 Certificate of Conformity

Product: Secured Wireless Access Point

Brand: Fortinet Inc.

Test Model: FAP-421E, FAP-423E

Series Model: FortiAP 421Exxxxxx, FAP-421Exxxxxx, FORTIAP-421Exxxxxx,
FortiAP 423Exxxxxx, FAP-423Exxxxxx, FORTIAP-423Exxxxxx (where "x" can be
used as "A-Z", or "0-9", or "-", or blank for software changes or marketing purposes
only) (refer to item 3.1 for more details)

Sample Status: Engineering sample

Applicant: Fortinet Inc.

Test Date: Oct. 26 ~ Dec. 16, 2016

Standards: 47 CFR FCC Part 15, Subpart E (Section 15.407)
ANSI C63.10:2013

The above equipment has been tested by **Bureau Veritas Consumer Products Services (H.K.) Ltd., Taoyuan Branch**, and found compliance with the requirement of the above standards. The test record, data evaluation & Equipment Under Test (EUT) configurations represented herein are true and accurate accounts of the measurements of the sample's EMC characteristics under the conditions specified in this report.

Prepared by :  , **Date:** Dec. 23, 2016
Pettie Chen / Senior Specialist

Approved by :  , **Date:** Dec. 23, 2016
Ken Liu / Senior Manager

2 Summary of Test Results

47 CFR FCC Part 15, Subpart E (SECTION 15.407)			
FCC Clause	Test Item	Result	Remarks
15.407(b)(6)	AC Power Conducted Emissions	Pass	Meet the requirement of limit. Minimum passing margin is -5.08dB at 0.53039MHz.
15.407(b) (1/2/3/4(i/ii)/6)	Radiated Emissions & Band Edge Measurement	Pass	Meet the requirement of limit. Minimum passing margin is -1.0dB at 10600.00MHz.
15.407(a) (1/2/3)	Max Average Transmit Power	Pass	Meet the requirement of limit.
15.407(a)(1/2/3)	Peak Power Spectral Density	Pass	Meet the requirement of limit.
15.407(g)	Frequency Stability	Pass	Meet the requirement of limit.
15.203	Antenna Requirement	PASS	Antenna connector is IPEX or RPSMA not a standard connector.

2.1 Measurement Uncertainty

Where relevant, the following measurement uncertainty levels have been estimated for tests performed on the EUT as specified in CISPR 16-4-2:

Measurement	Frequency	Expanded Uncertainty (k=2) (±)
Conducted Emissions at mains ports	150kHz ~ 30MHz	2.44 dB
Radiated Emissions up to 1 GHz	30MHz ~ 200MHz	3.86 dB
	200MHz ~ 1000MHz	3.87 dB
Radiated Emissions above 1 GHz	1GHz ~ 18GHz	2.29 dB
	18GHz ~ 40GHz	2.29 dB

2.2 Modification Record

There were no modifications required for compliance.

3 General Information

3.1 General Description of EUT

Product	Secured Wireless Access Point
Brand	Fortinet Inc.
Test Model	FAP-421E, FAP-423E
Series Model	FortiAP 421Exxxxxx, FAP-421Exxxxxx, FORTIAP-421Exxxxxx, FortiAP 423Exxxxxx, FAP-423Exxxxxx, FORTIAP-423Exxxxxx (where "x" can be used as "A-Z" or "0-9" or "-" or blank for software changes or marketing purposes only)
Model Difference	Refer to Note
Status of EUT	Engineering sample
Power Supply Rating	12Vdc (adapter) 54Vdc (POE)
Modulation Type	256QAM, 64QAM, 16QAM, QPSK, BPSK
Modulation Technology	OFDM
Transfer Rate	802.11a: 54/48/36/24/18/12/9/6Mbps 802.11n: up to 600Mbps 802.11ac: up to 1734Mbps
Operating Frequency	5260 ~ 5320MHz, 5500 ~ 5720MHz
Number of Channel	5260 ~ 5320MHz: 4 for 802.11a, 802.11n (HT20), 802.11ac (VHT20) 2 for 802.11n (HT40), 802.11ac (VHT40) 1 for 802.11ac (VHT80) 5500 ~ 5700MHz: 12 for 802.11a, 802.11n (HT20), 802.11ac (VHT20) 6 for 802.11n (HT40), 802.11ac (VHT40) 3 for 802.11ac (VHT80)
Output Power	CDD Mode: 5260 ~ 5320MHz: 134.400mW 5500 ~ 5700MHz: 241.466mW Beamforming Mode: 5260 ~ 5320MHz: 33.604mW 5500 ~ 5700MHz: 60.376mW
Antenna Type	Refer to Note 4
Antenna Connector	Refer to Note 4
Accessory Device	NA
Data Cable Supplied	NA

Note:

1. This report is prepared for FCC class II permissive change. This report is issued as a supplementary report of the original report no.: RF160219C14-1. The difference compared with original report is adding 5.26GHz to 5.32GHz and 5.50GHz to 5.70GHz by software.

2. All models are listed as below. Model: FAP-421E and FAP-423E were chosen for final test.

Brand	Model	Difference
Fortinet Inc.	FortiAP 421Exxxxxx	"x" can be used as "A-Z", or "0-9", or "-", or blank for software changes or marketing purposes only
	FAP-421Exxxxxx	
	FORTIAP-421Exxxxxx	
	FortiAP 423Exxxxxx	
	FAP-423Exxxxxx	
	FORTIAP-423Exxxxxx	
		With Internal Antenna
		With External Antenna

3. The EUT incorporates a MIMO function. Physically, the EUT provides 4 completed transmitters and 4 receivers.

Band	Modulation Mode	CDD Mode	Beamforming Mode	TX Function
5GHz	802.11a	Support	Not Support	4TX
	802.11n (HT20)	Support	Support	4TX
	802.11n (HT40)	Support	Support	4TX
	802.11ac (VHT20)	Support	Support	4TX
	802.11ac (VHT40)	Support	Support	4TX
	802.11ac (VHT80)	Support	Support	4TX

* CDD Mode: The modulation and bandwidth are similar for 802.11n mode for HT20/HT40 and 802.11ac mode for HT20/HT40, therefore investigated worst case to representative mode in test report. (Final test mode refer section 3.2.1)

* For 802.11n and 802.11ac, CDD mode is the worst case for final radiated emission up to 1 GHz and power line conducted emission tests after pretesting.

4. The following antennas were provided to the EUT.

Internal Antenna Type	Printed		
Antenna Connector	IPEX		
Gain (dBi)			
Item	2400-2500 MHz	Item	5150-5850 MHz
Ant. 1	3.81	Ant. 5	5.65
Ant. 2	3.98	Ant. 6	5.50
Ant. 3	3.47	Ant. 7	5.84
Ant. 4	3.75	Ant. 8	5.84

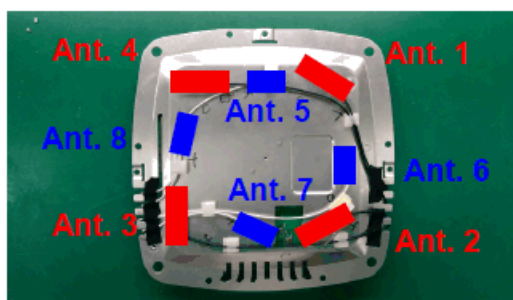
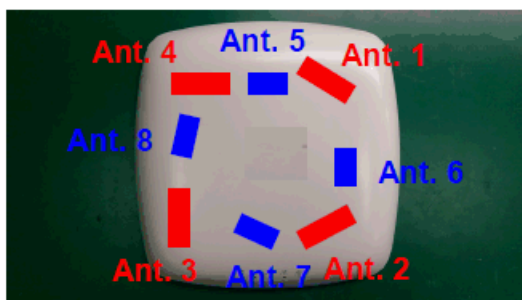

Antenna Type	Dipole	Antenna Connector	RPSMA
Gain (dBi)	Frequency (MHz)		
	2400~2500	5150~5850	
WLAN External Ant.	4.42	3.18	

5. WLAN 2.4GHz and WLAN 5GHz and BT technologies can transmit at same time.
6. Spurious emission of the simultaneous operation (WLAN 2.4GHz and WLAN 5GHz) has been evaluated and no non-compliance was found.
7. The EUT consumes power from the following adapter and POE (POE as support units only).

Adapter (optional)	
Brand	Asian Power Devices Inc.
Model	WA-36A12R
Input Power	100-240Vac, 50-60Hz, 0.9A Max.
Output Power	12Vdc, 3A
Power Line	1.75m power cable without core attached on adapter

POE	
Brand	EnGenius
Model	EPA5006GAT
Input Power	100-240Vac, 50-60Hz 0.8A
Output Power	54Vdc, 0.6A
Power Line	0.5m power cable without core

3.2 Description of Test Modes

FOR 5260 ~ 5320MHz:

4 channels are provided for 802.11a, 802.11n (HT20), 802.11ac (VHT20):

Channel	Frequency	Channel	Frequency
52	5260 MHz	60	5300 MHz
56	5280 MHz	64	5320 MHz

2 channels are provided for 802.11n (HT40), 802.11ac (VHT40):

Channel	Frequency	Channel	Frequency
54	5270 MHz	62	5310 MHz

1 channel is provided for 802.11ac (VHT80):

Channel	Frequency
58	5290 MHz

FOR 5500 ~ 5720MHz:

12 channels are provided for 802.11a, 802.11n (HT20), 802.11ac (VHT20):

Channel	Frequency	Channel	Frequency
100	5500 MHz	124	5620 MHz
104	5520 MHz	128	5640 MHz
108	5540 MHz	132	5660 MHz
112	5560 MHz	136	5680 MHz
116	5580 MHz	140	5700 MHz
120	5600 MHz	144	5720 MHz

6 channels are provided for 802.11n (HT40), 802.11ac (VHT40):

Channel	Frequency	Channel	Frequency
102	5510 MHz	126	5630 MHz
110	5550 MHz	134	5670 MHz
118	5590 MHz	142	5710 MHz

3 channels are provided for 802.11ac (VHT80):

Channel	Frequency	Channel	Frequency
106	5530 MHz	122	5610 MHz
138	5690 MHz		

3.2.1 Test Mode Applicability and Tested Channel Detail

EUT CONFIGURE MODE	APPLICABLE TO				DESCRIPTION
	RE \geq 1G	RE<1G	PLC	APCM	
A	√	√	√	√	Internal antenna, Power from adapter
B	-	√	√	-	Internal antenna, Power from POE
C	√	√	√	-	External antenna, Power from adapter
D	-	√	√	-	External antenna, Power from POE

Where **RE \geq 1G**: Radiated Emission above 1GHz & Bandedge Measurement
RE<1G: Radiated Emission below 1GHz
PLC: Power Line Conducted Emission
APCM: Antenna Port Conducted Measurement

Note:

1. The EUT had been pre-tested on the positioned of each 3 axis. The worst case was found when positioned on **Y-plane** (test mode A & B) and **X-plane** (test mode C & D).
2. "-" means no effect.

Radiated Emission Test (Above 1GHz):

- Pre-Scan has been conducted to determine the worst-case mode from all possible combinations between available modulations, data rates and antenna ports (if EUT with antenna diversity architecture).
- Following channel(s) was (were) selected for the final test as listed below.

EUT Configure Mode	Mode	Frequency Band (MHz)	Available Channel	Tested Channel	Modulation Technology	Data Rate (Mbps)
A, C	802.11a	5260-5320	52 to 64	52, 60, 64	OFDM	6.0
A, C	802.11ac (VHT20)		52 to 64	52, 60, 64	OFDM	7.2
A, C	802.11ac (VHT40)		54 to 62	54, 62	OFDM	15.0
A, C	802.11ac (VHT80)		58	58	OFDM	130.0
A, C	802.11a	5500-5720	100 to 144	100, 116, 140, 144	OFDM	6.0
A, C	802.11ac (VHT20)		100 to 144	100, 116, 140, 144	OFDM	7.2
A, C	802.11ac (VHT40)		102 to 142	102, 110, 134, 142	OFDM	15.0
A, C	802.11ac (VHT80)		106 to 138	106, 138	OFDM	130.0

Radiated Emission Test (Below 1GHz):

- Pre-Scan has been conducted to determine the worst-case mode from all possible combinations between available modulations, data rates and antenna ports (if EUT with antenna diversity architecture).
- Following channel(s) was (were) selected for the final test as listed below.

EUT Configure Mode	Mode	Frequency Band (MHz)	Available Channel	Tested Channel	Modulation Technology	Data Rate (Mbps)
A, B, C, D	802.11a	5260-5320	52 to 64	52	OFDM	6
	802.11a	5500-5720	100 to 144		OFDM	6

Power Line Conducted Emission Test:

- Pre-Scan has been conducted to determine the worst-case mode from all possible combinations between available modulations, data rates and antenna ports (if EUT with antenna diversity architecture).
- Following channel(s) was (were) selected for the final test as listed below.

EUT Configure Mode	Mode	Frequency Band (MHz)	Available Channel	Tested Channel	Modulation Technology	Data Rate (Mbps)
A, B, C, D	802.11a	5260-5320	52 to 64	52	OFDM	6
	802.11a	5500-5720	100 to 144		OFDM	6

Antenna Port Conducted Measurement:

- This item includes all test value of each mode, but only includes spectrum plot of worst value of each mode.
- Pre-Scan has been conducted to determine the worst-case mode from all possible combinations between available modulations, data rates and antenna ports (if EUT with antenna diversity architecture).
- Following channel(s) was (were) selected for the final test as listed below.

EUT Configure Mode	Mode	Frequency Band (MHz)	Available Channel	Tested Channel	Modulation Technology	Data Rate (Mbps)
A	802.11a	5260-5320	52 to 64	52, 60, 64	OFDM	6.0
A	802.11ac (VHT20)		52 to 64	52, 60, 64	OFDM	7.2
A	802.11ac (VHT40)		54 to 62	54, 62	OFDM	15.0
A	802.11ac (VHT80)		58	58	OFDM	130.0
A	802.11a	5500-5720	100 to 144	100, 116, 140, 144	OFDM	6.0
A	802.11ac (VHT20)		100 to 144	100, 116, 140, 144	OFDM	7.2
A	802.11ac (VHT40)		102 to 142	102, 110, 134, 142	OFDM	15.0
A	802.11ac (VHT80)		106 to 138	106, 138	OFDM	130.0

Test Condition:

APPLICABLE TO	ENVIRONMENTAL CONDITIONS	INPUT POWER	TESTED BY
RE\geq1G	16deg. C, 70%RH	120Vac, 60Hz	Nick Hsu
RE$<$1G	16deg. C, 70%RH	120Vac, 60Hz	Nick Hsu
PLC	16deg. C, 70%RH	120Vac, 60Hz	Nick Hsu
APCM	25deg. C, 60%RH	120Vac, 60Hz	Ted Chang

3.3 Duty Cycle of Test Signal

Duty cycle of test signal is < 98%, duty factor shall be considered.

802.11a: Duty cycle = 2.028/2.108 = 0.962, Duty factor = $10 * \log(1/0.962) = 0.17$

802.11ac (VHT20): Duty cycle = 4.953/5.028 = 0.985

802.11ac (VHT40): Duty cycle = 2.397/2.492 = 0.962, Duty factor = $10 * \log(1/0.962) = 0.17$

802.11ac (VHT80): Duty cycle = 1.132/1.210 = 0.936, Duty factor = $10 * \log(1/0.936) = 0.29$

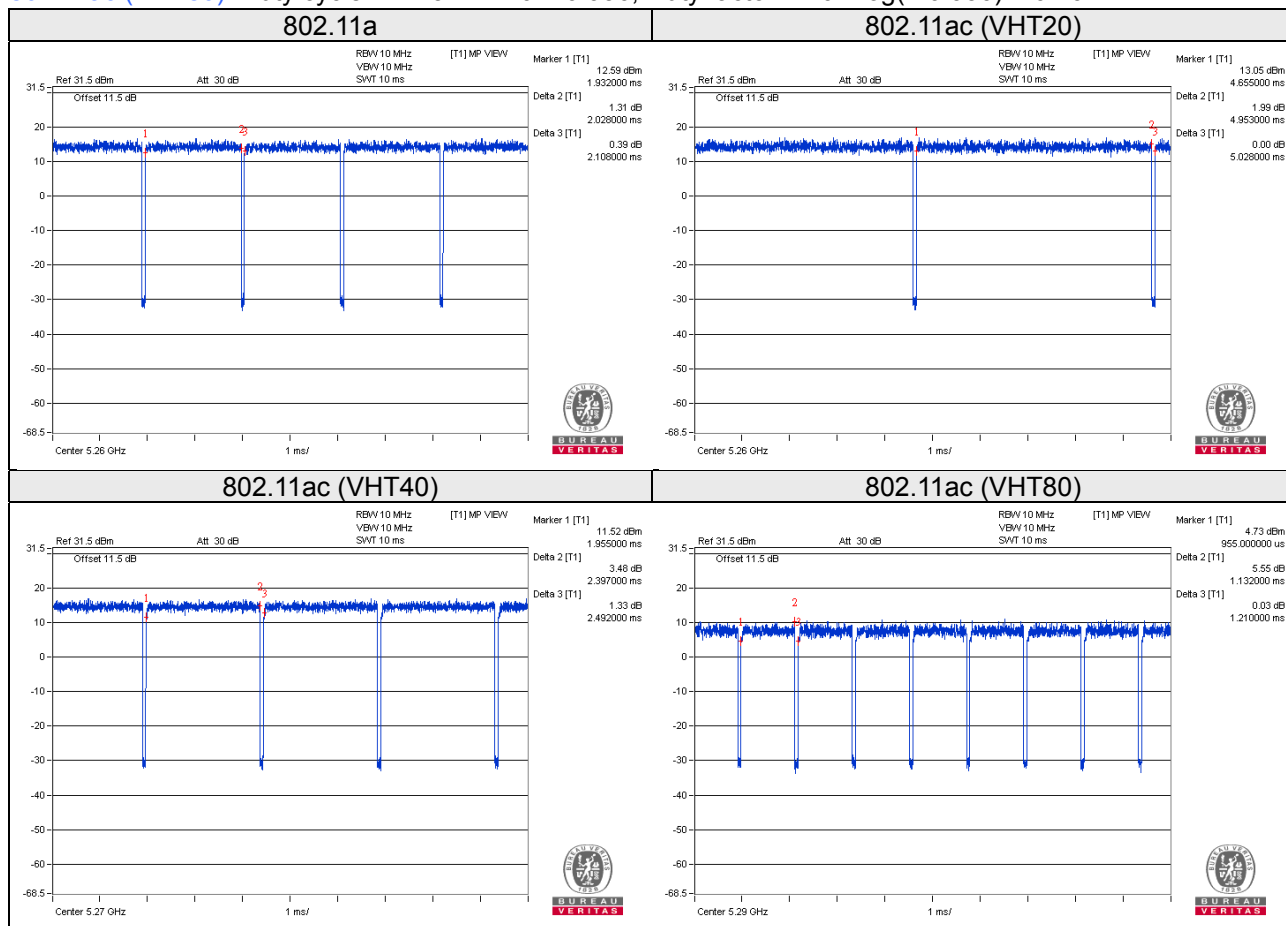

3.4 Description of Support Units

The EUT has been tested as an independent unit together with other necessary accessories or support units. The following support units or accessories were used to form a representative test configuration during the tests.

ID	Product	Brand	Model No.	Serial No.	FCC ID	Remarks
A.	Notebook	DELL	E5410	1HC2XM1	FCC DoC Approved	-
B.	Load	NA	NA	NA	NA	-
C.	Flash	HP	v250W	01	NA	-
D.	Adapter	Asian Power Devices Inc.	WA-36A12R	NA	NA	Optional
E.	POE	EnGenius	EPA5006GAT	NA	NA	Provided by manufacturer

Note:

1. All power cords of the above support units are non-shielded (1.8m).
2. Item A acted as a communication partner to transfer data.

ID	Descriptions	Qty.	Length (m)	Shielding (Yes/No)	Cores (Qty.)	Remarks
1.	RJ45	1	5	N	0	-
2.	RJ45	1	1.8	N	0	-
3.	RJ45	1	1.8	N	0	-
4.	RS232	1	1.8	N	0	-

3.4.1 Configuration of System under Test

Mode A, C

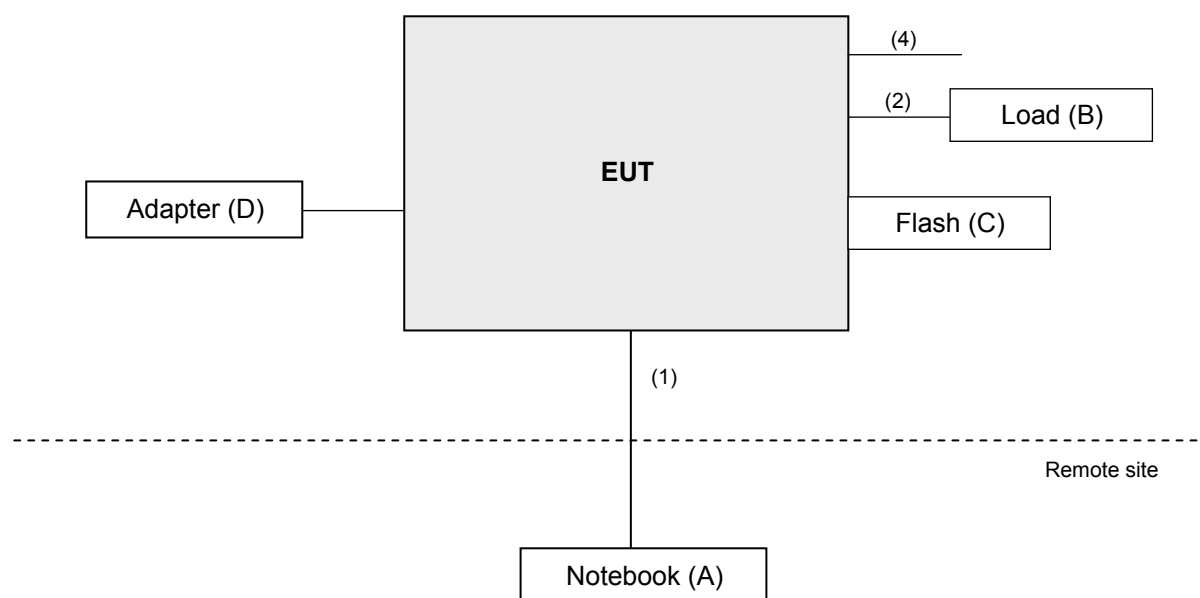

Mode B, D

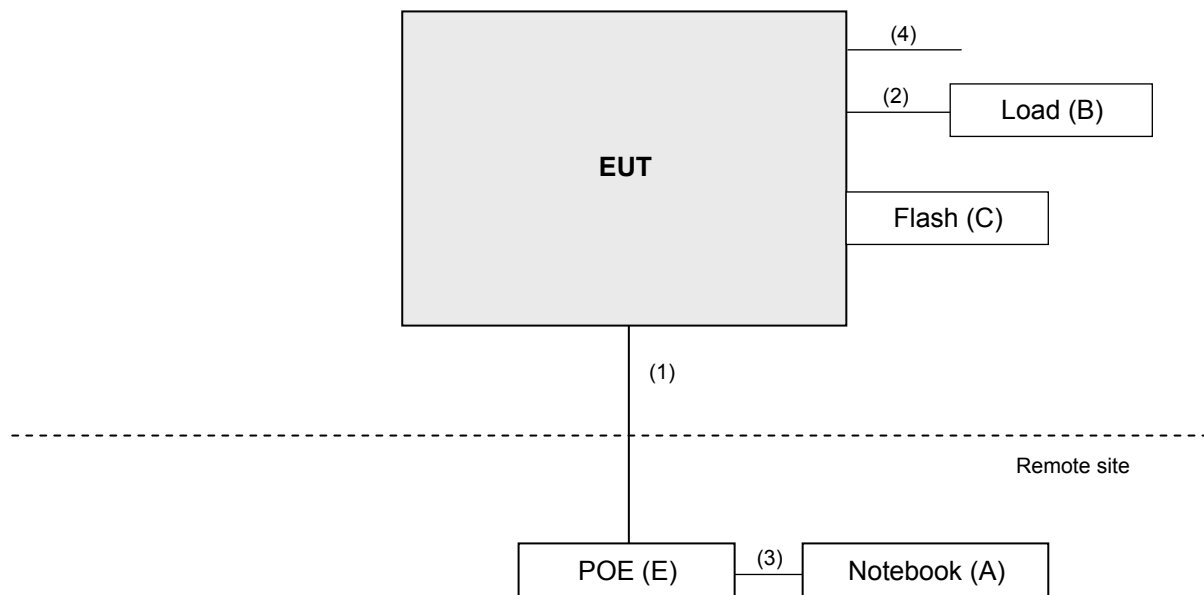

3.5 General Description of Applied Standards

The EUT is a RF Product. According to the specifications of the manufacturer, it must comply with the requirements of the following standards:

FCC Part 15, Subpart E (15.407)

KDB 789033 D02 General UNII Test Procedures New Rules v01r03

KDB 662911 D01 Multiple Transmitter Output v02r01

ANSI C63.10-2013

All test items have been performed and recorded as per the above standards.

Note: The EUT has been verified to comply with the requirements of FCC Part 15, Subpart B, Class B (DoC).
The test report has been issued separately.

4 Test Types and Results

4.1 Radiated Emission and Bandedge Measurement

4.1.1 Limits of Radiated Emission and Bandedge Measurement

Radiated emissions which fall in the restricted bands must comply with the radiated emission limits specified as below table. Other emissions shall be at least 20dB below the highest level of the desired power:

Frequencies (MHz)	Field Strength (microvolts/meter)	Measurement Distance (meters)
0.009 ~ 0.490	2400/F(kHz)	300
0.490 ~ 1.705	24000/F(kHz)	30
1.705 ~ 30.0	30	30
30 ~ 88	100	3
88 ~ 216	150	3
216 ~ 960	200	3
Above 960	500	3

NOTE:

1. The lower limit shall apply at the transition frequencies.
2. Emission level (dBuV/m) = 20 log Emission level (uV/m).
3. For frequencies above 1000MHz, the field strength limits are based on average detector, however, the peak field strength of any emission shall not exceed the maximum permitted average limits, specified above by more than 20dB under any condition of modulation.

Limits of Unwanted Emission Out of the Restricted Bands

Applicable To		Limit	
789033 D02 General UNII Test Procedure New Rules v01r03		Field Strength at 3m	
		PK:74 (dBuV/m)	AV:54 (dBuV/m)
Frequency Band	Applicable To	EIRP Limit	Equivalent Field Strength at 3m
5150~5250 MHz	15.407(b)(1)	PK:-27 (dBm/MHz)	PK:68.2(dBuV/m)
5250~5350 MHz	15.407(b)(2)		
5470~5725 MHz	15.407(b)(3)		
5725~5850 MHz	<input checked="" type="checkbox"/> 15.407(b)(4)(i)	PK:-27 (dBm/MHz) ^{*1} PK:10 (dBm/MHz) ^{*2} PK:15.6 (dBm/MHz) ^{*3} PK:27 (dBm/MHz) ^{*4}	PK: 68.2(dBuV/m) ^{*1} PK:105.2 (dBuV/m) ^{*2} PK: 110.8(dBuV/m) ^{*3} PK:122.2 (dBuV/m) ^{*4}
	<input type="checkbox"/> 15.407(b)(4)(ii)	Emission limits in section 15.247(d)	
^{*1} beyond 75 MHz or more above of the band edge.		^{*2} below the band edge increasing linearly to 10 dBm/MHz at 25 MHz above.	
^{*3} below the band edge increasing linearly to a level of 15.6 dBm/MHz at 5 MHz above.		^{*4} from 5 MHz above or below the band edge increasing linearly to a level of 27 dBm/MHz at the band edge.	

NOTE: The following formula is used to convert the equipment isotropic radiated power (eirp) to field strength:

$$E = \frac{1000000 \sqrt{30P}}{3} \mu\text{V/m, where } P \text{ is the eirp (Watts).}$$

4.1.2 Test Instruments

DESCRIPTION & MANUFACTURER	MODEL NO.	SERIAL NO.	DATE OF CALIBRATION	DUE DATE OF CALIBRATION
Test Receiver ROHDE & SCHWARZ	ESIB7	100187	Apr. 18, 2016	Apr. 17, 2017
Spectrum Analyzer ROHDE & SCHWARZ	FSP40	100040	Aug. 16, 2016	Aug. 15, 2017
BILOG Antenna SCHWARZBECK	VULB9168	9168-171	Jan. 07, 2016	Jan. 06, 2017
HORN Antenna SCHWARZBECK	9120D	209	Jan. 20, 2016	Jan. 19, 2017
HORN Antenna SCHWARZBECK	BBHA 9170	BBHA9170241	Jan. 18, 2016	Jan. 17, 2017
Loop Antenna	EM-6879	269	Aug. 11, 2016	Aug. 10, 2017
Preamplifier Agilent	8447D	2944A10738	Aug. 22, 2016	Aug. 21, 2017
Preamplifier Agilent	8449B	3008A01964	Aug. 22, 2016	Aug. 21, 2017
RF signal cable HUBER+SUHNER	SUCOFLEX 104	Cable-CH3-03 (214378)	Aug. 22, 2016	Aug. 21, 2017
RF signal cable HUBER+SUHNER	SUCOFLEX 106	Cable-CH3-03 (309224+12738)	Aug. 22, 2016	Aug. 21, 2017
Software BV ADT	ADT_Radiated_ V7.6.15.9.4	NA	NA	NA
Antenna Tower inn-co GmbH	MA 4000	013303	NA	NA
Antenna Tower Controller BV ADT	AT100	AT93021702	NA	NA
Turn Table BV ADT	TT100	TT93021702	NA	NA
Turn Table Controller BV ADT	SC100	SC93021702	NA	NA
26GHz ~ 40GHz Amplifier	EM26400	815221	Oct. 17, 2016	Oct. 16, 2017
High Speed Peak Power Meter	ML2495A	0842014	Apr. 28, 2016	Apr. 27, 2017
Power Sensor	MA2411B	0738171	Aug. 11, 2016	Aug. 10, 2017

Note: 1. The calibration interval of the above test instruments is 12 months and the calibrations are traceable to NML/ROC and NIST/USA.

2. The test was performed in HwaYa Chamber 3.

3. The horn antenna and preamplifier (model: 8449B) are used only for the measurement of emission frequency above 1GHz if tested.

4. The FCC Site Registration No. is 988962.

5. The IC Site Registration No. is IC 7450F-3.

4.1.3 Test Procedures

For Radiated emission below 30MHz

- a. The EUT was placed on the top of a rotating table 0.8 meters above the ground at a 3 meter chamber room. The table was rotated 360 degrees to determine the position of the highest radiation.
- b. The EUT was set 3 meters away from the interference-receiving antenna, which was mounted on the top of a variable-height antenna tower.
- c. Both X and Y axes of the antenna are set to make the measurement.
- d. For each suspected emission, the EUT was arranged to its worst case and the rotatable table was turned from 0 degrees to 360 degrees to find the maximum reading.
- e. The test-receiver system was set to Quasi-Peak Detect Function and Specified Bandwidth with Maximum Hold Mode.

NOTE:

1. The resolution bandwidth and video bandwidth of test receiver/spectrum analyzer is 9kHz at frequency below 30MHz.

For Radiated emission above 30MHz

- a. The EUT was placed on the top of a rotating table 0.8 meters (for 30MHz ~ 1GHz) / 1.5 meters (for above 1GHz) above the ground at 3 meter chamber room for test. The table was rotated 360 degrees to determine the position of the highest radiation.
- b. The EUT was set 3 meters away from the interference-receiving antenna, which was mounted on the top of a variable-height antenna tower.
- c. The height of antenna is varied from one meter to four meters above the ground to determine the maximum value of the field strength. Both horizontal and vertical polarizations of the antenna are set to make the measurement.
- d. For each suspected emission, the EUT was arranged to its worst case and then the antenna was tuned to heights from 1 meter to 4 meters and the rotatable table was turned from 0 degrees to 360 degrees to find the maximum reading.
- e. The test-receiver system was set to quasi-peak detect function and specified bandwidth with maximum hold mode when the test frequency is below 1 GHz.
- f. The test-receiver system was set to peak and average detect function and specified bandwidth with maximum hold mode when the test frequency is above 1 GHz. If the peak reading value also meets average limit, measurement with the average detector is unnecessary.

Note:

1. The resolution bandwidth and video bandwidth of test receiver/spectrum analyzer is 120kHz for Quasi-peak detection (QP) at frequency below 1GHz.
2. The resolution bandwidth of test receiver/spectrum analyzer is 1 MHz and the video bandwidth is 3 MHz for Peak detection (PK) at frequency above 1GHz.
3. The resolution bandwidth of test receiver/spectrum analyzer is 1MHz and the video bandwidth is $\geq 1/T$ (Duty cycle < 98%) or 10Hz (Duty cycle $\geq 98\%$) for Average detection (AV) at frequency above 1GHz.
4. All modes of operation were investigated and the worst-case emissions are reported.

4.1.4 Deviation from Test Standard

No deviation.

4.1.5 Test Setup

For Radiated emission below 30MHz

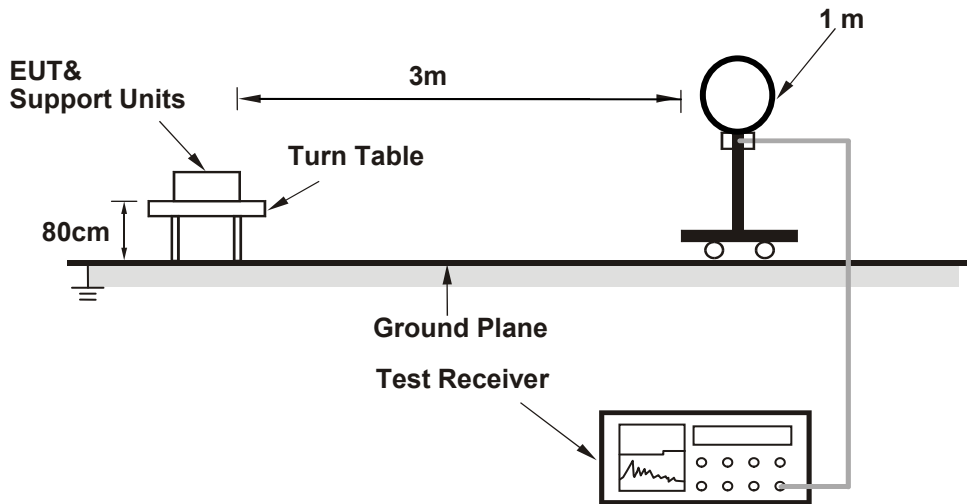

For Radiated emission 30MHz to 1GHz

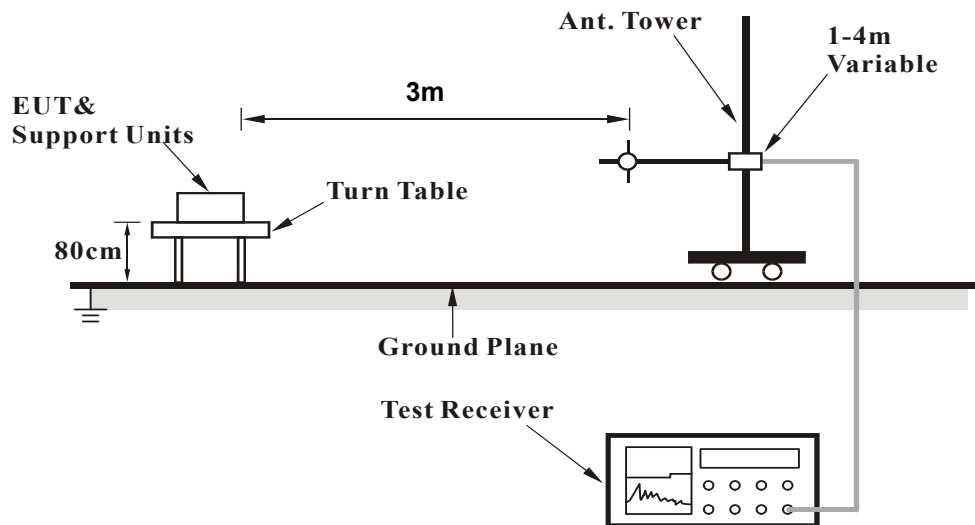

For Radiated emission above 1GHz

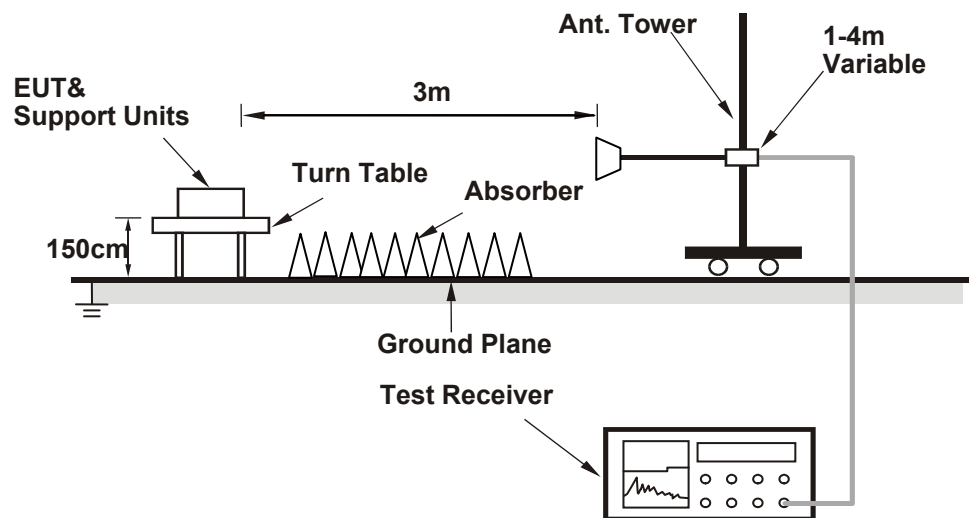

For the actual test configuration, please refer to the attached file (Test Setup Photo).

4.1.6 EUT Operating Conditions

- Placed the EUT on the testing table.
- Prepared a notebook to act as a communication partner and placed it outside of testing area.
- The communication partner connected with EUT via a RJ45 cable and ran a test program (provided by manufacturer) to enable EUT under transmission condition continuously at specific channel frequency.
- The communication partner sent data to EUT by command "PING".
- The necessary accessories enable the system in full functions.

4.1.7 Test Results

Above 1GHz data:

Mode A

802.11a

CHANNEL	TX Channel 52	DETECTOR FUNCTION	Peak (PK)
FREQUENCY RANGE	1GHz ~ 40GHz		Average (AV)

ANTENNA POLARITY & TEST DISTANCE: HORIZONTAL AT 3 M

NO.	FREQ. (MHz)	EMISSION LEVEL (dBuV/m)	LIMIT (dBuV/m)	MARGIN (dB)	ANTENNA HEIGHT (m)	TABLE ANGLE (Degree)	RAW VALUE (dBuV)	CORRECTION FACTOR (dB/m)
1	5150.00	55.6 PK	74.0	-18.4	1.71 H	283	50.8	4.8
2	5150.00	44.3 AV	54.0	-9.7	1.71 H	283	39.5	4.8
3	*5260.00	119.0 PK			1.88 H	280	80.1	38.9
4	*5260.00	108.8 AV			1.88 H	280	69.9	38.9
5	#10520.00	67.7 PK	74.0	-6.3	1.00 H	281	49.1	18.6
6	#10520.00	52.3 AV	54.0	-1.7	1.00 H	281	33.7	18.6

ANTENNA POLARITY & TEST DISTANCE: VERTICAL AT 3 M

NO.	FREQ. (MHz)	EMISSION LEVEL (dBuV/m)	LIMIT (dBuV/m)	MARGIN (dB)	ANTENNA HEIGHT (m)	TABLE ANGLE (Degree)	RAW VALUE (dBuV)	CORRECTION FACTOR (dB/m)
1	5150.00	55.1 PK	74.0	-18.9	3.44 V	83	50.3	4.8
2	5150.00	42.4 AV	54.0	-11.6	3.44 V	83	37.6	4.8
3	*5260.00	115.0 PK			3.75 V	0	76.1	38.9
4	*5260.00	104.5 AV			3.75 V	0	65.6	38.9
5	#10520.00	63.7 PK	74.0	-10.3	3.91 V	334	45.1	18.6
6	#10520.00	50.8 AV	54.0	-3.2	3.91 V	334	32.2	18.6

REMARKS:

1. Emission Level(dBuV/m) = Raw Value(dBuV) + Correction Factor(dB/m)
2. Correction Factor(dB/m) = Antenna Factor(dB/m) + Cable Factor(dB) – Pre-Amplifier Factor(dB)
3. The other emission levels were very low against the limit.
4. Margin value = Emission Level – Limit value
5. " * ": Fundamental frequency.
6. " # ": The radiated frequency is out of the restricted band.

CHANNEL	TX Channel 60	DETECTOR FUNCTION	Peak (PK)
FREQUENCY RANGE	1GHz ~ 40GHz		Average (AV)

ANTENNA POLARITY & TEST DISTANCE: HORIZONTAL AT 3 M

NO.	FREQ. (MHz)	EMISSION LEVEL (dBuV/m)	LIMIT (dBuV/m)	MARGIN (dB)	ANTENNA HEIGHT (m)	TABLE ANGLE (Degree)	RAW VALUE (dBuV)	CORRECTION FACTOR (dB/m)
1	*5300.00	118.2 PK			1.75 H	283	79.1	39.1
2	*5300.00	108.0 AV			1.75 H	283	68.9	39.1
3	10600.00	66.4 PK	74.0	-7.6	1.13 H	273	47.9	18.5
4	10600.00	53.0 AV	54.0	-1.0	1.13 H	273	34.5	18.5

ANTENNA POLARITY & TEST DISTANCE: VERTICAL AT 3 M

NO.	FREQ. (MHz)	EMISSION LEVEL (dBuV/m)	LIMIT (dBuV/m)	MARGIN (dB)	ANTENNA HEIGHT (m)	TABLE ANGLE (Degree)	RAW VALUE (dBuV)	CORRECTION FACTOR (dB/m)
1	*5300.00	114.5 PK			3.89 V	0	75.4	39.1
2	*5300.00	103.9 AV			3.89 V	0	64.8	39.1
3	10600.00	63.7 PK	74.0	-10.3	3.64 V	330	45.2	18.5
4	10600.00	50.3 AV	54.0	-3.7	3.64 V	330	31.8	18.5

REMARKS:

1. Emission Level(dBuV/m) = Raw Value(dBuV) + Correction Factor(dB/m)
2. Correction Factor(dB/m) = Antenna Factor(dB/m) + Cable Factor(dB) – Pre-Amplifier Factor(dB)
3. The other emission levels were very low against the limit.
4. Margin value = Emission Level – Limit value
5. " * ": Fundamental frequency.
6. " # ": The radiated frequency is out of the restricted band.

CHANNEL	TX Channel 64	DETECTOR FUNCTION	Peak (PK)
FREQUENCY RANGE	1GHz ~ 40GHz		Average (AV)

ANTENNA POLARITY & TEST DISTANCE: HORIZONTAL AT 3 M

NO.	FREQ. (MHz)	EMISSION LEVEL (dBuV/m)	LIMIT (dBuV/m)	MARGIN (dB)	ANTENNA HEIGHT (m)	TABLE ANGLE (Degree)	RAW VALUE (dBuV)	CORRECTION FACTOR (dB/m)
1	*5320.00	118.8 PK			1.70 H	284	79.7	39.1
2	*5320.00	108.1 AV			1.70 H	284	69.0	39.1
3	5350.00	57.6 PK	74.0	-16.4	1.68 H	284	52.1	5.5
4	5350.00	45.3 AV	54.0	-8.7	1.68 H	284	39.8	5.5
5	10640.00	66.8 PK	74.0	-7.2	1.00 H	271	48.3	18.5
6	10640.00	52.8 AV	54.0	-1.2	1.00 H	271	34.3	18.5

ANTENNA POLARITY & TEST DISTANCE: VERTICAL AT 3 M

NO.	FREQ. (MHz)	EMISSION LEVEL (dBuV/m)	LIMIT (dBuV/m)	MARGIN (dB)	ANTENNA HEIGHT (m)	TABLE ANGLE (Degree)	RAW VALUE (dBuV)	CORRECTION FACTOR (dB/m)
1	*5320.00	114.5 PK			3.65 V	3	75.4	39.1
2	*5320.00	103.4 AV			3.65 V	3	64.3	39.1
3	5350.00	57.3 PK	74.0	-16.7	3.83 V	349	51.8	5.5
4	5350.00	44.3 AV	54.0	-9.7	3.83 V	349	38.8	5.5
5	10640.00	64.6 PK	74.0	-9.4	3.71 V	332	46.1	18.5
6	10640.00	50.7 AV	54.0	-3.3	3.71 V	332	32.2	18.5

REMARKS:

1. Emission Level(dBuV/m) = Raw Value(dBuV) + Correction Factor(dB/m)
2. Correction Factor(dB/m) = Antenna Factor(dB/m) + Cable Factor(dB) – Pre-Amplifier Factor(dB)
3. The other emission levels were very low against the limit.
4. Margin value = Emission Level – Limit value
5. " * ": Fundamental frequency.

CHANNEL	TX Channel 100	DETECTOR FUNCTION	Peak (PK)
FREQUENCY RANGE	1GHz ~ 40GHz		Average (AV)

ANTENNA POLARITY & TEST DISTANCE: HORIZONTAL AT 3 M

NO.	FREQ. (MHz)	EMISSION LEVEL (dBuV/m)	LIMIT (dBuV/m)	MARGIN (dB)	ANTENNA HEIGHT (m)	TABLE ANGLE (Degree)	RAW VALUE (dBuV)	CORRECTION FACTOR (dB/m)
1	5460.00	57.1 PK	74.0	-16.9	1.78 H	279	51.4	5.7
2	5460.00	44.7 AV	54.0	-9.3	1.78 H	279	39.0	5.7
3	#5470.00	57.9 PK	74.0	-16.1	1.94 H	287	52.2	5.7
4	#5470.00	44.9 AV	54.0	-9.1	1.94 H	287	39.2	5.7
5	*5500.00	116.9 PK			1.83 H	283	77.3	39.6
6	*5500.00	106.3 AV			1.83 H	283	66.7	39.6
7	11000.00	65.9 PK	74.0	-8.1	1.00 H	279	46.2	19.7
8	11000.00	52.8 AV	54.0	-1.2	1.00 H	279	33.1	19.7

ANTENNA POLARITY & TEST DISTANCE: VERTICAL AT 3 M

NO.	FREQ. (MHz)	EMISSION LEVEL (dBuV/m)	LIMIT (dBuV/m)	MARGIN (dB)	ANTENNA HEIGHT (m)	TABLE ANGLE (Degree)	RAW VALUE (dBuV)	CORRECTION FACTOR (dB/m)
1	5460.00	55.9 PK	74.0	-18.1	3.63 V	354	50.2	5.7
2	5460.00	44.1 AV	54.0	-9.9	3.63 V	354	38.4	5.7
3	#5470.00	57.3 PK	74.0	-16.7	3.84 V	356	51.6	5.7
4	#5470.00	44.2 AV	54.0	-9.8	3.84 V	356	38.5	5.7
5	*5500.00	113.1 PK			3.85 V	348	73.5	39.6
6	*5500.00	101.8 AV			3.85 V	348	62.2	39.6
7	11000.00	60.6 PK	74.0	-13.4	3.52 V	328	40.9	19.7
8	11000.00	49.0 AV	54.0	-5.0	3.52 V	328	29.3	19.7

REMARKS:

1. Emission Level(dBuV/m) = Raw Value(dBuV) + Correction Factor(dB/m)
2. Correction Factor(dB/m) = Antenna Factor(dB/m) + Cable Factor(dB) – Pre-Amplifier Factor(dB)
3. The other emission levels were very low against the limit.
4. Margin value = Emission Level – Limit value
5. " * ": Fundamental frequency.
6. " # ": The radiated frequency is out of the restricted band.

CHANNEL	TX Channel 116	DETECTOR FUNCTION	Peak (PK)
FREQUENCY RANGE	1GHz ~ 40GHz		Average (AV)

ANTENNA POLARITY & TEST DISTANCE: HORIZONTAL AT 3 M

NO.	FREQ. (MHz)	EMISSION LEVEL (dBuV/m)	LIMIT (dBuV/m)	MARGIN (dB)	ANTENNA HEIGHT (m)	TABLE ANGLE (Degree)	RAW VALUE (dBuV)	CORRECTION FACTOR (dB/m)
1	*5580.00	116.4 PK			1.91 H	284	76.8	39.6
2	*5580.00	106.1 AV			1.91 H	284	66.5	39.6
3	11160.00	66.2 PK	74.0	-7.8	1.00 H	277	46.7	19.5
4	11160.00	52.7 AV	54.0	-1.3	1.00 H	277	33.2	19.5

ANTENNA POLARITY & TEST DISTANCE: VERTICAL AT 3 M

NO.	FREQ. (MHz)	EMISSION LEVEL (dBuV/m)	LIMIT (dBuV/m)	MARGIN (dB)	ANTENNA HEIGHT (m)	TABLE ANGLE (Degree)	RAW VALUE (dBuV)	CORRECTION FACTOR (dB/m)
1	*5580.00	112.2 PK			3.83 V	343	72.4	39.8
2	*5580.00	101.9 AV			3.83 V	343	62.1	39.8
3	11160.00	61.7 PK	74.0	-12.3	3.78 V	319	42.2	19.5
4	11160.00	49.2 AV	54.0	-4.8	3.78 V	319	29.7	19.5

REMARKS:

1. Emission Level(dBuV/m) = Raw Value(dBuV) + Correction Factor(dB/m)
2. Correction Factor(dB/m) = Antenna Factor(dB/m) + Cable Factor(dB) – Pre-Amplifier Factor(dB)
3. The other emission levels were very low against the limit.
4. Margin value = Emission Level – Limit value
5. " * ": Fundamental frequency.

CHANNEL	TX Channel 140	DETECTOR FUNCTION	Peak (PK)
FREQUENCY RANGE	1GHz ~ 40GHz		Average (AV)

ANTENNA POLARITY & TEST DISTANCE: HORIZONTAL AT 3 M

NO.	FREQ. (MHz)	EMISSION LEVEL (dBuV/m)	LIMIT (dBuV/m)	MARGIN (dB)	ANTENNA HEIGHT (m)	TABLE ANGLE (Degree)	RAW VALUE (dBuV)	CORRECTION FACTOR (dB/m)
1	*5700.00	116.7 PK			1.95 H	277	76.8	39.9
2	*5700.00	106.4 AV			1.95 H	277	66.5	39.9
3	#5725.00	58.4 PK	74.0	-15.6	2.28 H	300	52.1	6.3
4	#5725.00	45.8 AV	54.0	-8.2	2.28 H	300	39.5	6.3
5	11400.00	64.0 PK	74.0	-10.0	1.07 H	279	44.7	19.3
6	11400.00	52.7 AV	54.0	-1.3	1.07 H	279	33.4	19.3

ANTENNA POLARITY & TEST DISTANCE: VERTICAL AT 3 M

NO.	FREQ. (MHz)	EMISSION LEVEL (dBuV/m)	LIMIT (dBuV/m)	MARGIN (dB)	ANTENNA HEIGHT (m)	TABLE ANGLE (Degree)	RAW VALUE (dBuV)	CORRECTION FACTOR (dB/m)
1	*5700.00	112.2 PK			3.96 V	352	72.3	39.9
2	*5700.00	102.0 AV			3.96 V	352	62.1	39.9
3	#5725.00	57.4 PK	74.0	-16.6	3.72 V	350	51.1	6.3
4	#5725.00	44.6 AV	54.0	-9.4	3.72 V	350	38.3	6.3
5	11400.00	63.0 PK	74.0	-11.0	3.62 V	326	43.7	19.3
6	11400.00	49.7 AV	54.0	-4.3	3.62 V	326	30.4	19.3

REMARKS:

1. Emission Level(dBuV/m) = Raw Value(dBuV) + Correction Factor(dB/m)
2. Correction Factor(dB/m) = Antenna Factor(dB/m) + Cable Factor(dB) – Pre-Amplifier Factor(dB)
3. The other emission levels were very low against the limit.
4. Margin value = Emission Level – Limit value
5. " * ": Fundamental frequency.
6. " # ": The radiated frequency is out of the restricted band.

CHANNEL	TX Channel 144	DETECTOR FUNCTION	Peak (PK)
FREQUENCY RANGE	1GHz ~ 40GHz		Average (AV)

ANTENNA POLARITY & TEST DISTANCE: HORIZONTAL AT 3 M

NO.	FREQ. (MHz)	EMISSION LEVEL (dBuV/m)	LIMIT (dBuV/m)	MARGIN (dB)	ANTENNA HEIGHT (m)	TABLE ANGLE (Degree)	RAW VALUE (dBuV)	CORRECTION FACTOR (dB/m)
1	#5470.00	58.1 PK	74.0	-15.9	1.55 H	66	52.4	5.7
2	#5470.00	46.2 AV	54.0	-7.8	1.55 H	66	40.5	5.7
3	*5720.00	117.3 PK			1.68 H	56	77.3	40.0
4	*5720.00	107.1 AV			1.68 H	56	67.1	40.0
5	#5850.00	58.1 PK	74.0	-15.9	1.44 H	279	51.6	6.5
6	#5850.00	47.1 AV	54.0	-6.9	1.44 H	279	40.6	6.5
7	11440.00	65.8 PK	74.0	-8.2	1.01 H	277	46.5	19.3
8	11440.00	52.8 AV	54.0	-1.2	1.01 H	277	33.5	19.3

ANTENNA POLARITY & TEST DISTANCE: VERTICAL AT 3 M

NO.	FREQ. (MHz)	EMISSION LEVEL (dBuV/m)	LIMIT (dBuV/m)	MARGIN (dB)	ANTENNA HEIGHT (m)	TABLE ANGLE (Degree)	RAW VALUE (dBuV)	CORRECTION FACTOR (dB/m)
1	#5470.00	56.7 PK	74.0	-17.3	2.12 V	163	51.0	5.7
2	#5470.00	45.9 AV	54.0	-8.1	2.12 V	163	40.2	5.7
3	*5720.00	111.9 PK			2.48 V	3	71.9	40.0
4	*5720.00	101.5 AV			2.48 V	3	61.5	40.0
5	#5850.00	58.0 PK	74.0	-16.0	2.08 V	63	51.5	6.5
6	#5850.00	46.9 AV	54.0	-7.1	2.08 V	63	40.4	6.5
7	11440.00	61.6 PK	74.0	-12.4	1.77 V	219	42.3	19.3
8	11440.00	48.9 AV	54.0	-5.1	1.77 V	219	29.6	19.3

REMARKS:

1. Emission Level(dBuV/m) = Raw Value(dBuV) + Correction Factor(dB/m)
2. Correction Factor(dB/m) = Antenna Factor(dB/m) + Cable Factor(dB) – Pre-Amplifier Factor(dB)
3. The other emission levels were very low against the limit.
4. Margin value = Emission Level – Limit value
5. " * " : Fundamental frequency.
6. " # " : The radiated frequency is out of the restricted band.

802.11ac (VHT20)

CHANNEL	TX Channel 52	DETECTOR FUNCTION	Peak (PK)
FREQUENCY RANGE	1GHz ~ 40GHz		Average (AV)

ANTENNA POLARITY & TEST DISTANCE: HORIZONTAL AT 3 M

NO.	FREQ. (MHz)	EMISSION LEVEL (dBuV/m)	LIMIT (dBuV/m)	MARGIN (dB)	ANTENNA HEIGHT (m)	TABLE ANGLE (Degree)	RAW VALUE (dBuV)	CORRECTION FACTOR (dB/m)
1	5150.00	55.5 PK	74.0	-18.5	1.80 H	275	50.7	4.8
2	5150.00	43.7 AV	54.0	-10.3	1.80 H	275	38.9	4.8
3	*5260.00	120.9 PK			1.65 H	287	82.0	38.9
4	*5260.00	109.5 AV			1.65 H	287	70.6	38.9
5	#10520.00	66.8 PK	74.0	-7.2	1.11 H	277	48.2	18.6
6	#10520.00	52.3 AV	54.0	-1.7	1.11 H	277	33.7	18.6

ANTENNA POLARITY & TEST DISTANCE: VERTICAL AT 3 M

NO.	FREQ. (MHz)	EMISSION LEVEL (dBuV/m)	LIMIT (dBuV/m)	MARGIN (dB)	ANTENNA HEIGHT (m)	TABLE ANGLE (Degree)	RAW VALUE (dBuV)	CORRECTION FACTOR (dB/m)
1	5150.00	55.1 PK	74.0	-18.9	3.86 V	1	50.3	4.8
2	5150.00	43.3 AV	54.0	-10.7	3.86 V	1	38.5	4.8
3	*5260.00	116.7 PK			3.92 V	9	77.8	38.9
4	*5260.00	105.6 AV			3.92 V	9	66.7	38.9
5	#10520.00	64.2 PK	74.0	-9.8	3.82 V	337	45.6	18.6
6	#10520.00	50.7 AV	54.0	-3.3	3.82 V	337	32.1	18.6

REMARKS:

1. Emission Level(dBuV/m) = Raw Value(dBuV) + Correction Factor(dB/m)
2. Correction Factor(dB/m) = Antenna Factor(dB/m) + Cable Factor(dB) – Pre-Amplifier Factor(dB)
3. The other emission levels were very low against the limit.
4. Margin value = Emission Level – Limit value
5. " * ": Fundamental frequency.
6. " # ": The radiated frequency is out of the restricted band.

CHANNEL	TX Channel 60	DETECTOR FUNCTION	Peak (PK)
FREQUENCY RANGE	1GHz ~ 40GHz		Average (AV)

ANTENNA POLARITY & TEST DISTANCE: HORIZONTAL AT 3 M

NO.	FREQ. (MHz)	EMISSION LEVEL (dBuV/m)	LIMIT (dBuV/m)	MARGIN (dB)	ANTENNA HEIGHT (m)	TABLE ANGLE (Degree)	RAW VALUE (dBuV)	CORRECTION FACTOR (dB/m)
1	*5300.00	119.2 PK			1.78 H	282	80.1	39.1
2	*5300.00	107.7 AV			1.78 H	282	68.6	39.1
3	10600.00	67.0 PK	74.0	-7.0	1.16 H	276	48.5	18.5
4	10600.00	52.7 AV	54.0	-1.3	1.16 H	276	34.2	18.5

ANTENNA POLARITY & TEST DISTANCE: VERTICAL AT 3 M

NO.	FREQ. (MHz)	EMISSION LEVEL (dBuV/m)	LIMIT (dBuV/m)	MARGIN (dB)	ANTENNA HEIGHT (m)	TABLE ANGLE (Degree)	RAW VALUE (dBuV)	CORRECTION FACTOR (dB/m)
1	*5300.00	115.2 PK			3.88 V	356	76.1	39.1
2	*5300.00	103.6 AV			3.88 V	356	64.5	39.1
3	10600.00	63.7 PK	74.0	-10.3	3.63 V	332	45.2	18.5
4	10600.00	50.3 AV	54.0	-3.7	3.63 V	332	31.8	18.5

REMARKS:

1. Emission Level(dBuV/m) = Raw Value(dBuV) + Correction Factor(dB/m)
2. Correction Factor(dB/m) = Antenna Factor(dB/m) + Cable Factor(dB) – Pre-Amplifier Factor(dB)
3. The other emission levels were very low against the limit.
4. Margin value = Emission Level – Limit value
5. " * ": Fundamental frequency.

CHANNEL	TX Channel 64	DETECTOR FUNCTION	Peak (PK)
FREQUENCY RANGE	1GHz ~ 40GHz		Average (AV)

ANTENNA POLARITY & TEST DISTANCE: HORIZONTAL AT 3 M

NO.	FREQ. (MHz)	EMISSION LEVEL (dBuV/m)	LIMIT (dBuV/m)	MARGIN (dB)	ANTENNA HEIGHT (m)	TABLE ANGLE (Degree)	RAW VALUE (dBuV)	CORRECTION FACTOR (dB/m)
1	*5320.00	119.1 PK			1.68 H	284	80.0	39.1
2	*5320.00	107.9 AV			1.68 H	284	68.8	39.1
3	5350.00	58.8 PK	74.0	-15.2	1.71 H	281	53.3	5.5
4	5350.00	46.0 AV	54.0	-8.0	1.71 H	281	40.5	5.5
5	10640.00	67.4 PK	74.0	-6.6	1.00 H	279	48.9	18.5
6	10640.00	52.8 AV	54.0	-1.2	1.00 H	279	34.3	18.5

ANTENNA POLARITY & TEST DISTANCE: VERTICAL AT 3 M

NO.	FREQ. (MHz)	EMISSION LEVEL (dBuV/m)	LIMIT (dBuV/m)	MARGIN (dB)	ANTENNA HEIGHT (m)	TABLE ANGLE (Degree)	RAW VALUE (dBuV)	CORRECTION FACTOR (dB/m)
1	*5320.00	114.5 PK			3.64 V	4	75.4	39.1
2	*5320.00	103.5 AV			3.64 V	4	64.4	39.1
3	5350.00	56.7 PK	74.0	-17.3	3.45 V	2	51.2	5.5
4	5350.00	45.0 AV	54.0	-9.0	3.45 V	2	39.5	5.5
5	10640.00	63.7 PK	74.0	-10.3	3.81 V	333	45.2	18.5
6	10640.00	50.9 AV	54.0	-3.1	3.81 V	333	32.4	18.5

REMARKS:

1. Emission Level(dBuV/m) = Raw Value(dBuV) + Correction Factor(dB/m)
2. Correction Factor(dB/m) = Antenna Factor(dB/m) + Cable Factor(dB) – Pre-Amplifier Factor(dB)
3. The other emission levels were very low against the limit.
4. Margin value = Emission Level – Limit value
5. " * ": Fundamental frequency.



CHANNEL	TX Channel 100	DETECTOR FUNCTION	Peak (PK)
FREQUENCY RANGE	1GHz ~ 40GHz		Average (AV)

ANTENNA POLARITY & TEST DISTANCE: HORIZONTAL AT 3 M

NO.	FREQ. (MHz)	EMISSION LEVEL (dBuV/m)	LIMIT (dBuV/m)	MARGIN (dB)	ANTENNA HEIGHT (m)	TABLE ANGLE (Degree)	RAW VALUE (dBuV)	CORRECTION FACTOR (dB/m)
1	5460.00	57.4 PK	74.0	-16.6	1.80 H	288	51.7	5.7
2	5460.00	45.5 AV	54.0	-8.5	1.80 H	288	39.8	5.7
3	#5470.00	58.8 PK	74.0	-15.2	1.69 H	302	53.1	5.7
4	#5470.00	46.1 AV	54.0	-7.9	1.69 H	302	40.4	5.7
5	*5500.00	118.4 PK			1.89 H	286	78.8	39.6
6	*5500.00	107.0 AV			1.89 H	286	67.4	39.6
7	11000.00	67.5 PK	74.0	-6.5	1.00 H	279	47.8	19.7
8	11000.00	52.4 AV	54.0	-1.6	1.00 H	279	32.7	19.7

ANTENNA POLARITY & TEST DISTANCE: VERTICAL AT 3 M

NO.	FREQ. (MHz)	EMISSION LEVEL (dBuV/m)	LIMIT (dBuV/m)	MARGIN (dB)	ANTENNA HEIGHT (m)	TABLE ANGLE (Degree)	RAW VALUE (dBuV)	CORRECTION FACTOR (dB/m)
1	5460.00	56.6 PK	74.0	-17.4	3.74 V	343	50.9	5.7
2	5460.00	44.6 AV	54.0	-9.4	3.74 V	343	38.9	5.7
3	#5470.00	58.6 PK	74.0	-15.4	4.00 V	354	52.9	5.7
4	#5470.00	45.6 AV	54.0	-8.4	4.00 V	354	39.9	5.7
5	*5500.00	111.8 PK			3.78 V	7	72.2	39.6
6	*5500.00	101.2 AV			3.78 V	7	61.6	39.6
7	11000.00	62.5 PK	74.0	-11.5	3.90 V	335	42.8	19.7
8	11000.00	48.9 AV	54.0	-5.1	3.90 V	335	29.2	19.7

REMARKS:

1. Emission Level(dBuV/m) = Raw Value(dBuV) + Correction Factor(dB/m)
2. Correction Factor(dB/m) = Antenna Factor(dB/m) + Cable Factor(dB) – Pre-Amplifier Factor(dB)
3. The other emission levels were very low against the limit.
4. Margin value = Emission Level – Limit value
5. " * " : Fundamental frequency.
6. " # " : The radiated frequency is out of the restricted band.

CHANNEL	TX Channel 116	DETECTOR FUNCTION	Peak (PK)
FREQUENCY RANGE	1GHz ~ 40GHz		Average (AV)

ANTENNA POLARITY & TEST DISTANCE: HORIZONTAL AT 3 M

NO.	FREQ. (MHz)	EMISSION LEVEL (dBuV/m)	LIMIT (dBuV/m)	MARGIN (dB)	ANTENNA HEIGHT (m)	TABLE ANGLE (Degree)	RAW VALUE (dBuV)	CORRECTION FACTOR (dB/m)
1	*5580.00	118.6 PK			1.89 H	282	78.8	39.8
2	*5580.00	107.1 AV			1.89 H	282	67.3	39.8
3	11160.00	67.3 PK	74.0	-6.7	1.00 H	279	47.8	19.5
4	11160.00	52.8 AV	54.0	-1.2	1.00 H	279	33.3	19.5

ANTENNA POLARITY & TEST DISTANCE: VERTICAL AT 3 M

NO.	FREQ. (MHz)	EMISSION LEVEL (dBuV/m)	LIMIT (dBuV/m)	MARGIN (dB)	ANTENNA HEIGHT (m)	TABLE ANGLE (Degree)	RAW VALUE (dBuV)	CORRECTION FACTOR (dB/m)
1	*5580.00	112.5 PK			3.77 V	352	72.7	39.8
2	*5580.00	102.2 AV			3.77 V	352	62.4	39.8
3	11160.00	62.5 PK	74.0	-11.5	3.95 V	319	43.0	19.5
4	11160.00	49.3 AV	54.0	-4.7	3.95 V	319	29.8	19.5

REMARKS:

1. Emission Level(dBuV/m) = Raw Value(dBuV) + Correction Factor(dB/m)
2. Correction Factor(dB/m) = Antenna Factor(dB/m) + Cable Factor(dB) – Pre-Amplifier Factor(dB)
3. The other emission levels were very low against the limit.
4. Margin value = Emission Level – Limit value
5. " * ": Fundamental frequency.



CHANNEL	TX Channel 140	DETECTOR FUNCTION	Peak (PK)
FREQUENCY RANGE	1GHz ~ 40GHz		Average (AV)

ANTENNA POLARITY & TEST DISTANCE: HORIZONTAL AT 3 M

NO.	FREQ. (MHz)	EMISSION LEVEL (dBuV/m)	LIMIT (dBuV/m)	MARGIN (dB)	ANTENNA HEIGHT (m)	TABLE ANGLE (Degree)	RAW VALUE (dBuV)	CORRECTION FACTOR (dB/m)
1	*5700.00	116.4 PK			1.91 H	280	76.5	39.9
2	*5700.00	106.1 AV			1.91 H	280	66.2	39.9
3	#5725.00	63.7 PK	74.0	-10.3	1.91 H	302	57.4	6.3
4	#5725.00	49.9 AV	54.0	-4.1	1.91 H	302	43.6	6.3
5	11400.00	66.8 PK	74.0	-7.2	1.03 H	279	47.5	19.3
6	11400.00	52.9 AV	54.0	-1.1	1.03 H	279	33.6	19.3

ANTENNA POLARITY & TEST DISTANCE: VERTICAL AT 3 M

NO.	FREQ. (MHz)	EMISSION LEVEL (dBuV/m)	LIMIT (dBuV/m)	MARGIN (dB)	ANTENNA HEIGHT (m)	TABLE ANGLE (Degree)	RAW VALUE (dBuV)	CORRECTION FACTOR (dB/m)
1	*5700.00	112.6 PK			3.91 V	354	72.7	39.9
2	*5700.00	101.3 AV			3.91 V	354	61.4	39.9
3	#5725.00	59.0 PK	74.0	-15.0	3.91 V	13	52.7	6.3
4	#5725.00	46.4 AV	54.0	-7.6	3.91 V	13	40.1	6.3
5	11400.00	62.3 PK	74.0	-11.7	3.66 V	328	43.0	19.3
6	11400.00	49.4 AV	54.0	-4.6	3.66 V	328	30.1	19.3

REMARKS:

1. Emission Level(dBuV/m) = Raw Value(dBuV) + Correction Factor(dB/m)
2. Correction Factor(dB/m) = Antenna Factor(dB/m) + Cable Factor(dB) – Pre-Amplifier Factor(dB)
3. The other emission levels were very low against the limit.
4. Margin value = Emission Level – Limit value
5. " * ": Fundamental frequency.
6. " # ": The radiated frequency is out of the restricted band.

CHANNEL	TX Channel 144	DETECTOR FUNCTION	Peak (PK)
FREQUENCY RANGE	1GHz ~ 40GHz		Average (AV)

ANTENNA POLARITY & TEST DISTANCE: HORIZONTAL AT 3 M

NO.	FREQ. (MHz)	EMISSION LEVEL (dBuV/m)	LIMIT (dBuV/m)	MARGIN (dB)	ANTENNA HEIGHT (m)	TABLE ANGLE (Degree)	RAW VALUE (dBuV)	CORRECTION FACTOR (dB/m)
1	#5470.00	57.8 PK	74.0	-16.2	1.90 H	89	52.1	5.7
2	#5470.00	45.3 AV	54.0	-8.7	1.90 H	89	39.6	5.7
3	*5720.00	118.2 PK			2.07 H	289	78.2	40.0
4	*5720.00	106.9 AV			2.07 H	289	66.9	40.0
5	#5850.00	58.6 PK	74.0	-15.4	2.00 H	299	52.1	6.5
6	#5850.00	47.2 AV	54.0	-6.8	2.00 H	299	40.7	6.5
7	11440.00	67.6 PK	74.0	-6.4	1.00 H	280	48.3	19.3
8	11440.00	52.6 AV	54.0	-1.4	1.00 H	280	33.3	19.3

ANTENNA POLARITY & TEST DISTANCE: VERTICAL AT 3 M

NO.	FREQ. (MHz)	EMISSION LEVEL (dBuV/m)	LIMIT (dBuV/m)	MARGIN (dB)	ANTENNA HEIGHT (m)	TABLE ANGLE (Degree)	RAW VALUE (dBuV)	CORRECTION FACTOR (dB/m)
1	#5470.00	57.4 PK	74.0	-16.6	2.10 V	206	51.7	5.7
2	#5470.00	46.4 AV	54.0	-7.6	2.10 V	206	40.7	5.7
3	*5720.00	112.3 PK			2.15 V	3	72.3	40.0
4	*5720.00	101.6 AV			2.15 V	3	61.6	40.0
5	#5850.00	57.1 PK	74.0	-16.9	1.89 V	88	50.6	6.5
6	#5850.00	46.3 AV	54.0	-7.7	1.89 V	88	39.8	6.5
7	11440.00	61.4 PK	74.0	-12.6	1.79 V	201	42.1	19.3
8	11440.00	48.4 AV	54.0	-5.6	1.79 V	201	29.1	19.3

REMARKS:

1. Emission Level(dBuV/m) = Raw Value(dBuV) + Correction Factor(dB/m)
2. Correction Factor(dB/m) = Antenna Factor(dB/m) + Cable Factor(dB) – Pre-Amplifier Factor(dB)
3. The other emission levels were very low against the limit.
4. Margin value = Emission Level – Limit value
5. " * ": Fundamental frequency.
6. " # ": The radiated frequency is out of the restricted band.

802.11ac (VHT40)

CHANNEL	TX Channel 54	DETECTOR FUNCTION	Peak (PK)
FREQUENCY RANGE	1GHz ~ 40GHz		Average (AV)

ANTENNA POLARITY & TEST DISTANCE: HORIZONTAL AT 3 M

NO.	FREQ. (MHz)	EMISSION LEVEL (dBuV/m)	LIMIT (dBuV/m)	MARGIN (dB)	ANTENNA HEIGHT (m)	TABLE ANGLE (Degree)	RAW VALUE (dBuV)	CORRECTION FACTOR (dB/m)
1	*5270.00	117.2 PK			1.75 H	283	78.2	39.0
2	*5270.00	107.1 AV			1.75 H	283	68.1	39.0
3	5350.00	58.3 PK	74.0	-15.7	1.71 H	285	52.8	5.5
4	5350.00	46.4 AV	54.0	-7.6	1.71 H	285	40.9	5.5
5	#10540.00	63.2 PK	74.0	-10.8	1.00 H	282	44.6	18.6
6	#10540.00	51.1 AV	54.0	-2.9	1.00 H	282	32.5	18.6

ANTENNA POLARITY & TEST DISTANCE: VERTICAL AT 3 M

NO.	FREQ. (MHz)	EMISSION LEVEL (dBuV/m)	LIMIT (dBuV/m)	MARGIN (dB)	ANTENNA HEIGHT (m)	TABLE ANGLE (Degree)	RAW VALUE (dBuV)	CORRECTION FACTOR (dB/m)
1	*5270.00	110.9 PK			2.23 V	2	71.9	39.0
2	*5270.00	100.5 AV			2.23 V	2	61.5	39.0
3	5350.00	56.6 PK	74.0	-17.4	2.36 V	0	51.1	5.5
4	5350.00	43.9 AV	54.0	-10.1	2.36 V	0	38.4	5.5
5	#10540.00	62.2 PK	74.0	-11.8	3.78 V	334	43.6	18.6
6	#10540.00	49.7 AV	54.0	-4.3	3.78 V	334	31.1	18.6

REMARKS:

1. Emission Level(dBuV/m) = Raw Value(dBuV) + Correction Factor(dB/m)
2. Correction Factor(dB/m) = Antenna Factor(dB/m) + Cable Factor(dB) – Pre-Amplifier Factor(dB)
3. The other emission levels were very low against the limit.
4. Margin value = Emission Level – Limit value
5. " * ": Fundamental frequency.
6. " # ": The radiated frequency is out of the restricted band.

CHANNEL	TX Channel 62	DETECTOR FUNCTION	Peak (PK)
FREQUENCY RANGE	1GHz ~ 40GHz		Average (AV)

ANTENNA POLARITY & TEST DISTANCE: HORIZONTAL AT 3 M

NO.	FREQ. (MHz)	EMISSION LEVEL (dBuV/m)	LIMIT (dBuV/m)	MARGIN (dB)	ANTENNA HEIGHT (m)	TABLE ANGLE (Degree)	RAW VALUE (dBuV)	CORRECTION FACTOR (dB/m)
1	*5310.00	112.2 PK			1.72 H	281	73.1	39.1
2	*5310.00	102.2 AV			1.72 H	281	63.1	39.1
3	5350.00	64.6 PK	74.0	-9.4	1.61 H	279	59.1	5.5
4	5350.00	52.2 AV	54.0	-1.8	1.61 H	279	46.7	5.5
5	10620.00	60.9 PK	74.0	-13.1	1.00 H	274	42.4	18.5
6	10620.00	48.1 AV	54.0	-5.9	1.00 H	274	29.6	18.5

ANTENNA POLARITY & TEST DISTANCE: VERTICAL AT 3 M

NO.	FREQ. (MHz)	EMISSION LEVEL (dBuV/m)	LIMIT (dBuV/m)	MARGIN (dB)	ANTENNA HEIGHT (m)	TABLE ANGLE (Degree)	RAW VALUE (dBuV)	CORRECTION FACTOR (dB/m)
1	*5310.00	107.5 PK			3.85 V	0	68.4	39.1
2	*5310.00	97.5 AV			3.85 V	0	58.4	39.1
3	5350.00	60.6 PK	74.0	-13.4	4.00 V	0	55.1	5.5
4	5350.00	47.4 AV	54.0	-6.6	4.00 V	0	41.9	5.5
5	10620.00	59.9 PK	74.0	-14.1	3.71 V	334	41.4	18.5
6	10620.00	47.0 AV	54.0	-7.0	3.71 V	334	28.5	18.5

REMARKS:

1. Emission Level(dBuV/m) = Raw Value(dBuV) + Correction Factor(dB/m)
2. Correction Factor(dB/m) = Antenna Factor(dB/m) + Cable Factor(dB) – Pre-Amplifier Factor(dB)
3. The other emission levels were very low against the limit.
4. Margin value = Emission Level – Limit value
5. " * ": Fundamental frequency.

CHANNEL	TX Channel 102	DETECTOR FUNCTION	Peak (PK)
FREQUENCY RANGE	1GHz ~ 40GHz		Average (AV)

ANTENNA POLARITY & TEST DISTANCE: HORIZONTAL AT 3 M

NO.	FREQ. (MHz)	EMISSION LEVEL (dBuV/m)	LIMIT (dBuV/m)	MARGIN (dB)	ANTENNA HEIGHT (m)	TABLE ANGLE (Degree)	RAW VALUE (dBuV)	CORRECTION FACTOR (dB/m)
1	5460.00	60.2 PK	74.0	-13.8	1.02 H	301	54.5	5.7
2	5460.00	47.7 AV	54.0	-6.3	1.02 H	301	42.0	5.7
3	#5470.00	66.1 PK	74.0	-7.9	1.61 H	280	60.4	5.7
4	#5470.00	52.6 AV	54.0	-1.4	1.61 H	280	46.9	5.7
5	*5510.00	112.7 PK			1.81 H	287	73.1	39.6
6	*5510.00	102.9 AV			1.81 H	287	63.3	39.6
7	11020.00	62.1 PK	74.0	-11.9	1.05 H	278	42.5	19.6
8	11020.00	49.2 AV	54.0	-4.8	1.05 H	278	29.6	19.6

ANTENNA POLARITY & TEST DISTANCE: VERTICAL AT 3 M

NO.	FREQ. (MHz)	EMISSION LEVEL (dBuV/m)	LIMIT (dBuV/m)	MARGIN (dB)	ANTENNA HEIGHT (m)	TABLE ANGLE (Degree)	RAW VALUE (dBuV)	CORRECTION FACTOR (dB/m)
1	5460.00	56.9 PK	74.0	-17.1	3.01 V	307	51.2	5.7
2	5460.00	43.7 AV	54.0	-10.3	3.01 V	307	38.0	5.7
3	#5470.00	59.1 PK	74.0	-14.9	3.06 V	309	53.4	5.7
4	#5470.00	46.0 AV	54.0	-8.0	3.06 V	309	40.3	5.7
5	*5510.00	106.5 PK			3.13 V	308	66.9	39.6
6	*5510.00	96.4 AV			3.13 V	308	56.8	39.6
7	11020.00	59.2 PK	74.0	-14.8	2.87 V	210	39.6	19.6
8	11020.00	46.0 AV	54.0	-8.0	2.87 V	210	26.4	19.6

REMARKS:

1. Emission Level(dBuV/m) = Raw Value(dBuV) + Correction Factor(dB/m)
2. Correction Factor(dB/m) = Antenna Factor(dB/m) + Cable Factor(dB) – Pre-Amplifier Factor(dB)
3. The other emission levels were very low against the limit.
4. Margin value = Emission Level – Limit value
5. " * ": Fundamental frequency.
6. " # ": The radiated frequency is out of the restricted band.

CHANNEL	TX Channel 110	DETECTOR FUNCTION	Peak (PK)
FREQUENCY RANGE	1GHz ~ 40GHz		Average (AV)

ANTENNA POLARITY & TEST DISTANCE: HORIZONTAL AT 3 M

NO.	FREQ. (MHz)	EMISSION LEVEL (dBuV/m)	LIMIT (dBuV/m)	MARGIN (dB)	ANTENNA HEIGHT (m)	TABLE ANGLE (Degree)	RAW VALUE (dBuV)	CORRECTION FACTOR (dB/m)
1	#5470.00	62.4 PK	74.0	-11.6	1.60 H	280	56.7	5.7
2	#5470.00	49.3 AV	54.0	-4.7	1.60 H	280	43.6	5.7
3	*5550.00	116.2 PK			1.82 H	285	76.6	39.6
4	*5550.00	106.4 AV			1.82 H	285	66.8	39.6
5	11100.00	66.8 PK	74.0	-7.2	1.00 H	278	47.6	19.2
6	11100.00	52.8 AV	54.0	-1.2	1.00 H	278	33.6	19.2

ANTENNA POLARITY & TEST DISTANCE: VERTICAL AT 3 M

NO.	FREQ. (MHz)	EMISSION LEVEL (dBuV/m)	LIMIT (dBuV/m)	MARGIN (dB)	ANTENNA HEIGHT (m)	TABLE ANGLE (Degree)	RAW VALUE (dBuV)	CORRECTION FACTOR (dB/m)
1	#5470.00	57.0 PK	74.0	-17.0	2.98 V	357	51.3	5.7
2	#5470.00	44.4 AV	54.0	-9.6	2.98 V	357	38.7	5.7
3	*5550.00	109.5 PK			2.98 V	12	69.9	39.6
4	*5550.00	99.7 AV			2.98 V	12	60.1	39.6
5	11100.00	59.4 PK	74.0	-14.6	2.61 V	347	40.2	19.2
6	11100.00	46.7 AV	54.0	-7.3	2.61 V	347	27.5	19.2

REMARKS:

1. Emission Level(dBuV/m) = Raw Value(dBuV) + Correction Factor(dB/m)
2. Correction Factor(dB/m) = Antenna Factor(dB/m) + Cable Factor(dB) – Pre-Amplifier Factor(dB)
3. The other emission levels were very low against the limit.
4. Margin value = Emission Level – Limit value
5. " * ": Fundamental frequency.

CHANNEL	TX Channel 134	DETECTOR FUNCTION	Peak (PK)
FREQUENCY RANGE	1GHz ~ 40GHz		Average (AV)

ANTENNA POLARITY & TEST DISTANCE: HORIZONTAL AT 3 M

NO.	FREQ. (MHz)	EMISSION LEVEL (dBuV/m)	LIMIT (dBuV/m)	MARGIN (dB)	ANTENNA HEIGHT (m)	TABLE ANGLE (Degree)	RAW VALUE (dBuV)	CORRECTION FACTOR (dB/m)
1	*5670.00	114.4 PK			2.12 H	291	74.6	39.8
2	*5670.00	104.4 AV			2.12 H	291	64.6	39.8
3	#5725.00	62.4 PK	74.0	-11.6	1.87 H	285	56.1	6.3
4	#5725.00	48.0 AV	54.0	-6.0	1.87 H	285	41.7	6.3
5	11340.00	65.2 PK	74.0	-8.8	1.00 H	282	45.7	19.5
6	11340.00	52.8 AV	54.0	-1.2	1.00 H	282	33.3	19.5

ANTENNA POLARITY & TEST DISTANCE: VERTICAL AT 3 M

NO.	FREQ. (MHz)	EMISSION LEVEL (dBuV/m)	LIMIT (dBuV/m)	MARGIN (dB)	ANTENNA HEIGHT (m)	TABLE ANGLE (Degree)	RAW VALUE (dBuV)	CORRECTION FACTOR (dB/m)
1	*5670.00	110.9 PK			3.50 V	346	71.1	39.8
2	*5670.00	101.3 AV			3.50 V	346	61.5	39.8
3	#5725.00	58.9 PK	74.0	-15.1	3.49 V	357	52.6	6.3
4	#5725.00	45.0 AV	54.0	-9.0	3.49 V	357	38.7	6.3
5	11340.00	60.0 PK	74.0	-14.0	3.02 V	283	40.5	19.5
6	11340.00	47.4 AV	54.0	-6.6	3.02 V	283	27.9	19.5

REMARKS:

1. Emission Level(dBuV/m) = Raw Value(dBuV) + Correction Factor(dB/m)
2. Correction Factor(dB/m) = Antenna Factor(dB/m) + Cable Factor(dB) – Pre-Amplifier Factor(dB)
3. The other emission levels were very low against the limit.
4. Margin value = Emission Level – Limit value
5. " * ": Fundamental frequency.
6. " # ": The radiated frequency is out of the restricted band.

CHANNEL	TX Channel 142	DETECTOR FUNCTION	Peak (PK)
FREQUENCY RANGE	1GHz ~ 40GHz		Average (AV)

ANTENNA POLARITY & TEST DISTANCE: HORIZONTAL AT 3 M

NO.	FREQ. (MHz)	EMISSION LEVEL (dBuV/m)	LIMIT (dBuV/m)	MARGIN (dB)	ANTENNA HEIGHT (m)	TABLE ANGLE (Degree)	RAW VALUE (dBuV)	CORRECTION FACTOR (dB/m)
1	#5470.00	58.4 PK	74.0	-15.6	2.09 H	75	52.7	5.7
2	#5470.00	46.9 AV	54.0	-7.1	2.09 H	75	41.2	5.7
3	*5710.00	115.1 PK			2.60 H	281	75.1	40.0
4	*5710.00	105.8 AV			2.60 H	281	65.8	40.0
5	#5850.00	58.2 PK	74.0	-15.8	2.18 H	159	51.7	6.5
6	#5850.00	47.2 AV	54.0	-6.8	2.18 H	159	40.7	6.5
7	11420.00	64.5 PK	74.0	-9.5	1.01 H	277	45.2	19.3
8	11420.00	52.4 AV	54.0	-1.6	1.01 H	277	33.1	19.3

ANTENNA POLARITY & TEST DISTANCE: VERTICAL AT 3 M

NO.	FREQ. (MHz)	EMISSION LEVEL (dBuV/m)	LIMIT (dBuV/m)	MARGIN (dB)	ANTENNA HEIGHT (m)	TABLE ANGLE (Degree)	RAW VALUE (dBuV)	CORRECTION FACTOR (dB/m)
1	#5470.00	57.9 PK	74.0	-16.1	1.90 V	180	52.2	5.7
2	#5470.00	47.3 AV	54.0	-6.7	1.90 V	180	41.6	5.7
3	*5710.00	109.3 PK			2.02 V	3	69.3	40.0
4	*5710.00	99.8 AV			2.02 V	3	59.8	40.0
5	#5850.00	57.4 PK	74.0	-16.6	1.70 V	301	50.9	6.5
6	#5850.00	46.8 AV	54.0	-7.2	1.70 V	301	40.3	6.5
7	11420.00	61.8 PK	74.0	-12.2	2.10 V	300	42.5	19.3
8	11420.00	48.5 AV	54.0	-5.5	2.10 V	300	29.2	19.3

REMARKS:

1. Emission Level(dBuV/m) = Raw Value(dBuV) + Correction Factor(dB/m)
2. Correction Factor(dB/m) = Antenna Factor(dB/m) + Cable Factor(dB) – Pre-Amplifier Factor(dB)
3. The other emission levels were very low against the limit.
4. Margin value = Emission Level – Limit value
5. " * ": Fundamental frequency.
6. " # ": The radiated frequency is out of the restricted band.

802.11ac (VHT80)

CHANNEL	TX Channel 58	DETECTOR FUNCTION	Peak (PK)
FREQUENCY RANGE	1GHz ~ 40GHz		Average (AV)

ANTENNA POLARITY & TEST DISTANCE: HORIZONTAL AT 3 M

NO.	FREQ. (MHz)	EMISSION LEVEL (dBuV/m)	LIMIT (dBuV/m)	MARGIN (dB)	ANTENNA HEIGHT (m)	TABLE ANGLE (Degree)	RAW VALUE (dBuV)	CORRECTION FACTOR (dB/m)
1	5150.00	55.3 PK	74.0	-18.7	1.62 H	283	50.5	4.8
2	5150.00	43.5 AV	54.0	-10.5	1.62 H	283	38.7	4.8
3	*5290.00	107.5 PK			1.86 H	278	68.4	39.1
4	*5290.00	97.0 AV			1.86 H	278	57.9	39.1
5	5350.00	66.6 PK	74.0	-7.4	1.76 H	290	61.1	5.5
6	5350.00	52.3 AV	54.0	-1.7	1.76 H	290	46.8	5.5
7	#10580.00	59.2 PK	74.0	-14.8	1.10 H	266	40.6	18.6
8	#10580.00	46.9 AV	54.0	-7.1	1.10 H	266	28.3	18.6

ANTENNA POLARITY & TEST DISTANCE: VERTICAL AT 3 M

NO.	FREQ. (MHz)	EMISSION LEVEL (dBuV/m)	LIMIT (dBuV/m)	MARGIN (dB)	ANTENNA HEIGHT (m)	TABLE ANGLE (Degree)	RAW VALUE (dBuV)	CORRECTION FACTOR (dB/m)
1	5150.00	54.4 PK	74.0	-19.6	3.77 V	345	49.6	4.8
2	5150.00	41.7 AV	54.0	-12.3	3.77 V	345	36.9	4.8
3	*5290.00	103.6 PK			3.92 V	339	64.5	39.1
4	*5290.00	93.6 AV			3.92 V	339	54.5	39.1
5	5350.00	62.1 PK	74.0	-11.9	4.00 V	326	56.6	5.5
6	5350.00	49.0 AV	54.0	-5.0	4.00 V	326	43.5	5.5
7	#10580.00	59.1 PK	74.0	-14.9	3.96 V	335	40.5	18.6
8	#10580.00	46.7 AV	54.0	-7.3	3.96 V	335	28.1	18.6

REMARKS:

1. Emission Level(dBuV/m) = Raw Value(dBuV) + Correction Factor(dB/m)
2. Correction Factor(dB/m) = Antenna Factor(dB/m) + Cable Factor(dB) – Pre-Amplifier Factor(dB)
3. The other emission levels were very low against the limit.
4. Margin value = Emission Level – Limit value
5. " * ": Fundamental frequency.
6. " # ": The radiated frequency is out of the restricted band.

CHANNEL	TX Channel 106	DETECTOR FUNCTION	Peak (PK)
FREQUENCY RANGE	1GHz ~ 40GHz		Average (AV)

ANTENNA POLARITY & TEST DISTANCE: HORIZONTAL AT 3 M

NO.	FREQ. (MHz)	EMISSION LEVEL (dBuV/m)	LIMIT (dBuV/m)	MARGIN (dB)	ANTENNA HEIGHT (m)	TABLE ANGLE (Degree)	RAW VALUE (dBuV)	CORRECTION FACTOR (dB/m)
1	5460.00	64.9 PK	74.0	-9.1	1.00 H	296	59.2	5.7
2	5460.00	52.5 AV	54.0	-1.5	1.00 H	296	46.8	5.7
3	#5470.00	65.9 PK	74.0	-8.1	1.00 H	299	60.2	5.7
4	#5470.00	52.6 AV	54.0	-1.4	1.00 H	299	46.9	5.7
5	*5530.00	106.6 PK			1.77 H	283	67.0	39.6
6	*5530.00	96.3 AV			1.77 H	283	56.7	39.6
7	#5725.00	56.5 PK	74.0	-17.5	1.02 H	286	50.2	6.3
8	#5725.00	43.5 AV	54.0	-10.5	1.02 H	286	37.2	6.3
9	11060.00	59.4 PK	74.0	-14.6	1.22 H	324	40.1	19.3
10	11060.00	46.7 AV	54.0	-7.3	1.22 H	324	27.4	19.3

ANTENNA POLARITY & TEST DISTANCE: VERTICAL AT 3 M

NO.	FREQ. (MHz)	EMISSION LEVEL (dBuV/m)	LIMIT (dBuV/m)	MARGIN (dB)	ANTENNA HEIGHT (m)	TABLE ANGLE (Degree)	RAW VALUE (dBuV)	CORRECTION FACTOR (dB/m)
1	5460.00	61.9 PK	74.0	-12.1	2.72 V	336	56.2	5.7
2	5460.00	48.7 AV	54.0	-5.3	2.72 V	336	43.0	5.7
3	#5470.00	62.0 PK	74.0	-12.0	2.59 V	355	56.3	5.7
4	#5470.00	48.4 AV	54.0	-5.6	2.59 V	355	42.7	5.7
5	*5530.00	100.6 PK			3.26 V	309	61.0	39.6
6	*5530.00	90.5 AV			3.26 V	309	50.9	39.6
7	#5725.00	46.4 PK	74.0	-27.6	2.75 V	342	40.1	6.3
8	#5725.00	43.5 AV	54.0	-10.5	2.75 V	342	37.2	6.3
9	11340.00	60.1 PK	74.0	-13.9	1.76 V	289	40.6	19.5
10	11340.00	46.7 AV	54.0	-7.3	1.76 V	289	27.2	19.5

REMARKS:

1. Emission Level(dBuV/m) = Raw Value(dBuV) + Correction Factor(dB/m)
2. Correction Factor(dB/m) = Antenna Factor(dB/m) + Cable Factor(dB) – Pre-Amplifier Factor(dB)
3. The other emission levels were very low against the limit.
4. Margin value = Emission Level – Limit value
5. " * ": Fundamental frequency.
6. " # ": The radiated frequency is out of the restricted band.



CHANNEL	TX Channel 138	DETECTOR FUNCTION	Peak (PK)
FREQUENCY RANGE	1GHz ~ 40GHz		Average (AV)

ANTENNA POLARITY & TEST DISTANCE: HORIZONTAL AT 3 M

NO.	FREQ. (MHz)	EMISSION LEVEL (dBuV/m)	LIMIT (dBuV/m)	MARGIN (dB)	ANTENNA HEIGHT (m)	TABLE ANGLE (Degree)	RAW VALUE (dBuV)	CORRECTION FACTOR (dB/m)
1	#5470.00	56.8 PK	74.0	-17.2	1.94 H	220	51.1	5.7
2	#5470.00	46.2 AV	54.0	-7.8	1.94 H	220	40.5	5.7
3	*5690.00	114.4 PK			1.83 H	285	74.5	39.9
4	*5690.00	103.9 AV			1.83 H	285	64.0	39.9
5	#5850.00	61.8 PK	74.0	-12.2	2.03 H	27	55.3	6.5
6	#5850.00	48.2 AV	54.0	-5.8	2.03 H	27	41.7	6.5
7	11380.00	64.7 PK	74.0	-9.3	1.00 H	280	45.4	19.3
8	11380.00	52.3 AV	54.0	-1.7	1.00 H	280	33.0	19.3

ANTENNA POLARITY & TEST DISTANCE: VERTICAL AT 3 M

NO.	FREQ. (MHz)	EMISSION LEVEL (dBuV/m)	LIMIT (dBuV/m)	MARGIN (dB)	ANTENNA HEIGHT (m)	TABLE ANGLE (Degree)	RAW VALUE (dBuV)	CORRECTION FACTOR (dB/m)
1	#5470.00	57.6 PK	74.0	-16.4	1.90 V	79	51.9	5.7
2	#5470.00	46.1 AV	54.0	-7.9	1.90 V	79	40.4	5.7
3	*5690.00	108.0 PK			2.75 V	8	68.1	39.9
4	*5690.00	98.3 AV			2.75 V	8	58.4	39.9
5	#5850.00	57.4 PK	74.0	-16.6	2.35 V	19	50.9	6.5
6	#5850.00	46.0 AV	54.0	-8.0	2.35 V	19	39.5	6.5
7	11380.00	61.7 PK	74.0	-12.3	1.65 V	218	42.4	19.3
8	11380.00	48.6 AV	54.0	-5.4	1.65 V	218	29.3	19.3

REMARKS:

1. Emission Level(dBuV/m) = Raw Value(dBuV) + Correction Factor(dB/m)
2. Correction Factor(dB/m) = Antenna Factor(dB/m) + Cable Factor(dB) – Pre-Amplifier Factor(dB)
3. The other emission levels were very low against the limit.
4. Margin value = Emission Level – Limit value
5. " * ": Fundamental frequency.
6. " # ": The radiated frequency is out of the restricted band.

Mode C

802.11a

CHANNEL	TX Channel 52	DETECTOR FUNCTION	Peak (PK)
FREQUENCY RANGE	1GHz ~ 40GHz		Average (AV)

ANTENNA POLARITY & TEST DISTANCE: HORIZONTAL AT 3 M

NO.	FREQ. (MHz)	EMISSION LEVEL (dBuV/m)	LIMIT (dBuV/m)	MARGIN (dB)	ANTENNA HEIGHT (m)	TABLE ANGLE (Degree)	RAW VALUE (dBuV)	CORRECTION FACTOR (dB/m)
1	5150.00	55.4 PK	74.0	-18.6	2.69 H	223	50.6	4.8
2	5150.00	42.6 AV	54.0	-11.4	2.69 H	223	37.8	4.8
3	*5260.00	110.8 PK			2.89 H	204	71.9	38.9
4	*5260.00	100.2 AV			2.89 H	204	61.3	38.9
5	#10520.00	59.4 PK	74.0	-14.6	2.79 H	85	40.8	18.6
6	#10520.00	47.4 AV	54.0	-6.6	2.79 H	85	28.8	18.6

ANTENNA POLARITY & TEST DISTANCE: VERTICAL AT 3 M

NO.	FREQ. (MHz)	EMISSION LEVEL (dBuV/m)	LIMIT (dBuV/m)	MARGIN (dB)	ANTENNA HEIGHT (m)	TABLE ANGLE (Degree)	RAW VALUE (dBuV)	CORRECTION FACTOR (dB/m)
1	5150.00	55.9 PK	74.0	-18.1	3.58 V	352	51.1	4.8
2	5150.00	43.4 AV	54.0	-10.6	3.58 V	352	38.6	4.8
3	*5260.00	119.6 PK			3.74 V	7	80.7	38.9
4	*5260.00	108.8 AV			3.74 V	7	69.9	38.9
5	#10520.00	63.4 PK	74.0	-10.6	2.41 V	9	44.8	18.6
6	#10520.00	50.9 AV	54.0	-3.1	2.41 V	9	32.3	18.6

REMARKS:

1. Emission Level(dBuV/m) = Raw Value(dBuV) + Correction Factor(dB/m)
2. Correction Factor(dB/m) = Antenna Factor(dB/m) + Cable Factor(dB) – Pre-Amplifier Factor(dB)
3. The other emission levels were very low against the limit.
4. Margin value = Emission Level – Limit value
5. " * ": Fundamental frequency.
6. " # ": The radiated frequency is out of the restricted band.

CHANNEL	TX Channel 60	DETECTOR FUNCTION	Peak (PK)
FREQUENCY RANGE	1GHz ~ 40GHz		Average (AV)

ANTENNA POLARITY & TEST DISTANCE: HORIZONTAL AT 3 M

NO.	FREQ. (MHz)	EMISSION LEVEL (dBuV/m)	LIMIT (dBuV/m)	MARGIN (dB)	ANTENNA HEIGHT (m)	TABLE ANGLE (Degree)	RAW VALUE (dBuV)	CORRECTION FACTOR (dB/m)
1	*5300.00	106.7 PK			1.13 H	205	67.6	39.1
2	*5300.00	95.7 AV			1.13 H	205	56.6	39.1
3	10600.00	58.4 PK	74.0	-15.6	2.29 H	276	39.9	18.5
4	10600.00	46.5 AV	54.0	-7.5	2.29 H	276	28.0	18.5

ANTENNA POLARITY & TEST DISTANCE: VERTICAL AT 3 M

NO.	FREQ. (MHz)	EMISSION LEVEL (dBuV/m)	LIMIT (dBuV/m)	MARGIN (dB)	ANTENNA HEIGHT (m)	TABLE ANGLE (Degree)	RAW VALUE (dBuV)	CORRECTION FACTOR (dB/m)
1	*5300.00	117.9 PK			1.58 V	101	78.8	39.1
2	*5300.00	107.9 AV			1.58 V	101	68.8	39.1
3	10600.00	66.2 PK	74.0	-7.8	2.48 V	9	47.7	18.5
4	10600.00	52.5 AV	54.0	-1.5	2.48 V	9	34.0	18.5

REMARKS:

1. Emission Level(dBuV/m) = Raw Value(dBuV) + Correction Factor(dB/m)
2. Correction Factor(dB/m) = Antenna Factor(dB/m) + Cable Factor(dB) – Pre-Amplifier Factor(dB)
3. The other emission levels were very low against the limit.
4. Margin value = Emission Level – Limit value
5. " * ": Fundamental frequency.
6. " # ": The radiated frequency is out of the restricted band.

CHANNEL	TX Channel 64	DETECTOR FUNCTION	Peak (PK)
FREQUENCY RANGE	1GHz ~ 40GHz		Average (AV)

ANTENNA POLARITY & TEST DISTANCE: HORIZONTAL AT 3 M

NO.	FREQ. (MHz)	EMISSION LEVEL (dBuV/m)	LIMIT (dBuV/m)	MARGIN (dB)	ANTENNA HEIGHT (m)	TABLE ANGLE (Degree)	RAW VALUE (dBuV)	CORRECTION FACTOR (dB/m)
1	*5320.00	108.0 PK			1.09 H	204	68.9	39.1
2	*5320.00	97.0 AV			1.09 H	204	57.9	39.1
3	5350.00	56.2 PK	74.0	-17.8	1.19 H	210	50.7	5.5
4	5350.00	43.5 AV	54.0	-10.5	1.19 H	210	38.0	5.5
5	10640.00	58.6 PK	74.0	-15.4	2.36 H	229	40.1	18.5
6	10640.00	45.8 AV	54.0	-8.2	2.36 H	229	27.3	18.5

ANTENNA POLARITY & TEST DISTANCE: VERTICAL AT 3 M

NO.	FREQ. (MHz)	EMISSION LEVEL (dBuV/m)	LIMIT (dBuV/m)	MARGIN (dB)	ANTENNA HEIGHT (m)	TABLE ANGLE (Degree)	RAW VALUE (dBuV)	CORRECTION FACTOR (dB/m)
1	*5320.00	116.9 PK			1.70 V	8	77.8	39.1
2	*5320.00	106.4 AV			1.70 V	8	67.3	39.1
3	5350.00	56.6 PK	74.0	-17.4	1.70 V	1	51.1	5.5
4	5350.00	45.0 AV	54.0	-9.0	1.70 V	1	39.5	5.5
5	10640.00	65.6 PK	74.0	-8.4	2.47 V	10	47.1	18.5
6	10640.00	52.5 AV	54.0	-1.5	2.47 V	10	34.0	18.5

REMARKS:

1. Emission Level(dBuV/m) = Raw Value(dBuV) + Correction Factor(dB/m)
2. Correction Factor(dB/m) = Antenna Factor(dB/m) + Cable Factor(dB) – Pre-Amplifier Factor(dB)
3. The other emission levels were very low against the limit.
4. Margin value = Emission Level – Limit value
5. " * ": Fundamental frequency.

CHANNEL	TX Channel 100	DETECTOR FUNCTION	Peak (PK)
FREQUENCY RANGE	1GHz ~ 40GHz		Average (AV)

ANTENNA POLARITY & TEST DISTANCE: HORIZONTAL AT 3 M

NO.	FREQ. (MHz)	EMISSION LEVEL (dBuV/m)	LIMIT (dBuV/m)	MARGIN (dB)	ANTENNA HEIGHT (m)	TABLE ANGLE (Degree)	RAW VALUE (dBuV)	CORRECTION FACTOR (dB/m)
1	5460.00	56.0 PK	74.0	-18.0	1.66 H	142	50.3	5.7
2	5460.00	43.5 AV	54.0	-10.5	1.66 H	142	37.8	5.7
3	#5470.00	56.4 PK	74.0	-17.6	1.41 H	116	50.7	5.7
4	#5470.00	44.4 AV	54.0	-9.6	1.41 H	116	38.7	5.7
5	*5500.00	108.2 PK			1.04 H	139	68.6	39.6
6	*5500.00	97.5 AV			1.04 H	139	57.9	39.6
7	11000.00	60.1 PK	74.0	-13.9	2.19 H	174	40.4	19.7
8	11000.00	47.3 AV	54.0	-6.7	2.19 H	174	27.6	19.7

ANTENNA POLARITY & TEST DISTANCE: VERTICAL AT 3 M

NO.	FREQ. (MHz)	EMISSION LEVEL (dBuV/m)	LIMIT (dBuV/m)	MARGIN (dB)	ANTENNA HEIGHT (m)	TABLE ANGLE (Degree)	RAW VALUE (dBuV)	CORRECTION FACTOR (dB/m)
1	5460.00	58.2 PK	74.0	-15.8	1.82 V	34	52.5	5.7
2	5460.00	45.3 AV	54.0	-8.7	1.82 V	34	39.6	5.7
3	#5470.00	61.4 PK	74.0	-12.6	1.58 V	10	55.7	5.7
4	#5470.00	48.2 AV	54.0	-5.8	1.58 V	10	42.5	5.7
5	*5500.00	117.8 PK			1.52 V	8	78.2	39.6
6	*5500.00	107.2 AV			1.52 V	8	67.6	39.6
7	11000.00	63.3 PK	74.0	-10.7	2.44 V	11	43.6	19.7
8	11000.00	50.8 AV	54.0	-3.2	2.44 V	11	31.1	19.7

REMARKS:

1. Emission Level(dBuV/m) = Raw Value(dBuV) + Correction Factor(dB/m)
2. Correction Factor(dB/m) = Antenna Factor(dB/m) + Cable Factor(dB) – Pre-Amplifier Factor(dB)
3. The other emission levels were very low against the limit.
4. Margin value = Emission Level – Limit value
5. " * ": Fundamental frequency.
6. " # ": The radiated frequency is out of the restricted band.

CHANNEL	TX Channel 116	DETECTOR FUNCTION	Peak (PK)
FREQUENCY RANGE	1GHz ~ 40GHz		Average (AV)

ANTENNA POLARITY & TEST DISTANCE: HORIZONTAL AT 3 M

NO.	FREQ. (MHz)	EMISSION LEVEL (dBuV/m)	LIMIT (dBuV/m)	MARGIN (dB)	ANTENNA HEIGHT (m)	TABLE ANGLE (Degree)	RAW VALUE (dBuV)	CORRECTION FACTOR (dB/m)
1	*5580.00	108.6 PK			1.27 H	138	68.8	39.8
2	*5580.00	97.2 AV			1.27 H	138	57.4	39.8
3	11160.00	59.2 PK	74.0	-14.8	2.06 H	179	39.7	19.5
4	11160.00	46.6 AV	54.0	-7.4	2.06 H	179	27.1	19.5

ANTENNA POLARITY & TEST DISTANCE: VERTICAL AT 3 M

NO.	FREQ. (MHz)	EMISSION LEVEL (dBuV/m)	LIMIT (dBuV/m)	MARGIN (dB)	ANTENNA HEIGHT (m)	TABLE ANGLE (Degree)	RAW VALUE (dBuV)	CORRECTION FACTOR (dB/m)
1	*5580.00	117.8 PK			1.53 V	9	78.0	39.8
2	*5580.00	106.6 AV			1.53 V	9	66.8	39.8
3	11160.00	63.4 PK	74.0	-10.6	2.39 V	0	43.9	19.5
4	11160.00	50.7 AV	54.0	-3.3	2.39 V	0	31.2	19.5

REMARKS:

1. Emission Level(dBuV/m) = Raw Value(dBuV) + Correction Factor(dB/m)
2. Correction Factor(dB/m) = Antenna Factor(dB/m) + Cable Factor(dB) – Pre-Amplifier Factor(dB)
3. The other emission levels were very low against the limit.
4. Margin value = Emission Level – Limit value
5. " * ": Fundamental frequency.

CHANNEL	TX Channel 140	DETECTOR FUNCTION	Peak (PK)
FREQUENCY RANGE	1GHz ~ 40GHz		Average (AV)

ANTENNA POLARITY & TEST DISTANCE: HORIZONTAL AT 3 M

NO.	FREQ. (MHz)	EMISSION LEVEL (dBuV/m)	LIMIT (dBuV/m)	MARGIN (dB)	ANTENNA HEIGHT (m)	TABLE ANGLE (Degree)	RAW VALUE (dBuV)	CORRECTION FACTOR (dB/m)
1	*5700.00	107.3 PK			1.51 H	227	67.4	39.9
2	*5700.00	96.5 AV			1.51 H	227	56.6	39.9
3	#5725.00	56.1 PK	74.0	-17.9	1.40 H	203	49.8	6.3
4	#5725.00	43.6 AV	54.0	-10.4	1.40 H	203	37.3	6.3
5	11400.00	60.5 PK	74.0	-13.5	2.09 H	166	41.2	19.3
6	11400.00	47.6 AV	54.0	-6.4	2.09 H	166	28.3	19.3

ANTENNA POLARITY & TEST DISTANCE: VERTICAL AT 3 M

NO.	FREQ. (MHz)	EMISSION LEVEL (dBuV/m)	LIMIT (dBuV/m)	MARGIN (dB)	ANTENNA HEIGHT (m)	TABLE ANGLE (Degree)	RAW VALUE (dBuV)	CORRECTION FACTOR (dB/m)
1	*5700.00	118.8 PK			3.26 V	2	78.9	39.9
2	*5700.00	108.4 AV			3.26 V	2	68.5	39.9
3	#5725.00	65.2 PK	74.0	-8.8	3.24 V	0	58.9	6.3
4	#5725.00	50.9 AV	54.0	-3.1	3.24 V	0	44.6	6.3
5	11400.00	61.9 PK	74.0	-12.1	2.50 V	11	42.6	19.3
6	11400.00	49.3 AV	54.0	-4.7	2.50 V	11	30.0	19.3

REMARKS:

1. Emission Level(dBuV/m) = Raw Value(dBuV) + Correction Factor(dB/m)
2. Correction Factor(dB/m) = Antenna Factor(dB/m) + Cable Factor(dB) – Pre-Amplifier Factor(dB)
3. The other emission levels were very low against the limit.
4. Margin value = Emission Level – Limit value
5. " * ": Fundamental frequency.
6. " # ": The radiated frequency is out of the restricted band.

CHANNEL	TX Channel 144	DETECTOR FUNCTION	Peak (PK)
FREQUENCY RANGE	1GHz ~ 40GHz		Average (AV)

ANTENNA POLARITY & TEST DISTANCE: HORIZONTAL AT 3 M

NO.	FREQ. (MHz)	EMISSION LEVEL (dBuV/m)	LIMIT (dBuV/m)	MARGIN (dB)	ANTENNA HEIGHT (m)	TABLE ANGLE (Degree)	RAW VALUE (dBuV)	CORRECTION FACTOR (dB/m)
1	#5470.00	56.4 PK	74.0	-17.6	1.89 H	22	50.7	5.7
2	#5470.00	45.6 AV	54.0	-8.4	1.89 H	22	39.9	5.7
3	*5720.00	112.4 PK			2.00 H	301	72.4	40.0
4	*5720.00	102.1 AV			2.00 H	301	62.1	40.0
5	#5850.00	58.2 PK	74.0	-15.8	1.64 H	180	51.7	6.5
6	#5850.00	46.9 AV	54.0	-7.1	1.64 H	180	40.4	6.5
7	11440.00	62.1 PK	74.0	-11.9	2.31 H	234	42.8	19.3
8	11440.00	48.7 AV	54.0	-5.3	2.31 H	234	29.4	19.3

ANTENNA POLARITY & TEST DISTANCE: VERTICAL AT 3 M

NO.	FREQ. (MHz)	EMISSION LEVEL (dBuV/m)	LIMIT (dBuV/m)	MARGIN (dB)	ANTENNA HEIGHT (m)	TABLE ANGLE (Degree)	RAW VALUE (dBuV)	CORRECTION FACTOR (dB/m)
1	#5470.00	58.8 PK	74.0	-15.2	2.00 V	266	53.1	5.7
2	#5470.00	47.7 AV	54.0	-6.3	2.00 V	266	42.0	5.7
3	*5720.00	125.8 PK			2.96 V	310	85.8	40.0
4	*5720.00	114.7 AV			2.96 V	310	74.7	40.0
5	#5850.00	59.1 PK	74.0	-14.9	2.10 V	80	52.6	6.5
6	#5850.00	48.7 AV	54.0	-5.3	2.10 V	80	42.2	6.5
7	11440.00	63.6 PK	74.0	-10.4	3.12 V	67	44.3	19.3
8	11440.00	52.3 AV	54.0	-1.7	3.12 V	67	33.0	19.3

REMARKS:

1. Emission Level(dBuV/m) = Raw Value(dBuV) + Correction Factor(dB/m)
2. Correction Factor(dB/m) = Antenna Factor(dB/m) + Cable Factor(dB) – Pre-Amplifier Factor(dB)
3. The other emission levels were very low against the limit.
4. Margin value = Emission Level – Limit value
5. " * ": Fundamental frequency.
6. " # ": The radiated frequency is out of the restricted band.

802.11ac (VHT20)

CHANNEL	TX Channel 52	DETECTOR FUNCTION	Peak (PK)
FREQUENCY RANGE	1GHz ~ 40GHz		Average (AV)

ANTENNA POLARITY & TEST DISTANCE: HORIZONTAL AT 3 M

NO.	FREQ. (MHz)	EMISSION LEVEL (dBuV/m)	LIMIT (dBuV/m)	MARGIN (dB)	ANTENNA HEIGHT (m)	TABLE ANGLE (Degree)	RAW VALUE (dBuV)	CORRECTION FACTOR (dB/m)
1	5150.00	54.3 PK	74.0	-19.7	2.58 H	222	49.5	4.8
2	5150.00	41.9 AV	54.0	-12.1	2.58 H	222	37.1	4.8
3	*5260.00	109.9 PK			2.88 H	205	71.0	38.9
4	*5260.00	99.2 AV			2.88 H	205	60.3	38.9
5	#10520.00	58.9 PK	74.0	-15.1	2.09 H	167	40.3	18.6
6	#10520.00	46.1 AV	54.0	-7.9	2.09 H	167	27.5	18.6

ANTENNA POLARITY & TEST DISTANCE: VERTICAL AT 3 M

NO.	FREQ. (MHz)	EMISSION LEVEL (dBuV/m)	LIMIT (dBuV/m)	MARGIN (dB)	ANTENNA HEIGHT (m)	TABLE ANGLE (Degree)	RAW VALUE (dBuV)	CORRECTION FACTOR (dB/m)
1	5150.00	54.2 PK	74.0	-19.8	3.24 V	31	49.4	4.8
2	5150.00	42.9 AV	54.0	-11.1	3.24 V	31	38.1	4.8
3	*5260.00	118.9 PK			3.72 V	9	80.0	38.9
4	*5260.00	107.6 AV			3.72 V	9	68.7	38.9
5	#10520.00	63.1 PK	74.0	-10.9	2.35 V	9	44.5	18.6
6	#10520.00	50.0 AV	54.0	-4.0	2.35 V	9	31.4	18.6

REMARKS:

1. Emission Level(dBuV/m) = Raw Value(dBuV) + Correction Factor(dB/m)
2. Correction Factor(dB/m) = Antenna Factor(dB/m) + Cable Factor(dB) – Pre-Amplifier Factor(dB)
3. The other emission levels were very low against the limit.
4. Margin value = Emission Level – Limit value
5. " * ": Fundamental frequency.
6. " # ": The radiated frequency is out of the restricted band.

CHANNEL	TX Channel 60	DETECTOR FUNCTION	Peak (PK)
FREQUENCY RANGE	1GHz ~ 40GHz		Average (AV)

ANTENNA POLARITY & TEST DISTANCE: HORIZONTAL AT 3 M

NO.	FREQ. (MHz)	EMISSION LEVEL (dBuV/m)	LIMIT (dBuV/m)	MARGIN (dB)	ANTENNA HEIGHT (m)	TABLE ANGLE (Degree)	RAW VALUE (dBuV)	CORRECTION FACTOR (dB/m)
1	*5300.00	108.0 PK			1.13 H	204	68.9	39.1
2	*5300.00	96.9 AV			1.13 H	204	57.8	39.1
3	10600.00	58.6 PK	74.0	-15.4	2.62 H	228	40.1	18.5
4	10600.00	46.2 AV	54.0	-7.8	2.62 H	228	27.7	18.5

ANTENNA POLARITY & TEST DISTANCE: VERTICAL AT 3 M

NO.	FREQ. (MHz)	EMISSION LEVEL (dBuV/m)	LIMIT (dBuV/m)	MARGIN (dB)	ANTENNA HEIGHT (m)	TABLE ANGLE (Degree)	RAW VALUE (dBuV)	CORRECTION FACTOR (dB/m)
1	*5300.00	117.2 PK			1.62 V	8	78.1	39.1
2	*5300.00	105.9 AV			1.62 V	8	66.8	39.1
3	10600.00	67.0 PK	74.0	-7.0	2.45 V	10	48.5	18.5
4	10600.00	52.5 AV	54.0	-1.5	2.45 V	10	34.0	18.5

REMARKS:

1. Emission Level(dBuV/m) = Raw Value(dBuV) + Correction Factor(dB/m)
2. Correction Factor(dB/m) = Antenna Factor(dB/m) + Cable Factor(dB) – Pre-Amplifier Factor(dB)
3. The other emission levels were very low against the limit.
4. Margin value = Emission Level – Limit value
5. " * ": Fundamental frequency.

CHANNEL	TX Channel 64	DETECTOR FUNCTION	Peak (PK)
FREQUENCY RANGE	1GHz ~ 40GHz		Average (AV)

ANTENNA POLARITY & TEST DISTANCE: HORIZONTAL AT 3 M

NO.	FREQ. (MHz)	EMISSION LEVEL (dBuV/m)	LIMIT (dBuV/m)	MARGIN (dB)	ANTENNA HEIGHT (m)	TABLE ANGLE (Degree)	RAW VALUE (dBuV)	CORRECTION FACTOR (dB/m)
1	*5320.00	109.1 PK			1.09 H	203	70.0	39.1
2	*5320.00	98.2 AV			1.09 H	203	59.1	39.1
3	5350.00	57.6 PK	74.0	-16.4	1.25 H	192	52.1	5.5
4	5350.00	43.2 AV	54.0	-10.8	1.25 H	192	37.7	5.5
5	10640.00	58.2 PK	74.0	-15.8	1.08 H	247	39.7	18.5
6	10640.00	46.0 AV	54.0	-8.0	1.08 H	247	27.5	18.5

ANTENNA POLARITY & TEST DISTANCE: VERTICAL AT 3 M

NO.	FREQ. (MHz)	EMISSION LEVEL (dBuV/m)	LIMIT (dBuV/m)	MARGIN (dB)	ANTENNA HEIGHT (m)	TABLE ANGLE (Degree)	RAW VALUE (dBuV)	CORRECTION FACTOR (dB/m)
1	*5320.00	118.8 PK			1.71 V	8	79.7	39.1
2	*5320.00	107.4 AV			1.71 V	8	68.3	39.1
3	5350.00	59.4 PK	74.0	-14.6	1.98 V	357	53.9	5.5
4	5350.00	45.8 AV	54.0	-8.2	1.98 V	357	40.3	5.5
5	10640.00	66.7 PK	74.0	-7.3	2.46 V	8	48.2	18.5
6	10640.00	52.4 AV	54.0	-1.6	2.46 V	8	33.9	18.5

REMARKS:

1. Emission Level(dBuV/m) = Raw Value(dBuV) + Correction Factor(dB/m)
2. Correction Factor(dB/m) = Antenna Factor(dB/m) + Cable Factor(dB) – Pre-Amplifier Factor(dB)
3. The other emission levels were very low against the limit.
4. Margin value = Emission Level – Limit value
5. " * ": Fundamental frequency.

CHANNEL	TX Channel 100	DETECTOR FUNCTION	Peak (PK)
FREQUENCY RANGE	1GHz ~ 40GHz		Average (AV)

ANTENNA POLARITY & TEST DISTANCE: HORIZONTAL AT 3 M

NO.	FREQ. (MHz)	EMISSION LEVEL (dBuV/m)	LIMIT (dBuV/m)	MARGIN (dB)	ANTENNA HEIGHT (m)	TABLE ANGLE (Degree)	RAW VALUE (dBuV)	CORRECTION FACTOR (dB/m)
1	5460.00	56.0 PK	74.0	-18.0	1.92 H	105	50.3	5.7
2	5460.00	43.3 AV	54.0	-10.7	1.92 H	105	37.6	5.7
3	#5470.00	57.5 PK	74.0	-16.5	1.43 H	115	51.8	5.7
4	#5470.00	44.4 AV	54.0	-9.6	1.43 H	115	38.7	5.7
5	*5500.00	106.9 PK			1.49 H	142	67.3	39.6
6	*5500.00	96.4 AV			1.49 H	142	56.8	39.6
7	11000.00	59.9 PK	74.0	-14.1	1.92 H	205	40.2	19.7
8	11000.00	47.3 AV	54.0	-6.7	1.92 H	205	27.6	19.7

ANTENNA POLARITY & TEST DISTANCE: VERTICAL AT 3 M

NO.	FREQ. (MHz)	EMISSION LEVEL (dBuV/m)	LIMIT (dBuV/m)	MARGIN (dB)	ANTENNA HEIGHT (m)	TABLE ANGLE (Degree)	RAW VALUE (dBuV)	CORRECTION FACTOR (dB/m)
1	5460.00	58.6 PK	74.0	-15.4	1.68 V	277	52.9	5.7
2	5460.00	46.1 AV	54.0	-7.9	1.68 V	277	40.4	5.7
3	#5470.00	65.3 PK	74.0	-8.7	1.46 V	304	59.6	5.7
4	#5470.00	50.3 AV	54.0	-3.7	1.46 V	304	44.6	5.7
5	*5500.00	118.3 PK			1.30 V	8	78.7	39.6
6	*5500.00	107.4 AV			1.30 V	8	67.8	39.6
7	11000.00	63.8 PK	74.0	-10.2	2.35 V	10	44.1	19.7
8	11000.00	50.1 AV	54.0	-3.9	2.35 V	10	30.4	19.7

REMARKS:

1. Emission Level(dBuV/m) = Raw Value(dBuV) + Correction Factor(dB/m)
2. Correction Factor(dB/m) = Antenna Factor(dB/m) + Cable Factor(dB) – Pre-Amplifier Factor(dB)
3. The other emission levels were very low against the limit.
4. Margin value = Emission Level – Limit value
5. " * ": Fundamental frequency.
6. " # ": The radiated frequency is out of the restricted band.



CHANNEL	TX Channel 116	DETECTOR FUNCTION	Peak (PK)
FREQUENCY RANGE	1GHz ~ 40GHz		Average (AV)

ANTENNA POLARITY & TEST DISTANCE: HORIZONTAL AT 3 M

NO.	FREQ. (MHz)	EMISSION LEVEL (dBuV/m)	LIMIT (dBuV/m)	MARGIN (dB)	ANTENNA HEIGHT (m)	TABLE ANGLE (Degree)	RAW VALUE (dBuV)	CORRECTION FACTOR (dB/m)
1	*5580.00	109.6 PK			2.08 H	206	69.8	39.8
2	*5580.00	98.5 AV			2.08 H	206	58.7	39.8
3	11160.00	59.7 PK	74.0	-14.3	1.96 H	147	40.2	19.5
4	11160.00	46.7 AV	54.0	-7.3	1.96 H	147	27.2	19.5

ANTENNA POLARITY & TEST DISTANCE: VERTICAL AT 3 M

NO.	FREQ. (MHz)	EMISSION LEVEL (dBuV/m)	LIMIT (dBuV/m)	MARGIN (dB)	ANTENNA HEIGHT (m)	TABLE ANGLE (Degree)	RAW VALUE (dBuV)	CORRECTION FACTOR (dB/m)
1	*5580.00	117.9 PK			1.50 V	9	78.1	39.8
2	*5580.00	106.8 AV			1.50 V	9	67.0	39.8
3	11160.00	62.7 PK	74.0	-11.3	2.51 V	1	43.2	19.5
4	11160.00	50.1 AV	54.0	-3.9	2.51 V	1	30.6	19.5

REMARKS:

1. Emission Level(dBuV/m) = Raw Value(dBuV) + Correction Factor(dB/m)
2. Correction Factor(dB/m) = Antenna Factor(dB/m) + Cable Factor(dB) – Pre-Amplifier Factor(dB)
3. The other emission levels were very low against the limit.
4. Margin value = Emission Level – Limit value
5. " * ": Fundamental frequency.



CHANNEL	TX Channel 140	DETECTOR FUNCTION	Peak (PK)
FREQUENCY RANGE	1GHz ~ 40GHz		Average (AV)

ANTENNA POLARITY & TEST DISTANCE: HORIZONTAL AT 3 M

NO.	FREQ. (MHz)	EMISSION LEVEL (dBuV/m)	LIMIT (dBuV/m)	MARGIN (dB)	ANTENNA HEIGHT (m)	TABLE ANGLE (Degree)	RAW VALUE (dBuV)	CORRECTION FACTOR (dB/m)
1	*5700.00	106.9 PK			1.38 H	227	67.0	39.9
2	*5700.00	95.8 AV			1.38 H	227	55.9	39.9
3	#5725.00	57.3 PK	74.0	-16.7	1.34 H	227	51.0	6.3
4	#5725.00	44.3 AV	54.0	-9.7	1.34 H	227	38.0	6.3
5	11400.00	61.1 PK	74.0	-12.9	2.06 H	179	41.8	19.3
6	11400.00	47.8 AV	54.0	-6.2	2.06 H	179	28.5	19.3

ANTENNA POLARITY & TEST DISTANCE: VERTICAL AT 3 M

NO.	FREQ. (MHz)	EMISSION LEVEL (dBuV/m)	LIMIT (dBuV/m)	MARGIN (dB)	ANTENNA HEIGHT (m)	TABLE ANGLE (Degree)	RAW VALUE (dBuV)	CORRECTION FACTOR (dB/m)
1	*5700.00	117.9 PK			3.41 V	2	78.0	39.9
2	*5700.00	107.1 AV			3.41 V	2	67.2	39.9
3	#5725.00	66.5 PK	74.0	-7.5	1.62 V	351	60.2	6.3
4	#5725.00	52.4 AV	54.0	-1.6	1.62 V	351	46.1	6.3
5	11400.00	61.2 PK	74.0	-12.8	2.48 V	0	41.9	19.3
6	11400.00	48.9 AV	54.0	-5.1	2.48 V	0	29.6	19.3

REMARKS:

1. Emission Level(dBuV/m) = Raw Value(dBuV) + Correction Factor(dB/m)
2. Correction Factor(dB/m) = Antenna Factor(dB/m) + Cable Factor(dB) – Pre-Amplifier Factor(dB)
3. The other emission levels were very low against the limit.
4. Margin value = Emission Level – Limit value
5. " * ": Fundamental frequency.
6. " # ": The radiated frequency is out of the restricted band.

CHANNEL	TX Channel 144	DETECTOR FUNCTION	Peak (PK)
FREQUENCY RANGE	1GHz ~ 40GHz		Average (AV)

ANTENNA POLARITY & TEST DISTANCE: HORIZONTAL AT 3 M

NO.	FREQ. (MHz)	EMISSION LEVEL (dBuV/m)	LIMIT (dBuV/m)	MARGIN (dB)	ANTENNA HEIGHT (m)	TABLE ANGLE (Degree)	RAW VALUE (dBuV)	CORRECTION FACTOR (dB/m)
1	#5470.00	55.9 PK	74.0	-18.1	1.78 H	279	50.2	5.7
2	#5470.00	45.4 AV	54.0	-8.6	1.78 H	279	39.7	5.7
3	*5720.00	112.4 PK			1.99 H	301	72.4	40.0
4	*5720.00	101.6 AV			1.99 H	301	61.6	40.0
5	#5850.00	57.0 PK	74.0	-17.0	1.69 H	359	50.5	6.5
6	#5850.00	47.1 AV	54.0	-6.9	1.69 H	359	40.6	6.5
7	11440.00	62.0 PK	74.0	-12.0	2.40 H	177	42.7	19.3
8	11440.00	48.9 AV	54.0	-5.1	2.40 H	177	29.6	19.3

ANTENNA POLARITY & TEST DISTANCE: VERTICAL AT 3 M

NO.	FREQ. (MHz)	EMISSION LEVEL (dBuV/m)	LIMIT (dBuV/m)	MARGIN (dB)	ANTENNA HEIGHT (m)	TABLE ANGLE (Degree)	RAW VALUE (dBuV)	CORRECTION FACTOR (dB/m)
1	#5470.00	56.0 PK	74.0	-18.0	2.03 V	34	50.3	5.7
2	#5470.00	45.4 AV	54.0	-8.6	2.03 V	34	39.7	5.7
3	*5720.00	122.9 PK			2.29 V	344	82.9	40.0
4	*5720.00	112.2 AV			2.29 V	344	72.2	40.0
5	#5850.00	56.9 PK	74.0	-17.1	2.19 V	43	50.4	6.5
6	#5850.00	46.6 AV	54.0	-7.4	2.19 V	43	40.1	6.5
7	11440.00	66.2 PK	74.0	-7.8	2.60 V	292	46.9	19.3
8	11440.00	52.6 AV	54.0	-1.4	2.60 V	292	33.3	19.3

REMARKS:

1. Emission Level(dBuV/m) = Raw Value(dBuV) + Correction Factor(dB/m)
2. Correction Factor(dB/m) = Antenna Factor(dB/m) + Cable Factor(dB) – Pre-Amplifier Factor(dB)
3. The other emission levels were very low against the limit.
4. Margin value = Emission Level – Limit value
5. " * ": Fundamental frequency.
6. " # ": The radiated frequency is out of the restricted band.

802.11ac (VHT40)

CHANNEL	TX Channel 54	DETECTOR FUNCTION	Peak (PK)
FREQUENCY RANGE	1GHz ~ 40GHz		Average (AV)

ANTENNA POLARITY & TEST DISTANCE: HORIZONTAL AT 3 M

NO.	FREQ. (MHz)	EMISSION LEVEL (dBuV/m)	LIMIT (dBuV/m)	MARGIN (dB)	ANTENNA HEIGHT (m)	TABLE ANGLE (Degree)	RAW VALUE (dBuV)	CORRECTION FACTOR (dB/m)
1	*5270.00	107.1 PK			2.88 H	204	68.1	39.0
2	*5270.00	96.9 AV			2.88 H	204	57.9	39.0
3	5350.00	55.6 PK	74.0	-18.4	2.64 H	188	50.1	5.5
4	5350.00	42.9 AV	54.0	-11.1	2.64 H	188	37.4	5.5
5	#10540.00	59.1 PK	74.0	-14.9	2.03 H	139	40.5	18.6
6	#10540.00	46.2 AV	54.0	-7.8	2.03 H	139	27.6	18.6

ANTENNA POLARITY & TEST DISTANCE: VERTICAL AT 3 M

NO.	FREQ. (MHz)	EMISSION LEVEL (dBuV/m)	LIMIT (dBuV/m)	MARGIN (dB)	ANTENNA HEIGHT (m)	TABLE ANGLE (Degree)	RAW VALUE (dBuV)	CORRECTION FACTOR (dB/m)
1	*5270.00	114.3 PK			1.72 V	6	75.3	39.0
2	*5270.00	104.3 AV			1.72 V	6	65.3	39.0
3	5350.00	56.3 PK	74.0	-17.7	1.84 V	7	50.8	5.5
4	5350.00	44.5 AV	54.0	-9.5	1.84 V	7	39.0	5.5
5	#10540.00	61.0 PK	74.0	-13.0	2.62 V	9	42.4	18.6
6	#10540.00	48.8 AV	54.0	-5.2	2.62 V	9	30.2	18.6

REMARKS:

1. Emission Level(dBuV/m) = Raw Value(dBuV) + Correction Factor(dB/m)
2. Correction Factor(dB/m) = Antenna Factor(dB/m) + Cable Factor(dB) – Pre-Amplifier Factor(dB)
3. The other emission levels were very low against the limit.
4. Margin value = Emission Level – Limit value
5. " * ": Fundamental frequency.
6. " # ": The radiated frequency is out of the restricted band.

CHANNEL	TX Channel 62	DETECTOR FUNCTION	Peak (PK)
FREQUENCY RANGE	1GHz ~ 40GHz		Average (AV)

ANTENNA POLARITY & TEST DISTANCE: HORIZONTAL AT 3 M

NO.	FREQ. (MHz)	EMISSION LEVEL (dBuV/m)	LIMIT (dBuV/m)	MARGIN (dB)	ANTENNA HEIGHT (m)	TABLE ANGLE (Degree)	RAW VALUE (dBuV)	CORRECTION FACTOR (dB/m)
1	*5310.00	102.7 PK			3.10 H	190	63.6	39.1
2	*5310.00	92.5 AV			3.10 H	190	53.4	39.1
3	5350.00	58.0 PK	74.0	-16.0	2.87 H	207	52.5	5.5
4	5350.00	44.6 AV	54.0	-9.4	2.87 H	207	39.1	5.5
5	10620.00	59.1 PK	74.0	-14.9	2.34 H	171	40.6	18.5
6	10620.00	45.5 AV	54.0	-8.5	2.34 H	171	27.0	18.5

ANTENNA POLARITY & TEST DISTANCE: VERTICAL AT 3 M

NO.	FREQ. (MHz)	EMISSION LEVEL (dBuV/m)	LIMIT (dBuV/m)	MARGIN (dB)	ANTENNA HEIGHT (m)	TABLE ANGLE (Degree)	RAW VALUE (dBuV)	CORRECTION FACTOR (dB/m)
1	*5310.00	111.7 PK			1.59 V	8	72.6	39.1
2	*5310.00	101.7 AV			1.59 V	8	62.6	39.1
3	5350.00	65.9 PK	74.0	-8.1	1.80 V	7	60.4	5.5
4	5350.00	52.4 AV	54.0	-1.6	1.80 V	7	46.9	5.5
5	10620.00	60.8 PK	74.0	-13.2	2.52 V	8	42.3	18.5
6	10620.00	48.8 AV	54.0	-5.2	2.52 V	8	30.3	18.5

REMARKS:

1. Emission Level(dBuV/m) = Raw Value(dBuV) + Correction Factor(dB/m)
2. Correction Factor(dB/m) = Antenna Factor(dB/m) + Cable Factor(dB) – Pre-Amplifier Factor(dB)
3. The other emission levels were very low against the limit.
4. Margin value = Emission Level – Limit value
5. " * ": Fundamental frequency.

CHANNEL	TX Channel 102	DETECTOR FUNCTION	Peak (PK)
FREQUENCY RANGE	1GHz ~ 40GHz		Average (AV)

ANTENNA POLARITY & TEST DISTANCE: HORIZONTAL AT 3 M

NO.	FREQ. (MHz)	EMISSION LEVEL (dBuV/m)	LIMIT (dBuV/m)	MARGIN (dB)	ANTENNA HEIGHT (m)	TABLE ANGLE (Degree)	RAW VALUE (dBuV)	CORRECTION FACTOR (dB/m)
1	5460.00	57.7 PK	74.0	-16.3	1.82 H	139	52.0	5.7
2	5460.00	44.7 AV	54.0	-9.3	1.82 H	139	39.0	5.7
3	#5470.00	58.1 PK	74.0	-15.9	1.67 H	140	52.4	5.7
4	#5470.00	45.5 AV	54.0	-8.5	1.67 H	140	39.8	5.7
5	*5510.00	103.0 PK			1.14 H	139	63.4	39.6
6	*5510.00	93.0 AV			1.14 H	139	53.4	39.6
7	11020.00	60.2 PK	74.0	-13.8	2.29 H	243	40.6	19.6
8	11020.00	47.4 AV	54.0	-6.6	2.29 H	243	27.8	19.6

ANTENNA POLARITY & TEST DISTANCE: VERTICAL AT 3 M

NO.	FREQ. (MHz)	EMISSION LEVEL (dBuV/m)	LIMIT (dBuV/m)	MARGIN (dB)	ANTENNA HEIGHT (m)	TABLE ANGLE (Degree)	RAW VALUE (dBuV)	CORRECTION FACTOR (dB/m)
1	5460.00	61.8 PK	74.0	-12.2	1.99 V	203	56.1	5.7
2	5460.00	49.1 AV	54.0	-4.9	1.99 V	203	43.4	5.7
3	#5470.00	66.2 PK	74.0	-7.8	1.75 V	212	60.5	5.7
4	#5470.00	52.4 AV	54.0	-1.6	1.75 V	212	46.7	5.7
5	*5510.00	113.0 PK			1.47 V	8	73.4	39.6
6	*5510.00	102.9 AV			1.47 V	8	63.3	39.6
7	11020.00	61.6 PK	74.0	-12.4	2.50 V	9	42.0	19.6
8	11020.00	48.8 AV	54.0	-5.2	2.50 V	9	29.2	19.6

REMARKS:

1. Emission Level(dBuV/m) = Raw Value(dBuV) + Correction Factor(dB/m)
2. Correction Factor(dB/m) = Antenna Factor(dB/m) + Cable Factor(dB) – Pre-Amplifier Factor(dB)
3. The other emission levels were very low against the limit.
4. Margin value = Emission Level – Limit value
5. " * ": Fundamental frequency.
6. " # ": The radiated frequency is out of the restricted band.

CHANNEL	TX Channel 110	DETECTOR FUNCTION	Peak (PK)
FREQUENCY RANGE	1GHz ~ 40GHz		Average (AV)

ANTENNA POLARITY & TEST DISTANCE: HORIZONTAL AT 3 M

NO.	FREQ. (MHz)	EMISSION LEVEL (dBuV/m)	LIMIT (dBuV/m)	MARGIN (dB)	ANTENNA HEIGHT (m)	TABLE ANGLE (Degree)	RAW VALUE (dBuV)	CORRECTION FACTOR (dB/m)
1	*5550.00	105.4 PK			2.23 H	8	65.8	39.6
2	*5550.00	95.1 AV			2.23 H	8	55.5	39.6
3	11100.00	59.5 PK	74.0	-14.5	2.32 H	253	40.3	19.2
4	11100.00	47.2 AV	54.0	-6.8	2.32 H	253	28.0	19.2

ANTENNA POLARITY & TEST DISTANCE: VERTICAL AT 3 M

NO.	FREQ. (MHz)	EMISSION LEVEL (dBuV/m)	LIMIT (dBuV/m)	MARGIN (dB)	ANTENNA HEIGHT (m)	TABLE ANGLE (Degree)	RAW VALUE (dBuV)	CORRECTION FACTOR (dB/m)
1	*5550.00	113.5 PK			1.56 V	8	73.9	39.6
2	*5550.00	103.6 AV			1.56 V	8	64.0	39.6
3	11100.00	62.8 PK	74.0	-11.2	2.48 V	5	43.6	19.2
4	11100.00	50.5 AV	54.0	-3.5	2.48 V	5	31.3	19.2

REMARKS:

1. Emission Level(dBuV/m) = Raw Value(dBuV) + Correction Factor(dB/m)
2. Correction Factor(dB/m) = Antenna Factor(dB/m) + Cable Factor(dB) – Pre-Amplifier Factor(dB)
3. The other emission levels were very low against the limit.
4. Margin value = Emission Level – Limit value
5. " * ": Fundamental frequency.

CHANNEL	TX Channel 134	DETECTOR FUNCTION	Peak (PK)
FREQUENCY RANGE	1GHz ~ 40GHz		Average (AV)

ANTENNA POLARITY & TEST DISTANCE: HORIZONTAL AT 3 M

NO.	FREQ. (MHz)	EMISSION LEVEL (dBuV/m)	LIMIT (dBuV/m)	MARGIN (dB)	ANTENNA HEIGHT (m)	TABLE ANGLE (Degree)	RAW VALUE (dBuV)	CORRECTION FACTOR (dB/m)
1	*5670.00	105.0 PK			2.23 H	9	65.2	39.8
2	*5670.00	94.5 AV			2.23 H	9	54.7	39.8
3	#5725.00	56.9 PK	74.0	-17.1	2.53 H	11	50.6	6.3
4	#5725.00	44.3 AV	54.0	-9.7	2.53 H	11	38.0	6.3
5	11340.00	60.4 PK	74.0	-13.6	2.67 H	271	40.9	19.5
6	11340.00	47.8 AV	54.0	-6.2	2.67 H	271	28.3	19.5

ANTENNA POLARITY & TEST DISTANCE: VERTICAL AT 3 M

NO.	FREQ. (MHz)	EMISSION LEVEL (dBuV/m)	LIMIT (dBuV/m)	MARGIN (dB)	ANTENNA HEIGHT (m)	TABLE ANGLE (Degree)	RAW VALUE (dBuV)	CORRECTION FACTOR (dB/m)
1	*5670.00	114.0 PK			2.26 V	0	74.2	39.8
2	*5670.00	103.8 AV			2.26 V	0	64.0	39.8
3	#5725.00	61.0 PK	74.0	-13.0	1.88 V	4	54.7	6.3
4	#5725.00	47.7 AV	54.0	-6.3	1.88 V	4	41.4	6.3
5	11340.00	60.5 PK	74.0	-13.5	2.46 V	12	41.0	19.5
6	11340.00	48.1 AV	54.0	-5.9	2.46 V	12	28.6	19.5

REMARKS:

1. Emission Level(dBuV/m) = Raw Value(dBuV) + Correction Factor(dB/m)
2. Correction Factor(dB/m) = Antenna Factor(dB/m) + Cable Factor(dB) – Pre-Amplifier Factor(dB)
3. The other emission levels were very low against the limit.
4. Margin value = Emission Level – Limit value
5. " * ": Fundamental frequency.
6. " # ": The radiated frequency is out of the restricted band.



CHANNEL	TX Channel 142	DETECTOR FUNCTION	Peak (PK)
FREQUENCY RANGE	1GHz ~ 40GHz		Average (AV)

ANTENNA POLARITY & TEST DISTANCE: HORIZONTAL AT 3 M

NO.	FREQ. (MHz)	EMISSION LEVEL (dBuV/m)	LIMIT (dBuV/m)	MARGIN (dB)	ANTENNA HEIGHT (m)	TABLE ANGLE (Degree)	RAW VALUE (dBuV)	CORRECTION FACTOR (dB/m)
1	#5470.00	57.1 PK	74.0	-16.9	2.00 H	177	51.4	5.7
2	#5470.00	45.9 AV	54.0	-8.1	2.00 H	177	40.2	5.7
3	*5710.00	110.4 PK			1.62 H	220	70.4	40.0
4	*5710.00	100.4 AV			1.62 H	220	60.4	40.0
5	#5850.00	59.6 PK	74.0	-14.4	1.69 H	100	53.1	6.5
6	#5850.00	48.2 AV	54.0	-5.8	1.69 H	100	41.7	6.5
7	11420.00	61.8 PK	74.0	-12.2	1.86 H	291	42.5	19.3
8	11420.00	48.6 AV	54.0	-5.4	1.86 H	291	29.3	19.3

ANTENNA POLARITY & TEST DISTANCE: VERTICAL AT 3 M

NO.	FREQ. (MHz)	EMISSION LEVEL (dBuV/m)	LIMIT (dBuV/m)	MARGIN (dB)	ANTENNA HEIGHT (m)	TABLE ANGLE (Degree)	RAW VALUE (dBuV)	CORRECTION FACTOR (dB/m)
1	#5470.00	60.0 PK	74.0	-14.0	2.23 V	357	54.3	5.7
2	#5470.00	48.5 AV	54.0	-5.5	2.23 V	357	42.8	5.7
3	*5710.00	119.0 PK			2.14 V	19	79.0	40.0
4	*5710.00	108.8 AV			2.14 V	19	68.8	40.0
5	#5850.00	68.6 PK	74.0	-5.4	1.94 V	222	62.1	6.5
6	#5850.00	52.5 AV	54.0	-1.5	1.94 V	222	46.0	6.5
7	11420.00	64.3 PK	74.0	-9.7	2.66 V	346	45.0	19.3
8	11420.00	52.3 AV	54.0	-1.7	2.66 V	346	33.0	19.3

REMARKS:

1. Emission Level(dBuV/m) = Raw Value(dBuV) + Correction Factor(dB/m)
2. Correction Factor(dB/m) = Antenna Factor(dB/m) + Cable Factor(dB) – Pre-Amplifier Factor(dB)
3. The other emission levels were very low against the limit.
4. Margin value = Emission Level – Limit value
5. " * ": Fundamental frequency.
6. " # ": The radiated frequency is out of the restricted band.

802.11ac (VHT80)

CHANNEL	TX Channel 58	DETECTOR FUNCTION	Peak (PK)
FREQUENCY RANGE	1GHz ~ 40GHz		Average (AV)

ANTENNA POLARITY & TEST DISTANCE: HORIZONTAL AT 3 M

NO.	FREQ. (MHz)	EMISSION LEVEL (dBuV/m)	LIMIT (dBuV/m)	MARGIN (dB)	ANTENNA HEIGHT (m)	TABLE ANGLE (Degree)	RAW VALUE (dBuV)	CORRECTION FACTOR (dB/m)
1	5150.00	54.6 PK	74.0	-19.4	3.45 H	184	49.8	4.8
2	5150.00	42.1 AV	54.0	-11.9	3.45 H	184	37.3	4.8
3	*5290.00	98.2 PK			3.39 H	205	59.1	39.1
4	*5290.00	88.2 AV			3.39 H	205	49.1	39.1
5	5350.00	57.7 PK	74.0	-16.3	3.30 H	202	52.2	5.5
6	5350.00	45.3 AV	54.0	-8.7	3.30 H	202	39.8	5.5
7	#10580.00	58.4 PK	74.0	-15.6	2.17 H	225	39.8	18.6
8	#10580.00	45.9 AV	54.0	-8.1	2.17 H	225	27.3	18.6

ANTENNA POLARITY & TEST DISTANCE: VERTICAL AT 3 M

NO.	FREQ. (MHz)	EMISSION LEVEL (dBuV/m)	LIMIT (dBuV/m)	MARGIN (dB)	ANTENNA HEIGHT (m)	TABLE ANGLE (Degree)	RAW VALUE (dBuV)	CORRECTION FACTOR (dB/m)
1	5150.00	55.0 PK	74.0	-19.0	1.95 V	15	50.2	4.8
2	5150.00	42.3 AV	54.0	-11.7	1.95 V	15	37.5	4.8
3	*5290.00	107.5 PK			1.83 V	7	68.4	39.1
4	*5290.00	97.0 AV			1.83 V	7	57.9	39.1
5	5350.00	64.6 PK	74.0	-9.4	1.81 V	8	59.1	5.5
6	5350.00	52.3 AV	54.0	-1.7	1.81 V	8	46.8	5.5
7	#10580.00	58.6 PK	74.0	-15.4	2.65 V	4	40.0	18.6
8	#10580.00	46.4 AV	54.0	-7.6	2.65 V	4	27.8	18.6

REMARKS:

1. Emission Level(dBuV/m) = Raw Value(dBuV) + Correction Factor(dB/m)
2. Correction Factor(dB/m) = Antenna Factor(dB/m) + Cable Factor(dB) – Pre-Amplifier Factor(dB)
3. The other emission levels were very low against the limit.
4. Margin value = Emission Level – Limit value
5. " * ": Fundamental frequency.
6. " # ": The radiated frequency is out of the restricted band.

CHANNEL	TX Channel 106	DETECTOR FUNCTION	Peak (PK)
FREQUENCY RANGE	1GHz ~ 40GHz		Average (AV)

ANTENNA POLARITY & TEST DISTANCE: HORIZONTAL AT 3 M

NO.	FREQ. (MHz)	EMISSION LEVEL (dBuV/m)	LIMIT (dBuV/m)	MARGIN (dB)	ANTENNA HEIGHT (m)	TABLE ANGLE (Degree)	RAW VALUE (dBuV)	CORRECTION FACTOR (dB/m)
1	5460.00	56.7 PK	74.0	-17.3	2.40 H	3	51.0	5.7
2	5460.00	44.5 AV	54.0	-9.5	2.40 H	3	38.8	5.7
3	#5470.00	57.4 PK	74.0	-16.6	2.71 H	9	51.7	5.7
4	#5470.00	44.8 AV	54.0	-9.2	2.71 H	9	39.1	5.7
5	*5530.00	96.2 PK			2.24 H	7	56.6	39.6
6	*5530.00	85.8 AV			2.24 H	7	46.2	39.6
7	#5725.00	57.2 PK	74.0	-16.8	2.61 H	357	50.9	6.3
8	#5725.00	43.8 AV	54.0	-10.2	2.61 H	357	37.5	6.3
9	11060.00	59.2 PK	74.0	-14.8	2.32 H	227	39.9	19.3
10	11060.00	46.6 AV	54.0	-7.4	2.32 H	227	27.3	19.3

ANTENNA POLARITY & TEST DISTANCE: VERTICAL AT 3 M

NO.	FREQ. (MHz)	EMISSION LEVEL (dBuV/m)	LIMIT (dBuV/m)	MARGIN (dB)	ANTENNA HEIGHT (m)	TABLE ANGLE (Degree)	RAW VALUE (dBuV)	CORRECTION FACTOR (dB/m)
1	5460.00	64.9 PK	74.0	-9.1	2.23 V	169	59.2	5.7
2	5460.00	51.8 AV	54.0	-2.2	2.23 V	169	46.1	5.7
3	#5470.00	66.3 PK	74.0	-7.7	2.08 V	170	60.6	5.7
4	#5470.00	52.8 AV	54.0	-1.2	2.08 V	170	47.1	5.7
5	*5530.00	104.6 PK			1.51 V	8	65.0	39.6
6	*5530.00	94.3 AV			1.51 V	8	54.7	39.6
7	#5725.00	56.6 PK	74.0	-17.4	1.39 V	337	50.3	6.3
8	#5725.00	43.6 AV	54.0	-10.4	1.39 V	337	37.3	6.3
9	11060.00	60.0 PK	74.0	-14.0	2.63 V	9	40.7	19.3
10	11060.00	47.0 AV	54.0	-7.0	2.63 V	9	27.7	19.3

REMARKS:

1. Emission Level(dBuV/m) = Raw Value(dBuV) + Correction Factor(dB/m)
2. Correction Factor(dB/m) = Antenna Factor(dB/m) + Cable Factor(dB) – Pre-Amplifier Factor(dB)
3. The other emission levels were very low against the limit.
4. Margin value = Emission Level – Limit value
5. " * ": Fundamental frequency.
6. " # ": The radiated frequency is out of the restricted band.

CHANNEL	TX Channel 138	DETECTOR FUNCTION	Peak (PK)
FREQUENCY RANGE	1GHz ~ 40GHz		Average (AV)

ANTENNA POLARITY & TEST DISTANCE: HORIZONTAL AT 3 M

NO.	FREQ. (MHz)	EMISSION LEVEL (dBuV/m)	LIMIT (dBuV/m)	MARGIN (dB)	ANTENNA HEIGHT (m)	TABLE ANGLE (Degree)	RAW VALUE (dBuV)	CORRECTION FACTOR (dB/m)
1	#5470.00	57.6 PK	74.0	-16.4	1.70 H	241	51.9	5.7
2	#5470.00	45.9 AV	54.0	-8.1	1.70 H	241	40.2	5.7
3	*5690.00	101.7 PK			1.67 H	302	61.8	39.9
4	*5690.00	92.2 AV			1.67 H	302	52.3	39.9
5	#5850.00	58.5 PK	74.0	-15.5	1.74 H	237	52.0	6.5
6	#5850.00	46.6 AV	54.0	-7.4	1.74 H	237	40.1	6.5
7	11380.00	61.8 PK	74.0	-12.2	1.75 H	162	42.5	19.3
8	11380.00	49.0 AV	54.0	-5.0	1.75 H	162	29.7	19.3

ANTENNA POLARITY & TEST DISTANCE: VERTICAL AT 3 M

NO.	FREQ. (MHz)	EMISSION LEVEL (dBuV/m)	LIMIT (dBuV/m)	MARGIN (dB)	ANTENNA HEIGHT (m)	TABLE ANGLE (Degree)	RAW VALUE (dBuV)	CORRECTION FACTOR (dB/m)
1	#5470.00	60.4 PK	74.0	-13.6	2.37 V	96	54.7	5.7
2	#5470.00	49.1 AV	54.0	-4.9	2.37 V	96	43.4	5.7
3	*5690.00	117.4 PK			2.19 V	294	77.5	39.9
4	*5690.00	107.3 AV			2.19 V	294	67.4	39.9
5	#5850.00	66.9 PK	74.0	-7.1	2.67 V	235	60.4	6.5
6	#5850.00	52.4 AV	54.0	-1.6	2.67 V	235	45.9	6.5
7	11380.00	63.9 PK	74.0	-10.1	2.62 V	346	44.6	19.3
8	11380.00	51.1 AV	54.0	-2.9	2.62 V	346	31.8	19.3

REMARKS:

1. Emission Level(dBuV/m) = Raw Value(dBuV) + Correction Factor(dB/m)
2. Correction Factor(dB/m) = Antenna Factor(dB/m) + Cable Factor(dB) – Pre-Amplifier Factor(dB)
3. The other emission levels were very low against the limit.
4. Margin value = Emission Level – Limit value
5. " * ": Fundamental frequency.
6. " # ": The radiated frequency is out of the restricted band.

Below 1GHz worst-case data:

Mode A

802.11a

CHANNEL	TX Channel 52	DETECTOR FUNCTION	Quasi-Peak (QP)
FREQUENCY RANGE	30MHz ~ 1GHz		

ANTENNA POLARITY & TEST DISTANCE: HORIZONTAL AT 3 M								
NO.	FREQ. (MHz)	EMISSION LEVEL (dBuV/m)	LIMIT (dBuV/m)	MARGIN (dB)	ANTENNA HEIGHT (m)	TABLE ANGLE (Degree)	RAW VALUE (dBuV)	CORRECTION FACTOR (dB/m)
1	57.12	30.2 QP	40.0	-9.8	2.00 H	82	44.8	-14.6
2	125.17	37.0 QP	43.5	-6.5	1.50 H	250	53.1	-16.1
3	247.66	38.7 QP	46.0	-7.3	1.00 H	139	52.8	-14.1
4	374.04	39.2 QP	46.0	-6.8	1.00 H	86	49.7	-10.5
5	624.85	38.2 QP	46.0	-7.8	1.00 H	151	42.9	-4.7
6	875.67	40.9 QP	46.0	-5.1	1.50 H	114	41.0	-0.1
ANTENNA POLARITY & TEST DISTANCE: VERTICAL AT 3 M								
NO.	FREQ. (MHz)	EMISSION LEVEL (dBuV/m)	LIMIT (dBuV/m)	MARGIN (dB)	ANTENNA HEIGHT (m)	TABLE ANGLE (Degree)	RAW VALUE (dBuV)	CORRECTION FACTOR (dB/m)
1	38.88	35.6 QP	40.0	-4.4	1.06 V	325	50.8	-15.2
2	57.12	37.0 QP	40.0	-3.0	1.00 V	19	51.6	-14.6
3	99.89	38.2 QP	43.5	-5.3	1.00 V	218	57.0	-18.8
4	125.00	40.7 QP	43.5	-2.8	1.00 V	203	56.8	-16.1
5	374.04	38.0 QP	46.0	-8.0	1.50 V	61	48.5	-10.5
6	875.67	38.7 QP	46.0	-7.3	1.50 V	16	38.8	-0.1

REMARKS:

1. Emission Level(dBuV/m) = Raw Value(dBuV) + Correction Factor(dB/m)
2. Correction Factor(dB/m) = Antenna Factor(dB/m) + Cable Factor(dB)
3. The other emission levels were very low against the limit.
4. Margin value = Emission Level – Limit value

Mode B

802.11a

CHANNEL	TX Channel 52	DETECTOR FUNCTION	Quasi-Peak (QP)
FREQUENCY RANGE	30MHz ~ 1GHz		

ANTENNA POLARITY & TEST DISTANCE: HORIZONTAL AT 3 M

NO.	FREQ. (MHz)	EMISSION LEVEL (dBuV/m)	LIMIT (dBuV/m)	MARGIN (dB)	ANTENNA HEIGHT (m)	TABLE ANGLE (Degree)	RAW VALUE (dBuV)	CORRECTION FACTOR (dB/m)
1	70.73	31.9 QP	40.0	-8.1	2.00 H	261	48.4	-16.5
2	152.39	31.4 QP	43.5	-12.1	1.50 H	132	45.1	-13.7
3	249.60	43.0 QP	46.0	-3.0	1.00 H	151	57.0	-14.0
4	374.04	36.6 QP	46.0	-9.4	2.00 H	139	47.1	-10.5
5	624.85	36.1 QP	46.0	-9.9	1.00 H	149	40.8	-4.7
6	875.67	42.0 QP	46.0	-4.0	1.50 H	128	42.1	-0.1

ANTENNA POLARITY & TEST DISTANCE: VERTICAL AT 3 M

NO.	FREQ. (MHz)	EMISSION LEVEL (dBuV/m)	LIMIT (dBuV/m)	MARGIN (dB)	ANTENNA HEIGHT (m)	TABLE ANGLE (Degree)	RAW VALUE (dBuV)	CORRECTION FACTOR (dB/m)
1	33.79	37.4 QP	40.0	-2.6	1.00 V	270	53.1	-15.7
2	51.29	35.8 QP	40.0	-4.2	1.00 V	8	50.1	-14.3
3	70.73	37.1 QP	40.0	-2.9	1.00 V	146	53.6	-16.5
4	249.60	37.0 QP	46.0	-9.0	1.50 V	173	51.0	-14.0
5	374.04	38.5 QP	46.0	-7.5	1.50 V	340	49.0	-10.5
6	875.67	39.2 QP	46.0	-6.8	1.50 V	17	39.3	-0.1

REMARKS:

1. Emission Level(dBuV/m) = Raw Value(dBuV) + Correction Factor(dB/m)
2. Correction Factor(dB/m) = Antenna Factor(dB/m) + Cable Factor(dB)
3. The other emission levels were very low against the limit.
4. Margin value = Emission Level – Limit value

Mode C

802.11a

CHANNEL	TX Channel 52	DETECTOR FUNCTION	Quasi-Peak (QP)
FREQUENCY RANGE	30MHz ~ 1GHz		

ANTENNA POLARITY & TEST DISTANCE: HORIZONTAL AT 3 M								
NO.	FREQ. (MHz)	EMISSION LEVEL (dBuV/m)	LIMIT (dBuV/m)	MARGIN (dB)	ANTENNA HEIGHT (m)	TABLE ANGLE (Degree)	RAW VALUE (dBuV)	CORRECTION FACTOR (dB/m)
1	57.12	29.9 QP	40.0	-10.1	2.00 H	109	44.5	-14.6
2	154.33	31.0 QP	43.5	-12.5	2.00 H	252	44.7	-13.7
3	241.83	34.4 QP	46.0	-11.6	1.50 H	229	48.8	-14.4
4	374.04	36.4 QP	46.0	-9.6	1.00 H	65	46.9	-10.5
5	533.47	33.0 QP	46.0	-13.0	1.50 H	224	40.4	-7.4
6	624.85	35.2 QP	46.0	-10.8	1.50 H	210	39.9	-4.7
ANTENNA POLARITY & TEST DISTANCE: VERTICAL AT 3 M								
NO.	FREQ. (MHz)	EMISSION LEVEL (dBuV/m)	LIMIT (dBuV/m)	MARGIN (dB)	ANTENNA HEIGHT (m)	TABLE ANGLE (Degree)	RAW VALUE (dBuV)	CORRECTION FACTOR (dB/m)
1	55.18	38.1 QP	40.0	-1.9	1.00 V	319	52.5	-14.4
2	66.84	35.1 QP	40.0	-4.9	1.00 V	333	50.9	-15.8
3	125.17	34.9 QP	43.5	-8.6	1.00 V	240	51.0	-16.1
4	263.21	30.4 QP	46.0	-15.6	1.99 V	16	43.9	-13.5
5	374.04	35.4 QP	46.0	-10.6	1.49 V	62	45.9	-10.5
6	875.67	40.5 QP	46.0	-5.5	1.00 V	231	40.6	-0.1

REMARKS:

1. Emission Level(dBuV/m) = Raw Value(dBuV) + Correction Factor(dB/m)
2. Correction Factor(dB/m) = Antenna Factor(dB/m) + Cable Factor(dB)
3. The other emission levels were very low against the limit.
4. Margin value = Emission Level – Limit value

Mode D

802.11a

CHANNEL	TX Channel 52	DETECTOR FUNCTION	Quasi-Peak (QP)
FREQUENCY RANGE	30MHz ~ 1GHz		

ANTENNA POLARITY & TEST DISTANCE: HORIZONTAL AT 3 M

NO.	FREQ. (MHz)	EMISSION LEVEL (dBuV/m)	LIMIT (dBuV/m)	MARGIN (dB)	ANTENNA HEIGHT (m)	TABLE ANGLE (Degree)	RAW VALUE (dBuV)	CORRECTION FACTOR (dB/m)
1	70.73	31.6 QP	40.0	-8.4	1.00 H	259	48.1	-16.5
2	154.33	27.9 QP	43.5	-15.6	1.50 H	252	41.6	-13.7
3	241.83	36.4 QP	46.0	-9.6	1.00 H	250	50.8	-14.4
4	374.04	36.4 QP	46.0	-9.6	1.00 H	103	46.9	-10.5
5	624.85	35.4 QP	46.0	-10.6	1.00 H	232	40.1	-4.7
6	875.67	35.5 QP	46.0	-10.5	1.99 H	111	35.6	-0.1

ANTENNA POLARITY & TEST DISTANCE: VERTICAL AT 3 M

NO.	FREQ. (MHz)	EMISSION LEVEL (dBuV/m)	LIMIT (dBuV/m)	MARGIN (dB)	ANTENNA HEIGHT (m)	TABLE ANGLE (Degree)	RAW VALUE (dBuV)	CORRECTION FACTOR (dB/m)
1	43.51	36.1 QP	40.0	-3.9	1.00 V	4	50.9	-14.8
2	70.73	37.8 QP	40.0	-2.2	1.00 V	169	54.3	-16.5
3	125.17	30.8 QP	43.5	-12.7	1.00 V	256	46.9	-16.1
4	245.72	31.5 QP	46.0	-14.5	2.00 V	15	45.6	-14.1
5	374.04	36.4 QP	46.0	-9.6	1.50 V	80	46.9	-10.5
6	875.67	40.6 QP	46.0	-5.4	1.00 V	233	40.7	-0.1

REMARKS:

1. Emission Level(dBuV/m) = Raw Value(dBuV) + Correction Factor(dB/m)
2. Correction Factor(dB/m) = Antenna Factor(dB/m) + Cable Factor(dB)
3. The other emission levels were very low against the limit.
4. Margin value = Emission Level – Limit value

4.2 Conducted Emission Measurement

4.2.1 Limits of Conducted Emission Measurement

Frequency (MHz)	Conducted Limit (dBuV)	
	Quasi-peak	Average
0.15 - 0.5	66 - 56	56 - 46
0.50 - 5.0	56	46
5.0 - 30.0	60	50

- Note:** 1. The lower limit shall apply at the transition frequencies.
 2. The limit decreases in line with the logarithm of the frequency in the range of 0.15 to 0.50MHz.

4.2.2 Test Instruments

Tested Date: Nov. 02, 2016

Description & Manufacturer	Model No.	Serial No.	Date Of Calibration	Due Date Of Calibration
Test Receiver ROHDE & SCHWARZ	ESCI	100424	Oct. 24, 2016	Oct. 23, 2017
RF signal cable (with 10dB PAD) Woken	5D-FB	Cable-cond1-01	Dec. 26, 2015	Dec. 25, 2016
LISN ROHDE & SCHWARZ (EUT)	ESH3-Z5	835239/001	Feb. 26, 2016	Feb. 25, 2017
LISN ROHDE & SCHWARZ (Peripheral)	ESH3-Z5	100311	Jul. 28, 2016	Jul. 27, 2017
Software ADT	BV ADT_Cond_ V7.3.7.3	NA	NA	NA

- Note:** 1. The calibration interval of the above test instruments is 12 months and the calibrations are traceable to NML/ROC and NIST/USA.
 2. The test was performed in HwaYa Shielded Room 1.
 3. The VCCI Site Registration No. is C-2040.

4.2.3 Test Procedures

- The EUT was placed 0.4 meters from the conducting wall of the shielded room with EUT being connected to the power mains through a line impedance stabilization network (LISN). Other support units were connected to the power mains through another LISN. The two LISNs provide 50 ohm/ 50uH of coupling impedance for the measuring instrument.
- Both lines of the power mains connected to the EUT were checked for maximum conducted interference.
- The frequency range from 150kHz to 30MHz was searched. Emission levels under (Limit - 20dB) was not recorded.

NOTE: The resolution bandwidth and video bandwidth of test receiver is 9kHz for quasi-peak detection (QP) and average detection (AV) at frequency 0.15MHz-30MHz.

4.2.4 Deviation from Test Standard

No deviation.

4.2.5 Test Setup

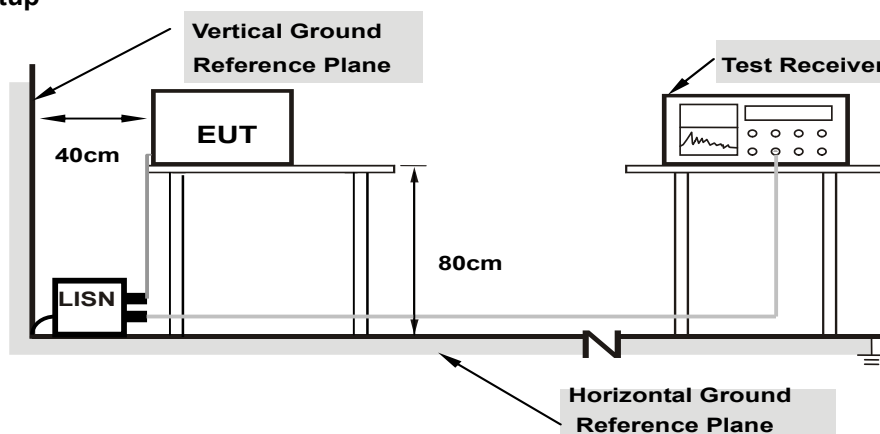

Note: 1.Support units were connected to second LISN.

For the actual test configuration, please refer to the attached file (Test Setup Photo).

4.2.6 EUT Operating Conditions

Same as 4.1.6.

4.2.7 Test Results

Phase	Line (L)	Detector Function	Quasi-Peak (QP) / Average (AV)
Test Mode	A		

No	Freq. [MHz]	Corr. Factor (dB)	Reading Value		Emission Level		Limit		Margin	
			[dB (uV)]		[dB (uV)]		[dB (uV)]		(dB)	
			Q.P.	AV.	Q.P.	AV.	Q.P.	AV.	Q.P.	AV.
1	0.15781	10.18	31.39	16.87	41.57	27.05	65.58	55.58	-24.01	-28.53
2	0.18906	10.20	28.42	16.63	38.62	26.83	64.08	54.08	-25.46	-27.25
3	0.37853	10.24	16.39	14.00	26.63	24.24	58.31	48.31	-31.68	-24.07
4	0.50084	10.25	26.36	25.59	36.61	35.84	56.00	46.00	-19.39	-10.16
5	3.64844	10.40	16.35	5.88	26.75	16.28	56.00	46.00	-29.25	-29.72
6	7.86328	10.49	18.35	10.01	28.84	20.50	60.00	50.00	-31.16	-29.50

REMARKS:

1. Q.P. and AV. are abbreviations of quasi-peak and average individually.
2. The emission levels of other frequencies were very low against the limit.
3. Margin value = Emission level - Limit value
4. Correction factor = Insertion loss + Cable loss
5. Emission Level = Correction Factor + Reading Value.

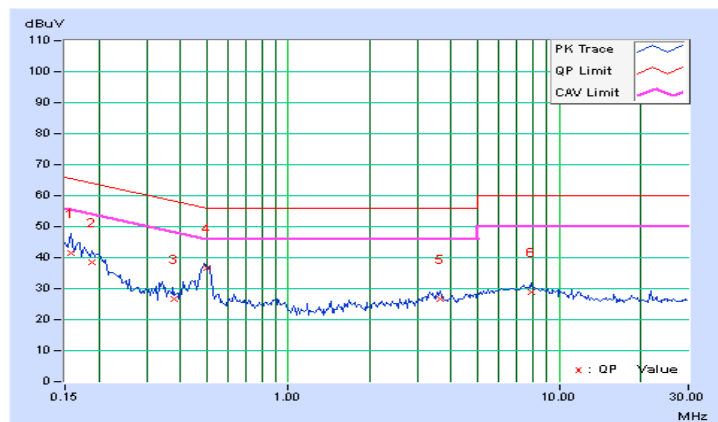

Phase	Neutral (N)	Detector Function	Quasi-Peak (QP) / Average (AV)
Test Mode	A		

No	Freq. [MHz]	Corr. Factor (dB)	Reading Value [dB (uV)]		Emission Level [dB (uV)]		Limit [dB (uV)]		Margin (dB)	
			Q.P.	AV.	Q.P.	AV.	Q.P.	AV.	Q.P.	AV.
			1	0.15000	10.19	33.44	17.97	43.63	28.16	66.00
2	0.18516	10.20	26.88	13.93	37.08	24.13	64.25	54.25	-27.17	-30.12
3	0.22422	10.21	21.86	9.25	32.07	19.46	62.66	52.66	-30.59	-33.20
4	0.49894	10.30	25.28	23.57	35.58	33.87	56.02	46.02	-20.44	-12.15
5	0.97539	10.29	13.56	10.97	23.85	21.26	56.00	46.00	-32.15	-24.74
6	7.72656	10.59	17.50	10.82	28.09	21.41	60.00	50.00	-31.91	-28.59

REMARKS:

1. Q.P. and AV. are abbreviations of quasi-peak and average individually.
2. The emission levels of other frequencies were very low against the limit.
3. Margin value = Emission level - Limit value
4. Correction factor = Insertion loss + Cable loss
5. Emission Level = Correction Factor + Reading Value.

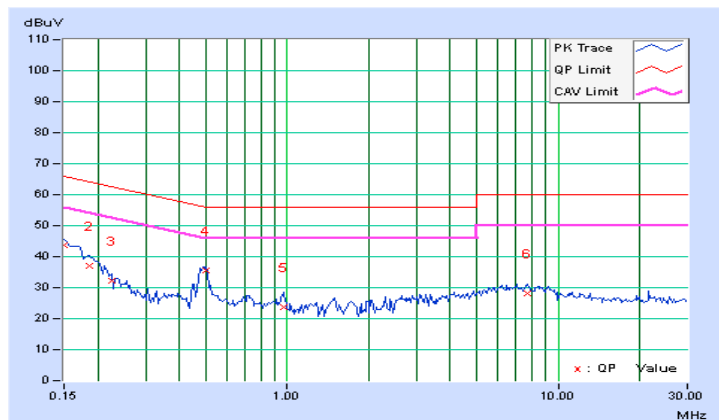

Phase	Line (L)	Detector Function	Quasi-Peak (QP) / Average (AV)
Test Mode	B		

No	Freq. [MHz]	Corr. Factor (dB)	Reading Value [dB (uV)]		Emission Level [dB (uV)]		Limit [dB (uV)]		Margin (dB)	
			Q.P.	AV.	Q.P.	AV.	Q.P.	AV.	Q.P.	AV.
			1	0.15000	10.18	42.27	27.78	52.45	37.96	66.00
2	0.18125	10.20	36.67	21.68	46.87	31.88	64.43	54.43	-17.56	-22.55
3	0.22812	10.21	29.83	17.27	40.04	27.48	62.52	52.52	-22.48	-25.04
4	0.53273	10.26	33.90	29.38	44.16	39.64	56.00	46.00	-11.84	-6.36
5	3.37891	10.40	22.28	17.70	32.68	28.10	56.00	46.00	-23.32	-17.90
6	11.31641	10.54	28.64	23.64	39.18	34.18	60.00	50.00	-20.82	-15.82

REMARKS:

1. Q.P. and AV. are abbreviations of quasi-peak and average individually.
2. The emission levels of other frequencies were very low against the limit.
3. Margin value = Emission level - Limit value
4. Correction factor = Insertion loss + Cable loss
5. Emission Level = Correction Factor + Reading Value.

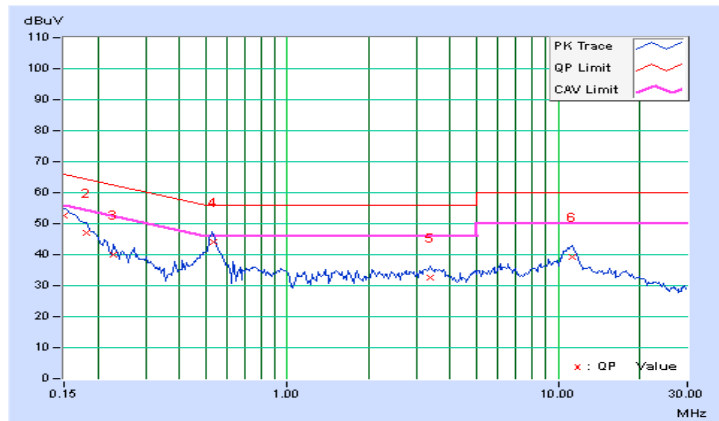

Phase	Neutral (N)	Detector Function	Quasi-Peak (QP) / Average (AV)
Test Mode	B		

No	Freq. [MHz]	Corr. Factor (dB)	Reading Value [dB (uV)]		Emission Level [dB (uV)]		Limit [dB (uV)]		Margin (dB)	
			Q.P.	AV.	Q.P.	AV.	Q.P.	AV.	Q.P.	AV.
			1	0.15000	10.19	41.88	27.17	52.07	37.36	66.00
2	0.18125	10.20	36.45	21.22	46.65	31.42	64.43	54.43	-17.78	-23.01
3	0.24375	10.22	26.83	14.14	37.05	24.36	61.97	51.97	-24.92	-27.61
4	0.53273	10.30	34.38	30.05	44.68	40.35	56.00	46.00	-11.32	-5.65
5	3.19922	10.49	18.23	13.12	28.72	23.61	56.00	46.00	-27.28	-22.39
6	11.00781	10.63	26.01	20.75	36.64	31.38	60.00	50.00	-23.36	-18.62

REMARKS:

1. Q.P. and AV. are abbreviations of quasi-peak and average individually.
2. The emission levels of other frequencies were very low against the limit.
3. Margin value = Emission level - Limit value
4. Correction factor = Insertion loss + Cable loss
5. Emission Level = Correction Factor + Reading Value.

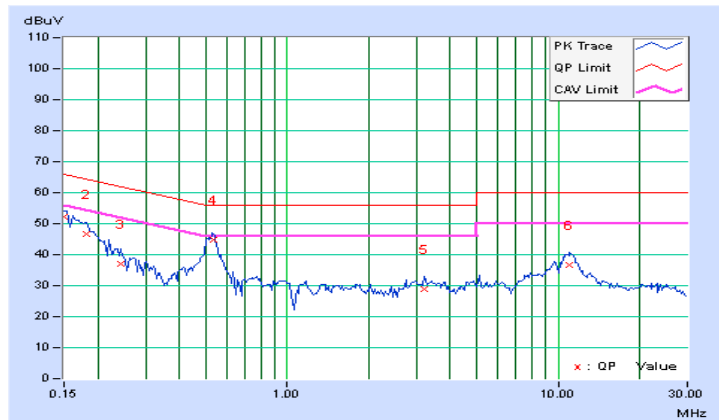

Phase	Line (L)	Detector Function	Quasi-Peak (QP) / Average (AV)
Test Mode	C		

No	Freq. [MHz]	Corr. Factor (dB)	Reading Value [dB (uV)]		Emission Level [dB (uV)]		Limit [dB (uV)]		Margin (dB)	
			Q.P.	AV.	Q.P.	AV.	Q.P.	AV.	Q.P.	AV.
			1	0.15000	10.18	34.12	20.17	44.30	30.35	66.00
2	0.18906	10.20	29.74	16.84	39.94	27.04	64.08	54.08	-24.14	-27.04
3	0.23984	10.22	20.28	9.27	30.50	19.49	62.10	52.10	-31.60	-32.61
4	0.49901	10.25	26.80	25.98	37.05	36.23	56.02	46.02	-18.97	-9.79
5	0.94688	10.30	15.28	9.27	25.58	19.57	56.00	46.00	-30.42	-26.43
6	7.37891	10.48	18.71	11.15	29.19	21.63	60.00	50.00	-30.81	-28.37

REMARKS:

1. Q.P. and AV. are abbreviations of quasi-peak and average individually.
2. The emission levels of other frequencies were very low against the limit.
3. Margin value = Emission level - Limit value
4. Correction factor = Insertion loss + Cable loss
5. Emission Level = Correction Factor + Reading Value.

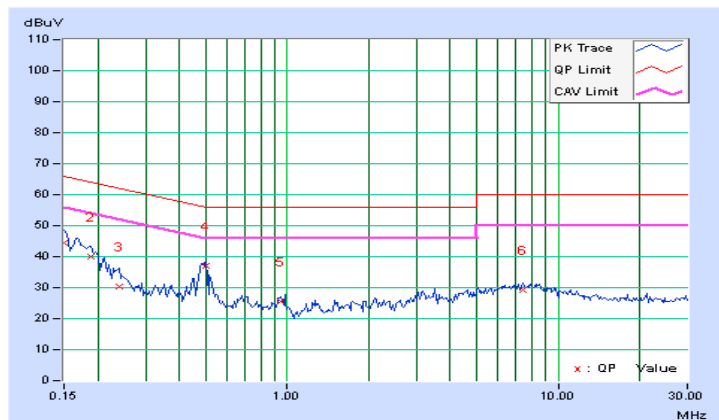

Phase	Neutral (N)	Detector Function	Quasi-Peak (QP) / Average (AV)
Test Mode	C		

No	Freq. [MHz]	Corr. Factor (dB)	Reading Value [dB (uV)]		Emission Level [dB (uV)]		Limit [dB (uV)]		Margin (dB)	
			Q.P.	AV.	Q.P.	AV.	Q.P.	AV.	Q.P.	AV.
			1	0.15391	10.19	32.88	17.55	43.07	27.74	65.79
2	0.18516	10.20	29.19	15.09	39.39	25.29	64.25	54.25	-24.86	-28.96
3	0.23203	10.22	20.24	9.33	30.46	19.55	62.38	52.38	-31.92	-32.83
4	0.49865	10.30	25.30	23.65	35.60	33.95	56.02	46.02	-20.42	-12.07
5	0.89609	10.29	15.41	6.79	25.70	17.08	56.00	46.00	-30.30	-28.92
6	8.69531	10.60	17.31	10.57	27.91	21.17	60.00	50.00	-32.09	-28.83

REMARKS:

1. Q.P. and AV. are abbreviations of quasi-peak and average individually.
2. The emission levels of other frequencies were very low against the limit.
3. Margin value = Emission level - Limit value
4. Correction factor = Insertion loss + Cable loss
5. Emission Level = Correction Factor + Reading Value.

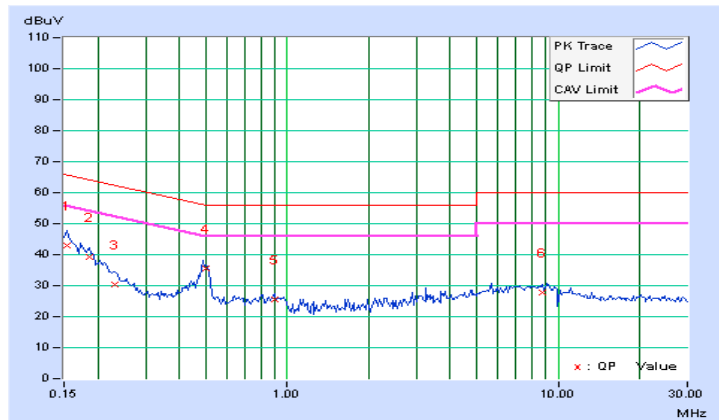

Phase	Line (L)	Detector Function	Quasi-Peak (QP) / Average (AV)
Test Mode	D		

No	Freq. [MHz]	Corr. Factor (dB)	Reading Value [dB (uV)]		Emission Level [dB (uV)]		Limit [dB (uV)]		Margin (dB)	
			Q.P.	AV.	Q.P.	AV.	Q.P.	AV.	Q.P.	AV.
			1	0.15000	10.18	42.78	28.10	52.96	38.28	66.00
2	0.18125	10.20	37.05	22.01	47.25	32.21	64.43	54.43	-17.18	-22.22
3	0.23203	10.21	29.93	17.79	40.14	28.00	62.38	52.38	-22.24	-24.38
4	0.53536	10.26	33.86	29.52	44.12	39.78	56.00	46.00	-11.88	-6.22
5	3.17188	10.40	22.10	17.39	32.50	27.79	56.00	46.00	-23.50	-18.21
6	11.28906	10.54	28.70	23.76	39.24	34.30	60.00	50.00	-20.76	-15.70

REMARKS:

1. Q.P. and AV. are abbreviations of quasi-peak and average individually.
2. The emission levels of other frequencies were very low against the limit.
3. Margin value = Emission level - Limit value
4. Correction factor = Insertion loss + Cable loss
5. Emission Level = Correction Factor + Reading Value.

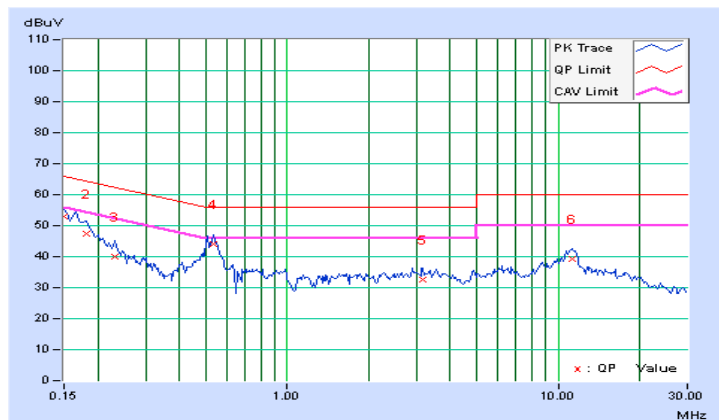

Phase	Neutral (N)	Detector Function	Quasi-Peak (QP) / Average (AV)
Test Mode	D		

No	Freq. [MHz]	Corr. Factor (dB)	Reading Value [dB (uV)]		Emission Level [dB (uV)]		Limit [dB (uV)]		Margin (dB)	
			Q.P.	AV.	Q.P.	AV.	Q.P.	AV.	Q.P.	AV.
			1	0.15391	10.19	42.78	27.92	52.97	38.11	65.79
2	0.19687	10.20	34.82	19.86	45.02	30.06	63.74	53.74	-18.72	-23.68
3	0.25156	10.23	28.32	17.34	38.55	27.57	61.71	51.71	-23.16	-24.14
4	0.53039	10.30	34.93	30.62	45.23	40.92	56.00	46.00	-10.77	-5.08
5	0.90781	10.29	16.73	13.30	27.02	23.59	56.00	46.00	-28.98	-22.41
6	11.38281	10.64	26.54	21.24	37.18	31.88	60.00	50.00	-22.82	-18.12

REMARKS:

1. Q.P. and AV. are abbreviations of quasi-peak and average individually.
2. The emission levels of other frequencies were very low against the limit.
3. Margin value = Emission level - Limit value
4. Correction factor = Insertion loss + Cable loss
5. Emission Level = Correction Factor + Reading Value.

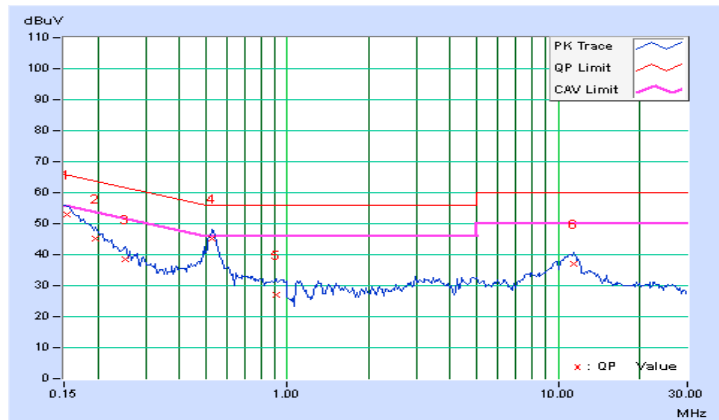

4.3 Transmit Power Measurement

4.3.1 Limits of Transmit Power Measurement

Operation Band	EUT Category		LIMIT
U-NII-1	-	Outdoor Access Point	1 Watt (30 dBm) (Max. e.i.r.p \leq 125mW(21 dBm) at any elevation angle above 30 degrees as measured from the horizon)
	-	Fixed point-to-point Access Point	1 Watt (30 dBm)
	-	Indoor Access Point	1 Watt (30 dBm)
	-	Mobile and Portable client device	250mW (24 dBm)
U-NII-2A	√		250mW (24 dBm) or 11 dBm+10 log B*
U-NII-2C	√		250mW (24 dBm) or 11 dBm+10 log B*
U-NII-3	-		1 Watt (30 dBm)

*B is the 26 dB emission bandwidth in megahertz

Per KDB 662911 Method of conducted output power measurement on IEEE 802.11 devices,

Array Gain = 0 dB (i.e., no array gain) for $N_{ANT} \leq 4$;

Array Gain = 0 dB (i.e., no array gain) for channel widths ≥ 40 MHz for any N_{ANT} ;

Array Gain = $5 \log(N_{ANT}/N_{SS})$ dB or 3 dB, whichever is less for 20-MHz channel widths with $N_{ANT} \geq 5$.

For power measurements on all other devices: Array Gain = $10 \log(N_{ANT}/N_{SS})$ dB.

4.3.2 Test Setup

For Power Output Measurement

For 802.11a, 802.11ac (VHT20), 802.11ac (VHT40)

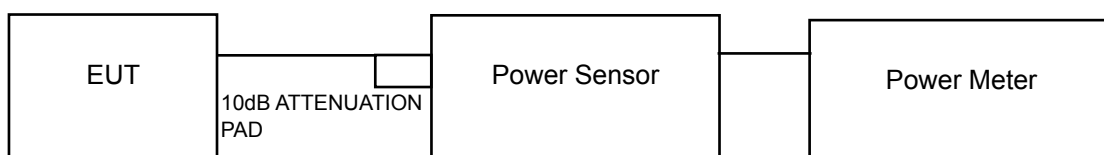

For 802.11ac (VHT80)

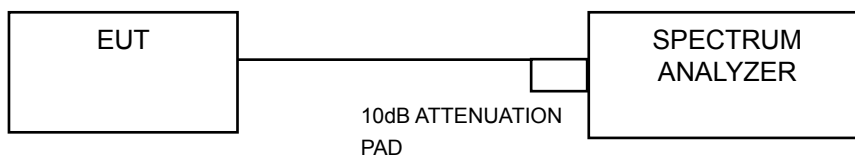

For 26dB and Occupied Bandwidth

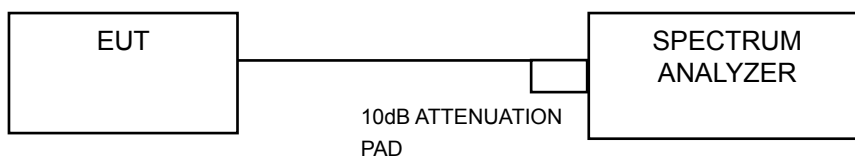

4.3.3 Test Instruments

Refer to section 4.1.2 to get information of above instrument.

4.3.4 Test Procedure

FOR AVERAGE POWER MEASUREMENT

For 802.11a, 802.11ac (VHT20), 802.11ac (VHT40)

Method PM is used to perform output power measurement, trigger and gating function of wide band power meter is enabled to measure max output power of TX on burst. Duty factor is not added to measured value.

For 802.11ac (VHT80)

- 1) Set span to encompass the entire 26 dB EBW (or, alternatively, the entire 99% occupied bandwidth) of the signal.
- 2) Set sweep trigger to "free run".
- 3) Set RBW = 1 MHz.
- 4) Set VBW \geq 3 MHz
- 5) Number of points in sweep \geq 2 Span / RBW.
- 6) Sweep time \leq (number of points in sweep) * T
- 7) Using emission bandwidth to determine the frequency span for integration the channel bandwidth.
- 8) Detector = RMS.
- 9) Trace mode = max hold.
- 10) Allow max hold to run for at least 60 seconds, or longer as needed to allow the trace to stabilize.

FOR 26dB BANDWIDTH

- 1) Set RBW = approximately 1% of the emission bandwidth.
- 2) Set the VBW > RBW.
- 3) Detector = Peak.
- 4) Trace mode = max hold.
- 5) Measure the maximum width of the emission that is 26 dB down from the peak of the emission. Compare this with the RBW setting of the analyzer. Readjust RBW and repeat measurement as needed until the RBW/EBW ratio is approximately 1%.

FOR OCCUPIED BANDWIDTH

The transmitter output was connected to the spectrum analyzer through an attenuator. The bandwidth of the fundamental frequency was measured by spectrum analyzer with resolution bandwidth in the range of 1% to 5% of the anticipated emission bandwidth, and a video bandwidth at least 3x the resolution bandwidth and set the detector to Sampling. The width of a frequency band such that, below the lower and above the upper frequency limits, the mean powers emitted are each equal to a specified percentage 0.5 % of the total mean power of a given emission.

4.3.5 Deviation from Test Standard

No deviation.

4.3.6 EUT Operating Conditions

The software provided by client to enable the EUT under transmission condition continuously at lowest, middle and highest channel frequencies individually.

4.3.7 Test Result

POWER OUTPUT:

CDD Mode

802.11a

Chan.	Freq. (MHz)	Maximum Conducted Power (dBm)				Total Power (mW)	Total Power (dBm)	Power Limit (dBm)	Pass / Fail
		Chain 0	Chain 1	Chain 2	Chain 3				
52	5260	12.07	12.38	12.12	12.35	66.876	18.25	23.96	Pass
60	5300	12.31	12.36	12.23	12.29	67.895	18.32	23.91	Pass
64	5320	12.32	12.44	12.38	12.17	68.380	18.35	23.92	Pass
100	5500	11.58	11.64	11.30	11.37	56.175	17.50	23.94	Pass
116	5580	11.43	11.62	11.44	11.15	55.385	17.43	23.88	Pass
140	5700	11.11	11.56	11.47	11.19	54.414	17.36	23.96	Pass
144	5720 For U-NII-2C	11.37	11.37	11.07	11.38	56.083	17.49	22.64	Pass
144	5720 For U-NII-3	7.06	8.30	8.54	6.49	24.371	13.87	30.00	Pass

Note:

Chain 0

1. $11\text{dBm} + 10\log(20.08) = 24.03\text{ dBm} > 24\text{dBm}$.
2. $11\text{dBm} + 10\log(19.97) = 24.00\text{ dBm} > 24\text{dBm}$.
3. $11\text{dBm} + 10\log(20.16) = 24.04\text{ dBm} > 24\text{dBm}$.
4. $11\text{dBm} + 10\log(19.96) = 24.00\text{ dBm} > 24\text{dBm}$.
5. $11\text{dBm} + 10\log(20.12) = 24.04\text{ dBm} > 24\text{dBm}$.
6. $11\text{dBm} + 10\log(20.08) = 24.03\text{ dBm} > 24\text{dBm}$.
7. $11\text{dBm} + 10\log(5725.00 - 5709.81) = 22.82\text{ dBm} < 24\text{dBm}$.

Chain 1

1. $11\text{dBm} + 10\log(20.14) = 24.04\text{ dBm} > 24\text{dBm}$.
2. $11\text{dBm} + 10\log(20.00) = 24.01\text{ dBm} > 24\text{dBm}$.
3. $11\text{dBm} + 10\log(19.98) = 24.01\text{ dBm} > 24\text{dBm}$.
4. $11\text{dBm} + 10\log(19.85) = 23.98\text{ dBm} < 24\text{dBm}$.
5. $11\text{dBm} + 10\log(20.09) = 24.03\text{ dBm} > 24\text{dBm}$.
6. $11\text{dBm} + 10\log(19.77) = 23.96\text{ dBm} < 24\text{dBm}$.
7. $11\text{dBm} + 10\log(5725.00 - 5704.81) = 24.05\text{ dBm} > 24\text{dBm}$.

Chain 2

1. $11\text{dBm} + 10\log(19.78) = 23.96\text{ dBm} < 24\text{dBm}$.
2. $11\text{dBm} + 10\log(20.27) = 24.07\text{ dBm} > 24\text{dBm}$.
3. $11\text{dBm} + 10\log(20.13) = 24.04\text{ dBm} > 24\text{dBm}$.
4. $11\text{dBm} + 10\log(19.72) = 23.95\text{ dBm} < 24\text{dBm}$.
5. $11\text{dBm} + 10\log(19.43) = 23.88\text{ dBm} < 24\text{dBm}$.
6. $11\text{dBm} + 10\log(20.01) = 24.01\text{ dBm} > 24\text{dBm}$.
7. $11\text{dBm} + 10\log(5725.00 - 5704.79) = 24.06\text{ dBm} > 24\text{dBm}$.

Chain 3

1. $11\text{dBm} + 10\log(19.80) = 23.96\text{ dBm} < 24\text{dBm}$.
2. $11\text{dBm} + 10\log(19.58) = 23.91\text{ dBm} < 24\text{dBm}$.
3. $11\text{dBm} + 10\log(19.59) = 23.92\text{ dBm} < 24\text{dBm}$.
4. $11\text{dBm} + 10\log(19.72) = 23.94\text{ dBm} < 24\text{dBm}$.
5. $11\text{dBm} + 10\log(19.45) = 23.88\text{ dBm} < 24\text{dBm}$.
6. $11\text{dBm} + 10\log(19.92) = 23.99\text{ dBm} < 24\text{dBm}$.
7. $11\text{dBm} + 10\log(5725.00 - 5710.40) = 22.64\text{ dBm} < 24\text{dBm}$.

802.11ac (VHT20)

Chan.	Freq. (MHz)	Maximum Conducted Power (dBm)				Total Power (mW)	Total Power (dBm)	Power Limit (dBm)	Pass / Fail
		Chain 0	Chain 1	Chain 2	Chain 3				
52	5260	12.22	12.64	12.43	12.45	70.114	18.46	24.00	Pass
60	5300	12.45	12.66	12.61	12.52	72.133	18.58	24.00	Pass
64	5320	12.64	12.77	12.60	12.43	72.983	18.63	24.00	Pass
100	5500	12.28	12.51	12.11	12.11	67.238	18.28	24.00	Pass
116	5580	11.76	11.94	11.84	11.32	59.456	17.74	24.00	Pass
140	5700	11.31	11.70	11.74	11.49	57.333	17.58	24.00	Pass
144	5720 For U-NII-2C	11.21	11.10	10.95	11.03	51.217	17.09	22.82	Pass
144	5720 For U-NII-3	6.53	7.96	7.88	6.58	21.438	13.31	30.00	Pass

Note:
Chain 0

1. $11\text{dBm} + 10\log(21.03) = 24.23\text{ dBm} > 24\text{dBm}$.
2. $11\text{dBm} + 10\log(21.01) = 24.22\text{ dBm} > 24\text{dBm}$.
3. $11\text{dBm} + 10\log(20.62) = 24.14\text{ dBm} > 24\text{dBm}$.
4. $11\text{dBm} + 10\log(20.78) = 24.18\text{ dBm} > 24\text{dBm}$.
5. $11\text{dBm} + 10\log(20.72) = 24.16\text{ dBm} > 24\text{dBm}$.
6. $11\text{dBm} + 10\log(20.60) = 24.14\text{ dBm} > 24\text{dBm}$.
7. $11\text{dBm} + 10\log(5725.00 - 5709.78) = 22.82\text{ dBm} < 24\text{dBm}$.

Chain 1

1. $11\text{dBm} + 10\log(20.80) = 24.18\text{ dBm} > 24\text{dBm}$.
2. $11\text{dBm} + 10\log(20.80) = 24.18\text{ dBm} > 24\text{dBm}$.
3. $11\text{dBm} + 10\log(20.86) = 24.19\text{ dBm} > 24\text{dBm}$.
4. $11\text{dBm} + 10\log(20.81) = 24.18\text{ dBm} > 24\text{dBm}$.
5. $11\text{dBm} + 10\log(20.67) = 24.15\text{ dBm} > 24\text{dBm}$.
6. $11\text{dBm} + 10\log(20.70) = 24.16\text{ dBm} > 24\text{dBm}$.
7. $11\text{dBm} + 10\log(5725.00 - 5704.09) = 24.20\text{ dBm} > 24\text{dBm}$.

Chain 2

1. $11\text{dBm} + 10\log(20.66) = 24.15\text{ dBm} > 24\text{dBm}$.
2. $11\text{dBm} + 10\log(20.83) = 24.19\text{ dBm} > 24\text{dBm}$.
3. $11\text{dBm} + 10\log(20.83) = 24.19\text{ dBm} > 24\text{dBm}$.
4. $11\text{dBm} + 10\log(20.95) = 24.21\text{ dBm} > 24\text{dBm}$.
5. $11\text{dBm} + 10\log(21.02) = 24.23\text{ dBm} > 24\text{dBm}$.
6. $11\text{dBm} + 10\log(20.73) = 24.17\text{ dBm} > 24\text{dBm}$.
7. $11\text{dBm} + 10\log(5725.00 - 5704.23) = 24.17\text{ dBm} > 24\text{dBm}$.

Chain 3

1. $11\text{dBm} + 10\log(20.58) = 24.13\text{ dBm} > 24\text{dBm}$.
2. $11\text{dBm} + 10\log(20.75) = 24.17\text{ dBm} > 24\text{dBm}$.
3. $11\text{dBm} + 10\log(20.53) = 24.12\text{ dBm} > 24\text{dBm}$.
4. $11\text{dBm} + 10\log(20.53) = 24.12\text{ dBm} > 24\text{dBm}$.
5. $11\text{dBm} + 10\log(20.54) = 24.13\text{ dBm} > 24\text{dBm}$.
6. $11\text{dBm} + 10\log(20.73) = 24.17\text{ dBm} > 24\text{dBm}$.
7. $11\text{dBm} + 10\log(5725.00 - 5709.72) = 22.84\text{ dBm} < 24\text{dBm}$.

802.11ac (VHT40)

Chan.	Freq. (MHz)	Maximum Conducted Power (dBm)				Total Power (mW)	Total Power (dBm)	Power Limit (dBm)	Pass / Fail
		Chain 0	Chain 1	Chain 2	Chain 3				
54	5270	15.20	15.41	15.24	15.20	134.400	21.28	24.00	Pass
62	5310	13.05	12.89	12.81	12.83	77.924	18.92	24.00	Pass
102	5510	13.84	13.73	13.50	13.44	92.282	19.65	24.00	Pass
110	5550	15.24	15.24	15.17	14.90	130.628	21.16	24.00	Pass
134	5670	17.19	17.49	17.34	17.56	219.681	23.42	24.00	Pass
142	5710 For U-NII-2C	14.41	14.35	14.28	14.10	111.569	20.48	24.00	Pass
142	5710 For U-NII-3	6.15	6.21	6.08	5.96	16.943	12.29	30.00	Pass

Note:

Chain 0

1. $11\text{dBm} + 10\log(40.59) = 27.08\text{ dBm} > 24\text{dBm}$.
2. $11\text{dBm} + 10\log(40.62) = 27.09\text{ dBm} > 24\text{dBm}$.
3. $11\text{dBm} + 10\log(40.85) = 27.11\text{ dBm} > 24\text{dBm}$.
4. $11\text{dBm} + 10\log(40.99) = 27.13\text{ dBm} > 24\text{dBm}$.
5. $11\text{dBm} + 10\log(40.58) = 27.08\text{ dBm} > 24\text{dBm}$.
6. $11\text{dBm} + 10\log(5725.00 - 5689.83) = 26.46\text{ dBm} > 24\text{dBm}$.

Chain 1

1. $11\text{dBm} + 10\log(40.66) = 27.09\text{ dBm} > 24\text{dBm}$.
2. $11\text{dBm} + 10\log(40.22) = 27.04\text{ dBm} > 24\text{dBm}$.
3. $11\text{dBm} + 10\log(40.82) = 27.11\text{ dBm} > 24\text{dBm}$.
4. $11\text{dBm} + 10\log(41.03) = 27.13\text{ dBm} > 24\text{dBm}$.
5. $11\text{dBm} + 10\log(40.63) = 27.09\text{ dBm} > 24\text{dBm}$.
6. $11\text{dBm} + 10\log(5725.00 - 5689.71) = 26.48\text{ dBm} > 24\text{dBm}$.

Chain 2

1. $11\text{dBm} + 10\log(40.59) = 27.08\text{ dBm} > 24\text{dBm}$.
2. $11\text{dBm} + 10\log(40.31) = 27.05\text{ dBm} > 24\text{dBm}$.
3. $11\text{dBm} + 10\log(40.60) = 27.09\text{ dBm} > 24\text{dBm}$.
4. $11\text{dBm} + 10\log(40.38) = 27.06\text{ dBm} > 24\text{dBm}$.
5. $11\text{dBm} + 10\log(40.22) = 27.04\text{ dBm} > 24\text{dBm}$.
6. $11\text{dBm} + 10\log(5725.00 - 5689.85) = 26.46\text{ dBm} > 24\text{dBm}$.

Chain 3

1. $11\text{dBm} + 10\log(40.64) = 27.09\text{ dBm} > 24\text{dBm}$.
2. $11\text{dBm} + 10\log(40.81) = 27.11\text{ dBm} > 24\text{dBm}$.
3. $11\text{dBm} + 10\log(40.57) = 27.08\text{ dBm} > 24\text{dBm}$.
4. $11\text{dBm} + 10\log(40.63) = 27.09\text{ dBm} > 24\text{dBm}$.
5. $11\text{dBm} + 10\log(40.54) = 27.08\text{ dBm} > 24\text{dBm}$.
6. $11\text{dBm} + 10\log(5725.00 - 5689.73) = 26.47\text{ dBm} > 24\text{dBm}$.

802.11ac (VHT80)

Chan.	Freq. (MHz)	Maximum Conducted Power (dBm)				Total Power (mW)	Total Power (dBm)	Power Limit (dBm)	Pass / Fail
		Chain 0	Chain 1	Chain 2	Chain 3				
58	5290	11.60	11.36	11.26	11.50	55.622	17.45	24.00	Pass
106	5530	11.06	10.84	10.59	10.60	47.835	16.80	24.00	Pass
138	5690 For U-NII-2C	17.46	17.65	17.51	17.46	241.466	23.83	24.00	Pass
138	5690 For U-NII-3	7.87	7.80	7.45	7.46	24.873	13.96	30.00	Pass

Note:

Chain 0

1. $11\text{dBm} + 10\log(85.46) = 30.32\text{ dBm} > 24\text{dBm}$.
2. $11\text{dBm} + 10\log(85.13) = 30.30\text{ dBm} > 24\text{dBm}$.
3. $11\text{dBm} + 10\log(5725.00 - 5647.00) = 29.92\text{ dBm} > 24\text{dBm}$.

Chain 1

1. $11\text{dBm} + 10\log(85.20) = 30.30\text{ dBm} > 24\text{dBm}$.
2. $11\text{dBm} + 10\log(85.17) = 30.30\text{ dBm} > 24\text{dBm}$.
3. $11\text{dBm} + 10\log(5725.00 - 5646.85) = 29.93\text{ dBm} > 24\text{dBm}$.

Chain 2

1. $11\text{dBm} + 10\log(84.34) = 30.26\text{ dBm} > 24\text{dBm}$.
2. $11\text{dBm} + 10\log(84.59) = 30.27\text{ dBm} > 24\text{dBm}$.
3. $11\text{dBm} + 10\log(5725.00 - 5646.38) = 29.96\text{ dBm} > 24\text{dBm}$.

Chain 3

1. $11\text{dBm} + 10\log(84.44) = 30.27\text{ dBm} > 24\text{dBm}$.
2. $11\text{dBm} + 10\log(84.67) = 30.28\text{ dBm} > 24\text{dBm}$.
3. $11\text{dBm} + 10\log(5725.00 - 5647.90) = 29.87\text{ dBm} > 24\text{dBm}$.

Beamforming Mode

802.11ac (VHT20)

Chan.	Freq. (MHz)	Maximum Conducted Power (dBm)				Total Power (mW)	Total Power (dBm)	Power Limit (dBm)	Pass / Fail
		Chain 0	Chain 1	Chain 2	Chain 3				
52	5260	6.20	6.62	6.41	6.43	17.531	12.44	24.00	Pass
60	5300	6.43	6.64	6.59	6.50	18.035	12.56	24.00	Pass
64	5320	6.62	6.75	6.58	6.41	18.249	12.61	24.00	Pass
100	5500	6.26	6.49	6.09	6.09	16.812	12.26	24.00	Pass
116	5580	5.74	5.92	5.82	5.30	14.865	11.72	24.00	Pass
140	5700	5.29	5.68	5.72	5.47	14.336	11.56	24.00	Pass
144	5720 For U-NII-2C	5.19	5.08	4.93	5.01	12.807	11.07	22.82	Pass
144	5720 For U-NII-3	0.51	1.94	1.86	0.56	5.361	7.29	30.00	Pass

Note:

Chain 0

1. $11\text{dBm} + 10\log(21.03) = 24.23\text{ dBm} > 24\text{dBm}$.
2. $11\text{dBm} + 10\log(21.01) = 24.22\text{ dBm} > 24\text{dBm}$.
3. $11\text{dBm} + 10\log(20.62) = 24.14\text{ dBm} > 24\text{dBm}$.
4. $11\text{dBm} + 10\log(20.78) = 24.18\text{ dBm} > 24\text{dBm}$.
5. $11\text{dBm} + 10\log(20.72) = 24.16\text{ dBm} > 24\text{dBm}$.
6. $11\text{dBm} + 10\log(20.60) = 24.14\text{ dBm} > 24\text{dBm}$.
7. $11\text{dBm} + 10\log(5725.00 - 5709.78) = 22.82\text{ dBm} < 24\text{dBm}$.

Chain 1

1. $11\text{dBm} + 10\log(20.80) = 24.18\text{ dBm} > 24\text{dBm}$.
2. $11\text{dBm} + 10\log(20.80) = 24.18\text{ dBm} > 24\text{dBm}$.
3. $11\text{dBm} + 10\log(20.86) = 24.19\text{ dBm} > 24\text{dBm}$.
4. $11\text{dBm} + 10\log(20.81) = 24.18\text{ dBm} > 24\text{dBm}$.
5. $11\text{dBm} + 10\log(20.67) = 24.15\text{ dBm} > 24\text{dBm}$.
6. $11\text{dBm} + 10\log(20.70) = 24.16\text{ dBm} > 24\text{dBm}$.
7. $11\text{dBm} + 10\log(5725.00 - 5704.09) = 24.20\text{ dBm} > 24\text{dBm}$.

Chain 2

1. $11\text{dBm} + 10\log(20.66) = 24.15\text{ dBm} > 24\text{dBm}$.
2. $11\text{dBm} + 10\log(20.83) = 24.19\text{ dBm} > 24\text{dBm}$.
3. $11\text{dBm} + 10\log(20.83) = 24.19\text{ dBm} > 24\text{dBm}$.
4. $11\text{dBm} + 10\log(20.95) = 24.21\text{ dBm} > 24\text{dBm}$.
5. $11\text{dBm} + 10\log(21.02) = 24.23\text{ dBm} > 24\text{dBm}$.
6. $11\text{dBm} + 10\log(20.73) = 24.17\text{ dBm} > 24\text{dBm}$.
7. $11\text{dBm} + 10\log(5725.00 - 5704.23) = 24.17\text{ dBm} > 24\text{dBm}$.

Chain 3

1. $11\text{dBm} + 10\log(20.58) = 24.13\text{ dBm} > 24\text{dBm}$.
2. $11\text{dBm} + 10\log(20.75) = 24.17\text{ dBm} > 24\text{dBm}$.
3. $11\text{dBm} + 10\log(20.53) = 24.12\text{ dBm} > 24\text{dBm}$.
4. $11\text{dBm} + 10\log(20.53) = 24.12\text{ dBm} > 24\text{dBm}$.
5. $11\text{dBm} + 10\log(20.54) = 24.13\text{ dBm} > 24\text{dBm}$.
6. $11\text{dBm} + 10\log(20.73) = 24.17\text{ dBm} > 24\text{dBm}$.
7. $11\text{dBm} + 10\log(5725.00 - 5709.72) = 22.84\text{ dBm} < 24\text{dBm}$.

802.11ac (VHT40)

Chan.	Freq. (MHz)	Maximum Conducted Power (dBm)				Total Power (mW)	Total Power (dBm)	Power Limit (dBm)	Pass / Fail
		Chain 0	Chain 1	Chain 2	Chain 3				
54	5270	9.18	9.39	9.22	9.18	33.604	15.26	24.00	Pass
62	5310	7.03	6.87	6.79	6.81	19.483	12.90	24.00	Pass
102	5510	7.82	7.71	7.48	7.42	23.074	13.63	24.00	Pass
110	5550	9.22	9.22	9.15	8.88	32.661	15.14	24.00	Pass
134	5670	8.70	8.59	8.30	8.70	28.815	14.60	24.00	Pass
142	5710 For U-NII-2C	8.39	8.33	8.26	8.08	27.896	14.46	24.00	Pass
142	5710 For U-NII-3	0.13	0.19	0.06	-0.06	4.236	6.27	30.00	Pass

Note:
Chain 0

1. $11\text{dBm} + 10\log(40.59) = 27.08\text{ dBm} > 24\text{dBm}$.
2. $11\text{dBm} + 10\log(40.62) = 27.09\text{ dBm} > 24\text{dBm}$.
3. $11\text{dBm} + 10\log(40.85) = 27.11\text{ dBm} > 24\text{dBm}$.
4. $11\text{dBm} + 10\log(40.99) = 27.13\text{ dBm} > 24\text{dBm}$.
5. $11\text{dBm} + 10\log(40.58) = 27.08\text{ dBm} > 24\text{dBm}$.
6. $11\text{dBm} + 10\log(5725.00 - 5689.83) = 26.46\text{ dBm} > 24\text{dBm}$.

Chain 1

1. $11\text{dBm} + 10\log(40.66) = 27.09\text{ dBm} > 24\text{dBm}$.
2. $11\text{dBm} + 10\log(40.22) = 27.04\text{ dBm} > 24\text{dBm}$.
3. $11\text{dBm} + 10\log(40.82) = 27.11\text{ dBm} > 24\text{dBm}$.
4. $11\text{dBm} + 10\log(41.03) = 27.13\text{ dBm} > 24\text{dBm}$.
5. $11\text{dBm} + 10\log(40.63) = 27.09\text{ dBm} > 24\text{dBm}$.
6. $11\text{dBm} + 10\log(5725.00 - 5689.71) = 26.48\text{ dBm} > 24\text{dBm}$.

Chain 2

1. $11\text{dBm} + 10\log(40.59) = 27.08\text{ dBm} > 24\text{dBm}$.
2. $11\text{dBm} + 10\log(40.31) = 27.05\text{ dBm} > 24\text{dBm}$.
3. $11\text{dBm} + 10\log(40.60) = 27.09\text{ dBm} > 24\text{dBm}$.
4. $11\text{dBm} + 10\log(40.38) = 27.06\text{ dBm} > 24\text{dBm}$.
5. $11\text{dBm} + 10\log(40.22) = 27.04\text{ dBm} > 24\text{dBm}$.
6. $11\text{dBm} + 10\log(5725.00 - 5689.85) = 26.46\text{ dBm} > 24\text{dBm}$.

Chain 3

1. $11\text{dBm} + 10\log(40.64) = 27.09\text{ dBm} > 24\text{dBm}$.
2. $11\text{dBm} + 10\log(40.81) = 27.11\text{ dBm} > 24\text{dBm}$.
3. $11\text{dBm} + 10\log(40.57) = 27.08\text{ dBm} > 24\text{dBm}$.
4. $11\text{dBm} + 10\log(40.63) = 27.09\text{ dBm} > 24\text{dBm}$.
5. $11\text{dBm} + 10\log(40.54) = 27.08\text{ dBm} > 24\text{dBm}$.
6. $11\text{dBm} + 10\log(5725.00 - 5689.73) = 26.47\text{ dBm} > 24\text{dBm}$.

802.11ac (VHT80)

Chan.	Freq. (MHz)	Maximum Conducted Power (dBm)				Total Power (mW)	Total Power (dBm)	Power Limit (dBm)	Pass / Fail
		Chain 0	Chain 1	Chain 2	Chain 3				
58	5290	5.58	5.34	5.24	5.48	13.908	11.43	24.00	Pass
106	5530	5.04	4.82	4.57	4.58	11.961	10.78	24.00	Pass
138	5690 For U-NII-2C	11.44	11.63	11.49	11.44	60.376	17.81	24.00	Pass
138	5690 For U-NII-3	1.85	1.78	1.43	1.44	6.219	7.94	30.00	Pass

Note:

Chain 0

1. $11\text{dBm} + 10\log(85.46) = 30.32\text{ dBm} > 24\text{dBm}$.
2. $11\text{dBm} + 10\log(85.13) = 30.30\text{ dBm} > 24\text{dBm}$.
3. $11\text{dBm} + 10\log(5725.00 - 5647.00) = 29.92\text{ dBm} > 24\text{dBm}$.

Chain 1

1. $11\text{dBm} + 10\log(85.20) = 30.30\text{ dBm} > 24\text{dBm}$.
2. $11\text{dBm} + 10\log(85.17) = 30.30\text{ dBm} > 24\text{dBm}$.
3. $11\text{dBm} + 10\log(5725.00 - 5646.85) = 29.93\text{ dBm} > 24\text{dBm}$.

Chain 2

1. $11\text{dBm} + 10\log(84.34) = 30.26\text{ dBm} > 24\text{dBm}$.
2. $11\text{dBm} + 10\log(84.59) = 30.27\text{ dBm} > 24\text{dBm}$.
3. $11\text{dBm} + 10\log(5725.00 - 5646.38) = 29.96\text{ dBm} > 24\text{dBm}$.

Chain 3

1. $11\text{dBm} + 10\log(84.44) = 30.27\text{ dBm} > 24\text{dBm}$.
2. $11\text{dBm} + 10\log(84.67) = 30.28\text{ dBm} > 24\text{dBm}$.
3. $11\text{dBm} + 10\log(5725.00 - 5647.90) = 29.87\text{ dBm} > 24\text{dBm}$.



26dB BANDWIDTH:

802.11a

Chan.	Freq. (MHz)	26dBc Bandwidth (MHz)				Pass / Fail
		Chain 0	Chain 1	Chain 2	Chain 3	
52	5260	20.08	20.14	19.78	19.80	Pass
60	5300	19.97	20.00	20.27	19.58	Pass
64	5320	20.16	19.98	20.13	19.59	Pass
100	5500	19.96	19.85	19.72	19.72	Pass
116	5580	20.12	20.09	19.43	19.45	Pass
140	5700	20.08	19.77	20.01	19.92	Pass
144	5720 For U-NII-2C	15.19	20.19	20.21	14.60	Pass

802.11ac (VHT20)

Chan.	Freq. (MHz)	26dBc Bandwidth (MHz)				Pass / Fail
		Chain 0	Chain 1	Chain 2	Chain 3	
52	5260	21.03	20.80	20.66	20.58	Pass
60	5300	21.01	20.80	20.83	20.75	Pass
64	5320	20.62	20.86	20.83	20.53	Pass
100	5500	20.78	20.81	20.95	20.53	Pass
116	5580	20.72	20.67	21.02	20.54	Pass
140	5700	20.60	20.70	20.73	20.73	Pass
144	5720 For U-NII-2C	15.22	20.91	20.77	15.28	Pass

802.11ac (VHT40)

Chan.	Freq. (MHz)	26dBc Bandwidth (MHz)				Pass / Fail
		Chain 0	Chain 1	Chain 2	Chain 3	
54	5270	40.59	40.66	40.59	40.64	Pass
62	5310	40.62	40.22	40.31	40.81	Pass
102	5510	40.85	40.82	40.60	40.57	Pass
110	5550	40.99	41.03	40.38	40.63	Pass
134	5670	40.58	40.63	40.22	40.54	Pass
142	5710 For U-NII-2C	35.17	35.29	35.15	35.27	Pass

802.11ac (VHT80)

Chan.	Freq. (MHz)	26dBc Bandwidth (MHz)				Pass / Fail
		Chain 0	Chain 1	Chain 2	Chain 3	
58	5290	85.46	85.20	84.34	84.44	Pass
106	5530	85.13	85.17	84.59	84.67	Pass
138	5690 For U-NII-2C	78.00	78.15	78.62	77.10	Pass



Spectrum Plot of Worst Value

802.11a

802.11ac (VHT20)

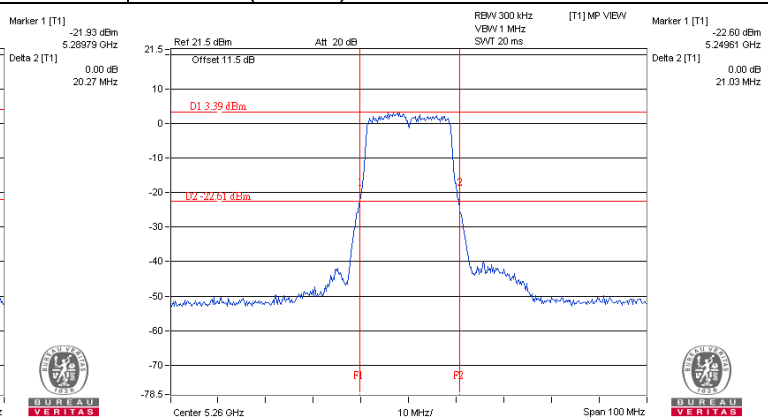
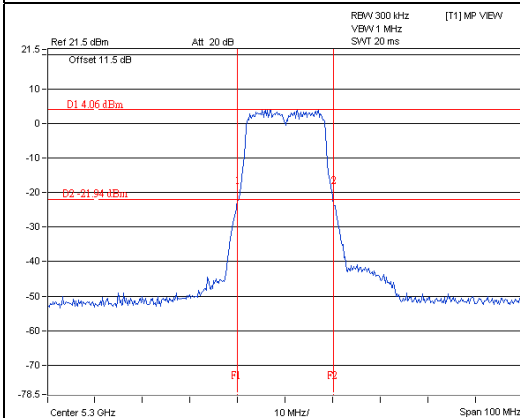

802.11ac (VHT40)

802.11ac (VHT80)

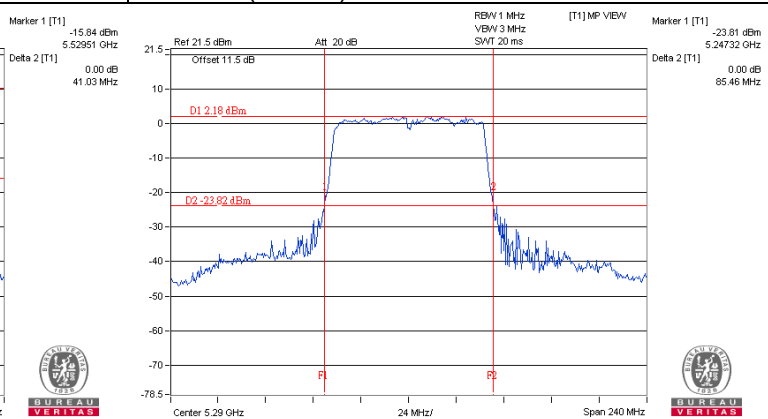
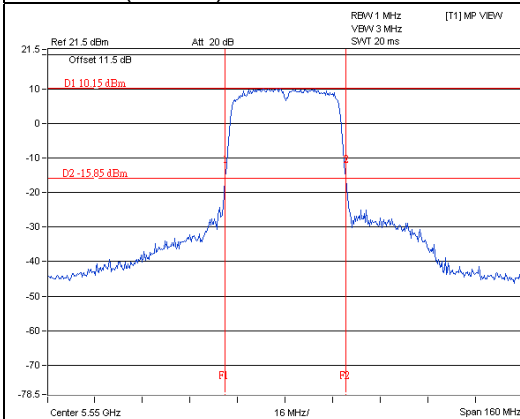



OCCUPIED BANDWIDTH:

802.11a

Chan.	Freq. (MHz)	Occupied Bandwidth (MHz)			
		Chain 0	Chain 1	Chain 2	Chain 3
52	5260	16.52	16.52	16.43	16.43
60	5300	16.44	16.56	16.56	16.44
64	5320	16.44	16.56	16.56	16.44
100	5500	16.44	16.44	16.56	16.32
116	5580	16.44	16.56	16.56	16.32
140	5700	16.44	16.44	16.56	16.44
144	5720 For U-NII-2C	13.28	13.28	13.28	13.16
144	5720 For U-NII-3	3.16	3.28	3.64	3.16

802.11ac (VHT20)

Chan.	Freq. (MHz)	Occupied Bandwidth (MHz)			
		Chain 0	Chain 1	Chain 2	Chain 3
52	5260	17.64	17.64	17.76	17.64
60	5300	17.76	17.76	17.76	17.64
64	5320	17.76	17.76	17.76	17.52
100	5500	17.64	17.64	17.76	17.52
116	5580	17.64	17.64	17.76	17.52
140	5700	17.64	17.52	17.76	17.52
144	5720 For U-NII-2C	13.76	13.88	13.88	13.76
144	5720 For U-NII-3	3.76	3.88	4.00	3.76

802.11ac (VHT40)

Chan.	Freq. (MHz)	Occupied Bandwidth (MHz)			
		Chain 0	Chain 1	Chain 2	Chain 3
54	5270	36.00	36.12	36.12	36.00
62	5310	36.12	36.00	36.00	36.12
102	5510	36.24	36.12	36.00	36.12
110	5550	36.12	36.12	36.00	36.24
134	5670	36.12	36.12	36.00	36.24
142	5710 For U-NII-2C	33.12	33.12	33.12	33.00
142	5710 For U-NII-3	3.00	3.12	3.00	3.12



BUREAU VERITAS

802.11ac (VHT80)

Chan.	Freq. (MHz)	Occupied Bandwidth (MHz)			
		Chain 0	Chain 1	Chain 2	Chain 3
58	5290	75.88	75.88	75.60	75.60
106	5530	75.60	75.88	75.88	75.88
138	5690 For U-NII-2C	72.92	72.92	72.92	72.92
138	5690 For U-NII-3	2.92	2.92	2.92	2.92

Spectrum Plot of Worst Value

802.11a

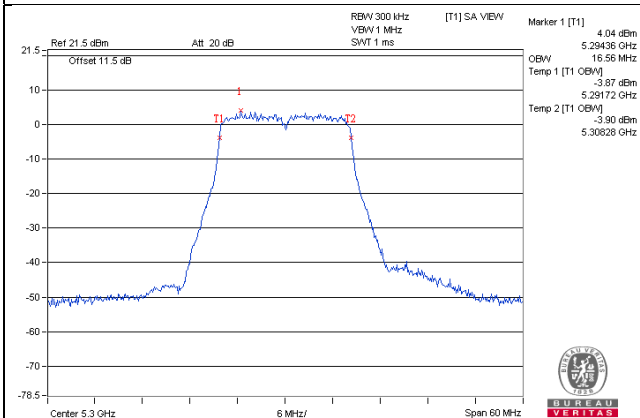

802.11ac (VHT20)

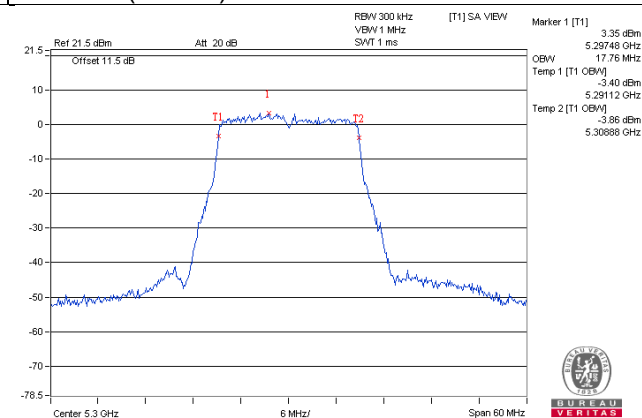

802.11ac (VHT40)

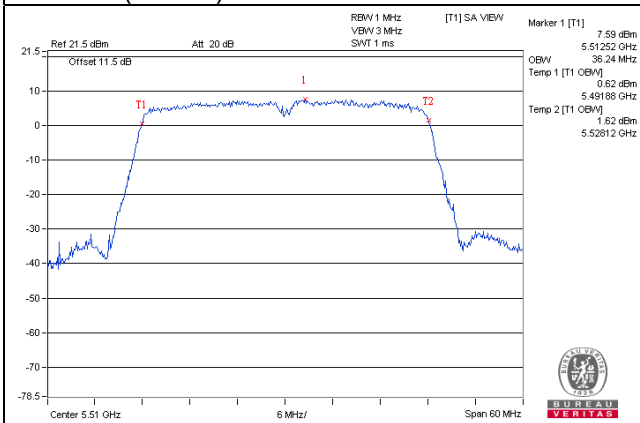

802.11ac (VHT80)

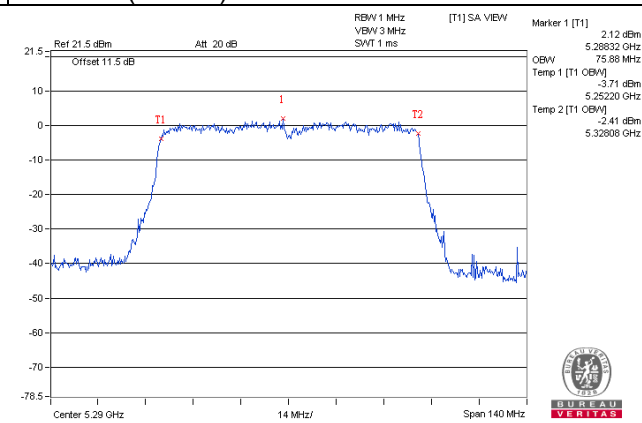

EUT MAXIMUM CONDUCTED POWER

CDD Mode

802.11a

Frequency Band (MHz)	Max. Power	
	Output Power (mW)	Output Power (dBm)
5250~5350	68.380	18.35
5470~5725	56.175	17.50

Note: Manufacturer provides Transmit Power Control description to meet this requirement.

802.11ac (VHT20)

Frequency Band (MHz)	Max. Power	
	Output Power (mW)	Output Power (dBm)
5250~5350	72.983	18.63
5470~5725	67.238	18.28

Note: Manufacturer provides Transmit Power Control description to meet this requirement.

802.11ac (VHT40)

Frequency Band (MHz)	Max. Power	
	Output Power (mW)	Output Power (dBm)
5250~5350	134.400	21.28
5470~5725	219.681	23.42

Note: Manufacturer provides Transmit Power Control description to meet this requirement.

802.11ac (VHT80)

Frequency Band (MHz)	Max. Power	
	Output Power (mW)	Output Power (dBm)
5250~5350	55.622	17.45
5470~5725	241.466	23.83

Note: Manufacturer provides Transmit Power Control description to meet this requirement.

Beamforming Mode

802.11ac (VHT20)

Frequency Band (MHz)	Max. Power	
	Output Power (mW)	Output Power (dBm)
5250~5350	18.249	12.61
5470~5725	16.812	12.26

Note: Manufacturer provides Transmit Power Control description to meet this requirement.

802.11ac (VHT40)

Frequency Band (MHz)	Max. Power	
	Output Power (mW)	Output Power (dBm)
5250~5350	33.604	15.26
5470~5725	32.661	15.14

Note: Manufacturer provides Transmit Power Control description to meet this requirement.

802.11ac (VHT80)

Frequency Band (MHz)	Max. Power	
	Output Power (mW)	Output Power (dBm)
5250~5350	13.908	11.43
5470~5725	60.376	17.81

Note: Manufacturer provides Transmit Power Control description to meet this requirement.

4.4 Peak Power Spectral Density Measurement

4.4.1 Limits of Peak Power Spectral Density Measurement

Operation Band	EUT Category		LIMIT
U-NII-1	-	Outdoor Access Point	17dBm/ MHz
	-	Fixed point-to-point Access Point	
	-	Indoor Access Point	
	-	Mobile and Portable client device	11dBm/ MHz
U-NII-2A	√		11dBm/ MHz
U-NII-2C	√		11dBm/ MHz
U-NII-3	-		30dBm/ 500kHz

4.4.2 Test Setup

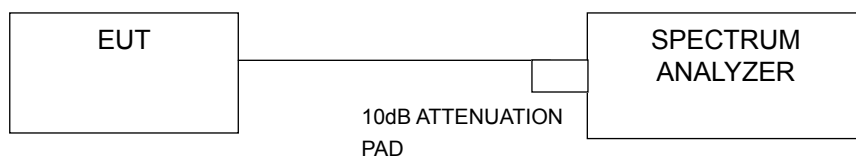

4.4.3 Test Instruments

Refer to section 4.1.2 to get information of above instrument.

4.4.4 Test Procedures

Without duty cycle (Using method SA-1):

- 1) Set span to encompass the entire emission bandwidth (EBW) of the signal.
- 2) Set RBW = 1MHz, Set VBW ≥ 3MHz, Detector = RMS
- 3) Set Channel power measure = 1MHz
- 4) Sweep time = auto, trigger set to “free run”.
- 5) Trace average at least 100 traces in power averaging mode.
- 6) Record the max value

With duty cycle (Using method SA-2):

- 1) Set span to encompass the entire emission bandwidth (EBW) of the signal.
- 2) Set RBW = 1MHz, Set VBW ≥ 3MHz, Detector = RMS
- 3) Set Channel power measure = 1MHz
- 4) Sweep time = auto, trigger set to “free run”.
- 5) Trace average at least 100 traces in power averaging mode.
- 6) Record the max value and add 10 log (1/duty cycle)

4.4.5 Deviation from Test Standard

No deviation.

4.4.6 EUT Operating Conditions

Same as Item 4.3.6.

4.4.7 Test Results

802.11a

Chan.	Freq. (MHz)	PSD (dBm)				Duty factor	Total PSD with duty factor (dBm)	Max. Limit (dBm)	Pass / Fail
		Chain 0	Chain 1	Chain 2	Chain 3				
52	5260	-1.32	-1.80	-1.65	-2.06	0.17	4.49	5.14	Pass
60	5300	-1.06	-1.24	-1.23	-1.82	0.17	4.86	5.14	Pass
64	5320	-0.93	-0.84	-1.15	-1.77	0.17	5.03	5.14	Pass
100	5500	-1.51	-1.39	-1.92	-2.14	0.17	4.46	5.14	Pass
116	5580	-1.20	-1.33	-1.68	-2.24	0.17	4.59	5.14	Pass
140	5700	-0.76	-1.32	-1.45	-1.43	0.17	4.96	5.14	Pass
144	5720 For U-NII-2C	-0.79	-0.99	-1.51	-1.69	0.17	4.96	5.14	Pass

Note:

- Method 1 of power density measurement of KDB 662911 is using for calculating total power density. Total power density is summing entire spectra across corresponding frequency bins on the various outputs by computer.
- Directional gain = $5.84\text{dBi} + 10\log(4) = 11.86\text{dBi} > 6\text{dBi}$, so the limit shall be reduced to $11 - (11.86 - 6) = 5.14\text{dBm}$.
- Refer to section 3.3 for duty cycle spectrum plot.

802.11ac (VHT20)

Chan.	Freq. (MHz)	PSD (dBm)				Total PSD (dBm)	Max. Limit (dBm)	Pass / Fail
		Chain 0	Chain 1	Chain 2	Chain 3			
52	5260	-1.42	-1.74	-1.65	-2.28	4.26	5.14	Pass
60	5300	-1.03	-1.19	-1.28	-1.84	4.70	5.14	Pass
64	5320	-0.94	-1.20	-1.19	-1.83	4.74	5.14	Pass
100	5500	-1.12	-0.85	-1.36	-1.81	4.75	5.14	Pass
116	5580	-1.60	-1.01	-1.81	-2.15	4.40	5.14	Pass
140	5700	-0.83	-1.41	-1.66	-1.31	4.73	5.14	Pass
144	5720 For U-NII-2C	-0.58	-0.89	-1.14	-1.25	5.06	5.14	Pass

Note:

- Method 1 of power density measurement of KDB 662911 is using for calculating total power density. Total power density is summing entire spectra across corresponding frequency bins on the various outputs by computer.
- Directional gain = $5.84\text{dBi} + 10\log(4) = 11.86\text{dBi} > 6\text{dBi}$, so the limit shall be reduced to $11 - (11.86 - 6) = 5.14\text{dBm}$.

802.11ac (VHT40)

Chan.	Freq. (MHz)	PSD (dBm)				Duty factor	Total PSD with duty factor (dBm)	Max. Limit (dBm)	Pass / Fail
		Chain 0	Chain 1	Chain 2	Chain 3				
54	5270	-1.68	-1.34	-1.05	-1.72	0.17	4.75	5.14	Pass
62	5310	-3.45	-3.71	-3.69	-4.21	0.17	2.43	5.14	Pass
102	5510	-2.59	-2.15	-2.67	-2.85	0.17	3.63	5.14	Pass
110	5550	-1.90	-1.67	-1.78	-1.81	0.17	4.40	5.14	Pass
134	5670	-1.40	-1.01	-2.30	-1.00	0.17	4.79	5.14	Pass
142	5710 For U-NII-2C	-0.53	-1.19	-1.56	-2.04	0.17	4.89	5.14	Pass

Note:

- Method 1 of power density measurement of KDB 662911 is using for calculating total power density. Total power density is summing entire spectra across corresponding frequency bins on the various outputs by computer.
- Directional gain = $5.84\text{dBi} + 10\log(4) = 11.86\text{dBi} > 6\text{dBi}$, so the limit shall be reduced to $11 - (11.86 - 6) = 5.14\text{dBm}$.
- Refer to section 3.3 for duty cycle spectrum plot.

802.11ac (VHT80)

Chan.	Freq. (MHz)	PSD (dBm)				Duty factor	Total PSD with duty factor (dBm)	Max. Limit (dBm)	Pass / Fail
		Chain 0	Chain 1	Chain 2	Chain 3				
58	5290	-8.79	-8.63	-8.05	-9.03	0.29	-2.30	5.14	Pass
106	5530	-9.38	-8.39	-8.83	-9.17	0.29	-2.62	5.14	Pass
138	5690 For U-NII-2C	-1.65	-1.35	-2.13	-1.78	0.29	4.59	5.14	Pass

Note:

- Method 1 of power density measurement of KDB 662911 is using for calculating total power density. Total power density is summing entire spectra across corresponding frequency bins on the various outputs by computer.
- Directional gain = $5.84\text{dBi} + 10\log(4) = 11.86\text{dBi} > 6\text{dBi}$, so the limit shall be reduced to $11 - (11.86 - 6) = 5.14\text{dBm}$.
- Refer to section 3.3 for duty cycle spectrum plot.



Spectrum Plot of Worst Value

802.11a / Chain 0 / Ch 140

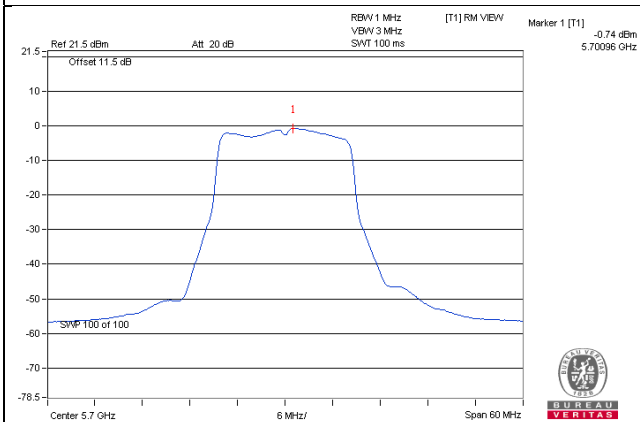

802.11ac (VHT20) / Chain 0 / Ch 144

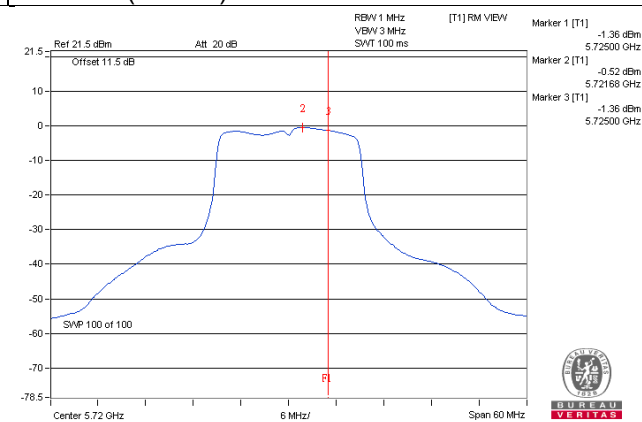

802.11ac (VHT40) / Chain 0 / Ch 142

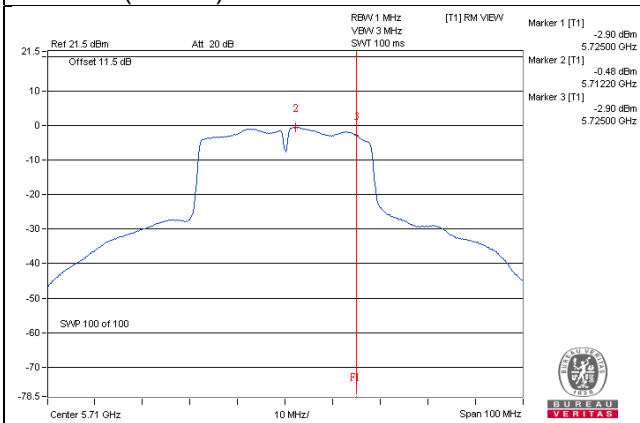

802.11ac (VHT80) / Chain 1 / Ch 138

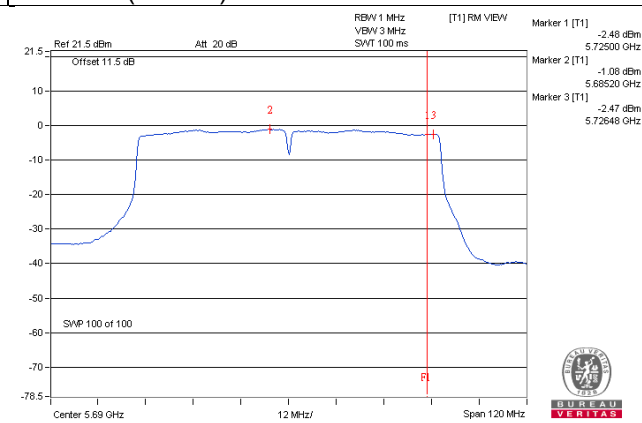

4.5 Frequency Stability

4.5.1 Limits of Frequency Stability Measurement

The frequency of the carrier signal shall be maintained within band of operation

4.5.2 Test Setup

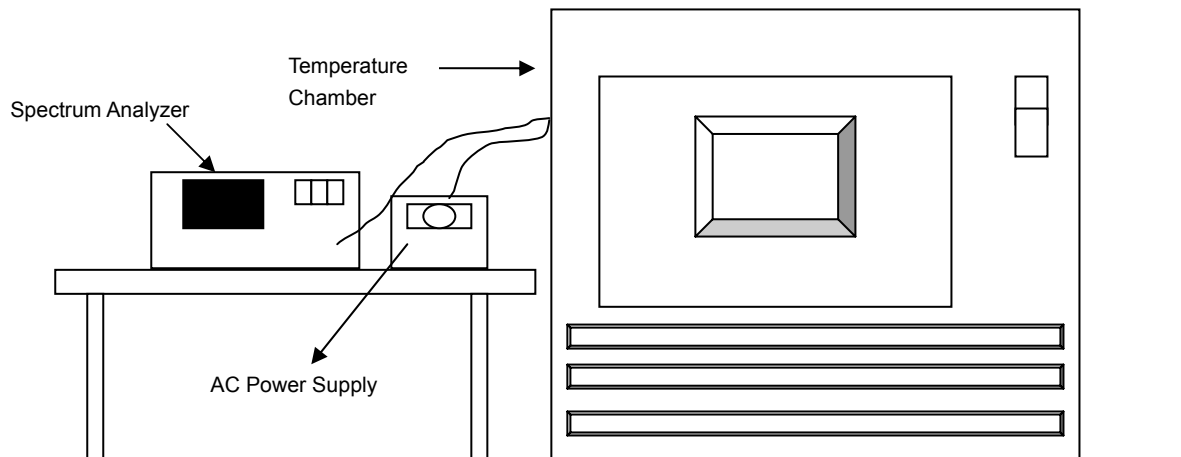

4.5.3 Test Instruments

Refer to section 4.1.2 to get information of above instrument.

4.5.4 Test Procedure

- The EUT was placed inside the environmental test chamber and powered by nominal AC voltage.
- Turn the EUT on and couple its output to a spectrum analyzer.
- Turn the EUT off and set the chamber to the highest temperature specified.
- Allow sufficient time (approximately 30 min) for the temperature of the chamber to stabilize, turn the EUT on and measure the operating frequency after 2, 5, and 10 minutes.
- Repeat step 2 and 3 with the temperature chamber set to the lowest temperature.
- The test chamber was allowed to stabilize at +20 degree C for a minimum of 30 minutes. The supply voltage was then adjusted on the EUT from 85% to 115% and the frequency record.

4.5.5 Deviation from Test Standard

No deviation.

4.5.6 EUT Operating Condition

Set the EUT transmit at un-modulation mode to test frequency stability.

4.5.7 Test Results

Frequency Stability Versus Temp.									
Operating Frequency: 5700MHz									
Temp. (°C)	Power Supply (Vac)	0 Minute		2 Minute		5 Minute		10 Minute	
		Measured Frequency (MHz)	Frequency Drift (%)	Measured Frequency (MHz)	Frequency Drift (%)	Measured Frequency (MHz)	Frequency Drift (%)	Measured Frequency (MHz)	Frequency Drift (%)
50	120	5700.0072	0.00013	5700.0070	0.00012	5700.0067	0.00012	5700.0084	0.00015
40	120	5699.9743	-0.00045	5699.9754	-0.00043	5699.9736	-0.00046	5699.9737	-0.00046
30	120	5700.0053	0.00009	5700.0048	0.00008	5700.0079	0.00014	5700.0066	0.00012
20	120	5699.9911	-0.00016	5699.9954	-0.00008	5699.9908	-0.00016	5699.9938	-0.00011
10	120	5699.9948	-0.00009	5699.9958	-0.00007	5699.9950	-0.00009	5699.9943	-0.00010
0	120	5699.9972	-0.00005	5699.9977	-0.00004	5699.9946	-0.00009	5699.9974	-0.00005
-10	120	5700.0201	0.00035	5700.0198	0.00035	5700.0246	0.00043	5700.0223	0.00039
-20	120	5700.0187	0.00033	5700.0198	0.00035	5700.0171	0.00030	5700.0200	0.00035
-30	120	5699.9994	-0.00001	5699.9996	-0.00001	5700.0011	0.00002	5699.9998	0.00000

Frequency Stability Versus Voltage									
Operating Frequency: 5700MHz									
Temp. (°C)	Power Supply (Vac)	0 Minute		2 Minute		5 Minute		10 Minute	
		Measured Frequency (MHz)	Frequency Drift (%)	Measured Frequency (MHz)	Frequency Drift (%)	Measured Frequency (MHz)	Frequency Drift (%)	Measured Frequency (MHz)	Frequency Drift (%)
20	138	5699.9905	-0.00017	5699.9943	-0.00010	5699.9900	-0.00018	5699.9936	-0.00011
	120	5699.9911	-0.00016	5699.9954	-0.00008	5699.9908	-0.00016	5699.9938	-0.00011
	102	5699.9904	-0.00017	5699.9944	-0.00010	5699.9907	-0.00016	5699.9943	-0.00010

5 Pictures of Test Arrangements

Please refer to the attached file (Test Setup Photo).

Appendix – Information on the Testing Laboratories

We, Bureau Veritas Consumer Products Services (H.K.) Ltd., Taoyuan Branch, were founded in 1988 to provide our best service in EMC, Radio, Telecom and Safety consultation. Our laboratories are accredited and approved according to ISO/IEC 17025.

If you have any comments, please feel free to contact us at the following:

Linko EMC/RF Lab

Tel: 886-2-26052180

Fax: 886-2-26051924

Hsin Chu EMC/RF/Telecom Lab

Tel: 886-3-6668565

Fax: 886-3-6668323

Hwa Ya EMC/RF/Safety

Tel: 886-3-3183232

Fax: 886-3-3270892

Email: service.adt@tw.bureauveritas.com

Web Site: www.bureauveritas-adt.com

The address and road map of all our labs can be found in our web site also.

--- END ---