

FCC Test Report

Report No.: RF160219C14-1

FCC ID: TVE-28166011

Test Model: FAP-421E, FAP-423E

Series Model: FortiAP 421Exxxxxx, FAP-421Exxxxxx, FORTIAP-421Exxxxxx, FortiAP 423Exxxxxx, FAP-423Exxxxxx, FORTIAP-423Exxxxxx (where "x" can be used as "A-Z" or "0-9" or "-" or blank for software changes or marketing purposes only) (refer to item 3.1 for more details)

Received Date: Feb. 19, 2016

Test Date: Feb. 22 ~ May 03, 2016

Issued Date: Sep. 06, 2016

Applicant: Fortinet Inc.

Address: 899 Kifer Road Sunnyvale, CA 94086 USA

Issued By: Bureau Veritas Consumer Products Services (H.K.) Ltd., Taoyuan Branch

Lab Address: No. 47-2, 14th Ling, Chia Pau Vil., Lin Kou Dist., New Taipei City, Taiwan (R.O.C.)

Test Location: No. 19, Hwa Ya 2nd Rd., Wen Hwa Vil., Kwei Shan Dist., Taoyuan City 33383, TAIWAN (R.O.C.)



This report is for your exclusive use. Any copying or replication of this report to or for any other person or entity, or use of our name or trademark, is permitted only with our prior written permission. This report sets forth our findings solely with respect to the test samples identified herein. The results set forth in this report are not indicative or representative of the quality or characteristics of the lot from which a test sample was taken or any similar or identical product unless specifically and expressly noted. Our report includes all of the tests requested by you and the results thereof based upon the information that you provided to us. You have 60 days from date of issuance of this report to notify us of any material error or omission caused by our negligence, provided, however, that such notice shall be in writing and shall specifically address the issue you wish to raise. A failure to raise such issue within the prescribed time shall constitute your unqualified acceptance of the completeness of this report, the tests conducted and the correctness of the report contents. Unless specifically mentioned, the uncertainty of measurement has been explicitly taken into account to declare the compliance or non-compliance to the specification. The report must not be used by the client to claim product certification, approval, or endorsement by TAF or any government agencies.

Table of Contents

Release Control Record	4
1 Certificate of Conformity	5
2 Summary of Test Results	6
2.1 Measurement Uncertainty	6
2.2 Modification Record	6
3 General Information	7
3.1 General Description of EUT	7
3.2 Description of Test Modes	10
3.2.1 Test Mode Applicability and Tested Channel Detail	11
3.3 Duty Cycle of Test Signal	13
3.4 Description of Support Units	15
3.4.1 Configuration of System under Test	15
3.5 General Description of Applied Standard	15
4 Test Types and Results	17
4.1 Radiated Emission and Bandedge Measurement.....	17
4.1.1 Limits of Radiated Emission and Bandedge Measurement	17
4.1.2 Test Instruments	18
4.1.3 Test Procedure	19
4.1.4 Deviation from Test Standard	19
4.1.5 Test Setup.....	20
4.1.6 EUT Operating Conditions.....	20
4.1.7 Test Results	21
4.2 Conducted Emission Measurement	85
4.2.1 Limits of Conducted Emission Measurement	85
4.2.2 Test Instruments	85
4.2.3 Test Procedure	86
4.2.4 Deviation from Test Standard	86
4.2.5 Test Setup.....	86
4.2.6 EUT Operating Conditions.....	86
4.2.7 Test Results	87
4.3 Transmit Power Measurement	95
4.3.1 Limits of Transmit Power Measurement	95
4.3.2 Test Setup.....	95
4.3.3 Test Instruments	95
4.3.4 Test Procedure	96
4.3.5 Deviation from Test Standard	96
4.3.6 EUT Operating Conditions.....	96
4.3.7 Test Result.....	97
4.4 Peak Power Spectral Density Measurement	106
4.4.1 Limits of Peak Power Spectral Density Measurement	106
4.4.2 Test Setup.....	106
4.4.3 Test Instruments	106
4.4.4 Test Procedure	107
4.4.5 Deviation from Test Standard	107
4.4.6 EUT Operating Condition	107
4.4.7 Test Results	108
4.5 Frequency Stability.....	117
4.5.1 Limits of Frequency Stability Measurement	117
4.5.2 Test Setup.....	117
4.5.3 Test Instruments	117
4.5.4 Test Procedure	117
4.5.5 Deviation from Test Standard	117
4.5.6 EUT Operating Condition	117

4.5.7 Test Results	118
4.6 6dB Bandwidth Measurement.....	119
4.6.1 Limits of 6dB Bandwidth Measurement.....	119
4.6.2 Test Setup.....	119
4.6.3 Test Instruments	119
4.6.4 Test Procedure	119
4.6.5 Deviation from Test Standard	119
4.6.6 EUT Operating Condition	119
4.6.7 Test Results	120
5 Pictures of Test Arrangements.....	123
Appendix – Information on the Testing Laboratories	124

Release Control Record

Issue No.	Description	Date Issued
RF160219C14-1	Original release.	Sep. 06, 2016

1 Certificate of Conformity

Product: Secured Wireless Access Point

Brand: Fortinet Inc.

Test Model: FAP-421E, FAP-423E

Series Model: FortiAP 421Exxxxxx, FAP-421Exxxxxx, FORTIAP-421Exxxxxx, FortiAP 423Exxxxxx, FAP-423Exxxxxx, FORTIAP-423Exxxxxx (where "x" can be used as "A-Z" or "0-9" or "-" or blank for software changes or marketing purposes only) (refer to item 3.1 for more details)

Sample Status: Engineering sample

Applicant: Fortinet Inc.

Test Date: Feb. 22 ~ May 03, 2016

Standard: 47 CFR FCC Part 15, Subpart E (Section 15.407)
ANSI C63.10:2013

The above equipment has been tested by **Bureau Veritas Consumer Products Services (H.K.) Ltd., Taoyuan Branch**, and found compliance with the requirement of the above standards. The test record, data evaluation & Equipment Under Test (EUT) configurations represented herein are true and accurate accounts of the measurements of the sample's EMC characteristics under the Conditions specified in this report.

Prepared by : Polly Chien , **Date:** Sep. 06, 2016
Polly Chien / Specialist

Approved by : Ken Liu , **Date:** Sep. 06, 2016
Ken Liu / Senior Manager

2 Summary of Test Results

47 CFR FCC Part 15, Subpart E (Section 15.407)			
FCC Clause	Test Item	Result	Remarks
15.407(b)(6)	AC Power Conducted Emissions	PASS	Meet the requirement of limit. Minimum passing margin is -4.14dB at 0.53300MHz.
15.407(b) (1/2/3/4(i/ii)/6)	Radiated Emissions & Band Edge Measurement	PASS	Meet the requirement of limit. Minimum passing margin is -1.0dB at 5150.00MHz.
15.407(a)(1/2/3)	Max Average Transmit Power	PASS	Meet the requirement of limit.
15.407(a)(1/2/3)	Peak Power Spectral Density	PASS	Meet the requirement of limit.
15.407(e)	6dB bandwidth	PASS	Meet the requirement of limit. (U-NII-3 Band only)
15.407(g)	Frequency Stability	PASS	Meet the requirement of limit.
15.203	Antenna Requirement	PASS	Antenna connector is IPEX or RPSMA not a standard connector.

2.1 Measurement Uncertainty

Where relevant, the following measurement uncertainty levels have been estimated for tests performed on the EUT as specified in CISPR 16-4-2:

Measurement	Frequency	Expanded Uncertainty (k=2) (\pm)
Conducted Emissions at mains ports	150kHz ~ 30MHz	2.44 dB
Radiated Emissions up to 1 GHz	30MHz ~ 200MHz	3.86 dB
	200MHz ~ 1000MHz	3.87 dB
Radiated Emissions above 1 GHz	1GHz ~ 18GHz	2.29 dB
	18GHz ~ 40GHz	2.29 dB

2.2 Modification Record

There were no modifications required for compliance.

3 General Information

3.1 General Description of EUT

Product	Secured Wireless Access Point
Brand	Fortinet Inc.
Test Model	FAP-421E, FAP-423E
Series Model	FortiAP 421Exxxxxx, FAP-421Exxxxxx, FORTIAP-421Exxxxxx, FortiAP 423Exxxxxx, FAP-423Exxxxxx, FORTIAP-423Exxxxxx (where "x" can be used as "A-Z" or "0-9" or "-" or blank for software changes or marketing purposes only)
Model Difference	Refer to note 1 for more details
Sample Status	Engineering sample
Power Supply Rating	12Vdc (adapter) 54Vdc (POE)
Modulation Type	256QAM, 64QAM, 16QAM, QPSK, BPSK
Modulation Technology	OFDM
Transfer Rate	802.11a: 54/48/36/24/18/12/9/6Mbps 802.11n: up to 600Mbps 802.11ac: up to 1734Mbps
Operating Frequency	5180~5240MHz, 5745~5825MHz
Number of Channel	5180~5240MHz: 802.11a, 802.11n (HT20), 802.11ac (VHT20): 4 802.11n (HT40), 802.11ac (VHT40): 2 802.11ac (VHT80): 1 5745~5825MHz: 802.11a, 802.11n (HT20), 802.11ac (VHT20): 5 802.11n (HT40), 802.11ac (VHT40): 2 802.11ac (VHT80): 1
Output Power	CDD Mode: 5180 ~ 5240MHz: 295.747mW 5745 ~ 5825MHz: 391.645mW Beamforming Mode: 5180 ~ 5240MHz: 201.692mW 5745 ~ 5825MHz: 196.309mW
Antenna Type	Refer to Note 3
Antenna Connector	Refer to Note 3
Accessory Device	Adapter (optional)
Data Cable Supplied	NA

Note:

1. All models are listed as below. Model: FAP-421E and FAP-423E were chosen for final test.

Brand	Model	Difference
Fortinet Inc.	FortiAP 421Exxxxxx	"x" can be used as "A-Z", or "0-9", or "-", or blank for software changes or marketing purposes only
	FAP-421Exxxxxx	
	FORTIAP-421Exxxxxx	
	FortiAP 423Exxxxxx	With Internal Antenna
	FAP-423Exxxxxx	
	FORTIAP-423Exxxxxx	

2. The EUT incorporates a MIMO function. Physically, the EUT provides 4 completed transmitters and 4 receivers.

Band	Modulation Mode	CDD Mode	Beamforming Mode	TX Function
5GHz	802.11a	Support	Not Support	4TX
	802.11n (HT20)	Support	Support	4TX
	802.11n (HT40)	Support	Support	4TX
	802.11ac (VHT20)	Support	Support	4TX
	802.11ac (VHT40)	Support	Support	4TX
	802.11ac (VHT80)	Support	Support	4TX

* CDD Mode: The modulation and bandwidth are similar for 802.11n mode for HT20/HT40 and 802.11ac mode for HT20/HT40, therefore investigated worst case to representative mode in test report. (Final test mode refer section 3.2.1)

* For 802.11n and 802.11ac, CDD mode is the worst case for final radiated emission up to 1 GHz and power line conducted emission tests after pretesting.

3. The following antennas were provided to the EUT.

Internal Antenna Type	Printed		
Antenna Connector	IPEX		
Gain (dBi)			
Item	2400-2500 MHz	Item	5150-5850 MHz
Ant. 1	3.81	Ant. 5	5.65
Ant. 2	3.98	Ant. 6	5.50
Ant. 3	3.47	Ant. 7	5.84
Ant. 4	3.75	Ant. 8	5.84

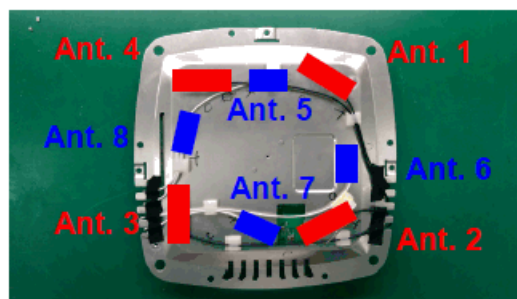
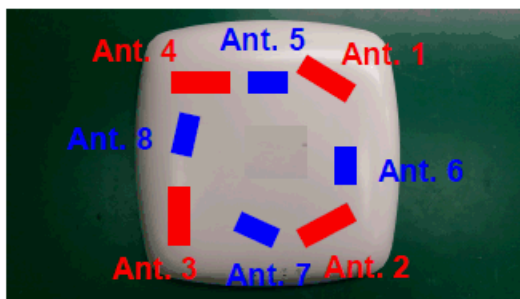

Antenna Type	Dipole	Antenna Connector	RPSMA
Gain (dBi)	Frequency (MHz)		
	2400~2500	5150~5850	
WLAN External Ant.	4.42	3.18	

4. WLAN 2.4GHz and WLAN 5GHz and BT technologies can transmit at same time.
5. Spurious emission of the simultaneous operation (WLAN 2.4GHz and WLAN 5GHz) has been evaluated and no non-compliance was found.
6. The EUT consumes power from the following adapter and POE (POE as support units only).

Adapter (optional)	
Brand	Asian Power Devices Inc.
Model	WA-36A12R
Input Power	100-240Vac, 50-60Hz, 0.9A Max.
Output Power	12Vdc, 3A
Power Line	1.75m power cable without core attached on adapter

POE	
Brand	EnGenius
Model	EPA5006GAT
Input Power	100-240Vac, 50-60Hz 0.8A
Output Power	54Vdc, 0.6A
Power Line	0.5m power cable without core

3.2 Description of Test Modes

FOR 5180 ~ 5240MHz:

4 channels are provided for 802.11a, 802.11n (HT20), 802.11ac (VHT20):

Channel	Frequency	Channel	Frequency
36	5180 MHz	44	5220 MHz
40	5200 MHz	48	5240 MHz

2 channels are provided for 802.11n (HT40), 802.11ac (VHT40):

Channel	Frequency	Channel	Frequency
38	5190 MHz	46	5230 MHz

1 channel is provided for 802.11ac (VHT80):

Channel	Frequency
42	5210MHz

FOR 5745 ~ 5825MHz:

5 channels are provided for 802.11a, 802.11n (HT20), 802.11ac (VHT20):

Channel	Frequency	Channel	Frequency
149	5745MHz	161	5805MHz
153	5765MHz	165	5825MHz
157	5785MHz		

2 channels are provided for 802.11n (HT40), 802.11ac (VHT40):

Channel	Frequency	Channel	Frequency
151	5755MHz	159	5795MHz

1 channel is provided for 802.11ac (VHT80):

Channel	Frequency
155	5775MHz

3.2.1 Test Mode Applicability and Tested Channel Detail

EUT Configure Mode	Applicable to				Description
	RE \geq 1G	RE<1G	PLC	APCM	
A	-	√	√	-	Internal antenna, Power from adapter
B	√	√	√	√	Internal antenna, Power from POE
C	-	√	√	-	External antenna, Power from adapter
D	√	√	√	-	External antenna, Power from POE

Where RE \geq 1G: Radiated Emission above 1GHz & Bandedge Measurement
 RE<1G: Radiated Emission below 1GHz
 PLC: Power Line Conducted Emission
 APCM: Antenna Port Conducted Measurement

Note:

- The EUT had been pre-tested on the positioned of each 3 axis. The worst case was found when positioned on **Y-plane** (test mode A & B) and **X-plane** (test mode C & D).
- "-" means no effect.

Radiated Emission Test (Above 1GHz):

- Pre-Scan has been conducted to determine the worst-case mode from all possible combinations between available modulations, data rates and antenna ports (if EUT with antenna diversity architecture).
- Following channel(s) was (were) selected for the final test as listed below.

EUT Configure Mode	Mode	Frequency Band (MHz)	Available Channel	Tested Channel	Modulation Technology	Data Rate (Mbps)
CDD Mode						
B, D	802.11a	5180-5240	36 to 48	36, 40, 48	OFDM	6.0
B, D	802.11ac (VHT20)		36 to 48	36, 40, 48	OFDM	7.2
B, D	802.11ac (VHT40)		38 to 46	38, 46	OFDM	15.0
B, D	802.11ac (VHT80)		42	42	OFDM	130.0
B, D	802.11a	5745-5825	149 to 165	149, 157, 165	OFDM	6.0
B, D	802.11ac (VHT20)		149 to 165	149, 157, 165	OFDM	7.2
B, D	802.11ac (VHT40)		151 to 159	151, 159	OFDM	15.0
B, D	802.11ac (VHT80)		155	155	OFDM	130.0
Beamforming Mode						
B, D	802.11ac (VHT20)	5180-5240	36 to 48	36, 40, 48	OFDM	7.2
B, D	802.11ac (VHT40)		38 to 46	38, 46	OFDM	15.0
B, D	802.11ac (VHT80)		42	42	OFDM	130.0
B, D	802.11ac (VHT20)	5745-5825	149 to 165	149, 157, 165	OFDM	7.2
B, D	802.11ac (VHT40)		151 to 159	151, 159	OFDM	15.0
B, D	802.11ac (VHT80)		155	155	OFDM	130.0

Radiated Emission Test (Below 1GHz):

- Pre-Scan has been conducted to determine the worst-case mode from all possible combinations between available modulations, data rates and antenna ports (if EUT with antenna diversity architecture).
- Following channel(s) was (were) selected for the final test as listed below.

EUT Configure Mode	Mode	Frequency Band (MHz)	Available Channel	Tested Channel	Modulation Technology	Data Rate (Mbps)
CDD Mode						
A, B, C, D	802.11a	5180-5240	36 to 48	157	OFDM	6.0
	802.11a	5745-5825	149 to 165		OFDM	6.0

Power Line Conducted Emission Test:

- Pre-Scan has been conducted to determine the worst-case mode from all possible combinations between available modulations, data rates and antenna ports (if EUT with antenna diversity architecture).
- Following channel(s) was (were) selected for the final test as listed below.

EUT Configure Mode	Mode	Frequency Band (MHz)	Available Channel	Tested Channel	Modulation Technology	Data Rate (Mbps)
CDD Mode						
A, B, C, D	802.11a	5180-5240	36 to 48	157	OFDM	6.0
	802.11a	5745-5825	149 to 165		OFDM	6.0

Antenna Port Conducted Measurement:

- This item includes all test value of each mode, but only includes spectrum plot of worst value of each mode.
- Pre-Scan has been conducted to determine the worst-case mode from all possible combinations between available modulations, data rates and antenna ports (if EUT with antenna diversity architecture).
- Following channel(s) was (were) selected for the final test as listed below.

EUT Configure Mode	Mode	Frequency Band (MHz)	Available Channel	Tested Channel	Modulation Technology	Data Rate (Mbps)
CDD Mode						
B	802.11a	5180-5240	36 to 48	36, 40, 48	OFDM	6.0
B	802.11ac (VHT20)		36 to 48	36, 40, 48	OFDM	7.2
B	802.11ac (VHT40)		38 to 46	38, 46	OFDM	15.0
B	802.11ac (VHT80)		42	42	OFDM	130.0
B	802.11a	5745-5825	149 to 165	149, 157, 165	OFDM	6.0
B	802.11ac (VHT20)		149 to 165	149, 157, 165	OFDM	7.2
B	802.11ac (VHT40)		151 to 159	151, 159	OFDM	15.0
B	802.11ac (VHT80)		155	155	OFDM	130.0
Beamforming Mode						
B	802.11ac (VHT20)	5180-5240	36 to 48	36, 40, 48	OFDM	7.2
B	802.11ac (VHT40)		38 to 46	38, 46	OFDM	15.0
B	802.11ac (VHT80)		42	42	OFDM	130.0
B	802.11ac (VHT20)	5745-5825	149 to 165	149, 157, 165	OFDM	7.2
B	802.11ac (VHT40)		151 to 159	151, 159	OFDM	15.0
B	802.11ac (VHT80)		155	155	OFDM	130.0

Test Condition:

Applicable to	Environmental Conditions	Input Power	Tested by
RE \geq 1G	18 deg. C, 70% RH	120Vac, 60Hz	Jones Chang
	16 deg. C, 70% RH	120Vac, 60Hz	Nick Hsu
RE<1G	19 deg. C, 70% RH	120Vac, 60Hz 54Vdc (POE)	Jones Chang
PLC	16 deg. C, 70% RH	120Vac, 60Hz 54Vdc (POE)	Nick Hsu
APCM	25 deg. C, 60% RH	120Vac, 60Hz	Leo Tsai

3.3 Duty Cycle of Test Signal

Duty cycle of test signal is > 98%, duty factor is not required

Duty cycle of test signal is < 98 %, duty factor is required

CDD Mode

802.11a: Duty cycle = $2.060/2.135 = 0.965$, Duty factor = $10 * \log(1/0.965) = 0.16$

802.11n (VHT20): Duty cycle = $4.977/5.089 = 0.982$

802.11n (VHT40): Duty cycle = $2.422/2.500 = 0.969$, Duty factor = $10 * \log(1/0.969) = 0.14$

802.11ac (VHT80): Duty cycle = $1.132/1.220 = 0.928$, Duty factor = $10 * \log(1/0.928) = 0.33$

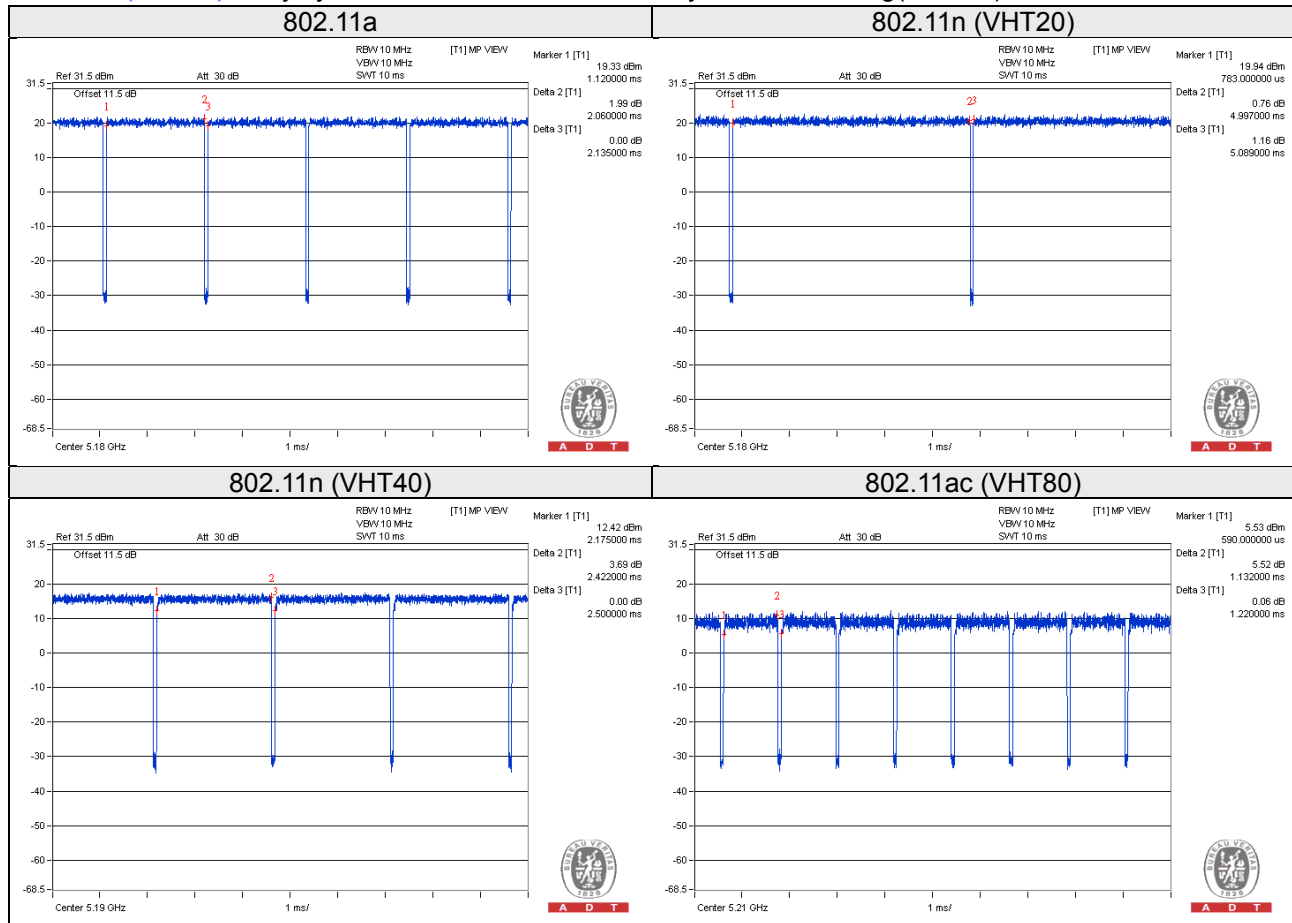

Beamforming Mode

802.11ac (VHT20): Duty cycle = $5.000/5.110 = 0.978$, Duty factor = $10 * \log(1/0.978) = 0.09$

802.11ac (VHT40): Duty cycle = $2.424/2.509 = 0.966$, Duty factor = $10 * \log(1/0.966) = 0.15$

802.11ac (VHT80): Duty cycle = $1.139/1.214 = 0.938$, Duty factor = $10 * \log(1/0.938) = 0.28$



3.4 Description of Support Units

The EUT has been tested as an independent unit together with other necessary accessories or support units. The following support units or accessories were used to form a representative test configuration during the tests.

ID	Product	Brand	Model No.	Serial No.	FCC ID	Remarks
A.	Notebook	DELL	E5410	1HC2XM1	FCC DoC Approved	-
B.	Load	NA	NA	NA	NA	-
C.	Flash	HP	v250W	01	NA	-
D.	Adapter	Asian Power Devices Inc.	WA-36A12R	NA	NA	Optional
E.	POE	EnGenius	EPA5006GAT	NA	NA	Provided by manufacturer

Note:

1. All power cords of the above support units are non-shielded (1.8m).
2. Item A acted as a communication partner to transfer data.

ID	Descriptions	Qty.	Length (m)	Shielding (Yes/No)	Cores (Qty.)	Remarks
1.	RJ45	1	5	N	0	-
2.	RJ45	1	1.8	N	0	-
3.	RJ45	1	1.8	N	0	-
4.	RS232	1	1.8	N	0	-

3.4.1 Configuration of System under Test

Mode A, C

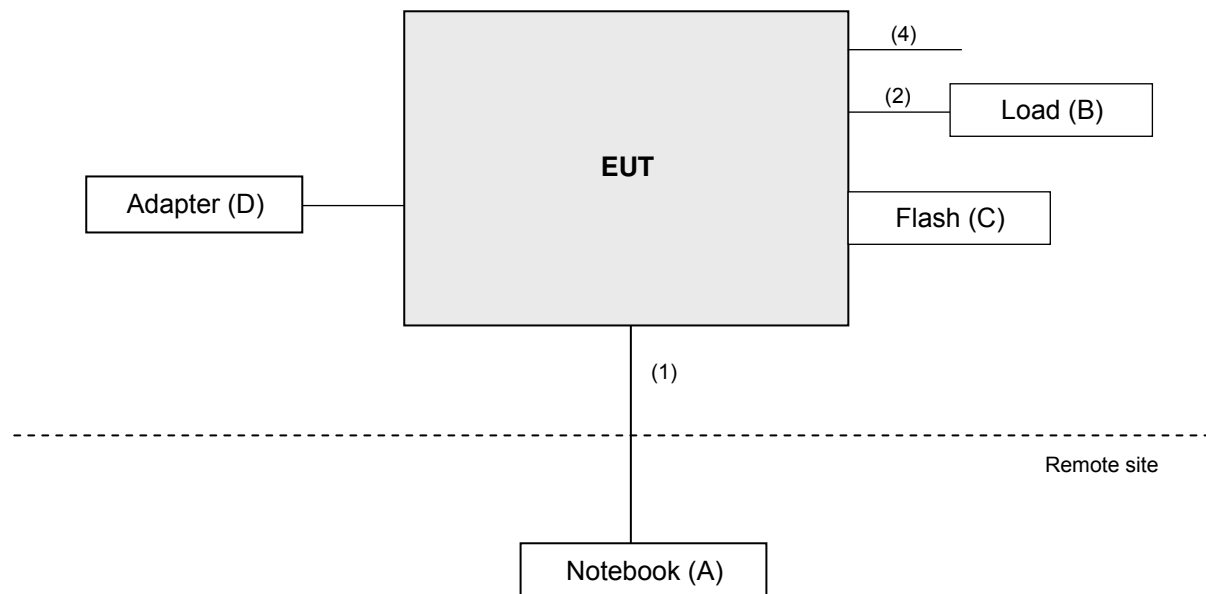

Mode B, D

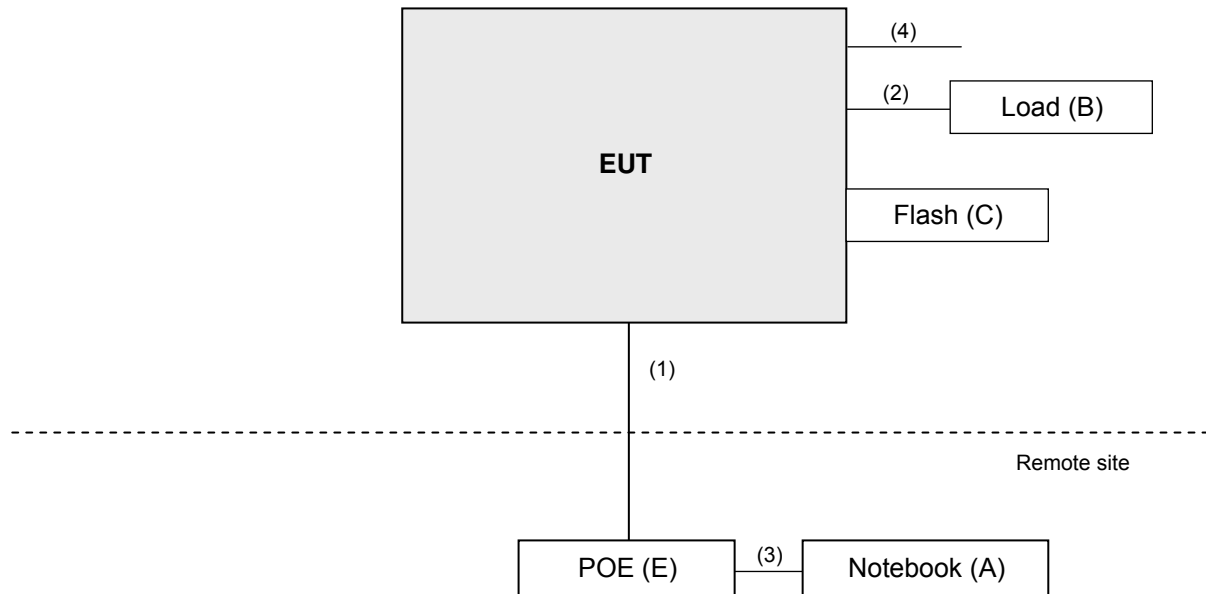

3.5 General Description of Applied Standard

The EUT is a RF Product. According to the specifications of the manufacturer, it must comply with the requirements of the following standards:

FCC Part 15, Subpart E (15.407)
789033 D02 General UNII Test Procedures New Rules v01r03
662911 D01 Multiple Transmitter Output v02r01
 ANSI C63.10:2013

All test items have been performed and recorded as per the above standards.

Note: The EUT has been verified to comply with the requirements of FCC Part 15, Subpart B, Class B (DoC).
 The test report has been issued separately.

4 Test Types and Results

4.1 Radiated Emission and Bandedge Measurement

4.1.1 Limits of Radiated Emission and Bandedge Measurement

Radiated emissions which fall in the restricted bands must comply with the radiated emission limits specified as below table.

Frequencies (MHz)	Field Strength (microvolts/meter)	Measurement Distance (meters)
0.009 ~ 0.490	2400/F(kHz)	300
0.490 ~ 1.705	24000/F(kHz)	30
1.705 ~ 30.0	30	30
30 ~ 88	100	3
88 ~ 216	150	3
216 ~ 960	200	3
Above 960	500	3

NOTE:

1. The lower limit shall apply at the transition frequencies.
2. Emission level (dBuV/m) = 20 log Emission level (uV/m).
3. For frequencies above 1000MHz, the field strength limits are based on average detector, however, the peak field strength of any emission shall not exceed the maximum permitted average limits, specified above by more than 20dB under any condition of modulation.

Limits of unwanted emission out of the restricted bands

Applicable To		Limit	
789033 D02 General UNII Test Procedure New Rules v01r03		Field Strength at 3m	
		PK:74 (dBuV/m)	AV:54 (dBuV/m)
Frequency Band	Applicable To	EIRP Limit	Equivalent Field Strength at 3m
5150~5250 MHz	15.407(b)(1)	PK:-27 (dBm/MHz)	PK:68.2(dBuV/m)
5250~5350 MHz	15.407(b)(2)		
5470~5725 MHz	15.407(b)(3)		
5725~5850 MHz	<input checked="" type="checkbox"/> 15.407(b)(4)(i)	PK:-27 (dBm/MHz) ^{*1} PK:10 (dBm/MHz) ^{*2} PK:15.6 (dBm/MHz) ^{*3} PK:27 (dBm/MHz) ^{*4}	PK: 68.2(dBuV/m) ^{*1} PK:105.2 (dBuV/m) ^{*2} PK: 110.8(dBuV/m) ^{*3} PK:122.2 (dBuV/m) ^{*4}
	<input type="checkbox"/> 15.407(b)(4)(ii)	Emission limits in section 15.247(d)	
^{*1} beyond 75 MHz or more above of the band edge.		^{*2} below the band edge increasing linearly to 10 dBm/MHz at 25 MHz above.	
^{*3} below the band edge increasing linearly to a level of 15.6 dBm/MHz at 5 MHz above.		^{*4} from 5 MHz above or below the band edge increasing linearly to a level of 27 dBm/MHz at the band edge.	

Note: The following formula is used to convert the equipment isotropic radiated power (eirp) to field strength:

$$E = \frac{1000000\sqrt{30P}}{3} \mu\text{V/m, where P is the eirp (Watts).}$$

4.1.2 Test Instruments

Description & Manufacturer	Model No.	Serial No.	Cal. Date	Cal. Due
Test Receiver ROHDE & SCHWARZ	ESIB7	100187	Apr. 10, 2015	Apr. 09, 2016
			Apr. 18, 2016	Apr. 17, 2017
Spectrum Analyzer ROHDE & SCHWARZ	FSP40	100041	Sep. 02, 2015	Sep. 01, 2016
BILOG Antenna SCHWARZBECK	VULB9168	9168-171	Jan. 07, 2016	Jan. 06, 2017
HORN Antenna SCHWARZBECK	9120D	209	Jan. 20, 2016	Jan. 19, 2017
HORN Antenna SCHWARZBECK	BBHA 9170	BBHA9170241	Jan. 18, 2016	Jan. 17, 2017
Preamplifier Agilent	8447D	2944A10738	Oct.18, 2015	Oct. 17, 2016
Preamplifier Agilent	8449B	3008A01964	Aug. 22, 2015	Aug. 21, 2016
RF signal cable HUBER+SUHNER	SUCOFLEX 104	Cable-CH3-03 (214378)	Aug. 22, 2015	Aug. 21, 2016
RF signal cable HUBER+SUHNER	SUCOFLEX 106	Cable-CH3-03 (309224+12738)	Aug. 22, 2015	Aug. 21, 2016
Software BV ADT	ADT_Radiated_ V7.6.15.9.4	NA	NA	NA
Antenna Tower inn-co GmbH	MA 4000	013303	NA	NA
Antenna Tower Controller BV ADT	AT100	AT93021702	NA	NA
Turn Table BV ADT	TT100	TT93021702	NA	NA
Turn Table Controller BV ADT	SC100	SC93021702	NA	NA
26GHz ~ 40GHz Amplifier	EM26400	815221	Oct. 18, 2015	Oct. 17, 2016
High Speed Peak Power Meter	ML2495A	0824011	Jul. 09, 2015	Jul. 08, 2016
Power Sensor	MA2411B	0738171	Jul. 09, 2015	Jul. 08, 2016
WIT Standard Temperature And Humidity Chamber	TH-4S-C	W981030	Jun. 08, 2016	Jun. 07, 2017

- Note: 1. The calibration interval of the above test instruments is 12 months and the calibrations are traceable to NML/ROC and NIST/USA.
 2. The test was performed in HwaYa Chamber 3.
 3. The horn antenna and preamplifier (model: 8449B) are used only for the measurement of emission frequency above 1GHz if tested.
 4. The FCC Site Registration No. is 988962.
 5. The IC Site Registration No. is IC 7450F-3.

4.1.3 Test Procedure

- a. The EUT was placed on the top of a rotating table 0.8 meters (for below 1GHz) / 1.5 meters (for above 1GHz) above the ground at 3 meter chamber room for test. The table was rotated 360 degrees to determine the position of the highest radiation.
- b. The EUT was set 3 meters away from the interference-receiving antenna, which was mounted on the top of a variable-height antenna tower.
- c. The height of antenna is varied from one meter to four meters above the ground to determine the maximum value of the field strength. Both horizontal and vertical polarizations of the antenna are set to make the measurement.
- d. For each suspected emission, the EUT was arranged to its worst case and then the antenna was tuned to heights from 1 meter to 4 meters and the rotatable table was turned from 0 degrees to 360 degrees to find the maximum reading.
- e. The test-receiver system was set to quasi-peak detect function and specified bandwidth with maximum hold mode when the test frequency is below 1 GHz.
- f. The test-receiver system was set to peak and average detect function and specified bandwidth with maximum hold mode when the test frequency is above 1 GHz. If the peak reading value also meets average limit, measurement with the average detector is unnecessary.

Note:

1. The resolution bandwidth and video bandwidth of test receiver/spectrum analyzer is 120kHz for Quasi-peak detection (QP) at frequency below 1GHz.
2. The resolution bandwidth of test receiver/spectrum analyzer is 1 MHz and the video bandwidth is 3 MHz for Peak detection (PK) at frequency above 1GHz.
3. The resolution bandwidth of test receiver/spectrum analyzer is 1MHz and the video bandwidth is 3MHz for RMS Average (Duty cycle < 98%) for Average detection (AV) at frequency above 1GHz, then the measurement results was added to a correction factor ($10 \log(1/\text{duty cycle})$).
4. The resolution bandwidth of test receiver/spectrum analyzer is 1MHz and the video bandwidth is 10Hz (Duty cycle $\geq 98\%$) for Average detection (AV) at frequency above 1GHz.
5. All modes of operation were investigated and the worst-case emissions are reported.

4.1.4 Deviation from Test Standard

No deviation.

4.1.5 Test Setup

<Frequency Range 30MHz~1GHz>

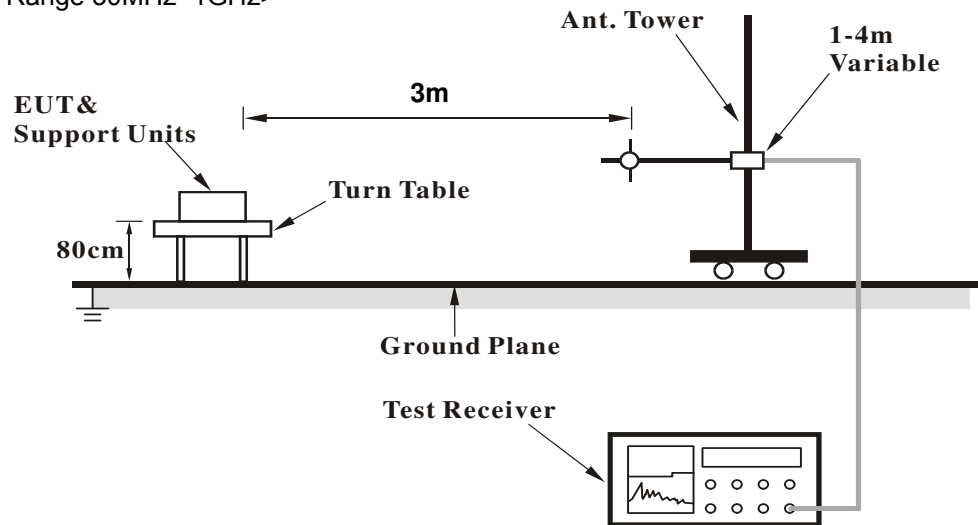

<Frequency Range above 1GHz>

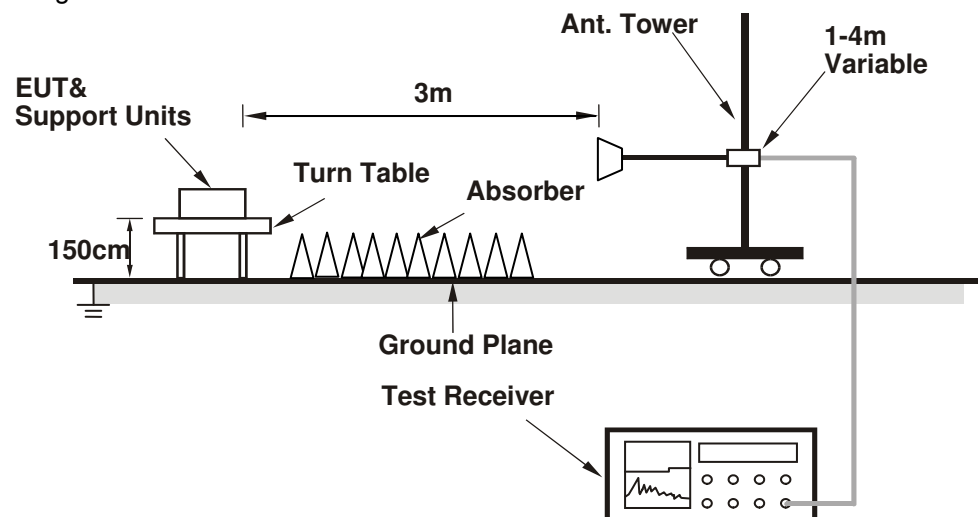

For the actual test configuration, please refer to the attached file (Test Setup Photo).

4.1.6 EUT Operating Conditions

- a. Placed the EUT on the testing table.
- b. Prepared a notebook to act as a communication partner and placed it outside of testing area.
- c. The communication partner connected with EUT via a RJ45 cable and ran a test program (provided by manufacturer) to enable EUT under transmission condition continuously at specific channel frequency.
- d. The communication partner sent data to EUT by command "PING".
- e. The necessary accessories enable the system in full functions.

4.1.7 Test Results

Above 1GHz Worst-case Data:

CDD Mode: Mode B

802.11a

CHANNEL	TX Channel 36	DETECTOR FUNCTION	Peak (PK)
FREQUENCY RANGE	1GHz ~ 40GHz		Average (AV)

ANTENNA POLARITY & TEST DISTANCE: HORIZONTAL AT 3 M								
NO.	FREQ. (MHz)	EMISSION LEVEL (dBuV/m)	LIMIT (dBuV/m)	MARGIN (dB)	ANTENNA HEIGHT (m)	TABLE ANGLE (Degree)	RAW VALUE (dBuV)	CORRECTION FACTOR (dB/m)
1	5150.00	65.2 PK	74.0	-8.8	1.80 H	301	59.20	6.00
2	5150.00	52.5 AV	54.0	-1.5	1.80 H	301	46.50	6.00
3	*5180.00	121.3 PK			1.64 H	282	81.90	39.40
4	*5180.00	111.3 AV			1.64 H	282	71.90	39.40
5	#10360.00	62.2 PK	74.0	-11.8	2.20 H	278	44.40	17.80
6	#10360.00	49.9 AV	54.0	-4.1	2.20 H	278	32.10	17.80
ANTENNA POLARITY & TEST DISTANCE: VERTICAL AT 3 M								
NO.	FREQ. (MHz)	EMISSION LEVEL (dBuV/m)	LIMIT (dBuV/m)	MARGIN (dB)	ANTENNA HEIGHT (m)	TABLE ANGLE (Degree)	RAW VALUE (dBuV)	CORRECTION FACTOR (dB/m)
1	5150.00	61.7 PK	74.0	-12.3	3.36 V	301	55.70	6.00
2	5150.00	49.1 AV	54.0	-4.9	3.36 V	301	43.10	6.00
3	*5180.00	115.1 PK			1.05 V	39	75.70	39.40
4	*5180.00	104.4 AV			1.05 V	39	65.00	39.40
5	#10360.00	59.8 PK	74.0	-14.2	1.35 V	5	42.00	17.80
6	#10360.00	47.2 AV	54.0	-6.8	1.35 V	5	29.40	17.80

Remarks:

1. Emission Level(dBuV/m) = Raw Value(dBuV) + Correction Factor(dB/m)
2. Correction Factor(dB/m) = Antenna Factor(dB/m) + Cable Factor(dB)
– Pre-Amplifier Factor(dB)
3. The other emission levels were very low against the limit.
4. Margin value = Emission Level – Limit value
5. " * ": Fundamental frequency.
6. " # ": The radiated frequency is out of the restricted band.

CHANNEL	TX Channel 40	DETECTOR FUNCTION	Peak (PK)
FREQUENCY RANGE	1GHz ~ 40GHz		Average (AV)

ANTENNA POLARITY & TEST DISTANCE: HORIZONTAL AT 3 M

NO.	FREQ. (MHz)	EMISSION LEVEL (dBuV/m)	LIMIT (dBuV/m)	MARGIN (dB)	ANTENNA HEIGHT (m)	TABLE ANGLE (Degree)	RAW VALUE (dBuV)	CORRECTION FACTOR (dB/m)
1	5150.00	65.1 PK	74.0	-8.9	1.54 H	46	59.10	6.00
2	5150.00	52.2 AV	54.0	-1.8	1.54 H	46	46.20	6.00
3	*5200.00	124.0 PK			1.84 H	281	84.50	39.50
4	*5200.00	114.3 AV			1.84 H	281	74.80	39.50
5	#10400.00	63.0 PK	74.0	-11.0	2.23 H	277	45.30	17.70
6	#10400.00	50.9 AV	54.0	-3.1	2.23 H	277	33.20	17.70

ANTENNA POLARITY & TEST DISTANCE: VERTICAL AT 3 M

NO.	FREQ. (MHz)	EMISSION LEVEL (dBuV/m)	LIMIT (dBuV/m)	MARGIN (dB)	ANTENNA HEIGHT (m)	TABLE ANGLE (Degree)	RAW VALUE (dBuV)	CORRECTION FACTOR (dB/m)
1	5150.00	58.8 PK	74.0	-15.2	1.62 V	43	52.80	6.00
2	5150.00	44.8 AV	54.0	-9.2	1.62 V	43	38.80	6.00
3	*5200.00	117.2 PK			1.00 V	47	77.70	39.50
4	*5200.00	106.6 AV			1.00 V	47	67.10	39.50
5	#10400.00	59.7 PK	74.0	-14.3	1.60 V	9	42.00	17.70
6	#10400.00	47.9 AV	54.0	-6.1	1.60 V	9	30.20	17.70

Remarks:

1. Emission Level(dBuV/m) = Raw Value(dBuV) + Correction Factor(dB/m)
2. Correction Factor(dB/m) = Antenna Factor(dB/m) + Cable Factor(dB)
– Pre-Amplifier Factor(dB)
3. The other emission levels were very low against the limit.
4. Margin value = Emission Level – Limit value
5. " * ": Fundamental frequency.
6. " # ": The radiated frequency is out of the restricted band.

CHANNEL	TX Channel 48	DETECTOR FUNCTION	Peak (PK)
FREQUENCY RANGE	1GHz ~ 40GHz		Average (AV)

ANTENNA POLARITY & TEST DISTANCE: HORIZONTAL AT 3 M

NO.	FREQ. (MHz)	EMISSION LEVEL (dBuV/m)	LIMIT (dBuV/m)	MARGIN (dB)	ANTENNA HEIGHT (m)	TABLE ANGLE (Degree)	RAW VALUE (dBuV)	CORRECTION FACTOR (dB/m)
1	5120.00	57.4 PK	74.0	-16.6	1.82 H	283	51.40	6.00
2	5120.00	46.0 AV	54.0	-8.0	1.82 H	283	40.00	6.00
3	*5240.00	123.8 PK			1.74 H	289	84.20	39.60
4	*5240.00	113.8 AV			1.74 H	289	74.20	39.60
5	#10480.00	67.6 PK	74.0	-6.4	1.00 H	278	48.90	18.70
6	#10480.00	52.8 AV	54.0	-1.2	1.00 H	278	34.10	18.70

ANTENNA POLARITY & TEST DISTANCE: VERTICAL AT 3 M

NO.	FREQ. (MHz)	EMISSION LEVEL (dBuV/m)	LIMIT (dBuV/m)	MARGIN (dB)	ANTENNA HEIGHT (m)	TABLE ANGLE (Degree)	RAW VALUE (dBuV)	CORRECTION FACTOR (dB/m)
1	5120.00	55.7 PK	74.0	-18.3	1.28 V	92	49.70	6.00
2	5120.00	44.0 AV	54.0	-10.0	1.28 V	92	38.00	6.00
3	*5240.00	116.5 PK			1.13 V	41	76.90	39.60
4	*5240.00	105.7 AV			1.13 V	41	66.10	39.60
5	#10480.00	60.3 PK	74.0	-13.7	2.11 V	306	41.60	18.70
6	#10480.00	47.4 AV	54.0	-6.6	2.11 V	306	28.70	18.70

Remarks:

1. Emission Level(dBuV/m) = Raw Value(dBuV) + Correction Factor(dB/m)
2. Correction Factor(dB/m) = Antenna Factor(dB/m) + Cable Factor(dB)
– Pre-Amplifier Factor(dB)
3. The other emission levels were very low against the limit.
4. Margin value = Emission Level – Limit value
5. " * ": Fundamental frequency.
6. " # ": The radiated frequency is out of the restricted band.

CHANNEL	TX Channel 149	DETECTOR FUNCTION	Peak (PK)
FREQUENCY RANGE	1GHz ~ 40GHz		Average (AV)

ANTENNA POLARITY & TEST DISTANCE: HORIZONTAL AT 3 M

NO.	FREQ. (MHz)	EMISSION LEVEL (dBuV/m)	LIMIT (dBuV/m)	MARGIN (dB)	ANTENNA HEIGHT (m)	TABLE ANGLE (Degree)	RAW VALUE (dBuV)	CORRECTION FACTOR (dB/m)
1	#5714.90	67.7 PK	109.4	-41.7	1.21 H	296	60.30	7.40
2	#5722.90	74.4 PK	117.4	-43.0	3.22 H	286	67.00	7.40
3	#5725.00	64.1 PK	122.2	-58.1	3.24 H	292	56.70	7.40
4	*5745.00	121.3 PK			1.90 H	286	80.80	40.50
5	*5745.00	111.3 AV			1.90 H	286	70.80	40.50
6	11490.00	65.9 PK	74.0	-8.1	1.02 H	279	47.20	18.70
7	11490.00	52.7 AV	54.0	-1.3	1.02 H	279	34.00	18.70

ANTENNA POLARITY & TEST DISTANCE: VERTICAL AT 3 M

NO.	FREQ. (MHz)	EMISSION LEVEL (dBuV/m)	LIMIT (dBuV/m)	MARGIN (dB)	ANTENNA HEIGHT (m)	TABLE ANGLE (Degree)	RAW VALUE (dBuV)	CORRECTION FACTOR (dB/m)
1	#5714.90	65.1 PK	109.4	-44.3	4.00 V	359	57.70	7.40
2	#5722.90	69.9 PK	117.4	-47.5	4.00 V	18	62.50	7.40
3	#5725.00	58.1 PK	122.2	-64.1	4.00 V	23	50.70	7.40
4	*5745.00	117.0 PK			3.30 V	336	76.50	40.50
5	*5745.00	106.0 AV			3.30 V	336	65.50	40.50
6	11490.00	61.4 PK	74.0	-12.6	3.83 V	328	42.70	18.70
7	11490.00	49.2 AV	54.0	-4.8	3.83 V	328	30.50	18.70

Remarks:

1. Emission Level(dBuV/m) = Raw Value(dBuV) + Correction Factor(dB/m)
2. Correction Factor(dB/m) = Antenna Factor(dB/m) + Cable Factor(dB)
– Pre-Amplifier Factor(dB)
3. The other emission levels were very low against the limit.
4. Margin value = Emission Level – Limit value
5. " * ": Fundamental frequency.
6. " # ": The radiated frequency is out of the restricted band.

CHANNEL	TX Channel 157	DETECTOR FUNCTION	Peak (PK)
FREQUENCY RANGE	1GHz ~ 40GHz		Average (AV)

ANTENNA POLARITY & TEST DISTANCE: HORIZONTAL AT 3 M

NO.	FREQ. (MHz)	EMISSION LEVEL (dBuV/m)	LIMIT (dBuV/m)	MARGIN (dB)	ANTENNA HEIGHT (m)	TABLE ANGLE (Degree)	RAW VALUE (dBuV)	CORRECTION FACTOR (dB/m)
1	*5785.00	124.0 PK			2.03 H	297	83.40	40.60
2	*5785.00	113.5 AV			2.03 H	297	72.90	40.60
3	11570.00	64.5 PK	74.0	-9.5	1.00 H	283	45.80	18.70
4	11570.00	52.7 AV	54.0	-1.3	1.00 H	283	34.00	18.70

ANTENNA POLARITY & TEST DISTANCE: VERTICAL AT 3 M

NO.	FREQ. (MHz)	EMISSION LEVEL (dBuV/m)	LIMIT (dBuV/m)	MARGIN (dB)	ANTENNA HEIGHT (m)	TABLE ANGLE (Degree)	RAW VALUE (dBuV)	CORRECTION FACTOR (dB/m)
1	*5785.00	119.0 PK			3.26 V	336	78.40	40.60
2	*5785.00	108.5 AV			3.26 V	336	67.90	40.60
3	11570.00	60.0 PK	74.0	-14.0	3.91 V	19	41.30	18.70
4	11570.00	48.0 AV	54.0	-6.0	3.91 V	19	29.30	18.70

Remarks:

1. Emission Level(dBuV/m) = Raw Value(dBuV) + Correction Factor(dB/m)
2. Correction Factor(dB/m) = Antenna Factor(dB/m) + Cable Factor(dB)
– Pre-Amplifier Factor(dB)
3. The other emission levels were very low against the limit.
4. Margin value = Emission Level – Limit value
5. " * ": Fundamental frequency.

CHANNEL	TX Channel 165	DETECTOR FUNCTION	Peak (PK)
FREQUENCY RANGE	1GHz ~ 40GHz		Average (AV)

ANTENNA POLARITY & TEST DISTANCE: HORIZONTAL AT 3 M

NO.	FREQ. (MHz)	EMISSION LEVEL (dBuV/m)	LIMIT (dBuV/m)	MARGIN (dB)	ANTENNA HEIGHT (m)	TABLE ANGLE (Degree)	RAW VALUE (dBuV)	CORRECTION FACTOR (dB/m)
1	*5825.00	124.5 PK			2.11 H	296	83.90	40.60
2	*5825.00	113.7 AV			2.11 H	296	73.10	40.60
3	#5850.00	59.1 PK	122.2	-63.1	1.05 H	308	51.50	7.60
4	#5852.10	71.2 PK	117.4	-46.2	1.12 H	307	63.50	7.70
5	#5860.10	67.4 PK	109.4	-42.0	1.26 H	302	59.70	7.70
6	11650.00	63.3 PK	74.0	-10.7	1.02 H	280	44.10	19.20
7	11650.00	51.1 AV	54.0	-2.9	1.02 H	280	31.90	19.20

ANTENNA POLARITY & TEST DISTANCE: VERTICAL AT 3 M

NO.	FREQ. (MHz)	EMISSION LEVEL (dBuV/m)	LIMIT (dBuV/m)	MARGIN (dB)	ANTENNA HEIGHT (m)	TABLE ANGLE (Degree)	RAW VALUE (dBuV)	CORRECTION FACTOR (dB/m)
1	*5825.00	118.8 PK			3.83 V	332	78.20	40.60
2	*5825.00	108.5 AV			3.83 V	332	67.90	40.60
3	#5850.00	60.2 PK	122.2	-62.0	4.00 V	336	52.60	7.60
4	#5852.10	71.4 PK	117.4	-46.0	4.00 V	337	63.70	7.70
5	#5860.10	61.6 PK	109.4	-47.8	4.00 V	337	53.90	7.70
6	11650.00	60.6 PK	74.0	-13.4	3.78 V	327	41.40	19.20
7	11650.00	49.0 AV	54.0	-5.0	3.78 V	327	29.80	19.20

Remarks:

1. Emission Level(dBuV/m) = Raw Value(dBuV) + Correction Factor(dB/m)
2. Correction Factor(dB/m) = Antenna Factor(dB/m) + Cable Factor(dB)
– Pre-Amplifier Factor(dB)
3. The other emission levels were very low against the limit.
4. Margin value = Emission Level – Limit value
5. " * ": Fundamental frequency.
6. " # ": The radiated frequency is out of the restricted band.

802.11ac (VHT20)

CHANNEL	TX Channel 36	DETECTOR FUNCTION	Peak (PK)
FREQUENCY RANGE	1GHz ~ 40GHz		Average (AV)

ANTENNA POLARITY & TEST DISTANCE: HORIZONTAL AT 3 M								
NO.	FREQ. (MHz)	EMISSION LEVEL (dBuV/m)	LIMIT (dBuV/m)	MARGIN (dB)	ANTENNA HEIGHT (m)	TABLE ANGLE (Degree)	RAW VALUE (dBuV)	CORRECTION FACTOR (dB/m)
1	5150.00	66.1 PK	74.0	-7.9	1.00 H	284	60.10	6.00
2	5150.00	52.2 AV	54.0	-1.8	1.00 H	284	46.20	6.00
3	*5180.00	121.9 PK			1.54 H	288	82.50	39.40
4	*5180.00	110.7 AV			1.54 H	288	71.30	39.40
5	#10360.00	62.5 PK	74.0	-11.5	2.07 H	275	44.70	17.80
6	#10360.00	48.8 AV	54.0	-5.2	2.07 H	275	31.00	17.80
ANTENNA POLARITY & TEST DISTANCE: VERTICAL AT 3 M								
NO.	FREQ. (MHz)	EMISSION LEVEL (dBuV/m)	LIMIT (dBuV/m)	MARGIN (dB)	ANTENNA HEIGHT (m)	TABLE ANGLE (Degree)	RAW VALUE (dBuV)	CORRECTION FACTOR (dB/m)
1	5150.00	57.4 PK	74.0	-16.6	1.65 V	42	51.40	6.00
2	5150.00	44.6 AV	54.0	-9.4	1.65 V	42	38.60	6.00
3	*5180.00	114.3 PK			1.06 V	40	74.90	39.40
4	*5180.00	103.3 AV			1.06 V	40	63.90	39.40
5	#10360.00	59.5 PK	74.0	-14.5	1.78 V	352	41.70	17.80
6	#10360.00	46.8 AV	54.0	-7.2	1.78 V	352	29.00	17.80

Remarks:

1. Emission Level(dBuV/m) = Raw Value(dBuV) + Correction Factor(dB/m)
2. Correction Factor(dB/m) = Antenna Factor(dB/m) + Cable Factor(dB) – Pre-Amplifier Factor(dB)
3. The other emission levels were very low against the limit.
4. Margin value = Emission Level – Limit value
5. " * ": Fundamental frequency.
6. " # ": The radiated frequency is out of the restricted band.

CHANNEL	TX Channel 40	DETECTOR FUNCTION	Peak (PK)
FREQUENCY RANGE	1GHz ~ 40GHz		Average (AV)

ANTENNA POLARITY & TEST DISTANCE: HORIZONTAL AT 3 M

NO.	FREQ. (MHz)	EMISSION LEVEL (dBuV/m)	LIMIT (dBuV/m)	MARGIN (dB)	ANTENNA HEIGHT (m)	TABLE ANGLE (Degree)	RAW VALUE (dBuV)	CORRECTION FACTOR (dB/m)
1	5150.00	67.2 PK	74.0	-6.8	3.86 H	288	61.20	6.00
2	5150.00	52.2 AV	54.0	-1.8	3.86 H	288	46.20	6.00
3	*5200.00	124.9 PK			1.87 H	286	85.40	39.50
4	*5200.00	113.6 AV			1.87 H	286	74.10	39.50
5	#10400.00	63.7 PK	74.0	-10.3	2.22 H	279	46.00	17.70
6	#10400.00	50.5 AV	54.0	-3.5	2.22 H	279	32.80	17.70

ANTENNA POLARITY & TEST DISTANCE: VERTICAL AT 3 M

NO.	FREQ. (MHz)	EMISSION LEVEL (dBuV/m)	LIMIT (dBuV/m)	MARGIN (dB)	ANTENNA HEIGHT (m)	TABLE ANGLE (Degree)	RAW VALUE (dBuV)	CORRECTION FACTOR (dB/m)
1	5150.00	59.2 PK	74.0	-14.8	1.60 V	48	53.20	6.00
2	5150.00	46.2 AV	54.0	-7.8	1.60 V	48	40.20	6.00
3	*5200.00	117.3 PK			1.00 V	48	77.80	39.50
4	*5200.00	106.2 AV			1.00 V	48	66.70	39.50
5	#10400.00	59.2 PK	74.0	-14.8	1.06 V	310	41.50	17.70
6	#10400.00	47.3 AV	54.0	-6.7	1.06 V	310	29.60	17.70

Remarks:

1. Emission Level(dBuV/m) = Raw Value(dBuV) + Correction Factor(dB/m)
2. Correction Factor(dB/m) = Antenna Factor(dB/m) + Cable Factor(dB) – Pre-Amplifier Factor(dB)
3. The other emission levels were very low against the limit.
4. Margin value = Emission Level – Limit value
5. " * ": Fundamental frequency.
6. " # ": The radiated frequency is out of the restricted band.

CHANNEL	TX Channel 48	DETECTOR FUNCTION	Peak (PK)
FREQUENCY RANGE	1GHz ~ 40GHz		Average (AV)

ANTENNA POLARITY & TEST DISTANCE: HORIZONTAL AT 3 M

NO.	FREQ. (MHz)	EMISSION LEVEL (dBuV/m)	LIMIT (dBuV/m)	MARGIN (dB)	ANTENNA HEIGHT (m)	TABLE ANGLE (Degree)	RAW VALUE (dBuV)	CORRECTION FACTOR (dB/m)
1	5120.00	57.5 PK	74.0	-16.5	1.61 H	283	51.50	6.00
2	5120.00	46.1 AV	54.0	-7.9	1.61 H	283	40.10	6.00
3	*5240.00	124.2 PK			1.71 H	287	84.60	39.60
4	*5240.00	112.9 AV			1.71 H	287	73.30	39.60
5	#10480.00	66.7 PK	74.0	-7.3	1.02 H	281	48.00	18.70
6	#10480.00	52.2 AV	54.0	-1.8	1.02 H	281	33.50	18.70

ANTENNA POLARITY & TEST DISTANCE: VERTICAL AT 3 M

NO.	FREQ. (MHz)	EMISSION LEVEL (dBuV/m)	LIMIT (dBuV/m)	MARGIN (dB)	ANTENNA HEIGHT (m)	TABLE ANGLE (Degree)	RAW VALUE (dBuV)	CORRECTION FACTOR (dB/m)
1	5120.00	57.1 PK	74.0	-16.9	1.29 V	102	51.10	6.00
2	5120.00	44.1 AV	54.0	-9.9	1.29 V	102	38.10	6.00
3	*5240.00	116.1 PK			1.12 V	41	76.50	39.60
4	*5240.00	105.3 AV			1.12 V	41	65.70	39.60
5	#10480.00	60.3 PK	74.0	-13.7	2.76 V	314	41.60	18.70
6	#10480.00	47.6 AV	54.0	-6.4	2.76 V	314	28.90	18.70

Remarks:

- Emission Level(dBuV/m) = Raw Value(dBuV) + Correction Factor(dB/m)
- Correction Factor(dB/m) = Antenna Factor(dB/m) + Cable Factor(dB)
– Pre-Amplifier Factor(dB)
- The other emission levels were very low against the limit.
- Margin value = Emission Level – Limit value
- " * ": Fundamental frequency.
- " # ": The radiated frequency is out of the restricted band.

CHANNEL	TX Channel 149	DETECTOR FUNCTION	Peak (PK)
FREQUENCY RANGE	1GHz ~ 40GHz		Average (AV)

ANTENNA POLARITY & TEST DISTANCE: HORIZONTAL AT 3 M

NO.	FREQ. (MHz)	EMISSION LEVEL (dBuV/m)	LIMIT (dBuV/m)	MARGIN (dB)	ANTENNA HEIGHT (m)	TABLE ANGLE (Degree)	RAW VALUE (dBuV)	CORRECTION FACTOR (dB/m)
1	#5714.90	67.5 PK	109.4	-41.9	2.68 H	296	60.10	7.40
2	#5722.90	74.8 PK	117.4	-42.6	2.77 H	291	67.40	7.40
3	#5725.00	63.9 PK	122.2	-58.3	2.84 H	294	56.50	7.40
4	*5745.00	121.9 PK			1.96 H	290	81.40	40.50
5	*5745.00	110.5 AV			1.96 H	290	70.00	40.50
6	11490.00	65.2 PK	74.0	-8.8	1.00 H	281	46.50	18.70
7	11490.00	52.2 AV	54.0	-1.8	1.00 H	281	33.50	18.70

ANTENNA POLARITY & TEST DISTANCE: VERTICAL AT 3 M

NO.	FREQ. (MHz)	EMISSION LEVEL (dBuV/m)	LIMIT (dBuV/m)	MARGIN (dB)	ANTENNA HEIGHT (m)	TABLE ANGLE (Degree)	RAW VALUE (dBuV)	CORRECTION FACTOR (dB/m)
1	#5714.90	63.4 PK	109.4	-46.0	2.75 V	358	56.00	7.40
2	#5722.90	71.1 PK	117.4	-46.3	2.60 V	356	63.70	7.40
3	#5725.00	62.5 PK	122.2	-59.7	2.46 V	4	55.10	7.40
4	*5745.00	116.0 PK			2.55 V	334	75.50	40.50
5	*5745.00	105.6 AV			2.55 V	334	65.10	40.50
6	11490.00	59.2 PK	74.0	-14.8	2.94 V	38	40.50	18.70
7	11490.00	47.1 AV	54.0	-6.9	2.94 V	38	28.40	18.70

Remarks:

1. Emission Level(dBuV/m) = Raw Value(dBuV) + Correction Factor(dB/m)
2. Correction Factor(dB/m) = Antenna Factor(dB/m) + Cable Factor(dB)
– Pre-Amplifier Factor(dB)
3. The other emission levels were very low against the limit.
4. Margin value = Emission Level – Limit value
5. " * ": Fundamental frequency.
6. " # ": The radiated frequency is out of the restricted band.

CHANNEL	TX Channel 157	DETECTOR FUNCTION	Peak (PK)
FREQUENCY RANGE	1GHz ~ 40GHz		Average (AV)

ANTENNA POLARITY & TEST DISTANCE: HORIZONTAL AT 3 M

NO.	FREQ. (MHz)	EMISSION LEVEL (dBuV/m)	LIMIT (dBuV/m)	MARGIN (dB)	ANTENNA HEIGHT (m)	TABLE ANGLE (Degree)	RAW VALUE (dBuV)	CORRECTION FACTOR (dB/m)
1	*5785.00	124.3 PK			1.84 H	291	83.70	40.60
2	*5785.00	113.0 AV			1.84 H	291	72.40	40.60
3	11570.00	66.0 PK	74.0	-8.0	1.00 H	281	47.30	18.70
4	11570.00	52.3 AV	54.0	-1.7	1.00 H	281	33.60	18.70

ANTENNA POLARITY & TEST DISTANCE: VERTICAL AT 3 M

NO.	FREQ. (MHz)	EMISSION LEVEL (dBuV/m)	LIMIT (dBuV/m)	MARGIN (dB)	ANTENNA HEIGHT (m)	TABLE ANGLE (Degree)	RAW VALUE (dBuV)	CORRECTION FACTOR (dB/m)
1	*5785.00	117.7 PK			3.12 V	332	77.10	40.60
2	*5785.00	106.8 AV			3.12 V	332	66.20	40.60
3	11570.00	60.5 PK	74.0	-13.5	2.73 V	14	41.80	18.70
4	11570.00	47.9 AV	54.0	-6.1	2.73 V	14	29.20	18.70

Remarks:

1. Emission Level(dBuV/m) = Raw Value(dBuV) + Correction Factor(dB/m)
2. Correction Factor(dB/m) = Antenna Factor(dB/m) + Cable Factor(dB)
– Pre-Amplifier Factor(dB)
3. The other emission levels were very low against the limit.
4. Margin value = Emission Level – Limit value
5. " * ": Fundamental frequency.

CHANNEL	TX Channel 165	DETECTOR FUNCTION	Peak (PK)
FREQUENCY RANGE	1GHz ~ 40GHz		Average (AV)

ANTENNA POLARITY & TEST DISTANCE: HORIZONTAL AT 3 M

NO.	FREQ. (MHz)	EMISSION LEVEL (dBuV/m)	LIMIT (dBuV/m)	MARGIN (dB)	ANTENNA HEIGHT (m)	TABLE ANGLE (Degree)	RAW VALUE (dBuV)	CORRECTION FACTOR (dB/m)
1	*5825.00	123.6 PK			2.16 H	297	83.00	40.60
2	*5825.00	112.6 AV			2.16 H	297	72.00	40.60
3	#5850.00	60.7 PK	122.2	-61.5	1.48 H	54	53.10	7.60
4	#5852.10	70.0 PK	117.4	-47.4	1.50 H	56	62.30	7.70
5	#5860.10	66.8 PK	109.4	-42.6	1.72 H	56	59.10	7.70
6	11650.00	64.5 PK	74.0	-9.5	1.03 H	281	45.30	19.20
7	11650.00	50.8 AV	54.0	-3.2	1.03 H	281	31.60	19.20

ANTENNA POLARITY & TEST DISTANCE: VERTICAL AT 3 M

NO.	FREQ. (MHz)	EMISSION LEVEL (dBuV/m)	LIMIT (dBuV/m)	MARGIN (dB)	ANTENNA HEIGHT (m)	TABLE ANGLE (Degree)	RAW VALUE (dBuV)	CORRECTION FACTOR (dB/m)
1	*5825.00	118.0 PK			3.35 V	332	77.40	40.60
2	*5825.00	107.0 AV			3.35 V	332	66.40	40.60
3	#5850.00	59.0 PK	122.2	-63.2	4.00 V	342	51.40	7.60
4	#5852.10	68.7 PK	117.4	-48.7	4.00 V	349	61.00	7.70
5	#5860.10	61.9 PK	109.4	-47.5	4.00 V	8	54.20	7.70
6	11650.00	61.0 PK	74.0	-13.0	4.00 V	332	41.80	19.20
7	11650.00	48.4 AV	54.0	-5.6	4.00 V	332	29.20	19.20

Remarks:

1. Emission Level(dBuV/m) = Raw Value(dBuV) + Correction Factor(dB/m)
2. Correction Factor(dB/m) = Antenna Factor(dB/m) + Cable Factor(dB)
– Pre-Amplifier Factor(dB)
3. The other emission levels were very low against the limit.
4. Margin value = Emission Level – Limit value
5. " * ": Fundamental frequency.
6. " # ": The radiated frequency is out of the restricted band.

802.11ac (VHT40)

CHANNEL	TX Channel 38	DETECTOR FUNCTION	Peak (PK)
FREQUENCY RANGE	1GHz ~ 40GHz		Average (AV)

ANTENNA POLARITY & TEST DISTANCE: HORIZONTAL AT 3 M								
NO.	FREQ. (MHz)	EMISSION LEVEL (dBuV/m)	LIMIT (dBuV/m)	MARGIN (dB)	ANTENNA HEIGHT (m)	TABLE ANGLE (Degree)	RAW VALUE (dBuV)	CORRECTION FACTOR (dB/m)
1	5150.00	66.1 PK	74.0	-7.9	1.65 H	275	60.10	6.00
2	5150.00	53.0 AV	54.0	-1.0	1.65 H	275	47.00	6.00
3	*5190.00	115.1 PK			1.73 H	287	75.70	39.40
4	*5190.00	105.1 AV			1.73 H	287	65.70	39.40
5	#10380.00	58.6 PK	74.0	-15.4	1.75 H	28	40.90	17.70
6	#10380.00	46.5 AV	54.0	-7.5	1.75 H	28	28.80	17.70
ANTENNA POLARITY & TEST DISTANCE: VERTICAL AT 3 M								
NO.	FREQ. (MHz)	EMISSION LEVEL (dBuV/m)	LIMIT (dBuV/m)	MARGIN (dB)	ANTENNA HEIGHT (m)	TABLE ANGLE (Degree)	RAW VALUE (dBuV)	CORRECTION FACTOR (dB/m)
1	5150.00	58.8 PK	74.0	-15.2	1.06 V	39	52.80	6.00
2	5150.00	45.8 AV	54.0	-8.2	1.06 V	39	39.80	6.00
3	*5190.00	107.4 PK			1.15 V	39	68.00	39.40
4	*5190.00	97.5 AV			1.15 V	39	58.10	39.40
5	#10380.00	58.7 PK	74.0	-15.3	1.36 V	142	41.00	17.70
6	#10380.00	46.0 AV	54.0	-8.0	1.36 V	142	28.30	17.70

Remarks:

1. Emission Level(dBuV/m) = Raw Value(dBuV) + Correction Factor(dB/m)
2. Correction Factor(dB/m) = Antenna Factor(dB/m) + Cable Factor(dB) – Pre-Amplifier Factor(dB)
3. The other emission levels were very low against the limit.
4. Margin value = Emission Level – Limit value
5. " * ": Fundamental frequency.
6. " # ": The radiated frequency is out of the restricted band.

CHANNEL	TX Channel 46	DETECTOR FUNCTION	Peak (PK)
FREQUENCY RANGE	1GHz ~ 40GHz		Average (AV)

ANTENNA POLARITY & TEST DISTANCE: HORIZONTAL AT 3 M

NO.	FREQ. (MHz)	EMISSION LEVEL (dBuV/m)	LIMIT (dBuV/m)	MARGIN (dB)	ANTENNA HEIGHT (m)	TABLE ANGLE (Degree)	RAW VALUE (dBuV)	CORRECTION FACTOR (dB/m)
1	5150.00	63.5 PK	74.0	-10.5	1.84 H	277	57.50	6.00
2	5150.00	52.2 AV	54.0	-1.8	1.84 H	277	46.20	6.00
3	*5230.00	119.3 PK			1.81 H	284	79.70	39.60
4	*5230.00	109.5 AV			1.81 H	284	69.90	39.60
5	#10460.00	62.5 PK	74.0	-11.5	1.00 H	277	44.00	18.50
6	#10460.00	49.7 AV	54.0	-4.3	1.00 H	277	31.20	18.50

ANTENNA POLARITY & TEST DISTANCE: VERTICAL AT 3 M

NO.	FREQ. (MHz)	EMISSION LEVEL (dBuV/m)	LIMIT (dBuV/m)	MARGIN (dB)	ANTENNA HEIGHT (m)	TABLE ANGLE (Degree)	RAW VALUE (dBuV)	CORRECTION FACTOR (dB/m)
1	5150.00	57.2 PK	74.0	-16.8	1.19 V	35	51.20	6.00
2	5150.00	45.7 AV	54.0	-8.3	1.19 V	35	39.70	6.00
3	*5230.00	112.7 PK			1.17 V	39	73.10	39.60
4	*5230.00	102.3 AV			1.17 V	39	62.70	39.60
5	#10460.00	59.8 PK	74.0	-14.2	1.43 V	217	41.30	18.50
6	#10460.00	46.8 AV	54.0	-7.2	1.43 V	217	28.30	18.50

Remarks:

1. Emission Level(dBuV/m) = Raw Value(dBuV) + Correction Factor(dB/m)
2. Correction Factor(dB/m) = Antenna Factor(dB/m) + Cable Factor(dB)
– Pre-Amplifier Factor(dB)
3. The other emission levels were very low against the limit.
4. Margin value = Emission Level – Limit value
5. " * ": Fundamental frequency.
6. " # ": The radiated frequency is out of the restricted band.

CHANNEL	TX Channel 151	DETECTOR FUNCTION	Peak (PK)
FREQUENCY RANGE	1GHz ~ 40GHz		Average (AV)

ANTENNA POLARITY & TEST DISTANCE: HORIZONTAL AT 3 M

NO.	FREQ. (MHz)	EMISSION LEVEL (dBuV/m)	LIMIT (dBuV/m)	MARGIN (dB)	ANTENNA HEIGHT (m)	TABLE ANGLE (Degree)	RAW VALUE (dBuV)	CORRECTION FACTOR (dB/m)
1	#5714.90	67.1 PK	109.4	-42.3	1.66 H	57	59.70	7.40
2	#5722.90	68.6 PK	117.4	-48.8	1.49 H	55	61.20	7.40
3	#5725.00	58.0 PK	122.2	-64.2	1.72 H	60	50.60	7.40
4	*5755.00	115.7 PK			2.03 H	297	75.10	40.60
5	*5755.00	106.0 AV			2.03 H	297	65.40	40.60
6	11510.00	62.3 PK	74.0	-11.7	1.05 H	278	43.60	18.70
7	11510.00	49.6 AV	54.0	-4.4	1.05 H	278	30.90	18.70

ANTENNA POLARITY & TEST DISTANCE: VERTICAL AT 3 M

NO.	FREQ. (MHz)	EMISSION LEVEL (dBuV/m)	LIMIT (dBuV/m)	MARGIN (dB)	ANTENNA HEIGHT (m)	TABLE ANGLE (Degree)	RAW VALUE (dBuV)	CORRECTION FACTOR (dB/m)
1	#5714.90	63.5 PK	109.4	-45.9	2.59 V	5	56.10	7.40
2	#5722.90	66.0 PK	117.4	-51.4	2.60 V	12	58.60	7.40
3	#5725.00	49.9 PK	122.2	-72.3	2.63 V	3	42.50	7.40
4	*5755.00	109.9 PK			2.13 V	4	69.30	40.60
5	*5755.00	100.3 AV			2.13 V	4	59.70	40.60
6	11510.00	59.7 PK	74.0	-14.3	1.82 V	45	41.00	18.70
7	11510.00	47.1 AV	54.0	-6.9	1.82 V	45	28.40	18.70

Remarks:

1. Emission Level(dBuV/m) = Raw Value(dBuV) + Correction Factor(dB/m)
2. Correction Factor(dB/m) = Antenna Factor(dB/m) + Cable Factor(dB) – Pre-Amplifier Factor(dB)
3. The other emission levels were very low against the limit.
4. Margin value = Emission Level – Limit value
5. " * ": Fundamental frequency.
6. " # ": The radiated frequency is out of the restricted band.

CHANNEL	TX Channel 159	DETECTOR FUNCTION	Peak (PK)
FREQUENCY RANGE	1GHz ~ 40GHz		Average (AV)

ANTENNA POLARITY & TEST DISTANCE: HORIZONTAL AT 3 M

NO.	FREQ. (MHz)	EMISSION LEVEL (dBuV/m)	LIMIT (dBuV/m)	MARGIN (dB)	ANTENNA HEIGHT (m)	TABLE ANGLE (Degree)	RAW VALUE (dBuV)	CORRECTION FACTOR (dB/m)
1	*5795.00	119.5 PK			2.05 H	294	78.90	40.60
2	*5795.00	109.6 AV			2.05 H	294	69.00	40.60
3	#5850.00	53.1 PK	122.2	-69.1	1.70 H	306	45.50	7.60
4	#5852.10	66.2 PK	117.4	-51.2	1.00 H	303	58.50	7.70
5	#5860.10	68.0 PK	109.4	-41.4	1.05 H	296	60.30	7.70
6	11590.00	62.2 PK	74.0	-11.8	1.06 H	279	43.40	18.80
7	11590.00	49.9 AV	54.0	-4.1	1.06 H	279	31.10	18.80

ANTENNA POLARITY & TEST DISTANCE: VERTICAL AT 3 M

NO.	FREQ. (MHz)	EMISSION LEVEL (dBuV/m)	LIMIT (dBuV/m)	MARGIN (dB)	ANTENNA HEIGHT (m)	TABLE ANGLE (Degree)	RAW VALUE (dBuV)	CORRECTION FACTOR (dB/m)
1	*5795.00	112.6 PK			1.92 V	4	72.00	40.60
2	*5795.00	102.9 AV			1.92 V	4	62.30	40.60
3	#5850.00	52.1 PK	122.2	-70.1	2.06 V	3	44.50	7.60
4	#5852.10	66.1 PK	117.4	-51.3	2.06 V	2	58.40	7.70
5	#5860.10	65.0 PK	109.4	-44.4	3.23 V	21	57.30	7.70
6	11590.00	59.9 PK	74.0	-14.1	2.75 V	204	41.10	18.80
7	11590.00	47.6 AV	54.0	-6.4	2.75 V	204	28.80	18.80

Remarks:

1. Emission Level(dBuV/m) = Raw Value(dBuV) + Correction Factor(dB/m)
2. Correction Factor(dB/m) = Antenna Factor(dB/m) + Cable Factor(dB) – Pre-Amplifier Factor(dB)
3. The other emission levels were very low against the limit.
4. Margin value = Emission Level – Limit value
5. " * ": Fundamental frequency.
6. " # ": The radiated frequency is out of the restricted band.

802.11ac (VHT80)

CHANNEL	TX Channel 42	DETECTOR FUNCTION	Peak (PK)
FREQUENCY RANGE	1GHz ~ 40GHz		Average (AV)

ANTENNA POLARITY & TEST DISTANCE: HORIZONTAL AT 3 M								
NO.	FREQ. (MHz)	EMISSION LEVEL (dBuV/m)	LIMIT (dBuV/m)	MARGIN (dB)	ANTENNA HEIGHT (m)	TABLE ANGLE (Degree)	RAW VALUE (dBuV)	CORRECTION FACTOR (dB/m)
1	5150.00	65.7 PK	74.0	-8.3	2.56 H	283	59.70	6.00
2	5150.00	52.2 AV	54.0	-1.8	2.56 H	283	46.20	6.00
3	*5210.00	107.2 PK			1.79 H	283	67.70	39.50
4	*5210.00	97.3 AV			1.79 H	283	57.80	39.50
5	#10420.00	59.3 PK	74.0	-14.7	1.30 H	152	41.40	17.90
6	#10420.00	46.4 AV	54.0	-7.6	1.30 H	152	28.50	17.90
ANTENNA POLARITY & TEST DISTANCE: VERTICAL AT 3 M								
NO.	FREQ. (MHz)	EMISSION LEVEL (dBuV/m)	LIMIT (dBuV/m)	MARGIN (dB)	ANTENNA HEIGHT (m)	TABLE ANGLE (Degree)	RAW VALUE (dBuV)	CORRECTION FACTOR (dB/m)
1	5150.00	58.9 PK	74.0	-15.1	1.07 V	42	52.90	6.00
2	5150.00	47.1 AV	54.0	-6.9	1.07 V	42	41.10	6.00
3	*5210.00	100.5 PK			1.03 V	40	61.00	39.50
4	*5210.00	90.4 AV			1.03 V	40	50.90	39.50
5	#10420.00	58.7 PK	74.0	-15.3	1.28 V	331	40.80	17.90
6	#10420.00	46.4 AV	54.0	-7.6	1.28 V	331	28.50	17.90

Remarks:

1. Emission Level(dBuV/m) = Raw Value(dBuV) + Correction Factor(dB/m)
2. Correction Factor(dB/m) = Antenna Factor(dB/m) + Cable Factor(dB) – Pre-Amplifier Factor(dB)
3. The other emission levels were very low against the limit.
4. Margin value = Emission Level – Limit value
5. " * ": Fundamental frequency.
6. " # ": The radiated frequency is out of the restricted band.

CHANNEL	TX Channel 155	DETECTOR FUNCTION	Peak (PK)
FREQUENCY RANGE	1GHz ~ 40GHz		Average (AV)

ANTENNA POLARITY & TEST DISTANCE: HORIZONTAL AT 3 M

NO.	FREQ. (MHz)	EMISSION LEVEL (dBuV/m)	LIMIT (dBuV/m)	MARGIN (dB)	ANTENNA HEIGHT (m)	TABLE ANGLE (Degree)	RAW VALUE (dBuV)	CORRECTION FACTOR (dB/m)
1	#5714.90	67.2 PK	109.4	-42.2	1.38 H	292	59.80	7.40
2	#5722.90	68.8 PK	117.4	-48.6	2.22 H	285	61.40	7.40
3	#5725.00	53.9 PK	122.2	-68.3	1.60 H	285	46.50	7.40
4	*5775.00	106.4 PK			2.19 H	298	65.80	40.60
5	*5775.00	96.4 AV			2.19 H	298	55.80	40.60
6	#5850.00	51.4 PK	122.2	-70.8	2.29 H	308	43.80	7.60
7	#5852.10	65.2 PK	117.4	-52.2	2.70 H	295	57.50	7.70
8	#5860.10	64.2 PK	109.4	-45.2	2.43 H	287	56.50	7.70
9	11550.00	60.1 PK	74.0	-13.9	1.50 H	216	41.50	18.60
10	11550.00	47.4 AV	54.0	-6.6	1.50 H	216	28.80	18.60

ANTENNA POLARITY & TEST DISTANCE: VERTICAL AT 3 M

NO.	FREQ. (MHz)	EMISSION LEVEL (dBuV/m)	LIMIT (dBuV/m)	MARGIN (dB)	ANTENNA HEIGHT (m)	TABLE ANGLE (Degree)	RAW VALUE (dBuV)	CORRECTION FACTOR (dB/m)
1	#5714.90	63.6 PK	109.4	-45.8	3.98 V	3	56.20	7.40
2	#5722.90	67.5 PK	117.4	-49.9	3.87 V	349	60.10	7.40
3	#5725.00	50.2 PK	122.2	-72.0	3.88 V	353	42.80	7.40
4	*5775.00	101.8 PK			3.94 V	347	61.20	40.60
5	*5775.00	91.7 AV			3.94 V	347	51.10	40.60
6	#5850.00	48.5 PK	122.2	-73.7	3.87 V	2	40.90	7.60
7	#5852.10	63.7 PK	117.4	-53.7	3.89 V	348	56.00	7.70
8	#5860.10	60.6 PK	109.4	-48.8	4.00 V	346	52.90	7.70
9	11550.00	59.6 PK	74.0	-14.4	3.42 V	281	41.00	18.60
10	11550.00	47.4 AV	54.0	-6.6	3.42 V	281	28.80	18.60

Remarks:

- Emission Level(dBuV/m) = Raw Value(dBuV) + Correction Factor(dB/m)
- Correction Factor(dB/m) = Antenna Factor(dB/m) + Cable Factor(dB)
– Pre-Amplifier Factor(dB)
- The other emission levels were very low against the limit.
- Margin value = Emission Level – Limit value
- " * ": Fundamental frequency.
- " # ": The radiated frequency is out of the restricted band.

Mode D

802.11a

CHANNEL	TX Channel 36	DETECTOR FUNCTION	Peak (PK)
FREQUENCY RANGE	1GHz ~ 40GHz		Average (AV)

ANTENNA POLARITY & TEST DISTANCE: HORIZONTAL AT 3 M

NO.	FREQ. (MHz)	EMISSION LEVEL (dBuV/m)	LIMIT (dBuV/m)	MARGIN (dB)	ANTENNA HEIGHT (m)	TABLE ANGLE (Degree)	RAW VALUE (dBuV)	CORRECTION FACTOR (dB/m)
1	5150.00	58.1 PK	74.0	-15.9	2.11 H	116	52.10	6.00
2	5150.00	47.0 AV	54.0	-7.0	2.11 H	116	41.00	6.00
3	*5180.00	113.1 PK			3.00 H	204	73.70	39.40
4	*5180.00	102.4 AV			3.00 H	204	63.00	39.40
5	#10360.00	60.1 PK	74.0	-13.9	1.15 H	21	42.30	17.80
6	#10360.00	46.9 AV	54.0	-7.1	1.15 H	21	29.10	17.80

ANTENNA POLARITY & TEST DISTANCE: VERTICAL AT 3 M

NO.	FREQ. (MHz)	EMISSION LEVEL (dBuV/m)	LIMIT (dBuV/m)	MARGIN (dB)	ANTENNA HEIGHT (m)	TABLE ANGLE (Degree)	RAW VALUE (dBuV)	CORRECTION FACTOR (dB/m)
1	5150.00	66.4 PK	74.0	-7.6	2.97 V	186	60.40	6.00
2	5150.00	52.1 AV	54.0	-1.9	2.97 V	186	46.10	6.00
3	*5180.00	121.5 PK			2.73 V	173	82.10	39.40
4	*5180.00	110.7 AV			2.73 V	173	71.30	39.40
5	#10360.00	61.1 PK	74.0	-12.9	2.65 V	27	43.30	17.80
6	#10360.00	48.0 AV	54.0	-6.0	2.65 V	27	30.20	17.80

Remarks:

1. Emission Level(dBuV/m) = Raw Value(dBuV) + Correction Factor(dB/m)
2. Correction Factor(dB/m) = Antenna Factor(dB/m) + Cable Factor(dB) – Pre-Amplifier Factor(dB)
3. The other emission levels were very low against the limit.
4. Margin value = Emission Level – Limit value
5. " * ": Fundamental frequency.
6. " # ": The radiated frequency is out of the restricted band.

CHANNEL	TX Channel 40	DETECTOR FUNCTION	Peak (PK)
FREQUENCY RANGE	1GHz ~ 40GHz		Average (AV)

ANTENNA POLARITY & TEST DISTANCE: HORIZONTAL AT 3 M

NO.	FREQ. (MHz)	EMISSION LEVEL (dBuV/m)	LIMIT (dBuV/m)	MARGIN (dB)	ANTENNA HEIGHT (m)	TABLE ANGLE (Degree)	RAW VALUE (dBuV)	CORRECTION FACTOR (dB/m)
1	5150.00	58.1 PK	74.0	-15.9	2.42 H	266	52.10	6.00
2	5150.00	48.7 AV	54.0	-5.3	2.42 H	266	42.70	6.00
3	*5200.00	116.0 PK			2.90 H	206	76.50	39.50
4	*5200.00	105.0 AV			2.90 H	206	65.50	39.50
5	#10400.00	60.2 PK	74.0	-13.8	1.79 H	28	42.50	17.70
6	#10400.00	47.2 AV	54.0	-6.8	1.79 H	28	29.50	17.70

ANTENNA POLARITY & TEST DISTANCE: VERTICAL AT 3 M

NO.	FREQ. (MHz)	EMISSION LEVEL (dBuV/m)	LIMIT (dBuV/m)	MARGIN (dB)	ANTENNA HEIGHT (m)	TABLE ANGLE (Degree)	RAW VALUE (dBuV)	CORRECTION FACTOR (dB/m)
1	5150.00	66.9 PK	74.0	-7.1	2.94 V	186	60.90	6.00
2	5150.00	52.7 AV	54.0	-1.3	2.94 V	186	46.70	6.00
3	*5200.00	122.6 PK			1.89 V	9	83.10	39.50
4	*5200.00	112.3 AV			1.89 V	9	72.80	39.50
5	#10400.00	62.6 PK	74.0	-11.4	2.63 V	19	44.90	17.70
6	#10400.00	49.4 AV	54.0	-4.6	2.63 V	19	31.70	17.70

Remarks:

1. Emission Level(dBuV/m) = Raw Value(dBuV) + Correction Factor(dB/m)
2. Correction Factor(dB/m) = Antenna Factor(dB/m) + Cable Factor(dB)
– Pre-Amplifier Factor(dB)
3. The other emission levels were very low against the limit.
4. Margin value = Emission Level – Limit value
5. " * ": Fundamental frequency.
6. " # ": The radiated frequency is out of the restricted band.

CHANNEL	TX Channel 48	DETECTOR FUNCTION	Peak (PK)
FREQUENCY RANGE	1GHz ~ 40GHz		Average (AV)

ANTENNA POLARITY & TEST DISTANCE: HORIZONTAL AT 3 M

NO.	FREQ. (MHz)	EMISSION LEVEL (dBuV/m)	LIMIT (dBuV/m)	MARGIN (dB)	ANTENNA HEIGHT (m)	TABLE ANGLE (Degree)	RAW VALUE (dBuV)	CORRECTION FACTOR (dB/m)
1	5150.00	56.3 PK	74.0	-17.7	1.89 H	289	50.30	6.00
2	5150.00	46.4 AV	54.0	-7.6	1.89 H	289	40.40	6.00
3	*5240.00	115.6 PK			2.40 H	136	76.00	39.60
4	*5240.00	105.2 AV			2.40 H	136	65.60	39.60
5	#10480.00	61.5 PK	74.0	-12.5	2.50 H	154	42.80	18.70
6	#10480.00	48.4 AV	54.0	-5.6	2.50 H	154	29.70	18.70

ANTENNA POLARITY & TEST DISTANCE: VERTICAL AT 3 M

NO.	FREQ. (MHz)	EMISSION LEVEL (dBuV/m)	LIMIT (dBuV/m)	MARGIN (dB)	ANTENNA HEIGHT (m)	TABLE ANGLE (Degree)	RAW VALUE (dBuV)	CORRECTION FACTOR (dB/m)
1	5150.00	58.5 PK	74.0	-15.5	3.00 V	188	52.50	6.00
2	5150.00	52.1 AV	54.0	-1.9	3.00 V	188	46.10	6.00
3	*5240.00	125.6 PK			1.86 V	8	86.00	39.60
4	*5240.00	115.2 AV			1.86 V	8	75.60	39.60
5	#10480.00	64.7 PK	74.0	-9.3	2.43 V	66	46.00	18.70
6	#10480.00	50.7 AV	54.0	-3.3	2.43 V	66	32.00	18.70

Remarks:

1. Emission Level(dBuV/m) = Raw Value(dBuV) + Correction Factor(dB/m)
2. Correction Factor(dB/m) = Antenna Factor(dB/m) + Cable Factor(dB)
– Pre-Amplifier Factor(dB)
3. The other emission levels were very low against the limit.
4. Margin value = Emission Level – Limit value
5. " * ": Fundamental frequency.
6. " # ": The radiated frequency is out of the restricted band.

CHANNEL	TX Channel 149	DETECTOR FUNCTION	Peak (PK)
FREQUENCY RANGE	1GHz ~ 40GHz		Average (AV)

ANTENNA POLARITY & TEST DISTANCE: HORIZONTAL AT 3 M

NO.	FREQ. (MHz)	EMISSION LEVEL (dBuV/m)	LIMIT (dBuV/m)	MARGIN (dB)	ANTENNA HEIGHT (m)	TABLE ANGLE (Degree)	RAW VALUE (dBuV)	CORRECTION FACTOR (dB/m)
1	#5714.90	60.4 PK	109.4	-49.0	1.00 H	322	53.00	7.40
2	#5722.90	62.0 PK	117.4	-55.4	1.00 H	325	54.60	7.40
3	#5725.00	50.9 PK	122.2	-71.3	1.28 H	323	43.50	7.40
4	*5745.00	109.1 PK			1.01 H	324	68.60	40.50
5	*5745.00	99.0 AV			1.01 H	324	58.50	40.50
6	11490.00	58.9 PK	74.0	-15.1	1.10 H	192	40.20	18.70
7	11490.00	46.5 AV	54.0	-7.5	1.10 H	192	27.80	18.70

ANTENNA POLARITY & TEST DISTANCE: VERTICAL AT 3 M

NO.	FREQ. (MHz)	EMISSION LEVEL (dBuV/m)	LIMIT (dBuV/m)	MARGIN (dB)	ANTENNA HEIGHT (m)	TABLE ANGLE (Degree)	RAW VALUE (dBuV)	CORRECTION FACTOR (dB/m)
1	#5714.90	67.5 PK	109.4	-41.9	2.00 V	187	60.10	7.40
2	#5722.90	69.6 PK	117.4	-47.8	2.95 V	186	62.20	7.40
3	#5725.00	57.6 PK	122.2	-64.6	2.85 V	183	50.20	7.40
4	*5745.00	118.4 PK			2.08 V	275	77.90	40.50
5	*5745.00	107.6 AV			2.08 V	275	67.10	40.50
6	11490.00	61.9 PK	74.0	-12.1	1.12 V	178	43.20	18.70
7	11490.00	48.7 AV	54.0	-5.3	1.12 V	178	30.00	18.70

Remarks:

1. Emission Level(dBuV/m) = Raw Value(dBuV) + Correction Factor(dB/m)
2. Correction Factor(dB/m) = Antenna Factor(dB/m) + Cable Factor(dB)
– Pre-Amplifier Factor(dB)
3. The other emission levels were very low against the limit.
4. Margin value = Emission Level – Limit value
5. " * ": Fundamental frequency.
6. " # ": The radiated frequency is out of the restricted band.

CHANNEL	TX Channel 157	DETECTOR FUNCTION	Peak (PK)
FREQUENCY RANGE	1GHz ~ 40GHz		Average (AV)

ANTENNA POLARITY & TEST DISTANCE: HORIZONTAL AT 3 M

NO.	FREQ. (MHz)	EMISSION LEVEL (dBuV/m)	LIMIT (dBuV/m)	MARGIN (dB)	ANTENNA HEIGHT (m)	TABLE ANGLE (Degree)	RAW VALUE (dBuV)	CORRECTION FACTOR (dB/m)
1	#5714.90	60.2 PK	109.4	-49.2	1.29 H	324	52.80	7.40
2	*5785.00	114.2 PK			1.08 H	323	73.60	40.60
3	*5785.00	103.5 AV			1.08 H	323	62.90	40.60
4	11570.00	60.0 PK	74.0	-14.0	1.46 H	241	41.30	18.70
5	11570.00	47.3 AV	54.0	-6.7	1.46 H	241	28.60	18.70

ANTENNA POLARITY & TEST DISTANCE: VERTICAL AT 3 M

NO.	FREQ. (MHz)	EMISSION LEVEL (dBuV/m)	LIMIT (dBuV/m)	MARGIN (dB)	ANTENNA HEIGHT (m)	TABLE ANGLE (Degree)	RAW VALUE (dBuV)	CORRECTION FACTOR (dB/m)
1	#5714.90	67.0 PK	109.4	-42.4	2.06 V	73	59.60	7.40
2	*5785.00	125.6 PK			1.99 V	275	85.00	40.60
3	*5785.00	115.0 AV			1.99 V	275	74.40	40.60
4	11570.00	62.3 PK	74.0	-11.7	1.76 V	112	43.60	18.70
5	11570.00	50.2 AV	54.0	-3.8	1.76 V	112	31.50	18.70

Remarks:

1. Emission Level(dBuV/m) = Raw Value(dBuV) + Correction Factor(dB/m)
2. Correction Factor(dB/m) = Antenna Factor(dB/m) + Cable Factor(dB)
– Pre-Amplifier Factor(dB)
3. The other emission levels were very low against the limit.
4. Margin value = Emission Level – Limit value
5. " * ": Fundamental frequency.
6. " # ": The radiated frequency is out of the restricted band.

CHANNEL	TX Channel 165	DETECTOR FUNCTION	Peak (PK)
FREQUENCY RANGE	1GHz ~ 40GHz		Average (AV)

ANTENNA POLARITY & TEST DISTANCE: HORIZONTAL AT 3 M

NO.	FREQ. (MHz)	EMISSION LEVEL (dBuV/m)	LIMIT (dBuV/m)	MARGIN (dB)	ANTENNA HEIGHT (m)	TABLE ANGLE (Degree)	RAW VALUE (dBuV)	CORRECTION FACTOR (dB/m)
1	*5825.00	112.2 PK			1.21 H	326	71.60	40.60
2	*5825.00	101.6 AV			1.21 H	326	61.00	40.60
3	#5850.00	53.0 PK	122.2	-69.2	1.21 H	329	45.40	7.60
4	#5852.10	65.3 PK	117.4	-52.1	1.20 H	329	57.60	7.70
5	#5860.10	60.1 PK	109.4	-49.3	1.29 H	324	52.40	7.70
6	11650.00	60.3 PK	74.0	-13.7	1.23 H	184	41.10	19.20
7	11650.00	47.1 AV	54.0	-6.9	1.23 H	184	27.90	19.20

ANTENNA POLARITY & TEST DISTANCE: VERTICAL AT 3 M

NO.	FREQ. (MHz)	EMISSION LEVEL (dBuV/m)	LIMIT (dBuV/m)	MARGIN (dB)	ANTENNA HEIGHT (m)	TABLE ANGLE (Degree)	RAW VALUE (dBuV)	CORRECTION FACTOR (dB/m)
1	*5825.00	123.1 PK			3.52 V	275	82.50	40.60
2	*5825.00	112.7 AV			3.52 V	275	72.10	40.60
3	#5850.00	63.8 PK	122.2	-58.4	2.81 V	295	56.20	7.60
4	#5852.10	73.6 PK	117.4	-43.8	2.81 V	299	65.90	7.70
5	#5860.10	66.8 PK	109.4	-42.6	2.79 V	259	59.10	7.70
6	11650.00	61.2 PK	74.0	-12.8	3.44 V	34	42.00	19.20
7	11650.00	49.0 AV	54.0	-5.0	3.44 V	34	29.80	19.20

Remarks:

1. Emission Level(dBuV/m) = Raw Value(dBuV) + Correction Factor(dB/m)
2. Correction Factor(dB/m) = Antenna Factor(dB/m) + Cable Factor(dB) – Pre-Amplifier Factor(dB)
3. The other emission levels were very low against the limit.
4. Margin value = Emission Level – Limit value
5. " * ": Fundamental frequency.
6. " # ": The radiated frequency is out of the restricted band.

802.11ac (VHT20)

CHANNEL	TX Channel 36	DETECTOR FUNCTION	Peak (PK)
FREQUENCY RANGE	1GHz ~ 40GHz		Average (AV)

ANTENNA POLARITY & TEST DISTANCE: HORIZONTAL AT 3 M								
NO.	FREQ. (MHz)	EMISSION LEVEL (dBuV/m)	LIMIT (dBuV/m)	MARGIN (dB)	ANTENNA HEIGHT (m)	TABLE ANGLE (Degree)	RAW VALUE (dBuV)	CORRECTION FACTOR (dB/m)
1	5150.00	57.9 PK	74.0	-16.1	1.73 H	343	51.90	6.00
2	5150.00	46.3 AV	54.0	-7.7	1.73 H	343	40.30	6.00
3	*5180.00	109.7 PK			1.68 H	94	70.30	39.40
4	*5180.00	98.9 AV			1.68 H	94	59.50	39.40
5	#10360.00	60.2 PK	74.0	-13.8	2.18 H	186	42.40	17.80
6	#10360.00	47.1 AV	54.0	-6.9	2.18 H	186	29.30	17.80
ANTENNA POLARITY & TEST DISTANCE: VERTICAL AT 3 M								
NO.	FREQ. (MHz)	EMISSION LEVEL (dBuV/m)	LIMIT (dBuV/m)	MARGIN (dB)	ANTENNA HEIGHT (m)	TABLE ANGLE (Degree)	RAW VALUE (dBuV)	CORRECTION FACTOR (dB/m)
1	5150.00	65.1 PK	74.0	-8.9	2.98 V	189	59.10	6.00
2	5150.00	52.2 AV	54.0	-1.8	2.98 V	189	46.20	6.00
3	*5180.00	120.1 PK			3.13 V	230	80.70	39.40
4	*5180.00	109.2 AV			3.13 V	230	69.80	39.40
5	#10360.00	60.6 PK	74.0	-13.4	2.50 V	43	42.80	17.80
6	#10360.00	47.7 AV	54.0	-6.3	2.50 V	43	29.90	17.80

Remarks:

1. Emission Level(dBuV/m) = Raw Value(dBuV) + Correction Factor(dB/m)
2. Correction Factor(dB/m) = Antenna Factor(dB/m) + Cable Factor(dB) – Pre-Amplifier Factor(dB)
3. The other emission levels were very low against the limit.
4. Margin value = Emission Level – Limit value
5. " * ": Fundamental frequency.
6. " # ": The radiated frequency is out of the restricted band.

CHANNEL	TX Channel 40	DETECTOR FUNCTION	Peak (PK)
FREQUENCY RANGE	1GHz ~ 40GHz		Average (AV)

ANTENNA POLARITY & TEST DISTANCE: HORIZONTAL AT 3 M

NO.	FREQ. (MHz)	EMISSION LEVEL (dBuV/m)	LIMIT (dBuV/m)	MARGIN (dB)	ANTENNA HEIGHT (m)	TABLE ANGLE (Degree)	RAW VALUE (dBuV)	CORRECTION FACTOR (dB/m)
1	5150.00	59.3 PK	74.0	-14.7	1.68 H	99	53.30	6.00
2	5150.00	47.4 AV	54.0	-6.6	1.68 H	99	41.40	6.00
3	*5200.00	113.9 PK			1.65 H	354	74.40	39.50
4	*5200.00	102.9 AV			1.65 H	354	63.40	39.50
5	#10400.00	60.1 PK	74.0	-13.9	1.99 H	222	42.40	17.70
6	#10400.00	47.4 AV	54.0	-6.6	1.99 H	222	29.70	17.70

ANTENNA POLARITY & TEST DISTANCE: VERTICAL AT 3 M

NO.	FREQ. (MHz)	EMISSION LEVEL (dBuV/m)	LIMIT (dBuV/m)	MARGIN (dB)	ANTENNA HEIGHT (m)	TABLE ANGLE (Degree)	RAW VALUE (dBuV)	CORRECTION FACTOR (dB/m)
1	5150.00	67.2 PK	74.0	-6.8	2.85 V	186	61.20	6.00
2	5150.00	52.3 AV	54.0	-1.7	2.85 V	186	46.30	6.00
3	*5200.00	123.4 PK			3.14 V	186	83.90	39.50
4	*5200.00	111.9 AV			3.14 V	186	72.40	39.50
5	#10400.00	62.4 PK	74.0	-11.6	3.14 V	186	44.70	17.70
6	#10400.00	49.3 AV	54.0	-4.7	3.14 V	186	31.60	17.70

Remarks:

1. Emission Level(dBuV/m) = Raw Value(dBuV) + Correction Factor(dB/m)
2. Correction Factor(dB/m) = Antenna Factor(dB/m) + Cable Factor(dB)
– Pre-Amplifier Factor(dB)
3. The other emission levels were very low against the limit.
4. Margin value = Emission Level – Limit value
5. " * ": Fundamental frequency.
6. " # ": The radiated frequency is out of the restricted band.

CHANNEL	TX Channel 48	DETECTOR FUNCTION	Peak (PK)
FREQUENCY RANGE	1GHz ~ 40GHz		Average (AV)

ANTENNA POLARITY & TEST DISTANCE: HORIZONTAL AT 3 M

NO.	FREQ. (MHz)	EMISSION LEVEL (dBuV/m)	LIMIT (dBuV/m)	MARGIN (dB)	ANTENNA HEIGHT (m)	TABLE ANGLE (Degree)	RAW VALUE (dBuV)	CORRECTION FACTOR (dB/m)
1	5150.00	60.1 PK	74.0	-13.9	1.64 H	162	54.10	6.00
2	5150.00	47.0 AV	54.0	-7.0	1.64 H	162	41.00	6.00
3	*5240.00	114.7 PK			1.76 H	96	75.10	39.60
4	*5240.00	104.0 AV			1.76 H	96	64.40	39.60
5	#10480.00	61.6 PK	74.0	-12.4	2.18 H	353	42.90	18.70
6	#10480.00	48.7 AV	54.0	-5.3	2.18 H	353	30.00	18.70

ANTENNA POLARITY & TEST DISTANCE: VERTICAL AT 3 M

NO.	FREQ. (MHz)	EMISSION LEVEL (dBuV/m)	LIMIT (dBuV/m)	MARGIN (dB)	ANTENNA HEIGHT (m)	TABLE ANGLE (Degree)	RAW VALUE (dBuV)	CORRECTION FACTOR (dB/m)
1	5150.00	67.7 PK	74.0	-6.3	2.69 V	184	61.70	6.00
2	5150.00	52.5 AV	54.0	-1.5	2.69 V	184	46.50	6.00
3	*5240.00	125.9 PK			3.20 V	185	86.30	39.60
4	*5240.00	115.5 AV			3.20 V	185	75.90	39.60
5	#10480.00	64.2 PK	74.0	-9.8	2.86 V	22	45.50	18.70
6	#10480.00	50.9 AV	54.0	-3.1	2.86 V	22	32.20	18.70

Remarks:

- Emission Level(dBuV/m) = Raw Value(dBuV) + Correction Factor(dB/m)
- Correction Factor(dB/m) = Antenna Factor(dB/m) + Cable Factor(dB)
– Pre-Amplifier Factor(dB)
- The other emission levels were very low against the limit.
- Margin value = Emission Level – Limit value
- " * ": Fundamental frequency.
- " # ": The radiated frequency is out of the restricted band.

CHANNEL	TX Channel 149	DETECTOR FUNCTION	Peak (PK)
FREQUENCY RANGE	1GHz ~ 40GHz		Average (AV)

ANTENNA POLARITY & TEST DISTANCE: HORIZONTAL AT 3 M

NO.	FREQ. (MHz)	EMISSION LEVEL (dBuV/m)	LIMIT (dBuV/m)	MARGIN (dB)	ANTENNA HEIGHT (m)	TABLE ANGLE (Degree)	RAW VALUE (dBuV)	CORRECTION FACTOR (dB/m)
1	#5714.90	59.3 PK	109.4	-50.1	1.16 H	322	51.90	7.40
2	#5722.90	59.9 PK	117.4	-57.5	1.62 H	305	52.50	7.40
3	#5725.00	49.8 PK	122.2	-72.4	1.71 H	321	42.40	7.40
4	*5745.00	108.6 PK			1.00 H	325	68.10	40.50
5	*5745.00	98.3 AV			1.00 H	325	57.80	40.50
6	11490.00	58.8 PK	74.0	-15.2	1.44 H	222	40.10	18.70
7	11490.00	46.4 AV	54.0	-7.6	1.44 H	222	27.70	18.70

ANTENNA POLARITY & TEST DISTANCE: VERTICAL AT 3 M

NO.	FREQ. (MHz)	EMISSION LEVEL (dBuV/m)	LIMIT (dBuV/m)	MARGIN (dB)	ANTENNA HEIGHT (m)	TABLE ANGLE (Degree)	RAW VALUE (dBuV)	CORRECTION FACTOR (dB/m)
1	#5714.90	67.3 PK	109.4	-42.1	1.17 V	184	59.90	7.40
2	#5722.90	71.1 PK	117.4	-46.3	1.99 V	123	63.70	7.40
3	#5725.00	59.3 PK	122.2	-62.9	1.70 V	120	51.90	7.40
4	*5745.00	119.0 PK			2.06 V	274	78.50	40.50
5	*5745.00	107.9 AV			2.06 V	274	67.40	40.50
6	11490.00	60.3 PK	74.0	-13.7	3.17 V	301	41.60	18.70
7	11490.00	48.0 AV	54.0	-6.0	3.17 V	301	29.30	18.70

Remarks:

1. Emission Level(dBuV/m) = Raw Value(dBuV) + Correction Factor(dB/m)
2. Correction Factor(dB/m) = Antenna Factor(dB/m) + Cable Factor(dB)
– Pre-Amplifier Factor(dB)
3. The other emission levels were very low against the limit.
4. Margin value = Emission Level – Limit value
5. " * ": Fundamental frequency.
6. " # ": The radiated frequency is out of the restricted band.

CHANNEL	TX Channel 157	DETECTOR FUNCTION	Peak (PK)
FREQUENCY RANGE	1GHz ~ 40GHz		Average (AV)

ANTENNA POLARITY & TEST DISTANCE: HORIZONTAL AT 3 M

NO.	FREQ. (MHz)	EMISSION LEVEL (dBuV/m)	LIMIT (dBuV/m)	MARGIN (dB)	ANTENNA HEIGHT (m)	TABLE ANGLE (Degree)	RAW VALUE (dBuV)	CORRECTION FACTOR (dB/m)
1	#5714.90	59.6 PK	109.4	-49.8	1.14 H	324	52.20	7.40
2	*5785.00	113.8 PK			1.10 H	323	73.20	40.60
3	*5785.00	103.2 AV			1.10 H	323	62.60	40.60
4	11570.00	59.8 PK	74.0	-14.2	1.17 H	186	41.10	18.70
5	11570.00	47.2 AV	54.0	-6.8	1.17 H	186	28.50	18.70

ANTENNA POLARITY & TEST DISTANCE: VERTICAL AT 3 M

NO.	FREQ. (MHz)	EMISSION LEVEL (dBuV/m)	LIMIT (dBuV/m)	MARGIN (dB)	ANTENNA HEIGHT (m)	TABLE ANGLE (Degree)	RAW VALUE (dBuV)	CORRECTION FACTOR (dB/m)
1	#5714.90	68.2 PK	109.4	-41.2	3.12 V	306	60.80	7.40
2	*5785.00	125.9 PK			2.99 V	311	85.30	40.60
3	*5785.00	115.0 AV			2.99 V	311	74.40	40.60
4	11570.00	62.3 PK	74.0	-11.7	2.72 V	89	43.60	18.70
5	11570.00	49.5 AV	54.0	-4.5	2.72 V	89	30.80	18.70

Remarks:

1. Emission Level(dBuV/m) = Raw Value(dBuV) + Correction Factor(dB/m)
2. Correction Factor(dB/m) = Antenna Factor(dB/m) + Cable Factor(dB)
– Pre-Amplifier Factor(dB)
3. The other emission levels were very low against the limit.
4. Margin value = Emission Level – Limit value
5. " * ": Fundamental frequency.
6. " # ": The radiated frequency is out of the restricted band.

CHANNEL	TX Channel 165	DETECTOR FUNCTION	Peak (PK)
FREQUENCY RANGE	1GHz ~ 40GHz		Average (AV)

ANTENNA POLARITY & TEST DISTANCE: HORIZONTAL AT 3 M

NO.	FREQ. (MHz)	EMISSION LEVEL (dBuV/m)	LIMIT (dBuV/m)	MARGIN (dB)	ANTENNA HEIGHT (m)	TABLE ANGLE (Degree)	RAW VALUE (dBuV)	CORRECTION FACTOR (dB/m)
1	*5825.00	110.8 PK			1.00 H	327	70.20	40.60
2	*5825.00	100.3 AV			1.00 H	327	59.70	40.60
3	#5850.00	49.9 PK	122.2	-72.3	1.44 H	330	42.30	7.60
4	#5852.10	60.4 PK	117.4	-57.0	1.31 H	328	52.70	7.70
5	#5860.10	59.0 PK	109.4	-50.4	1.43 H	325	51.30	7.70
6	11650.00	59.7 PK	74.0	-14.3	1.20 H	228	40.50	19.20
7	11650.00	47.4 AV	54.0	-6.6	1.20 H	228	28.20	19.20

ANTENNA POLARITY & TEST DISTANCE: VERTICAL AT 3 M

NO.	FREQ. (MHz)	EMISSION LEVEL (dBuV/m)	LIMIT (dBuV/m)	MARGIN (dB)	ANTENNA HEIGHT (m)	TABLE ANGLE (Degree)	RAW VALUE (dBuV)	CORRECTION FACTOR (dB/m)
1	*5825.00	123.2 PK			3.08 V	310	82.60	40.60
2	*5825.00	112.6 AV			3.08 V	310	72.00	40.60
3	#5850.00	64.7 PK	122.2	-57.5	3.05 V	314	57.10	7.60
4	#5852.10	72.9 PK	117.4	-44.5	3.08 V	314	65.20	7.70
5	#5860.10	66.3 PK	109.4	-43.1	3.16 V	309	58.60	7.70
6	11650.00	60.6 PK	74.0	-13.4	2.82 V	186	41.40	19.20
7	11650.00	47.9 AV	54.0	-6.1	2.82 V	186	28.70	19.20

Remarks:

1. Emission Level(dBuV/m) = Raw Value(dBuV) + Correction Factor(dB/m)
2. Correction Factor(dB/m) = Antenna Factor(dB/m) + Cable Factor(dB)
– Pre-Amplifier Factor(dB)
3. The other emission levels were very low against the limit.
4. Margin value = Emission Level – Limit value
5. " * ": Fundamental frequency.
6. " # ": The radiated frequency is out of the restricted band.

802.11ac (VHT40)

CHANNEL	TX Channel 38	DETECTOR FUNCTION	Peak (PK)
FREQUENCY RANGE	1GHz ~ 40GHz		Average (AV)

ANTENNA POLARITY & TEST DISTANCE: HORIZONTAL AT 3 M								
NO.	FREQ. (MHz)	EMISSION LEVEL (dBuV/m)	LIMIT (dBuV/m)	MARGIN (dB)	ANTENNA HEIGHT (m)	TABLE ANGLE (Degree)	RAW VALUE (dBuV)	CORRECTION FACTOR (dB/m)
1	5150.00	48.3 PK	74.0	-25.7	1.06 H	359	42.30	6.00
2	5150.00	46.7 AV	54.0	-7.3	1.06 H	359	40.70	6.00
3	*5190.00	103.5 PK			1.57 H	234	64.10	39.40
4	*5190.00	94.1 AV			1.57 H	234	54.70	39.40
5	#10380.00	60.1 PK	74.0	-13.9	1.76 H	222	42.40	17.70
6	#10380.00	45.9 AV	54.0	-8.1	1.76 H	222	28.20	17.70
ANTENNA POLARITY & TEST DISTANCE: VERTICAL AT 3 M								
NO.	FREQ. (MHz)	EMISSION LEVEL (dBuV/m)	LIMIT (dBuV/m)	MARGIN (dB)	ANTENNA HEIGHT (m)	TABLE ANGLE (Degree)	RAW VALUE (dBuV)	CORRECTION FACTOR (dB/m)
1	5150.00	67.4 PK	74.0	-6.6	1.97 V	172	61.40	6.00
2	5150.00	52.5 AV	54.0	-1.5	1.97 V	172	46.50	6.00
3	*5190.00	115.7 PK			2.59 V	172	76.30	39.40
4	*5190.00	105.7 AV			2.59 V	172	66.30	39.40
5	#10360.00	60.1 PK	74.0	-13.9	2.49 V	33	42.30	17.80
6	#10360.00	47.1 AV	54.0	-6.9	2.49 V	33	29.30	17.80

Remarks:

1. Emission Level(dBuV/m) = Raw Value(dBuV) + Correction Factor(dB/m)
2. Correction Factor(dB/m) = Antenna Factor(dB/m) + Cable Factor(dB) – Pre-Amplifier Factor(dB)
3. The other emission levels were very low against the limit.
4. Margin value = Emission Level – Limit value
5. " * ": Fundamental frequency.
6. " # ": The radiated frequency is out of the restricted band.

CHANNEL	TX Channel 46	DETECTOR FUNCTION	Peak (PK)
FREQUENCY RANGE	1GHz ~ 40GHz		Average (AV)

ANTENNA POLARITY & TEST DISTANCE: HORIZONTAL AT 3 M

NO.	FREQ. (MHz)	EMISSION LEVEL (dBuV/m)	LIMIT (dBuV/m)	MARGIN (dB)	ANTENNA HEIGHT (m)	TABLE ANGLE (Degree)	RAW VALUE (dBuV)	CORRECTION FACTOR (dB/m)
1	5150.00	58.5 PK	74.0	-15.5	2.03 H	171	52.50	6.00
2	5150.00	46.3 AV	54.0	-7.7	2.03 H	171	40.30	6.00
3	*5230.00	107.5 PK			1.41 H	235	67.90	39.60
4	*5230.00	98.1 AV			1.41 H	235	58.50	39.60
5	#10460.00	60.0 PK	74.0	-14.0	1.69 H	190	41.50	18.50
6	#10460.00	46.9 AV	54.0	-7.1	1.69 H	190	28.40	18.50

ANTENNA POLARITY & TEST DISTANCE: VERTICAL AT 3 M

NO.	FREQ. (MHz)	EMISSION LEVEL (dBuV/m)	LIMIT (dBuV/m)	MARGIN (dB)	ANTENNA HEIGHT (m)	TABLE ANGLE (Degree)	RAW VALUE (dBuV)	CORRECTION FACTOR (dB/m)
1	5150.00	64.8 PK	74.0	-9.2	2.60 V	174	58.80	6.00
2	5150.00	52.1 AV	54.0	-1.9	2.60 V	174	46.10	6.00
3	*5230.00	118.9 PK			2.60 V	170	79.30	39.60
4	*5230.00	109.3 AV			2.60 V	170	69.70	39.60
5	#10460.00	60.6 PK	74.0	-13.4	2.46 V	29	42.10	18.50
6	#10460.00	47.9 AV	54.0	-6.1	2.46 V	29	29.40	18.50

Remarks:

1. Emission Level(dBuV/m) = Raw Value(dBuV) + Correction Factor(dB/m)
2. Correction Factor(dB/m) = Antenna Factor(dB/m) + Cable Factor(dB)
– Pre-Amplifier Factor(dB)
3. The other emission levels were very low against the limit.
4. Margin value = Emission Level – Limit value
5. " * ": Fundamental frequency.
6. " # ": The radiated frequency is out of the restricted band.

CHANNEL	TX Channel 151	DETECTOR FUNCTION	Peak (PK)
FREQUENCY RANGE	1GHz ~ 40GHz		Average (AV)

ANTENNA POLARITY & TEST DISTANCE: HORIZONTAL AT 3 M

NO.	FREQ. (MHz)	EMISSION LEVEL (dBuV/m)	LIMIT (dBuV/m)	MARGIN (dB)	ANTENNA HEIGHT (m)	TABLE ANGLE (Degree)	RAW VALUE (dBuV)	CORRECTION FACTOR (dB/m)
1	#5714.90	59.1 PK	109.4	-50.3	1.59 H	340	51.70	7.40
2	#5722.00	60.3 PK	115.4	-55.1	1.98 H	94	52.90	7.40
3	#5725.00	51.8 PK	122.2	-70.4	1.98 H	94	44.40	7.40
4	*5755.00	106.4 PK			1.31 H	330	65.80	40.60
5	*5755.00	96.0 AV			1.31 H	330	55.40	40.60
6	11510.00	59.7 PK	74.0	-14.3	1.36 H	52	41.00	18.70
7	11510.00	47.0 AV	54.0	-7.0	1.36 H	52	28.30	18.70

ANTENNA POLARITY & TEST DISTANCE: VERTICAL AT 3 M

NO.	FREQ. (MHz)	EMISSION LEVEL (dBuV/m)	LIMIT (dBuV/m)	MARGIN (dB)	ANTENNA HEIGHT (m)	TABLE ANGLE (Degree)	RAW VALUE (dBuV)	CORRECTION FACTOR (dB/m)
1	#5714.90	66.9 PK	109.4	-42.5	3.01 V	242	59.50	7.40
2	#5722.90	66.8 PK	117.4	-50.6	3.00 V	246	59.40	7.40
3	#5725.00	62.1 PK	122.2	-60.1	3.00 V	246	54.70	7.40
4	*5755.00	115.4 PK			3.39 V	190	74.80	40.60
5	*5755.00	105.9 AV			3.39 V	190	65.30	40.60
6	11510.00	61.5 PK	74.0	-12.5	2.41 V	166	42.80	18.70
7	11510.00	48.4 AV	54.0	-5.6	2.41 V	166	29.70	18.70

Remarks:

1. Emission Level(dBuV/m) = Raw Value(dBuV) + Correction Factor(dB/m)
2. Correction Factor(dB/m) = Antenna Factor(dB/m) + Cable Factor(dB)
– Pre-Amplifier Factor(dB)
3. The other emission levels were very low against the limit.
4. Margin value = Emission Level – Limit value
5. " * ": Fundamental frequency.
6. " # ": The radiated frequency is out of the restricted band.

CHANNEL	TX Channel 159	DETECTOR FUNCTION	Peak (PK)
FREQUENCY RANGE	1GHz ~ 40GHz		Average (AV)

ANTENNA POLARITY & TEST DISTANCE: HORIZONTAL AT 3 M

NO.	FREQ. (MHz)	EMISSION LEVEL (dBuV/m)	LIMIT (dBuV/m)	MARGIN (dB)	ANTENNA HEIGHT (m)	TABLE ANGLE (Degree)	RAW VALUE (dBuV)	CORRECTION FACTOR (dB/m)
1	*5795.00	105.4 PK			1.26 H	328	64.80	40.60
2	*5795.00	95.1 AV			1.26 H	328	54.50	40.60
3	#5850.00	50.0 PK	122.2	-72.2	1.50 H	293	42.40	7.60
4	#5853.00	59.5 PK	115.4	-55.9	1.50 H	293	51.80	7.70
5	#5860.10	58.8 PK	109.4	-50.6	1.60 H	233	51.10	7.70
6	11590.00	60.3 PK	74.0	-13.7	1.89 H	212	41.50	18.80
7	11590.00	47.0 AV	54.0	-7.0	1.89 H	212	28.20	18.80

ANTENNA POLARITY & TEST DISTANCE: VERTICAL AT 3 M

NO.	FREQ. (MHz)	EMISSION LEVEL (dBuV/m)	LIMIT (dBuV/m)	MARGIN (dB)	ANTENNA HEIGHT (m)	TABLE ANGLE (Degree)	RAW VALUE (dBuV)	CORRECTION FACTOR (dB/m)
1	*5795.00	115.9 PK			2.02 V	245	75.30	40.60
2	*5795.00	105.8 AV			2.02 V	245	65.20	40.60
3	#5850.00	69.9 PK	122.2	-52.3	2.03 V	214	62.30	7.60
4	#5853.00	68.0 PK	115.4	-47.4	2.03 V	214	60.30	7.70
5	#5860.10	67.5 PK	109.4	-41.9	1.61 V	351	59.80	7.70
6	11590.00	61.2 PK	74.0	-12.8	1.89 V	23	42.40	18.80
7	11590.00	48.3 AV	54.0	-5.7	1.89 V	23	29.50	18.80

Remarks:

1. Emission Level(dBuV/m) = Raw Value(dBuV) + Correction Factor(dB/m)
2. Correction Factor(dB/m) = Antenna Factor(dB/m) + Cable Factor(dB)
– Pre-Amplifier Factor(dB)
3. The other emission levels were very low against the limit.
4. Margin value = Emission Level – Limit value
5. " * ": Fundamental frequency.
6. " # ": The radiated frequency is out of the restricted band.

802.11ac (VHT80)

CHANNEL	TX Channel 42	DETECTOR FUNCTION	Peak (PK)
FREQUENCY RANGE	1GHz ~ 40GHz		Average (AV)

ANTENNA POLARITY & TEST DISTANCE: HORIZONTAL AT 3 M								
NO.	FREQ. (MHz)	EMISSION LEVEL (dBuV/m)	LIMIT (dBuV/m)	MARGIN (dB)	ANTENNA HEIGHT (m)	TABLE ANGLE (Degree)	RAW VALUE (dBuV)	CORRECTION FACTOR (dB/m)
1	5150.00	56.6 PK	74.0	-17.4	1.73 H	194	50.60	6.00
2	5150.00	45.7 AV	54.0	-8.3	1.73 H	194	39.70	6.00
3	*5210.00	95.6 PK			1.54 H	235	56.10	39.50
4	*5210.00	85.8 AV			1.54 H	235	46.30	39.50
5	#10420.00	58.8 PK	74.0	-15.2	2.01 H	256	40.90	17.90
6	#10420.00	45.9 AV	54.0	-8.1	2.01 H	256	28.00	17.90
ANTENNA POLARITY & TEST DISTANCE: VERTICAL AT 3 M								
NO.	FREQ. (MHz)	EMISSION LEVEL (dBuV/m)	LIMIT (dBuV/m)	MARGIN (dB)	ANTENNA HEIGHT (m)	TABLE ANGLE (Degree)	RAW VALUE (dBuV)	CORRECTION FACTOR (dB/m)
1	5150.00	65.9 PK	74.0	-8.1	3.49 V	232	59.90	6.00
2	5150.00	52.6 AV	54.0	-1.4	3.49 V	232	46.60	6.00
3	*5210.00	106.8 PK			2.78 V	171	67.30	39.50
4	*5210.00	96.7 AV			2.78 V	171	57.20	39.50
5	#10420.00	59.8 PK	74.0	-14.2	2.09 V	40	41.90	17.90
6	#10420.00	46.9 AV	54.0	-7.1	2.09 V	40	29.00	17.90

Remarks:

1. Emission Level(dBuV/m) = Raw Value(dBuV) + Correction Factor(dB/m)
2. Correction Factor(dB/m) = Antenna Factor(dB/m) + Cable Factor(dB) – Pre-Amplifier Factor(dB)
3. The other emission levels were very low against the limit.
4. Margin value = Emission Level – Limit value
5. " * ": Fundamental frequency.
6. " # ": The radiated frequency is out of the restricted band.

CHANNEL	TX Channel 155	DETECTOR FUNCTION	Peak (PK)
FREQUENCY RANGE	1GHz ~ 40GHz		Average (AV)

ANTENNA POLARITY & TEST DISTANCE: HORIZONTAL AT 3 M

NO.	FREQ. (MHz)	EMISSION LEVEL (dBuV/m)	LIMIT (dBuV/m)	MARGIN (dB)	ANTENNA HEIGHT (m)	TABLE ANGLE (Degree)	RAW VALUE (dBuV)	CORRECTION FACTOR (dB/m)
1	#5714.90	56.9 PK	109.4	-52.5	2.09 H	303	49.50	7.40
2	#5722.00	58.9 PK	115.4	-56.5	1.40 H	189	51.50	7.40
3	#5725.00	48.1 PK	122.2	-74.1	1.40 H	189	40.70	7.40
4	*5775.00	95.1 PK			2.17 H	293	54.50	40.60
5	*5775.00	85.5 AV			2.17 H	293	44.90	40.60
6	#5850.00	51.1 PK	122.2	-71.1	2.12 H	303	43.50	7.60
7	#5853.00	59.8 PK	115.4	-55.6	2.12 H	303	52.10	7.70
8	#5860.10	55.3 PK	109.4	-54.1	2.00 H	322	47.60	7.70
9	11550.00	59.5 PK	74.0	-14.5	1.63 H	26	40.90	18.60
10	11550.00	46.4 AV	54.0	-7.6	1.63 H	26	27.80	18.60

ANTENNA POLARITY & TEST DISTANCE: VERTICAL AT 3 M

NO.	FREQ. (MHz)	EMISSION LEVEL (dBuV/m)	LIMIT (dBuV/m)	MARGIN (dB)	ANTENNA HEIGHT (m)	TABLE ANGLE (Degree)	RAW VALUE (dBuV)	CORRECTION FACTOR (dB/m)
1	#5710.00	69.6 PK	108.0	-38.4	1.57 V	2	62.20	7.40
2	#5722.00	65.0 PK	115.4	-50.4	1.70 V	128	57.60	7.40
3	#5725.00	53.0 PK	122.2	-69.2	1.70 V	128	45.60	7.40
4	*5775.00	106.0 PK			2.99 V	220	65.40	40.60
5	*5775.00	96.0 AV			2.99 V	220	55.40	40.60
6	#5850.00	54.0 PK	122.2	-68.2	2.78 V	202	46.40	7.60
7	#5853.00	59.2 PK	115.4	-56.2	2.88 V	321	51.50	7.70
8	#5860.10	62.7 PK	109.4	-46.7	1.60 V	359	55.00	7.70
9	11550.00	60.5 PK	74.0	-13.5	2.86 V	354	41.90	18.60
10	11550.00	47.3 AV	54.0	-6.7	2.86 V	354	28.70	18.60

Remarks:

- Emission Level(dBuV/m) = Raw Value(dBuV) + Correction Factor(dB/m)
- Correction Factor(dB/m) = Antenna Factor(dB/m) + Cable Factor(dB)
– Pre-Amplifier Factor(dB)
- The other emission levels were very low against the limit.
- Margin value = Emission Level – Limit value
- " * ": Fundamental frequency.
- " # ": The radiated frequency is out of the restricted band.

Beamforming Mode
Mode B
802.11ac (VHT20)

CHANNEL	TX Channel 36	DETECTOR FUNCTION	Peak (PK)
FREQUENCY RANGE	1GHz ~ 40GHz		Average (AV)

ANTENNA POLARITY & TEST DISTANCE: HORIZONTAL AT 3 M								
NO.	FREQ. (MHz)	EMISSION LEVEL (dBuV/m)	LIMIT (dBuV/m)	MARGIN (dB)	ANTENNA HEIGHT (m)	TABLE ANGLE (Degree)	RAW VALUE (dBuV)	CORRECTION FACTOR (dB/m)
1	5150.00	65.3 PK	74.0	-8.7	2.72 H	284	59.30	6.00
2	5150.00	47.7 AV	54.0	-6.3	2.72 H	284	41.70	6.00
3	*5180.00	119.9 PK			3.53 H	288	80.50	39.40
4	*5180.00	107.6 AV			3.53 H	288	68.20	39.40
5	#10360.00	61.8 PK	74.0	-12.2	2.56 H	353	44.00	17.80
6	#10360.00	48.7 AV	54.0	-5.3	2.56 H	353	30.90	17.80
ANTENNA POLARITY & TEST DISTANCE: VERTICAL AT 3 M								
NO.	FREQ. (MHz)	EMISSION LEVEL (dBuV/m)	LIMIT (dBuV/m)	MARGIN (dB)	ANTENNA HEIGHT (m)	TABLE ANGLE (Degree)	RAW VALUE (dBuV)	CORRECTION FACTOR (dB/m)
1	5150.00	58.6 PK	74.0	-15.4	2.33 V	19	52.60	6.00
2	5150.00	46.1 AV	54.0	-7.9	2.33 V	19	40.10	6.00
3	*5180.00	115.1 PK			2.93 V	4	75.70	39.40
4	*5180.00	106.2 AV			2.93 V	4	66.80	39.40
5	#10360.00	60.4 PK	74.0	-13.6	1.97 V	108	42.60	17.80
6	#10360.00	48.4 AV	54.0	-5.6	1.97 V	108	30.60	17.80

Remarks:

1. Emission Level(dBuV/m) = Raw Value(dBuV) + Correction Factor(dB/m)
2. Correction Factor(dB/m) = Antenna Factor(dB/m) + Cable Factor(dB)
– Pre-Amplifier Factor(dB)
3. The other emission levels were very low against the limit.
4. Margin value = Emission Level – Limit value
5. " * ": Fundamental frequency.
6. " # ": The radiated frequency is out of the restricted band.

CHANNEL	TX Channel 40	DETECTOR FUNCTION	Peak (PK)
FREQUENCY RANGE	1GHz ~ 40GHz		Average (AV)

ANTENNA POLARITY & TEST DISTANCE: HORIZONTAL AT 3 M

NO.	FREQ. (MHz)	EMISSION LEVEL (dBuV/m)	LIMIT (dBuV/m)	MARGIN (dB)	ANTENNA HEIGHT (m)	TABLE ANGLE (Degree)	RAW VALUE (dBuV)	CORRECTION FACTOR (dB/m)
1	*5200.00	123.1 PK			1.00 H	283	83.60	39.50
2	*5200.00	111.4 AV			1.00 H	283	71.90	39.50
3	#10400.00	60.6 PK	74.0	-13.4	1.32 H	245	42.90	17.70
4	#10400.00	49.2 AV	54.0	-4.8	1.32 H	245	31.50	17.70

ANTENNA POLARITY & TEST DISTANCE: VERTICAL AT 3 M

NO.	FREQ. (MHz)	EMISSION LEVEL (dBuV/m)	LIMIT (dBuV/m)	MARGIN (dB)	ANTENNA HEIGHT (m)	TABLE ANGLE (Degree)	RAW VALUE (dBuV)	CORRECTION FACTOR (dB/m)
1	*5200.00	111.7 PK			1.00 V	303	72.20	39.50
2	*5200.00	99.7 AV			1.00 V	303	60.20	39.50
3	#10400.00	59.2 PK	74.0	-14.8	1.21 V	280	41.50	17.70
4	#10400.00	46.8 AV	54.0	-7.2	1.21 V	280	29.10	17.70

Remarks:

1. Emission Level(dBuV/m) = Raw Value(dBuV) + Correction Factor(dB/m)
2. Correction Factor(dB/m) = Antenna Factor(dB/m) + Cable Factor(dB)
– Pre-Amplifier Factor(dB)
3. The other emission levels were very low against the limit.
4. Margin value = Emission Level – Limit value
5. " * ": Fundamental frequency.
6. " # ": The radiated frequency is out of the restricted band.

CHANNEL	TX Channel 48	DETECTOR FUNCTION	Peak (PK)
FREQUENCY RANGE	1GHz ~ 40GHz		Average (AV)

ANTENNA POLARITY & TEST DISTANCE: HORIZONTAL AT 3 M

NO.	FREQ. (MHz)	EMISSION LEVEL (dBuV/m)	LIMIT (dBuV/m)	MARGIN (dB)	ANTENNA HEIGHT (m)	TABLE ANGLE (Degree)	RAW VALUE (dBuV)	CORRECTION FACTOR (dB/m)
1	*5240.00	123.2 PK			1.00 H	282	83.60	39.60
2	*5240.00	112.3 AV			1.00 H	282	72.70	39.60
3	5350.00	61.1 PK	74.0	-12.9	1.11 H	272	54.60	6.50
4	5350.00	48.1 AV	54.0	-5.9	1.11 H	272	41.60	6.50
5	#10480.00	63.5 PK	74.0	-10.5	1.16 H	276	44.80	18.70
6	#10480.00	52.0 AV	54.0	-2.0	1.16 H	276	33.30	18.70

ANTENNA POLARITY & TEST DISTANCE: VERTICAL AT 3 M

NO.	FREQ. (MHz)	EMISSION LEVEL (dBuV/m)	LIMIT (dBuV/m)	MARGIN (dB)	ANTENNA HEIGHT (m)	TABLE ANGLE (Degree)	RAW VALUE (dBuV)	CORRECTION FACTOR (dB/m)
1	*5240.00	113.2 PK			1.64 V	302	73.60	39.60
2	*5240.00	102.9 AV			1.64 V	302	63.30	39.60
3	5350.00	58.5 PK	74.0	-15.5	1.70 V	312	52.00	6.50
4	5350.00	45.9 AV	54.0	-8.1	1.70 V	312	39.40	6.50
5	#10480.00	58.5 PK	74.0	-15.5	1.56 V	234	39.80	18.70
6	#10480.00	46.8 AV	54.0	-7.2	1.56 V	234	28.10	18.70

Remarks:

1. Emission Level(dBuV/m) = Raw Value(dBuV) + Correction Factor(dB/m)
2. Correction Factor(dB/m) = Antenna Factor(dB/m) + Cable Factor(dB)
– Pre-Amplifier Factor(dB)
3. The other emission levels were very low against the limit.
4. Margin value = Emission Level – Limit value
5. " * ": Fundamental frequency.
6. " # ": The radiated frequency is out of the restricted band.

CHANNEL	TX Channel 149	DETECTOR FUNCTION	Peak (PK)
FREQUENCY RANGE	1GHz ~ 40GHz		Average (AV)

ANTENNA POLARITY & TEST DISTANCE: HORIZONTAL AT 3 M

NO.	FREQ. (MHz)	EMISSION LEVEL (dBuV/m)	LIMIT (dBuV/m)	MARGIN (dB)	ANTENNA HEIGHT (m)	TABLE ANGLE (Degree)	RAW VALUE (dBuV)	CORRECTION FACTOR (dB/m)
1	#5714.90	72.9 PK	109.4	-36.5	2.36 H	289	65.50	7.40
2	#5722.00	76.2 PK	115.4	-39.2	2.33 H	301	68.80	7.40
3	#5725.00	58.6 PK	122.2	-63.6	2.33 H	301	51.20	7.40
4	*5745.00	119.8 PK			3.02 H	299	79.30	40.50
5	*5745.00	108.3 AV			3.02 H	299	67.80	40.50
6	11490.00	65.1 PK	74.0	-8.9	1.55 H	282	46.40	18.70
7	11490.00	51.3 AV	54.0	-2.7	1.55 H	282	32.60	18.70

ANTENNA POLARITY & TEST DISTANCE: VERTICAL AT 3 M

NO.	FREQ. (MHz)	EMISSION LEVEL (dBuV/m)	LIMIT (dBuV/m)	MARGIN (dB)	ANTENNA HEIGHT (m)	TABLE ANGLE (Degree)	RAW VALUE (dBuV)	CORRECTION FACTOR (dB/m)
1	#5714.90	66.7 PK	109.4	-42.7	2.19 V	1	59.30	7.40
2	#5722.00	74.5 PK	115.4	-40.9	2.10 V	357	67.10	7.40
3	#5725.00	58.8 PK	122.2	-63.4	2.10 V	357	51.40	7.40
4	*5745.00	112.8 PK			2.46 V	359	72.30	40.50
5	*5745.00	102.3 AV			2.46 V	359	61.80	40.50
6	11490.00	60.6 PK	74.0	-13.4	1.96 V	300	41.90	18.70
7	11490.00	47.7 AV	54.0	-6.3	1.96 V	300	29.00	18.70

Remarks:

1. Emission Level(dBuV/m) = Raw Value(dBuV) + Correction Factor(dB/m)
2. Correction Factor(dB/m) = Antenna Factor(dB/m) + Cable Factor(dB) – Pre-Amplifier Factor(dB)
3. The other emission levels were very low against the limit.
4. Margin value = Emission Level – Limit value
5. " * ": Fundamental frequency.
6. " # ": The radiated frequency is out of the restricted band.

CHANNEL	TX Channel 157	DETECTOR FUNCTION	Peak (PK)
FREQUENCY RANGE	1GHz ~ 40GHz		Average (AV)

ANTENNA POLARITY & TEST DISTANCE: HORIZONTAL AT 3 M

NO.	FREQ. (MHz)	EMISSION LEVEL (dBuV/m)	LIMIT (dBuV/m)	MARGIN (dB)	ANTENNA HEIGHT (m)	TABLE ANGLE (Degree)	RAW VALUE (dBuV)	CORRECTION FACTOR (dB/m)
1	*5785.00	122.3 PK			2.90 H	287	81.70	40.60
2	*5785.00	111.0 AV			2.90 H	287	70.40	40.60
3	11570.00	63.0 PK	74.0	-11.0	1.59 H	321	44.30	18.70
4	11570.00	50.3 AV	54.0	-3.7	1.59 H	321	31.60	18.70

ANTENNA POLARITY & TEST DISTANCE: VERTICAL AT 3 M

NO.	FREQ. (MHz)	EMISSION LEVEL (dBuV/m)	LIMIT (dBuV/m)	MARGIN (dB)	ANTENNA HEIGHT (m)	TABLE ANGLE (Degree)	RAW VALUE (dBuV)	CORRECTION FACTOR (dB/m)
1	*5785.00	115.1 PK			2.11 V	0	74.50	40.60
2	*5785.00	104.0 AV			2.11 V	0	63.40	40.60
3	11570.00	61.2 PK	74.0	-12.8	1.89 V	321	42.50	18.70
4	11570.00	48.3 AV	54.0	-5.7	1.89 V	321	29.60	18.70

Remarks:

1. Emission Level(dBuV/m) = Raw Value(dBuV) + Correction Factor(dB/m)
2. Correction Factor(dB/m) = Antenna Factor(dB/m) + Cable Factor(dB)
– Pre-Amplifier Factor(dB)
3. The other emission levels were very low against the limit.
4. Margin value = Emission Level – Limit value
5. " * ": Fundamental frequency.

CHANNEL	TX Channel 165	DETECTOR FUNCTION	Peak (PK)
FREQUENCY RANGE	1GHz ~ 40GHz		Average (AV)

ANTENNA POLARITY & TEST DISTANCE: HORIZONTAL AT 3 M

NO.	FREQ. (MHz)	EMISSION LEVEL (dBuV/m)	LIMIT (dBuV/m)	MARGIN (dB)	ANTENNA HEIGHT (m)	TABLE ANGLE (Degree)	RAW VALUE (dBuV)	CORRECTION FACTOR (dB/m)
1	*5825.00	122.4 PK			3.08 H	298	81.80	40.60
2	*5825.00	111.1 AV			3.08 H	298	70.50	40.60
3	#5850.00	60.4 PK	122.2	-61.8	2.21 H	297	52.80	7.60
4	#5853.00	75.3 PK	115.4	-40.1	2.21 H	297	67.60	7.70
5	#5860.90	62.0 PK	109.1	-47.1	2.15 H	300	54.30	7.70
6	11650.00	63.2 PK	74.0	-10.8	1.99 H	311	44.00	19.20
7	11650.00	50.4 AV	54.0	-3.6	1.99 H	311	31.20	19.20

ANTENNA POLARITY & TEST DISTANCE: VERTICAL AT 3 M

NO.	FREQ. (MHz)	EMISSION LEVEL (dBuV/m)	LIMIT (dBuV/m)	MARGIN (dB)	ANTENNA HEIGHT (m)	TABLE ANGLE (Degree)	RAW VALUE (dBuV)	CORRECTION FACTOR (dB/m)
1	*5825.00	115.0 PK			2.31 V	0	74.40	40.60
2	*5825.00	105.4 AV			2.31 V	0	64.80	40.60
3	#5850.00	53.5 PK	122.2	-68.7	2.18 V	297	45.90	7.60
4	#5853.00	62.0 PK	115.4	-53.4	2.18 V	297	54.30	7.70
5	#5861.00	60.1 PK	109.1	-49.0	2.10 V	311	52.40	7.70
6	11650.00	61.5 PK	74.0	-12.5	2.22 V	19	42.30	19.20
7	11650.00	48.6 AV	54.0	-5.4	2.22 V	19	29.40	19.20

Remarks:

1. Emission Level(dBuV/m) = Raw Value(dBuV) + Correction Factor(dB/m)
2. Correction Factor(dB/m) = Antenna Factor(dB/m) + Cable Factor(dB)
– Pre-Amplifier Factor(dB)
3. The other emission levels were very low against the limit.
4. Margin value = Emission Level – Limit value
5. " * ": Fundamental frequency.
6. " # ": The radiated frequency is out of the restricted band.

802.11ac (VHT40)

CHANNEL	TX Channel 38	DETECTOR FUNCTION	Peak (PK)
FREQUENCY RANGE	1GHz ~ 40GHz		Average (AV)

ANTENNA POLARITY & TEST DISTANCE: HORIZONTAL AT 3 M								
NO.	FREQ. (MHz)	EMISSION LEVEL (dBuV/m)	LIMIT (dBuV/m)	MARGIN (dB)	ANTENNA HEIGHT (m)	TABLE ANGLE (Degree)	RAW VALUE (dBuV)	CORRECTION FACTOR (dB/m)
1	5150.00	72.7 PK	74.0	-1.3	2.52 H	302	66.70	6.00
2	5150.00	46.0 AV	54.0	-8.0	2.52 H	302	40.00	6.00
3	*5190.00	113.5 PK			2.60 H	316	74.10	39.40
4	*5190.00	98.4 AV			2.60 H	316	59.00	39.40
5	#10380.00	59.9 PK	74.0	-14.1	1.99 H	22	42.20	17.70
6	#10380.00	47.2 AV	54.0	-6.8	1.99 H	22	29.50	17.70
ANTENNA POLARITY & TEST DISTANCE: VERTICAL AT 3 M								
NO.	FREQ. (MHz)	EMISSION LEVEL (dBuV/m)	LIMIT (dBuV/m)	MARGIN (dB)	ANTENNA HEIGHT (m)	TABLE ANGLE (Degree)	RAW VALUE (dBuV)	CORRECTION FACTOR (dB/m)
1	*5190.00	106.7 PK			1.75 V	8	67.30	39.40
2	*5190.00	89.8 AV			1.75 V	8	50.40	39.40
3	5350.00	56.4 PK	74.0	-17.6	2.00 V	292	49.90	6.50
4	5350.00	45.0 AV	54.0	-9.0	2.00 V	292	38.50	6.50
5	#10380.00	60.2 PK	74.0	-13.8	1.56 V	88	42.50	17.70
6	#10380.00	47.0 AV	54.0	-7.0	1.56 V	88	29.30	17.70

Remarks:

1. Emission Level(dBuV/m) = Raw Value(dBuV) + Correction Factor(dB/m)
2. Correction Factor(dB/m) = Antenna Factor(dB/m) + Cable Factor(dB) – Pre-Amplifier Factor(dB)
3. The other emission levels were very low against the limit.
4. Margin value = Emission Level – Limit value
5. " * ": Fundamental frequency.
6. " # ": The radiated frequency is out of the restricted band.

CHANNEL	TX Channel 46	DETECTOR FUNCTION	Peak (PK)
FREQUENCY RANGE	1GHz ~ 40GHz		Average (AV)

ANTENNA POLARITY & TEST DISTANCE: HORIZONTAL AT 3 M

NO.	FREQ. (MHz)	EMISSION LEVEL (dBuV/m)	LIMIT (dBuV/m)	MARGIN (dB)	ANTENNA HEIGHT (m)	TABLE ANGLE (Degree)	RAW VALUE (dBuV)	CORRECTION FACTOR (dB/m)
1	*5230.00	117.9 PK			2.96 H	288	78.30	39.60
2	*5230.00	106.1 AV			2.96 H	288	66.50	39.60
3	5350.00	58.7 PK	74.0	-15.3	2.88 H	321	52.20	6.50
4	5350.00	47.6 AV	54.0	-6.4	2.88 H	321	41.10	6.50
5	#10460.00	61.4 PK	74.0	-12.6	1.76 H	289	42.90	18.50
6	#10460.00	48.4 AV	54.0	-5.6	1.76 H	289	29.90	18.50

ANTENNA POLARITY & TEST DISTANCE: VERTICAL AT 3 M

NO.	FREQ. (MHz)	EMISSION LEVEL (dBuV/m)	LIMIT (dBuV/m)	MARGIN (dB)	ANTENNA HEIGHT (m)	TABLE ANGLE (Degree)	RAW VALUE (dBuV)	CORRECTION FACTOR (dB/m)
1	*5230.00	112.3 PK			1.75 V	343	72.70	39.60
2	*5230.00	102.0 AV			1.75 V	343	62.40	39.60
3	5350.00	57.1 PK	74.0	-16.9	1.60 V	222	50.60	6.50
4	5350.00	45.5 AV	54.0	-8.5	1.60 V	222	39.00	6.50
5	#10460.00	60.4 PK	74.0	-13.6	1.50 V	340	41.90	18.50
6	#10460.00	47.9 AV	54.0	-6.1	1.50 V	340	29.40	18.50

Remarks:

1. Emission Level(dBuV/m) = Raw Value(dBuV) + Correction Factor(dB/m)
2. Correction Factor(dB/m) = Antenna Factor(dB/m) + Cable Factor(dB)
– Pre-Amplifier Factor(dB)
3. The other emission levels were very low against the limit.
4. Margin value = Emission Level – Limit value
5. " * ": Fundamental frequency.
6. " # ": The radiated frequency is out of the restricted band.

CHANNEL	TX Channel 151	DETECTOR FUNCTION	Peak (PK)
FREQUENCY RANGE	1GHz ~ 40GHz		Average (AV)

ANTENNA POLARITY & TEST DISTANCE: HORIZONTAL AT 3 M

NO.	FREQ. (MHz)	EMISSION LEVEL (dBuV/m)	LIMIT (dBuV/m)	MARGIN (dB)	ANTENNA HEIGHT (m)	TABLE ANGLE (Degree)	RAW VALUE (dBuV)	CORRECTION FACTOR (dB/m)
1	#5714.90	66.3 PK	109.4	-43.1	1.64 H	47	58.90	7.40
2	#5722.90	77.0 PK	117.4	-40.4	1.66 H	51	69.60	7.40
3	#5725.00	51.8 PK	122.2	-70.4	1.50 H	60	44.40	7.40
4	*5755.00	111.7 PK			1.50 H	311	71.10	40.60
5	*5755.00	97.6 AV			1.50 H	311	57.00	40.60
6	11510.00	59.7 PK	74.0	-14.3	1.32 H	243	41.00	18.70
7	11510.00	47.1 AV	54.0	-6.9	1.32 H	243	28.40	18.70

ANTENNA POLARITY & TEST DISTANCE: VERTICAL AT 3 M

NO.	FREQ. (MHz)	EMISSION LEVEL (dBuV/m)	LIMIT (dBuV/m)	MARGIN (dB)	ANTENNA HEIGHT (m)	TABLE ANGLE (Degree)	RAW VALUE (dBuV)	CORRECTION FACTOR (dB/m)
1	#5714.90	62.3 PK	109.4	-47.1	2.02 V	5	54.90	7.40
2	#5722.00	72.3 PK	115.4	-43.1	2.20 V	19	64.90	7.40
3	#5725.00	59.3 PK	122.2	-62.9	2.20 V	19	51.90	7.40
4	*5755.00	105.7 PK			1.99 V	312	65.10	40.60
5	*5755.00	92.3 AV			1.99 V	312	51.70	40.60
6	11510.00	60.8 PK	74.0	-13.2	1.45 V	356	42.10	18.70
7	11510.00	47.9 AV	54.0	-6.1	1.45 V	356	29.20	18.70

Remarks:

1. Emission Level(dBuV/m) = Raw Value(dBuV) + Correction Factor(dB/m)
2. Correction Factor(dB/m) = Antenna Factor(dB/m) + Cable Factor(dB) – Pre-Amplifier Factor(dB)
3. The other emission levels were very low against the limit.
4. Margin value = Emission Level – Limit value
5. " * ": Fundamental frequency.
6. " # ": The radiated frequency is out of the restricted band.

CHANNEL	TX Channel 159	DETECTOR FUNCTION	Peak (PK)
FREQUENCY RANGE	1GHz ~ 40GHz		Average (AV)

ANTENNA POLARITY & TEST DISTANCE: HORIZONTAL AT 3 M

NO.	FREQ. (MHz)	EMISSION LEVEL (dBuV/m)	LIMIT (dBuV/m)	MARGIN (dB)	ANTENNA HEIGHT (m)	TABLE ANGLE (Degree)	RAW VALUE (dBuV)	CORRECTION FACTOR (dB/m)
1	*5795.00	119.9 PK			2.78 H	293	79.30	40.60
2	*5795.00	108.2 AV			2.78 H	293	67.60	40.60
3	#5850.00	57.9 PK	122.2	-64.3	2.40 H	301	50.30	7.60
4	#5853.00	71.4 PK	115.4	-44.0	2.40 H	301	63.70	7.70
5	#5861.00	71.4 PK	109.1	-37.7	2.52 H	291	63.70	7.70
6	11590.00	63.2 PK	74.0	-10.8	1.40 H	287	44.40	18.80
7	11590.00	50.1 AV	54.0	-3.9	1.40 H	287	31.30	18.80

ANTENNA POLARITY & TEST DISTANCE: VERTICAL AT 3 M

NO.	FREQ. (MHz)	EMISSION LEVEL (dBuV/m)	LIMIT (dBuV/m)	MARGIN (dB)	ANTENNA HEIGHT (m)	TABLE ANGLE (Degree)	RAW VALUE (dBuV)	CORRECTION FACTOR (dB/m)
1	*5795.00	113.6 PK			1.97 V	0	73.00	40.60
2	*5795.00	103.4 AV			1.97 V	0	62.80	40.60
3	#5850.00	52.9 PK	122.2	-69.3	2.21 V	28	45.30	7.60
4	#5853.00	65.2 PK	115.4	-50.2	2.21 V	28	57.50	7.70
5	#5861.00	62.1 PK	109.1	-47.0	2.15 V	4	54.40	7.70
6	11590.00	62.3 PK	74.0	-11.7	1.50 V	333	43.50	18.80
7	11590.00	49.1 AV	54.0	-4.9	1.50 V	333	30.30	18.80

Remarks:

1. Emission Level(dBuV/m) = Raw Value(dBuV) + Correction Factor(dB/m)
2. Correction Factor(dB/m) = Antenna Factor(dB/m) + Cable Factor(dB)
– Pre-Amplifier Factor(dB)
3. The other emission levels were very low against the limit.
4. Margin value = Emission Level – Limit value
5. " * ": Fundamental frequency.
6. " # ": The radiated frequency is out of the restricted band.

802.11ac (VHT80)

CHANNEL	TX Channel 42	DETECTOR FUNCTION	Peak (PK)
FREQUENCY RANGE	1GHz ~ 40GHz		Average (AV)

ANTENNA POLARITY & TEST DISTANCE: HORIZONTAL AT 3 M								
NO.	FREQ. (MHz)	EMISSION LEVEL (dBuV/m)	LIMIT (dBuV/m)	MARGIN (dB)	ANTENNA HEIGHT (m)	TABLE ANGLE (Degree)	RAW VALUE (dBuV)	CORRECTION FACTOR (dB/m)
1	5120.00	72.1 PK	74.0	-1.9	2.55 H	306	66.10	6.00
2	5120.00	50.8 AV	54.0	-3.2	2.55 H	306	44.80	6.00
3	*5210.00	108.1 PK			2.43 H	297	68.60	39.50
4	*5210.00	93.1 AV			2.43 H	297	53.60	39.50
5	#10420.00	59.1 PK	74.0	-14.9	2.01 H	350	41.20	17.90
6	#10420.00	46.1 AV	54.0	-7.9	2.01 H	350	28.20	17.90
ANTENNA POLARITY & TEST DISTANCE: VERTICAL AT 3 M								
NO.	FREQ. (MHz)	EMISSION LEVEL (dBuV/m)	LIMIT (dBuV/m)	MARGIN (dB)	ANTENNA HEIGHT (m)	TABLE ANGLE (Degree)	RAW VALUE (dBuV)	CORRECTION FACTOR (dB/m)
1	5150.00	63.4 PK	74.0	-10.6	2.14 V	204	57.40	6.00
2	5150.00	50.0 AV	54.0	-4.0	2.14 V	204	44.00	6.00
3	*5210.00	103.3 PK			2.03 V	332	63.80	39.50
4	*5210.00	88.4 AV			2.03 V	332	48.90	39.50
5	#10420.00	59.5 PK	74.0	-14.5	1.49 V	359	41.60	17.90
6	#10420.00	46.3 AV	54.0	-7.7	1.49 V	359	28.40	17.90

Remarks:

1. Emission Level(dBuV/m) = Raw Value(dBuV) + Correction Factor(dB/m)
2. Correction Factor(dB/m) = Antenna Factor(dB/m) + Cable Factor(dB) – Pre-Amplifier Factor(dB)
3. The other emission levels were very low against the limit.
4. Margin value = Emission Level – Limit value
5. " * ": Fundamental frequency.
6. " # ": The radiated frequency is out of the restricted band.

CHANNEL	TX Channel 155	DETECTOR FUNCTION	Peak (PK)
FREQUENCY RANGE	1GHz ~ 40GHz		Average (AV)

ANTENNA POLARITY & TEST DISTANCE: HORIZONTAL AT 3 M

NO.	FREQ. (MHz)	EMISSION LEVEL (dBuV/m)	LIMIT (dBuV/m)	MARGIN (dB)	ANTENNA HEIGHT (m)	TABLE ANGLE (Degree)	RAW VALUE (dBuV)	CORRECTION FACTOR (dB/m)
1	#5700.00	73.0 PK	105.2	-32.2	2.44 H	290	65.70	7.30
2	#5722.00	73.7 PK	115.4	-41.7	2.67 H	293	66.30	7.40
3	#5725.00	57.5 PK	122.2	-64.7	2.67 H	293	50.10	7.40
4	*5775.00	110.2 PK			1.95 H	299	69.60	40.60
5	*5775.00	97.4 AV			1.95 H	299	56.80	40.60
6	#5850.00	54.9 PK	122.2	-67.3	1.99 H	289	47.30	7.60
7	#5853.00	65.3 PK	115.4	-50.1	1.99 H	289	57.60	7.70
8	#5860.10	67.8 PK	109.4	-41.6	2.45 H	277	60.10	7.70
9	11550.00	60.8 PK	74.0	-13.2	1.40 H	313	42.20	18.60
10	11550.00	48.0 AV	54.0	-6.0	1.40 H	313	29.40	18.60

ANTENNA POLARITY & TEST DISTANCE: VERTICAL AT 3 M

NO.	FREQ. (MHz)	EMISSION LEVEL (dBuV/m)	LIMIT (dBuV/m)	MARGIN (dB)	ANTENNA HEIGHT (m)	TABLE ANGLE (Degree)	RAW VALUE (dBuV)	CORRECTION FACTOR (dB/m)
1	#5714.90	72.3 PK	109.4	-37.1	2.96 V	269	64.90	7.40
2	#5722.00	71.9 PK	115.4	-43.5	3.25 V	351	64.50	7.40
3	#5725.00	57.9 PK	122.2	-64.3	3.25 V	351	50.50	7.40
4	*5775.00	101.7 PK			1.76 V	34	61.10	40.60
5	*5775.00	87.7 AV			1.76 V	34	47.10	40.60
6	#5850.00	52.4 PK	122.2	-69.8	1.77 V	50	44.80	7.60
7	#5853.00	64.4 PK	115.4	-51.0	1.77 V	50	56.70	7.70
8	#5860.10	66.2 PK	109.4	-43.2	2.89 V	333	58.50	7.70
9	11550.00	60.2 PK	74.0	-13.8	1.56 V	294	41.60	18.60
10	11550.00	47.4 AV	54.0	-6.6	1.56 V	294	28.80	18.60

Remarks:

- Emission Level(dBuV/m) = Raw Value(dBuV) + Correction Factor(dB/m)
- Correction Factor(dB/m) = Antenna Factor(dB/m) + Cable Factor(dB)
– Pre-Amplifier Factor(dB)
- The other emission levels were very low against the limit.
- Margin value = Emission Level – Limit value
- " * ": Fundamental frequency.
- " # ": The radiated frequency is out of the restricted band.

Mode D
 802.11ac (VHT20)

CHANNEL	TX Channel 36	DETECTOR FUNCTION	Peak (PK)
FREQUENCY RANGE	1GHz ~ 40GHz		Average (AV)

ANTENNA POLARITY & TEST DISTANCE: HORIZONTAL AT 3 M								
NO.	FREQ. (MHz)	EMISSION LEVEL (dBuV/m)	LIMIT (dBuV/m)	MARGIN (dB)	ANTENNA HEIGHT (m)	TABLE ANGLE (Degree)	RAW VALUE (dBuV)	CORRECTION FACTOR (dB/m)
1	5150.00	56.3 PK	74.0	-17.7	1.41 H	291	50.30	6.00
2	5150.00	43.4 AV	54.0	-10.6	1.41 H	291	37.40	6.00
3	*5180.00	105.5 PK			1.06 H	251	66.10	39.40
4	*5180.00	91.6 AV			1.06 H	251	52.20	39.40
5	#10360.00	58.0 PK	74.0	-16.0	1.19 H	211	40.20	17.80
6	#10360.00	46.3 AV	54.0	-7.7	1.19 H	211	28.50	17.80
ANTENNA POLARITY & TEST DISTANCE: VERTICAL AT 3 M								
NO.	FREQ. (MHz)	EMISSION LEVEL (dBuV/m)	LIMIT (dBuV/m)	MARGIN (dB)	ANTENNA HEIGHT (m)	TABLE ANGLE (Degree)	RAW VALUE (dBuV)	CORRECTION FACTOR (dB/m)
1	5150.00	73.0 PK	74.0	-1.0	2.46 V	165	67.00	6.00
2	5150.00	49.1 AV	54.0	-4.9	2.46 V	165	43.10	6.00
3	*5180.00	116.8 PK			1.64 V	303	77.40	39.40
4	*5180.00	102.7 AV			1.64 V	303	63.30	39.40
5	#10360.00	61.6 PK	74.0	-12.4	2.13 V	20	43.80	17.80
6	#10360.00	48.5 AV	54.0	-5.5	2.13 V	20	30.70	17.80

Remarks:

- Emission Level(dBuV/m) = Raw Value(dBuV) + Correction Factor(dB/m)
- Correction Factor(dB/m) = Antenna Factor(dB/m) + Cable Factor(dB)
 – Pre-Amplifier Factor(dB)
- The other emission levels were very low against the limit.
- Margin value = Emission Level – Limit value
- " * ": Fundamental frequency.
- " # ": The radiated frequency is out of the restricted band.

CHANNEL	TX Channel 40	DETECTOR FUNCTION	Peak (PK)
FREQUENCY RANGE	1GHz ~ 40GHz		Average (AV)

ANTENNA POLARITY & TEST DISTANCE: HORIZONTAL AT 3 M

NO.	FREQ. (MHz)	EMISSION LEVEL (dBuV/m)	LIMIT (dBuV/m)	MARGIN (dB)	ANTENNA HEIGHT (m)	TABLE ANGLE (Degree)	RAW VALUE (dBuV)	CORRECTION FACTOR (dB/m)
1	5150.00	55.6 PK	74.0	-18.4	2.28 H	145	49.60	6.00
2	5150.00	43.3 AV	54.0	-10.7	2.28 H	145	37.30	6.00
3	*5200.00	112.0 PK			2.53 H	118	72.50	39.50
4	*5200.00	100.0 AV			2.53 H	118	60.50	39.50
5	#10400.00	56.7 PK	74.0	-17.3	1.46 H	109	39.00	17.70
6	#10400.00	44.8 AV	54.0	-9.2	1.46 H	109	27.10	17.70

ANTENNA POLARITY & TEST DISTANCE: VERTICAL AT 3 M

NO.	FREQ. (MHz)	EMISSION LEVEL (dBuV/m)	LIMIT (dBuV/m)	MARGIN (dB)	ANTENNA HEIGHT (m)	TABLE ANGLE (Degree)	RAW VALUE (dBuV)	CORRECTION FACTOR (dB/m)
1	5150.00	61.5 PK	74.0	-12.5	2.40 V	174	55.50	6.00
2	5150.00	46.0 AV	54.0	-8.0	2.40 V	174	40.00	6.00
3	*5200.00	120.2 PK			2.48 V	355	80.70	39.50
4	*5200.00	108.9 AV			2.48 V	355	69.40	39.50
5	#10400.00	62.1 PK	74.0	-11.9	1.93 V	202	44.40	17.70
6	#10400.00	48.8 AV	54.0	-5.2	1.93 V	202	31.10	17.70

Remarks:

1. Emission Level(dBuV/m) = Raw Value(dBuV) + Correction Factor(dB/m)
2. Correction Factor(dB/m) = Antenna Factor(dB/m) + Cable Factor(dB)
– Pre-Amplifier Factor(dB)
3. The other emission levels were very low against the limit.
4. Margin value = Emission Level – Limit value
5. " * " : Fundamental frequency.

CHANNEL	TX Channel 48	DETECTOR FUNCTION	Peak (PK)
FREQUENCY RANGE	1GHz ~ 40GHz		Average (AV)

ANTENNA POLARITY & TEST DISTANCE: HORIZONTAL AT 3 M

NO.	FREQ. (MHz)	EMISSION LEVEL (dBuV/m)	LIMIT (dBuV/m)	MARGIN (dB)	ANTENNA HEIGHT (m)	TABLE ANGLE (Degree)	RAW VALUE (dBuV)	CORRECTION FACTOR (dB/m)
1	*5240.00	111.7 PK			1.00 H	251	72.10	39.60
2	*5240.00	99.0 AV			1.00 H	251	59.40	39.60
3	5350.00	57.4 PK	74.0	-16.6	1.22 H	283	50.90	6.50
4	5350.00	44.4 AV	54.0	-9.6	1.22 H	283	37.90	6.50
5	#10480.00	57.6 PK	74.0	-16.4	1.30 H	211	38.90	18.70
6	#10480.00	44.8 AV	54.0	-9.2	1.30 H	211	26.10	18.70

ANTENNA POLARITY & TEST DISTANCE: VERTICAL AT 3 M

NO.	FREQ. (MHz)	EMISSION LEVEL (dBuV/m)	LIMIT (dBuV/m)	MARGIN (dB)	ANTENNA HEIGHT (m)	TABLE ANGLE (Degree)	RAW VALUE (dBuV)	CORRECTION FACTOR (dB/m)
1	*5240.00	122.4 PK			2.45 V	269	82.80	39.60
2	*5240.00	110.3 AV			2.45 V	269	70.70	39.60
3	5350.00	58.7 PK	74.0	-15.3	2.40 V	293	52.20	6.50
4	5350.00	47.6 AV	54.0	-6.4	2.40 V	293	41.10	6.50
5	#10480.00	62.5 PK	74.0	-11.5	2.22 V	180	43.80	18.70
6	#10480.00	49.6 AV	54.0	-4.4	2.22 V	180	30.90	18.70

Remarks:

1. Emission Level(dBuV/m) = Raw Value(dBuV) + Correction Factor(dB/m)
2. Correction Factor(dB/m) = Antenna Factor(dB/m) + Cable Factor(dB)
– Pre-Amplifier Factor(dB)
3. The other emission levels were very low against the limit.
4. Margin value = Emission Level – Limit value
5. " * ": Fundamental frequency.
6. " # ": The radiated frequency is out of the restricted band.

CHANNEL	TX Channel 149	DETECTOR FUNCTION	Peak (PK)
FREQUENCY RANGE	1GHz ~ 40GHz		Average (AV)

ANTENNA POLARITY & TEST DISTANCE: HORIZONTAL AT 3 M

NO.	FREQ. (MHz)	EMISSION LEVEL (dBuV/m)	LIMIT (dBuV/m)	MARGIN (dB)	ANTENNA HEIGHT (m)	TABLE ANGLE (Degree)	RAW VALUE (dBuV)	CORRECTION FACTOR (dB/m)
1	#5714.90	57.3 PK	109.4	-52.1	1.39 H	267	49.90	7.40
2	#5722.90	58.0 PK	117.4	-59.4	1.54 H	266	50.60	7.40
3	#5725.00	46.7 PK	122.2	-75.5	1.43 H	311	39.30	7.40
4	*5745.00	104.8 PK			1.27 H	238	64.30	40.50
5	*5745.00	90.1 AV			1.27 H	238	49.60	40.50
6	11490.00	57.6 PK	74.0	-16.4	1.33 H	238	38.90	18.70
7	11490.00	45.3 AV	54.0	-8.7	1.33 H	238	26.60	18.70

ANTENNA POLARITY & TEST DISTANCE: VERTICAL AT 3 M

NO.	FREQ. (MHz)	EMISSION LEVEL (dBuV/m)	LIMIT (dBuV/m)	MARGIN (dB)	ANTENNA HEIGHT (m)	TABLE ANGLE (Degree)	RAW VALUE (dBuV)	CORRECTION FACTOR (dB/m)
1	#5714.90	61.3 PK	109.4	-48.1	1.36 V	275	53.90	7.40
2	#5722.90	76.5 PK	117.4	-40.9	1.22 V	277	69.10	7.40
3	#5725.00	54.5 PK	122.2	-67.7	1.32 V	277	47.10	7.40
4	*5745.00	114.5 PK			1.96 V	304	74.00	40.50
5	*5745.00	101.2 AV			1.96 V	304	60.70	40.50
6	11490.00	58.5 PK	74.0	-15.5	1.58 V	221	39.80	18.70
7	11490.00	46.2 AV	54.0	-7.8	1.58 V	221	27.50	18.70

Remarks:

1. Emission Level(dBuV/m) = Raw Value(dBuV) + Correction Factor(dB/m)
2. Correction Factor(dB/m) = Antenna Factor(dB/m) + Cable Factor(dB)
– Pre-Amplifier Factor(dB)
3. The other emission levels were very low against the limit.
4. Margin value = Emission Level – Limit value
5. " * ": Fundamental frequency.
6. " # ": The radiated frequency is out of the restricted band.

CHANNEL	TX Channel 157	DETECTOR FUNCTION	Peak (PK)
FREQUENCY RANGE	1GHz ~ 40GHz		Average (AV)

ANTENNA POLARITY & TEST DISTANCE: HORIZONTAL AT 3 M

NO.	FREQ. (MHz)	EMISSION LEVEL (dBuV/m)	LIMIT (dBuV/m)	MARGIN (dB)	ANTENNA HEIGHT (m)	TABLE ANGLE (Degree)	RAW VALUE (dBuV)	CORRECTION FACTOR (dB/m)
1	*5785.00	109.9 PK			1.28 H	225	69.30	40.60
2	*5785.00	97.8 AV			1.28 H	225	57.20	40.60
3	11570.00	59.1 PK	74.0	-14.9	1.24 H	95	40.40	18.70
4	11570.00	46.5 AV	54.0	-7.5	1.24 H	95	27.80	18.70

ANTENNA POLARITY & TEST DISTANCE: VERTICAL AT 3 M

NO.	FREQ. (MHz)	EMISSION LEVEL (dBuV/m)	LIMIT (dBuV/m)	MARGIN (dB)	ANTENNA HEIGHT (m)	TABLE ANGLE (Degree)	RAW VALUE (dBuV)	CORRECTION FACTOR (dB/m)
1	*5785.00	120.4 PK			1.44 V	321	79.80	40.60
2	*5785.00	108.2 AV			1.44 V	321	67.60	40.60
3	11570.00	59.7 PK	74.0	-14.3	1.22 V	139	41.00	18.70
4	11570.00	47.1 AV	54.0	-6.9	1.22 V	139	28.40	18.70

Remarks:

1. Emission Level(dBuV/m) = Raw Value(dBuV) + Correction Factor(dB/m)
2. Correction Factor(dB/m) = Antenna Factor(dB/m) + Cable Factor(dB)
– Pre-Amplifier Factor(dB)
3. The other emission levels were very low against the limit.
4. Margin value = Emission Level – Limit value
5. " * ": Fundamental frequency.

CHANNEL	TX Channel 165	DETECTOR FUNCTION	Peak (PK)
FREQUENCY RANGE	1GHz ~ 40GHz		Average (AV)

ANTENNA POLARITY & TEST DISTANCE: HORIZONTAL AT 3 M

NO.	FREQ. (MHz)	EMISSION LEVEL (dBuV/m)	LIMIT (dBuV/m)	MARGIN (dB)	ANTENNA HEIGHT (m)	TABLE ANGLE (Degree)	RAW VALUE (dBuV)	CORRECTION FACTOR (dB/m)
1	*5825.00	108.7 PK			2.13 H	135	68.10	40.60
2	*5825.00	98.4 AV			2.13 H	135	57.80	40.60
3	#5850.00	46.3 PK	122.2	-75.9	1.86 H	141	38.70	7.60
4	#5852.10	58.8 PK	117.4	-58.6	1.63 H	159	51.10	7.70
5	#5860.10	57.6 PK	109.4	-51.8	1.48 H	126	49.90	7.70
6	11650.00	59.4 PK	74.0	-14.6	1.08 H	199	40.20	19.20
7	11650.00	46.5 AV	54.0	-7.5	1.08 H	199	27.30	19.20

ANTENNA POLARITY & TEST DISTANCE: VERTICAL AT 3 M

NO.	FREQ. (MHz)	EMISSION LEVEL (dBuV/m)	LIMIT (dBuV/m)	MARGIN (dB)	ANTENNA HEIGHT (m)	TABLE ANGLE (Degree)	RAW VALUE (dBuV)	CORRECTION FACTOR (dB/m)
1	*5825.00	122.2 PK			2.03 V	266	81.60	40.60
2	*5825.00	109.1 AV			2.03 V	266	68.50	40.60
3	#5850.00	55.7 PK	122.2	-66.5	1.47 V	177	48.10	7.60
4	#5852.10	71.2 PK	117.4	-46.2	1.70 V	176	63.50	7.70
5	#5860.10	60.6 PK	109.4	-48.8	1.45 V	179	52.90	7.70
6	11650.00	60.3 PK	74.0	-13.7	1.85 V	136	41.10	19.20
7	11650.00	47.5 AV	54.0	-6.5	1.85 V	136	28.30	19.20

Remarks:

1. Emission Level(dBuV/m) = Raw Value(dBuV) + Correction Factor(dB/m)
2. Correction Factor(dB/m) = Antenna Factor(dB/m) + Cable Factor(dB) – Pre-Amplifier Factor(dB)
3. The other emission levels were very low against the limit.
4. Margin value = Emission Level – Limit value
5. " * ": Fundamental frequency.
6. " # ": The radiated frequency is out of the restricted band.

802.11ac (VHT40)

CHANNEL	TX Channel 38	DETECTOR FUNCTION	Peak (PK)
FREQUENCY RANGE	1GHz ~ 40GHz		Average (AV)

ANTENNA POLARITY & TEST DISTANCE: HORIZONTAL AT 3 M								
NO.	FREQ. (MHz)	EMISSION LEVEL (dBuV/m)	LIMIT (dBuV/m)	MARGIN (dB)	ANTENNA HEIGHT (m)	TABLE ANGLE (Degree)	RAW VALUE (dBuV)	CORRECTION FACTOR (dB/m)
1	5150.00	63.2 PK	74.0	-10.8	1.24 H	108	57.20	6.00
2	5150.00	43.9 AV	54.0	-10.1	1.24 H	108	37.90	6.00
3	*5190.00	103.7 PK			1.09 H	118	64.30	39.40
4	*5190.00	88.7 AV			1.09 H	118	49.30	39.40
5	#10380.00	58.4 PK	74.0	-15.6	1.31 H	244	40.70	17.70
6	#10380.00	45.9 AV	54.0	-8.1	1.31 H	244	28.20	17.70
ANTENNA POLARITY & TEST DISTANCE: VERTICAL AT 3 M								
NO.	FREQ. (MHz)	EMISSION LEVEL (dBuV/m)	LIMIT (dBuV/m)	MARGIN (dB)	ANTENNA HEIGHT (m)	TABLE ANGLE (Degree)	RAW VALUE (dBuV)	CORRECTION FACTOR (dB/m)
1	5150.00	72.8 PK	74.0	-1.2	2.18 V	117	66.80	6.00
2	5150.00	46.2 AV	54.0	-7.8	2.18 V	117	40.20	6.00
3	*5190.00	111.2 PK			2.27 V	302	71.80	39.40
4	*5190.00	98.4 AV			2.27 V	302	59.00	39.40
5	#10380.00	58.5 PK	74.0	-15.5	1.54 V	119	40.80	17.70
6	#10380.00	45.9 AV	54.0	-8.1	1.54 V	119	28.20	17.70

Remarks:

1. Emission Level(dBuV/m) = Raw Value(dBuV) + Correction Factor(dB/m)
2. Correction Factor(dB/m) = Antenna Factor(dB/m) + Cable Factor(dB) – Pre-Amplifier Factor(dB)
3. The other emission levels were very low against the limit.
4. Margin value = Emission Level – Limit value
5. " * ": Fundamental frequency.
6. " # ": The radiated frequency is out of the restricted band.

CHANNEL	TX Channel 46	DETECTOR FUNCTION	Peak (PK)
FREQUENCY RANGE	1GHz ~ 40GHz		Average (AV)

ANTENNA POLARITY & TEST DISTANCE: HORIZONTAL AT 3 M

NO.	FREQ. (MHz)	EMISSION LEVEL (dBuV/m)	LIMIT (dBuV/m)	MARGIN (dB)	ANTENNA HEIGHT (m)	TABLE ANGLE (Degree)	RAW VALUE (dBuV)	CORRECTION FACTOR (dB/m)
1	5150.00	56.8 PK	74.0	-17.2	1.21 H	94	50.80	6.00
2	5150.00	43.6 AV	54.0	-10.4	1.21 H	94	37.60	6.00
3	*5230.00	109.6 PK			1.10 H	100	70.00	39.60
4	*5230.00	97.8 AV			1.10 H	100	58.20	39.60
5	#10460.00	56.6 PK	74.0	-17.4	1.11 H	53	38.10	18.50
6	#10460.00	44.4 AV	54.0	-9.6	1.11 H	53	25.90	18.50

ANTENNA POLARITY & TEST DISTANCE: VERTICAL AT 3 M

NO.	FREQ. (MHz)	EMISSION LEVEL (dBuV/m)	LIMIT (dBuV/m)	MARGIN (dB)	ANTENNA HEIGHT (m)	TABLE ANGLE (Degree)	RAW VALUE (dBuV)	CORRECTION FACTOR (dB/m)
1	5150.00	67.5 PK	74.0	-6.5	2.41 V	277	61.50	6.00
2	5150.00	48.5 AV	54.0	-5.5	2.41 V	277	42.50	6.00
3	*5230.00	120.7 PK			2.05 V	179	81.10	39.60
4	*5230.00	109.6 AV			2.05 V	179	70.00	39.60
5	#10460.00	62.1 PK	74.0	-11.9	2.33 V	266	43.60	18.50
6	#10460.00	49.2 AV	54.0	-4.8	2.33 V	266	30.70	18.50

Remarks:

1. Emission Level(dBuV/m) = Raw Value(dBuV) + Correction Factor(dB/m)
2. Correction Factor(dB/m) = Antenna Factor(dB/m) + Cable Factor(dB)
– Pre-Amplifier Factor(dB)
3. The other emission levels were very low against the limit.
4. Margin value = Emission Level – Limit value
5. " * ": Fundamental frequency.
6. " # ": The radiated frequency is out of the restricted band.

CHANNEL	TX Channel 151	DETECTOR FUNCTION	Peak (PK)
FREQUENCY RANGE	1GHz ~ 40GHz		Average (AV)

ANTENNA POLARITY & TEST DISTANCE: HORIZONTAL AT 3 M

NO.	FREQ. (MHz)	EMISSION LEVEL (dBuV/m)	LIMIT (dBuV/m)	MARGIN (dB)	ANTENNA HEIGHT (m)	TABLE ANGLE (Degree)	RAW VALUE (dBuV)	CORRECTION FACTOR (dB/m)
1	#5714.90	58.0 PK	109.4	-51.4	1.22 H	245	50.60	7.40
2	#5722.90	61.3 PK	117.4	-56.1	1.45 H	290	53.90	7.40
3	#5725.00	46.5 PK	122.2	-75.7	1.35 H	301	39.10	7.40
4	*5755.00	101.5 PK			1.35 H	228	60.90	40.60
5	*5755.00	85.8 AV			1.35 H	228	45.20	40.60
6	11510.00	58.9 PK	74.0	-15.1	1.14 H	182	40.20	18.70
7	11510.00	45.8 AV	54.0	-8.2	1.14 H	182	27.10	18.70

ANTENNA POLARITY & TEST DISTANCE: VERTICAL AT 3 M

NO.	FREQ. (MHz)	EMISSION LEVEL (dBuV/m)	LIMIT (dBuV/m)	MARGIN (dB)	ANTENNA HEIGHT (m)	TABLE ANGLE (Degree)	RAW VALUE (dBuV)	CORRECTION FACTOR (dB/m)
1	#5714.90	66.6 PK	109.4	-42.8	1.27 V	57	59.20	7.40
2	#5722.90	76.2 PK	117.4	-41.2	1.30 V	12	68.80	7.40
3	#5725.00	56.8 PK	122.2	-65.4	1.32 V	78	49.40	7.40
4	*5755.00	110.1 PK			2.22 V	307	69.50	40.60
5	*5755.00	97.8 AV			2.22 V	307	57.20	40.60
6	11510.00	58.9 PK	74.0	-15.1	1.62 V	185	40.20	18.70
7	11510.00	46.6 AV	54.0	-7.4	1.62 V	185	27.90	18.70

Remarks:

1. Emission Level(dBuV/m) = Raw Value(dBuV) + Correction Factor(dB/m)
2. Correction Factor(dB/m) = Antenna Factor(dB/m) + Cable Factor(dB)
– Pre-Amplifier Factor(dB)
3. The other emission levels were very low against the limit.
4. Margin value = Emission Level – Limit value
5. " * ": Fundamental frequency.
6. " # ": The radiated frequency is out of the restricted band.

CHANNEL	TX Channel 159	DETECTOR FUNCTION	Peak (PK)
FREQUENCY RANGE	1GHz ~ 40GHz		Average (AV)

ANTENNA POLARITY & TEST DISTANCE: HORIZONTAL AT 3 M

NO.	FREQ. (MHz)	EMISSION LEVEL (dBuV/m)	LIMIT (dBuV/m)	MARGIN (dB)	ANTENNA HEIGHT (m)	TABLE ANGLE (Degree)	RAW VALUE (dBuV)	CORRECTION FACTOR (dB/m)
1	*5795.00	105.9 PK			1.28 H	227	65.30	40.60
2	*5795.00	94.7 AV			1.28 H	227	54.10	40.60
3	#5850.00	47.1 PK	122.2	-75.1	1.16 H	244	39.50	7.60
4	#5852.10	61.9 PK	117.4	-55.5	1.20 H	220	54.20	7.70
5	#5860.10	58.2 PK	109.4	-51.2	1.12 H	190	50.50	7.70
6	11590.00	58.6 PK	74.0	-15.4	1.16 H	86	39.80	18.80
7	11590.00	46.5 AV	54.0	-7.5	1.16 H	86	27.70	18.80

ANTENNA POLARITY & TEST DISTANCE: VERTICAL AT 3 M

NO.	FREQ. (MHz)	EMISSION LEVEL (dBuV/m)	LIMIT (dBuV/m)	MARGIN (dB)	ANTENNA HEIGHT (m)	TABLE ANGLE (Degree)	RAW VALUE (dBuV)	CORRECTION FACTOR (dB/m)
1	*5795.00	116.5 PK			1.59 V	140	75.90	40.60
2	*5795.00	104.4 AV			1.59 V	140	63.80	40.60
3	#5850.00	56.0 PK	122.2	-66.2	1.92 V	3	48.40	7.60
4	#5852.10	71.9 PK	117.4	-45.5	1.85 V	5	64.20	7.70
5	#5860.10	71.8 PK	109.4	-37.6	1.82 V	2	64.10	7.70
6	11590.00	58.9 PK	74.0	-15.1	1.33 V	69	40.10	18.80
7	11590.00	46.5 AV	54.0	-7.5	1.33 V	69	27.70	18.80

Remarks:

1. Emission Level(dBuV/m) = Raw Value(dBuV) + Correction Factor(dB/m)
2. Correction Factor(dB/m) = Antenna Factor(dB/m) + Cable Factor(dB)
– Pre-Amplifier Factor(dB)
3. The other emission levels were very low against the limit.
4. Margin value = Emission Level – Limit value
5. " * ": Fundamental frequency.
6. " # ": The radiated frequency is out of the restricted band.

802.11ac (VHT80)

CHANNEL	TX Channel 42	DETECTOR FUNCTION	Peak (PK)
FREQUENCY RANGE	1GHz ~ 40GHz		Average (AV)

ANTENNA POLARITY & TEST DISTANCE: HORIZONTAL AT 3 M

NO.	FREQ. (MHz)	EMISSION LEVEL (dBuV/m)	LIMIT (dBuV/m)	MARGIN (dB)	ANTENNA HEIGHT (m)	TABLE ANGLE (Degree)	RAW VALUE (dBuV)	CORRECTION FACTOR (dB/m)
1	5150.00	64.6 PK	74.0	-9.4	1.35 H	193	58.60	6.00
2	5150.00	44.9 AV	54.0	-9.1	1.35 H	193	38.90	6.00
3	*5210.00	97.7 PK			1.00 H	169	58.20	39.50
4	*5210.00	85.2 AV			1.00 H	169	45.70	39.50
5	#10420.00	58.5 PK	74.0	-15.5	1.18 H	99	40.60	17.90
6	#10420.00	45.7 AV	54.0	-8.3	1.18 H	99	27.80	17.90

ANTENNA POLARITY & TEST DISTANCE: VERTICAL AT 3 M

NO.	FREQ. (MHz)	EMISSION LEVEL (dBuV/m)	LIMIT (dBuV/m)	MARGIN (dB)	ANTENNA HEIGHT (m)	TABLE ANGLE (Degree)	RAW VALUE (dBuV)	CORRECTION FACTOR (dB/m)
1	5150.00	72.5 PK	74.0	-1.5	1.00 V	269	66.50	6.00
2	5150.00	48.0 AV	54.0	-6.0	1.00 V	269	42.00	6.00
3	*5210.00	107.9 PK			2.14 V	303	68.40	39.50
4	*5210.00	94.8 AV			2.14 V	303	55.30	39.50
5	#10420.00	58.2 PK	74.0	-15.8	1.67 V	218	40.30	17.90
6	#10420.00	45.6 AV	54.0	-8.4	1.67 V	218	27.70	17.90

Remarks:

1. Emission Level(dBuV/m) = Raw Value(dBuV) + Correction Factor(dB/m)
2. Correction Factor(dB/m) = Antenna Factor(dB/m) + Cable Factor(dB)
– Pre-Amplifier Factor(dB)
3. The other emission levels were very low against the limit.
4. Margin value = Emission Level – Limit value
5. " * ": Fundamental frequency.
6. " # ": The radiated frequency is out of the restricted band.

CHANNEL	TX Channel 155	DETECTOR FUNCTION	Peak (PK)
FREQUENCY RANGE	1GHz ~ 40GHz		Average (AV)

ANTENNA POLARITY & TEST DISTANCE: HORIZONTAL AT 3 M

NO.	FREQ. (MHz)	EMISSION LEVEL (dBuV/m)	LIMIT (dBuV/m)	MARGIN (dB)	ANTENNA HEIGHT (m)	TABLE ANGLE (Degree)	RAW VALUE (dBuV)	CORRECTION FACTOR (dB/m)
1	#5714.90	58.8 PK	109.4	-50.6	1.08 H	242	51.40	7.40
2	#5722.90	63.2 PK	117.4	-54.2	1.20 H	222	55.80	7.40
3	#5725.00	47.5 PK	122.2	-74.7	1.28 H	215	40.10	7.40
4	*5775.00	95.6 PK			1.00 H	225	55.00	40.60
5	*5775.00	82.2 AV			1.00 H	225	41.60	40.60
6	#5850.00	49.9 PK	122.2	-72.3	1.43 H	280	42.30	7.60
7	#5853.00	63.8 PK	115.4	-51.6	1.50 H	243	56.10	7.70
8	#5860.10	55.6 PK	109.4	-53.8	1.44 H	290	47.90	7.70
9	11550.00	58.7 PK	74.0	-15.3	1.20 H	116	40.10	18.60
10	11550.00	46.3 AV	54.0	-7.7	1.20 H	116	27.70	18.60

ANTENNA POLARITY & TEST DISTANCE: VERTICAL AT 3 M

NO.	FREQ. (MHz)	EMISSION LEVEL (dBuV/m)	LIMIT (dBuV/m)	MARGIN (dB)	ANTENNA HEIGHT (m)	TABLE ANGLE (Degree)	RAW VALUE (dBuV)	CORRECTION FACTOR (dB/m)
1	#5714.90	72.3 PK	109.4	-37.1	1.30 V	169	64.90	7.40
2	#5722.90	72.2 PK	117.4	-45.2	1.35 V	178	64.80	7.40
3	#5725.00	50.4 PK	122.2	-71.8	1.37 V	193	43.00	7.40
4	*5775.00	107.2 PK			1.88 V	306	66.60	40.60
5	*5775.00	92.5 AV			1.88 V	306	51.90	40.60
6	#5850.00	52.8 PK	122.2	-69.4	1.46 V	180	45.20	7.60
7	#5853.00	64.6 PK	115.4	-50.8	1.46 V	180	56.90	7.70
8	#5860.10	64.9 PK	109.4	-44.5	1.70 V	300	57.20	7.70
9	11550.00	58.0 PK	74.0	-16.0	1.25 V	182	39.40	18.60
10	11550.00	45.3 AV	54.0	-8.7	1.25 V	182	26.70	18.60

Remarks:

- Emission Level(dBuV/m) = Raw Value(dBuV) + Correction Factor(dB/m)
- Correction Factor(dB/m) = Antenna Factor(dB/m) + Cable Factor(dB)
– Pre-Amplifier Factor(dB)
- The other emission levels were very low against the limit.
- Margin value = Emission Level – Limit value
- " * ": Fundamental frequency.
- " # ": The radiated frequency is out of the restricted band.

Below 1GHz Worst-Case Data: 802.11a

Mode A

CHANNEL	TX Channel 157	DETECTOR FUNCTION	Quasi-Peak (QP)
FREQUENCY RANGE	9kHz ~ 1GHz		

ANTENNA POLARITY & TEST DISTANCE: HORIZONTAL AT 3 M								
NO.	FREQ. (MHz)	EMISSION LEVEL (dBuV/m)	LIMIT (dBuV/m)	MARGIN (dB)	ANTENNA HEIGHT (m)	TABLE ANGLE (Degree)	RAW VALUE (dBuV)	CORRECTION FACTOR (dB/m)
1	57.12	31.1 QP	40.0	-8.9	2.00 H	78	45.70	-14.60
2	125.17	33.2 QP	43.5	-10.3	2.00 H	86	49.10	-15.90
3	247.66	32.5 QP	46.0	-13.5	1.00 H	130	46.80	-14.30
4	374.04	38.9 QP	46.0	-7.1	1.00 H	123	49.50	-10.60
5	533.47	33.7 QP	46.0	-12.3	1.50 H	298	41.20	-7.50
6	875.67	35.8 QP	46.0	-10.2	1.50 H	136	36.50	-0.70
ANTENNA POLARITY & TEST DISTANCE: VERTICAL AT 3 M								
NO.	FREQ. (MHz)	EMISSION LEVEL (dBuV/m)	LIMIT (dBuV/m)	MARGIN (dB)	ANTENNA HEIGHT (m)	TABLE ANGLE (Degree)	RAW VALUE (dBuV)	CORRECTION FACTOR (dB/m)
1	37.68	36.9 QP	40.0	-3.1	1.00 V	46	52.30	-15.40
2	45.45	36.5 QP	40.0	-3.5	1.49 V	15	51.30	-14.80
3	59.06	36.7 QP	40.0	-3.3	1.00 V	67	51.30	-14.60
4	374.04	39.4 QP	46.0	-6.6	1.99 V	4	50.00	-10.60
5	500.42	31.4 QP	46.0	-14.6	1.00 V	244	39.50	-8.10
6	875.67	37.2 QP	46.0	-8.8	1.49 V	11	37.90	-0.70

Remarks:

1. Emission Level(dBuV/m) = Raw Value(dBuV) + Correction Factor(dB/m)
2. Correction Factor(dB/m) = Antenna Factor(dB/m) + Cable Factor(dB) – Pre-Amplifier Factor(dB)
3. The other emission levels were very low against the limit.
4. Margin value = Emission Level – Limit value

Mode B

CHANNEL	TX Channel 157	DETECTOR FUNCTION	Quasi-Peak (QP)
FREQUENCY RANGE	9kHz ~ 1GHz		

ANTENNA POLARITY & TEST DISTANCE: HORIZONTAL AT 3 M

NO.	FREQ. (MHz)	EMISSION LEVEL (dBuV/m)	LIMIT (dBuV/m)	MARGIN (dB)	ANTENNA HEIGHT (m)	TABLE ANGLE (Degree)	RAW VALUE (dBuV)	CORRECTION FACTOR (dB/m)
1	57.12	30.9 QP	40.0	-9.1	2.00 H	154	45.50	-14.60
2	125.17	36.1 QP	43.5	-7.4	1.50 H	283	52.00	-15.90
3	247.66	35.6 QP	46.0	-10.4	1.00 H	131	49.90	-14.30
4	374.04	39.8 QP	46.0	-6.2	1.00 H	120	50.40	-10.60
5	533.47	38.3 QP	46.0	-7.7	1.50 H	345	45.80	-7.50
6	875.67	37.2 QP	46.0	-8.8	1.50 H	134	37.90	-0.70

ANTENNA POLARITY & TEST DISTANCE: VERTICAL AT 3 M

NO.	FREQ. (MHz)	EMISSION LEVEL (dBuV/m)	LIMIT (dBuV/m)	MARGIN (dB)	ANTENNA HEIGHT (m)	TABLE ANGLE (Degree)	RAW VALUE (dBuV)	CORRECTION FACTOR (dB/m)
1	30.90	36.6 QP	40.0	-3.4	1.49 V	251	52.50	-15.90
2	61.01	34.1 QP	40.0	-5.9	1.49 V	281	49.00	-14.90
3	125.17	33.1 QP	43.5	-10.4	1.00 V	25	49.00	-15.90
4	249.60	30.8 QP	46.0	-15.2	1.00 V	185	45.00	-14.20
5	374.04	38.6 QP	46.0	-7.4	1.49 V	319	49.20	-10.60
6	533.47	35.5 QP	46.0	-10.5	1.00 V	301	43.00	-7.50

Remarks:

1. Emission Level(dBuV/m) = Raw Value(dBuV) + Correction Factor(dB/m)
2. Correction Factor(dB/m) = Antenna Factor(dB/m) + Cable Factor(dB)
– Pre-Amplifier Factor(dB)
3. The other emission levels were very low against the limit.
4. Margin value = Emission Level – Limit value

Mode C

CHANNEL	TX Channel 157	DETECTOR FUNCTION	Quasi-Peak (QP)
FREQUENCY RANGE	9kHz ~ 1GHz		

ANTENNA POLARITY & TEST DISTANCE: HORIZONTAL AT 3 M

NO.	FREQ. (MHz)	EMISSION LEVEL (dBuV/m)	LIMIT (dBuV/m)	MARGIN (dB)	ANTENNA HEIGHT (m)	TABLE ANGLE (Degree)	RAW VALUE (dBuV)	CORRECTION FACTOR (dB/m)
1	57.12	31.1 QP	40.0	-8.9	1.99 H	39	45.70	-14.60
2	125.17	31.6 QP	43.5	-11.9	1.99 H	131	47.50	-15.90
3	255.44	42.9 QP	46.0	-3.1	1.99 H	95	57.00	-14.10
4	375.98	41.3 QP	46.0	-4.7	1.00 H	8	51.90	-10.60
5	624.85	35.6 QP	46.0	-10.4	1.49 H	144	40.70	-5.10
6	875.67	37.6 QP	46.0	-8.4	1.00 H	208	38.30	-0.70

ANTENNA POLARITY & TEST DISTANCE: VERTICAL AT 3 M

NO.	FREQ. (MHz)	EMISSION LEVEL (dBuV/m)	LIMIT (dBuV/m)	MARGIN (dB)	ANTENNA HEIGHT (m)	TABLE ANGLE (Degree)	RAW VALUE (dBuV)	CORRECTION FACTOR (dB/m)
1	53.23	37.3 QP	40.0	-2.7	1.00 V	331	51.50	-14.20
2	259.33	39.0 QP	46.0	-7.0	1.00 V	347	52.90	-13.90
3	375.98	39.4 QP	46.0	-6.6	1.50 V	300	50.00	-10.60
4	624.85	33.1 QP	46.0	-12.9	1.50 V	175	38.20	-5.10
5	875.67	35.4 QP	46.0	-10.6	1.00 V	98	36.10	-0.70
6	1000.00	35.3 QP	54.0	-18.7	1.00 V	115	34.30	1.00

Remarks:

- Emission Level(dBuV/m) = Raw Value(dBuV) + Correction Factor(dB/m)
- Correction Factor(dB/m) = Antenna Factor(dB/m) + Cable Factor(dB)
– Pre-Amplifier Factor(dB)
- The other emission levels were very low against the limit.
- Margin value = Emission Level – Limit value

Mode D

CHANNEL	TX Channel 157	DETECTOR FUNCTION	Quasi-Peak (QP)
FREQUENCY RANGE	9kHz ~ 1GHz		

ANTENNA POLARITY & TEST DISTANCE: HORIZONTAL AT 3 M

NO.	FREQ. (MHz)	EMISSION LEVEL (dBuV/m)	LIMIT (dBuV/m)	MARGIN (dB)	ANTENNA HEIGHT (m)	TABLE ANGLE (Degree)	RAW VALUE (dBuV)	CORRECTION FACTOR (dB/m)
1	57.12	31.0 QP	40.0	-9.0	1.99 H	18	45.60	-14.60
2	249.60	36.9 QP	46.0	-9.1	1.00 H	117	51.10	-14.20
3	375.98	40.5 QP	46.0	-5.5	1.00 H	239	51.10	-10.60
4	533.47	37.2 QP	46.0	-8.8	1.49 H	105	44.70	-7.50
5	624.85	36.3 QP	46.0	-9.7	1.49 H	135	41.40	-5.10
6	875.67	36.8 QP	46.0	-9.2	1.00 H	235	37.50	-0.70

ANTENNA POLARITY & TEST DISTANCE: VERTICAL AT 3 M

NO.	FREQ. (MHz)	EMISSION LEVEL (dBuV/m)	LIMIT (dBuV/m)	MARGIN (dB)	ANTENNA HEIGHT (m)	TABLE ANGLE (Degree)	RAW VALUE (dBuV)	CORRECTION FACTOR (dB/m)
1	39.62	37.0 QP	40.0	-3.0	1.00 V	2	52.30	-15.30
2	49.14	36.7 QP	40.0	-3.3	1.00 V	333	51.20	-14.50
3	257.38	40.9 QP	46.0	-5.1	1.49 V	179	54.90	-14.00
4	375.98	39.0 QP	46.0	-7.0	1.49 V	299	49.60	-10.60
5	556.80	38.6 QP	46.0	-7.4	1.00 V	229	45.70	-7.10
6	737.62	40.1 QP	46.0	-5.9	1.00 V	281	43.10	-3.00

Remarks:

1. Emission Level(dBuV/m) = Raw Value(dBuV) + Correction Factor(dB/m)
2. Correction Factor(dB/m) = Antenna Factor(dB/m) + Cable Factor(dB)
– Pre-Amplifier Factor(dB)
3. The other emission levels were very low against the limit.
4. Margin value = Emission Level – Limit value

4.2 Conducted Emission Measurement

4.2.1 Limits of Conducted Emission Measurement

Frequency (MHz)	Conducted Limit (dBuV)	
	Quasi-peak	Average
0.15 - 0.5	66 - 56	56 - 46
0.50 - 5.0	56	46
5.0 - 30.0	60	50

Note: 1. The lower limit shall apply at the transition frequencies.

2. The limit decreases in line with the logarithm of the frequency in the range of 0.15 to 0.50MHz.

4.2.2 Test Instruments

Tested date: Mar. 09, 2016

Description & Manufacturer	Model No.	Serial No.	Cal. Date	Cal. Due
Test Receiver ROHDE & SCHWARZ	ESCS30	100289	Dec. 23, 2015	Dec. 22, 2016
RF signal cable (with 10dB PAD) Woken	5D-FB	Cable-cond2-01	Dec. 26, 2015	Dec. 25, 2016
LISN ROHDE & SCHWARZ (EUT)	ESH2-Z5	100100	Jan. 11, 2016	Jan. 10, 2017
LISN ROHDE & SCHWARZ (Peripheral)	ESH3-Z5	100312	Jul. 21, 2015	Jul. 20, 2016
Software ADT	BV ADT_Cond_ V7.3.7.3	NA	NA	NA

Note: 1. The calibration interval of the above test instruments is 12 months and the calibrations are traceable to NML/ROC and NIST/USA.

2. The test was performed in HwaYa Shielded Room 2.

3. The VCCI Site Registration No. is C-2047.

4.2.3 Test Procedure

- The EUT was placed 0.4 meters from the conducting wall of the shielded room with EUT being connected to the power mains through a line impedance stabilization network (LISN). Other support units were connected to the power mains through another LISN. The two LISNs provide 50 ohm/ 50uH of coupling impedance for the measuring instrument.
- Both lines of the power mains connected to the EUT were checked for maximum conducted interference.
- The frequency range from 150kHz to 30MHz was searched. Emission levels under (Limit - 20dB) was not recorded.

NOTE: The resolution bandwidth and video bandwidth of test receiver is 9kHz for quasi-peak detection (QP) and average detection (AV) at frequency 0.15MHz-30MHz.

4.2.4 Deviation from Test Standard

No deviation.

4.2.5 Test Setup

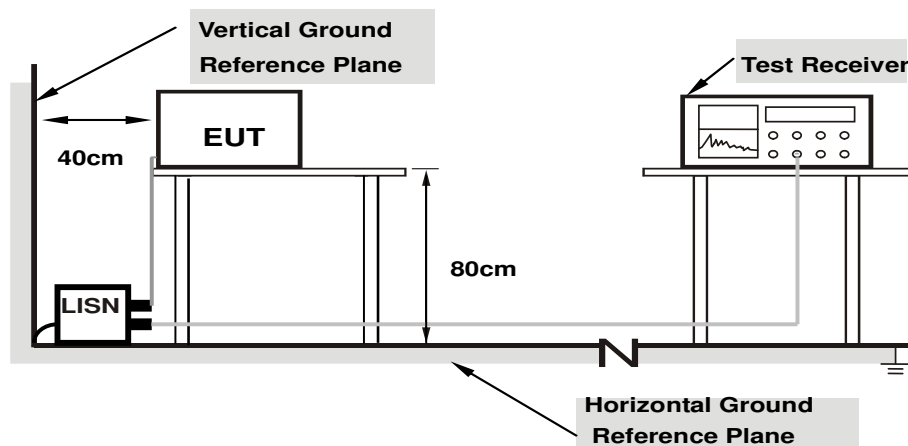

- Note:**
- Support units were connected to second LISN.
 - Both of LISNs (AMN) are 80 cm from EUT and at least 80 from other units and other metal planes

For the actual test configuration, please refer to the attached file (Test Setup Photo).

4.2.6 EUT Operating Conditions

Same as 4.1.6.

4.2.7 Test Results

Worst-Case Data: 802.11a

Phase	Line (L)	Detector Function	Quasi-Peak (QP) / Average (AV)
Test Mode	A		

No	Freq. [MHz]	Corr. Factor (dB)	Reading Value [dB (uV)]		Emission Level [dB (uV)]		Limit [dB (uV)]		Margin (dB)	
			Q.P.	AV.	Q.P.	AV.	Q.P.	AV.	Q.P.	AV.
			1	0.15000	9.77	33.54	19.15	43.31	28.92	66.00
2	0.16953	9.76	29.79	15.66	39.55	25.42	64.98	54.98	-25.43	-29.56
3	0.20859	9.75	24.25	19.27	34.00	29.02	63.26	53.26	-29.26	-24.24
4	0.49375	9.75	18.03	14.90	27.78	24.65	56.10	46.10	-28.33	-21.46
5	0.90000	9.78	13.24	10.35	23.02	20.13	56.00	46.00	-32.98	-25.87
6	3.40625	9.82	14.25	10.24	24.07	20.06	56.00	46.00	-31.93	-25.94

Remarks:

1. Q.P. and AV. are abbreviations of quasi-peak and average individually.
2. The emission levels of other frequencies were very low against the limit.
3. Margin value = Emission level - Limit value
4. Correction factor = Insertion loss + Cable loss
5. Emission Level = Correction Factor + Reading Value.

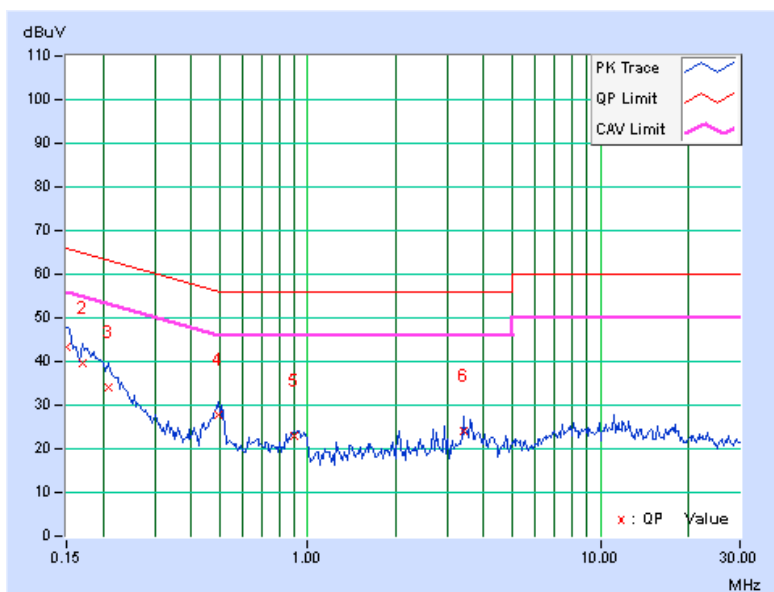

Phase	Neutral (N)	Detector Function	Quasi-Peak (QP) / Average (AV)
Test Mode	A		

No	Freq. [MHz]	Corr. Factor (dB)	Reading Value [dB (uV)]		Emission Level [dB (uV)]		Limit [dB (uV)]		Margin (dB)	
			Q.P.	AV.	Q.P.	AV.	Q.P.	AV.	Q.P.	AV.
			1	0.15000	9.85	33.62	20.52	43.47	30.37	66.00
2	0.18125	9.82	28.75	17.12	38.57	26.94	64.43	54.43	-25.86	-27.49
3	0.22812	9.81	21.86	9.53	31.67	19.34	62.52	52.52	-30.85	-33.18
4	0.34141	9.86	15.60	6.83	25.46	16.69	59.17	49.17	-33.71	-32.48
5	0.48984	9.88	23.51	18.78	33.39	28.66	56.17	46.17	-22.78	-17.51
6	3.64063	9.99	12.83	1.83	22.82	11.82	56.00	46.00	-33.18	-34.18

Remarks:

1. Q.P. and AV. are abbreviations of quasi-peak and average individually.
2. The emission levels of other frequencies were very low against the limit.
3. Margin value = Emission level - Limit value
4. Correction factor = Insertion loss + Cable loss
5. Emission Level = Correction Factor + Reading Value.

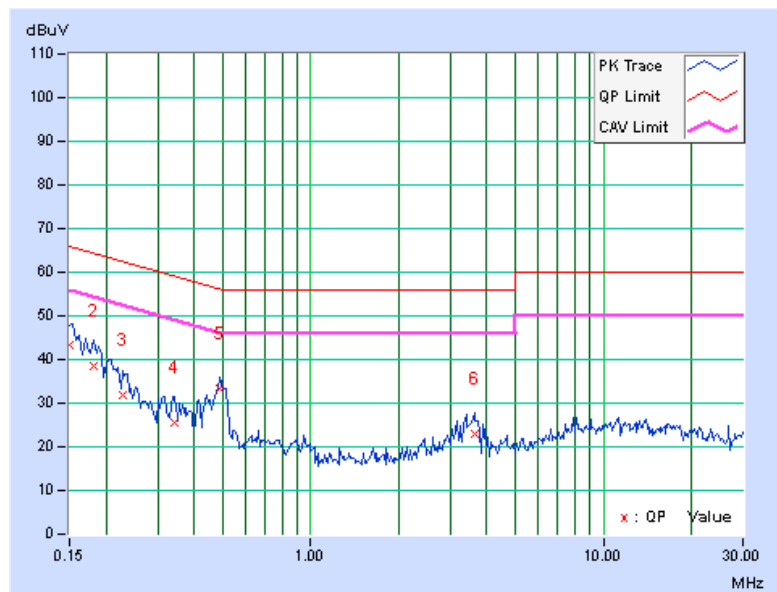

Phase	Line (L)	Detector Function	Quasi-Peak (QP) / Average (AV)
Test Mode	B		

No	Freq. [MHz]	Corr. Factor (dB)	Reading Value [dB (uV)]		Emission Level [dB (uV)]		Limit [dB (uV)]		Margin (dB)	
			Q.P.	AV.	Q.P.	AV.	Q.P.	AV.	Q.P.	AV.
			1	0.15000	9.77	43.78	29.67	53.55	39.44	66.00
2	0.19297	9.75	35.68	21.19	45.43	30.94	63.91	53.91	-18.48	-22.97
3	0.25156	9.75	29.11	18.97	38.86	28.72	61.71	51.71	-22.85	-22.99
4	0.53672	9.75	34.21	30.05	43.96	39.80	56.00	46.00	-12.04	-6.20
5	3.57813	9.82	22.65	17.97	32.47	27.79	56.00	46.00	-23.53	-18.21
6	11.41797	9.94	29.37	25.06	39.31	35.00	60.00	50.00	-20.69	-15.00

Remarks:

1. Q.P. and AV. are abbreviations of quasi-peak and average individually.
2. The emission levels of other frequencies were very low against the limit.
3. Margin value = Emission level - Limit value
4. Correction factor = Insertion loss + Cable loss
5. Emission Level = Correction Factor + Reading Value.

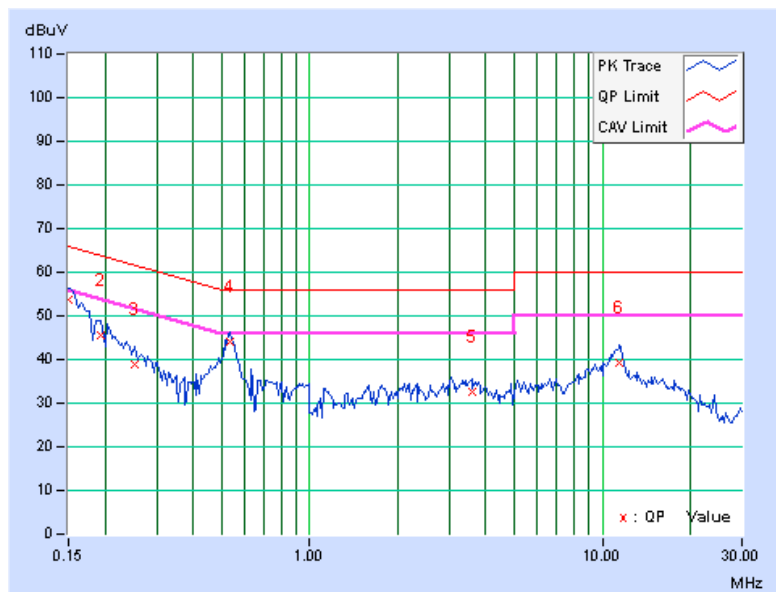

Phase	Neutral (N)	Detector Function	Quasi-Peak (QP) / Average (AV)
Test Mode	B		

No	Freq. [MHz]	Corr. Factor (dB)	Reading Value [dB (uV)]		Emission Level [dB (uV)]		Limit [dB (uV)]		Margin (dB)	
			Q.P.	AV.	Q.P.	AV.	Q.P.	AV.	Q.P.	AV.
			1	0.15391	9.84	42.99	28.45	52.83	38.29	65.79
2	0.18125	9.82	37.51	22.74	47.33	32.56	64.43	54.43	-17.10	-21.87
3	0.23594	9.82	29.25	16.41	39.07	26.23	62.24	52.24	-23.17	-26.01
4	0.53672	9.88	34.49	30.40	44.37	40.28	56.00	46.00	-11.63	-5.72
5	3.92969	10.01	14.85	9.03	24.86	19.04	56.00	46.00	-31.14	-26.96
6	11.25391	10.02	27.43	22.73	37.45	32.75	60.00	50.00	-22.55	-17.25

Remarks:

1. Q.P. and AV. are abbreviations of quasi-peak and average individually.
2. The emission levels of other frequencies were very low against the limit.
3. Margin value = Emission level - Limit value
4. Correction factor = Insertion loss + Cable loss
5. Emission Level = Correction Factor + Reading Value.

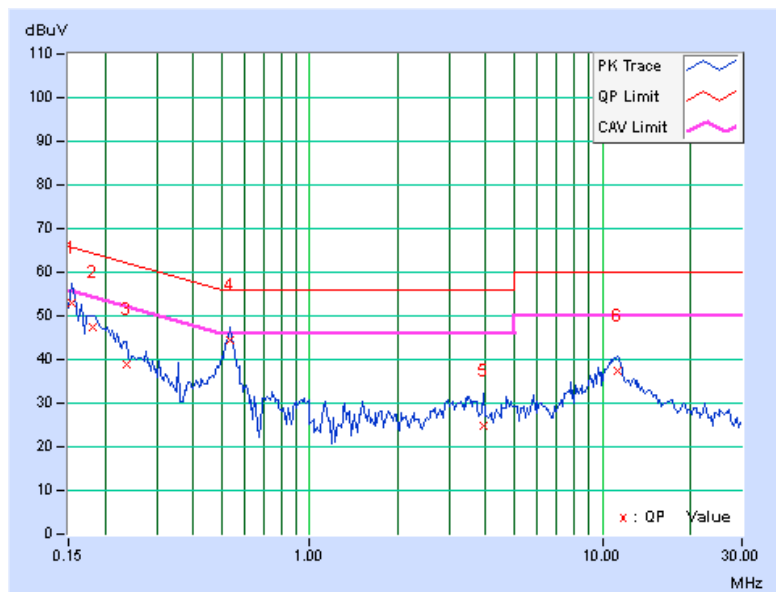

Phase	Line (L)	Detector Function	Quasi-Peak (QP) / Average (AV)
Test Mode	C		

No	Freq. [MHz]	Corr. Factor (dB)	Reading Value [dB (uV)]		Emission Level [dB (uV)]		Limit [dB (uV)]		Margin (dB)	
			Q.P.	AV.	Q.P.	AV.	Q.P.	AV.	Q.P.	AV.
			1	0.15000	9.77	34.62	19.58	44.39	29.35	66.00
2	0.16562	9.76	32.16	18.22	41.92	27.98	65.18	55.18	-23.26	-27.20
3	0.49375	9.75	27.18	25.64	36.93	35.39	56.10	46.10	-19.18	-10.72
4	0.70859	9.77	14.10	8.51	23.87	18.28	56.00	46.00	-32.13	-27.72
5	0.93906	9.78	15.15	11.81	24.93	21.59	56.00	46.00	-31.07	-24.41
6	7.01953	9.88	15.87	10.58	25.75	20.46	60.00	50.00	-34.25	-29.54

Remarks:

1. Q.P. and AV. are abbreviations of quasi-peak and average individually.
2. The emission levels of other frequencies were very low against the limit.
3. Margin value = Emission level - Limit value
4. Correction factor = Insertion loss + Cable loss
5. Emission Level = Correction Factor + Reading Value.

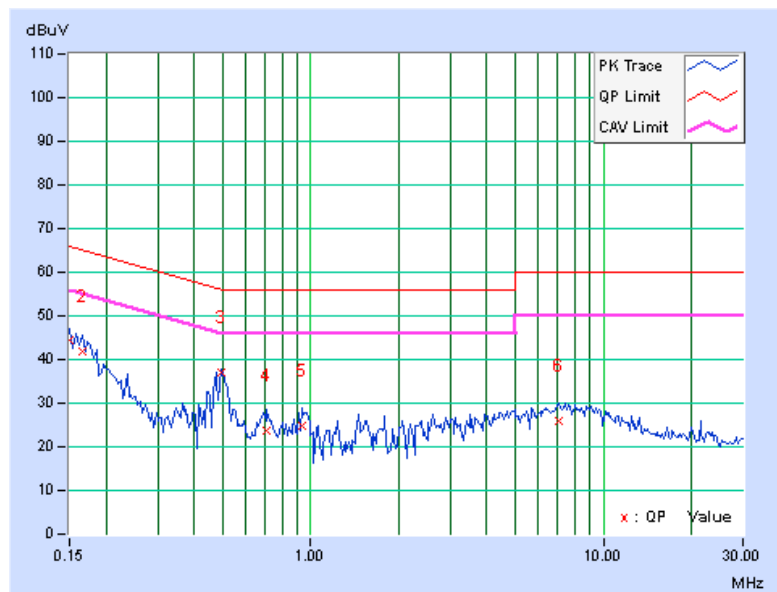

Phase	Neutral (N)	Detector Function	Quasi-Peak (QP) / Average (AV)
Test Mode	C		

No	Freq. [MHz]	Corr. Factor (dB)	Reading Value [dB (uV)]		Emission Level [dB (uV)]		Limit [dB (uV)]		Margin (dB)	
			Q.P.	AV.	Q.P.	AV.	Q.P.	AV.	Q.P.	AV.
			1	0.15781	9.84	32.61	19.07	42.45	28.91	65.58
2	0.20078	9.80	27.10	14.93	36.90	24.73	63.58	53.58	-26.68	-28.85
3	0.28281	9.84	16.19	4.77	26.03	14.61	60.73	50.73	-34.71	-36.13
4	0.49375	9.88	28.79	27.53	38.67	37.41	56.10	46.10	-17.43	-8.69
5	0.70469	9.86	10.50	6.38	20.36	16.24	56.00	46.00	-35.64	-29.76
6	8.19922	10.01	15.65	10.08	25.66	20.09	60.00	50.00	-34.34	-29.91

Remarks:

1. Q.P. and AV. are abbreviations of quasi-peak and average individually.
2. The emission levels of other frequencies were very low against the limit.
3. Margin value = Emission level - Limit value
4. Correction factor = Insertion loss + Cable loss
5. Emission Level = Correction Factor + Reading Value.

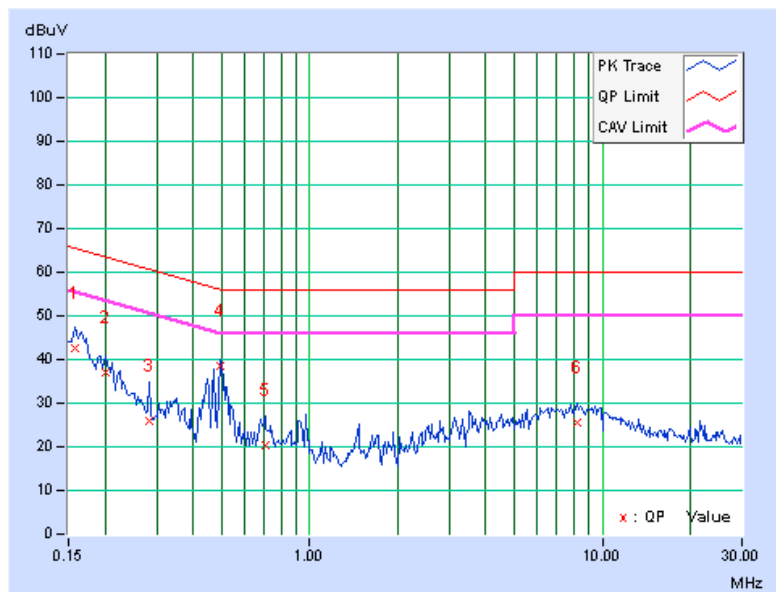

Phase	Line (L)	Detector Function	Quasi-Peak (QP) / Average (AV)
Test Mode	D		

No	Freq. [MHz]	Corr. Factor (dB)	Reading Value [dB (uV)]		Emission Level [dB (uV)]		Limit [dB (uV)]		Margin (dB)	
			Q.P.	AV.	Q.P.	AV.	Q.P.	AV.	Q.P.	AV.
			1	0.15000	9.77	44.68	30.61	54.45	40.38	66.00
2	0.25156	9.75	29.52	20.47	39.27	30.22	61.71	51.71	-22.44	-21.49
3	0.53300	9.75	36.35	32.11	46.10	41.86	56.00	46.00	-9.90	-4.14
4	0.79063	9.77	20.24	14.32	30.01	24.09	56.00	46.00	-25.99	-21.91
5	6.98828	9.88	22.59	17.77	32.47	27.65	60.00	50.00	-27.53	-22.35
6	10.80078	9.94	28.69	24.13	38.63	34.07	60.00	50.00	-21.37	-15.93

Remarks:

1. Q.P. and AV. are abbreviations of quasi-peak and average individually.
2. The emission levels of other frequencies were very low against the limit.
3. Margin value = Emission level - Limit value
4. Correction factor = Insertion loss + Cable loss
5. Emission Level = Correction Factor + Reading Value.

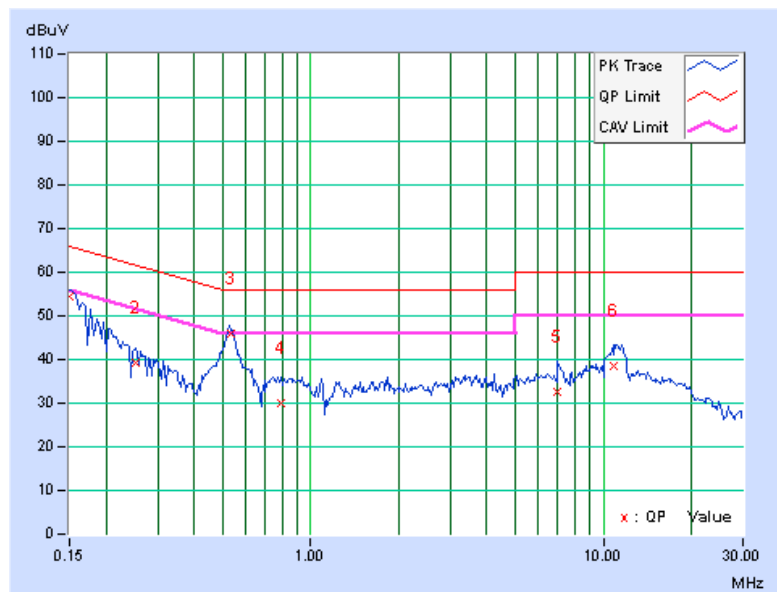

Phase	Neutral (N)	Detector Function	Quasi-Peak (QP) / Average (AV)
Test Mode	D		

No	Freq. [MHz]	Corr. Factor (dB)	Reading Value [dB (uV)]		Emission Level [dB (uV)]		Limit [dB (uV)]		Margin (dB)	
			Q.P.	AV.	Q.P.	AV.	Q.P.	AV.	Q.P.	AV.
			1	0.15000	9.85	44.11	29.97	53.96	39.82	66.00
2	0.18125	9.82	38.00	23.54	47.82	33.36	64.43	54.43	-16.61	-21.07
3	0.22031	9.81	31.70	17.31	41.51	27.12	62.81	52.81	-21.30	-25.69
4	0.25938	9.83	27.26	16.41	37.09	26.24	61.45	51.45	-24.36	-25.21
5	0.53281	9.88	36.20	31.93	46.08	41.81	56.00	46.00	-9.92	-4.19
6	11.10547	10.02	27.48	22.66	37.50	32.68	60.00	50.00	-22.50	-17.32

Remarks:

1. Q.P. and AV. are abbreviations of quasi-peak and average individually.
2. The emission levels of other frequencies were very low against the limit.
3. Margin value = Emission level - Limit value
4. Correction factor = Insertion loss + Cable loss
5. Emission Level = Correction Factor + Reading Value.

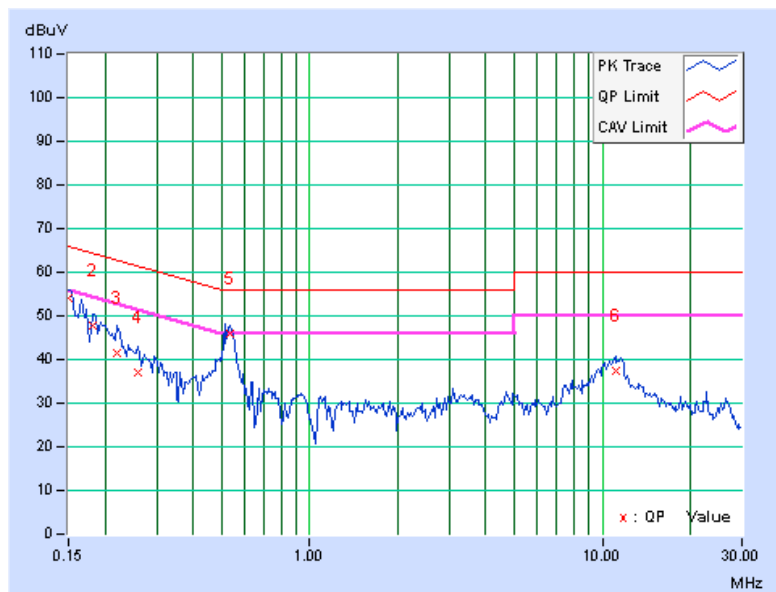

4.3 Transmit Power Measurement

4.3.1 Limits of Transmit Power Measurement

Operation Band	EUT Category		LIMIT
U-NII-1		Outdoor Access Point	1 Watt (30 dBm) (Max. e.i.r.p \leq 125mW (21 dBm) at any elevation angle above 30 degrees as measured from the horizon)
		Fixed point-to-point Access Point	1 Watt (30 dBm)
	√	Indoor Access Point	1 Watt (30 dBm)
		Mobile and Portable client device	250mW (24 dBm)
U-NII-2A	---		250mW (24 dBm) or 11 dBm+10 log B*
U-NII-2C	---		250mW (24 dBm) or 11 dBm+10 log B*
U-NII-3	√		1 Watt (30 dBm)

*B is the 26 dB emission bandwidth in megahertz

Per KDB 662911 Method of conducted output power measurement on IEEE 802.11 devices,

Array Gain = 0 dB (i.e., no array gain) for $N_{ANT} \leq 4$;

Array Gain = 0 dB (i.e., no array gain) for channel widths ≥ 40 MHz for any N_{ANT} ;

Array Gain = $5 \log(N_{ANT}/N_{SS})$ dB or 3 dB, whichever is less for 20-MHz channel widths with $N_{ANT} \geq 5$.

For power measurements on all other devices: Array Gain = $10 \log(N_{ANT}/N_{SS})$ dB.

4.3.2 Test Setup

For Power Output Measurement

802.11a, 802.11ac (VHT20), 802.11ac (VHT40)

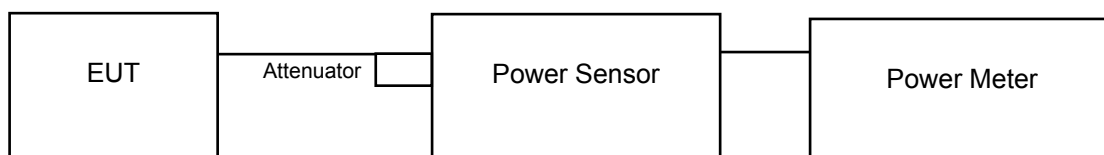

802.11ac (VHT80)

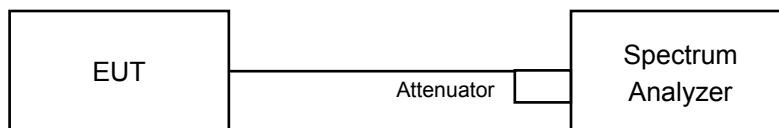

For 26dB and Occupied Bandwidth

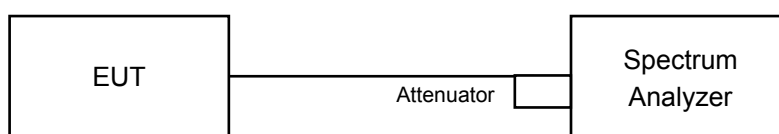

4.3.3 Test Instruments

Refer to section 4.1.2 to get information of above instrument.

4.3.4 Test Procedure

For Average Power Measurement

802.11a, 802.11ac (VHT20), 802.11ac (VHT40)

Method PM is used to perform output power measurement, trigger and gating function of wide band power meter is enabled to measure max output power of TX on burst. Duty factor is not added to measured value.

802.11ac (VHT80)

- a. Set span to encompass the entire 26 dB EBW (or, alternatively, the entire 99% occupied bandwidth) of the signal.
- b. Set sweep trigger to "free run".
- c. Set RBW = 1 MHz
- d. Set VBW \geq 3 MHz
- e. Number of points in sweep \geq 2 Span / RBW
- f. Sweep time \leq (number of points in sweep) * T
- g. Using emission bandwidth to determine the frequency span for integration the channel bandwidth.
- h. Detector = RMS
- i. Trace mode = max hold
- j. Allow max hold to run for at least 60 seconds, or longer as needed to allow the trace to stabilize.

For Occupied Bandwidth

The transmitter output was connected to the spectrum analyzer through an attenuator. The bandwidth of the fundamental frequency was measured by spectrum analyzer with resolution bandwidth in the range of 1% to 5% of the anticipated emission bandwidth, and a video bandwidth at least 3x the resolution bandwidth and set the detector to Sampling. The width of a frequency band such that, below the lower and above the upper frequency limits, the mean powers emitted are each equal to a specified percentage 0.5 % of the total mean power of a given emission.

4.3.5 Deviation from Test Standard

No deviation.

4.3.6 EUT Operating Conditions

The software provided by client to enable the EUT under transmission Condition continuously at lowest, middle and highest channel frequencies individually.

4.3.7 Test Result

Average Power:

CDD Mode

802.11a

Channel	Freq. (MHz)	Maximum Conducted Power (dBm)				Total Power (mW)	Total Power (dBm)	Limit (dBm)	Pass / Fail
		Chain 0	Chain 1	Chain 2	Chain 3				
36	5180	17.65	18.46	18.35	18.29	264.200	24.22	30.00	Pass
40	5200	17.84	18.47	18.45	18.37	269.812	24.31	30.00	Pass
48	5240	17.95	18.70	18.54	18.61	280.565	24.48	30.00	Pass
149	5745	17.46	18.24	17.76	17.70	240.988	23.82	30.00	Pass
157	5785	19.83	20.28	19.80	19.70	391.645	25.93	30.00	Pass
165	5825	19.30	20.06	19.24	18.95	348.975	25.43	30.00	Pass

802.11ac (VHT20)

Channel	Freq. (MHz)	Maximum Conducted Power (dBm)				Total Power (mW)	Total Power (dBm)	Limit (dBm)	Pass / Fail
		Chain 0	Chain 1	Chain 2	Chain 3				
36	5180	18.22	18.74	18.71	18.65	288.775	24.61	30.00	Pass
40	5200	17.65	18.36	18.32	18.31	262.443	24.19	30.00	Pass
48	5240	17.83	18.51	18.41	18.48	271.444	24.34	30.00	Pass
149	5745	17.33	17.99	17.54	17.52	230.274	23.62	30.00	Pass
157	5785	19.49	19.98	19.72	19.49	371.137	25.70	30.00	Pass
165	5825	19.03	19.64	19.19	18.80	330.871	25.20	30.00	Pass

802.11ac (VHT40)

Channel	Freq. (MHz)	Maximum Conducted Power (dBm)				Total Power (mW)	Total Power (dBm)	Limit (dBm)	Pass / Fail
		Chain 0	Chain 1	Chain 2	Chain 3				
38	5190	14.80	15.30	15.08	14.95	127.556	21.06	30.00	Pass
46	5230	18.47	18.96	18.64	18.67	295.747	24.71	30.00	Pass
151	5755	13.92	14.46	14.01	13.81	101.806	20.08	30.00	Pass
159	5795	17.38	17.89	17.41	17.45	226.891	23.56	30.00	Pass

802.11ac (VHT80)

Channel	Freq. (MHz)	Maximum Conducted Power (dBm)				Total Power (mW)	Total Power (dBm)	Limit (dBm)	Pass / Fail
		Chain 0	Chain 1	Chain 2	Chain 3				
42	5210	10.27	10.97	10.54	10.35	45.307	16.56	30.00	Pass
155	5775	9.01	9.43	9.12	9.14	33.102	15.20	30.00	Pass

Beamforming Mode

802.11ac (VHT20)

Channel	Freq. (MHz)	Maximum Conducted Power (dBm)				Total Power (mW)	Total Power (dBm)	Limit (dBm)	Pass / Fail
		Chain 0	Chain 1	Chain 2	Chain 3				
36	5180	9.77	10.80	10.10	9.96	41.648	16.20	24.14	Pass
40	5200	15.92	15.95	16.11	16.20	160.958	22.07	24.14	Pass
48	5240	16.08	16.03	16.25	16.19	164.399	22.16	24.14	Pass
149	5745	9.54	9.61	9.84	9.67	37.042	15.69	24.14	Pass
157	5785	15.76	16.19	16.12	16.04	160.366	22.05	24.14	Pass
165	5825	15.92	16.36	16.01	15.90	161.142	22.07	24.14	Pass

Note: Internal antenna Directional gain = $5.84\text{dBi} + 10\log(4) = 11.86\text{dBi}$ (which is the highest value to calculation) $> 6\text{dBi}$, so the limit shall be reduced to $30 - (11.86 - 6) = 24.14\text{dBm}$.

External antenna Directional gain = $3.18\text{dBi} + 10\log(4) = 9.20\text{dBi}$

802.11ac (VHT40)

Channel	Freq. (MHz)	Maximum Conducted Power (dBm)				Total Power (mW)	Total Power (dBm)	Limit (dBm)	Pass / Fail
		Chain 0	Chain 1	Chain 2	Chain 3				
38	5190	8.79	8.72	8.74	8.61	29.758	14.74	24.14	Pass
46	5230	17.02	16.87	17.17	17.04	201.692	23.05	24.14	Pass
151	5755	7.81	7.61	7.80	7.57	23.548	13.72	24.14	Pass
159	5795	16.71	17.18	16.95	16.78	196.309	22.93	24.14	Pass

Note: Internal antenna Directional gain = $5.84\text{dBi} + 10\log(4) = 11.86\text{dBi}$ (which is the highest value to calculation) $> 6\text{dBi}$, so the power limit shall be reduced to $30 - (11.86 - 6) = 24.14\text{dBm}$.

External antenna Directional gain = $3.18\text{dBi} + 10\log(4) = 9.20\text{dBi}$

802.11ac (VHT80)

Channel	Freq. (MHz)	Maximum Conducted Power (dBm)				Total Power (mW)	Total Power (dBm)	Limit (dBm)	Pass / Fail
		Chain 0	Chain 1	Chain 2	Chain 3				
42	5210	6.52	6.71	6.79	6.24	18.157	12.59	24.14	Pass
155	5775	6.38	6.67	6.62	6.45	17.998	12.55	24.14	Pass

Note: Internal antenna Directional gain = $5.84\text{dBi} + 10\log(4) = 11.86\text{dBi}$ (which is the highest value to calculation) $> 6\text{dBi}$, so the power limit shall be reduced to $30 - (11.86 - 6) = 24.14\text{dBm}$.

External antenna Directional gain = $3.18\text{dBi} + 10\log(4) = 9.20\text{dBi}$

26dB Bandwidth:

CDD Mode

802.11a

Channel	Frequency (MHz)	26dBc Bandwidth (MHz)				Pass / Fail
		Chain 0	Chain 1	Chain 2	Chain 3	
36	5180	32.48	24.09	28.13	21.89	Pass
40	5200	32.48	26.41	28.19	21.59	Pass
48	5240	30.16	23.79	24.39	21.41	Pass

802.11ac (VHT20)

Channel	Frequency (MHz)	26dBc Bandwidth (MHz)				Pass / Fail
		Chain 0	Chain 1	Chain 2	Chain 3	
36	5180	32.30	26.56	29.27	22.82	Pass
40	5200	31.14	26.36	26.63	22.75	Pass
48	5240	28.13	26.24	26.63	22.37	Pass

802.11ac (VHT40)

Channel	Frequency (MHz)	26dBc Bandwidth (MHz)				Pass / Fail
		Chain 0	Chain 1	Chain 2	Chain 3	
38	5190	41.02	40.80	40.96	40.69	Pass
46	5230	71.07	63.17	65.81	53.40	Pass

802.11ac (VHT80)

Channel	Frequency (MHz)	26dBc Bandwidth (MHz)				Pass / Fail
		Chain 0	Chain 1	Chain 2	Chain 3	
42	5210	84.75	85.12	84.63	85.93	Pass

Spectrum Plot of Worst Value

802.11a

802.11ac (VHT20)

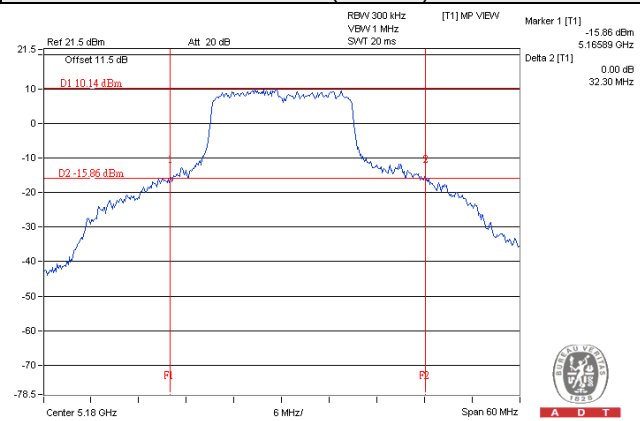
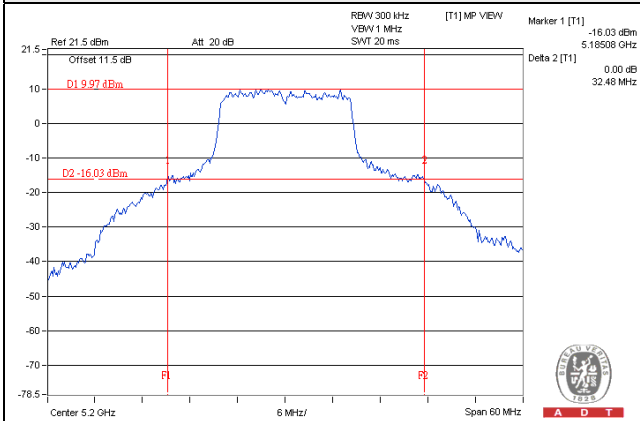

802.11ac (VHT40)

802.11ac (VHT80)

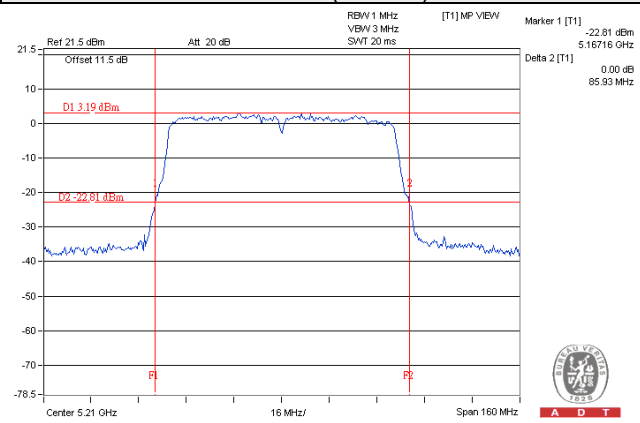
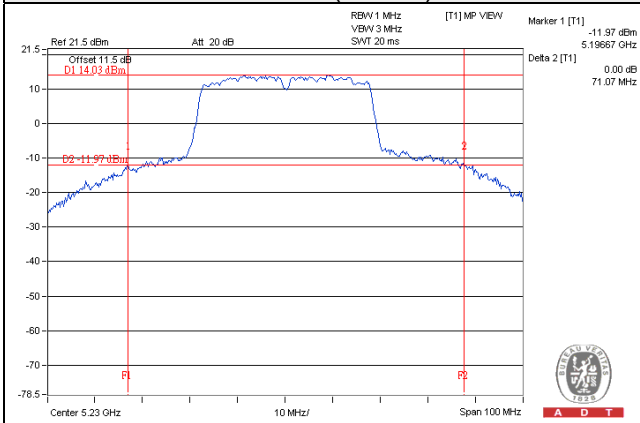

Beamforming Mode

802.11ac (VHT20)

Channel	Frequency (MHz)	26dBc Bandwidth (MHz)				Pass / Fail
		Chain 0	Chain 1	Chain 2	Chain 3	
36	5180	20.81	20.77	20.78	20.62	Pass
40	5200	22.30	21.62	21.82	21.21	Pass
48	5240	22.35	21.85	21.90	21.18	Pass

802.11ac (VHT40)

Channel	Frequency (MHz)	26dBc Bandwidth (MHz)				Pass / Fail
		Chain 0	Chain 1	Chain 2	Chain 3	
38	5190	40.56	40.63	40.50	40.32	Pass
46	5230	41.99	40.93	41.26	40.78	Pass

802.11ac (VHT80)

Channel	Frequency (MHz)	26dBc Bandwidth (MHz)				Pass / Fail
		Chain 0	Chain 1	Chain 2	Chain 3	
42	5210	84.85	85.10	85.06	86.11	Pass

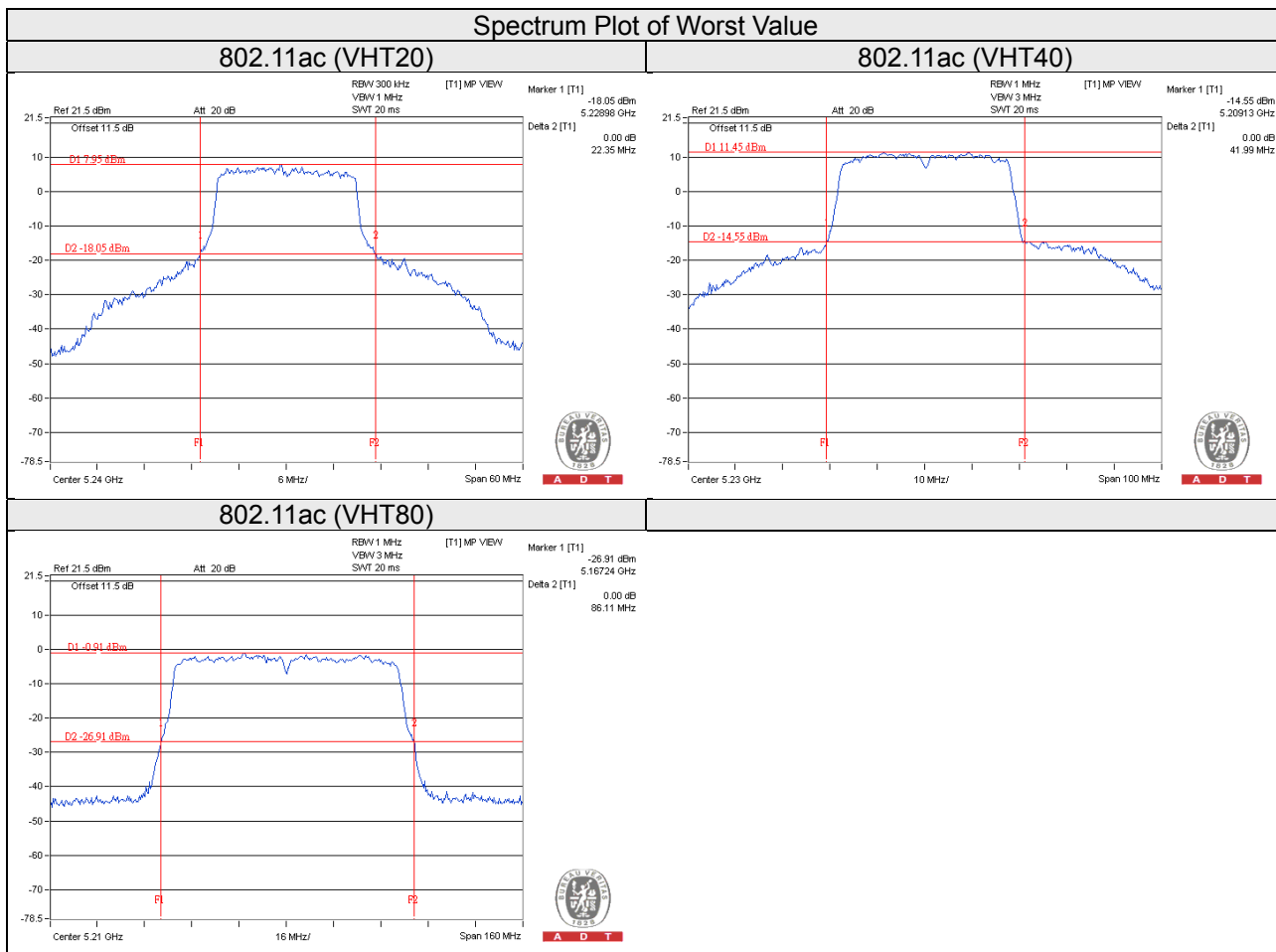

Occupied Bandwidth:

CDD Mode

802.11a

Channel	Frequency (MHz)	Occupied Bandwidth (MHz)			
		Chain 0	Chain 1	Chain 2	Chain 3
36	5180	17.16	16.68	16.68	16.56
40	5200	17.04	17.76	16.68	16.56
48	5240	16.92	16.68	16.68	16.56
149	5745	16.96	17.13	17.22	16.70
157	5785	20.04	21.96	21.00	19.08
165	5825	18.48	19.44	18.84	17.52

802.11ac (VHT20)

Channel	Frequency (MHz)	Occupied Bandwidth (MHz)			
		Chain 0	Chain 1	Chain 2	Chain 3
36	5180	18.36	17.88	17.88	17.76
40	5200	18.12	17.88	17.88	17.76
48	5240	18.00	17.76	17.88	17.76
149	5745	18.00	18.12	18.12	17.88
157	5785	20.76	22.20	21.72	20.16
165	5825	18.96	19.92	19.08	18.24

802.11ac (VHT40)

Channel	Frequency (MHz)	Occupied Bandwidth (MHz)			
		Chain 0	Chain 1	Chain 2	Chain 3
38	5190	36.00	36.12	36.12	36.12
46	5230	36.48	36.36	36.36	36.36
151	5755	36.12	36.09	36.12	36.00
159	5795	36.12	36.12	36.24	36.12

802.11ac (VHT80)

Channel	Frequency (MHz)	Occupied Bandwidth (MHz)			
		Chain 0	Chain 1	Chain 2	Chain 3
42	5210	75.88	75.88	75.60	75.88
155	5775	75.88	75.88	76.16	75.88

Spectrum Plot of Worst Value

802.11a

802.11ac (VHT20)

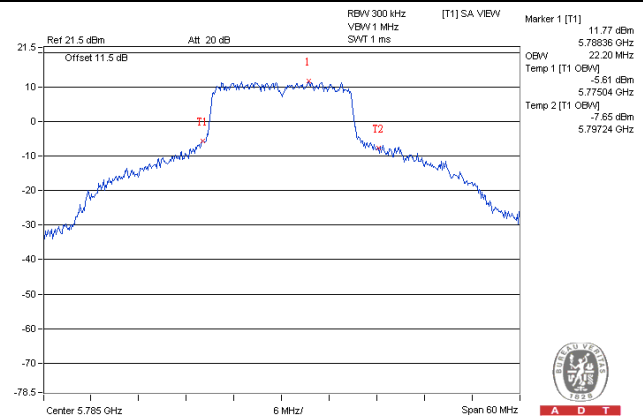
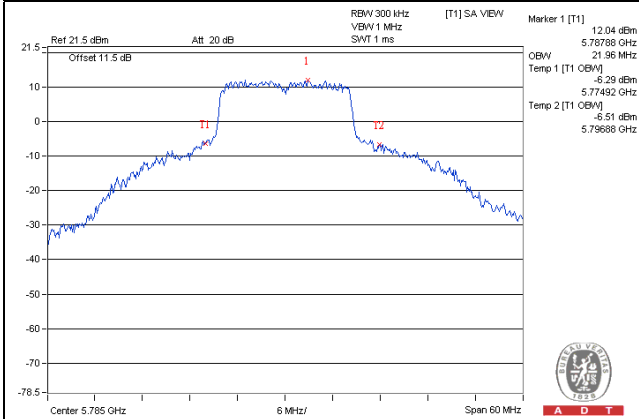

802.11ac (VHT40)

802.11ac (VHT80)

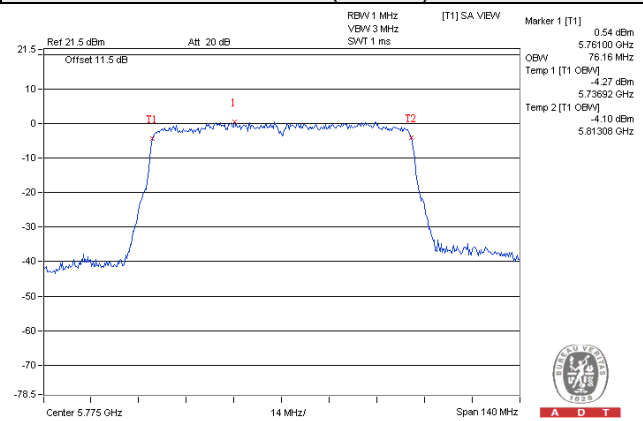
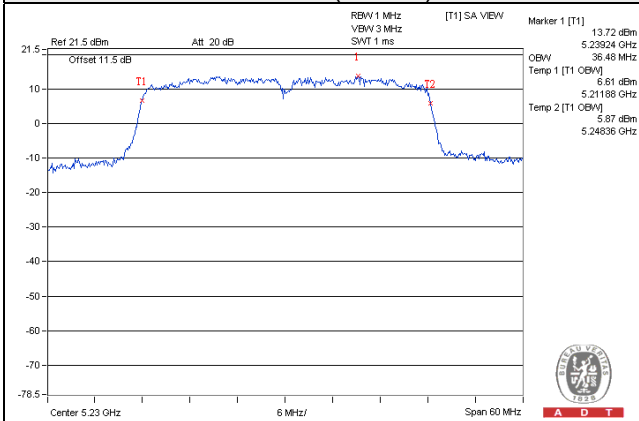

Beamforming Mode

802.11ac (VHT20)

Channel	Frequency (MHz)	Occupied Bandwidth (MHz)			
		Chain 0	Chain 1	Chain 2	Chain 3
36	5180	17.76	17.76	17.76	17.76
40	5200	17.76	17.76	17.76	17.76
48	5240	17.76	17.76	17.76	17.76
149	5745	17.57	17.65	17.57	17.57
157	5785	17.64	17.76	17.76	17.76
165	5825	17.76	17.76	17.76	17.76

802.11ac (VHT40)

Channel	Frequency (MHz)	Occupied Bandwidth (MHz)			
		Chain 0	Chain 1	Chain 2	Chain 3
38	5190	36.00	36.00	35.88	36.00
46	5230	36.24	36.12	36.12	36.12
151	5755	36.00	36.00	36.00	36.00
159	5795	36.24	36.12	36.24	36.12

802.11ac (VHT80)

Channel	Frequency (MHz)	Occupied Bandwidth (MHz)			
		Chain 0	Chain 1	Chain 2	Chain 3
42	5210	75.88	75.88	75.88	75.88
155	5775	75.88	75.88	75.88	76.16

Spectrum Plot of Worst Value

802.11ac (VHT20)

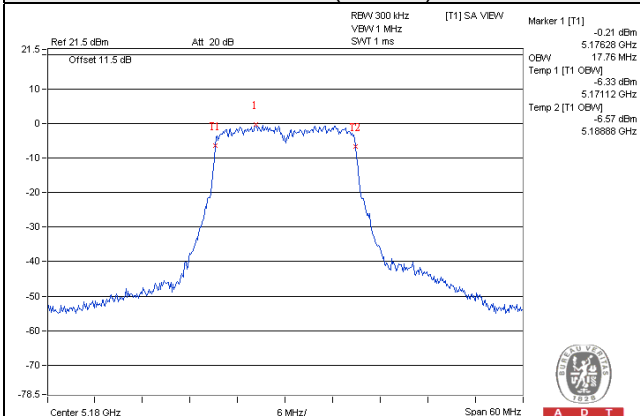

802.11ac (VHT40)

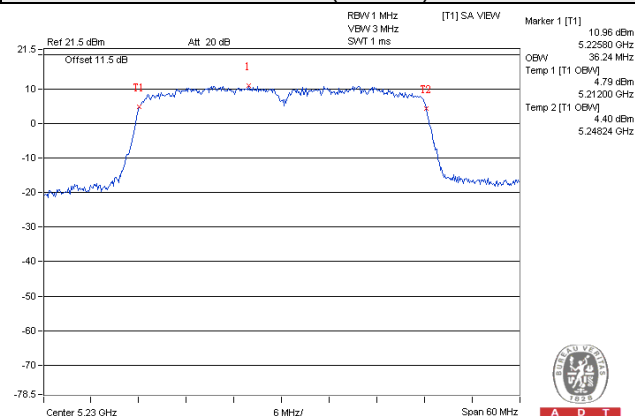

802.11ac (VHT80)

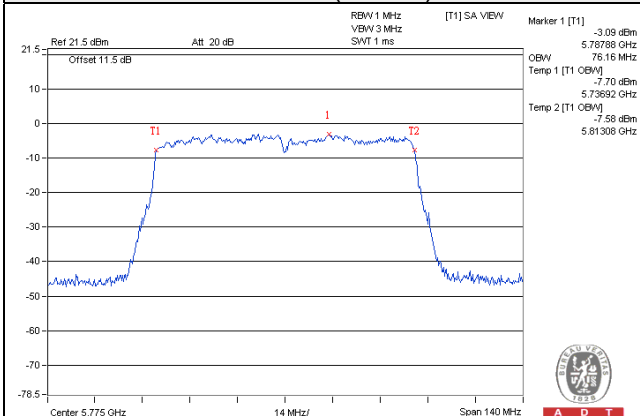

4.4 Peak Power Spectral Density Measurement

4.4.1 Limits of Peak Power Spectral Density Measurement

Operation Band	EUT Category		LIMIT
U-NII-1		Outdoor Access Point	17dBm/ MHz
		Fixed point-to-point Access Point	
	√	Indoor Access Point	
		Mobile and Portable client device	11dBm/ MHz
U-NII-2A	---		11dBm/ MHz
U-NII-2C	---		11dBm/ MHz
U-NII-3	√		30dBm/ 500kHz

4.4.2 Test Setup

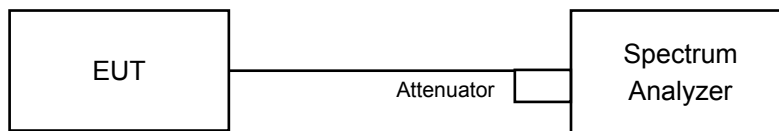

4.4.3 Test Instruments

Refer to section 4.1.2 to get information of above instrument.

4.4.4 Test Procedure

For U-NII-1 band:

Using method SA-1, Duty cycle >98%:

- a. Set span to encompass the entire emission bandwidth (EBW) of the signal.
- b. Set RBW = 1 MHz, Set VBW \geq 3 MHz, Detector = RMS
- c. Sweep time = auto, trigger set to "free run".
- d. Trace average at least 100 traces in power averaging mode.
- e. Record the max value

Using method SA-2, Duty cycle <98%

- a. Set span to encompass the entire emission bandwidth (EBW) of the signal.
- b. Set RBW = 1 MHz, Set VBW \geq 3 MHz, Detector = RMS
- c. Sweep time = auto, trigger set to "free run".
- d. Trace average at least 100 traces in power averaging mode.
- e. Record the max value and add $10 \log (1/\text{duty cycle})$

For U-NII-3 band:

Duty cycle >98%

- a. Set span to encompass the entire emission bandwidth (EBW) of the signal.
- b. Set RBW = 300 kHz, Set VBW \geq 1 MHz, Detector = RMS
- c. Use the peak marker function to determine the maximum power level in any 300 kHz band segment within the fundamental EBW.
- d. Scale the observed power level to an equivalent value in 500 kHz by adjusting (reducing) the measured power by a bandwidth correction factor (BWCF) where $BWCF = 10\log(500 \text{ kHz}/300\text{kHz})$
- e. Sweep time = auto, trigger set to "free run".
- f. Trace average at least 100 traces in power averaging mode.
- g. Record the max value

Duty cycle <98%

- a. Set span to encompass the entire emission bandwidth (EBW) of the signal.
- b. Set RBW = 300 kHz, Set VBW \geq 1 MHz, Detector = RMS
- c. Use the peak marker function to determine the maximum power level in any 300 kHz band segment within the fundamental EBW.
- d. Scale the observed power level to an equivalent value in 500 kHz by adjusting (reducing) the measured power by a bandwidth correction factor (BWCF) where $BWCF = 10\log(500 \text{ kHz}/300\text{kHz})$
- e. Sweep time = auto, trigger set to "free run".
- f. Trace average at least 100 traces in power averaging mode.
- g. Record the max value and add $10 \log (1/\text{duty cycle})$

4.4.5 Deviation from Test Standard

No deviation.

4.4.6 EUT Operating Condition

Same as 4.3.6.

4.4.7 Test Results

For U-NII-1 Band

CDD Mode

802.11a

Chan.	Freq. (MHz)	PSD (dBm)				Total PSD w/o duty factor (dBm)	Duty factor	Total PSD with duty factor (dBm)	Max. Limit (dBm)	Pass / Fail
		Chain 0	Chain 1	Chain 2	Chain 3					
36	5180	5.16	4.43	5.11	4.59	10.85	0.16	11.01	11.14	Pass
40	5200	5.17	4.65	5.17	4.76	10.96	0.16	11.12	11.14	Pass
48	5240	5.19	4.67	5.06	4.82	10.96	0.16	11.12	11.14	Pass

Note:

- Method 1 of power density measurement of KDB 662911 is using for calculating total power density. Total power density is summing entire spectra across corresponding frequency bins on the various outputs by computer.
- Internal antenna Directional gain = $5.84\text{dBi} + 10\log(4) = 11.86\text{dBi}$ (which is the highest value to calculation) $> 6\text{dBi}$, so the limit shall be reduced to $17 - (11.86 - 6) = 11.14\text{dBm}$.
External antenna Directional gain = $3.18\text{dBi} + 10\log(4) = 9.20\text{dBi}$
- Refer to section 3.3 for duty cycle spectrum plot.

802.11ac (VHT20)

Chan.	Freq. (MHz)	PSD (dBm)				Total PSD (dBm)	Max. Limit (dBm)	Pass / Fail
		Chain 0	Chain 1	Chain 2	Chain 3			
36	5180	5.36	4.68	5.19	4.74	11.02	11.14	Pass
40	5200	4.86	4.29	4.82	4.40	10.62	11.14	Pass
48	5240	5.00	4.69	4.72	4.73	10.81	11.14	Pass

Note:

- Method 1 of power density measurement of KDB 662911 is using for calculating total power density. Total power density is summing entire spectra across corresponding frequency bins on the various outputs by computer.
- Internal antenna Directional gain = $5.84\text{dBi} + 10\log(4) = 11.86\text{dBi}$ (which is the highest value to calculation) $> 6\text{dBi}$, so the limit shall be reduced to $17 - (11.86 - 6) = 11.14\text{dBm}$.
External antenna Directional gain = $3.18\text{dBi} + 10\log(4) = 9.20\text{dBi}$

802.11ac (VHT40)

Chan.	Freq. (MHz)	PSD (dBm)				Total PSD w/o duty factor (dBm)	Duty factor	Total PSD with duty factor (dBm)	Max. Limit (dBm)	Pass / Fail
		Chain 0	Chain 1	Chain 2	Chain 3					
38	5190	-0.05	-0.33	-0.27	-0.44	5.75	0.14	5.89	11.14	Pass
46	5230	3.27	3.05	3.53	2.92	9.22	0.14	9.36	11.14	Pass

Note:

- Method 1 of power density measurement of KDB 662911 is using for calculating total power density. Total power density is summing entire spectra across corresponding frequency bins on the various outputs by computer.
- Internal antenna Directional gain = $5.84\text{dBi} + 10\log(4) = 11.86\text{dBi}$ (which is the highest value to calculation) $> 6\text{dBi}$, so the limit shall be reduced to $17 - (11.86 - 6) = 11.14\text{dBm}$.
External antenna Directional gain = $3.18\text{dBi} + 10\log(4) = 9.20\text{dBi}$
- Refer to section 3.3 for duty cycle spectrum plot.

802.11ac (VHT80)

Chan.	Freq. (MHz)	PSD (dBm)				Total PSD w/o duty factor (dBm)	Duty factor	Total PSD with duty factor (dBm)	Max. Limit (dBm)	Pass / Fail
		Chain 0	Chain 1	Chain 2	Chain 3					
42	5210	-7.98	-8.10	-8.25	-8.30	-2.14	0.33	-1.81	11.14	Pass

Note:

- Method 1 of power density measurement of KDB 662911 is using for calculating total power density. Total power density is summing entire spectra across corresponding frequency bins on the various outputs by computer.
- Internal antenna Directional gain = $5.84\text{dBi} + 10\log(4) = 11.86\text{dBi}$ (which is the highest value to calculation) $> 6\text{dBi}$, so the limit shall be reduced to $17 - (11.86 - 6) = 11.14\text{dBm}$.
External antenna Directional gain = $3.18\text{dBi} + 10\log(4) = 9.20\text{dBi}$
- Refer to section 3.3 for duty cycle spectrum plot.

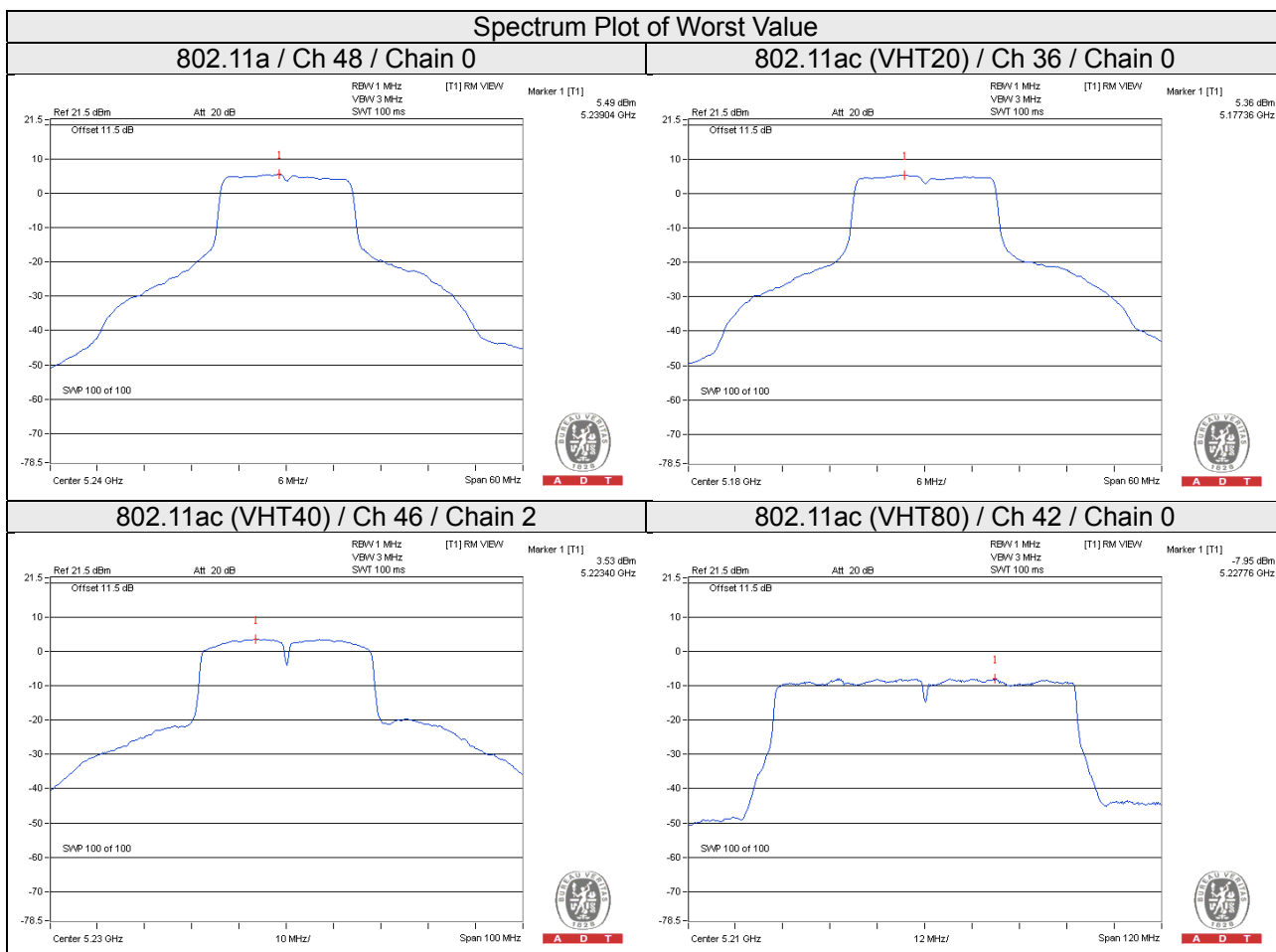

Beamforming Mode

802.11ac (VHT20)

Chan.	Freq. (MHz)	PSD (dBm)				Total PSD w/o duty factor (dBm)	Duty factor	Total PSD with duty factor (dBm)	Max. Limit (dBm)	Pass / Fail
		Chain 0	Chain 1	Chain 2	Chain 3					
36	5180	-4.77	-5.06	-5.03	-4.50	1.19	0.09	1.28	11.14	Pass
40	5200	2.82	2.05	2.09	2.26	8.34	0.09	8.43	11.14	Pass
48	5240	2.86	2.36	2.31	2.69	8.59	0.09	8.68	11.14	Pass

Note:

- Method 1 of power density measurement of KDB 662911 is using for calculating total power density. Total power density is summing entire spectra across corresponding frequency bins on the various outputs by computer.
- Internal antenna Directional gain = $5.84\text{dBi} + 10\log(4) = 11.86\text{dBi}$ (which is the highest value to calculation) $> 6\text{dBi}$, so the limit shall be reduced to $17 - (11.86 - 6) = 11.14\text{dBm}$.
External antenna Directional gain = $3.18\text{dBi} + 10\log(4) = 9.20\text{dBi}$
- Refer to section 3.3 for duty cycle spectrum plot.

802.11ac (VHT40)

Chan.	Freq. (MHz)	PSD (dBm)				Total PSD w/o duty factor (dBm)	Duty factor	Total PSD with duty factor (dBm)	Max. Limit (dBm)	Pass / Fail
		Chain 0	Chain 1	Chain 2	Chain 3					
38	5190	-7.38	-7.83	-7.89	-7.64	-1.66	0.15	-1.51	11.14	Pass
46	5230	0.83	0.08	0.05	0.56	6.41	0.15	6.56	11.14	Pass

Note:

- Method 1 of power density measurement of KDB 662911 is using for calculating total power density. Total power density is summing entire spectra across corresponding frequency bins on the various outputs by computer.
- Internal antenna Directional gain = $5.84\text{dBi} + 10\log(4) = 11.86\text{dBi}$ (which is the highest value to calculation) $> 6\text{dBi}$, so the limit shall be reduced to $17 - (11.86 - 6) = 11.14\text{dBm}$.
External antenna Directional gain = $3.18\text{dBi} + 10\log(4) = 9.20\text{dBi}$
- Refer to section 3.3 for duty cycle spectrum plot.

802.11ac (VHT80)

Chan.	Freq. (MHz)	PSD (dBm)				Total PSD w/o duty factor (dBm)	Duty factor	Total PSD with duty factor (dBm)	Max. Limit (dBm)	Pass / Fail
		Chain 0	Chain 1	Chain 2	Chain 3					
42	5210	-12.26	-12.48	-12.41	-12.46	-6.38	0.28	-6.10	11.14	Pass

Note:

- Method 1 of power density measurement of KDB 662911 is using for calculating total power density. Total power density is summing entire spectra across corresponding frequency bins on the various outputs by computer.
- Internal antenna Directional gain = $5.84\text{dBi} + 10\log(4) = 11.86\text{dBi}$ (which is the highest value to calculation) $> 6\text{dBi}$, so the limit shall be reduced to $17 - (11.86 - 6) = 11.14\text{dBm}$.
External antenna Directional gain = $3.18\text{dBi} + 10\log(4) = 9.20\text{dBi}$
- Refer to section 3.3 for duty cycle spectrum plot.

Spectrum Plot of Worst Value

802.11ac (VHT20) / Ch 48 / Chain 0

802.11ac (VHT40) / Ch 46 / Chain 0

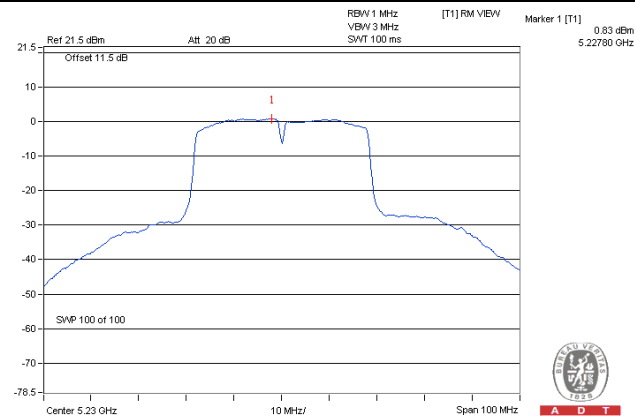
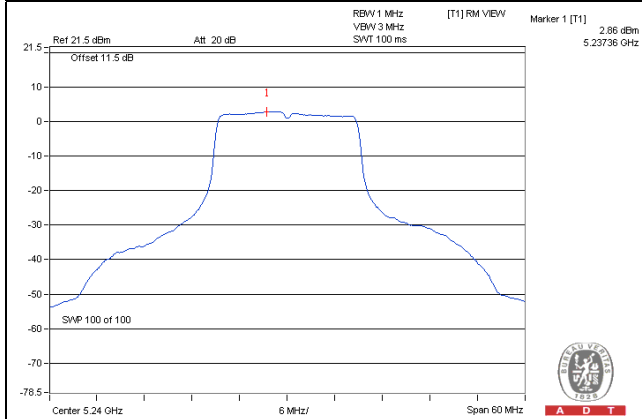

802.11ac (VHT80) / Ch 42 / Chain 0

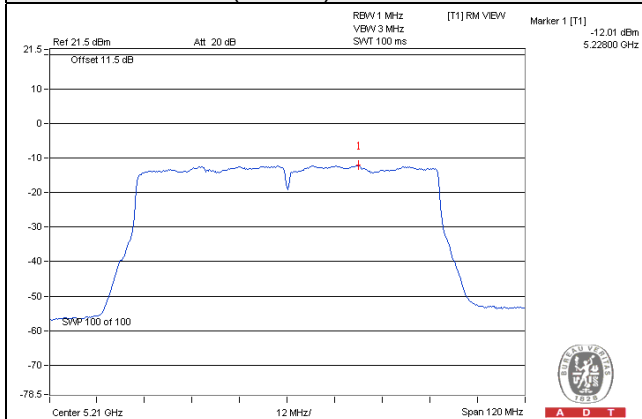

For U-NII-3 Band

CDD Mode

802.11a

TX chain	Channel	Freq. (MHz)	PSD (dBm/300kHz)	PSD (dBm/500kHz)	10 log (N=4) dB	Duty factor	Total PSD (dBm/500kHz)	Limit (dBm/500kHz)	Pass / Fail
0	149	5745	-3.37	-1.15	6.02	0.16	5.03	24.14	Pass
	157	5785	-1.35	0.87	6.02	0.16	7.05	24.14	Pass
	165	5825	-1.82	0.40	6.02	0.16	6.58	24.14	Pass
1	149	5745	-3.07	-0.85	6.02	0.16	5.33	24.14	Pass
	157	5785	-0.78	1.44	6.02	0.16	7.62	24.14	Pass
	165	5825	-1.10	1.12	6.02	0.16	7.30	24.14	Pass
2	149	5745	-3.09	-0.87	6.02	0.16	5.31	24.14	Pass
	157	5785	-1.20	1.02	6.02	0.16	7.20	24.14	Pass
	165	5825	-1.76	0.46	6.02	0.16	6.64	24.14	Pass
3	149	5745	-3.45	-1.23	6.02	0.16	4.95	24.14	Pass
	157	5785	-1.24	0.98	6.02	0.16	7.16	24.14	Pass
	165	5825	-2.03	0.19	6.02	0.16	6.37	24.14	Pass

Note:

- Method 1 of power density measurement of KDB 662911 is using for calculating total power density. Total power density is summing entire spectra across corresponding frequency bins on the various outputs by computer.
- Internal antenna Directional gain = $5.84\text{dBi} + 10\log(4) = 11.86\text{dBi}$ (which is the highest value to calculation) $> 6\text{dBi}$, so the limit shall be reduced to $17 - (11.86 - 6) = 11.14\text{dBm}$.
External antenna Directional gain = $3.18\text{dBi} + 10\log(4) = 9.20\text{dBi}$
- Refer to section 3.3 for duty cycle spectrum plot.

802.11ac (VHT20)

TX chain	Channel	Freq. (MHz)	PSD (dBm/300kHz)	PSD (dBm/500kHz)	10 log (N=4) dB	Total PSD (dBm/500kHz)	Limit (dBm/500kHz)	Pass / Fail
0	149	5745	-4.01	-1.79	6.02	4.23	24.14	Pass
	157	5785	-1.80	0.42	6.02	6.44	24.14	Pass
	165	5825	-2.36	-0.14	6.02	5.88	24.14	Pass
1	149	5745	-3.38	-1.16	6.02	4.86	24.14	Pass
	157	5785	-1.22	1.00	6.02	7.02	24.14	Pass
	165	5825	-1.56	0.66	6.02	6.68	24.14	Pass
2	149	5745	-3.52	-1.30	6.02	4.72	24.14	Pass
	157	5785	-1.60	0.62	6.02	6.64	24.14	Pass
	165	5825	-2.13	0.09	6.02	6.11	24.14	Pass
3	149	5745	-3.67	-1.45	6.02	4.57	24.14	Pass
	157	5785	-1.46	0.76	6.02	6.78	24.14	Pass
	165	5825	-2.05	0.17	6.02	6.19	24.14	Pass

Note:

- Method 1 of power density measurement of KDB 662911 is using for calculating total power density. Total power density is summing entire spectra across corresponding frequency bins on the various outputs by computer.
- Internal antenna Directional gain = $5.84\text{dBi} + 10\log(4) = 11.86\text{dBi}$ (which is the highest value to calculation) $> 6\text{dBi}$, so the limit shall be reduced to $17 - (11.86 - 6) = 11.14\text{dBm}$.
External antenna Directional gain = $3.18\text{dBi} + 10\log(4) = 9.20\text{dBi}$

802.11ac (VHT40)

TX chain	Channel	Freq. (MHz)	PSD (dBm/300kHz)	PSD (dBm/500kHz)	10 log (N=4) dB	Duty factor	Total PSD (dBm/500kHz)	Limit (dBm/500kHz)	Pass / Fail
0	151	5755	-11.63	-9.41	6.02	0.14	-3.25	24.14	Pass
	159	5795	-8.54	-6.32	6.02	0.14	-0.16	24.14	Pass
1	151	5755	-11.47	-9.25	6.02	0.14	-3.09	24.14	Pass
	159	5795	-8.14	-5.92	6.02	0.14	0.24	24.14	Pass
2	151	5755	-11.62	-9.40	6.02	0.14	-3.24	24.14	Pass
	159	5795	-8.43	-6.21	6.02	0.14	-0.05	24.14	Pass
3	151	5755	-11.93	-9.71	6.02	0.14	-3.55	24.14	Pass
	159	5795	-8.65	-6.43	6.02	0.14	-0.27	24.14	Pass

Note:

- Method 1 of power density measurement of KDB 662911 is using for calculating total power density. Total power density is summing entire spectra across corresponding frequency bins on the various outputs by computer.
- Internal antenna Directional gain = $5.84\text{dBi} + 10\log(4) = 11.86\text{dBi}$ (which is the highest value to calculation) $> 6\text{dBi}$, so the limit shall be reduced to $17 - (11.86 - 6) = 11.14\text{dBm}$.
External antenna Directional gain = $3.18\text{dBi} + 10\log(4) = 9.20\text{dBi}$
- Refer to section 3.3 for duty cycle spectrum plot.

802.11ac (VHT80)

TX chain	Channel	Freq. (MHz)	PSD (dBm/300kHz)	PSD (dBm/500kHz)	10 log (N=4) dB	Duty factor	Total PSD (dBm/500kHz)	Limit (dBm/500kHz)	Pass / Fail
0	155	5775	-18.56	-16.34	6.02	0.33	-9.99	24.14	Pass
1	155	5775	-18.13	-15.91	6.02	0.33	-9.56	24.14	Pass
2	155	5775	-18.79	-16.57	6.02	0.33	-10.22	24.14	Pass
3	155	5775	-18.53	-16.31	6.02	0.33	-9.96	24.14	Pass

Note:

- Method 1 of power density measurement of KDB 662911 is using for calculating total power density. Total power density is summing entire spectra across corresponding frequency bins on the various outputs by computer.
- Internal antenna Directional gain = $5.84\text{dBi} + 10\log(4) = 11.86\text{dBi}$ (which is the highest value to calculation) $> 6\text{dBi}$, so the limit shall be reduced to $17 - (11.86 - 6) = 11.14\text{dBm}$.
External antenna Directional gain = $3.18\text{dBi} + 10\log(4) = 9.20\text{dBi}$
- Refer to section 3.3 for duty cycle spectrum plot.

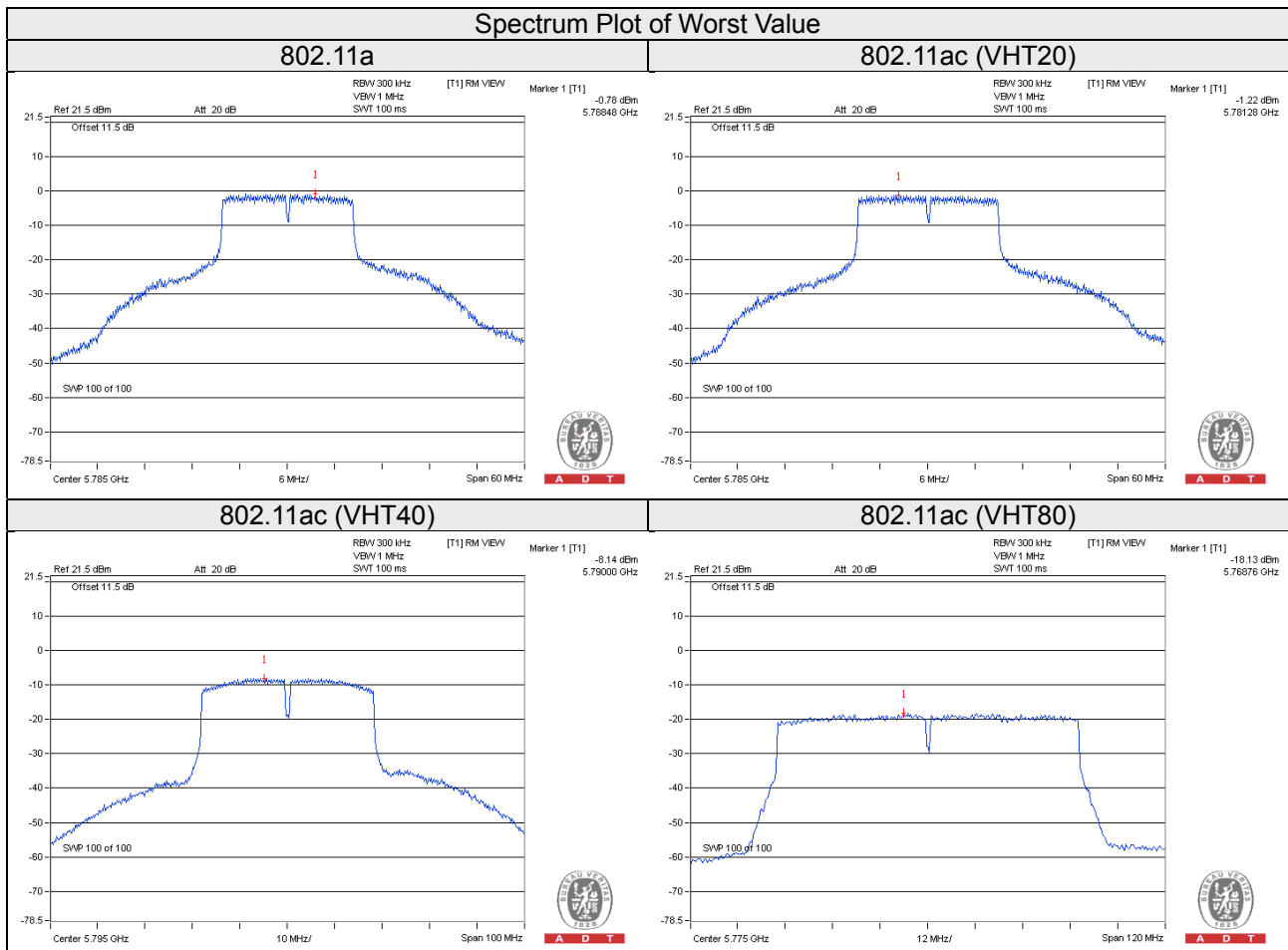

Beamforming Mode

802.11ac (VHT20)

TX chain	Channel	Freq. (MHz)	PSD (dBm/300kHz)	PSD (dBm/500kHz)	10 log (N=4) dB	Duty factor	Total PSD (dBm/500kHz)	Limit (dBm/500kHz)	Pass / Fail
0	149	5745	-12.81	-10.59	6.02	0.09	-4.48	24.14	Pass
	157	5785	-5.34	-3.12	6.02	0.09	2.99	24.14	Pass
	165	5825	-5.26	-3.04	6.02	0.09	3.07	24.14	Pass
1	149	5745	-13.55	-11.33	6.02	0.09	-5.22	24.14	Pass
	157	5785	-6.19	-3.97	6.02	0.09	2.14	24.14	Pass
	165	5825	-5.74	-3.52	6.02	0.09	2.59	24.14	Pass
2	149	5745	-13.07	-10.85	6.02	0.09	-4.74	24.14	Pass
	157	5785	-5.43	-3.21	6.02	0.09	2.90	24.14	Pass
	165	5825	-5.51	-3.29	6.02	0.09	2.82	24.14	Pass
3	149	5745	-12.74	-10.52	6.02	0.09	-4.41	24.14	Pass
	157	5785	-5.49	-3.27	6.02	0.09	2.84	24.14	Pass
	165	5825	-5.72	-3.50	6.02	0.09	2.61	24.14	Pass

Note:

- Method 1 of power density measurement of KDB 662911 is using for calculating total power density. Total power density is summing entire spectra across corresponding frequency bins on the various outputs by computer.
- Directional gain = 5.84dBi + 10log(4) = 11.86dBi > 6dBi, so the limit shall be reduced to 30-(11.86-6) = 24.14dBm.
- Refer to section 3.3 for duty cycle spectrum plot.

802.11ac (VHT40)

TX chain	Channel	Freq. (MHz)	PSD (dBm/300kHz)	PSD (dBm/500kHz)	10 log (N=4) dB	Duty factor	Total PSD (dBm/500kHz)	Limit (dBm/500kHz)	Pass / Fail
0	151	5755	-16.99	-14.77	6.02	0.15	-8.60	24.14	Pass
	159	5795	-8.59	-6.37	6.02	0.15	-0.20	24.14	Pass
1	151	5755	-17.89	-15.67	6.02	0.15	-9.50	24.14	Pass
	159	5795	-9.55	-7.33	6.02	0.15	-1.16	24.14	Pass
2	151	5755	-17.45	-15.23	6.02	0.15	-9.06	24.14	Pass
	159	5795	-8.77	-6.55	6.02	0.15	-0.38	24.14	Pass
3	151	5755	-17.42	-15.20	6.02	0.15	-9.03	24.14	Pass
	159	5795	-9.10	-6.88	6.02	0.15	-0.71	24.14	Pass

Note:

- Method 1 of power density measurement of KDB 662911 is using for calculating total power density. Total power density is summing entire spectra across corresponding frequency bins on the various outputs by computer.
- Directional gain = 5.84dBi + 10log(4) = 11.86dBi > 6dBi, so the limit shall be reduced to 30-(11.86-6) = 24.14dBm.
- Refer to section 3.3 for duty cycle spectrum plot.

802.11ac (VHT80)

TX chain	Channel	Freq. (MHz)	PSD (dBm/300kHz)	PSD (dBm/500kHz)	10 log (N=4) dB	Duty factor	Total PSD (dBm/500kHz)	Limit (dBm/500kHz)	Pass / Fail
0	155	5775	-21.37	-19.15	6.02	0.28	-12.85	24.14	Pass
1	155	5775	-23.00	-20.78	6.02	0.28	-14.48	24.14	Pass
2	155	5775	-22.23	-20.01	6.02	0.28	-13.71	24.14	Pass
3	155	5775	-22.03	-19.81	6.02	0.28	-13.51	24.14	Pass

Note:

- Method 1 of power density measurement of KDB 662911 is using for calculating total power density. Total power density is summing entire spectra across corresponding frequency bins on the various outputs by computer.
- Directional gain = 5.84dBi + 10log(4) = 11.86dBi > 6dBi, so the limit shall be reduced to 30-(11.86-6) = 24.14dBm.
- Refer to section 3.3 for duty cycle spectrum plot.

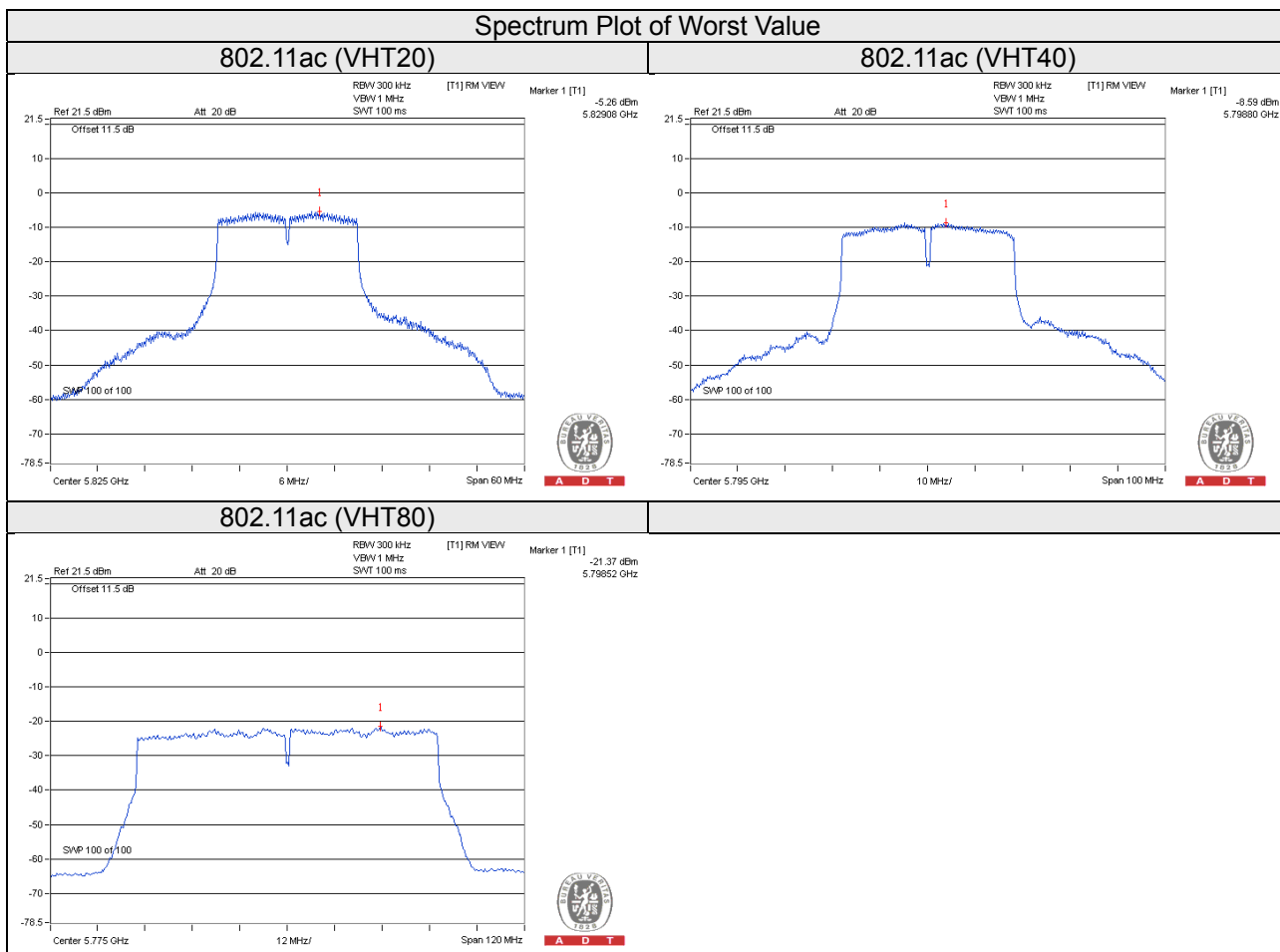

4.5 Frequency Stability

4.5.1 Limits of Frequency Stability Measurement

The frequency of the carrier signal shall be maintained within band of operation

4.5.2 Test Setup

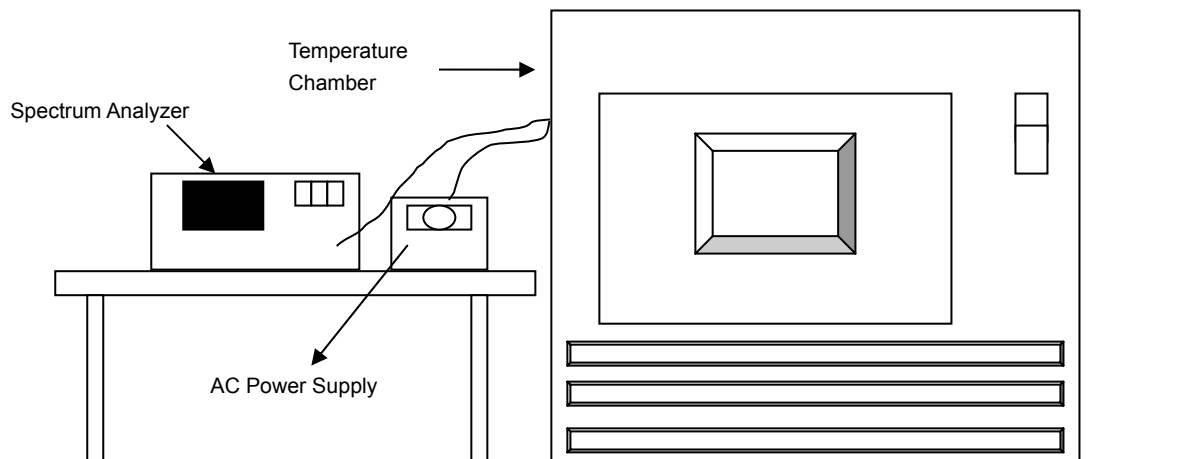

4.5.3 Test Instruments

Refer to section 4.1.2 to get information of above instrument.

4.5.4 Test Procedure

- The EUT was placed inside the environmental test chamber and powered by nominal AC voltage.
- Turn the EUT on and couple its output to a spectrum analyzer.
- Turn the EUT off and set the chamber to the highest temperature specified.
- Allow sufficient time (approximately 30 min) for the temperature of the chamber to stabilize, turn the EUT on and measure the operating frequency after 2, 5, and 10 minutes.
- Repeat step 2 and 3 with the temperature chamber set to the lowest temperature.
- The test chamber was allowed to stabilize at +20 degree C for a minimum of 30 minutes. The supply voltage was then adjusted on the EUT from 85% to 115% and the frequency record.

4.5.5 Deviation from Test Standard

No deviation.

4.5.6 EUT Operating Condition

Set the EUT transmit at un-modulation mode to test frequency stability.

4.5.7 Test Results

Frequency Stability Versus Temp.									
Operating Frequency: 5180MHz									
Temp. (°C)	Power Supply (Vac)	0 Minute		2 Minute		5 Minute		10 Minute	
		Measured Frequency (MHz)	Frequency Drift (%)	Measured Frequency (MHz)	Frequency Drift (%)	Measured Frequency (MHz)	Frequency Drift (%)	Measured Frequency (MHz)	Frequency Drift (%)
50	120	5179.9767	-0.00045	5179.9753	-0.00048	5179.9773	-0.00044	5179.9775	-0.00043
40	120	5179.9908	-0.00018	5179.9901	-0.00019	5179.9922	-0.00015	5179.9923	-0.00015
30	120	5179.9976	-0.00005	5179.9967	-0.00006	5179.9974	-0.00005	5179.9978	-0.00004
20	120	5179.9831	-0.00033	5179.9830	-0.00033	5179.988	-0.00023	5179.9836	-0.00032
10	120	5179.9996	-0.00001	5180.0003	0.00001	5180.0035	0.00007	5180.0033	0.00006
0	120	5180.0019	0.00004	5180.0042	0.00008	5180.0037	0.00007	5180.0029	0.00006
-10	120	5180.0142	0.00027	5180.0165	0.00032	5180.0142	0.00027	5180.0150	0.00029
-20	120	5179.9972	-0.00005	5179.9993	-0.00001	5179.9990	-0.00002	5179.9956	-0.00008
-30	120	5179.9999	0.00000	5179.9992	-0.00002	5180.0013	0.00003	5180.0001	0.00000

Frequency Stability Versus Voltage									
Operating Frequency: 5180MHz									
Temp. (°C)	Power Supply (Vac)	0 Minute		2 Minute		5 Minute		10 Minute	
		Measured Frequency (MHz)	Frequency Drift (%)	Measured Frequency (MHz)	Frequency Drift (%)	Measured Frequency (MHz)	Frequency Drift (%)	Measured Frequency (MHz)	Frequency Drift (%)
20	138	5179.9828	-0.00033	5179.9837	-0.00031	5179.9877	-0.00024	5179.9846	-0.00030
	120	5179.9831	-0.00033	5179.9830	-0.00033	5179.9880	-0.00023	5179.9836	-0.00032
	102	5179.9828	-0.00033	5179.9821	-0.00035	5179.9871	-0.00025	5179.9840	-0.00031

4.6 6dB Bandwidth Measurement

4.6.1 Limits of 6dB Bandwidth Measurement

The minimum of 6dB Bandwidth Measurement is 0.5MHz.

4.6.2 Test Setup

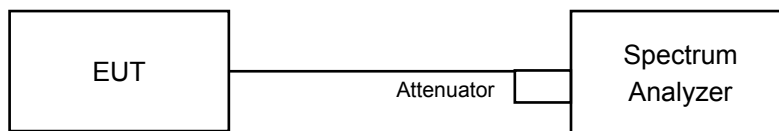

4.6.3 Test Instruments

Refer to section 4.1.2 to get information of above instrument.

4.6.4 Test Procedure

- Set resolution bandwidth (RBW) = 100kHz
- Set the video bandwidth (VBW) $\geq 3 \times$ RBW, Detector = Peak
- Trace mode = max hold
- Sweep = auto couple
- Measure the maximum width of the emission that is constrained by the frequencies associated with the two amplitude points (upper and lower) that are attenuated by 6 dB relative to the maximum level measured in the fundamental emission

4.6.5 Deviation from Test Standard

No deviation.

4.6.6 EUT Operating Condition

The software provided by client to enable the EUT under transmission Condition continuously at lowest, middle and highest channel frequencies individually.

4.6.7 Test Results

CDD Mode

802.11a

Channel	Frequency (MHz)	6dB Bandwidth (MHz)				Minimum Limit (MHz)	Pass / Fail
		Chain 0	Chain 1	Chain 2	Chain 3		
149	5745	15.70	16.33	16.34	16.33	0.5	Pass
157	5785	16.32	16.37	15.18	16.35	0.5	Pass
165	5825	16.04	16.07	16.06	16.35	0.5	Pass

802.11ac (VHT20)

Channel	Frequency (MHz)	6dB Bandwidth (MHz)				Minimum Limit (MHz)	Pass / Fail
		Chain 0	Chain 1	Chain 2	Chain 3		
149	5745	16.61	17.31	15.99	17.59	0.5	Pass
157	5785	17.23	17.59	17.19	17.20	0.5	Pass
165	5825	17.56	17.60	16.97	17.53	0.5	Pass

802.11ac (VHT40)

Channel	Frequency (MHz)	6dB Bandwidth (MHz)				Minimum Limit (MHz)	Pass / Fail
		Chain 0	Chain 1	Chain 2	Chain 3		
151	5755	35.25	35.18	35.23	35.17	0.5	Pass
159	5795	35.13	35.22	35.15	33.96	0.5	Pass

802.11ac (VHT80)

Channel	Frequency (MHz)	6dB Bandwidth (MHz)				Minimum Limit (MHz)	Pass / Fail
		Chain 0	Chain 1	Chain 2	Chain 3		
155	5775	75.96	75.38	75.42	69.30	0.5	Pass

Spectrum Plot of Worst Value

802.11a

802.11ac (VHT20)

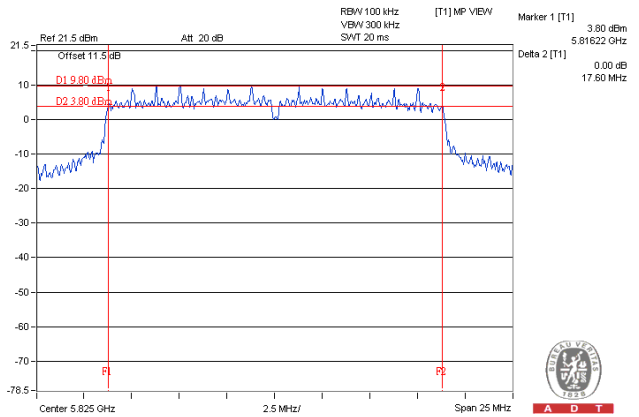
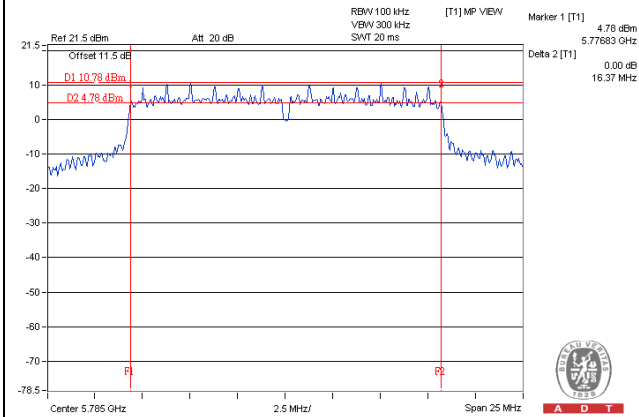

802.11ac (VHT40)

802.11ac (VHT80)

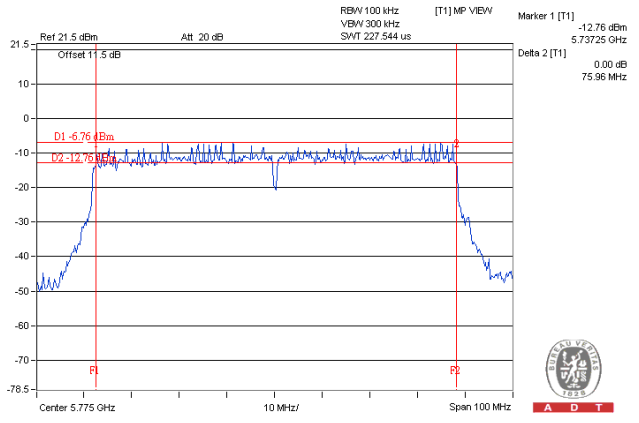
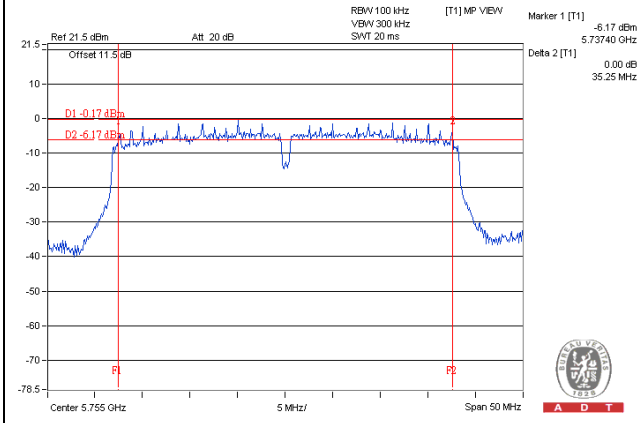

Beamforming Mode

802.11ac (VHT20)

Channel	Frequency (MHz)	6dB Bandwidth (MHz)				Minimum Limit (MHz)	Pass / Fail
		Chain 0	Chain 1	Chain 2	Chain 3		
149	5745	16.57	17.20	17.19	16.57	0.5	Pass
157	5785	15.78	16.61	16.56	16.60	0.5	Pass
165	5825	16.57	16.62	15.95	17.56	0.5	Pass

802.11ac (VHT40)

Channel	Frequency (MHz)	6dB Bandwidth (MHz)				Minimum Limit (MHz)	Pass / Fail
		Chain 0	Chain 1	Chain 2	Chain 3		
151	5755	35.21	35.11	35.32	35.22	0.5	Pass
159	5795	35.14	33.98	35.16	33.96	0.5	Pass

802.11ac (VHT80)

Channel	Frequency (MHz)	6dB Bandwidth (MHz)				Minimum Limit (MHz)	Pass / Fail
		Chain 0	Chain 1	Chain 2	Chain 3		
155	5775	75.36	75.41	75.38	75.37	0.5	Pass

Spectrum Plot of Worst Value

802.11ac (VHT20)

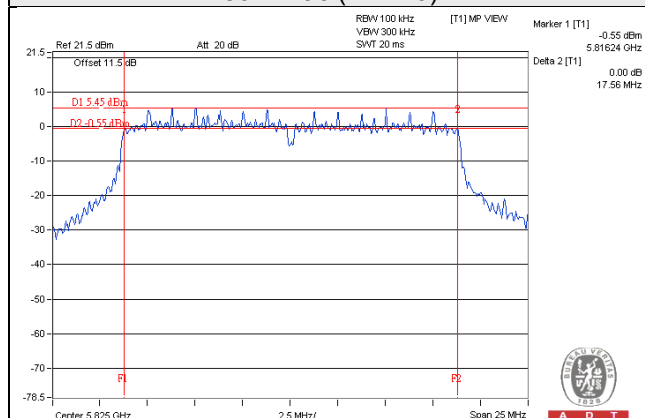

802.11ac (VHT40)

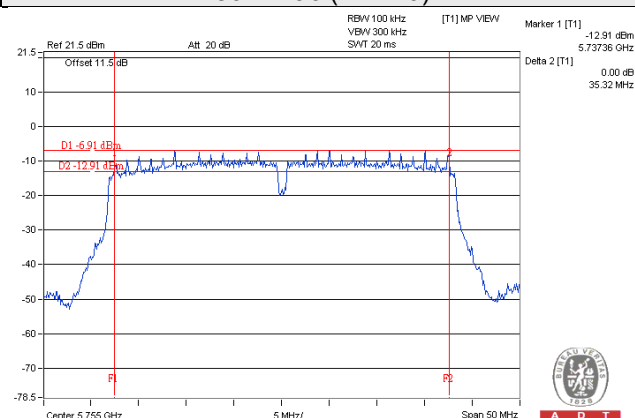

802.11ac (VHT80)

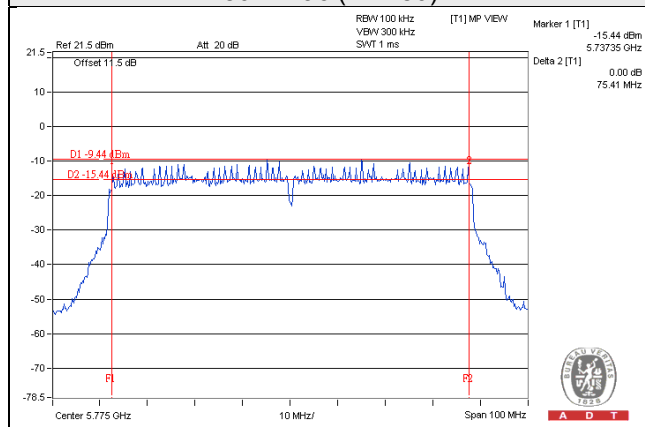

5 Pictures of Test Arrangements

Please refer to the attached file (Test Setup Photo).

Appendix – Information on the Testing Laboratories

We, Bureau Veritas Consumer Products Services (H.K.) Ltd., Taoyuan Branch, were founded in 1988 to provide our best service in EMC, Radio, Telecom and Safety consultation. Our laboratories are accredited and approved according to ISO/IEC 17025.

If you have any comments, please feel free to contact us at the following:

Linko EMC/RF Lab

Tel: 886-2-26052180

Fax: 886-2-26051924

Hsin Chu EMC/RF/Telecom Lab

Tel: 886-3-6668565

Fax: 886-3-6668323

Hwa Ya EMC/RF/Safety Lab

Tel: 886-3-3183232

Fax: 886-3-3270892

Email: service.adt@tw.bureauveritas.com

Web Site: www.bureauveritas-adt.com

The address and road map of all our labs can be found in our web site also.

--- END ---