

FCC Test Report

Equipment : Secured Wireless Access Point
Brand Name : Fortinet, Inc.
Model No. : FORTIAP-U321EVxxxxxx, FAP-U321EVxxxxxx;
FORTIAP-U323EVxxxxxx, FAP-U323EVxxxxxx.
(Refer to Section 1.1.5 for more details)
FCC ID : TVE-261DD011
Standard : 47 CFR FCC Part 15.247
Operating Band : 2400 MHz – 2483.5 MHz
Applicant : Fortinet, Inc.
899 Kifer Road, Sunnyvale, CA 94086, USA
Manufacturer : Universal Global Scientific Industrial Co., Ltd
141, Lane 351, Sec. 1, Taiping Road., Tsaotuen, Nantou
54261, Taiwan

The product sample received on May 15, 2017 and completely tested on Sep. 08, 2017. We, SPORTON, would like to declare that the tested sample has been evaluated in accordance with the procedures given in ANSI C63.10-2013 and shown compliance with the applicable technical standards.

The test results in this report apply exclusively to the tested model / sample. Without written approval of SPORTON INTERNATIONAL INC., the test report shall not be reproduced except in full.

Phoenix Chen
SPORTON INTERNATIONAL INC.





Table of Contents

- 1 GENERAL DESCRIPTION5**
- 1.1 Information.....5
- 1.2 Testing Applied Standards7
- 1.3 Testing Location Information7
- 1.4 Measurement Uncertainty7
- 2 TEST CONFIGURATION OF EUT.....8**
- 2.1 Test Condition8
- 2.2 Test Channel Mode8
- 2.3 The Worst Case Measurement Configuration.....9
- 2.4 Support Equipment.....11
- 2.5 Test Setup Diagram12
- 3 TRANSMITTER TEST RESULT14**
- 3.1 AC Power-line Conducted Emissions14
- 3.2 20dB Bandwidth and Carrier Frequency Separation.....15
- 3.3 Maximum Conducted Output Power16
- 3.4 Number of Hopping Frequencies and Hopping Bandedge17
- 3.5 Time of Occupancy (Dwell Time)18
- 3.6 Emissions in Non-restricted Frequency Bands19
- 3.7 Emissions in Restricted Frequency Bands.....20
- 4 TEST EQUIPMENT AND CALIBRATION DATA23**

APPENDIX A. TEST RESULTS OF AC POWER-LINE CONDUCTED EMISSIONS

APPENDIX B. TEST RESULTS OF 20DB BANDWIDTH AND CARRIER FREQUENCY SEPARATION

APPENDIX C. TEST RESULTS OF MAXIMUM CONDUCTED OUTPUT POWER

APPENDIX D. TEST RESULTS OF NUMBER OF HOPPING FREQUENCIES AND HOPPING BANDEDGE

APPENDIX E. TEST RESULTS OF TIME OF OCCUPANCY (DWELL TIME)

APPENDIX F. TEST RESULTS OF EMISSIONS IN NON-RESTRICTED FREQUENCY BANDS

APPENDIX G. TEST RESULTS OF EMISSIONS IN RESTRICTED FREQUENCY BANDS

APPENDIX H. TEST RESULTS OF RADIATED EMISSION CO-LOCATION

APPENDIX I. TEST PHOTOS

PHOTOGRAPHS OF EUT v01



Summary of Test Result

Conformance Test Specifications				
Report Clause	Ref. Std. Clause	Description	Limit	Result
1.1.2	15.203	Antenna Requirement	FCC 15.203	Complied
3.1	15.207	AC Power-line Conducted Emissions	FCC 15.207	Complied
3.2	15.247(a)	20dB Bandwidth	15.247(a)	Complied
3.2	15.247(a)	Carrier Frequency Separation	15.247(a)	Complied
3.3	15.247(b)	Maximum Conducted Output Power	15.247(b)	Complied
3.4	15.247(a)	Number of Hopping Frequencies and Hopping Bandedge	15.247(a)	Complied
3.5	15.247(a)	Time of Occupancy (Dwell Time)	15.247(a)	Complied
3.6	15.247(d)	Emissions in Non-restricted Frequency Bands	15.247(d)	Complied
3.7	15.247(d)	Emissions in Restricted Frequency Bands	Restricted Bands: FCC 15.209	Complied



Revision History

Report No.	Version	Description	Issued Date
FR751119AD	Rev. 01	Initial issue of report	Aug. 10, 2017
FR751119AD	Rev. 02	Revise typo	Sep. 11, 2017

1 General Description

1.1 Information

1.1.1 RF General Information

Frequency Range (MHz)	Bluetooth Version	Ch. Frequency (MHz)	Channel Number
2400-2483.5	BR / EDR	2402-2480	0-78 [79]

Band	Mode	BWch (MHz)	Nant
2.4-2.4835GHz	BT-BR(1Mbps)	1	1TX
2.4-2.4835GHz	BT-EDR(2Mbps)	1	1TX
2.4-2.4835GHz	BT-EDR(3Mbps)	1	1TX

Note:

- ◆ Bluetooth BR uses a GFSK (1Mbps).
- ◆ Bluetooth EDR uses a combination of $\pi/4$ -DQPSK (2Mbps) and 8DPSK (3Mbps).
- ◆ Bluetooth BR/EDR uses as a system using FHSS modulation.
- ◆ BWch is the nominal channel bandwidth.

1.1.2 Antenna Information

Ant.	Brand	Model Name	Antenna Type	Connector	Gain (dBi)
A	-	-	PIFA Antenna	I-PEX	4.5

1.1.3 EUT Information

Operational Condition	
EUT Power Type	From AC Adapter / PoE
Type of EUT	
<input checked="" type="checkbox"/>	Stand-alone
<input type="checkbox"/>	Combined (EUT where the radio part is fully integrated within another device)
	Combined Equipment - Brand Name / Model No.: ...
<input type="checkbox"/>	Plug-in radio (EUT intended for a variety of host systems)
	Host System - Brand Name / Model No.: ...
<input type="checkbox"/>	Other:

1.1.4 Mode Test Duty Cycle

Mode	DC	DCF(dB)	T(s)	VBW(Hz) $\geq 1/T$
BT-BR(1Mbps)	0.784	1.057	2.888m	1k
BT-EDR(2Mbps)	0.745	1.278	2.89m	1k
BT-EDR(3Mbps)	0.744	1.284	2.892m	1k



1.1.5 Table for Multiple Listing

The detail in the following table are all refer to the identical product.

Model	Difference	Description
FORTIAP-U321EVxxxxxx	Internal antenna	where "x" can be used as "A-Z", or "-0-9, or"-", or blank for software changes or marketing purposes only
FAP-U321EVxxxxxx		
FORTIAP-U323EVxxxxxx	External antenna	where "x" can be used as "A-Z", or "-0-9, or"-", or blank for software changes or marketing purposes only
FAP-U323EVxxxxxx		
Note 1: The sample is the same one, only the antenna configuration is different.		
Note 2: For more detailed features description, please refer to the specifications or user's manual.		



1.2 Testing Applied Standards

According to the specifications of the manufacturer, the EUT must comply with the requirements of the following standards:

- ◆ 47 CFR FCC Part 15
- ◆ Public Notice DA 00-705
- ◆ ANSI C63.10-2013
- ◆ ANSI C63.4-2014

1.3 Testing Location Information

Testing Location		
<input checked="" type="checkbox"/>	HWA YA	ADD : No. 52, Huaya 1st Rd., Guishan Dist., Taoyuan City, Taiwan (R.O.C.) TEL : 886-3-327-3456 FAX : 886-3-327-0973
Test site Designation No. TW1190 with FCC.		
<input type="checkbox"/>	JHUBEI	ADD : No.8, Ln. 724, Bo'ai St., Zhubei City, Hsinchu County, Taiwan (R.O.C.) TEL : 886-3-656-9065 FAX : 886-3-656-9085
Test site Designation No. TW0006 with FCC.		

Test Condition	Test Site No.	Test Engineer	Test Environment	Test Date
AC Conduction	CO04-HY	Teddy	22°C / 58%	23/Jun/2017
RF Conducted	TH01-HY	Gary	22.5°C / 64%	09/Jun/2017
Radiated < 1GHz	03CH09-HY	Eric	23.5°C / 55%	08/Sep/2017
Radiated > 1GHz	03CH09-HY	Jeff	23.2°C / 59%	16/Jun/2017

1.4 Measurement Uncertainty

ISO/IEC 17025 requires that an estimate of the measurement uncertainties associated with the emissions test results be included in the report. The measurement uncertainties given below are based on a 95% confidence level (based on a coverage factor (k=2))

Test Items	Uncertainty	Remark
Conducted Emission (150kHz ~ 30MHz)	3.6 dB	Confidence levels of 95%
Radiated Emission (30MHz ~ 1,000MHz)	2.1 dB	Confidence levels of 95%
Radiated Emission (1GHz ~ 18GHz)	2.6 dB	Confidence levels of 95%
Radiated Emission (18GHz ~ 40GHz)	2.9 dB	Confidence levels of 95%
Conducted Emission	1.3 dB	Confidence levels of 95%



2 Test Configuration of EUT

2.1 Test Condition

RF Conducted	Abbreviation	Remark
RF Conducted-FS	Abbreviation	Remark
TnomVnom	Tnom	20°C
-	Vnom	120V

2.2 Test Channel Mode



Test Software	Putty
---------------	-------

Mode	Power Setting
BT-BR(1Mbps)	-
2402MHz	default
2440MHz	default
2480MHz	default
BT-EDR(2Mbps)	-
2402MHz	default
2440MHz	default
2480MHz	default
BT-EDR(3Mbps)	-
2402MHz	default
2440MHz	default
2480MHz	default

2.3 The Worst Case Measurement Configuration

The Worst Case Mode for Following Conformance Tests	
Tests Item	AC power-line conducted emissions
Condition	AC power-line conducted measurement for line and neutral
Operating Mode	Normal Link
1	FAP-U321EV + WiFi 2.4G+5G+BT , USB R/W + LAN 1Gbps (LAN1 & LAN2) + ADAPTER
2	FAP-U321EV + WiFi 2.4G+5G+BT , USB R/W + LAN 1Gbps (LAN2) + PoE Adapter(LAN1)
3	FAP-U321EV + WiFi 2.4G+5G+BT , USB R/W + LAN 1Gbps (LAN1) + PoE Adapter(LAN2)
4	FAP-U323EV+ WiFi 2.4G+5G+BT , USB R/W + LAN 1Gbps (LAN1 & LAN2) + ADAPTER
Mode 4 configuration was tested and found to be the worst case and measured during the test.	

The Worst Case Mode for Following Conformance Tests	
Tests Item	20dB Bandwidth Carrier Frequency Separation Maximum Conducted Output Power Number of Hopping Frequencies Hopping Bandedge Time of Occupancy (Dwell Time) Emissions in Non-restricted Frequency Bands
Test Condition	Conducted measurement at transmit chains

The Worst Case Mode for Following Conformance Tests		
Tests Item	Emissions in Restricted Frequency Bands	
Test Condition	Radiated measurement If EUT consist of multiple antenna assembly (multiple antenna are used in EUT regardless of spatial multiplexing MIMO configuration), the radiated test should be performed with highest antenna gain of each antenna type.	
Operating Mode	CTX	
1	Adapter mode <FAP-U323EV>	
Orthogonal Planes of EUT	Y Plane	Z Plane
		
Worst Planes of EUT		V



The Worst Case Mode for Following Conformance Tests	
Tests Item	Simultaneous Transmission Analysis
Test Condition	Radiated measurement
Operating Mode	CTX
1	Adapter mode <FAP-U323EV>

Refer to Sporton Test Report No.: FA751119 for Co-location RF Exposure Evaluation and Appendix H for Radiated Emission Co-location.

2.4 Support Equipment

Support Equipment – AC Conduction				
No.	Equipment	Brand Name	Model Name	FCC ID
A	Adapter	NETGEAR	2ABL030F	DoC
B	USB 3.0 Flash Disk	Kingston	DTSE9G2/16GBFR	DoC
Z	Notebook	DELL	VOSTRO 3350	DoC
Z	Notebook	DELL	E5430	DoC
Z	Notebook1(5G)	DELL	P55G	DoC
Z	Notebook2(2.4G)	DELL	VOSTRO 3350	DoC

Support Equipment – RF Conducted				
No.	Equipment	Brand Name	Model Name	FCC ID
1	Notebook	DELL	E5410	DoC
2	Adapter for NB	DELL	HA65NM130	DoC
3	AC Source	GW	APS-9102	-

Support Equipment – Radiated Emission < 1GHz				
No.	Equipment	Brand Name	Model Name	FCC ID
-	-	-	-	-

Support Equipment – Radiated Emission > 1GHz				
No.	Equipment	Brand Name	Model Name	FCC ID
1	AC Adapter for EUT	APD	WA-30J12R	-

Note: Support equipment No.1 was provided by customer.

2.5 Test Setup Diagram

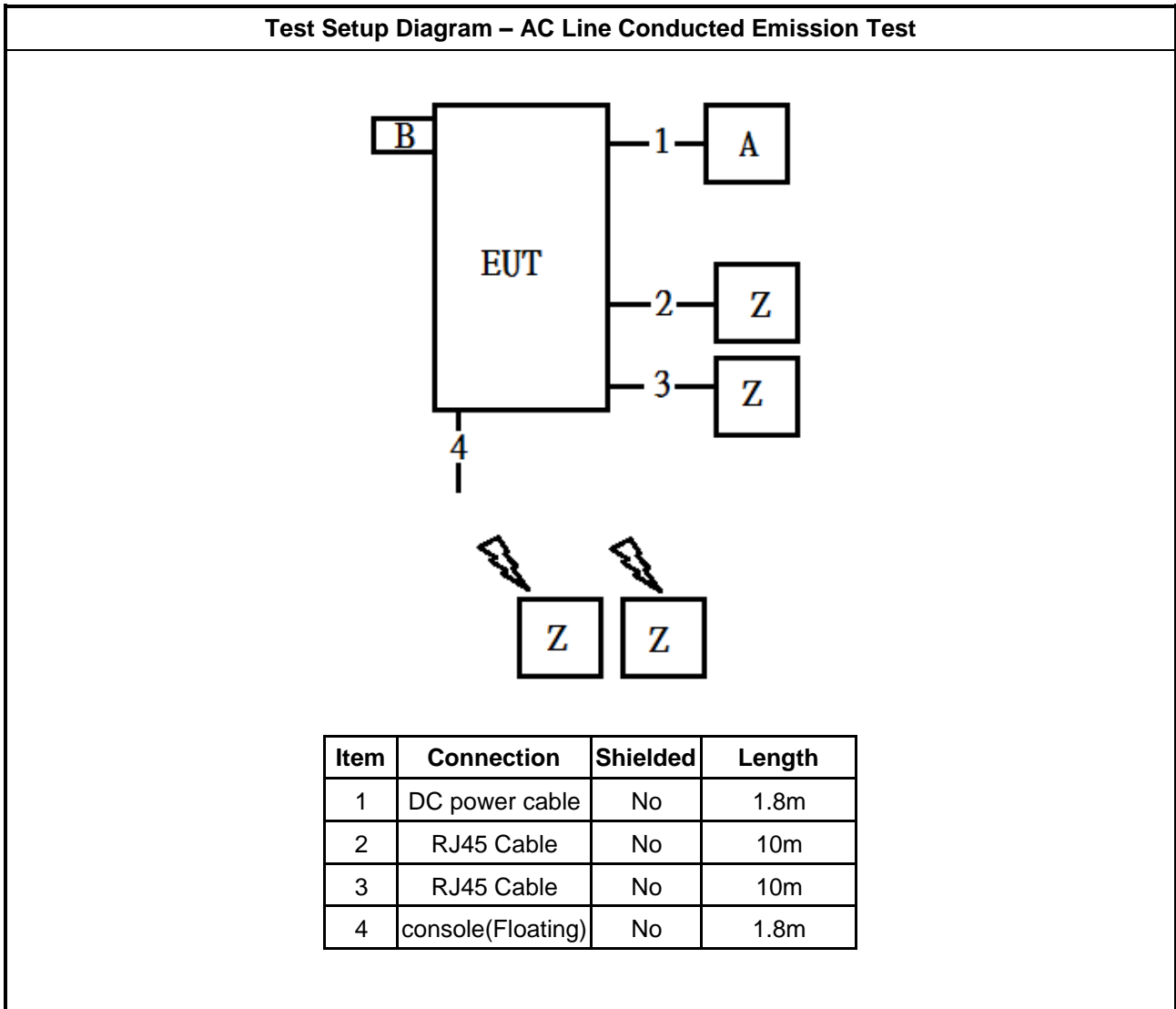

Test Setup Diagram - Radiated Test

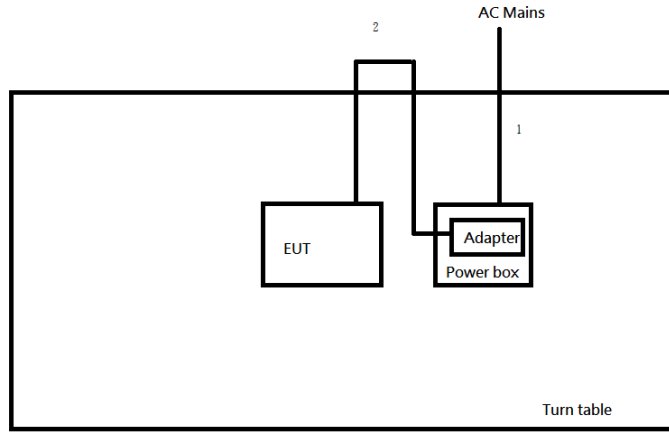

Item	Connection	Shielded	Length
1	AC Power Line	No	1.8m
2	DC Power Line	No	1.5m

3 Transmitter Test Result

3.1 AC Power-line Conducted Emissions

3.1.1 AC Power-line Conducted Emissions Limit

AC Power-line Conducted Emissions Limit		
Frequency Emission (MHz)	Quasi-Peak	Average
0.15-0.5	66 - 56 *	56 - 46 *
0.5-5	56	46
5-30	60	50

Note 1: * Decreases with the logarithm of the frequency.

3.1.2 Measuring Instruments

Refer a test equipment and calibration data table in this test report.

3.1.3 Test Procedures

Test Method
<ul style="list-style-type: none"> Refer as ANSI C63.10-2013, clause 6.2 foray power-line conducted emissions.

3.1.4 Test Setup

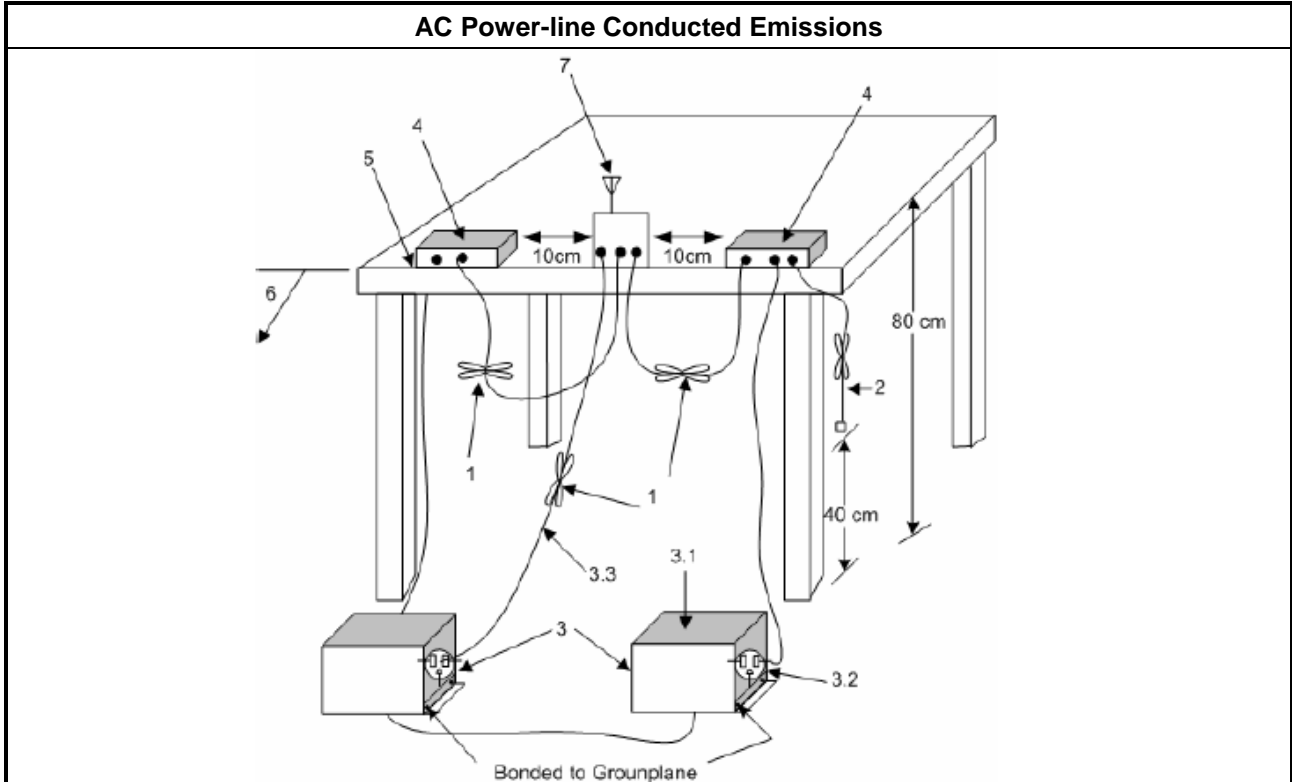

3.1.5 Test Result of AC Power-line Conducted Emissions

Refer as Appendix A

3.2 20dB Bandwidth and Carrier Frequency Separation

3.2.1 20dB Bandwidth and Carrier Frequency Separation Limit

20dB Bandwidth and Carrier Frequency Separation Limit for Frequency Hopping Systems	
<ul style="list-style-type: none"> 902-928 MHz Band: <ul style="list-style-type: none"> $N \geq 50$ and $ChS \geq \text{MAX}$ (20 dB bandwidth, 25 kHz); 20 dB bandwidth \leq 250 kHz. $50 > N \geq 25$ and $ChS \geq \text{MAX}$ (20 dB bandwidth, 25 kHz); 20 dB bandwidth $>$ 250 kHz. 	
<ul style="list-style-type: none"> 2400-2483.5 MHz Band: <ul style="list-style-type: none"> $N \geq 75$ and $ChS \geq \text{MAX}$ (20 dB bandwidth, 25 kHz). $75 > N \geq 15$ and $ChS \geq \text{MAX}$ (20 dB bandwidth 2/3, 25 kHz). 	
<ul style="list-style-type: none"> 5725-5850 MHz Band: <ul style="list-style-type: none"> $N \geq 75$ and $ChS \geq \text{MAX}$ (20 dB bandwidth, 25 kHz); 20 dB bandwidth \leq 1 MHz. 	
<p>N:Number of Hopping Frequencies; ChS: Hopping Channel Separation</p>	

3.2.2 Measuring Instruments

Refer a test equipment and calibration data table in this test report.

3.2.3 Test Procedures

Test Method
<ul style="list-style-type: none"> Refer as ANSI C63.10-2013, clause 6.9.2 for 20 dB bandwidth measurement.
<ul style="list-style-type: none"> Refer as ANSI C63.10-2013, clause 7.8.2 for carrier frequency separation measurement.

3.2.4 Test Setup

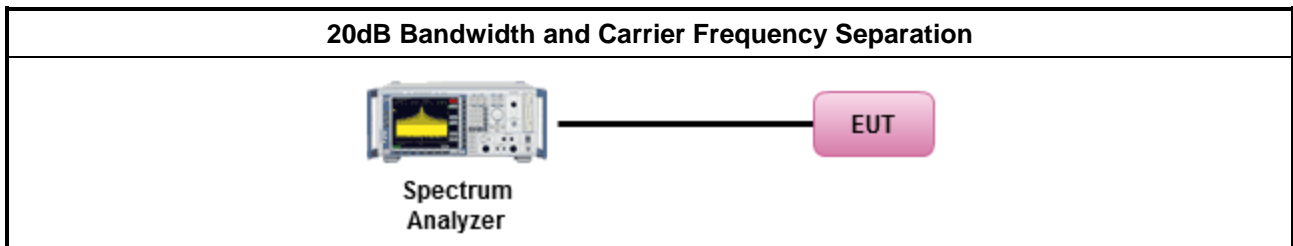

3.2.5 Test Result of 20dB Bandwidth

Refer as Appendix B

3.2.6 Test Result of Carrier Frequency Separation

Refer as Appendix B

3.3 Maximum Conducted Output Power

3.3.1 Maximum Conducted Output Power Limit

Maximum Conducted Output Power Limit	
<ul style="list-style-type: none"> ▪ 902-928 MHz Band: 	
	<ul style="list-style-type: none"> ▪ $N \geq 50$; Power 30dBm; EIRP 36dBm
	<ul style="list-style-type: none"> ▪ $50 > N \geq 25$; Power 24dBm; EIRP 30dBm
<ul style="list-style-type: none"> ▪ 2400-2483.5 MHz Band: 	
	<ul style="list-style-type: none"> ▪ $N \geq 75$; Power 30dBm; EIRP 36dBm
	<ul style="list-style-type: none"> ▪ $75 > N \geq 15$; Power 21dBm; EIRP 27dBm
<ul style="list-style-type: none"> ▪ 5725-5850 MHz Band: 	
	<ul style="list-style-type: none"> ▪ $N \geq 75$; Power 30dBm; EIRP 36dBm
<p>N: Number of Hopping Frequencies</p>	

3.3.2 Measuring Instruments

Refer a test equipment and calibration data table in this test report.

3.3.3 Test Procedures

Test Method
<ul style="list-style-type: none"> ▪ Refer as ANSI C63.10-2013, clause 7.8.5 for output power measurement.

3.3.4 Test Setup

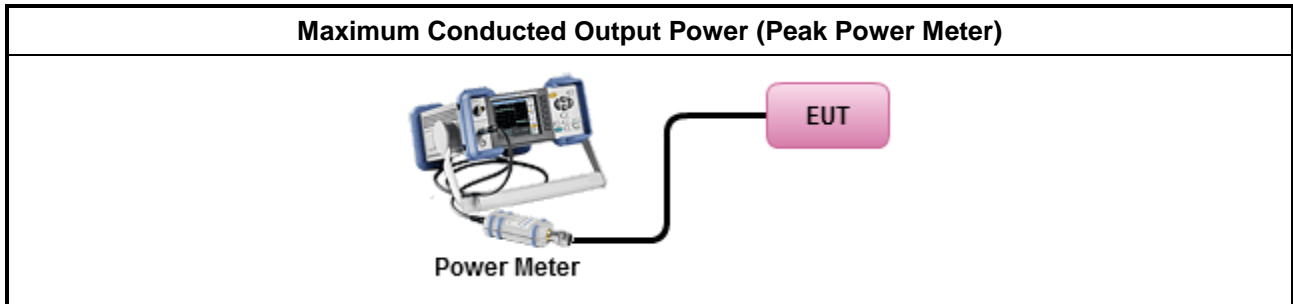

3.3.5 Test Result of Maximum Conducted Output Power

Refer as Appendix C

3.4 Number of Hopping Frequencies and Hopping Bandedge

3.4.1 Number of Hopping Frequencies Limit

Number of Hopping Frequencies Limit	
▪	902-928 MHz Band:
	▪ $N \geq 50$ and $ChS \geq MAX$ (20 dB bandwidth, 25 kHz); 20 dB bandwidth \leq 250 kHz.
	▪ $50 > N \geq 25$ and $ChS \geq MAX$ (20 dB bandwidth, 25 kHz); 20 dB bandwidth $>$ 250 kHz.
▪	2400-2483.5 MHz Band:
	▪ $N \geq 75$ and $ChS \geq MAX$ (20 dB bandwidth, 25 kHz).
	▪ $75 > N \geq 15$ and $ChS \geq MAX$ (20 dB bandwidth 2/3, 25 kHz).
▪	5725-5850 MHz Band:
	▪ $N \geq 75$ and $ChS \geq MAX$ (20 dB bandwidth, 25 kHz); 20 dB bandwidth \leq 1 MHz.
N: Number of Hopping Frequencies; ChS : Hopping Channel Separation	

3.4.2 Hopping Bandedge Limit

Refer clause 3.6.1 and clause 3.7.1

3.4.3 Measuring Instruments

Refer a test equipment and calibration data table in this test report.

3.4.4 Test Procedures

Test Method
▪ Refer as ANSI C63.10-2013, clause 7.8.3 for number of hopping frequencies measurement.
▪ Refer as ANSI C63.10-2013, clause 7.8.6 for hopping frequencies Bandedge measurement.

3.4.5 Test Setup

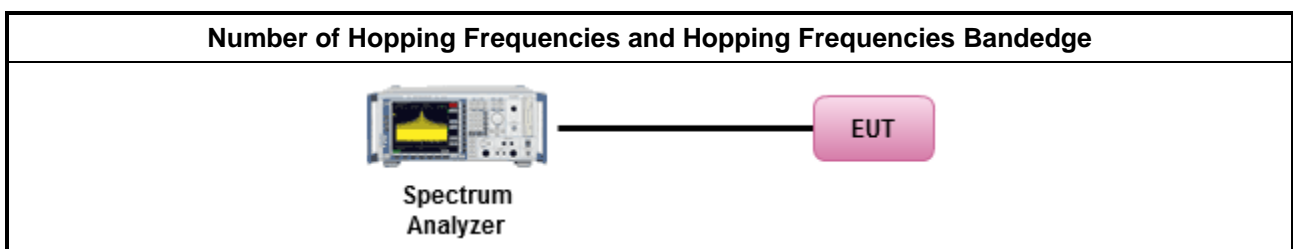

3.4.6 Test Result of Number of Hopping Frequencies

Refer as Appendix D

3.4.7 Test Result of Number of Hopping Frequencies Bandedge

Refer as Appendix D

3.5 Time of Occupancy (Dwell Time)

3.5.1 Time of Occupancy (Dwell Time) Limit

Time of Occupancy (Dwell Time) Limit for Frequency Hopping Systems	
<ul style="list-style-type: none"> 902-928 MHz Band: 	
	<ul style="list-style-type: none"> N ≥ 50; 0.4s in 20s period
	<ul style="list-style-type: none"> 50 > N ≥ 25; 0.4s in 10s period
<ul style="list-style-type: none"> 2400-2483.5 MHz Band: 	
	<ul style="list-style-type: none"> N ≥ 75; 0.4s in N x 0.4 period
	<ul style="list-style-type: none"> 75 > N ≥ 15; 0.4s in N x 0.4 period
<ul style="list-style-type: none"> 5725-5850 MHz Band: 	
	<ul style="list-style-type: none"> N ≥ 75; 0.4s in 30s period
N: Number of Hopping Frequencies	

3.5.2 Measuring Instruments

Refer a test equipment and calibration data table in this test report.

3.5.3 Test Procedures

Test Method	
<ul style="list-style-type: none"> Refer as ANSI C63.10-2013, clause 7.8.4 for dwell time measurement. 	
<ul style="list-style-type: none"> Bluetooth ACL packets can be 1, 3, or 5 time slots. Following as dwell time. Operate DH5 at maximum dwell time and maximum duty cycle. 	
	<ul style="list-style-type: none"> The DH5 packet can cover up to 5 time slots. Operate DH5 at maximum dwell time and maximum duty cycle. A maximum length packet has duration of 5 time slots. The hopping rate is 1600 hops/second so the maximum dwell time is 5/1600 seconds, or 3.125ms. DH5 Packet permit maximum 1600/ 79 / 6 = 3.37 hops per second in each channel.

3.5.4 Test Setup

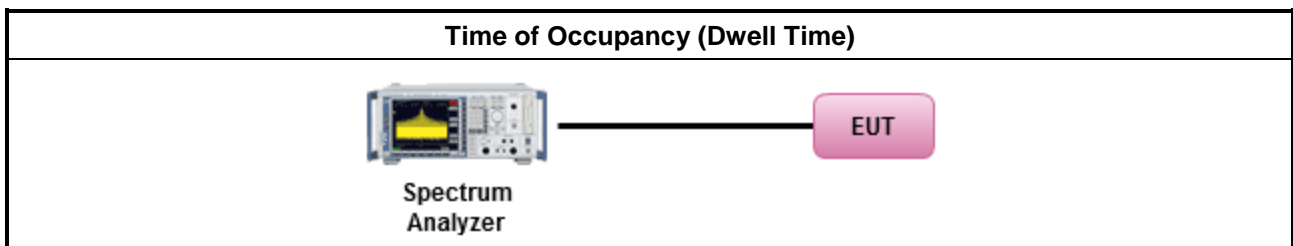

3.5.5 Test Result of Time of Occupancy (Dwell Time)

Refer as Appendix E

3.6 Emissions in Non-restricted Frequency Bands

3.6.1 Emissions in Non-restricted Frequency Bands Limit

Un-restricted Band Emissions Limit	
RF output power procedure	Limit (dB)
Peak output power procedure	20
Note 1: If the peak output power procedure is used to measure the fundamental emission power to demonstrate compliance to requirements, then the peak conducted output power measured within any 100 kHz outside the authorized frequency band shall be attenuated by at least 20 dB relative to the maximum measured in-band peak PSD level.	

3.6.2 Measuring Instruments

Refer a test equipment and calibration data table in this test report.

3.6.3 Test Procedures

Test Method
<ul style="list-style-type: none"> Refer as ANSI C63.10-2013, clause 7.8.8 for unwanted emissions into non-restricted bands.

3.6.4 Test Setup

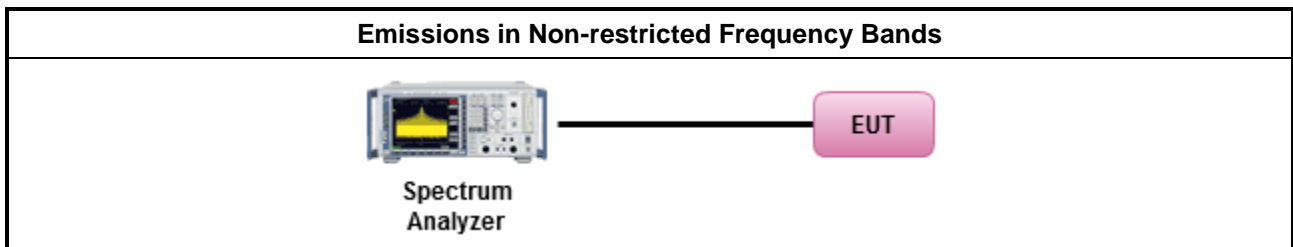

3.6.5 Test Result of Emissions in Non-restricted Frequency Bands

Refer as Appendix F

3.7 Emissions in Restricted Frequency Bands

3.7.1 Emissions in Restricted Frequency Bands Limit

Restricted Band Emissions Limit			
Frequency Range (MHz)	Field Strength (uV/m)	Field Strength (dBuV/m)	Measure Distance (m)
0.009~0.490	2400/F(kHz)	48.5 - 13.8	300
0.490~1.705	24000/F(kHz)	33.8 - 23	30
1.705~30.0	30	29	30
30~88	100	40	3
88~216	150	43.5	3
216~960	200	46	3
Above 960	500	54	3

Note 1: Test distance for frequencies at or above 30 MHz, measurements may be performed at a distance other than the limit distance provided they are not performed in the near field and the emissions to be measured can be detected by the measurement equipment. When performing measurements at a distance other than that specified, the results shall be extrapolated to the specified distance using an extrapolation factor of 20 dB/decade (inverse of linear distance for field-strength measurements, inverse of linear distance-squared for power-density measurements).

Note 2: Test distance for frequencies at below 30 MHz, measurements may be performed at a distance closer than the EUT limit distance; however, an attempt should be made to avoid making measurements in the near field. When performing measurements below 30 MHz at a closer distance than the limit distance, the results shall be extrapolated to the specified distance by either making measurements at a minimum of two or more distances on at least one radial to determine the proper extrapolation factor or by using the square of an inverse linear distance extrapolation factor (40 dB / decade). The test report shall specify the extrapolation method used to determine compliance of the EUT.

3.7.2 Measuring Instruments

Refer a test equipment and calibration data table in this test report.

3.7.3 Test Procedures

Test Method	
	<ul style="list-style-type: none"> ▪ The average emission levels shall be measured in [hopping duty factor].
	<ul style="list-style-type: none"> ▪ Refer as ANSI C63.10; clause 6.9.2.2 band-edge testing shall be performed at the lowest frequency channel and highest frequency channel within the allowed operating band.
	<ul style="list-style-type: none"> ▪ For the transmitter unwanted emissions shall be measured using following options below: <ul style="list-style-type: none"> ▪ Refer as ANSI C63.10, clause 4.1.4.2.1 QP value. ▪ Refer as ANSI C63.10, clause 4.1.4.2.2 measurement procedure peak. ▪ Refer as ANSI C63.10, clause 4.1.4.2.4 average value of hopping pulsed emissions.

3.7.4 Test Setup

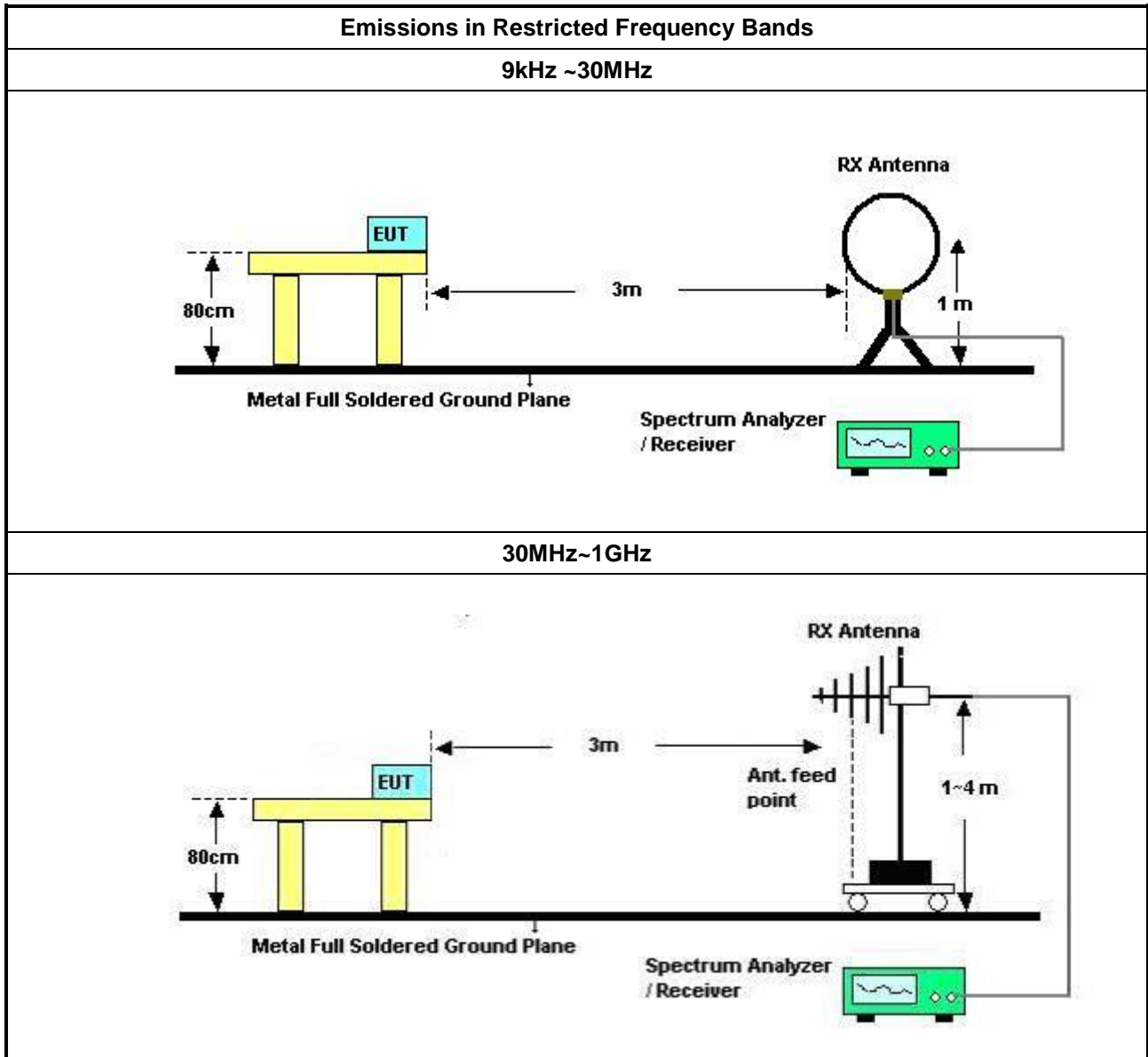

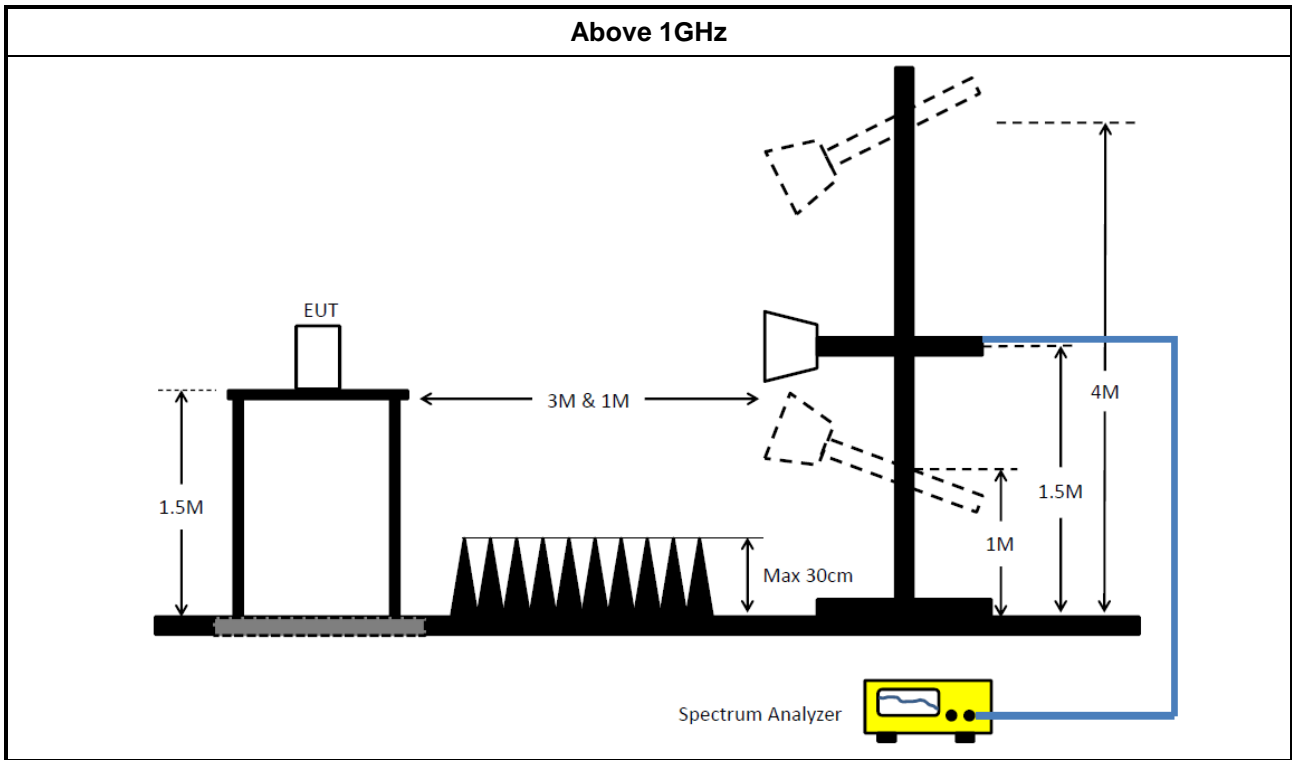

3.7.5 Test Result of Emissions in Restricted Frequency Bands (Below 30MHz)

The amplitude of spurious emissions which are attenuated by more than 20dB below the permissible value has no need to be reported. All amplitude of spurious emissions that are attenuated by more than 20 dB below the permissible value has no need to be reported.

3.7.6 Test Result of Emissions in Restricted Frequency Bands

Refer as Appendix G



4 Test Equipment and Calibration Data

Instrument for AC Conduction

Instrument	Manufacturer	Model No.	Serial No.	Spec.	Calibration Date	Calibration Due Date
EMC Receiver	R&S	ESR3	102051	9kHz ~ 3.6GHz	29/Apr/2017	28/Apr/2018
LISN	R&S	ENV216	101295	9kHz ~ 30MHz	15/Nov/2016	14/Nov/2017
RF Cable-CON	HUBER+SUHNER	RG213/U	07611832020001	9kHz ~ 30MHz	24/Oct/2016	23/Oct/2017
Impedance Stabilization Network	TESEQ	ISN T800	30330	9kHz ~ 30MHz	13/Apr/2017	12/Apr/2018
Impuls Begrenzer Pulse Limiter	R&S	ESH3-Z2	100921	10 kHz ~ 30 MHz	20/Oct/2016	19/Oct/2017

Instrument for Conducted Test

Instrument	Manufacturer	Model No.	Serial No.	Spec.	Calibration Date	Calibration Due Date
Spectrum Analyzer	R&S	FSV 40	101013	10Hz~40GHz	30/Dec/2016	29/Dec/2017
Power Sensor	Anritsu	MA2411B	1027452	300MHz ~ 40GHz	24/Feb/2017	23/Feb/2018
Power Meter	Anritsu	ML2495A	1124009	300MHz ~ 40GHz	24/Feb/2017	23/Feb/2018
Signal Generator	R&S	SMR40	100116	10MHz ~ 40GHz	21/Jul/2016	20/Jul/2017
RF Cable-0.2m	HUBER+SUHNER	SUCOFLEX_104	MY677/3	30MHz~26.5GHz	02/Oct/2016	01/Oct/2017
RF Cable-0.2m	HUBER+SUHNER	SUCOFLEX_104	MY678/3	30MHz~26.5GHz	02/Oct/2016	01/Oct/2017
RF Cable-0.5m	HUBER+SUHNER	SUCOFLEX_104	MY10717/4	30MHz~26.5GHz	02/Oct/2016	01/Oct/2017

Instrument for Radiated Test < 1GHz

Instrument	Manufacturer	Model No.	Serial No.	Spec.	Calibration Date	Calibration Due Date
3m Semi Anechoic Chamber	TDK	SAC-3M	03CH09-HY	30MHz ~ 1GHz	25/Apr/2017	24/Apr/2018
Amplifier	EMC	EMC9135	980232	9KHz~1GHz	25/Apr/2017	24/Apr/2018
Spectrum Analyzer	KEYSIGHT	N9010A	MY54200885	10Hz ~ 44GHz	20/Jul/2017	19/Jul/2018
Bilog Antenna	TESEQ	CBL 6111D	35418	30MHz~1GHz	01/Oct/2016	30/Sep/2017
Loop Antenna	R&S	HFH2-Z2	100330	9 kHz~30 MHz	10/Nov/2016	09/Nov/2017
RF Cable-R03m	Jye Bao	RG142	CB021	9kHz ~ 1GHz	02/Feb/2017	01/Feb/2018
Receiver	R&S	ESU-26	100422/026	20Hz ~ 26.5GHz	21/Sep/2016	20/Sep/2017



Instrument for Radiated Test > 1GHz

Instrument	Manufacturer	Model No.	Serial No.	Spec.	Calibration Date	Calibration Due Date
3m Semi Anechoic Chamber	TDK	SAC-3M	03CH09-HY	1GHz ~ 18GHz	18/Jun/2017	17/Jun/2018
Amplifier	Agilent	8449B	3008A02096	1GHz ~ 26.5GHz	25/Apr/2017	24/Apr/2018
Spectrum Analyzer	KEYSIGHT	N9010A	MY54200885	10Hz ~ 44GHz	04/Jul/2016	03/Jul/2017
Horn Antenna	SCHWARZBECK	BBHA 9120D	BBHA9120D 1534	1GHz~18GHz	28/Apr/2017	27/Apr/2018
Horn Antenna	SCHWARZBECK	BBHA9170	BBHA9170614	18GHz ~ 40GHz	06/Feb/2017	05/Feb/2018
RF Cable-high	Jye Bao	RG142	03CH09-HY	1GHz ~ 40GHz	23/Jul/2016	22/Jul/2017



AC Power-line Conducted Emissions Result																																																																																																																																		
Operating Mode	4	Power Phase	Neutral																																																																																																																															
Operating Function	FAP-U323EV+ WiFi 2.4G+5G+BT , USB R/W + LAN 1Gbps (LAN1 & LAN2) + ADAPTER																																																																																																																																	
<div style="text-align: right;">Date: 2017-06-22</div>																																																																																																																																		
	<table border="1"> <thead> <tr> <th></th> <th>Freq</th> <th>Level</th> <th>Over Limit</th> <th>Limit Line</th> <th>Read Level</th> <th>LISM Factor</th> <th>Cable Loss</th> <th>Remark</th> </tr> <tr> <th></th> <th>MHz</th> <th>dBuV</th> <th>dB</th> <th>dBuV</th> <th>dBuV</th> <th>dB</th> <th>dB</th> <th></th> </tr> </thead> <tbody> <tr><td>1</td><td>0.16</td><td>34.61</td><td>-20.95</td><td>55.56</td><td>24.77</td><td>9.61</td><td>0.23</td><td>Average</td></tr> <tr><td>2</td><td>0.16</td><td>43.23</td><td>-22.33</td><td>65.56</td><td>33.39</td><td>9.61</td><td>0.23</td><td>QP</td></tr> <tr><td>3</td><td>0.21</td><td>37.60</td><td>-15.80</td><td>53.40</td><td>27.64</td><td>9.67</td><td>0.29</td><td>Average</td></tr> <tr><td>4</td><td>0.21</td><td>43.14</td><td>-20.26</td><td>63.40</td><td>33.18</td><td>9.67</td><td>0.29</td><td>QP</td></tr> <tr><td>5 MAX</td><td>0.30</td><td>41.70</td><td>-8.58</td><td>50.28</td><td>31.87</td><td>9.65</td><td>0.18</td><td>Average</td></tr> <tr><td>6</td><td>0.30</td><td>43.46</td><td>-16.82</td><td>60.28</td><td>33.63</td><td>9.65</td><td>0.18</td><td>QP</td></tr> <tr><td>7</td><td>0.33</td><td>36.67</td><td>-12.90</td><td>49.57</td><td>26.87</td><td>9.64</td><td>0.16</td><td>Average</td></tr> <tr><td>8</td><td>0.33</td><td>39.77</td><td>-19.80</td><td>59.57</td><td>29.97</td><td>9.64</td><td>0.16</td><td>QP</td></tr> <tr><td>9</td><td>2.25</td><td>18.44</td><td>-27.56</td><td>46.00</td><td>8.51</td><td>9.66</td><td>0.27</td><td>Average</td></tr> <tr><td>10</td><td>2.25</td><td>27.61</td><td>-28.39</td><td>56.00</td><td>17.68</td><td>9.66</td><td>0.27</td><td>QP</td></tr> <tr><td>11</td><td>9.91</td><td>21.46</td><td>-28.54</td><td>50.00</td><td>11.52</td><td>9.74</td><td>0.20</td><td>Average</td></tr> <tr><td>12</td><td>9.91</td><td>26.43</td><td>-33.57</td><td>60.00</td><td>16.49</td><td>9.74</td><td>0.20</td><td>QP</td></tr> </tbody> </table>		Freq	Level	Over Limit	Limit Line	Read Level	LISM Factor	Cable Loss	Remark		MHz	dBuV	dB	dBuV	dBuV	dB	dB		1	0.16	34.61	-20.95	55.56	24.77	9.61	0.23	Average	2	0.16	43.23	-22.33	65.56	33.39	9.61	0.23	QP	3	0.21	37.60	-15.80	53.40	27.64	9.67	0.29	Average	4	0.21	43.14	-20.26	63.40	33.18	9.67	0.29	QP	5 MAX	0.30	41.70	-8.58	50.28	31.87	9.65	0.18	Average	6	0.30	43.46	-16.82	60.28	33.63	9.65	0.18	QP	7	0.33	36.67	-12.90	49.57	26.87	9.64	0.16	Average	8	0.33	39.77	-19.80	59.57	29.97	9.64	0.16	QP	9	2.25	18.44	-27.56	46.00	8.51	9.66	0.27	Average	10	2.25	27.61	-28.39	56.00	17.68	9.66	0.27	QP	11	9.91	21.46	-28.54	50.00	11.52	9.74	0.20	Average	12	9.91	26.43	-33.57	60.00	16.49	9.74	0.20	QP			
	Freq	Level	Over Limit	Limit Line	Read Level	LISM Factor	Cable Loss	Remark																																																																																																																										
	MHz	dBuV	dB	dBuV	dBuV	dB	dB																																																																																																																											
1	0.16	34.61	-20.95	55.56	24.77	9.61	0.23	Average																																																																																																																										
2	0.16	43.23	-22.33	65.56	33.39	9.61	0.23	QP																																																																																																																										
3	0.21	37.60	-15.80	53.40	27.64	9.67	0.29	Average																																																																																																																										
4	0.21	43.14	-20.26	63.40	33.18	9.67	0.29	QP																																																																																																																										
5 MAX	0.30	41.70	-8.58	50.28	31.87	9.65	0.18	Average																																																																																																																										
6	0.30	43.46	-16.82	60.28	33.63	9.65	0.18	QP																																																																																																																										
7	0.33	36.67	-12.90	49.57	26.87	9.64	0.16	Average																																																																																																																										
8	0.33	39.77	-19.80	59.57	29.97	9.64	0.16	QP																																																																																																																										
9	2.25	18.44	-27.56	46.00	8.51	9.66	0.27	Average																																																																																																																										
10	2.25	27.61	-28.39	56.00	17.68	9.66	0.27	QP																																																																																																																										
11	9.91	21.46	-28.54	50.00	11.52	9.74	0.20	Average																																																																																																																										
12	9.91	26.43	-33.57	60.00	16.49	9.74	0.20	QP																																																																																																																										
Note 1: ">20dB" means emission levels that exceed the level of 20 dB below the applicable limit. Note 2: "N/F" means Nothing Found emissions (No emissions were detected.)																																																																																																																																		



AC Power-line Conducted Emissions Result																																																																																																																																	
Operating Mode	4	Power Phase	Line																																																																																																																														
Operating Function	FAP-U323EV+ WiFi 2.4G+5G+BT , USB R/W + LAN 1Gbps (LAN1 & LAN2) + ADAPTER																																																																																																																																
Date: 2017-06-22																																																																																																																																	
<table border="1"> <thead> <tr> <th></th> <th>Freq</th> <th>Level</th> <th>Over Limit</th> <th>Limit Line</th> <th>Read Level</th> <th>LISN Factor</th> <th>Cable Loss</th> <th>Remark</th> </tr> <tr> <th></th> <th>MHz</th> <th>dBuV</th> <th>dB</th> <th>dBuV</th> <th>dBuV</th> <th>dB</th> <th>dB</th> <th></th> </tr> </thead> <tbody> <tr> <td>1</td> <td>0.16</td> <td>34.98</td> <td>-20.40</td> <td>55.38</td> <td>25.08</td> <td>9.66</td> <td>0.24</td> <td>Average</td> </tr> <tr> <td>2</td> <td>0.16</td> <td>44.69</td> <td>-20.69</td> <td>65.38</td> <td>34.79</td> <td>9.66</td> <td>0.24</td> <td>QP</td> </tr> <tr> <td>3</td> <td>0.21</td> <td>38.85</td> <td>-14.47</td> <td>53.32</td> <td>28.91</td> <td>9.65</td> <td>0.29</td> <td>Average</td> </tr> <tr> <td>4</td> <td>0.21</td> <td>44.62</td> <td>-18.70</td> <td>63.32</td> <td>34.68</td> <td>9.65</td> <td>0.29</td> <td>QP</td> </tr> <tr> <td>5 MAX</td> <td>0.30</td> <td>45.06</td> <td>-5.22</td> <td>50.28</td> <td>35.21</td> <td>9.67</td> <td>0.18</td> <td>Average</td> </tr> <tr> <td>6</td> <td>0.30</td> <td>46.63</td> <td>-13.65</td> <td>60.28</td> <td>36.78</td> <td>9.67</td> <td>0.18</td> <td>QP</td> </tr> <tr> <td>7</td> <td>0.32</td> <td>40.73</td> <td>-8.98</td> <td>49.71</td> <td>30.89</td> <td>9.67</td> <td>0.17</td> <td>Average</td> </tr> <tr> <td>8</td> <td>0.32</td> <td>43.84</td> <td>-15.87</td> <td>59.71</td> <td>34.00</td> <td>9.67</td> <td>0.17</td> <td>QP</td> </tr> <tr> <td>9</td> <td>0.34</td> <td>35.22</td> <td>-13.91</td> <td>49.13</td> <td>25.41</td> <td>9.67</td> <td>0.14</td> <td>Average</td> </tr> <tr> <td>10</td> <td>0.34</td> <td>39.36</td> <td>-19.77</td> <td>59.13</td> <td>29.55</td> <td>9.67</td> <td>0.14</td> <td>QP</td> </tr> <tr> <td>11</td> <td>9.55</td> <td>22.31</td> <td>-27.69</td> <td>50.00</td> <td>12.38</td> <td>9.74</td> <td>0.19</td> <td>Average</td> </tr> <tr> <td>12</td> <td>9.55</td> <td>27.29</td> <td>-32.71</td> <td>60.00</td> <td>17.36</td> <td>9.74</td> <td>0.19</td> <td>QP</td> </tr> </tbody> </table>					Freq	Level	Over Limit	Limit Line	Read Level	LISN Factor	Cable Loss	Remark		MHz	dBuV	dB	dBuV	dBuV	dB	dB		1	0.16	34.98	-20.40	55.38	25.08	9.66	0.24	Average	2	0.16	44.69	-20.69	65.38	34.79	9.66	0.24	QP	3	0.21	38.85	-14.47	53.32	28.91	9.65	0.29	Average	4	0.21	44.62	-18.70	63.32	34.68	9.65	0.29	QP	5 MAX	0.30	45.06	-5.22	50.28	35.21	9.67	0.18	Average	6	0.30	46.63	-13.65	60.28	36.78	9.67	0.18	QP	7	0.32	40.73	-8.98	49.71	30.89	9.67	0.17	Average	8	0.32	43.84	-15.87	59.71	34.00	9.67	0.17	QP	9	0.34	35.22	-13.91	49.13	25.41	9.67	0.14	Average	10	0.34	39.36	-19.77	59.13	29.55	9.67	0.14	QP	11	9.55	22.31	-27.69	50.00	12.38	9.74	0.19	Average	12	9.55	27.29	-32.71	60.00	17.36	9.74	0.19	QP
	Freq	Level	Over Limit	Limit Line	Read Level	LISN Factor	Cable Loss	Remark																																																																																																																									
	MHz	dBuV	dB	dBuV	dBuV	dB	dB																																																																																																																										
1	0.16	34.98	-20.40	55.38	25.08	9.66	0.24	Average																																																																																																																									
2	0.16	44.69	-20.69	65.38	34.79	9.66	0.24	QP																																																																																																																									
3	0.21	38.85	-14.47	53.32	28.91	9.65	0.29	Average																																																																																																																									
4	0.21	44.62	-18.70	63.32	34.68	9.65	0.29	QP																																																																																																																									
5 MAX	0.30	45.06	-5.22	50.28	35.21	9.67	0.18	Average																																																																																																																									
6	0.30	46.63	-13.65	60.28	36.78	9.67	0.18	QP																																																																																																																									
7	0.32	40.73	-8.98	49.71	30.89	9.67	0.17	Average																																																																																																																									
8	0.32	43.84	-15.87	59.71	34.00	9.67	0.17	QP																																																																																																																									
9	0.34	35.22	-13.91	49.13	25.41	9.67	0.14	Average																																																																																																																									
10	0.34	39.36	-19.77	59.13	29.55	9.67	0.14	QP																																																																																																																									
11	9.55	22.31	-27.69	50.00	12.38	9.74	0.19	Average																																																																																																																									
12	9.55	27.29	-32.71	60.00	17.36	9.74	0.19	QP																																																																																																																									
<p>Note 1: ">20dB" means emission levels that exceed the level of 20 dB below the applicable limit. Note 2: "N/F" means Nothing Found emissions (No emissions were detected.)</p>																																																																																																																																	



Summary

Mode	Max-N dB (Hz)	Max-OBW (Hz)	ITU-Code	Min-N dB (Hz)	Min-OBW (Hz)
BT-BR(1Mbps)	-	-	-	-	-
2.4-2.4835GHz	937.5k	890.805k	891kF1D	918.75k	885.807k
BT-EDR(2Mbps)	-	-	-	-	-
2.4-2.4835GHz	1.335M	1.227M	1M23G1D	1.331M	1.222M
BT-EDR(3Mbps)	-	-	-	-	-
2.4-2.4835GHz	1.331M	1.223M	1M22G1D	1.284M	1.221M

Max-N dB = Maximum 20dB down bandwidth; **Max-OBW** = Maximum 99% occupied bandwidth;
Min-N dB = Minimum 20dB down bandwidth; **Min-OBW** = Minimum 99% occupied bandwidth;

Result

Mode	Result	Limit (Hz)	Port 1-N dB (Hz)	Port 1-OBW (Hz)
BT-BR(1Mbps)	-	-	-	-
2402MHz_TnomVnom	Pass	Inf	937.5k	885.807k
2440MHz_TnomVnom	Pass	Inf	918.75k	890.805k
2480MHz_TnomVnom	Pass	Inf	920k	888.306k
BT-EDR(2Mbps)	-	-	-	-
2402MHz_TnomVnom	Pass	Inf	1.331M	1.227M
2440MHz_TnomVnom	Pass	Inf	1.334M	1.224M
2480MHz_TnomVnom	Pass	Inf	1.335M	1.222M
BT-EDR(3Mbps)	-	-	-	-
2402MHz_TnomVnom	Pass	Inf	1.284M	1.222M
2440MHz_TnomVnom	Pass	Inf	1.331M	1.223M
2480MHz_TnomVnom	Pass	Inf	1.301M	1.221M

Port X-N dB = Port X 20dB down bandwidth; **Port X-OBW** = Port X 99% occupied bandwidth;

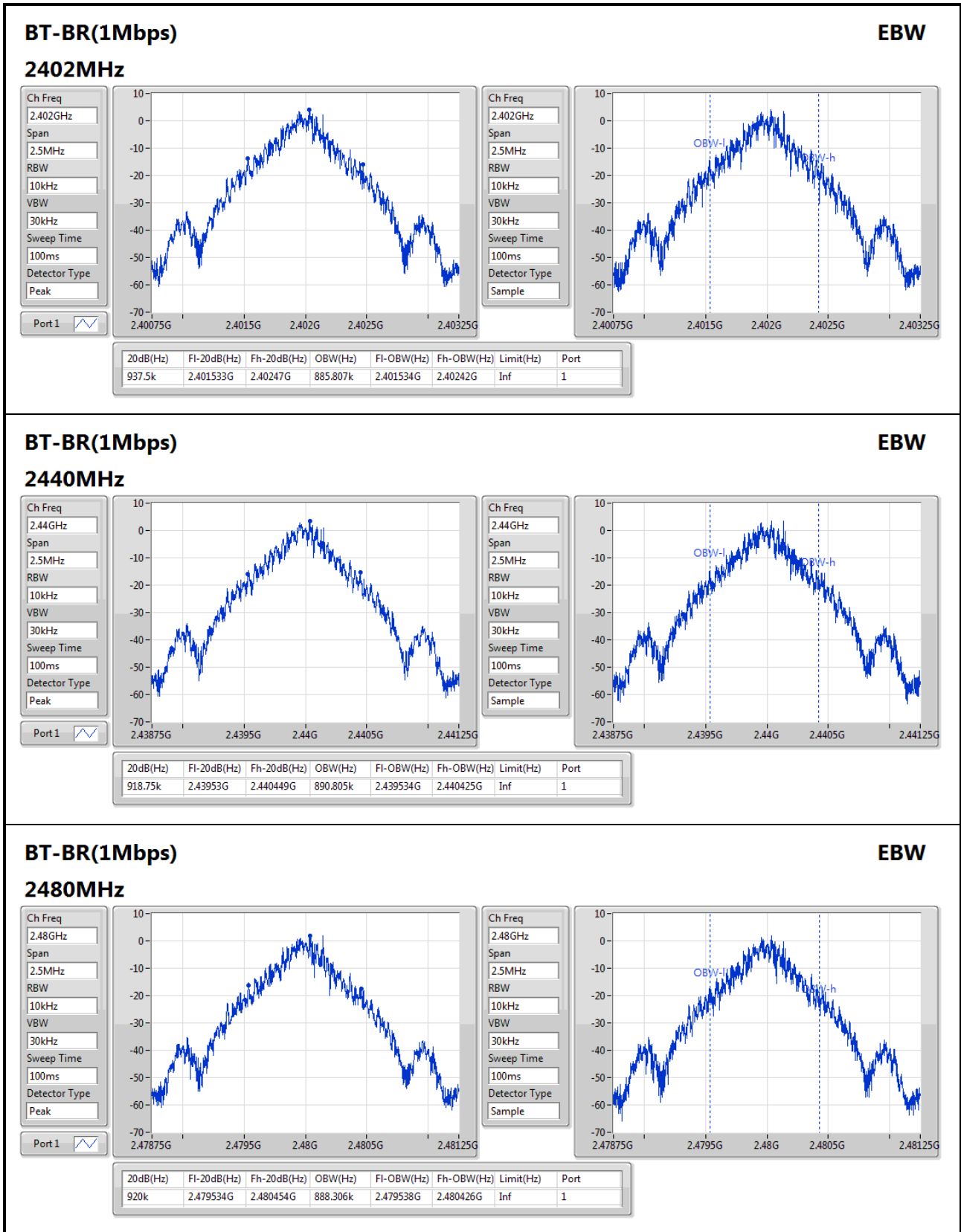

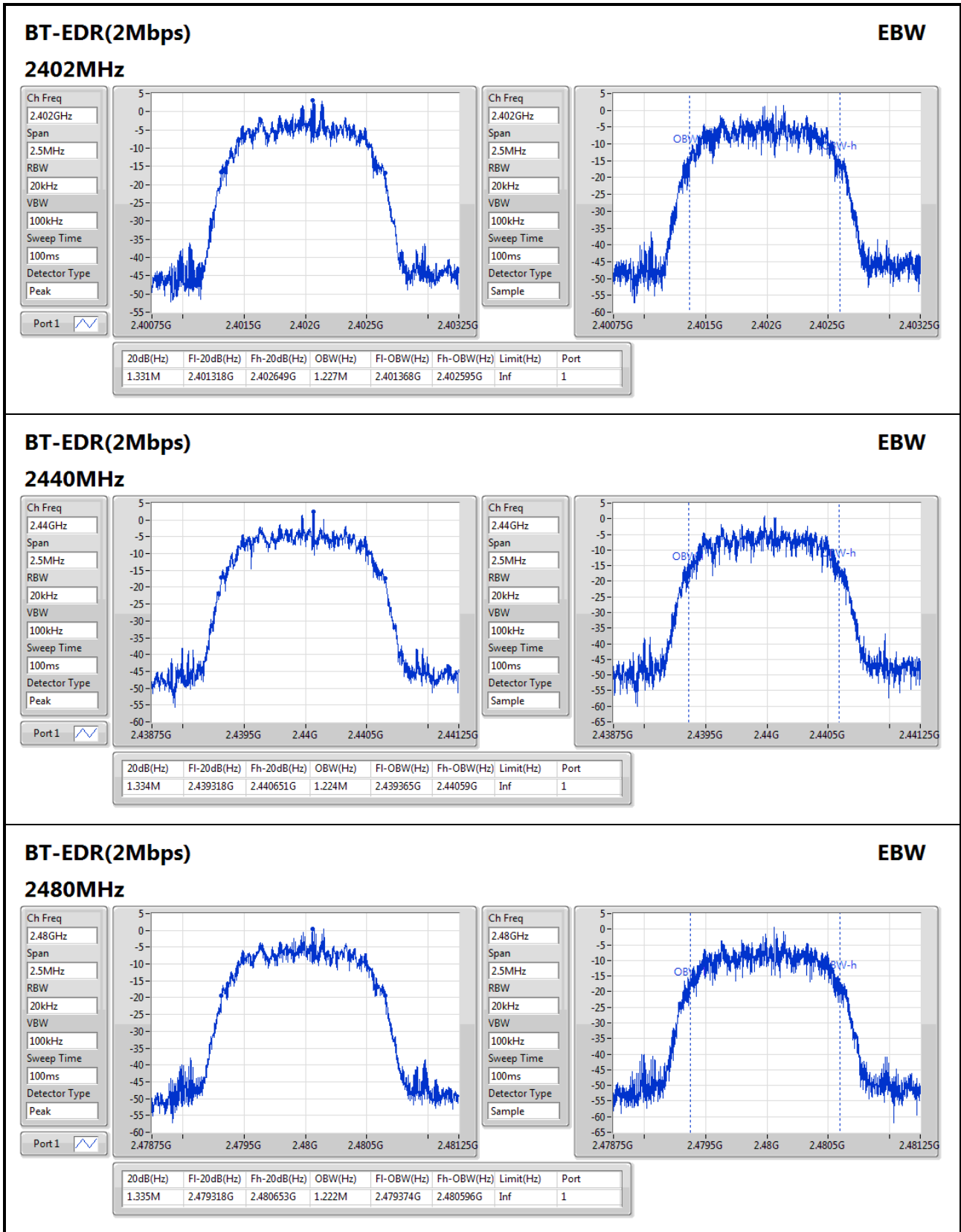

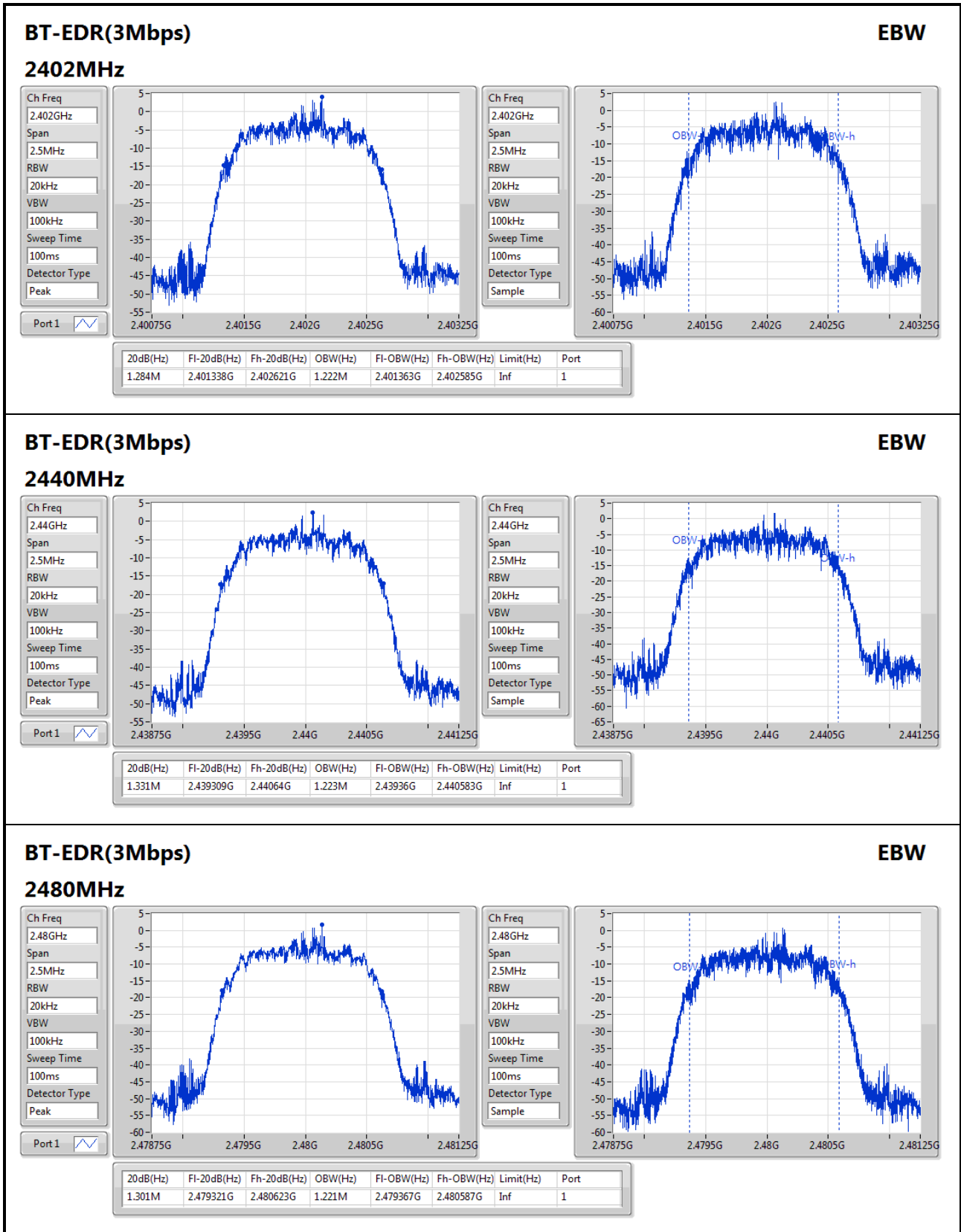



Summary

Mode	Max-Space (Hz)	Min-Space (Hz)
BT-BR(1Mbps)	-	-
2.4-2.4835GHz	1.002M	1.0005M
BT-EDR(2Mbps)	-	-
2.4-2.4835GHz	1.0035M	999k
BT-EDR(3Mbps)	-	-
2.4-2.4835GHz	1.002M	997.5k

Result

Mode	Result	Fl (Hz)	Fh (Hz)	Ch.Space (Hz)	Limit (Hz)
BT-BR(1Mbps)	-	-	-	-	-
2402MHz_TnomVnom	Pass	2.402134G	2.403135G	1.0005M	624.375k
2440MHz_TnomVnom	Pass	2.440136G	2.441136G	1.0005M	477.855k
2480MHz_TnomVnom	Pass	2.479137G	2.480139G	1.002M	612.72k
BT-EDR(2Mbps)	-	-	-	-	-
2402MHz_TnomVnom	Pass	2.402067G	2.403066G	999k	886.446k
2440MHz_TnomVnom	Pass	2.440071G	2.441072G	1.0005M	666k
2480MHz_TnomVnom	Pass	2.47907G	2.480073G	1.0035M	889.11k
BT-EDR(3Mbps)	-	-	-	-	-
2402MHz_TnomVnom	Pass	2.402134G	2.403135G	1.0005M	855.144k
2440MHz_TnomVnom	Pass	2.440134G	2.441136G	1.002M	666k
2480MHz_TnomVnom	Pass	2.47914G	2.480138G	997.5k	866.466k

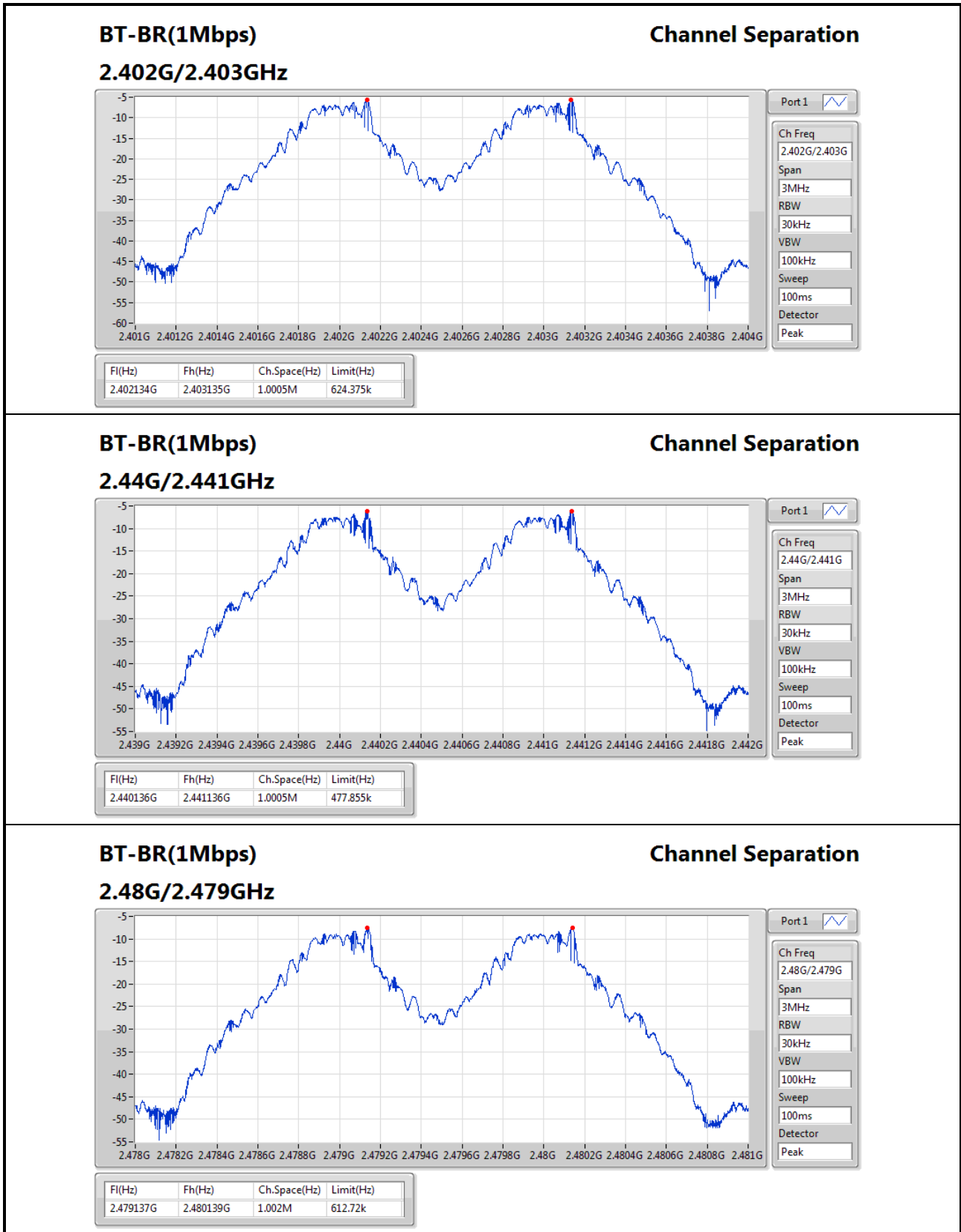

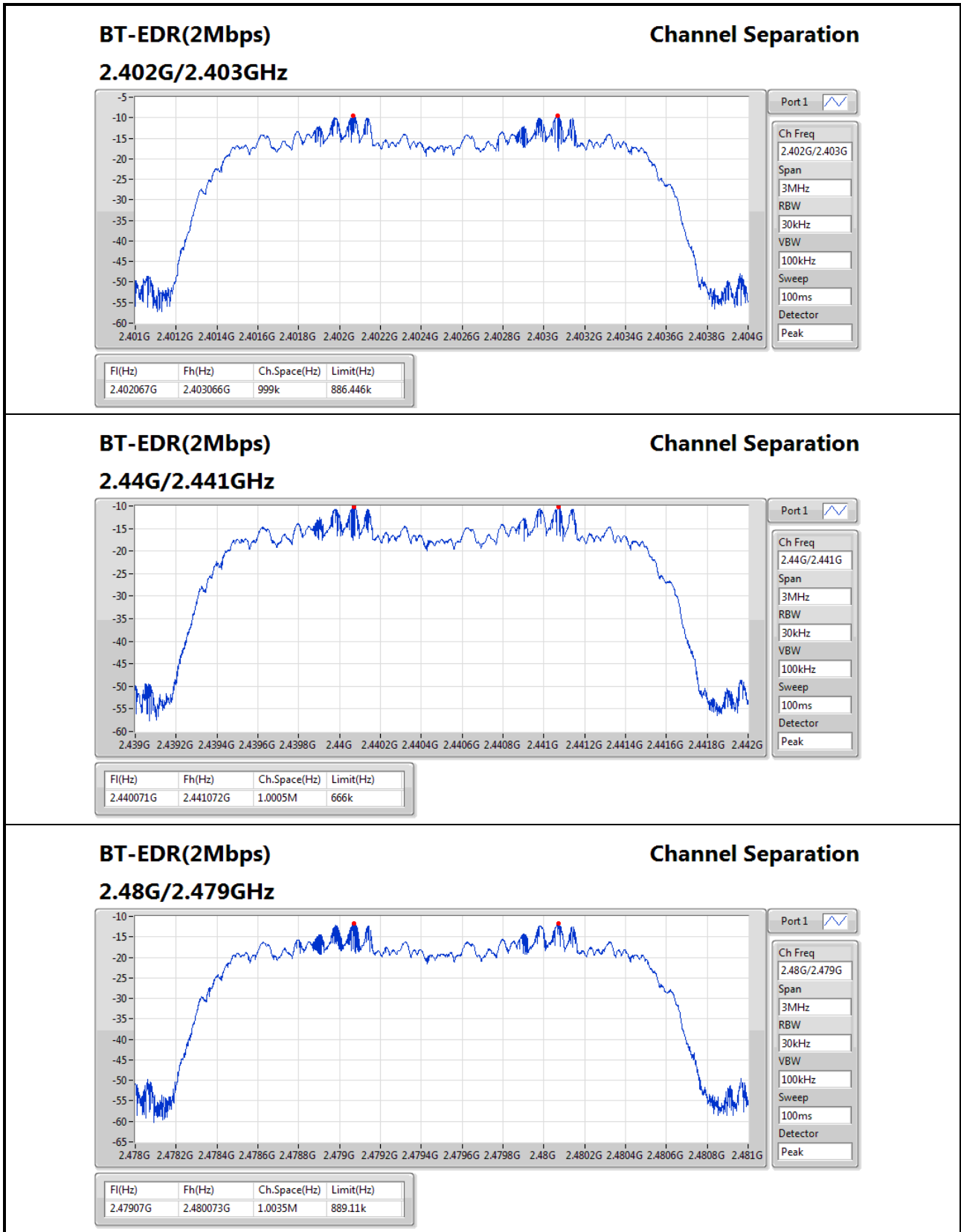

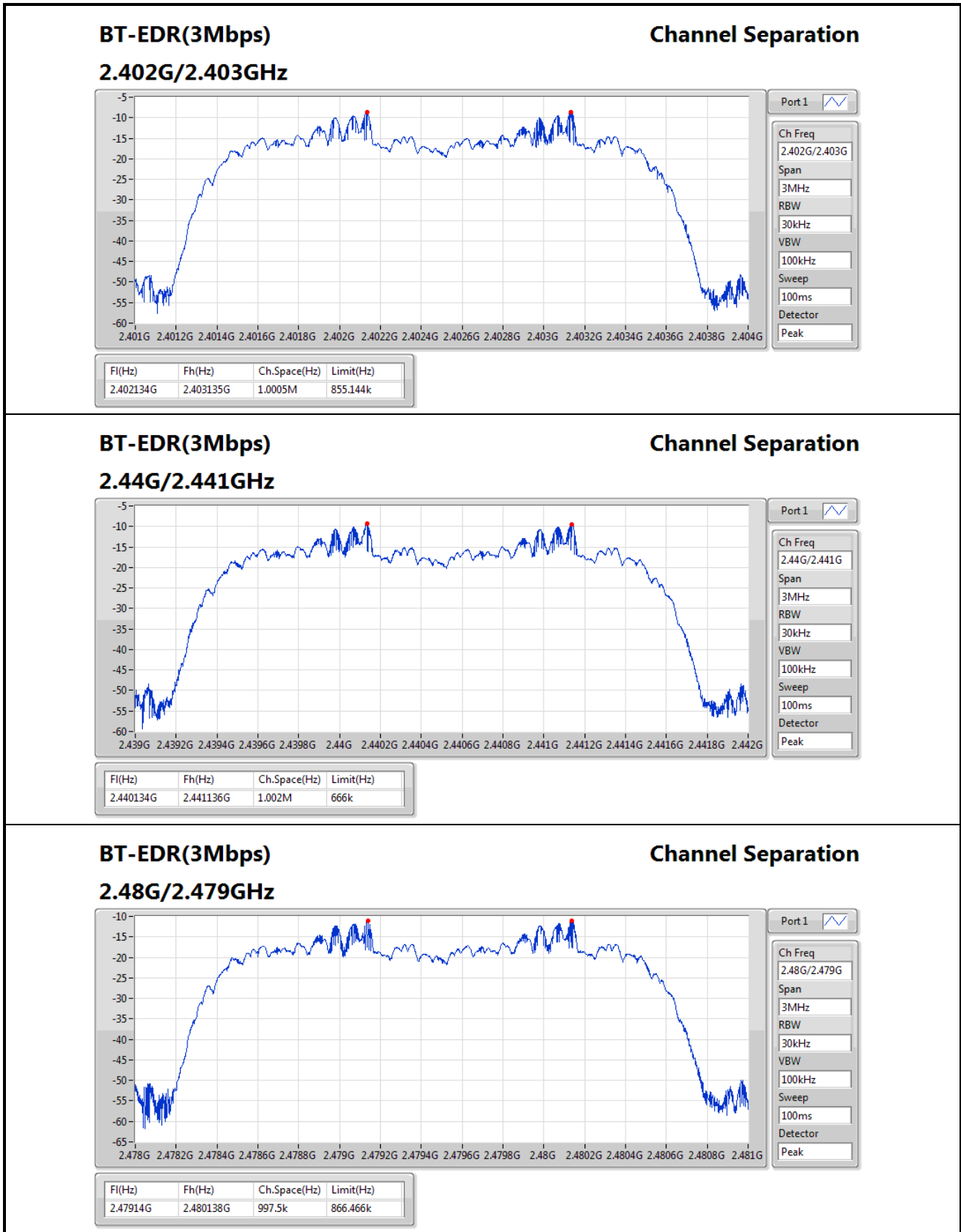



Summary

Mode	Power (dBm)	Power (W)
BT-BR(1Mbps)	-	-
2.4-2.4835GHz	10.13	0.0103
BT-EDR(2Mbps)	-	-
2.4-2.4835GHz	9.60	0.00912
BT-EDR(3Mbps)	-	-
2.4-2.4835GHz	9.77	0.00948

Result

Mode	Result	Gain (dBi)	Power (dBm)	Power Limit (dBm)
BT-BR(1Mbps)	-	-	-	-
2402MHz	Pass	4.50	10.13	21.00
2440MHz	Pass	4.50	9.65	21.00
2480MHz	Pass	4.50	8.26	21.00
BT-EDR(2Mbps)	-	-	-	-
2402MHz	Pass	4.50	9.60	21.00
2440MHz	Pass	4.50	9.10	21.00
2480MHz	Pass	4.50	7.60	21.00
BT-EDR(3Mbps)	-	-	-	-
2402MHz	Pass	4.50	9.77	21.00
2440MHz	Pass	4.50	9.27	21.00
2480MHz	Pass	4.50	7.77	21.00



Summary

Mode	Power (dBm)	Power (W)
BT-BR(1Mbps)	-	-
2.4-2.4835GHz	9.85	0.00966
BT-EDR(2Mbps)	-	-
2.4-2.4835GHz	7.10	0.00513
BT-EDR(3Mbps)	-	-
2.4-2.4835GHz	7.07	0.00509

Result

Mode	Result	Gain (dBi)	Power (dBm)	Power Limit (dBm)
BT-BR(1Mbps)	-	-	-	-
2402MHz	Pass	4.50	9.85	21.00
2440MHz	Pass	4.50	9.36	21.00
2480MHz	Pass	4.50	7.99	21.00
BT-EDR(2Mbps)	-	-	-	-
2402MHz	Pass	4.50	7.10	21.00
2440MHz	Pass	4.50	6.51	21.00
2480MHz	Pass	4.50	4.93	21.00
BT-EDR(3Mbps)	-	-	-	-
2402MHz	Pass	4.50	7.07	21.00
2440MHz	Pass	4.50	6.54	21.00
2480MHz	Pass	4.50	4.95	21.00



Summary

Mode	Max-Hop No
BT-BR(1Mbps)	-
2.4-2.4835GHz	79
BT-EDR(2Mbps)	-
2.4-2.4835GHz	79
BT-EDR(3Mbps)	-
2.4-2.4835GHz	79

Result

Mode	Result	Hopping No	Limit
BT-BR(1Mbps)	-	-	-
2440MHz_TnomVnom	Pass	79	15
BT-EDR(2Mbps)	-	-	-
2440MHz_TnomVnom	Pass	79	15
BT-EDR(3Mbps)	-	-	-
2440MHz_TnomVnom	Pass	79	15



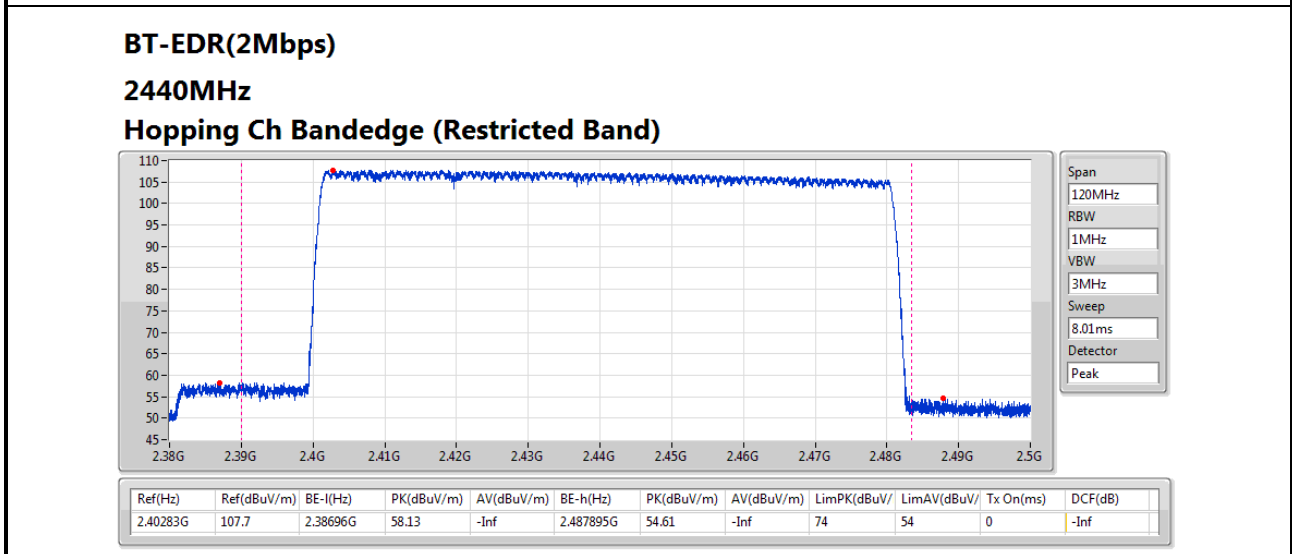
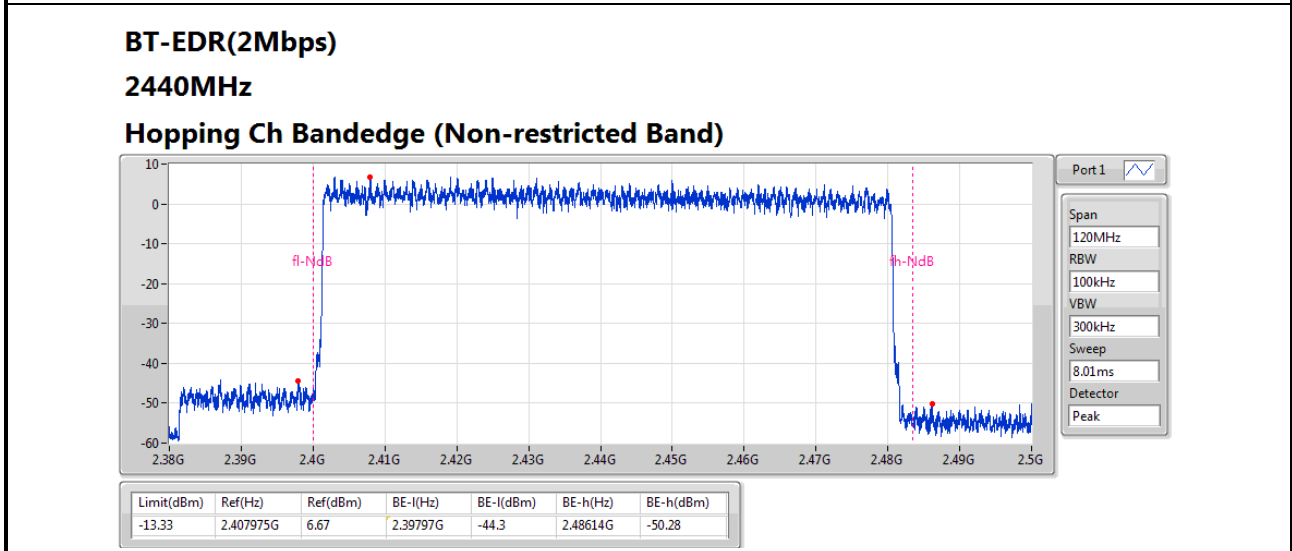
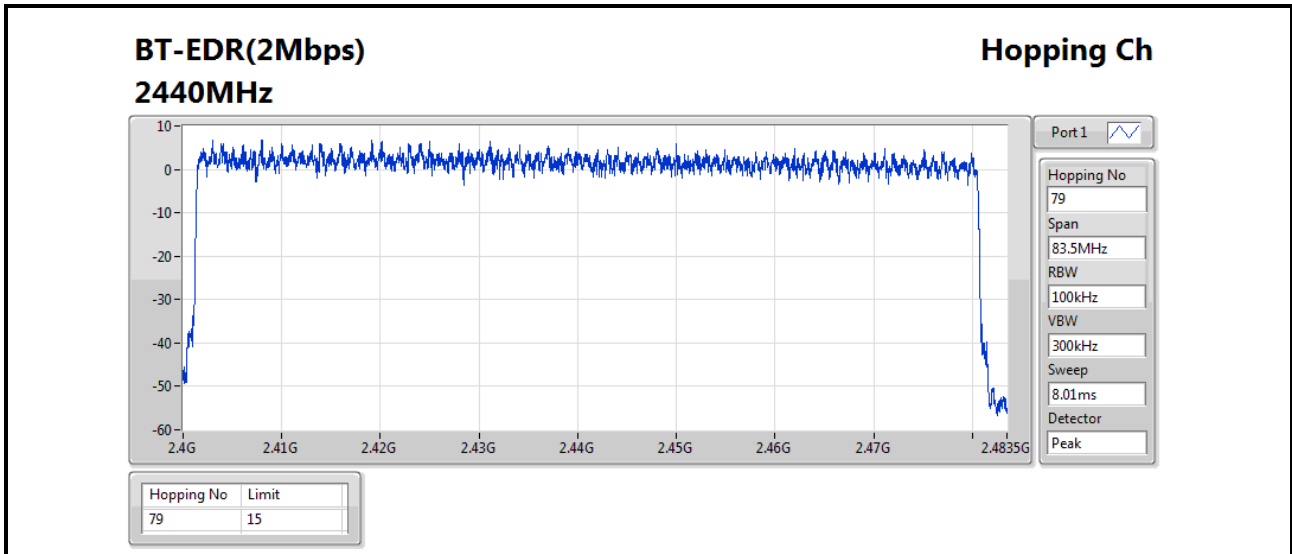

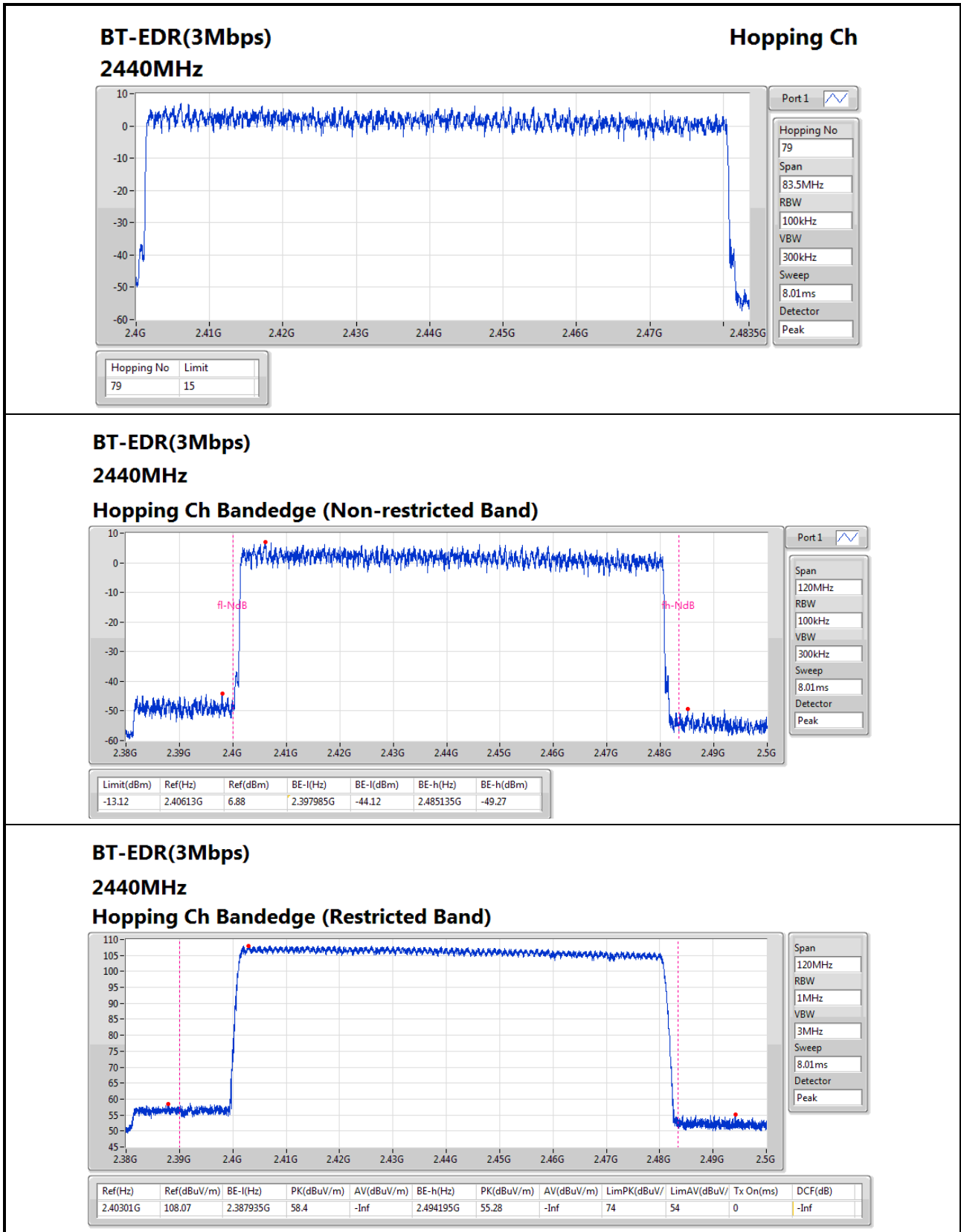



Summary

Mode	Max-Dwell (s)
BT-BR(1Mbps)	-
2.4-2.4835GHz	308.2872m
BT-EDR(2Mbps)	-
2.4-2.4835GHz	308.5004m
BT-EDR(3Mbps)	-
2.4-2.4835GHz	308.8202m

Result

Mode	Result	Period (s)	Dwell (s)	Limit (s)	Tx On (s)
BT-BR(1Mbps)	-	-	-	-	-
2440MHz_TnomVnom	Pass	31.6	308.2872m	400m	2.892m
BT-EDR(2Mbps)	-	-	-	-	-
2440MHz_TnomVnom	Pass	31.6	308.5004m	400m	2.894m
BT-EDR(3Mbps)	-	-	-	-	-
2440MHz_TnomVnom	Pass	31.6	308.8202m	400m	2.897m

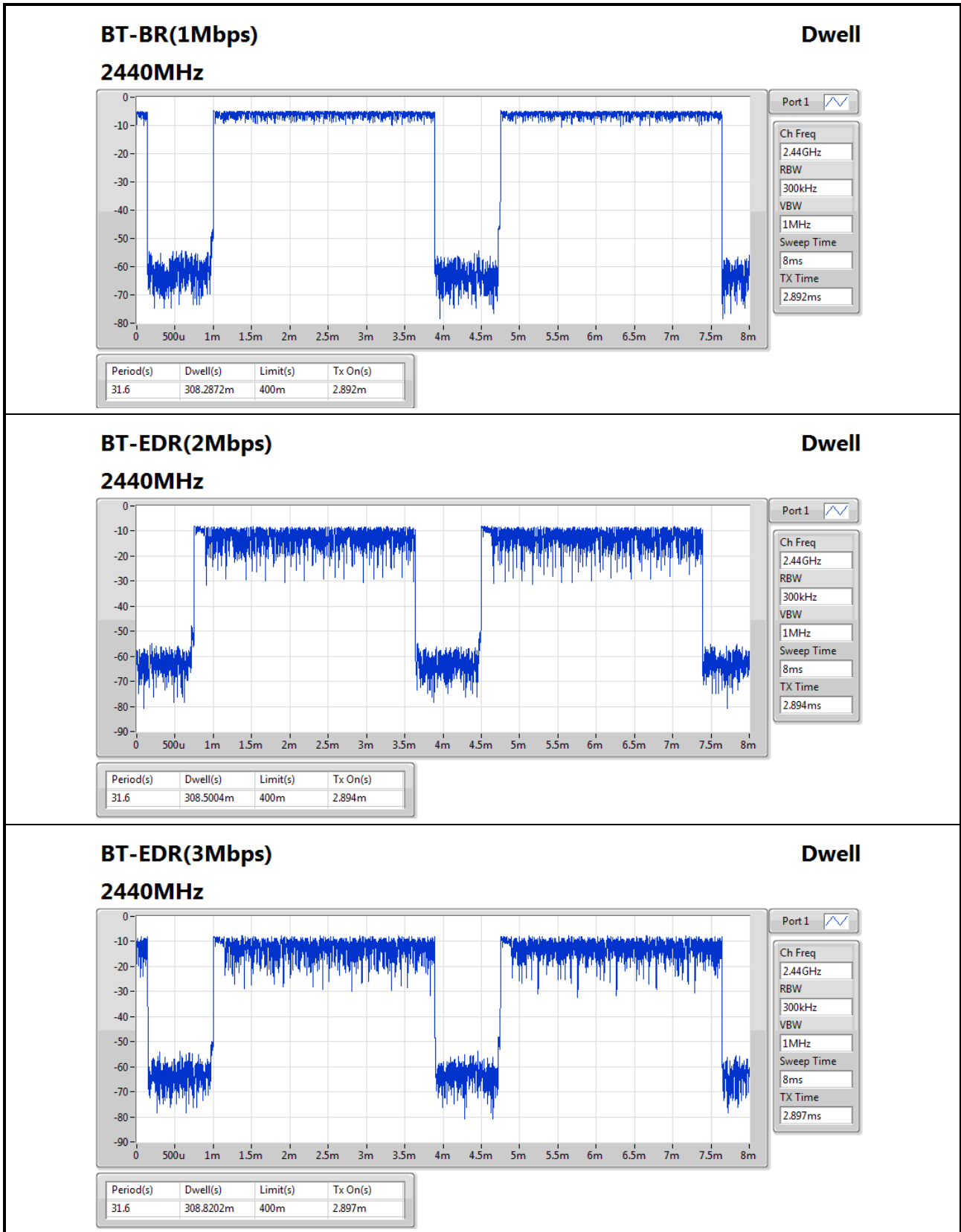



Summary

Mode	Result	Ref (Hz)	Ref (dBm)	Limit (dBm)	Freq (Hz)	Level (dBm)	Freq (Hz)	Level (dBm)	Freq (Hz)	Level (dBm)	Freq (Hz)	Level (dBm)	Port
BT-EDR(2Mbps)	-	-	-	-	-	-	-	-	-	-	-	-	-
2.4-2.4835GHz	Pass	2.401837G	4.38	-15.62	624.368M	-58.83	2.399964G	-48.39	2.484512G	-55.30	5.184426G	-51.53	1

Result

Mode	Result	Ref (Hz)	Ref (dBm)	Limit (dBm)	Freq (Hz)	Level (dBm)	Freq (Hz)	Level (dBm)	Freq (Hz)	Level (dBm)	Freq (Hz)	Level (dBm)	Port
BT-BR(1Mbps)	-	-	-	-	-	-	-	-	-	-	-	-	-
2402MHz_TnomVnom	Pass	2.402004G	9.27	-10.73	2.002544G	-57.24	2.399988G	-48.68	2.484052G	-56.65	6.853313G	-52.73	1
2440MHz_TnomVnom	Pass	2.44008G	8.97	-11.03	1.880592G	-58.30	2.399984G	-52.81	2.48544G	-56.30	15.265293G	-52.28	1
2480MHz_TnomVnom	Pass	2.479993G	7.24	-12.76	1.984784G	-57.84	2.39996G	-55.63	2.48486G	-55.16	2.499572G	-50.00	1
BT-EDR(2Mbps)	-	-	-	-	-	-	-	-	-	-	-	-	-
2402MHz_TnomVnom	Pass	2.401837G	4.38	-15.62	624.368M	-58.83	2.399964G	-48.39	2.484512G	-55.30	5.184426G	-51.53	1
2440MHz_TnomVnom	Pass	2.44008G	5.69	-14.31	2.390896G	-58.32	2.399984G	-55.44	2.483944G	-55.58	6.909599G	-51.91	1
2480MHz_TnomVnom	Pass	2.479993G	2.38	-17.62	2.394448G	-58.06	2.398128G	-56.03	2.483724G	-54.35	24.361151G	-52.26	1
BT-EDR(3Mbps)	-	-	-	-	-	-	-	-	-	-	-	-	-
2402MHz_TnomVnom	Pass	2.401837G	5.02	-14.98	743.952M	-57.05	2.39996G	-49.15	2.483772G	-56.61	6.236979G	-52.74	1
2440MHz_TnomVnom	Pass	2.439913G	3.61	-16.39	1.621296G	-57.97	2.399932G	-55.57	2.483572G	-55.71	6.819541G	-53.15	1
2480MHz_TnomVnom	Pass	2.48016G	2.99	-17.01	1.946896G	-58.12	2.3997G	-56.83	2.4837G	-55.24	6.82517G	-52.33	1

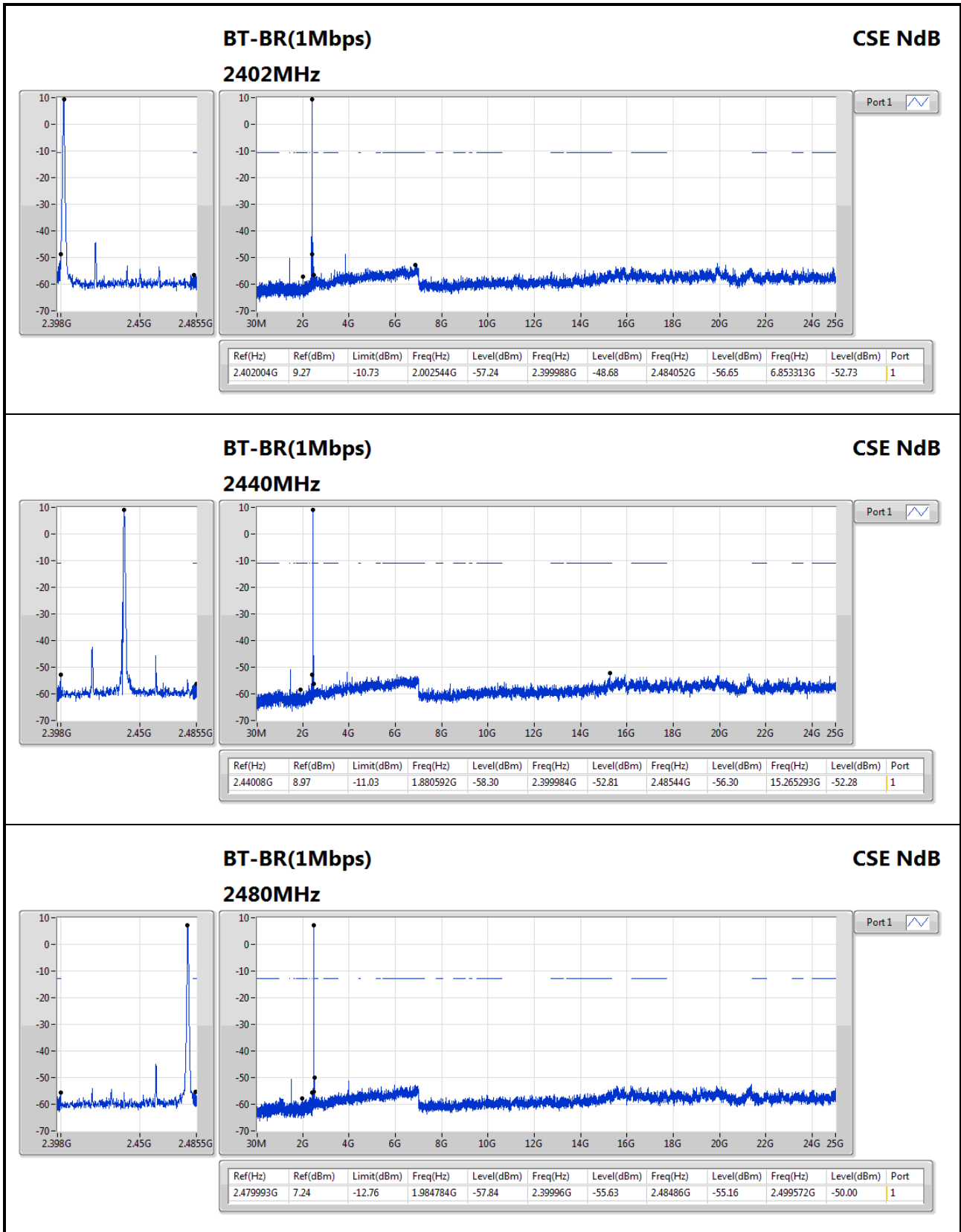

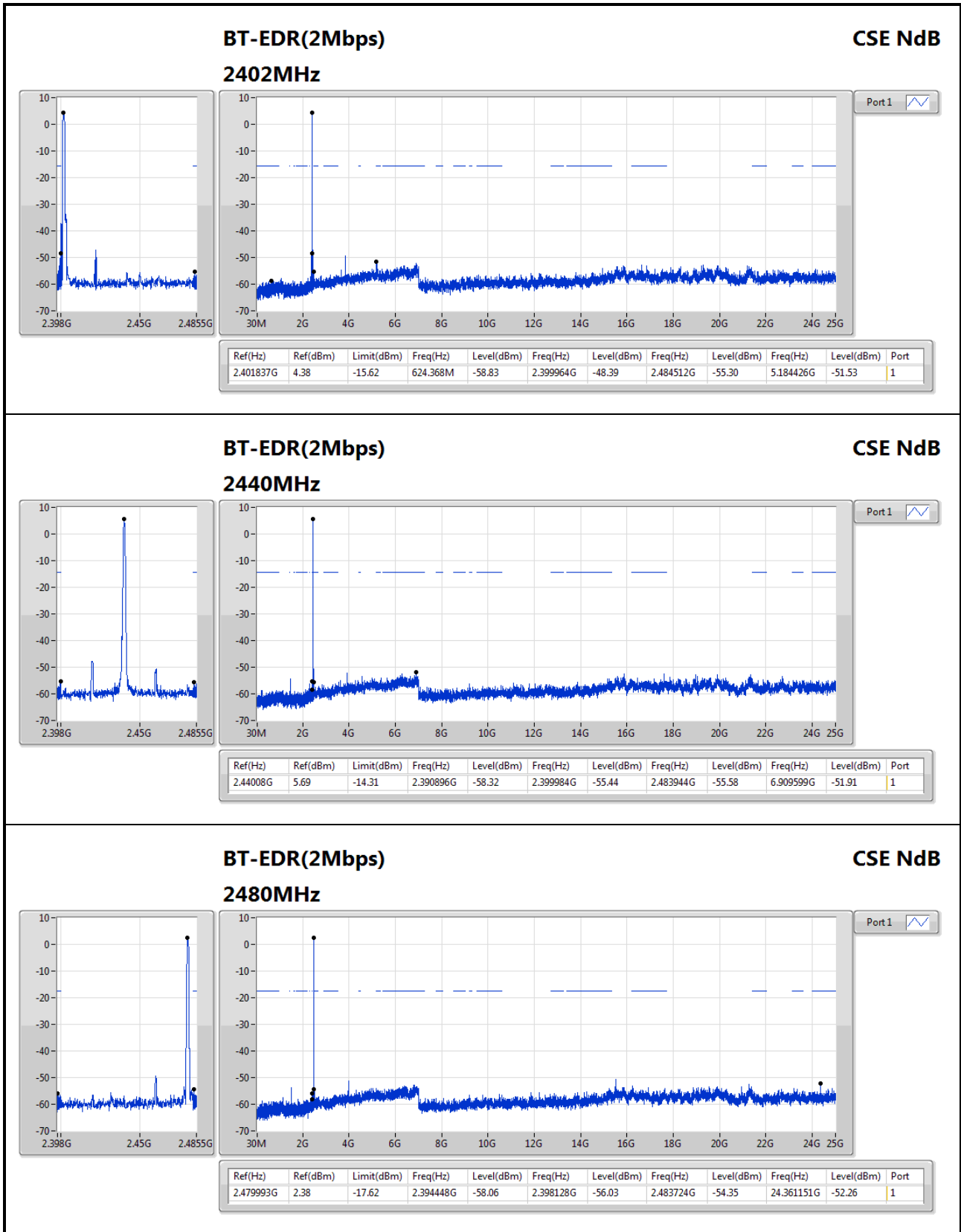

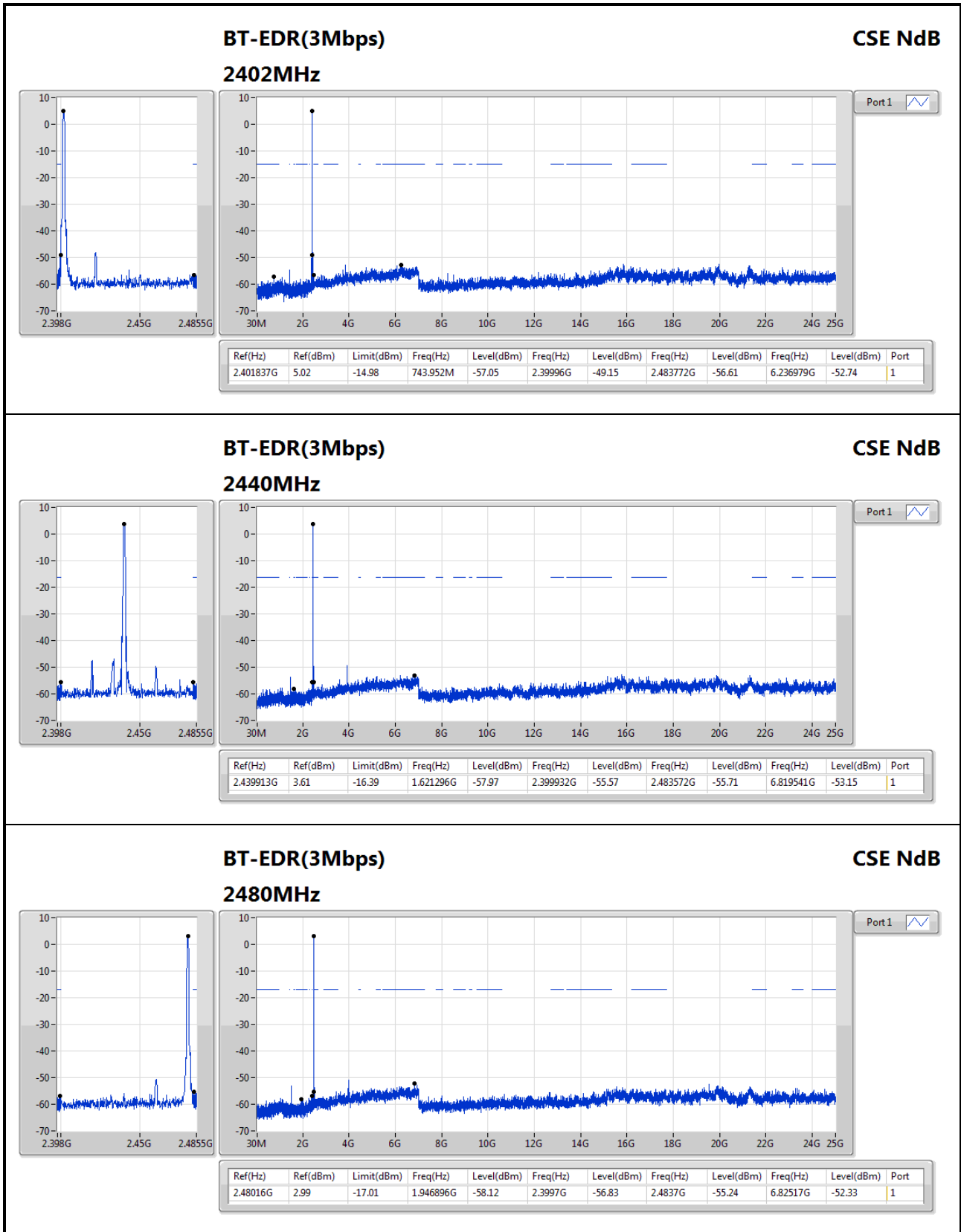



Summary

Mode	Result	Type	Freq (Hz)	Level (dBuV/m)	Limit (dBuV/m)	Margin (dB)	Factor (dB)	Dist (m)	Condition	Azimuth (°)	Height (m)	Comments
2.4-2.4835GHz	-	-	-	-	-	-	-	-	-	-	-	-
BT-EDR(3Mbps)	Pass	PK	951.5M	33.13	46.00	-12.87	-2.41	3	Vertical	360	1.00	-



Result

Mode	Result	Type	Freq (Hz)	Level (dBuV/m)	Limit (dBuV/m)	Margin (dB)	Factor (dB)	Dist (m)	Condition	Azimuth (°)	Height (m)	Comments
BT-EDR(3Mbps)	-	-	-	-	-	-	-	-	-	-	-	-
2441MHz	Pass	PK	30M	15.96	40.00	-24.04	-14.06	3	Horizontal	0	1.00	-
2441MHz	Pass	PK	134.76M	13.43	43.50	-30.07	-18.27	3	Horizontal	0	1.00	-
2441MHz	Pass	PK	229.82M	13.10	46.00	-32.90	-18.82	3	Horizontal	0	1.00	-
2441MHz	Pass	PK	559.62M	24.42	46.00	-21.58	-8.03	3	Horizontal	0	1.00	-
2441MHz	Pass	PK	743.92M	26.55	46.00	-19.45	-6.19	3	Horizontal	0	1.00	-
2441MHz	Pass	PK	918.52M	29.52	46.00	-16.48	-3.87	3	Horizontal	0	1.00	-
2441MHz	Pass	PK	134.76M	13.43	43.50	-30.07	-18.27	3	Vertical	360	1.00	-
2441MHz	Pass	PK	229.82M	13.10	46.00	-32.90	-18.82	3	Vertical	360	1.00	-
2441MHz	Pass	PK	272.5M	15.90	46.00	-30.10	-15.58	3	Vertical	360	1.00	-
2441MHz	Pass	PK	776.9M	32.43	46.00	-13.57	-5.78	3	Vertical	360	1.00	-
2441MHz	Pass	PK	831.22M	29.34	46.00	-16.66	-5.08	3	Vertical	360	1.00	-
2441MHz	Pass	PK	951.5M	33.13	46.00	-12.87	-2.41	3	Vertical	360	1.00	-

BT-EDR(3Mbps) 2441MHz_Adapter

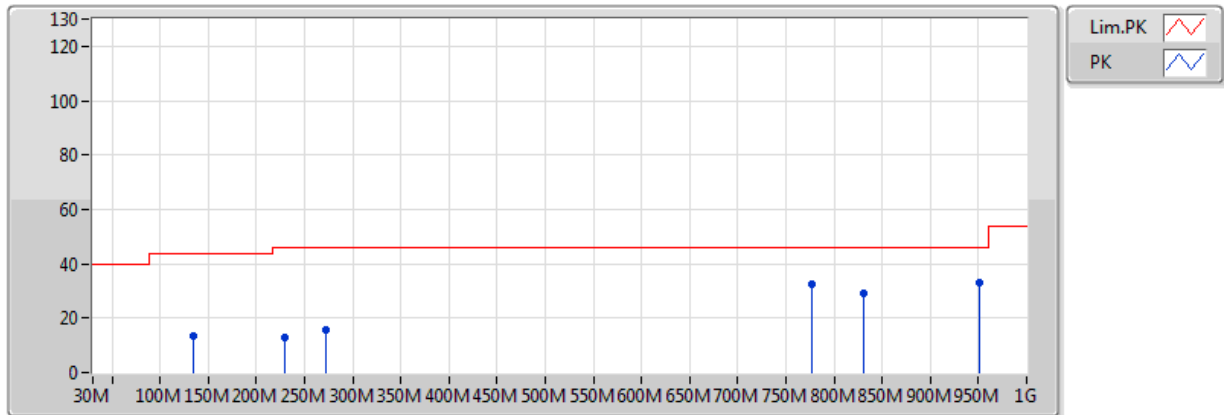

EUT = Z ANT = Y

Type	Freq (Hz)	Level (dBuV/m)	Limit (dBuV/m)	Margin (dB)	Factor (dB)	Dist (m)	Condition	Azimuth (°)	Height (m)	Comments	Raw (dBuV)	AF (dB)	CL (dB)	PA (dB)
PK	134.76M	13.43	43.50	-30.07	-18.27	3	Vertical	360	1.00	-	31.70	16.47	1.91	36.65
PK	229.82M	13.10	46.00	-32.90	-18.82	3	Vertical	360	1.00	-	31.92	15.12	2.46	36.40
PK	272.5M	15.90	46.00	-30.10	-15.58	3	Vertical	360	1.00	-	31.48	18.09	2.75	36.42
PK	776.9M	32.43	46.00	-13.57	-5.78	3	Vertical	360	1.00	-	38.21	26.91	4.76	37.45
PK	831.22M	29.34	46.00	-16.66	-5.08	3	Vertical	360	1.00	-	34.42	27.39	5.02	37.49
PK	951.5M	33.13	46.00	-12.87	-2.41	3	Vertical	360	1.00	-	35.54	29.49	5.43	37.33

BT-EDR(3Mbps) 2441MHz_Adapter

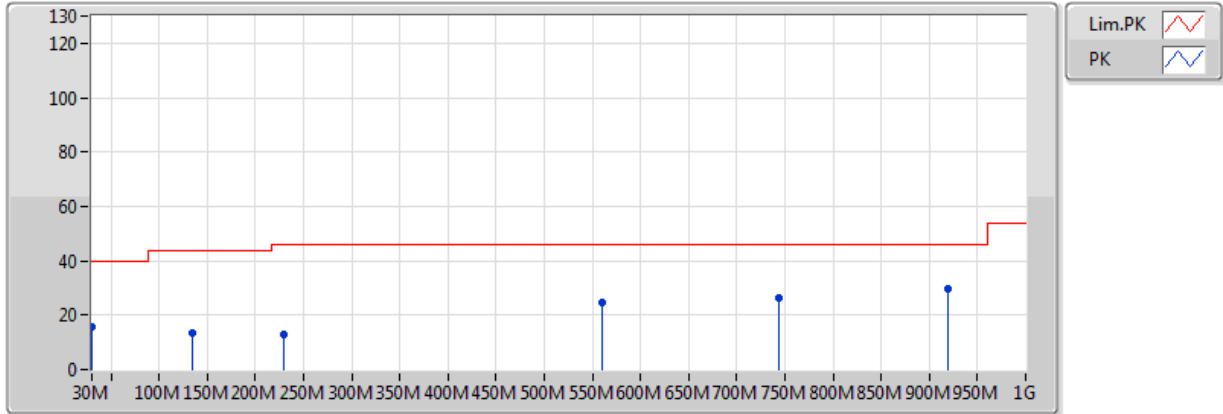

EUT = Z ANT = Y

Type	Freq (Hz)	Level (dBuV/m)	Limit (dBuV/m)	Margin (dB)	Factor (dB)	Dist (m)	Condition	Azimuth (°)	Height (m)	Comments	Raw (dBuV)	AF (dB)	CL (dB)	PA (dB)
PK	30M	15.96	40.00	-24.04	-14.06	3	Horizontal	0	1.00	-	30.02	22.34	0.94	37.34
PK	134.76M	13.43	43.50	-30.07	-18.27	3	Horizontal	0	1.00	-	31.70	16.47	1.91	36.65
PK	229.82M	13.10	46.00	-32.90	-18.82	3	Horizontal	0	1.00	-	31.92	15.12	2.46	36.40
PK	559.62M	24.42	46.00	-21.58	-8.03	3	Horizontal	0	1.00	-	32.45	24.99	4.06	37.08
PK	743.92M	26.55	46.00	-19.45	-6.19	3	Horizontal	0	1.00	-	32.74	26.76	4.46	37.40
PK	918.52M	29.52	46.00	-16.48	-3.87	3	Horizontal	0	1.00	-	33.39	28.39	5.20	37.46



Summary

Mode	Result	Type	Freq (Hz)	Level (dBuV/m)	Limit (dBuV/m)	Margin (dB)	Factor (dB)	Dist (m)	Pol. (H/V)	Azimuth (°)	Height (m)	Comments
BT-BR(1Mbps)	-	-	-	-	-	-	-	-	-	-	-	-
2.4-2.4835GHz	Pass	AV	2.3822G	50.34	54.00	-3.66	31.14	3	V	8	3.20	-



Result

Mode	Result	Type	Freq (Hz)	Level (dBuV/m)	Limit (dBuV/m)	Margin (dB)	Factor (dB)	Dist (m)	Pol. (H/V)	Azimuth (°)	Height (m)	Comments
BT-BR(1Mbps)	-	-	-	-	-	-	-	-	-	-	-	-
2402MHz	Pass	AV	2.3818G	48.28	54.00	-5.72	31.14	3	H	118	3.07	-
2402MHz	Pass	AV	2.402G	98.51	Inf	-Inf	31.22	3	H	118	3.07	-
2402MHz	Pass	PK	2.371G	58.00	74.00	-16.00	31.10	3	H	118	3.07	-
2402MHz	Pass	PK	2.4018G	99.80	Inf	-Inf	31.22	3	H	118	3.07	-
2402MHz	Pass	AV	2.3822G	50.34	54.00	-3.66	31.14	3	V	8	3.20	-
2402MHz	Pass	AV	2.402G	103.18	Inf	-Inf	31.22	3	V	8	3.20	-
2402MHz	Pass	PK	2.3818G	59.12	74.00	-14.88	31.14	3	V	8	3.20	-
2402MHz	Pass	PK	2.4018G	104.45	Inf	-Inf	31.22	3	V	8	3.20	-
2402MHz	Pass	AV	4.804G	33.94	54.00	-20.06	2.46	3	H	0	1.50	-
2402MHz	Pass	PK	4.804G	45.19	74.00	-28.81	2.46	3	H	0	1.50	-
2402MHz	Pass	AV	4.804G	32.51	54.00	-21.49	2.46	3	V	360	1.50	-
2402MHz	Pass	PK	4.804G	44.03	74.00	-29.97	2.46	3	V	360	1.50	-
2440MHz	Pass	AV	2.3892G	46.68	54.00	-7.32	31.17	3	V	12	2.82	-
2440MHz	Pass	AV	2.44G	103.19	Inf	-Inf	31.36	3	V	12	2.82	-
2440MHz	Pass	AV	2.4996G	47.59	54.00	-6.41	31.59	3	V	12	2.82	-
2440MHz	Pass	PK	2.3568G	57.71	74.00	-16.29	31.04	3	V	12	2.82	-
2440MHz	Pass	PK	2.4396G	104.65	Inf	-Inf	31.36	3	V	12	2.82	-
2440MHz	Pass	PK	2.4948G	58.93	74.00	-15.07	31.57	3	V	12	2.82	-
2440MHz	Pass	AV	4.88G	33.78	54.00	-20.22	2.56	3	H	189	3.43	-
2440MHz	Pass	AV	7.32G	39.45	54.00	-14.55	8.43	3	H	342	2.25	-
2440MHz	Pass	PK	4.88G	45.20	74.00	-28.80	2.56	3	H	189	3.43	-
2440MHz	Pass	PK	7.32G	50.32	74.00	-23.68	8.43	3	H	342	2.25	-
2440MHz	Pass	AV	4.88G	33.42	54.00	-20.58	2.56	3	V	328	2.45	-
2440MHz	Pass	AV	7.32G	39.76	54.00	-14.24	8.43	3	V	335	2.22	-
2440MHz	Pass	PK	4.88G	45.32	74.00	-28.68	2.56	3	V	328	2.45	-
2440MHz	Pass	PK	7.32G	50.24	74.00	-23.76	8.43	3	V	335	2.22	-
2480MHz	Pass	AV	2.48G	96.29	Inf	-Inf	31.51	3	H	31	3.69	-
2480MHz	Pass	AV	2.4998G	47.96	54.00	-6.04	31.59	3	H	31	3.69	-
2480MHz	Pass	PK	2.4796G	97.61	Inf	-Inf	31.51	3	H	31	3.69	-
2480MHz	Pass	PK	2.489G	58.53	74.00	-15.47	31.55	3	H	31	3.69	-
2480MHz	Pass	AV	2.48G	101.12	Inf	-Inf	31.51	3	V	8	3.46	-
2480MHz	Pass	AV	2.5G	48.82	54.00	-5.18	31.59	3	V	8	3.46	-
2480MHz	Pass	PK	2.4798G	102.38	Inf	-Inf	31.51	3	V	8	3.46	-
2480MHz	Pass	PK	2.5G	58.45	74.00	-15.55	31.59	3	V	8	3.46	-
2480MHz	Pass	AV	4.96G	33.50	54.00	-20.50	2.68	3	H	360	1.50	-
2480MHz	Pass	AV	7.44G	38.66	54.00	-15.34	8.59	3	H	0	1.50	-
2480MHz	Pass	PK	4.96G	45.02	74.00	-28.98	2.68	3	H	360	1.50	-
2480MHz	Pass	PK	7.44G	50.13	74.00	-23.87	8.59	3	H	0	1.50	-
2480MHz	Pass	AV	4.96G	32.96	54.00	-21.04	2.68	3	V	0	1.50	-
2480MHz	Pass	AV	7.44G	38.77	54.00	-15.23	8.59	3	V	360	1.50	-
2480MHz	Pass	PK	4.96G	44.65	74.00	-29.35	2.68	3	V	0	1.50	-
2480MHz	Pass	PK	7.44G	50.35	74.00	-23.65	8.59	3	V	360	1.50	-
BT-EDR(2Mbps)	-	-	-	-	-	-	-	-	-	-	-	-
2402MHz	Pass	AV	2.382G	47.61	54.00	-6.39	31.14	3	H	118	3.12	-
2402MHz	Pass	AV	2.402G	95.37	Inf	-Inf	31.22	3	H	118	3.12	-
2402MHz	Pass	PK	2.3562G	57.81	74.00	-16.19	31.04	3	H	118	3.12	-
2402MHz	Pass	PK	2.402G	99.05	Inf	-Inf	31.22	3	H	118	3.12	-
2402MHz	Pass	AV	2.3818G	48.99	54.00	-5.01	31.14	3	V	11	3.61	-



RSE TX above 1GHz Result

Appendix G.2

Mode	Result	Type	Freq (Hz)	Level (dBuV/m)	Limit (dBuV/m)	Margin (dB)	Factor (dB)	Dist (m)	Pol. (H/V)	Azimuth (°)	Height (m)	Comments
2402MHz	Pass	AV	2.402G	100.22	Inf	-Inf	31.22	3	V	11	3.61	-
2402MHz	Pass	PK	2.382G	58.55	74.00	-15.45	31.14	3	V	11	3.61	-
2402MHz	Pass	PK	2.402G	103.81	Inf	-Inf	31.22	3	V	11	3.61	-
2440MHz	Pass	AV	2.386G	46.43	54.00	-7.57	31.16	3	H	109	1.38	-
2440MHz	Pass	AV	2.44G	90.82	Inf	-Inf	31.36	3	H	109	1.38	-
2440MHz	Pass	AV	2.4988G	47.30	54.00	-6.70	31.59	3	H	109	1.38	-
2440MHz	Pass	PK	2.3896G	57.47	74.00	-16.53	31.17	3	H	109	1.38	-
2440MHz	Pass	PK	2.44G	94.64	Inf	-Inf	31.36	3	H	109	1.38	-
2440MHz	Pass	PK	2.4996G	59.42	74.00	-14.58	31.59	3	H	109	1.38	-
2440MHz	Pass	AV	2.3844G	46.57	54.00	-7.43	31.15	3	V	13	2.86	-
2440MHz	Pass	AV	2.44G	99.72	Inf	-Inf	31.36	3	V	13	2.86	-
2440MHz	Pass	AV	2.4992G	47.40	54.00	-6.60	31.59	3	V	13	2.86	-
2440MHz	Pass	PK	2.3512G	57.67	74.00	-16.33	31.02	3	V	13	2.86	-
2440MHz	Pass	PK	2.44G	103.51	Inf	-Inf	31.36	3	V	13	2.86	-
2440MHz	Pass	PK	2.488G	58.05	74.00	-15.95	31.54	3	V	13	2.86	-
2480MHz	Pass	AV	2.48G	93.02	Inf	-Inf	31.51	3	H	27	3.61	-
2480MHz	Pass	AV	2.4998G	47.52	54.00	-6.48	31.59	3	H	27	3.61	-
2480MHz	Pass	PK	2.4798G	96.67	Inf	-Inf	31.51	3	H	27	3.61	-
2480MHz	Pass	PK	2.4904G	58.28	74.00	-15.72	31.55	3	H	27	3.61	-
2480MHz	Pass	AV	2.48G	97.79	Inf	-Inf	31.51	3	V	13	3.02	-
2480MHz	Pass	AV	2.4998G	47.92	54.00	-6.08	31.59	3	V	13	3.02	-
2480MHz	Pass	PK	2.48G	101.41	Inf	-Inf	31.51	3	V	13	3.02	-
2480MHz	Pass	PK	2.4854G	58.50	74.00	-15.50	31.53	3	V	13	3.02	-
BT-EDR(3Mbps)	-	-	-	-	-	-	-	-	-	-	-	-
2402MHz	Pass	AV	2.382G	47.66	54.00	-6.34	31.14	3	H	122	3.08	-
2402MHz	Pass	AV	2.402G	95.94	Inf	-Inf	31.22	3	H	122	3.08	-
2402MHz	Pass	PK	2.3626G	57.75	74.00	-16.25	31.06	3	H	122	3.08	-
2402MHz	Pass	PK	2.402G	100.02	Inf	-Inf	31.22	3	H	122	3.08	-
2402MHz	Pass	AV	2.382G	49.21	54.00	-4.79	31.14	3	V	17	3.19	-
2402MHz	Pass	AV	2.402G	100.17	Inf	-Inf	31.22	3	V	17	3.19	-
2402MHz	Pass	PK	2.3824G	58.65	74.00	-15.35	31.14	3	V	17	3.19	-
2402MHz	Pass	PK	2.402G	104.22	Inf	-Inf	31.22	3	V	17	3.19	-
2440MHz	Pass	AV	2.39G	46.52	54.00	-7.48	31.17	3	H	123	2.96	-
2440MHz	Pass	AV	2.44G	93.49	Inf	-Inf	31.36	3	H	123	2.96	-
2440MHz	Pass	AV	2.4988G	47.39	54.00	-6.61	31.59	3	H	123	2.96	-
2440MHz	Pass	PK	2.3656G	58.39	74.00	-15.61	31.08	3	H	123	2.96	-
2440MHz	Pass	PK	2.44G	97.78	Inf	-Inf	31.36	3	H	123	2.96	-
2440MHz	Pass	PK	2.4956G	58.52	74.00	-15.48	31.57	3	H	123	2.96	-
2440MHz	Pass	AV	2.3772G	46.69	54.00	-7.31	31.12	3	V	16	2.86	-
2440MHz	Pass	AV	2.44G	99.74	Inf	-Inf	31.36	3	V	16	2.86	-
2440MHz	Pass	AV	2.4928G	47.56	54.00	-6.44	31.56	3	V	16	2.86	-
2440MHz	Pass	PK	2.3512G	57.53	74.00	-16.47	31.02	3	V	16	2.86	-
2440MHz	Pass	PK	2.44G	103.99	Inf	-Inf	31.36	3	V	16	2.86	-
2440MHz	Pass	PK	2.4928G	57.88	74.00	-16.12	31.56	3	V	16	2.86	-
2480MHz	Pass	AV	2.48G	93.15	Inf	-Inf	31.51	3	H	35	3.64	-
2480MHz	Pass	AV	2.4998G	47.69	54.00	-6.31	31.59	3	H	35	3.64	-
2480MHz	Pass	PK	2.48G	97.29	Inf	-Inf	31.51	3	H	35	3.64	-
2480MHz	Pass	PK	2.5G	58.69	74.00	-15.31	31.59	3	H	35	3.64	-
2480MHz	Pass	AV	2.48G	97.17	Inf	-Inf	31.51	3	V	15	3.05	-



RSE TX above 1GHz Result

Appendix G.2

Mode	Result	Type	Freq (Hz)	Level (dBuV/m)	Limit (dBuV/m)	Margin (dB)	Factor (dB)	Dist (m)	Pol. (H/V)	Azimuth (°)	Height (m)	Comments
2480MHz	Pass	AV	2.5G	47.94	54.00	-6.06	31.59	3	V	15	3.05	-
2480MHz	Pass	PK	2.48G	101.31	Inf	-Inf	31.51	3	V	15	3.05	-
2480MHz	Pass	PK	2.495G	58.96	74.00	-15.04	31.57	3	V	15	3.05	-

BT-BR(1Mbps)

2402MHz_TX

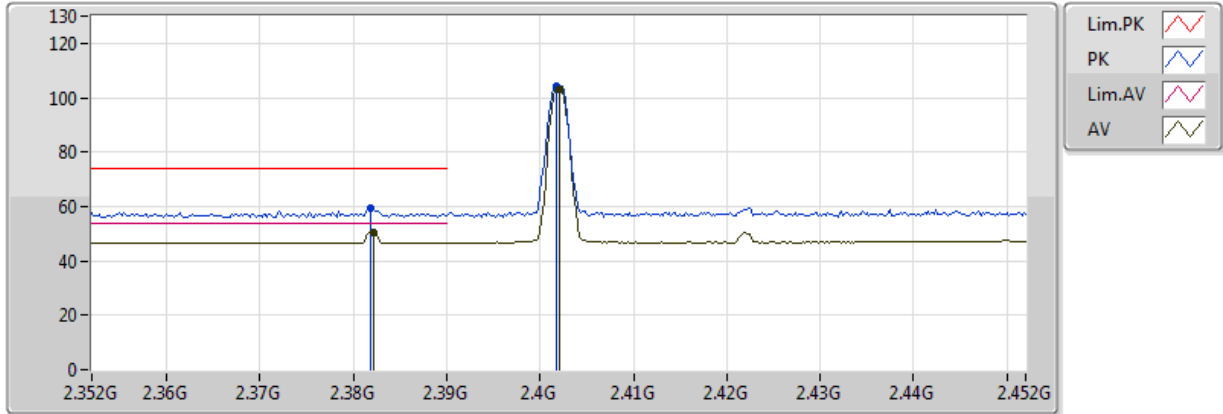

EUT : Z axis ANT : Z axis

Type	Freq(Hz)	Level(dBuV/m)	Limit(dBuV/m)	Margin(dB)	Factor(dB)	Dist(m)	Pol.(H/V)	Azimuth(°)	Height(m)	Comments
AV	2.3822G	50.34	54.00	-3.66	31.14	3	V	8	3.20	-
AV	2.402G	103.18	Inf	-Inf	31.22	3	V	8	3.20	-
PK	2.3818G	59.12	74.00	-14.88	31.14	3	V	8	3.20	-
PK	2.4018G	104.45	Inf	-Inf	31.22	3	V	8	3.20	-

BT-BR(1Mbps)

2402MHz_TX

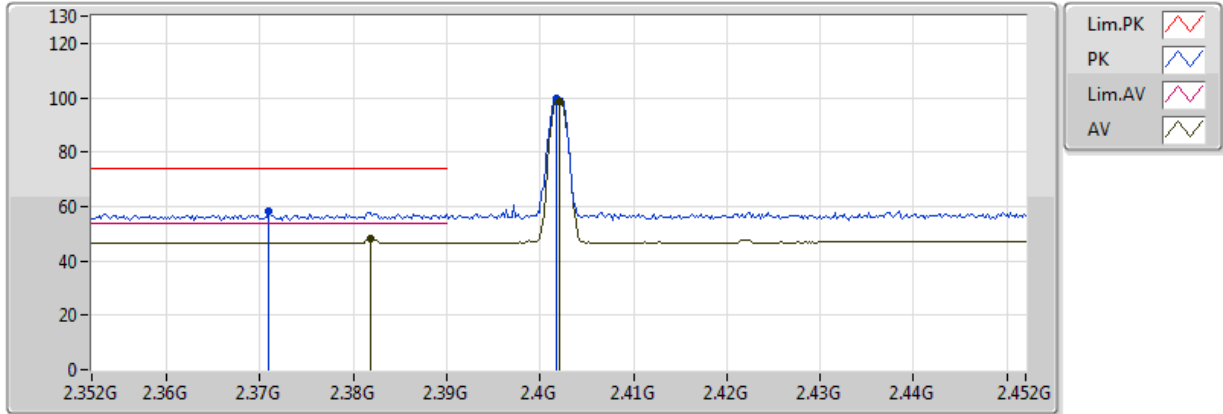

EUT : Z axis ANT : Z axis

Type	Freq(Hz)	Level(dBuV/m)	Limit(dBuV/m)	Margin(dB)	Factor(dB)	Dist(m)	Pol.(H/V)	Azimuth(°)	Height(m)	Comments
AV	2.3818G	48.28	54.00	-5.72	31.14	3	H	118	3.07	-
AV	2.402G	98.51	Inf	-Inf	31.22	3	H	118	3.07	-
PK	2.371G	58.00	74.00	-16.00	31.10	3	H	118	3.07	-
PK	2.4018G	99.80	Inf	-Inf	31.22	3	H	118	3.07	-

BT-BR(1Mbps)

2402MHz_TX

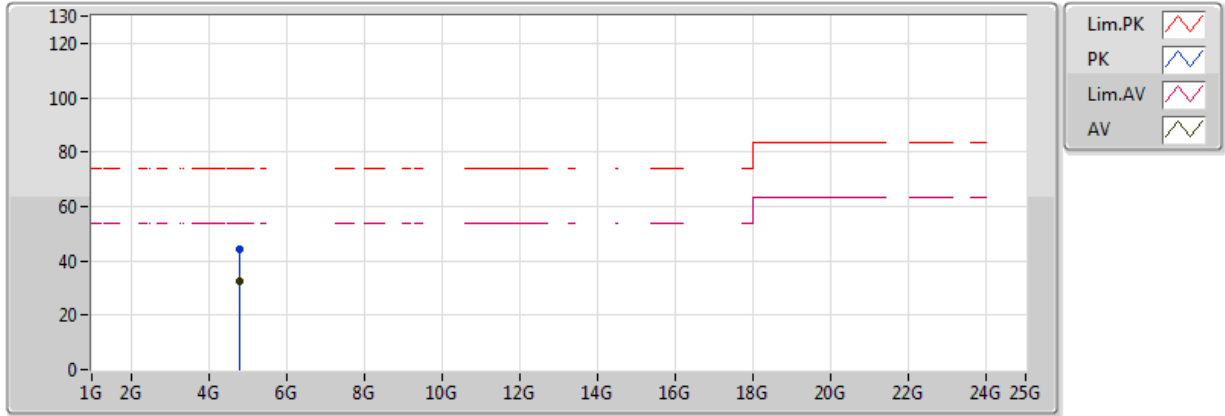

EUT : Z axis ANT : Z axis

Type	Freq(Hz)	Level(dBuV/m)	Limit(dBuV/m)	Margin(dB)	Factor(dB)	Dist(m)	Pol.(H/V)	Azimuth(°)	Height(m)	Comments
AV	4.804G	32.51	54.00	-21.49	2.46	3	V	360	1.50	-
PK	4.804G	44.03	74.00	-29.97	2.46	3	V	360	1.50	-

BT-BR(1Mbps)

2402MHz_TX

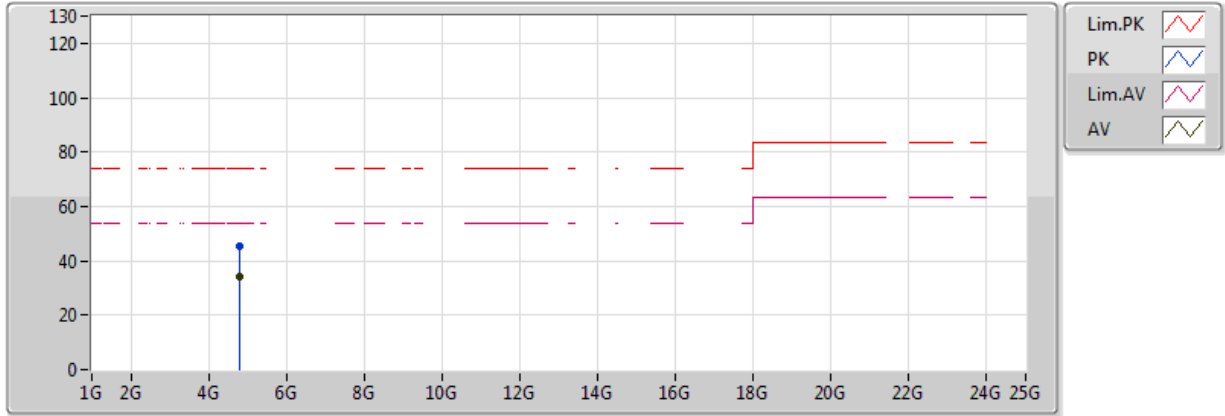

EUT : Z axis ANT : Z axis

Type	Freq(Hz)	Level(dBuV/m)	Limit(dBuV/m)	Margin(dB)	Factor(dB)	Dist(m)	Pol.(H/V)	Azimuth(°)	Height(m)	Comments
AV	4.804G	33.94	54.00	-20.06	2.46	3	H	0	1.50	-
PK	4.804G	45.19	74.00	-28.81	2.46	3	H	0	1.50	-

BT-BR(1Mbps)

2440MHz_TX

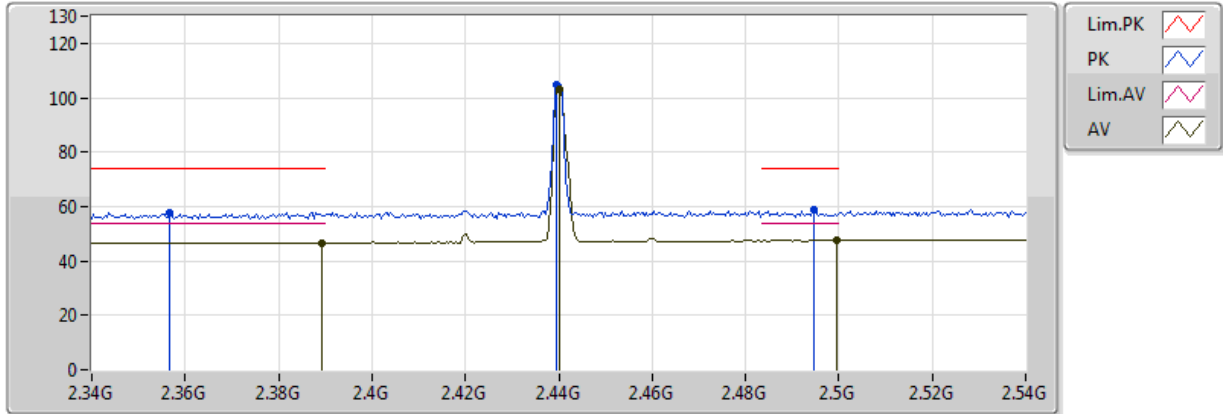

EUT : Z axis ANT : Z axis

Type	Freq(Hz)	Level(dBuV/m)	Limit(dBuV/m)	Margin(dB)	Factor(dB)	Dist(m)	Pol.(H/V)	Azimuth(°)	Height(m)	Comments
AV	2.3892G	46.68	54.00	-7.32	31.17	3	V	12	2.82	-
AV	2.44G	103.19	Inf	-Inf	31.36	3	V	12	2.82	-
AV	2.4996G	47.59	54.00	-6.41	31.59	3	V	12	2.82	-
PK	2.3568G	57.71	74.00	-16.29	31.04	3	V	12	2.82	-
PK	2.4396G	104.65	Inf	-Inf	31.36	3	V	12	2.82	-
PK	2.4948G	58.93	74.00	-15.07	31.57	3	V	12	2.82	-

BT-BR(1Mbps)

2440MHz_TX

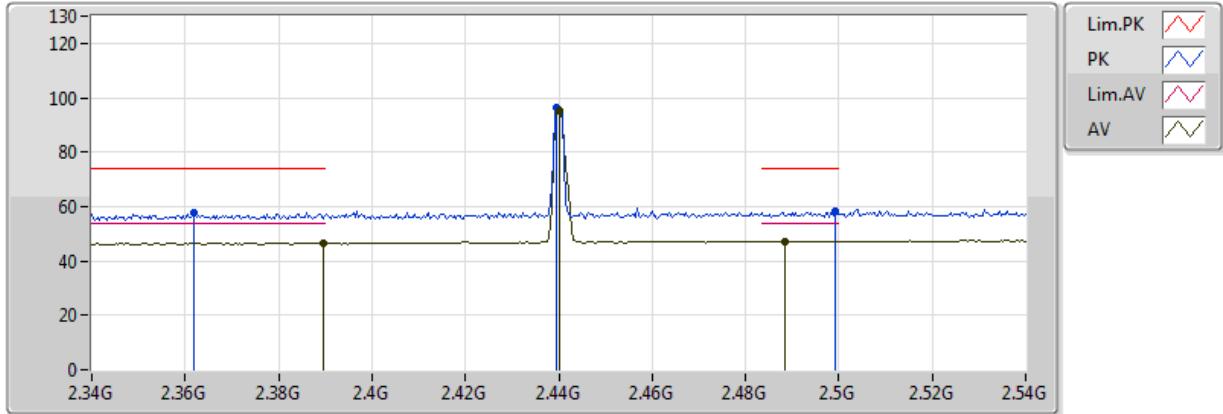

EUT : Z axis ANT : Z axis

Type	Freq(Hz)	Level(dBuV/m)	Limit(dBuV/m)	Margin(dB)	Factor(dB)	Dist(m)	Pol.(H/V)	Azimuth(°)	Height(m)	Comments
AV	2.3896G	46.50	54.00	-7.50	31.17	3	H	110	3.32	-
AV	2.44G	95.17	Inf	-Inf	31.36	3	H	110	3.32	-
AV	2.4884G	47.26	54.00	-6.74	31.55	3	H	110	3.32	-
PK	2.362G	57.65	74.00	-16.35	31.06	3	H	110	3.32	-
PK	2.4396G	96.63	Inf	-Inf	31.36	3	H	110	3.32	-
PK	2.4992G	58.36	74.00	-15.64	31.59	3	H	110	3.32	-

BT-BR(1Mbps)

2440MHz_TX

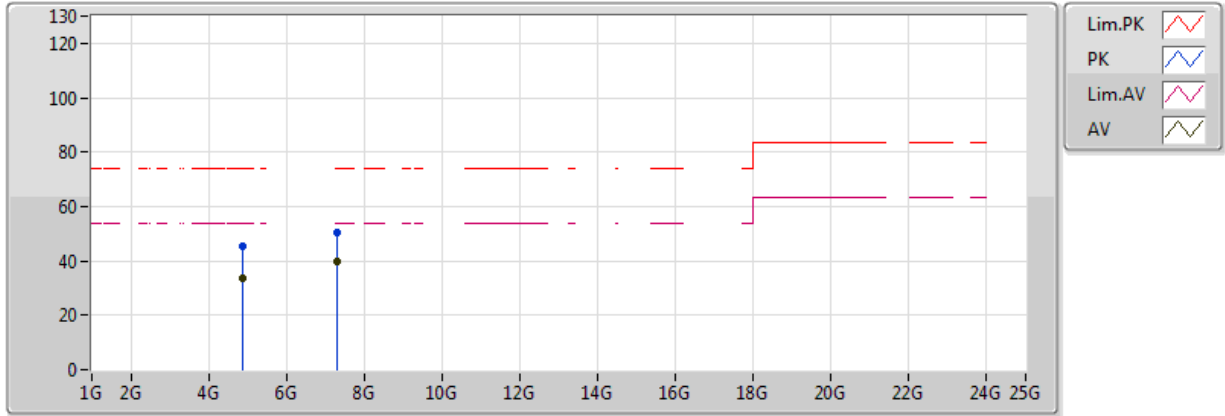

EUT : Z axis ANT : Z axis

Type	Freq(Hz)	Level(dBuV/m)	Limit(dBuV/m)	Margin(dB)	Factor(dB)	Dist(m)	Pol.(H/V)	Azimuth(°)	Height(m)	Comments
AV	4.88G	33.42	54.00	-20.58	2.56	3	V	328	2.45	-
AV	7.32G	39.76	54.00	-14.24	8.43	3	V	335	2.22	-
PK	4.88G	45.32	74.00	-28.68	2.56	3	V	328	2.45	-
PK	7.32G	50.24	74.00	-23.76	8.43	3	V	335	2.22	-

BT-BR(1Mbps)

2440MHz_TX

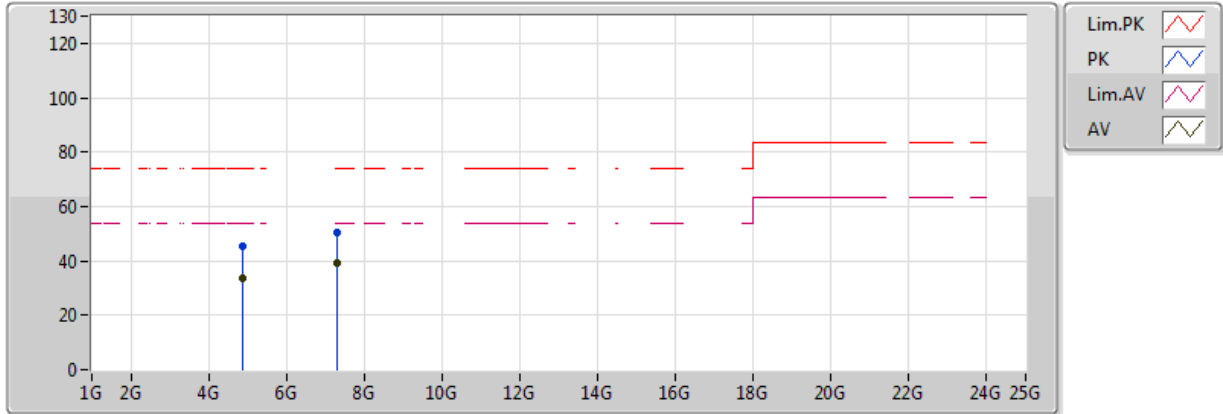

EUT : Z axis ANT : Z axis

Type	Freq(Hz)	Level(dBuV/m)	Limit(dBuV/m)	Margin(dB)	Factor(dB)	Dist(m)	Pol.(H/V)	Azimuth(°)	Height(m)	Comments
AV	4.88G	33.78	54.00	-20.22	2.56	3	H	189	3.43	-
AV	7.32G	39.45	54.00	-14.55	8.43	3	H	342	2.25	-
PK	4.88G	45.20	74.00	-28.80	2.56	3	H	189	3.43	-
PK	7.32G	50.32	74.00	-23.68	8.43	3	H	342	2.25	-

BT-BR(1Mbps)

2480MHz_TX

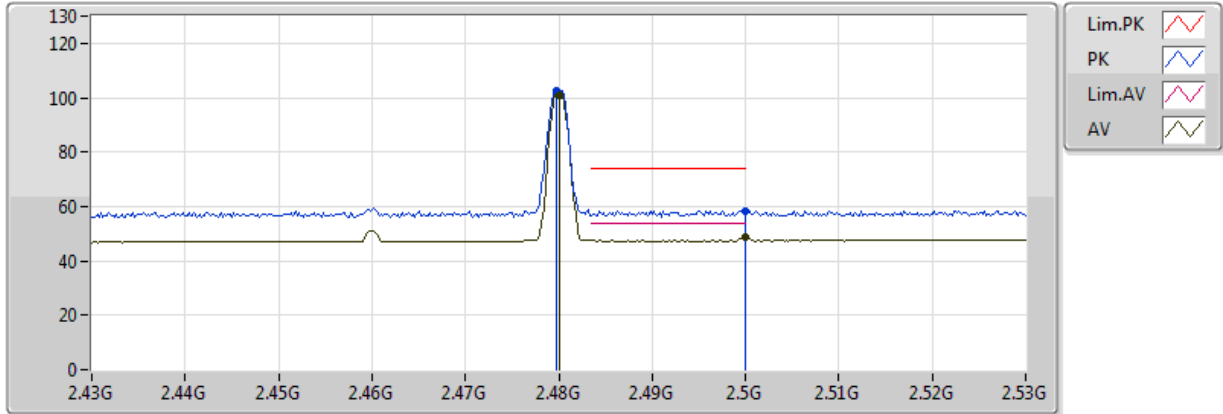

EUT : Z axis ANT : Z axis

Type	Freq(Hz)	Level(dBuV/m)	Limit(dBuV/m)	Margin(dB)	Factor(dB)	Dist(m)	Pol.(H/V)	Azimuth(°)	Height(m)	Comments
AV	2.48G	101.12	Inf	-Inf	31.51	3	V	8	3.46	-
AV	2.5G	48.82	54.00	-5.18	31.59	3	V	8	3.46	-
PK	2.4798G	102.38	Inf	-Inf	31.51	3	V	8	3.46	-
PK	2.5G	58.45	74.00	-15.55	31.59	3	V	8	3.46	-

BT-BR(1Mbps)

2480MHz_TX

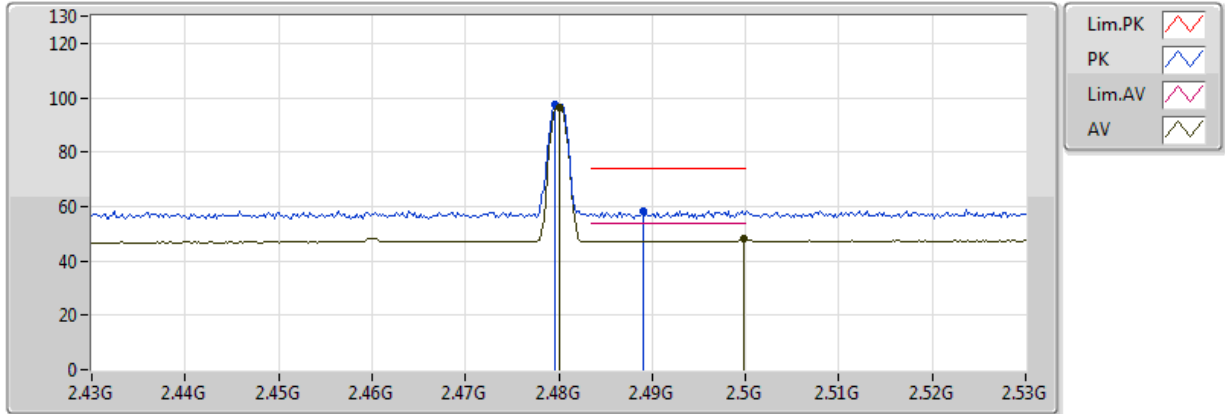

EUT : Z axis ANT : Z axis

Type	Freq(Hz)	Level(dBuV/m)	Limit(dBuV/m)	Margin(dB)	Factor(dB)	Dist(m)	Pol.(H/V)	Azimuth(°)	Height(m)	Comments
AV	2.48G	96.29	Inf	-Inf	31.51	3	H	31	3.69	-
AV	2.4998G	47.96	54.00	-6.04	31.59	3	H	31	3.69	-
PK	2.4796G	97.61	Inf	-Inf	31.51	3	H	31	3.69	-
PK	2.489G	58.53	74.00	-15.47	31.55	3	H	31	3.69	-

BT-BR(1Mbps)

2480MHz_TX

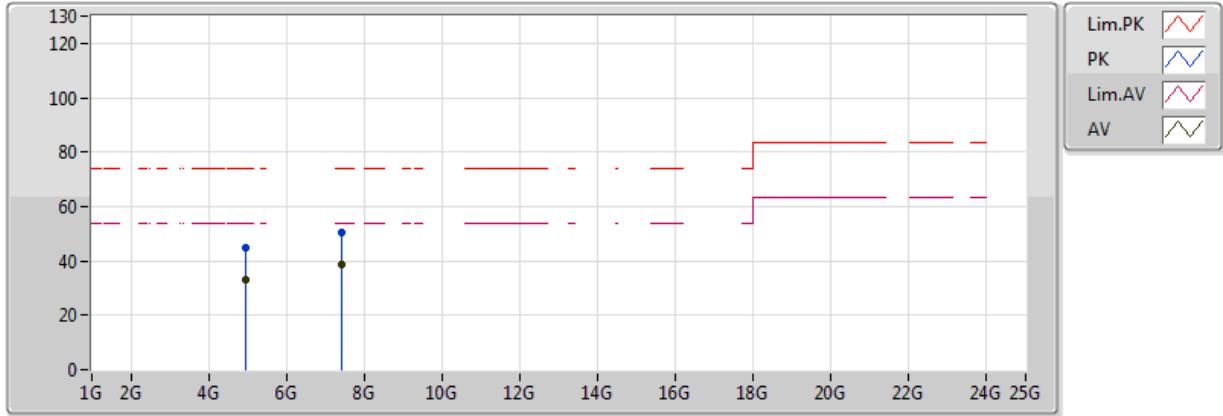

EUT : Z axis ANT : Z axis

Type	Freq(Hz)	Level(dBuV/m)	Limit(dBuV/m)	Margin(dB)	Factor(dB)	Dist(m)	Pol.(H/V)	Azimuth(°)	Height(m)	Comments
AV	4.96G	32.96	54.00	-21.04	2.68	3	V	0	1.50	-
AV	7.44G	38.77	54.00	-15.23	8.59	3	V	360	1.50	-
PK	4.96G	44.65	74.00	-29.35	2.68	3	V	0	1.50	-
PK	7.44G	50.35	74.00	-23.65	8.59	3	V	360	1.50	-

BT-BR(1Mbps)

2480MHz_TX

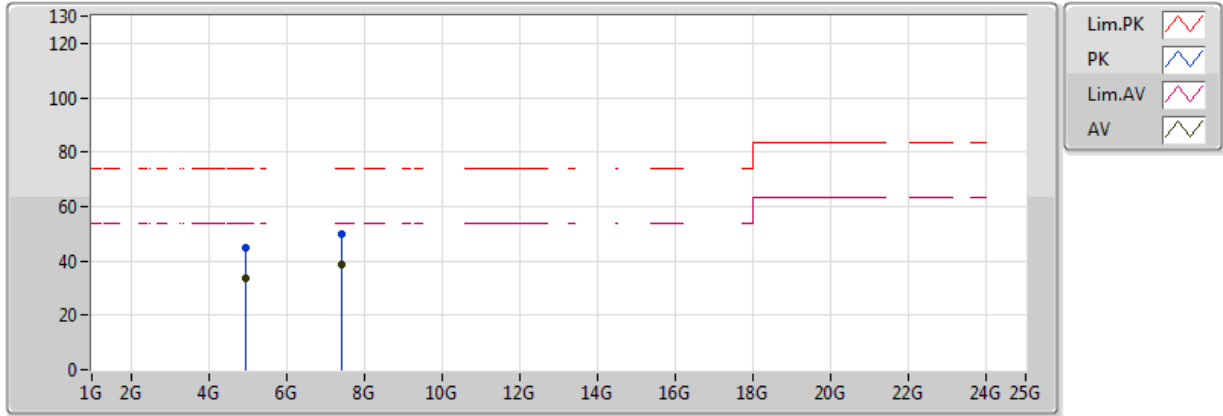

EUT : Z axis ANT : Z axis

Type	Freq(Hz)	Level(dBuV/m)	Limit(dBuV/m)	Margin(dB)	Factor(dB)	Dist(m)	Pol.(H/V)	Azimuth(°)	Height(m)	Comments
AV	4.96G	33.50	54.00	-20.50	2.68	3	H	360	1.50	-
AV	7.44G	38.66	54.00	-15.34	8.59	3	H	0	1.50	-
PK	4.96G	45.02	74.00	-28.98	2.68	3	H	360	1.50	-
PK	7.44G	50.13	74.00	-23.87	8.59	3	H	0	1.50	-

BT-EDR(2Mbps)

2402MHz_TX

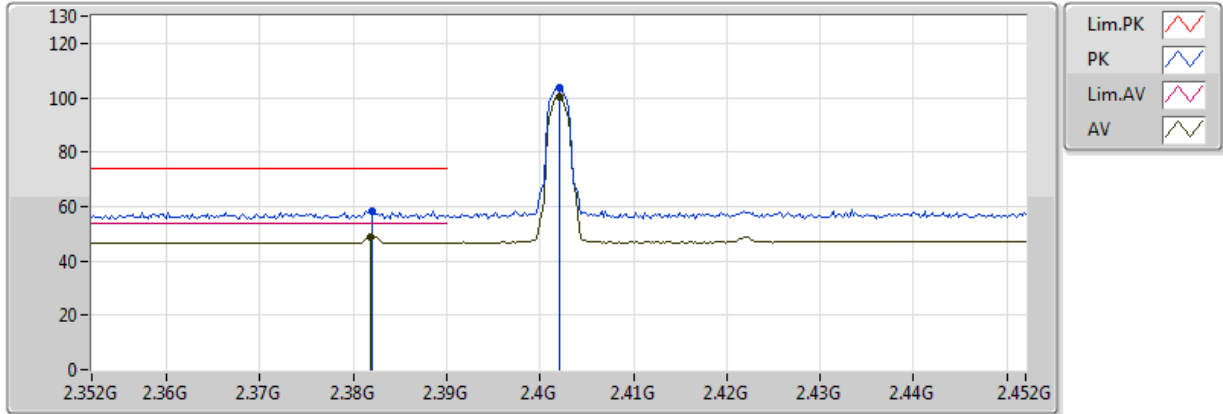

EUT : Z axis ANT : Z axis

Type	Freq(Hz)	Level(dBuV/m)	Limit(dBuV/m)	Margin(dB)	Factor(dB)	Dist(m)	Pol.(H/V)	Azimuth(°)	Height(m)	Comments
AV	2.3818G	48.99	54.00	-5.01	31.14	3	V	11	3.61	-
AV	2.402G	100.22	Inf	-Inf	31.22	3	V	11	3.61	-
PK	2.382G	58.55	74.00	-15.45	31.14	3	V	11	3.61	-
PK	2.402G	103.81	Inf	-Inf	31.22	3	V	11	3.61	-

BT-EDR(2Mbps)

2402MHz_TX

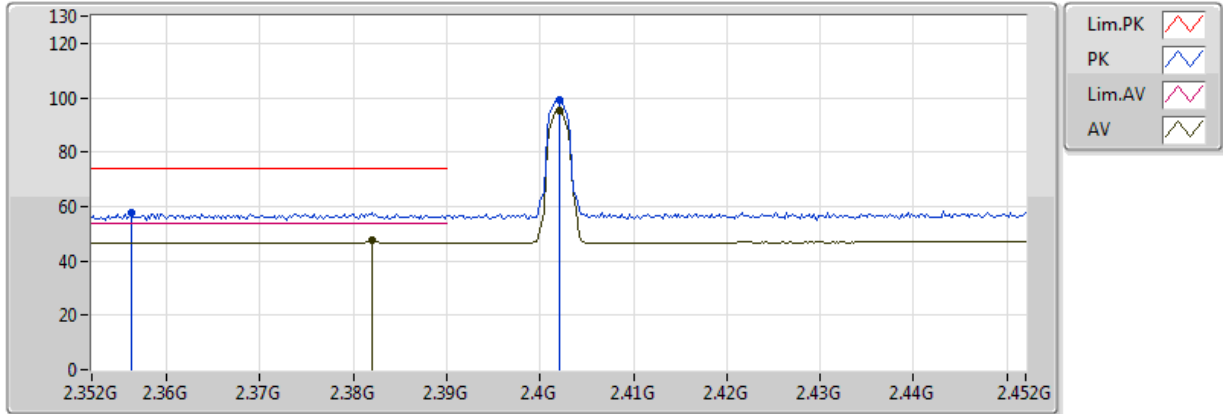

EUT : Z axis ANT : Z axis

Type	Freq(Hz)	Level(dBuV/m)	Limit(dBuV/m)	Margin(dB)	Factor(dB)	Dist(m)	Pol.(H/V)	Azimuth(°)	Height(m)	Comments
AV	2.382G	47.61	54.00	-6.39	31.14	3	H	118	3.12	-
AV	2.402G	95.37	Inf	-Inf	31.22	3	H	118	3.12	-
PK	2.3562G	57.81	74.00	-16.19	31.04	3	H	118	3.12	-
PK	2.402G	99.05	Inf	-Inf	31.22	3	H	118	3.12	-

BT-EDR(2Mbps)

2440MHz_TX

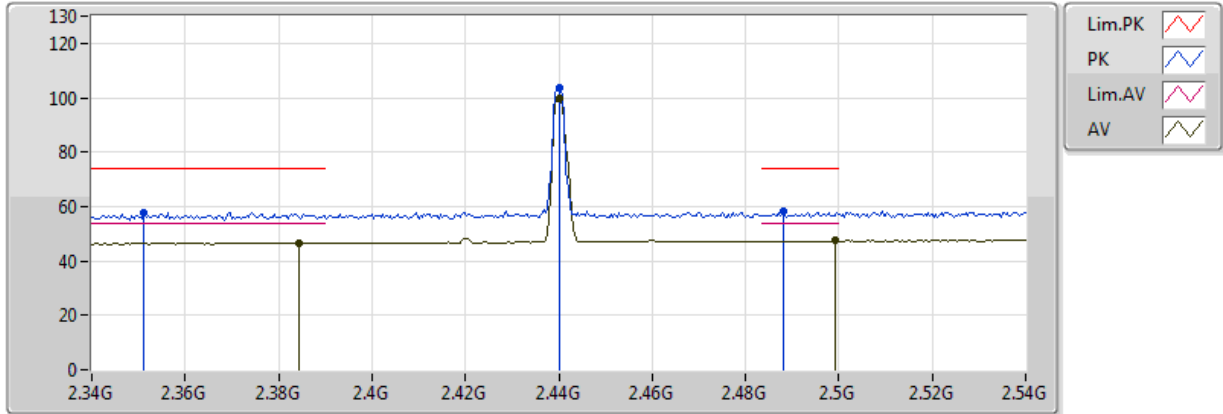

EUT : Z axis ANT : Z axis

Type	Freq(Hz)	Level(dBuV/m)	Limit(dBuV/m)	Margin(dB)	Factor(dB)	Dist(m)	Pol.(H/V)	Azimuth(°)	Height(m)	Comments
AV	2.3844G	46.57	54.00	-7.43	31.15	3	V	13	2.86	-
AV	2.44G	99.72	Inf	-Inf	31.36	3	V	13	2.86	-
AV	2.4992G	47.40	54.00	-6.60	31.59	3	V	13	2.86	-
PK	2.3512G	57.67	74.00	-16.33	31.02	3	V	13	2.86	-
PK	2.44G	103.51	Inf	-Inf	31.36	3	V	13	2.86	-
PK	2.488G	58.05	74.00	-15.95	31.54	3	V	13	2.86	-

BT-EDR(2Mbps)

2440MHz_TX

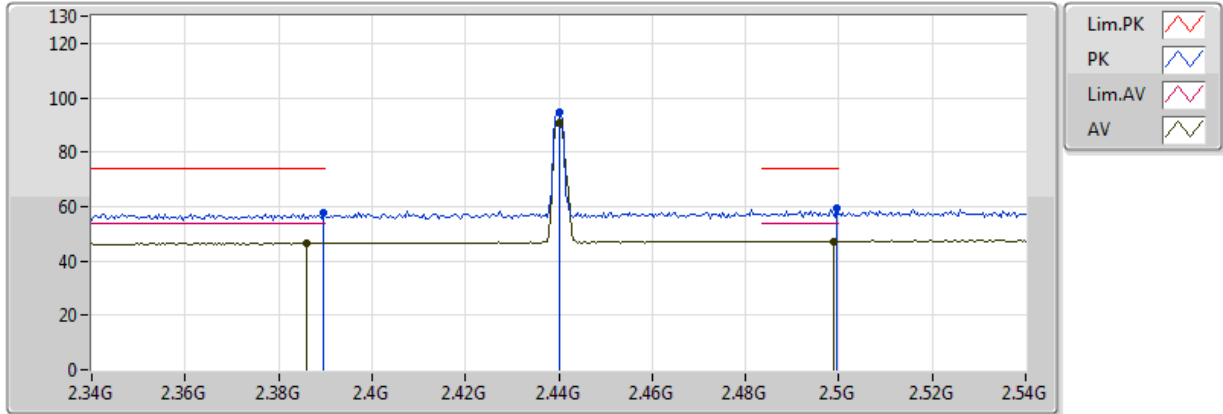

EUT : Z axis ANT : Z axis

Type	Freq(Hz)	Level(dBuV/m)	Limit(dBuV/m)	Margin(dB)	Factor(dB)	Dist(m)	Pol.(H/V)	Azimuth(°)	Height(m)	Comments
AV	2.386G	46.43	54.00	-7.57	31.16	3	H	109	1.38	-
AV	2.44G	90.82	Inf	-Inf	31.36	3	H	109	1.38	-
AV	2.4988G	47.30	54.00	-6.70	31.59	3	H	109	1.38	-
PK	2.3896G	57.47	74.00	-16.53	31.17	3	H	109	1.38	-
PK	2.44G	94.64	Inf	-Inf	31.36	3	H	109	1.38	-
PK	2.4996G	59.42	74.00	-14.58	31.59	3	H	109	1.38	-

BT-EDR(2Mbps)

2480MHz_TX

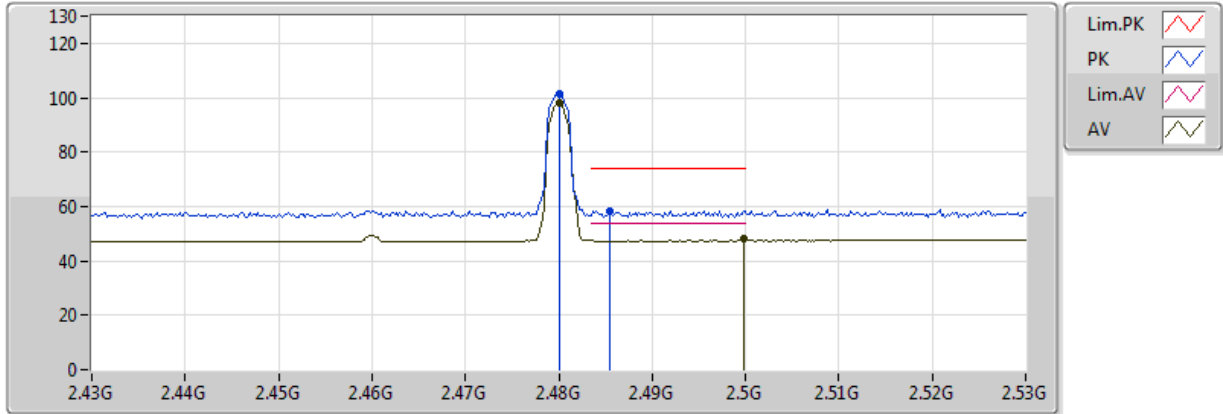

EUT : Z axis ANT : Z axis

Type	Freq(Hz)	Level(dBuV/m)	Limit(dBuV/m)	Margin(dB)	Factor(dB)	Dist(m)	Pol.(H/V)	Azimuth(°)	Height(m)	Comments
AV	2.48G	97.79	Inf	-Inf	31.51	3	V	13	3.02	-
AV	2.4998G	47.92	54.00	-6.08	31.59	3	V	13	3.02	-
PK	2.48G	101.41	Inf	-Inf	31.51	3	V	13	3.02	-
PK	2.4854G	58.50	74.00	-15.50	31.53	3	V	13	3.02	-

BT-EDR(2Mbps)

2480MHz_TX

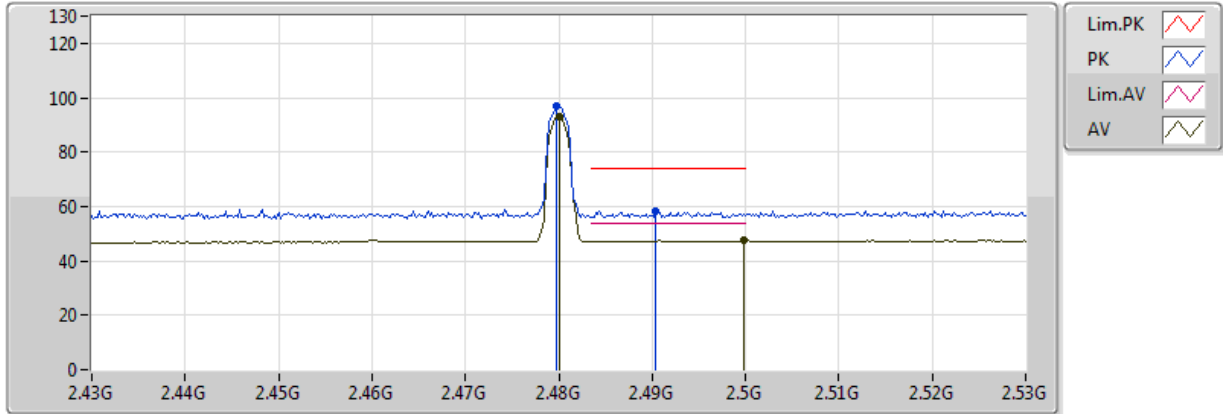

EUT : Z axis ANT : Z axis

Type	Freq(Hz)	Level(dBuV/m)	Limit(dBuV/m)	Margin(dB)	Factor(dB)	Dist(m)	Pol.(H/V)	Azimuth(°)	Height(m)	Comments
AV	2.48G	93.02	Inf	-Inf	31.51	3	H	27	3.61	-
AV	2.4998G	47.52	54.00	-6.48	31.59	3	H	27	3.61	-
PK	2.4798G	96.67	Inf	-Inf	31.51	3	H	27	3.61	-
PK	2.4904G	58.28	74.00	-15.72	31.55	3	H	27	3.61	-

BT-EDR(3Mbps)

2402MHz_TX

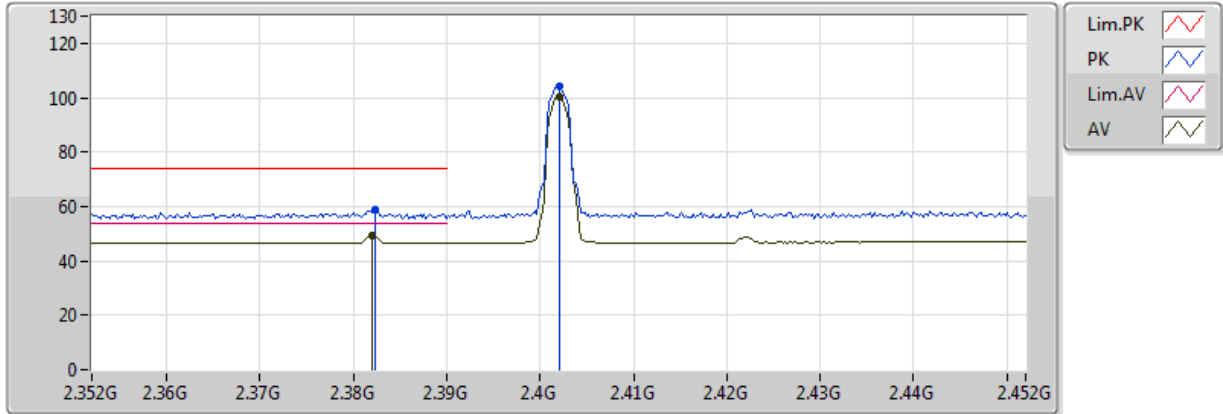

EUT : Z axis ANT : Z axis

Type	Freq(Hz)	Level(dBuV/m)	Limit(dBuV/m)	Margin(dB)	Factor(dB)	Dist(m)	Pol.(H/V)	Azimuth(°)	Height(m)	Comments
AV	2.382G	49.21	54.00	-4.79	31.14	3	V	17	3.19	-
AV	2.402G	100.17	Inf	-Inf	31.22	3	V	17	3.19	-
PK	2.3824G	58.65	74.00	-15.35	31.14	3	V	17	3.19	-
PK	2.402G	104.22	Inf	-Inf	31.22	3	V	17	3.19	-

BT-EDR(3Mbps)

2402MHz_TX

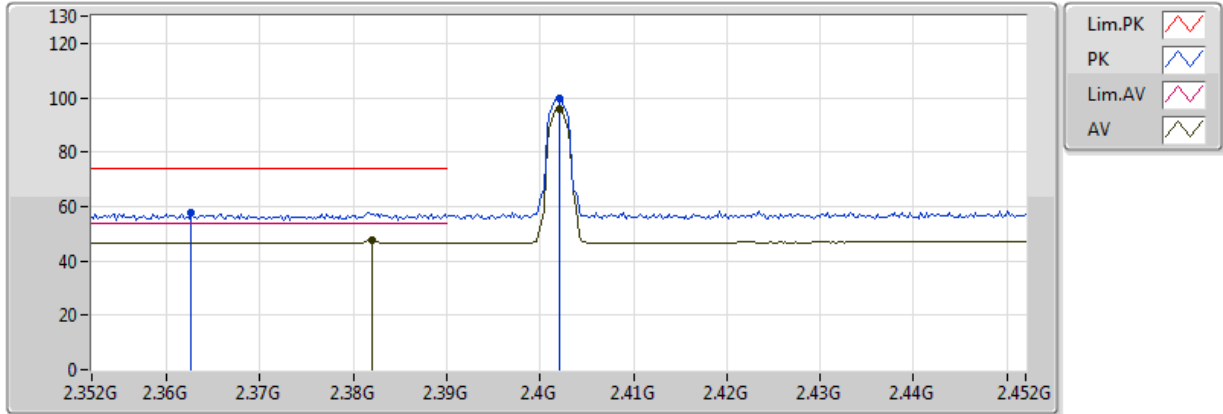

EUT : Z axis ANT : Z axis

Type	Freq(Hz)	Level(dBuV/m)	Limit(dBuV/m)	Margin(dB)	Factor(dB)	Dist(m)	Pol.(H/V)	Azimuth(°)	Height(m)	Comments
AV	2.382G	47.66	54.00	-6.34	31.14	3	H	122	3.08	-
AV	2.402G	95.94	Inf	-Inf	31.22	3	H	122	3.08	-
PK	2.3626G	57.75	74.00	-16.25	31.06	3	H	122	3.08	-
PK	2.402G	100.02	Inf	-Inf	31.22	3	H	122	3.08	-

BT-EDR(3Mbps)

2440MHz_TX

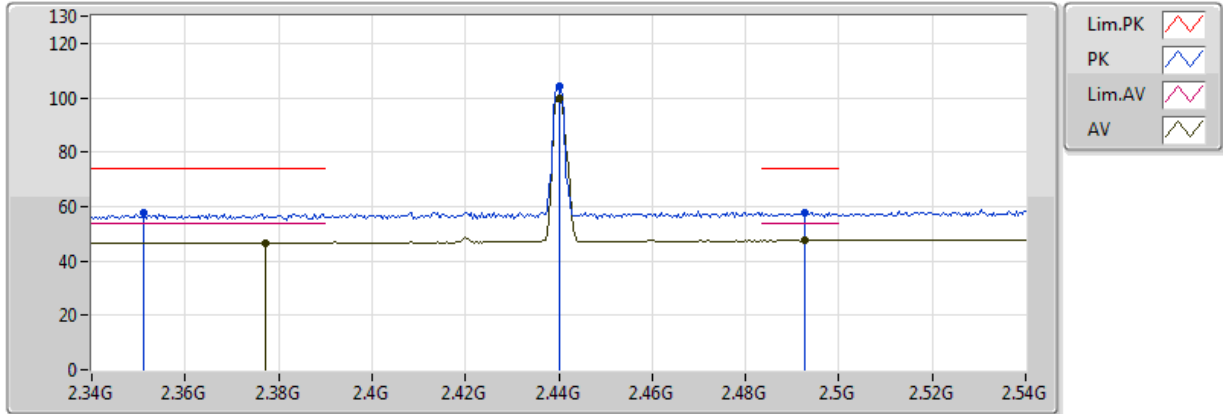

EUT : Z axis ANT : Z axis

Type	Freq(Hz)	Level(dBuV/m)	Limit(dBuV/m)	Margin(dB)	Factor(dB)	Dist(m)	Pol.(H/V)	Azimuth(°)	Height(m)	Comments
AV	2.3772G	46.69	54.00	-7.31	31.12	3	V	16	2.86	-
AV	2.44G	99.74	Inf	-Inf	31.36	3	V	16	2.86	-
AV	2.4928G	47.56	54.00	-6.44	31.56	3	V	16	2.86	-
PK	2.3512G	57.53	74.00	-16.47	31.02	3	V	16	2.86	-
PK	2.44G	103.99	Inf	-Inf	31.36	3	V	16	2.86	-
PK	2.4928G	57.88	74.00	-16.12	31.56	3	V	16	2.86	-

BT-EDR(3Mbps)

2440MHz_TX

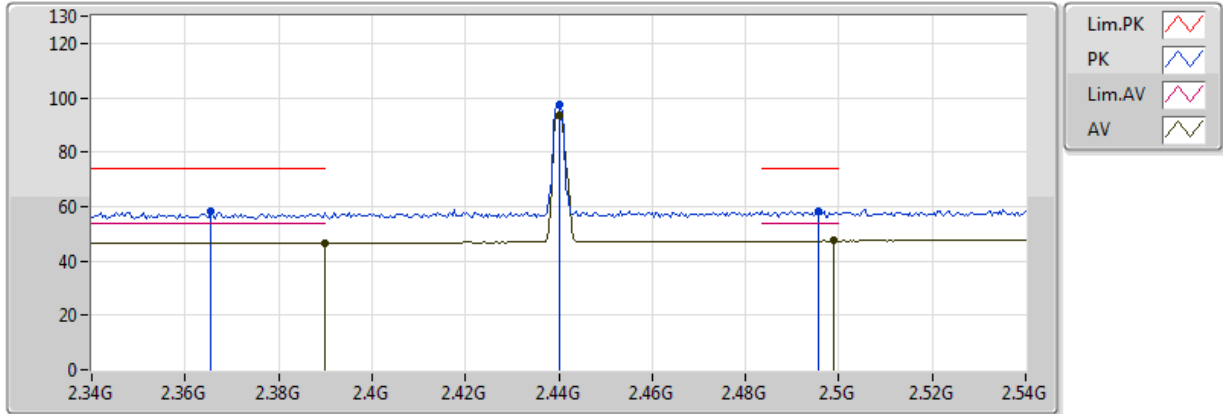

EUT : Z axis ANT : Z axis

Type	Freq(Hz)	Level(dBuV/m)	Limit(dBuV/m)	Margin(dB)	Factor(dB)	Dist(m)	Pol.(H/V)	Azimuth(°)	Height(m)	Comments
AV	2.39G	46.52	54.00	-7.48	31.17	3	H	123	2.96	-
AV	2.44G	93.49	Inf	-Inf	31.36	3	H	123	2.96	-
AV	2.4988G	47.39	54.00	-6.61	31.59	3	H	123	2.96	-
PK	2.3656G	58.39	74.00	-15.61	31.08	3	H	123	2.96	-
PK	2.44G	97.78	Inf	-Inf	31.36	3	H	123	2.96	-
PK	2.4956G	58.52	74.00	-15.48	31.57	3	H	123	2.96	-

BT-EDR(3Mbps)

2480MHz_TX

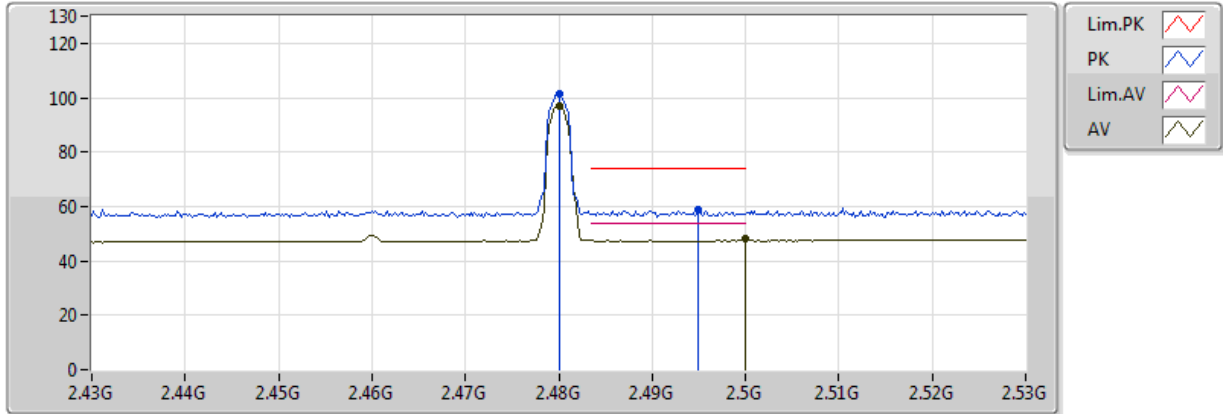

EUT : Z axis ANT : Z axis

Type	Freq(Hz)	Level(dBuV/m)	Limit(dBuV/m)	Margin(dB)	Factor(dB)	Dist(m)	Pol.(H/V)	Azimuth(°)	Height(m)	Comments
AV	2.48G	97.17	Inf	-Inf	31.51	3	V	15	3.05	-
AV	2.5G	47.94	54.00	-6.06	31.59	3	V	15	3.05	-
PK	2.48G	101.31	Inf	-Inf	31.51	3	V	15	3.05	-
PK	2.495G	58.96	74.00	-15.04	31.57	3	V	15	3.05	-

BT-EDR(3Mbps)

2480MHz_TX

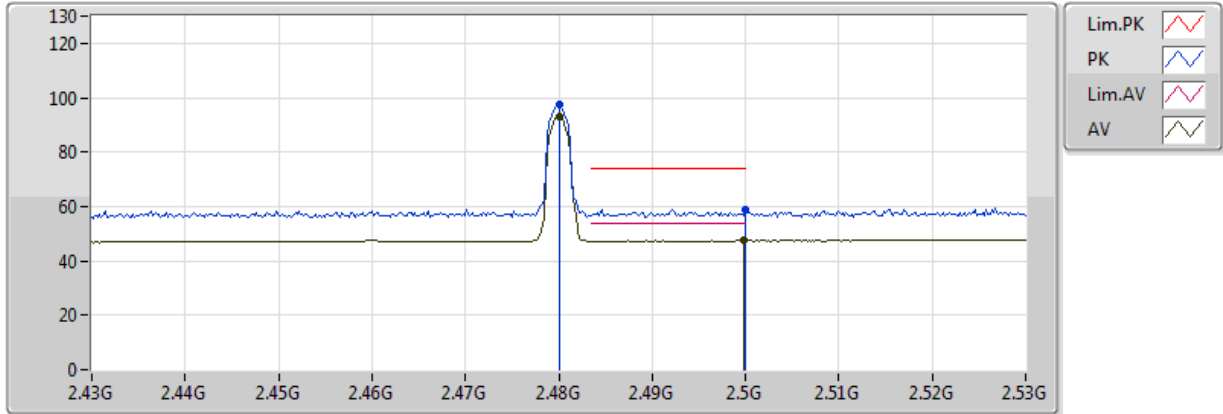

EUT : Z axis ANT : Z axis

Type	Freq(Hz)	Level(dBuV/m)	Limit(dBuV/m)	Margin(dB)	Factor(dB)	Dist(m)	Pol.(H/V)	Azimuth(°)	Height(m)	Comments
AV	2.48G	93.15	Inf	-Inf	31.51	3	H	35	3.64	-
AV	2.4998G	47.69	54.00	-6.31	31.59	3	H	35	3.64	-
PK	2.48G	97.29	Inf	-Inf	31.51	3	H	35	3.64	-
PK	2.5G	58.69	74.00	-15.31	31.59	3	H	35	3.64	-



Radiated Emission Co-Location (Below 1GHz)

Operating Mode	3	Polarization	V
Operating Function	(Z Plane) FAP-U321EV + WiFi 2.4G+5G+BT , USB R/W + LAN 1Gbps (LAN2) + PoE Adapter(LAN1)		

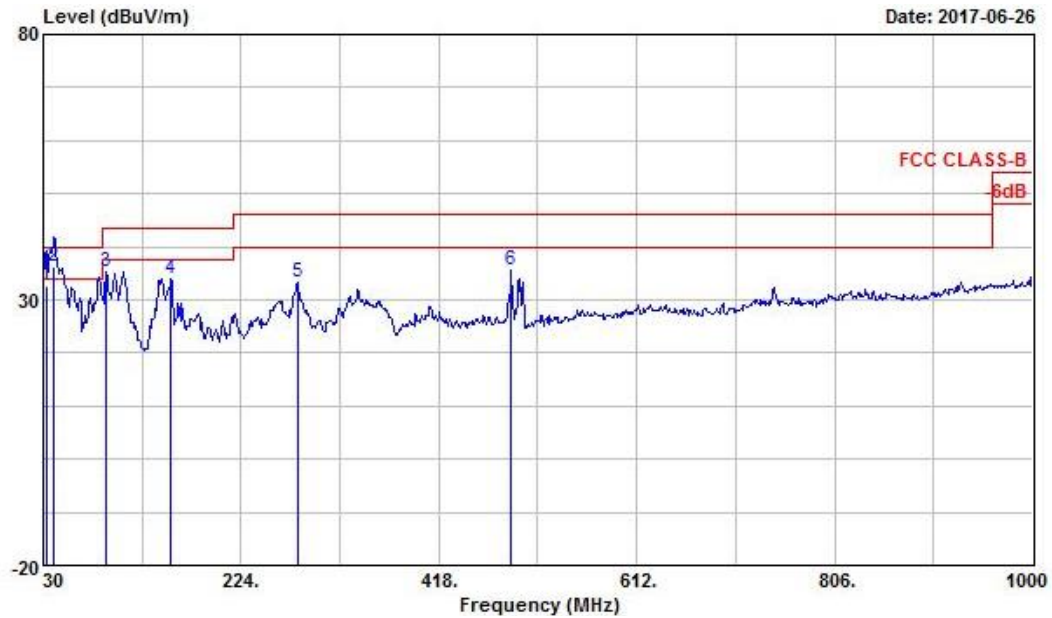

	Freq	Level	Over Limit	Limit Line	ReadAntenna Level	Preamp Factor	Cable Loss	Ant Pos	Table Pos	Remark
	MHz	dBuV/m	dB	dBuV/m	dBuV	dB/m	dB	cm	deg	
1	32.700	32.48	-7.52	40.00	39.11	23.13	30.31	100	162	QP
2 @	40.530	36.35	-3.65	40.00	47.00	19.07	30.31	100	0	QP
3	92.100	35.18	-8.32	43.50	49.53	15.08	30.23	---	---	Peak
4	154.740	33.92	-9.58	43.50	46.12	16.79	30.01	---	---	Peak
5	278.940	33.36	-12.64	46.00	42.78	18.78	29.56	---	---	Peak
6	489.000	35.49	-10.51	46.00	40.26	23.90	30.48	---	---	Peak

Note 1: ">20dB" means spurious emission levels that exceed the level of 20 dB below the applicable limit.
 Note 2: "N/F" means Nothing Found spurious emissions (No spurious emissions were detected.)
 Note 3: Measurement receive antenna polarization: H (Horizontal), V (Vertical)



Radiated Emission Co-Location (Below 1GHz)			
Operating Mode	3	Polarization	H
Operating Function	(Z Plane) FAP-U321EV + WiFi 2.4G+5G+BT , USB R/W + LAN 1Gbps (LAN2) + PoE Adapter(LAN1)		

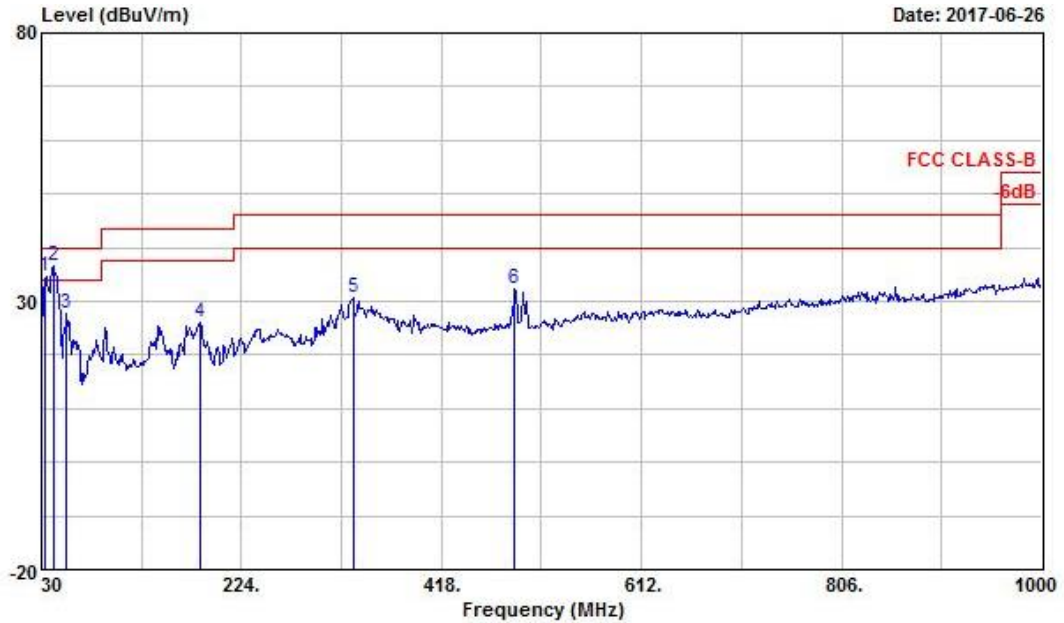

	Freq	Level	Over Limit	Limit Line	Read Level	Antenna Factor	Preamp Factor	Cable Loss	Ant Pos	Table Pos	Remark	
	MHz	dBuV/m	dB	dBuV/m	dBuV	dB/m	dB	dB	cm	deg		
1	!	34.050	34.66	-5.34	40.00	41.80	22.62	30.31	0.56	---	---	Peak
2	@	41.340	36.61	-3.39	40.00	47.79	18.54	30.31	0.59	100	120	Peak
3		53.490	27.84	-12.16	40.00	44.29	13.20	30.30	0.65	---	---	Peak
4		184.170	26.10	-17.40	43.50	40.04	14.86	29.91	1.11	---	---	Peak
5		332.200	30.52	-15.48	46.00	38.80	19.89	29.67	1.49	---	---	Peak
6		489.000	32.34	-13.66	46.00	37.11	23.90	30.48	1.82	---	---	Peak

Note 1: ">20dB" means spurious emission levels that exceed the level of 20 dB below the applicable limit.
 Note 2: "N/F" means Nothing Found spurious emissions (No spurious emissions were detected.)
 Note 3: Measurement receive antenna polarization: H (Horizontal), V (Vertical)



Radiated Emission Co-Location (Above 1GHz)

Operating Mode	3	Polarization	V
Operating Function	(Z Plane) FAP-U321EV + WiFi 2.4G+5G+BT , USB R/W + LAN 1Gbps (LAN2) + PoE Adapter(LAN1)		

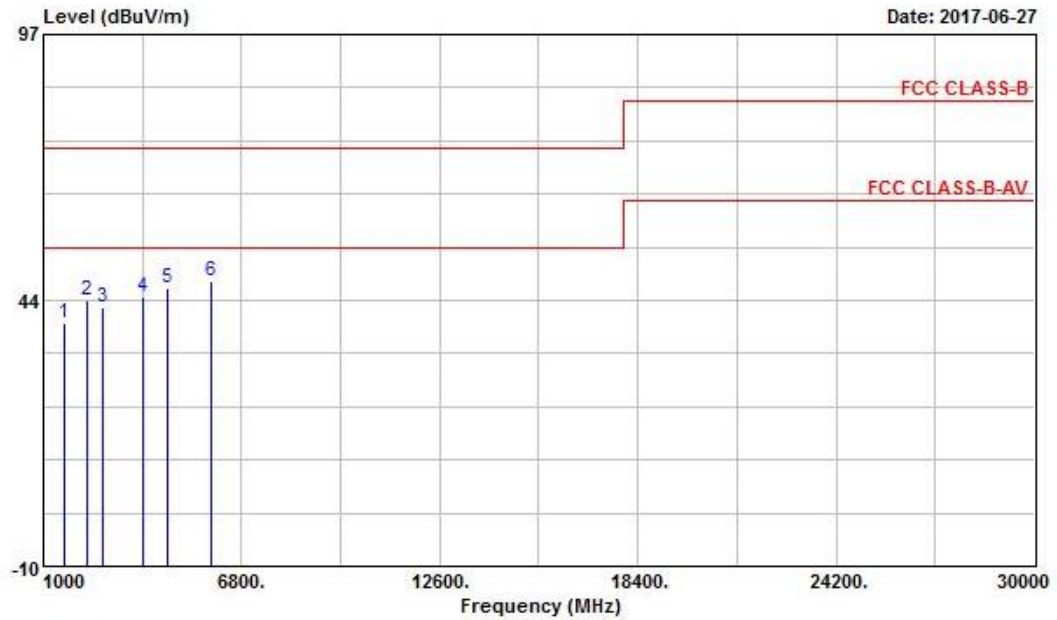

	Freq	Level	Over Limit	Limit Line	ReadAntenna Level	Preamp Factor	Cable Loss	Ant Pos	Table Pos	Remark
	MHz	dBuV/m	dB	dBuV/m	dBuV	dB/m	dB	cm	deg	
1	1612.000	38.93	-35.07	74.00	43.47	25.82	34.70	4.35	---	Peak
2	2300.000	43.65	-30.35	74.00	46.42	26.84	34.75	5.13	---	Peak
3	2758.000	42.02	-31.98	74.00	43.67	27.80	34.98	5.53	---	Peak
4	3933.000	44.15	-29.85	74.00	43.33	29.61	35.16	6.37	---	Peak
5	4641.000	45.82	-28.18	74.00	43.02	30.92	35.13	7.01	---	Peak
6 @	5889.000	47.20	-26.80	74.00	42.13	32.36	35.25	7.96	---	Peak

Note 1: ">20dB" means spurious emission levels that exceed the level of 20 dB below the applicable limit.
 Note 2: "N/F" means Nothing Found spurious emissions (No spurious emissions were detected.)
 Note 3: Measurement receive antenna polarization: H (Horizontal), V (Vertical)



Radiated Emission Co-Location (Above 1GHz)

Operating Mode	3	Polarization	H
Operating Function	(Z Plane) FAP-U321EV + WiFi 2.4G+5G+BT , USB R/W + LAN 1Gbps (LAN2) + PoE Adapter(LAN1)		

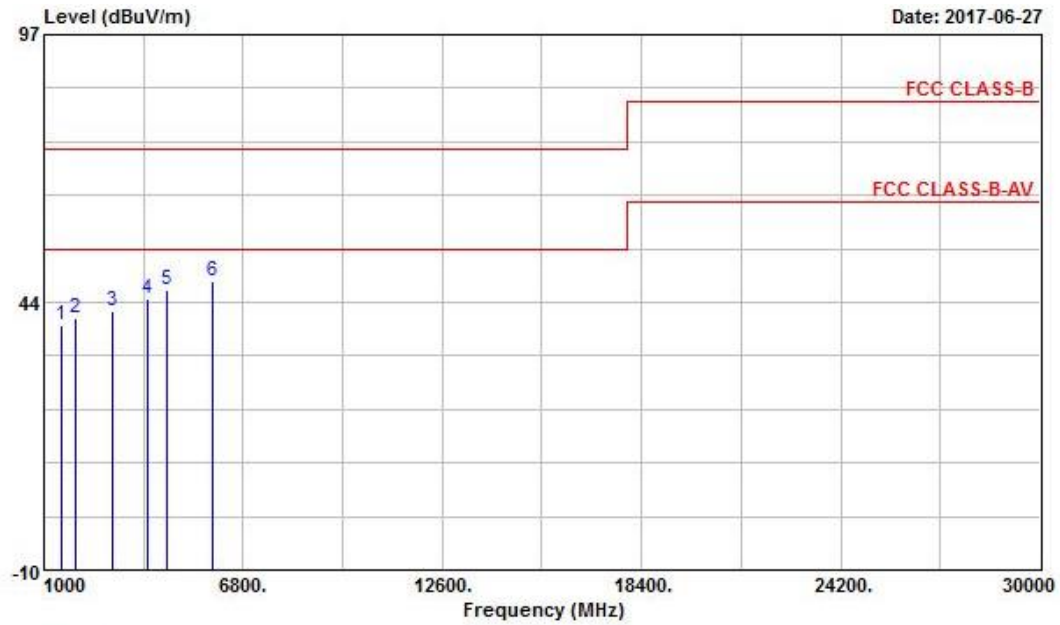

	Freq	Level	Over Limit	Limit Line	ReadAntenna Level	Preamp Factor	Preamp Factor	Cable Loss	Ant Pos	Table Pos	Remark
	MHz	dBuV/m	dB	dBuV/m	dBuV	dB/m	dB	dB	cm	deg	
1	1532.000	39.07	-34.93	74.00	43.80	25.73	34.72	4.26	---	---	Peak
2	1900.000	40.17	-33.83	74.00	44.03	26.10	34.64	4.68	---	---	Peak
3	2990.000	41.69	-32.31	74.00	42.83	28.27	35.10	5.69	---	---	Peak
4	4017.000	44.12	-29.88	74.00	43.13	29.73	35.16	6.42	---	---	Peak
5	4566.000	46.04	-27.96	74.00	43.42	30.81	35.12	6.94	---	---	Peak
6 @	5898.000	47.76	-26.24	74.00	42.69	32.36	35.25	7.96	100	190	Peak

Note 1: ">20dB" means spurious emission levels that exceed the level of 20 dB below the applicable limit.
 Note 2: "N/F" means Nothing Found spurious emissions (No spurious emissions were detected.)
 Note 3: Measurement receive antenna polarization: H (Horizontal), V (Vertical)