

FCC Test Report

Report No.: RF161026C20D

FCC ID: TVE-241BC041

Test Model: FortiAP U221EV, FortiAP U223EV

Series Model: FortiAP U221EVxxxxxx, FAP-U221EVxxxxxx, FORTIAP-U221EVxxxxxx, FortiAP U223EVxxxxxx, FAP-U223EVxxxxxx, FORTIAP-U223EVxxxxxx (where "x" can be used as "A-Z" or "0-9" or "-" or blank for software changes or marketing purposes only) (refer to item 3.1 for more details)

Received Date: Mar. 28, 2018

Test Date: Mar. 28 ~ Jun. 01, 2018

Issued Date: Jun. 04, 2018

Applicant: Fortinet Inc.

Address: 899 Kifer Road Sunnyvale, CA 94086 USA

Issued By: Bureau Veritas Consumer Products Services (H.K.) Ltd., Taoyuan Branch

Lab Address: No. 47-2, 14th Ling, Chia Pau Vil., Lin Kou Dist., New Taipei City, Taiwan, R.O.C.

Test Location: No. 19, Hwa Ya 2nd Rd., Wen Hwa Vil., Kwei Shan Dist., Taoyuan City 33383, TAIWAN (R.O.C.)

FCC Registration / Designation Number: 788550 / TW0003



This report is for your exclusive use. Any copying or replication of this report to or for any other person or entity, or use of our name or trademark, is permitted only with our prior written permission. This report sets forth our findings solely with respect to the test samples identified herein. The results set forth in this report are not indicative or representative of the quality or characteristics of the lot from which a test sample was taken or any similar or identical product specifically and expressly noted. Our report includes all of the tests requested by you and the results thereof based upon the information that you provided to us. You have 60 days from date of issuance of this report to notify us of any material error or omission caused by our negligence, provided, however, that such notice shall be in writing and shall specifically address the issue you wish to raise. A failure to raise such issue within the prescribed time shall constitute your unqualified acceptance of the completeness of this report, the tests conducted and the correctness of the report contents. Unless specific mention, the uncertainty of measurement has been explicitly taken into account to declare the compliance or non-compliance to the specification. The report must not be used by the client to claim product certification, approval, or endorsement by TAF or any government agencies.

Table of Contents

Release Control Record	4
1 Certificate of Conformity	5
2 Summary of Test Results	6
2.1 Measurement Uncertainty.....	6
2.2 Modification Record.....	6
3 General Information	7
3.1 General Description of EUT.....	7
3.2 Description of Test Modes.....	10
3.2.1 Test Mode Applicability and Tested Channel Detail.....	11
3.3 Duty Cycle of Test Signal.....	13
3.4 Description of Support Units.....	15
3.4.1 Configuration of System under Test.....	15
3.5 General Description of Applied Standards.....	16
4 Test Types and Results	17
4.1 Radiated Emission and Bandedge Measurement.....	17
4.1.1 Limits of Radiated Emission and Bandedge Measurement.....	17
4.1.2 Test Instruments.....	18
4.1.3 Test Procedures.....	19
4.1.4 Deviation from Test Standard.....	19
4.1.5 Test Setup.....	20
4.1.6 EUT Operating Conditions.....	21
4.1.7 Test Results.....	22
4.2 Conducted Emission Measurement.....	74
4.2.1 Limits of Conducted Emission Measurement.....	74
4.2.2 Test Instruments.....	74
4.2.3 Test Procedures.....	75
4.2.4 Deviation from Test Standard.....	75
4.2.5 Test Setup.....	76
4.2.6 EUT Operating Conditions.....	76
4.2.7 Test Results.....	77
4.3 Transmit Power Measurement.....	85
4.3.1 Limits of Transmit Power Measurement.....	85
4.3.2 Test Setup.....	85
4.3.3 Test Instruments.....	86
4.3.4 Test Procedure.....	86
4.3.5 Deviation from Test Standard.....	86
4.3.6 EUT Operating Conditions.....	86
4.3.7 Test Result.....	87
4.4 Occupied Bandwidth Measurement.....	105
4.4.1 Test Setup.....	105
4.4.2 Test Instruments.....	105
4.4.3 Test Procedure.....	105
4.4.4 Test Results.....	106
4.5 Peak Power Spectral Density Measurement.....	116
4.5.1 Limits of Peak Power Spectral Density Measurement.....	116
4.5.2 Test Setup.....	116
4.5.3 Test Instruments.....	116
4.5.4 Test Procedures.....	116
4.5.5 Deviation from Test Standard.....	116
4.5.6 EUT Operating Conditions.....	116
4.5.7 Test Results.....	117
4.6 Frequency Stability.....	127
4.6.1 Limits of Frequency Stability Measurement.....	127

4.6.2	Test Setup.....	127
4.6.3	Test Instruments	127
4.6.4	Test Procedure	127
4.6.5	Deviation from Test Standard	127
4.6.6	EUT Operating Condition	127
4.6.7	Test Results	128
4.7	6dB Bandwidth Measurement.....	130
4.7.1	Limits of 6dB Bandwidth Measurement.....	130
4.7.2	Test Setup.....	130
4.7.3	Test Instruments	130
4.7.4	Test Procedure	130
4.7.5	Deviation from Test Standard	130
4.7.6	EUT Operating Condition	130
4.7.7	Test Results	131
5	Pictures of Test Arrangements.....	135
	Appendix – Information on the Testing Laboratories	136

Release Control Record

Issue No.	Description	Date Issued
RF161026C20D	Original release	Jun. 04, 2018

1 Certificate of Conformity

Product: Secured Wireless Access Point

Brand: Fortinet Inc.

Test Model: FortiAP U221EV, FortiAP U223EV

Series Model: FortiAP U221EVxxxxxx, FAP-U221EVxxxxxx, FORTIAP-U221EVxxxxxx, FortiAP U223EVxxxxxx, FAP-U223EVxxxxxx, FORTIAP-U223EVxxxxxx (where "x" can be used as "A-Z" or "0-9" or "-" or blank for software changes or marketing purposes only) (refer to item 3.1 for more details)

Sample Status: Engineering sample

Applicant: Fortinet Inc.

Test Date: Mar. 28 ~ Jun. 01, 2018

Standards: 47 CFR FCC Part 15, Subpart E (Section 15.407)
ANSI C63.10:2013

The above equipment has been tested by **Bureau Veritas Consumer Products Services (H.K.) Ltd., Taoyuan Branch**, and found compliance with the requirement of the above standards. The test record, data evaluation & Equipment Under Test (EUT) configurations represented herein are true and accurate accounts of the measurements of the sample's RF characteristics under the conditions specified in this report.

Prepared by : Pettie Chen , **Date:** Jun. 04, 2018
Pettie Chen / Senior Specialist

Approved by : Bruce Chen , **Date:** Jun. 04, 2018
Bruce Chen / Project Engineer

2 Summary of Test Results

47 CFR FCC Part 15, Subpart E (SECTION 15.407)			
FCC Clause	Test Item	Result	Remarks
15.407(b)(6)	AC Power Conducted Emissions	Pass	Meet the requirement of limit. Minimum passing margin is -10.13dB at 0.33661MHz.
15.407(b)(1/2/3/4/6)	Radiated Emissions & Band Edge Measurement	Pass	Meet the requirement of limit. Minimum passing margin is -1.1dB at 5350.00 & 5470.00MHz.
15.407(a)(1/2/3)	Max Average Transmit Power	Pass	Meet the requirement of limit.
15.407(a)(1/2/3)	Peak Power Spectral Density	Pass	Meet the requirement of limit.
15.407(e)	6dB bandwidth	Pass	Meet the requirement of limit. (U-NII-3 Band only)
15.407(g)	Frequency Stability	Pass	Meet the requirement of limit.
15.203	Antenna Requirement	Pass	Antenna connector is IPEX or RP SMA plug not a standard connector.

2.1 Measurement Uncertainty

Where relevant, the following measurement uncertainty levels have been estimated for tests performed on the EUT as specified in CISPR 16-4-2:

Measurement	Frequency	Expanded Uncertainty (k=2) (\pm)
Conducted Emissions at mains ports	150kHz ~ 30MHz	2.94 dB
Radiated Emissions up to 1 GHz	30MHz ~ 200MHz	3.86 dB
	200MHz ~ 1000MHz	3.87 dB
Radiated Emissions above 1 GHz	1GHz ~ 18GHz	2.29 dB
	18GHz ~ 40GHz	2.29 dB

2.2 Modification Record

There were no modifications required for compliance.

3 General Information

3.1 General Description of EUT

Product	Secured Wireless Access Point
Brand	Fortinet Inc.
Test Model	FortiAP U221EV, FortiAP U223EV
Series Model	FortiAP U221EVxxxxxx, FAP-U221EVxxxxxx, FORTIAP-U221EVxxxxxx, FortiAP U223EVxxxxxx, FAP-U223EVxxxxxx, FORTIAP-U223EVxxxxxx (where "x" can be used as "A-Z" or "0-9" or "-" or blank for software changes or marketing purposes only)
Model Difference	Refer to Note 1 for more details
Status of EUT	Engineering sample
Power Supply Rating	12Vdc (adapter) 54Vdc (POE)
Modulation Type	256QAM, 64QAM, 16QAM, QPSK, BPSK
Modulation Technology	OFDM
Transfer Rate	802.11a: 54.0/ 48.0/ 36.0/ 24.0/ 18.0/ 12.0/ 9.0/ 6.0Mbps 802.11n: up to 300.0Mbps 802.11ac: up to 867Mbps
Operating Frequency	5250 ~ 5350MHz, 5470 ~ 5725MHz
Number of Channel	5250 ~ 5350MHz: 4 for 802.11a, 802.11n (HT20), 802.11ac (VHT20) 2 for 802.11n (HT40), 802.11ac (VHT40) 1 for 802.11ac (VHT80) 5470 ~ 5725MHz: 12 for 802.11a, 802.11n (HT20), 802.11ac (VHT20) 6 for 802.11n (HT40), 802.11ac (VHT40) 3 for 802.11ac (VHT80)
Output Power	For Internal antenna: CDD Mode: 5250 ~ 5350MHz: 126.658mW 5470 ~ 5725MHz: 128.250mW Beamforming Mode: 5250 ~ 5350MHz: 63.333mW 5470 ~ 5725MHz: 64.129mW For External antenna: CDD Mode: 5250 ~ 5350MHz: 138.933mW 5470 ~ 5725MHz: 139.999mW Beamforming Mode: 5250 ~ 5350MHz: 69.031mW 5470 ~ 5725MHz: 70.004mW
Antenna Type	Refer to Note
Antenna Connector	Refer to Note
Accessory Device	Adapter
Data Cable Supplied	NA

Note:

1. This report is prepared for FCC class II permissive change. This report is issued as a supplementary report of the original report no.: RF161026C20-1. The difference compared with original report is adding 5.25GHz to 5.35GHz and 5.47GHz to 5.725GHz by software.
2. All models are listed as below (where “x” can be used as “A-Z” or “0-9” or “-“ or blank for software changes or marketing purposes only). Model FortiAP U221EV, FortiAP U223EV are the representative for final test.

Brand	Model	Difference
Fortinet Inc.	FortiAP U221EVxxxxxx	Internal antenna
	FAP-U221EVxxxxxx	
	FORTIAP-U221EVxxxxxx	
	FortiAP U223EVxxxxxx	External antenna
	FAP-U223EVxxxxxx	
	FORTIAP-U223EVxxxxxx	

3. The EUT incorporates a MIMO function. Physically, the EUT provides 2 completed transmitters and 2 receivers.

Band	Modulation Mode	CDD Mode	Beamforming Mode	TX Function
5GHz	802.11a	Support	Not Support	2TX
	802.11n (HT20)	Support	Support	2TX
	802.11n (HT40)	Support	Support	2TX
	802.11ac (VHT20)	Support	Support	2TX
	802.11ac (VHT40)	Support	Support	2TX
	802.11ac (VHT80)	Support	Support	2TX

* The modulation and bandwidth are similar for 802.11n mode for HT20/HT40 and 802.11ac mode for HT20/HT40, therefore investigated worst case to representative mode in test report. (Final test mode refer section 3.2.1)

* For 802.11n and 802.11ac, CDD mode and Beamforming mode are presented in power output test item. For other test items, CDD mode is the worst case for final tests after pretesting.

4. The EUT consumes power from the following adapter and POE (POE as support units only).

Adapter	
Brand	Asian Power Devices Inc.
Model	WA-30J12R
Input Power	100-240Vac, 50-60Hz, 0.9A Max.
Output Power	12Vdc, 2.5A
Power Line	1.8m power cable without core attached on adapter

POE (support units only)	
Brand	SENAO
Model	EPA5006GAT
Input Power	100-240Vac, 50-60Hz, 0.8A
Output Power	54Vdc, 0.6A
Power Line	0.5m power cable without core

5. The EUT uses following antennas.

Antenna Type	PIFA	Antenna Connector	IPEX
Gain (dBi)	Frequency (MHz)		
	2400~2500	5150~5850	
WLAN Internal Ant. 1	4.36	-	
WLAN Internal Ant. 2	4.95	-	
WLAN Internal Ant. 3	-	5.64	
WLAN Internal Ant. 4	-	5.83	
BT Ant.	3.67	-	



Antenna Type	Dipole	Antenna Connector	RP SMA plug
Gain (dBi)	Frequency (MHz)		
	2400~2500	5150~5850	
WLAN External Ant.	4.58	5.35	

6. WLAN 2.4GHz and WLAN 5GHz and BT technologies can transmit at same time.
7. Spurious emission of the simultaneous operation (WLAN 2.4GHz and WLAN 5GHz and BT) has been evaluated and no non-compliance was found.
8. The EUT is without Transmit Power Control function.

3.2 Description of Test Modes

For 5250 ~ 5350MHz

4 channels are provided for 802.11a, 802.11n (HT20), 802.11ac (VHT20):

Channel	Frequency	Channel	Frequency
52	5260 MHz	60	5300 MHz
56	5280 MHz	64	5320 MHz

2 channels are provided for 802.11n (HT40), 802.11ac (VHT40):

Channel	Frequency	Channel	Frequency
54	5270 MHz	62	5310 MHz

1 channel is provided for 802.11ac (VHT80):

Channel	Frequency
58	5290 MHz

For 5470 ~ 5725MHz

12 channels are provided for 802.11a, 802.11n (HT20), 802.11ac (VHT20):

Channel	Frequency	Channel	Frequency
100	5500 MHz	124	5620 MHz
104	5520 MHz	128	5640 MHz
108	5540 MHz	132	5660 MHz
112	5560 MHz	136	5680 MHz
116	5580 MHz	140	5700 MHz
120	5600 MHz	144	5720 MHz

6 channels are provided for 802.11n (HT40), 802.11ac (VHT40):

Channel	Frequency	Channel	Frequency
102	5510 MHz	126	5630 MHz
110	5550 MHz	134	5670 MHz
118	5590 MHz	142	5710 MHz

3 channels are provided for 802.11ac (VHT80):

Channel	Frequency	Channel	Frequency
106	5530 MHz	122	5610 MHz
138	5690 MHz		

3.2.1 Test Mode Applicability and Tested Channel Detail

EUT CONFIGURE MODE	APPLICABLE TO				DESCRIPTION
	RE \geq 1G	RE<1G	PLC	APCM	
A	√	√	√	√	Internal antenna, Power from adapter
B	-	√	√	-	Internal antenna, Power from POE
C	√	√	√	√	External antenna, Power from adapter
D	-	√	√	-	External antenna, Power from POE

Where **RE \geq 1G**: Radiated Emission above 1GHz & Bandedge Measurement
RE<1G: Radiated Emission below 1GHz
PLC: Power Line Conducted Emission
APCM: Antenna Port Conducted Measurement

Note:

- The EUT had been pre-tested on the positioned of each 3 axis.
The worst case was found when positioned on **X-plane** (test mode A & B) and **Z-plane** (test mode C & D).
- "-" means no effect.

Radiated Emission Test (Above 1GHz):

- Pre-Scan has been conducted to determine the worst-case mode from all possible combinations between available modulations, data rates and antenna ports (if EUT with antenna diversity architecture).
- Following channel(s) was (were) selected for the final test as listed below.

EUT Configure Mode	Mode	Frequency Band (MHz)	Available Channel	Tested Channel	Modulation Technology	Data Rate (Mbps)
A, C	802.11a	5250-5350	52 to 64	52, 60, 64	OFDM	6.0
	802.11n (HT20)		52 to 64	52, 60, 64	OFDM	7.2
	802.11n (HT40)		54 to 62	54, 62	OFDM	15.0
	802.11ac (VHT80)		58	58	OFDM	130.0
A, C	802.11a	5470-5725	100 to 144	100, 116, 140, 144	OFDM	6.0
	802.11n (HT20)		100 to 144	100, 116, 140, 144	OFDM	7.2
	802.11n (HT40)		102 to 142	102, 110, 134, 142	OFDM	15.0
	802.11ac (VHT80)		106 to 138	106, 122, 138	OFDM	130.0

Radiated Emission Test (Below 1GHz):

- Pre-Scan has been conducted to determine the worst-case mode from all possible combinations between available modulations, data rates and antenna ports (if EUT with antenna diversity architecture).
- Following channel(s) was (were) selected for the final test as listed below.

EUT Configure Mode	Mode	Frequency Band (MHz)	Available Channel	Tested Channel	Modulation Technology	Data Rate (Mbps)
A, B, C, D	802.11a	5250-5350	52 to 64	52	OFDM	6.0
		5470-5725	100 to 140		OFDM	6.0

Power Line Conducted Emission Test:

- Pre-Scan has been conducted to determine the worst-case mode from all possible combinations between available modulations, data rates and antenna ports (if EUT with antenna diversity architecture).
- Following channel(s) was (were) selected for the final test as listed below.

EUT Configure Mode	Mode	Frequency Band (MHz)	Available Channel	Tested Channel	Modulation Technology	Data Rate (Mbps)
A, B, C, D	802.11a	5250-5350	52 to 64	52	OFDM	6.0
		5470-5725	100 to 140		OFDM	6.0

Antenna Port Conducted Measurement:

- This item includes all test value of each mode, but only includes spectrum plot of worst value of each mode.
- Pre-Scan has been conducted to determine the worst-case mode from all possible combinations between available modulations, data rates and antenna ports (if EUT with antenna diversity architecture).
- Following channel(s) was (were) selected for the final test as listed below.

EUT Configure Mode	Mode	Frequency Band (MHz)	Available Channel	Tested Channel	Modulation Technology	Data Rate (Mbps)
A, C	802.11a	5250-5350	52 to 64	52, 60, 64	OFDM	6.0
	802.11n (HT20)		52 to 64	52, 60, 64	OFDM	7.2
	802.11n (HT40)		54 to 62	54, 62	OFDM	15.0
	802.11ac (VHT80)		58	58	OFDM	130.0
A, C	802.11a	5470-5725	100 to 144	100, 116, 140, 144	OFDM	6.0
	802.11n (HT20)		100 to 144	100, 116, 140, 144	OFDM	7.2
	802.11n (HT40)		102 to 142	102, 110, 134, 142	OFDM	15.0
	802.11ac (VHT80)		106 to 138	106, 122, 138	OFDM	130.0

Test Condition:

APPLICABLE TO	ENVIRONMENTAL CONDITIONS	INPUT POWER	TESTED BY
RE\geq1G	25 deg. C, 65% RH	120Vac, 60Hz	Adair Peng
RE$<$1G	25 deg. C, 64% RH	120Vac, 60Hz 54Vdc (POE)	Willy Cheng
PLC	25 deg. C, 75% RH	120Vac, 60Hz 54Vdc (POE)	Adair Peng
APCM	25 deg. C, 60% RH	120Vac, 60Hz	Alan Wu

3.3 Duty Cycle of Test Signal

Mode A

Duty cycle of test signal is > 98%, duty factor is not required

Duty cycle of test signal is < 98 %, duty factor is required

802.11a: Duty cycle = $2.062/2.089 = 0.987$

802.11n (HT20): Duty cycle = $1.917/1.957 = 0.980$

802.11n (HT40): Duty cycle = $0.941/0.971 = 0.969$, Duty factor = $10 * \log(1/0.969) = 0.14$

802.11ac (VHT80): Duty cycle = $0.459/0.480 = 0.956$, Duty factor = $10 * \log(1/0.956) = 0.19$

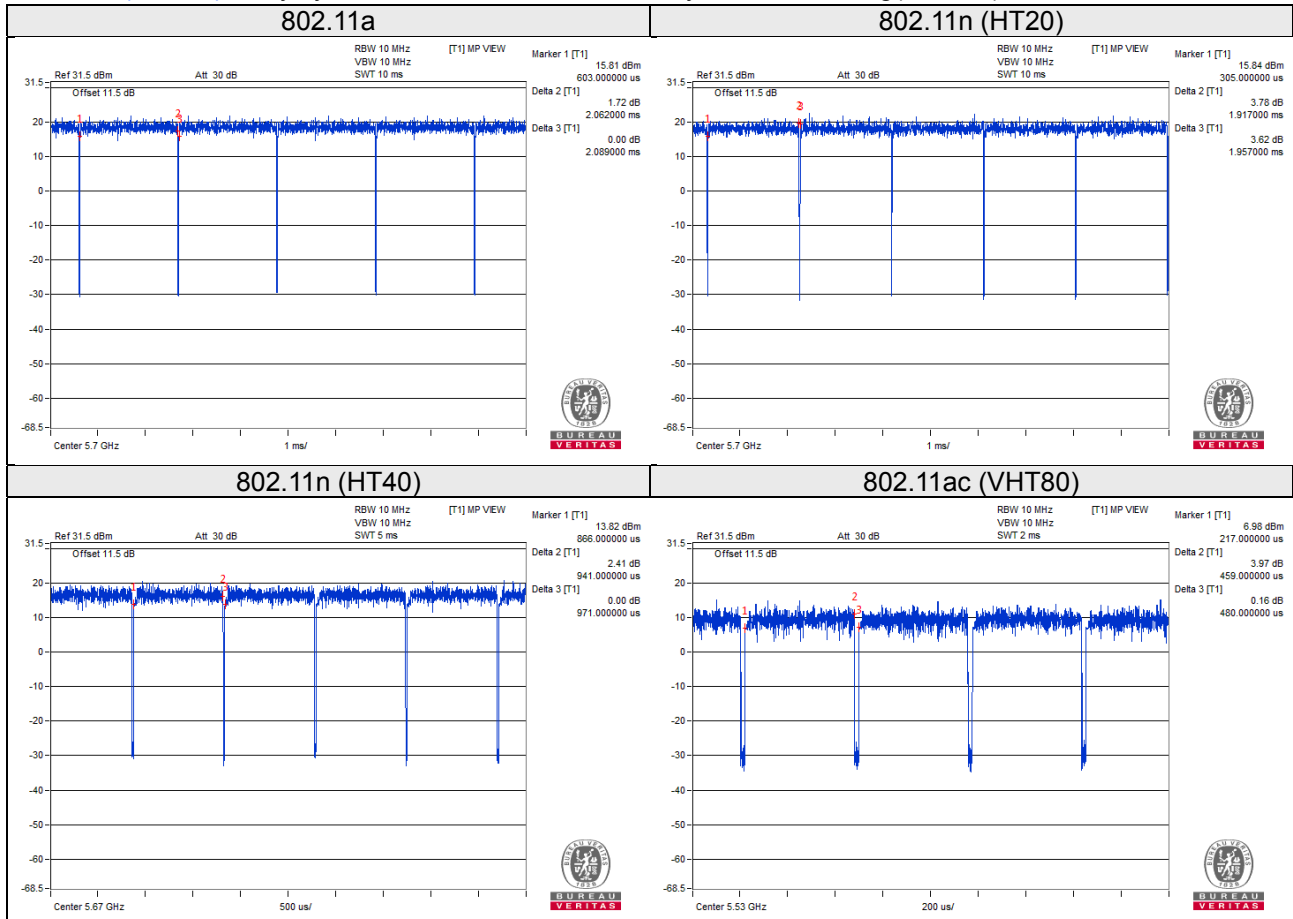

Mode C

Duty cycle of test signal is > 98%, duty factor is not required

Duty cycle of test signal is < 98 %, duty factor is required

802.11a: Duty cycle = $2.061/2.089 = 0.987$

802.11n (HT20): Duty cycle = $1.917/1.942 = 0.987$

802.11n (HT40): Duty cycle = $0.942/0.963 = 0.978$, Duty factor = $10 * \log(1/0.978) = 0.10$

802.11ac (VHT80): Duty cycle = $0.459/0.487 = 0.943$, Duty factor = $10 * \log(1/0.943) = 0.26$

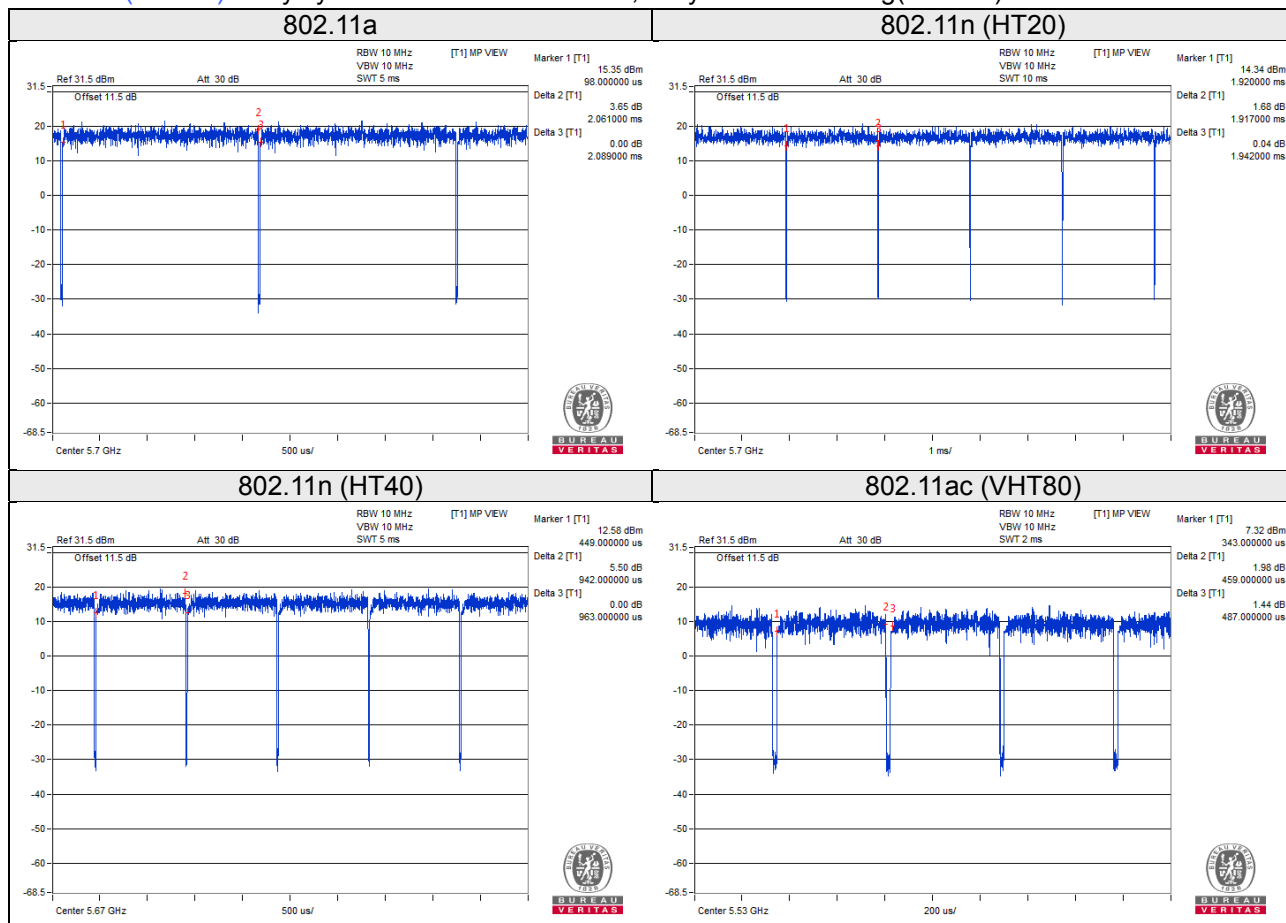

3.4 Description of Support Units

The EUT has been tested as an independent unit together with other necessary accessories or support units. The following support units or accessories were used to form a representative test configuration during the tests.

ID	Product	Brand	Model No.	Serial No.	FCC ID	Remarks
A.	Notebook	DELL	E5410	1HC2XM1	FCC DoC Approved	-
B.	Flash	HP	v250W	01	NA	-
C.	POE	SENAO	EPA5006GAT	NA	NA	Option of EUT I/P: 100-240Vac, 50-60Hz, 0.8A O/P: 54Vdc, 0.6A 0.5m power cable w/o core

Note:

1. All power cords of the above support units are non-shielded (1.8m).
2. Item A acted as a communication partner to transfer data.

ID	Descriptions	Qty.	Length (m)	Shielding (Yes/No)	Cores (Qty.)	Remarks
1.	RJ45	1	3	N	0	-
2.	RJ45	1	1.5	N	0	-

3.4.1 Configuration of System under Test

Mode A, C

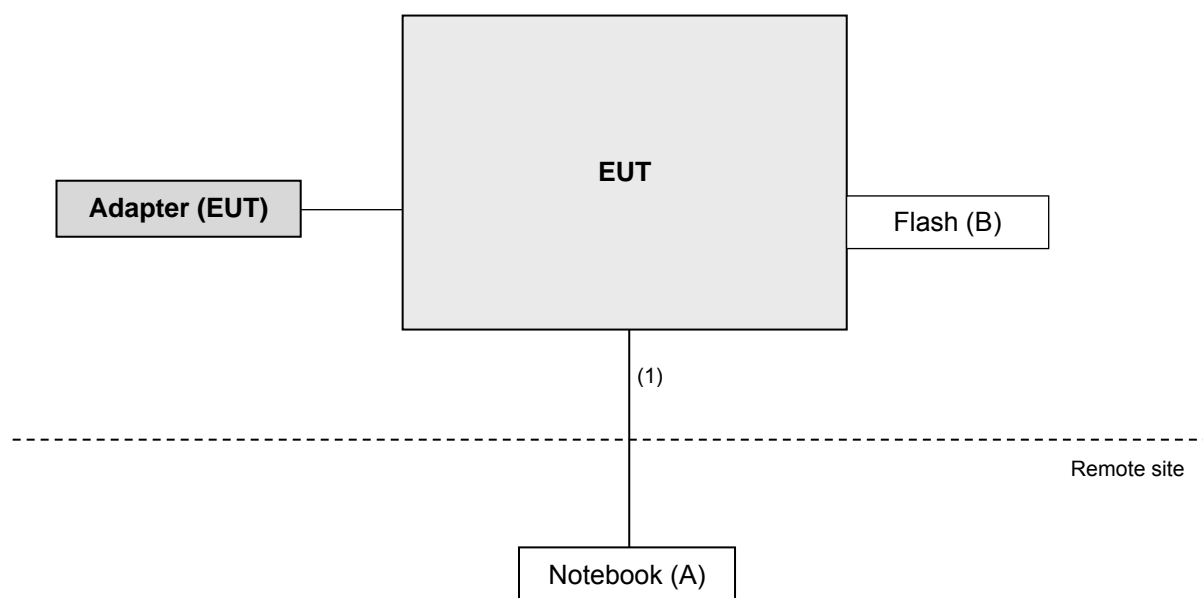

Mode B, D

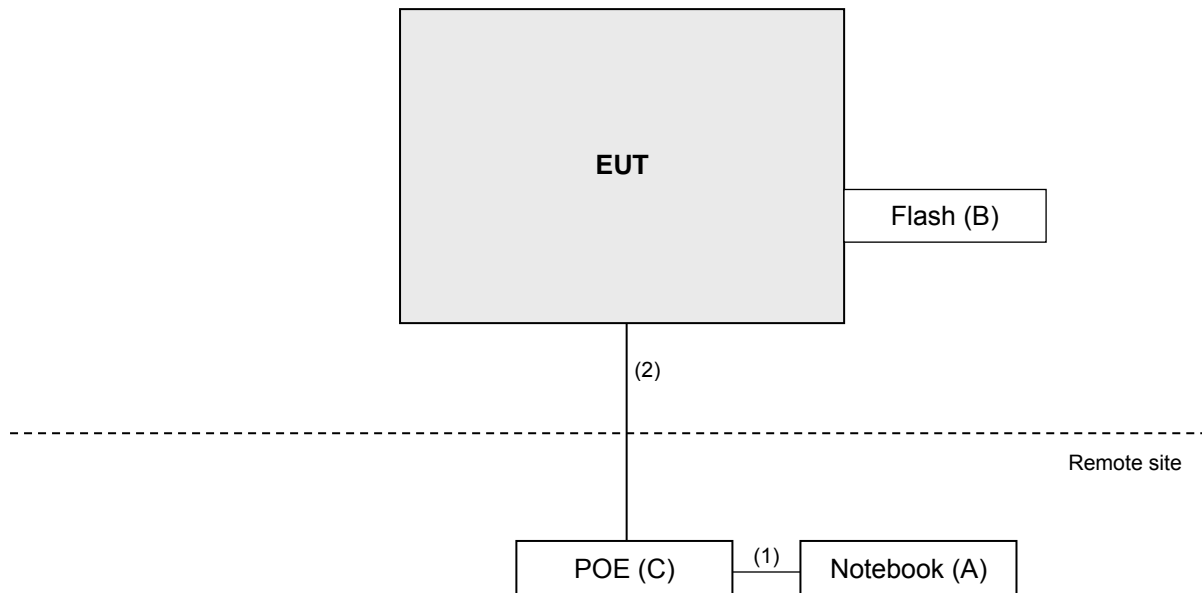

3.5 General Description of Applied Standards

The EUT is a RF Product. According to the specifications of the manufacturer, it must comply with the requirements of the following standards:

FCC Part 15, Subpart E (15.407)

KDB 789033 D02 General UNII Test Procedures New Rules v02r01

KDB 662911 D01 Multiple Transmitter Output v02r01

ANSI C63.10-2013

All test items have been performed and recorded as per the above standards.

4 Test Types and Results

4.1 Radiated Emission and Bandedge Measurement

4.1.1 Limits of Radiated Emission and Bandedge Measurement

Radiated emissions which fall in the restricted bands must comply with the radiated emission limits specified as below table.

Frequencies (MHz)	Field Strength (microvolts/meter)	Measurement Distance (meters)
0.009 ~ 0.490	2400/F(kHz)	300
0.490 ~ 1.705	24000/F(kHz)	30
1.705 ~ 30.0	30	30
30 ~ 88	100	3
88 ~ 216	150	3
216 ~ 960	200	3
Above 960	500	3

NOTE:

1. The lower limit shall apply at the transition frequencies.
2. Emission level (dBuV/m) = 20 log Emission level (uV/m).
3. For frequencies above 1000MHz, the field strength limits are based on average detector, however, the peak field strength of any emission shall not exceed the maximum permitted average limits, specified above by more than 20dB under any condition of modulation.

Limits of Unwanted Emission Out of the Restricted Bands

Applicable To		Limit	
789033 D02 General UNII Test Procedure New Rules v02r01		Field Strength at 3m	
		PK:74 (dBµV/m)	AV:54 (dBµV/m)
Frequency Band	Applicable To	EIRP Limit	Equivalent Field Strength at 3m
5150~5250 MHz	15.407(b)(1)	PK:-27 (dBm/MHz)	PK:68.2(dBµV/m)
5250~5350 MHz	15.407(b)(2)		
5470~5725 MHz	15.407(b)(3)		
5725~5850 MHz	<input checked="" type="checkbox"/> 15.407(b)(4)(i)	PK:-27 (dBm/MHz) ^{*1} PK:10 (dBm/MHz) ^{*2} PK:15.6 (dBm/MHz) ^{*3} PK:27 (dBm/MHz) ^{*4}	PK: 68.2 (dBµV/m) ^{*1} PK:105.2 (dBµV/m) ^{*2} PK: 110.8 (dBµV/m) ^{*3} PK:122.2 (dBµV/m) ^{*4}
	<input type="checkbox"/> 15.407(b)(4)(ii)	Emission limits in section 15.247(d)	
^{*1} beyond 75 MHz or more above of the band edge. ^{*3} below the band edge increasing linearly to a level of 15.6 dBm/MHz at 5 MHz above.		^{*2} below the band edge increasing linearly to 10 dBm/MHz at 25 MHz above. ^{*4} from 5 MHz above or below the band edge increasing linearly to a level of 27 dBm/MHz at the band edge.	

NOTE: The following formula is used to convert the equipment isotropic radiated power (eirp) to field strength:

$$E = \frac{1000000\sqrt{30P}}{3} \mu\text{V/m, where P is the eirp (Watts).}$$

4.1.2 Test Instruments

Description & Manufacturer	Model No.	Serial No.	Cal. Date	Cal. Due
Test Receiver ROHDE & SCHWARZ	ESCI	100424	Oct. 17, 2017	Oct. 16, 2018
Spectrum Analyzer ROHDE & SCHWARZ	FSP40	100041	Dec. 12, 2017	Dec. 11, 2018
BILOG Antenna SCHWARZBECK	VULB9168	9168-171	Dec. 11, 2017	Dec. 10, 2018
HORN Antenna SCHWARZBECK	9120D	209	Dec. 13, 2017	Dec. 12, 2018
HORN Antenna SCHWARZBECK	BBHA 9170	BBHA9170241	Dec. 01, 2017	Nov. 30, 2018
Loop Antenna EMCI	EM-6879	269	Aug. 11, 2017	Aug. 10, 2018
Preamplifier Agilent (Below 1GHz)	8447D	2944A10738	Aug. 21, 2017	Aug. 20, 2018
Preamplifier Agilent (Above 1GHz)	8449B	3008A01922	Sep. 15, 2017	Sep. 14, 2018
RF signal cable HUBER+SUHNER	SUCOFLEX 104	Cable-CH3-03 (223653/4)	Aug. 21, 2017	Aug. 20, 2018
RF signal cable HUBER+SUHNER& EMCI	SUCOFLEX 104&EMC104-SM-S M-8000	Cable-CH3-03 (309224+170907)	Sep.11, 2017	Sep. 10, 2018
Software BV ADT	ADT_Radiated_ V7.6.15.9.4	NA	NA	NA
Antenna Tower inn-co GmbH	MA 4000	013303	NA	NA
Antenna Tower Controller BV ADT	AT100	AT93021702	NA	NA
Turn Table BV ADT	TT100	TT93021702	NA	NA
Turn Table Controller BV ADT	SC100	SC93021702	NA	NA
Boresight Antenna Fixture	FBA-01	FBA-SIP01	NA	NA
26GHz ~ 40GHz Amplifier Agilent	8449B	3008A1960	Aug. 08, 2017	Aug. 07, 2018
High Speed Peak Power Meter	ML2495A	0824012	Aug. 18, 2017	Aug. 17, 2018
Power Sensor	MA2411B	0738171	Aug. 18, 2017	Aug. 17, 2018

- Note:
1. The calibration interval of the above test instruments is 12 months and the calibrations are traceable to NML/ROC and NIST/USA.
 2. The test was performed in HwaYa Chamber 3.
 3. The horn antenna and preamplifier (model: 8449B) are used only for the measurement of emission frequency above 1GHz if tested.
 4. The FCC Designation Number is TW0003. The number will be varied with the Lab location and scope as attached.
 5. The IC Site Registration No. is IC 7450F-3.

4.1.3 Test Procedures

For Radiated emission below 30MHz

- a. The EUT was placed on the top of a rotating table 0.8 meters above the ground at a 3 meter chamber room. The table was rotated 360 degrees to determine the position of the highest radiation.
- b. The EUT was set 3 meters away from the interference-receiving antenna, which was mounted on the top of a variable-height antenna tower.
- c. Both X and Y axes of the antenna are set to make the measurement.
- d. For each suspected emission, the EUT was arranged to its worst case and the rotatable table was turned from 0 degrees to 360 degrees to find the maximum reading.
- e. The test-receiver system was set to Quasi-Peak Detect Function and Specified Bandwidth with Maximum Hold Mode.

NOTE:

1. The resolution bandwidth and video bandwidth of test receiver/spectrum analyzer is 9kHz at frequency below 30MHz.

For Radiated emission above 30MHz

- a. The EUT was placed on the top of a rotating table 0.8 meters (for 30MHz ~ 1GHz) / 1.5 meters (for above 1GHz) above the ground at 3 meter chamber room for test. The table was rotated 360 degrees to determine the position of the highest radiation.
- b. The EUT was set 3 meters away from the interference-receiving antenna, which was mounted on the top of a variable-height antenna tower.
- c. The height of antenna is varied from one meter to four meters above the ground to determine the maximum value of the field strength. Both horizontal and vertical polarizations of the antenna are set to make the measurement.
- d. For each suspected emission, the EUT was arranged to its worst case and then the antenna was tuned to heights from 1 meter to 4 meters and the rotatable table was turned from 0 degrees to 360 degrees to find the maximum reading.
- e. The test-receiver system was set to quasi-peak detect function and specified bandwidth with maximum hold mode when the test frequency is below 1 GHz.
- f. The test-receiver system was set to peak and average detect function and specified bandwidth with maximum hold mode when the test frequency is above 1 GHz. If the peak reading value also meets average limit, measurement with the average detector is unnecessary.

Note:

1. The resolution bandwidth and video bandwidth of test receiver/spectrum analyzer is 120kHz for Quasi-peak detection (QP) at frequency below 1GHz.
2. The resolution bandwidth of test receiver/spectrum analyzer is 1 MHz and the video bandwidth is 3 MHz for Peak detection (PK) at frequency above 1GHz.
3. The resolution bandwidth of test receiver/spectrum analyzer is 1MHz and the video bandwidth is $\geq 1/T$ (Duty cycle < 98%) or 10Hz (Duty cycle $\geq 98\%$) for Average detection (AV) at frequency above 1GHz.
4. All modes of operation were investigated and the worst-case emissions are reported.

4.1.4 Deviation from Test Standard

No deviation.

4.1.5 Test Setup

For Radiated emission below 30MHz

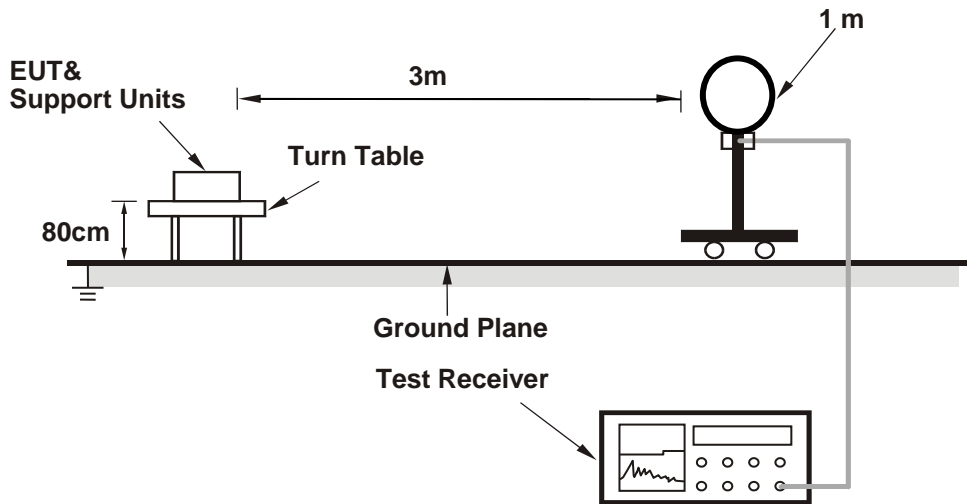

For Radiated emission 30MHz to 1GHz

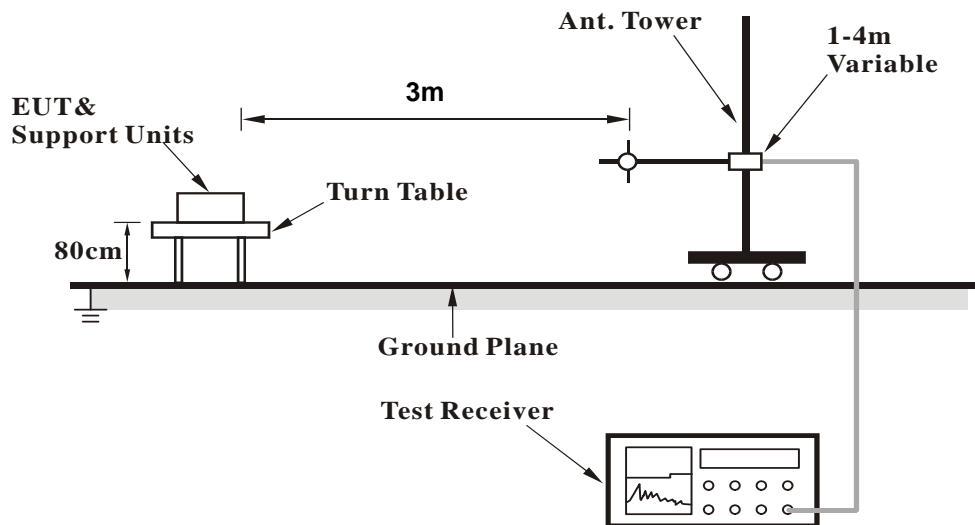

For Radiated emission above 1GHz

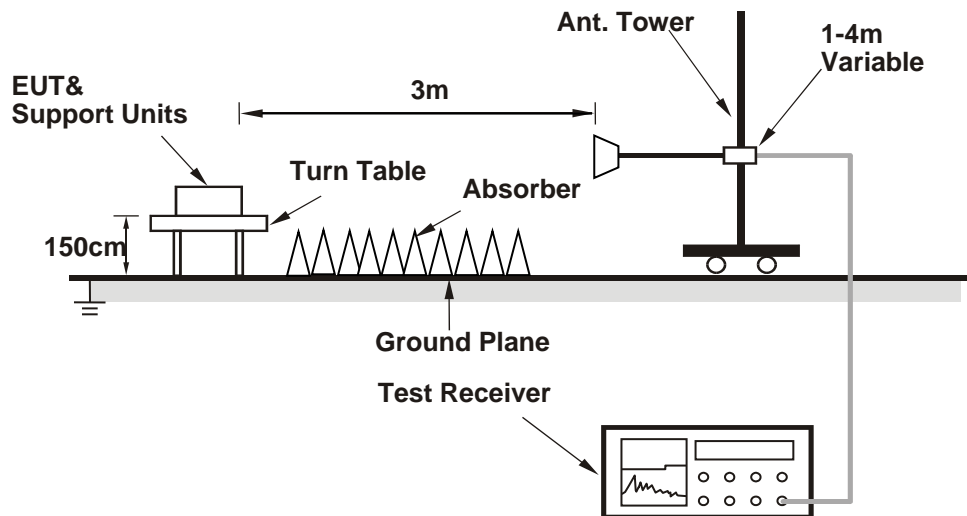

For the actual test configuration, please refer to the attached file (Test Setup Photo).

4.1.6 EUT Operating Conditions

- Placed the EUT on the testing table.
- Prepared a notebook to act as a communication partner and placed it outside of testing area.
- The communication partner connected with EUT via a RJ45 cable and ran a test program (provided by manufacturer) to enable EUT under transmission condition continuously at specific channel frequency.
- The communication partner sent data to EUT by command "PING".
- The necessary accessories enable the system in full functions.

4.1.7 Test Results

Above 1GHz data:

Mode A

802.11a

CHANNEL	TX Channel 52	DETECTOR FUNCTION	Peak (PK)
FREQUENCY RANGE	1GHz ~ 40GHz		Average (AV)

ANTENNA POLARITY & TEST DISTANCE: HORIZONTAL AT 3 M

NO.	FREQ. (MHz)	EMISSION LEVEL (dBuV/m)	LIMIT (dBuV/m)	MARGIN (dB)	ANTENNA HEIGHT (m)	TABLE ANGLE (Degree)	RAW VALUE (dBuV)	CORRECTION FACTOR (dB/m)
1	5150.00	55.9 PK	74.0	-18.1	2.93 H	261	52.2	3.7
2	5150.00	42.6 AV	54.0	-11.4	2.93 H	261	38.9	3.7
3	*5260.00	110.1 PK			2.73 H	238	70.7	39.4
4	*5260.00	100.4 AV			2.73 H	238	61.0	39.4
5	#10520.00	59.1 PK	74.0	-14.9	3.22 H	261	42.3	16.8
6	#10520.00	45.5 AV	54.0	-8.5	3.22 H	261	28.7	16.8

ANTENNA POLARITY & TEST DISTANCE: VERTICAL AT 3 M

NO.	FREQ. (MHz)	EMISSION LEVEL (dBuV/m)	LIMIT (dBuV/m)	MARGIN (dB)	ANTENNA HEIGHT (m)	TABLE ANGLE (Degree)	RAW VALUE (dBuV)	CORRECTION FACTOR (dB/m)
1	5150.00	57.1 PK	74.0	-16.9	1.99 V	252	53.4	3.7
2	5150.00	44.9 AV	54.0	-9.1	1.99 V	252	41.2	3.7
3	*5260.00	115.4 PK			2.33 V	224	76.0	39.4
4	*5260.00	105.8 AV			2.33 V	224	66.4	39.4
5	#10520.00	60.3 PK	74.0	-13.7	1.35 V	74	43.5	16.8
6	#10520.00	48.0 AV	54.0	-6.0	1.35 V	74	31.2	16.8

REMARKS:

1. Emission Level(dBuV/m) = Raw Value(dBuV) + Correction Factor(dB/m)
2. Correction Factor(dB/m) = Antenna Factor(dB/m) + Cable Factor(dB) – Pre-Amplifier Factor(dB)
3. The other emission levels were very low against the limit.
4. Margin value = Emission Level – Limit value
5. " * ": Fundamental frequency.
6. " # ": The radiated frequency is out of the restricted band.

CHANNEL	TX Channel 60	DETECTOR FUNCTION	Peak (PK)
FREQUENCY RANGE	1GHz ~ 40GHz		Average (AV)

ANTENNA POLARITY & TEST DISTANCE: HORIZONTAL AT 3 M

NO.	FREQ. (MHz)	EMISSION LEVEL (dBuV/m)	LIMIT (dBuV/m)	MARGIN (dB)	ANTENNA HEIGHT (m)	TABLE ANGLE (Degree)	RAW VALUE (dBuV)	CORRECTION FACTOR (dB/m)
1	*5300.00	110.3 PK			2.87 H	254	70.9	39.4
2	*5300.00	100.7 AV			2.87 H	254	61.3	39.4
3	10600.00	59.3 PK	74.0	-14.7	3.03 H	299	42.4	16.9
4	10600.00	45.9 AV	54.0	-8.1	3.03 H	299	29.0	16.9

ANTENNA POLARITY & TEST DISTANCE: VERTICAL AT 3 M

NO.	FREQ. (MHz)	EMISSION LEVEL (dBuV/m)	LIMIT (dBuV/m)	MARGIN (dB)	ANTENNA HEIGHT (m)	TABLE ANGLE (Degree)	RAW VALUE (dBuV)	CORRECTION FACTOR (dB/m)
1	*5300.00	116.0 PK			2.27 V	206	76.6	39.4
2	*5300.00	106.3 AV			2.27 V	206	66.9	39.4
3	10600.00	60.9 PK	74.0	-13.1	1.13 V	76	44.0	16.9
4	10600.00	48.7 AV	54.0	-5.3	1.13 V	76	31.8	16.9

REMARKS:

1. Emission Level(dBuV/m) = Raw Value(dBuV) + Correction Factor(dB/m)
2. Correction Factor(dB/m) = Antenna Factor(dB/m) + Cable Factor(dB) – Pre-Amplifier Factor(dB)
3. The other emission levels were very low against the limit.
4. Margin value = Emission Level – Limit value
5. " * ": Fundamental frequency.

CHANNEL	TX Channel 64	DETECTOR FUNCTION	Peak (PK)
FREQUENCY RANGE	1GHz ~ 40GHz		Average (AV)

ANTENNA POLARITY & TEST DISTANCE: HORIZONTAL AT 3 M

NO.	FREQ. (MHz)	EMISSION LEVEL (dBuV/m)	LIMIT (dBuV/m)	MARGIN (dB)	ANTENNA HEIGHT (m)	TABLE ANGLE (Degree)	RAW VALUE (dBuV)	CORRECTION FACTOR (dB/m)
1	*5320.00	108.6 PK			2.73 H	244	69.1	39.5
2	*5320.00	99.4 AV			2.73 H	244	59.9	39.5
3	5350.00	65.5 PK	74.0	-8.5	2.93 H	261	61.7	3.8
4	5350.00	47.1 AV	54.0	-6.9	2.93 H	261	43.3	3.8
5	10640.00	60.8 PK	74.0	-13.2	2.92 H	307	43.8	17.0
6	10640.00	48.1 AV	54.0	-5.9	2.92 H	307	31.1	17.0

ANTENNA POLARITY & TEST DISTANCE: VERTICAL AT 3 M

NO.	FREQ. (MHz)	EMISSION LEVEL (dBuV/m)	LIMIT (dBuV/m)	MARGIN (dB)	ANTENNA HEIGHT (m)	TABLE ANGLE (Degree)	RAW VALUE (dBuV)	CORRECTION FACTOR (dB/m)
1	*5320.00	114.4 PK			2.61 V	225	74.9	39.5
2	*5320.00	104.6 AV			2.61 V	225	65.1	39.5
3	5350.00	72.6 PK	74.0	-1.4	3.81 V	178	68.8	3.8
4	5350.00	52.9 AV	54.0	-1.1	3.81 V	178	49.1	3.8
5	10640.00	61.2 PK	74.0	-12.8	1.20 V	77	44.2	17.0
6	10640.00	48.9 AV	54.0	-5.1	1.20 V	77	31.9	17.0

REMARKS:

1. Emission Level(dBuV/m) = Raw Value(dBuV) + Correction Factor(dB/m)
2. Correction Factor(dB/m) = Antenna Factor(dB/m) + Cable Factor(dB) – Pre-Amplifier Factor(dB)
3. The other emission levels were very low against the limit.
4. Margin value = Emission Level – Limit value
5. " * ": Fundamental frequency.

CHANNEL	TX Channel 100	DETECTOR FUNCTION	Peak (PK)
FREQUENCY RANGE	1GHz ~ 40GHz		Average (AV)

ANTENNA POLARITY & TEST DISTANCE: HORIZONTAL AT 3 M

NO.	FREQ. (MHz)	EMISSION LEVEL (dBuV/m)	LIMIT (dBuV/m)	MARGIN (dB)	ANTENNA HEIGHT (m)	TABLE ANGLE (Degree)	RAW VALUE (dBuV)	CORRECTION FACTOR (dB/m)
1	5460.00	56.5 PK	74.0	-17.5	2.91 H	233	52.3	4.2
2	5460.00	44.4 AV	54.0	-9.6	2.91 H	233	40.2	4.2
3	#5470.00	64.1 PK	74.0	-9.9	2.63 H	255	59.9	4.2
4	#5470.00	46.4 AV	54.0	-7.6	2.63 H	255	42.2	4.2
5	*5500.00	109.5 PK			2.89 H	238	69.4	40.1
6	*5500.00	99.4 AV			2.89 H	238	59.3	40.1
7	11000.00	59.9 PK	74.0	-14.1	3.29 H	288	41.2	18.7
8	11000.00	46.4 AV	54.0	-7.6	3.29 H	288	27.7	18.7

ANTENNA POLARITY & TEST DISTANCE: VERTICAL AT 3 M

NO.	FREQ. (MHz)	EMISSION LEVEL (dBuV/m)	LIMIT (dBuV/m)	MARGIN (dB)	ANTENNA HEIGHT (m)	TABLE ANGLE (Degree)	RAW VALUE (dBuV)	CORRECTION FACTOR (dB/m)
1	5460.00	61.3 PK	74.0	-12.7	2.55 V	241	57.1	4.2
2	5460.00	47.8 AV	54.0	-6.2	2.55 V	241	43.6	4.2
3	#5470.00	72.9 PK	74.0	-1.1	2.43 V	244	68.7	4.2
4	#5470.00	52.7 AV	54.0	-1.3	2.43 V	244	48.5	4.2
5	*5500.00	115.3 PK			2.53 V	239	75.2	40.1
6	*5500.00	105.5 AV			2.53 V	239	65.4	40.1
7	11000.00	60.4 PK	74.0	-13.6	1.84 V	52	41.7	18.7
8	11000.00	47.0 AV	54.0	-7.0	1.84 V	52	28.3	18.7

REMARKS:

1. Emission Level(dBuV/m) = Raw Value(dBuV) + Correction Factor(dB/m)
2. Correction Factor(dB/m) = Antenna Factor(dB/m) + Cable Factor(dB) – Pre-Amplifier Factor(dB)
3. The other emission levels were very low against the limit.
4. Margin value = Emission Level – Limit value
5. " * ": Fundamental frequency.
6. " # ": The radiated frequency is out of the restricted band.

CHANNEL	TX Channel 116	DETECTOR FUNCTION	Peak (PK)
FREQUENCY RANGE	1GHz ~ 40GHz		Average (AV)

ANTENNA POLARITY & TEST DISTANCE: HORIZONTAL AT 3 M

NO.	FREQ. (MHz)	EMISSION LEVEL (dBuV/m)	LIMIT (dBuV/m)	MARGIN (dB)	ANTENNA HEIGHT (m)	TABLE ANGLE (Degree)	RAW VALUE (dBuV)	CORRECTION FACTOR (dB/m)
1	*5580.00	108.9 PK			2.79 H	239	68.9	40.0
2	*5580.00	100.8 AV			2.79 H	239	60.8	40.0
3	11160.00	59.4 PK	74.0	-14.6	3.22 H	280	41.7	17.7
4	11160.00	45.9 AV	54.0	-8.1	3.22 H	280	28.2	17.7

ANTENNA POLARITY & TEST DISTANCE: VERTICAL AT 3 M

NO.	FREQ. (MHz)	EMISSION LEVEL (dBuV/m)	LIMIT (dBuV/m)	MARGIN (dB)	ANTENNA HEIGHT (m)	TABLE ANGLE (Degree)	RAW VALUE (dBuV)	CORRECTION FACTOR (dB/m)
1	*5580.00	115.9 PK			2.53 V	242	75.9	40.0
2	*5580.00	106.4 AV			2.53 V	242	66.4	40.0
3	11160.00	59.9 PK	74.0	-14.1	1.91 V	66	42.2	17.7
4	11160.00	46.3 AV	54.0	-7.7	1.91 V	66	28.6	17.7

REMARKS:

1. Emission Level(dBuV/m) = Raw Value(dBuV) + Correction Factor(dB/m)
2. Correction Factor(dB/m) = Antenna Factor(dB/m) + Cable Factor(dB) – Pre-Amplifier Factor(dB)
3. The other emission levels were very low against the limit.
4. Margin value = Emission Level – Limit value
5. " * ": Fundamental frequency.

CHANNEL	TX Channel 140	DETECTOR FUNCTION	Peak (PK)
FREQUENCY RANGE	1GHz ~ 40GHz		Average (AV)

ANTENNA POLARITY & TEST DISTANCE: HORIZONTAL AT 3 M

NO.	FREQ. (MHz)	EMISSION LEVEL (dBuV/m)	LIMIT (dBuV/m)	MARGIN (dB)	ANTENNA HEIGHT (m)	TABLE ANGLE (Degree)	RAW VALUE (dBuV)	CORRECTION FACTOR (dB/m)
1	*5700.00	108.3 PK			2.82 H	237	68.3	40.0
2	*5700.00	98.1 AV			2.82 H	237	58.1	40.0
3	#5725.00	64.4 PK	74.0	-9.6	2.69 H	249	60.3	4.1
4	#5725.00	46.2 AV	54.0	-7.8	2.69 H	249	42.1	4.1
5	11400.00	60.5 PK	74.0	-13.5	3.09 H	341	42.8	17.7
6	11400.00	46.8 AV	54.0	-7.2	3.09 H	341	29.1	17.7

ANTENNA POLARITY & TEST DISTANCE: VERTICAL AT 3 M

NO.	FREQ. (MHz)	EMISSION LEVEL (dBuV/m)	LIMIT (dBuV/m)	MARGIN (dB)	ANTENNA HEIGHT (m)	TABLE ANGLE (Degree)	RAW VALUE (dBuV)	CORRECTION FACTOR (dB/m)
1	*5700.00	113.1 PK			2.54 V	243	73.1	40.0
2	*5700.00	103.4 AV			2.54 V	243	63.4	40.0
3	#5725.00	72.7 PK	74.0	-1.3	2.40 V	246	68.6	4.1
4	#5725.00	52.3 AV	54.0	-1.7	2.40 V	246	48.2	4.1
5	11400.00	60.9 PK	74.0	-13.1	2.03 V	88	43.2	17.7
6	11400.00	47.3 AV	54.0	-6.7	2.03 V	88	29.6	17.7

REMARKS:

1. Emission Level(dBuV/m) = Raw Value(dBuV) + Correction Factor(dB/m)
2. Correction Factor(dB/m) = Antenna Factor(dB/m) + Cable Factor(dB) – Pre-Amplifier Factor(dB)
3. The other emission levels were very low against the limit.
4. Margin value = Emission Level – Limit value
5. " * ": Fundamental frequency.
6. " # ": The radiated frequency is out of the restricted band.

CHANNEL	TX Channel 144	DETECTOR FUNCTION	Peak (PK)
FREQUENCY RANGE	1GHz ~ 40GHz		Average (AV)

ANTENNA POLARITY & TEST DISTANCE: HORIZONTAL AT 3 M

NO.	FREQ. (MHz)	EMISSION LEVEL (dBuV/m)	LIMIT (dBuV/m)	MARGIN (dB)	ANTENNA HEIGHT (m)	TABLE ANGLE (Degree)	RAW VALUE (dBuV)	CORRECTION FACTOR (dB/m)
1	5460.00	56.3 PK	74.0	-17.7	2.99 H	219	52.1	4.2
2	5460.00	43.4 AV	54.0	-10.6	2.99 H	219	39.2	4.2
3	#5470.00	57.6 PK	74.0	-16.4	3.05 H	222	53.4	4.2
4	#5470.00	43.8 AV	54.0	-10.2	3.05 H	222	39.6	4.2
5	*5720.00	109.0 PK			2.96 H	211	69.0	40.0
6	*5720.00	99.5 AV			2.96 H	211	59.5	40.0
7	#5825.00	57.6 PK	74.0	-16.4	3.10 H	244	53.0	4.6
8	#5825.00	44.4 AV	54.0	-9.6	3.10 H	244	39.8	4.6
9	11440.00	61.2 PK	74.0	-12.8	2.66 H	313	43.3	17.9
10	11440.00	47.3 AV	54.0	-6.7	2.66 H	313	29.4	17.9

ANTENNA POLARITY & TEST DISTANCE: VERTICAL AT 3 M

NO.	FREQ. (MHz)	EMISSION LEVEL (dBuV/m)	LIMIT (dBuV/m)	MARGIN (dB)	ANTENNA HEIGHT (m)	TABLE ANGLE (Degree)	RAW VALUE (dBuV)	CORRECTION FACTOR (dB/m)
1	5460.00	56.3 PK	74.0	-17.7	2.55 V	248	52.1	4.2
2	5460.00	43.4 AV	54.0	-10.6	2.55 V	248	39.2	4.2
3	#5470.00	57.4 PK	74.0	-16.6	2.48 V	240	53.2	4.2
4	#5470.00	44.0 AV	54.0	-10.0	2.48 V	240	39.8	4.2
5	*5720.00	116.3 PK			2.58 V	245	76.3	40.0
6	*5720.00	105.2 AV			2.58 V	245	65.2	40.0
7	#5825.00	58.4 PK	74.0	-15.6	2.63 V	251	53.8	4.6
8	#5825.00	45.1 AV	54.0	-8.9	2.63 V	251	40.5	4.6
9	11440.00	60.4 PK	74.0	-13.6	2.87 V	294	42.5	17.9
10	11440.00	47.2 AV	54.0	-6.8	2.87 V	294	29.3	17.9

REMARKS:

1. Emission Level(dBuV/m) = Raw Value(dBuV) + Correction Factor(dB/m)
2. Correction Factor(dB/m) = Antenna Factor(dB/m) + Cable Factor(dB) – Pre-Amplifier Factor(dB)
3. The other emission levels were very low against the limit.
4. Margin value = Emission Level – Limit value
5. " * ": Fundamental frequency.
6. " # ": The radiated frequency is out of the restricted band.

802.11n (HT20)

CHANNEL	TX Channel 52	DETECTOR FUNCTION	Peak (PK)
FREQUENCY RANGE	1GHz ~ 40GHz		Average (AV)

ANTENNA POLARITY & TEST DISTANCE: HORIZONTAL AT 3 M

NO.	FREQ. (MHz)	EMISSION LEVEL (dBuV/m)	LIMIT (dBuV/m)	MARGIN (dB)	ANTENNA HEIGHT (m)	TABLE ANGLE (Degree)	RAW VALUE (dBuV)	CORRECTION FACTOR (dB/m)
1	5150.00	55.6 PK	74.0	-18.4	2.94 H	255	51.9	3.7
2	5150.00	43.6 AV	54.0	-10.4	2.94 H	255	39.9	3.7
3	*5260.00	109.6 PK			2.74 H	239	70.2	39.4
4	*5260.00	99.5 AV			2.74 H	239	60.1	39.4
5	#10520.00	58.5 PK	74.0	-15.5	3.22 H	278	41.7	16.8
6	#10520.00	46.2 AV	54.0	-7.8	3.22 H	278	29.4	16.8

ANTENNA POLARITY & TEST DISTANCE: VERTICAL AT 3 M

NO.	FREQ. (MHz)	EMISSION LEVEL (dBuV/m)	LIMIT (dBuV/m)	MARGIN (dB)	ANTENNA HEIGHT (m)	TABLE ANGLE (Degree)	RAW VALUE (dBuV)	CORRECTION FACTOR (dB/m)
1	5150.00	56.8 PK	74.0	-17.2	2.09 V	259	53.1	3.7
2	5150.00	43.5 AV	54.0	-10.5	2.09 V	259	39.8	3.7
3	*5260.00	114.9 PK			2.54 V	244	75.5	39.4
4	*5260.00	105.1 AV			2.54 V	244	65.7	39.4
5	#10520.00	59.1 PK	74.0	-14.9	1.49 V	79	42.3	16.8
6	#10520.00	46.8 AV	54.0	-7.2	1.49 V	79	30.0	16.8

REMARKS:

1. Emission Level(dBuV/m) = Raw Value(dBuV) + Correction Factor(dB/m)
2. Correction Factor(dB/m) = Antenna Factor(dB/m) + Cable Factor(dB) – Pre-Amplifier Factor(dB)
3. The other emission levels were very low against the limit.
4. Margin value = Emission Level – Limit value
5. " * ": Fundamental frequency.
6. " # ": The radiated frequency is out of the restricted band.

CHANNEL	TX Channel 60	DETECTOR FUNCTION	Peak (PK)
FREQUENCY RANGE	1GHz ~ 40GHz		Average (AV)

ANTENNA POLARITY & TEST DISTANCE: HORIZONTAL AT 3 M

NO.	FREQ. (MHz)	EMISSION LEVEL (dBuV/m)	LIMIT (dBuV/m)	MARGIN (dB)	ANTENNA HEIGHT (m)	TABLE ANGLE (Degree)	RAW VALUE (dBuV)	CORRECTION FACTOR (dB/m)
1	*5300.00	110.5 PK			2.77 H	244	71.1	39.4
2	*5300.00	100.6 AV			2.77 H	244	61.2	39.4
3	10600.00	59.1 PK	74.0	-14.9	3.30 H	287	42.2	16.9
4	10600.00	46.6 AV	54.0	-7.4	3.30 H	287	29.7	16.9

ANTENNA POLARITY & TEST DISTANCE: VERTICAL AT 3 M

NO.	FREQ. (MHz)	EMISSION LEVEL (dBuV/m)	LIMIT (dBuV/m)	MARGIN (dB)	ANTENNA HEIGHT (m)	TABLE ANGLE (Degree)	RAW VALUE (dBuV)	CORRECTION FACTOR (dB/m)
1	*5300.00	115.9 PK			2.78 V	210	76.5	39.4
2	*5300.00	105.9 AV			2.78 V	210	66.5	39.4
3	10600.00	59.7 PK	74.0	-14.3	1.64 V	77	42.8	16.9
4	10600.00	47.3 AV	54.0	-6.7	1.64 V	77	30.4	16.9

REMARKS:

1. Emission Level(dBuV/m) = Raw Value(dBuV) + Correction Factor(dB/m)
2. Correction Factor(dB/m) = Antenna Factor(dB/m) + Cable Factor(dB) – Pre-Amplifier Factor(dB)
3. The other emission levels were very low against the limit.
4. Margin value = Emission Level – Limit value
5. " * ": Fundamental frequency.

CHANNEL	TX Channel 64	DETECTOR FUNCTION	Peak (PK)
FREQUENCY RANGE	1GHz ~ 40GHz		Average (AV)

ANTENNA POLARITY & TEST DISTANCE: HORIZONTAL AT 3 M

NO.	FREQ. (MHz)	EMISSION LEVEL (dBuV/m)	LIMIT (dBuV/m)	MARGIN (dB)	ANTENNA HEIGHT (m)	TABLE ANGLE (Degree)	RAW VALUE (dBuV)	CORRECTION FACTOR (dB/m)
1	*5320.00	108.6 PK			2.81 H	233	69.1	39.5
2	*5320.00	98.8 AV			2.81 H	233	59.3	39.5
3	5350.00	65.0 PK	74.0	-9.0	2.62 H	244	61.2	3.8
4	5350.00	46.7 AV	54.0	-7.3	2.62 H	244	42.9	3.8
5	10640.00	60.7 PK	74.0	-13.3	3.01 H	322	43.7	17.0
6	10640.00	48.0 AV	54.0	-6.0	3.01 H	322	31.0	17.0

ANTENNA POLARITY & TEST DISTANCE: VERTICAL AT 3 M

NO.	FREQ. (MHz)	EMISSION LEVEL (dBuV/m)	LIMIT (dBuV/m)	MARGIN (dB)	ANTENNA HEIGHT (m)	TABLE ANGLE (Degree)	RAW VALUE (dBuV)	CORRECTION FACTOR (dB/m)
1	*5320.00	113.9 PK			2.82 V	216	74.4	39.5
2	*5320.00	104.0 AV			2.82 V	216	64.5	39.5
3	5350.00	72.8 PK	74.0	-1.2	2.95 V	208	69.0	3.8
4	5350.00	52.9 AV	54.0	-1.1	2.95 V	208	49.1	3.8
5	10640.00	61.0 PK	74.0	-13.0	1.39 V	81	44.0	17.0
6	10640.00	48.7 AV	54.0	-5.3	1.39 V	81	31.7	17.0

REMARKS:

1. Emission Level(dBuV/m) = Raw Value(dBuV) + Correction Factor(dB/m)
2. Correction Factor(dB/m) = Antenna Factor(dB/m) + Cable Factor(dB) – Pre-Amplifier Factor(dB)
3. The other emission levels were very low against the limit.
4. Margin value = Emission Level – Limit value
5. " * ": Fundamental frequency.

CHANNEL	TX Channel 100	DETECTOR FUNCTION	Peak (PK)
FREQUENCY RANGE	1GHz ~ 40GHz		Average (AV)

ANTENNA POLARITY & TEST DISTANCE: HORIZONTAL AT 3 M

NO.	FREQ. (MHz)	EMISSION LEVEL (dBuV/m)	LIMIT (dBuV/m)	MARGIN (dB)	ANTENNA HEIGHT (m)	TABLE ANGLE (Degree)	RAW VALUE (dBuV)	CORRECTION FACTOR (dB/m)
1	5460.00	66.3 PK	74.0	-7.7	2.86 H	234	62.1	4.2
2	5460.00	43.4 AV	54.0	-10.6	2.86 H	234	39.2	4.2
3	#5470.00	62.4 PK	74.0	-11.6	2.71 H	254	58.2	4.2
4	#5470.00	45.3 AV	54.0	-8.7	2.71 H	254	41.1	4.2
5	*5500.00	109.3 PK			2.84 H	239	69.2	40.1
6	*5500.00	99.2 AV			2.84 H	239	59.1	40.1
7	11000.00	59.5 PK	74.0	-14.5	3.09 H	281	40.8	18.7
8	11000.00	45.9 AV	54.0	-8.1	3.09 H	281	27.2	18.7

ANTENNA POLARITY & TEST DISTANCE: VERTICAL AT 3 M

NO.	FREQ. (MHz)	EMISSION LEVEL (dBuV/m)	LIMIT (dBuV/m)	MARGIN (dB)	ANTENNA HEIGHT (m)	TABLE ANGLE (Degree)	RAW VALUE (dBuV)	CORRECTION FACTOR (dB/m)
1	5460.00	61.2 PK	74.0	-12.8	2.51 V	241	57.0	4.2
2	5460.00	47.7 AV	54.0	-6.3	2.51 V	241	43.5	4.2
3	#5470.00	72.8 PK	74.0	-1.2	2.61 V	233	68.6	4.2
4	#5470.00	52.6 AV	54.0	-1.4	2.61 V	233	48.4	4.2
5	*5500.00	114.9 PK			2.54 V	240	74.8	40.1
6	*5500.00	105.0 AV			2.54 V	240	64.9	40.1
7	11000.00	60.2 PK	74.0	-13.8	1.91 V	66	41.5	18.7
8	11000.00	46.8 AV	54.0	-7.2	1.91 V	66	28.1	18.7

REMARKS:

1. Emission Level(dBuV/m) = Raw Value(dBuV) + Correction Factor(dB/m)
2. Correction Factor(dB/m) = Antenna Factor(dB/m) + Cable Factor(dB) – Pre-Amplifier Factor(dB)
3. The other emission levels were very low against the limit.
4. Margin value = Emission Level – Limit value
5. " * ": Fundamental frequency.
6. " # ": The radiated frequency is out of the restricted band.

CHANNEL	TX Channel 116	DETECTOR FUNCTION	Peak (PK)
FREQUENCY RANGE	1GHz ~ 40GHz		Average (AV)

ANTENNA POLARITY & TEST DISTANCE: HORIZONTAL AT 3 M

NO.	FREQ. (MHz)	EMISSION LEVEL (dBuV/m)	LIMIT (dBuV/m)	MARGIN (dB)	ANTENNA HEIGHT (m)	TABLE ANGLE (Degree)	RAW VALUE (dBuV)	CORRECTION FACTOR (dB/m)
1	*5580.00	110.1 PK			2.88 H	220	70.1	40.0
2	*5580.00	101.3 AV			2.88 H	220	61.3	40.0
3	11160.00	58.9 PK	74.0	-15.1	3.31 H	287	41.2	17.7
4	11160.00	45.3 AV	54.0	-8.7	3.31 H	287	27.6	17.7

ANTENNA POLARITY & TEST DISTANCE: VERTICAL AT 3 M

NO.	FREQ. (MHz)	EMISSION LEVEL (dBuV/m)	LIMIT (dBuV/m)	MARGIN (dB)	ANTENNA HEIGHT (m)	TABLE ANGLE (Degree)	RAW VALUE (dBuV)	CORRECTION FACTOR (dB/m)
1	*5580.00	79.4 PK			2.59 V	237	75.3	4.1
2	*5580.00	70.2 AV			2.59 V	237	66.1	4.1
3	11160.00	59.5 PK	74.0	-14.5	2.01 V	71	41.8	17.7
4	11160.00	45.9 AV	54.0	-8.1	2.01 V	71	28.2	17.7

REMARKS:

1. Emission Level(dBuV/m) = Raw Value(dBuV) + Correction Factor(dB/m)
2. Correction Factor(dB/m) = Antenna Factor(dB/m) + Cable Factor(dB) – Pre-Amplifier Factor(dB)
3. The other emission levels were very low against the limit.
4. Margin value = Emission Level – Limit value
5. " * ": Fundamental frequency.

CHANNEL	TX Channel 140	DETECTOR FUNCTION	Peak (PK)
FREQUENCY RANGE	1GHz ~ 40GHz		Average (AV)

ANTENNA POLARITY & TEST DISTANCE: HORIZONTAL AT 3 M

NO.	FREQ. (MHz)	EMISSION LEVEL (dBuV/m)	LIMIT (dBuV/m)	MARGIN (dB)	ANTENNA HEIGHT (m)	TABLE ANGLE (Degree)	RAW VALUE (dBuV)	CORRECTION FACTOR (dB/m)
1	*5700.00	106.7 PK			1.97 H	182	66.7	40.0
2	*5700.00	96.5 AV			1.97 H	182	56.5	40.0
3	#5725.00	64.3 PK	74.0	-9.7	2.21 H	213	60.2	4.1
4	#5725.00	45.4 AV	54.0	-8.6	2.21 H	213	41.3	4.1
5	11400.00	59.8 PK	74.0	-14.2	3.03 H	254	42.1	17.7
6	11400.00	46.1 AV	54.0	-7.9	3.03 H	254	28.4	17.7

ANTENNA POLARITY & TEST DISTANCE: VERTICAL AT 3 M

NO.	FREQ. (MHz)	EMISSION LEVEL (dBuV/m)	LIMIT (dBuV/m)	MARGIN (dB)	ANTENNA HEIGHT (m)	TABLE ANGLE (Degree)	RAW VALUE (dBuV)	CORRECTION FACTOR (dB/m)
1	*5700.00	112.4 PK			2.52 V	244	72.4	40.0
2	*5700.00	102.2 AV			2.52 V	244	62.2	40.0
3	#5725.00	72.5 PK	74.0	-1.5	2.57 V	245	68.4	4.1
4	#5725.00	52.1 AV	54.0	-1.9	2.57 V	245	48.0	4.1
5	11400.00	60.4 PK	74.0	-13.6	1.87 V	76	42.7	17.7
6	11400.00	46.8 AV	54.0	-7.2	1.87 V	76	29.1	17.7

REMARKS:

1. Emission Level(dBuV/m) = Raw Value(dBuV) + Correction Factor(dB/m)
2. Correction Factor(dB/m) = Antenna Factor(dB/m) + Cable Factor(dB) – Pre-Amplifier Factor(dB)
3. The other emission levels were very low against the limit.
4. Margin value = Emission Level – Limit value
5. " * ": Fundamental frequency.
6. " # ": The radiated frequency is out of the restricted band.

CHANNEL	TX Channel 144	DETECTOR FUNCTION	Peak (PK)
FREQUENCY RANGE	1GHz ~ 40GHz		Average (AV)

ANTENNA POLARITY & TEST DISTANCE: HORIZONTAL AT 3 M

NO.	FREQ. (MHz)	EMISSION LEVEL (dBuV/m)	LIMIT (dBuV/m)	MARGIN (dB)	ANTENNA HEIGHT (m)	TABLE ANGLE (Degree)	RAW VALUE (dBuV)	CORRECTION FACTOR (dB/m)
1	5460.00	55.7 PK	74.0	-18.3	2.49 H	255	51.5	4.2
2	5460.00	43.4 AV	54.0	-10.6	2.49 H	255	39.2	4.2
3	#5470.00	56.8 PK	74.0	-17.2	2.55 H	261	52.6	4.2
4	#5470.00	43.8 AV	54.0	-10.2	2.55 H	261	39.6	4.2
5	*5720.00	109.0 PK			2.47 H	232	69.0	40.0
6	*5720.00	99.5 AV			2.47 H	232	59.5	40.0
7	#5825.00	57.8 PK	74.0	-16.2	2.39 H	244	53.2	4.6
8	#5825.00	44.5 AV	54.0	-9.5	2.39 H	244	39.9	4.6
9	11440.00	60.9 PK	74.0	-13.1	2.55 H	303	43.0	17.9
10	11440.00	47.5 AV	54.0	-6.5	2.55 H	303	29.6	17.9

ANTENNA POLARITY & TEST DISTANCE: VERTICAL AT 3 M

NO.	FREQ. (MHz)	EMISSION LEVEL (dBuV/m)	LIMIT (dBuV/m)	MARGIN (dB)	ANTENNA HEIGHT (m)	TABLE ANGLE (Degree)	RAW VALUE (dBuV)	CORRECTION FACTOR (dB/m)
1	5460.00	56.7 PK	74.0	-17.3	2.40 V	253	52.5	4.2
2	5460.00	43.4 AV	54.0	-10.6	2.40 V	253	39.2	4.2
3	#5470.00	57.5 PK	74.0	-16.5	2.44 V	249	53.3	4.2
4	#5470.00	44.2 AV	54.0	-9.8	2.44 V	249	40.0	4.2
5	*5720.00	114.5 PK			2.36 V	247	74.5	40.0
6	*5720.00	104.6 AV			2.36 V	247	64.6	40.0
7	#5825.00	59.2 PK	74.0	-14.8	2.51 V	255	54.6	4.6
8	#5825.00	45.3 AV	54.0	-8.7	2.51 V	255	40.7	4.6
9	11440.00	61.4 PK	74.0	-12.6	2.91 V	289	43.5	17.9
10	11440.00	47.4 AV	54.0	-6.6	2.91 V	289	29.5	17.9

REMARKS:

1. Emission Level(dBuV/m) = Raw Value(dBuV) + Correction Factor(dB/m)
2. Correction Factor(dB/m) = Antenna Factor(dB/m) + Cable Factor(dB) – Pre-Amplifier Factor(dB)
3. The other emission levels were very low against the limit.
4. Margin value = Emission Level – Limit value
5. " * ": Fundamental frequency.
6. " # ": The radiated frequency is out of the restricted band.

802.11n (HT40)

CHANNEL	TX Channel 54	DETECTOR FUNCTION	Peak (PK)
FREQUENCY RANGE	1GHz ~ 40GHz		Average (AV)

ANTENNA POLARITY & TEST DISTANCE: HORIZONTAL AT 3 M

NO.	FREQ. (MHz)	EMISSION LEVEL (dBuV/m)	LIMIT (dBuV/m)	MARGIN (dB)	ANTENNA HEIGHT (m)	TABLE ANGLE (Degree)	RAW VALUE (dBuV)	CORRECTION FACTOR (dB/m)
1	5150.00	55.9 PK	74.0	-18.1	2.54 H	213	52.2	3.7
2	5150.00	42.6 AV	54.0	-11.4	2.54 H	213	38.9	3.7
3	*5270.00	107.5 PK			2.72 H	241	68.1	39.4
4	*5270.00	96.3 AV			2.72 H	241	56.9	39.4
5	#10540.00	58.5 PK	74.0	-15.5	2.93 H	299	41.6	16.9
6	#10540.00	46.0 AV	54.0	-8.0	2.93 H	299	29.1	16.9

ANTENNA POLARITY & TEST DISTANCE: VERTICAL AT 3 M

NO.	FREQ. (MHz)	EMISSION LEVEL (dBuV/m)	LIMIT (dBuV/m)	MARGIN (dB)	ANTENNA HEIGHT (m)	TABLE ANGLE (Degree)	RAW VALUE (dBuV)	CORRECTION FACTOR (dB/m)
1	5150.00	57.7 PK	74.0	-16.3	2.99 V	221	54.0	3.7
2	5150.00	45.0 AV	54.0	-9.0	2.99 V	221	41.3	3.7
3	*5270.00	112.8 PK			2.86 V	213	73.4	39.4
4	*5270.00	102.9 AV			2.86 V	213	63.5	39.4
5	#10540.00	58.9 PK	74.0	-15.1	1.54 V	72	42.0	16.9
6	#10540.00	46.8 AV	54.0	-7.2	1.54 V	72	29.9	16.9

REMARKS:

1. Emission Level(dBuV/m) = Raw Value(dBuV) + Correction Factor(dB/m)
2. Correction Factor(dB/m) = Antenna Factor(dB/m) + Cable Factor(dB) – Pre-Amplifier Factor(dB)
3. The other emission levels were very low against the limit.
4. Margin value = Emission Level – Limit value
5. " * ": Fundamental frequency.
6. " # ": The radiated frequency is out of the restricted band.

CHANNEL	TX Channel 62	DETECTOR FUNCTION	Peak (PK)
FREQUENCY RANGE	1GHz ~ 40GHz		Average (AV)

ANTENNA POLARITY & TEST DISTANCE: HORIZONTAL AT 3 M

NO.	FREQ. (MHz)	EMISSION LEVEL (dBuV/m)	LIMIT (dBuV/m)	MARGIN (dB)	ANTENNA HEIGHT (m)	TABLE ANGLE (Degree)	RAW VALUE (dBuV)	CORRECTION FACTOR (dB/m)
1	*5310.00	104.2 PK			2.90 H	237	64.8	39.4
2	*5310.00	94.3 AV			2.90 H	237	54.9	39.4
3	5350.00	65.1 PK	74.0	-8.9	2.77 H	251	61.3	3.8
4	5350.00	46.9 AV	54.0	-7.1	2.77 H	251	43.1	3.8
5	10620.00	58.9 PK	74.0	-15.1	3.29 H	309	41.8	17.1
6	10620.00	46.3 AV	54.0	-7.7	3.29 H	309	29.2	17.1

ANTENNA POLARITY & TEST DISTANCE: VERTICAL AT 3 M

NO.	FREQ. (MHz)	EMISSION LEVEL (dBuV/m)	LIMIT (dBuV/m)	MARGIN (dB)	ANTENNA HEIGHT (m)	TABLE ANGLE (Degree)	RAW VALUE (dBuV)	CORRECTION FACTOR (dB/m)
1	*5310.00	110.2 PK			2.53 V	207	70.8	39.4
2	*5310.00	99.8 AV			2.53 V	207	60.4	39.4
3	5350.00	72.8 PK	74.0	-1.2	2.67 V	223	69.0	3.8
4	5350.00	52.3 AV	54.0	-1.7	2.67 V	223	48.5	3.8
5	10620.00	59.3 PK	74.0	-14.7	1.23 V	70	42.2	17.1
6	10620.00	46.9 AV	54.0	-7.1	1.23 V	70	29.8	17.1

REMARKS:

1. Emission Level(dBuV/m) = Raw Value(dBuV) + Correction Factor(dB/m)
2. Correction Factor(dB/m) = Antenna Factor(dB/m) + Cable Factor(dB) – Pre-Amplifier Factor(dB)
3. The other emission levels were very low against the limit.
4. Margin value = Emission Level – Limit value
5. " * ": Fundamental frequency.

CHANNEL	TX Channel 102	DETECTOR FUNCTION	Peak (PK)
FREQUENCY RANGE	1GHz ~ 40GHz		Average (AV)

ANTENNA POLARITY & TEST DISTANCE: HORIZONTAL AT 3 M

NO.	FREQ. (MHz)	EMISSION LEVEL (dBuV/m)	LIMIT (dBuV/m)	MARGIN (dB)	ANTENNA HEIGHT (m)	TABLE ANGLE (Degree)	RAW VALUE (dBuV)	CORRECTION FACTOR (dB/m)
1	5460.00	58.2 PK	74.0	-15.8	2.16 H	208	54.0	4.2
2	5460.00	44.5 AV	54.0	-9.5	2.16 H	208	40.3	4.2
3	#5470.00	65.5 PK	74.0	-8.5	2.39 H	238	61.3	4.2
4	#5470.00	47.5 AV	54.0	-6.5	2.39 H	238	43.3	4.2
5	*5510.00	103.2 PK			2.74 H	239	63.1	40.1
6	*5510.00	93.1 AV			2.74 H	239	53.0	40.1
7	11020.00	60.8 PK	74.0	-13.2	2.77 H	313	42.3	18.5
8	11020.00	47.2 AV	54.0	-6.8	2.77 H	313	28.7	18.5

ANTENNA POLARITY & TEST DISTANCE: VERTICAL AT 3 M

NO.	FREQ. (MHz)	EMISSION LEVEL (dBuV/m)	LIMIT (dBuV/m)	MARGIN (dB)	ANTENNA HEIGHT (m)	TABLE ANGLE (Degree)	RAW VALUE (dBuV)	CORRECTION FACTOR (dB/m)
1	5460.00	66.4 PK	74.0	-7.6	2.48 V	206	62.2	4.2
2	5460.00	48.3 AV	54.0	-5.7	2.48 V	206	44.1	4.2
3	#5470.00	71.1 PK	74.0	-2.9	2.84 V	204	66.9	4.2
4	#5470.00	52.9 AV	54.0	-1.1	2.84 V	204	48.7	4.2
5	*5510.00	109.2 PK			2.44 V	242	69.1	40.1
6	*5510.00	98.7 AV			2.44 V	242	58.6	40.1
7	11020.00	61.1 PK	74.0	-12.9	1.39 V	34	42.6	18.5
8	11020.00	48.7 AV	54.0	-5.3	1.39 V	34	30.2	18.5

REMARKS:

1. Emission Level(dBuV/m) = Raw Value(dBuV) + Correction Factor(dB/m)
2. Correction Factor(dB/m) = Antenna Factor(dB/m) + Cable Factor(dB) – Pre-Amplifier Factor(dB)
3. The other emission levels were very low against the limit.
4. Margin value = Emission Level – Limit value
5. " * ": Fundamental frequency.
6. " # ": The radiated frequency is out of the restricted band.

CHANNEL	TX Channel 110	DETECTOR FUNCTION	Peak (PK)
FREQUENCY RANGE	1GHz ~ 40GHz		Average (AV)

ANTENNA POLARITY & TEST DISTANCE: HORIZONTAL AT 3 M

NO.	FREQ. (MHz)	EMISSION LEVEL (dBuV/m)	LIMIT (dBuV/m)	MARGIN (dB)	ANTENNA HEIGHT (m)	TABLE ANGLE (Degree)	RAW VALUE (dBuV)	CORRECTION FACTOR (dB/m)
1	*5550.00	107.1 PK			2.44 H	236	67.1	40.0
2	*5550.00	96.9 AV			2.44 H	236	56.9	40.0
3	11100.00	59.7 PK	74.0	-14.3	2.50 H	269	42.1	17.6
4	11100.00	46.5 AV	54.0	-7.5	2.50 H	269	28.9	17.6

ANTENNA POLARITY & TEST DISTANCE: VERTICAL AT 3 M

NO.	FREQ. (MHz)	EMISSION LEVEL (dBuV/m)	LIMIT (dBuV/m)	MARGIN (dB)	ANTENNA HEIGHT (m)	TABLE ANGLE (Degree)	RAW VALUE (dBuV)	CORRECTION FACTOR (dB/m)
1	*5550.00	112.9 PK			2.79 V	207	72.9	40.0
2	*5550.00	102.7 AV			2.79 V	207	62.7	40.0
3	11100.00	60.4 PK	74.0	-13.6	1.21 V	33	42.8	17.6
4	11100.00	48.1 AV	54.0	-5.9	1.21 V	33	30.5	17.6

REMARKS:

1. Emission Level(dBuV/m) = Raw Value(dBuV) + Correction Factor(dB/m)
2. Correction Factor(dB/m) = Antenna Factor(dB/m) + Cable Factor(dB) – Pre-Amplifier Factor(dB)
3. The other emission levels were very low against the limit.
4. Margin value = Emission Level – Limit value
5. " * ": Fundamental frequency.

CHANNEL	TX Channel 134	DETECTOR FUNCTION	Peak (PK)
FREQUENCY RANGE	1GHz ~ 40GHz		Average (AV)

ANTENNA POLARITY & TEST DISTANCE: HORIZONTAL AT 3 M

NO.	FREQ. (MHz)	EMISSION LEVEL (dBuV/m)	LIMIT (dBuV/m)	MARGIN (dB)	ANTENNA HEIGHT (m)	TABLE ANGLE (Degree)	RAW VALUE (dBuV)	CORRECTION FACTOR (dB/m)
1	*5670.00	104.1 PK			2.50 H	238	64.0	40.1
2	*5670.00	93.8 AV			2.50 H	238	53.7	40.1
3	#5725.00	63.1 PK	74.0	-10.9	2.71 H	214	59.0	4.1
4	#5725.00	46.9 AV	54.0	-7.1	2.71 H	214	42.8	4.1
5	11340.00	60.9 PK	74.0	-13.1	2.03 H	169	43.0	17.9
6	11340.00	47.4 AV	54.0	-6.6	2.03 H	169	29.5	17.9

ANTENNA POLARITY & TEST DISTANCE: VERTICAL AT 3 M

NO.	FREQ. (MHz)	EMISSION LEVEL (dBuV/m)	LIMIT (dBuV/m)	MARGIN (dB)	ANTENNA HEIGHT (m)	TABLE ANGLE (Degree)	RAW VALUE (dBuV)	CORRECTION FACTOR (dB/m)
1	*5670.00	111.7 PK			2.42 V	242	71.6	40.1
2	*5670.00	101.4 AV			2.42 V	242	61.3	40.1
3	#5725.00	69.0 PK	74.0	-5.0	2.30 V	243	64.9	4.1
4	#5725.00	52.8 AV	54.0	-1.2	2.30 V	243	48.7	4.1
5	11340.00	61.7 PK	74.0	-12.3	1.14 V	36	43.8	17.9
6	11340.00	47.8 AV	54.0	-6.2	1.14 V	36	29.9	17.9

REMARKS:

1. Emission Level(dBuV/m) = Raw Value(dBuV) + Correction Factor(dB/m)
2. Correction Factor(dB/m) = Antenna Factor(dB/m) + Cable Factor(dB) – Pre-Amplifier Factor(dB)
3. The other emission levels were very low against the limit.
4. Margin value = Emission Level – Limit value
5. " * ": Fundamental frequency.
6. " # ": The radiated frequency is out of the restricted band.

CHANNEL	TX Channel 142	DETECTOR FUNCTION	Peak (PK)
FREQUENCY RANGE	1GHz ~ 40GHz		Average (AV)

ANTENNA POLARITY & TEST DISTANCE: HORIZONTAL AT 3 M

NO.	FREQ. (MHz)	EMISSION LEVEL (dBuV/m)	LIMIT (dBuV/m)	MARGIN (dB)	ANTENNA HEIGHT (m)	TABLE ANGLE (Degree)	RAW VALUE (dBuV)	CORRECTION FACTOR (dB/m)
1	5460.00	54.5 PK	74.0	-19.5	3.02 H	231	50.3	4.2
2	5460.00	43.5 AV	54.0	-10.5	3.02 H	231	39.3	4.2
3	#5470.00	57.2 PK	74.0	-16.8	2.99 H	219	53.0	4.2
4	#5470.00	43.9 AV	54.0	-10.1	2.99 H	219	39.7	4.2
5	*5710.00	105.0 PK			2.97 H	213	65.0	40.0
6	*5710.00	95.5 AV			2.97 H	213	55.5	40.0
7	#5825.00	58.6 PK	74.0	-15.4	2.91 H	222	54.0	4.6
8	#5825.00	44.5 AV	54.0	-9.5	2.91 H	222	39.9	4.6
9	11420.00	60.7 PK	74.0	-13.3	2.61 H	319	42.9	17.8
10	11420.00	47.2 AV	54.0	-6.8	2.61 H	319	29.4	17.8

ANTENNA POLARITY & TEST DISTANCE: VERTICAL AT 3 M

NO.	FREQ. (MHz)	EMISSION LEVEL (dBuV/m)	LIMIT (dBuV/m)	MARGIN (dB)	ANTENNA HEIGHT (m)	TABLE ANGLE (Degree)	RAW VALUE (dBuV)	CORRECTION FACTOR (dB/m)
1	5460.00	55.8 PK	74.0	-18.2	2.33 V	251	51.6	4.2
2	5460.00	43.7 AV	54.0	-10.3	2.33 V	251	39.5	4.2
3	#5470.00	57.7 PK	74.0	-16.3	2.39 V	244	53.5	4.2
4	#5470.00	44.4 AV	54.0	-9.6	2.39 V	244	40.2	4.2
5	*5710.00	112.5 PK			2.28 V	243	72.5	40.0
6	*5710.00	101.6 AV			2.28 V	243	61.6	40.0
7	#5825.00	59.2 PK	74.0	-14.8	2.50 V	244	54.6	4.6
8	#5825.00	46.1 AV	54.0	-7.9	2.50 V	244	41.5	4.6
9	11420.00	60.4 PK	74.0	-13.6	2.77 V	293	42.6	17.8
10	11420.00	47.2 AV	54.0	-6.8	2.77 V	293	29.4	17.8

REMARKS:

1. Emission Level(dBuV/m) = Raw Value(dBuV) + Correction Factor(dB/m)
2. Correction Factor(dB/m) = Antenna Factor(dB/m) + Cable Factor(dB) – Pre-Amplifier Factor(dB)
3. The other emission levels were very low against the limit.
4. Margin value = Emission Level – Limit value
5. " * ": Fundamental frequency.
6. " # ": The radiated frequency is out of the restricted band.

802.11ac (VHT80)

CHANNEL	TX Channel 58	DETECTOR FUNCTION	Peak (PK)
FREQUENCY RANGE	1GHz ~ 40GHz		Average (AV)

ANTENNA POLARITY & TEST DISTANCE: HORIZONTAL AT 3 M

NO.	FREQ. (MHz)	EMISSION LEVEL (dBuV/m)	LIMIT (dBuV/m)	MARGIN (dB)	ANTENNA HEIGHT (m)	TABLE ANGLE (Degree)	RAW VALUE (dBuV)	CORRECTION FACTOR (dB/m)
1	5150.00	57.1 PK	74.0	-16.9	3.03 H	244	53.4	3.7
2	5150.00	43.6 AV	54.0	-10.4	3.03 H	244	39.9	3.7
3	*5290.00	101.3 PK			2.95 H	235	61.9	39.4
4	*5290.00	91.1 AV			2.95 H	235	51.7	39.4
5	5350.00	56.6 PK	74.0	-17.4	3.12 H	254	52.8	3.8
6	5350.00	47.2 AV	54.0	-6.8	3.12 H	254	43.4	3.8
7	#10580.00	58.8 PK	74.0	-15.2	1.93 H	321	41.8	17.0
8	#10580.00	46.0 AV	54.0	-8.0	1.93 H	321	29.0	17.0

ANTENNA POLARITY & TEST DISTANCE: VERTICAL AT 3 M

NO.	FREQ. (MHz)	EMISSION LEVEL (dBuV/m)	LIMIT (dBuV/m)	MARGIN (dB)	ANTENNA HEIGHT (m)	TABLE ANGLE (Degree)	RAW VALUE (dBuV)	CORRECTION FACTOR (dB/m)
1	5150.00	58.4 PK	74.0	-15.6	2.55 V	223	54.7	3.7
2	5150.00	45.1 AV	54.0	-8.9	2.55 V	223	41.4	3.7
3	*5290.00	106.4 PK			2.59 V	214	67.0	39.4
4	*5290.00	96.4 AV			2.59 V	214	57.0	39.4
5	5350.00	72.1 PK	74.0	-1.9	2.37 V	248	68.3	3.8
6	5350.00	52.3 AV	54.0	-1.7	2.37 V	248	48.5	3.8
7	#10580.00	59.5 PK	74.0	-14.5	1.29 V	71	42.5	17.0
8	#10580.00	46.8 AV	54.0	-7.2	1.29 V	71	29.8	17.0

REMARKS:

1. Emission Level(dBuV/m) = Raw Value(dBuV) + Correction Factor(dB/m)
2. Correction Factor(dB/m) = Antenna Factor(dB/m) + Cable Factor(dB) – Pre-Amplifier Factor(dB)
3. The other emission levels were very low against the limit.
4. Margin value = Emission Level – Limit value
5. " * ": Fundamental frequency.
6. " # ": The radiated frequency is out of the restricted band.

CHANNEL	TX Channel 106	DETECTOR FUNCTION	Peak (PK)
FREQUENCY RANGE	1GHz ~ 40GHz		Average (AV)

ANTENNA POLARITY & TEST DISTANCE: HORIZONTAL AT 3 M

NO.	FREQ. (MHz)	EMISSION LEVEL (dBuV/m)	LIMIT (dBuV/m)	MARGIN (dB)	ANTENNA HEIGHT (m)	TABLE ANGLE (Degree)	RAW VALUE (dBuV)	CORRECTION FACTOR (dB/m)
1	5460.00	59.9 PK	74.0	-14.1	2.66 H	245	55.7	4.2
2	5460.00	46.7 AV	54.0	-7.3	2.66 H	245	42.5	4.2
3	#5470.00	65.1 PK	74.0	-8.9	2.72 H	239	60.9	4.2
4	#5470.00	47.7 AV	54.0	-6.3	2.72 H	239	43.5	4.2
5	*5530.00	99.1 PK			2.40 H	239	59.0	40.1
6	*5530.00	88.7 AV			2.40 H	239	48.6	40.1
7	#5725.00	56.5 PK	74.0	-17.5	2.89 H	242	52.4	4.1
8	#5725.00	43.0 AV	54.0	-11.0	2.89 H	242	38.9	4.1
9	11060.00	60.1 PK	74.0	-13.9	2.83 H	255	42.1	18.0
10	11060.00	47.2 AV	54.0	-6.8	2.83 H	255	29.2	18.0

ANTENNA POLARITY & TEST DISTANCE: VERTICAL AT 3 M

NO.	FREQ. (MHz)	EMISSION LEVEL (dBuV/m)	LIMIT (dBuV/m)	MARGIN (dB)	ANTENNA HEIGHT (m)	TABLE ANGLE (Degree)	RAW VALUE (dBuV)	CORRECTION FACTOR (dB/m)
1	5460.00	65.4 PK	74.0	-8.6	2.74 V	205	61.2	4.2
2	5460.00	51.4 AV	54.0	-2.6	2.74 V	205	47.2	4.2
3	#5470.00	70.0 PK	74.0	-4.0	2.38 V	203	65.8	4.2
4	#5470.00	52.9 AV	54.0	-1.1	2.38 V	203	48.7	4.2
5	*5530.00	105.5 PK			2.75 V	205	65.4	40.1
6	*5530.00	94.8 AV			2.75 V	205	54.7	40.1
7	#5725.00	56.7 PK	74.0	-17.3	2.64 V	298	52.6	4.1
8	#5725.00	44.1 AV	54.0	-9.9	2.64 V	298	40.0	4.1
9	11060.00	61.0 PK	74.0	-13.0	1.01 V	29	43.0	18.0
10	11060.00	48.6 AV	54.0	-5.4	1.01 V	29	30.6	18.0

REMARKS:

1. Emission Level(dBuV/m) = Raw Value(dBuV) + Correction Factor(dB/m)
2. Correction Factor(dB/m) = Antenna Factor(dB/m) + Cable Factor(dB) – Pre-Amplifier Factor(dB)
3. The other emission levels were very low against the limit.
4. Margin value = Emission Level – Limit value
5. " * ": Fundamental frequency.
6. " # ": The radiated frequency is out of the restricted band.

CHANNEL	TX Channel 122	DETECTOR FUNCTION	Peak (PK)
FREQUENCY RANGE	1GHz ~ 40GHz		Average (AV)

ANTENNA POLARITY & TEST DISTANCE: HORIZONTAL AT 3 M

NO.	FREQ. (MHz)	EMISSION LEVEL (dBuV/m)	LIMIT (dBuV/m)	MARGIN (dB)	ANTENNA HEIGHT (m)	TABLE ANGLE (Degree)	RAW VALUE (dBuV)	CORRECTION FACTOR (dB/m)
1	5460.00	56.0 PK	74.0	-18.0	2.41 H	206	51.8	4.2
2	5460.00	43.5 AV	54.0	-10.5	2.41 H	206	39.3	4.2
3	#5470.00	58.0 PK	74.0	-16.0	2.89 H	263	53.8	4.2
4	#5470.00	46.6 AV	54.0	-7.4	2.89 H	263	42.4	4.2
5	*5610.00	102.8 PK			2.61 H	239	62.7	40.1
6	*5610.00	92.7 AV			2.61 H	239	52.6	40.1
7	#5725.00	58.0 PK	74.0	-16.0	2.82 H	236	53.9	4.1
8	#5725.00	45.6 AV	54.0	-8.4	2.82 H	236	41.5	4.1
9	11220.00	60.7 PK	74.0	-13.3	2.53 H	297	42.8	17.9
10	11220.00	47.4 AV	54.0	-6.6	2.53 H	297	29.5	17.9

ANTENNA POLARITY & TEST DISTANCE: VERTICAL AT 3 M

NO.	FREQ. (MHz)	EMISSION LEVEL (dBuV/m)	LIMIT (dBuV/m)	MARGIN (dB)	ANTENNA HEIGHT (m)	TABLE ANGLE (Degree)	RAW VALUE (dBuV)	CORRECTION FACTOR (dB/m)
1	5460.00	60.3 PK	74.0	-13.7	2.18 V	202	56.1	4.2
2	5460.00	48.4 AV	54.0	-5.6	2.18 V	202	44.2	4.2
3	#5470.00	64.5 PK	74.0	-9.5	2.21 V	243	60.3	4.2
4	#5470.00	49.4 AV	54.0	-4.6	2.21 V	243	45.2	4.2
5	*5610.00	109.4 PK			2.33 V	244	69.3	40.1
6	*5610.00	98.7 AV			2.33 V	244	58.6	40.1
7	#5725.00	66.6 PK	74.0	-7.4	2.34 V	244	62.5	4.1
8	#5725.00	52.3 AV	54.0	-1.7	2.34 V	244	48.2	4.1
9	11220.00	61.5 PK	74.0	-12.5	1.06 V	33	43.6	17.9
10	11220.00	48.1 AV	54.0	-5.9	1.06 V	33	30.2	17.9

REMARKS:

1. Emission Level(dBuV/m) = Raw Value(dBuV) + Correction Factor(dB/m)
2. Correction Factor(dB/m) = Antenna Factor(dB/m) + Cable Factor(dB) – Pre-Amplifier Factor(dB)
3. The other emission levels were very low against the limit.
4. Margin value = Emission Level – Limit value
5. " * ": Fundamental frequency.
6. " # ": The radiated frequency is out of the restricted band.

CHANNEL	TX Channel 138	DETECTOR FUNCTION	Peak (PK)
FREQUENCY RANGE	1GHz ~ 40GHz		Average (AV)

ANTENNA POLARITY & TEST DISTANCE: HORIZONTAL AT 3 M								
NO.	FREQ. (MHz)	EMISSION LEVEL (dBuV/m)	LIMIT (dBuV/m)	MARGIN (dB)	ANTENNA HEIGHT (m)	TABLE ANGLE (Degree)	RAW VALUE (dBuV)	CORRECTION FACTOR (dB/m)
1	5460.00	55.9 PK	74.0	-18.1	2.99 H	222	51.7	4.2
2	5460.00	43.6 AV	54.0	-10.4	2.99 H	222	39.4	4.2
3	#5470.00	57.8 PK	74.0	-16.2	2.95 H	218	53.6	4.2
4	#5470.00	44.1 AV	54.0	-9.9	2.95 H	218	39.9	4.2
5	*5690.00	101.1 PK			3.00 H	214	61.1	40.0
6	*5690.00	91.2 AV			3.00 H	214	51.2	40.0
7	#5825.00	59.5 PK	74.0	-14.5	2.90 H	219	54.9	4.6
8	#5825.00	45.9 AV	54.0	-8.1	2.90 H	219	41.3	4.6
9	11380.00	60.8 PK	74.0	-13.2	2.66 H	321	43.0	17.8
10	11380.00	47.0 AV	54.0	-7.0	2.66 H	321	29.2	17.8

ANTENNA POLARITY & TEST DISTANCE: VERTICAL AT 3 M								
NO.	FREQ. (MHz)	EMISSION LEVEL (dBuV/m)	LIMIT (dBuV/m)	MARGIN (dB)	ANTENNA HEIGHT (m)	TABLE ANGLE (Degree)	RAW VALUE (dBuV)	CORRECTION FACTOR (dB/m)
1	5460.00	57.0 PK	74.0	-17.0	2.55 V	239	52.8	4.2
2	5460.00	44.6 AV	54.0	-9.4	2.55 V	239	40.4	4.2
3	#5470.00	58.7 PK	74.0	-15.3	2.60 V	255	54.5	4.2
4	#5470.00	45.9 AV	54.0	-8.1	2.60 V	255	41.7	4.2
5	*5690.00	108.3 PK			2.48 V	245	68.3	40.0
6	*5690.00	98.1 AV			2.48 V	245	58.1	40.0
7	#5825.00	62.9 PK	74.0	-11.1	2.57 V	241	58.3	4.6
8	#5825.00	48.8 AV	54.0	-5.2	2.57 V	241	44.2	4.6
9	11380.00	60.6 PK	74.0	-13.4	2.88 V	287	42.8	17.8
10	11380.00	47.0 AV	54.0	-7.0	2.88 V	287	29.2	17.8

REMARKS:

1. Emission Level(dBuV/m) = Raw Value(dBuV) + Correction Factor(dB/m)
2. Correction Factor(dB/m) = Antenna Factor(dB/m) + Cable Factor(dB) – Pre-Amplifier Factor(dB)
3. The other emission levels were very low against the limit.
4. Margin value = Emission Level – Limit value
5. " * ": Fundamental frequency.
6. " # ": The radiated frequency is out of the restricted band.

Mode C

802.11a

CHANNEL	TX Channel 52	DETECTOR FUNCTION	Peak (PK)
FREQUENCY RANGE	1GHz ~ 40GHz		Average (AV)

ANTENNA POLARITY & TEST DISTANCE: HORIZONTAL AT 3 M

NO.	FREQ. (MHz)	EMISSION LEVEL (dBuV/m)	LIMIT (dBuV/m)	MARGIN (dB)	ANTENNA HEIGHT (m)	TABLE ANGLE (Degree)	RAW VALUE (dBuV)	CORRECTION FACTOR (dB/m)
1	5150.00	56.0 PK	74.0	-18.0	1.58 H	88	52.3	3.7
2	5150.00	43.2 AV	54.0	-10.8	1.58 H	88	39.5	3.7
3	*5260.00	112.4 PK			1.24 H	50	73.0	39.4
4	*5260.00	102.5 AV			1.24 H	50	63.1	39.4
5	#10520.00	60.2 PK	74.0	-13.8	1.83 H	171	43.4	16.8
6	#10520.00	50.9 AV	54.0	-3.1	1.83 H	171	34.1	16.8

ANTENNA POLARITY & TEST DISTANCE: VERTICAL AT 3 M

NO.	FREQ. (MHz)	EMISSION LEVEL (dBuV/m)	LIMIT (dBuV/m)	MARGIN (dB)	ANTENNA HEIGHT (m)	TABLE ANGLE (Degree)	RAW VALUE (dBuV)	CORRECTION FACTOR (dB/m)
1	5150.00	57.2 PK	74.0	-16.8	1.81 V	171	53.5	3.7
2	5150.00	44.0 AV	54.0	-10.0	1.81 V	171	40.3	3.7
3	*5260.00	117.1 PK			1.66 V	148	77.7	39.4
4	*5260.00	107.4 AV			1.66 V	148	68.0	39.4
5	#10520.00	59.3 PK	74.0	-14.7	1.69 V	169	42.5	16.8
6	#10520.00	47.7 AV	54.0	-6.3	1.69 V	169	30.9	16.8

REMARKS:

1. Emission Level(dBuV/m) = Raw Value(dBuV) + Correction Factor(dB/m)
2. Correction Factor(dB/m) = Antenna Factor(dB/m) + Cable Factor(dB) – Pre-Amplifier Factor(dB)
3. The other emission levels were very low against the limit.
4. Margin value = Emission Level – Limit value
5. " * ": Fundamental frequency.
6. " # ": The radiated frequency is out of the restricted band.

CHANNEL	TX Channel 60	DETECTOR FUNCTION	Peak (PK)
FREQUENCY RANGE	1GHz ~ 40GHz		Average (AV)

ANTENNA POLARITY & TEST DISTANCE: HORIZONTAL AT 3 M

NO.	FREQ. (MHz)	EMISSION LEVEL (dBuV/m)	LIMIT (dBuV/m)	MARGIN (dB)	ANTENNA HEIGHT (m)	TABLE ANGLE (Degree)	RAW VALUE (dBuV)	CORRECTION FACTOR (dB/m)
1	*5300.00	110.7 PK			2.01 H	114	71.3	39.4
2	*5300.00	101.1 AV			2.01 H	114	61.7	39.4
3	10600.00	60.3 PK	74.0	-13.7	1.77 H	170	43.4	16.9
4	10600.00	51.6 AV	54.0	-2.4	1.77 H	170	34.7	16.9

ANTENNA POLARITY & TEST DISTANCE: VERTICAL AT 3 M

NO.	FREQ. (MHz)	EMISSION LEVEL (dBuV/m)	LIMIT (dBuV/m)	MARGIN (dB)	ANTENNA HEIGHT (m)	TABLE ANGLE (Degree)	RAW VALUE (dBuV)	CORRECTION FACTOR (dB/m)
1	*5300.00	116.5 PK			1.68 V	206	77.1	39.4
2	*5300.00	106.9 AV			1.68 V	206	67.5	39.4
3	10600.00	59.5 PK	74.0	-14.5	1.79 V	161	42.6	16.9
4	10600.00	48.1 AV	54.0	-5.9	1.79 V	161	31.2	16.9

REMARKS:

1. Emission Level(dBuV/m) = Raw Value(dBuV) + Correction Factor(dB/m)
2. Correction Factor(dB/m) = Antenna Factor(dB/m) + Cable Factor(dB) – Pre-Amplifier Factor(dB)
3. The other emission levels were very low against the limit.
4. Margin value = Emission Level – Limit value
5. " * ": Fundamental frequency.

CHANNEL	TX Channel 64	DETECTOR FUNCTION	Peak (PK)
FREQUENCY RANGE	1GHz ~ 40GHz		Average (AV)

ANTENNA POLARITY & TEST DISTANCE: HORIZONTAL AT 3 M

NO.	FREQ. (MHz)	EMISSION LEVEL (dBuV/m)	LIMIT (dBuV/m)	MARGIN (dB)	ANTENNA HEIGHT (m)	TABLE ANGLE (Degree)	RAW VALUE (dBuV)	CORRECTION FACTOR (dB/m)
1	*5320.00	103.3 PK			1.73 H	110	63.8	39.5
2	*5320.00	93.4 AV			1.73 H	110	53.9	39.5
3	5350.00	60.5 PK	74.0	-13.5	1.86 H	304	56.7	3.8
4	5350.00	46.6 AV	54.0	-7.4	1.86 H	304	42.8	3.8
5	10640.00	60.2 PK	74.0	-13.8	1.74 H	173	43.2	17.0
6	10640.00	50.7 AV	54.0	-3.3	1.74 H	173	33.7	17.0

ANTENNA POLARITY & TEST DISTANCE: VERTICAL AT 3 M

NO.	FREQ. (MHz)	EMISSION LEVEL (dBuV/m)	LIMIT (dBuV/m)	MARGIN (dB)	ANTENNA HEIGHT (m)	TABLE ANGLE (Degree)	RAW VALUE (dBuV)	CORRECTION FACTOR (dB/m)
1	*5320.00	113.8 PK			1.63 V	204	74.3	39.5
2	*5320.00	104.2 AV			1.63 V	204	64.7	39.5
3	5350.00	71.7 PK	74.0	-2.3	1.66 V	189	67.9	3.8
4	5350.00	52.4 AV	54.0	-1.6	1.66 V	189	48.6	3.8
5	10640.00	58.8 PK	74.0	-15.2	1.68 V	169	41.8	17.0
6	10640.00	47.8 AV	54.0	-6.2	1.68 V	169	30.8	17.0

REMARKS:

1. Emission Level(dBuV/m) = Raw Value(dBuV) + Correction Factor(dB/m)
2. Correction Factor(dB/m) = Antenna Factor(dB/m) + Cable Factor(dB) – Pre-Amplifier Factor(dB)
3. The other emission levels were very low against the limit.
4. Margin value = Emission Level – Limit value
5. " * ": Fundamental frequency.

CHANNEL	TX Channel 100	DETECTOR FUNCTION	Peak (PK)
FREQUENCY RANGE	1GHz ~ 40GHz		Average (AV)

ANTENNA POLARITY & TEST DISTANCE: HORIZONTAL AT 3 M

NO.	FREQ. (MHz)	EMISSION LEVEL (dBuV/m)	LIMIT (dBuV/m)	MARGIN (dB)	ANTENNA HEIGHT (m)	TABLE ANGLE (Degree)	RAW VALUE (dBuV)	CORRECTION FACTOR (dB/m)
1	5460.00	61.5 PK	74.0	-12.5	1.33 H	327	57.3	4.2
2	5460.00	47.6 AV	54.0	-6.4	1.33 H	327	43.4	4.2
3	#5470.00	71.1 PK	74.0	-2.9	1.16 H	353	66.9	4.2
4	#5470.00	52.8 AV	54.0	-1.2	1.16 H	353	48.6	4.2
5	*5500.00	114.6 PK			2.54 H	354	74.5	40.1
6	*5500.00	104.7 AV			2.54 H	354	64.6	40.1
7	11000.00	60.7 PK	74.0	-13.3	2.61 H	153	42.0	18.7
8	11000.00	48.3 AV	54.0	-5.7	2.61 H	153	29.6	18.7

ANTENNA POLARITY & TEST DISTANCE: VERTICAL AT 3 M

NO.	FREQ. (MHz)	EMISSION LEVEL (dBuV/m)	LIMIT (dBuV/m)	MARGIN (dB)	ANTENNA HEIGHT (m)	TABLE ANGLE (Degree)	RAW VALUE (dBuV)	CORRECTION FACTOR (dB/m)
1	5460.00	57.5 PK	74.0	-16.5	2.98 V	112	53.3	4.2
2	5460.00	44.8 AV	54.0	-9.2	2.98 V	112	40.6	4.2
3	#5470.00	66.7 PK	74.0	-7.3	3.36 V	81	62.5	4.2
4	#5470.00	48.4 AV	54.0	-5.6	3.36 V	81	44.2	4.2
5	*5500.00	108.7 PK			3.56 V	56	68.6	40.1
6	*5500.00	99.0 AV			3.56 V	56	58.9	40.1
7	11000.00	61.6 PK	74.0	-12.4	2.05 V	174	42.9	18.7
8	11000.00	50.7 AV	54.0	-3.3	2.05 V	174	32.0	18.7

REMARKS:

1. Emission Level(dBuV/m) = Raw Value(dBuV) + Correction Factor(dB/m)
2. Correction Factor(dB/m) = Antenna Factor(dB/m) + Cable Factor(dB) – Pre-Amplifier Factor(dB)
3. The other emission levels were very low against the limit.
4. Margin value = Emission Level – Limit value
5. " * ": Fundamental frequency.
6. " # ": The radiated frequency is out of the restricted band.

CHANNEL	TX Channel 116	DETECTOR FUNCTION	Peak (PK)
FREQUENCY RANGE	1GHz ~ 40GHz		Average (AV)

ANTENNA POLARITY & TEST DISTANCE: HORIZONTAL AT 3 M

NO.	FREQ. (MHz)	EMISSION LEVEL (dBuV/m)	LIMIT (dBuV/m)	MARGIN (dB)	ANTENNA HEIGHT (m)	TABLE ANGLE (Degree)	RAW VALUE (dBuV)	CORRECTION FACTOR (dB/m)
1	*5580.00	117.0 PK			2.26 H	352	77.0	40.0
2	*5580.00	107.5 AV			2.26 H	352	67.5	40.0
3	11160.00	60.5 PK	74.0	-13.5	1.79 H	168	42.8	17.7
4	11160.00	47.7 AV	54.0	-6.3	1.79 H	168	30.0	17.7

ANTENNA POLARITY & TEST DISTANCE: VERTICAL AT 3 M

NO.	FREQ. (MHz)	EMISSION LEVEL (dBuV/m)	LIMIT (dBuV/m)	MARGIN (dB)	ANTENNA HEIGHT (m)	TABLE ANGLE (Degree)	RAW VALUE (dBuV)	CORRECTION FACTOR (dB/m)
1	*5580.00	110.6 PK			3.79 V	50	70.6	40.0
2	*5580.00	101.2 AV			3.79 V	50	61.2	40.0
3	11160.00	60.3 PK	74.0	-13.7	2.06 V	183	42.6	17.7
4	11160.00	48.7 AV	54.0	-5.3	2.06 V	183	31.0	17.7

REMARKS:

1. Emission Level(dBuV/m) = Raw Value(dBuV) + Correction Factor(dB/m)
2. Correction Factor(dB/m) = Antenna Factor(dB/m) + Cable Factor(dB) – Pre-Amplifier Factor(dB)
3. The other emission levels were very low against the limit.
4. Margin value = Emission Level – Limit value
5. " * ": Fundamental frequency.

CHANNEL	TX Channel 140	DETECTOR FUNCTION	Peak (PK)
FREQUENCY RANGE	1GHz ~ 40GHz		Average (AV)

ANTENNA POLARITY & TEST DISTANCE: HORIZONTAL AT 3 M

NO.	FREQ. (MHz)	EMISSION LEVEL (dBuV/m)	LIMIT (dBuV/m)	MARGIN (dB)	ANTENNA HEIGHT (m)	TABLE ANGLE (Degree)	RAW VALUE (dBuV)	CORRECTION FACTOR (dB/m)
1	*5700.00	112.2 PK			2.07 H	353	72.2	40.0
2	*5700.00	102.5 AV			2.07 H	353	62.5	40.0
3	#5725.00	72.4 PK	74.0	-1.6	2.04 H	352	68.3	4.1
4	#5725.00	51.5 AV	54.0	-2.5	2.04 H	352	47.4	4.1
5	11400.00	61.5 PK	74.0	-12.5	1.85 H	187	43.8	17.7
6	11400.00	48.6 AV	54.0	-5.4	1.85 H	187	30.9	17.7

ANTENNA POLARITY & TEST DISTANCE: VERTICAL AT 3 M

NO.	FREQ. (MHz)	EMISSION LEVEL (dBuV/m)	LIMIT (dBuV/m)	MARGIN (dB)	ANTENNA HEIGHT (m)	TABLE ANGLE (Degree)	RAW VALUE (dBuV)	CORRECTION FACTOR (dB/m)
1	*5700.00	106.1 PK			3.56 V	71	66.1	40.0
2	*5700.00	96.6 AV			3.56 V	71	56.6	40.0
3	#5725.00	64.1 PK	74.0	-9.9	3.41 V	58	60.0	4.1
4	#5725.00	45.8 AV	54.0	-8.2	3.41 V	58	41.7	4.1
5	11400.00	61.5 PK	74.0	-12.5	1.99 V	184	43.8	17.7
6	11400.00	48.4 AV	54.0	-5.6	1.99 V	184	30.7	17.7

REMARKS:

1. Emission Level(dBuV/m) = Raw Value(dBuV) + Correction Factor(dB/m)
2. Correction Factor(dB/m) = Antenna Factor(dB/m) + Cable Factor(dB) – Pre-Amplifier Factor(dB)
3. The other emission levels were very low against the limit.
4. Margin value = Emission Level – Limit value
5. " * ": Fundamental frequency.
6. " # ": The radiated frequency is out of the restricted band.

CHANNEL	TX Channel 144	DETECTOR FUNCTION	Peak (PK)
FREQUENCY RANGE	1GHz ~ 40GHz		Average (AV)

ANTENNA POLARITY & TEST DISTANCE: HORIZONTAL AT 3 M

NO.	FREQ. (MHz)	EMISSION LEVEL (dBuV/m)	LIMIT (dBuV/m)	MARGIN (dB)	ANTENNA HEIGHT (m)	TABLE ANGLE (Degree)	RAW VALUE (dBuV)	CORRECTION FACTOR (dB/m)
1	5460.00	55.9 PK	74.0	-18.1	2.50 H	350	51.5	4.4
2	5460.00	44.4 AV	54.0	-9.6	2.50 H	350	40.0	4.4
3	#5470.00	57.7 PK	74.0	-16.3	2.52 H	343	53.3	4.4
4	#5470.00	44.4 AV	54.0	-9.6	2.52 H	343	40.0	4.4
5	*5720.00	116.5 PK			2.52 H	347	76.5	40.0
6	*5720.00	106.6 AV			2.52 H	347	66.6	40.0
7	#5825.00	59.6 PK	74.0	-14.4	2.61 H	354	54.8	4.8
8	#5825.00	46.0 AV	54.0	-8.0	2.61 H	354	41.2	4.8
9	11440.00	61.4 PK	74.0	-12.6	1.80 H	131	43.8	17.6
10	11440.00	48.2 AV	54.0	-5.8	1.80 H	131	30.6	17.6

ANTENNA POLARITY & TEST DISTANCE: VERTICAL AT 3 M

NO.	FREQ. (MHz)	EMISSION LEVEL (dBuV/m)	LIMIT (dBuV/m)	MARGIN (dB)	ANTENNA HEIGHT (m)	TABLE ANGLE (Degree)	RAW VALUE (dBuV)	CORRECTION FACTOR (dB/m)
1	5460.00	55.7 PK	74.0	-18.3	1.75 V	61	51.3	4.4
2	5460.00	43.6 AV	54.0	-10.4	1.75 V	61	39.2	4.4
3	#5470.00	57.4 PK	74.0	-16.6	1.85 V	66	53.0	4.4
4	#5470.00	44.1 AV	54.0	-9.9	1.85 V	66	39.7	4.4
5	*5720.00	109.0 PK			1.79 V	63	69.0	40.0
6	*5720.00	100.1 AV			1.79 V	63	60.1	40.0
7	#5825.00	58.1 PK	74.0	-15.9	1.91 V	77	53.3	4.8
8	#5825.00	44.5 AV	54.0	-9.5	1.91 V	77	39.7	4.8
9	11440.00	60.8 PK	74.0	-13.2	1.81 V	163	43.2	17.6
10	11440.00	48.1 AV	54.0	-5.9	1.81 V	163	30.5	17.6

REMARKS:

1. Emission Level(dBuV/m) = Raw Value(dBuV) + Correction Factor(dB/m)
2. Correction Factor(dB/m) = Antenna Factor(dB/m) + Cable Factor(dB) – Pre-Amplifier Factor(dB)
3. The other emission levels were very low against the limit.
4. Margin value = Emission Level – Limit value
5. " * ": Fundamental frequency.
6. " # ": The radiated frequency is out of the restricted band.

802.11n (HT20)

CHANNEL	TX Channel 52	DETECTOR FUNCTION	Peak (PK)
FREQUENCY RANGE	1GHz ~ 40GHz		Average (AV)

ANTENNA POLARITY & TEST DISTANCE: HORIZONTAL AT 3 M								
NO.	FREQ. (MHz)	EMISSION LEVEL (dBuV/m)	LIMIT (dBuV/m)	MARGIN (dB)	ANTENNA HEIGHT (m)	TABLE ANGLE (Degree)	RAW VALUE (dBuV)	CORRECTION FACTOR (dB/m)
1	5150.00	55.8 PK	74.0	-18.2	1.61 H	101	52.1	3.7
2	5150.00	43.4 AV	54.0	-10.6	1.61 H	101	39.7	3.7
3	*5260.00	112.2 PK			1.51 H	99	72.8	39.4
4	*5260.00	102.3 AV			1.51 H	99	62.9	39.4
5	#10520.00	60.3 PK	74.0	-13.7	1.91 H	170	43.5	16.8
6	#10520.00	50.8 AV	54.0	-3.2	1.91 H	170	34.0	16.8

ANTENNA POLARITY & TEST DISTANCE: VERTICAL AT 3 M								
NO.	FREQ. (MHz)	EMISSION LEVEL (dBuV/m)	LIMIT (dBuV/m)	MARGIN (dB)	ANTENNA HEIGHT (m)	TABLE ANGLE (Degree)	RAW VALUE (dBuV)	CORRECTION FACTOR (dB/m)
1	5150.00	57.2 PK	74.0	-16.8	1.69 V	151	53.5	3.7
2	5150.00	43.9 AV	54.0	-10.1	1.69 V	151	40.2	3.7
3	*5260.00	117.7 PK			1.64 V	146	78.3	39.4
4	*5260.00	107.3 AV			1.64 V	146	67.9	39.4
5	#10520.00	59.6 PK	74.0	-14.4	1.61 V	182	42.8	16.8
6	#10520.00	47.5 AV	54.0	-6.5	1.61 V	182	30.7	16.8

REMARKS:

1. Emission Level(dBuV/m) = Raw Value(dBuV) + Correction Factor(dB/m)
2. Correction Factor(dB/m) = Antenna Factor(dB/m) + Cable Factor(dB) – Pre-Amplifier Factor(dB)
3. The other emission levels were very low against the limit.
4. Margin value = Emission Level – Limit value
5. " * ": Fundamental frequency.
6. " # ": The radiated frequency is out of the restricted band.

CHANNEL	TX Channel 60	DETECTOR FUNCTION	Peak (PK)
FREQUENCY RANGE	1GHz ~ 40GHz		Average (AV)

ANTENNA POLARITY & TEST DISTANCE: HORIZONTAL AT 3 M

NO.	FREQ. (MHz)	EMISSION LEVEL (dBuV/m)	LIMIT (dBuV/m)	MARGIN (dB)	ANTENNA HEIGHT (m)	TABLE ANGLE (Degree)	RAW VALUE (dBuV)	CORRECTION FACTOR (dB/m)
1	*5300.00	110.8 PK			1.87 H	110	71.4	39.4
2	*5300.00	100.9 AV			1.87 H	110	61.5	39.4
3	10600.00	60.0 PK	74.0	-14.0	1.83 H	166	43.1	16.9
4	10600.00	51.5 AV	54.0	-2.5	1.83 H	166	34.6	16.9

ANTENNA POLARITY & TEST DISTANCE: VERTICAL AT 3 M

NO.	FREQ. (MHz)	EMISSION LEVEL (dBuV/m)	LIMIT (dBuV/m)	MARGIN (dB)	ANTENNA HEIGHT (m)	TABLE ANGLE (Degree)	RAW VALUE (dBuV)	CORRECTION FACTOR (dB/m)
1	*5300.00	116.7 PK			1.71 V	193	77.3	39.4
2	*5300.00	106.8 AV			1.71 V	193	67.4	39.4
3	10600.00	59.4 PK	74.0	-14.6	1.81 V	171	42.5	16.9
4	10600.00	48.0 AV	54.0	-6.0	1.81 V	171	31.1	16.9

REMARKS:

1. Emission Level(dBuV/m) = Raw Value(dBuV) + Correction Factor(dB/m)
2. Correction Factor(dB/m) = Antenna Factor(dB/m) + Cable Factor(dB) – Pre-Amplifier Factor(dB)
3. The other emission levels were very low against the limit.
4. Margin value = Emission Level – Limit value
5. " * ": Fundamental frequency.

CHANNEL	TX Channel 64	DETECTOR FUNCTION	Peak (PK)
FREQUENCY RANGE	1GHz ~ 40GHz		Average (AV)

ANTENNA POLARITY & TEST DISTANCE: HORIZONTAL AT 3 M

NO.	FREQ. (MHz)	EMISSION LEVEL (dBuV/m)	LIMIT (dBuV/m)	MARGIN (dB)	ANTENNA HEIGHT (m)	TABLE ANGLE (Degree)	RAW VALUE (dBuV)	CORRECTION FACTOR (dB/m)
1	*5320.00	103.4 PK			1.91 H	108	63.9	39.5
2	*5320.00	93.5 AV			1.91 H	108	54.0	39.5
3	5350.00	60.3 PK	74.0	-13.7	1.70 H	123	56.5	3.8
4	5350.00	46.5 AV	54.0	-7.5	1.70 H	123	42.7	3.8
5	10640.00	60.3 PK	74.0	-13.7	1.81 H	183	43.3	17.0
6	10640.00	50.9 AV	54.0	-3.1	1.81 H	183	33.9	17.0

ANTENNA POLARITY & TEST DISTANCE: VERTICAL AT 3 M

NO.	FREQ. (MHz)	EMISSION LEVEL (dBuV/m)	LIMIT (dBuV/m)	MARGIN (dB)	ANTENNA HEIGHT (m)	TABLE ANGLE (Degree)	RAW VALUE (dBuV)	CORRECTION FACTOR (dB/m)
1	*5320.00	113.6 PK			1.69 V	183	74.1	39.5
2	*5320.00	104.0 AV			1.69 V	183	64.5	39.5
3	5350.00	71.1 PK	74.0	-2.9	1.81 V	177	67.3	3.8
4	5350.00	52.3 AV	54.0	-1.7	1.81 V	177	48.5	3.8
5	10640.00	58.9 PK	74.0	-15.1	1.91 V	160	41.9	17.0
6	10640.00	48.0 AV	54.0	-6.0	1.91 V	160	31.0	17.0

REMARKS:

1. Emission Level(dBuV/m) = Raw Value(dBuV) + Correction Factor(dB/m)
2. Correction Factor(dB/m) = Antenna Factor(dB/m) + Cable Factor(dB) – Pre-Amplifier Factor(dB)
3. The other emission levels were very low against the limit.
4. Margin value = Emission Level – Limit value
5. " * ": Fundamental frequency.

CHANNEL	TX Channel 100	DETECTOR FUNCTION	Peak (PK)
FREQUENCY RANGE	1GHz ~ 40GHz		Average (AV)

ANTENNA POLARITY & TEST DISTANCE: HORIZONTAL AT 3 M

NO.	FREQ. (MHz)	EMISSION LEVEL (dBuV/m)	LIMIT (dBuV/m)	MARGIN (dB)	ANTENNA HEIGHT (m)	TABLE ANGLE (Degree)	RAW VALUE (dBuV)	CORRECTION FACTOR (dB/m)
1	5460.00	58.1 PK	74.0	-15.9	2.42 H	349	53.9	4.2
2	5460.00	45.7 AV	54.0	-8.3	2.42 H	349	41.5	4.2
3	#5470.00	72.6 PK	74.0	-1.4	2.80 H	355	68.4	4.2
4	#5470.00	47.0 AV	54.0	-7.0	2.80 H	355	42.8	4.2
5	*5500.00	110.4 PK			3.00 H	343	70.3	40.1
6	*5500.00	100.7 AV			3.00 H	343	60.6	40.1
7	11000.00	61.5 PK	74.0	-12.5	1.76 H	188	42.8	18.7
8	11000.00	48.6 AV	54.0	-5.4	1.76 H	188	29.9	18.7

ANTENNA POLARITY & TEST DISTANCE: VERTICAL AT 3 M

NO.	FREQ. (MHz)	EMISSION LEVEL (dBuV/m)	LIMIT (dBuV/m)	MARGIN (dB)	ANTENNA HEIGHT (m)	TABLE ANGLE (Degree)	RAW VALUE (dBuV)	CORRECTION FACTOR (dB/m)
1	5460.00	55.3 PK	74.0	-18.7	3.31 V	89	51.1	4.2
2	5460.00	43.7 AV	54.0	-10.3	3.31 V	89	39.5	4.2
3	#5470.00	67.7 PK	74.0	-6.3	3.49 V	74	63.5	4.2
4	#5470.00	44.5 AV	54.0	-9.5	3.49 V	74	40.3	4.2
5	*5500.00	106.0 PK			3.45 V	75	65.9	40.1
6	*5500.00	95.6 AV			3.45 V	75	55.5	40.1
7	11000.00	61.1 PK	74.0	-12.9	1.68 V	161	42.4	18.7
8	11000.00	49.7 AV	54.0	-4.3	1.68 V	161	31.0	18.7

REMARKS:

1. Emission Level(dBuV/m) = Raw Value(dBuV) + Correction Factor(dB/m)
2. Correction Factor(dB/m) = Antenna Factor(dB/m) + Cable Factor(dB) – Pre-Amplifier Factor(dB)
3. The other emission levels were very low against the limit.
4. Margin value = Emission Level – Limit value
5. " * ": Fundamental frequency.
6. " # ": The radiated frequency is out of the restricted band.

CHANNEL	TX Channel 116	DETECTOR FUNCTION	Peak (PK)
FREQUENCY RANGE	1GHz ~ 40GHz		Average (AV)

ANTENNA POLARITY & TEST DISTANCE: HORIZONTAL AT 3 M

NO.	FREQ. (MHz)	EMISSION LEVEL (dBuV/m)	LIMIT (dBuV/m)	MARGIN (dB)	ANTENNA HEIGHT (m)	TABLE ANGLE (Degree)	RAW VALUE (dBuV)	CORRECTION FACTOR (dB/m)
1	*5580.00	116.6 PK			2.91 H	341	76.6	40.0
2	*5580.00	106.6 AV			2.91 H	341	66.6	40.0
3	11160.00	59.9 PK	74.0	-14.1	1.97 H	181	42.2	17.7
4	11160.00	47.3 AV	54.0	-6.7	1.97 H	181	29.6	17.7

ANTENNA POLARITY & TEST DISTANCE: VERTICAL AT 3 M

NO.	FREQ. (MHz)	EMISSION LEVEL (dBuV/m)	LIMIT (dBuV/m)	MARGIN (dB)	ANTENNA HEIGHT (m)	TABLE ANGLE (Degree)	RAW VALUE (dBuV)	CORRECTION FACTOR (dB/m)
1	*5580.00	110.6 PK			1.80 V	62	70.6	40.0
2	*5580.00	100.7 AV			1.80 V	62	60.7	40.0
3	11160.00	60.2 PK	74.0	-13.8	1.73 V	154	42.5	17.7
4	11160.00	48.6 AV	54.0	-5.4	1.73 V	154	30.9	17.7

REMARKS:

1. Emission Level(dBuV/m) = Raw Value(dBuV) + Correction Factor(dB/m)
2. Correction Factor(dB/m) = Antenna Factor(dB/m) + Cable Factor(dB) – Pre-Amplifier Factor(dB)
3. The other emission levels were very low against the limit.
4. Margin value = Emission Level – Limit value
5. " * ": Fundamental frequency.

CHANNEL	TX Channel 140	DETECTOR FUNCTION	Peak (PK)
FREQUENCY RANGE	1GHz ~ 40GHz		Average (AV)

ANTENNA POLARITY & TEST DISTANCE: HORIZONTAL AT 3 M

NO.	FREQ. (MHz)	EMISSION LEVEL (dBuV/m)	LIMIT (dBuV/m)	MARGIN (dB)	ANTENNA HEIGHT (m)	TABLE ANGLE (Degree)	RAW VALUE (dBuV)	CORRECTION FACTOR (dB/m)
1	*5700.00	110.7 PK			1.34 H	350	70.7	40.0
2	*5700.00	100.7 AV			1.34 H	350	60.7	40.0
3	#5725.00	72.7 PK	74.0	-1.3	1.15 H	346	68.6	4.1
4	#5725.00	48.9 AV	54.0	-5.1	1.15 H	346	44.8	4.1
5	11400.00	61.0 PK	74.0	-13.0	1.87 H	176	43.3	17.7
6	11400.00	47.6 AV	54.0	-6.4	1.87 H	176	29.9	17.7

ANTENNA POLARITY & TEST DISTANCE: VERTICAL AT 3 M

NO.	FREQ. (MHz)	EMISSION LEVEL (dBuV/m)	LIMIT (dBuV/m)	MARGIN (dB)	ANTENNA HEIGHT (m)	TABLE ANGLE (Degree)	RAW VALUE (dBuV)	CORRECTION FACTOR (dB/m)
1	*5700.00	104.3 PK			3.66 V	60	64.3	40.0
2	*5700.00	93.7 AV			3.66 V	60	53.7	40.0
3	#5725.00	65.1 PK	74.0	-8.9	3.50 V	76	61.0	4.1
4	#5725.00	44.7 AV	54.0	-9.3	3.50 V	76	40.6	4.1
5	11400.00	61.1 PK	74.0	-12.9	1.68 V	163	43.4	17.7
6	11400.00	48.7 AV	54.0	-5.3	1.68 V	163	31.0	17.7

REMARKS:

1. Emission Level(dBuV/m) = Raw Value(dBuV) + Correction Factor(dB/m)
2. Correction Factor(dB/m) = Antenna Factor(dB/m) + Cable Factor(dB) – Pre-Amplifier Factor(dB)
3. The other emission levels were very low against the limit.
4. Margin value = Emission Level – Limit value
5. " * ": Fundamental frequency.
6. " # ": The radiated frequency is out of the restricted band.

CHANNEL	TX Channel 144	DETECTOR FUNCTION	Peak (PK)
FREQUENCY RANGE	1GHz ~ 40GHz		Average (AV)

ANTENNA POLARITY & TEST DISTANCE: HORIZONTAL AT 3 M

NO.	FREQ. (MHz)	EMISSION LEVEL (dBuV/m)	LIMIT (dBuV/m)	MARGIN (dB)	ANTENNA HEIGHT (m)	TABLE ANGLE (Degree)	RAW VALUE (dBuV)	CORRECTION FACTOR (dB/m)
1	5460.00	56.8 PK	74.0	-17.2	2.49 H	346	52.4	4.4
2	5460.00	43.9 AV	54.0	-10.1	2.49 H	346	39.5	4.4
3	#5470.00	58.4 PK	74.0	-15.6	2.39 H	345	54.0	4.4
4	#5470.00	44.4 AV	54.0	-9.6	2.39 H	345	40.0	4.4
5	*5720.00	116.7 PK			2.54 H	345	76.7	40.0
6	*5720.00	106.5 AV			2.54 H	345	66.5	40.0
7	#5825.00	59.4 PK	74.0	-14.6	1.39 H	353	54.6	4.8
8	#5825.00	45.7 AV	54.0	-8.3	1.39 H	353	40.9	4.8
9	11440.00	60.9 PK	74.0	-13.1	1.91 H	129	43.3	17.6
10	11440.00	48.6 AV	54.0	-5.4	1.91 H	129	31.0	17.6

ANTENNA POLARITY & TEST DISTANCE: VERTICAL AT 3 M

NO.	FREQ. (MHz)	EMISSION LEVEL (dBuV/m)	LIMIT (dBuV/m)	MARGIN (dB)	ANTENNA HEIGHT (m)	TABLE ANGLE (Degree)	RAW VALUE (dBuV)	CORRECTION FACTOR (dB/m)
1	5460.00	55.8 PK	74.0	-18.2	1.78 V	63	51.4	4.4
2	5460.00	43.7 AV	54.0	-10.3	1.78 V	63	39.3	4.4
3	#5470.00	57.9 PK	74.0	-16.1	1.83 V	70	53.5	4.4
4	#5470.00	44.1 AV	54.0	-9.9	1.83 V	70	39.7	4.4
5	*5720.00	110.7 PK			1.80 V	65	70.7	40.0
6	*5720.00	100.4 AV			1.80 V	65	60.4	40.0
7	#5825.00	57.8 PK	74.0	-16.2	1.70 V	59	53.0	4.8
8	#5825.00	44.3 AV	54.0	-9.7	1.70 V	59	39.5	4.8
9	11440.00	60.6 PK	74.0	-13.4	1.91 V	183	43.0	17.6
10	11440.00	48.3 AV	54.0	-5.7	1.91 V	183	30.7	17.6

REMARKS:

1. Emission Level(dBuV/m) = Raw Value(dBuV) + Correction Factor(dB/m)
2. Correction Factor(dB/m) = Antenna Factor(dB/m) + Cable Factor(dB) – Pre-Amplifier Factor(dB)
3. The other emission levels were very low against the limit.
4. Margin value = Emission Level – Limit value
5. " * ": Fundamental frequency.
6. " # ": The radiated frequency is out of the restricted band.

802.11n (HT40)

CHANNEL	TX Channel 54	DETECTOR FUNCTION	Peak (PK)
FREQUENCY RANGE	1GHz ~ 40GHz		Average (AV)

ANTENNA POLARITY & TEST DISTANCE: HORIZONTAL AT 3 M								
NO.	FREQ. (MHz)	EMISSION LEVEL (dBuV/m)	LIMIT (dBuV/m)	MARGIN (dB)	ANTENNA HEIGHT (m)	TABLE ANGLE (Degree)	RAW VALUE (dBuV)	CORRECTION FACTOR (dB/m)
1	5150.00	57.5 PK	74.0	-16.5	1.69 H	119	53.8	3.7
2	5150.00	43.6 AV	54.0	-10.4	1.69 H	119	39.9	3.7
3	*5270.00	107.6 PK			1.59 H	108	68.2	39.4
4	*5270.00	98.7 AV			1.59 H	108	59.3	39.4
5	#10540.00	60.5 PK	74.0	-13.5	1.72 H	171	43.6	16.9
6	#10540.00	50.6 AV	54.0	-3.4	1.72 H	171	33.7	16.9

ANTENNA POLARITY & TEST DISTANCE: VERTICAL AT 3 M								
NO.	FREQ. (MHz)	EMISSION LEVEL (dBuV/m)	LIMIT (dBuV/m)	MARGIN (dB)	ANTENNA HEIGHT (m)	TABLE ANGLE (Degree)	RAW VALUE (dBuV)	CORRECTION FACTOR (dB/m)
1	5150.00	58.3 PK	74.0	-15.7	1.73 V	159	54.6	3.7
2	5150.00	44.9 AV	54.0	-9.1	1.73 V	159	41.2	3.7
3	*5270.00	113.5 PK			1.67 V	148	74.1	39.4
4	*5270.00	103.7 AV			1.67 V	148	64.3	39.4
5	#10540.00	59.2 PK	74.0	-14.8	1.74 V	172	42.3	16.9
6	#10540.00	47.7 AV	54.0	-6.3	1.74 V	172	30.8	16.9

REMARKS:

1. Emission Level(dBuV/m) = Raw Value(dBuV) + Correction Factor(dB/m)
2. Correction Factor(dB/m) = Antenna Factor(dB/m) + Cable Factor(dB) – Pre-Amplifier Factor(dB)
3. The other emission levels were very low against the limit.
4. Margin value = Emission Level – Limit value
5. " * ": Fundamental frequency.
6. " # ": The radiated frequency is out of the restricted band.

CHANNEL	TX Channel 62	DETECTOR FUNCTION	Peak (PK)
FREQUENCY RANGE	1GHz ~ 40GHz		Average (AV)

ANTENNA POLARITY & TEST DISTANCE: HORIZONTAL AT 3 M

NO.	FREQ. (MHz)	EMISSION LEVEL (dBuV/m)	LIMIT (dBuV/m)	MARGIN (dB)	ANTENNA HEIGHT (m)	TABLE ANGLE (Degree)	RAW VALUE (dBuV)	CORRECTION FACTOR (dB/m)
1	*5310.00	102.4 PK			1.93 H	112	63.0	39.4
2	*5310.00	92.8 AV			1.93 H	112	53.4	39.4
3	5350.00	64.4 PK	74.0	-9.6	1.77 H	101	60.6	3.8
4	5350.00	45.4 AV	54.0	-8.6	1.77 H	101	41.6	3.8
5	10620.00	59.9 PK	74.0	-14.1	1.67 H	174	42.8	17.1
6	10620.00	50.7 AV	54.0	-3.3	1.67 H	174	33.6	17.1

ANTENNA POLARITY & TEST DISTANCE: VERTICAL AT 3 M

NO.	FREQ. (MHz)	EMISSION LEVEL (dBuV/m)	LIMIT (dBuV/m)	MARGIN (dB)	ANTENNA HEIGHT (m)	TABLE ANGLE (Degree)	RAW VALUE (dBuV)	CORRECTION FACTOR (dB/m)
1	*5310.00	109.6 PK			2.13 V	105	70.2	39.4
2	*5310.00	99.8 AV			2.13 V	105	60.4	39.4
3	5350.00	72.4 PK	74.0	-1.6	2.02 V	268	68.6	3.8
4	5350.00	50.9 AV	54.0	-3.1	2.02 V	268	47.1	3.8
5	10620.00	58.5 PK	74.0	-15.5	1.91 V	142	41.4	17.1
6	10620.00	46.6 AV	54.0	-7.4	1.91 V	142	29.5	17.1

REMARKS:

1. Emission Level(dBuV/m) = Raw Value(dBuV) + Correction Factor(dB/m)
2. Correction Factor(dB/m) = Antenna Factor(dB/m) + Cable Factor(dB) – Pre-Amplifier Factor(dB)
3. The other emission levels were very low against the limit.
4. Margin value = Emission Level – Limit value
5. " * ": Fundamental frequency.

CHANNEL	TX Channel 102	DETECTOR FUNCTION	Peak (PK)
FREQUENCY RANGE	1GHz ~ 40GHz		Average (AV)

ANTENNA POLARITY & TEST DISTANCE: HORIZONTAL AT 3 M

NO.	FREQ. (MHz)	EMISSION LEVEL (dBuV/m)	LIMIT (dBuV/m)	MARGIN (dB)	ANTENNA HEIGHT (m)	TABLE ANGLE (Degree)	RAW VALUE (dBuV)	CORRECTION FACTOR (dB/m)
1	5460.00	64.1 PK	74.0	-9.9	2.14 H	343	59.9	4.2
2	5460.00	48.4 AV	54.0	-5.6	2.14 H	343	44.2	4.2
3	#5470.00	72.8 PK	74.0	-1.2	2.56 H	354	68.6	4.2
4	#5470.00	52.7 AV	54.0	-1.3	2.56 H	354	48.5	4.2
5	*5510.00	109.3 PK			2.55 H	353	69.2	40.1
6	*5510.00	98.7 AV			2.55 H	353	58.6	40.1
7	11020.00	61.0 PK	74.0	-13.0	1.80 H	166	42.5	18.5
8	11020.00	48.9 AV	54.0	-5.1	1.80 H	166	30.4	18.5

ANTENNA POLARITY & TEST DISTANCE: VERTICAL AT 3 M

NO.	FREQ. (MHz)	EMISSION LEVEL (dBuV/m)	LIMIT (dBuV/m)	MARGIN (dB)	ANTENNA HEIGHT (m)	TABLE ANGLE (Degree)	RAW VALUE (dBuV)	CORRECTION FACTOR (dB/m)
1	5460.00	57.6 PK	74.0	-16.4	3.46 V	66	53.4	4.2
2	5460.00	43.9 AV	54.0	-10.1	3.46 V	66	39.7	4.2
3	#5470.00	64.9 PK	74.0	-9.1	3.82 V	57	60.7	4.2
4	#5470.00	47.1 AV	54.0	-6.9	3.82 V	57	42.9	4.2
5	*5510.00	102.7 PK			3.79 V	64	62.6	40.1
6	*5510.00	92.8 AV			3.79 V	64	52.7	40.1
7	11020.00	61.5 PK	74.0	-12.5	2.01 V	178	43.0	18.5
8	11020.00	50.4 AV	54.0	-3.6	2.01 V	178	31.9	18.5

REMARKS:

1. Emission Level(dBuV/m) = Raw Value(dBuV) + Correction Factor(dB/m)
2. Correction Factor(dB/m) = Antenna Factor(dB/m) + Cable Factor(dB) – Pre-Amplifier Factor(dB)
3. The other emission levels were very low against the limit.
4. Margin value = Emission Level – Limit value
5. " * ": Fundamental frequency.
6. " # ": The radiated frequency is out of the restricted band.

CHANNEL	TX Channel 110	DETECTOR FUNCTION	Peak (PK)
FREQUENCY RANGE	1GHz ~ 40GHz		Average (AV)

ANTENNA POLARITY & TEST DISTANCE: HORIZONTAL AT 3 M

NO.	FREQ. (MHz)	EMISSION LEVEL (dBuV/m)	LIMIT (dBuV/m)	MARGIN (dB)	ANTENNA HEIGHT (m)	TABLE ANGLE (Degree)	RAW VALUE (dBuV)	CORRECTION FACTOR (dB/m)
1	#5470.00	69.4 PK	74.0	-4.6	3.47 H	341	65.2	4.2
2	#5470.00	51.5 AV	54.0	-2.5	3.47 H	341	47.3	4.2
3	*5550.00	114.0 PK			2.31 H	353	74.0	40.0
4	*5550.00	103.6 AV			2.31 H	353	63.6	40.0
5	11100.00	60.0 PK	74.0	-14.0	1.92 H	166	42.4	17.6
6	11100.00	48.1 AV	54.0	-5.9	1.92 H	166	30.5	17.6

ANTENNA POLARITY & TEST DISTANCE: VERTICAL AT 3 M

NO.	FREQ. (MHz)	EMISSION LEVEL (dBuV/m)	LIMIT (dBuV/m)	MARGIN (dB)	ANTENNA HEIGHT (m)	TABLE ANGLE (Degree)	RAW VALUE (dBuV)	CORRECTION FACTOR (dB/m)
1	#5470.00	63.2 PK	74.0	-10.8	3.49 V	75	59.0	4.2
2	#5470.00	47.8 AV	54.0	-6.2	3.49 V	75	43.6	4.2
3	*5550.00	107.9 PK			3.50 V	66	67.9	40.0
4	*5550.00	98.0 AV			3.50 V	66	58.0	40.0
5	11100.00	60.5 PK	74.0	-13.5	1.73 V	162	42.9	17.6
6	11100.00	48.2 AV	54.0	-5.8	1.73 V	162	30.6	17.6

REMARKS:

1. Emission Level(dBuV/m) = Raw Value(dBuV) + Correction Factor(dB/m)
2. Correction Factor(dB/m) = Antenna Factor(dB/m) + Cable Factor(dB) – Pre-Amplifier Factor(dB)
3. The other emission levels were very low against the limit.
4. Margin value = Emission Level – Limit value
5. " * ": Fundamental frequency.

CHANNEL	TX Channel 134	DETECTOR FUNCTION	Peak (PK)
FREQUENCY RANGE	1GHz ~ 40GHz		Average (AV)

ANTENNA POLARITY & TEST DISTANCE: HORIZONTAL AT 3 M

NO.	FREQ. (MHz)	EMISSION LEVEL (dBuV/m)	LIMIT (dBuV/m)	MARGIN (dB)	ANTENNA HEIGHT (m)	TABLE ANGLE (Degree)	RAW VALUE (dBuV)	CORRECTION FACTOR (dB/m)
1	*5670.00	111.3 PK			2.31 H	352	71.2	40.1
2	*5670.00	101.0 AV			2.31 H	352	60.9	40.1
3	#5725.00	68.3 PK	74.0	-5.7	1.31 H	350	64.2	4.1
4	#5725.00	52.3 AV	54.0	-1.7	1.31 H	350	48.2	4.1
5	11340.00	61.4 PK	74.0	-12.6	1.78 H	185	43.5	17.9
6	11340.00	48.5 AV	54.0	-5.5	1.78 H	185	30.6	17.9

ANTENNA POLARITY & TEST DISTANCE: VERTICAL AT 3 M

NO.	FREQ. (MHz)	EMISSION LEVEL (dBuV/m)	LIMIT (dBuV/m)	MARGIN (dB)	ANTENNA HEIGHT (m)	TABLE ANGLE (Degree)	RAW VALUE (dBuV)	CORRECTION FACTOR (dB/m)
1	*5670.00	104.4 PK			3.69 V	59	64.3	40.1
2	*5670.00	94.7 AV			3.69 V	59	54.6	40.1
3	#5725.00	61.7 PK	74.0	-12.3	3.50 V	67	57.6	4.1
4	#5725.00	46.8 AV	54.0	-7.2	3.50 V	67	42.7	4.1
5	11340.00	61.2 PK	74.0	-12.8	2.08 V	186	43.3	17.9
6	11340.00	49.1 AV	54.0	-4.9	2.08 V	186	31.2	17.9

REMARKS:

1. Emission Level(dBuV/m) = Raw Value(dBuV) + Correction Factor(dB/m)
2. Correction Factor(dB/m) = Antenna Factor(dB/m) + Cable Factor(dB) – Pre-Amplifier Factor(dB)
3. The other emission levels were very low against the limit.
4. Margin value = Emission Level – Limit value
5. " * ": Fundamental frequency.
6. " # ": The radiated frequency is out of the restricted band.

CHANNEL	TX Channel 142	DETECTOR FUNCTION	Peak (PK)
FREQUENCY RANGE	1GHz ~ 40GHz		Average (AV)

ANTENNA POLARITY & TEST DISTANCE: HORIZONTAL AT 3 M

NO.	FREQ. (MHz)	EMISSION LEVEL (dBuV/m)	LIMIT (dBuV/m)	MARGIN (dB)	ANTENNA HEIGHT (m)	TABLE ANGLE (Degree)	RAW VALUE (dBuV)	CORRECTION FACTOR (dB/m)
1	5460.00	55.9 PK	74.0	-18.1	2.51 H	355	51.5	4.4
2	5460.00	44.0 AV	54.0	-10.0	2.51 H	355	39.6	4.4
3	#5470.00	57.9 PK	74.0	-16.1	2.40 H	346	53.5	4.4
4	#5470.00	44.4 AV	54.0	-9.6	2.40 H	346	40.0	4.4
5	*5710.00	113.0 PK			2.54 H	345	73.0	40.0
6	*5710.00	102.9 AV			2.54 H	345	62.9	40.0
7	#5825.00	61.6 PK	74.0	-12.4	2.36 H	349	56.8	4.8
8	#5825.00	47.2 AV	54.0	-6.8	2.36 H	349	42.4	4.8
9	11420.00	60.8 PK	74.0	-13.2	2.06 H	145	43.3	17.5
10	11420.00	48.0 AV	54.0	-6.0	2.06 H	145	30.5	17.5

ANTENNA POLARITY & TEST DISTANCE: VERTICAL AT 3 M

NO.	FREQ. (MHz)	EMISSION LEVEL (dBuV/m)	LIMIT (dBuV/m)	MARGIN (dB)	ANTENNA HEIGHT (m)	TABLE ANGLE (Degree)	RAW VALUE (dBuV)	CORRECTION FACTOR (dB/m)
1	5460.00	56.7 PK	74.0	-17.3	1.83 V	65	52.3	4.4
2	5460.00	43.7 AV	54.0	-10.3	1.83 V	65	39.3	4.4
3	#5470.00	58.0 PK	74.0	-16.0	1.75 V	66	53.6	4.4
4	#5470.00	44.3 AV	54.0	-9.7	1.75 V	66	39.9	4.4
5	*5710.00	106.9 PK			1.79 V	62	66.9	40.0
6	*5710.00	96.8 AV			1.79 V	62	56.8	40.0
7	#5825.00	58.5 PK	74.0	-15.5	1.92 V	77	53.7	4.8
8	#5825.00	44.7 AV	54.0	-9.3	1.92 V	77	39.9	4.8
9	11420.00	60.5 PK	74.0	-13.5	1.85 V	156	43.0	17.5
10	11420.00	47.7 AV	54.0	-6.3	1.85 V	156	30.2	17.5

REMARKS:

1. Emission Level(dBuV/m) = Raw Value(dBuV) + Correction Factor(dB/m)
2. Correction Factor(dB/m) = Antenna Factor(dB/m) + Cable Factor(dB) – Pre-Amplifier Factor(dB)
3. The other emission levels were very low against the limit.
4. Margin value = Emission Level – Limit value
5. " * ": Fundamental frequency.
6. " # ": The radiated frequency is out of the restricted band.

802.11ac (VHT80)

CHANNEL	TX Channel 58	DETECTOR FUNCTION	Peak (PK)
FREQUENCY RANGE	1GHz ~ 40GHz		Average (AV)

ANTENNA POLARITY & TEST DISTANCE: HORIZONTAL AT 3 M								
NO.	FREQ. (MHz)	EMISSION LEVEL (dBuV/m)	LIMIT (dBuV/m)	MARGIN (dB)	ANTENNA HEIGHT (m)	TABLE ANGLE (Degree)	RAW VALUE (dBuV)	CORRECTION FACTOR (dB/m)
1	5150.00	56.3 PK	74.0	-17.7	1.66 H	193	52.6	3.7
2	5150.00	43.2 AV	54.0	-10.8	1.66 H	193	39.5	3.7
3	*5290.00	100.6 PK			1.63 H	213	61.2	39.4
4	*5290.00	90.2 AV			1.63 H	213	50.8	39.4
5	5350.00	64.8 PK	74.0	-9.2	1.70 H	189	61.0	3.8
6	5350.00	46.7 AV	54.0	-7.3	1.70 H	189	42.9	3.8
7	#10580.00	60.5 PK	74.0	-13.5	1.59 H	171	43.5	17.0
8	#10580.00	51.4 AV	54.0	-2.6	1.59 H	171	34.4	17.0

ANTENNA POLARITY & TEST DISTANCE: VERTICAL AT 3 M								
NO.	FREQ. (MHz)	EMISSION LEVEL (dBuV/m)	LIMIT (dBuV/m)	MARGIN (dB)	ANTENNA HEIGHT (m)	TABLE ANGLE (Degree)	RAW VALUE (dBuV)	CORRECTION FACTOR (dB/m)
1	5150.00	59.0 PK	74.0	-15.0	2.01 V	263	55.3	3.7
2	5150.00	44.6 AV	54.0	-9.4	2.01 V	263	40.9	3.7
3	*5290.00	106.6 PK			2.12 V	103	67.2	39.4
4	*5290.00	96.4 AV			2.12 V	103	57.0	39.4
5	5350.00	72.8 PK	74.0	-1.2	2.11 V	255	69.0	3.8
6	5350.00	51.8 AV	54.0	-2.2	2.11 V	255	48.0	3.8
7	#10580.00	59.7 PK	74.0	-14.3	2.33 V	197	42.7	17.0
8	#10580.00	48.3 AV	54.0	-5.7	2.33 V	197	31.3	17.0

REMARKS:

1. Emission Level(dBuV/m) = Raw Value(dBuV) + Correction Factor(dB/m)
2. Correction Factor(dB/m) = Antenna Factor(dB/m) + Cable Factor(dB) – Pre-Amplifier Factor(dB)
3. The other emission levels were very low against the limit.
4. Margin value = Emission Level – Limit value
5. " * ": Fundamental frequency.
6. " # ": The radiated frequency is out of the restricted band.

CHANNEL	TX Channel 106	DETECTOR FUNCTION	Peak (PK)
FREQUENCY RANGE	1GHz ~ 40GHz		Average (AV)

ANTENNA POLARITY & TEST DISTANCE: HORIZONTAL AT 3 M

NO.	FREQ. (MHz)	EMISSION LEVEL (dBuV/m)	LIMIT (dBuV/m)	MARGIN (dB)	ANTENNA HEIGHT (m)	TABLE ANGLE (Degree)	RAW VALUE (dBuV)	CORRECTION FACTOR (dB/m)
1	5460.00	67.0 PK	74.0	-7.0	2.99 H	351	62.8	4.2
2	5460.00	50.6 AV	54.0	-3.4	2.99 H	351	46.4	4.2
3	#5470.00	71.7 PK	74.0	-2.3	3.44 H	346	67.5	4.2
4	#5470.00	52.8 AV	54.0	-1.2	3.44 H	346	48.6	4.2
5	*5530.00	105.9 PK			2.64 H	353	65.8	40.1
6	*5530.00	95.6 AV			2.64 H	353	55.5	40.1
7	#5725.00	57.4 PK	74.0	-16.6	2.83 H	343	53.3	4.1
8	#5725.00	43.9 AV	54.0	-10.1	2.83 H	343	39.8	4.1
9	11060.00	60.9 PK	74.0	-13.1	1.87 H	166	42.9	18.0
10	11060.00	48.7 AV	54.0	-5.3	1.87 H	166	30.7	18.0

ANTENNA POLARITY & TEST DISTANCE: VERTICAL AT 3 M

NO.	FREQ. (MHz)	EMISSION LEVEL (dBuV/m)	LIMIT (dBuV/m)	MARGIN (dB)	ANTENNA HEIGHT (m)	TABLE ANGLE (Degree)	RAW VALUE (dBuV)	CORRECTION FACTOR (dB/m)
1	5460.00	62.5 PK	74.0	-11.5	3.24 V	89	58.3	4.2
2	5460.00	47.7 AV	54.0	-6.3	3.24 V	89	43.5	4.2
3	#5470.00	66.8 PK	74.0	-7.2	3.51 V	75	62.6	4.2
4	#5470.00	49.4 AV	54.0	-4.6	3.51 V	75	45.2	4.2
5	*5530.00	100.6 PK			3.56 V	68	60.5	40.1
6	*5530.00	90.2 AV			3.56 V	68	50.1	40.1
7	#5725.00	56.3 PK	74.0	-17.7	3.05 V	67	52.2	4.1
8	#5725.00	43.1 AV	54.0	-10.9	3.05 V	67	39.0	4.1
9	11060.00	61.1 PK	74.0	-12.9	1.75 V	158	43.1	18.0
10	11060.00	49.7 AV	54.0	-4.3	1.75 V	158	31.7	18.0

REMARKS:

1. Emission Level(dBuV/m) = Raw Value(dBuV) + Correction Factor(dB/m)
2. Correction Factor(dB/m) = Antenna Factor(dB/m) + Cable Factor(dB) – Pre-Amplifier Factor(dB)
3. The other emission levels were very low against the limit.
4. Margin value = Emission Level – Limit value
5. " * ": Fundamental frequency.
6. " # ": The radiated frequency is out of the restricted band.

CHANNEL	TX Channel 122	DETECTOR FUNCTION	Peak (PK)
FREQUENCY RANGE	1GHz ~ 40GHz		Average (AV)

ANTENNA POLARITY & TEST DISTANCE: HORIZONTAL AT 3 M

NO.	FREQ. (MHz)	EMISSION LEVEL (dBuV/m)	LIMIT (dBuV/m)	MARGIN (dB)	ANTENNA HEIGHT (m)	TABLE ANGLE (Degree)	RAW VALUE (dBuV)	CORRECTION FACTOR (dB/m)
1	5460.00	60.3 PK	74.0	-13.7	2.55 H	347	56.1	4.2
2	5460.00	47.9 AV	54.0	-6.1	2.55 H	347	43.7	4.2
3	#5470.00	64.4 PK	74.0	-9.6	2.69 H	353	60.2	4.2
4	#5470.00	49.6 AV	54.0	-4.4	2.69 H	353	45.4	4.2
5	*5610.00	110.1 PK			2.36 H	355	70.0	40.1
6	*5610.00	99.2 AV			2.36 H	355	59.1	40.1
7	#5725.00	66.8 PK	74.0	-7.2	2.58 H	354	62.7	4.1
8	#5725.00	52.6 AV	54.0	-1.4	2.58 H	354	48.5	4.1
9	11220.00	60.1 PK	74.0	-13.9	1.62 H	153	42.2	17.9
10	11220.00	47.2 AV	54.0	-6.8	1.62 H	153	29.3	17.9

ANTENNA POLARITY & TEST DISTANCE: VERTICAL AT 3 M

NO.	FREQ. (MHz)	EMISSION LEVEL (dBuV/m)	LIMIT (dBuV/m)	MARGIN (dB)	ANTENNA HEIGHT (m)	TABLE ANGLE (Degree)	RAW VALUE (dBuV)	CORRECTION FACTOR (dB/m)
1	5460.00	57.3 PK	74.0	-16.7	3.31 V	62	53.1	4.2
2	5460.00	45.4 AV	54.0	-8.6	3.31 V	62	41.2	4.2
3	#5470.00	59.9 PK	74.0	-14.1	3.48 V	75	55.7	4.2
4	#5470.00	45.8 AV	54.0	-8.2	3.48 V	75	41.6	4.2
5	*5610.00	103.4 PK			3.53 V	76	63.3	40.1
6	*5610.00	93.2 AV			3.53 V	76	53.1	40.1
7	#5725.00	59.9 PK	74.0	-14.1	3.50 V	72	55.8	4.1
8	#5725.00	46.8 AV	54.0	-7.2	3.50 V	72	42.7	4.1
9	11220.00	60.5 PK	74.0	-13.5	1.76 V	160	42.6	17.9
10	11220.00	48.5 AV	54.0	-5.5	1.76 V	160	30.6	17.9

REMARKS:

1. Emission Level(dBuV/m) = Raw Value(dBuV) + Correction Factor(dB/m)
2. Correction Factor(dB/m) = Antenna Factor(dB/m) + Cable Factor(dB) – Pre-Amplifier Factor(dB)
3. The other emission levels were very low against the limit.
4. Margin value = Emission Level – Limit value
5. " * ": Fundamental frequency.
6. " # ": The radiated frequency is out of the restricted band.

CHANNEL	TX Channel 138	DETECTOR FUNCTION	Peak (PK)
FREQUENCY RANGE	1GHz ~ 40GHz		Average (AV)

ANTENNA POLARITY & TEST DISTANCE: HORIZONTAL AT 3 M

NO.	FREQ. (MHz)	EMISSION LEVEL (dBuV/m)	LIMIT (dBuV/m)	MARGIN (dB)	ANTENNA HEIGHT (m)	TABLE ANGLE (Degree)	RAW VALUE (dBuV)	CORRECTION FACTOR (dB/m)
1	5460.00	57.7 PK	74.0	-16.3	2.51 H	352	53.3	4.4
2	5460.00	45.4 AV	54.0	-8.6	2.51 H	352	41.0	4.4
3	#5470.00	60.9 PK	74.0	-13.1	2.60 H	340	56.5	4.4
4	#5470.00	46.1 AV	54.0	-7.9	2.60 H	340	41.7	4.4
5	*5690.00	110.9 PK			2.35 H	345	70.9	40.0
6	*5690.00	100.6 AV			2.35 H	345	60.6	40.0
7	#5825.00	66.2 PK	74.0	-7.8	2.44 H	345	61.4	4.8
8	#5825.00	52.8 AV	54.0	-1.2	2.44 H	345	48.0	4.8
9	11380.00	59.9 PK	74.0	-14.1	2.20 H	141	42.4	17.5
10	11380.00	47.6 AV	54.0	-6.4	2.20 H	141	30.1	17.5

ANTENNA POLARITY & TEST DISTANCE: VERTICAL AT 3 M

NO.	FREQ. (MHz)	EMISSION LEVEL (dBuV/m)	LIMIT (dBuV/m)	MARGIN (dB)	ANTENNA HEIGHT (m)	TABLE ANGLE (Degree)	RAW VALUE (dBuV)	CORRECTION FACTOR (dB/m)
1	5460.00	56.4 PK	74.0	-17.6	1.73 V	50	52.0	4.4
2	5460.00	44.2 AV	54.0	-9.8	1.73 V	50	39.8	4.4
3	#5470.00	58.6 PK	74.0	-15.4	1.69 V	60	54.2	4.4
4	#5470.00	44.8 AV	54.0	-9.2	1.69 V	60	40.4	4.4
5	*5690.00	105.5 PK			1.64 V	69	65.5	40.0
6	*5690.00	95.2 AV			1.64 V	69	55.2	40.0
7	#5825.00	60.3 PK	74.0	-13.7	1.71 V	57	55.5	4.8
8	#5825.00	47.1 AV	54.0	-6.9	1.71 V	57	42.3	4.8
9	11380.00	60.1 PK	74.0	-13.9	1.78 V	158	42.6	17.5
10	11380.00	48.1 AV	54.0	-5.9	1.78 V	158	30.6	17.5

REMARKS:

1. Emission Level(dBuV/m) = Raw Value(dBuV) + Correction Factor(dB/m)
2. Correction Factor(dB/m) = Antenna Factor(dB/m) + Cable Factor(dB) – Pre-Amplifier Factor(dB)
3. The other emission levels were very low against the limit.
4. Margin value = Emission Level – Limit value
5. " * ": Fundamental frequency.
6. " # ": The radiated frequency is out of the restricted band.

Below 1GHz worst-case data:

802.11a

CHANNEL	TX Channel 52	DETECTOR FUNCTION	Quasi-Peak (QP)
FREQUENCY RANGE	9kHz ~ 1GHz	TEST MODE	A

ANTENNA POLARITY & TEST DISTANCE: HORIZONTAL AT 3 M

NO.	FREQ. (MHz)	EMISSION LEVEL (dBuV/m)	LIMIT (dBuV/m)	MARGIN (dB)	ANTENNA HEIGHT (m)	TABLE ANGLE (Degree)	RAW VALUE (dBuV)	CORRECTION FACTOR (dB/m)
1	35.73	28.7 QP	40.0	-11.3	1.50 H	201	44.3	-15.6
2	76.56	34.2 QP	40.0	-5.8	1.50 H	257	51.5	-17.3
3	105.73	26.4 QP	43.5	-17.1	1.50 H	285	44.2	-17.8
4	142.67	31.4 QP	43.5	-12.1	1.50 H	261	45.6	-14.2
5	286.55	26.5 QP	46.0	-19.5	1.00 H	272	39.5	-13.0
6	533.47	41.8 QP	46.0	-4.2	1.50 H	261	50.9	-9.1

ANTENNA POLARITY & TEST DISTANCE: VERTICAL AT 3 M

NO.	FREQ. (MHz)	EMISSION LEVEL (dBuV/m)	LIMIT (dBuV/m)	MARGIN (dB)	ANTENNA HEIGHT (m)	TABLE ANGLE (Degree)	RAW VALUE (dBuV)	CORRECTION FACTOR (dB/m)
1	51.59	35.2 QP	40.0	-4.8	1.00 V	303	49.3	-14.1
2	121.28	29.4 QP	43.5	-14.1	1.00 V	5	45.4	-16.0
3	193.22	22.8 QP	43.5	-20.7	1.00 V	76	39.3	-16.5
4	374.04	21.6 QP	46.0	-24.4	1.49 V	221	33.2	-11.6
5	533.32	39.1 QP	46.0	-6.9	1.00 V	114	48.2	-9.1
6	624.85	25.3 QP	46.0	-20.7	1.00 V	15	32.1	-6.8

Remarks:

1. Emission Level(dBuV/m) = Raw Value(dBuV) + Correction Factor(dB/m)
2. Correction Factor(dB/m) = Antenna Factor(dB/m) + Cable Factor(dB) – Pre-Amplifier Factor(dB)
3. The other emission levels were very low against the limit.
4. Margin value = Emission Level – Limit value

CHANNEL	TX Channel 52	DETECTOR FUNCTION	Quasi-Peak (QP)
FREQUENCY RANGE	9kHz ~ 1GHz	TEST MODE	B

ANTENNA POLARITY & TEST DISTANCE: HORIZONTAL AT 3 M

NO.	FREQ. (MHz)	EMISSION LEVEL (dBuV/m)	LIMIT (dBuV/m)	MARGIN (dB)	ANTENNA HEIGHT (m)	TABLE ANGLE (Degree)	RAW VALUE (dBuV)	CORRECTION FACTOR (dB/m)
1	39.62	26.8 QP	40.0	-13.2	1.49 H	68	41.8	-15.0
2	57.12	26.6 QP	40.0	-13.4	1.99 H	117	41.0	-14.4
3	90.17	31.8 QP	43.5	-11.7	1.99 H	73	51.3	-19.5
4	132.95	30.5 QP	43.5	-13.0	1.99 H	212	45.7	-15.2
5	307.93	37.3 QP	46.0	-8.7	1.00 H	91	49.9	-12.6
6	533.47	41.8 QP	46.0	-4.2	1.49 H	288	50.9	-9.1

ANTENNA POLARITY & TEST DISTANCE: VERTICAL AT 3 M

NO.	FREQ. (MHz)	EMISSION LEVEL (dBuV/m)	LIMIT (dBuV/m)	MARGIN (dB)	ANTENNA HEIGHT (m)	TABLE ANGLE (Degree)	RAW VALUE (dBuV)	CORRECTION FACTOR (dB/m)
1	39.71	35.8 QP	40.0	-4.2	1.00 V	0	50.8	-15.0
2	61.01	34.9 QP	40.0	-5.1	1.00 V	298	49.5	-14.6
3	76.56	31.9 QP	40.0	-8.1	1.49 V	136	49.2	-17.3
4	132.95	30.9 QP	43.5	-12.6	1.00 V	300	46.1	-15.2
5	284.60	34.1 QP	46.0	-11.9	1.49 V	188	47.1	-13.0
6	533.47	40.0 QP	46.0	-6.0	1.00 V	147	49.1	-9.1

Remarks:

1. Emission Level(dBuV/m) = Raw Value(dBuV) + Correction Factor(dB/m)
2. Correction Factor(dB/m) = Antenna Factor(dB/m) + Cable Factor(dB) – Pre-Amplifier Factor(dB)
3. The other emission levels were very low against the limit.
4. Margin value = Emission Level – Limit value

CHANNEL	TX Channel 52	DETECTOR FUNCTION	Quasi-Peak (QP)
FREQUENCY RANGE	9kHz ~ 1GHz	TEST MODE	C

ANTENNA POLARITY & TEST DISTANCE: HORIZONTAL AT 3 M

NO.	FREQ. (MHz)	EMISSION LEVEL (dBuV/m)	LIMIT (dBuV/m)	MARGIN (dB)	ANTENNA HEIGHT (m)	TABLE ANGLE (Degree)	RAW VALUE (dBuV)	CORRECTION FACTOR (dB/m)
1	57.12	27.9 QP	40.0	-12.1	2.00 H	70	42.3	-14.4
2	107.67	27.5 QP	43.5	-16.0	1.49 H	67	45.1	-17.6
3	206.83	25.7 QP	43.5	-17.8	1.00 H	181	42.5	-16.8
4	500.42	32.4 QP	46.0	-13.6	1.49 H	177	41.8	-9.4
5	533.47	34.1 QP	46.0	-11.9	1.49 H	13	43.2	-9.1
6	624.85	35.2 QP	46.0	-10.8	1.00 H	184	42.0	-6.8

ANTENNA POLARITY & TEST DISTANCE: VERTICAL AT 3 M

NO.	FREQ. (MHz)	EMISSION LEVEL (dBuV/m)	LIMIT (dBuV/m)	MARGIN (dB)	ANTENNA HEIGHT (m)	TABLE ANGLE (Degree)	RAW VALUE (dBuV)	CORRECTION FACTOR (dB/m)
1	52.75	35.8 QP	40.0	-4.2	1.00 V	358	49.9	-14.1
2	80.45	27.5 QP	40.0	-12.5	2.00 V	144	45.8	-18.3
3	206.83	29.3 QP	43.5	-14.2	1.50 V	157	46.1	-16.8
4	500.42	29.6 QP	46.0	-16.4	1.00 V	215	39.0	-9.4
5	533.47	35.5 QP	46.0	-10.5	1.00 V	17	44.6	-9.1
6	624.85	32.4 QP	46.0	-13.6	1.50 V	257	39.2	-6.8

Remarks:

1. Emission Level(dBuV/m) = Raw Value(dBuV) + Correction Factor(dB/m)
2. Correction Factor(dB/m) = Antenna Factor(dB/m) + Cable Factor(dB) – Pre-Amplifier Factor(dB)
3. The other emission levels were very low against the limit.
4. Margin value = Emission Level – Limit value

CHANNEL	TX Channel 52	DETECTOR FUNCTION	Quasi-Peak (QP)
FREQUENCY RANGE	9kHz ~ 1GHz	TEST MODE	D

ANTENNA POLARITY & TEST DISTANCE: HORIZONTAL AT 3 M

NO.	FREQ. (MHz)	EMISSION LEVEL (dBuV/m)	LIMIT (dBuV/m)	MARGIN (dB)	ANTENNA HEIGHT (m)	TABLE ANGLE (Degree)	RAW VALUE (dBuV)	CORRECTION FACTOR (dB/m)
1	35.73	28.7 QP	40.0	-11.3	1.50 H	201	44.3	-15.6
2	76.56	34.2 QP	40.0	-5.8	1.50 H	257	51.5	-17.3
3	105.73	26.4 QP	43.5	-17.1	1.50 H	285	44.2	-17.8
4	142.67	31.4 QP	43.5	-12.1	1.50 H	261	45.6	-14.2
5	286.55	26.5 QP	46.0	-19.5	1.00 H	272	39.5	-13.0
6	533.47	41.8 QP	46.0	-4.2	1.50 H	261	50.9	-9.1

ANTENNA POLARITY & TEST DISTANCE: VERTICAL AT 3 M

NO.	FREQ. (MHz)	EMISSION LEVEL (dBuV/m)	LIMIT (dBuV/m)	MARGIN (dB)	ANTENNA HEIGHT (m)	TABLE ANGLE (Degree)	RAW VALUE (dBuV)	CORRECTION FACTOR (dB/m)
1	51.59	35.2 QP	40.0	-4.8	1.00 V	303	49.3	-14.1
2	121.28	29.4 QP	43.5	-14.1	1.00 V	5	45.4	-16.0
3	193.22	22.8 QP	43.5	-20.7	1.00 V	76	39.3	-16.5
4	374.04	21.6 QP	46.0	-24.4	1.49 V	221	33.2	-11.6
5	533.32	39.1 QP	46.0	-6.9	1.00 V	114	48.2	-9.1
6	624.85	25.3 QP	46.0	-20.7	1.00 V	15	32.1	-6.8

Remarks:

1. Emission Level(dBuV/m) = Raw Value(dBuV) + Correction Factor(dB/m)
2. Correction Factor(dB/m) = Antenna Factor(dB/m) + Cable Factor(dB) – Pre-Amplifier Factor(dB)
3. The other emission levels were very low against the limit.
4. Margin value = Emission Level – Limit value

4.2 Conducted Emission Measurement

4.2.1 Limits of Conducted Emission Measurement

Frequency (MHz)	Conducted Limit (dBuV)	
	Quasi-peak	Average
0.15 - 0.5	66 - 56	56 - 46
0.50 - 5.0	56	46
5.0 - 30.0	60	50

- Note:** 1. The lower limit shall apply at the transition frequencies.
 2. The limit decreases in line with the logarithm of the frequency in the range of 0.15 to 0.50MHz.

4.2.2 Test Instruments

Description & Manufacturer	Model No.	Serial No.	Cal. Date	Cal. Due
Test Receiver ROHDE & SCHWARZ	ESCI	100613	Nov. 23, 2017	Nov. 22, 2018
RF signal cable (with 10dB PAD) Woken	5D-FB	Cable-cond1-01	Sep. 05, 2017	Sep. 04, 2018
LISN ROHDE & SCHWARZ (EUT)	ESH3-Z5	835239/001	Mar. 06, 2018	Mar. 05, 2019
LISN ROHDE & SCHWARZ (Peripheral)	ESH3-Z5	100311	Aug. 15, 2017	Aug. 14, 2018
Software ADT	BV ADT_Cond_ V7.3.7.4	NA	NA	NA

- Note:** 1. The calibration interval of the above test instruments is 12 months and the calibrations are traceable to NML/ROC and NIST/USA.
 2. The test was performed in HwaYa Shielded Room 1.
 3. The VCCI Site Registration No. is C-2040.

4.2.3 Test Procedures

- a. The EUT was placed 0.4 meters from the conducting wall of the shielded room with EUT being connected to the power mains through a line impedance stabilization network (LISN). Other support units were connected to the power mains through another LISN. The two LISNs provide 50 ohm/ 50uH of coupling impedance for the measuring instrument.
- b. Both lines of the power mains connected to the EUT were checked for maximum conducted interference.
- c. The frequency range from 150kHz to 30MHz was searched. Emission levels under (Limit - 20dB) was not recorded.

NOTE: The resolution bandwidth and video bandwidth of test receiver is 9kHz for quasi-peak detection (QP) and average detection (AV) at frequency 0.15MHz-30MHz.

4.2.4 Deviation from Test Standard

No deviation.

4.2.5 Test Setup

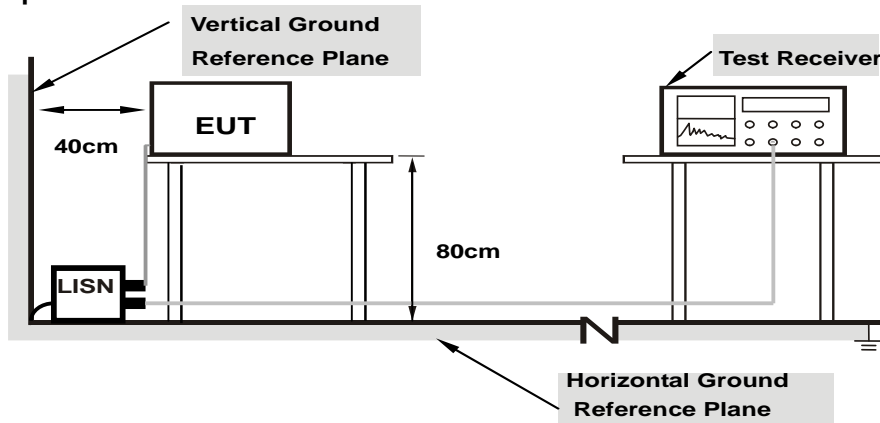

Note: 1.Support units were connected to second LISN.

For the actual test configuration, please refer to the attached file (Test Setup Photo).

4.2.6 EUT Operating Conditions

Same as 4.1.6.

4.2.7 Test Results

Worst-case data: 802.11a

Phase	Line (L)	Detector Function	Quasi-Peak (QP) / Average (AV)
Test Mode	A		

No	Freq. [MHz]	Corr. Factor (dB)	Reading Value [dB (uV)]		Emission Level [dB (uV)]		Limit [dB (uV)]		Margin (dB)	
			Q.P.	AV.	Q.P.	AV.	Q.P.	AV.	Q.P.	AV.
	1	0.16955	10.16	33.86	21.42	44.02	31.58	64.98	54.98	-20.96
2	0.18903	10.16	30.34	18.25	40.50	28.41	64.08	54.08	-23.58	-25.67
3	0.33661	10.19	35.93	28.97	46.12	39.16	59.29	49.29	-13.17	-10.13
4	0.54882	10.20	15.26	9.63	25.46	19.83	56.00	46.00	-30.54	-26.17
5	5.06096	10.40	13.36	6.40	23.76	16.80	60.00	50.00	-36.24	-33.20
6	13.94839	10.89	10.22	4.18	21.11	15.07	60.00	50.00	-38.89	-34.93

Remarks:

1. Q.P. and AV. are abbreviations of quasi-peak and average individually.
2. The emission levels of other frequencies were very low against the limit.
3. Margin value = Emission level - Limit value
4. Correction factor = Insertion loss + Cable loss
5. Emission Level = Correction Factor + Reading Value.

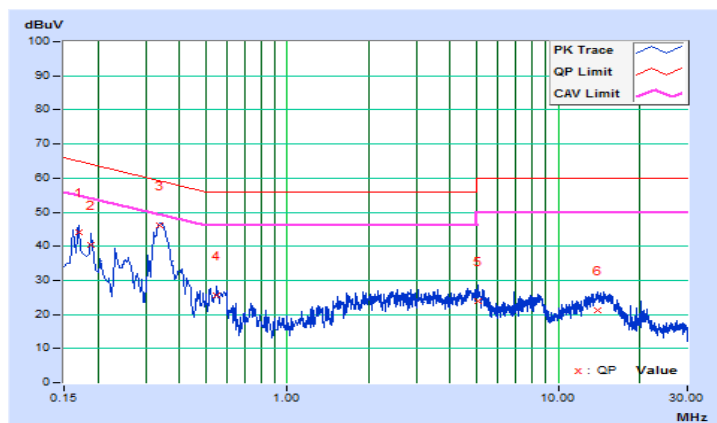

Phase	Neutral (N)	Detector Function	Quasi-Peak (QP) / Average (AV)
Test Mode	A		

No	Freq. [MHz]	Corr. Factor (dB)	Reading Value [dB (uV)]		Emission Level [dB (uV)]		Limit [dB (uV)]		Margin (dB)	
			Q.P.	AV.	Q.P.	AV.	Q.P.	AV.	Q.P.	AV.
			1	0.15000	10.14	34.48	23.38	44.62	33.52	66.00
2	0.19665	10.16	30.45	20.04	40.61	30.20	63.75	53.75	-23.14	-23.55
3	0.35332	10.19	31.35	24.56	41.54	34.75	58.88	48.88	-17.34	-14.13
4	0.46280	10.20	11.92	3.32	22.12	13.52	56.64	46.64	-34.52	-33.12
5	1.20961	10.21	14.45	10.49	24.66	20.70	56.00	46.00	-31.34	-25.30
6	8.52913	10.51	11.90	6.60	22.41	17.11	60.00	50.00	-37.59	-32.89

Remarks:

1. Q.P. and AV. are abbreviations of quasi-peak and average individually.
2. The emission levels of other frequencies were very low against the limit.
3. Margin value = Emission level - Limit value
4. Correction factor = Insertion loss + Cable loss
5. Emission Level = Correction Factor + Reading Value.

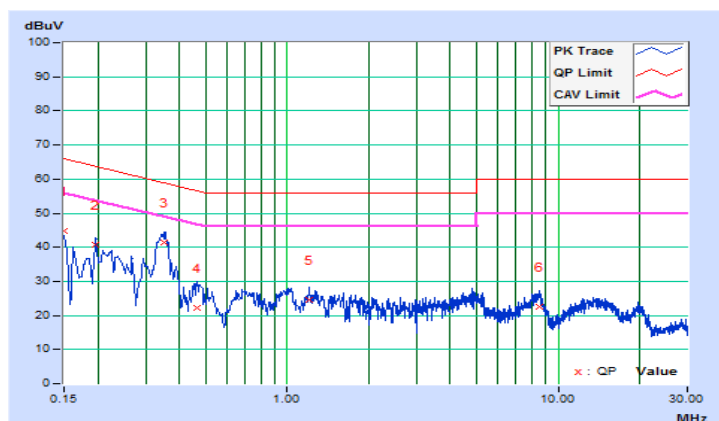

Phase	Line (L)	Detector Function	Quasi-Peak (QP) / Average (AV)
Test Mode	B		

No	Freq. [MHz]	Corr. Factor (dB)	Reading Value [dB (uV)]		Emission Level [dB (uV)]		Limit [dB (uV)]		Margin (dB)	
			Q.P.	AV.	Q.P.	AV.	Q.P.	AV.	Q.P.	AV.
			1	0.15782	10.10	34.46	13.85	44.56	23.95	65.58
2	0.21256	10.10	26.50	10.00	36.60	20.10	63.10	53.10	-26.50	-33.00
3	0.25557	10.11	22.33	7.80	32.44	17.91	61.57	51.57	-29.13	-33.66
4	0.51993	10.12	33.99	23.05	44.11	33.17	56.00	46.00	-11.89	-12.83
5	2.47645	10.21	20.72	10.10	30.93	20.31	56.00	46.00	-25.07	-25.69
6	10.80084	10.67	23.35	13.25	34.02	23.92	60.00	50.00	-25.98	-26.08

Remarks:

1. Q.P. and AV. are abbreviations of quasi-peak and average individually.
2. The emission levels of other frequencies were very low against the limit.
3. Margin value = Emission level - Limit value
4. Correction factor = Insertion loss + Cable loss
5. Emission Level = Correction Factor + Reading Value.

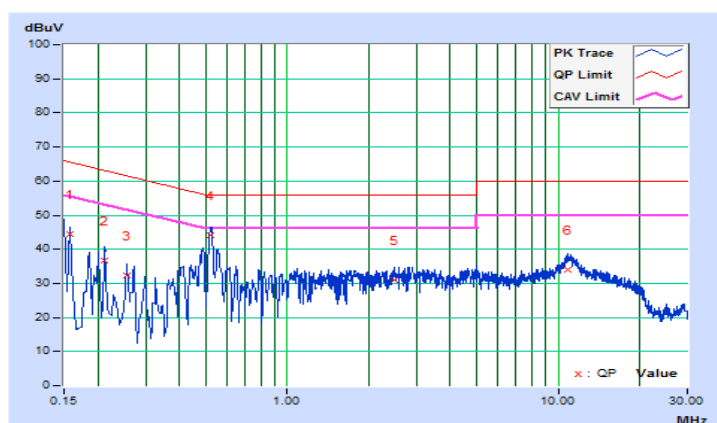

Phase	Neutral (N)	Detector Function	Quasi-Peak (QP) / Average (AV)
Test Mode	B		

No	Freq. [MHz]	Corr. Factor (dB)	Reading Value [dB (uV)]		Emission Level [dB (uV)]		Limit [dB (uV)]		Margin (dB)	
			Q.P.	AV.	Q.P.	AV.	Q.P.	AV.	Q.P.	AV.
			1	0.15782	10.10	34.40	12.63	44.50	22.73	65.58
2	0.20474	10.10	26.84	8.75	36.94	18.85	63.42	53.42	-26.48	-34.57
3	0.52130	10.12	34.62	23.76	44.74	33.88	56.00	46.00	-11.26	-12.12
4	0.83425	10.13	18.25	8.62	28.38	18.75	56.00	46.00	-27.62	-27.25
5	4.40017	10.28	16.89	7.11	27.17	17.39	56.00	46.00	-28.83	-28.61
6	10.62098	10.55	21.73	11.79	32.28	22.34	60.00	50.00	-27.72	-27.66

Remarks:

1. Q.P. and AV. are abbreviations of quasi-peak and average individually.
2. The emission levels of other frequencies were very low against the limit.
3. Margin value = Emission level - Limit value
4. Correction factor = Insertion loss + Cable loss
5. Emission Level = Correction Factor + Reading Value.

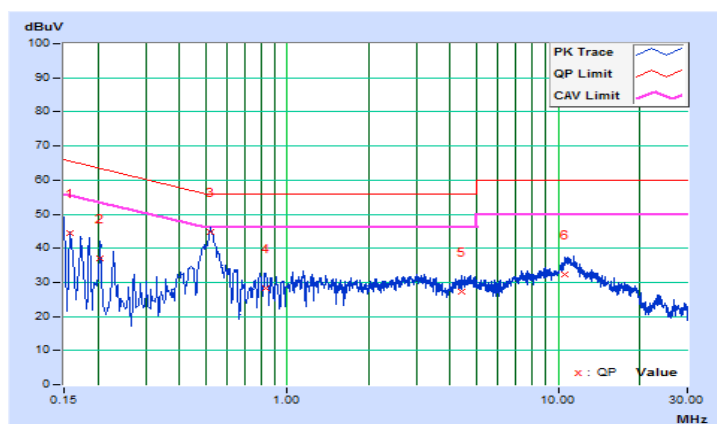

Phase	Line (L)	Detector Function	Quasi-Peak (QP) / Average (AV)
Test Mode	C		

No	Freq. [MHz]	Corr. Factor (dB)	Reading Value [dB (uV)]		Emission Level [dB (uV)]		Limit [dB (uV)]		Margin (dB)	
			Q.P.	AV.	Q.P.	AV.	Q.P.	AV.	Q.P.	AV.
			1	0.15000	10.16	36.68	23.68	46.84	33.84	66.00
2	0.23993	10.16	24.97	14.47	35.13	24.63	62.10	52.10	-26.97	-27.47
3	0.33396	10.19	35.37	28.49	45.56	38.68	59.35	49.35	-13.79	-10.67
4	0.57620	10.20	15.82	9.93	26.02	20.13	56.00	46.00	-29.98	-25.87
5	5.14307	10.40	13.26	6.19	23.66	16.59	60.00	50.00	-36.34	-33.41
6	15.06665	10.96	9.84	3.70	20.80	14.66	60.00	50.00	-39.20	-35.34

Remarks:

1. Q.P. and AV. are abbreviations of quasi-peak and average individually.
2. The emission levels of other frequencies were very low against the limit.
3. Margin value = Emission level - Limit value
4. Correction factor = Insertion loss + Cable loss
5. Emission Level = Correction Factor + Reading Value.

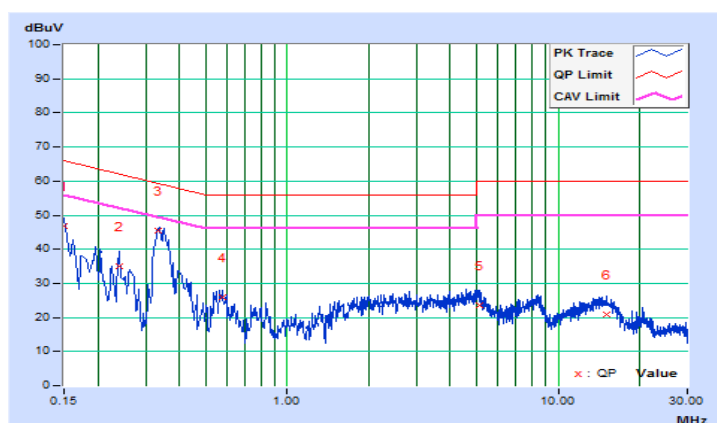

Phase	Neutral (N)	Detector Function	Quasi-Peak (QP) / Average (AV)
Test Mode	C		

No	Freq. [MHz]	Corr. Factor (dB)	Reading Value [dB (uV)]		Emission Level [dB (uV)]		Limit [dB (uV)]		Margin (dB)	
			Q.P.	AV.	Q.P.	AV.	Q.P.	AV.	Q.P.	AV.
			1	0.17346	10.15	31.57	19.96	41.72	30.11	64.79
2	0.20084	10.16	29.25	20.29	39.41	30.45	63.58	53.58	-24.17	-23.13
3	0.35389	10.19	31.15	24.53	41.34	34.72	58.87	48.87	-17.53	-14.15
4	1.31518	10.21	12.60	8.63	22.81	18.84	56.00	46.00	-33.19	-27.16
5	4.86933	10.38	14.06	7.52	24.44	17.90	56.00	46.00	-31.56	-28.10
6	8.41183	10.51	12.35	6.95	22.86	17.46	60.00	50.00	-37.14	-32.54

Remarks:

1. Q.P. and AV. are abbreviations of quasi-peak and average individually.
2. The emission levels of other frequencies were very low against the limit.
3. Margin value = Emission level - Limit value
4. Correction factor = Insertion loss + Cable loss
5. Emission Level = Correction Factor + Reading Value.

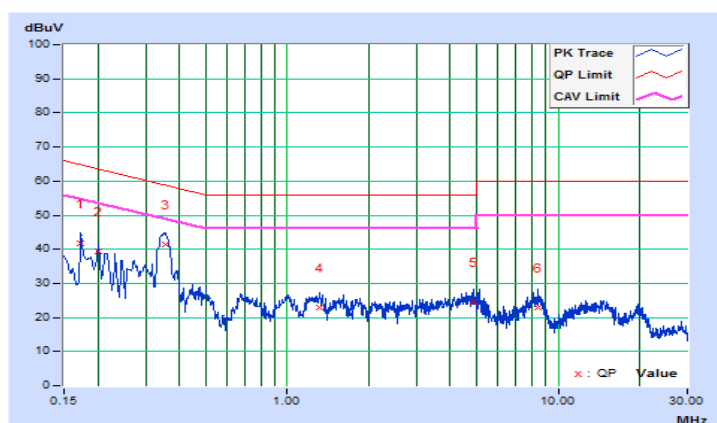

Phase	Line (L)	Detector Function	Quasi-Peak (QP) / Average (AV)
Test Mode	D		

No	Freq. [MHz]	Corr. Factor (dB)	Reading Value [dB (uV)]		Emission Level [dB (uV)]		Limit [dB (uV)]		Margin (dB)	
			Q.P.	AV.	Q.P.	AV.	Q.P.	AV.	Q.P.	AV.
			1	0.16955	10.10	32.66	12.12	42.76	22.22	64.98
2	0.20865	10.10	28.27	11.03	38.37	21.13	63.26	53.26	-24.89	-32.13
3	0.50000	10.12	29.51	17.21	39.63	27.33	56.00	46.00	-16.37	-18.67
4	0.52960	10.12	34.44	23.65	44.56	33.77	56.00	46.00	-11.44	-12.23
5	2.19884	10.20	20.60	10.17	30.80	20.37	56.00	46.00	-25.20	-25.63
6	11.02371	10.68	23.62	13.53	34.30	24.21	60.00	50.00	-25.70	-25.79

Remarks:

1. Q.P. and AV. are abbreviations of quasi-peak and average individually.
2. The emission levels of other frequencies were very low against the limit.
3. Margin value = Emission level - Limit value
4. Correction factor = Insertion loss + Cable loss
5. Emission Level = Correction Factor + Reading Value.

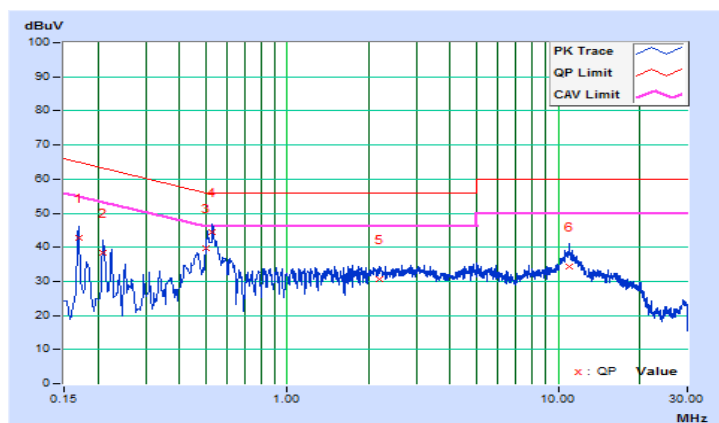

Phase	Neutral (N)	Detector Function	Quasi-Peak (QP) / Average (AV)
Test Mode	D		

No	Freq. [MHz]	Corr. Factor (dB)	Reading Value [dB (uV)]		Emission Level [dB (uV)]		Limit [dB (uV)]		Margin (dB)	
			Q.P.	AV.	Q.P.	AV.	Q.P.	AV.	Q.P.	AV.
			1	0.16955	10.10	32.70	10.95	42.80	21.05	64.98
2	0.21256	10.10	26.47	8.09	36.57	18.19	63.10	53.10	-26.53	-34.91
3	0.51448	10.12	33.82	22.41	43.94	32.53	56.00	46.00	-12.06	-13.47
4	2.72278	10.21	17.65	7.56	27.86	17.77	56.00	46.00	-28.14	-28.23
5	11.03935	10.56	22.78	12.76	33.34	23.32	60.00	50.00	-26.66	-26.68
6	17.74109	10.85	14.16	4.83	25.01	15.68	60.00	50.00	-34.99	-34.32

Remarks:

1. Q.P. and AV. are abbreviations of quasi-peak and average individually.
2. The emission levels of other frequencies were very low against the limit.
3. Margin value = Emission level - Limit value
4. Correction factor = Insertion loss + Cable loss
5. Emission Level = Correction Factor + Reading Value.

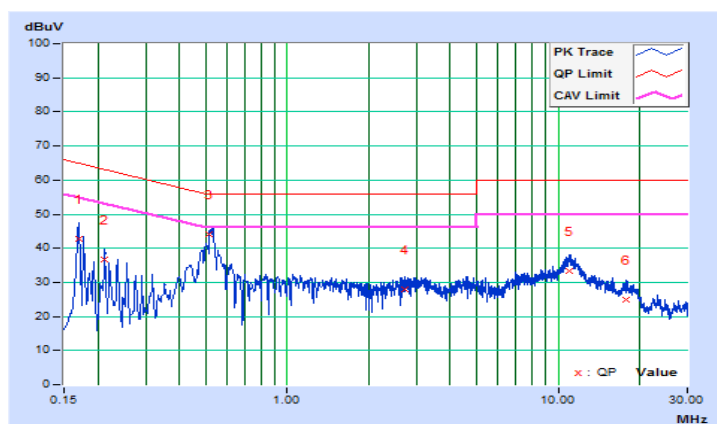

4.3 Transmit Power Measurement

4.3.1 Limits of Transmit Power Measurement

Operation Band	EUT Category		LIMIT
U-NII-1	-	Outdoor Wi-Fi & BLE Array AP	1 Watt (30 dBm) (Max. e.i.r.p \leq 125mW(21 dBm) at any elevation angle above 30 degrees as measured from the horizon)
	-	Fixed point-to-point Wi-Fi & BLE Array AP	1 Watt (30 dBm)
	-	Indoor Wi-Fi & BLE Array AP	1 Watt (30 dBm)
	-	Mobile and Portable client device	250mW (24 dBm)
U-NII-2A	√		250mW (24 dBm) or 11 dBm+10 log B*
U-NII-2C	√		250mW (24 dBm) or 11 dBm+10 log B*
U-NII-3	√		1 Watt (30 dBm)

*B is the 26 dB emission bandwidth in megahertz

Per KDB 662911 Method of conducted output power measurement on IEEE 802.11 devices,

Array Gain = 0 dB (i.e., no array gain) for $N_{ANT} \leq 4$;

Array Gain = 0 dB (i.e., no array gain) for channel widths ≥ 40 MHz for any N_{ANT} ;

Array Gain = $5 \log(N_{ANT}/N_{SS})$ dB or 3 dB, whichever is less for 20-MHz channel widths with $N_{ANT} \geq 5$.

For power measurements on all other devices: Array Gain = $10 \log(N_{ANT}/N_{SS})$ dB.

4.3.2 Test Setup

For Power Output Measurement

For 802.11a, 802.11n (HT20), 802.11n (HT40), 802.11ac (VHT20), 802.11ac (VHT40)

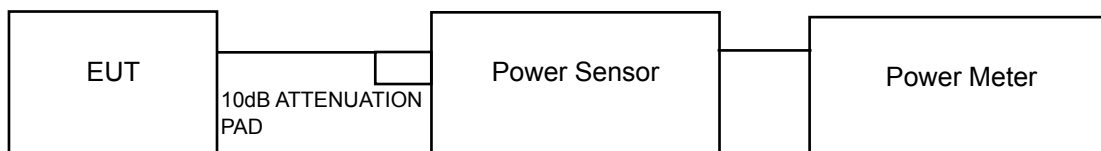

For 802.11ac (VHT80)

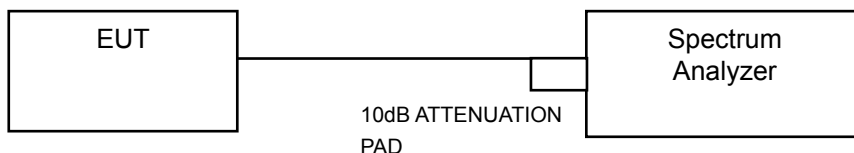

For 26dB Bandwidth

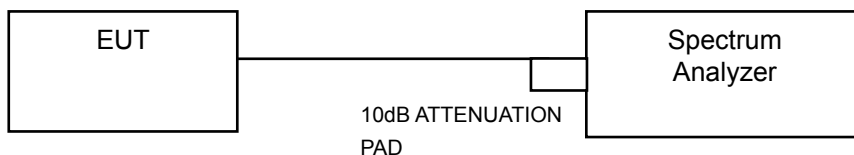

4.3.3 Test Instruments

Refer to section 4.1.2 to get information of above instrument.

4.3.4 Test Procedure

FOR AVERAGE POWER MEASUREMENT

For 802.11a, 802.11n (HT20), 802.11n (HT40), 802.11ac (VHT20), 802.11ac (VHT40)

Method PM is used to perform output power measurement, trigger and gating function of wide band power meter is enabled to measure max output power of TX on burst and set the detector to AVERAGE. Duty factor is not added to measured value.

For 802.11ac (VHT80)

- 1) Set span to encompass the entire 26 dB EBW (or, alternatively, the entire 99% occupied bandwidth) of the signal.
- 2) Set sweep trigger to "free run".
- 3) Set RBW = 1 MHz.
- 4) Set VBW \geq 3 MHz
- 5) Number of points in sweep \geq 2 Span / RBW.
- 6) Sweep time \leq (number of points in sweep) * T
- 7) Using emission bandwidth to determine the frequency span for integration the channel bandwidth.
- 8) Detector = RMS.
- 9) Trace mode = max hold.
- 10) Allow max hold to run for at least 60 seconds, or longer as needed to allow the trace to stabilize.

For 26dB Bandwidth

- 1) Set RBW = approximately 1% of the emission bandwidth.
- 2) Set the VBW > RBW.
- 3) Detector = Peak.
- 4) Trace mode = max hold.
- 5) Measure the maximum width of the emission that is 26 dB down from the peak of the emission. Compare this with the RBW setting of the analyzer. Readjust RBW and repeat measurement as needed until the RBW/EBW ratio is approximately 1%.

4.3.5 Deviation from Test Standard

No deviation.

4.3.6 EUT Operating Conditions

The software provided by client to enable the EUT under transmission condition continuously at lowest, middle and highest channel frequencies individually.

4.3.7 Test Result

POWER OUTPUT:

Mode A

CDD Mode

802.11a

Chan.	Freq. (MHz)	Maximum Conducted Power (dBm)		Total Power (mW)	Total Power (dBm)	Power Limit (dBm)	Pass / Fail
		Chain 0	Chain 1				
52	5260	18.18	17.47	121.613	20.85	24.00	Pass
60	5300	18.19	17.65	124.127	20.94	24.00	Pass
64	5320	18.34	17.45	123.824	20.93	24.00	Pass
100	5500	17.42	17.37	109.784	20.41	24.00	Pass
116	5580	18.32	17.59	125.332	20.98	24.00	Pass
140	5700	15.19	16.58	78.536	18.95	24.00	Pass
144	5720 For U-NII-2C	15.56	16.77	83.509	19.22	23.04	Pass
144	5720 For U-NII-3	11.21	12.34	30.353	14.82	30.00	Pass

Note:

Chain 0

1. $11\text{dBm} + 10\log (22.00) = 24.42 > 24\text{dBm}$
2. $11\text{dBm} + 10\log (21.95) = 24.41 > 24\text{dBm}$
3. $11\text{dBm} + 10\log (21.78) = 24.38 > 24\text{dBm}$
4. $11\text{dBm} + 10\log (21.81) = 24.39 > 24\text{dBm}$
5. $11\text{dBm} + 10\log (22.10) = 24.44 > 24\text{dBm}$
6. $11\text{dBm} + 10\log (21.82) = 24.39 > 24\text{dBm}$
7. $11\text{dBm} + 10\log (5725.00 - 5709.00) = 23.04 < 24\text{dBm}$.

Chain 1

1. $11\text{dBm} + 10\log (23.25) = 24.66 > 24\text{dBm}$
2. $11\text{dBm} + 10\log (23.35) = 24.68 > 24\text{dBm}$
3. $11\text{dBm} + 10\log (21.97) = 24.42 > 24\text{dBm}$
4. $11\text{dBm} + 10\log (21.98) = 24.42 > 24\text{dBm}$
5. $11\text{dBm} + 10\log (26.18) = 25.18 > 24\text{dBm}$
6. $11\text{dBm} + 10\log (21.87) = 24.40 > 24\text{dBm}$
7. $11\text{dBm} + 10\log (5725.00 - 5708.90) = 23.07 < 24\text{dBm}$.

802.11n (HT20)

Chan.	Freq. (MHz)	Maximum Conducted Power (dBm)		Total Power (mW)	Total Power (dBm)	Power Limit (dBm)	Pass / Fail
		Chain 0	Chain 1				
52	5260	18.19	17.70	124.801	20.96	24.00	Pass
60	5300	18.15	17.65	123.523	20.92	24.00	Pass
64	5320	18.22	17.39	121.202	20.84	24.00	Pass
100	5500	17.30	17.37	108.279	20.35	24.00	Pass
116	5580	18.47	17.63	128.250	21.08	24.00	Pass
140	5700	15.07	16.42	75.990	18.81	24.00	Pass
144	5720 For U-NII-2C	14.87	16.46	74.949	18.75	23.96	Pass
144	5720 For U-NII-3	13.32	13.45	43.609	16.39	30.00	Pass

Note:

Chain 0

1. $11\text{dBm} + 10\log (34.11) = 26.33 > 24\text{dBm}$
2. $11\text{dBm} + 10\log (35.56) = 26.51 > 24\text{dBm}$
3. $11\text{dBm} + 10\log (33.75) = 26.28 > 24\text{dBm}$
4. $11\text{dBm} + 10\log (22.16) = 24.46 > 24\text{dBm}$
5. $11\text{dBm} + 10\log (38.43) = 26.85 > 24\text{dBm}$
6. $11\text{dBm} + 10\log (22.02) = 24.43 > 24\text{dBm}$
7. $11\text{dBm} + 10\log (5725.00 - 5705.21) = 23.96 < 24\text{dBm}$.

Chain 1

1. $11\text{dBm} + 10\log (39.25) = 26.94 > 24\text{dBm}$
2. $11\text{dBm} + 10\log (31.94) = 26.04 > 24\text{dBm}$
3. $11\text{dBm} + 10\log (23.30) = 24.67 > 24\text{dBm}$
4. $11\text{dBm} + 10\log (31.02) = 25.92 > 24\text{dBm}$
5. $11\text{dBm} + 10\log (38.52) = 26.86 > 24\text{dBm}$
6. $11\text{dBm} + 10\log (21.80) = 24.38 > 24\text{dBm}$
7. $11\text{dBm} + 10\log (5725.00 - 5700.90) = 24.82 > 24\text{dBm}$.

802.11n (HT40)

Chan.	Freq. (MHz)	Maximum Conducted Power (dBm)		Total Power (mW)	Total Power (dBm)	Power Limit (dBm)	Pass / Fail
		Chain 0	Chain 1				
54	5270	18.11	17.92	126.658	21.03	24.00	Pass
62	5310	16.44	15.84	82.426	19.16	24.00	Pass
102	5510	15.08	15.26	65.785	18.18	24.00	Pass
110	5550	18.72	17.26	127.684	21.06	24.00	Pass
134	5670	17.41	17.83	115.754	20.64	24.00	Pass
142	5710 For U-NII-2C	16.27	16.66	88.716	19.48	24.00	Pass
142	5710 For U-NII-3	12.79	14.08	44.566	16.49	30.00	Pass

Note:

Chain 0

1. $11\text{dBm} + 10\log (84.20) = 30.25 > 24\text{dBm}$
2. $11\text{dBm} + 10\log (51.49) = 28.12 > 24\text{dBm}$
3. $11\text{dBm} + 10\log (41.49) = 27.18 > 24\text{dBm}$
4. $11\text{dBm} + 10\log (89.40) = 30.51 > 24\text{dBm}$
5. $11\text{dBm} + 10\log (64.76) = 29.11 > 24\text{dBm}$
6. $11\text{dBm} + 10\log (5725.00 - 5667.37) = 28.61 > 24\text{dBm}$.

Chain 1

1. $11\text{dBm} + 10\log (84.40) = 30.26 > 24\text{dBm}$
2. $11\text{dBm} + 10\log (46.38) = 27.66 > 24\text{dBm}$
3. $11\text{dBm} + 10\log (41.31) = 27.16 > 24\text{dBm}$
4. $11\text{dBm} + 10\log (85.86) = 30.34 > 24\text{dBm}$
5. $11\text{dBm} + 10\log (58.43) = 28.67 > 24\text{dBm}$
6. $11\text{dBm} + 10\log (5725.00 - 5675.58) = 27.94 > 24\text{dBm}$.

802.11ac (VHT80)

Chan.	Freq. (MHz)	Maximum Conducted Power (dBm)		Total Power (mW)	Total Power (dBm)	Power Limit (dBm)	Pass / Fail
		Chain 0	Chain 1				
58	5290	16.76	15.96	86.870	19.39	24.00	Pass
106	5530	14.21	14.95	57.624	17.61	24.00	Pass
122	5610	18.37	17.58	125.987	21.00	24.00	Pass
138	5690 For U-NII-2C	16.95	16.37	92.897	19.68	24.00	Pass
138	5690 For U-NII-3	9.66	13.11	29.717	14.73	30.00	Pass

Note:

Chain 0

1. $11\text{dBm} + 10\log (82.40) = 30.16 > 24\text{dBm}$
2. $11\text{dBm} + 10\log (82.65) = 30.17 > 24\text{dBm}$
3. $11\text{dBm} + 10\log (151.95) = 32.82 > 24\text{dBm}$
4. $11\text{dBm} + 10\log (5725.00 - 5645.44) = 30.01 > 24\text{dBm}$.

Chain 1

1. $11\text{dBm} + 10\log (82.53) = 30.17 > 24\text{dBm}$
2. $11\text{dBm} + 10\log (81.98) = 30.14 > 24\text{dBm}$
3. $11\text{dBm} + 10\log (152.51) = 32.83 > 24\text{dBm}$
4. $11\text{dBm} + 10\log (5725.00 - 5624.62) = 31.02 > 24\text{dBm}$.

Beamforming Mode

802.11n (HT20)

Chan.	Freq. (MHz)	Maximum Conducted Power (dBm)		Total Power (mW)	Total Power (dBm)	Power Limit (dBm)	Pass / Fail
		Chain 0	Chain 1				
52	5260	15.18	14.69	62.405	17.95	21.16	Pass
60	5300	15.14	14.64	61.766	17.91	21.16	Pass
64	5320	15.21	14.38	60.605	17.83	21.16	Pass
100	5500	14.29	14.36	54.143	17.34	21.16	Pass
116	5580	15.46	14.62	64.129	18.07	21.16	Pass
140	5700	12.06	13.41	37.997	15.80	21.16	Pass
144	5720 For U-NII-2C	11.86	13.45	37.477	15.74	21.12	Pass
144	5720 For U-NII-3	10.31	10.44	21.806	13.38	27.16	Pass

* For U-NII-2A, U-NII-2C: Directional gain = $5.83\text{dBi} + 10\log(2) = 8.84\text{dBi} > 6\text{dBi}$, so the power limit shall be reduced to $24 - (8.84 - 6) = 21.16\text{dBm}$.

* For chan. 144(U-NII-2C): Directional gain = $5.83\text{dBi} + 10\log(2) = 8.84\text{dBi} > 6\text{dBi}$, so the power limit shall be reduced to $23.96 - (8.84 - 6) = 21.12\text{dBm}$.

* For chan. 144(U-NII-3): Directional gain = $5.83\text{dBi} + 10\log(2) = 8.84\text{dBi} > 6\text{dBi}$, so the power limit shall be reduced to $30 - (8.84 - 6) = 27.16\text{dBm}$.

Note:

Chain 0

1. $11\text{dBm} + 10\log (34.11) = 26.33 > 24\text{dBm}$.
2. $11\text{dBm} + 10\log (35.56) = 26.51 > 24\text{dBm}$.
3. $11\text{dBm} + 10\log (33.75) = 26.28 > 24\text{dBm}$.
4. $11\text{dBm} + 10\log (22.16) = 24.46 > 24\text{dBm}$.
5. $11\text{dBm} + 10\log (38.43) = 26.85 > 24\text{dBm}$.
6. $11\text{dBm} + 10\log (22.02) = 24.43 > 24\text{dBm}$.
7. $11\text{dBm} + 10\log (5725.00 - 5705.21) = 23.96 > 24\text{dBm}$

Chain 1

1. $11\text{dBm} + 10\log (39.25) = 26.94 > 24\text{dBm}$.
2. $11\text{dBm} + 10\log (31.94) = 26.04 > 24\text{dBm}$.
3. $11\text{dBm} + 10\log (23.30) = 24.67 > 24\text{dBm}$.
4. $11\text{dBm} + 10\log (31.02) = 25.92 > 24\text{dBm}$.
5. $11\text{dBm} + 10\log (38.52) = 26.86 > 24\text{dBm}$.
6. $11\text{dBm} + 10\log (21.80) = 24.38 > 24\text{dBm}$.
7. $11\text{dBm} + 10\log (5725.00 - 5700.90) = 24.82 > 24\text{dBm}$

802.11n (HT40)

Chan.	Freq. (MHz)	Maximum Conducted Power (dBm)		Total Power (mW)	Total Power (dBm)	Power Limit (dBm)	Pass / Fail
		Chain 0	Chain 1				
54	5270	15.10	14.91	63.333	18.02	21.16	Pass
62	5310	13.43	12.83	41.216	16.15	21.16	Pass
102	5510	12.07	12.25	32.894	15.17	21.16	Pass
110	5550	15.71	14.25	63.846	18.05	21.16	Pass
134	5670	14.40	14.82	57.881	17.63	21.16	Pass
142	5710 For U-NII-2C	13.26	13.65	44.361	16.47	21.16	Pass
142	5710 For U-NII-3	9.78	11.07	22.284	13.48	27.16	Pass

* For U-NII-2A, U-NII-2C: Directional gain = $5.83\text{dBi} + 10\log(2) = 8.84\text{dBi} > 6\text{dBi}$, so the power limit shall be reduced to $24 - (8.84 - 6) = 21.16\text{dBm}$.

* For chan. 142(U-NII-2C): Directional gain = $5.83\text{dBi} + 10\log(2) = 8.84\text{dBi} > 6\text{dBi}$, so the power limit shall be reduced to $24 - (8.84 - 6) = 21.16\text{dBm}$.

* For chan. 142(U-NII-3): Directional gain = $5.83\text{dBi} + 10\log(2) = 8.84\text{dBi} > 6\text{dBi}$, so the power limit shall be reduced to $30 - (8.84 - 6) = 27.16\text{dBm}$.

Note:

Chain 0

1. $11\text{dBm} + 10\log (84.20) = 30.25 > 24\text{dBm}$.
2. $11\text{dBm} + 10\log (51.49) = 28.12 > 24\text{dBm}$.
3. $11\text{dBm} + 10\log (41.49) = 27.18 > 24\text{dBm}$.
4. $11\text{dBm} + 10\log (89.40) = 30.51 > 24\text{dBm}$.
5. $11\text{dBm} + 10\log (64.76) = 29.11 > 24\text{dBm}$.
6. $11\text{dBm} + 10\log (5725.00 - 5667.37) = 28.61 > 24\text{dBm}$.

Chain 1

1. $11\text{dBm} + 10\log (84.40) = 30.26 > 24\text{dBm}$.
2. $11\text{dBm} + 10\log (46.38) = 27.66 > 24\text{dBm}$.
3. $11\text{dBm} + 10\log (41.31) = 27.16 > 24\text{dBm}$.
4. $11\text{dBm} + 10\log (85.86) = 30.34 > 24\text{dBm}$.
5. $11\text{dBm} + 10\log (58.43) = 28.67 > 24\text{dBm}$.
6. $11\text{dBm} + 10\log (5725.00 - 5675.58) = 27.94 > 24\text{dBm}$.

802.11ac (VHT80)

Chan.	Freq. (MHz)	Maximum Conducted Power (dBm)		Total Power (mW)	Total Power (dBm)	Power Limit (dBm)	Pass / Fail
		Chain 0	Chain 1				
58	5290	13.75	12.95	43.438	16.38	21.16	Pass
106	5530	11.20	11.94	28.814	14.60	21.16	Pass
122	5610	15.36	14.57	62.998	17.99	21.16	Pass
138	5690 For U-NII-2C	13.94	13.36	46.452	16.67	21.16	Pass
138	5690 For U-NII-3	6.65	10.10	14.859	11.72	27.16	Pass

* For U-NII-2A, U-NII-2C: Directional gain = $5.83\text{dBi} + 10\log(2) = 8.84\text{dBi} > 6\text{dBi}$, so the power limit shall be reduced to $24 - (8.84 - 6) = 21.16\text{dBm}$.

* For chan. 138(U-NII-2C): Directional gain = $5.83\text{dBi} + 10\log(2) = 8.84\text{dBi} > 6\text{dBi}$, so the power limit shall be reduced to $24 - (8.84 - 6) = 21.16\text{dBm}$.

* For chan. 138(U-NII-3): Directional gain = $5.83\text{dBi} + 10\log(2) = 8.84\text{dBi} > 6\text{dBi}$, so the power limit shall be reduced to $30 - (8.84 - 6) = 27.16\text{dBm}$.

Note:

Chain 0

1. $11\text{dBm} + 10\log (82.40) = 30.16 > 24\text{dBm}$.
2. $11\text{dBm} + 10\log (82.65) = 30.17 > 24\text{dBm}$.
3. $11\text{dBm} + 10\log (151.95) = 32.82 > 24\text{dBm}$.
4. $11\text{dBm} + 10\log (5725.00 - 5645.44) = 30.01 > 24\text{dBm}$

Chain 1

1. $11\text{dBm} + 10\log (82.53) = 30.17 > 24\text{dBm}$.
2. $11\text{dBm} + 10\log (81.98) = 30.14 > 24\text{dBm}$.
3. $11\text{dBm} + 10\log (152.51) = 32.83 > 24\text{dBm}$.
4. $11\text{dBm} + 10\log (5725.00 - 5624.62) = 31.02 > 24\text{dBm}$

Mode C

CDD Mode

802.11a

Chan.	Freq. (MHz)	Maximum Conducted Power (dBm)		Total Power (mW)	Total Power (dBm)	Power Limit (dBm)	Pass / Fail
		Chain 0	Chain 1				
52	5260	18.26	18.57	138.933	21.43	24.00	Pass
60	5300	18.27	18.41	136.486	21.35	24.00	Pass
64	5320	16.63	16.16	87.331	19.41	24.00	Pass
100	5500	16.37	16.49	87.917	19.44	24.00	Pass
116	5580	18.65	18.15	138.595	21.42	24.00	Pass
140	5700	14.36	15.69	64.358	18.09	24.00	Pass
144	5720 For U-NII-2C	17.47	17.82	116.381	20.66	24.00	Pass
144	5720 For U-NII-3	15.06	15.46	67.219	18.28	30.00	Pass

Note:

Chain 0

1. $11\text{dBm} + 10\log (35.76) = 26.53 > 24\text{dBm}$
2. $11\text{dBm} + 10\log (33.00) = 26.19 > 24\text{dBm}$
3. $11\text{dBm} + 10\log (21.84) = 24.39 > 24\text{dBm}$
4. $11\text{dBm} + 10\log (21.95) = 24.41 > 24\text{dBm}$
5. $11\text{dBm} + 10\log (32.96) = 26.18 > 24\text{dBm}$
6. $11\text{dBm} + 10\log (21.83) = 24.39 > 24\text{dBm}$
7. $11\text{dBm} + 10\log (5725.00 - 5699.84) = 25.01 > 24\text{dBm}$.

Chain 1

1. $11\text{dBm} + 10\log (35.95) = 26.56 > 24\text{dBm}$
2. $11\text{dBm} + 10\log (35.79) = 26.54 > 24\text{dBm}$
3. $11\text{dBm} + 10\log (21.80) = 24.38 > 24\text{dBm}$
4. $11\text{dBm} + 10\log (21.85) = 24.39 > 24\text{dBm}$
5. $11\text{dBm} + 10\log (37.36) = 26.72 > 24\text{dBm}$
6. $11\text{dBm} + 10\log (21.81) = 24.39 > 24\text{dBm}$
7. $11\text{dBm} + 10\log (5725.00 - 5700.81) = 24.84 < 24\text{dBm}$.

802.11n (HT20)

Chan.	Freq. (MHz)	Maximum Conducted Power (dBm)		Total Power (mW)	Total Power (dBm)	Power Limit (dBm)	Pass / Fail
		Chain 0	Chain 1				
52	5260	18.45	18.25	136.818	21.36	24.00	Pass
60	5300	18.42	18.36	138.051	21.40	24.00	Pass
64	5320	16.62	16.15	87.130	19.40	24.00	Pass
100	5500	13.73	14.07	49.132	16.91	24.00	Pass
116	5580	18.54	18.36	139.999	21.46	24.00	Pass
140	5700	13.24	14.52	49.400	16.94	24.00	Pass
144	5720 For U-NII-2C	17.37	17.43	109.911	20.41	24.00	Pass
144	5720 For U-NII-3	15.58	15.23	69.484	18.42	30.00	Pass

Note:

Chain 0

1. $11\text{dBm} + 10\log (39.56) = 26.97 > 24\text{dBm}$
2. $11\text{dBm} + 10\log (40.49) = 27.07 > 24\text{dBm}$
3. $11\text{dBm} + 10\log (24.83) = 24.95 > 24\text{dBm}$
4. $11\text{dBm} + 10\log (21.63) = 24.35 > 24\text{dBm}$
5. $11\text{dBm} + 10\log (40.76) = 27.10 > 24\text{dBm}$
6. $11\text{dBm} + 10\log (21.68) = 24.36 > 24\text{dBm}$
7. $11\text{dBm} + 10\log (5725.00 - 5699.51) = 25.06 > 24\text{dBm}$.

Chain 1

1. $11\text{dBm} + 10\log (42.93) = 27.33 > 24\text{dBm}$
2. $11\text{dBm} + 10\log (42.67) = 27.30 > 24\text{dBm}$
3. $11\text{dBm} + 10\log (31.83) = 26.03 > 24\text{dBm}$
4. $11\text{dBm} + 10\log (22.11) = 24.45 > 24\text{dBm}$
5. $11\text{dBm} + 10\log (42.59) = 27.29 > 24\text{dBm}$
6. $11\text{dBm} + 10\log (22.08) = 24.44 > 24\text{dBm}$
7. $11\text{dBm} + 10\log (5725.00 - 5701.91) = 24.63 > 24\text{dBm}$.

802.11n (HT40)

Chan.	Freq. (MHz)	Maximum Conducted Power (dBm)		Total Power (mW)	Total Power (dBm)	Power Limit (dBm)	Pass / Fail
		Chain 0	Chain 1				
54	5270	18.11	18.22	131.088	21.18	24.00	Pass
62	5310	15.26	14.89	64.406	18.09	24.00	Pass
102	5510	14.68	14.82	59.715	17.76	24.00	Pass
110	5550	18.67	17.69	132.370	21.22	24.00	Pass
134	5670	16.34	17.02	93.403	19.70	24.00	Pass
142	5710 For U-NII-2C	16.75	17.43	102.565	20.12	24.00	Pass
142	5710 For U-NII-3	13.30	14.41	48.978	16.90	30.00	Pass

Note:

Chain 0

1. $11\text{dBm} + 10\log (70.94) = 29.51 > 24\text{dBm}$
2. $11\text{dBm} + 10\log (41.16) = 27.14 > 24\text{dBm}$
3. $11\text{dBm} + 10\log (45.06) = 27.54 > 24\text{dBm}$
4. $11\text{dBm} + 10\log (81.46) = 30.11 > 24\text{dBm}$
5. $11\text{dBm} + 10\log (60.08) = 28.79 > 24\text{dBm}$
6. $11\text{dBm} + 10\log (5725.00 - 5667.54) = 28.59 > 24\text{dBm}.$

Chain 1

1. $11\text{dBm} + 10\log (91.28) = 30.60 > 24\text{dBm}$
2. $11\text{dBm} + 10\log (41.61) = 27.19 > 24\text{dBm}$
3. $11\text{dBm} + 10\log (41.53) = 27.18 > 24\text{dBm}$
4. $11\text{dBm} + 10\log (80.28) = 30.05 > 24\text{dBm}$
5. $11\text{dBm} + 10\log (60.85) = 28.84 > 24\text{dBm}$
6. $11\text{dBm} + 10\log (5725.00 - 5675.93) = 27.91 > 24\text{dBm}.$

802.11ac (VHT80)

Chan.	Freq. (MHz)	Maximum Conducted Power (dBm)		Total Power (mW)	Total Power (dBm)	Power Limit (dBm)	Pass / Fail
		Chain 0	Chain 1				
58	5290	15.87	15.06	70.700	18.49	24.00	Pass
106	5530	14.38	14.66	56.658	17.53	24.00	Pass
122	5610	17.73	17.91	121.095	20.83	24.00	Pass
138	5690 For U-NII-2C	18.16	17.85	126.474	21.02	24.00	Pass
138	5690 For U-NII-3	14.17	14.54	54.576	17.37	30.00	Pass

Note:

Chain 0

1. $11\text{dBm} + 10\log (82.02) = 30.14 > 24\text{dBm}$
2. $11\text{dBm} + 10\log (82.36) = 30.16 > 24\text{dBm}$
3. $11\text{dBm} + 10\log (126.97) = 32.04 > 24\text{dBm}$
4. $11\text{dBm} + 10\log (5725.00 - 5615.18) = 31.41 > 24\text{dBm}$.

Chain 1

1. $11\text{dBm} + 10\log (82.33) = 30.16 > 24\text{dBm}$
2. $11\text{dBm} + 10\log (82.38) = 30.16 > 24\text{dBm}$
3. $11\text{dBm} + 10\log (123.26) = 31.91 > 24\text{dBm}$
4. $11\text{dBm} + 10\log (5725.00 - 5619.07) = 31.25 > 24\text{dBm}$.

Beamforming Mode

802.11n (HT20)

Chan.	Freq. (MHz)	Maximum Conducted Power (dBm)		Total Power (mW)	Total Power (dBm)	Power Limit (dBm)	Pass / Fail
		Chain 0	Chain 1				
52	5260	15.44	15.24	68.415	18.35	21.64	Pass
60	5300	15.41	15.35	69.031	18.39	21.64	Pass
64	5320	13.61	13.14	43.567	16.39	21.64	Pass
100	5500	10.72	11.06	24.567	13.90	21.64	Pass
116	5580	15.53	15.35	70.004	18.45	21.64	Pass
140	5700	10.23	11.51	24.702	13.93	21.64	Pass
144	5720 For U-NII-2C	14.36	14.42	54.959	17.40	21.64	Pass
144	5720 For U-NII-3	12.57	12.22	34.744	15.41	27.64	Pass

* For U-NII-2A, U-NII-2C: Directional gain = $5.35\text{dBi} + 10\log(2) = 8.36\text{dBi} > 6\text{dBi}$, so the limit shall be reduced to $24 - (8.36 - 6) = 21.64\text{dBm}$.

* For chan. 144(U-NII-2C): Directional gain = $5.35\text{dBi} + 10\log(2) = 8.36\text{dBi} > 6\text{dBi}$, so the power limit shall be reduced to $24 - (8.36 - 6) = 21.64\text{dBm}$.

* For chan. 144(U-NII-3): Directional gain = $5.35\text{dBi} + 10\log(2) = 8.36\text{dBi} > 6\text{dBi}$, so the power limit shall be reduced to $30 - (8.36 - 6) = 27.64\text{dBm}$.

Note:

Chain 0

1. $11\text{dBm} + 10\log (39.56) = 26.97 > 24\text{dBm}$.
2. $11\text{dBm} + 10\log (40.49) = 27.07 > 24\text{dBm}$.
3. $11\text{dBm} + 10\log (24.83) = 24.95 > 24\text{dBm}$.
4. $11\text{dBm} + 10\log (21.63) = 24.35 > 24\text{dBm}$.
5. $11\text{dBm} + 10\log (40.76) = 27.10 > 24\text{dBm}$.
6. $11\text{dBm} + 10\log (21.68) = 24.36 > 24\text{dBm}$.
7. $11\text{dBm} + 10\log (5725.00 - 5699.51) = 25.06 > 24\text{dBm}$

Chain 1

1. $11\text{dBm} + 10\log (42.93) = 27.33 > 24\text{dBm}$.
2. $11\text{dBm} + 10\log (42.67) = 27.30 > 24\text{dBm}$.
3. $11\text{dBm} + 10\log (31.83) = 26.03 > 24\text{dBm}$.
4. $11\text{dBm} + 10\log (22.11) = 24.45 > 24\text{dBm}$.
5. $11\text{dBm} + 10\log (42.59) = 27.29 > 24\text{dBm}$.
6. $11\text{dBm} + 10\log (22.08) = 24.44 > 24\text{dBm}$.
7. $11\text{dBm} + 10\log (5725.00 - 5701.91) = 24.63 > 24\text{dBm}$

802.11n (HT40)

Chan.	Freq. (MHz)	Maximum Conducted Power (dBm)		Total Power (mW)	Total Power (dBm)	Power Limit (dBm)	Pass / Fail
		Chain 0	Chain 1				
54	5270	15.10	15.21	65.548	18.17	21.64	Pass
62	5310	12.25	11.88	32.205	15.08	21.64	Pass
102	5510	11.67	11.81	29.860	14.75	21.64	Pass
110	5550	15.66	14.68	66.189	18.21	21.64	Pass
134	5670	13.33	14.01	46.705	16.69	21.64	Pass
142	5710 For U-NII-2C	13.74	14.42	51.286	17.11	21.64	Pass
142	5710 For U-NII-3	10.29	11.40	24.491	13.89	27.64	Pass

* For U-NII-2A, U-NII-2C: Directional gain = $5.35\text{dBi} + 10\log(2) = 8.36\text{dBi} > 6\text{dBi}$, so the limit shall be reduced to $24 - (8.36 - 6) = 21.64\text{dBm}$.

* For chan. 142(U-NII-2C): Directional gain = $5.35\text{dBi} + 10\log(2) = 8.36\text{dBi} > 6\text{dBi}$, so the power limit shall be reduced to $24 - (8.36 - 6) = 21.64\text{dBm}$.

* For chan. 142(U-NII-3): Directional gain = $5.35\text{dBi} + 10\log(2) = 8.36\text{dBi} > 6\text{dBi}$, so the power limit shall be reduced to $30 - (8.36 - 6) = 27.64\text{dBm}$.

Note:

Chain 0

1. $11\text{dBm} + 10\log (70.94) = 29.51 > 24\text{dBm}$.
2. $11\text{dBm} + 10\log (41.16) = 27.14 > 24\text{dBm}$.
3. $11\text{dBm} + 10\log (45.06) = 27.54 > 24\text{dBm}$.
4. $11\text{dBm} + 10\log (81.46) = 30.11 > 24\text{dBm}$.
5. $11\text{dBm} + 10\log (60.08) = 28.79 > 24\text{dBm}$.
6. $11\text{dBm} + 10\log (5725.00 - 5667.54) = 28.59 > 24\text{dBm}$

Chain 1

1. $11\text{dBm} + 10\log (91.28) = 30.60 > 24\text{dBm}$.
2. $11\text{dBm} + 10\log (41.61) = 27.19 > 24\text{dBm}$.
3. $11\text{dBm} + 10\log (41.53) = 27.18 > 24\text{dBm}$.
4. $11\text{dBm} + 10\log (80.28) = 30.05 > 24\text{dBm}$.
5. $11\text{dBm} + 10\log (60.85) = 28.84 > 24\text{dBm}$.
6. $11\text{dBm} + 10\log (5725.00 - 5675.93) = 27.91 > 24\text{dBm}$

802.11ac (VHT80)

Chan.	Freq. (MHz)	Maximum Conducted Power (dBm)		Total Power (mW)	Total Power (dBm)	Power Limit (dBm)	Pass / Fail
		Chain 0	Chain 1				
58	5290	12.86	12.05	35.318	15.48	21.64	Pass
106	5530	11.37	11.65	28.314	14.52	21.64	Pass
122	5610	14.72	14.90	60.534	17.82	21.64	Pass
138	5690 For U-NII-2C	15.15	14.84	63.241	18.01	21.64	Pass
138	5690 For U-NII-3	11.16	11.53	27.290	14.36	27.64	Pass

* For U-NII-2A, U-NII-2C: Directional gain = $5.35\text{dBi} + 10\log(2) = 8.36\text{dBi} > 6\text{dBi}$, so the limit shall be reduced to $24 - (8.36 - 6) = 21.64\text{dBm}$.

* For chan. 138(U-NII-2C): Directional gain = $5.35\text{dBi} + 10\log(2) = 8.36\text{dBi} > 6\text{dBi}$, so the power limit shall be reduced to $24 - (8.36 - 6) = 21.64\text{dBm}$.

* For chan. 138(U-NII-3): Directional gain = $5.35\text{dBi} + 10\log(2) = 8.36\text{dBi} > 6\text{dBi}$, so the power limit shall be reduced to $30 - (8.36 - 6) = 27.64\text{dBm}$.

Note:

Chain 0

1. $11\text{dBm} + 10\log (82.02) = 30.14 > 24\text{dBm}$.
2. $11\text{dBm} + 10\log (82.36) = 30.16 > 24\text{dBm}$.
3. $11\text{dBm} + 10\log (126.97) = 32.04 > 24\text{dBm}$.
4. $11\text{dBm} + 10\log (5725.00 - 5615.18) = 31.41 > 24\text{dBm}$

Chain 1

1. $11\text{dBm} + 10\log (82.33) = 30.16 > 24\text{dBm}$.
2. $11\text{dBm} + 10\log (82.38) = 30.16 > 24\text{dBm}$.
3. $11\text{dBm} + 10\log (123.26) = 31.91 > 24\text{dBm}$.
4. $11\text{dBm} + 10\log (5725.00 - 5619.07) = 31.25 > 24\text{dBm}$

26dB BANDWIDTH:

Mode A

802.11a

Chan.	Freq. (MHz)	26dBc Bandwidth (MHz)	
		Chain 0	Chain 1
52	5260	22.00	23.25
60	5300	21.95	23.35
64	5320	21.78	21.97
100	5500	21.81	21.98
116	5580	22.10	26.18
140	5700	21.82	21.87
144	5720 For U-NII-2C	16.00	16.10

802.11n (HT20)

Chan.	Freq. (MHz)	26dBc Bandwidth (MHz)	
		Chain 0	Chain 1
52	5260	34.11	39.25
60	5300	35.56	31.94
64	5320	33.75	23.30
100	5500	22.16	31.02
116	5580	38.43	38.52
140	5700	22.02	21.80
144	5720 For U-NII-2C	19.79	24.10

802.11n (HT40)

Chan.	Freq. (MHz)	26dBc Bandwidth (MHz)	
		Chain 0	Chain 1
54	5270	84.20	84.40
62	5310	51.49	46.38
102	5510	41.49	41.31
110	5550	89.40	85.86
134	5670	64.76	58.43
142	5710 For U-NII-2C	57.63	49.42

802.11ac (VHT80)

Chan.	Freq. (MHz)	26dBc Bandwidth (MHz)	
		Chain 0	Chain 1
58	5290	82.40	82.53
106	5530	82.65	81.98
122	5610	151.95	152.51
138	5690 For U-NII-2C	79.56	100.38

Spectrum Plot of Worst Value

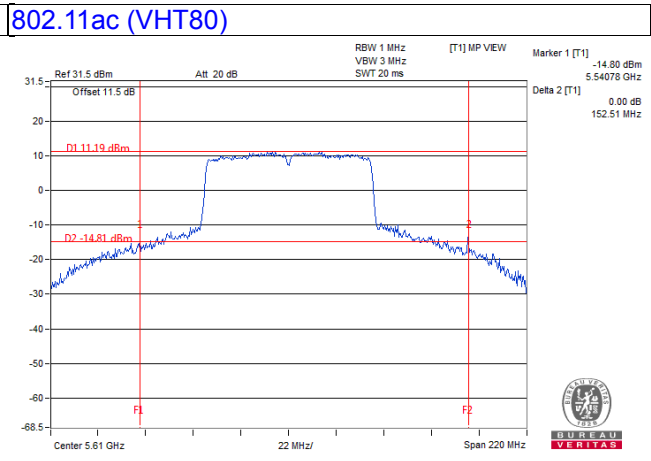
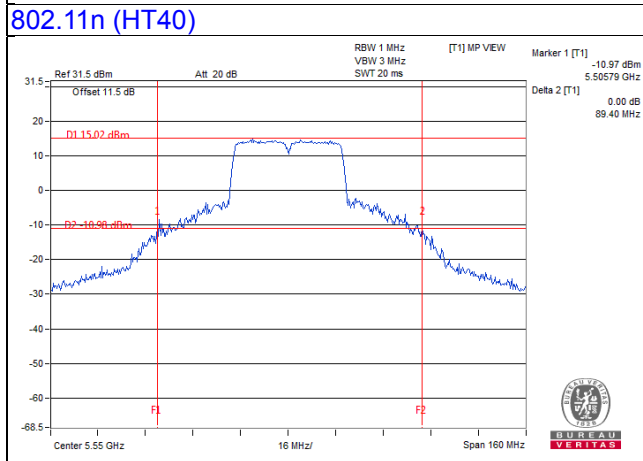
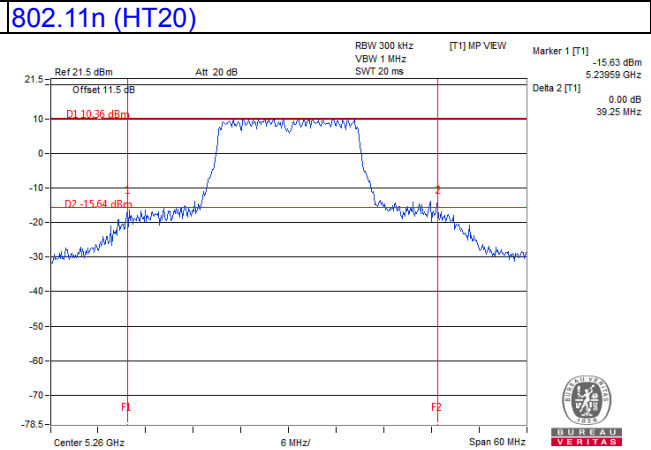
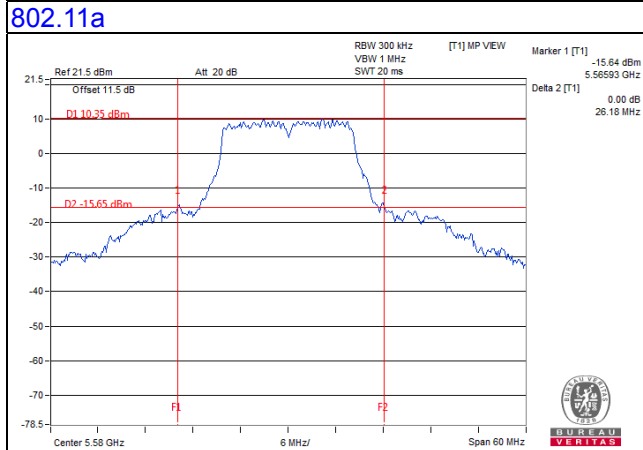

Mode C

802.11a

Chan.	Freq. (MHz)	26dBc Bandwidth (MHz)	
		Chain 0	Chain 1
52	5260	35.76	35.95
60	5300	33.00	35.79
64	5320	21.84	21.80
100	5500	21.95	21.85
116	5580	32.96	37.36
140	5700	21.83	21.81
144	5720 For U-NII-2C	25.16	24.19

802.11n (HT20)

Chan.	Freq. (MHz)	26dBc Bandwidth (MHz)	
		Chain 0	Chain 1
52	5260	39.56	42.93
60	5300	40.49	42.67
64	5320	24.83	31.83
100	5500	21.63	22.11
116	5580	40.76	42.59
140	5700	21.68	22.08
144	5720 For U-NII-2C	25.49	23.09

802.11n (HT40)

Chan.	Freq. (MHz)	26dBc Bandwidth (MHz)	
		Chain 0	Chain 1
54	5270	70.94	91.28
62	5310	41.16	41.61
102	5510	45.06	41.53
110	5550	81.46	80.28
134	5670	60.08	60.85
142	5710 For U-NII-2C	57.46	49.07

802.11ac (VHT80)

Chan.	Freq. (MHz)	26dBc Bandwidth (MHz)	
		Chain 0	Chain 1
58	5290	82.02	82.33
106	5530	82.36	82.38
122	5610	126.97	123.26
138	5690 For U-NII-2C	109.82	105.93

Spectrum Plot of Worst Value

802.11a

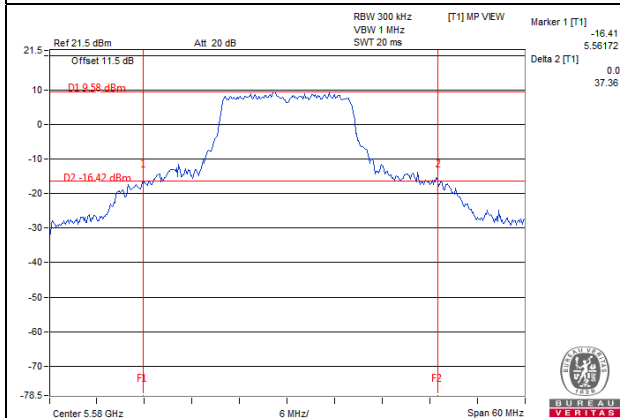

802.11n (HT20)

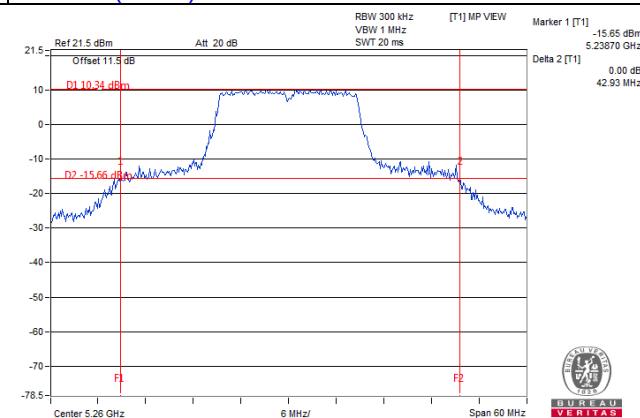

802.11n (HT40)

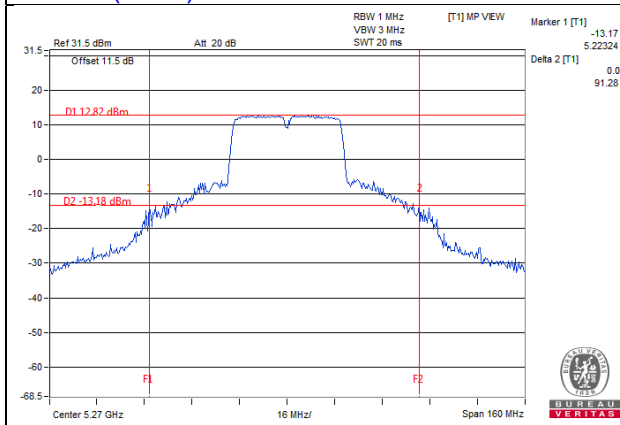

802.11ac (VHT80)

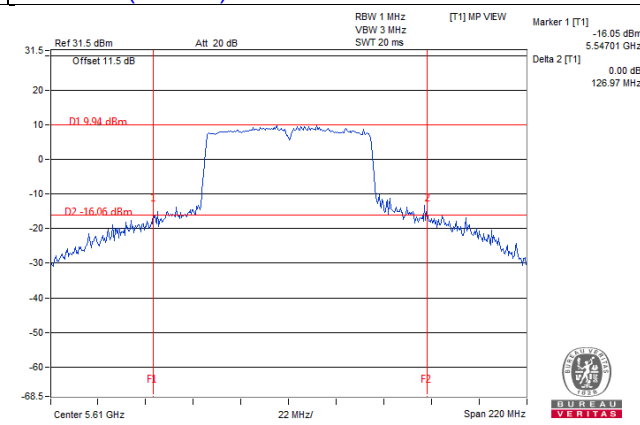

4.4 Occupied Bandwidth Measurement

4.4.1 Test Setup



4.4.2 Test Instruments

Refer to section 4.1.2 to get information of above instrument.

4.4.3 Test Procedure

The transmitter output was connected to the spectrum analyzer through an attenuator. The bandwidth of the fundamental frequency was measured by spectrum analyzer with resolution bandwidth in the range of 1% to 5% of the anticipated emission bandwidth, and a video bandwidth at least 3x the resolution bandwidth and set the detector to SAMPLE. The width of a frequency band such that, below the lower and above the upper frequency limits, the mean powers emitted are each equal to a specified percentage 0.5 %of the total mean power of a given emission.

4.4.4 Test Results

Mode A

802.11a

Chan.	Freq. (MHz)	Occupied Bandwidth (MHz)	
		Chain 0	Chain 1
52	5260	17.16	17.16
60	5300	17.28	17.28
64	5320	17.16	17.04
100	5500	17.16	17.16
116	5580	17.28	17.40
140	5700	17.16	17.04
144	5720 For U-NII-2C	13.40	13.40
144	5720 For U-NII-3	3.16	3.16

802.11n (HT20)

Chan.	Freq. (MHz)	Occupied Bandwidth (MHz)	
		Chain 0	Chain 1
52	5260	18.36	18.36
60	5300	18.36	18.24
64	5320	18.36	18.12
100	5500	18.24	18.12
116	5580	18.48	18.72
140	5700	18.24	18.12
144	5720 For U-NII-2C	14.00	14.00
144	5720 For U-NII-3	3.76	3.76

802.11n (HT40)

Chan.	Freq. (MHz)	Occupied Bandwidth (MHz)	
		Chain 0	Chain 1
54	5270	37.56	37.56
62	5310	36.84	36.84
102	5510	36.84	36.72
110	5550	38.04	37.44
134	5670	37.08	36.84
142	5710 For U-NII-2C	33.72	33.60
142	5710 For U-NII-3	3.60	3.48

802.11ac (VHT80)

Chan.	Freq. (MHz)	Occupied Bandwidth (MHz)	
		Chain 0	Chain 1
58	5290	75.84	75.84
106	5530	76.08	75.84
122	5610	76.56	76.32
138	5690 For U-NII-2C	73.16	73.16
138	5690 For U-NII-3	2.92	2.92



BUREAU
VERITAS

Spectrum Plot of Worst Value

802.11a

802.11n (HT20)

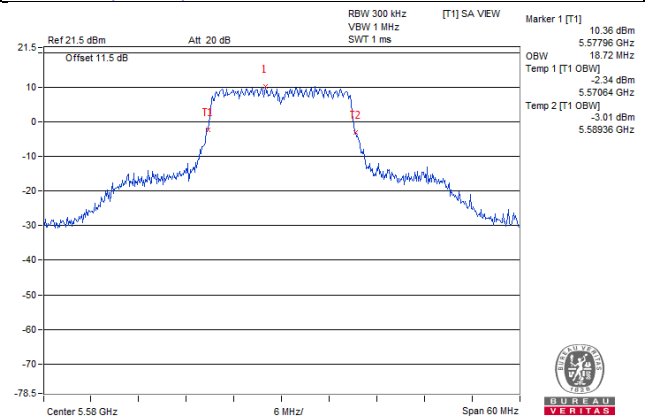
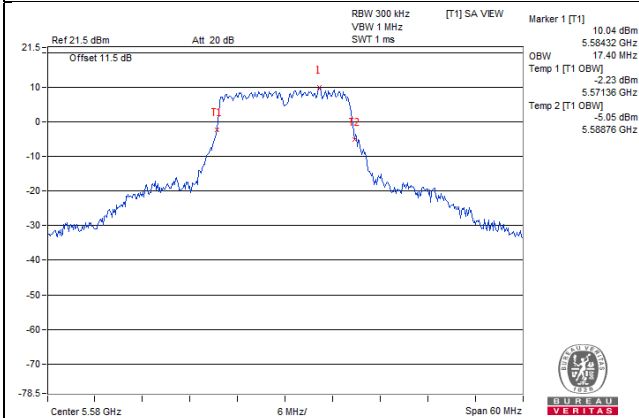

802.11n (HT40)

802.11ac (VHT80)

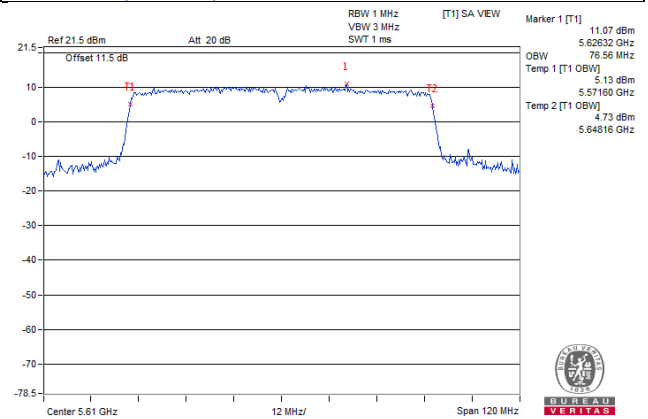
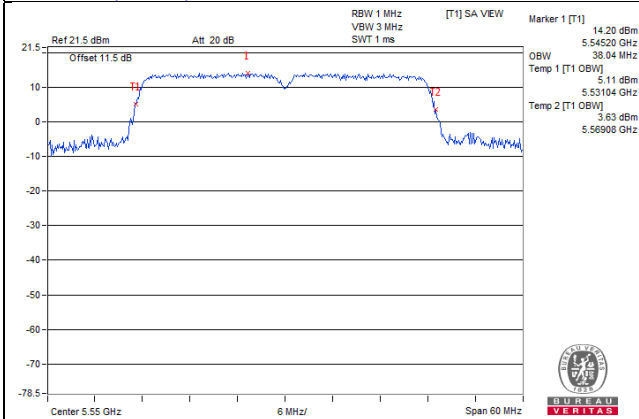

Mode C

802.11a

Chan.	Freq. (MHz)	Occupied Bandwidth (MHz)	
		Chain 0	Chain 1
52	5260	18.12	18.24
60	5300	17.88	18.12
64	5320	17.04	17.16
100	5500	17.04	17.16
116	5580	17.88	18.48
140	5700	17.04	17.04
144	5720 For U-NII-2C	14.00	13.64
144	5720 For U-NII-3	3.88	3.52

802.11n (HT20)

Chan.	Freq. (MHz)	Occupied Bandwidth (MHz)	
		Chain 0	Chain 1
52	5260	18.48	19.32
60	5300	18.60	19.44
64	5320	18.12	18.36
100	5500	18.00	18.12
116	5580	18.72	19.80
140	5700	18.00	18.24
144	5720 For U-NII-2C	14.48	14.24
144	5720 For U-NII-3	4.60	4.24

802.11n (HT40)

Chan.	Freq. (MHz)	Occupied Bandwidth (MHz)	
		Chain 0	Chain 1
54	5270	37.08	37.56
62	5310	36.72	36.96
102	5510	36.72	36.72
110	5550	37.20	37.56
134	5670	36.96	37.08
142	5710 For U-NII-2C	33.72	33.60
142	5710 For U-NII-3	3.72	3.48

802.11ac (VHT80)

Chan.	Freq. (MHz)	Occupied Bandwidth (MHz)	
		Chain 0	Chain 1
58	5290	75.84	75.84
106	5530	75.84	75.60
122	5610	76.08	76.08
138	5690 For U-NII-2C	73.16	73.16
138	5690 For U-NII-3	3.16	3.16



BUREAU
VERITAS

Spectrum Plot of Worst Value

802.11a

802.11n (HT20)

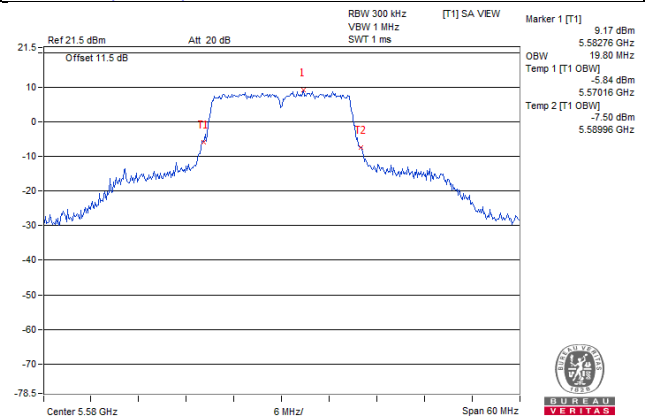
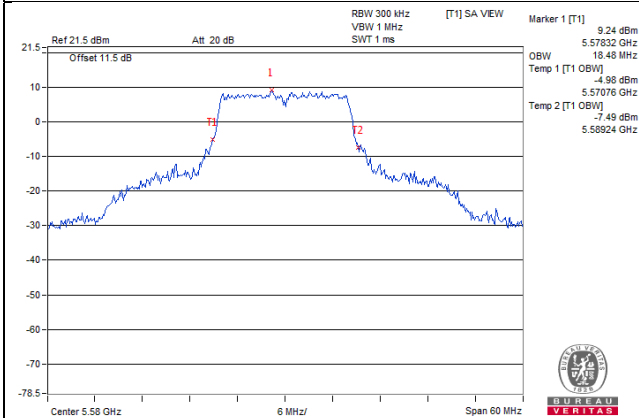

802.11n (HT40)

802.11ac (VHT80)

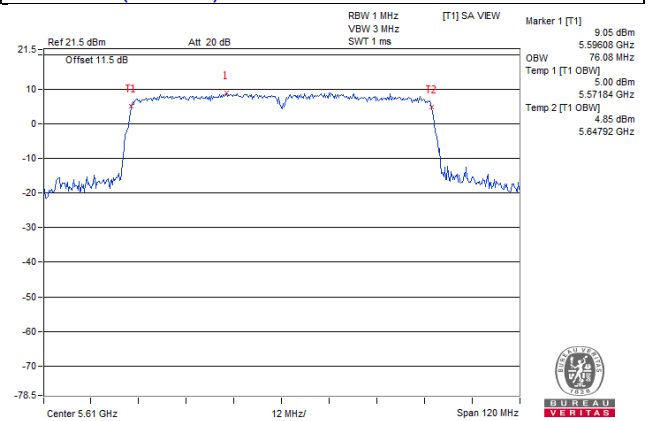
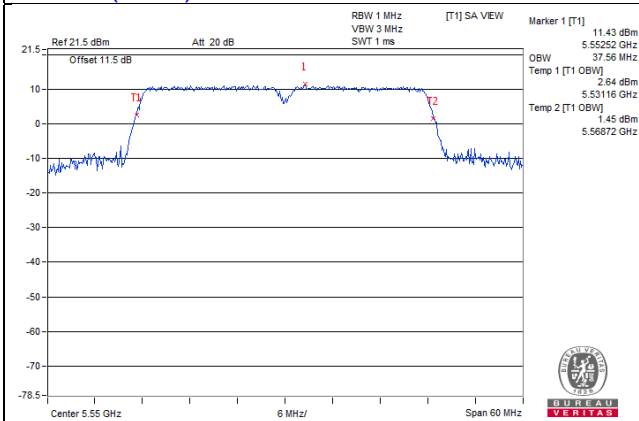

EUT MAXIMUM CONDUCTED POWER

Mode A

CDD Mode

802.11a

Frequency Band (MHz)	Max. Power	
	Output Power (mW)	Output Power (dBm)
5250~5350	124.127	20.94
5470~5725	125.332	20.98

802.11n (HT20)

Frequency Band (MHz)	Max. Power	
	Output Power (mW)	Output Power (dBm)
5250~5350	124.801	20.96
5470~5725	128.250	21.08

802.11n (HT40)

Frequency Band (MHz)	Max. Power	
	Output Power (mW)	Output Power (dBm)
5250~5350	126.658	21.03
5470~5725	127.684	21.06

802.11ac (VHT80)

Frequency Band (MHz)	Max. Power	
	Output Power (mW)	Output Power (dBm)
5250~5350	86.870	19.39
5470~5725	125.987	21.00

Beamforming Mode

802.11n (HT20)

Frequency Band (MHz)	Max. Power	
	Output Power (mW)	Output Power (dBm)
5250~5350	62.405	17.95
5470~5725	64.129	18.07

802.11n (HT40)

Frequency Band (MHz)	Max. Power	
	Output Power (mW)	Output Power (dBm)
5250~5350	63.333	18.02
5470~5725	63.846	18.05

802.11ac (VHT80)

Frequency Band (MHz)	Max. Power	
	Output Power (mW)	Output Power (dBm)
5250~5350	43.438	16.38
5470~5725	62.998	17.99

Mode C

CDD Mode

802.11a

Frequency Band (MHz)	Max. Power	
	Output Power (mW)	Output Power (dBm)
5250~5350	138.933	21.43
5470~5725	138.595	21.42

802.11n (HT20)

Frequency Band (MHz)	Max. Power	
	Output Power (mW)	Output Power (dBm)
5250~5350	138.051	21.40
5470~5725	139.999	21.46

802.11n (HT40)

Frequency Band (MHz)	Max. Power	
	Output Power (mW)	Output Power (dBm)
5250~5350	131.088	21.18
5470~5725	132.370	21.22

802.11ac (VHT80)

Frequency Band (MHz)	Max. Power	
	Output Power (mW)	Output Power (dBm)
5250~5350	70.700	18.49
5470~5725	126.474	21.02

Beamforming Mode

802.11n (HT20)

Frequency Band (MHz)	Max. Power	
	Output Power (mW)	Output Power (dBm)
5250~5350	69.031	18.39
5470~5725	70.004	18.45

802.11n (HT40)

Frequency Band (MHz)	Max. Power	
	Output Power (mW)	Output Power (dBm)
5250~5350	65.548	18.17
5470~5725	66.189	18.21

802.11ac (VHT80)

Frequency Band (MHz)	Max. Power	
	Output Power (mW)	Output Power (dBm)
5250~5350	35.318	15.48
5470~5725	63.241	18.01

4.5 Peak Power Spectral Density Measurement

4.5.1 Limits of Peak Power Spectral Density Measurement

Operation Band	EUT Category		LIMIT
U-NII-1	-	Outdoor Wi-Fi & BLE Array AP	17dBm/ MHz
	-	Fixed point-to-point Wi-Fi & BLE Array AP	
	-	Indoor Wi-Fi & BLE Array AP	
	-	Mobile and Portable client device	11dBm/ MHz
U-NII-2A	√		11dBm/ MHz
U-NII-2C	√		11dBm/ MHz
U-NII-3	√		30dBm/ 500kHz

4.5.2 Test Setup

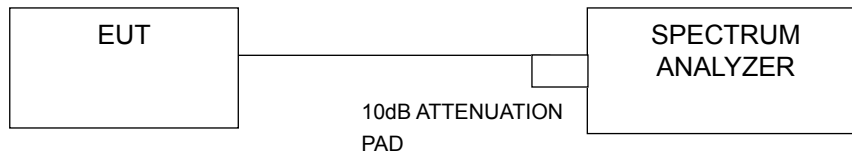

4.5.3 Test Instruments

Refer to section 4.1.2 to get information of above instrument.

4.5.4 Test Procedures

Using method SA-1

- 1) Set span to encompass the entire emission bandwidth (EBW) of the signal.
- 2) Set RBW = 30 kHz, Set VBW ≥ 1 MHz, Detector = RMS
- 3) Set Channel power measure = 1MHz
- 4) Sweep time = auto, trigger set to “free run”.
- 5) Trace average at least 100 traces in power averaging mode.
- 6) Record the max value

Using method SA-2

- 1) Set span to encompass the entire emission bandwidth (EBW) of the signal.
- 2) Set RBW = 30 kHz, Set VBW ≥ 1 MHz, Detector = RMS
- 3) Set Channel power measure = 1MHz
- 4) Sweep time = auto, trigger set to “free run”.
- 5) Trace average at least 100 traces in power averaging mode.
- 6) Record the max value and add 10 log (1/duty cycle)

4.5.5 Deviation from Test Standard

No deviation.

4.5.6 EUT Operating Conditions

Same as Item 4.3.6.

4.5.7 Test Results

For U-NII-2A, U-NII-2C band

Mode A

802.11a

Chan.	Freq. (MHz)	PSD (dBm/MHz)		Total PSD (dBm/MHz)	Max. Limit (dBm/MHz)	Pass / Fail
		Chain 0	Chain 1			
52	5260	4.82	4.43	7.64	8.16	Pass
60	5300	5.08	4.52	7.82	8.16	Pass
64	5320	4.78	3.95	7.40	8.16	Pass
100	5500	3.78	3.63	6.72	8.16	Pass
116	5580	4.40	3.80	7.12	8.16	Pass
140	5700	1.77	3.26	5.59	8.16	Pass
144	5720 For U-NII-2C	4.77	5.03	7.91	8.16	Pass

Note:

1. Method 1 of power density measurement of KDB 662911 is using for calculating total power density. Total power density is summing entire spectra across corresponding frequency bins on the various outputs by computer.
2. Directional gain = $5.83\text{dBi} + 10\log(2) = 8.84\text{dBi} > 6\text{dBi}$, so the limit shall be reduced to $11 - (8.84 - 6) = 8.16\text{dBm}$.

802.11n (HT20)

Chan.	Freq. (MHz)	PSD (dBm/MHz)		Total PSD (dBm/MHz)	Max. Limit (dBm/MHz)	Pass / Fail
		Chain 0	Chain 1			
52	5260	4.65	4.51	7.59	8.16	Pass
60	5300	4.72	4.30	7.53	8.16	Pass
64	5320	4.33	3.58	6.98	8.16	Pass
100	5500	3.26	3.27	6.28	8.16	Pass
116	5580	4.81	4.89	7.86	8.16	Pass
140	5700	1.33	2.90	5.20	8.16	Pass
144	5720 For U-NII-2C	3.90	5.23	7.63	8.16	Pass

Note:

1. Method 1 of power density measurement of KDB 662911 is using for calculating total power density. Total power density is summing entire spectra across corresponding frequency bins on the various outputs by computer.
2. Directional gain = $5.83\text{dBi} + 10\log(2) = 8.84\text{dBi} > 6\text{dBi}$, so the limit shall be reduced to $11 - (8.84 - 6) = 8.16\text{dBm}$.

802.11n (HT40)

Chan.	Freq. (MHz)	PSD W/O Duty Factor (dBm/MHz)		Duty Factor (dB)	Total PSD With Duty Factor (dBm/MHz)	Max. Limit (dBm/MHz)	Pass / Fail
		Chain 0	Chain 1				
54	5270	1.97	2.16	0.14	5.21	8.16	Pass
62	5310	0.05	-0.78	0.14	2.80	8.16	Pass
102	5510	-1.87	-1.93	0.14	1.25	8.16	Pass
110	5550	2.14	1.36	0.14	4.91	8.16	Pass
134	5670	0.43	1.47	0.14	4.13	8.16	Pass
142	5710 For U-NII-2C	0.15	0.57	0.14	3.51	8.16	Pass

Note:

- Method 1 of power density measurement of KDB 662911 is using for calculating total power density. Total power density is summing entire spectra across corresponding frequency bins on the various outputs by computer.
- Directional gain = $5.83\text{dBi} + 10\log(2) = 8.84\text{dBi} > 6\text{dBi}$, so the limit shall be reduced to $11 - (8.84 - 6) = 8.16\text{dBm}$.
- Refer to section 3.3 for duty cycle spectrum plot.

802.11ac (VHT80)

Chan.	Freq. (MHz)	PSD W/O Duty Factor (dBm/MHz)		Duty Factor (dB)	Total PSD With Duty Factor (dBm/MHz)	Max. Limit (dBm/MHz)	Pass / Fail
		Chain 0	Chain 1				
58	5290	-2.77	-3.68	0.19	0.00	8.16	Pass
106	5530	-5.41	-5.26	0.19	-2.13	8.16	Pass
122	5610	-0.91	-1.15	0.19	2.18	8.16	Pass
138	5690 For U-NII-2C	-3.26	-2.80	0.19	0.12	8.16	Pass

Note:

- Method 1 of power density measurement of KDB 662911 is using for calculating total power density. Total power density is summing entire spectra across corresponding frequency bins on the various outputs by computer.
- Directional gain = $5.83\text{dBi} + 10\log(2) = 8.84\text{dBi} > 6\text{dBi}$, so the limit shall be reduced to $11 - (8.84 - 6) = 8.16\text{dBm}$.
- Refer to section 3.3 for duty cycle spectrum plot.



BUREAU
VERITAS

Spectrum Plot of Worst Value

802.11a / Chain 0 / Ch 60

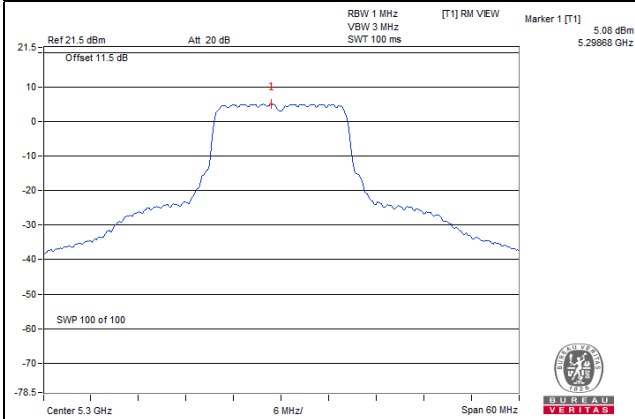

802.11n (HT20) / Chain 1 / Ch 144

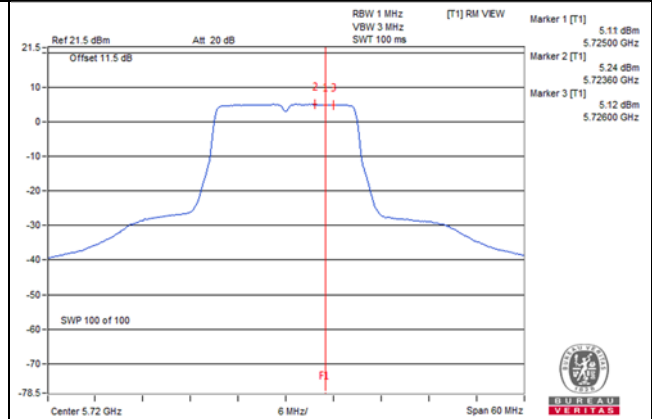

802.11n (HT40) / Chain 0 / Ch 110

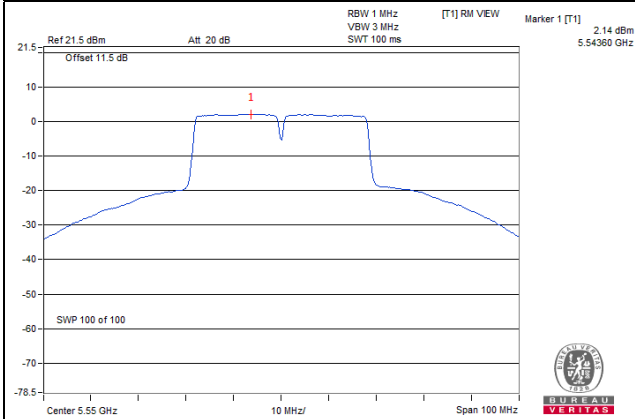

802.11ac (VHT80) / Chain 0 / Ch 122

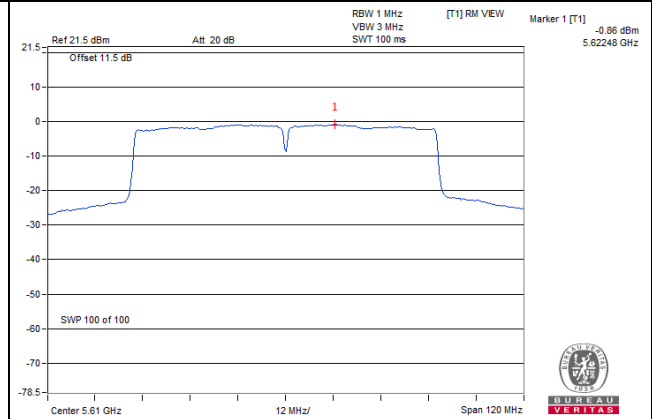

Mode C

802.11a

Chan.	Freq. (MHz)	PSD (dBm/MHz)		Total PSD (dBm/MHz)	Max. Limit (dBm/MHz)	Pass / Fail
		Chain 0	Chain 1			
52	5260	4.61	5.18	7.91	8.64	Pass
60	5300	4.54	5.46	8.03	8.64	Pass
64	5320	2.34	2.92	5.65	8.64	Pass
100	5500	2.23	1.82	5.04	8.64	Pass
116	5580	4.51	4.77	7.65	8.64	Pass
140	5700	1.48	0.59	4.07	8.64	Pass
144	5720 For U-NII-2C	5.25	5.88	8.59	8.64	Pass

Note:

- Method 1 of power density measurement of KDB 662911 is using for calculating total power density. Total power density is summing entire spectra across corresponding frequency bins on the various outputs by computer.
- Directional gain = $5.35\text{dBi} + 10\log(2) = 8.36\text{dBi} > 6\text{dBi}$, so the limit shall be reduced to $11-(8.36-6) = 8.64\text{dBm}$.

802.11n (HT20)

Chan.	Freq. (MHz)	PSD (dBm/MHz)		Total PSD (dBm/MHz)	Max. Limit (dBm/MHz)	Pass / Fail
		Chain 0	Chain 1			
52	5260	4.09	5.15	7.66	8.64	Pass
60	5300	4.36	5.34	7.89	8.64	Pass
64	5320	1.81	2.51	5.18	8.64	Pass
100	5500	-0.55	-1.14	2.18	8.64	Pass
116	5580	4.64	4.52	7.59	8.64	Pass
140	5700	0.03	-0.90	2.60	8.64	Pass
144	5720 For U-NII-2C	5.46	5.45	8.47	8.64	Pass

Note:

- Method 1 of power density measurement of KDB 662911 is using for calculating total power density. Total power density is summing entire spectra across corresponding frequency bins on the various outputs by computer.
- Directional gain = $5.35\text{dBi} + 10\log(2) = 8.36\text{dBi} > 6\text{dBi}$, so the limit shall be reduced to $11-(8.36-6) = 8.64\text{dBm}$.

802.11n (HT40)

Chan.	Freq. (MHz)	PSD W/O Duty Factor (dBm/MHz)		Duty Factor (dB)	Total PSD With Duty Factor (dBm/MHz)	Max. Limit (dBm/MHz)	Pass / Fail
		Chain 0	Chain 1				
54	5270	0.97	1.85	0.10	4.54	8.64	Pass
62	5310	-2.82	-1.68	0.10	0.89	8.64	Pass
102	5510	-2.60	-3.04	0.10	0.29	8.64	Pass
110	5550	0.80	0.84	0.10	3.93	8.64	Pass
134	5670	-0.53	-0.68	0.10	2.50	8.64	Pass
142	5710 For U-NII-2C	-0.37	0.05	0.10	2.95	8.64	Pass

Note:

- Method 1 of power density measurement of KDB 662911 is using for calculating total power density. Total power density is summing entire spectra across corresponding frequency bins on the various outputs by computer.
- Directional gain = $5.35\text{dBi} + 10\log(2) = 8.36\text{dBi} > 6\text{dBi}$, so the limit shall be reduced to $11 - (8.36 - 6) = 8.64\text{dBm}$.
- Refer to section 3.3 for duty cycle spectrum plot.

802.11ac (VHT80)

Chan.	Freq. (MHz)	PSD W/O Duty Factor (dBm/MHz)		Duty Factor (dB)	Total PSD With Duty Factor (dBm/MHz)	Max. Limit (dBm/MHz)	Pass / Fail
		Chain 0	Chain 1				
58	5290	-5.21	-4.30	0.26	-1.46	8.64	Pass
106	5530	-5.33	-6.24	0.26	-2.49	8.64	Pass
122	5610	-0.97	-0.77	0.26	2.40	8.64	Pass
138	5690 For U-NII-2C	-2.55	-2.12	0.26	0.94	8.64	Pass

Note:

- Method 1 of power density measurement of KDB 662911 is using for calculating total power density. Total power density is summing entire spectra across corresponding frequency bins on the various outputs by computer.
- Directional gain = $5.35\text{dBi} + 10\log(2) = 8.36\text{dBi} > 6\text{dBi}$, so the limit shall be reduced to $11 - (8.36 - 6) = 8.64\text{dBm}$.
- Refer to section 3.3 for duty cycle spectrum plot.



BUREAU
VERITAS

Spectrum Plot of Worst Value

802.11a / Chain 1 / Ch 60

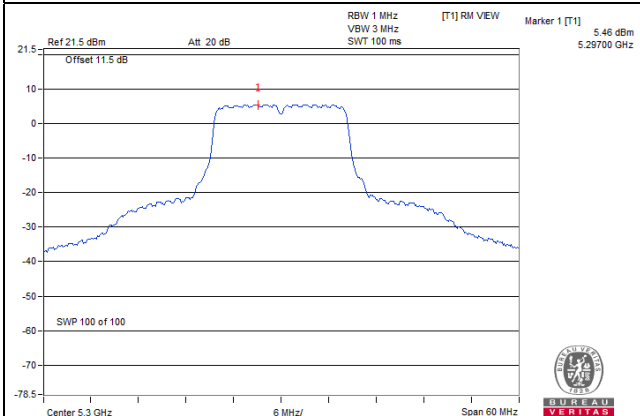

802.11n (HT20) / Chain 0 / Ch 144

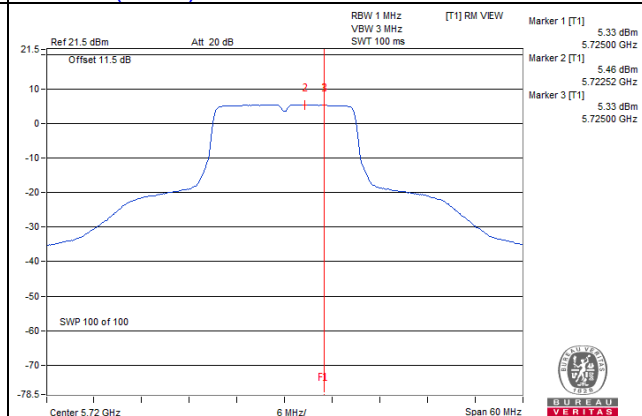

802.11n (HT40) / Chain 1 / Ch 54

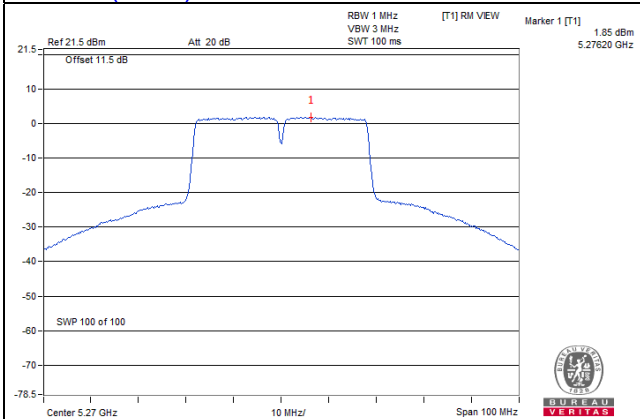

802.11ac (VHT80) / Chain 1 / Ch 122

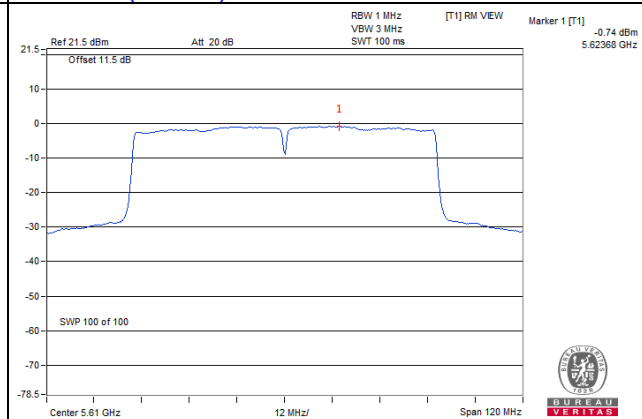

For U-NII-3 band:

Mode A

802.11a

TX chain	Channel	Freq. (MHz)	PSD (dBm/300kHz)	PSD (dBm/500kHz)	10 log (N=2) dB	Total PSD (dBm/500kHz)	Limit (dBm/500kHz)	Pass / Fail
0	144	5720 (For U-NII-3)	-3.89	-1.67	3.01	1.34	27.16	Pass
1	144	5720 (For U-NII-3)	-3.04	-0.82	3.01	2.19	27.16	Pass

Note:

- Method 1 of power density measurement of KDB 662911 is using for calculating total power density. Total power density is summing entire spectra across corresponding frequency bins on the various outputs by computer.
- Directional gain = $5.83\text{dBi} + 10\log(2) = 8.84\text{dBi} > 6\text{dBi}$, so the limit shall be reduced to $30 - (8.84 - 6) = 27.16\text{dBm}$.

802.11n (HT20)

TX chain	Channel	Freq. (MHz)	PSD (dBm/300kHz)	PSD (dBm/500kHz)	10 log (N=2) dB	Total PSD (dBm/500kHz)	Limit (dBm/500kHz)	Pass / Fail
0	144	5720 (For U-NII-3)	-4.78	-2.56	3.01	0.45	27.16	Pass
1	144	5720 (For U-NII-3)	-3.53	-1.31	3.01	1.70	27.16	Pass

Note:

- Method 1 of power density measurement of KDB 662911 is using for calculating total power density. Total power density is summing entire spectra across corresponding frequency bins on the various outputs by computer.
- Directional gain = $5.83\text{dBi} + 10\log(2) = 8.84\text{dBi} > 6\text{dBi}$, so the limit shall be reduced to $30 - (8.84 - 6) = 27.16\text{dBm}$.

802.11n (HT40)

TX chain	Channel	Freq. (MHz)	PSD (dBm/300kHz)	PSD (dBm/500kHz)	10 log (N=2) dB	Duty factor	Total PSD (dBm/500kHz)	Limit (dBm/500kHz)	Pass / Fail
0	142	5710 (For U-NII-3)	-9.18	-6.96	3.01	0.14	-3.81	27.16	Pass
1	142	5710 (For U-NII-3)	-8.26	-6.04	3.01	0.14	-2.89	27.16	Pass

Note:

- Method 1 of power density measurement of KDB 662911 is using for calculating total power density. Total power density is summing entire spectra across corresponding frequency bins on the various outputs by computer.
- Directional gain = $5.83\text{dBi} + 10\log(2) = 8.84\text{dBi} > 6\text{dBi}$, so the limit shall be reduced to $30 - (8.84 - 6) = 27.16\text{dBm}$.
- Refer to section 3.3 for duty cycle spectrum plot.

802.11ac (VHT80)

TX chain	Channel	Freq. (MHz)	PSD (dBm/300kHz)	PSD (dBm/500kHz)	10 log (N=2) dB	Duty factor	Total PSD (dBm/500kHz)	Limit (dBm/500kHz)	Pass / Fail
0	138	5690 (For U-NII-3)	-13.54	-11.32	3.01	0.19	-8.17	27.16	Pass
1	138	5690 (For U-NII-3)	-12.57	-10.35	3.01	0.19	-7.20	27.16	Pass

Note:

- Method 1 of power density measurement of KDB 662911 is using for calculating total power density. Total power density is summing entire spectra across corresponding frequency bins on the various outputs by computer.
- Directional gain = $5.83\text{dBi} + 10\log(2) = 8.84\text{dBi} > 6\text{dBi}$, so the limit shall be reduced to $30 - (8.84 - 6) = 27.16\text{dBm}$.
- Refer to section 3.3 for duty cycle spectrum plot.

Spectrum Plot of Worst Value

802.11a

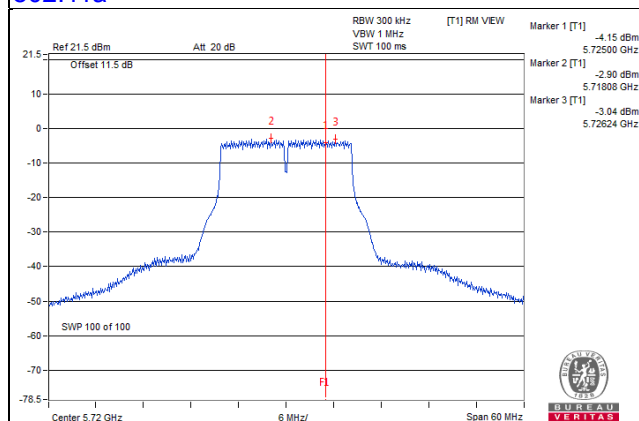

802.11n (HT20)

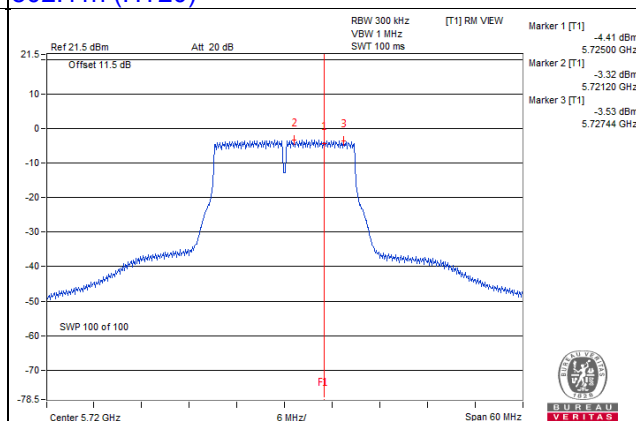

802.11n (HT40)

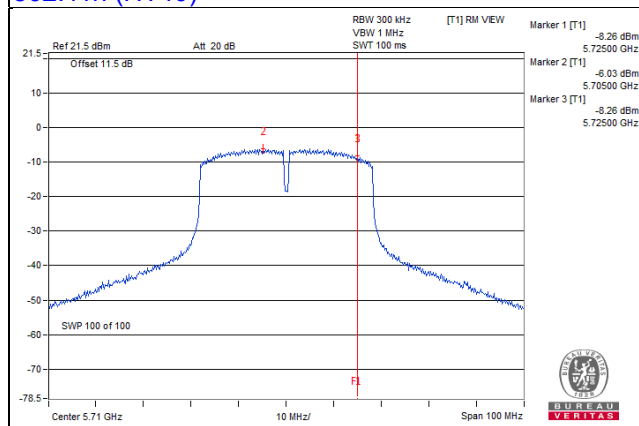

802.11ac (VHT80)

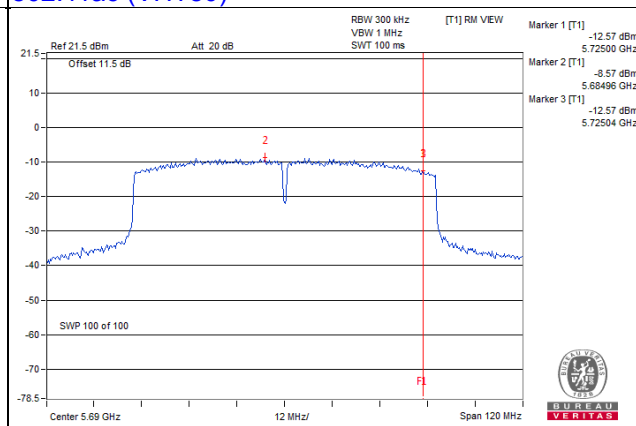

Mode C

802.11a

TX chain	Channel	Freq. (MHz)	PSD (dBm/300kHz)	PSD (dBm/500kHz)	10 log (N=2) dB	Total PSD (dBm/500kHz)	Limit (dBm/500kHz)	Pass / Fail
0	144	5720 (For U-NII-3)	-2.69	-0.47	3.01	2.54	27.64	Pass
1	144	5720 (For U-NII-3)	-2.84	-0.62	3.01	2.39	27.64	Pass

Note:

- Method 1 of power density measurement of KDB 662911 is using for calculating total power density. Total power density is summing entire spectra across corresponding frequency bins on the various outputs by computer.
- Directional gain = $5.35\text{dBi} + 10\log(2) = 8.36\text{dBi} > 6\text{dBi}$, so the limit shall be reduced to $30 - (8.36 - 6) = 27.64\text{dBm}$.

802.11n (HT20)

TX chain	Channel	Freq. (MHz)	PSD (dBm/300kHz)	PSD (dBm/500kHz)	10 log (N=2) dB	Total PSD (dBm/500kHz)	Limit (dBm/500kHz)	Pass / Fail
0	144	5720 (For U-NII-3)	-3.29	-1.07	3.01	1.94	27.64	Pass
1	144	5720 (For U-NII-3)	-3.03	-0.81	3.01	2.20	27.64	Pass

Note:

- Method 1 of power density measurement of KDB 662911 is using for calculating total power density. Total power density is summing entire spectra across corresponding frequency bins on the various outputs by computer.
- Directional gain = $5.35\text{dBi} + 10\log(2) = 8.36\text{dBi} > 6\text{dBi}$, so the limit shall be reduced to $30 - (8.36 - 6) = 27.64\text{dBm}$.

802.11n (HT40)

TX chain	Channel	Freq. (MHz)	PSD (dBm/300kHz)	PSD (dBm/500kHz)	10 log (N=2) dB	Duty factor	Total PSD (dBm/500kHz)	Limit (dBm/500kHz)	Pass / Fail
0	142	5710 (For U-NII-3)	-9.61	-7.39	3.01	0.10	-4.28	27.64	Pass
1	142	5710 (For U-NII-3)	-8.25	-6.03	3.01	0.10	-2.92	27.64	Pass

Note:

- Method 1 of power density measurement of KDB 662911 is using for calculating total power density. Total power density is summing entire spectra across corresponding frequency bins on the various outputs by computer.
- Directional gain = $5.35\text{dBi} + 10\log(2) = 8.36\text{dBi} > 6\text{dBi}$, so the limit shall be reduced to $30 - (8.36 - 6) = 27.64\text{dBm}$.
- Refer to section 3.3 for duty cycle spectrum plot.

802.11ac (VHT80)

TX chain	Channel	Freq. (MHz)	PSD (dBm/300kHz)	PSD (dBm/500kHz)	10 log (N=2) dB	Duty factor	Total PSD (dBm/500kHz)	Limit (dBm/500kHz)	Pass / Fail
0	138	5690 (For U-NII-3)	-11.91	-9.69	3.01	0.26	-6.42	27.64	Pass
1	138	5690 (For U-NII-3)	-11.56	-9.34	3.01	0.26	-6.07	27.64	Pass

Note:

- Method 1 of power density measurement of KDB 662911 is using for calculating total power density. Total power density is summing entire spectra across corresponding frequency bins on the various outputs by computer.
- Directional gain = $5.35\text{dBi} + 10\log(2) = 8.36\text{dBi} > 6\text{dBi}$, so the limit shall be reduced to $30 - (8.36 - 6) = 27.64\text{dBm}$.
- Refer to section 3.3 for duty cycle spectrum plot.

Spectrum Plot of Worst Value

802.11a

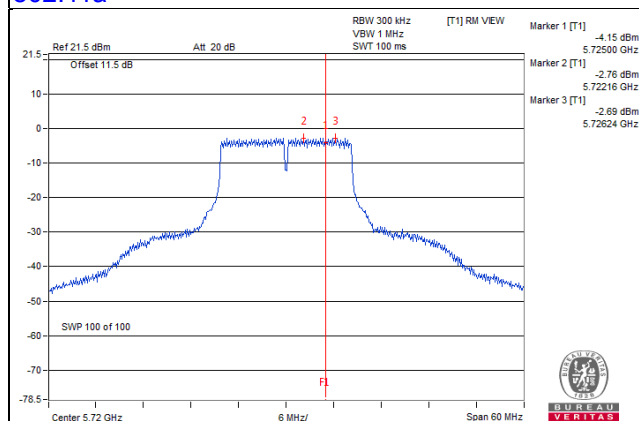

802.11n (HT20)

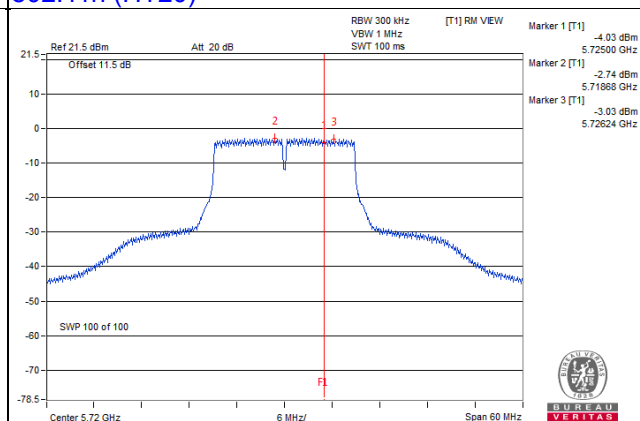

802.11n (HT40)

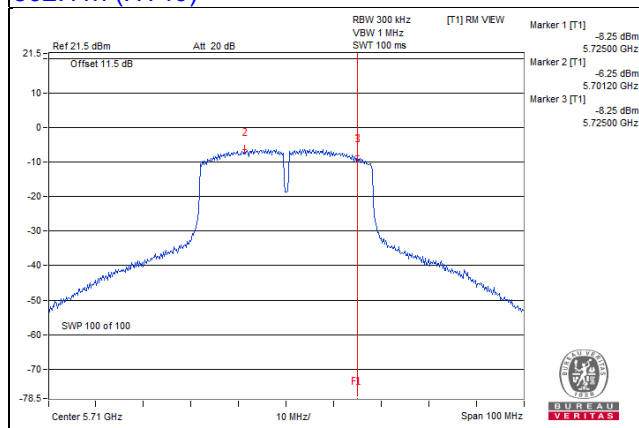

802.11ac (VHT80)

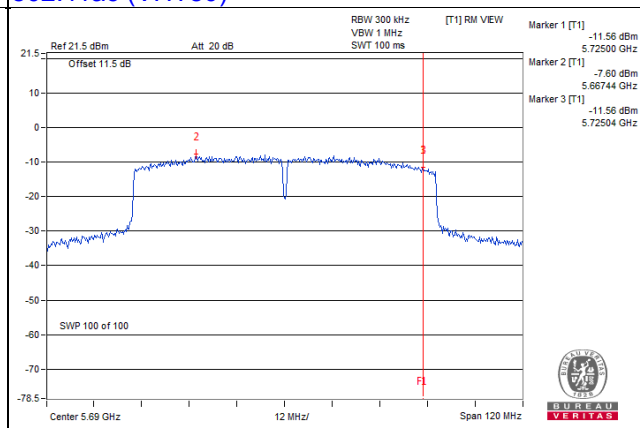

4.6 Frequency Stability

4.6.1 Limits of Frequency Stability Measurement

The frequency of the carrier signal shall be maintained within band of operation

4.6.2 Test Setup

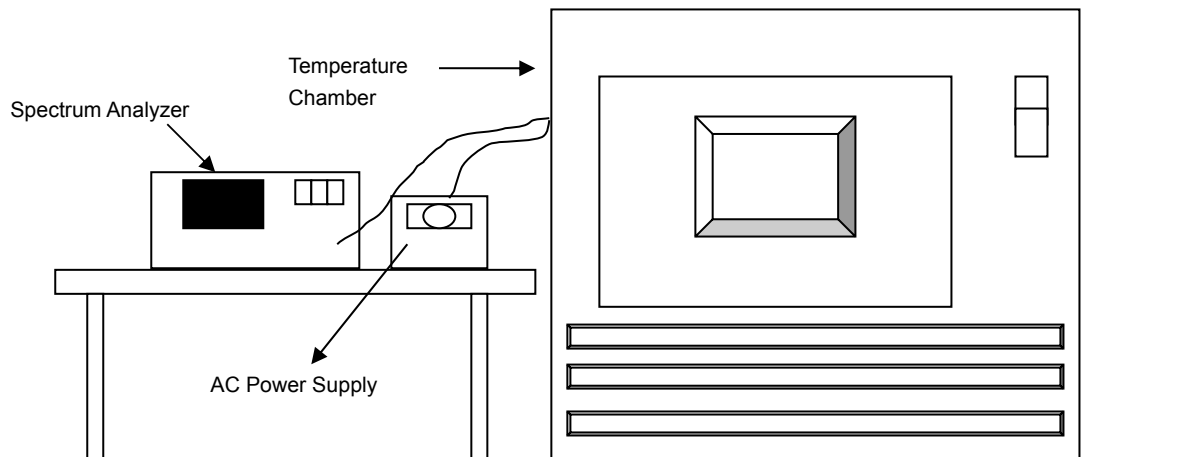

4.6.3 Test Instruments

Refer to section 4.1.2 to get information of above instrument.

4.6.4 Test Procedure

- The EUT was placed inside the environmental test chamber and powered by nominal AC voltage.
- Turn the EUT on and couple its output to a spectrum analyzer.
- Turn the EUT off and set the chamber to the highest temperature specified.
- Allow sufficient time (approximately 30 min) for the temperature of the chamber to stabilize, turn the EUT on and measure the operating frequency after 2, 5, and 10 minutes.
- Repeat step 2 and 3 with the temperature chamber set to the lowest temperature.
- The test chamber was allowed to stabilize at +20 degree C for a minimum of 30 minutes. The supply voltage was then adjusted on the EUT from 85% to 115% and the frequency record.

4.6.5 Deviation from Test Standard

No deviation.

4.6.6 EUT Operating Condition

Set the EUT transmit at un-modulation mode to test frequency stability.

4.6.7 Test Results

Mode A

Frequency Stability Versus Temp.									
Operating Frequency: 5260MHz									
Temp. (°C)	Power Supply (Vac)	0 Minute		2 Minute		5 Minute		10 Minute	
		Measured Frequency (MHz)	Pass/Fail	Measured Frequency (MHz)	Pass/Fail	Measured Frequency (MHz)	Pass/Fail	Measured Frequency (MHz)	Pass/Fail
50	120	5260.0020	Pass	5259.9977	Pass	5260.0004	Pass	5260.0006	Pass
40	120	5260.0108	Pass	5260.0149	Pass	5260.0116	Pass	5260.0150	Pass
30	120	5260.0170	Pass	5260.0175	Pass	5260.0158	Pass	5260.0171	Pass
20	120	5259.9913	Pass	5259.9889	Pass	5259.9875	Pass	5259.9879	Pass
10	120	5260.0236	Pass	5260.0248	Pass	5260.0242	Pass	5260.0258	Pass
0	120	5259.9809	Pass	5259.9810	Pass	5259.9814	Pass	5259.9832	Pass
-10	120	5259.9813	Pass	5259.9815	Pass	5259.9830	Pass	5259.9789	Pass
-20	120	5260.0092	Pass	5260.0096	Pass	5260.0089	Pass	5260.0071	Pass
-30	120	5259.9877	Pass	5259.9838	Pass	5259.9881	Pass	5259.9858	Pass

Frequency Stability Versus Voltage									
Operating Frequency: 5260MHz									
Temp. (°C)	Power Supply (Vac)	0 Minute		2 Minute		5 Minute		10 Minute	
		Measured Frequency (MHz)	Pass/Fail	Measured Frequency (MHz)	Pass/Fail	Measured Frequency (MHz)	Pass/Fail	Measured Frequency (MHz)	Pass/Fail
20	138	5259.9918	Pass	5259.9893	Pass	5259.9877	Pass	5259.9870	Pass
	120	5259.9913	Pass	5259.9889	Pass	5259.9875	Pass	5259.9879	Pass
	102	5259.9917	Pass	5259.9893	Pass	5259.9872	Pass	5259.9880	Pass

Mode C

Frequency Stability Versus Temp.									
Operating Frequency: 5260MHz									
Temp. (°C)	Power Supply (Vac)	0 Minute		2 Minute		5 Minute		10 Minute	
		Measured Frequency (MHz)	Pass/Fail	Measured Frequency (MHz)	Pass/Fail	Measured Frequency (MHz)	Pass/Fail	Measured Frequency (MHz)	Pass/Fail
50	120	5259.9833	Pass	5259.9837	Pass	5259.9816	Pass	5259.9834	Pass
40	120	5259.9809	Pass	5259.9795	Pass	5259.9801	Pass	5259.9839	Pass
30	120	5260.0157	Pass	5260.0142	Pass	5260.0148	Pass	5260.0149	Pass
20	120	5260.0192	Pass	5260.0203	Pass	5260.0193	Pass	5260.0176	Pass
10	120	5260.0157	Pass	5260.0166	Pass	5260.0160	Pass	5260.0150	Pass
0	120	5259.9888	Pass	5259.9940	Pass	5259.9927	Pass	5259.9905	Pass
-10	120	5259.9825	Pass	5259.9858	Pass	5259.9848	Pass	5259.9832	Pass
-20	120	5259.9931	Pass	5259.9933	Pass	5259.9934	Pass	5259.9935	Pass
-30	120	5259.9929	Pass	5259.9924	Pass	5259.9906	Pass	5259.9937	Pass

Frequency Stability Versus Voltage									
Operating Frequency: 5260MHz									
Temp. (°C)	Power Supply (Vac)	0 Minute		2 Minute		5 Minute		10 Minute	
		Measured Frequency (MHz)	Pass/Fail	Measured Frequency (MHz)	Pass/Fail	Measured Frequency (MHz)	Pass/Fail	Measured Frequency (MHz)	Pass/Fail
20	138	5260.0190	Pass	5260.0208	Pass	5260.0193	Pass	5260.0176	Pass
	120	5260.0192	Pass	5260.0203	Pass	5260.0193	Pass	5260.0176	Pass
	102	5260.0195	Pass	5260.0213	Pass	5260.0191	Pass	5260.0174	Pass

4.7 6dB Bandwidth Measurement

4.7.1 Limits of 6dB Bandwidth Measurement

The minimum of 6dB Bandwidth Measurement is 0.5MHz.

4.7.2 Test Setup

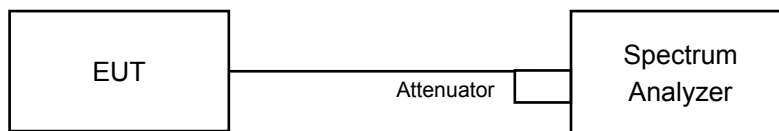

4.7.3 Test Instruments

Refer to section 4.1.2 to get information of above instrument.

4.7.4 Test Procedure

Measurement Procedure REF

- Set resolution bandwidth (RBW) = 100kHz
- Set the video bandwidth (VBW) $\geq 3 \times$ RBW, Detector = Peak.
- Trace mode = max hold.
- Sweep = auto couple.
- Measure the maximum width of the emission that is constrained by the frequencies associated with the two amplitude points (upper and lower) that are attenuated by 6 dB relative to the maximum level measured in the fundamental emission

4.7.5 Deviation from Test Standard

No deviation.

4.7.6 EUT Operating Condition

The software provided by client to enable the EUT under transmission condition continuously at lowest, middle and highest channel frequencies individually.

4.7.7 Test Results

Mode A

802.11a

Chan.	Freq. (MHz)	6dB Bandwidth (MHz)		Minimum Limit (MHz)	Pass / Fail
		Chain 0	Chain 1		
144	5720 (For U-NII-3)	3.17	3.17	0.5	Pass

802.11n (HT20)

Chan.	Freq. (MHz)	6dB Bandwidth (MHz)		Minimum Limit (MHz)	Pass / Fail
		Chain 0	Chain 1		
144	5720 (For U-NII-3)	3.78	3.79	0.5	Pass

802.11n (HT40)

Chan.	Freq. (MHz)	6dB Bandwidth (MHz)		Minimum Limit (MHz)	Pass / Fail
		Chain 0	Chain 1		
142	5710 (For U-NII-3)	3.20	3.16	0.5	Pass

802.11ac (VHT80)

Chan.	Freq. (MHz)	6dB Bandwidth (MHz)		Minimum Limit (MHz)	Pass / Fail
		Chain 0	Chain 1		
138	5690 (For U-NII-3)	2.87	3.21	0.5	Pass

Spectrum Plot of Worst Value

802.11a

802.11n (HT20)

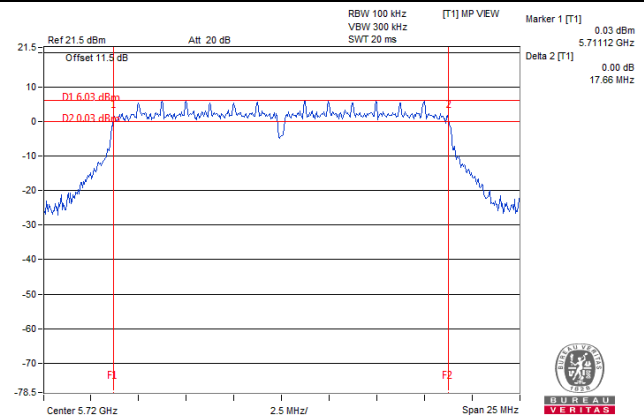
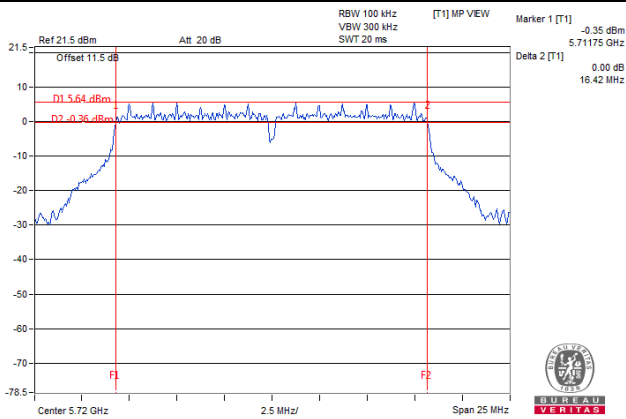

802.11n (HT40)

802.11ac (VHT80)

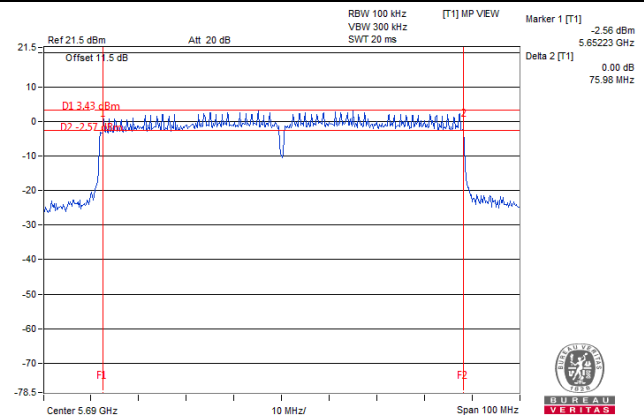
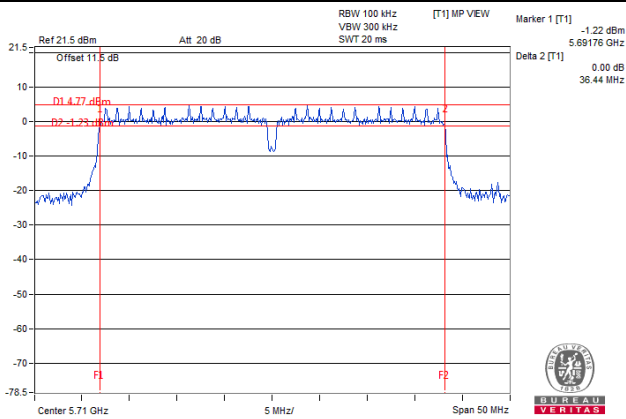

Note:

For CH144 (UNII-3 Band): The 6dB bandwidth above 5725MHz = Marker 1 + Delta 2 - 5725MHz

For CH142 (UNII-3 Band): The 6dB bandwidth above 5725MHz = Marker 1 + Delta 2 - 5725MHz

For CH138 (UNII-3 Band): The 6dB bandwidth above 5725MHz = Marker 1 + Delta 2 - 5725MHz

Mode C

802.11a

Chan.	Freq. (MHz)	6dB Bandwidth (MHz)		Minimum Limit (MHz)	Pass / Fail
		Chain 0	Chain 1		
144	5720 (For U-NII-3)	3.16	3.16	0.5	Pass

802.11n (HT20)

Chan.	Freq. (MHz)	6dB Bandwidth (MHz)		Minimum Limit (MHz)	Pass / Fail
		Chain 0	Chain 1		
144	5720 (For U-NII-3)	3.76	3.78	0.5	Pass

802.11n (HT40)

Chan.	Freq. (MHz)	6dB Bandwidth (MHz)		Minimum Limit (MHz)	Pass / Fail
		Chain 0	Chain 1		
142	5710 (For U-NII-3)	3.17	3.20	0.5	Pass

802.11ac (VHT80)

Chan.	Freq. (MHz)	6dB Bandwidth (MHz)		Minimum Limit (MHz)	Pass / Fail
		Chain 0	Chain 1		
138	5690 (For U-NII-3)	2.92	3.22	0.5	Pass

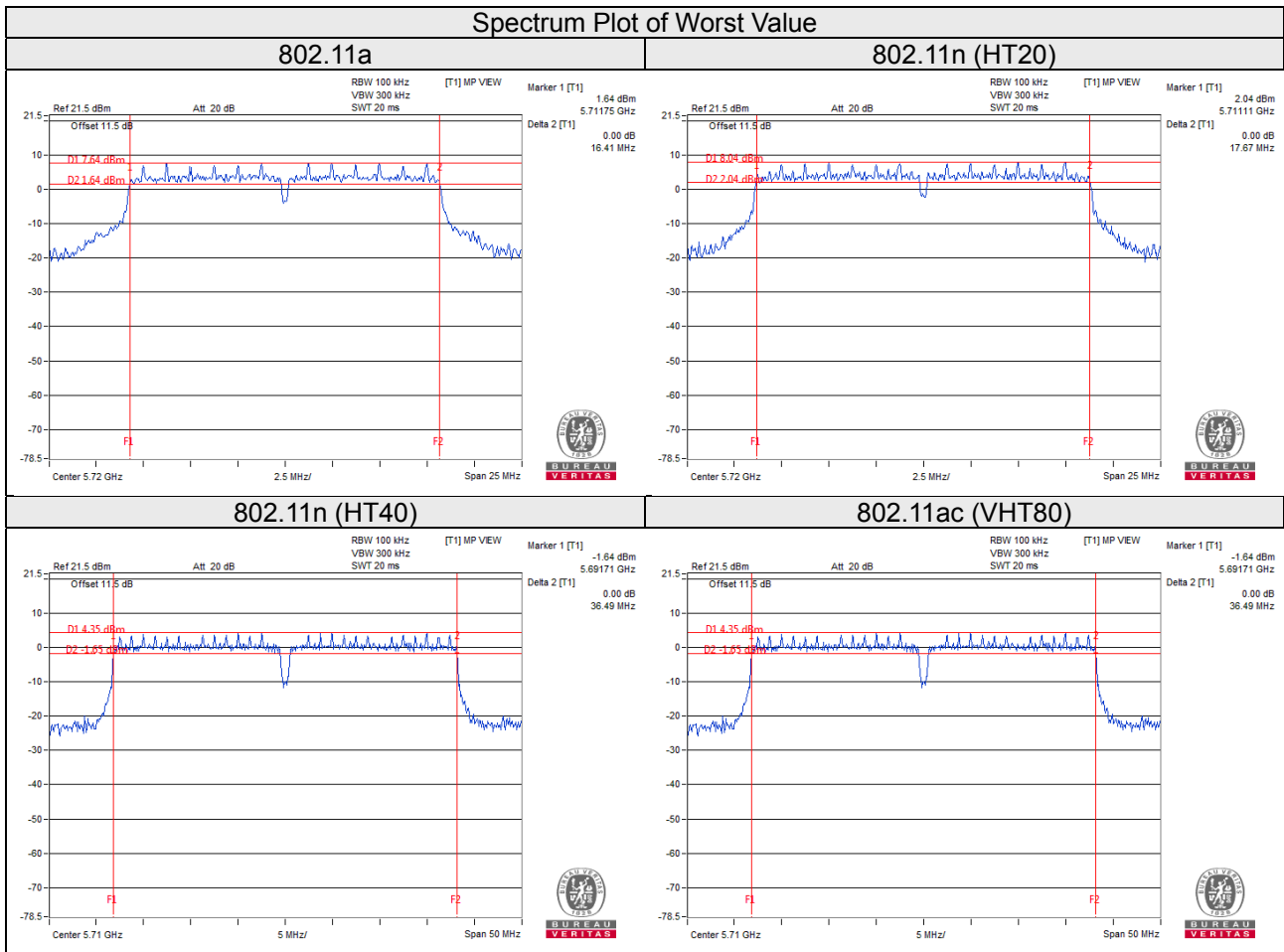

Note:

For CH144 (UNII-3 Band): The 6dB bandwidth above 5725MHz = Marker 1 + Delta 2 - 5725MHz

For CH142 (UNII-3 Band): The 6dB bandwidth above 5725MHz = Marker 1 + Delta 2 - 5725MHz

For CH138 (UNII-3 Band): The 6dB bandwidth above 5725MHz = Marker 1 + Delta 2 - 5725MHz

5 Pictures of Test Arrangements

Please refer to the attached file (Test Setup Photo).

Appendix – Information on the Testing Laboratories

We, Bureau Veritas Consumer Products Services (H.K.) Ltd., Taoyuan Branch, were founded in 1988 to provide our best service in EMC, Radio, Telecom and Safety consultation. Our laboratories are FCC recognized accredited test firms and accredited and approved according to ISO/IEC 17025.

If you have any comments, please feel free to contact us at the following:

Linko EMC/RF Lab

Tel: 886-2-26052180

Fax: 886-2-26051924

Hsin Chu EMC/RF/Telecom Lab

Tel: 886-3-6668565

Fax: 886-3-6668323

Hwa Ya EMC/RF/Safety

Tel: 886-3-3183232

Fax: 886-3-3270892

Email: service.adt@tw.bureauveritas.com

Web Site: www.bureauveritas-adt.com

The address and road map of all our labs can be found in our web site also.

--- END ---