

FCC Test Report

Report No.: RF161026C20-1

FCC ID: TVE-241BC041

Test Model: FortiAP U221EV, FortiAP U223EV

Series Model: FortiAP U221EVxxxxxx, FAP-U221EVxxxxxx, FORTIAP-U221EVxxxxxx, FortiAP U223EVxxxxxx, FAP-U223EVxxxxxx, FORTIAP-U223EVxxxxxx (where "x" can be used as "A-Z" or "0-9" or "-" or blank for software changes or marketing purposes only) (refer to item 3.1 for more details)

Received Date: Oct. 25, 2016

Test Date: Oct. 26 ~ Dec. 28, 2016

Issued Date: Dec. 28, 2016

Applicant: Fortinet Inc.

Address: 899 Kifer Road Sunnyvale, CA 94086 USA

Issued By: Bureau Veritas Consumer Products Services (H.K.) Ltd., Taoyuan Branch

Lab Address: No. 47-2, 14th Ling, Chia Pau Vil., Lin Kou Dist., New Taipei City, Taiwan (R.O.C.)

Test Location: No. 19, Hwa Ya 2nd Rd., Wen Hwa Vil., Kwei Shan Dist., Taoyuan City 33383, TAIWAN (R.O.C.)



This report is for your exclusive use. Any copying or replication of this report to or for any other person or entity, or use of our name or trademark, is permitted only with our prior written permission. This report sets forth our findings solely with respect to the test samples identified herein. The results set forth in this report are not indicative or representative of the quality or characteristics of the lot from which a test sample was taken or any similar or identical product unless specifically and expressly noted. Our report includes all of the tests requested by you and the results thereof based upon the information that you provided to us. You have 60 days from date of issuance of this report to notify us of any material error or omission caused by our negligence, provided, however, that such notice shall be in writing and shall specifically address the issue you wish to raise. A failure to raise such issue within the prescribed time shall constitute your unqualified acceptance of the completeness of this report, the tests conducted and the correctness of the report contents. Unless specifically mentioned, the uncertainty of measurement has been explicitly taken into account to declare the compliance or non-compliance to the specification. The report must not be used by the client to claim product certification, approval, or endorsement by TAF or any government agencies.

Table of Contents

Release Control Record	4
1 Certificate of Conformity	5
2 Summary of Test Results	6
2.1 Measurement Uncertainty.....	6
2.2 Modification Record.....	6
3 General Information	7
3.1 General Description of EUT.....	7
3.2 Description of Test Modes.....	10
3.2.1 Test Mode Applicability and Tested Channel Detail.....	11
3.3 Duty Cycle of Test Signal.....	13
3.4 Description of Support Units.....	14
3.4.1 Configuration of System under Test.....	14
3.5 General Description of Applied Standard.....	15
4 Test Types and Results	16
4.1 Radiated Emission and Bandedge Measurement.....	16
4.1.1 Limits of Radiated Emission and Bandedge Measurement.....	16
4.1.2 Test Instruments.....	17
4.1.3 Test Procedure.....	18
4.1.4 Deviation from Test Standard.....	18
4.1.5 Test Setup.....	19
4.1.6 EUT Operating Conditions.....	20
4.1.7 Test Results.....	21
4.2 Conducted Emission Measurement.....	61
4.2.1 Limits of Conducted Emission Measurement.....	61
4.2.2 Test Instruments.....	61
4.2.3 Test Procedure.....	62
4.2.4 Deviation from Test Standard.....	62
4.2.5 Test Setup.....	62
4.2.6 EUT Operating Conditions.....	62
4.2.7 Test Results.....	63
4.3 Transmit Power Measurement.....	71
4.3.1 Limits of Transmit Power Measurement.....	71
4.3.2 Test Setup.....	71
4.3.3 Test Instruments.....	72
4.3.4 Test Procedure.....	72
4.3.5 Deviation from Test Standard.....	72
4.3.6 EUT Operating Conditions.....	72
4.3.7 Test Result.....	73
4.4 Occupied Bandwidth Measurement.....	77
4.4.1 Test Setup.....	77
4.4.2 Test Instruments.....	77
4.4.3 Test Procedure.....	77
4.4.4 Test Results.....	78
4.5 Peak Power Spectral Density Measurement.....	80
4.5.1 Limits of Peak Power Spectral Density Measurement.....	80
4.5.2 Test Setup.....	80
4.5.3 Test Instruments.....	80
4.5.4 Test Procedure.....	81
4.5.5 Deviation from Test Standard.....	81
4.5.6 EUT Operating Condition.....	81
4.5.7 Test Results.....	82
4.6 Frequency Stability.....	87
4.6.1 Limits of Frequency Stability Measurement.....	87

4.6.2	Test Setup.....	87
4.6.3	Test Instruments	87
4.6.4	Test Procedure	87
4.6.5	Deviation from Test Standard	87
4.6.6	EUT Operating Condition	87
4.6.7	Test Results	88
4.7	6dB Bandwidth Measurement.....	89
4.7.1	Limits of 6dB Bandwidth Measurement.....	89
4.7.2	Test Setup.....	89
4.7.3	Test Instruments	89
4.7.4	Test Procedure	89
4.7.5	Deviation from Test Standard	89
4.7.6	EUT Operating Condition	89
4.7.7	Test Results	90
5	Pictures of Test Arrangements.....	92
	Annex A- Radiated Out of Band Emission (OOBE) Measurement (For U-NII-3 band).....	93
	Appendix – Information on the Testing Laboratories	99

Release Control Record

Issue No.	Description	Date Issued
RF161026C20-1	Original release	Dec. 28, 2016

1 Certificate of Conformity

Product: Secured Wireless Access Point

Brand: Fortinet Inc.

Test Model: FortiAP U221EV, FortiAP U223EV

Series Model: FortiAP U221EVxxxxxx, FAP-U221EVxxxxxx, FORTIAP-U221EVxxxxxx, FortiAP U223EVxxxxxx, FAP-U223EVxxxxxx, FORTIAP-U223EVxxxxxx (where "x" can be used as "A-Z" or "0-9" or "-" or blank for software changes or marketing purposes only) (refer to item 3.1 for more details)

Sample Status: Engineering sample

Applicant: Fortinet Inc.

Test Date: Oct. 26 ~ Dec. 28, 2016

Standard: 47 CFR FCC Part 15, Subpart E (Section 15.407)
ANSI C63.10:2013

The above equipment has been tested by **Bureau Veritas Consumer Products Services (H.K.) Ltd., Taoyuan Branch**, and found compliance with the requirement of the above standards. The test record, data evaluation & Equipment Under Test (EUT) configurations represented herein are true and accurate accounts of the measurements of the sample's EMC characteristics under the Conditions specified in this report.

Prepared by :  , **Date:** Dec. 28, 2016
Pettie Chen / Senior Specialist

Approved by :  , **Date:** Dec. 28, 2016
Ken Liu / Senior Manager

2 Summary of Test Results

47 CFR FCC Part 15, Subpart E (Section 15.407)			
FCC Clause	Test Item	Result	Remarks
15.407(b)(6)	AC Power Conducted Emissions	Pass	Meet the requirement of limit. Minimum passing margin is -5.10dB at 0.51719MHz.
15.407(b) (1/2/3/4(i/ii)/6)	Radiated Emissions & Band Edge Measurement	Pass	Meet the requirement of limit. Minimum passing margin is -1.2dB at 5150.00MHz.
15.407(a)(1/2/3)	Max Average Transmit Power	Pass	Meet the requirement of limit.
15.407(a)(1/2/3)	Peak Power Spectral Density	Pass	Meet the requirement of limit.
15.407(e)	6dB bandwidth	Pass	Meet the requirement of limit. (U-NII-3 Band only)
15.407(g)	Frequency Stability	Pass	Meet the requirement of limit.
15.203	Antenna Requirement	Pass	Antenna connector is IPEX or RP SMA plug not a standard connector.

2.1 Measurement Uncertainty

Where relevant, the following measurement uncertainty levels have been estimated for tests performed on the EUT as specified in CISPR 16-4-2:

Measurement	Frequency	Expanded Uncertainty (k=2) (\pm)
Conducted Emissions at mains ports	150kHz ~ 30MHz	2.44 dB
Radiated Emissions up to 1 GHz	30MHz ~ 200MHz	3.86 dB
	200MHz ~ 1000MHz	3.87 dB
Radiated Emissions above 1 GHz	1GHz ~ 18GHz	2.29 dB
	18GHz ~ 40GHz	2.29 dB

2.2 Modification Record

There were no modifications required for compliance.

3 General Information

3.1 General Description of EUT

Product	Secured Wireless Access Point
Brand	Fortinet Inc.
Test Model	FortiAP U221EV, FortiAP U223EV
Series Model	FortiAP U221EVxxxxxx, FAP-U221EVxxxxxx, FORTIAP-U221EVxxxxxx, FortiAP U223EVxxxxxx, FAP-U223EVxxxxxx, FORTIAP-U223EVxxxxxx (where "x" can be used as "A-Z" or "0-9" or "-" or blank for software changes or marketing purposes only)
Model Difference	Refer to Note 1 for more details
Sample Status	Engineering sample
Power Supply Rating	12Vdc (adapter) 54Vdc (POE)
Modulation Type	256QAM, 64QAM, 16QAM, QPSK, BPSK
Modulation Technology	OFDM
Transfer Rate	802.11a: 54/48/36/24/18/12/9/6Mbps 802.11n: up to 300Mbps 802.11ac: up to 867Mbps
Operating Frequency	5180~5240MHz, 5745~5825MHz
Number of Channel	5180~5240MHz: 802.11a, 802.11n (HT20), 802.11ac (VHT20): 4 802.11n (HT40), 802.11ac (VHT40): 2 802.11ac (VHT80): 1 5745~5825MHz: 802.11a, 802.11n (HT20), 802.11ac (VHT20): 5 802.11n (HT40), 802.11ac (VHT40): 2 802.11ac (VHT80): 1
Output Power	CDD Mode: 5180 ~ 5240MHz: 148.263mW 5745 ~ 5825MHz: 145.758mW Beamforming Mode: 5180 ~ 5240MHz: 74.307mW 5745 ~ 5825MHz: 73.052mW
Antenna Type	Refer to Note 4
Antenna Connector	Refer to Note 4
Accessory Device	Adapter
Data Cable Supplied	NA

Note:

1. All models are listed as below (where “x” can be used as “A-Z” or “0-9” or “-“ or blank for software changes or marketing purposes only). Model FortiAP U221EV, FortiAP U223EV are the representative for final test.

Brand	Model	Difference
Fortinet Inc.	FortiAP U221EVxxxxxx	Internal antenna
	FAP-U221EVxxxxxx	
	FORTIAP-U221EVxxxxxx	
	FortiAP U223EVxxxxxx	External antenna
	FAP-U223EVxxxxxx	
	FORTIAP-U223EVxxxxxx	

2. The EUT incorporates a MIMO function. Physically, the EUT provides 2 completed transmitters and 2 receivers.

Band	Modulation Mode	CDD Mode	Beamforming Mode	TX Function
5GHz	802.11a	Support	Not Support	2TX
	802.11n (HT20)	Support	Support	2TX
	802.11n (HT40)	Support	Support	2TX
	802.11ac (VHT20)	Support	Support	2TX
	802.11ac (VHT40)	Support	Support	2TX
	802.11ac (VHT80)	Support	Support	2TX

* The modulation and bandwidth are similar for 802.11n mode for HT20/HT40 and 802.11ac mode for HT20/HT40, therefore investigated worst case to representative mode in test report. (Final test mode refer section 3.2.1)

* For 802.11n and 802.11ac, CDD mode and Beamforming mode are presented in power output test item. For other test items, CDD mode is the worst case for final tests after pretesting.

3. The EUT consumes power from the following adapter and POE (POE as support units only).

Adapter	
Brand	Asian Power Devices Inc.
Model	WA-30J12R
Input Power	100-240Vac, 50-60Hz, 0.9A Max.
Output Power	12Vdc, 2.5A
Power Line	1.8m power cable without core attached on adapter

POE (support units only)	
Brand	EnGenius
Model	EPA5006GAT
Input Power	100-240Vac, 50-60Hz, 0.8A
Output Power	54Vdc, 0.6A
Power Line	0.5m power cable without core

4. The EUT uses following antennas.

Antenna Type	PIFA	Antenna Connector	IPEX
Gain (dBi)	Frequency (MHz)		
	2400~2500	5150~5850	
WLAN Internal Ant. 1	4.36	-	
WLAN Internal Ant. 2	4.95	-	
WLAN Internal Ant. 3	-	5.64	
WLAN Internal Ant. 4	-	5.83	
BT Ant.	3.67	-	

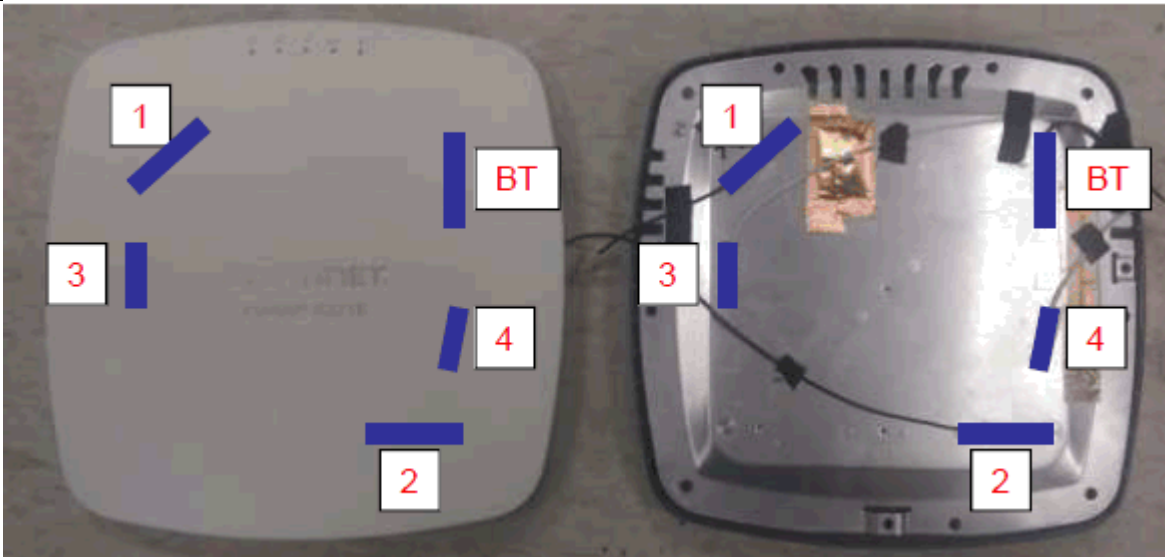

Antenna Type	Dipole	Antenna Connector	RP SMA plug
Gain (dBi)	Frequency (MHz)		
	2400~2500	5150~5850	
WLAN External Ant.	4.58	5.35	

5. WLAN 2.4GHz and WLAN 5GHz and BT technologies can transmit at same time.

6. Spurious emission of the simultaneous operation (WLAN 2.4GHz and WLAN 5GHz and BT) has been evaluated and no non-compliance was found.

3.2 Description of Test Modes

FOR 5180 ~ 5240MHz:

4 channels are provided for 802.11a, 802.11n (HT20), 802.11ac (VHT20):

Channel	Frequency	Channel	Frequency
36	5180 MHz	44	5220 MHz
40	5200 MHz	48	5240 MHz

2 channels are provided for 802.11n (HT40), 802.11ac (VHT40):

Channel	Frequency	Channel	Frequency
38	5190 MHz	46	5230 MHz

1 channel is provided for 802.11ac (VHT80):

Channel	Frequency
42	5210MHz

FOR 5745 ~ 5825MHz:

5 channels are provided for 802.11a, 802.11n (HT20), 802.11ac (VHT20):

Channel	Frequency	Channel	Frequency
149	5745MHz	161	5805MHz
153	5765MHz	165	5825MHz
157	5785MHz		

2 channels are provided for 802.11n (HT40), 802.11ac (VHT40):

Channel	Frequency	Channel	Frequency
151	5755MHz	159	5795MHz

1 channel is provided for 802.11ac (VHT80):

Channel	Frequency
155	5775MHz

3.2.1 Test Mode Applicability and Tested Channel Detail

EUT Configure Mode	Applicable to				Description
	RE \geq 1G	RE<1G	PLC	APCM	
A	√	√	√	√	Internal antenna, Power from adapter
B	-	√	√	-	Internal antenna, Power from POE
C	√	√	√	-	External antenna, Power from adapter
D	-	√	√	-	External antenna, Power from POE

Where RE \geq 1G: Radiated Emission above 1GHz & Bandedge Measurement
 RE<1G: Radiated Emission below 1GHz
 PLC: Power Line Conducted Emission
 APCM: Antenna Port Conducted Measurement

Note:

- The EUT had been pre-tested on the positioned of each 3 axis.
 RE<1G: The worst case was found when positioned on **Z-plane**
 RE \geq 1G: The worst case was found when positioned on **X-plane** (test mode A & B) and **Z-plane** (test mode C & D).
- "-" means no effect.
- After pre-testing, test mode A was the worst for the final test.

Radiated Emission Test (Above 1GHz):

- Pre-Scan has been conducted to determine the worst-case mode from all possible combinations between available modulations, data rates and antenna ports (if EUT with antenna diversity architecture).
- Following channel(s) was (were) selected for the final test as listed below.

EUT Configure Mode	Mode	Frequency Band (MHz)	Available Channel	Tested Channel	Modulation Technology	Data Rate (Mbps)
A, C	802.11a	5180-5240	36 to 48	36, 40, 48	OFDM	6.0
A, C	802.11n (HT20)		36 to 48	36, 40, 48	OFDM	7.2
A, C	802.11n (HT40)		38 to 46	38, 46	OFDM	15.0
A, C	802.11ac (VHT80)		42	42	OFDM	130.0
A, C	802.11a	5745-5825	149 to 165	149, 157, 165	OFDM	6.0
A, C	802.11n (HT20)		149 to 165	149, 157, 165	OFDM	7.2
A, C	802.11n (HT40)		151 to 159	151, 159	OFDM	15.0
A, C	802.11ac (VHT80)		155	155	OFDM	130.0

Radiated Emission Test (Below 1GHz):

- Pre-Scan has been conducted to determine the worst-case mode from all possible combinations between available modulations, data rates and antenna ports (if EUT with antenna diversity architecture).
- Following channel(s) was (were) selected for the final test as listed below.

EUT Configure Mode	Mode	Frequency Band (MHz)	Available Channel	Tested Channel	Modulation Technology	Data Rate (Mbps)
A, B, C, D	802.11a	5180-5240	36 to 48	149	OFDM	6.0
	802.11a	5745-5825	149 to 165		OFDM	6.0

Power Line Conducted Emission Test:

- Pre-Scan has been conducted to determine the worst-case mode from all possible combinations between available modulations, data rates and antenna ports (if EUT with antenna diversity architecture).
- Following channel(s) was (were) selected for the final test as listed below.

EUT Configure Mode	Mode	Frequency Band (MHz)	Available Channel	Tested Channel	Modulation Technology	Data Rate (Mbps)
A, B, C, D	802.11a	5180-5240	36 to 48	149	OFDM	6.0
	802.11a	5745-5825	149 to 165		OFDM	6.0

Antenna Port Conducted Measurement:

- This item includes all test value of each mode, but only includes spectrum plot of worst value of each mode.
- Pre-Scan has been conducted to determine the worst-case mode from all possible combinations between available modulations, data rates and antenna ports (if EUT with antenna diversity architecture).
- Following channel(s) was (were) selected for the final test as listed below.

EUT Configure Mode	Mode	Frequency Band (MHz)	Available Channel	Tested Channel	Modulation Technology	Data Rate (Mbps)
CDD Mode						
A	802.11a	5180-5240	36 to 48	36, 40, 48	OFDM	6.0
A	802.11n (HT20)		36 to 48	36, 40, 48	OFDM	7.2
A	802.11n (HT40)		38 to 46	38, 46	OFDM	15.0
A	802.11ac (VHT80)		42	42	OFDM	130.0
A	802.11a	5745-5825	149 to 165	149, 157, 165	OFDM	6.0
A	802.11n (HT20)		149 to 165	149, 157, 165	OFDM	7.2
A	802.11n (HT40)		151 to 159	151, 159	OFDM	15.0
A	802.11ac (VHT80)		155	155	OFDM	130.0
Beamforming Mode						
A	802.11n (HT20)	5180-5240	36 to 48	36, 40, 48	OFDM	7.2
A	802.11n (HT40)		38 to 46	38, 46	OFDM	15.0
A	802.11ac (VHT80)		42	42	OFDM	130.0
A	802.11n (HT20)	5745-5825	149 to 165	149, 157, 165	OFDM	7.2
A	802.11n (HT40)		151 to 159	151, 159	OFDM	15.0
A	802.11ac (VHT80)		155	155	OFDM	130.0

Test Condition:

Applicable to	Environmental Conditions	Input Power	Tested by
RE \geq 1G	20 deg. C, 66% RH	120Vac, 60Hz	James Yang
RE $<$ 1G	22 deg. C, 68% RH	120Vac, 60Hz	James Yang
	19 deg. C, 70% RH	54Vdc (POE)	Jones Chang
PLC	20 deg. C, 66% RH	120Vac, 60Hz	James Yang
	22 deg. C, 66% RH	54Vdc (POE)	Jones Chang
APCM	25 deg. C, 60% RH	120Vac, 60Hz	Leo Tsai

3.3 Duty Cycle of Test Signal

Duty cycle of test signal is < 98 %, duty factor is required

802.11a: Duty cycle = $2.060/2.190 = 0.941$, Duty factor = $10 * \log(1/0.941) = 0.27$

802.11n (HT20): Duty cycle = $1.92/2.02 = 0.950$, Duty factor = $10 * \log(1/0.950) = 0.22$

802.11n (HT40): Duty cycle = $0.935/1.04 = 0.899$, Duty factor = $10 * \log(1/0.899) = 0.46$

802.11ac (VHT80): Duty cycle = $0.452/0.49 = 0.922$, Duty factor = $10 * \log(1/0.922) = 0.35$

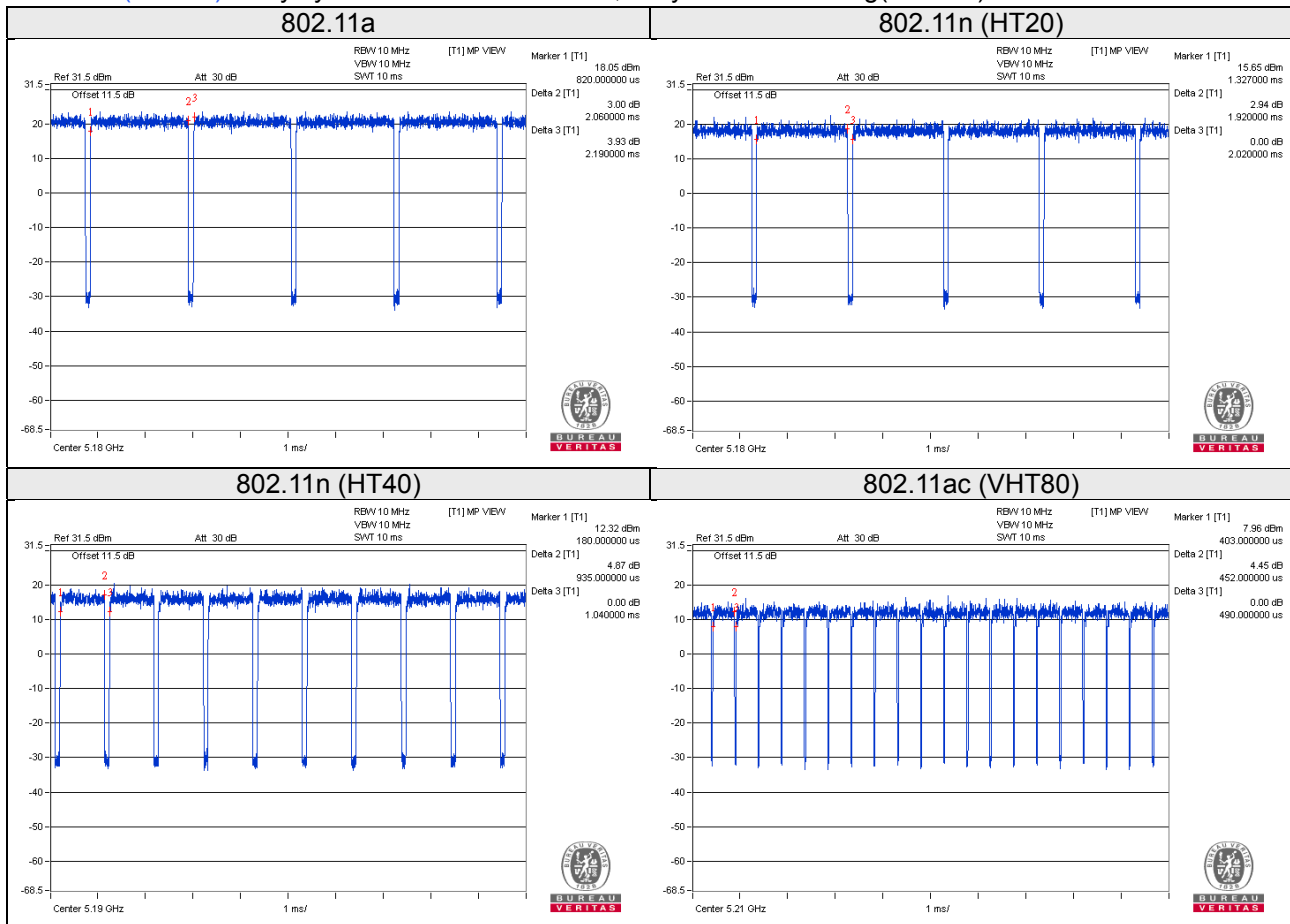

3.4 Description of Support Units

The EUT has been tested as an independent unit together with other necessary accessories or support units. The following support units or accessories were used to form a representative test configuration during the tests.

ID	Product	Brand	Model No.	Serial No.	FCC ID	Remarks
A.	Notebook	DELL	E5410	1HC2XM1	FCC DoC Approved	-
B.	Flash	HP	v250W	01	NA	-
C.	POE	EnGenius	EPA5006GAT	NA	NA	Option of EUT I/P: 100-240Vac, 50-60Hz, 0.8A O/P: 54Vdc, 0.6A 0.5m power cable w/o core

Note:

1. All power cords of the above support units are non-shielded (1.8m).
2. Item A acted as a communication partner to transfer data.

ID	Descriptions	Qty.	Length (m)	Shielding (Yes/No)	Cores (Qty.)	Remarks
1.	RJ45	1	10	N	0	-
2.	RJ45	1	1.8	N	0	-

3.4.1 Configuration of System under Test

Mode A, C

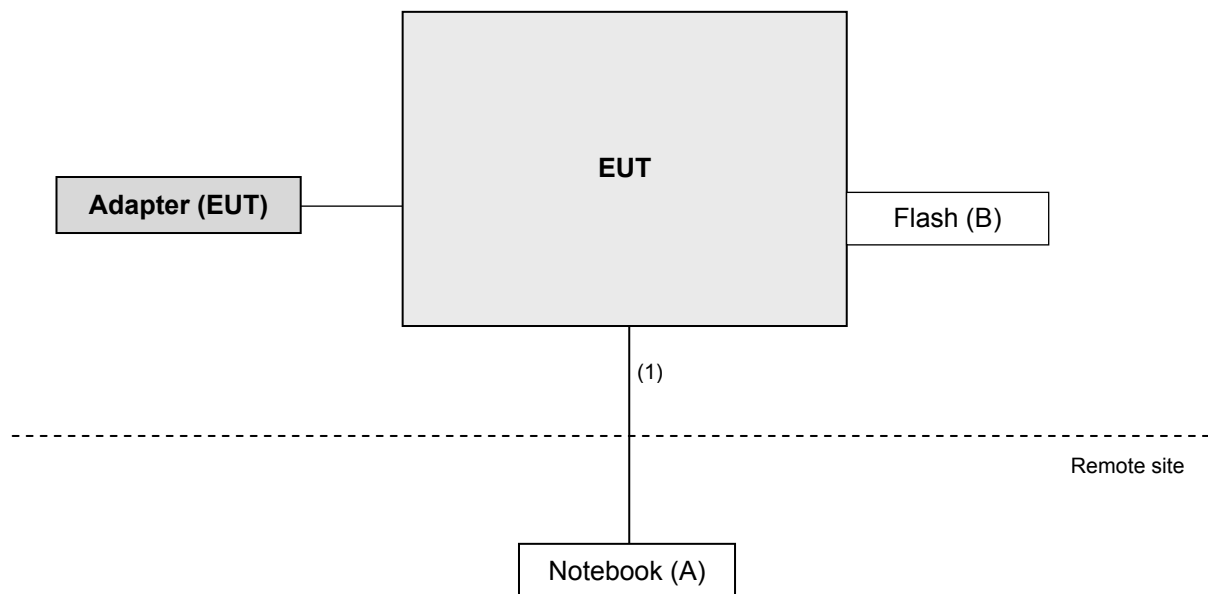

Mode B, D

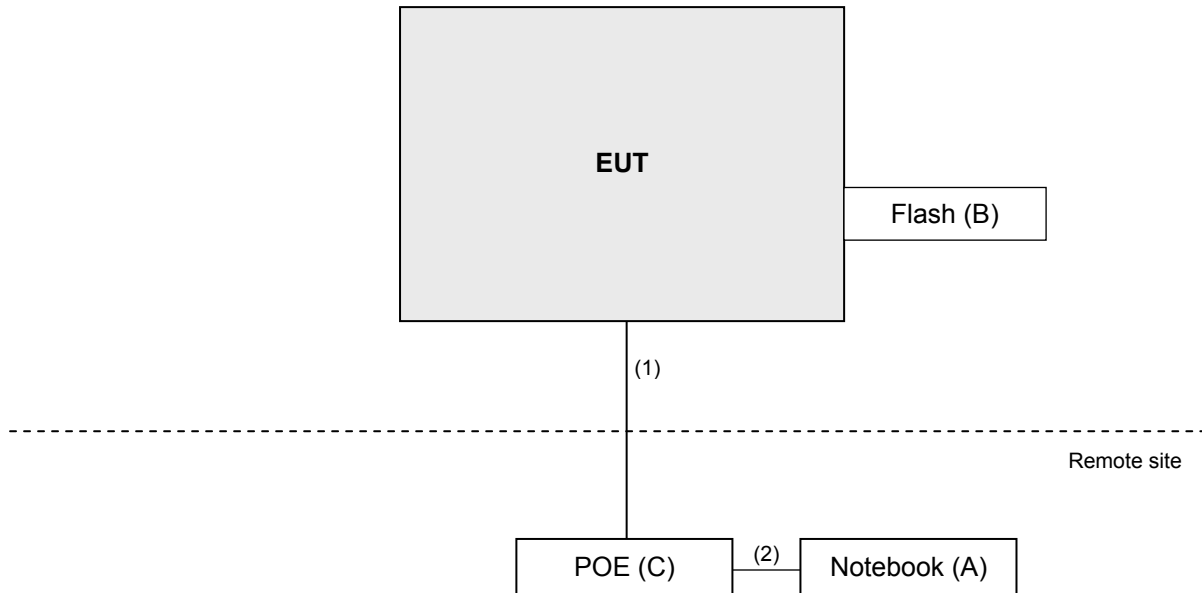

3.5 General Description of Applied Standard

The EUT is a RF Product. According to the specifications of the manufacturer, it must comply with the requirements of the following standards:

FCC Part 15, Subpart E (15.407)

789033 D02 General UNII Test Procedures New Rules v01r04

662911 D01 Multiple Transmitter Output v02r01

ANSI C63.10:2013

All test items have been performed and recorded as per the above standards.

Note: The EUT has been verified to comply with the requirements of FCC Part 15, Subpart B, Class B (DoC).
The test report has been issued separately.

4 Test Types and Results

4.1 Radiated Emission and Bandedge Measurement

4.1.1 Limits of Radiated Emission and Bandedge Measurement

Radiated emissions which fall in the restricted bands must comply with the radiated emission limits specified as below table.

Frequencies (MHz)	Field Strength (microvolts/meter)	Measurement Distance (meters)
0.009 ~ 0.490	2400/F(kHz)	300
0.490 ~ 1.705	24000/F(kHz)	30
1.705 ~ 30.0	30	30
30 ~ 88	100	3
88 ~ 216	150	3
216 ~ 960	200	3
Above 960	500	3

NOTE:

1. The lower limit shall apply at the transition frequencies.
2. Emission level (dBuV/m) = 20 log Emission level (uV/m).
3. For frequencies above 1000MHz, the field strength limits are based on average detector, however, the peak field strength of any emission shall not exceed the maximum permitted average limits, specified above by more than 20dB under any condition of modulation.

Limits of unwanted emission out of the restricted bands

Applicable To		Limit	
789033 D02 General UNII Test Procedure New Rules v01r04		Field Strength at 3m	
		PK:74 (dBuV/m)	AV:54 (dBuV/m)
Frequency Band	Applicable To	EIRP Limit	Equivalent Field Strength at 3m
5150~5250 MHz	15.407(b)(1)	PK:-27 (dBm/MHz)	PK:68.2(dBuV/m)
5250~5350 MHz	15.407(b)(2)		
5470~5725 MHz	15.407(b)(3)		
5725~5850 MHz	<input checked="" type="checkbox"/> 15.407(b)(4)(i)	PK:-27 (dBm/MHz) ^{*1} PK:10 (dBm/MHz) ^{*2} PK:15.6 (dBm/MHz) ^{*3} PK:27 (dBm/MHz) ^{*4}	PK: 68.2(dBuV/m) ^{*1} PK:105.2 (dBuV/m) ^{*2} PK: 110.8(dBuV/m) ^{*3} PK:122.2 (dBuV/m) ^{*4}
	<input type="checkbox"/> 15.407(b)(4)(ii)	Emission limits in section 15.247(d)	
^{*1} beyond 75 MHz or more above of the band edge.		^{*2} below the band edge increasing linearly to 10 dBm/MHz at 25 MHz above.	
^{*3} below the band edge increasing linearly to a level of 15.6 dBm/MHz at 5 MHz above.		^{*4} from 5 MHz above or below the band edge increasing linearly to a level of 27 dBm/MHz at the band edge.	

Note: The following formula is used to convert the equipment isotropic radiated power (eirp) to field strength:

$$E = \frac{1000000\sqrt{30P}}{3} \mu\text{V/m, where P is the eirp (Watts).}$$

4.1.2 Test Instruments

Description & Manufacturer	Model No.	Serial No.	Cal. Date	Cal. Due
Test Receiver ROHDE & SCHWARZ	ESIB7	100187	Apr. 18, 2016	Apr. 17, 2017
Spectrum Analyzer ROHDE & SCHWARZ	FSP40	100041	Nov. 16, 2016	Nov. 15, 2017
BILOG Antenna SCHWARZBECK	VULB9168	9168-171	Jan. 07, 2016	Jan. 06, 2017
HORN Antenna SCHWARZBECK	9120D	209	Dec. 27, 2016	Dec. 26, 2017
HORN Antenna SCHWARZBECK	BBHA 9170	BBHA9170241	Jan. 18, 2016	Jan. 17, 2017
Loop Antenna	EM-6879	269	Aug. 11, 2016	Aug. 10, 2017
Preamplifier Agilent	8447D	2944A10738	Aug. 22, 2016	Aug. 21, 2017
Preamplifier Agilent	8449B	3008A01964	Aug. 22, 2016	Aug. 21, 2017
RF signal cable HUBER+SUHNER	SUCOFLEX 104	Cable-CH3-03 (214378)	Aug. 22, 2016	Aug. 21, 2017
RF signal cable HUBER+SUHNER	SUCOFLEX 106	Cable-CH3-03 (309224+12738)	Aug. 22, 2016	Aug. 21, 2017
Software BV ADT	ADT_Radiated_ V7.6.15.9.4	NA	NA	NA
Antenna Tower inn-co GmbH	MA 4000	013303	NA	NA
Antenna Tower Controller BV ADT	AT100	AT93021702	NA	NA
Turn Table BV ADT	TT100	TT93021702	NA	NA
Turn Table Controller BV ADT	SC100	SC93021702	NA	NA
26GHz ~ 40GHz Amplifier	EM26400	815221	Oct. 17, 2016	Oct. 16, 2017
High Speed Peak Power Meter	ML2495A	0824012	Aug. 11, 2016	Aug. 10, 2017
Power Sensor	MA2411B	0738171	Aug. 11, 2016	Aug. 10, 2017

- Note:
1. The calibration interval of the above test instruments is 12 months and the calibrations are traceable to NML/ROC and NIST/USA.
 2. The test was performed in HwaYa Chamber 3.
 3. The horn antenna and preamplifier (model: 8449B) are used only for the measurement of emission frequency above 1GHz if tested.
 4. The FCC Site Registration No. is 988962.
 5. The IC Site Registration No. is IC 7450F-3.

4.1.3 Test Procedure

For Radiated emission below 30MHz

- a. The EUT was placed on the top of a rotating table 0.8 meters above the ground at a 3 meter chamber room. The table was rotated 360 degrees to determine the position of the highest radiation.
- b. The EUT was set 3 meters away from the interference-receiving antenna, which was mounted on the top of a variable-height antenna tower.
- c. Both X and Y axes of the antenna are set to make the measurement.
- d. For each suspected emission, the EUT was arranged to its worst case and the rotatable table was turned from 0 degrees to 360 degrees to find the maximum reading.
- e. The test-receiver system was set to Quasi-Peak Detect Function and Specified Bandwidth with Maximum Hold Mode.

NOTE:

1. The resolution bandwidth and video bandwidth of test receiver/spectrum analyzer is 9kHz at frequency below 30MHz.

For Radiated emission above 30MHz

- a. The EUT was placed on the top of a rotating table 0.8 meters (for 30MHz ~ 1GHz) / 1.5 meters (for above 1GHz) above the ground at 3 meter chamber room for test. The table was rotated 360 degrees to determine the position of the highest radiation.
- b. The EUT was set 3 meters away from the interference-receiving antenna, which was mounted on the top of a variable-height antenna tower.
- c. The height of antenna is varied from one meter to four meters above the ground to determine the maximum value of the field strength. Both horizontal and vertical polarizations of the antenna are set to make the measurement.
- d. For each suspected emission, the EUT was arranged to its worst case and then the antenna was tuned to heights from 1 meter to 4 meters and the rotatable table was turned from 0 degrees to 360 degrees to find the maximum reading.
- e. The test-receiver system was set to quasi-peak detect function and specified bandwidth with maximum hold mode when the test frequency is below 1 GHz.
- f. The test-receiver system was set to peak and average detect function and specified bandwidth with maximum hold mode when the test frequency is above 1 GHz. If the peak reading value also meets average limit, measurement with the average detector is unnecessary.

Note:

1. The resolution bandwidth and video bandwidth of test receiver/spectrum analyzer is 120kHz for Quasi-peak detection (QP) at frequency below 1GHz.
2. The resolution bandwidth of test receiver/spectrum analyzer is 1 MHz and the video bandwidth is 3 MHz for Peak detection (PK) at frequency above 1GHz.
3. The resolution bandwidth of test receiver/spectrum analyzer is 1MHz and the video bandwidth is $\geq 1/T$ (Duty cycle < 98%) or 10Hz (Duty cycle $\geq 98\%$) for Average detection (AV) at frequency above 1GHz.
4. All modes of operation were investigated and the worst-case emissions are reported.

4.1.4 Deviation from Test Standard

No deviation.

4.1.5 Test Setup

For Radiated emission below 30MHz

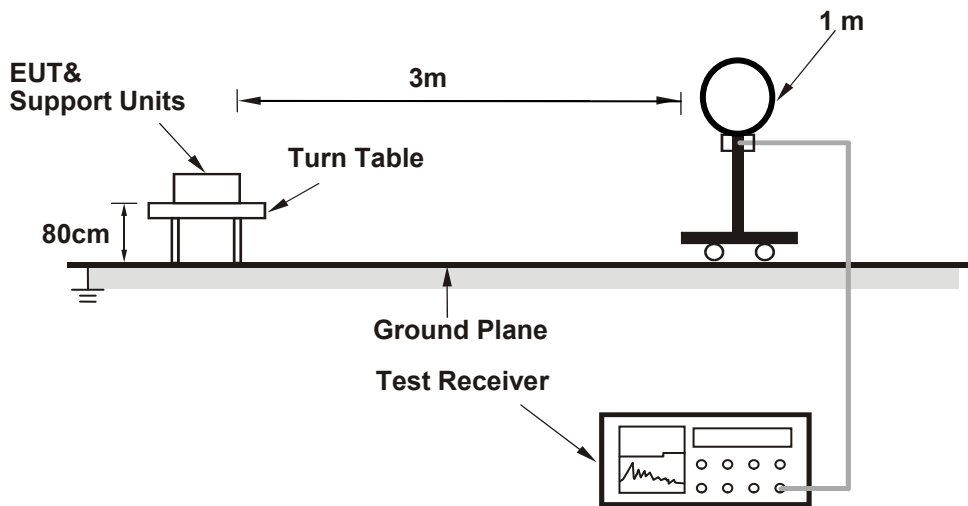

For Radiated emission 30MHz to 1GHz

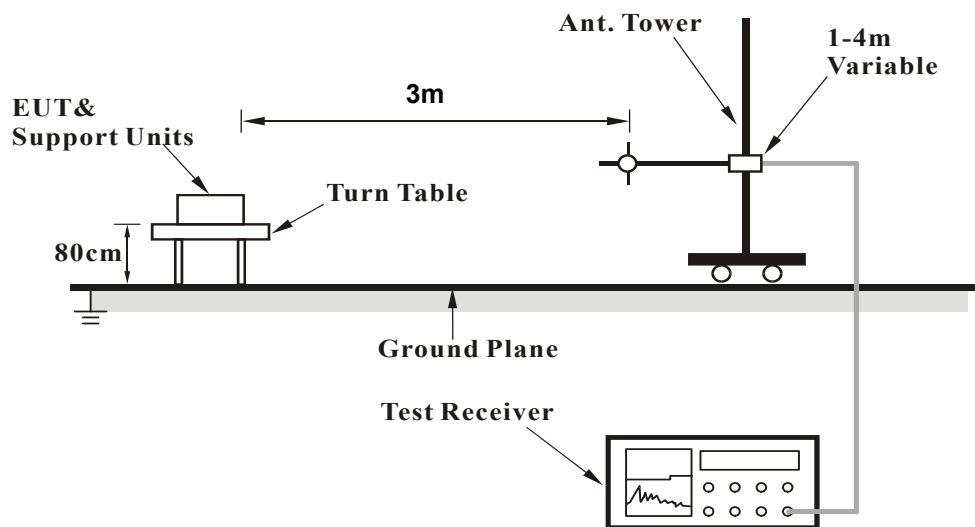

For Radiated emission above 1GHz

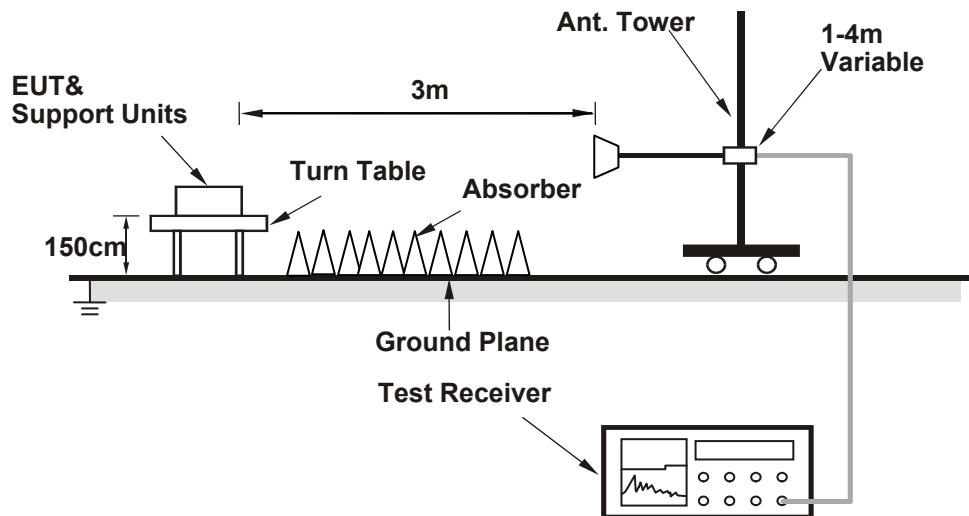

For the actual test configuration, please refer to the attached file (Test Setup Photo).

4.1.6 EUT Operating Conditions

- Placed the EUT on the testing table.
- Prepared a notebook to act as a communication partner and placed it outside of testing area.
- The communication partner connected with EUT via a RJ45 cable and ran a test program (provided by manufacturer) to enable EUT under transmission condition continuously at specific channel frequency.
- The communication partner sent data to EUT by command "PING".
- The necessary accessories enable the system in full functions.

4.1.7 Test Results

Above 1GHz Worst-case Data:

Mode A

802.11a

CHANNEL	TX Channel 36	DETECTOR FUNCTION	Peak (PK)
FREQUENCY RANGE	1GHz ~ 40GHz		Average (AV)

ANTENNA POLARITY & TEST DISTANCE: HORIZONTAL AT 3 M								
NO.	FREQ. (MHz)	EMISSION LEVEL (dBuV/m)	LIMIT (dBuV/m)	MARGIN (dB)	ANTENNA HEIGHT (m)	TABLE ANGLE (Degree)	RAW VALUE (dBuV)	CORRECTION FACTOR (dB/m)
1	5150.00	63.0 PK	74.0	-11.0	2.48 H	242	58.2	4.8
2	5150.00	46.0 AV	54.0	-8.0	2.48 H	242	41.2	4.8
3	*5180.00	106.9 PK			2.49 H	237	68.2	38.7
4	*5180.00	97.3 AV			2.49 H	237	58.6	38.7
5	#10360.00	58.6 PK	74.0	-15.4	1.76 H	248	41.0	17.6
6	#10360.00	46.0 AV	54.0	-8.0	1.76 H	248	28.4	17.6
ANTENNA POLARITY & TEST DISTANCE: VERTICAL AT 3 M								
NO.	FREQ. (MHz)	EMISSION LEVEL (dBuV/m)	LIMIT (dBuV/m)	MARGIN (dB)	ANTENNA HEIGHT (m)	TABLE ANGLE (Degree)	RAW VALUE (dBuV)	CORRECTION FACTOR (dB/m)
1	5150.00	70.1 PK	74.0	-3.9	2.85 V	225	65.3	4.8
2	5150.00	52.6 AV	54.0	-1.4	2.85 V	225	47.8	4.8
3	*5180.00	114.0 PK			2.63 V	220	75.3	38.7
4	*5180.00	104.5 AV			2.63 V	220	65.8	38.7
5	#10360.00	60.5 PK	74.0	-13.5	2.92 V	265	42.9	17.6
6	#10360.00	49.1 AV	54.0	-4.9	2.92 V	265	31.5	17.6

Remarks:

1. Emission Level(dBuV/m) = Raw Value(dBuV) + Correction Factor(dB/m)
2. Correction Factor(dB/m) = Antenna Factor(dB/m) + Cable Factor(dB)
– Pre-Amplifier Factor(dB)
3. The other emission levels were very low against the limit.
4. Margin value = Emission Level – Limit value
5. " * ": Fundamental frequency.
6. " # ": The radiated frequency is out of the restricted band.

CHANNEL	TX Channel 40	DETECTOR FUNCTION	Peak (PK)
FREQUENCY RANGE	1GHz ~ 40GHz		Average (AV)

ANTENNA POLARITY & TEST DISTANCE: HORIZONTAL AT 3 M

NO.	FREQ. (MHz)	EMISSION LEVEL (dBuV/m)	LIMIT (dBuV/m)	MARGIN (dB)	ANTENNA HEIGHT (m)	TABLE ANGLE (Degree)	RAW VALUE (dBuV)	CORRECTION FACTOR (dB/m)
1	*5200.00	109.1 PK			2.45 H	84	70.4	38.7
2	*5200.00	99.5 AV			2.45 H	84	60.8	38.7
3	#10400.00	60.4 PK	74.0	-13.6	2.73 H	219	42.8	17.6
4	#10400.00	46.4 AV	54.0	-7.6	2.73 H	219	28.8	17.6

ANTENNA POLARITY & TEST DISTANCE: VERTICAL AT 3 M

NO.	FREQ. (MHz)	EMISSION LEVEL (dBuV/m)	LIMIT (dBuV/m)	MARGIN (dB)	ANTENNA HEIGHT (m)	TABLE ANGLE (Degree)	RAW VALUE (dBuV)	CORRECTION FACTOR (dB/m)
1	*5200.00	116.5 PK			2.73 V	218	77.8	38.7
2	*5200.00	106.7 AV			2.73 V	218	68.0	38.7
3	#10400.00	59.6 PK	74.0	-14.4	2.38 V	254	42.0	17.6
4	#10400.00	46.7 AV	54.0	-7.3	2.38 V	254	29.1	17.6

Remarks:

1. Emission Level(dBuV/m) = Raw Value(dBuV) + Correction Factor(dB/m)
2. Correction Factor(dB/m) = Antenna Factor(dB/m) + Cable Factor(dB)
– Pre-Amplifier Factor(dB)
3. The other emission levels were very low against the limit.
4. Margin value = Emission Level – Limit value
5. " * ": Fundamental frequency.
6. " # ": The radiated frequency is out of the restricted band.

CHANNEL	TX Channel 48	DETECTOR FUNCTION	Peak (PK)
FREQUENCY RANGE	1GHz ~ 40GHz		Average (AV)

ANTENNA POLARITY & TEST DISTANCE: HORIZONTAL AT 3 M

NO.	FREQ. (MHz)	EMISSION LEVEL (dBuV/m)	LIMIT (dBuV/m)	MARGIN (dB)	ANTENNA HEIGHT (m)	TABLE ANGLE (Degree)	RAW VALUE (dBuV)	CORRECTION FACTOR (dB/m)
1	*5240.00	108.7 PK			2.38 H	84	69.8	38.9
2	*5240.00	99.0 AV			2.38 H	84	60.1	38.9
3	5350.00	57.2 PK	74.0	-16.8	2.30 H	89	51.7	5.5
4	5350.00	44.0 AV	54.0	-10.0	2.30 H	89	38.5	5.5
5	#10480.00	60.6 PK	74.0	-13.4	2.03 H	308	42.2	18.4
6	#10480.00	46.9 AV	54.0	-7.1	2.03 H	308	28.5	18.4

ANTENNA POLARITY & TEST DISTANCE: VERTICAL AT 3 M

NO.	FREQ. (MHz)	EMISSION LEVEL (dBuV/m)	LIMIT (dBuV/m)	MARGIN (dB)	ANTENNA HEIGHT (m)	TABLE ANGLE (Degree)	RAW VALUE (dBuV)	CORRECTION FACTOR (dB/m)
1	*5240.00	116.2 PK			2.51 V	33	77.3	38.9
2	*5240.00	106.7 AV			2.51 V	33	67.8	38.9
3	5350.00	58.5 PK	74.0	-15.5	2.69 V	37	53.0	5.5
4	5350.00	45.4 AV	54.0	-8.6	2.69 V	37	39.9	5.5
5	#10480.00	60.2 PK	74.0	-13.8	2.85 V	244	41.8	18.4
6	#10480.00	47.0 AV	54.0	-7.0	2.85 V	244	28.6	18.4

Remarks:

1. Emission Level(dBuV/m) = Raw Value(dBuV) + Correction Factor(dB/m)
2. Correction Factor(dB/m) = Antenna Factor(dB/m) + Cable Factor(dB)
– Pre-Amplifier Factor(dB)
3. The other emission levels were very low against the limit.
4. Margin value = Emission Level – Limit value
5. " * ": Fundamental frequency.
6. " # ": The radiated frequency is out of the restricted band.

CHANNEL	TX Channel 149	DETECTOR FUNCTION	Peak (PK)
FREQUENCY RANGE	1GHz ~ 40GHz		Average (AV)

ANTENNA POLARITY & TEST DISTANCE: HORIZONTAL AT 3 M

NO.	FREQ. (MHz)	EMISSION LEVEL (dBuV/m)	LIMIT (dBuV/m)	MARGIN (dB)	ANTENNA HEIGHT (m)	TABLE ANGLE (Degree)	RAW VALUE (dBuV)	CORRECTION FACTOR (dB/m)
1	1600.00	48.3 PK	74.0	-25.7	1.49 H	270	53.1	-4.8
2	1600.00	46.4 AV	54.0	-7.6	1.49 H	270	51.2	-4.8
3	#5612.00	59.3 PK	68.2	-8.9	2.20 H	94	53.4	5.9
4	#5714.90	61.9 PK	109.4	-47.5	2.72 H	98	55.6	6.3
5	#5722.90	68.8 PK	117.4	-48.6	2.76 H	97	62.5	6.3
6	#5725.00	52.5 PK	122.2	-69.7	2.48 H	106	46.2	6.3
7	*5745.00	103.2 PK			2.20 H	94	63.2	40.0
8	*5745.00	94.1 AV			2.20 H	94	54.1	40.0
9	#5965.60	59.7 PK	68.2	-8.5	2.20 H	94	52.8	6.9
10	11490.00	60.3 PK	74.0	-13.7	1.97 H	162	41.0	19.3
11	11490.00	47.5 AV	54.0	-6.5	1.97 H	162	28.2	19.3

ANTENNA POLARITY & TEST DISTANCE: VERTICAL AT 3 M

NO.	FREQ. (MHz)	EMISSION LEVEL (dBuV/m)	LIMIT (dBuV/m)	MARGIN (dB)	ANTENNA HEIGHT (m)	TABLE ANGLE (Degree)	RAW VALUE (dBuV)	CORRECTION FACTOR (dB/m)
1	1600.00	50.1 PK	74.0	-23.9	2.98 V	44	54.9	-4.8
2	1600.00	48.3 AV	54.0	-5.7	2.98 V	44	53.1	-4.8
3	#5620.00	59.3 PK	68.2	-8.9	2.21 V	241	53.2	6.1
4	#5714.90	67.6 PK	109.4	-41.8	2.74 V	113	61.3	6.3
5	#5722.90	76.5 PK	117.4	-40.9	2.69 V	109	70.2	6.3
6	#5725.00	58.7 PK	122.2	-63.5	3.03 V	142	52.4	6.3
7	*5745.00	109.7 PK			2.21 V	241	69.7	40.0
8	*5745.00	100.5 AV			2.21 V	241	60.5	40.0
9	#5949.60	59.6 PK	68.2	-8.6	2.21 V	241	53.0	6.6
10	11490.00	60.6 PK	74.0	-13.4	2.84 V	2	41.3	19.3
11	11490.00	48.2 AV	54.0	-5.8	2.84 V	2	28.9	19.3

Remarks:

- Emission Level(dBuV/m) = Raw Value(dBuV) + Correction Factor(dB/m)
- Correction Factor(dB/m) = Antenna Factor(dB/m) + Cable Factor(dB)
– Pre-Amplifier Factor(dB)
- The other emission levels were very low against the limit.
- Margin value = Emission Level – Limit value
- " * ": Fundamental frequency.
- " # ": The radiated frequency is out of the restricted band.

CHANNEL	TX Channel 157	DETECTOR FUNCTION	Peak (PK)
FREQUENCY RANGE	1GHz ~ 40GHz		Average (AV)

ANTENNA POLARITY & TEST DISTANCE: HORIZONTAL AT 3 M

NO.	FREQ. (MHz)	EMISSION LEVEL (dBuV/m)	LIMIT (dBuV/m)	MARGIN (dB)	ANTENNA HEIGHT (m)	TABLE ANGLE (Degree)	RAW VALUE (dBuV)	CORRECTION FACTOR (dB/m)
1	#5637.60	59.0 PK	68.2	-9.2	2.34 H	98	53.1	5.9
2	*5785.00	108.0 PK			2.34 H	98	67.9	40.1
3	*5785.00	98.2 AV			2.34 H	98	58.1	40.1
4	#5974.40	60.4 PK	68.2	-7.8	2.34 H	98	53.5	6.9
5	11570.00	60.4 PK	74.0	-13.6	1.83 H	166	41.2	19.2
6	11570.00	47.5 AV	54.0	-6.5	1.83 H	166	28.3	19.2

ANTENNA POLARITY & TEST DISTANCE: VERTICAL AT 3 M

NO.	FREQ. (MHz)	EMISSION LEVEL (dBuV/m)	LIMIT (dBuV/m)	MARGIN (dB)	ANTENNA HEIGHT (m)	TABLE ANGLE (Degree)	RAW VALUE (dBuV)	CORRECTION FACTOR (dB/m)
1	#5616.80	58.5 PK	68.2	-9.7	2.20 V	63	52.4	6.1
2	*5785.00	113.0 PK			2.20 V	63	72.9	40.1
3	*5785.00	103.1 AV			2.20 V	63	63.0	40.1
4	#5942.40	59.4 PK	68.2	-8.8	2.20 V	63	52.8	6.6
5	11570.00	60.8 PK	74.0	-13.2	1.11 V	306	41.6	19.2
6	11570.00	49.5 AV	54.0	-4.5	1.11 V	306	30.3	19.2

Remarks:

1. Emission Level(dBuV/m) = Raw Value(dBuV) + Correction Factor(dB/m)
2. Correction Factor(dB/m) = Antenna Factor(dB/m) + Cable Factor(dB)
– Pre-Amplifier Factor(dB)
3. The other emission levels were very low against the limit.
4. Margin value = Emission Level – Limit value
5. " * ": Fundamental frequency.
6. " # ": The radiated frequency is out of the restricted band.

CHANNEL	TX Channel 165	DETECTOR FUNCTION	Peak (PK)
FREQUENCY RANGE	1GHz ~ 40GHz		Average (AV)

ANTENNA POLARITY & TEST DISTANCE: HORIZONTAL AT 3 M

NO.	FREQ. (MHz)	EMISSION LEVEL (dBuV/m)	LIMIT (dBuV/m)	MARGIN (dB)	ANTENNA HEIGHT (m)	TABLE ANGLE (Degree)	RAW VALUE (dBuV)	CORRECTION FACTOR (dB/m)
1	#5646.40	58.3 PK	68.2	-9.9	2.49 H	98	52.4	5.9
2	*5825.00	106.7 PK			2.49 H	98	66.6	40.1
3	*5825.00	97.0 AV			2.49 H	98	56.9	40.1
4	#5850.00	51.2 PK	122.2	-71.0	2.60 H	102	44.7	6.5
5	#5852.10	71.7 PK	117.4	-45.7	2.47 H	95	65.2	6.5
6	#5860.10	59.5 PK	109.4	-49.9	2.20 H	97	53.0	6.5
7	#5971.20	60.7 PK	68.2	-7.5	2.49 H	98	53.8	6.9
8	11650.00	59.9 PK	74.0	-14.1	1.86 H	167	40.6	19.3
9	11650.00	47.7 AV	54.0	-6.3	1.86 H	167	28.4	19.3

ANTENNA POLARITY & TEST DISTANCE: VERTICAL AT 3 M

NO.	FREQ. (MHz)	EMISSION LEVEL (dBuV/m)	LIMIT (dBuV/m)	MARGIN (dB)	ANTENNA HEIGHT (m)	TABLE ANGLE (Degree)	RAW VALUE (dBuV)	CORRECTION FACTOR (dB/m)
1	#5635.20	58.0 PK	68.2	-10.2	2.43 V	266	51.9	6.1
2	*5825.00	111.7 PK			2.43 V	266	71.6	40.1
3	*5825.00	101.9 AV			2.43 V	266	61.8	40.1
4	#5850.00	57.9 PK	122.2	-64.3	2.62 V	267	51.4	6.5
5	#5852.10	76.7 PK	117.4	-40.7	2.34 V	242	70.2	6.5
6	#5860.10	63.2 PK	109.4	-46.2	2.54 V	250	56.7	6.5
7	#5948.00	59.5 PK	68.2	-8.7	2.43 V	266	52.9	6.6
8	11650.00	62.0 PK	74.0	-12.0	1.08 V	306	42.7	19.3
9	11650.00	49.5 AV	54.0	-4.5	1.08 V	306	30.2	19.3

Remarks:

- Emission Level(dBuV/m) = Raw Value(dBuV) + Correction Factor(dB/m)
- Correction Factor(dB/m) = Antenna Factor(dB/m) + Cable Factor(dB)
– Pre-Amplifier Factor(dB)
- The other emission levels were very low against the limit.
- Margin value = Emission Level – Limit value
- " * ": Fundamental frequency.
- " # ": The radiated frequency is out of the restricted band.

802.11n (HT20)

CHANNEL	TX Channel 36	DETECTOR FUNCTION	Peak (PK)
FREQUENCY RANGE	1GHz ~ 40GHz		Average (AV)

ANTENNA POLARITY & TEST DISTANCE: HORIZONTAL AT 3 M								
NO.	FREQ. (MHz)	EMISSION LEVEL (dBuV/m)	LIMIT (dBuV/m)	MARGIN (dB)	ANTENNA HEIGHT (m)	TABLE ANGLE (Degree)	RAW VALUE (dBuV)	CORRECTION FACTOR (dB/m)
1	5150.00	63.0 PK	74.0	-11.0	2.78 H	88	58.2	4.8
2	5150.00	43.2 AV	54.0	-10.8	2.78 H	88	38.4	4.8
3	*5180.00	103.9 PK			2.75 H	85	65.2	38.7
4	*5180.00	93.7 AV			2.75 H	85	55.0	38.7
5	#10360.00	59.6 PK	74.0	-14.4	2.61 H	263	42.0	17.6
6	#10360.00	46.4 AV	54.0	-7.6	2.61 H	263	28.8	17.6
ANTENNA POLARITY & TEST DISTANCE: VERTICAL AT 3 M								
NO.	FREQ. (MHz)	EMISSION LEVEL (dBuV/m)	LIMIT (dBuV/m)	MARGIN (dB)	ANTENNA HEIGHT (m)	TABLE ANGLE (Degree)	RAW VALUE (dBuV)	CORRECTION FACTOR (dB/m)
1	5150.00	72.7 PK	74.0	-1.3	2.60 V	34	67.9	4.8
2	5150.00	46.8 AV	54.0	-7.2	2.60 V	34	42.0	4.8
3	*5180.00	110.4 PK			3.05 V	38	71.7	38.7
4	*5180.00	100.6 AV			3.05 V	38	61.9	38.7
5	#10360.00	60.3 PK	74.0	-13.7	2.87 V	305	42.7	17.6
6	#10360.00	46.7 AV	54.0	-7.3	2.87 V	305	29.1	17.6

Remarks:

1. Emission Level(dBuV/m) = Raw Value(dBuV) + Correction Factor(dB/m)
2. Correction Factor(dB/m) = Antenna Factor(dB/m) + Cable Factor(dB)
– Pre-Amplifier Factor(dB)
3. The other emission levels were very low against the limit.
4. Margin value = Emission Level – Limit value
5. " * ": Fundamental frequency.
6. " # ": The radiated frequency is out of the restricted band.

CHANNEL	TX Channel 40	DETECTOR FUNCTION	Peak (PK)
FREQUENCY RANGE	1GHz ~ 40GHz		Average (AV)

ANTENNA POLARITY & TEST DISTANCE: HORIZONTAL AT 3 M

NO.	FREQ. (MHz)	EMISSION LEVEL (dBuV/m)	LIMIT (dBuV/m)	MARGIN (dB)	ANTENNA HEIGHT (m)	TABLE ANGLE (Degree)	RAW VALUE (dBuV)	CORRECTION FACTOR (dB/m)
1	*5200.00	108.8 PK			2.86 H	85	70.1	38.7
2	*5200.00	98.8 AV			2.86 H	85	60.1	38.7
3	#10400.00	59.7 PK	74.0	-14.3	2.13 H	149	42.1	17.6
4	#10400.00	46.3 AV	54.0	-7.7	2.13 H	149	28.7	17.6

ANTENNA POLARITY & TEST DISTANCE: VERTICAL AT 3 M

NO.	FREQ. (MHz)	EMISSION LEVEL (dBuV/m)	LIMIT (dBuV/m)	MARGIN (dB)	ANTENNA HEIGHT (m)	TABLE ANGLE (Degree)	RAW VALUE (dBuV)	CORRECTION FACTOR (dB/m)
1	*5200.00	116.2 PK			3.00 V	36	77.5	38.7
2	*5200.00	106.3 AV			3.00 V	36	67.6	38.7
3	#10400.00	59.3 PK	74.0	-14.7	2.54 V	119	41.7	17.6
4	#10400.00	46.4 AV	54.0	-7.6	2.54 V	119	28.8	17.6

Remarks:

1. Emission Level(dBuV/m) = Raw Value(dBuV) + Correction Factor(dB/m)
2. Correction Factor(dB/m) = Antenna Factor(dB/m) + Cable Factor(dB)
– Pre-Amplifier Factor(dB)
3. The other emission levels were very low against the limit.
4. Margin value = Emission Level – Limit value
5. " * ": Fundamental frequency.
6. " # ": The radiated frequency is out of the restricted band.

CHANNEL	TX Channel 48	DETECTOR FUNCTION	Peak (PK)
FREQUENCY RANGE	1GHz ~ 40GHz		Average (AV)

ANTENNA POLARITY & TEST DISTANCE: HORIZONTAL AT 3 M

NO.	FREQ. (MHz)	EMISSION LEVEL (dBuV/m)	LIMIT (dBuV/m)	MARGIN (dB)	ANTENNA HEIGHT (m)	TABLE ANGLE (Degree)	RAW VALUE (dBuV)	CORRECTION FACTOR (dB/m)
1	*5240.00	108.2 PK			2.64 H	235	69.3	38.9
2	*5240.00	98.2 AV			2.64 H	235	59.3	38.9
3	5350.00	56.3 PK	74.0	-17.7	2.71 H	267	50.8	5.5
4	5350.00	44.0 AV	54.0	-10.0	2.71 H	267	38.5	5.5
5	#10480.00	59.6 PK	74.0	-14.4	1.76 H	220	41.2	18.4
6	#10480.00	46.8 AV	54.0	-7.2	1.76 H	220	28.4	18.4

ANTENNA POLARITY & TEST DISTANCE: VERTICAL AT 3 M

NO.	FREQ. (MHz)	EMISSION LEVEL (dBuV/m)	LIMIT (dBuV/m)	MARGIN (dB)	ANTENNA HEIGHT (m)	TABLE ANGLE (Degree)	RAW VALUE (dBuV)	CORRECTION FACTOR (dB/m)
1	*5240.00	116.1 PK			3.04 V	37	77.2	38.9
2	*5240.00	106.6 AV			3.04 V	37	67.7	38.9
3	5350.00	58.9 PK	74.0	-15.1	2.90 V	38	53.4	5.5
4	5350.00	45.4 AV	54.0	-8.6	2.90 V	38	39.9	5.5
5	#10480.00	59.9 PK	74.0	-14.1	2.66 V	187	41.5	18.4
6	#10480.00	46.9 AV	54.0	-7.1	2.66 V	187	28.5	18.4

Remarks:

1. Emission Level(dBuV/m) = Raw Value(dBuV) + Correction Factor(dB/m)
2. Correction Factor(dB/m) = Antenna Factor(dB/m) + Cable Factor(dB)
– Pre-Amplifier Factor(dB)
3. The other emission levels were very low against the limit.
4. Margin value = Emission Level – Limit value
5. " * ": Fundamental frequency.
6. " # ": The radiated frequency is out of the restricted band.

CHANNEL	TX Channel 149	DETECTOR FUNCTION	Peak (PK)
FREQUENCY RANGE	1GHz ~ 40GHz		Average (AV)

ANTENNA POLARITY & TEST DISTANCE: HORIZONTAL AT 3 M

NO.	FREQ. (MHz)	EMISSION LEVEL (dBuV/m)	LIMIT (dBuV/m)	MARGIN (dB)	ANTENNA HEIGHT (m)	TABLE ANGLE (Degree)	RAW VALUE (dBuV)	CORRECTION FACTOR (dB/m)
1	#5628.00	58.2 PK	68.2	-10.0	2.84 H	233	52.1	6.1
2	#5714.90	64.8 PK	109.4	-44.6	2.60 H	238	58.5	6.3
3	#5722.90	68.2 PK	117.4	-49.2	2.40 H	233	61.9	6.3
4	#5725.00	51.3 PK	122.2	-70.9	2.35 H	237	45.0	6.3
5	*5745.00	103.8 PK			2.84 H	233	63.8	40.0
6	*5745.00	93.7 AV			2.84 H	233	53.7	40.0
7	#5967.20	59.3 PK	68.2	-8.9	2.84 H	233	52.6	6.7
8	11490.00	59.7 PK	74.0	-14.3	2.06 H	184	40.4	19.3
9	11490.00	47.4 AV	54.0	-6.6	2.06 H	184	28.1	19.3

ANTENNA POLARITY & TEST DISTANCE: VERTICAL AT 3 M

NO.	FREQ. (MHz)	EMISSION LEVEL (dBuV/m)	LIMIT (dBuV/m)	MARGIN (dB)	ANTENNA HEIGHT (m)	TABLE ANGLE (Degree)	RAW VALUE (dBuV)	CORRECTION FACTOR (dB/m)
1	#5612.80	58.2 PK	68.2	-10.0	2.33 V	244	52.1	6.1
2	#5714.90	70.4 PK	109.4	-39.0	2.44 V	237	64.1	6.3
3	#5722.90	76.4 PK	117.4	-41.0	2.34 V	242	70.1	6.3
4	#5725.00	56.0 PK	122.2	-66.2	2.50 V	244	49.7	6.3
5	*5745.00	109.2 PK			2.33 V	244	69.2	40.0
6	*5745.00	98.3 AV			2.33 V	244	58.3	40.0
7	#5989.60	59.9 PK	68.2	-8.3	2.33 V	244	53.2	6.7
8	11490.00	61.2 PK	74.0	-12.8	2.14 V	299	41.9	19.3
9	11490.00	48.4 AV	54.0	-5.6	2.14 V	299	29.1	19.3

Remarks:

1. Emission Level(dBuV/m) = Raw Value(dBuV) + Correction Factor(dB/m)
2. Correction Factor(dB/m) = Antenna Factor(dB/m) + Cable Factor(dB)
- Pre-Amplifier Factor(dB)
3. The other emission levels were very low against the limit.
4. Margin value = Emission Level – Limit value
5. " * ": Fundamental frequency.
6. " # ": The radiated frequency is out of the restricted band.

CHANNEL	TX Channel 157	DETECTOR FUNCTION	Peak (PK)
FREQUENCY RANGE	1GHz ~ 40GHz		Average (AV)

ANTENNA POLARITY & TEST DISTANCE: HORIZONTAL AT 3 M

NO.	FREQ. (MHz)	EMISSION LEVEL (dBuV/m)	LIMIT (dBuV/m)	MARGIN (dB)	ANTENNA HEIGHT (m)	TABLE ANGLE (Degree)	RAW VALUE (dBuV)	CORRECTION FACTOR (dB/m)
1	#5632.00	59.8 PK	68.2	-8.4	2.34 H	97	53.7	6.1
2	*5785.00	107.6 PK			2.32 H	97	67.5	40.1
3	*5785.00	97.2 AV			2.32 H	97	57.1	40.1
4	#5925.60	59.6 PK	68.2	-8.6	2.34 H	97	53.0	6.6
5	11570.00	60.2 PK	74.0	-13.8	1.81 H	167	41.0	19.2
6	11570.00	47.5 AV	54.0	-6.5	1.81 H	167	28.3	19.2

ANTENNA POLARITY & TEST DISTANCE: VERTICAL AT 3 M

NO.	FREQ. (MHz)	EMISSION LEVEL (dBuV/m)	LIMIT (dBuV/m)	MARGIN (dB)	ANTENNA HEIGHT (m)	TABLE ANGLE (Degree)	RAW VALUE (dBuV)	CORRECTION FACTOR (dB/m)
1	#5632.00	58.5 PK	68.2	-9.7	2.40 V	70	52.4	6.1
2	*5785.00	113.0 PK			2.40 V	70	72.9	40.1
3	*5785.00	102.8 AV			2.40 V	70	62.7	40.1
4	#5947.20	59.3 PK	68.2	-8.9	2.40 V	70	52.7	6.6
5	11570.00	61.2 PK	74.0	-12.8	1.94 V	172	42.0	19.2
6	11570.00	48.8 AV	54.0	-5.2	1.94 V	172	29.6	19.2

Remarks:

1. Emission Level(dBuV/m) = Raw Value(dBuV) + Correction Factor(dB/m)
2. Correction Factor(dB/m) = Antenna Factor(dB/m) + Cable Factor(dB)
– Pre-Amplifier Factor(dB)
3. The other emission levels were very low against the limit.
4. Margin value = Emission Level – Limit value
5. " * ": Fundamental frequency.
6. " # ": The radiated frequency is out of the restricted band.

CHANNEL	TX Channel 165	DETECTOR FUNCTION	Peak (PK)
FREQUENCY RANGE	1GHz ~ 40GHz		Average (AV)

ANTENNA POLARITY & TEST DISTANCE: HORIZONTAL AT 3 M

NO.	FREQ. (MHz)	EMISSION LEVEL (dBuV/m)	LIMIT (dBuV/m)	MARGIN (dB)	ANTENNA HEIGHT (m)	TABLE ANGLE (Degree)	RAW VALUE (dBuV)	CORRECTION FACTOR (dB/m)
1	#5622.40	59.1 PK	68.2	-9.1	2.49 H	233	53.0	6.1
2	*5825.00	106.1 PK			2.49 H	233	66.0	40.1
3	*5825.00	96.0 AV			2.49 H	233	55.9	40.1
4	#5850.00	53.8 PK	122.2	-68.4	3.10 H	219	47.3	6.5
5	#5852.10	71.0 PK	117.4	-46.4	2.81 H	219	64.5	6.5
6	#5860.10	65.0 PK	109.4	-44.4	2.51 H	222	58.5	6.5
7	#5942.40	59.4 PK	68.2	-8.8	2.49 H	233	52.8	6.6
8	11650.00	60.3 PK	74.0	-13.7	2.18 H	157	41.0	19.3
9	11650.00	47.6 AV	54.0	-6.4	2.18 H	157	28.3	19.3

ANTENNA POLARITY & TEST DISTANCE: VERTICAL AT 3 M

NO.	FREQ. (MHz)	EMISSION LEVEL (dBuV/m)	LIMIT (dBuV/m)	MARGIN (dB)	ANTENNA HEIGHT (m)	TABLE ANGLE (Degree)	RAW VALUE (dBuV)	CORRECTION FACTOR (dB/m)
1	#5630.40	59.4 PK	68.2	-8.8	2.37 V	47	53.3	6.1
2	*5825.00	111.5 PK			2.37 V	47	71.4	40.1
3	*5825.00	101.8 AV			2.37 V	47	61.7	40.1
4	#5850.00	59.0 PK	122.2	-63.2	2.50 V	51	52.5	6.5
5	#5852.10	76.8 PK	117.4	-40.6	2.54 V	57	70.3	6.5
6	#5860.10	69.0 PK	109.4	-40.4	2.48 V	48	62.5	6.5
7	#5968.80	60.9 PK	68.2	-7.3	2.37 V	47	54.2	6.7
8	11650.00	60.5 PK	74.0	-13.5	2.14 V	296	41.2	19.3
9	11650.00	48.4 AV	54.0	-5.6	2.14 V	296	29.1	19.3

Remarks:

- Emission Level(dBuV/m) = Raw Value(dBuV) + Correction Factor(dB/m)
- Correction Factor(dB/m) = Antenna Factor(dB/m) + Cable Factor(dB)
– Pre-Amplifier Factor(dB)
- The other emission levels were very low against the limit.
- Margin value = Emission Level – Limit value
- " * ": Fundamental frequency.
- " # ": The radiated frequency is out of the restricted band.

802.11n (HT40)

CHANNEL	TX Channel 38	DETECTOR FUNCTION	Peak (PK)
FREQUENCY RANGE	1GHz ~ 40GHz		Average (AV)

ANTENNA POLARITY & TEST DISTANCE: HORIZONTAL AT 3 M								
NO.	FREQ. (MHz)	EMISSION LEVEL (dBuV/m)	LIMIT (dBuV/m)	MARGIN (dB)	ANTENNA HEIGHT (m)	TABLE ANGLE (Degree)	RAW VALUE (dBuV)	CORRECTION FACTOR (dB/m)
1	5150.00	62.0 PK	74.0	-12.0	2.80 H	87	57.2	4.8
2	5150.00	45.7 AV	54.0	-8.3	2.80 H	87	40.9	4.8
3	*5190.00	100.8 PK			2.64 H	86	62.1	38.7
4	*5190.00	91.1 AV			2.64 H	86	52.4	38.7
5	#10380.00	59.3 PK	74.0	-14.7	2.27 H	293	41.7	17.6
6	#10380.00	46.1 AV	54.0	-7.9	2.27 H	293	28.5	17.6
ANTENNA POLARITY & TEST DISTANCE: VERTICAL AT 3 M								
NO.	FREQ. (MHz)	EMISSION LEVEL (dBuV/m)	LIMIT (dBuV/m)	MARGIN (dB)	ANTENNA HEIGHT (m)	TABLE ANGLE (Degree)	RAW VALUE (dBuV)	CORRECTION FACTOR (dB/m)
1	5150.00	69.5 PK	74.0	-4.5	2.73 V	220	64.7	4.8
2	5150.00	52.4 AV	54.0	-1.6	2.73 V	220	47.6	4.8
3	*5190.00	108.9 PK			2.76 V	221	70.2	38.7
4	*5190.00	99.0 AV			2.76 V	221	60.3	38.7
5	#10380.00	59.9 PK	74.0	-14.1	2.75 V	264	42.3	17.6
6	#10380.00	49.1 AV	54.0	-4.9	2.75 V	264	31.5	17.6

Remarks:

1. Emission Level(dBuV/m) = Raw Value(dBuV) + Correction Factor(dB/m)
2. Correction Factor(dB/m) = Antenna Factor(dB/m) + Cable Factor(dB)
– Pre-Amplifier Factor(dB)
3. The other emission levels were very low against the limit.
4. Margin value = Emission Level – Limit value
5. " * ": Fundamental frequency.
6. " # ": The radiated frequency is out of the restricted band.

CHANNEL	TX Channel 46	DETECTOR FUNCTION	Peak (PK)
FREQUENCY RANGE	1GHz ~ 40GHz		Average (AV)

ANTENNA POLARITY & TEST DISTANCE: HORIZONTAL AT 3 M

NO.	FREQ. (MHz)	EMISSION LEVEL (dBuV/m)	LIMIT (dBuV/m)	MARGIN (dB)	ANTENNA HEIGHT (m)	TABLE ANGLE (Degree)	RAW VALUE (dBuV)	CORRECTION FACTOR (dB/m)
1	*5230.00	103.6 PK			2.52 H	84	64.7	38.9
2	*5230.00	94.1 AV			2.52 H	84	55.2	38.9
3	5350.00	56.8 PK	74.0	-17.2	2.60 H	88	51.3	5.5
4	5350.00	44.0 AV	54.0	-10.0	2.60 H	88	38.5	5.5
5	#10460.00	60.0 PK	74.0	-14.0	1.43 H	186	41.8	18.2
6	#10460.00	46.7 AV	54.0	-7.3	1.43 H	186	28.5	18.2

ANTENNA POLARITY & TEST DISTANCE: VERTICAL AT 3 M

NO.	FREQ. (MHz)	EMISSION LEVEL (dBuV/m)	LIMIT (dBuV/m)	MARGIN (dB)	ANTENNA HEIGHT (m)	TABLE ANGLE (Degree)	RAW VALUE (dBuV)	CORRECTION FACTOR (dB/m)
1	*5230.00	112.0 PK			2.67 V	216	73.1	38.9
2	*5230.00	101.8 AV			2.67 V	216	62.9	38.9
3	5350.00	58.6 PK	74.0	-15.4	2.88 V	219	53.1	5.5
4	5350.00	45.1 AV	54.0	-8.9	2.88 V	219	39.6	5.5
5	#10460.00	59.7 PK	74.0	-14.3	2.64 V	183	41.5	18.2
6	#10460.00	46.9 AV	54.0	-7.1	2.64 V	183	28.7	18.2

Remarks:

1. Emission Level(dBuV/m) = Raw Value(dBuV) + Correction Factor(dB/m)
2. Correction Factor(dB/m) = Antenna Factor(dB/m) + Cable Factor(dB)
– Pre-Amplifier Factor(dB)
3. The other emission levels were very low against the limit.
4. Margin value = Emission Level – Limit value
5. " * ": Fundamental frequency.
6. " # ": The radiated frequency is out of the restricted band.

CHANNEL	TX Channel 151	DETECTOR FUNCTION	Peak (PK)
FREQUENCY RANGE	1GHz ~ 40GHz		Average (AV)

ANTENNA POLARITY & TEST DISTANCE: HORIZONTAL AT 3 M

NO.	FREQ. (MHz)	EMISSION LEVEL (dBuV/m)	LIMIT (dBuV/m)	MARGIN (dB)	ANTENNA HEIGHT (m)	TABLE ANGLE (Degree)	RAW VALUE (dBuV)	CORRECTION FACTOR (dB/m)
1	#5612.00	58.7 PK	68.2	-9.5	2.69 H	97	52.6	6.1
2	#5714.90	57.9 PK	109.4	-51.5	2.58 H	102	51.6	6.3
3	#5722.90	67.2 PK	117.4	-50.2	3.10 H	64	60.9	6.3
4	#5725.00	49.7 PK	122.2	-72.5	3.13 H	60	43.4	6.3
5	*5755.00	99.2 PK			2.69 H	97	59.2	40.0
6	*5755.00	89.4 AV			2.69 H	97	49.4	40.0
7	#5949.60	59.4 PK	68.2	-8.8	2.69 H	97	52.8	6.6
8	11510.00	59.8 PK	74.0	-14.2	2.37 H	119	40.5	19.3
9	11510.00	47.3 AV	54.0	-6.7	2.37 H	119	28.0	19.3

ANTENNA POLARITY & TEST DISTANCE: VERTICAL AT 3 M

NO.	FREQ. (MHz)	EMISSION LEVEL (dBuV/m)	LIMIT (dBuV/m)	MARGIN (dB)	ANTENNA HEIGHT (m)	TABLE ANGLE (Degree)	RAW VALUE (dBuV)	CORRECTION FACTOR (dB/m)
1	#5631.20	58.6 PK	68.2	-9.6	2.46 V	244	52.5	6.1
2	#5714.90	70.0 PK	109.4	-39.4	2.99 V	206	63.7	6.3
3	#5722.90	71.1 PK	117.4	-46.3	2.91 V	204	64.8	6.3
4	#5725.00	53.8 PK	122.2	-68.4	2.73 V	208	47.5	6.3
5	*5755.00	105.0 PK			2.46 V	244	65.0	40.0
6	*5755.00	95.1 AV			2.46 V	244	55.1	40.0
7	#5983.20	60.5 PK	68.2	-7.7	2.46 V	244	53.8	6.7
8	11510.00	61.3 PK	74.0	-12.7	2.33 V	174	42.0	19.3
9	11510.00	48.3 AV	54.0	-5.7	2.33 V	174	29.0	19.3

Remarks:

1. Emission Level(dBuV/m) = Raw Value(dBuV) + Correction Factor(dB/m)
2. Correction Factor(dB/m) = Antenna Factor(dB/m) + Cable Factor(dB)
- Pre-Amplifier Factor(dB)
3. The other emission levels were very low against the limit.
4. Margin value = Emission Level – Limit value
5. " * ": Fundamental frequency.
6. " # ": The radiated frequency is out of the restricted band.

CHANNEL	TX Channel 159	DETECTOR FUNCTION	Peak (PK)
FREQUENCY RANGE	1GHz ~ 40GHz		Average (AV)

ANTENNA POLARITY & TEST DISTANCE: HORIZONTAL AT 3 M

NO.	FREQ. (MHz)	EMISSION LEVEL (dBuV/m)	LIMIT (dBuV/m)	MARGIN (dB)	ANTENNA HEIGHT (m)	TABLE ANGLE (Degree)	RAW VALUE (dBuV)	CORRECTION FACTOR (dB/m)
1	#5628.80	58.7 PK	68.2	-9.5	2.67 H	99	52.6	6.1
2	*5795.00	103.9 PK			2.67 H	99	63.8	40.1
3	*5795.00	94.4 AV			2.67 H	99	54.3	40.1
4	#5850.00	50.6 PK	122.2	-71.6	2.60 H	97	44.1	6.5
5	#5852.10	63.9 PK	117.4	-53.5	2.43 H	97	57.4	6.5
6	#5860.10	63.2 PK	109.4	-46.2	2.30 H	101	56.7	6.5
7	#5927.20	59.7 PK	68.2	-8.5	2.67 H	99	53.1	6.6
8	11590.00	59.4 PK	74.0	-14.6	1.86 H	130	40.2	19.2
9	11590.00	47.8 AV	54.0	-6.2	1.86 H	130	28.6	19.2

ANTENNA POLARITY & TEST DISTANCE: VERTICAL AT 3 M

NO.	FREQ. (MHz)	EMISSION LEVEL (dBuV/m)	LIMIT (dBuV/m)	MARGIN (dB)	ANTENNA HEIGHT (m)	TABLE ANGLE (Degree)	RAW VALUE (dBuV)	CORRECTION FACTOR (dB/m)
1	#5625.60	58.7 PK	68.2	-9.5	2.49 V	48	52.6	6.1
2	*5795.00	110.1 PK			2.49 V	48	70.0	40.1
3	*5795.00	99.9 AV			2.49 V	48	59.8	40.1
4	#5850.00	55.4 PK	122.2	-66.8	2.27 V	270	48.9	6.5
5	#5852.10	69.1 PK	117.4	-48.3	2.49 V	242	62.6	6.5
6	#5860.10	67.5 PK	109.4	-41.9	2.44 V	265	61.0	6.5
7	#5956.80	59.5 PK	68.2	-8.7	2.49 V	48	52.9	6.6
8	11590.00	60.4 PK	74.0	-13.6	2.41 V	298	41.2	19.2
9	11590.00	48.5 AV	54.0	-5.5	2.41 V	298	29.3	19.2

Remarks:

1. Emission Level(dBuV/m) = Raw Value(dBuV) + Correction Factor(dB/m)
2. Correction Factor(dB/m) = Antenna Factor(dB/m) + Cable Factor(dB)
– Pre-Amplifier Factor(dB)
3. The other emission levels were very low against the limit.
4. Margin value = Emission Level – Limit value
5. " * ": Fundamental frequency.
6. " # ": The radiated frequency is out of the restricted band.

802.11ac (VHT80)

CHANNEL	TX Channel 42	DETECTOR FUNCTION	Peak (PK)
FREQUENCY RANGE	1GHz ~ 40GHz		Average (AV)

ANTENNA POLARITY & TEST DISTANCE: HORIZONTAL AT 3 M

NO.	FREQ. (MHz)	EMISSION LEVEL (dBuV/m)	LIMIT (dBuV/m)	MARGIN (dB)	ANTENNA HEIGHT (m)	TABLE ANGLE (Degree)	RAW VALUE (dBuV)	CORRECTION FACTOR (dB/m)
1	5150.00	62.4 PK	74.0	-11.6	2.48 H	236	57.6	4.8
2	5150.00	46.5 AV	54.0	-7.5	2.48 H	236	41.7	4.8
3	*5210.00	97.8 PK			2.51 H	238	59.1	38.7
4	*5210.00	86.7 AV			2.51 H	238	48.0	38.7
5	5350.00	57.4 PK	74.0	-16.6	2.37 H	227	51.9	5.5
6	5350.00	44.9 AV	54.0	-9.1	2.37 H	227	39.4	5.5
7	#10420.00	59.8 PK	74.0	-14.2	2.10 H	155	42.0	17.8
8	#10420.00	46.6 AV	54.0	-7.4	2.10 H	155	28.8	17.8

ANTENNA POLARITY & TEST DISTANCE: VERTICAL AT 3 M

NO.	FREQ. (MHz)	EMISSION LEVEL (dBuV/m)	LIMIT (dBuV/m)	MARGIN (dB)	ANTENNA HEIGHT (m)	TABLE ANGLE (Degree)	RAW VALUE (dBuV)	CORRECTION FACTOR (dB/m)
1	5150.00	69.1 PK	74.0	-4.9	2.63 V	220	64.3	4.8
2	5150.00	52.6 AV	54.0	-1.4	2.63 V	220	47.8	4.8
3	*5210.00	104.8 PK			2.55 V	35	66.1	38.7
4	*5210.00	95.1 AV			2.55 V	35	56.4	38.7
5	5350.00	58.5 PK	74.0	-15.5	2.82 V	213	53.0	5.5
6	5350.00	45.9 AV	54.0	-8.1	2.82 V	213	40.4	5.5
7	#10420.00	60.0 PK	74.0	-14.0	2.17 V	272	42.2	17.8
8	#10420.00	50.4 AV	54.0	-3.6	2.17 V	272	32.6	17.8

Remarks:

1. Emission Level(dBuV/m) = Raw Value(dBuV) + Correction Factor(dB/m)
2. Correction Factor(dB/m) = Antenna Factor(dB/m) + Cable Factor(dB)
– Pre-Amplifier Factor(dB)
3. The other emission levels were very low against the limit.
4. Margin value = Emission Level – Limit value
5. " * ": Fundamental frequency.
6. " # ": The radiated frequency is out of the restricted band.

CHANNEL	TX Channel 155	DETECTOR FUNCTION	Peak (PK)
FREQUENCY RANGE	1GHz ~ 40GHz		Average (AV)

ANTENNA POLARITY & TEST DISTANCE: HORIZONTAL AT 3 M

NO.	FREQ. (MHz)	EMISSION LEVEL (dBuV/m)	LIMIT (dBuV/m)	MARGIN (dB)	ANTENNA HEIGHT (m)	TABLE ANGLE (Degree)	RAW VALUE (dBuV)	CORRECTION FACTOR (dB/m)
1	#5633.60	58.8 PK	68.2	-9.4	2.35 H	95	52.7	6.1
2	#5714.90	60.0 PK	109.4	-49.4	2.20 H	99	53.7	6.3
3	#5722.90	63.3 PK	117.4	-54.1	2.41 H	97	57.0	6.3
4	#5725.00	48.5 PK	122.2	-73.7	2.64 H	101	42.2	6.3
5	*5775.00	96.9 PK			2.39 H	95	56.9	40.0
6	*5775.00	86.9 AV			2.39 H	95	46.9	40.0
7	#5850.00	44.8 PK	122.2	-77.4	2.86 H	94	38.3	6.5
8	#5852.10	58.8 PK	117.4	-58.6	2.65 H	97	52.3	6.5
9	#5860.10	57.8 PK	109.4	-51.6	2.81 H	95	51.3	6.5
10	#5963.20	59.8 PK	68.2	-8.4	2.35 H	95	53.1	6.7
11	11550.00	60.7 PK	74.0	-13.3	2.38 H	164	41.5	19.2
12	11550.00	48.4 AV	54.0	-5.6	2.38 H	164	29.2	19.2

ANTENNA POLARITY & TEST DISTANCE: VERTICAL AT 3 M

NO.	FREQ. (MHz)	EMISSION LEVEL (dBuV/m)	LIMIT (dBuV/m)	MARGIN (dB)	ANTENNA HEIGHT (m)	TABLE ANGLE (Degree)	RAW VALUE (dBuV)	CORRECTION FACTOR (dB/m)
1	#5626.40	59.6 PK	68.2	-8.6	2.49 V	241	53.5	6.1
2	#5714.90	68.5 PK	109.4	-40.9	2.08 V	246	62.2	6.3
3	#5722.90	69.4 PK	117.4	-48.0	2.31 V	240	63.1	6.3
4	#5725.00	52.6 PK	122.2	-69.6	2.55 V	240	46.3	6.3
5	*5775.00	102.1 PK			2.49 V	241	62.1	40.0
6	*5775.00	92.9 AV			2.49 V	241	52.9	40.0
7	#5850.00	49.2 PK	122.2	-73.0	2.51 V	204	42.7	6.5
8	#5852.10	65.3 PK	117.4	-52.1	2.53 V	203	58.8	6.5
9	#5860.10	62.8 PK	109.4	-46.6	2.73 V	203	56.3	6.5
10	#5961.60	59.8 PK	68.2	-8.4	2.49 V	241	53.1	6.7
11	11550.00	60.7 PK	74.0	-13.3	2.23 V	204	41.5	19.2
12	11550.00	48.2 AV	54.0	-5.8	2.23 V	204	29.0	19.2

Remarks:

1. Emission Level(dBuV/m) = Raw Value(dBuV) + Correction Factor(dB/m)
2. Correction Factor(dB/m) = Antenna Factor(dB/m) + Cable Factor(dB)
– Pre-Amplifier Factor(dB)
3. The other emission levels were very low against the limit.
4. Margin value = Emission Level – Limit value
5. " * ": Fundamental frequency.
6. " # ": The radiated frequency is out of the restricted band.

Mode C

802.11a

CHANNEL	TX Channel 36	DETECTOR FUNCTION	Peak (PK)
FREQUENCY RANGE	1GHz ~ 40GHz		Average (AV)

ANTENNA POLARITY & TEST DISTANCE: HORIZONTAL AT 3 M

NO.	FREQ. (MHz)	EMISSION LEVEL (dBuV/m)	LIMIT (dBuV/m)	MARGIN (dB)	ANTENNA HEIGHT (m)	TABLE ANGLE (Degree)	RAW VALUE (dBuV)	CORRECTION FACTOR (dB/m)
1	5150.00	69.9 PK	74.0	-4.1	1.48 H	170	65.1	4.8
2	5150.00	52.5 AV	54.0	-1.5	1.48 H	170	47.7	4.8
3	*5180.00	114.6 PK			1.80 H	168	75.9	38.7
4	*5180.00	104.8 AV			1.80 H	168	66.1	38.7
5	#10360.00	60.4 PK	74.0	-13.6	1.47 H	220	42.8	17.6
6	#10360.00	49.6 AV	54.0	-4.4	1.47 H	220	32.0	17.6

ANTENNA POLARITY & TEST DISTANCE: VERTICAL AT 3 M

NO.	FREQ. (MHz)	EMISSION LEVEL (dBuV/m)	LIMIT (dBuV/m)	MARGIN (dB)	ANTENNA HEIGHT (m)	TABLE ANGLE (Degree)	RAW VALUE (dBuV)	CORRECTION FACTOR (dB/m)
1	5150.00	65.4 PK	74.0	-8.6	1.31 V	38	60.6	4.8
2	5150.00	47.8 AV	54.0	-6.2	1.31 V	38	43.0	4.8
3	*5180.00	109.0 PK			1.30 V	36	70.3	38.7
4	*5180.00	98.6 AV			1.30 V	36	59.9	38.7
5	#10360.00	59.7 PK	74.0	-14.3	1.37 V	185	42.1	17.6
6	#10360.00	49.4 AV	54.0	-4.6	1.37 V	185	31.8	17.6

Remarks:

1. Emission Level(dBuV/m) = Raw Value(dBuV) + Correction Factor(dB/m)
2. Correction Factor(dB/m) = Antenna Factor(dB/m) + Cable Factor(dB)
- Pre-Amplifier Factor(dB)
3. The other emission levels were very low against the limit.
4. Margin value = Emission Level – Limit value
5. " * ": Fundamental frequency.
6. " # ": The radiated frequency is out of the restricted band.

CHANNEL	TX Channel 40	DETECTOR FUNCTION	Peak (PK)
FREQUENCY RANGE	1GHz ~ 40GHz		Average (AV)

ANTENNA POLARITY & TEST DISTANCE: HORIZONTAL AT 3 M

NO.	FREQ. (MHz)	EMISSION LEVEL (dBuV/m)	LIMIT (dBuV/m)	MARGIN (dB)	ANTENNA HEIGHT (m)	TABLE ANGLE (Degree)	RAW VALUE (dBuV)	CORRECTION FACTOR (dB/m)
1	*5200.00	117.2 PK			1.79 H	168	78.5	38.7
2	*5200.00	107.5 AV			1.79 H	168	68.8	38.7
3	#10400.00	60.1 PK	74.0	-13.9	1.59 H	220	42.5	17.6
4	#10400.00	49.4 AV	54.0	-4.6	1.59 H	220	31.8	17.6

ANTENNA POLARITY & TEST DISTANCE: VERTICAL AT 3 M

NO.	FREQ. (MHz)	EMISSION LEVEL (dBuV/m)	LIMIT (dBuV/m)	MARGIN (dB)	ANTENNA HEIGHT (m)	TABLE ANGLE (Degree)	RAW VALUE (dBuV)	CORRECTION FACTOR (dB/m)
1	*5200.00	110.8 PK			1.38 V	33	72.1	38.7
2	*5200.00	100.5 AV			1.38 V	33	61.8	38.7
3	#10400.00	60.4 PK	74.0	-13.6	1.33 V	186	42.8	17.6
4	#10400.00	49.7 AV	54.0	-4.3	1.33 V	186	32.1	17.6

Remarks:

1. Emission Level(dBuV/m) = Raw Value(dBuV) + Correction Factor(dB/m)
2. Correction Factor(dB/m) = Antenna Factor(dB/m) + Cable Factor(dB)
– Pre-Amplifier Factor(dB)
3. The other emission levels were very low against the limit.
4. Margin value = Emission Level – Limit value
5. " * ": Fundamental frequency.
6. " # ": The radiated frequency is out of the restricted band.

CHANNEL	TX Channel 48	DETECTOR FUNCTION	Peak (PK)
FREQUENCY RANGE	1GHz ~ 40GHz		Average (AV)

ANTENNA POLARITY & TEST DISTANCE: HORIZONTAL AT 3 M

NO.	FREQ. (MHz)	EMISSION LEVEL (dBuV/m)	LIMIT (dBuV/m)	MARGIN (dB)	ANTENNA HEIGHT (m)	TABLE ANGLE (Degree)	RAW VALUE (dBuV)	CORRECTION FACTOR (dB/m)
1	*5240.00	117.0 PK			1.81 H	170	78.1	38.9
2	*5240.00	107.3 AV			1.81 H	170	68.4	38.9
3	5350.00	57.7 PK	74.0	-16.3	1.85 H	168	52.2	5.5
4	5350.00	46.5 AV	54.0	-7.5	1.85 H	168	41.0	5.5
5	#10480.00	60.7 PK	74.0	-13.3	1.74 H	193	42.3	18.4
6	#10480.00	50.0 AV	54.0	-4.0	1.74 H	193	31.6	18.4

ANTENNA POLARITY & TEST DISTANCE: VERTICAL AT 3 M

NO.	FREQ. (MHz)	EMISSION LEVEL (dBuV/m)	LIMIT (dBuV/m)	MARGIN (dB)	ANTENNA HEIGHT (m)	TABLE ANGLE (Degree)	RAW VALUE (dBuV)	CORRECTION FACTOR (dB/m)
1	*5240.00	110.4 PK			1.39 V	33	71.5	38.9
2	*5240.00	100.8 AV			1.39 V	33	61.9	38.9
3	5350.00	57.0 PK	74.0	-17.0	1.45 V	38	51.5	5.5
4	5350.00	43.9 AV	54.0	-10.1	1.45 V	38	38.4	5.5
5	#10480.00	60.7 PK	74.0	-13.3	1.34 V	187	42.3	18.4
6	#10480.00	49.7 AV	54.0	-4.3	1.34 V	187	31.3	18.4

Remarks:

1. Emission Level(dBuV/m) = Raw Value(dBuV) + Correction Factor(dB/m)
2. Correction Factor(dB/m) = Antenna Factor(dB/m) + Cable Factor(dB)
– Pre-Amplifier Factor(dB)
3. The other emission levels were very low against the limit.
4. Margin value = Emission Level – Limit value
5. " * ": Fundamental frequency.
6. " # ": The radiated frequency is out of the restricted band.

CHANNEL	TX Channel 149	DETECTOR FUNCTION	Peak (PK)
FREQUENCY RANGE	1GHz ~ 40GHz		Average (AV)

ANTENNA POLARITY & TEST DISTANCE: HORIZONTAL AT 3 M

NO.	FREQ. (MHz)	EMISSION LEVEL (dBuV/m)	LIMIT (dBuV/m)	MARGIN (dB)	ANTENNA HEIGHT (m)	TABLE ANGLE (Degree)	RAW VALUE (dBuV)	CORRECTION FACTOR (dB/m)
1	#5611.20	58.7 PK	68.2	-9.5	2.32 H	346	52.6	6.1
2	#5714.90	69.5 PK	109.4	-39.9	1.27 H	170	63.2	6.3
3	#5722.90	76.8 PK	117.4	-40.6	1.48 H	171	70.5	6.3
4	#5725.00	64.1 PK	122.2	-58.1	1.48 H	171	57.8	6.3
5	*5745.00	114.6 PK			2.32 H	346	74.6	40.0
6	*5745.00	105.0 AV			2.32 H	346	65.0	40.0
7	#5973.60	60.3 PK	68.2	-7.9	2.32 H	346	53.6	6.7
8	11490.00	60.3 PK	74.0	-13.7	1.22 H	218	41.0	19.3
9	11490.00	48.1 AV	54.0	-5.9	1.22 H	218	28.8	19.3

ANTENNA POLARITY & TEST DISTANCE: VERTICAL AT 3 M

NO.	FREQ. (MHz)	EMISSION LEVEL (dBuV/m)	LIMIT (dBuV/m)	MARGIN (dB)	ANTENNA HEIGHT (m)	TABLE ANGLE (Degree)	RAW VALUE (dBuV)	CORRECTION FACTOR (dB/m)
1	#5643.20	57.6 PK	68.2	-10.6	1.01 V	49	51.5	6.1
2	#5714.90	62.5 PK	109.4	-46.9	1.07 V	40	56.2	6.3
3	#5722.90	71.3 PK	117.4	-46.1	1.06 V	48	65.0	6.3
4	#5725.00	58.5 PK	122.2	-63.7	1.03 V	48	52.2	6.3
5	*5745.00	106.9 PK			1.01 V	49	66.9	40.0
6	*5745.00	96.8 AV			1.01 V	49	56.8	40.0
7	#5993.60	59.1 PK	68.2	-9.1	1.01 V	49	52.4	6.7
8	11490.00	61.5 PK	74.0	-12.5	1.01 V	164	42.2	19.3
9	11490.00	49.3 AV	54.0	-4.7	1.01 V	164	30.0	19.3

Remarks:

1. Emission Level(dBuV/m) = Raw Value(dBuV) + Correction Factor(dB/m)
2. Correction Factor(dB/m) = Antenna Factor(dB/m) + Cable Factor(dB)
- Pre-Amplifier Factor(dB)
3. The other emission levels were very low against the limit.
4. Margin value = Emission Level – Limit value
5. " * ": Fundamental frequency.
6. " # ": The radiated frequency is out of the restricted band.

CHANNEL	TX Channel 157	DETECTOR FUNCTION	Peak (PK)
FREQUENCY RANGE	1GHz ~ 40GHz		Average (AV)

ANTENNA POLARITY & TEST DISTANCE: HORIZONTAL AT 3 M

NO.	FREQ. (MHz)	EMISSION LEVEL (dBuV/m)	LIMIT (dBuV/m)	MARGIN (dB)	ANTENNA HEIGHT (m)	TABLE ANGLE (Degree)	RAW VALUE (dBuV)	CORRECTION FACTOR (dB/m)
1	#5635.20	57.9 PK	68.2	-10.3	2.36 H	346	51.8	6.1
2	*5785.00	116.7 PK			2.36 H	346	76.6	40.1
3	*5785.00	107.6 AV			2.36 H	346	67.5	40.1
4	#5944.80	58.8 PK	68.2	-9.4	2.36 H	346	52.2	6.6
5	11570.00	60.7 PK	74.0	-13.3	2.15 H	219	41.5	19.2
6	11570.00	49.6 AV	54.0	-4.4	2.15 H	219	30.4	19.2

ANTENNA POLARITY & TEST DISTANCE: VERTICAL AT 3 M

NO.	FREQ. (MHz)	EMISSION LEVEL (dBuV/m)	LIMIT (dBuV/m)	MARGIN (dB)	ANTENNA HEIGHT (m)	TABLE ANGLE (Degree)	RAW VALUE (dBuV)	CORRECTION FACTOR (dB/m)
1	#5616.80	58.0 PK	68.2	-10.2	1.04 V	44	51.9	6.1
2	*5785.00	108.6 PK			1.04 V	44	68.5	40.1
3	*5785.00	98.6 AV			1.04 V	44	58.5	40.1
4	#5947.20	59.1 PK	68.2	-9.1	1.04 V	44	52.5	6.6
5	11570.00	61.8 PK	74.0	-12.2	1.03 V	166	42.6	19.2
6	11570.00	50.2 AV	54.0	-3.8	1.03 V	166	31.0	19.2

Remarks:

- Emission Level(dBuV/m) = Raw Value(dBuV) + Correction Factor(dB/m)
- Correction Factor(dB/m) = Antenna Factor(dB/m) + Cable Factor(dB)
– Pre-Amplifier Factor(dB)
- The other emission levels were very low against the limit.
- Margin value = Emission Level – Limit value
- " * ": Fundamental frequency.
- " # ": The radiated frequency is out of the restricted band.

CHANNEL	TX Channel 165	DETECTOR FUNCTION	Peak (PK)
FREQUENCY RANGE	1GHz ~ 40GHz		Average (AV)

ANTENNA POLARITY & TEST DISTANCE: HORIZONTAL AT 3 M

NO.	FREQ. (MHz)	EMISSION LEVEL (dBuV/m)	LIMIT (dBuV/m)	MARGIN (dB)	ANTENNA HEIGHT (m)	TABLE ANGLE (Degree)	RAW VALUE (dBuV)	CORRECTION FACTOR (dB/m)
1	#5629.60	58.6 PK	68.2	-9.6	2.47 H	343	52.5	6.1
2	*5825.00	113.6 PK			2.47 H	343	73.5	40.1
3	*5825.00	103.7 AV			2.47 H	343	63.6	40.1
4	#5850.00	61.7 PK	122.2	-60.5	2.26 H	345	55.2	6.5
5	#5852.10	77.0 PK	117.4	-40.4	2.26 H	345	70.5	6.5
6	#5860.10	64.8 PK	109.4	-44.6	2.16 H	344	58.3	6.5
7	#5964.80	59.6 PK	68.2	-8.6	2.47 H	343	52.9	6.7
8	11650.00	61.8 PK	74.0	-12.2	1.97 H	219	42.5	19.3
9	11650.00	49.2 AV	54.0	-4.8	1.97 H	219	29.9	19.3

ANTENNA POLARITY & TEST DISTANCE: VERTICAL AT 3 M

NO.	FREQ. (MHz)	EMISSION LEVEL (dBuV/m)	LIMIT (dBuV/m)	MARGIN (dB)	ANTENNA HEIGHT (m)	TABLE ANGLE (Degree)	RAW VALUE (dBuV)	CORRECTION FACTOR (dB/m)
1	#5652.80	58.6 PK	70.3	-11.7	1.16 V	48	52.5	6.1
2	*5825.00	105.3 PK			1.16 V	48	65.2	40.1
3	*5825.00	94.9 AV			1.16 V	48	54.8	40.1
4	#5850.00	54.1 PK	122.2	-68.1	1.06 V	46	47.6	6.5
5	#5852.10	66.4 PK	117.4	-51.0	1.06 V	46	59.9	6.5
6	#5860.10	58.0 PK	109.4	-51.4	1.14 V	45	51.5	6.5
7	#5988.00	59.2 PK	68.2	-9.0	1.16 V	48	52.5	6.7
8	11650.00	61.5 PK	74.0	-12.5	1.02 V	165	42.2	19.3
9	11650.00	50.2 AV	54.0	-3.8	1.02 V	165	30.9	19.3

Remarks:

1. Emission Level(dBuV/m) = Raw Value(dBuV) + Correction Factor(dB/m)
2. Correction Factor(dB/m) = Antenna Factor(dB/m) + Cable Factor(dB)
– Pre-Amplifier Factor(dB)
3. The other emission levels were very low against the limit.
4. Margin value = Emission Level – Limit value
5. " * ": Fundamental frequency.
6. " # ": The radiated frequency is out of the restricted band.

802.11n (HT20)

CHANNEL	TX Channel 36	DETECTOR FUNCTION	Peak (PK)
FREQUENCY RANGE	1GHz ~ 40GHz		Average (AV)

ANTENNA POLARITY & TEST DISTANCE: HORIZONTAL AT 3 M								
NO.	FREQ. (MHz)	EMISSION LEVEL (dBuV/m)	LIMIT (dBuV/m)	MARGIN (dB)	ANTENNA HEIGHT (m)	TABLE ANGLE (Degree)	RAW VALUE (dBuV)	CORRECTION FACTOR (dB/m)
1	5150.00	72.8 PK	74.0	-1.2	1.82 H	170	68.0	4.8
2	5150.00	46.8 AV	54.0	-7.2	1.82 H	170	42.0	4.8
3	*5180.00	111.2 PK			1.80 H	167	72.5	38.7
4	*5180.00	101.1 AV			1.80 H	167	62.4	38.7
5	#10360.00	59.9 PK	74.0	-14.1	1.49 H	216	42.3	17.6
6	#10360.00	49.2 AV	54.0	-4.8	1.49 H	216	31.6	17.6
ANTENNA POLARITY & TEST DISTANCE: VERTICAL AT 3 M								
NO.	FREQ. (MHz)	EMISSION LEVEL (dBuV/m)	LIMIT (dBuV/m)	MARGIN (dB)	ANTENNA HEIGHT (m)	TABLE ANGLE (Degree)	RAW VALUE (dBuV)	CORRECTION FACTOR (dB/m)
1	5150.00	62.9 PK	74.0	-11.1	1.31 V	37	58.1	4.8
2	5150.00	43.5 AV	54.0	-10.5	1.31 V	37	38.7	4.8
3	*5180.00	106.5 PK			1.30 V	37	67.8	38.7
4	*5180.00	95.2 AV			1.30 V	37	56.5	38.7
5	#10360.00	60.9 PK	74.0	-13.1	1.34 V	186	43.3	17.6
6	#10360.00	49.5 AV	54.0	-4.5	1.34 V	186	31.9	17.6

Remarks:

1. Emission Level(dBuV/m) = Raw Value(dBuV) + Correction Factor(dB/m)
2. Correction Factor(dB/m) = Antenna Factor(dB/m) + Cable Factor(dB)
– Pre-Amplifier Factor(dB)
3. The other emission levels were very low against the limit.
4. Margin value = Emission Level – Limit value
5. " * ": Fundamental frequency.
6. " # ": The radiated frequency is out of the restricted band.

CHANNEL	TX Channel 40	DETECTOR FUNCTION	Peak (PK)
FREQUENCY RANGE	1GHz ~ 40GHz		Average (AV)

ANTENNA POLARITY & TEST DISTANCE: HORIZONTAL AT 3 M

NO.	FREQ. (MHz)	EMISSION LEVEL (dBuV/m)	LIMIT (dBuV/m)	MARGIN (dB)	ANTENNA HEIGHT (m)	TABLE ANGLE (Degree)	RAW VALUE (dBuV)	CORRECTION FACTOR (dB/m)
1	*5200.00	117.0 PK			1.78 H	168	78.3	38.7
2	*5200.00	106.4 AV			1.78 H	168	67.7	38.7
3	#10400.00	60.2 PK	74.0	-13.8	1.43 H	218	42.6	17.6
4	#10400.00	49.9 AV	54.0	-4.1	1.43 H	218	32.3	17.6

ANTENNA POLARITY & TEST DISTANCE: VERTICAL AT 3 M

NO.	FREQ. (MHz)	EMISSION LEVEL (dBuV/m)	LIMIT (dBuV/m)	MARGIN (dB)	ANTENNA HEIGHT (m)	TABLE ANGLE (Degree)	RAW VALUE (dBuV)	CORRECTION FACTOR (dB/m)
1	*5200.00	110.9 PK			1.35 V	33	72.2	38.7
2	*5200.00	99.8 AV			1.35 V	33	61.1	38.7
3	#10400.00	60.1 PK	74.0	-13.9	1.32 V	186	42.5	17.6
4	#10400.00	49.6 AV	54.0	-4.4	1.32 V	186	32.0	17.6

Remarks:

1. Emission Level(dBuV/m) = Raw Value(dBuV) + Correction Factor(dB/m)
2. Correction Factor(dB/m) = Antenna Factor(dB/m) + Cable Factor(dB)
– Pre-Amplifier Factor(dB)
3. The other emission levels were very low against the limit.
4. Margin value = Emission Level – Limit value
5. " * ": Fundamental frequency.
6. " # ": The radiated frequency is out of the restricted band.

CHANNEL	TX Channel 48	DETECTOR FUNCTION	Peak (PK)
FREQUENCY RANGE	1GHz ~ 40GHz		Average (AV)

ANTENNA POLARITY & TEST DISTANCE: HORIZONTAL AT 3 M

NO.	FREQ. (MHz)	EMISSION LEVEL (dBuV/m)	LIMIT (dBuV/m)	MARGIN (dB)	ANTENNA HEIGHT (m)	TABLE ANGLE (Degree)	RAW VALUE (dBuV)	CORRECTION FACTOR (dB/m)
1	*5240.00	116.7 PK			1.74 H	167	77.8	38.9
2	*5240.00	106.5 AV			1.74 H	167	67.6	38.9
3	5350.00	58.1 PK	74.0	-15.9	1.76 H	171	52.6	5.5
4	5350.00	45.5 AV	54.0	-8.5	1.76 H	171	40.0	5.5
5	#10480.00	60.9 PK	74.0	-13.1	1.71 H	194	42.5	18.4
6	#10480.00	50.2 AV	54.0	-3.8	1.71 H	194	31.8	18.4

ANTENNA POLARITY & TEST DISTANCE: VERTICAL AT 3 M

NO.	FREQ. (MHz)	EMISSION LEVEL (dBuV/m)	LIMIT (dBuV/m)	MARGIN (dB)	ANTENNA HEIGHT (m)	TABLE ANGLE (Degree)	RAW VALUE (dBuV)	CORRECTION FACTOR (dB/m)
1	*5240.00	110.9 PK			1.40 V	33	72.0	38.9
2	*5240.00	100.1 AV			1.40 V	33	61.2	38.9
3	5350.00	56.9 PK	74.0	-17.1	1.47 V	50	51.4	5.5
4	5350.00	43.4 AV	54.0	-10.6	1.47 V	50	37.9	5.5
5	#10480.00	60.9 PK	74.0	-13.1	1.38 V	188	42.5	18.4
6	#10480.00	49.5 AV	54.0	-4.5	1.38 V	188	31.1	18.4

Remarks:

- Emission Level(dBuV/m) = Raw Value(dBuV) + Correction Factor(dB/m)
- Correction Factor(dB/m) = Antenna Factor(dB/m) + Cable Factor(dB)
– Pre-Amplifier Factor(dB)
- The other emission levels were very low against the limit.
- Margin value = Emission Level – Limit value
- " * ": Fundamental frequency.
- " # ": The radiated frequency is out of the restricted band.

CHANNEL	TX Channel 149	DETECTOR FUNCTION	Peak (PK)
FREQUENCY RANGE	1GHz ~ 40GHz		Average (AV)

ANTENNA POLARITY & TEST DISTANCE: HORIZONTAL AT 3 M

NO.	FREQ. (MHz)	EMISSION LEVEL (dBuV/m)	LIMIT (dBuV/m)	MARGIN (dB)	ANTENNA HEIGHT (m)	TABLE ANGLE (Degree)	RAW VALUE (dBuV)	CORRECTION FACTOR (dB/m)
1	#5652.00	59.7 PK	69.7	-10.0	2.23 H	346	53.6	6.1
2	#5714.90	72.4 PK	109.4	-37.0	2.68 H	344	66.1	6.3
3	#5722.90	77.1 PK	117.4	-40.3	2.23 H	344	70.8	6.3
4	#5725.00	61.2 PK	122.2	-61.0	2.23 H	344	54.9	6.3
5	*5745.00	110.9 PK			2.23 H	346	70.9	40.0
6	*5745.00	101.0 AV			2.23 H	346	61.0	40.0
7	#5986.40	59.8 PK	68.2	-8.4	2.23 H	346	53.1	6.7
8	11490.00	60.0 PK	74.0	-14.0	1.43 H	155	40.7	19.3
9	11490.00	48.2 AV	54.0	-5.8	1.43 H	155	28.9	19.3

ANTENNA POLARITY & TEST DISTANCE: VERTICAL AT 3 M

NO.	FREQ. (MHz)	EMISSION LEVEL (dBuV/m)	LIMIT (dBuV/m)	MARGIN (dB)	ANTENNA HEIGHT (m)	TABLE ANGLE (Degree)	RAW VALUE (dBuV)	CORRECTION FACTOR (dB/m)
1	#5629.60	57.8 PK	68.2	-10.4	1.00 V	51	51.7	6.1
2	#5714.90	63.4 PK	109.4	-46.0	1.00 V	56	57.1	6.3
3	#5722.90	70.8 PK	117.4	-46.6	1.02 V	43	64.5	6.3
4	#5725.00	55.7 PK	122.2	-66.5	1.02 V	43	49.4	6.3
5	*5745.00	104.9 PK			1.00 V	51	64.9	40.0
6	*5745.00	94.3 AV			1.00 V	51	54.3	40.0
7	#5987.20	59.0 PK	68.2	-9.2	1.00 V	51	52.3	6.7
8	11490.00	61.3 PK	74.0	-12.7	1.90 V	187	42.0	19.3
9	11490.00	49.6 AV	54.0	-4.4	1.90 V	187	30.3	19.3

Remarks:

1. Emission Level(dBuV/m) = Raw Value(dBuV) + Correction Factor(dB/m)
2. Correction Factor(dB/m) = Antenna Factor(dB/m) + Cable Factor(dB)
- Pre-Amplifier Factor(dB)
3. The other emission levels were very low against the limit.
4. Margin value = Emission Level – Limit value
5. " * ": Fundamental frequency.
6. " # ": The radiated frequency is out of the restricted band.

CHANNEL	TX Channel 157	DETECTOR FUNCTION	Peak (PK)
FREQUENCY RANGE	1GHz ~ 40GHz		Average (AV)

ANTENNA POLARITY & TEST DISTANCE: HORIZONTAL AT 3 M

NO.	FREQ. (MHz)	EMISSION LEVEL (dBuV/m)	LIMIT (dBuV/m)	MARGIN (dB)	ANTENNA HEIGHT (m)	TABLE ANGLE (Degree)	RAW VALUE (dBuV)	CORRECTION FACTOR (dB/m)
1	#5618.40	58.3 PK	68.2	-9.9	2.23 H	347	52.2	6.1
2	*5785.00	115.3 PK			2.23 H	347	75.2	40.1
3	*5785.00	105.2 AV			2.23 H	347	65.1	40.1
4	#5954.40	59.2 PK	68.2	-9.0	2.23 H	347	52.6	6.6
5	11570.00	60.8 PK	74.0	-13.2	1.99 H	221	41.6	19.2
6	11570.00	49.3 AV	54.0	-4.7	1.99 H	221	30.1	19.2

ANTENNA POLARITY & TEST DISTANCE: VERTICAL AT 3 M

NO.	FREQ. (MHz)	EMISSION LEVEL (dBuV/m)	LIMIT (dBuV/m)	MARGIN (dB)	ANTENNA HEIGHT (m)	TABLE ANGLE (Degree)	RAW VALUE (dBuV)	CORRECTION FACTOR (dB/m)
1	#5631.20	58.0 PK	68.2	-10.2	1.00 V	52	51.9	6.1
2	*5785.00	109.2 PK			1.00 V	52	69.1	40.1
3	*5785.00	97.9 AV			1.00 V	52	57.8	40.1
4	#5966.40	61.0 PK	68.2	-7.2	1.00 V	52	54.3	6.7
5	11570.00	61.2 PK	74.0	-12.8	1.91 V	188	42.0	19.2
6	11570.00	50.4 AV	54.0	-3.6	1.91 V	188	31.2	19.2

Remarks:

1. Emission Level(dBuV/m) = Raw Value(dBuV) + Correction Factor(dB/m)
2. Correction Factor(dB/m) = Antenna Factor(dB/m) + Cable Factor(dB)
– Pre-Amplifier Factor(dB)
3. The other emission levels were very low against the limit.
4. Margin value = Emission Level – Limit value
5. " * ": Fundamental frequency.
6. " # ": The radiated frequency is out of the restricted band.

CHANNEL	TX Channel 165	DETECTOR FUNCTION	Peak (PK)
FREQUENCY RANGE	1GHz ~ 40GHz		Average (AV)

ANTENNA POLARITY & TEST DISTANCE: HORIZONTAL AT 3 M

NO.	FREQ. (MHz)	EMISSION LEVEL (dBuV/m)	LIMIT (dBuV/m)	MARGIN (dB)	ANTENNA HEIGHT (m)	TABLE ANGLE (Degree)	RAW VALUE (dBuV)	CORRECTION FACTOR (dB/m)
1	#5624.80	58.1 PK	68.2	-10.1	2.20 H	343	52.0	6.1
2	*5825.00	113.0 PK			2.20 H	343	72.9	40.1
3	*5825.00	102.3 AV			2.20 H	343	62.2	40.1
4	#5850.00	64.4 PK	122.2	-57.8	2.17 H	345	57.9	6.5
5	#5852.10	76.8 PK	117.4	-40.6	2.17 H	345	70.3	6.5
6	#5860.10	70.1 PK	109.4	-39.3	2.16 H	346	63.6	6.5
7	#5952.80	59.2 PK	68.2	-9.0	2.20 H	343	52.6	6.6
8	11650.00	60.6 PK	74.0	-13.4	1.94 H	220	41.3	19.3
9	11650.00	49.1 AV	54.0	-4.9	1.94 H	220	29.8	19.3

ANTENNA POLARITY & TEST DISTANCE: VERTICAL AT 3 M

NO.	FREQ. (MHz)	EMISSION LEVEL (dBuV/m)	LIMIT (dBuV/m)	MARGIN (dB)	ANTENNA HEIGHT (m)	TABLE ANGLE (Degree)	RAW VALUE (dBuV)	CORRECTION FACTOR (dB/m)
1	#5628.00	57.9 PK	68.2	-10.3	1.00 V	55	51.8	6.1
2	*5825.00	106.1 PK			1.00 V	55	66.0	40.1
3	*5825.00	94.4 AV			1.00 V	55	54.3	40.1
4	#5850.00	55.8 PK	122.2	-66.4	1.03 V	61	49.3	6.5
5	#5852.10	68.0 PK	117.4	-49.4	1.03 V	61	61.5	6.5
6	#5860.10	60.6 PK	109.4	-48.8	1.00 V	52	54.1	6.5
7	#5949.60	58.7 PK	68.2	-9.5	1.00 V	55	52.1	6.6
8	11650.00	61.3 PK	74.0	-12.7	1.92 V	188	42.0	19.3
9	11650.00	50.3 AV	54.0	-3.7	1.92 V	188	31.0	19.3

Remarks:

1. Emission Level(dBuV/m) = Raw Value(dBuV) + Correction Factor(dB/m)
2. Correction Factor(dB/m) = Antenna Factor(dB/m) + Cable Factor(dB)
- Pre-Amplifier Factor(dB)
3. The other emission levels were very low against the limit.
4. Margin value = Emission Level – Limit value
5. " * ": Fundamental frequency.
6. " # ": The radiated frequency is out of the restricted band.

802.11n (HT40)

CHANNEL	TX Channel 38	DETECTOR FUNCTION	Peak (PK)
FREQUENCY RANGE	1GHz ~ 40GHz		Average (AV)

ANTENNA POLARITY & TEST DISTANCE: HORIZONTAL AT 3 M								
NO.	FREQ. (MHz)	EMISSION LEVEL (dBuV/m)	LIMIT (dBuV/m)	MARGIN (dB)	ANTENNA HEIGHT (m)	TABLE ANGLE (Degree)	RAW VALUE (dBuV)	CORRECTION FACTOR (dB/m)
1	5150.00	71.3 PK	74.0	-2.7	1.79 H	169	66.5	4.8
2	5150.00	52.6 AV	54.0	-1.4	1.79 H	169	47.8	4.8
3	*5190.00	108.3 PK			1.77 H	168	69.6	38.7
4	*5190.00	98.6 AV			1.77 H	168	59.9	38.7
5	#10380.00	60.4 PK	74.0	-13.6	1.65 H	213	42.8	17.6
6	#10380.00	50.1 AV	54.0	-3.9	1.65 H	213	32.5	17.6
ANTENNA POLARITY & TEST DISTANCE: VERTICAL AT 3 M								
NO.	FREQ. (MHz)	EMISSION LEVEL (dBuV/m)	LIMIT (dBuV/m)	MARGIN (dB)	ANTENNA HEIGHT (m)	TABLE ANGLE (Degree)	RAW VALUE (dBuV)	CORRECTION FACTOR (dB/m)
1	5150.00	63.5 PK	74.0	-10.5	1.36 V	33	58.7	4.8
2	5150.00	46.9 AV	54.0	-7.1	1.36 V	33	42.1	4.8
3	*5190.00	103.0 PK			1.37 V	34	64.3	38.7
4	*5190.00	91.9 AV			1.37 V	34	53.2	38.7
5	#10380.00	59.3 PK	74.0	-14.7	1.58 V	154	41.7	17.6
6	#10380.00	47.0 AV	54.0	-7.0	1.58 V	154	29.4	17.6

Remarks:

1. Emission Level(dBuV/m) = Raw Value(dBuV) + Correction Factor(dB/m)
2. Correction Factor(dB/m) = Antenna Factor(dB/m) + Cable Factor(dB)
– Pre-Amplifier Factor(dB)
3. The other emission levels were very low against the limit.
4. Margin value = Emission Level – Limit value
5. " * ": Fundamental frequency.
6. " # ": The radiated frequency is out of the restricted band.

CHANNEL	TX Channel 46	DETECTOR FUNCTION	Peak (PK)
FREQUENCY RANGE	1GHz ~ 40GHz		Average (AV)

ANTENNA POLARITY & TEST DISTANCE: HORIZONTAL AT 3 M

NO.	FREQ. (MHz)	EMISSION LEVEL (dBuV/m)	LIMIT (dBuV/m)	MARGIN (dB)	ANTENNA HEIGHT (m)	TABLE ANGLE (Degree)	RAW VALUE (dBuV)	CORRECTION FACTOR (dB/m)
1	*5230.00	112.8 PK			1.74 H	168	73.9	38.9
2	*5230.00	103.1 AV			1.74 H	168	64.2	38.9
3	5350.00	58.3 PK	74.0	-15.7	1.78 H	172	52.8	5.5
4	5350.00	46.1 AV	54.0	-7.9	1.78 H	172	40.6	5.5
5	#10460.00	60.5 PK	74.0	-13.5	1.41 H	215	42.3	18.2
6	#10460.00	50.2 AV	54.0	-3.8	1.41 H	215	32.0	18.2

ANTENNA POLARITY & TEST DISTANCE: VERTICAL AT 3 M

NO.	FREQ. (MHz)	EMISSION LEVEL (dBuV/m)	LIMIT (dBuV/m)	MARGIN (dB)	ANTENNA HEIGHT (m)	TABLE ANGLE (Degree)	RAW VALUE (dBuV)	CORRECTION FACTOR (dB/m)
1	*5230.00	105.2 PK			1.65 V	63	66.3	38.9
2	*5230.00	94.0 AV			1.65 V	63	55.1	38.9
3	5350.00	57.0 PK	74.0	-17.0	1.67 V	45	51.5	5.5
4	5350.00	44.7 AV	54.0	-9.3	1.67 V	45	39.2	5.5
5	#10460.00	59.8 PK	74.0	-14.2	1.60 V	154	41.6	18.2
6	#10460.00	48.1 AV	54.0	-5.9	1.60 V	154	29.9	18.2

Remarks:

1. Emission Level(dBuV/m) = Raw Value(dBuV) + Correction Factor(dB/m)
2. Correction Factor(dB/m) = Antenna Factor(dB/m) + Cable Factor(dB)
– Pre-Amplifier Factor(dB)
3. The other emission levels were very low against the limit.
4. Margin value = Emission Level – Limit value
5. " * ": Fundamental frequency.
6. " # ": The radiated frequency is out of the restricted band.

CHANNEL	TX Channel 151	DETECTOR FUNCTION	Peak (PK)
FREQUENCY RANGE	1GHz ~ 40GHz		Average (AV)

ANTENNA POLARITY & TEST DISTANCE: HORIZONTAL AT 3 M

NO.	FREQ. (MHz)	EMISSION LEVEL (dBuV/m)	LIMIT (dBuV/m)	MARGIN (dB)	ANTENNA HEIGHT (m)	TABLE ANGLE (Degree)	RAW VALUE (dBuV)	CORRECTION FACTOR (dB/m)
1	#5632.80	58.1 PK	68.2	-10.1	2.13 H	349	52.0	6.1
2	#5714.90	72.4 PK	109.4	-37.0	2.56 H	347	66.1	6.3
3	#5722.90	74.0 PK	117.4	-43.4	2.46 H	346	67.7	6.3
4	#5725.00	61.4 PK	122.2	-60.8	2.46 H	346	55.1	6.3
5	*5755.00	107.1 PK			2.13 H	349	67.1	40.0
6	*5755.00	97.5 AV			2.13 H	349	57.5	40.0
7	#5933.60	59.2 PK	68.2	-9.0	2.13 H	349	52.6	6.6
8	11510.00	60.4 PK	74.0	-13.6	2.15 H	135	41.1	19.3
9	11510.00	49.8 AV	54.0	-4.2	2.15 H	135	30.5	19.3

ANTENNA POLARITY & TEST DISTANCE: VERTICAL AT 3 M

NO.	FREQ. (MHz)	EMISSION LEVEL (dBuV/m)	LIMIT (dBuV/m)	MARGIN (dB)	ANTENNA HEIGHT (m)	TABLE ANGLE (Degree)	RAW VALUE (dBuV)	CORRECTION FACTOR (dB/m)
1	#5634.40	57.9 PK	68.2	-10.3	1.01 V	51	51.8	6.1
2	#5714.90	62.5 PK	109.4	-46.9	1.00 V	49	56.2	6.3
3	#5722.90	67.3 PK	117.4	-50.1	1.04 V	58	61.0	6.3
4	#5725.00	54.3 PK	122.2	-67.9	1.04 V	58	48.0	6.3
5	*5755.00	101.2 PK			1.01 V	51	61.2	40.0
6	*5755.00	90.4 AV			1.01 V	51	50.4	40.0
7	#5977.60	59.6 PK	68.2	-8.6	1.01 V	51	52.9	6.7
8	11510.00	61.4 PK	74.0	-12.6	1.92 V	188	42.1	19.3
9	11510.00	51.1 AV	54.0	-2.9	1.92 V	188	31.8	19.3

Remarks:

1. Emission Level(dBuV/m) = Raw Value(dBuV) + Correction Factor(dB/m)
2. Correction Factor(dB/m) = Antenna Factor(dB/m) + Cable Factor(dB)
- Pre-Amplifier Factor(dB)
3. The other emission levels were very low against the limit.
4. Margin value = Emission Level – Limit value
5. " * ": Fundamental frequency.
6. " # ": The radiated frequency is out of the restricted band.

CHANNEL	TX Channel 159	DETECTOR FUNCTION	Peak (PK)
FREQUENCY RANGE	1GHz ~ 40GHz		Average (AV)

ANTENNA POLARITY & TEST DISTANCE: HORIZONTAL AT 3 M

NO.	FREQ. (MHz)	EMISSION LEVEL (dBuV/m)	LIMIT (dBuV/m)	MARGIN (dB)	ANTENNA HEIGHT (m)	TABLE ANGLE (Degree)	RAW VALUE (dBuV)	CORRECTION FACTOR (dB/m)
1	#5636.00	58.9 PK	68.2	-9.3	2.22 H	349	52.8	6.1
2	*5795.00	111.5 PK			2.22 H	349	71.4	40.1
3	*5795.00	101.4 AV			2.22 H	349	61.3	40.1
4	#5850.00	60.2 PK	122.2	-62.0	1.92 H	348	53.7	6.5
5	#5852.10	69.5 PK	117.4	-47.9	1.92 H	348	63.0	6.5
6	#5860.10	67.2 PK	109.4	-42.2	1.94 H	349	60.7	6.5
7	#5936.80	59.0 PK	68.2	-9.2	2.22 H	349	52.4	6.6
8	11590.00	61.7 PK	74.0	-12.3	2.33 H	136	42.5	19.2
9	11590.00	51.2 AV	54.0	-2.8	2.33 H	136	32.0	19.2

ANTENNA POLARITY & TEST DISTANCE: VERTICAL AT 3 M

NO.	FREQ. (MHz)	EMISSION LEVEL (dBuV/m)	LIMIT (dBuV/m)	MARGIN (dB)	ANTENNA HEIGHT (m)	TABLE ANGLE (Degree)	RAW VALUE (dBuV)	CORRECTION FACTOR (dB/m)
1	#5624.00	58.8 PK	68.2	-9.4	1.00 V	53	52.7	6.1
2	*5795.00	104.7 PK			1.00 V	53	64.6	40.1
3	*5795.00	93.6 AV			1.00 V	53	53.5	40.1
4	#5850.00	52.6 PK	122.2	-69.6	1.01 V	48	46.1	6.5
5	#5852.10	61.1 PK	117.4	-56.3	1.01 V	48	54.6	6.5
6	#5860.10	58.6 PK	109.4	-50.8	1.00 V	52	52.1	6.5
7	#5926.40	59.1 PK	68.2	-9.1	1.00 V	53	52.5	6.6
8	11590.00	61.4 PK	74.0	-12.6	1.91 V	187	42.2	19.2
9	11590.00	51.4 AV	54.0	-2.6	1.91 V	187	32.2	19.2

Remarks:

1. Emission Level(dBuV/m) = Raw Value(dBuV) + Correction Factor(dB/m)
2. Correction Factor(dB/m) = Antenna Factor(dB/m) + Cable Factor(dB)
- Pre-Amplifier Factor(dB)
3. The other emission levels were very low against the limit.
4. Margin value = Emission Level – Limit value
5. " * ": Fundamental frequency.
6. " # ": The radiated frequency is out of the restricted band.

802.11ac (VHT80)

CHANNEL	TX Channel 42	DETECTOR FUNCTION	Peak (PK)
FREQUENCY RANGE	1GHz ~ 40GHz		Average (AV)

ANTENNA POLARITY & TEST DISTANCE: HORIZONTAL AT 3 M								
NO.	FREQ. (MHz)	EMISSION LEVEL (dBuV/m)	LIMIT (dBuV/m)	MARGIN (dB)	ANTENNA HEIGHT (m)	TABLE ANGLE (Degree)	RAW VALUE (dBuV)	CORRECTION FACTOR (dB/m)
1	5150.00	70.1 PK	74.0	-3.9	1.82 H	169	65.3	4.8
2	5150.00	52.6 AV	54.0	-1.4	1.82 H	169	47.8	4.8
3	*5210.00	105.7 PK			1.70 H	169	67.0	38.7
4	*5210.00	95.3 AV			1.70 H	169	56.6	38.7
5	5350.00	57.2 PK	74.0	-16.8	1.87 H	165	51.7	5.5
6	5350.00	45.1 AV	54.0	-8.9	1.87 H	165	39.6	5.5
7	#10420.00	60.0 PK	74.0	-14.0	1.54 H	216	42.2	17.8
8	#10420.00	50.6 AV	54.0	-3.4	1.54 H	216	32.8	17.8
ANTENNA POLARITY & TEST DISTANCE: VERTICAL AT 3 M								
NO.	FREQ. (MHz)	EMISSION LEVEL (dBuV/m)	LIMIT (dBuV/m)	MARGIN (dB)	ANTENNA HEIGHT (m)	TABLE ANGLE (Degree)	RAW VALUE (dBuV)	CORRECTION FACTOR (dB/m)
1	5150.00	61.4 PK	74.0	-12.6	1.43 V	34	56.6	4.8
2	5150.00	47.2 AV	54.0	-6.8	1.43 V	34	42.4	4.8
3	*5210.00	100.1 PK			1.47 V	38	61.4	38.7
4	*5210.00	88.6 AV			1.47 V	38	49.9	38.7
5	5350.00	57.2 PK	74.0	-16.8	1.45 V	28	51.7	5.5
6	5350.00	45.0 AV	54.0	-9.0	1.45 V	28	39.5	5.5
7	#10420.00	60.4 PK	74.0	-13.6	1.91 V	185	42.6	17.8
8	#10420.00	49.3 AV	54.0	-4.7	1.91 V	185	31.5	17.8

Remarks:

1. Emission Level(dBuV/m) = Raw Value(dBuV) + Correction Factor(dB/m)
2. Correction Factor(dB/m) = Antenna Factor(dB/m) + Cable Factor(dB)
– Pre-Amplifier Factor(dB)
3. The other emission levels were very low against the limit.
4. Margin value = Emission Level – Limit value
5. " * ": Fundamental frequency.
6. " # ": The radiated frequency is out of the restricted band.

CHANNEL	TX Channel 155	DETECTOR FUNCTION	Peak (PK)
FREQUENCY RANGE	1GHz ~ 40GHz		Average (AV)

ANTENNA POLARITY & TEST DISTANCE: HORIZONTAL AT 3 M

NO.	FREQ. (MHz)	EMISSION LEVEL (dBuV/m)	LIMIT (dBuV/m)	MARGIN (dB)	ANTENNA HEIGHT (m)	TABLE ANGLE (Degree)	RAW VALUE (dBuV)	CORRECTION FACTOR (dB/m)
1	#5612.80	59.1 PK	68.2	-9.1	2.27 H	347	53.0	6.1
2	#5714.90	67.3 PK	109.4	-42.1	2.17 H	348	61.0	6.3
3	#5722.90	70.4 PK	117.4	-47.0	2.16 H	349	64.1	6.3
4	#5725.00	57.8 PK	122.2	-64.4	2.16 H	348	51.5	6.3
5	*5775.00	104.2 PK			2.27 H	347	64.2	40.0
6	*5775.00	93.8 AV			2.27 H	347	53.8	40.0
7	#5850.00	51.3 PK	122.2	-70.9	2.13 H	345	44.8	6.5
8	#5852.10	63.3 PK	117.4	-54.1	2.13 H	345	56.8	6.5
9	#5860.10	60.9 PK	109.4	-48.5	2.15 H	348	54.4	6.5
10	#5949.60	59.3 PK	68.2	-8.9	2.27 H	347	52.7	6.6
11	11550.00	62.1 PK	74.0	-11.9	2.11 H	221	42.9	19.2
12	11550.00	50.3 AV	54.0	-3.7	2.11 H	221	31.1	19.2

ANTENNA POLARITY & TEST DISTANCE: VERTICAL AT 3 M

NO.	FREQ. (MHz)	EMISSION LEVEL (dBuV/m)	LIMIT (dBuV/m)	MARGIN (dB)	ANTENNA HEIGHT (m)	TABLE ANGLE (Degree)	RAW VALUE (dBuV)	CORRECTION FACTOR (dB/m)
1	#5632.80	58.4 PK	68.2	-9.8	1.02 V	47	52.3	6.1
2	#5714.90	62.0 PK	109.4	-47.4	1.00 V	52	55.7	6.3
3	#5722.90	63.4 PK	117.4	-54.0	1.01 V	51	57.1	6.3
4	#5725.00	52.8 PK	122.2	-69.4	1.01 V	51	46.5	6.3
5	*5775.00	98.1 PK			1.02 V	47	58.1	40.0
6	*5775.00	87.0 AV			1.02 V	47	47.0	40.0
7	#5850.00	50.1 PK	122.2	-72.1	1.03 V	49	43.6	6.5
8	#5852.10	57.8 PK	117.4	-59.6	1.03 V	49	51.3	6.5
9	#5860.10	58.4 PK	109.4	-51.0	1.00 V	55	51.9	6.5
10	#5948.00	59.3 PK	68.2	-8.9	1.02 V	47	52.7	6.6
11	11550.00	61.7 PK	74.0	-12.3	1.93 V	186	42.5	19.2
12	11550.00	51.3 AV	54.0	-2.7	1.93 V	186	32.1	19.2

Remarks:

1. Emission Level(dBuV/m) = Raw Value(dBuV) + Correction Factor(dB/m)
2. Correction Factor(dB/m) = Antenna Factor(dB/m) + Cable Factor(dB)
– Pre-Amplifier Factor(dB)
3. The other emission levels were very low against the limit.
4. Margin value = Emission Level – Limit value
5. " * ": Fundamental frequency.
6. " # ": The radiated frequency is out of the restricted band.

Below 1GHz Worst-Case Data:

802.11a

Mode A

CHANNEL	TX Channel 149	DETECTOR FUNCTION	Quasi-Peak (QP)
FREQUENCY RANGE	9kHz ~ 1GHz		

ANTENNA POLARITY & TEST DISTANCE: HORIZONTAL AT 3 M								
NO.	FREQ. (MHz)	EMISSION LEVEL (dBuV/m)	LIMIT (dBuV/m)	MARGIN (dB)	ANTENNA HEIGHT (m)	TABLE ANGLE (Degree)	RAW VALUE (dBuV)	CORRECTION FACTOR (dB/m)
1	57.12	26.4 QP	40.0	-13.6	1.50 H	30	41.0	-14.6
2	150.45	29.5 QP	43.5	-14.0	1.00 H	144	43.2	-13.7
3	290.43	23.7 QP	46.0	-22.3	1.00 H	177	36.0	-12.3
4	401.26	33.3 QP	46.0	-12.7	1.00 H	217	43.4	-10.1
5	533.47	38.5 QP	46.0	-7.5	1.50 H	39	45.9	-7.4
6	875.67	33.3 QP	46.0	-12.7	1.00 H	153	33.4	-0.1
ANTENNA POLARITY & TEST DISTANCE: VERTICAL AT 3 M								
NO.	FREQ. (MHz)	EMISSION LEVEL (dBuV/m)	LIMIT (dBuV/m)	MARGIN (dB)	ANTENNA HEIGHT (m)	TABLE ANGLE (Degree)	RAW VALUE (dBuV)	CORRECTION FACTOR (dB/m)
1	31.84	35.5 QP	40.0	-4.5	1.49 V	216	51.9	-16.4
2	105.73	28.7 QP	43.5	-14.8	1.49 V	123	46.6	-17.9
3	187.39	27.6 QP	43.5	-15.9	1.00 V	220	43.5	-15.9
4	403.20	32.9 QP	46.0	-13.1	1.49 V	14	43.0	-10.1
5	500.42	34.3 QP	46.0	-11.7	1.00 V	73	42.2	-7.9
6	895.11	30.4 QP	46.0	-15.6	1.00 V	296	29.8	0.6

Remarks:

1. Emission Level(dBuV/m) = Raw Value(dBuV) + Correction Factor(dB/m)
2. Correction Factor(dB/m) = Antenna Factor(dB/m) + Cable Factor(dB)
– Pre-Amplifier Factor(dB)
3. The other emission levels were very low against the limit.
4. Margin value = Emission Level – Limit value

Mode B

CHANNEL	TX Channel 149	DETECTOR FUNCTION	Quasi-Peak (QP)
FREQUENCY RANGE	9kHz ~ 1GHz		

ANTENNA POLARITY & TEST DISTANCE: HORIZONTAL AT 3 M

NO.	FREQ. (MHz)	EMISSION LEVEL (dBuV/m)	LIMIT (dBuV/m)	MARGIN (dB)	ANTENNA HEIGHT (m)	TABLE ANGLE (Degree)	RAW VALUE (dBuV)	CORRECTION FACTOR (dB/m)
1	39.62	26.1 QP	40.0	-13.9	2.00 H	90	41.2	-15.1
2	115.45	27.5 QP	43.5	-16.0	1.49 H	102	44.1	-16.6
3	249.60	32.7 QP	46.0	-13.3	1.00 H	242	46.6	-13.9
4	325.43	33.2 QP	46.0	-12.8	1.00 H	230	44.6	-11.4
5	500.42	40.7 QP	46.0	-5.3	1.49 H	232	48.5	-7.8
6	1000.00	36.6 QP	54.0	-17.4	1.49 H	16	34.7	1.9

ANTENNA POLARITY & TEST DISTANCE: VERTICAL AT 3 M

NO.	FREQ. (MHz)	EMISSION LEVEL (dBuV/m)	LIMIT (dBuV/m)	MARGIN (dB)	ANTENNA HEIGHT (m)	TABLE ANGLE (Degree)	RAW VALUE (dBuV)	CORRECTION FACTOR (dB/m)
1	41.92	35.3 QP	40.0	-4.7	1.00 V	7	50.2	-14.9
2	171.83	30.5 QP	43.5	-13.0	1.00 V	161	44.5	-14.0
3	249.60	29.5 QP	46.0	-16.5	2.00 V	155	43.4	-13.9
4	305.99	32.4 QP	46.0	-13.6	1.00 V	175	44.2	-11.8
5	500.42	40.4 QP	46.0	-5.6	1.00 V	164	48.2	-7.8
6	1000.00	37.3 QP	54.0	-16.7	1.49 V	177	35.4	1.9

Remarks:

- Emission Level(dBuV/m) = Raw Value(dBuV) + Correction Factor(dB/m)
- Correction Factor(dB/m) = Antenna Factor(dB/m) + Cable Factor(dB)
– Pre-Amplifier Factor(dB)
- The other emission levels were very low against the limit.
- Margin value = Emission Level – Limit value

Mode C

CHANNEL	TX Channel 149	DETECTOR FUNCTION	Quasi-Peak (QP)
FREQUENCY RANGE	9kHz ~ 1GHz		

ANTENNA POLARITY & TEST DISTANCE: HORIZONTAL AT 3 M

NO.	FREQ. (MHz)	EMISSION LEVEL (dBuV/m)	LIMIT (dBuV/m)	MARGIN (dB)	ANTENNA HEIGHT (m)	TABLE ANGLE (Degree)	RAW VALUE (dBuV)	CORRECTION FACTOR (dB/m)
1	57.12	28.5 QP	40.0	-11.5	2.00 H	302	43.1	-14.6
2	129.06	25.9 QP	43.5	-17.6	1.49 H	248	41.5	-15.6
3	288.49	30.5 QP	46.0	-15.5	2.00 H	5	42.9	-12.4
4	500.42	37.1 QP	46.0	-8.9	1.49 H	283	45.0	-7.9
5	533.47	39.9 QP	46.0	-6.1	1.49 H	128	47.3	-7.4
6	922.33	31.1 QP	46.0	-14.9	1.00 H	266	29.9	1.2

ANTENNA POLARITY & TEST DISTANCE: VERTICAL AT 3 M

NO.	FREQ. (MHz)	EMISSION LEVEL (dBuV/m)	LIMIT (dBuV/m)	MARGIN (dB)	ANTENNA HEIGHT (m)	TABLE ANGLE (Degree)	RAW VALUE (dBuV)	CORRECTION FACTOR (dB/m)
1	32.60	28.5 QP	40.0	-11.5	1.50 V	345	44.7	-16.2
2	162.11	37.9 QP	43.5	-5.6	1.00 V	359	51.7	-13.8
3	302.10	27.3 QP	46.0	-18.7	1.50 V	340	39.4	-12.1
4	500.42	34.7 QP	46.0	-11.3	1.00 V	318	42.6	-7.9
5	533.47	35.3 QP	46.0	-10.7	1.00 V	169	42.7	-7.4
6	803.73	30.2 QP	46.0	-15.8	1.00 V	5	31.5	-1.3

Remarks:

- Emission Level(dBuV/m) = Raw Value(dBuV) + Correction Factor(dB/m)
- Correction Factor(dB/m) = Antenna Factor(dB/m) + Cable Factor(dB)
– Pre-Amplifier Factor(dB)
- The other emission levels were very low against the limit.
- Margin value = Emission Level – Limit value

Mode D

CHANNEL	TX Channel 149	DETECTOR FUNCTION	Quasi-Peak (QP)
FREQUENCY RANGE	9kHz ~ 1GHz		

ANTENNA POLARITY & TEST DISTANCE: HORIZONTAL AT 3 M

NO.	FREQ. (MHz)	EMISSION LEVEL (dBuV/m)	LIMIT (dBuV/m)	MARGIN (dB)	ANTENNA HEIGHT (m)	TABLE ANGLE (Degree)	RAW VALUE (dBuV)	CORRECTION FACTOR (dB/m)
1	39.62	27.1 QP	40.0	-12.9	1.01 H	41	42.2	-15.1
2	107.67	29.0 QP	43.5	-14.5	1.50 H	314	46.4	-17.4
3	302.10	36.8 QP	46.0	-9.2	1.01 H	153	48.7	-11.9
4	500.42	41.3 QP	46.0	-4.7	1.50 H	150	49.1	-7.8
5	624.85	33.5 QP	46.0	-12.5	1.01 H	148	38.3	-4.8
6	747.34	39.1 QP	46.0	-6.9	1.01 H	8	41.4	-2.3

ANTENNA POLARITY & TEST DISTANCE: VERTICAL AT 3 M

NO.	FREQ. (MHz)	EMISSION LEVEL (dBuV/m)	LIMIT (dBuV/m)	MARGIN (dB)	ANTENNA HEIGHT (m)	TABLE ANGLE (Degree)	RAW VALUE (dBuV)	CORRECTION FACTOR (dB/m)
1	39.62	36.2 QP	40.0	-3.8	1.50 V	13	51.3	-15.1
2	280.71	32.1 QP	46.0	-13.9	1.50 V	198	44.5	-12.4
3	313.77	32.7 QP	46.0	-13.3	1.00 V	105	44.4	-11.7
4	374.04	32.1 QP	46.0	-13.9	1.50 V	13	42.5	-10.4
5	500.42	36.4 QP	46.0	-9.6	1.00 V	195	44.2	-7.8
6	731.79	38.3 QP	46.0	-7.7	1.00 V	286	41.1	-2.8

Remarks:

1. Emission Level(dBuV/m) = Raw Value(dBuV) + Correction Factor(dB/m)
2. Correction Factor(dB/m) = Antenna Factor(dB/m) + Cable Factor(dB)
– Pre-Amplifier Factor(dB)
3. The other emission levels were very low against the limit.
4. Margin value = Emission Level – Limit value

4.2 Conducted Emission Measurement

4.2.1 Limits of Conducted Emission Measurement

Frequency (MHz)	Conducted Limit (dBuV)	
	Quasi-peak	Average
0.15 - 0.5	66 - 56	56 - 46
0.50 - 5.0	56	46
5.0 - 30.0	60	50

Note: 1. The lower limit shall apply at the transition frequencies.

2. The limit decreases in line with the logarithm of the frequency in the range of 0.15 to 0.50MHz.

4.2.2 Test Instruments

Description & Manufacturer	Model No.	Serial No.	Cal. Date	Cal. Due
Test Receiver ROHDE & SCHWARZ	ESCI	100424	Oct. 24, 2016	Oct. 23, 2017
RF signal cable (with 10dB PAD) Woken	5D-FB	Cable-cond2-01	Dec. 22, 2016	Dec. 21, 2017
LISN ROHDE & SCHWARZ (EUT)	ESH2-Z5	100100	Jan. 11, 2016	Jan. 10, 2017
LISN ROHDE & SCHWARZ (Peripheral)	ESH3-Z5	100312	Jul. 26, 2016	Jul. 25, 2017
Software ADT	BV ADT_Cond_ V7.3.7.3	NA	NA	NA

Note: 1. The calibration interval of the above test instruments is 12 months and the calibrations are traceable to NML/ROC and NIST/USA.

2. The test was performed in HwaYa Shielded Room 2.

3. The VCCI Site Registration No. is C-2047.

4.2.3 Test Procedure

- The EUT was placed 0.4 meters from the conducting wall of the shielded room with EUT being connected to the power mains through a line impedance stabilization network (LISN). Other support units were connected to the power mains through another LISN. The two LISNs provide 50 ohm/ 50uH of coupling impedance for the measuring instrument.
- Both lines of the power mains connected to the EUT were checked for maximum conducted interference.
- The frequency range from 150kHz to 30MHz was searched. Emission levels under (Limit - 20dB) was not recorded.

NOTE: The resolution bandwidth and video bandwidth of test receiver is 9kHz for quasi-peak detection (QP) and average detection (AV) at frequency 0.15MHz-30MHz.

4.2.4 Deviation from Test Standard

No deviation.

4.2.5 Test Setup

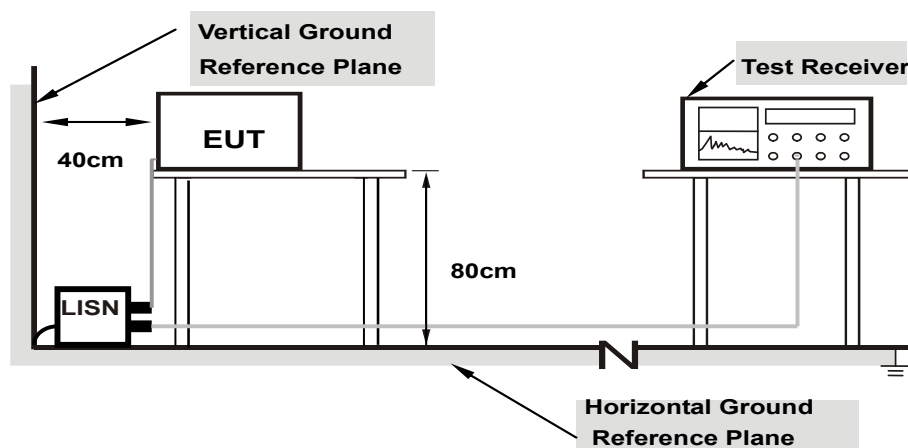

- Note:**
- Support units were connected to second LISN.
 - Both of LISNs (AMN) are 80 cm from EUT and at least 80 from other units and other metal planes

For the actual test configuration, please refer to the attached file (Test Setup Photo).

4.2.6 EUT Operating Conditions

Same as 4.1.6.

4.2.7 Test Results

Worst-Case Data: 802.11a

Phase	Line (L)	Detector Function	Quasi-Peak (QP) / Average (AV)
Test Mode	A		

No	Freq. [MHz]	Corr. Factor (dB)	Reading Value [dB (uV)]		Emission Level [dB (uV)]		Limit [dB (uV)]		Margin (dB)	
			Q.P.	AV.	Q.P.	AV.	Q.P.	AV.	Q.P.	AV.
			1	0.17344	10.14	33.04	18.64	43.18	28.78	64.79
2	0.47031	10.19	25.11	23.36	35.30	33.55	56.51	46.51	-21.21	-12.96
3	1.57422	10.25	13.58	1.20	23.83	11.45	56.00	46.00	-32.17	-34.55
4	3.50391	10.33	17.52	4.90	27.85	15.23	56.00	46.00	-28.15	-30.77
5	8.28125	10.45	20.14	7.86	30.59	18.31	60.00	50.00	-29.41	-31.69
6	21.78516	10.58	18.20	-2.42	28.78	8.16	60.00	50.00	-31.22	-41.84

Remarks:

1. Q.P. and AV. are abbreviations of quasi-peak and average individually.
2. The emission levels of other frequencies were very low against the limit.
3. Margin value = Emission level - Limit value
4. Correction factor = Insertion loss + Cable loss
5. Emission Level = Correction Factor + Reading Value.

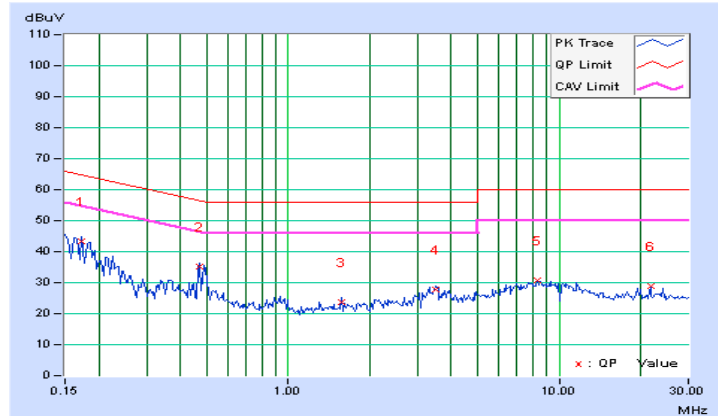

Phase	Neutral (N)	Detector Function	Quasi-Peak (QP) / Average (AV)
Test Mode	A		

No	Freq. [MHz]	Corr. Factor (dB)	Reading Value [dB (uV)]		Emission Level [dB (uV)]		Limit [dB (uV)]		Margin (dB)	
			Q.P.	AV.	Q.P.	AV.	Q.P.	AV.	Q.P.	AV.
			1	0.15000	10.13	33.59	20.54	43.72	30.67	66.00
2	0.46641	10.19	22.96	15.83	33.15	26.02	56.58	46.58	-23.43	-20.56
3	1.53125	10.26	13.58	2.00	23.84	12.26	56.00	46.00	-32.16	-33.74
4	3.64453	10.37	18.01	5.53	28.38	15.90	56.00	46.00	-27.62	-30.10
5	8.65625	10.52	18.21	10.15	28.73	20.67	60.00	50.00	-31.27	-29.33
6	25.01563	10.66	15.93	-2.41	26.59	8.25	60.00	50.00	-33.41	-41.75

Remarks:

1. Q.P. and AV. are abbreviations of quasi-peak and average individually.
2. The emission levels of other frequencies were very low against the limit.
3. Margin value = Emission level - Limit value
4. Correction factor = Insertion loss + Cable loss
5. Emission Level = Correction Factor + Reading Value.

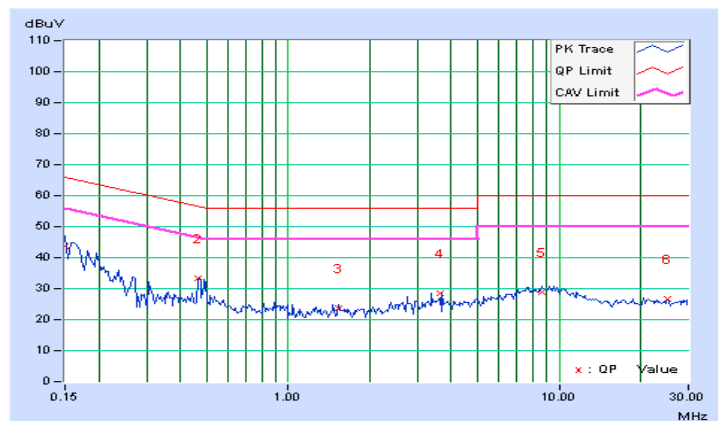

Phase	Line (L)	Detector Function	Quasi-Peak (QP) / Average (AV)
Test Mode	B		

No	Freq. [MHz]	Corr. Factor (dB)	Reading Value [dB (uV)]		Emission Level [dB (uV)]		Limit [dB (uV)]		Margin (dB)	
			Q.P.	AV.	Q.P.	AV.	Q.P.	AV.	Q.P.	AV.
			1	0.16172	9.99	33.70	17.64	43.69	27.63	65.38
2	0.52157	10.05	34.08	29.68	44.13	39.73	56.00	46.00	-11.87	-6.27
3	0.99375	10.10	22.40	19.15	32.50	29.25	56.00	46.00	-23.50	-16.75
4	3.66406	10.17	24.72	20.11	34.89	30.28	56.00	46.00	-21.11	-15.72
5	10.75391	10.27	28.87	24.12	39.14	34.39	60.00	50.00	-20.86	-15.61
6	24.20421	10.41	28.16	27.37	38.57	37.78	60.00	50.00	-21.43	-12.22

Remarks:

1. Q.P. and AV. are abbreviations of quasi-peak and average individually.
2. The emission levels of other frequencies were very low against the limit.
3. Margin value = Emission level - Limit value
4. Correction factor = Insertion loss + Cable loss
5. Emission Level = Correction Factor + Reading Value.

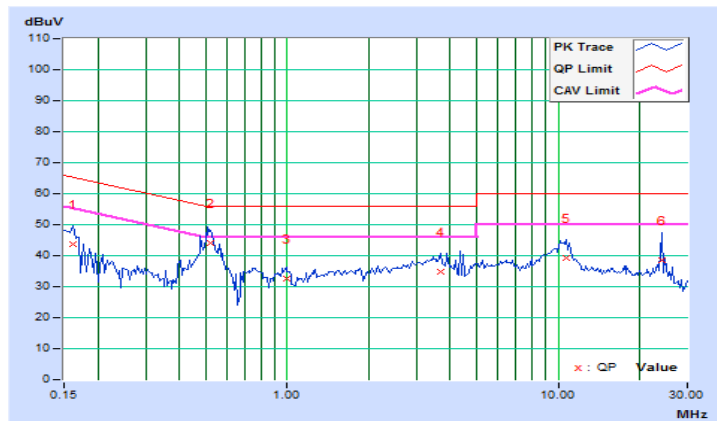

Phase	Neutral (N)	Detector Function	Quasi-Peak (QP) / Average (AV)
Test Mode	B		

No	Freq. [MHz]	Corr. Factor (dB)	Reading Value [dB (uV)]		Emission Level [dB (uV)]		Limit [dB (uV)]		Margin (dB)	
			Q.P.	AV.	Q.P.	AV.	Q.P.	AV.	Q.P.	AV.
			1	0.15000	10.00	35.17	18.43	45.17	28.43	66.00
2	0.52109	10.10	34.00	29.78	44.10	39.88	56.00	46.00	-11.90	-6.12
3	1.30859	10.11	18.01	12.57	28.12	22.68	56.00	46.00	-27.88	-23.32
4	3.68750	10.30	21.22	15.66	31.52	25.96	56.00	46.00	-24.48	-20.04
5	10.60938	10.35	28.59	23.81	38.94	34.16	60.00	50.00	-21.06	-15.84
6	23.95703	10.60	29.65	29.52	40.25	40.12	60.00	50.00	-19.75	-9.88

Remarks:

1. Q.P. and AV. are abbreviations of quasi-peak and average individually.
2. The emission levels of other frequencies were very low against the limit.
3. Margin value = Emission level - Limit value
4. Correction factor = Insertion loss + Cable loss
5. Emission Level = Correction Factor + Reading Value.

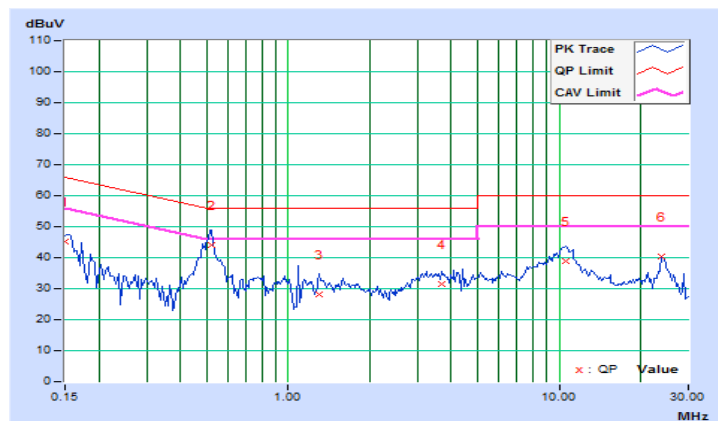

Phase	Line (L)	Detector Function	Quasi-Peak (QP) / Average (AV)
Test Mode	C		

No	Freq. [MHz]	Corr. Factor (dB)	Reading Value [dB (uV)]		Emission Level [dB (uV)]		Limit [dB (uV)]		Margin (dB)	
			Q.P.	AV.	Q.P.	AV.	Q.P.	AV.	Q.P.	AV.
			1	0.16953	10.14	33.20	17.62	43.34	27.76	64.98
2	0.46766	10.19	24.18	22.56	34.37	32.75	56.56	46.56	-22.19	-13.81
3	1.37891	10.24	13.56	1.58	23.80	11.82	56.00	46.00	-32.20	-34.18
4	3.10938	10.32	18.90	3.52	29.22	13.84	56.00	46.00	-26.78	-32.16
5	9.35156	10.47	19.63	10.48	30.10	20.95	60.00	50.00	-29.90	-29.05
6	22.69531	10.56	16.88	2.62	27.44	13.18	60.00	50.00	-32.56	-36.82

Remarks:

1. Q.P. and AV. are abbreviations of quasi-peak and average individually.
2. The emission levels of other frequencies were very low against the limit.
3. Margin value = Emission level - Limit value
4. Correction factor = Insertion loss + Cable loss
5. Emission Level = Correction Factor + Reading Value.

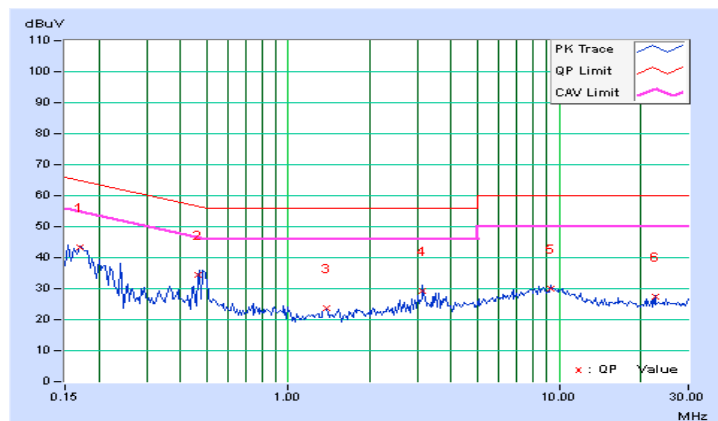

Phase	Neutral (N)	Detector Function	Quasi-Peak (QP) / Average (AV)
Test Mode	C		

No	Freq. [MHz]	Corr. Factor (dB)	Reading Value [dB (uV)]		Emission Level [dB (uV)]		Limit [dB (uV)]		Margin (dB)	
			Q.P.	AV.	Q.P.	AV.	Q.P.	AV.	Q.P.	AV.
			1	0.15391	10.13	33.11	19.34	43.24	29.47	65.79
2	0.46641	10.19	22.48	16.43	32.67	26.62	56.58	46.58	-23.91	-19.96
3	0.95469	10.21	15.87	1.24	26.08	11.45	56.00	46.00	-29.92	-34.55
4	3.49219	10.37	16.58	4.76	26.95	15.13	56.00	46.00	-29.05	-30.87
5	7.43359	10.49	19.57	8.52	30.06	19.01	60.00	50.00	-29.94	-30.99
6	21.81641	10.74	16.88	1.58	27.62	12.32	60.00	50.00	-32.38	-37.68

Remarks:

1. Q.P. and AV. are abbreviations of quasi-peak and average individually.
2. The emission levels of other frequencies were very low against the limit.
3. Margin value = Emission level - Limit value
4. Correction factor = Insertion loss + Cable loss
5. Emission Level = Correction Factor + Reading Value.

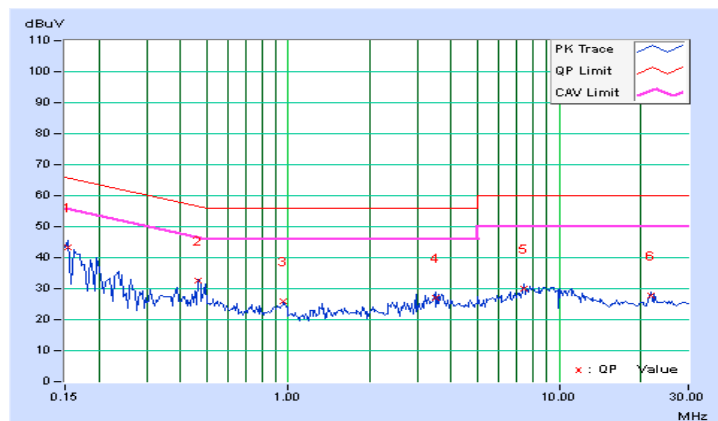

Phase	Line (L)	Detector Function	Quasi-Peak (QP) / Average (AV)
Test Mode	D		

No	Freq. [MHz]	Corr. Factor (dB)	Reading Value [dB (uV)]		Emission Level [dB (uV)]		Limit [dB (uV)]		Margin (dB)	
			Q.P.	AV.	Q.P.	AV.	Q.P.	AV.	Q.P.	AV.
			1	0.15000	9.99	36.41	20.60	46.40	30.59	66.00
2	0.51328	10.05	34.71	30.46	44.76	40.51	56.00	46.00	-11.24	-5.49
3	0.79453	10.08	22.50	19.40	32.58	29.48	56.00	46.00	-23.42	-16.52
4	3.19141	10.16	24.69	20.12	34.85	30.28	56.00	46.00	-21.15	-15.72
5	10.42578	10.26	29.40	24.73	39.66	34.99	60.00	50.00	-20.34	-15.01
6	23.80859	10.42	29.00	28.66	39.42	39.08	60.00	50.00	-20.58	-10.92

Remarks:

1. Q.P. and AV. are abbreviations of quasi-peak and average individually.
2. The emission levels of other frequencies were very low against the limit.
3. Margin value = Emission level - Limit value
4. Correction factor = Insertion loss + Cable loss
5. Emission Level = Correction Factor + Reading Value.

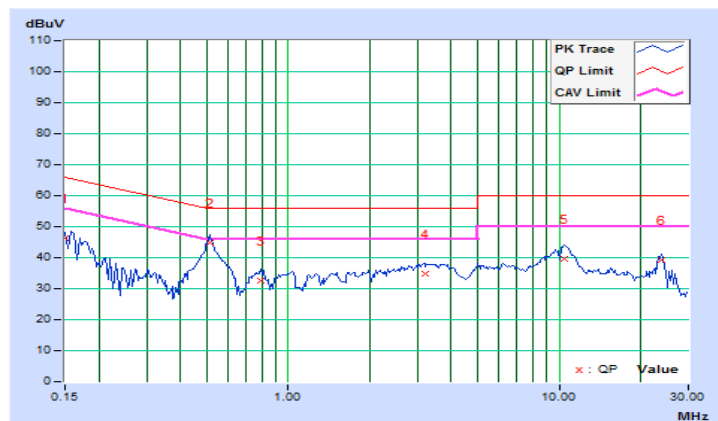

Phase	Neutral (N)	Detector Function	Quasi-Peak (QP) / Average (AV)
Test Mode	D		

No	Freq. [MHz]	Corr. Factor (dB)	Reading Value [dB (uV)]		Emission Level [dB (uV)]		Limit [dB (uV)]		Margin (dB)	
			Q.P.	AV.	Q.P.	AV.	Q.P.	AV.	Q.P.	AV.
			1	0.15000	10.00	37.06	20.08	47.06	30.08	66.00
2	0.51719	10.10	34.65	30.80	44.75	40.90	56.00	46.00	-11.25	-5.10
3	1.04297	10.08	20.72	16.80	30.80	26.88	56.00	46.00	-25.20	-19.12
4	3.57813	10.29	21.22	15.82	31.51	26.11	56.00	46.00	-24.49	-19.89
5	10.90234	10.36	27.99	23.06	38.35	33.42	60.00	50.00	-21.65	-16.58
6	23.80859	10.61	29.89	29.58	40.50	40.19	60.00	50.00	-19.50	-9.81

Remarks:

1. Q.P. and AV. are abbreviations of quasi-peak and average individually.
2. The emission levels of other frequencies were very low against the limit.
3. Margin value = Emission level - Limit value
4. Correction factor = Insertion loss + Cable loss
5. Emission Level = Correction Factor + Reading Value.

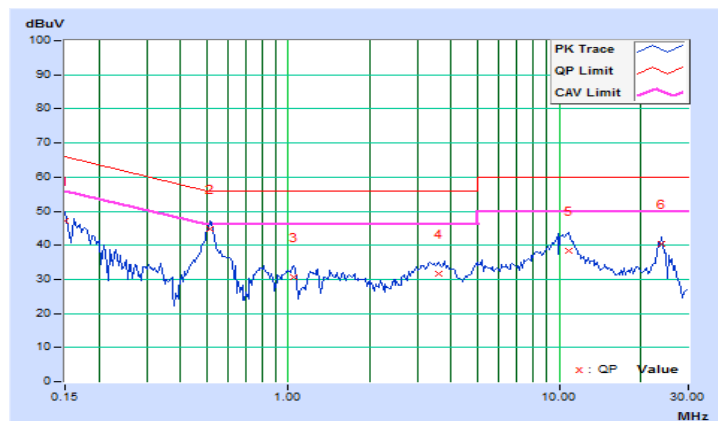

4.3 Transmit Power Measurement

4.3.1 Limits of Transmit Power Measurement

Operation Band	EUT Category		LIMIT
U-NII-1		Outdoor Access Point	1 Watt (30 dBm) (Max. e.i.r.p \leq 125mW (21 dBm) at any elevation angle above 30 degrees as measured from the horizon)
		Fixed point-to-point Access Point	1 Watt (30 dBm)
	√	Indoor Access Point	1 Watt (30 dBm)
		Mobile and Portable client device	250mW (24 dBm)
U-NII-2A	---		250mW (24 dBm) or 11 dBm+10 log B*
U-NII-2C	---		250mW (24 dBm) or 11 dBm+10 log B*
U-NII-3	√		1 Watt (30 dBm)

*B is the 26 dB emission bandwidth in megahertz

Per KDB 662911 Method of conducted output power measurement on IEEE 802.11 devices,

Array Gain = 0 dB (i.e., no array gain) for $N_{ANT} \leq 4$;

Array Gain = 0 dB (i.e., no array gain) for channel widths ≥ 40 MHz for any N_{ANT} ;

Array Gain = $5 \log(N_{ANT}/N_{SS})$ dB or 3 dB, whichever is less for 20-MHz channel widths with $N_{ANT} \geq 5$.

For power measurements on all other devices: Array Gain = $10 \log(N_{ANT}/N_{SS})$ dB.

4.3.2 Test Setup

For Power Output Measurement

802.11a, 802.11n (HT20), 802.11n (HT40)

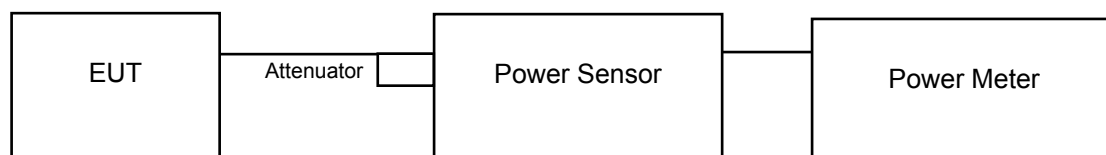

802.11ac (VHT80)

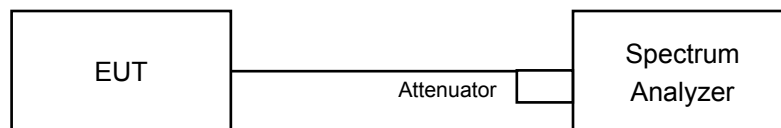

For 26dB Bandwidth

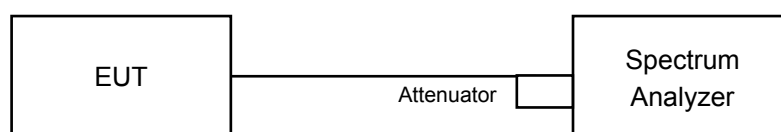

4.3.3 Test Instruments

Refer to section 4.1.2 to get information of above instrument.

4.3.4 Test Procedure

For Average Power Measurement

802.11a, 802.11n (HT20), 802.11n (HT40)

Method PM is used to perform output power measurement, trigger and gating function of wide band power meter is enabled to measure max output power of TX on burst. Duty factor is not added to measured value.

802.11ac (VHT80)

- a. Set span to encompass the entire 26 dB EBW (or, alternatively, the entire 99% occupied bandwidth) of the signal.
- b. Set sweep trigger to "free run".
- c. Set RBW = 1 MHz
- d. Set VBW \geq 3 MHz
- e. Number of points in sweep \geq 2 Span / RBW
- f. Sweep time \leq (number of points in sweep) * T
- g. Using emission bandwidth to determine the frequency span for integration the channel bandwidth.
- h. Detector = RMS
- i. Trace mode = max hold
- j. Allow max hold to run for at least 60 seconds, or longer as needed to allow the trace to stabilize.

For 26dB Bandwidth

- 1) Set RBW = approximately 1% of the emission bandwidth.
- 2) Set the VBW > RBW.
- 3) Detector = Peak.
- 4) Trace mode = max hold.
- 5) Measure the maximum width of the emission that is 26 dB down from the peak of the emission. Compare this with the RBW setting of the analyzer. Readjust RBW and repeat measurement as needed until the RBW/EBW ratio is approximately 1%.

4.3.5 Deviation from Test Standard

No deviation.

4.3.6 EUT Operating Conditions

The software provided by client to enable the EUT under transmission Condition continuously at lowest, middle and highest channel frequencies individually.

4.3.7 Test Result

Average Power:

CDD Mode

802.11a

Chan.	Freq. (MHz)	Maximum Conducted Power (dBm)		Total Power (mW)	Total Power (dBm)	Power Limit (dBm)	Pass / Fail
		Chain 0	Chain 1				
36	5180	16.27	16.24	84.437	19.27	30	Pass
40	5200	18.14	18.13	130.176	21.15	30	Pass
48	5240	18.68	18.52	144.911	21.61	30	Pass
149	5745	15.45	15.35	69.352	18.41	30	Pass
157	5785	18.53	18.29	138.738	21.42	30	Pass
165	5825	16.52	16.46	89.134	19.50	30	Pass

802.11n (HT20)

Chan.	Freq. (MHz)	Maximum Conducted Power (dBm)		Total Power (mW)	Total Power (dBm)	Power Limit (dBm)	Pass / Fail
		Chain 0	Chain 1				
36	5180	13.66	13.79	47.160	16.74	30	Pass
40	5200	18.69	18.71	148.263	21.71	30	Pass
48	5240	18.16	18.20	131.533	21.19	30	Pass
149	5745	13.86	13.65	47.496	16.77	30	Pass
157	5785	18.72	18.53	145.758	21.64	30	Pass
165	5825	16.43	16.71	90.835	19.58	30	Pass

802.11n (HT40)

Chan.	Freq. (MHz)	Maximum Conducted Power (dBm)		Total Power (mW)	Total Power (dBm)	Power Limit (dBm)	Pass / Fail
		Chain 0	Chain 1				
38	5190	14.63	14.42	56.709	17.54	30	Pass
46	5230	18.47	18.05	134.133	21.28	30	Pass
151	5755	13.44	13.03	42.171	16.25	30	Pass
159	5795	18.19	17.42	121.125	20.83	30	Pass

802.11ac (VHT80)

Chan.	Freq. (MHz)	Maximum Conducted Power (dBm)		Total Power (mW)	Total Power (dBm)	Power Limit (dBm)	Pass / Fail
		Chain 0	Chain 1				
42	5210	13.88	14.35	51.661	17.13	30	Pass
155	5775	13.47	13.34	43.810	16.42	30	Pass

Beamforming Mode

802.11n (HT20)

Chan.	Freq. (MHz)	Maximum Conducted Power (dBm)		Total Power (mW)	Total Power (dBm)	Power Limit (dBm)	Pass / Fail
		Chain 0	Chain 1				
36	5180	10.66	10.79	23.636	13.74	27.16	Pass
40	5200	15.69	15.71	74.307	18.71	27.16	Pass
48	5240	15.16	15.20	65.923	18.19	27.16	Pass
149	5745	10.86	10.65	23.804	13.77	27.16	Pass
157	5785	15.72	15.53	73.052	18.64	27.16	Pass
165	5825	13.43	13.71	45.525	16.58	27.16	Pass

Note: Internal antenna Directional gain = $5.83\text{dBi} + 10\log(2) = 8.84\text{dBi}$ (which is the highest value to calculation) $> 6\text{dBi}$, so the limit shall be reduced to $30 - (8.84 - 6) = 27.16\text{dBm}$.

External antenna Directional gain = $5.35\text{dBi} + 10\log(2) = 8.36\text{dBi}$

802.11n (HT40)

Chan.	Freq. (MHz)	Maximum Conducted Power (dBm)		Total Power (mW)	Total Power (dBm)	Power Limit (dBm)	Pass / Fail
		Chain 0	Chain 1				
38	5190	11.63	11.42	28.423	14.54	27.16	Pass
46	5230	15.47	15.05	67.226	18.28	27.16	Pass
151	5755	10.44	10.03	21.135	13.25	27.16	Pass
159	5795	15.19	14.42	60.706	17.83	27.16	Pass

Note: Internal antenna Directional gain = $5.83\text{dBi} + 10\log(2) = 8.84\text{dBi}$ (which is the highest value to calculation) $> 6\text{dBi}$, so the limit shall be reduced to $30 - (8.84 - 6) = 27.16\text{dBm}$.

External antenna Directional gain = $5.35\text{dBi} + 10\log(2) = 8.36\text{dBi}$

802.11ac (VHT80)

Chan.	Freq. (MHz)	Maximum Conducted Power (dBm)		Total Power (mW)	Total Power (dBm)	Power Limit (dBm)	Pass / Fail
		Chain 0	Chain 1				
42	5210	10.88	11.35	25.892	14.13	27.16	Pass
155	5775	10.47	10.34	21.957	13.42	27.16	Pass

Note: Internal antenna Directional gain = $5.83\text{dBi} + 10\log(2) = 8.84\text{dBi}$ (which is the highest value to calculation) $> 6\text{dBi}$, so the limit shall be reduced to $30 - (8.84 - 6) = 27.16\text{dBm}$.

External antenna Directional gain = $5.35\text{dBi} + 10\log(2) = 8.36\text{dBi}$

26dB Bandwidth:

802.11a

Channel	Frequency (MHz)	26dBc Bandwidth (MHz)	
		Chain 0	Chain 1
36	5180	21.88	21.80
40	5200	35.71	32.87
48	5240	37.32	33.05

802.11n (HT20)

Channel	Frequency (MHz)	26dBc Bandwidth (MHz)	
		Chain 0	Chain 1
36	5180	22.13	21.91
40	5200	41.44	39.08
48	5240	41.54	41.62

802.11n (HT40)

Channel	Frequency (MHz)	26dBc Bandwidth (MHz)	
		Chain 0	Chain 1
38	5190	41.23	41.12
46	5230	71.49	66.42

802.11ac (VHT80)

Channel	Frequency (MHz)	26dBc Bandwidth (MHz)	
		Chain 0	Chain 1
42	5210	82.53	82.00

Spectrum Plot of Worst Value

802.11a

802.11n (HT20)

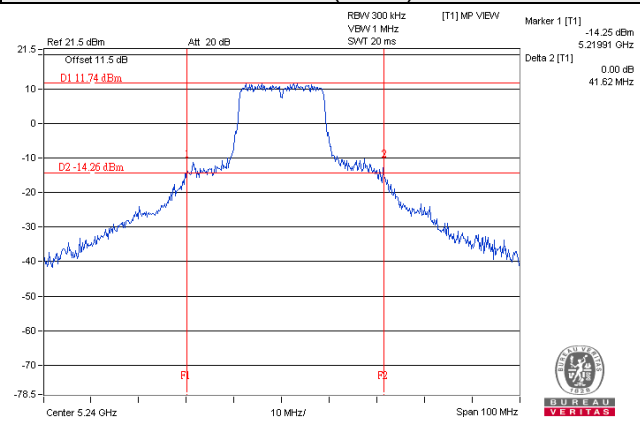
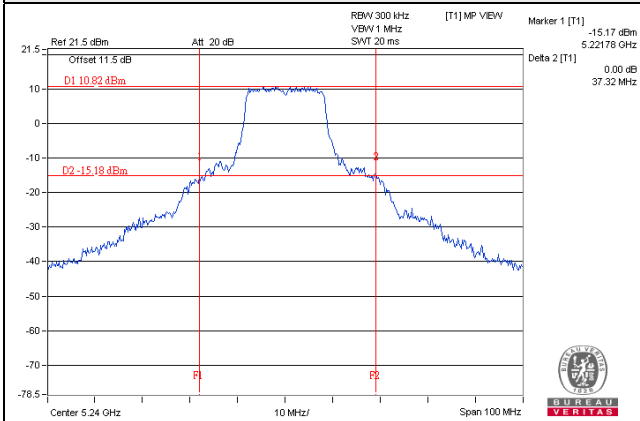

802.11n (HT40)

802.11ac (VHT80)

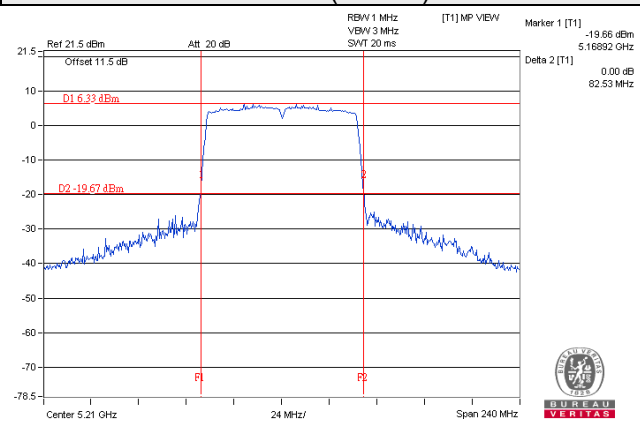
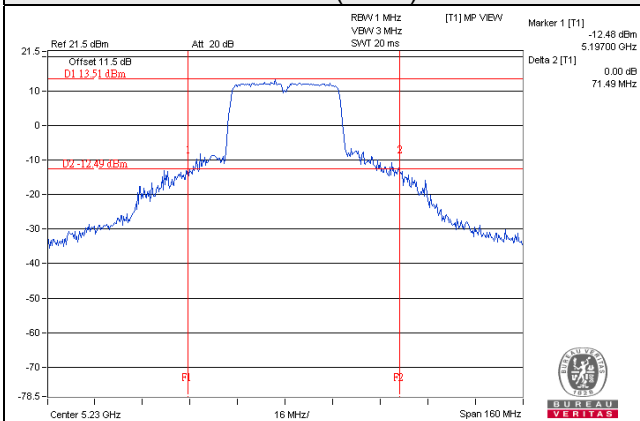

4.4 Occupied Bandwidth Measurement

4.4.1 Test Setup

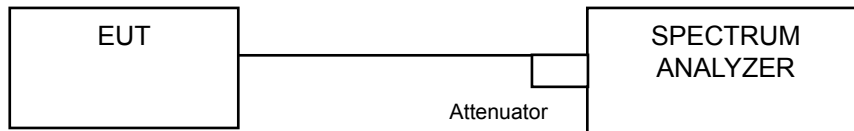

4.4.2 Test Instruments

Refer to section 4.1.2 to get information of above instrument.

4.4.3 Test Procedure

The transmitter output was connected to the spectrum analyzer through an attenuator. The bandwidth of the fundamental frequency was measured by spectrum analyzer with resolution bandwidth in the range of 1% to 5% of the anticipated emission bandwidth, and a video bandwidth at least 3x the resolution bandwidth and set the detector to SAMPLE. The width of a frequency band such that, below the lower and above the upper frequency limits, the mean powers emitted are each equal to a specified percentage 0.5 %of the total mean power of a given emission.

4.4.4 Test Results

802.11a

Channel	Frequency (MHz)	Occupied Bandwidth (MHz)	
		Chain 0	Chain 1
36	5180	17.04	17.04
40	5200	17.88	17.88
48	5240	18.48	18.00
149	5745	17.21	17.04
157	5785	18.00	18.24
165	5825	17.16	17.04

802.11n (HT20)

Channel	Frequency (MHz)	Occupied Bandwidth (MHz)	
		Chain 0	Chain 1
36	5180	18.24	18.00
40	5200	18.96	18.48
48	5240	19.32	18.84
149	5745	18.24	18.00
157	5785	18.84	19.20
165	5825	18.24	18.00

802.11n (HT40)

Channel	Frequency (MHz)	Occupied Bandwidth (MHz)	
		Chain 0	Chain 1
38	5190	36.72	36.72
46	5230	37.20	36.96
151	5755	36.84	36.72
159	5795	37.20	37.08

802.11ac (VHT80)

Channel	Frequency (MHz)	Occupied Bandwidth (MHz)	
		Chain 0	Chain 1
42	5210	75.88	75.88
155	5775	75.88	75.88

Spectrum Plot of Worst Value

802.11a

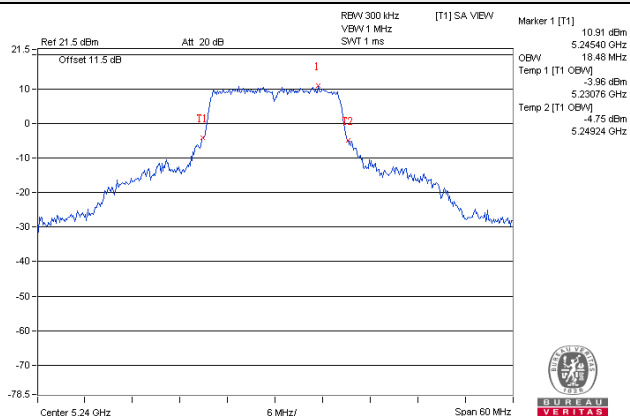

802.11n (HT20)

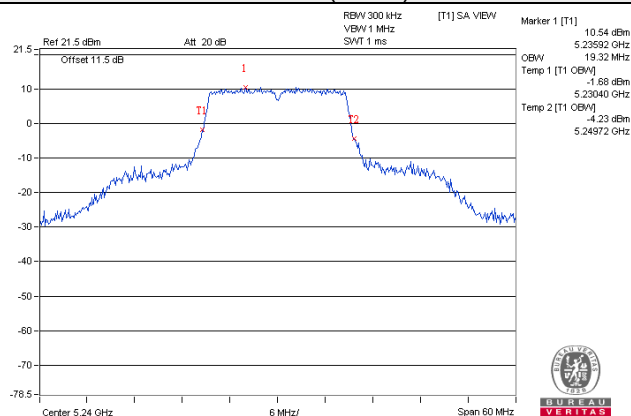

802.11n (HT40)

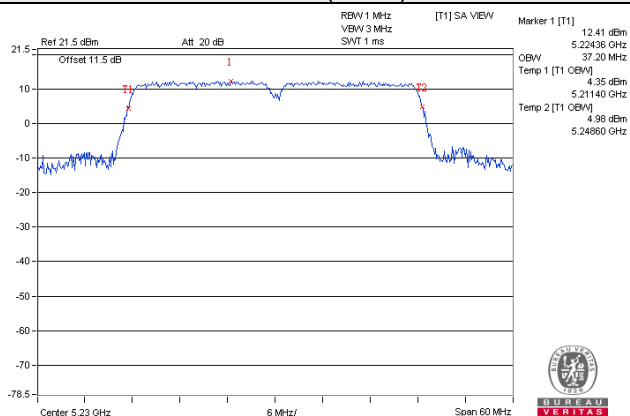

802.11ac (VHT80)

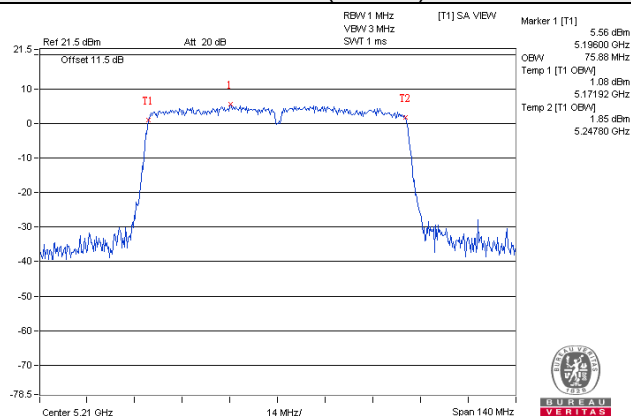

4.5 Peak Power Spectral Density Measurement

4.5.1 Limits of Peak Power Spectral Density Measurement

Operation Band	EUT Category		LIMIT
U-NII-1		Outdoor Access Point	17dBm/ MHz
		Fixed point-to-point Access Point	
	√	Indoor Access Point	
		Mobile and Portable client device	11dBm/ MHz
U-NII-2A	---		11dBm/ MHz
U-NII-2C	---		11dBm/ MHz
U-NII-3	√		30dBm/ 500kHz

4.5.2 Test Setup

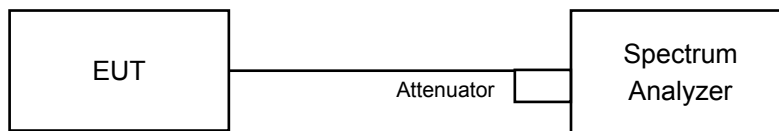

4.5.3 Test Instruments

Refer to section 4.1.2 to get information of above instrument.

4.5.4 Test Procedure

For U-NII-1 band:

Using method SA-2, Duty cycle <98%

- a. Set span to encompass the entire emission bandwidth (EBW) of the signal.
- b. Set RBW = 1 MHz, Set VBW \geq 3 MHz, Detector = RMS
- c. Sweep time = auto, trigger set to "free run".
- d. Trace average at least 100 traces in power averaging mode.
- e. Record the max value and add $10 \log (1/\text{duty cycle})$

For U-NII-3 band:

Duty cycle <98%

- a. Set span to encompass the entire emission bandwidth (EBW) of the signal.
- b. Set RBW = 300 kHz, Set VBW \geq 1 MHz, Detector = RMS
- c. Use the peak marker function to determine the maximum power level in any 300 kHz band segment within the fundamental EBW.
- d. Scale the observed power level to an equivalent value in 500 kHz by adjusting (reducing) the measured power by a bandwidth correction factor (BWCF) where $\text{BWCF} = 10\log(500 \text{ kHz}/300\text{kHz})$
- e. Sweep time = auto, trigger set to "free run".
- f. Trace average at least 100 traces in power averaging mode.
- g. Record the max value and add $10 \log (1/\text{duty cycle})$

4.5.5 Deviation from Test Standard

No deviation.

4.5.6 EUT Operating Condition

Same as 4.3.6.

4.5.7 Test Results

For U-NII-1 Band

802.11a

Chan.	Freq. (MHz)	PSD (dBm)		Duty factor	Total PSD with duty factor (dBm)	Max. Limit (dBm)	Pass / Fail
		Chain 0	Chain 1				
36	5180	3.79	4.29	0.27	7.32	14.16	Pass
40	5200	6.70	7.22	0.27	10.24	14.16	Pass
48	5240	6.39	6.99	0.27	9.97	14.16	Pass

Note:

- Method 1 of power density measurement of KDB 662911 is using for calculating total power density. Total power density is summing entire spectra across corresponding frequency bins on the various outputs by computer.
- Internal antenna Directional gain = $5.83\text{dBi} + 10\log(2) = 8.84\text{dBi}$ (which is the highest value to calculation) $> 6\text{dBi}$, so the limit shall be reduced to $17 - (8.84 - 6) = 14.16\text{dBm}$.
External antenna Directional gain = $5.35\text{dBi} + 10\log(2) = 8.36\text{dBi}$
- Refer to section 3.3 for duty cycle spectrum plot.

802.11n (HT20)

Chan.	Freq. (MHz)	PSD (dBm)		Duty factor	Total PSD with duty factor (dBm)	Max. Limit (dBm)	Pass / Fail
		Chain 0	Chain 1				
36	5180	1.09	1.42	0.22	4.49	14.16	Pass
40	5200	6.23	6.67	0.22	9.69	14.16	Pass
48	5240	6.18	6.49	0.22	9.57	14.16	Pass

Note:

- Method 1 of power density measurement of KDB 662911 is using for calculating total power density. Total power density is summing entire spectra across corresponding frequency bins on the various outputs by computer.
- Internal antenna Directional gain = $5.83\text{dBi} + 10\log(2) = 8.84\text{dBi}$ (which is the highest value to calculation) $> 6\text{dBi}$, so the limit shall be reduced to $17 - (8.84 - 6) = 14.16\text{dBm}$.
External antenna Directional gain = $5.35\text{dBi} + 10\log(2) = 8.36\text{dBi}$
- Refer to section 3.3 for duty cycle spectrum plot.

802.11n (HT40)

Chan.	Freq. (MHz)	PSD (dBm)		Duty factor	Total PSD with duty factor (dBm)	Max. Limit (dBm)	Pass / Fail
		Chain 0	Chain 1				
38	5190	-1.04	-1.11	0.46	2.40	14.16	Pass
46	5230	2.41	2.23	0.46	5.79	14.16	Pass

Note:

- Method 1 of power density measurement of KDB 662911 is using for calculating total power density. Total power density is summing entire spectra across corresponding frequency bins on the various outputs by computer.
- Internal antenna Directional gain = $5.83\text{dBi} + 10\log(2) = 8.84\text{dBi}$ (which is the highest value to calculation) $> 6\text{dBi}$, so the limit shall be reduced to $17 - (8.84 - 6) = 14.16\text{dBm}$.
External antenna Directional gain = $5.35\text{dBi} + 10\log(2) = 8.36\text{dBi}$
- Refer to section 3.3 for duty cycle spectrum plot.

802.11ac (VHT80)

Chan.	Freq. (MHz)	PSD (dBm)		Duty factor	Total PSD with duty factor (dBm)	Max. Limit (dBm)	Pass / Fail
		Chain 0	Chain 1				
42	5210	-4.58	-4.55	0.35	-1.20	14.16	Pass

Note:

- Method 1 of power density measurement of KDB 662911 is using for calculating total power density. Total power density is summing entire spectra across corresponding frequency bins on the various outputs by computer.
- Internal antenna Directional gain = $5.83\text{dBi} + 10\log(2) = 8.84\text{dBi}$ (which is the highest value to calculation) $> 6\text{dBi}$, so the limit shall be reduced to $17 - (8.84 - 6) = 14.16\text{dBm}$.
External antenna Directional gain = $5.35\text{dBi} + 10\log(2) = 8.36\text{dBi}$
- Refer to section 3.3 for duty cycle spectrum plot.

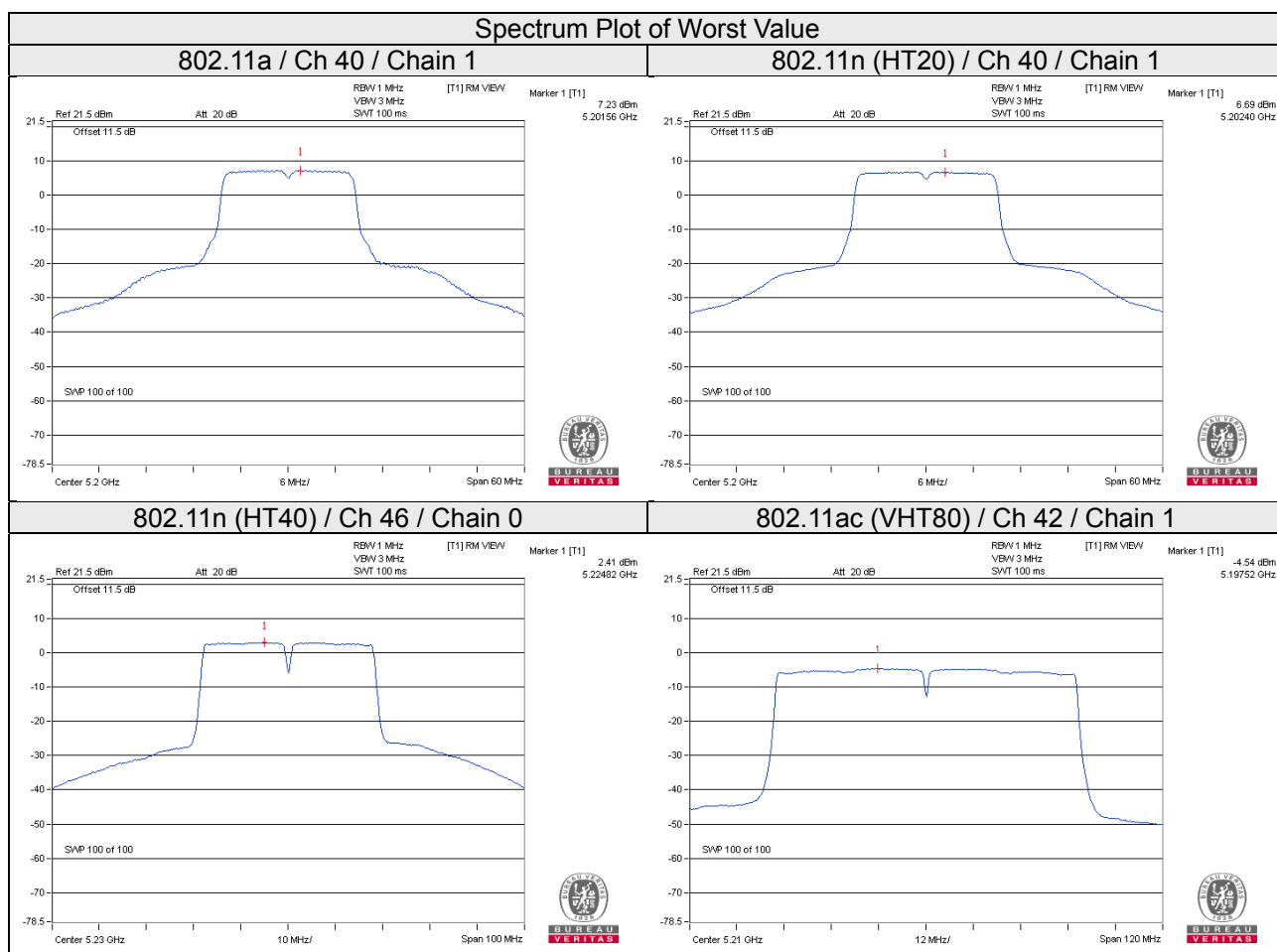

For U-NII-3 Band

802.11a

TX chain	Channel	Freq. (MHz)	PSD (dBm/300kHz)	PSD (dBm/500kHz)	10 log (N=2) dB	Duty factor	Total PSD (dBm/500kHz)	Limit (dBm/500kHz)	Pass / Fail
0	149	5745	-5.18	-2.96	3.01	0.27	0.32	27.16	Pass
	157	5785	-2.13	0.09	3.01	0.27	3.37	27.16	Pass
	165	5825	-3.87	-1.65	3.01	0.27	1.63	27.16	Pass
1	149	5745	-5.54	-3.32	3.01	0.27	-0.04	27.16	Pass
	157	5785	-2.65	-0.43	3.01	0.27	2.85	27.16	Pass
	165	5825	-4.42	-2.20	3.01	0.27	1.08	27.16	Pass

Note:

- Method 1 of power density measurement of KDB 662911 is using for calculating total power density. Total power density is summing entire spectra across corresponding frequency bins on the various outputs by computer.
- Internal antenna Directional gain = $5.83\text{dBi} + 10\log(2) = 8.84\text{dBi}$ (which is the highest value to calculation) $> 6\text{dBi}$, so the limit shall be reduced to $30 - (8.84 - 6) = 27.16\text{dBm}$.
External antenna Directional gain = $5.35\text{dBi} + 10\log(2) = 8.36\text{dBi}$
- Refer to section 3.3 for duty cycle spectrum plot.

802.11n (HT20)

TX chain	Channel	Freq. (MHz)	PSD (dBm/300kHz)	PSD (dBm/500kHz)	10 log (N=2) dB	Duty factor	Total PSD (dBm/500kHz)	Limit (dBm/500kHz)	Pass / Fail
0	149	5745	-7.07	-4.85	3.01	0.22	-1.62	27.16	Pass
	157	5785	-2.58	-0.36	3.01	0.22	2.87	27.16	Pass
	165	5825	-4.42	-2.20	3.01	0.22	1.03	27.16	Pass
1	149	5745	-7.53	-5.31	3.01	0.22	-2.08	27.16	Pass
	157	5785	-2.95	-0.73	3.01	0.22	2.50	27.16	Pass
	165	5825	-5.00	-2.78	3.01	0.22	0.45	27.16	Pass

Note:

- Method 1 of power density measurement of KDB 662911 is using for calculating total power density. Total power density is summing entire spectra across corresponding frequency bins on the various outputs by computer.
- Internal antenna Directional gain = $5.83\text{dBi} + 10\log(2) = 8.84\text{dBi}$ (which is the highest value to calculation) $> 6\text{dBi}$, so the limit shall be reduced to $30 - (8.84 - 6) = 27.16\text{dBm}$.
External antenna Directional gain = $5.35\text{dBi} + 10\log(2) = 8.36\text{dBi}$
- Refer to section 3.3 for duty cycle spectrum plot.

802.11n (HT40)

TX chain	Channel	Freq. (MHz)	PSD (dBm/300kHz)	PSD (dBm/500kHz)	10 log (N=2) dB	Duty factor	Total PSD (dBm/500kHz)	Limit (dBm/500kHz)	Pass / Fail
0	151	5755	-11.37	-9.15	3.01	0.46	-5.68	27.16	Pass
	159	5795	-6.53	-4.31	3.01	0.46	-0.84	27.16	Pass
1	151	5755	-12.04	-9.82	3.01	0.46	-6.35	27.16	Pass
	159	5795	-7.29	-5.07	3.01	0.46	-1.60	27.16	Pass

Note:

- Method 1 of power density measurement of KDB 662911 is using for calculating total power density. Total power density is summing entire spectra across corresponding frequency bins on the various outputs by computer.
- Internal antenna Directional gain = $5.83\text{dBi} + 10\log(2) = 8.84\text{dBi}$ (which is the highest value to calculation) $> 6\text{dBi}$, so the limit shall be reduced to $30 - (8.84 - 6) = 27.16\text{dBm}$.
External antenna Directional gain = $5.35\text{dBi} + 10\log(2) = 8.36\text{dBi}$
- Refer to section 3.3 for duty cycle spectrum plot.

802.11ac (VHT80)

TX chain	Channel	Freq. (MHz)	PSD (dBm/300kHz)	PSD (dBm/500kHz)	10 log (N=2) dB	Duty factor	Total PSD (dBm/500kHz)	Limit (dBm/500kHz)	Pass / Fail
0	155	5775	-13.93	-11.71	3.01	0.35	-8.35	27.16	Pass
1	155	5775	-13.91	-11.69	3.01	0.35	-8.33	27.16	Pass

Note:

- Method 1 of power density measurement of KDB 662911 is using for calculating total power density. Total power density is summing entire spectra across corresponding frequency bins on the various outputs by computer.
- Internal antenna Directional gain = $5.83\text{dBi} + 10\log(2) = 8.84\text{dBi}$ (which is the highest value to calculation) $> 6\text{dBi}$, so the limit shall be reduced to $30 - (8.84 - 6) = 27.16\text{dBm}$.
External antenna Directional gain = $5.35\text{dBi} + 10\log(2) = 8.36\text{dBi}$
- Refer to section 3.3 for duty cycle spectrum plot.

Spectrum Plot of Worst Value

802.11a

802.11n (HT20)

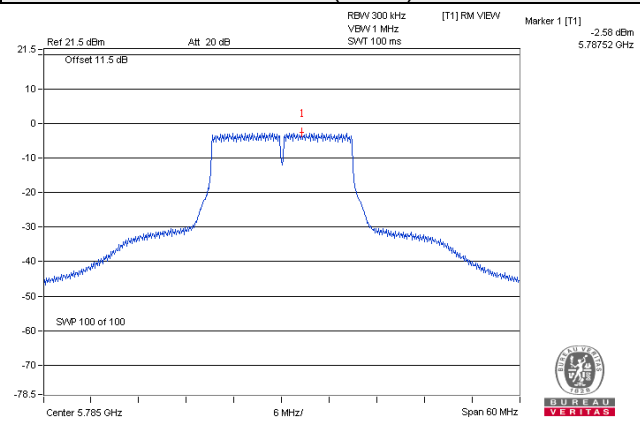
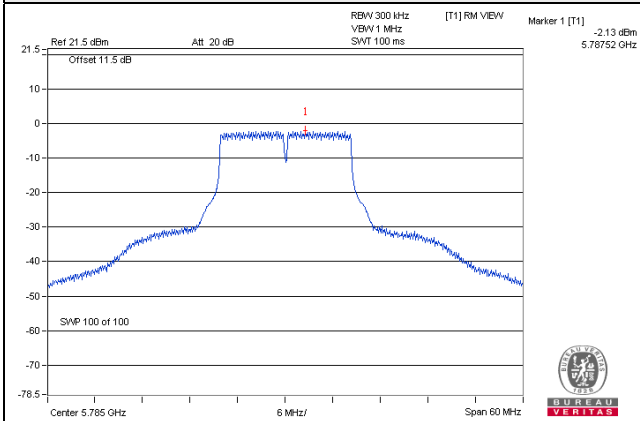

802.11n (HT40)

802.11ac (VHT80)

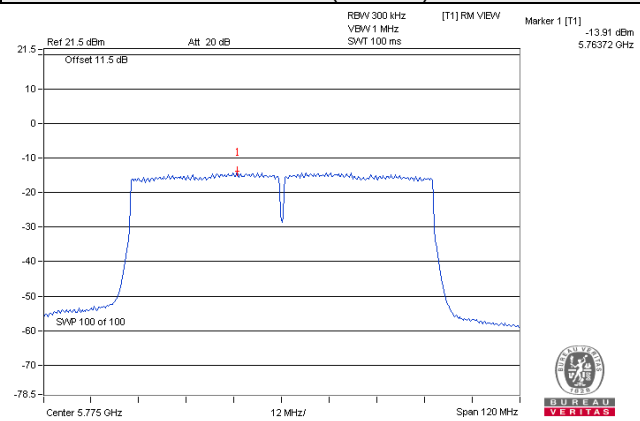
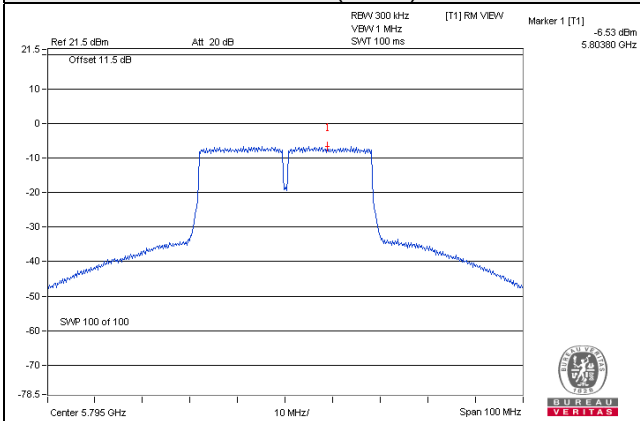

4.6 Frequency Stability

4.6.1 Limits of Frequency Stability Measurement

The frequency of the carrier signal shall be maintained within band of operation

4.6.2 Test Setup

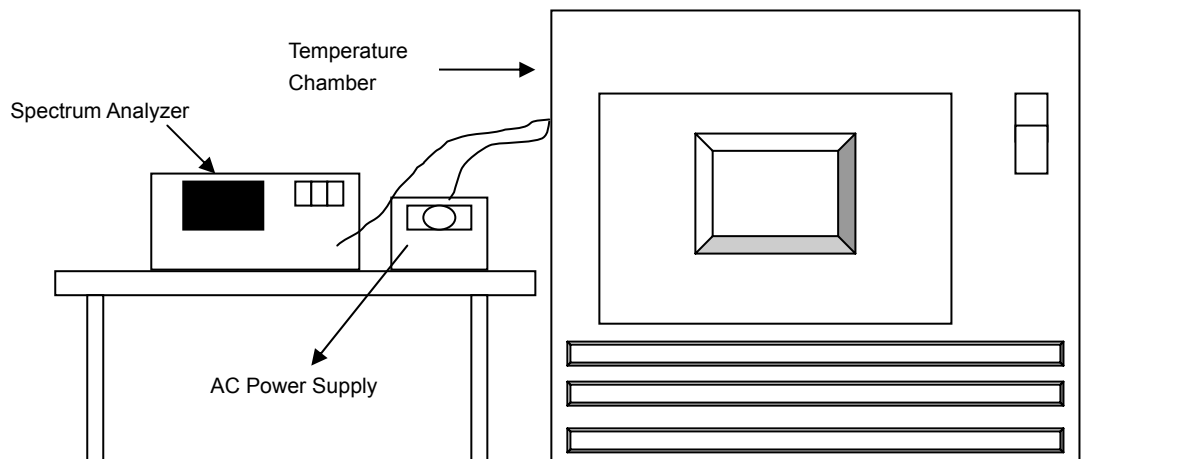

4.6.3 Test Instruments

Refer to section 4.1.2 to get information of above instrument.

4.6.4 Test Procedure

- The EUT was placed inside the environmental test chamber and powered by nominal AC voltage.
- Turn the EUT on and couple its output to a spectrum analyzer.
- Turn the EUT off and set the chamber to the highest temperature specified.
- Allow sufficient time (approximately 30 min) for the temperature of the chamber to stabilize, turn the EUT on and measure the operating frequency after 2, 5, and 10 minutes.
- Repeat step 2 and 3 with the temperature chamber set to the lowest temperature.
- The test chamber was allowed to stabilize at +20 degree C for a minimum of 30 minutes. The supply voltage was then adjusted on the EUT from 85% to 115% and the frequency record.

4.6.5 Deviation from Test Standard

No deviation.

4.6.6 EUT Operating Condition

Set the EUT transmit at un-modulation mode to test frequency stability.

4.6.7 Test Results

Frequency Stability Versus Temp.									
Operating Frequency: 5180MHz									
Temp. (°C)	Power Supply (Vac)	0 Minute		2 Minute		5 Minute		10 Minute	
		Measured Frequency (MHz)	Frequency Drift (%)	Measured Frequency (MHz)	Frequency Drift (%)	Measured Frequency (MHz)	Frequency Drift (%)	Measured Frequency (MHz)	Frequency Drift (%)
50	120	5180.0231	0.00045	5180.0206	0.00040	5180.0214	0.00041	5180.0235	0.00045
40	120	5179.9823	-0.00034	5179.9796	-0.00039	5179.9805	-0.00038	5179.9796	-0.00039
30	120	5179.9847	-0.00030	5179.9863	-0.00026	5179.9855	-0.00028	5179.9834	-0.00032
20	120	5180.0045	0.00009	5180.0057	0.00011	5180.0046	0.00009	5180.0035	0.00007
10	120	5179.9919	-0.00016	5179.9909	-0.00018	5179.9896	-0.00020	5179.9907	-0.00018
0	120	5180.0092	0.00018	5180.0090	0.00017	5180.0089	0.00017	5180.0128	0.00025
-10	120	5180.0234	0.00045	5180.0188	0.00036	5180.0221	0.00043	5180.0197	0.00038
-20	120	5179.9773	-0.00044	5179.9765	-0.00045	5179.9779	-0.00043	5179.9752	-0.00048
-30	120	5180.0136	0.00026	5180.0146	0.00028	5180.0174	0.00034	5180.0171	0.00033

Frequency Stability Versus Voltage									
Operating Frequency: 5180MHz									
Temp. (°C)	Power Supply (Vac)	0 Minute		2 Minute		5 Minute		10 Minute	
		Measured Frequency (MHz)	Frequency Drift (%)	Measured Frequency (MHz)	Frequency Drift (%)	Measured Frequency (MHz)	Frequency Drift (%)	Measured Frequency (MHz)	Frequency Drift (%)
20	138	5180.0042	0.00008	5180.0051	0.00010	5180.0036	0.00007	5180.0025	0.00005
	120	5180.0045	0.00009	5180.0057	0.00011	5180.0046	0.00009	5180.0035	0.00007
	102	5180.0038	0.00007	5180.0055	0.00011	5180.004	0.00008	5180.0037	0.00007

4.7 6dB Bandwidth Measurement

4.7.1 Limits of 6dB Bandwidth Measurement

The minimum of 6dB Bandwidth Measurement is 0.5MHz.

4.7.2 Test Setup

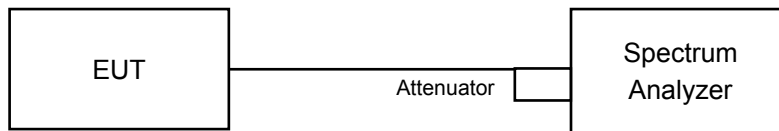

4.7.3 Test Instruments

Refer to section 4.1.2 to get information of above instrument.

4.7.4 Test Procedure

- Set resolution bandwidth (RBW) = 100kHz
- Set the video bandwidth (VBW) $\geq 3 \times$ RBW, Detector = Peak
- Trace mode = max hold
- Sweep = auto couple
- Measure the maximum width of the emission that is constrained by the frequencies associated with the two amplitude points (upper and lower) that are attenuated by 6 dB relative to the maximum level measured in the fundamental emission

4.7.5 Deviation from Test Standard

No deviation.

4.7.6 EUT Operating Condition

The software provided by client to enable the EUT under transmission Condition continuously at lowest, middle and highest channel frequencies individually.

4.7.7 Test Results

802.11a

Channel	Frequency (MHz)	6dB Bandwidth (MHz)		Minimum Limit (MHz)	Pass / Fail
		Chain 0	Chain 1		
149	5745	16.40	16.41	0.5	Pass
157	5785	16.40	16.44	0.5	Pass
165	5825	16.42	16.44	0.5	Pass

802.11n (HT20)

Channel	Frequency (MHz)	6dB Bandwidth (MHz)		Minimum Limit (MHz)	Pass / Fail
		Chain 0	Chain 1		
149	5745	17.67	17.67	0.5	Pass
157	5785	17.65	17.68	0.5	Pass
165	5825	17.67	17.66	0.5	Pass

802.11n (HT40)

Channel	Frequency (MHz)	6dB Bandwidth (MHz)		Minimum Limit (MHz)	Pass / Fail
		Chain 0	Chain 1		
151	5755	36.48	36.47	0.5	Pass
159	5795	36.47	36.47	0.5	Pass

802.11ac (VHT80)

Channel	Frequency (MHz)	6dB Bandwidth (MHz)		Minimum Limit (MHz)	Pass / Fail
		Chain 0	Chain 1		
155	5775	76.11	76.47	0.5	Pass

Spectrum Plot of Worst Value

802.11a

802.11n (HT20)

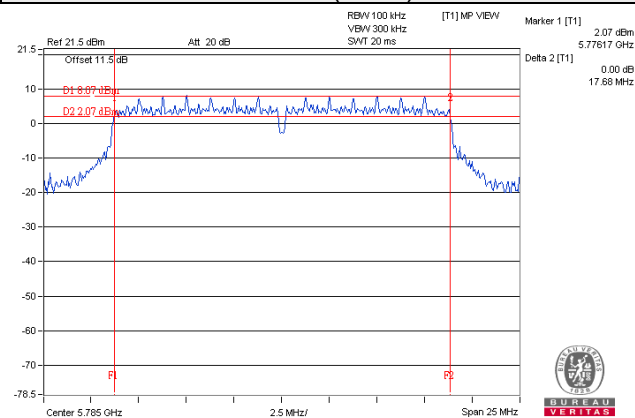
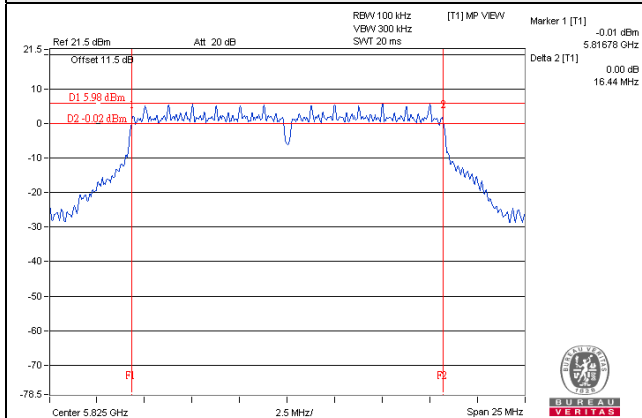

802.11n (HT40)

802.11ac (VHT80)

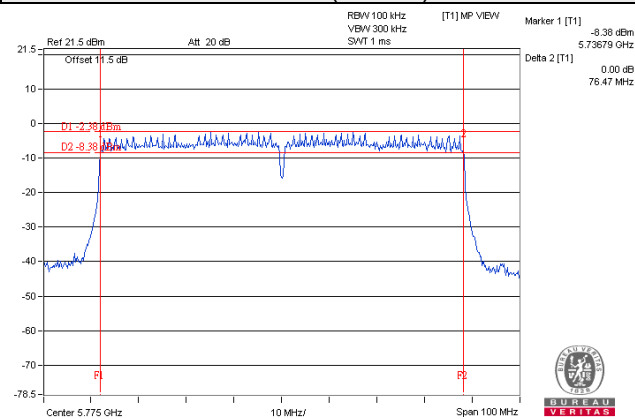
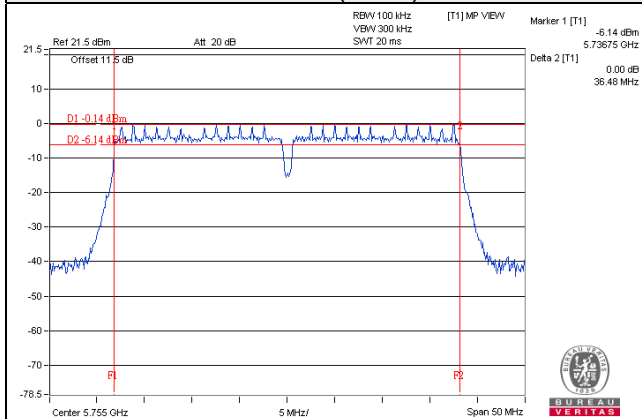

5 Pictures of Test Arrangements

Please refer to the attached file (Test Setup Photo).

Annex A- Radiated Out of Band Emission (OOBE) Measurement (For U-NII-3 band)

Test Mode A

802.11a

CH149

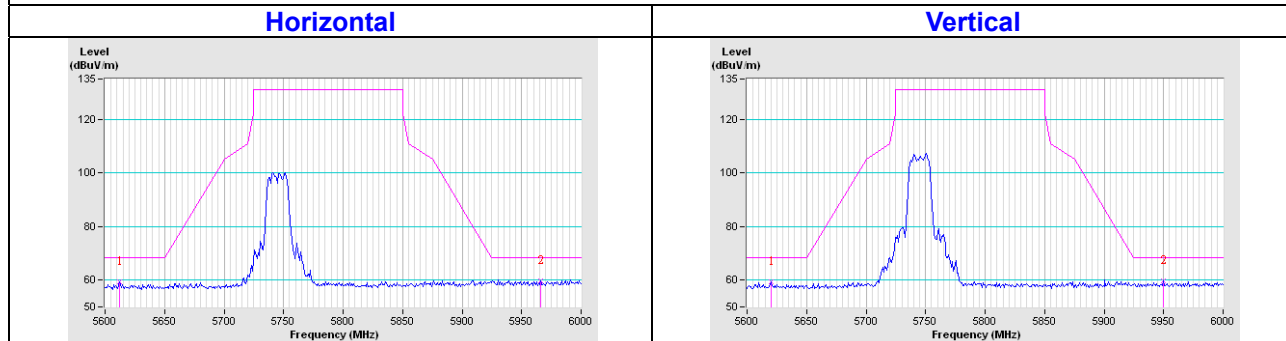

CH157

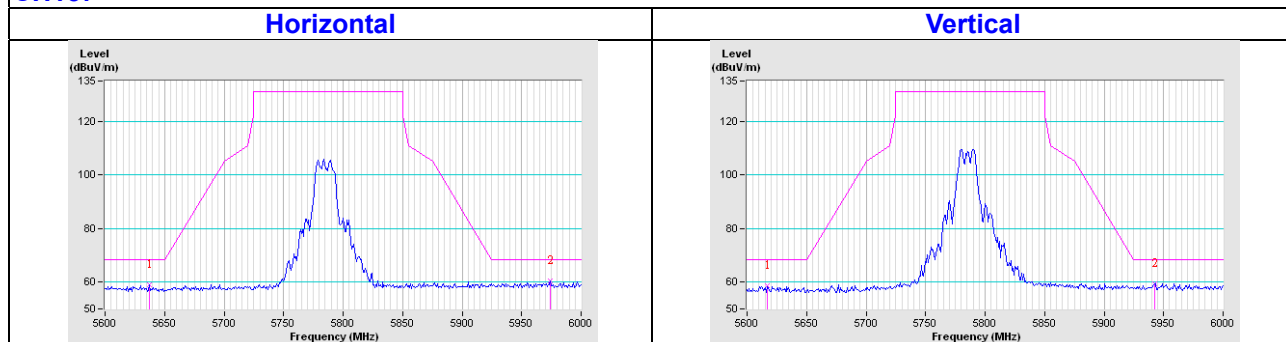

CH165

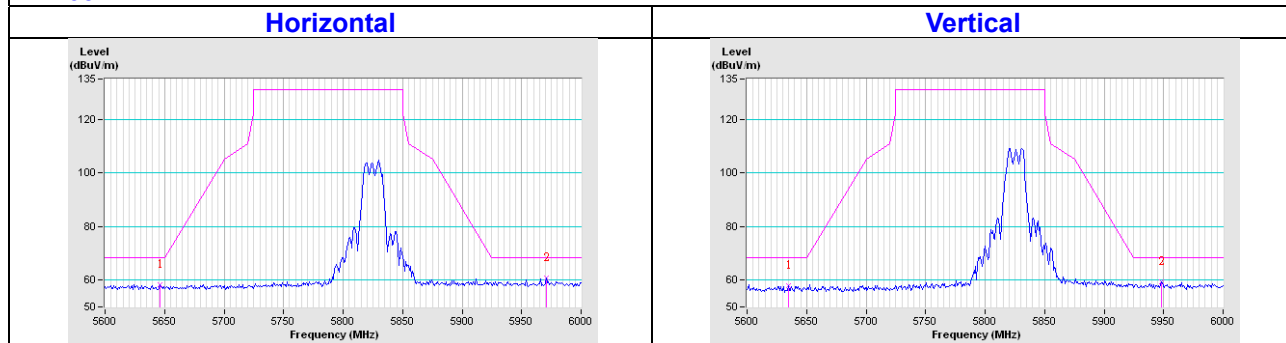

802.11n (HT20)

CH149

Horizontal

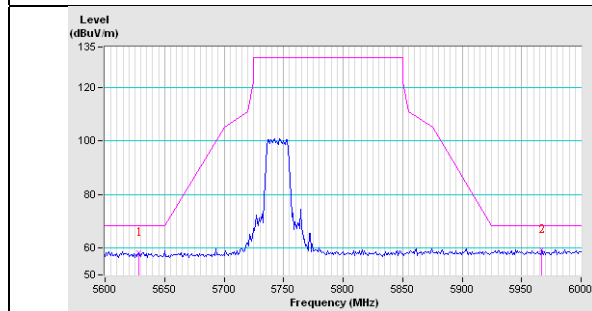

Vertical

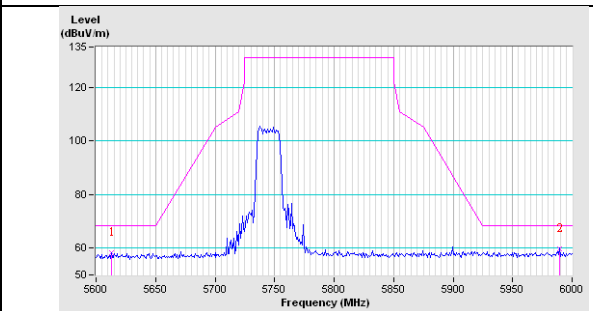

CH157

Horizontal

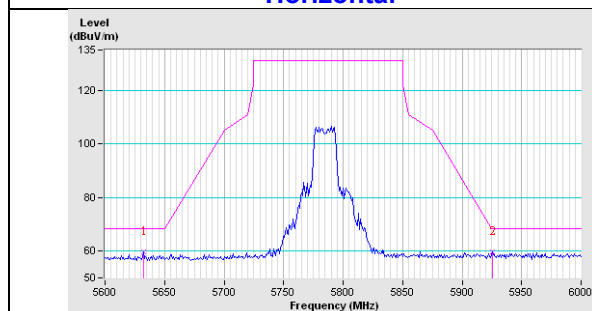

Vertical

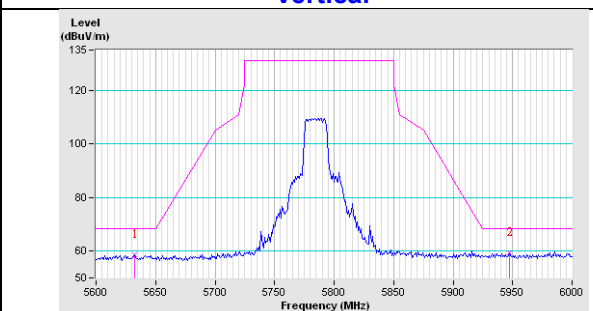

CH165

Horizontal

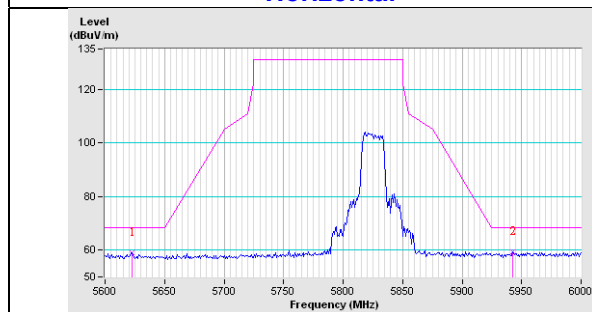

Vertical

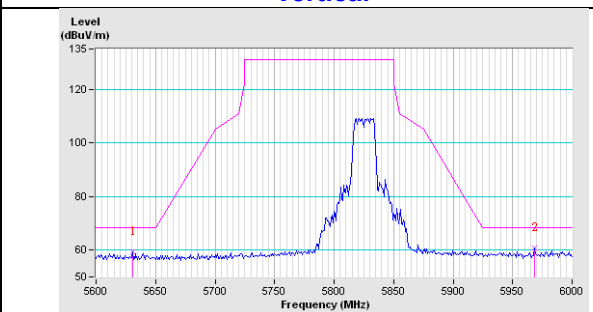

802.11n (HT40)

CH151

Horizontal

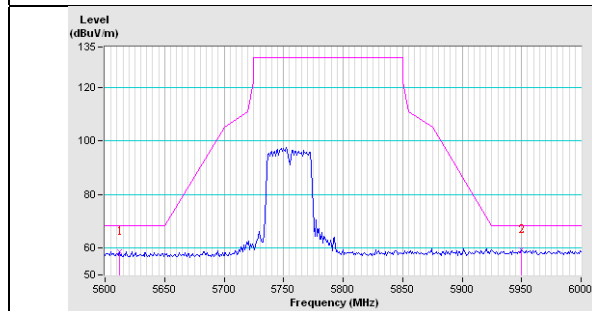

Vertical

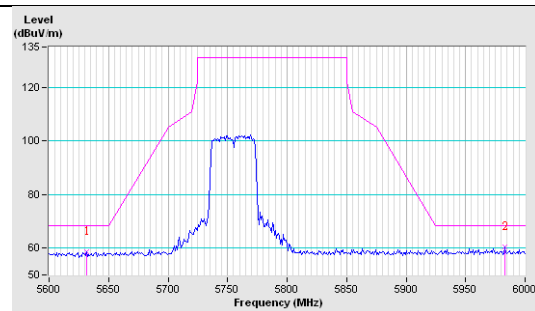

CH159

Horizontal

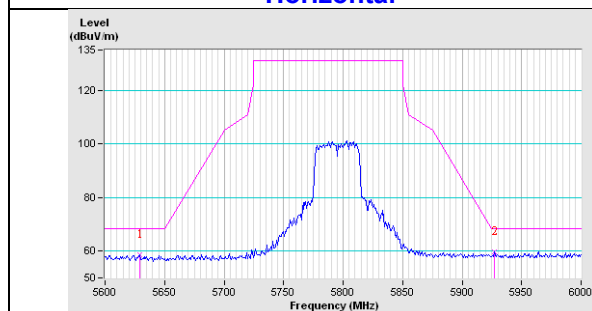

Vertical

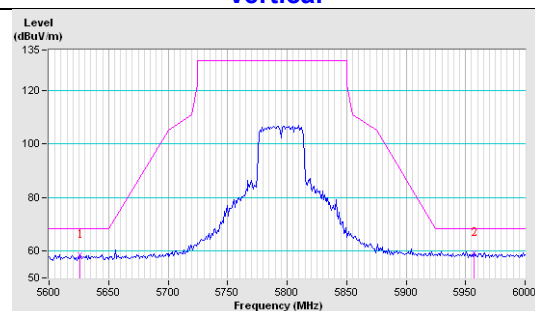

802.11ac (VHT80)

CH155

Horizontal

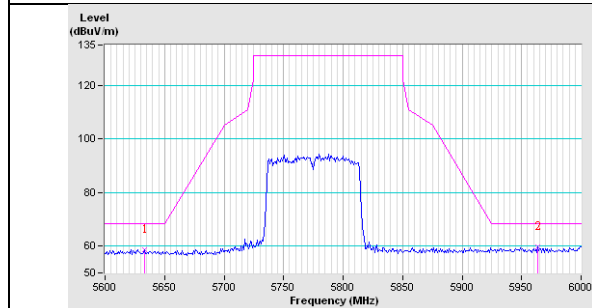

Vertical

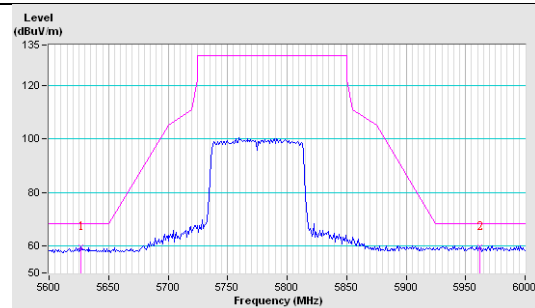

Test Mode C
802.11a
CH149

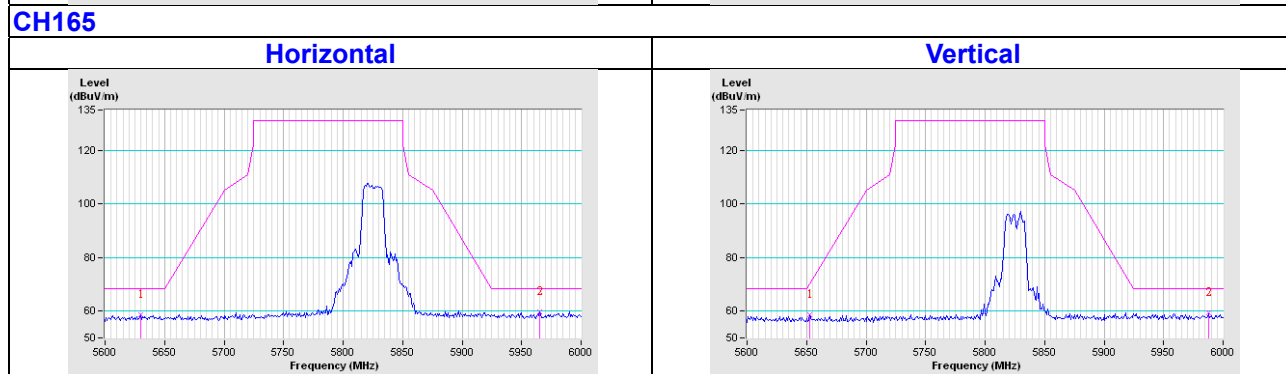
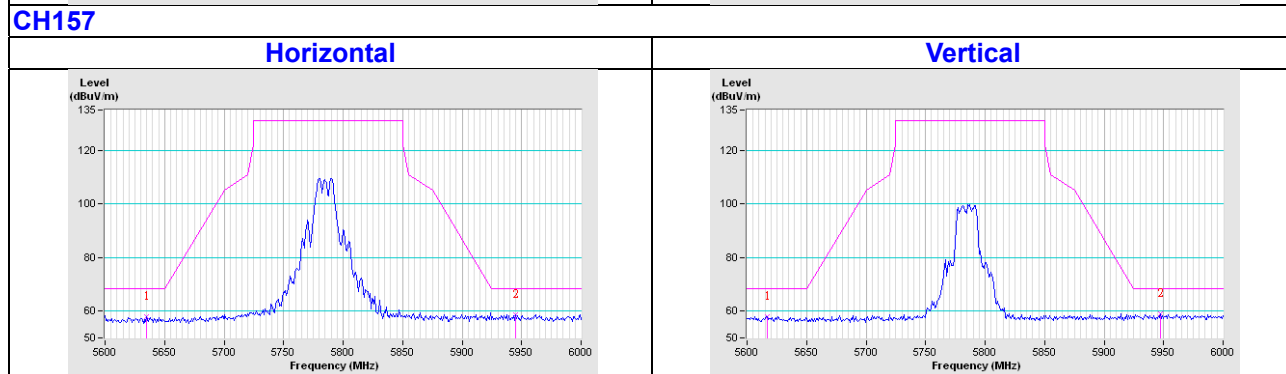
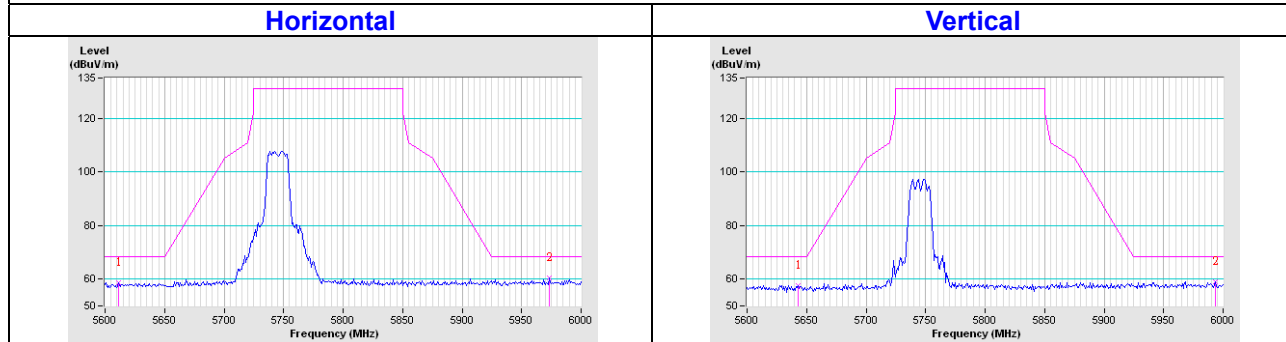

802.11n (HT20)

CH149

Horizontal

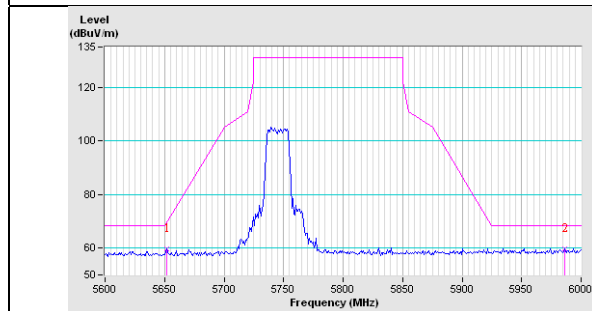

Vertical

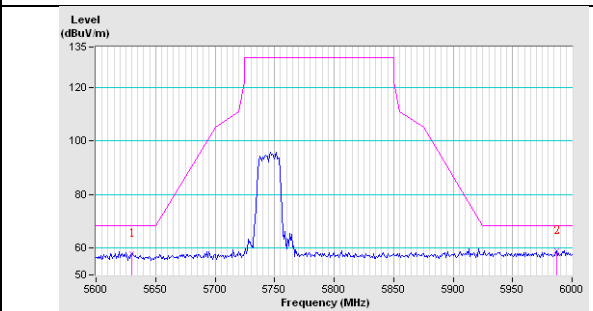

CH157

Horizontal

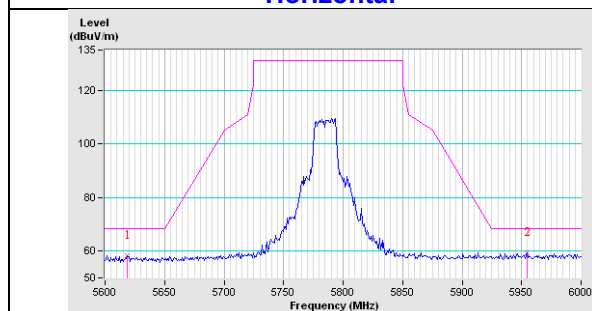

Vertical

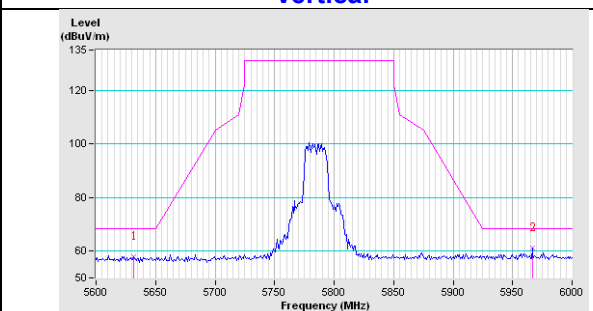

CH165

Horizontal

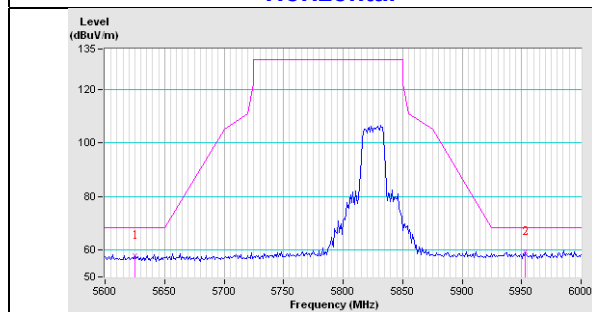

Vertical

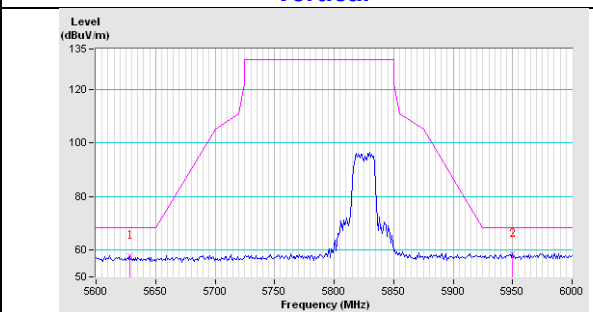

802.11n (HT40)

CH151

Horizontal

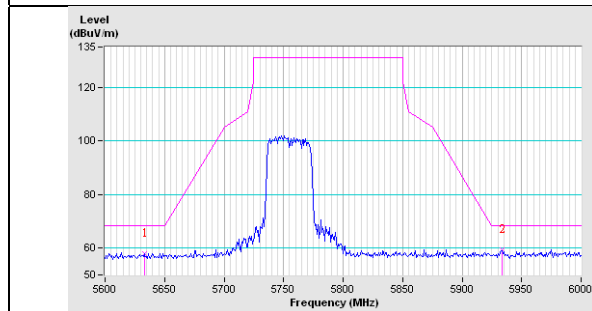

Vertical

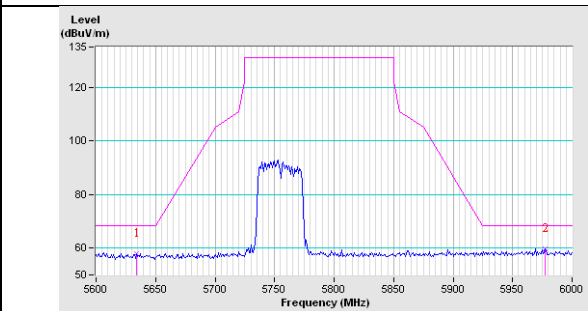

CH159

Horizontal

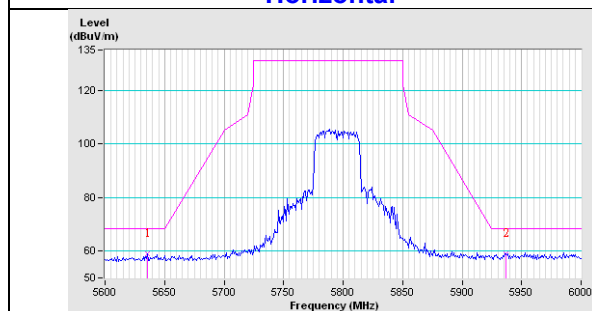

Vertical

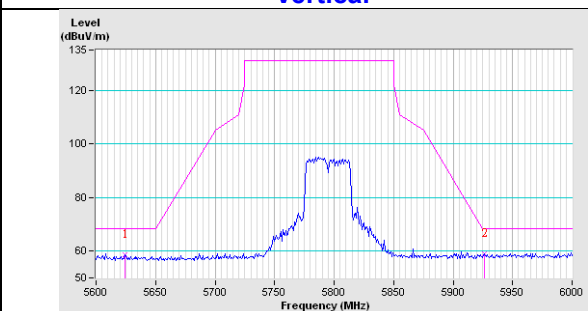

802.11ac (VHT80)

CH155

Horizontal

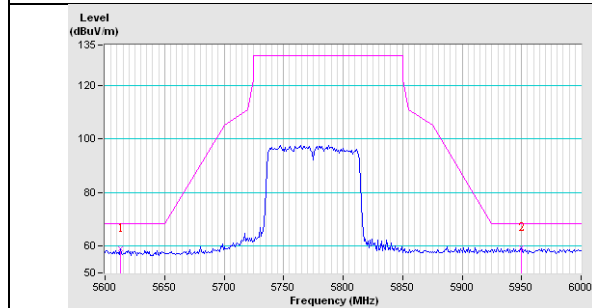

Vertical

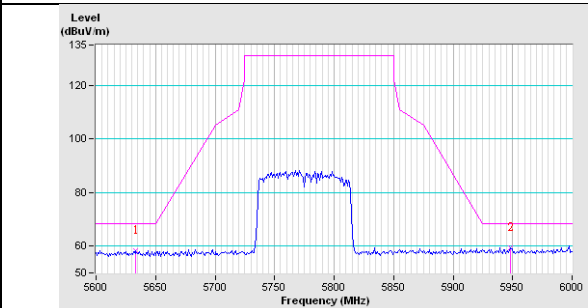

Appendix – Information on the Testing Laboratories

We, Bureau Veritas Consumer Products Services (H.K.) Ltd., Taoyuan Branch, were founded in 1988 to provide our best service in EMC, Radio, Telecom and Safety consultation. Our laboratories are accredited and approved according to ISO/IEC 17025.

If you have any comments, please feel free to contact us at the following:

Linko EMC/RF Lab

Tel: 886-2-26052180

Fax: 886-2-26051924

Hsin Chu EMC/RF/Telecom Lab

Tel: 886-3-6668565

Fax: 886-3-6668323

Hwa Ya EMC/RF/Safety Lab

Tel: 886-3-3183232

Fax: 886-3-3270892

Email: service.adt@tw.bureauveritas.com

Web Site: www.bureauveritas-adt.com

The address and road map of all our labs can be found in our web site also.

--- END ---