

FCC&IC Radio Test Report

FCC ID: TVE-24100012

IC: 7280B-24100012

This report concerns (check one): Original Grant Class II Change

Project No. : 1504C174
Equipment : Wireless Access Point
Model Name for FCC : FORTIAP-C220Cxxxxxx; FAP-C220Cxxxxxx;
Model Name for IC : FORTIAP-C225Cxxxxxx; FAP-C225Cxxxxxx
Applicant : Fortinet, Inc.
Address : 899 Kifer Road, Sunnyvale, CA 94086 USA

Date of Receipt : May 05. 2015
Date of Test : May 05. 2015~Jun.15.2015
Issued Date : Jun.16.2015
Tested by : BTL Inc.

Testing Engineer :



(David Mao)

Technical Manager :

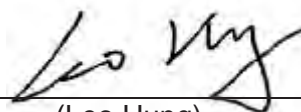

(Leo Hung)

Authorized Signatory :



(Steven Lu)

B T L I N C .

No.3, Jinshagang 1st Road, Shixia, Dalang Town, Dongguan,
Guangdong, China.

TEL: +86-769-8318-3000 FAX: +86-769-8319-6000

Declaration

BTL represents to the client that testing is done in accordance with standard procedures as applicable and that test instruments used has been calibrated with the standards traceable to National Measurement Laboratory (**NML**) of **R.O.C.**, or National Institute of Standards and Technology (**NIST**) of **U.S.A.**

BTL's reports apply only to the specific samples tested under conditions. It is manufacture's responsibility to ensure that additional production units of this model are manufactured with the identical electrical and mechanical components. **BTL** shall have no liability for any declarations, inferences or generalizations drawn by the client or others from **BTL** issued reports.

BTL's report must not be used by the client to claim product certification, approval, or endorsement by NVLAP, NIST, or any agency of the Federal Government.

This report is the confidential property of the client. As a mutual protection to the clients, the public and **BTL-self**, extracts from the test report shall not be reproduced except in full with **BTL's** authorized written approval.

BTL's laboratory quality assurance procedures are in compliance with the **ISO Guide 17025** requirements, and accredited by the conformity assessment authorities listed in this test report.

Limitation

For the use of the authority's logo is limited unless the Test Standard(s)/Scope(s)/Item(s) mentioned in this test report is (are) included in the conformity assessment authorities acceptance respective.

Table of Contents	Page
1 . CERTIFICATION	7
2 . SUMMARY OF TEST RESULTS	8
2.1 TEST FACILITY	9
2.2 MEASUREMENT UNCERTAINTY	9
3 . GENERAL INFORMATION	10
3.1 GENERAL DESCRIPTION OF EUT	10
3.2 DESCRIPTION OF TEST MODES	15
3.3 TABLE OF PARAMETERS OF TEST SOFTWARE SETTING	17
3.4 BLOCK DIAGRAM SHOWING THE CONFIGURATION OF SYSTEM TESTED	21
3.5 DESCRIPTION OF SUPPORT UNITS	21
4 . EMC EMISSION TEST	22
4.1 CONDUCTED EMISSION MEASUREMENT	22
4.1.1 POWER LINE CONDUCTED EMISSION	22
4.1.2 TEST PROCEDURE	22
4.1.3 DEVIATION FROM TEST STANDARD	22
4.1.4 TEST SETUP	23
4.1.5 EUT OPERATING CONDITIONS	23
4.1.6 EUT TEST CONDITIONS	23
4.1.7 TEST RESULTS	23
4.2 RADIATED EMISSION MEASUREMENT	24
4.2.1 RADIATED EMISSION LIMITS	24
4.2.2 TEST PROCEDURE	25
4.2.3 DEVIATION FROM TEST STANDARD	25
4.2.4 TEST SETUP	25
4.2.5 EUT OPERATING CONDITIONS	26
4.2.6 EUT TEST CONDITIONS	26
4.2.7 TEST RESULTS (9K TO 30MHz)	27
4.2.8 TEST RESULTS (BETWEEN 30 TO 1000 MHz)	27
4.2.9 TEST RESULTS (ABOVE 1000 MHz)	27
5 . 26dB SPECTRUM BANDWIDTH	28
5.1 APPLIED PROCEDURES / LIMIT	28
5.1.1 TEST PROCEDURE	28
5.1.2 DEVIATION FROM STANDARD	28
5.1.3 TEST SETUP	28
5.1.4 EUT OPERATION CONDITIONS	28
5.1.5 EUT TEST CONDITIONS	28
5.1.6 TEST RESULTS	28
6 . MAXIMUM CONDUCTED OUTPUT POWER	29

Table of Contents	Page
6.1 APPLIED PROCEDURES / LIMIT	29
6.1.1 TEST PROCEDURE	29
6.1.2 DEVIATION FROM STANDARD	30
6.1.3 TEST SETUP	30
6.1.4 EUT OPERATION CONDITIONS	30
6.1.5 EUT TEST CONDITIONS	30
6.1.6 TEST RESULTS	30
7 . ANTENNA CONDUCTED SPURIOUS EMISSION	31
7.1 APPLIED PROCEDURES / LIMIT	31
7.1.1 TEST PROCEDURE	31
7.1.2 DEVIATION FROM STANDARD	31
7.1.3 TEST SETUP	31
7.1.4 EUT OPERATION CONDITIONS	31
7.1.5 EUT TEST CONDITIONS	31
7.1.6 TEST RESULTS	31
8 . POWER SPECTRAL DENSITY TEST	32
8.1 APPLIED PROCEDURES / LIMIT	32
8.1.1 TEST PROCEDURE	32
8.1.1 DEVIATION FROM STANDARD	33
8.1.2 TEST SETUP	33
8.1.3 EUT OPERATION CONDITIONS	33
8.1.4 EUT TEST CONDITIONS	33
8.1.5 TEST RESULTS	33
9 . FREQUENCY STABILITY MEASUREMENT	34
9.1 APPLIED PROCEDURES / LIMIT	34
9.1.1 TEST PROCEDURE	34
9.1.2 DEVIATION FROM STANDARD	34
9.1.3 TEST SETUP	35
9.1.4 EUT OPERATION CONDITIONS	35
9.1.5 EUT TEST CONDITIONS	35
9.1.6 TEST RESULTS	35
10 . MEASUREMENT INSTRUMENTS LIST	36
ATTACHMENT A - CONDUCTED EMISSION	46
ATTACHMENT B - RADIATED EMISSION (9KHZ TO 30MHZ)	51
ATTACHMENT C - RADIATED EMISSION (30MHZ TO 1000MHZ)	54
ATTACHMENT D - RADIATED EMISSION (ABOVE 1000MHZ)	79
ATTACHMENT E - BANDWIDTH	316
ATTACHMENT F - MAXIMUM OUTPUT POWER	361

Table of Contents

Page

ATTACHMENT G - ANTENNA CONDUCTED SPURIOUS EMISSION	396
ATTACHMENT H - POWER SPECTRAL DENSITY	441
ATTACHMENT I - FREQUENCY STABILITY	542

REPORT ISSUED HISTORY

Issued No.	Description	Issued Date
BTL-FICP-2-1504C174	Original Issue.	Jun. 16, 2015

1. CERTIFICATION

Equipment : Wireless Access Point
Brand Name : fortinet
Model Name for FCC : FORTIAP-C220Cxxxxxx; FAP-C220Cxxxxxx;
FORTIAP-C225Cxxxxxx; FAP-C225Cxxxxxx
Model Name for IC : FORTIAP-C220C; FAP-C220C; FORTIAP-C225C; FAP-C225C
Applicant : Fortinet, Inc.
Manufacturer : Shenzhen Netcore Industrial Ltd.
Address : 4F&5F R&D Building, Oriental Cyberport, High-Tech Industrial Park,
Nanshan, Shenzhen, China.
Factory : Dongguan City Netcore Network Technology Co.,Ltd.
Address : No.10-1,Sankeng Road,Qinghutou,Tangxia Town,Don guan City
Date of Test : May 05. 2015~Jun.15.2015
Test Sample : ENGINEERING SAMPLE
Standard(s) : FCC Part15, Subpart E(15.407) / ANSI C63.10: 2013
FCC KDB 789033 D02 General UNII Test Procedures New Rules
v01.
Canada RSS-247 Issue 1 May 2015
RSS-GEN Issue 4, Nov 2014

The above equipment has been tested and found compliance with the requirement of the relative standards by BTL Inc.

The test data, data evaluation, and equipment configuration contained in our test report (Ref No. BTL-FICP-2-1504C174) were obtained utilizing the test procedures, test instruments, test sites that has been accredited by the Authority of TAF according to the ISO-17025 quality assessment standard and technical standard(s).

2. SUMMARY OF TEST RESULTS

Test procedures according to the technical standard(s):

FCC Part15, Subpart E Canada RSS-247 Issue 1 May 2015/RSS-GEN Issue 4, Nov 2014				
Standard(s) Section		Test Item	Judgment	Remark
FCC	IC			
15.207	RSS-GEN 8.8	AC Power Line Conducted Emissions	PASS	
15.407(a)	RSS-247 6.2.2 (1)	26dB Spectrum Bandwidth	PASS	
15.407(a)	RSS-247 6.2.2 (1)	Maximum Conducted Output Power	PASS	
15.407(a)	RSS-247 6.2.2 (1)	Power Spectral Density	PASS	
15.407(a)	RSS-247 6.2.2 (2)	Radiated Emissions	PASS	
15.407(b)	RSS-247 6.2.2 (2)	Band Edge Emissions	PASS	
15.407(g)	-	Frequency Stability	PASS	
15.203	-	Antenna Requirements	PASS	

NOTE:

(1) "N/A" denotes test is not applicable in this test report.

2.1 TEST FACILITY

The test facilities used to collect the test data in this report is **DG-C02/DG-CB03** at the location of No.3, Jinshagang 1st Road, Shixia, Dalang Town, Dongguan, Guangdong, China. 523792
 BTL's test firm number for FCC: 319330
 BTL's test firm number for IC: 4428B-1

2.2 MEASUREMENT UNCERTAINTY

The reported uncertainty of measurement $y \pm U$, where expanded uncertainty **U** is based on a standard uncertainty multiplied by a coverage factor of **k=2**, providing a level of confidence of approximately **95%** ◦

The BTL measurement uncertainty is less than the CISPR 16-4-2 U_{cispr} requirement.

A. Conducted Measurement:

Test Site	Method	Measurement Frequency Range	U, (dB)	Note
DG-C02	CISPR	150 KHz ~ 30MHz	1.94	

B. Radiated Measurement:

Test Site	Method	Measurement Frequency Range	Ant. H / V	U, (dB)	Note
DG-CB03	CISPR	9kHz~30MHz	V	3.79	
		9kHz~30MHz	H	3.57	
		30MHz ~ 200MHz	V	3.82	
		30MHz ~ 200MHz	H	3.60	
		200MHz ~ 1,000MHz	V	3.86	
		200MHz ~ 1,000MHz	H	3.94	
		1GHz~18GHz	V	3.12	
		1GHz~18GHz	H	3.68	
		18GHz~40GHz	V	4.15	
18GHz~40GHz	H	4.14			

Note: Unless specifically mentioned, the uncertainty of measurement has not been taken into account to declare the compliance or non-compliance to the specification.

3. GENERAL INFORMATION

3.1 GENERAL DESCRIPTION OF EUT

Equipment	Wireless Access Point	
Brand Name	fortinet	
Model Name for FCC	FORTIAP-C220Cxxxxxx; FAP-C220Cxxxxxx; FORTIAP-C225Cxxxxxx; FAP-C225Cxxxxxx	
Model Name for IC	FORTIAP-C220C; FAP-C220C; FORTIAP-C225C; FAP-C225C	
Model Difference	(1) where “x” can be “0-9”, or “A-Z”, or “-”, or blank for marketing purposes or software changes only (2) The model FORTIAP-C220Cxxxxxx; FAP-C220Cxxxxxx with internal antenna, model FORTIAP-C225Cxxxxxx; FAP-C225Cxxxxxx with external antenna.	
Product Description	Operation Frequency	UNII-1: 5150-5250MHz UNII-3: 5725-5850MHz
	Modulation Type	OFDM
	Bit Rate of Transmitter	300Mbps
	Output Power (Max.)for FCC UNII-1 for Internal antenna	802.11a: 15.02dBm 802.11n (20M): 15.27dBm 802.11n (40M): 15.71dBm 802.11ac (20M): 16.18dBm 802.11ac (40M): 17.30dBm 802.11ac (80M): 15.89dBm
	Output Power (Max.)for RSS UNII-1 for Internal antenna	802.11a: 18.30dBm 802.11n (20M): 18.21dBm 802.11n (40M): 18.18dBm 802.11ac (20M): 18.21dBm 802.11ac (40M): 18.19dBm 802.11ac (80M): 18.08dBm
	Output Power (Max.)for UNII-3 for Internal antenna	802.11a: 15.05dBm 802.11n (20M): 15.24dBm 802.11n (40M): 15.71dBm 802.11ac (20M): 16.11dBm 802.11ac (40M): 17.32dBm 802.11ac (80M): 15.91dBm

	Output Power (Max.)for FCC UNII-1 for External antenna	802.11a: 15.10dBm 802.11n (20M): 15.09dBm 802.11n (40M): 15.76dBm 802.11ac (20M): 16.85dBm 802.11ac (40M): 17.75dBm 802.11ac (80M): 15.56dBm
	Output Power (Max.)for RSS UNII-1 for External antenna	802.11a: 19.56dBm 802.11n (20M): 19.60dBm 802.11n (40M): 19.50dBm 802.11ac (20M): 19.61dBm 802.11ac (40M): 19.54dBm 802.11ac (80M): 19.53dBm
	Output Power (Max.)for UNII-3 for External antenna	802.11a: 15.07dBm 802.11n (20M): 15.07dBm 802.11n (40M): 15.72dBm 802.11ac (20M): 16.80dBm 802.11ac (40M): 17.73dBm 802.11ac (80M): 15.54dBm
Power Source	#1 DC Voltage supplied from AC/DC adapter.(support unit) #2 Supplied from PoE. (support unit)	
Power Rating	#1 I/P: AC 100-230V O/P: DC 12V/2A #2 DC 48V	

Note:

1. For a more detailed features description, please refer to the manufacturer's specifications or the user's manual.



2. Channel List:

UNII-1		UNII-1		UNII-1	
Channel	Frequency (MHz)	Channel	Frequency (MHz)	Channel	Frequency (MHz)
36	5180	38	5190	42	5210
40	5200	46	5230		
44	5220				
48	5240				

UNII-3		UNII-3		UNII-3	
Channel	Frequency (MHz)	Channel	Frequency (MHz)	Channel	Frequency (MHz)
149	5745	151	5755	155	5775
153	5765	159	5795		
157	5785				
161	5805				
165	5825				

3.

Internal antenna



Ant.	Brand	P/N	Antenna Type	Connector	Gain (dBi)	Note
3		RFPCA1610 06NN5B301	PCB	N/A	3.38	5G
4		RFPCA1610 13NN5B301	PCB	N/A	3.08	5G

Note:

- (1) The EUT incorporates a MIMO function. Physically, the EUT provides two completed transmitters and receivers (2T2R), all transmit signals are completely uncorrelated, then, **Direction gain = G_{ANT}** , that is Directional gain=3.38
- (2) ANT 3 for 1TX is the worst case.

4.

External antenna

Ant.	Brand	P/N	Antenna Type	Connector	Gain (dBi)	Note
3		RF21S00081A	Dipole	R-SMA	4.64	5G
4		RF21S00081A	Dipole	R-SMA	4.64	5G

Note:

- (1) The EUT incorporates a MIMO function. Physically, the EUT provides two completed transmitters and receivers (2T2R), all transmit signals are completely uncorrelated, then, **Direction gain = G_{ANT}** , that is Directional gain=4.64
- (2) ANT 3 for 1TX is the worst case.

5.

Internal antenna

Operating Mode TX Mode	1TX	2TX
802.11a	V (ANT 3)	-
802.11n (20MHz)	-	V (ANT 3+ANT 4)
802.11n (40MHz)	-	V (ANT 3+ANT 4)
802.11ac (20MHz)	-	V (ANT 3+ANT 4)
802.11ac (40MHz)	-	V (ANT 3+ANT 4)
802.11ac (80MHz)	-	V (ANT 3+ANT 4)

External antenna

Operating Mode TX Mode	1TX	2TX
802.11a	V (ANT 3)	-
802.11n (20MHz)	-	V (ANT 3+ANT 4)
802.11n (40MHz)	-	V (ANT 3+ANT 4)
802.11ac (20MHz)	-	V (ANT 3+ANT 4)
802.11ac (40MHz)	-	V (ANT 3+ANT 4)
802.11ac (80MHz)	-	V (ANT 3+ANT 4)

3.2 DESCRIPTION OF TEST MODES

To investigate the maximum EMI emission characteristics generates from EUT, the test system was pre-scanning tested base on the consideration of following EUT operation mode or test configuration mode which possible have effect on EMI emission level. Each of these EUT operation mode(s) or test configuration mode(s) mentioned above was evaluated respectively.

Pretest Test Mode	Description
Mode 1	TX A Mode / CH36, CH40, CH48 (UNII-1)
Mode 2	TX N20 Mode / CH36, CH40, CH48 (UNII-1)
Mode 3	TX N40 Mode / CH38, CH46 (UNII-1)
Mode 4	TX AC20 Mode / CH36, CH40, CH48 (UNII-1)
Mode 5	TX AC40 Mode / CH38, CH46 (UNII-1)
Mode 6	TX AC80 Mode / CH42 (UNII-1)
Mode 7	TX A Mode / CH149,CH157,CH165 (UNII-3)
Mode 8	TX N20 Mode / CH149,CH157,CH165 (UNII-3)
Mode 9	TX N40 Mode / CH151,CH159 (UNII-3)
Mode 10	TX AC20 Mode / CH149,CH157,CH165 (UNII-3)
Mode 11	TX AC40 Mode / CH151,CH159 (UNII-3)
Mode 12	TX AC80 Mode / CH155 (UNII-3)
Mode 13	TX Mode

The EUT system operated these modes were found to be the worst case during the pre-scanning test as following:

For Conducted Test	
Final Test Mode	Description
Mode 13	TX Mode

For Radiated Test	
Final Test Mode	Description
Mode 1	TX A Mode / CH36, CH40, CH48 (UNII-1)
Mode 2	TX N20 Mode / CH36, CH40, CH48 (UNII-1)
Mode 3	TX N40 Mode / CH38, CH46 (UNII-1)
Mode 4	TX AC20 Mode / CH36, CH40, CH48 (UNII-1)
Mode 5	TX AC40 Mode / CH38, CH46 (UNII-1)
Mode 6	TX AC80 Mode / CH42 (UNII-1)
Mode 7	TX A Mode / CH149,CH157,CH165 (UNII-3)
Mode 8	TX N20 Mode / CH149,CH157,CH165 (UNII-3)
Mode 9	TX N40 Mode / CH151,CH159 (UNII-3)
Mode 10	TX AC20 Mode / CH149,CH157,CH165 (UNII-3)
Mode 11	TX AC40 Mode / CH151,CH159 (UNII-3)
Mode 12	TX AC80 Mode / CH155 (UNII-3)

Note:

(1) For radiated below 1GHz test, the 802.11a mode is found to be the worst case and recorded.

3.3 TABLE OF PARAMETERS OF TEST SOFTWARE SETTING

During testing channel & power controlling software provided by the customer was used to control the operating channel as well as the output power level. The RF output power selection is for the setting of RF output power expected by the customer and is going to be fixed on the firmware of the final end product

Internal antenna

UNII-1			
Test Software Version	N/A		
Frequency (MHz)	5180	5200	5240
A Mode	51	49	48

UNII-3			
Test Software Version	N/A		
Frequency (MHz)	5745	5785	5825
A Mode	47	46	46

UNII-1			
Test Software Version	N/A		
Frequency (MHz)	5180	5200	5240
N20 Mode	48	47	45
Frequency (MHz)	5190	5230	
N40 Mode	48	46	

UNII-3			
Test Software Version	N/A		
Frequency (MHz)	5745	5785	5825
N20 Mode	37	36	37
Frequency (MHz)	5755	5795	
N40 Mode	40	40	

UNII-1			
Test Software Version	N/A		
Frequency (MHz)	5180	5200	5240
AC20 Mode	51	50	46
Frequency (MHz)	5190	5230	
AC40 Mode	53	48	
Frequency (MHz)	5210		
AC80 Mode	53		

UNII-3			
Test Software Version	N/A		
Frequency (MHz)	5745	5785	5825
AC20 Mode	40	39	39
Frequency (MHz)	5755	5795	
AC40 Mode	41	42	
Frequency (MHz)	5775		
AC80 Mode	43		

External antenna

UNII-1			
Test Software Version	N/A		
Frequency (MHz)	5180	5200	5240
A Mode	55	55	54

UNII-3			
Test Software Version	N/A		
Frequency (MHz)	5745	5785	5825
A Mode	46	45	45

UNII-1			
Test Software Version	N/A		
Frequency (MHz)	5180	5200	5240
N20 Mode	45	45	44
Frequency (MHz)	5190	5230	
N40 Mode	48	47	

UNII-3			
Test Software Version	N/A		
Frequency (MHz)	5745	5785	5825
N20 Mode	38	36	36
Frequency (MHz)	5755	5795	
N40 Mode	41	40	

UNII-1			
Test Software Version	N/A		
Frequency (MHz)	5180	5200	5240
AC20 Mode	49	48	45
Frequency (MHz)	5190	5230	
AC40 Mode	53	48	
Frequency (MHz)	5210		
AC80 Mode	53		

UNII-3			
Test Software Version	N/A		
Frequency (MHz)	5745	5785	5825
AC20 Mode	40	39	39
Frequency (MHz)	5755	5795	
AC40 Mode	42	42	
Frequency (MHz)	5775		
AC80 Mode	44		

3.4 BLOCK DIAGRAM SHOWING THE CONFIGURATION OF SYSTEM TESTED

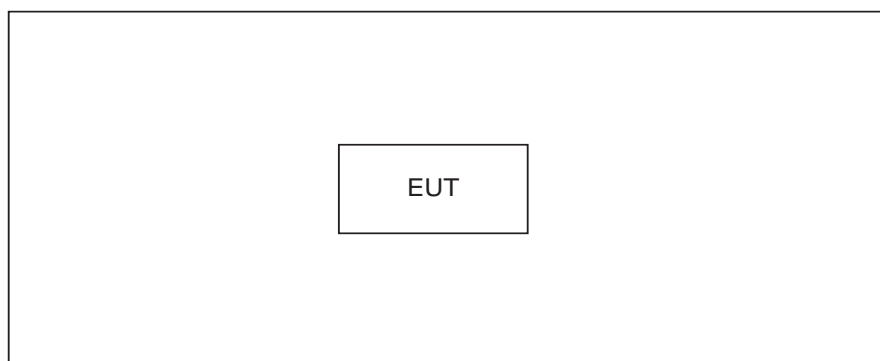

3.5 DESCRIPTION OF SUPPORT UNITS

The EUT has been tested as an independent unit together with other necessary accessories or support units. The following support units or accessories were used to form a representative test configuration during the tests.

Item	Equipment	Mfr/Brand	Model/Type No.	FCC ID/IC	Series No.	Note
-	-	-	-	-	-	

Item	Shielded Type	Ferrite Core	Length	Note
-	-	-	-	

4. EMC EMISSION TEST

4.1 CONDUCTED EMISSION MEASUREMENT

4.1.1 POWER LINE CONDUCTED EMISSION (Frequency Range 150kHz-30MHz)

FREQUENCY (MHz)	Class A (dBuV)		Class B (dBuV)	
	Quasi-peak	Average	Quasi-peak	Average
0.15 -0.5	79.00	66.00	66 - 56 *	56 - 46 *
0.50 -5.0	73.00	60.00	56.00	46.00
5.0 -30.0	73.00	60.00	60.00	50.00

Note:

- (1) The tighter limit applies at the band edges.
- (2) The limit of " * " marked band means the limitation decreases linearly with the logarithm of the frequency in the range.
- (3) The test result calculated as following:
 Measurement Value = Reading Level + Correct Factor
 Correct Factor = Insertion Loss + Cable Loss + Attenuator Factor(if use)
 Margin Level = Measurement Value - Limit Value

4.1.2 TEST PROCEDURE

- a. The EUT was placed 0.8 meters from the horizontal ground plane with EUT being connected to the power mains through a line impedance stabilization network (LISN). All other support equipments powered from additional LISN(s). The LISN provide 50 Ohm/ 50uH of coupling impedance for the measuring instrument.
- b. Interconnecting cables that hang closer than 40 cm to the ground plane shall be folded back and forth in the center forming a bundle 30 to 40 cm long.
- c. I/O cables that are not connected to a peripheral shall be bundled in the center. The end of the cable may be terminated, if required, using the correct terminating impedance. The overall length shall not exceed 1 m.
- d. LISN at least 80 cm from nearest part of EUT chassis.
- e. For the actual test configuration, please refer to the related Item –EUT Test Photos.

4.1.3 DEVIATION FROM TEST STANDARD

No deviation

4.1.4 TEST SETUP

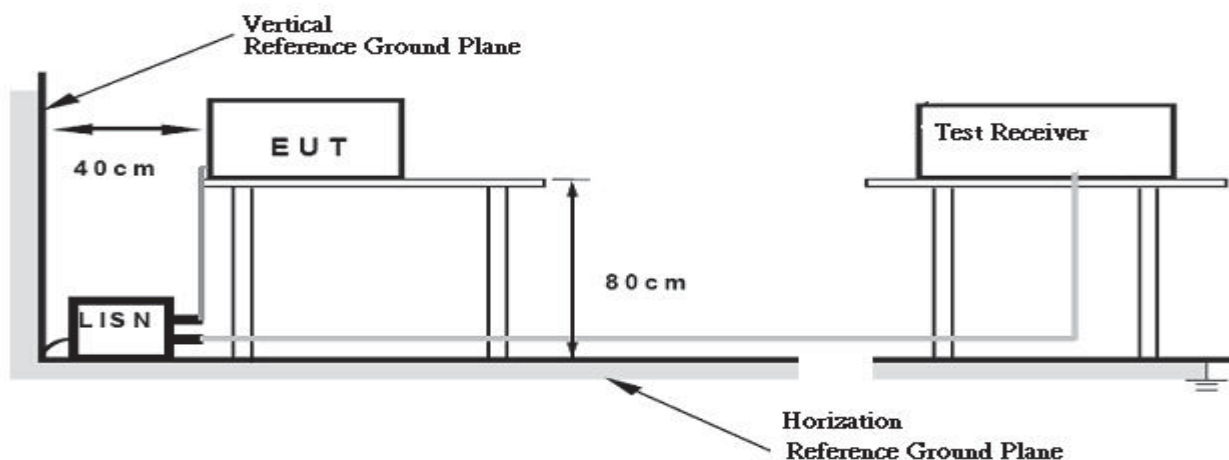

4.1.5 EUT OPERATING CONDITIONS

The EUT was configured for testing in a typical fashion (as a customer would normally use it). The EUT has been programmed to continuously transmit during test. This operating condition was tested and used to collect the included data.

The EUT was programmed to be in continuously transmitting/TX Mode mode.

4.1.6 EUT TEST CONDITIONS

Temperature: 24°C Relative Humidity: 60% Test Voltage: AC 120V/60Hz

4.1.7 TEST RESULTS

Please refer to the Attachment A.

Remark:

- (1) All readings are QP Mode value unless otherwise stated AVG in column of 『Note』. If the QP Mode Measured value compliance with the QP Limits and lower than AVG Limits, the EUT shall be deemed to meet both QP & AVG Limits and then only QP Mode was measured, but AVG Mode didn't perform. In this case, a “*” marked in AVG Mode column of Interference Voltage Measured.
- (2) Measuring frequency range from 150kHz to 30MHz.

4.2 RADIATED EMISSION MEASUREMENT

4.2.1 RADIATED EMISSION LIMITS

20dBc in any 100 kHz bandwidth outside the operating frequency band. In case the emission fall within the restricted band specified on 15.205(a) and RSS-247 6.2.2 (2), then the 15.209(a) and RSS-Gen limit in the table below has to be followed.

Frequencies (MHz)	Field Strength (micorvolts/meter)	Measurement Distance (meters)
0.009~0.490	2400/F(kHz)	300
0.490~1.705	24000/F(kHz)	30
1.705~30.0	30	30
30~88	100	3
88~216	150	3
216~960	200	3
Above 960	500	3

Note:

(1) The limit for radiated test was performed according to FCC PART 15C.

(2) The tighter limit applies at the band edges.

LIMITS OF UNWANTED EMISSION OUT OF THE RESTRICTED BANDS

Frequencies (MHz)	EIRP Limit (dBm)	Equivalent Field Strength at 3m (dB μ V/m)
5150-5250	-27	68.3
5250-5350	-27	68.3
5470-5725	-27	68.3
5725-5850	-27 (beyond 10MHz of the band edge)	68.3
	-17 (within 10 MHz of band edge)	78.3

Note: The following formula is used to convert the equipment isotropic radiated power (eirp) to field

strength: $E = \frac{1000000\sqrt{30P}}{3} \mu\text{V/m}$, where P is the eirp (Watts)

4.2.2 TEST PROCEDURE

- a. The measuring distance of at 3m shall be used for measurements at frequency up to 1GHz. For frequencies above 1GHz, any suitable measuring distance may be used.
- b. The EUT was placed on the top of a rotating table 0.8 meters above the ground at a 3 meter semi-anechoic chamber. The table was rotated 360 degrees to determine the position of the highest radiation.
- c. The height of the equipment or of the substitution antenna shall be 0.8 mor 1.5m; the height of the test antenna shall vary between 1 m to 4 m. Both horizontal and vertical polarizations of the antenna are set to make the measurement.
- d. The initial step in collecting conducted emission data is a spectrum analyzer peak detector mode pre-scanning the measurement frequency range. Significant peaks are then marked and then Quasi Peak detector mode re-measured.
- e. If the Peak Mode measured value compliance with and lower than Quasi Peak Mode Limit, the EUT shall be deemed to meet QP Limits and then no additional QP Mode measurement performed.
- f. For the actual test configuration, please refer to the related Item –EUT Test Photos.

4.2.3 DEVIATION FROM TEST STANDARD

No deviation

4.2.4 TEST SETUP

(A) Radiated Emission Test Set-Up Frequency Below 1GHz

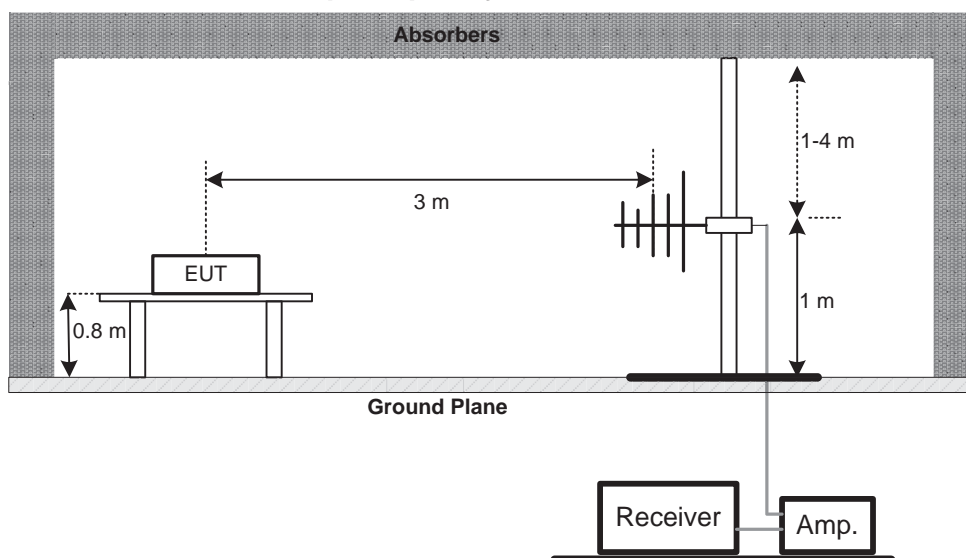

(B) Radiated Emission Test Set-Up Frequency Above 1 GHz

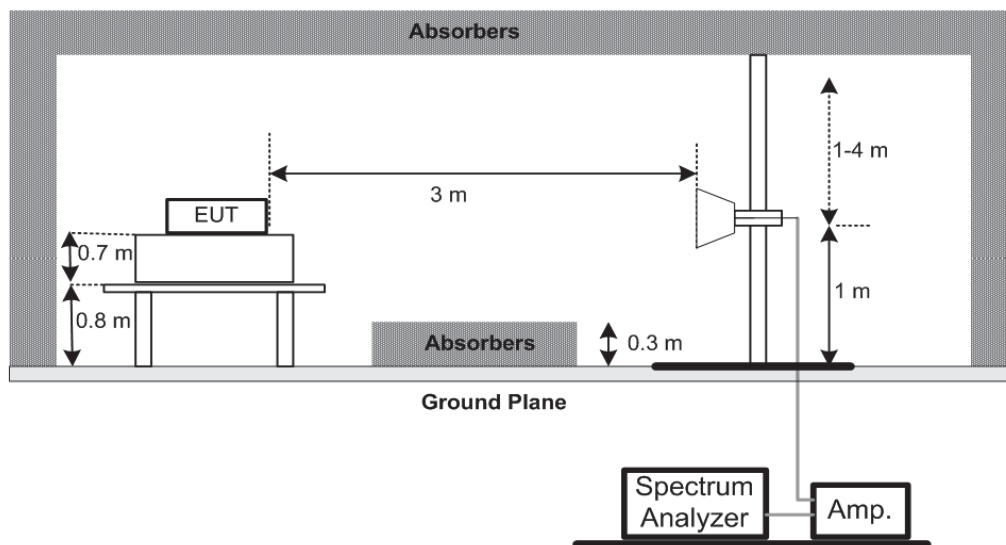

(C) Radiated emissions below 30MHz

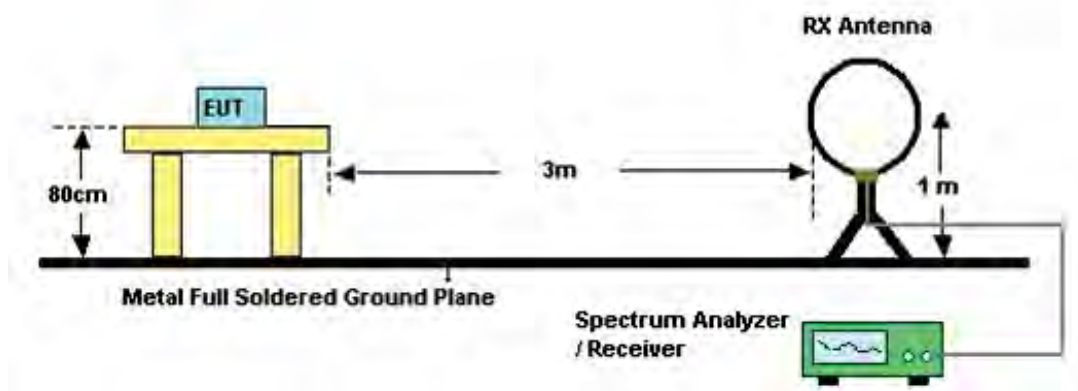

4.2.5 EUT OPERATING CONDITIONS

The EUT tested system was configured as the statements of 4.1.5 Unless otherwise a special operating condition is specified in the follows during the testing.

4.2.6 EUT TEST CONDITIONS

Temperature: 28°C Relative Humidity: 60% Test Voltage: AC 120V/60Hz

4.2.7 TEST RESULTS (9K TO 30MHz)

Please refer to the Attachment B

Remark:

- (1) The amplitude of spurious emissions which are attenuated by more than 20 dB below the permissible value has no need to be reported.
- (2) Distance extrapolation factor = $40 \log$ (specific distance / test distance) (dB);
- (3) Limit line = specific limits (dBuV) + distance extrapolation factor.

4.2.8 TEST RESULTS (BETWEEN 30 TO 1000 MHz)

Please refer to the Attachment C.

Remark:

- (1) Reading in which marked as QP or Peak means measurements by using are Quasi-Peak Mode or Peak Mode with Detector BW=120kHz ; SPA setting in RBW=120kHz, VBW =120kHz, Swp. Time = 0.3 sec./MHz ◦
- (2) All readings are Peak unless otherwise stated QP in column of 『Note』 . Peak denotes that the Peak reading compliance with the QP Limits and then QP Mode measurement didn't perform ◦
- (3) Measuring frequency range from 30MHz to 1000MHz ◦
- (4) If the peak scan value lower limit more than 20dB, then this signal data does not show in table ◦

4.2.9 TEST RESULTS (ABOVE 1000 MHz)

Please refer to the Attachment D.

Remark:

- (1) Spectrum Setting: 30MHz – 1000MHz , RBW= 100kHz, VBW=100kHz, Sweep time = 200 ms. 1GHz- 40GHz, RBW= 1MHz, VBW= 1MHz, Sweep time = Auto
- (2) All readings are Peak unless otherwise stated AV in column of 『Note』 . Peak denotes that the Peak reading compliance with the AV Limits and then AV Mode measurement didn't perform.
- (3) Radiated emissions measured in frequency range above 1000MHz were made with an instrument using Peak detector mode and AV detector mode of the emission ◦
- (4) Data of measurement within this frequency range shown “ * ” in the table above means the reading of emissions are attenuated more than 20dB below the permissible limits or the field strength is too small to be measured.
- (5) A preamp and high pass filter were used for this test in order to provide sufficient measurement sensitivity.
- (6) EUT Orthogonal Axes:
“X” - denotes Laid on Table ; “Y” - denotes Vertical Stand ; “Z” - denotes Side Stand
- (7) During the measurements above 1GHz it is taken care of that the EUT is always within the 3dB cone of radiation BW of the used antenna.
- (8) No limit: This is fundamental signal, the judgment is not applicable.
For fundamental signal judgment was referred to Peak output test.

5. 26dB SPECTRUM BANDWIDTH

5.1 APPLIED PROCEDURES / LIMIT

FCC Part15, Subpart E/ RSS-247			
Test Item	Limit	Frequency Range (MHz)	Result
Bandwidth	26 dB Bandwidth	5150-5250	PASS
	Minimum 500kHz 6dB Bandwidth	5725-5850	PASS

5.1.1 TEST PROCEDURE

a. The EUT was directly connected to the spectrum analyzer and antenna output port as show in the block diagram below,

b.

Spectrum Parameters	Setting
Attenuation	Auto
Span Frequency	> 26dB Bandwidth
RBW	300 kHz
VBW	1000 kHz
Detector	Peak
Trace	Max Hold
Sweep Time	Auto

c. Measured the spectrum width with power higher than 26dB below carrier

5.1.2 DEVIATION FROM STANDARD

No deviation.

5.1.3 TEST SETUP



5.1.4 EUT OPERATION CONDITIONS

The EUT tested system was configured as the statements of 4.1.5 Unless otherwise a special operating condition is specified in the follows during the testing.

5.1.5 EUT TEST CONDITIONS

Temperature: 28°C Relative Humidity: 60% Test Voltage: AC 120V/60Hz

5.1.6 TEST RESULTS

Please refer to the Attachment E.

6. MAXIMUM CONDUCTED OUTPUT POWER

6.1 APPLIED PROCEDURES / LIMIT

FCC Part15, Subpart E/ RSS-247			
Test Item	Limit	Frequency Range (MHz)	Result
Conducted Output Power	For FCC: Fixed:1 Watt (30dBm) Mobile and portable: 250mW (24dBm)	5150-5250	PASS
	For RSS:e.i.r.p. power: not exceed 200 mW(23dBm) or 10 + 10 log ₁₀ B		
	1 Watt (30dBm)	5725-5850	PASS
Note: The maximum e.i.r.p at anyelevation angle above 30 degrees as measured from the horizon must not exceed 125mW(21dBm)			

6.1.1 TEST PROCEDURE

- a. The EUT was directly connected to the power meter and antenna output port as show in the block diagram below,
- b.

Spectrum Parameter	Setting
Attenuation	Auto
Span Frequency	Encompass the entire emissions bandwidth (EBW) of the signal
RBW	= 1MHz.
VBW	≥ 3MHz.
Detector	RMS
Trace	Max Hold
Sweep Time	auto

- c. Test was performed in accordance with method of KDB 789033 D02.

6.1.2 DEVIATION FROM STANDARD

No deviation.

6.1.3 TEST SETUP



6.1.4 EUT OPERATION CONDITIONS

The EUT tested system was configured as the statements of 4.1.5 Unless otherwise a special operating condition is specified in the follows during the testing.

6.1.5 EUT TEST CONDITIONS

Temperature: 28°C Relative Humidity: 60% Test Voltage: AC 120V/60Hz

6.1.6 TEST RESULTS

Please refer to the Attachment F.

7. ANTENNA CONDUCTED SPURIOUS EMISSION

7.1 APPLIED PROCEDURES / LIMIT

FCC Part15, Subpart E/ RSS-247			
Test Item	Limit	Frequency Range (MHz)	Result
Antenna conducted Spurious Emission	-27dBm/MHz	5150-5250	PASS
	Below -17dBm/MHz within 10MHz of band edge, below -27dBm/MHz beyond 10MHz of the band edge	5725-5850	PASS

7.1.1 TEST PROCEDURE

a. The EUT was directly connected to the spectrum analyzer and antenna output port as show in the block diagram below,

b.

Spectrum Parameter	Setting
Attenuation	Auto
RBW	1000kHz
VBW	1000kHz
Trace	Max Hold
Sweep Time	Auto

7.1.2 DEVIATION FROM STANDARD

No deviation.

7.1.3 TEST SETUP



7.1.4 EUT OPERATION CONDITIONS

The EUT tested system was configured as the statements of 4.1.5 Unless otherwise a special operating condition is specified in the follows during the testing.

7.1.5 EUT TEST CONDITIONS

Temperature: 28°C Relative Humidity: 60% Test Voltage: AC 120V/60Hz

7.1.6 TEST RESULTS

Please refer to the Attachment G.

8. POWER SPECTRAL DENSITY TEST

8.1 APPLIED PROCEDURES / LIMIT

FCC Part15, Subpart E/ RSS-247			
Test Item	Limit	Frequency Range (MHz)	Result
Power Spectral Density	For FCC: Other then Mobile and portable:17dBm/MHz Mobile and portable:11dBm/MHz	5150-5250	PASS
	For RSS:10dBm/MHz		
	30dBm/500kHz	5725-5850	PASS

8.1.1 TEST PROCEDURE

a. The EUT was directly connected to the spectrum analyzer and antenna output port as show in the block diagram below,

b.

Spectrum Parameter	Setting
Attenuation	Auto
Span Frequency	Encompass the entire emissions bandwidth (EBW) of the signal
RBW	= 1MHz.
VBW	≥ 3MHz.
Detector	RMS
Trace	Max Hold
Sweep Time	Auto

Note:

1. For UNII-3, according to KDB publication 789033 D02 General UNII Test Procedures New Rules v01, section II.F.5., it is acceptable to set RBW at 1MHz and VBW at 3MHz if the spectrum analyzer does not have 500kHz RBW.
2. The value measured with RBW=1MHz is to be added with $10\log(500\text{kHz}/1\text{MHz})$ which is -3dB. For example, if the measured value is +10dBm using RBW=1MHz (that is +10dBm/MHz), then the converted value will be +7dBm/500kHz.

8.1.1 DEVIATION FROM STANDARD

No deviation.

8.1.2 TEST SETUP



8.1.3 EUT OPERATION CONDITIONS

The EUT tested system was configured as the statements of 4.1.5 Unless otherwise a special operating condition is specified in the follows during the testing.

8.1.4 EUT TEST CONDITIONS

Temperature: 28°C Relative Humidity: 60% Test Voltage: AC 120V/60Hz

8.1.5 TEST RESULTS

Please refer to the Attachment H.

9. FREQUENCY STABILITY MEASUREMENT

9.1 APPLIED PROCEDURES / LIMIT

FCC Part15, Subpart E/ RSS-247			
Test Item	Limit	Frequency Range (MHz)	Result
Frequency Stability	Specified in the user's manual	5150-5250	PASS
		5725-5850	PASS

9.1.1 TEST PROCEDURE

a. The EUT was directly connected to the spectrum analyzer and antenna output port as show in the block diagram below,

b.

Spectrum Parameter	Setting
Attenuation	Auto
Span Frequency	Entire absence of modulation emissions bandwidth
RBW	10 kHz
VBW	10 kHz
Sweep Time	Auto

c. The test extreme voltage is to change the primary supply voltage from 85 to 115 percent of the nominal value.

d. User manual temperature is 0°C~40°C.

9.1.2 DEVIATION FROM STANDARD

No deviation.

9.1.3 TEST SETUP

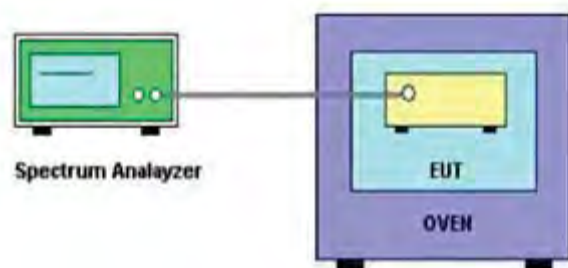

9.1.4 EUT OPERATION CONDITIONS

The EUT tested system was configured as the statements of 4.1.5 Unless otherwise a special operating condition is specified in the follows during the testing.

9.1.5 EUT TEST CONDITIONS

Temperature: 25°C Relative Humidity: 55% Test Voltage: AC 120V/60Hz

9.1.6 TEST RESULTS

Please refer to the Attachment I.

10. MEASUREMENT INSTRUMENTS LIST

Conducted Emission Measurement					
Item	Kind of Equipment	Manufacturer	Type No.	Serial No.	Calibrated until
1	LISN	EMCO	3816/2	00052765	Mar. 28, 2016
2	LISN	R&S	ENV216	101447	Mar. 28, 2016
3	Test Cable	N/A	C_17	N/A	Mar.13, 2016
4	EMI TEST RECEIVER	R&S	ESCS30	833364/017	Mar. 28, 2016
5	50Ω Terminator	SHX	TF2-3G-A	08122902	Mar. 28, 2016
6	Measurement Software	Farad	EZ-EMC Ver.NB-03A1 -01	N/A	N/A

Radiated Emission Measurement					
Item	Kind of Equipment	Manufacturer	Type No.	Serial No.	Calibrated until
1	Antenna	Schwarzbeck	VULB9160	9160-3232	Mar. 28, 2016
2	Amplifier	HP	8447D	2944A09673	Nov. 17, 2015
3	Receiver	AGILENT	N9038A	MY5213003 9	Sep. 30, 2015
4	Test Cable	N/A	C-01_CB03	N/A	Jul. 01, 2015
5	Controller	CT	SC100	N/A	N/A
6	Antenna	ETS	3115	00075789	Mar. 28, 2016
7	Amplifier	Agilent	8449B	3008A02274	Nov. 02, 2015
8	Receiver	AGILENT	N9038A	MY5213003 9	Sep. 30, 2015
9	Test Cable	N/A	C-68	N/A	Jul. 01, 2015
10	Controller	CT	SC100	N/A	N/A
11	Broad-Band Horn Antenna	Schwarzbeck	BBHA 9170	9170319	Mar. 28, 2016
12	Microwave Preamplifier With Adaptor	EMC INSTRUMENT	EMC2654045	980039 & HA01	Mar. 28, 2016
13	Active Loop Antenna	R&S	HFH2-Z2	830749/020	Aug. 16, 2015
14	Measurement Software	Farad	EZ-EMC Ver.NB-03A1-01	N/A	N/A

Spectrum Bandwidth Measurement					
Item	Kind of Equipment	Manufacturer	Type No.	Serial No.	Calibrated until
1	Spectrum Analyzer	R&S	FSP 40	100185	Nov. 02, 2015

Maximum Conducted Output Power Measurement					
Item	Kind of Equipment	Manufacturer	Type No.	Serial No.	Calibrated until
1	power Meter	ANRITSU	ML2495A	1128009	Mar. 28, 2016
2	Pulse Power Sensor	ANRITSU	MA 2411B	1027500	Mar. 28, 2016

Antenna Conducted Spurious Emission Measurement					
Item	Kind of Equipment	Manufacturer	Type No.	Serial No.	Calibrated until
1	Spectrum Analyzer	R&S	FSP 40	100185	Nov. 02, 2015

Power Spectral Density Measurement					
Item	Kind of Equipment	Manufacturer	Type No.	Serial No.	Calibrated until
1	Spectrum Analyzer	R&S	FSP 40	100185	Nov. 02, 2015

Frequency Stability Measurement					
Item	Kind of Equipment	Manufacturer	Type No.	Serial No.	Calibrated until
1	Spectrum Analyzer	R&S	FSP 40	100185	Nov. 02, 2015

Remark: "N/A" denotes no model name, serial no. or calibration specified.
 All calibration period of equipment list is one year.

10.1. EUT TEST PHOTOS**Conducted Measurement Photos****Internal antenna**

Conducted Measurement Photos

External antenna



Radiated Measurement Photos

9KHz to 30MHz
Internal antenna



Radiated Measurement Photos

9KHz to 30MHz
External antenna



Radiated Measurement Photos

30MHz to 1000MHz
Internal antenna



Radiated Measurement Photos

30MHz to 1000MHz
External antenna



Radiated Measurement Photos

Above 1000MHz
Internal antenna



Radiated Measurement Photos

Above 1000MHz
External antenna



ATTACHMENT A - CONDUCTED EMISSION

Test Mode: TX MODE- Internal antenna

Line

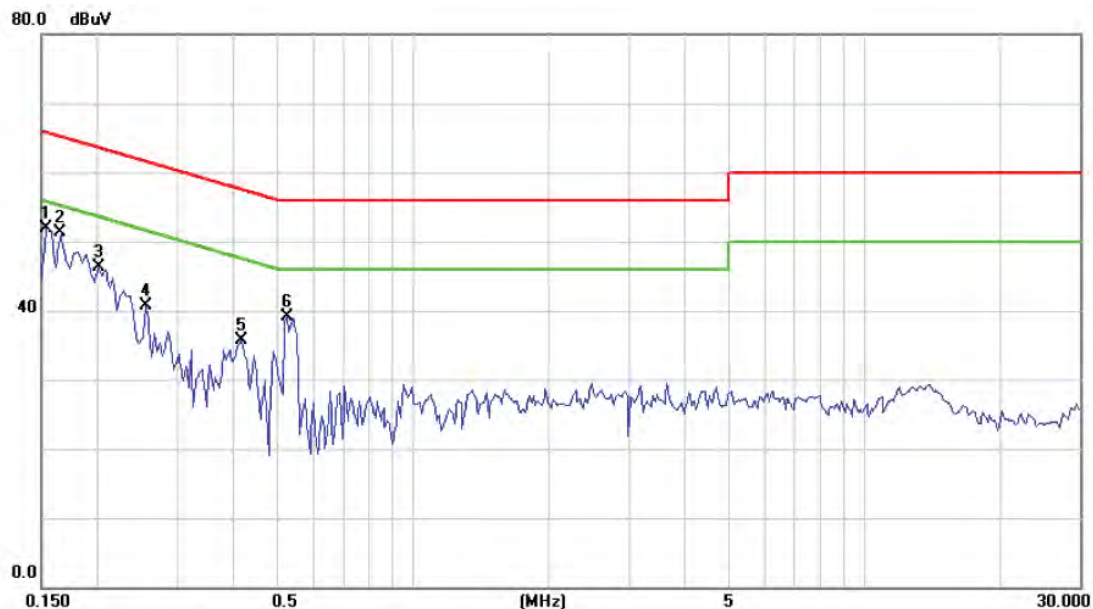

No.	Mk.	Freq. MHz	Reading Level dBuV	Correct Factor dB	Measure- ment dBuV	Limit dBuV	Margin dB	Detector	Comment
1		0.1540	42.36	9.54	51.90	65.78	-13.88	peak	
2	*	0.1655	41.84	9.56	51.40	65.18	-13.78	peak	
3		0.2008	36.76	9.57	46.33	63.58	-17.25	peak	
4		0.2555	31.06	9.61	40.67	61.58	-20.91	peak	
5		0.4156	25.95	9.68	35.63	57.54	-21.91	peak	
6		0.5250	29.48	9.69	39.17	56.00	-16.83	peak	

Note : The test result has included the cable loss.

Test Mode: TX MODE- Internal antenna

Neutral

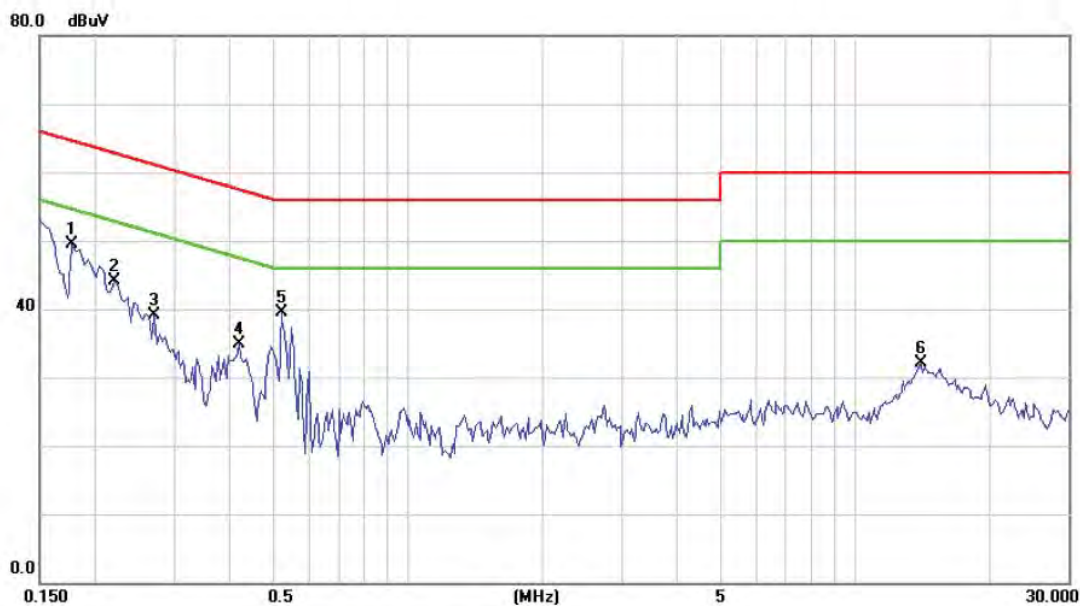

No.	Mk.	Freq. MHz	Reading Level dBuV	Correct Factor dB	Measure- ment dBuV	Limit dBuV	Margin dB	Detector	Comment
1	*	0.1773	40.00	9.48	49.48	64.61	-15.13	peak	
2		0.2203	34.51	9.50	44.01	62.81	-18.80	peak	
3		0.2711	29.56	9.51	39.07	61.08	-22.01	peak	
4		0.4195	25.29	9.54	34.83	57.46	-22.63	peak	
5		0.5211	29.94	9.56	39.50	56.00	-16.50	peak	
6		14.0117	22.11	9.91	32.02	60.00	-27.98	peak	

Note : The test result has included the cable loss.

Test Mode: TX MODE- External antenna

Line

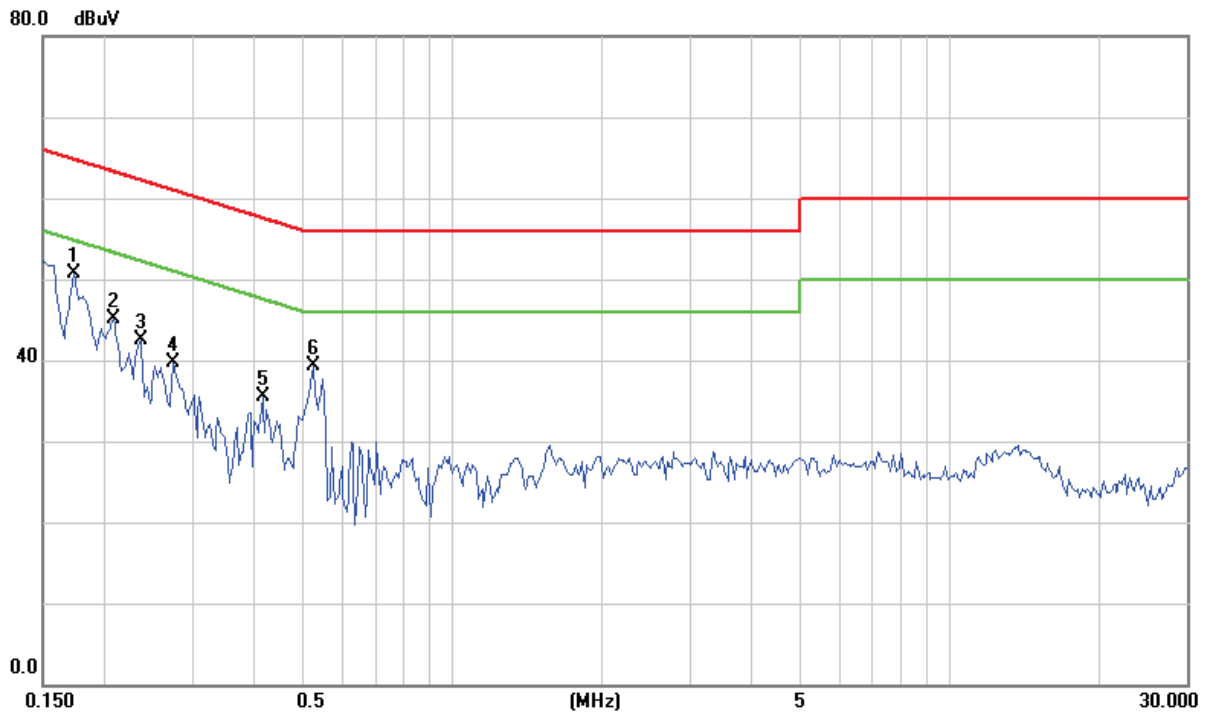

No.	Freq. MHz	Reading Level dBuV	Correct Factor dB	Measure ment dBuV	Limit dBuV	Over dB	Detector	Comment
1	0.1734	41.20	9.56	50.76	64.80	-14.04	Peak	
2	0.2086	35.55	9.58	45.13	63.26	-18.13	Peak	
3	0.2359	32.95	9.60	42.55	62.24	-19.69	Peak	
4	0.2750	30.12	9.63	39.75	60.97	-21.22	Peak	
5	0.4156	25.83	9.68	35.51	57.54	-22.03	Peak	
6	0.5250	29.70	9.69	39.39	56.00	-16.61	Peak	

Note : The test result has included the cable loss.

Test Mode: TX MODE- External antenna

Neutral

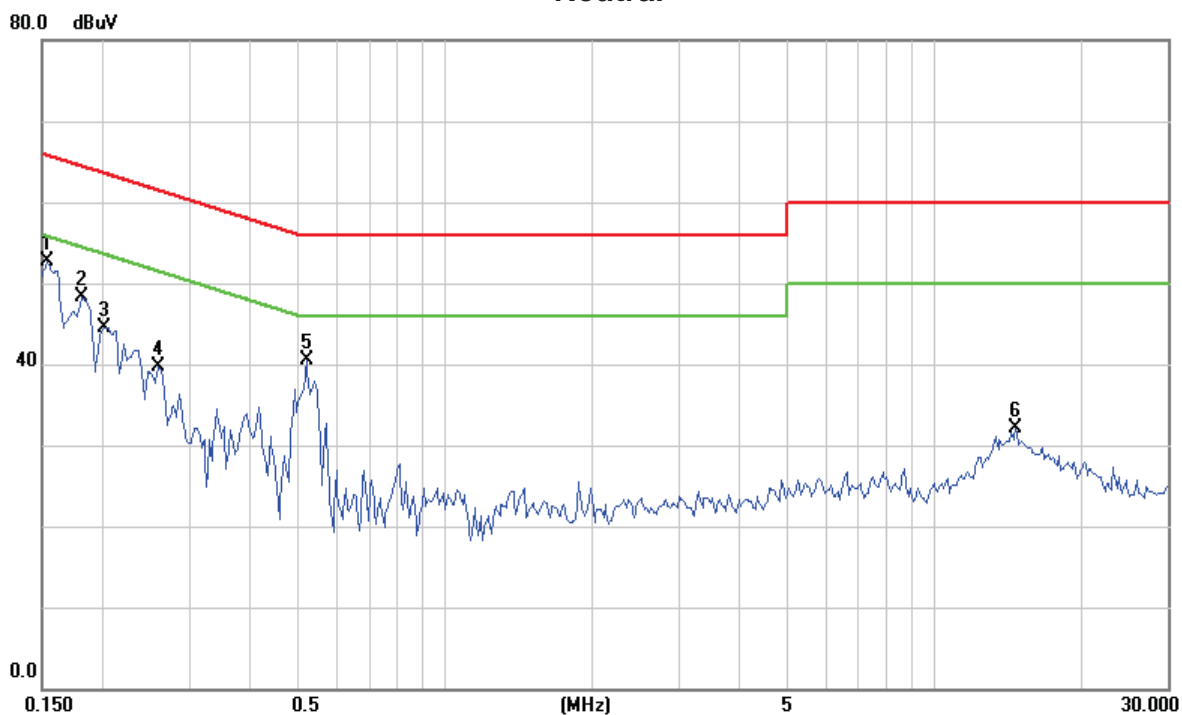

No.	Freq. MHz	Reading Level dBuV	Correct Factor dB	Measure ment dBuV	Limit dBuV	Over dB	Detector	Comment
1	0.1539	43.13	9.49	52.62	65.79	- 3.17	Peak	
2	0.1812	38.73	9.49	48.22	64.43	-16.21	Peak	
3	0.2008	35.09	9.50	44.59	63.58	-18.99	Peak	
4	0.2594	30.29	9.51	39.80	61.45	-21.65	Peak	
5	0.5211	30.85	9.56	40.41	56.00	-15.59	Peak	
6	14.6953	22.25	9.92	32.17	60.00	-27.83	Peak	

Note : The test result has included the cable loss.

ATTACHMENT B - RADIATED EMISSION (9KHZ TO 30MHZ)

Test Mode:	TX MODE- Internal antenna
------------	---------------------------

Frequency (MHz)	Ant 0°/90°	Read level dBuV/m	Factor (dB)	Measured(FS) (dBuV/m)	Limit (dBuV/m)	Margin (dB)	Note
0.0126	0°	8.74	24.7687	33.5087	125.5968	-92.0881	AVG
0.0126	0°	10.13	24.7687	34.8987	145.5968	-110.6981	PEAK
0.0239	0°	5.32	24.0530	29.3730	120.0363	-90.6633	AVG
0.0239	0°	6.51	24.0530	30.5630	140.0363	-109.4733	PEAK
0.0382	0°	2.15	23.1473	25.2973	115.9630	-90.6656	AVG
0.0382	0°	3.27	23.1473	26.4173	135.9630	-109.5456	PEAK
0.0427	0°	0.55	22.8623	23.4123	114.9957	-91.5833	AVG
0.0427	0°	1.34	22.8623	24.2023	134.9957	-110.7933	PEAK
0.5374	0°	18.26	19.9197	38.1797	72.9983	-34.8186	QP
2.1821	0°	22.45	19.3907	41.8407	69.5400	-27.6993	QP

Frequency (MHz)	Ant 0°/90°	Read level dBuV/m	Factor (dB)	Measured(FS) (dBuV/m)	Limit (dBuV/m)	Margin (dB)	Note
0.0076	90°	12.51	24.3000	36.8100	129.9880	-93.1780	AVG
0.0076	90°	13.82	24.3000	38.1200	149.9880	-111.8680	PEAK
0.0154	90°	8.16	24.3000	32.4600	123.8538	-91.3938	AVG
0.0154	90°	9.42	24.3000	33.7200	143.8538	-110.1338	PEAK
0.0237	90°	3.64	24.0657	27.7057	120.1093	-92.4036	AVG
0.0237	90°	5.06	24.0657	29.1257	140.1093	-110.9836	PEAK
0.0389	90°	1.23	23.1030	24.3330	115.8052	-91.4722	AVG
0.0389	90°	2.07	23.1030	25.1730	135.8052	-110.6322	PEAK
0.5061	90°	19.36	19.8195	39.1795	73.5195	-34.3400	QP
2.0357	90°	22.48	19.4786	41.9586	69.5400	-27.5814	QP

Test Mode:	TX MODE- External antenna
------------	---------------------------

Frequency (MHz)	Ant 0°/90°	Read level dBuV/m	Factor (dB)	Measured(FS) (dBuV/m)	Limit (dBuV/m)	Margin (dB)	Note
0.0153	0°	9.13	24.5977	33.7277	123.9104	-90.1827	AVG
0.0153	0°	12.28	24.5977	36.8777	143.9104	-107.0327	PEAK
0.0216	0°	6.85	24.1987	31.0487	120.9151	-89.8665	AVG
0.0216	0°	8.14	24.1987	32.3387	140.9151	-108.5765	PEAK
0.0372	0°	3.72	23.2107	26.9307	116.1934	-89.2627	AVG
0.0372	0°	4.53	23.2107	27.7407	136.1934	-108.4527	PEAK
0.0425	0°	1.02	22.8750	23.8950	115.0364	-91.1414	AVG
0.0425	0°	2.18	22.8750	25.0550	135.0364	-109.9814	PEAK
0.5863	0°	18.36	20.0762	38.4362	72.2418	-33.8057	QP
2.3695	0°	24.43	19.2783	43.7083	69.5400	-25.8317	QP

Frequency (MHz)	Ant 0°/90°	Read level dBuV/m	Factor (dB)	Measured(FS) (dBuV/m)	Limit (dBuV/m)	Margin (dB)	Note
0.0089	90°	12.21	24.3000	36.5100	128.6164	-92.1064	AVG
0.0089	90°	13.57	24.3000	37.8700	148.6164	-110.7464	PEAK
0.0133	90°	8.36	24.3000	32.6600	125.1272	-92.4672	AVG
0.0133	90°	9.64	24.3000	33.9400	145.1272	-111.1872	PEAK
0.0261	90°	3.72	23.9137	27.6337	119.2714	-91.6377	AVG
0.0261	90°	4.58	23.9137	28.4937	139.2714	-110.7777	PEAK
0.0374	90°	1.28	23.1980	24.4780	116.1468	-91.6688	AVG
0.0374	90°	2.65	23.1980	25.8480	136.1468	-110.2988	PEAK
0.5518	90°	18.24	19.9658	38.2058	72.7686	-34.5628	QP
1.7152	90°	23.51	19.5285	43.0385	69.5400	-26.5015	QP

ATTACHMENT C - RADIATED EMISSION (30MHZ TO 1000MHZ)

Test Mode: UNII-1/TX A Mode 5180MHz- Internal antenna

Vertical

66.9 dBuV/m

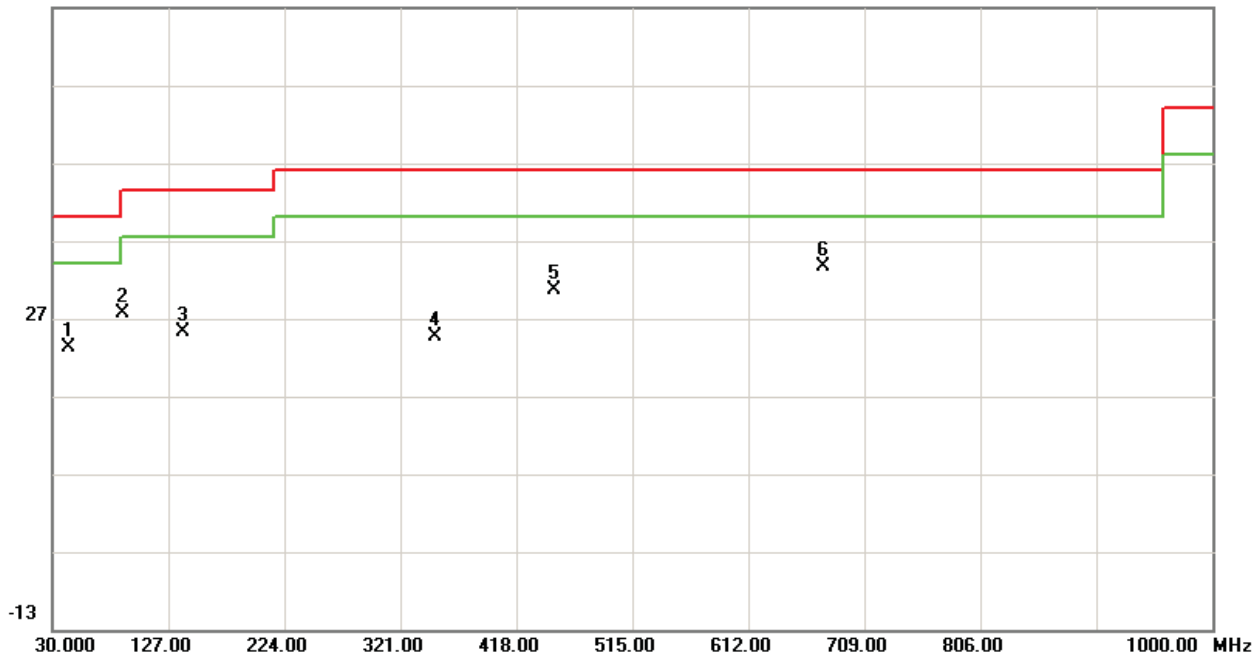

No.	Freq. MHz	Reading Level dBuV/m	Correct Factor dB	Measure ment dBuV/m	Limit dBuV/m	Over dB	Detector	Comment
1	43.5800	38.42	-15.22	23.20	40.00	-16.80	Peak	
2	89.1700	44.63	-16.96	27.67	43.50	-15.83	Peak	
3	138.6400	39.23	-13.94	25.29	43.50	-18.21	Peak	
4	350.1000	35.53	-10.94	24.59	46.00	-21.41	Peak	
5	450.0100	40.03	-9.35	30.68	46.00	-15.32	Peak	
6	675.0500	39.47	-5.95	33.52	46.00	-12.48	Peak	

Test Mode: UNII-1/TX A Mode 5180MHz- Internal antenna

Horizontal

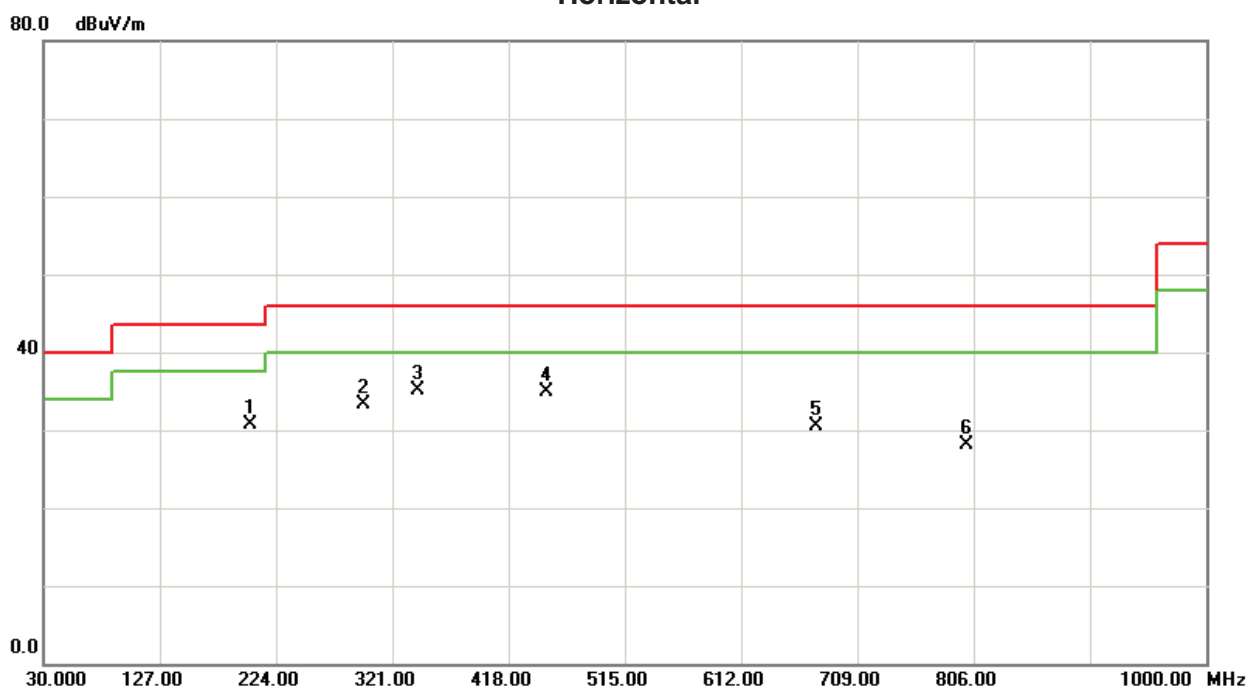

No.	Freq. MHz	Reading Level dBuV/m	Correct Factor dB	Measure ment dBuV/m	Limit dBuV/m	Over dB	Detector	Comment
1	202.6600	45.41	-14.62	30.79	43.50	-12.71	Peak	
2	296.7500	44.63	-11.29	33.34	46.00	-12.66	Peak	
3	342.3400	45.96	-10.92	35.04	46.00	-10.96	Peak	
4	450.0100	44.29	-9.35	34.94	46.00	-11.06	Peak	
5	675.0500	36.38	-5.95	30.43	46.00	-15.57	Peak	
6	800.1800	32.17	-3.97	28.20	46.00	-17.80	Peak	

Test Mode: UNII-1/TX A Mode 5200MHz- Internal antenna

Vertical

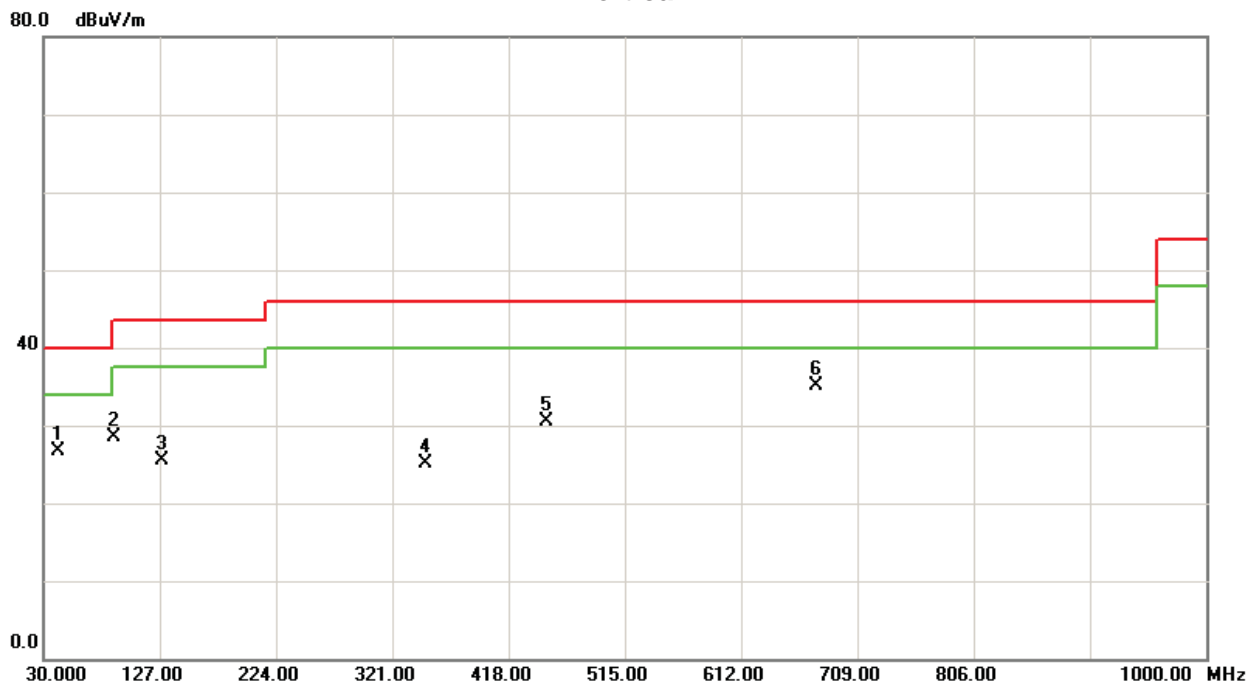

No.	Freq. MHz	Reading Level dBuV/m	Correct Factor dB	Measure ment dBuV/m	Limit dBuV/m	Over dB	Detector	Comment
1	41.6400	41.60	-14.97	26.63	40.00	-13.37	Peak	
2	88.2000	45.29	-16.84	28.45	43.50	-15.05	Peak	
3	128.9400	39.26	-13.73	25.53	43.50	-17.97	Peak	
4	349.1300	36.08	-10.94	25.14	46.00	-20.86	Peak	
5	450.0100	39.91	-9.35	30.56	46.00	-15.44	Peak	
6	675.0500	41.07	-5.95	35.12	46.00	-10.88	Peak	

Test Mode: UNII-1/TX A Mode 5200MHz- Internal antenna

Horizontal

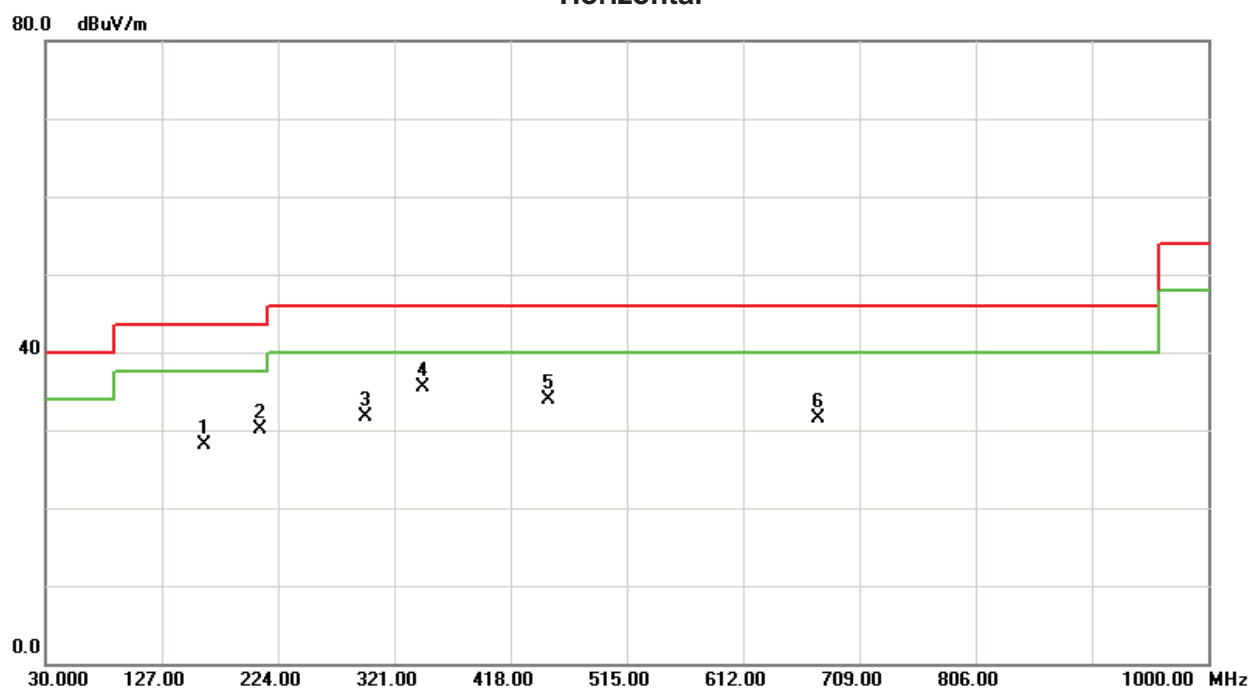

No.	Freq. MHz	Reading Level dBuV/m	Correct Factor dB	Measure ment dBuV/m	Limit dBuV/m	Over dB	Detector	Comment
1	162.8900	41.50	-13.48	28.02	43.50	-15.48	Peak	
2	209.4500	44.66	-14.55	30.11	43.50	-13.39	Peak	
3	296.7500	42.94	-11.29	31.65	46.00	-14.35	Peak	
4	344.2800	46.46	-10.92	35.54	46.00	-10.46	Peak	
5	450.0100	43.24	-9.35	33.89	46.00	-12.11	Peak	
6	675.0500	37.47	-5.95	31.52	46.00	-14.48	Peak	

Test Mode: UNII-1/TX A Mode 5240MHz- Internal antenna

Vertical

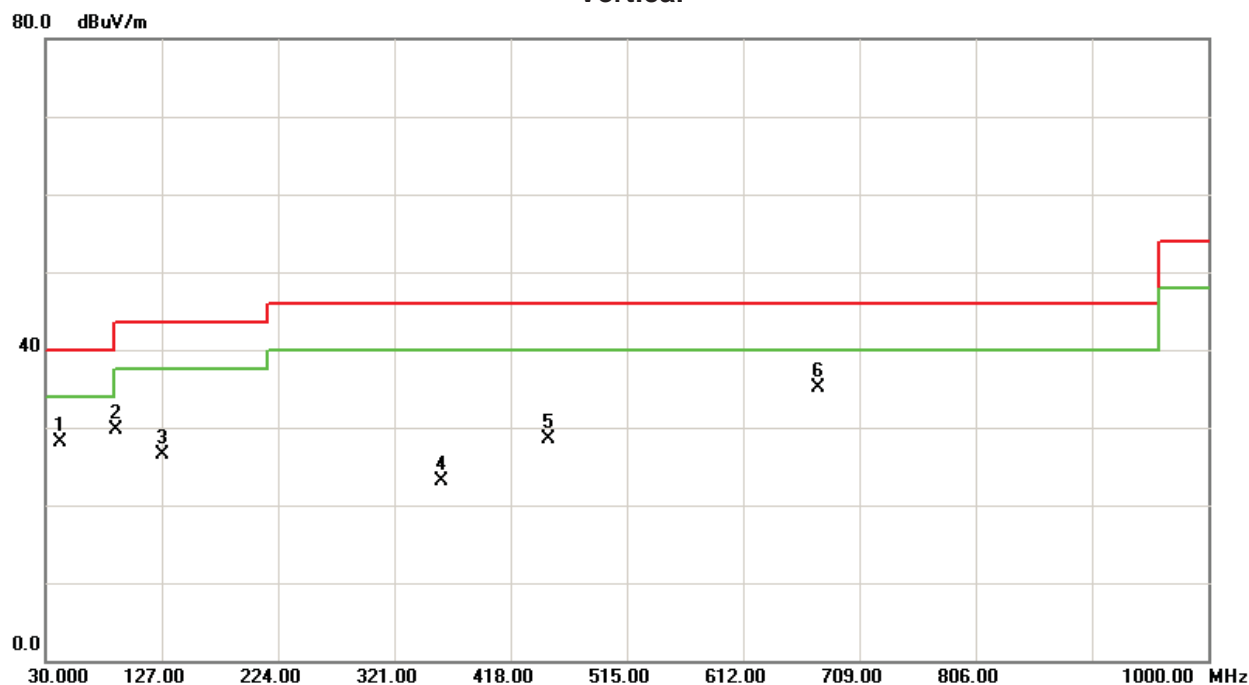

No.	Freq. MHz	Reading Level dBuV/m	Correct Factor dB	Measure ment dBuV/m	Limit dBuV/m	Over dB	Detector	Comment
1	41.6400	43.00	-14.97	28.03	40.00	-11.97	Peak	
2	88.2000	46.45	-16.84	29.61	43.50	-13.89	Peak	
3	127.9700	40.27	-13.79	26.48	43.50	-17.02	Peak	
4	360.7700	34.05	-10.91	23.14	46.00	-22.86	Peak	
5	450.0100	37.90	-9.35	28.55	46.00	-17.45	Peak	
6	675.0500	41.02	-5.95	35.07	46.00	-10.93	Peak	

Test Mode: UNII-1/TX A Mode 5240MHz- Internal antenna

Horizontal

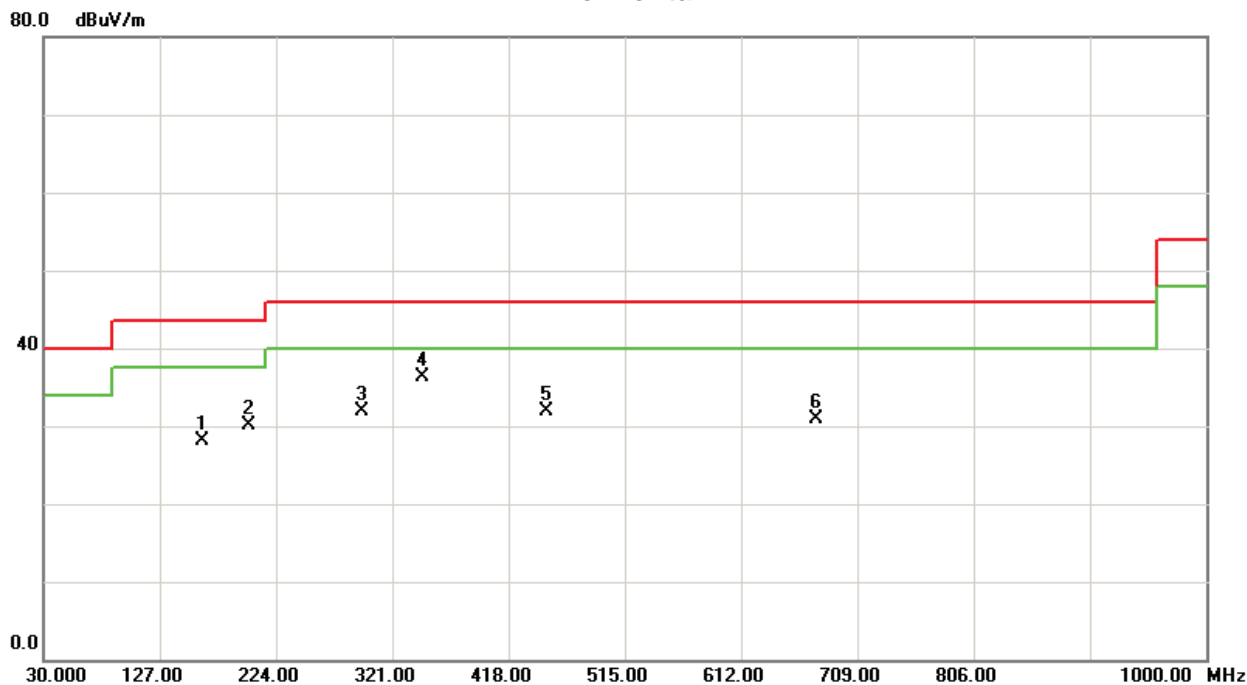

No.	Freq. MHz	Reading Level dBuV/m	Correct Factor dB	Measure ment dBuV/m	Limit dBuV/m	Over dB	Detector	Comment
1	162.8900	41.55	-13.48	28.07	43.50	-15.43	Peak	
2	201.6900	44.78	-14.63	30.15	43.50	-13.35	Peak	
3	295.7800	43.39	-11.43	31.96	46.00	-14.04	Peak	
4	346.2200	47.23	-10.93	36.30	46.00	-9.70	Peak	
5	450.0100	41.31	-9.35	31.96	46.00	-14.04	Peak	
6	675.0500	36.90	-5.95	30.95	46.00	-15.05	Peak	

Test Mode: UNII-3/TX A Mode 5745MHz- Internal antenna

Vertical

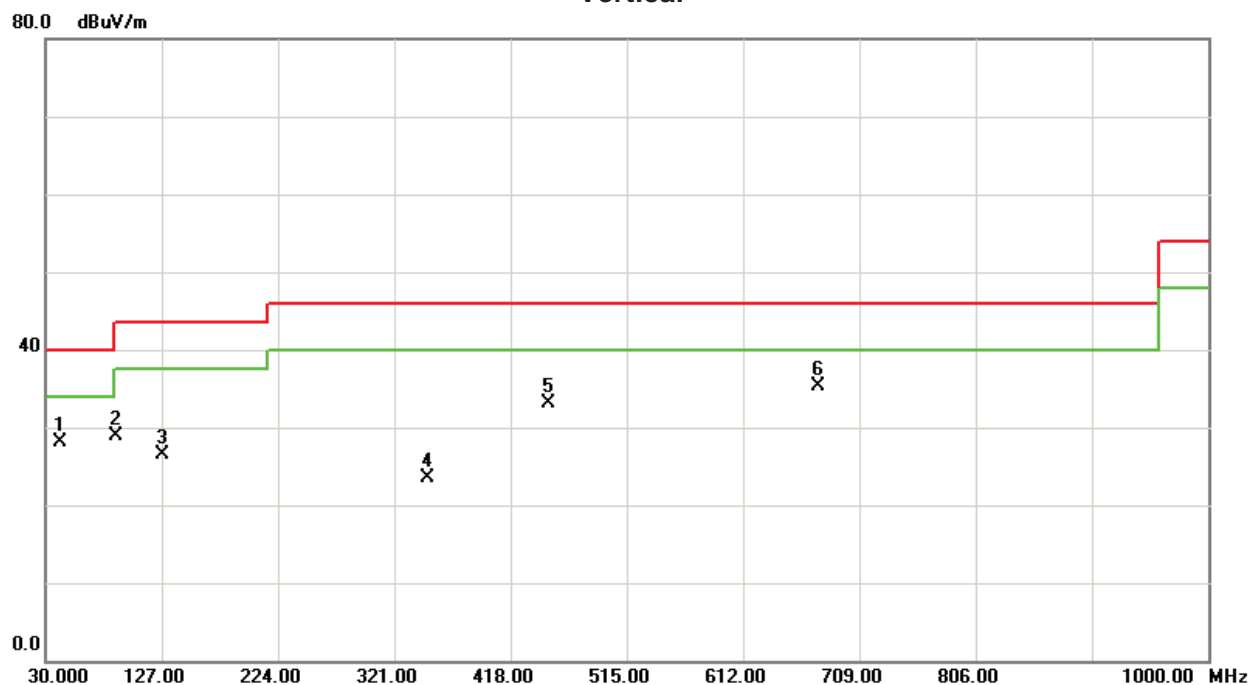

No.	Freq. MHz	Reading Level dBuV/m	Correct Factor dB	Measure ment dBuV/m	Limit dBuV/m	Over dB	Detector	Comment
1	42.6100	43.21	-15.07	28.14	40.00	-11.86	Peak	
2	89.1700	45.87	-16.96	28.91	43.50	-14.59	Peak	
3	127.9700	40.31	-13.79	26.52	43.50	-16.98	Peak	
4	348.1600	34.52	-10.93	23.59	46.00	-22.41	Peak	
5	450.0100	42.54	-9.35	33.19	46.00	-12.81	Peak	
6	675.0500	41.22	-5.95	35.27	46.00	-10.73	Peak	

Test Mode: UNII-3/TX A Mode 5745MHz- Internal antenna

Horizontal

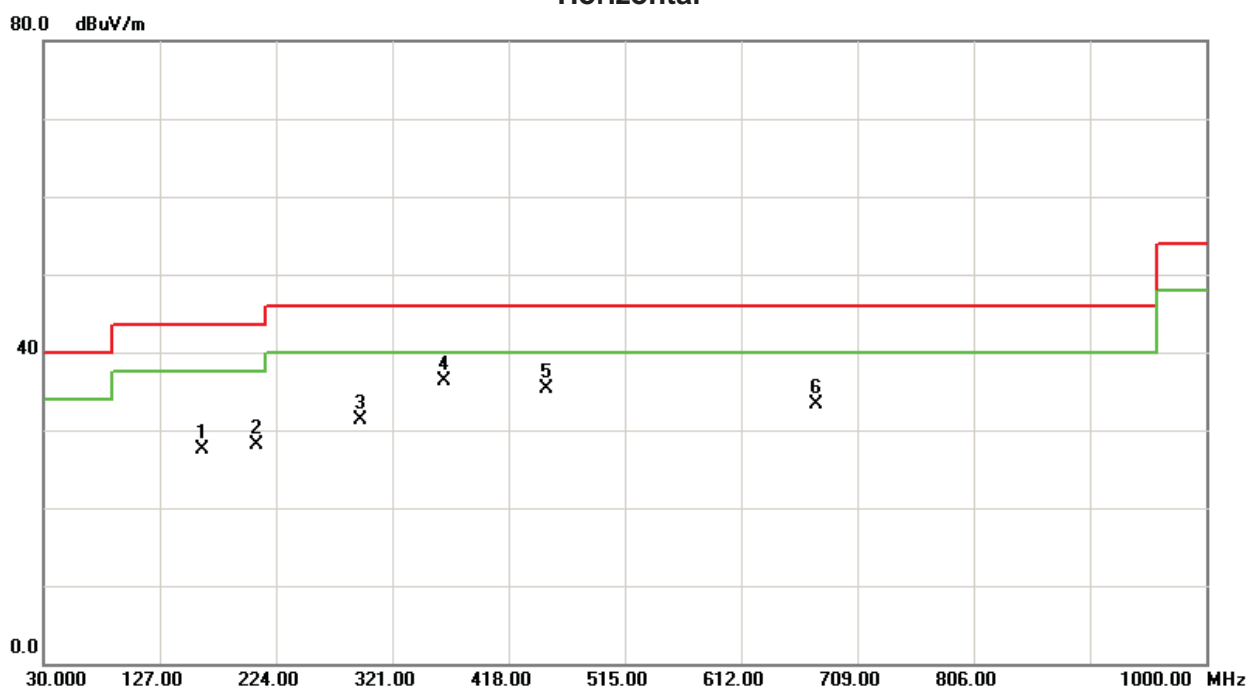

No.	Freq. MHz	Reading Level dBuV/m	Correct Factor dB	Measure ment dBuV/m	Limit dBuV/m	Over dB	Detector	Comment
1	162.8900	40.99	-13.48	27.51	43.50	-15.99	Peak	
2	207.5100	42.71	-14.57	28.14	43.50	-15.36	Peak	
3	293.8400	43.11	-11.73	31.38	46.00	-14.62	Peak	
4	364.6500	47.24	-10.90	36.34	46.00	-9.66	Peak	
5	450.0100	44.65	-9.35	35.30	46.00	-10.70	Peak	
6	675.0500	39.18	-5.95	33.23	46.00	-12.77	Peak	

Test Mode: UNII-3/TX A Mode 5785MHz- Internal antenna

Vertical

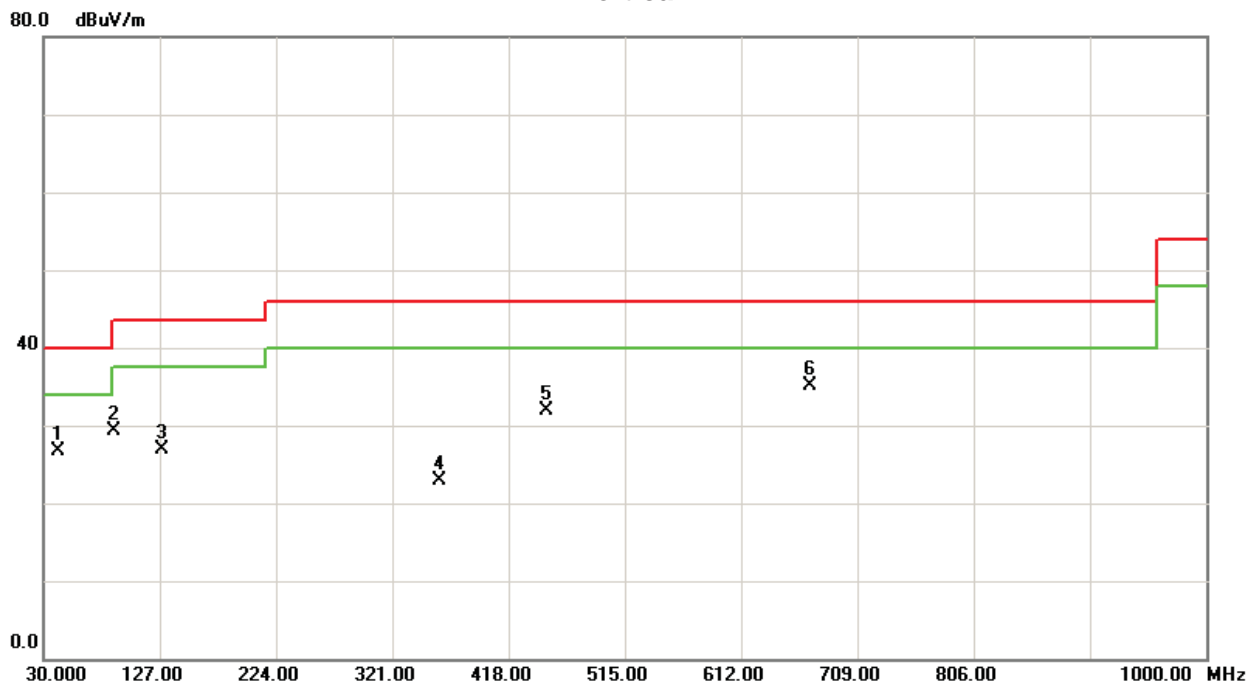

No.	Freq. MHz	Reading Level dBuV/m	Correct Factor dB	Measure ment dBuV/m	Limit dBuV/m	Over dB	Detector	Comment
1	42.6100	41.73	-15.07	26.66	40.00	-13.34	Peak	
2	89.1700	46.29	-16.96	29.33	43.50	-14.17	Peak	
3	128.9400	40.64	-13.73	26.91	43.50	-16.59	Peak	
4	360.7700	33.89	-10.91	22.98	46.00	-23.02	Peak	
5	450.0100	41.29	-9.35	31.94	46.00	-14.06	Peak	
6	669.2300	41.03	-5.92	35.11	46.00	-10.89	Peak	

Test Mode: UNII-3/TX A Mode 5785MHz- Internal antenna

Horizontal

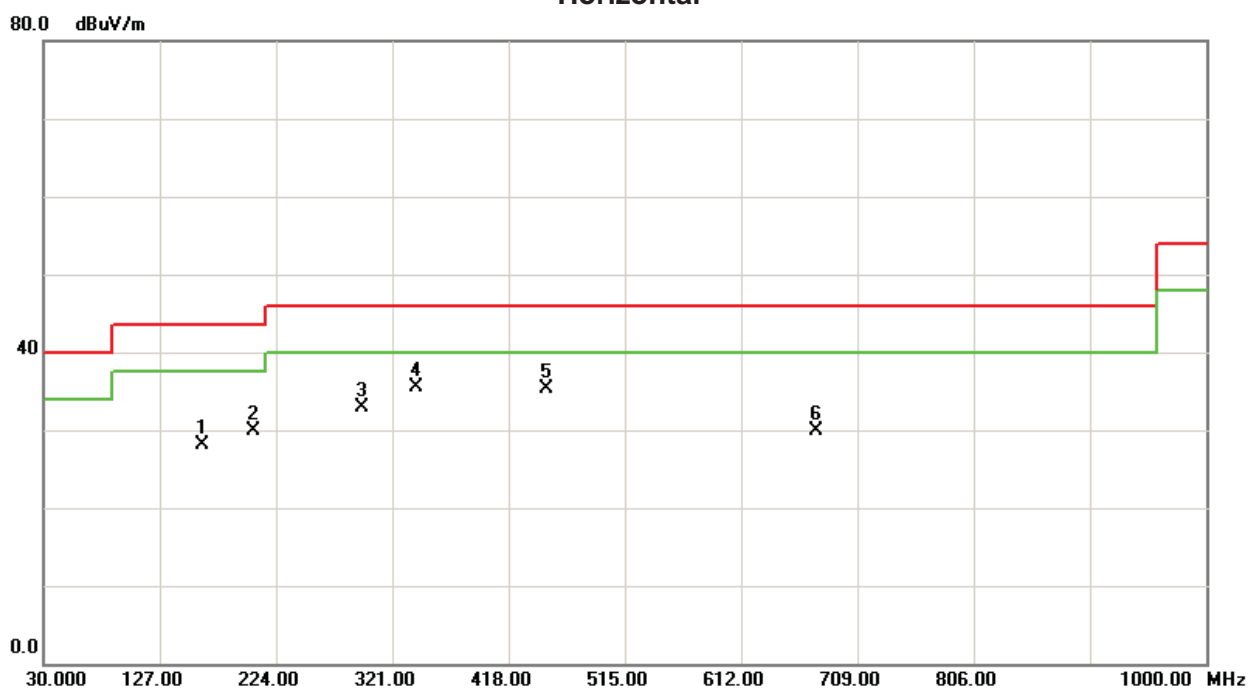

No.	Freq. MHz	Reading Level dBuV/m	Correct Factor dB	Measure ment dBuV/m	Limit dBuV/m	Over dB	Detector	Comment
1	162.8900	41.62	-13.48	28.14	43.50	-15.36	Peak	
2	204.6000	44.52	-14.60	29.92	43.50	-13.58	Peak	
3	295.7800	44.39	-11.43	32.96	46.00	-13.04	Peak	
4	340.4000	46.47	-10.91	35.56	46.00	-10.44	Peak	
5	450.0100	44.62	-9.35	35.27	46.00	-10.73	Peak	
6	675.0500	35.94	-5.95	29.99	46.00	-16.01	Peak	

Test Mode: UNII-3/TX A Mode 5825MHz- Internal antenna

Vertical

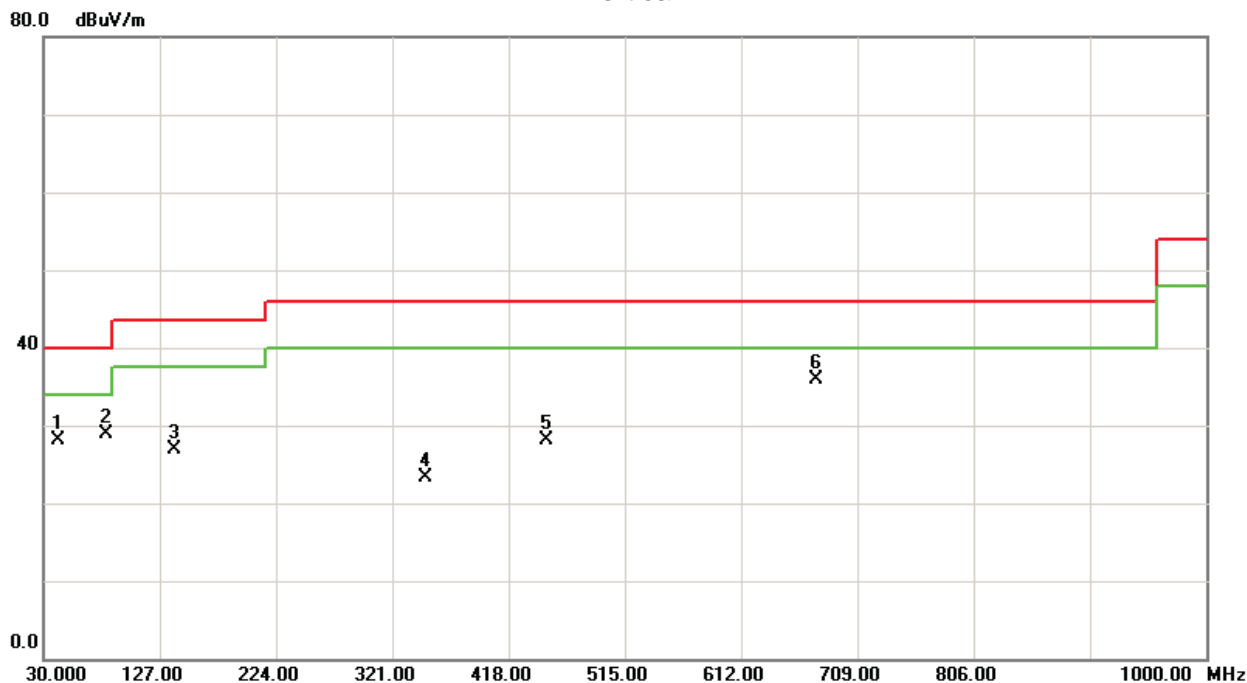

No.	Freq. MHz	Reading Level dBuV/m	Correct Factor dB	Measure ment dBuV/m	Limit dBuV/m	Over dB	Detector	Comment
1	42.6100	43.21	-15.07	28.14	40.00	-11.86	Peak	
2	82.3800	45.12	-16.22	28.90	40.00	-11.10	Peak	
3	138.6400	40.85	-13.94	26.91	43.50	-16.59	Peak	
4	349.1300	34.24	-10.94	23.30	46.00	-22.70	Peak	
5	450.0100	37.50	-9.35	28.15	46.00	-17.85	Peak	
6	675.0500	41.81	-5.95	35.86	46.00	-10.14	Peak	

Test Mode: UNII-3/TX A Mode 5825MHz- Internal antenna

Horizontal

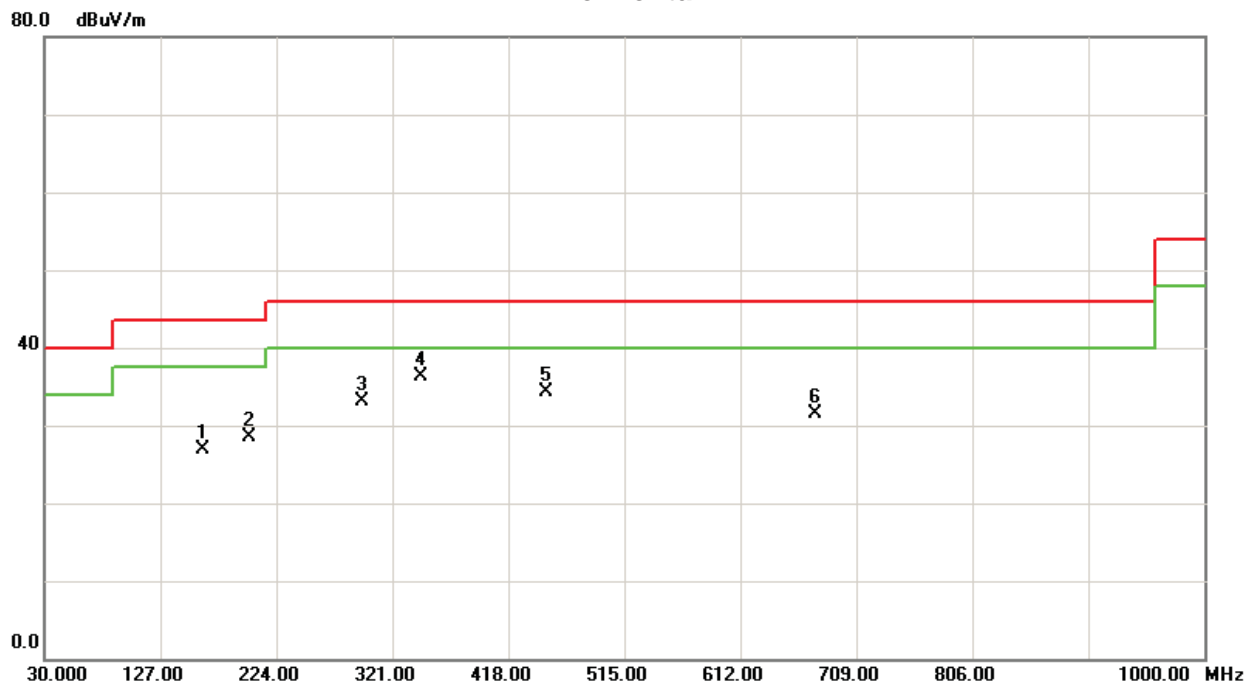

No.	Freq. MHz	Reading Level dBuV/m	Correct Factor dB	Measure ment dBuV/m	Limit dBuV/m	Over dB	Detector	Comment
1	162.8900	40.34	-13.48	26.86	43.50	-16.64	Peak	
2	200.7200	43.17	-14.64	28.53	43.50	-14.97	Peak	
3	295.7800	44.46	-11.43	33.03	46.00	-12.97	Peak	
4	345.2500	47.27	-10.93	36.34	46.00	-9.66	Peak	
5	450.0100	43.56	-9.35	34.21	46.00	-11.79	Peak	
6	675.0500	37.46	-5.95	31.51	46.00	-14.49	Peak	

Test Mode: UNII-1/TX A Mode 5180MHz- External antenna

Vertical

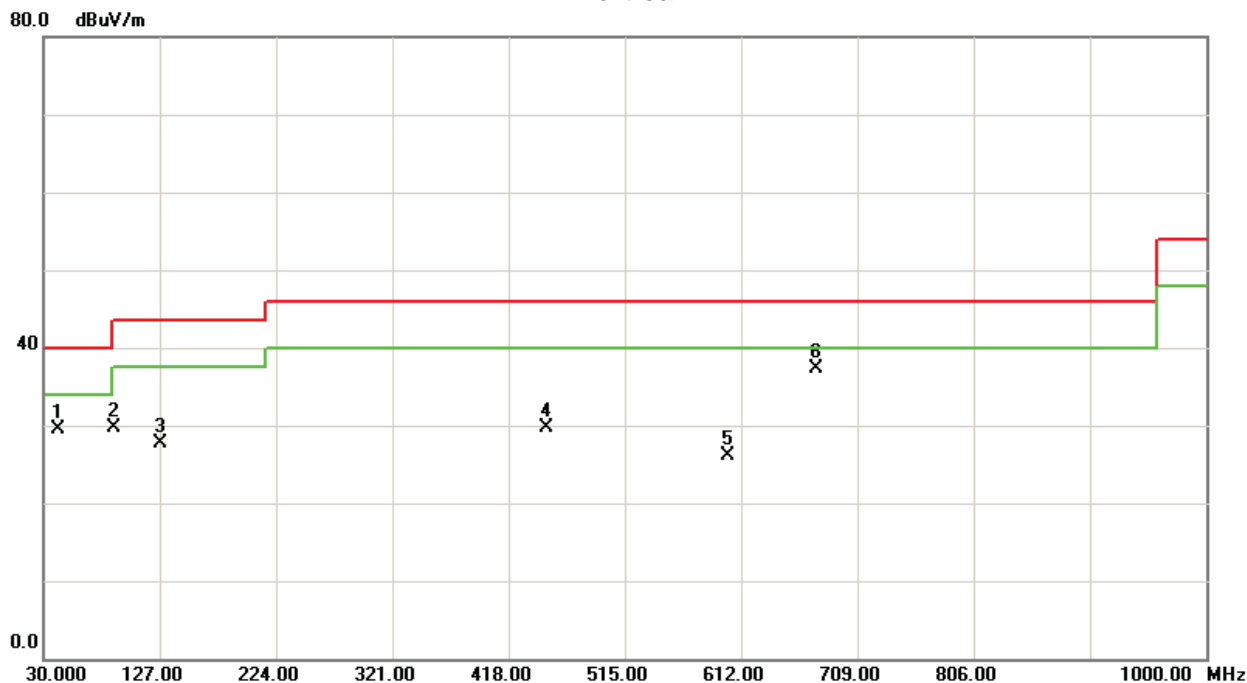

No.	Freq. MHz	Reading Level dBuV/m	Correct Factor dB	Measure ment dBuV/m	Limit dBuV/m	Over dB	Detector	Comment
1	42.6100	44.52	-15.07	29.45	40.00	-10.55	Peak	
2	89.1700	46.70	-16.96	29.74	43.50	-13.76	Peak	
3	127.9700	41.54	-13.79	27.75	43.50	-15.75	Peak	
4	450.0100	39.01	-9.35	29.66	46.00	-16.34	Peak	
5	600.3600	32.86	-6.75	26.11	46.00	-19.89	Peak	
6	675.0500	43.24	-5.95	37.29	46.00	-8.71	Peak	

Test Mode: UNII-1/TX A Mode 5180MHz- External antenna

Horizontal

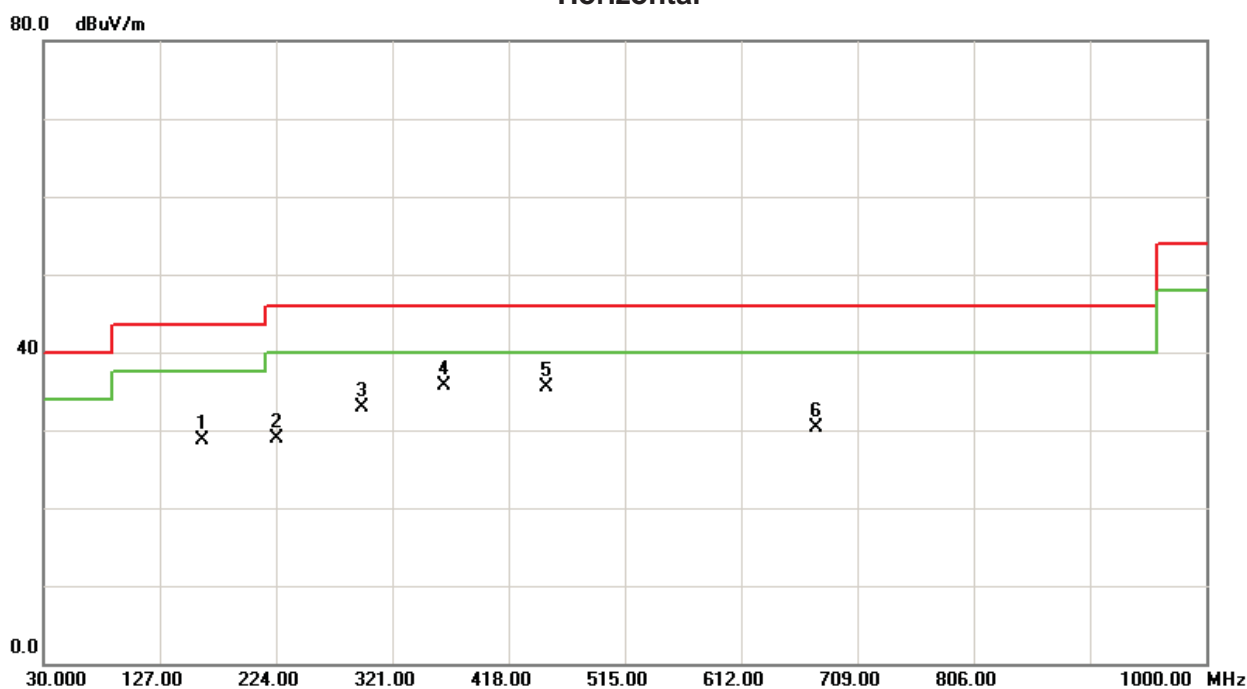

No.	Freq. MHz	Reading Level dBuV/m	Correct Factor dB	Measure ment dBuV/m	Limit dBuV/m	Over dB	Detector	Comment
1	161.9200	42.24	-13.56	28.68	43.50	-14.82	Peak	
2	224.0000	43.80	-14.80	29.00	46.00	-17.00	Peak	
3	295.7800	44.33	-11.43	32.90	46.00	-13.10	Peak	
4	364.6500	46.58	-10.90	35.68	46.00	-10.32	Peak	
5	450.0100	44.92	-9.35	35.57	46.00	-10.43	Peak	
6	675.0500	36.16	-5.95	30.21	46.00	-15.79	Peak	

Test Mode: UNII-1/TX A Mode 5200MHz- External antenna

Vertical

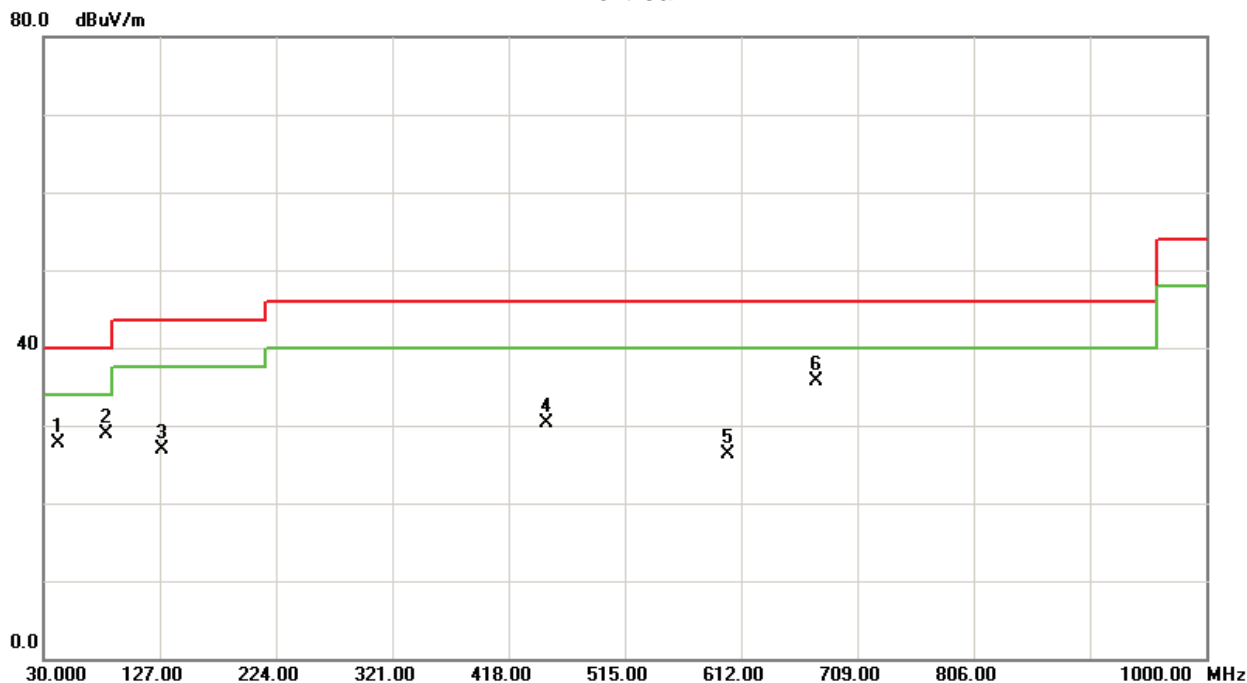

No.	Freq. MHz	Reading Level dBuV/m	Correct Factor dB	Measure ment dBuV/m	Limit dBuV/m	Over dB	Detector	Comment
1	42.6100	42.70	-15.07	27.63	40.00	-12.37	Peak	
2	82.3800	45.21	-16.22	28.99	40.00	-11.01	Peak	
3	128.9400	40.56	-13.73	26.83	43.50	-16.67	Peak	
4	450.0100	39.71	-9.35	30.36	46.00	-15.64	Peak	
5	600.3600	33.04	-6.75	26.29	46.00	-19.71	Peak	
6	675.0500	41.56	-5.95	35.61	46.00	-10.39	Peak	

Test Mode: UNII-1/TX A Mode 5200MHz- External antenna

Horizontal

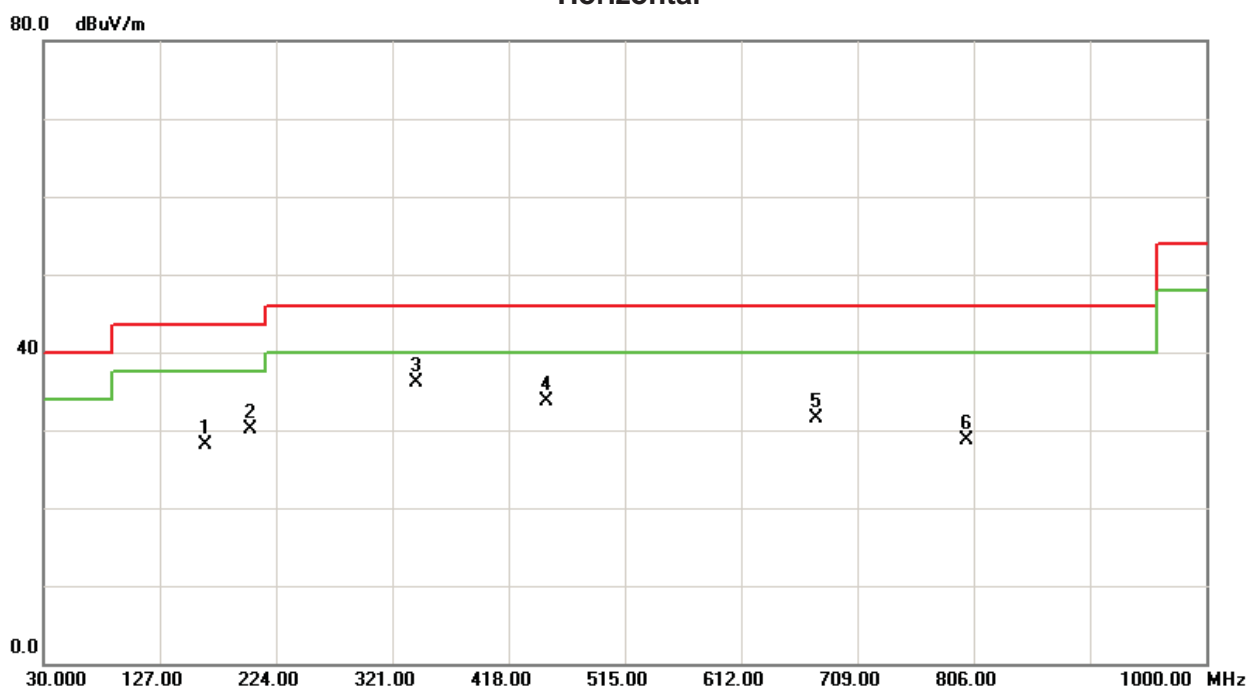

No.	Freq. MHz	Reading Level dBuV/m	Correct Factor dB	Measure ment dBuV/m	Limit dBuV/m	Over dB	Detector	Comment
1	164.8300	41.36	-13.32	28.04	43.50	-15.46	Peak	
2	202.6600	44.64	-14.62	30.02	43.50	-13.48	Peak	
3	341.3700	47.05	-10.92	36.13	46.00	-9.87	Peak	
4	450.0100	43.04	-9.35	33.69	46.00	-12.31	Peak	
5	675.0500	37.39	-5.95	31.44	46.00	-14.56	Peak	
6	800.1800	32.60	-3.97	28.63	46.00	-17.37	Peak	

Test Mode: UNII-1/TX A Mode 5240MHz- External antenna

Vertical

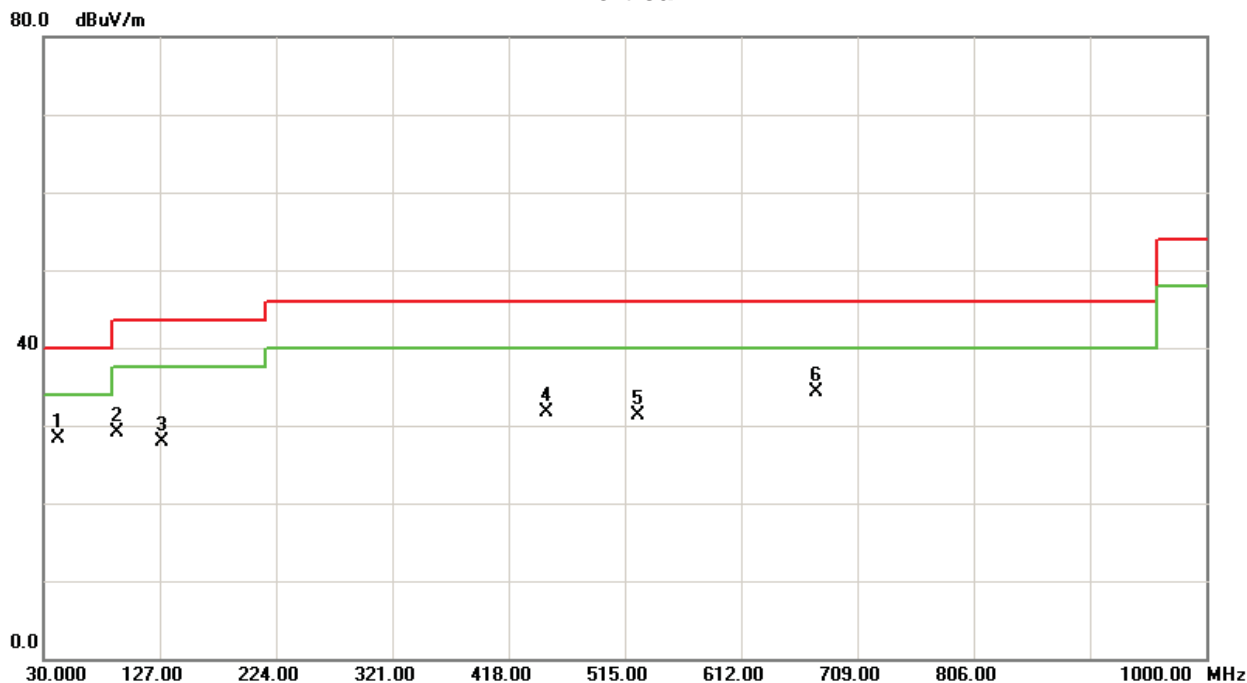

No.	Freq. MHz	Reading Level dBuV/m	Correct Factor dB	Measure ment dBuV/m	Limit dBuV/m	Over dB	Detector	Comment
1	42.6100	43.28	-15.07	28.21	40.00	-11.79	Peak	
2	91.1100	46.20	-17.00	29.20	43.50	-14.30	Peak	
3	128.9400	41.56	-13.73	27.83	43.50	-15.67	Peak	
4	450.0100	41.04	-9.35	31.69	46.00	-14.31	Peak	
5	525.6700	39.87	-8.53	31.34	46.00	-14.66	Peak	
6	675.0500	40.28	-5.95	34.33	46.00	-11.67	Peak	

Test Mode: UNII-1/TX A Mode 5240MHz- External antenna

Horizontal

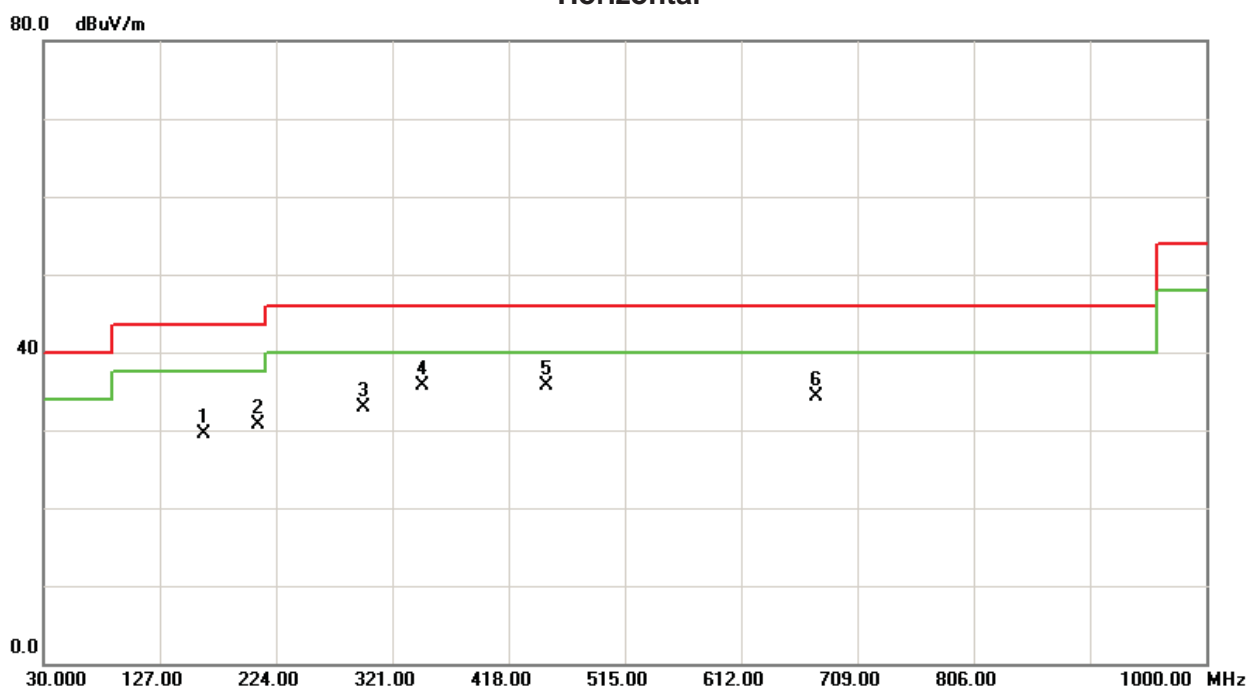

No.	Freq. MHz	Reading Level dBuV/m	Correct Factor dB	Measure ment dBuV/m	Limit dBuV/m	Over dB	Detector	Comment
1	163.8600	42.93	-13.40	29.53	43.50	-13.97	Peak	
2	209.4500	45.20	-14.55	30.65	43.50	-12.85	Peak	
3	296.7500	44.15	-11.29	32.86	46.00	-13.14	Peak	
4	346.2200	46.59	-10.93	35.66	46.00	-10.34	Peak	
5	450.0100	45.00	-9.35	35.65	46.00	-10.35	Peak	
6	675.0500	40.21	-5.95	34.26	46.00	-11.74	Peak	

Test Mode: UNII-3/TX A Mode 5745MHz- External antenna

Vertical

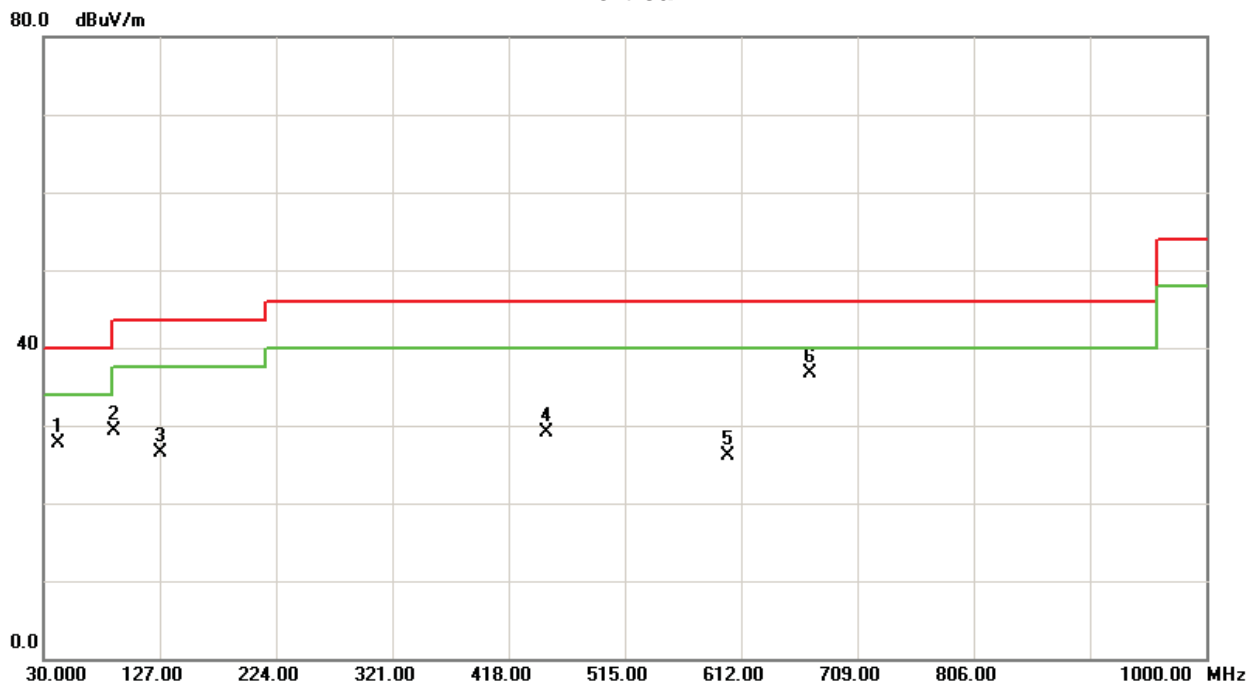

No.	Freq. MHz	Reading Level dBuV/m	Correct Factor dB	Measure ment dBuV/m	Limit dBuV/m	Over dB	Detector	Comment
1	42.6100	42.71	-15.07	27.64	40.00	-12.36	Peak	
2	89.1700	46.24	-16.96	29.28	43.50	-14.22	Peak	
3	127.9700	40.20	-13.79	26.41	43.50	-17.09	Peak	
4	450.0100	38.47	-9.35	29.12	46.00	-16.88	Peak	
5	600.3600	32.85	-6.75	26.10	46.00	-19.90	Peak	
6	669.2300	42.67	-5.92	36.75	46.00	-9.25	Peak	

Test Mode: UNII-3/TX A Mode 5745MHz- External antenna

Horizontal

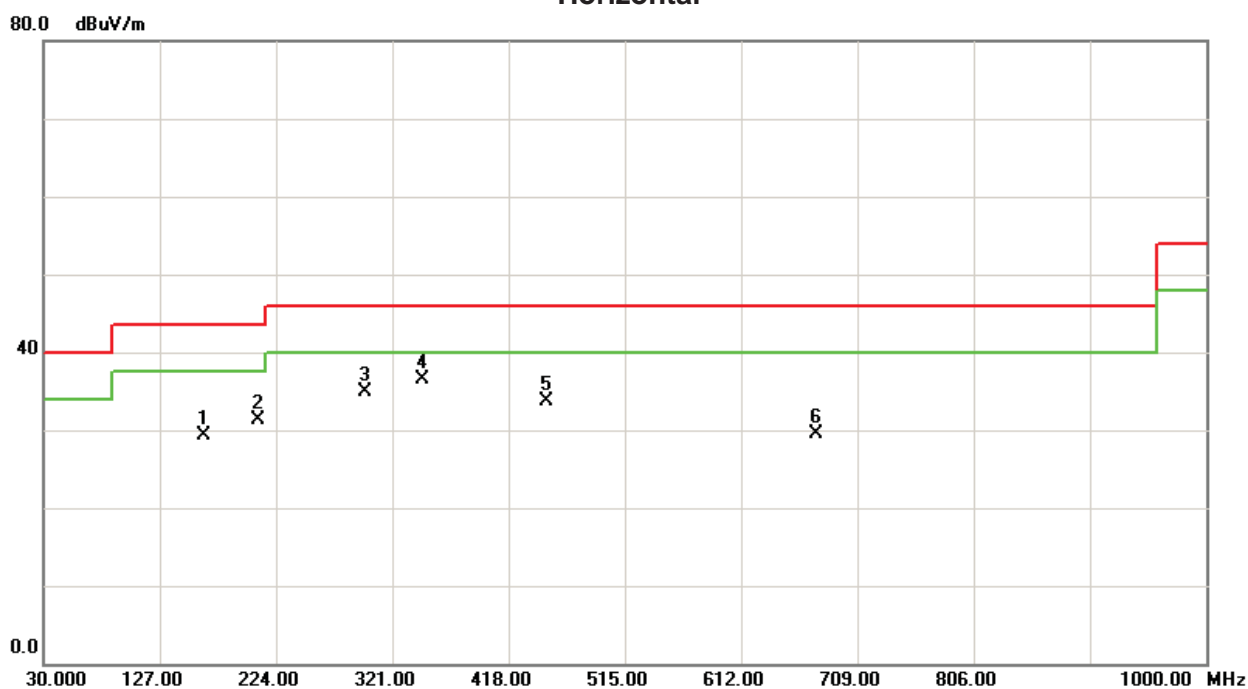

No.	Freq. MHz	Reading Level dBuV/m	Correct Factor dB	Measure ment dBuV/m	Limit dBuV/m	Over dB	Detector	Comment
1	163.8600	42.62	-13.40	29.22	43.50	-14.28	Peak	
2	209.4500	45.81	-14.55	31.26	43.50	-12.24	Peak	
3	297.7200	45.99	-11.14	34.85	46.00	-11.15	Peak	
4	346.2200	47.41	-10.93	36.48	46.00	-9.52	Peak	
5	450.0100	43.06	-9.35	33.71	46.00	-12.29	Peak	
6	675.0500	35.40	-5.95	29.45	46.00	-16.55	Peak	

Test Mode: UNII-3/TX A Mode 5785MHz- External antenna

Vertical

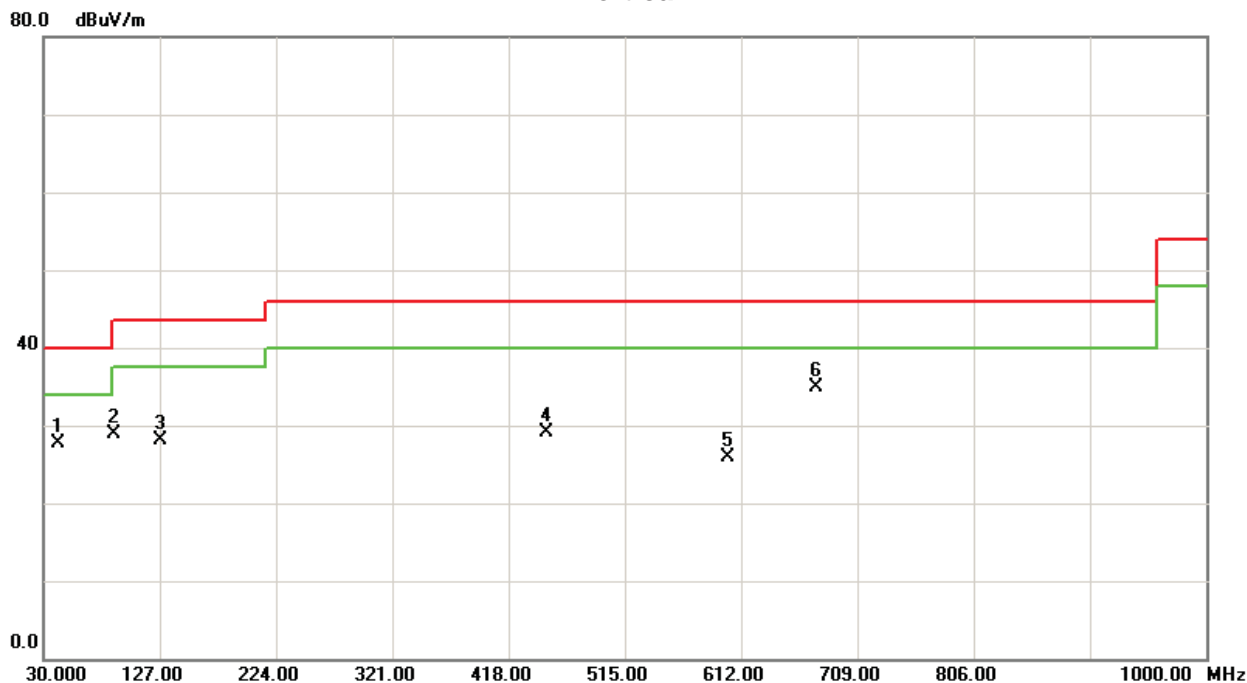

No.	Freq. MHz	Reading Level dBuV/m	Correct Factor dB	Measure ment dBuV/m	Limit dBuV/m	Over dB	Detector	Comment
1	42.6100	42.84	-15.07	27.77	40.00	-12.23	Peak	
2	89.1700	45.78	-16.96	28.82	43.50	-14.68	Peak	
3	127.9700	41.89	-13.79	28.10	43.50	-15.40	Peak	
4	450.0100	38.54	-9.35	29.19	46.00	-16.81	Peak	
5	600.3600	32.73	-6.75	25.98	46.00	-20.02	Peak	
6	675.0500	40.83	-5.95	34.88	46.00	-11.12	Peak	

Test Mode: UNII-3/TX A Mode 5785MHz- External antenna

Horizontal

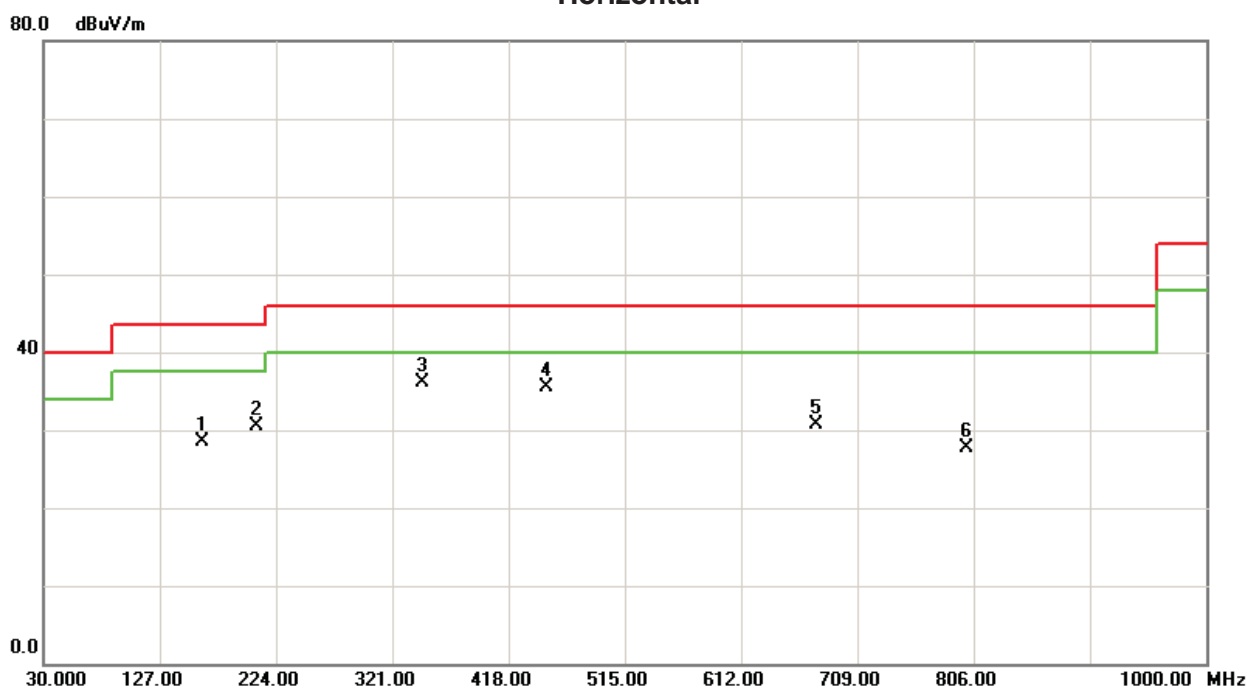

No.	Freq. MHz	Reading Level dBuV/m	Correct Factor dB	Measure ment dBuV/m	Limit dBuV/m	Over dB	Detector	Comment
1	162.8900	41.98	-13.48	28.50	43.50	-15.00	Peak	
2	207.5100	45.05	-14.57	30.48	43.50	-13.02	Peak	
3	346.2200	47.12	-10.93	36.19	46.00	-9.81	Peak	
4	450.0100	44.91	-9.35	35.56	46.00	-10.44	Peak	
5	675.0500	36.75	-5.95	30.80	46.00	-15.20	Peak	
6	800.1800	31.63	-3.97	27.66	46.00	-18.34	Peak	

Test Mode: UNII-3/TX A Mode 5825MHz- External antenna

Vertical

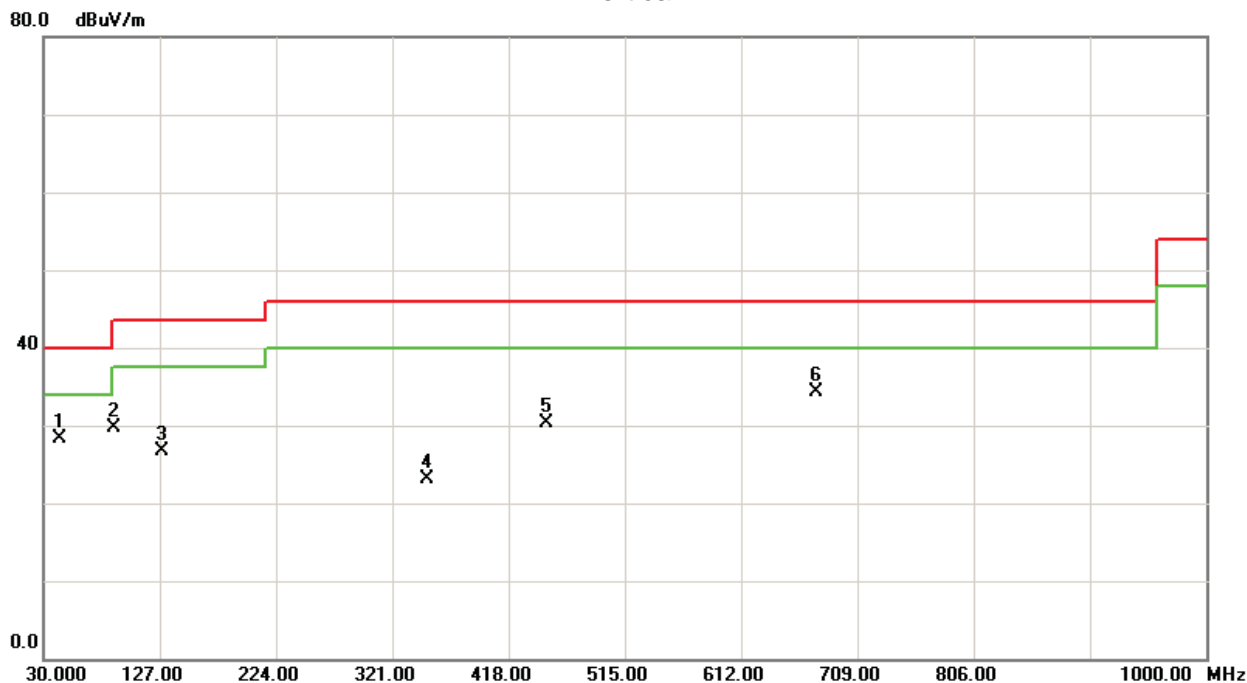

No.	Freq. MHz	Reading Level dBuV/m	Correct Factor dB	Measure ment dBuV/m	Limit dBuV/m	Over dB	Detector	Comment
1	43.5800	43.43	-15.22	28.21	40.00	-11.79	Peak	
2	89.1700	46.62	-16.96	29.66	43.50	-13.84	Peak	
3	128.9400	40.40	-13.73	26.67	43.50	-16.83	Peak	
4	350.1000	34.06	-10.94	23.12	46.00	-22.88	Peak	
5	450.0100	39.60	-9.35	30.25	46.00	-15.75	Peak	
6	675.0500	40.28	-5.95	34.33	46.00	-11.67	Peak	

Test Mode: UNII-3/TX A Mode 5825MHz- External antenna

Horizontal

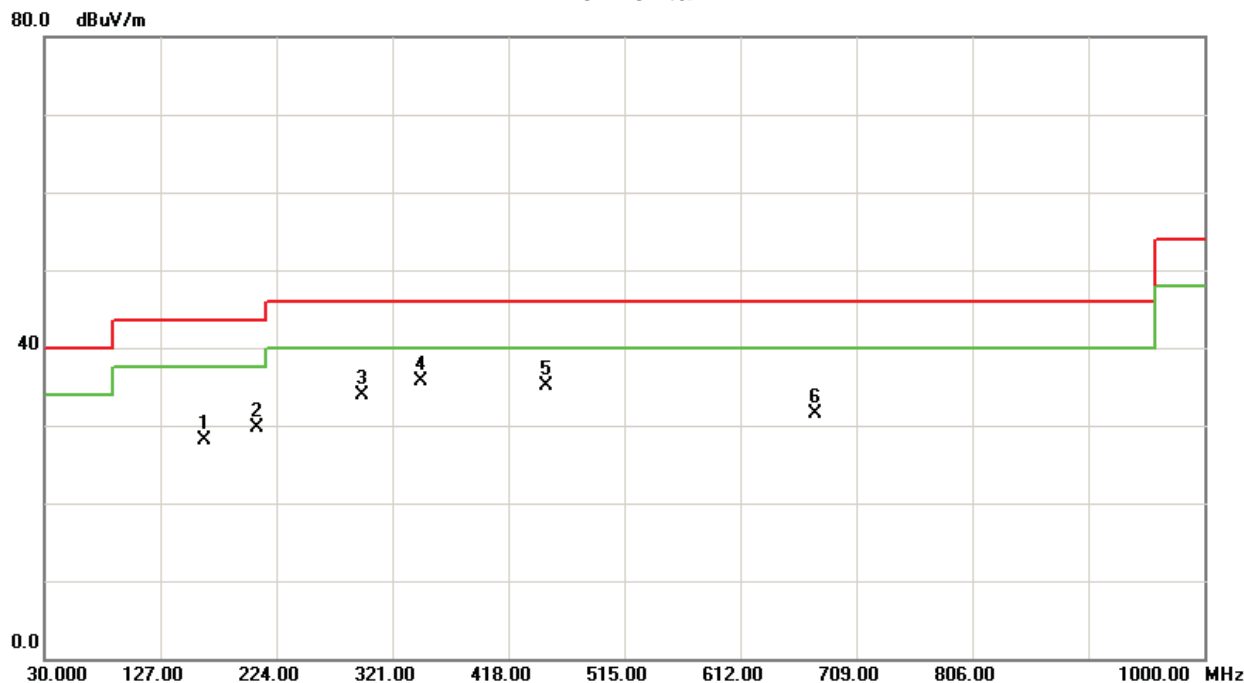

No.	Freq. MHz	Reading Level dBuV/m	Correct Factor dB	Measure ment dBuV/m	Limit dBuV/m	Over dB	Detector	Comment
1	163.8600	41.45	-13.40	28.05	43.50	-15.45	Peak	
2	207.5100	44.37	-14.57	29.80	43.50	-13.70	Peak	
3	295.7800	45.24	-11.43	33.81	46.00	-12.19	Peak	
4	344.2800	46.60	-10.92	35.68	46.00	-10.32	Peak	
5	450.0100	44.40	-9.35	35.05	46.00	-10.95	Peak	
6	675.0500	37.54	-5.95	31.59	46.00	-14.41	Peak	

ATTACHMENT D - RADIATED EMISSION (ABOVE 1000MHZ)

Orthogonal Axis:	X
Test Mode:	UNII-1/ TX A Mode 5180MHz - Internal antenna

Vertical

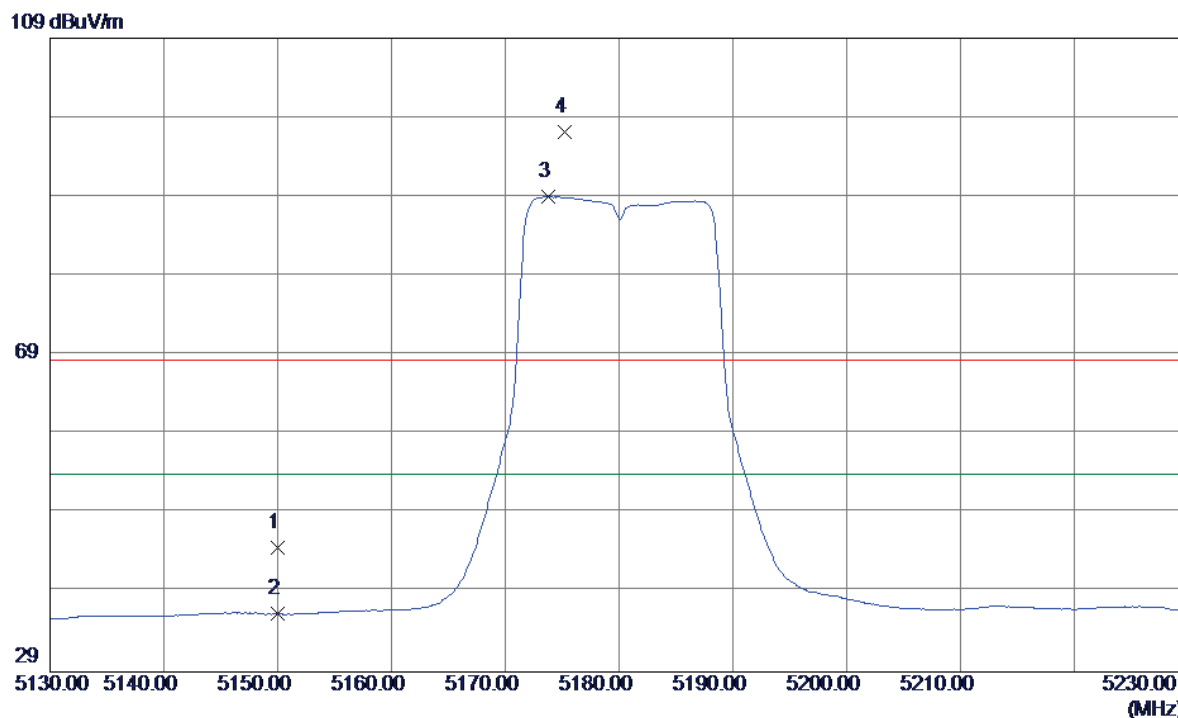

No.	Freq. MHz	Reading Level dBuV/m	Correct Factor dB	Measure ment dBuV/m	Limit dBuV/m	Over dB	Detector	Comment
1	5150.0000	4.46	40.22	44.68	68.30	-23.62	Peak	
2	5150.0000	-3.91	40.22	36.31	54.00	-17.69	AVG	
3	5173.8000	48.72	40.27	88.99	54.00	34.99	AVG	No Limit
4	5175.2000	56.88	40.27	97.15	68.30	28.85	Peak	No Limit

Orthogonal Axis:	X
Test Mode:	UNII-1/ TX A Mode 5180MHz - Internal antenna

Vertical

80 dBuV/m

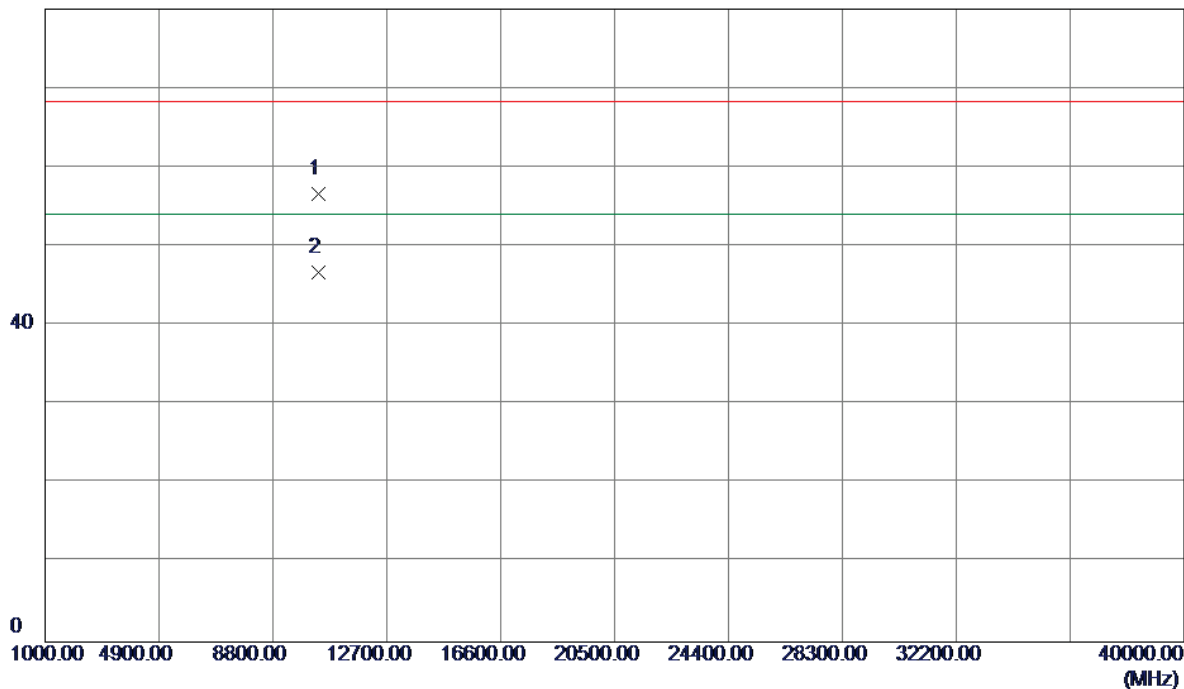

No.	Freq. MHz	Reading Level dBuV/m	Correct Factor dB	Measure ment dBuV/m	Limit dBuV/m	Over dB	Detector	Comment
1	10360.1000	42.75	13.86	56.61	68.30	-11.69	Peak	
2	10360.1200	32.89	13.86	46.75	54.00	-7.25	AVG	

Orthogonal Axis:	X
Test Mode:	UNII-1/ TX A Mode 5180MHz - Internal antenna

Horizontal

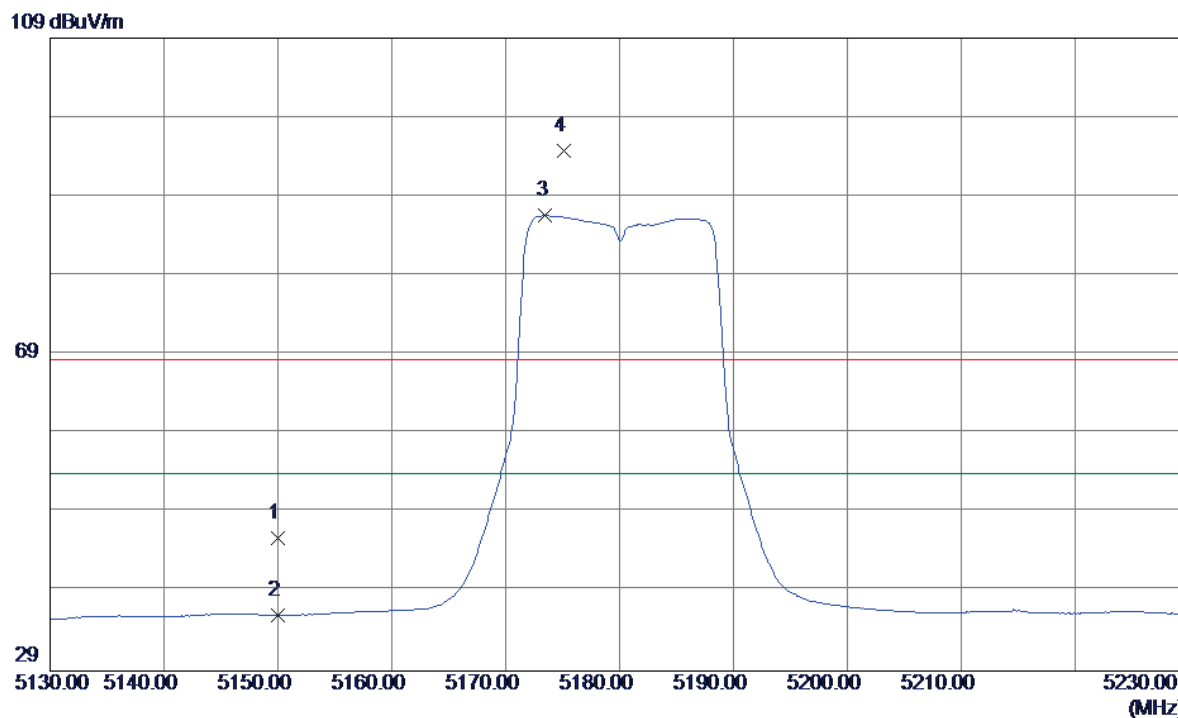

No.	Freq. MHz	Reading Level dBuV/m	Correct Factor dB	Measure ment dBuV/m	Limit dBuV/m	Over dB	Detector	Comment
1	5150.0000	5.61	40.22	45.83	68.30	-22.47	Peak	
2	5150.0000	-4.17	40.22	36.05	54.00	-17.95	AVG	
3	5173.5000	46.32	40.27	86.59	54.00	32.59	AVG	No Limit
4	5175.1000	54.43	40.27	94.70	68.30	26.40	Peak	No Limit

Orthogonal Axis:	X
Test Mode:	UNII-1/ TX A Mode 5180MHz - Internal antenna

Horizontal

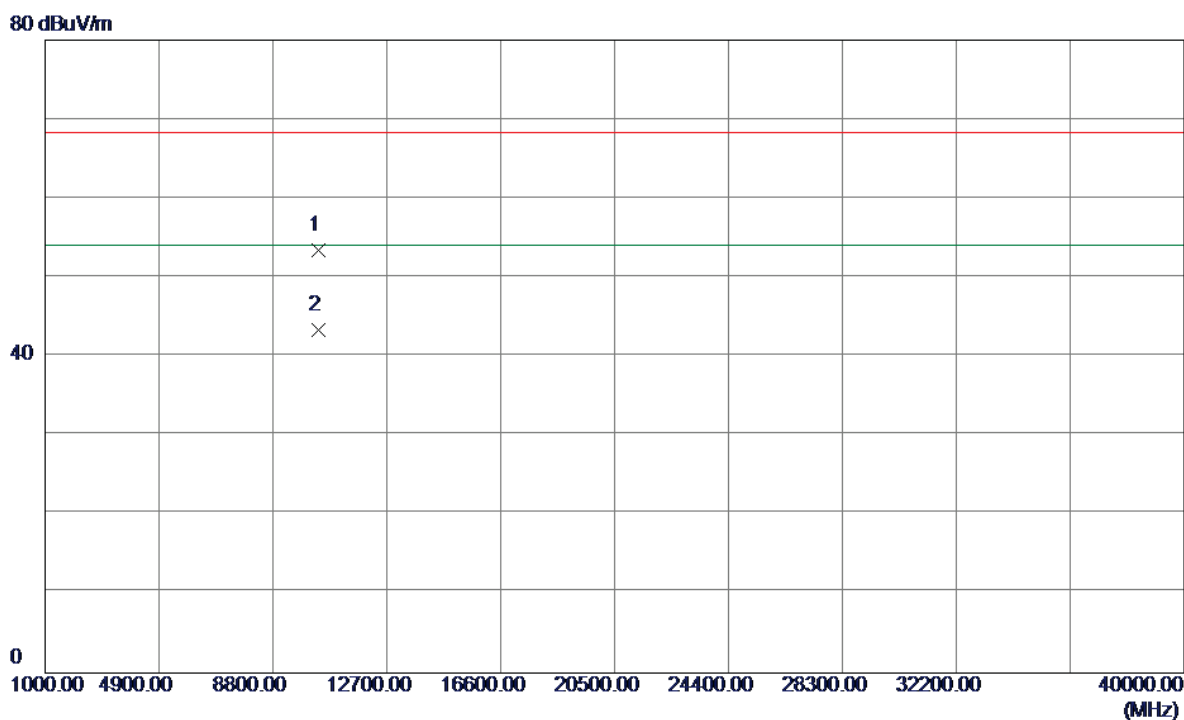

No.	Freq. MHz	Reading Level dBuV/m	Correct Factor dB	Measure ment dBuV/m	Limit dBuV/m	Over dB	Detector	Comment
1	10360.0599	39.59	13.86	53.45	68.30	-14.85	Peak	
2	10360.0900	29.57	13.86	43.43	54.00	-10.57	AVG	

Orthogonal Axis:	X
Test Mode:	UNII-1/ TX A Mode 5200MHz - Internal antenna

Vertical

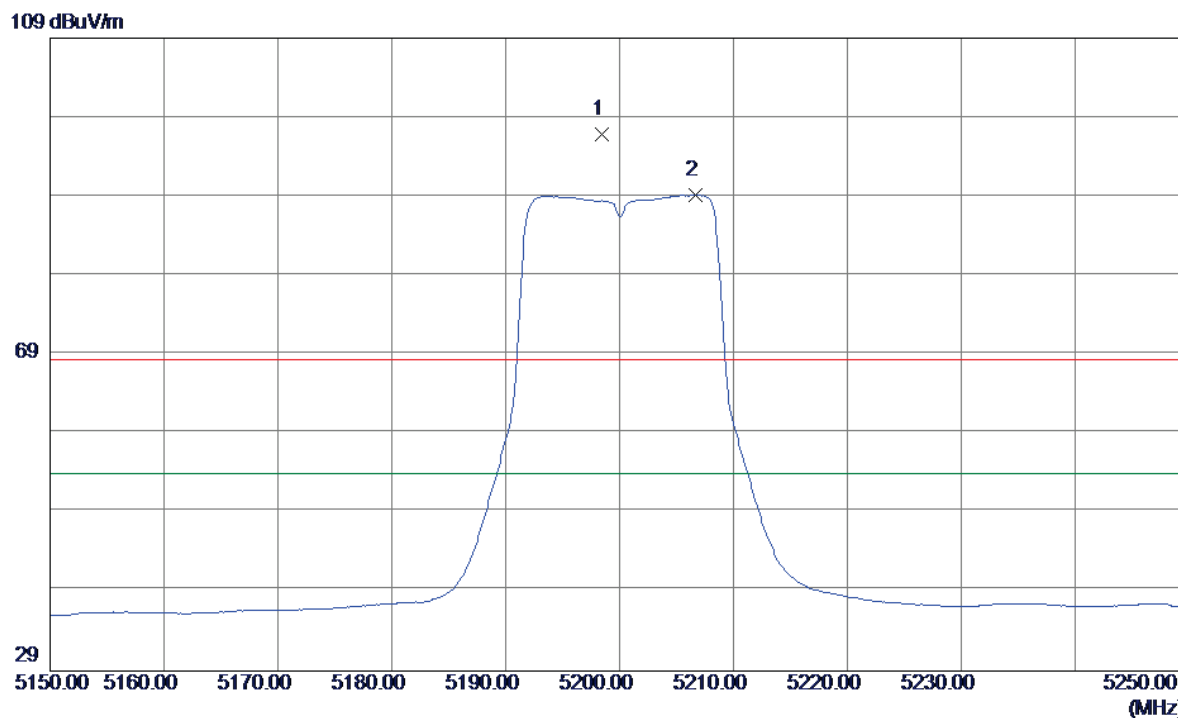

No.	Freq. MHz	Reading Level dBuV/m	Correct Factor dB	Measure ment dBuV/m	Limit dBuV/m	Over dB	Detector	Comment
1	5198.4000	56.53	40.32	96.85	68.30	28.55	Peak	No Limit
2	5206.7000	48.85	40.34	89.19	54.00	35.19	AVG	No Limit

Orthogonal Axis:	X
Test Mode:	UNII-1/ TX A Mode 5200MHz - Internal antenna

Vertical

80 dBuV/m

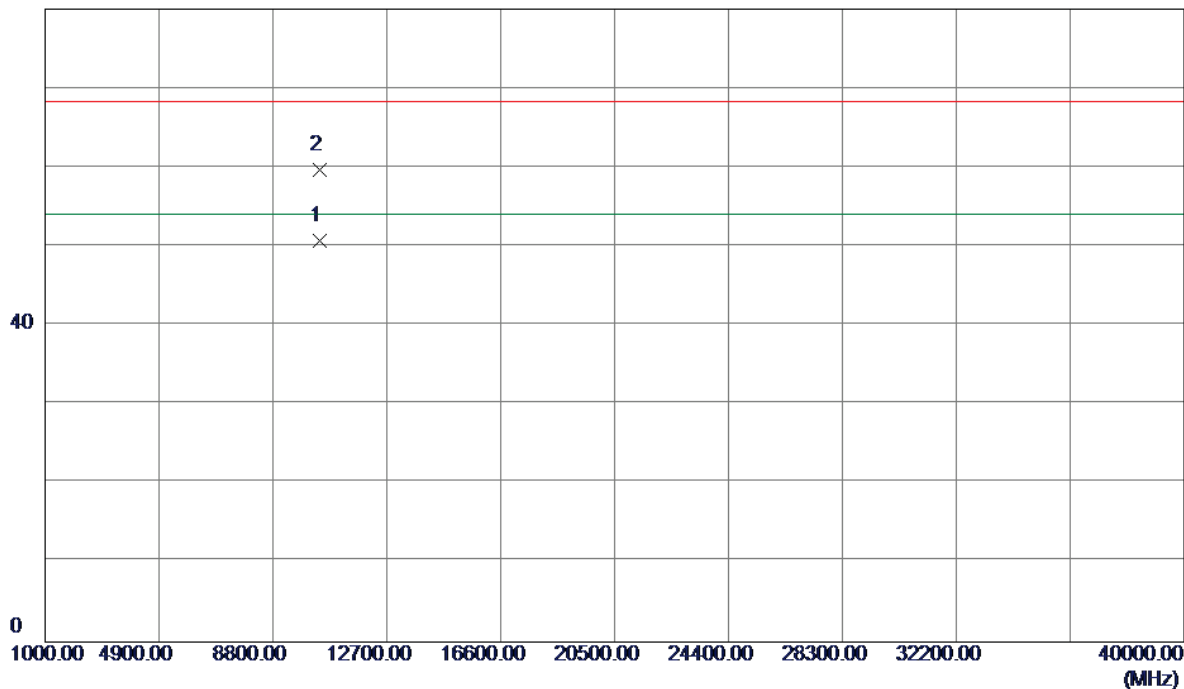

No.	Freq. MHz	Reading Level dBuV/m	Correct Factor dB	Measure ment dBuV/m	Limit dBuV/m	Over dB	Detector	Comment
1	10400.1200	36.95	13.80	50.75	54.00	-3.25	AVG	
2	10400.2600	45.84	13.80	59.64	68.30	-8.66	Peak	

Orthogonal Axis:	X
Test Mode:	UNII-1/ TX A Mode 5200MHz - Internal antenna

Horizontal

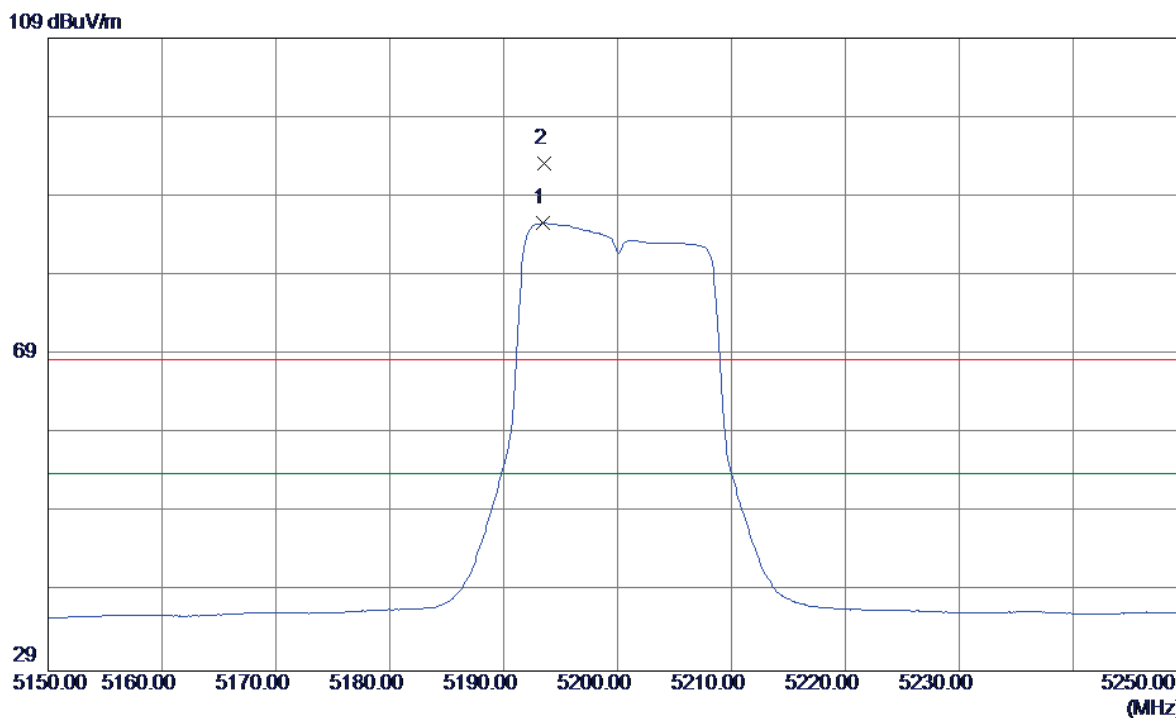

No.	Freq. MHz	Reading Level dBuV/m	Correct Factor dB	Measure ment dBuV/m	Limit dBuV/m	Over dB	Detector	Comment
1	5193.4000	45.31	40.31	85.62	54.00	31.62	AVG	No Limit
2	5193.6000	52.87	40.31	93.18	68.30	24.88	Peak	No Limit

Orthogonal Axis:	X
Test Mode:	UNII-1/ TX A Mode 5200MHz - Internal antenna

Horizontal

80 dBuV/m

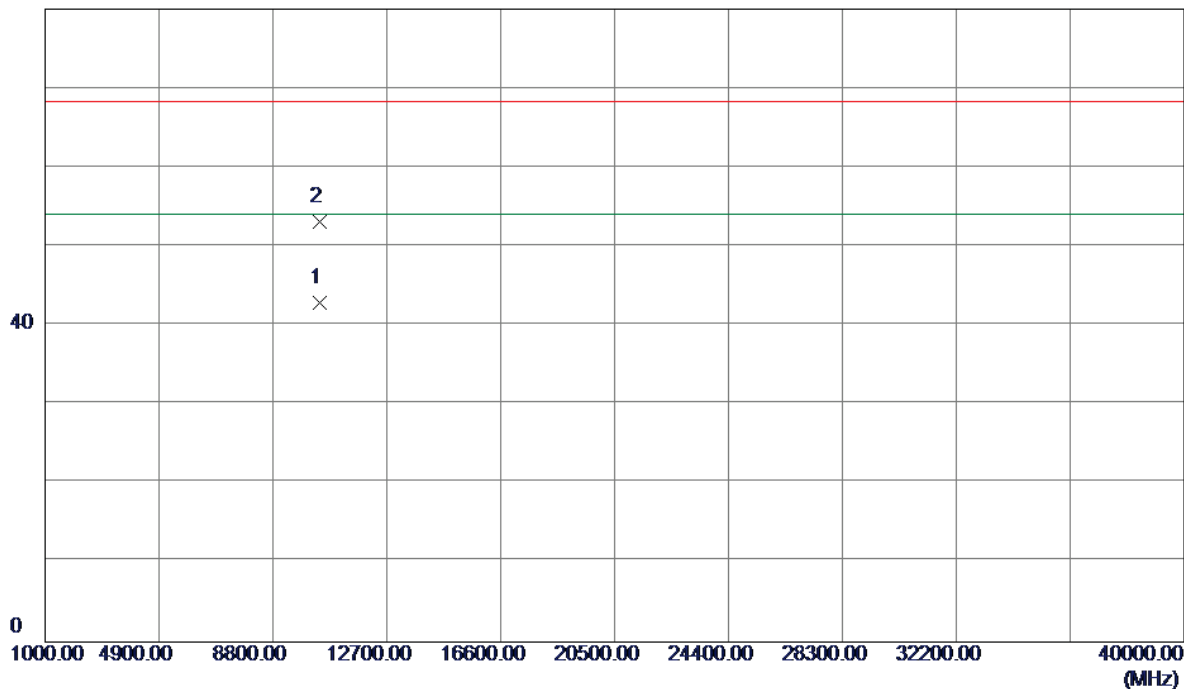

No.	Freq. MHz	Reading Level dBuV/m	Correct Factor dB	Measure ment dBuV/m	Limit dBuV/m	Over dB	Detector	Comment
1	10400.1500	29.14	13.80	42.94	54.00	-11.06	AVG	
2	10400.1900	39.34	13.80	53.14	68.30	-15.16	Peak	

Orthogonal Axis:	X
Test Mode:	UNII-1/ TX A Mode 5240MHz - Internal antenna

Vertical

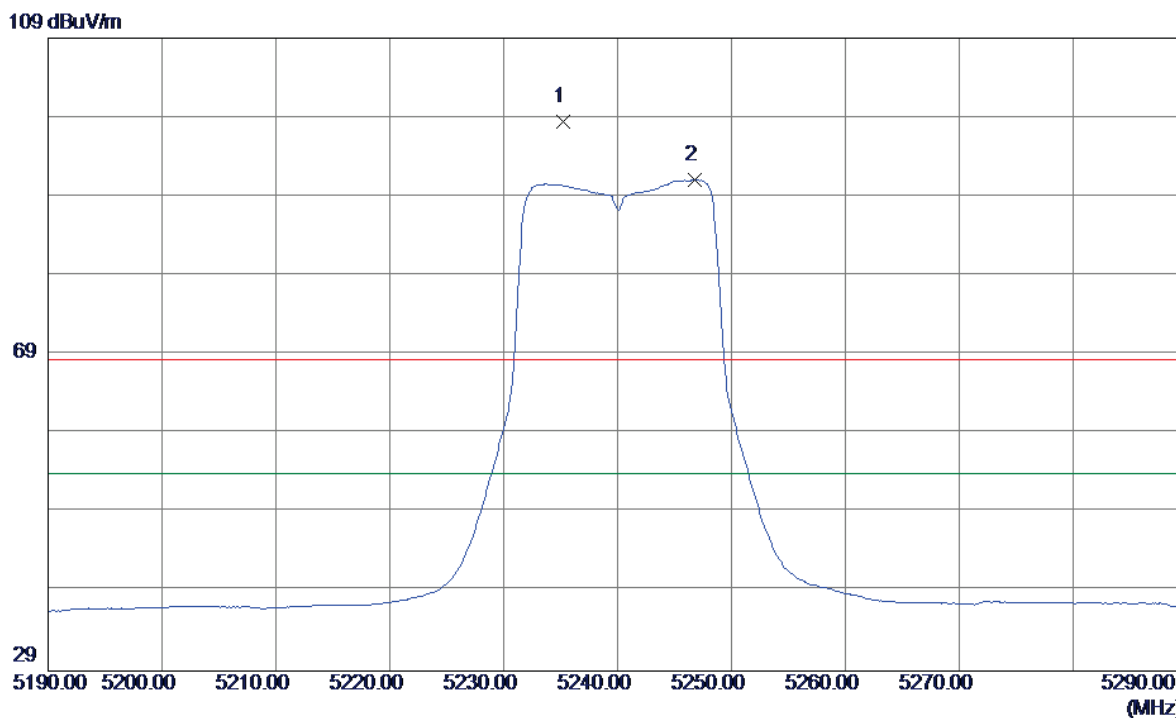

No.	Freq. MHz	Reading Level dBuV/m	Correct Factor dB	Measure ment dBuV/m	Limit dBuV/m	Over dB	Detector	Comment
1	5235.2000	58.08	40.40	98.48	68.30	30.18	Peak	No Limit
2	5246.8000	50.65	40.42	91.07	54.00	37.07	AVG	No Limit

Orthogonal Axis:	X
Test Mode:	UNII-1/ TX A Mode 5240MHz - Internal antenna

Vertical

80 dBuV/m

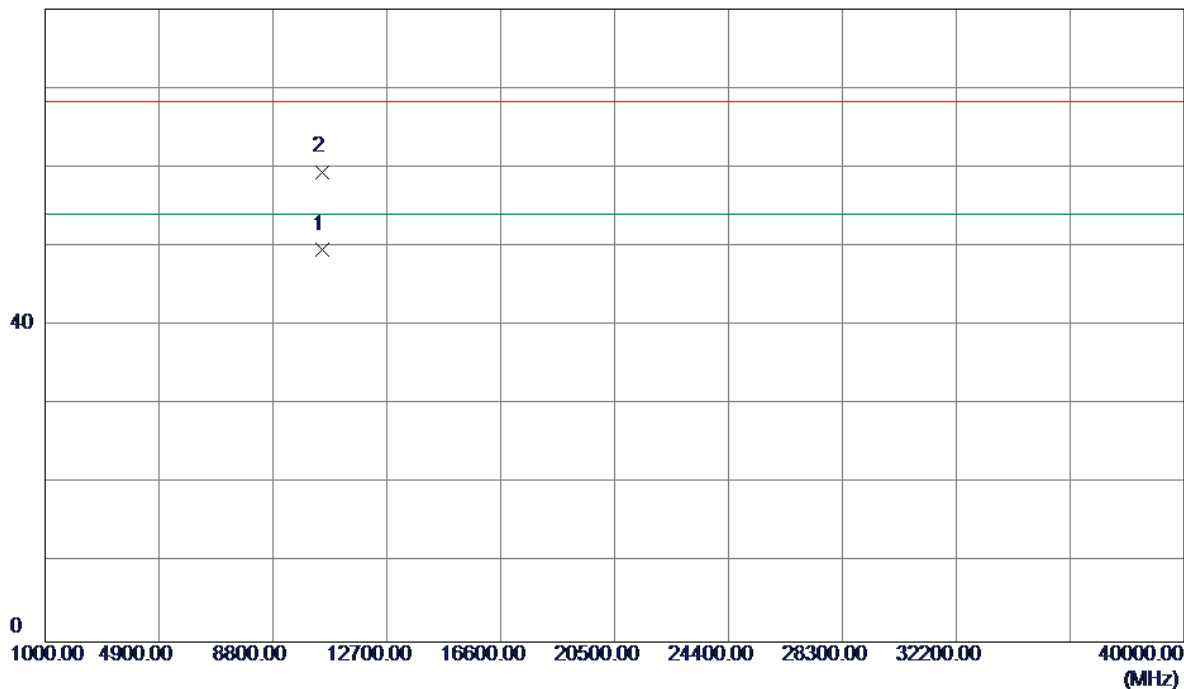

No.	Freq. MHz	Reading Level dBuV/m	Correct Factor dB	Measure ment dBuV/m	Limit dBuV/m	Over dB	Detector	Comment
1	10480.1200	35.94	13.69	49.63	54.00	-4.37	AVG	
2	10480.1700	45.75	13.69	59.44	68.30	-8.86	Peak	

Orthogonal Axis:	X
Test Mode:	UNII-1/ TX A Mode 5240MHz - Internal antenna

Horizontal

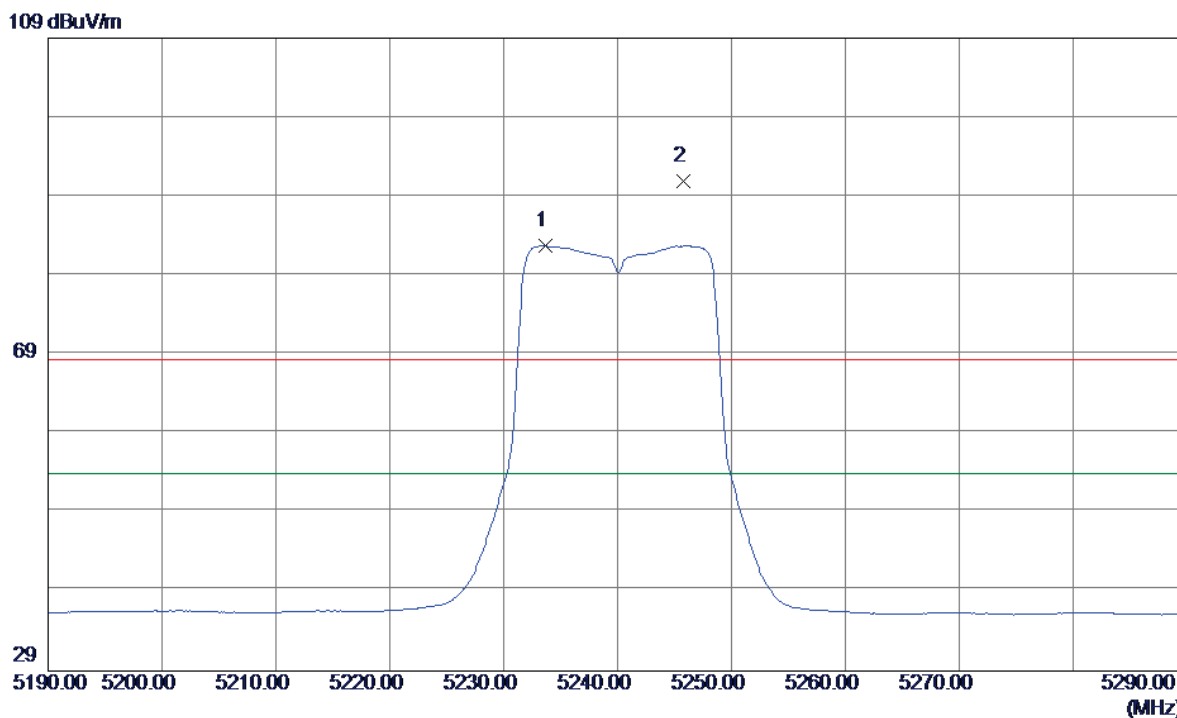

No.	Freq. MHz	Reading Level dBuV/m	Correct Factor dB	Measure ment dBuV/m	Limit dBuV/m	Over dB	Detector	Comment
1	5233.7000	42.34	40.40	82.74	54.00	28.74	AVG	No Limit
2	5245.8000	50.53	40.42	90.95	68.30	22.65	Peak	No Limit

Orthogonal Axis:	X
Test Mode:	UNII-1/ TX A Mode 5240MHz - Internal antenna

Horizontal

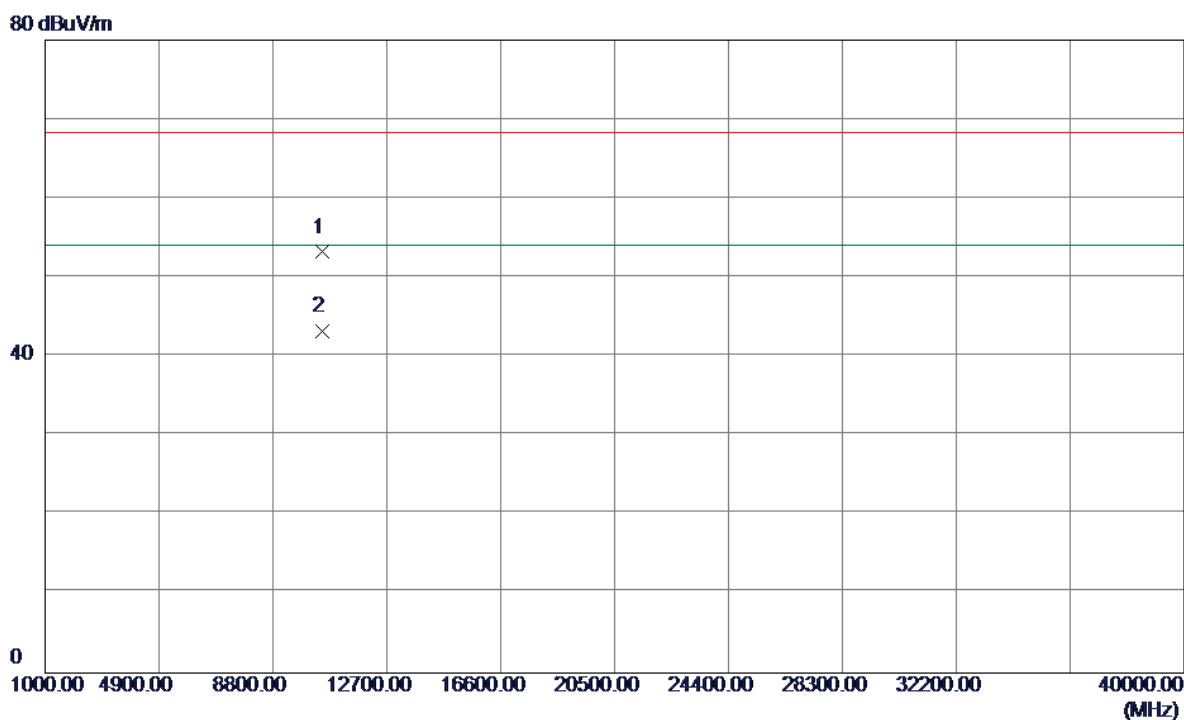

No.	Freq. MHz	Reading Level dBuV/m	Correct Factor dB	Measure ment dBuV/m	Limit dBuV/m	Over dB	Detector	Comment
1	10479.8000	39.51	13.69	53.20	68.30	-15.10	Peak	
2	10480.1200	29.49	13.69	43.18	54.00	-10.82	AVG	

Orthogonal Axis:	X
Test Mode:	UNII-1/ TX N20 Mode 5180MHz - Internal antenna

Vertical

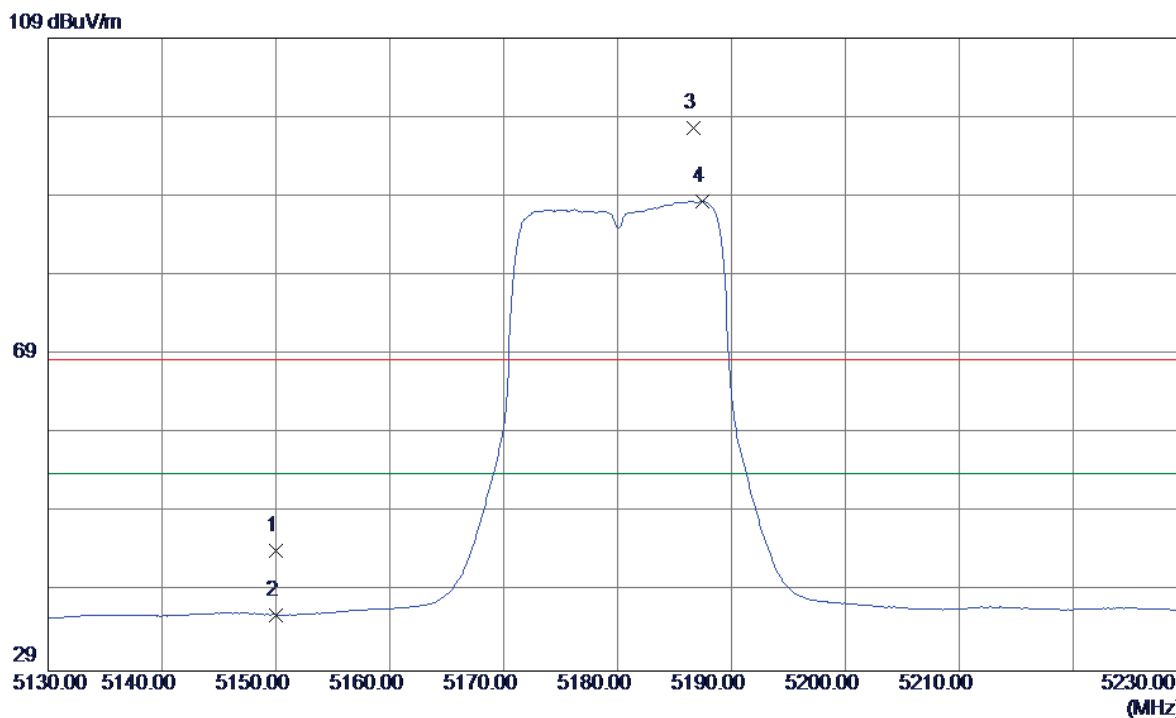

No.	Freq. MHz	Reading Level dBuV/m	Correct Factor dB	Measure ment dBuV/m	Limit dBuV/m	Over dB	Detector	Comment
1	5150.0000	3.96	40.22	44.18	68.30	-24.12	Peak	
2	5150.0000	-4.11	40.22	36.11	54.00	-17.89	AVG	
3	5186.7000	57.33	40.30	97.63	68.30	29.33	Peak	No Limit
4	5187.4000	48.09	40.30	88.39	54.00	34.39	AVG	No Limit

Orthogonal Axis:	X
Test Mode:	UNII-1/ TX N20 Mode 5180MHz - Internal antenna

Vertical

80 dBuV/m

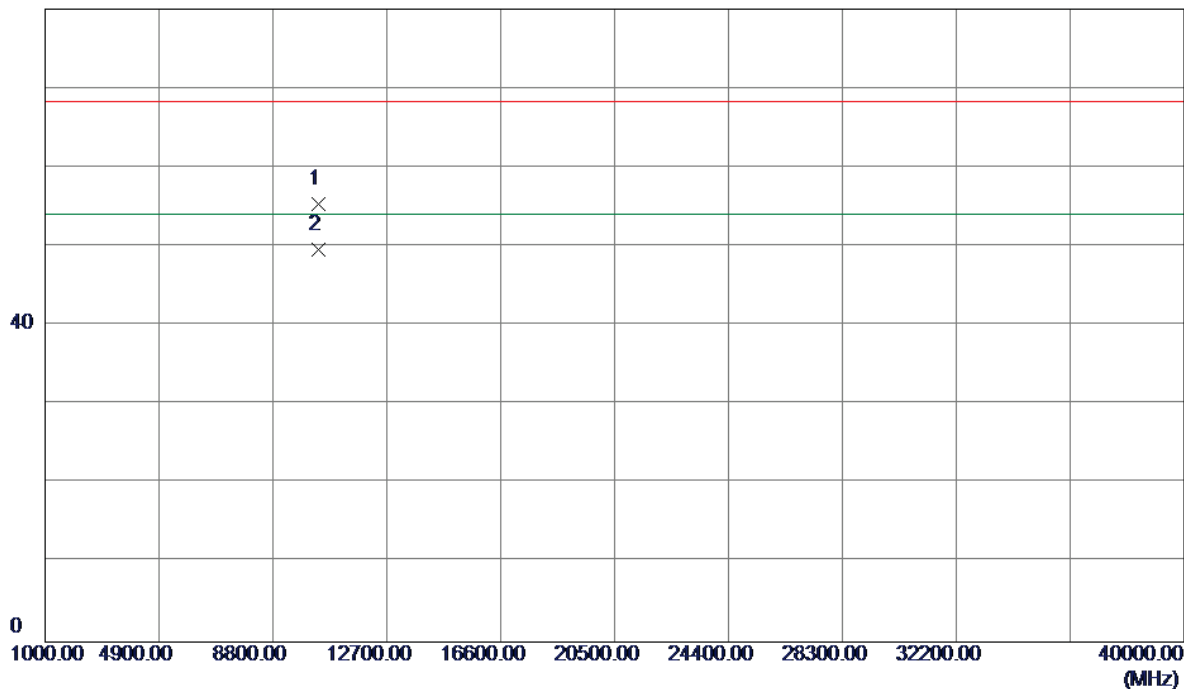

No.	Freq. MHz	Reading Level dBuV/m	Correct Factor dB	Measure ment dBuV/m	Limit dBuV/m	Over dB	Detector	Comment
1	10360.1200	41.45	13.86	55.31	68.30	-12.99	Peak	
2	10360.1200	35.74	13.86	49.60	54.00	-4.40	AVG	

Orthogonal Axis:	X
Test Mode:	UNII-1/ TX N20 Mode 5180MHz - Internal antenna

Horizontal

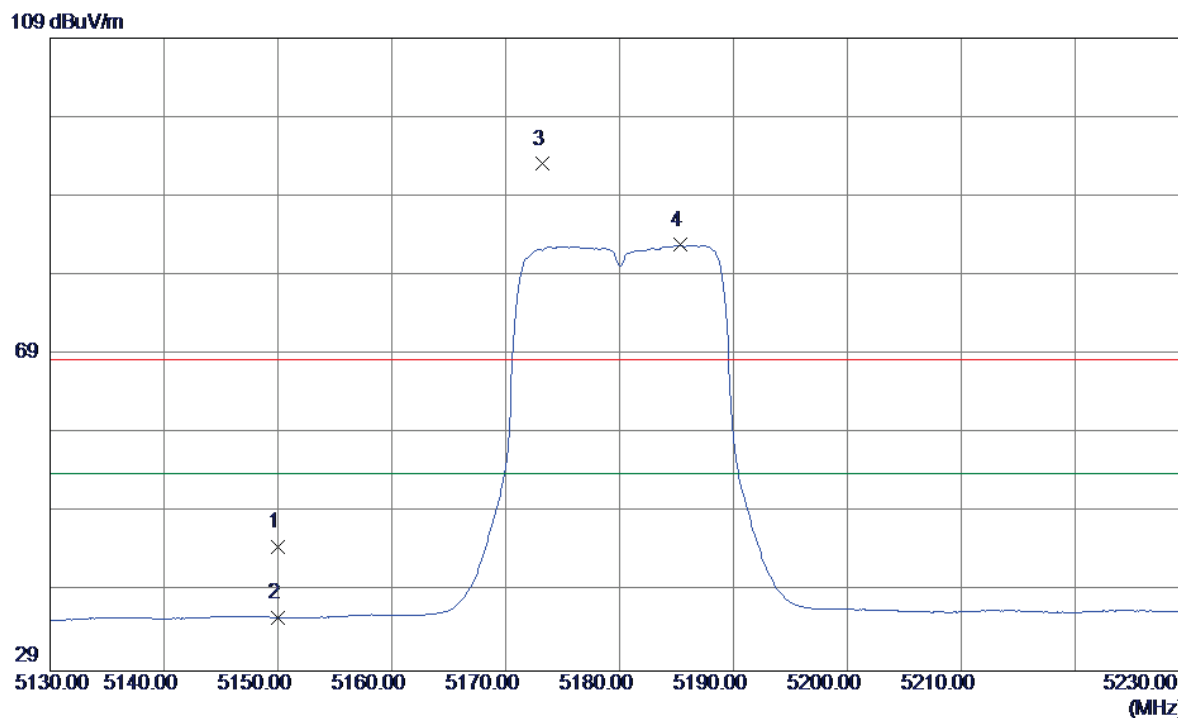

No.	Freq. MHz	Reading Level dBuV/m	Correct Factor dB	Measure ment dBuV/m	Limit dBuV/m	Over dB	Detector	Comment
1	5150.0000	4.50	40.22	44.72	68.30	-23.58	Peak	
2	5150.0000	-4.49	40.22	35.73	54.00	-18.27	AVG	
3	5173.2000	52.81	40.27	93.08	68.30	24.78	Peak	No Limit
4	5185.3000	42.55	40.29	82.84	54.00	28.84	AVG	No Limit

Orthogonal Axis:	X
Test Mode:	UNII-1/ TX N20 Mode 5180MHz - Internal antenna

Horizontal

80 dBuV/m

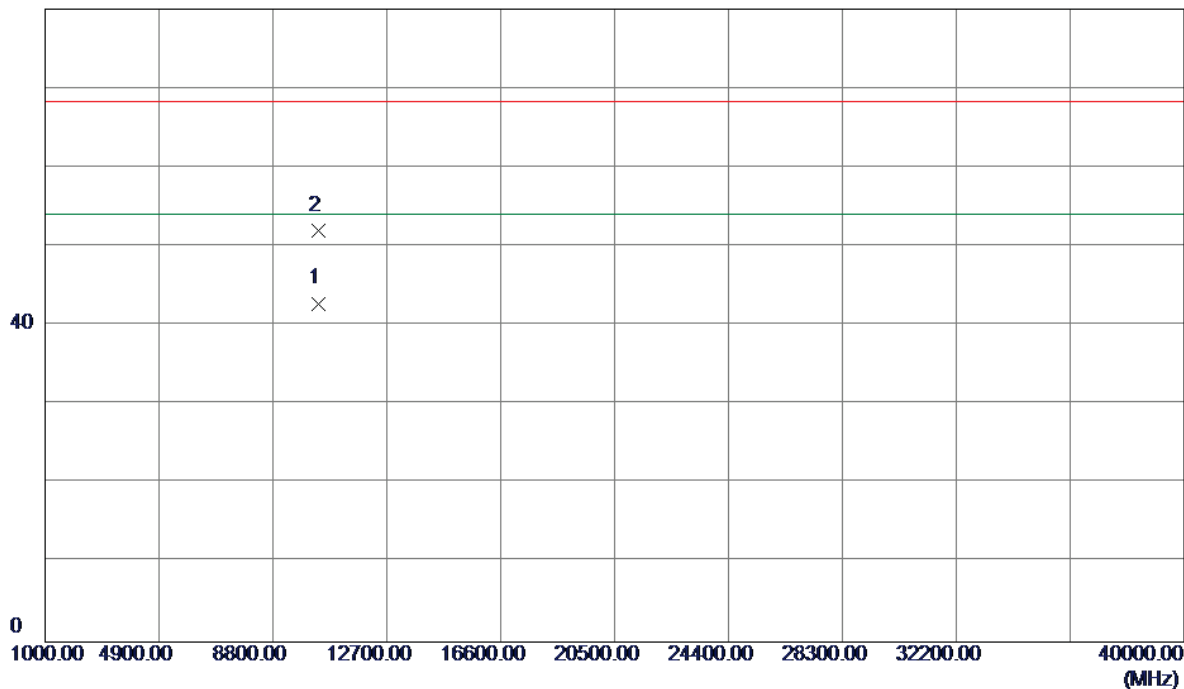

No.	Freq. MHz	Reading Level dBuV/m	Correct Factor dB	Measure ment dBuV/m	Limit dBuV/m	Over dB	Detector	Comment
1	10360.1300	28.94	13.86	42.80	54.00	-11.20	AVG	
2	10360.2100	38.10	13.86	51.96	68.30	-16.34	Peak	

Orthogonal Axis:	X
Test Mode:	UNII-1/ TX N20 Mode 5200MHz - Internal antenna

Vertical

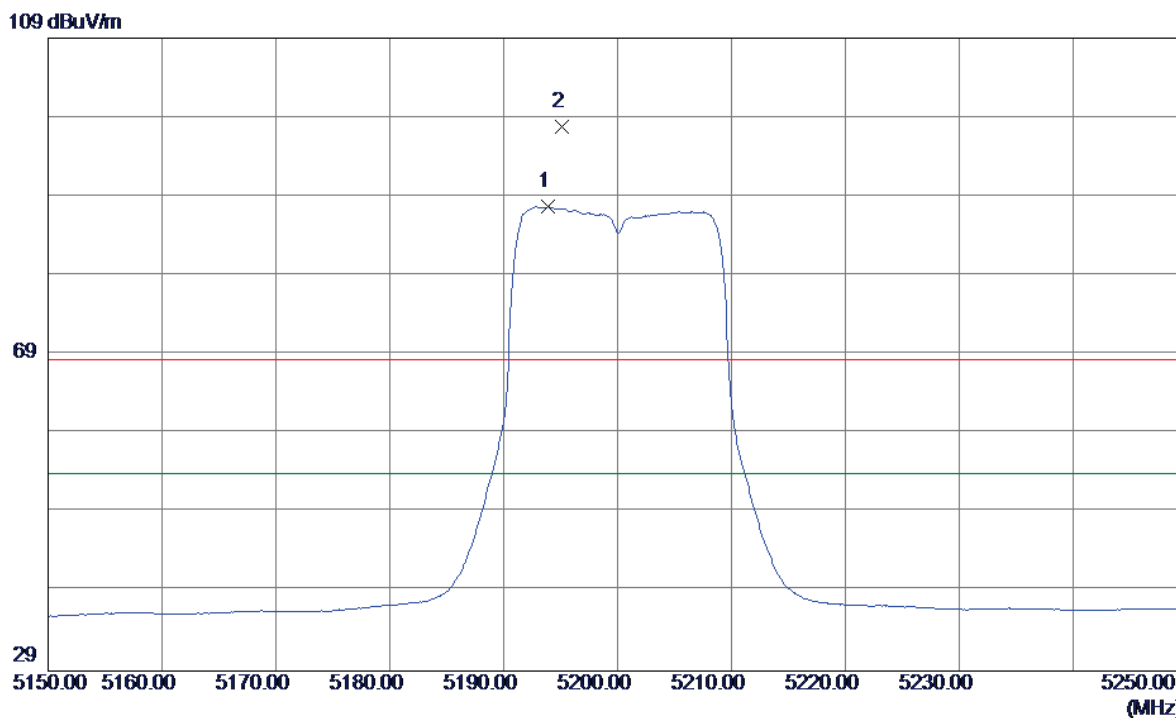

No.	Freq. MHz	Reading Level dBuV/m	Correct Factor dB	Measure ment dBuV/m	Limit dBuV/m	Over dB	Detector	Comment
1	5193.9000	47.38	40.31	87.69	54.00	33.69	AVG	No Limit
2	5195.1000	57.49	40.31	97.80	68.30	29.50	Peak	No Limit

Orthogonal Axis:	X
Test Mode:	UNII-1/ TX N20 Mode 5200MHz - Internal antenna

Vertical

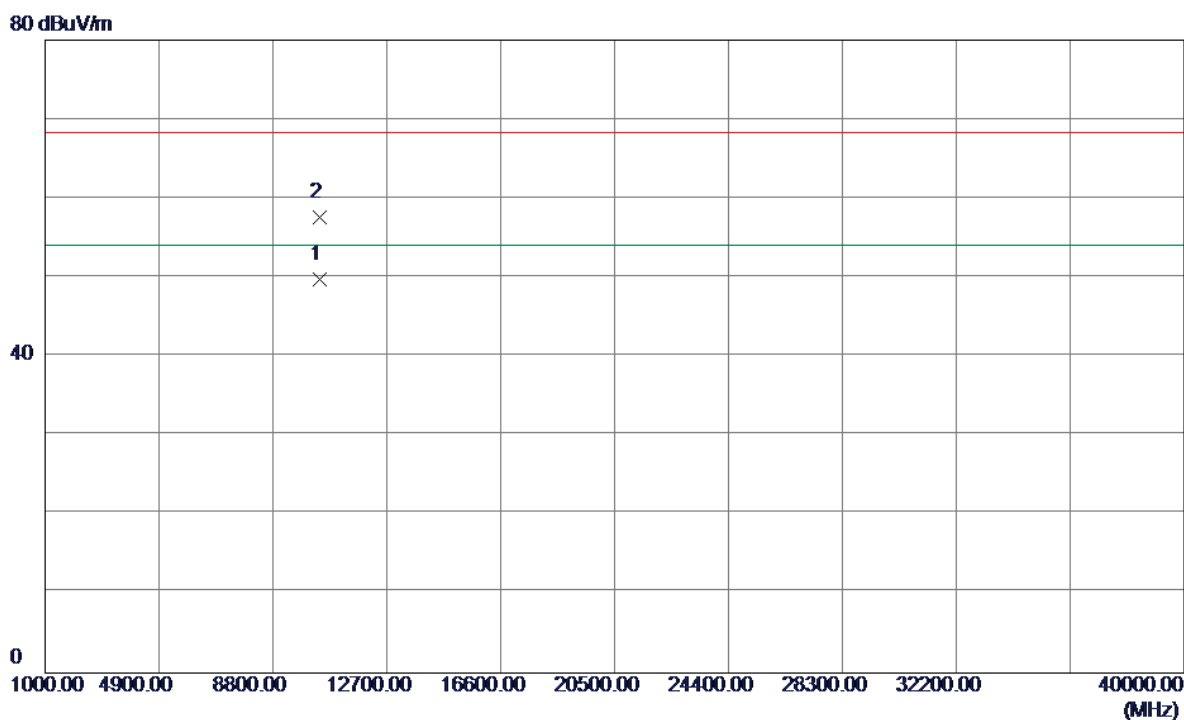

No.	Freq. MHz	Reading Level dBuV/m	Correct Factor dB	Measure ment dBuV/m	Limit dBuV/m	Over dB	Detector	Comment
1	10400.1200	35.96	13.80	49.76	54.00	-4.24	AVG	
2	10400.1400	43.87	13.80	57.67	68.30	-10.63	Peak	

Orthogonal Axis:	X
Test Mode:	UNII-1/ TX N20 Mode 5200MHz - Internal antenna

Horizontal

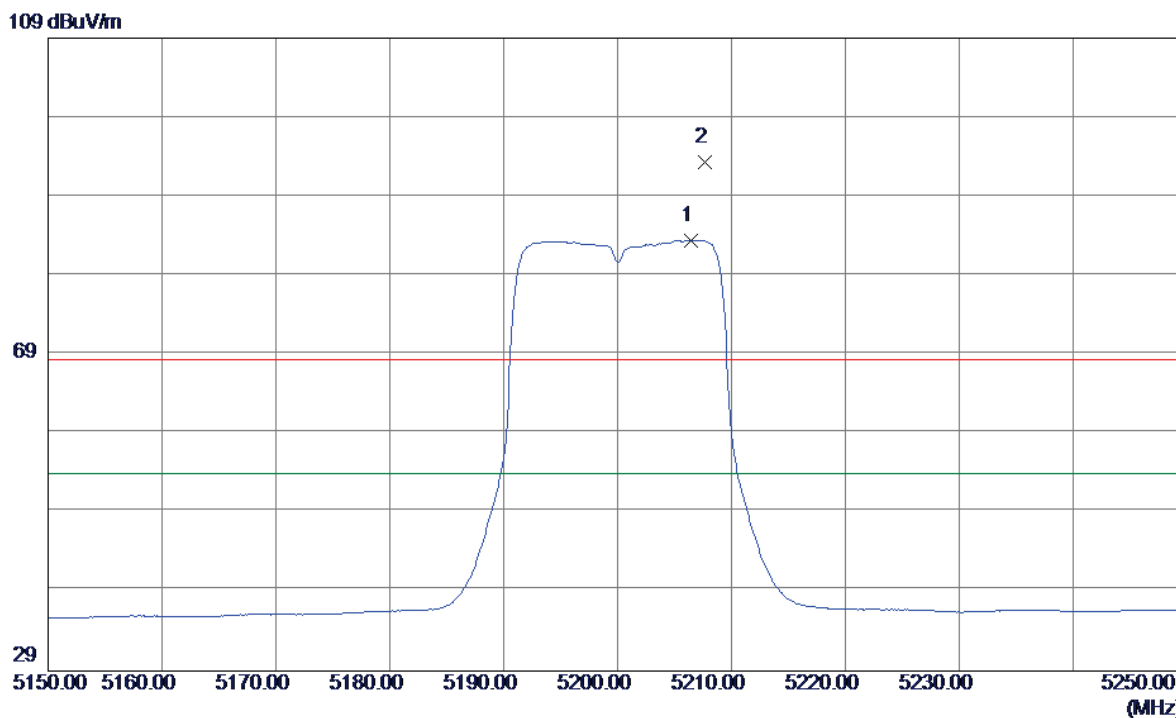

No.	Freq. MHz	Reading Level dBuV/m	Correct Factor dB	Measure ment dBuV/m	Limit dBuV/m	Over dB	Detector	Comment
1	5206.4000	43.09	40.34	83.43	54.00	29.43	AVG	No Limit
2	5207.7000	53.03	40.34	93.37	68.30	25.07	Peak	No Limit

Orthogonal Axis:	X
Test Mode:	UNII-1/ TX N20 Mode 5200MHz - Internal antenna

Horizontal

80 dBuV/m

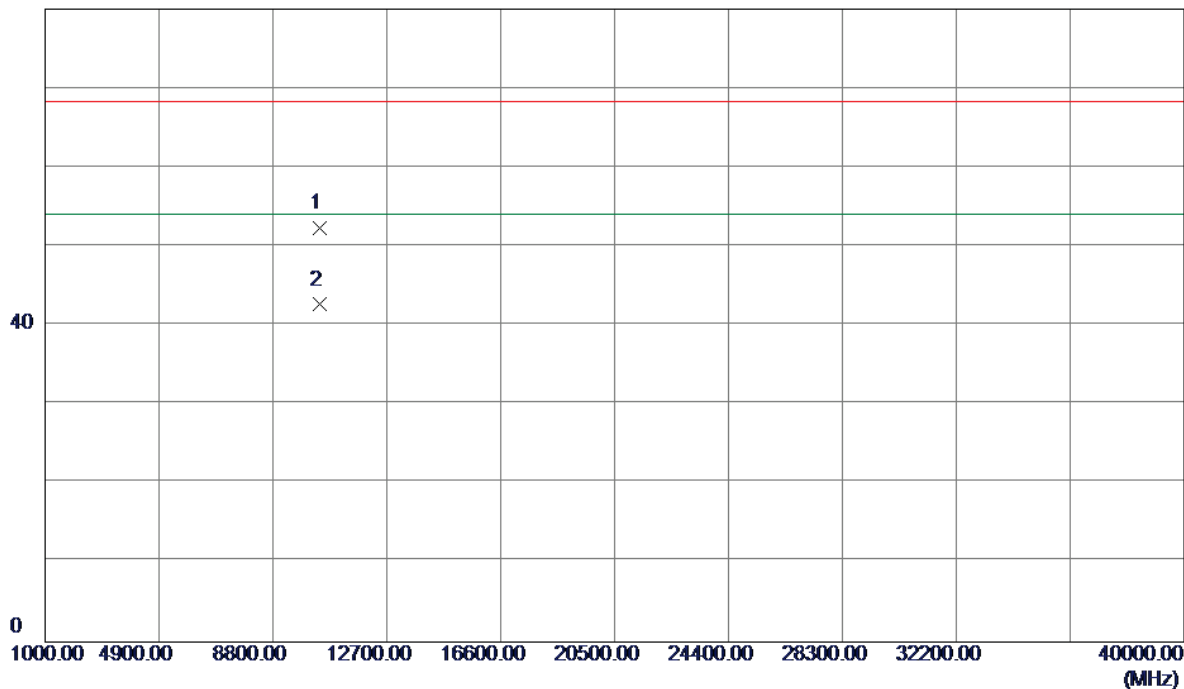

No.	Freq. MHz	Reading Level dBuV/m	Correct Factor dB	Measure ment dBuV/m	Limit dBuV/m	Over dB	Detector	Comment
1	10399.9400	38.56	13.80	52.36	68.30	-15.94	Peak	
2	10400.1100	28.84	13.80	42.64	54.00	-11.36	AVG	

Orthogonal Axis:	X
Test Mode:	UNII-1/ TX N20 Mode 5240MHz - Internal antenna

Vertical

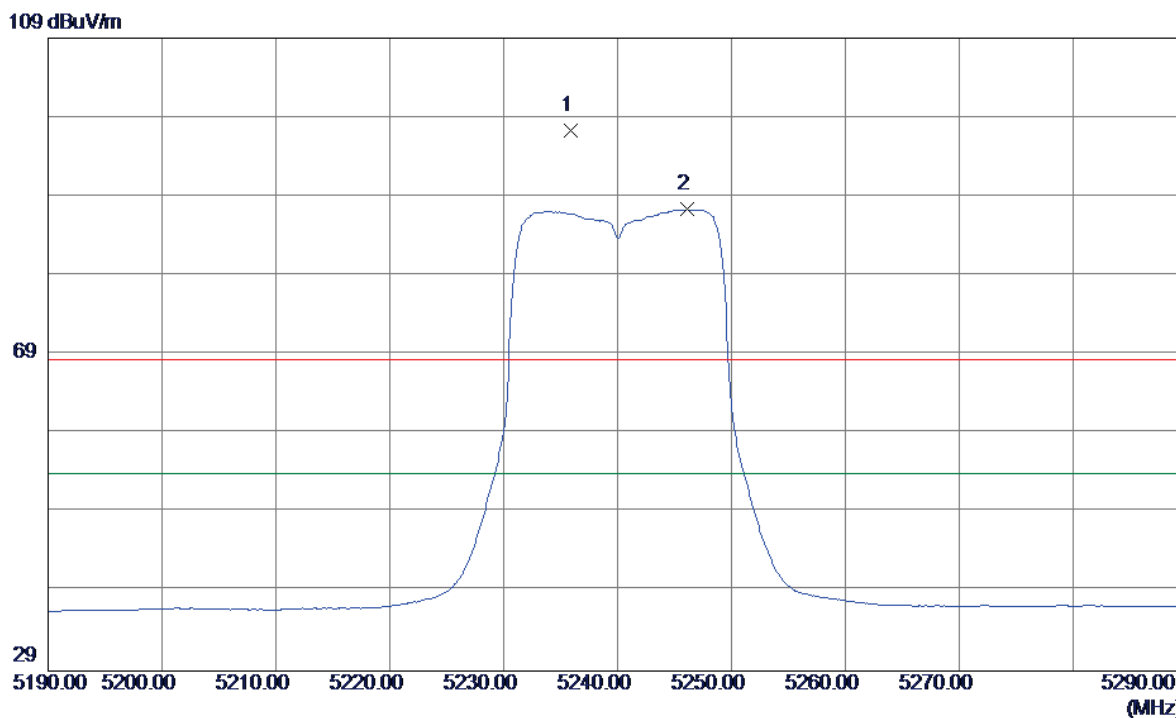

No.	Freq. MHz	Reading Level dBuV/m	Correct Factor dB	Measure ment dBuV/m	Limit dBuV/m	Over dB	Detector	Comment
1	5235.9000	56.95	40.40	97.35	68.30	29.05	Peak	No Limit
2	5246.1000	46.91	40.42	87.33	54.00	33.33	AVG	No Limit

Orthogonal Axis:	X
Test Mode:	UNII-1/ TX N20 Mode 5240MHz - Internal antenna

Vertical

80 dBuV/m

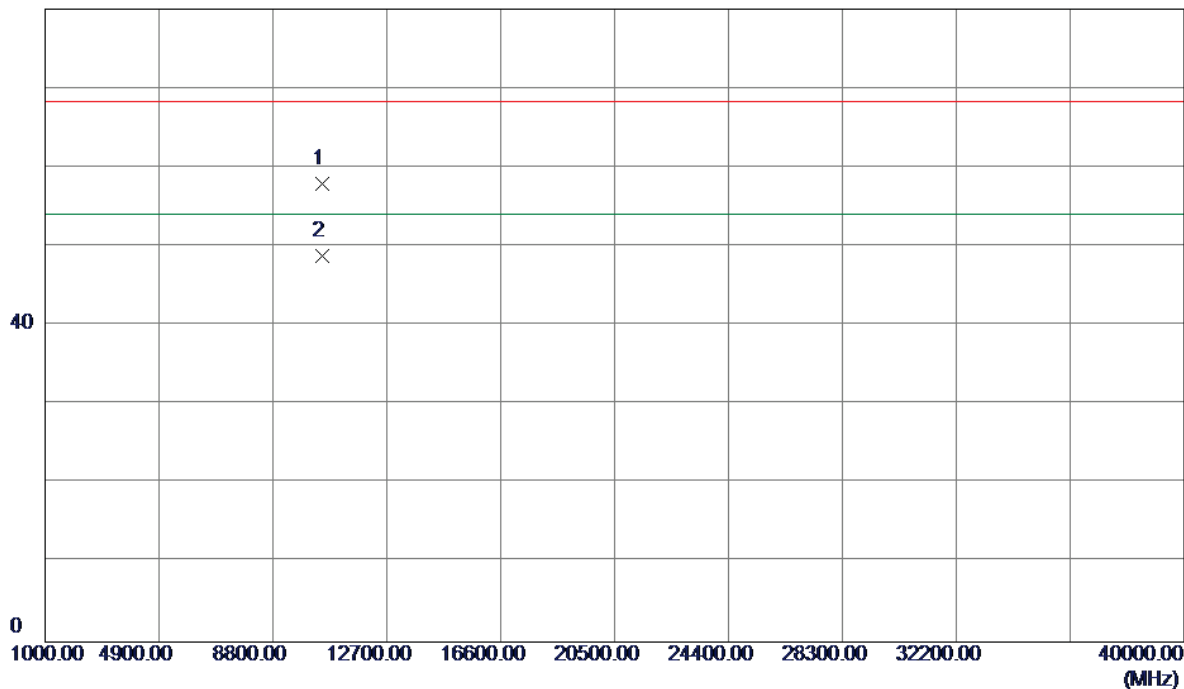

No.	Freq. MHz	Reading Level dBuV/m	Correct Factor dB	Measure ment dBuV/m	Limit dBuV/m	Over dB	Detector	Comment
1	10480.0100	44.27	13.69	57.96	68.30	-10.34	Peak	
2	10480.1000	35.13	13.69	48.82	54.00	-5.18	AVG	

Orthogonal Axis:	X
Test Mode:	UNII-1/ TX N20 Mode 5240MHz - Internal antenna

Horizontal

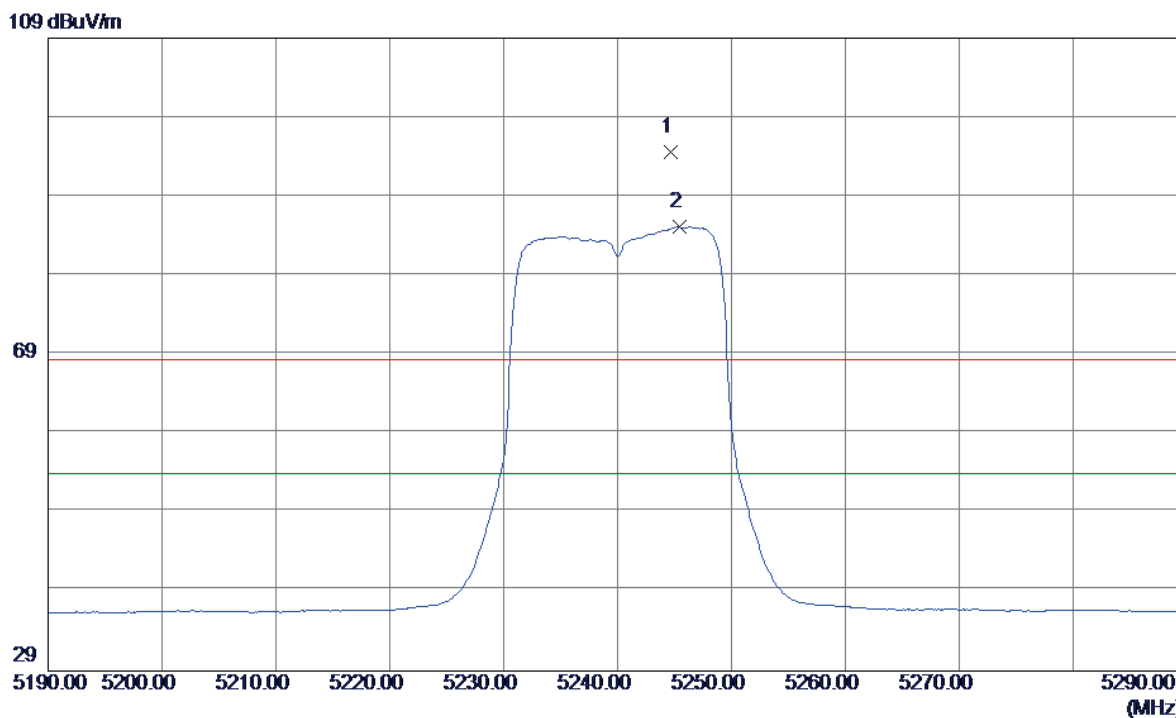

No.	Freq. MHz	Reading Level dBuV/m	Correct Factor dB	Measure ment dBuV/m	Limit dBuV/m	Over dB	Detector	Comment
1	5244.7000	54.20	40.42	94.62	68.30	26.32	Peak	No Limit
2	5245.4000	44.72	40.42	85.14	54.00	31.14	AVG	No Limit

Orthogonal Axis:	X
Test Mode:	UNII-1/ TX N20 Mode 5240MHz - Internal antenna

Horizontal

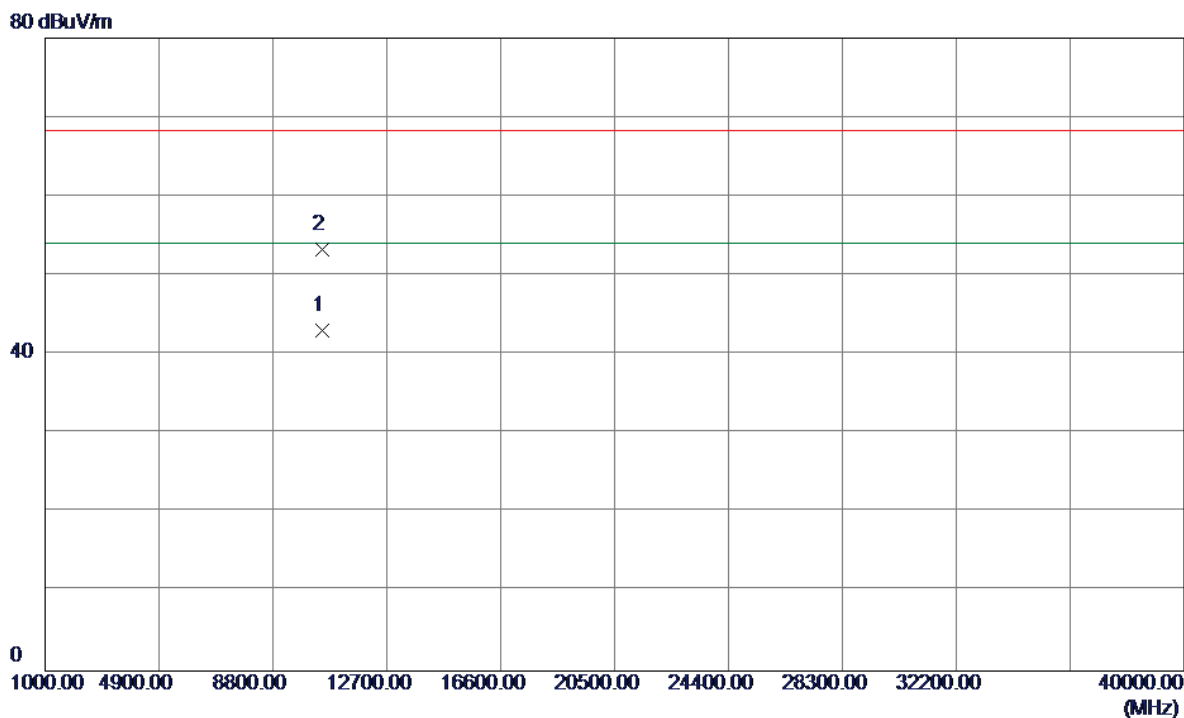

No.	Freq. MHz	Reading Level dBuV/m	Correct Factor dB	Measure ment dBuV/m	Limit dBuV/m	Over dB	Detector	Comment
1	10480.1200	29.35	13.69	43.04	54.00	-10.96	AVG	
2	10480.2200	39.52	13.69	53.21	68.30	-15.09	Peak	

Orthogonal Axis:	X
Test Mode:	UNII-1/ TX N40 Mode 5190MHz - Internal antenna

Vertical

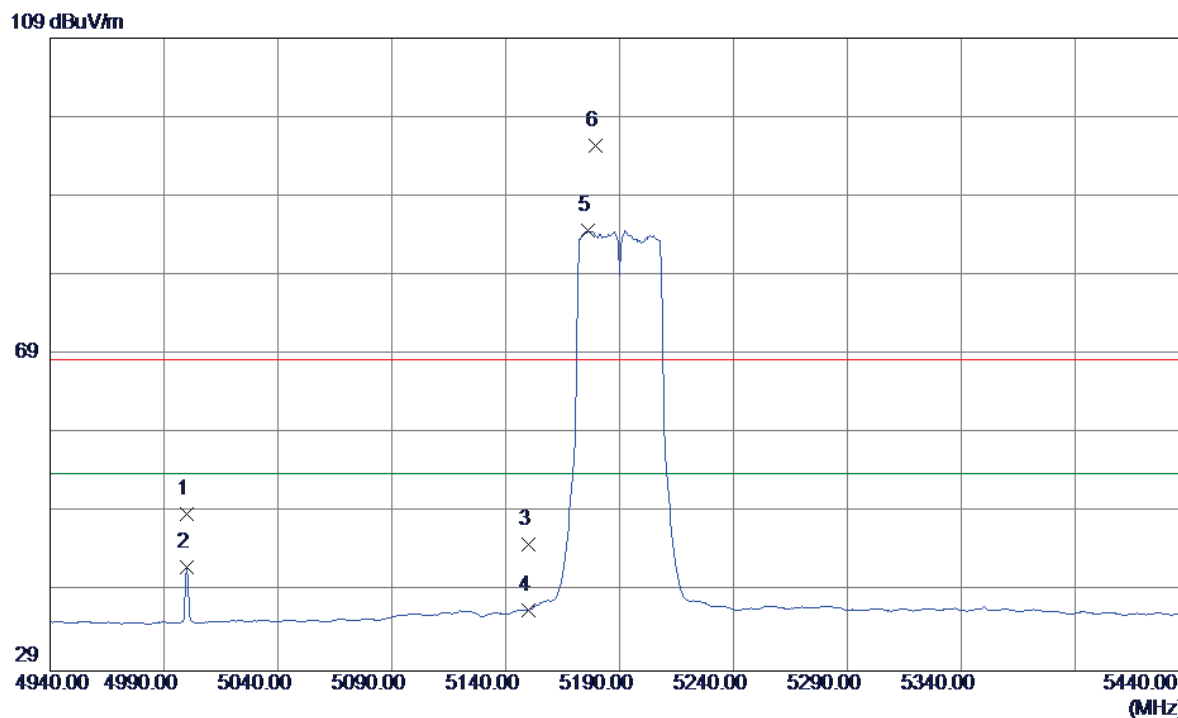

No.	Freq. MHz	Reading Level dBuV/m	Correct Factor dB	Measure ment dBuV/m	Limit dBuV/m	Over dB	Detector	Comment
1	5000.0000	8.99	39.90	48.89	68.30	-19.41	Peak	
2	5000.0000	2.17	39.90	42.07	54.00	-11.93	AVG	
3	5150.0000	4.82	40.22	45.04	68.30	-23.26	Peak	
4	5150.0000	-3.52	40.22	36.70	54.00	-17.30	AVG	
5	5176.0000	44.36	40.27	84.63	54.00	30.63	AVG	No Limit
6	5179.5000	55.09	40.28	95.37	68.30	27.07	Peak	No Limit

Orthogonal Axis:	X
Test Mode:	UNII-1/ TX N40 Mode 5190MHz- Internal antenna

Vertical

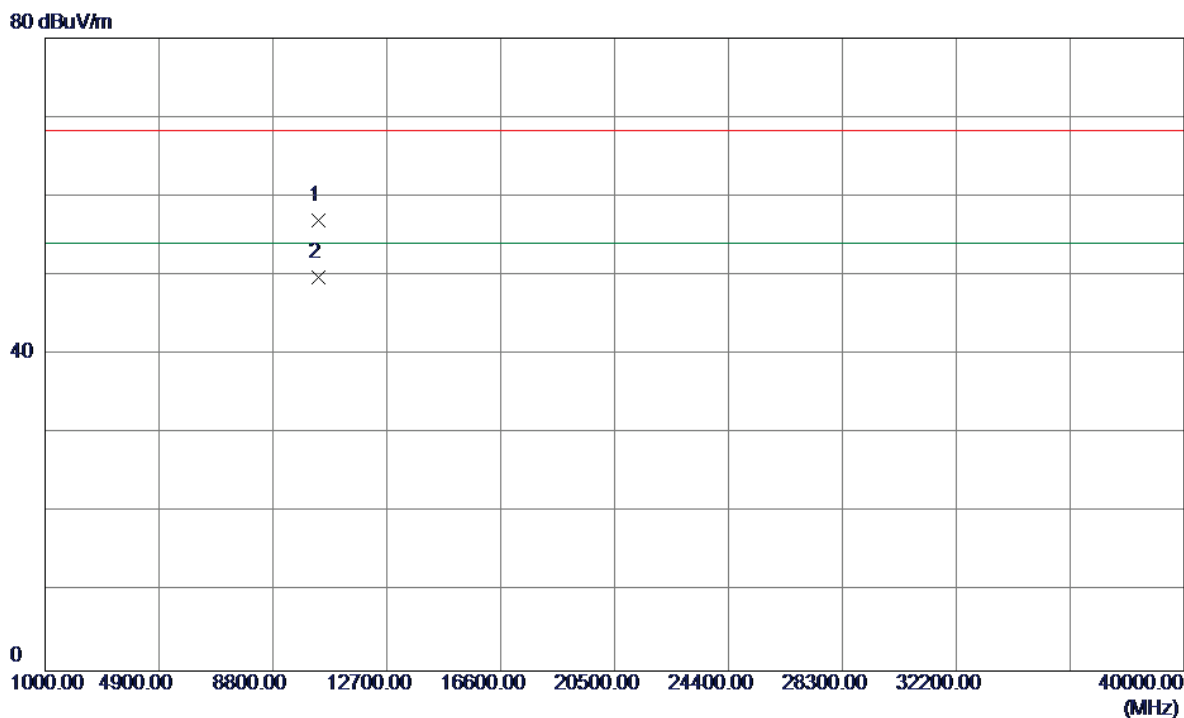

No.	Freq. MHz	Reading Level dBuV/m	Correct Factor dB	Measure ment dBuV/m	Limit dBuV/m	Over dB	Detector	Comment
1	10380.1100	43.10	13.83	56.93	68.30	-11.37	Peak	
2	10380.1100	35.86	13.83	49.69	54.00	-4.31	AVG	

Orthogonal Axis:	X
Test Mode:	UNII-1/ TX N40 Mode 5190MHz- Internal antenna

Horizontal

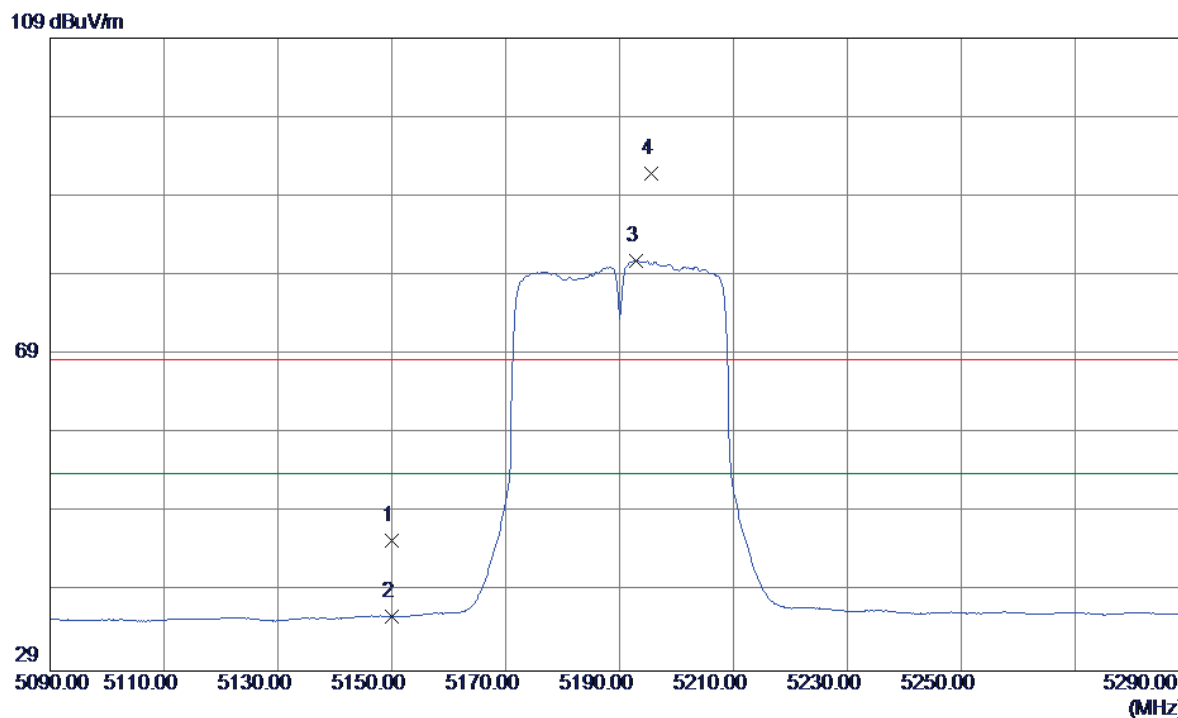

No.	Freq. MHz	Reading Level dBuV/m	Correct Factor dB	Measure ment dBuV/m	Limit dBuV/m	Over dB	Detector	Comment
1	5150.0000	5.31	40.22	45.53	68.30	-22.77	Peak	
2	5150.0000	-4.37	40.22	35.85	54.00	-18.15	AVG	
3	5192.8000	40.60	40.31	80.91	54.00	26.91	AVG	No Limit
4	5195.6000	51.63	40.31	91.94	68.30	23.64	Peak	No Limit

Orthogonal Axis:	X
Test Mode:	UNII-1/ TX N40 Mode 5190MHz- Internal antenna

Horizontal

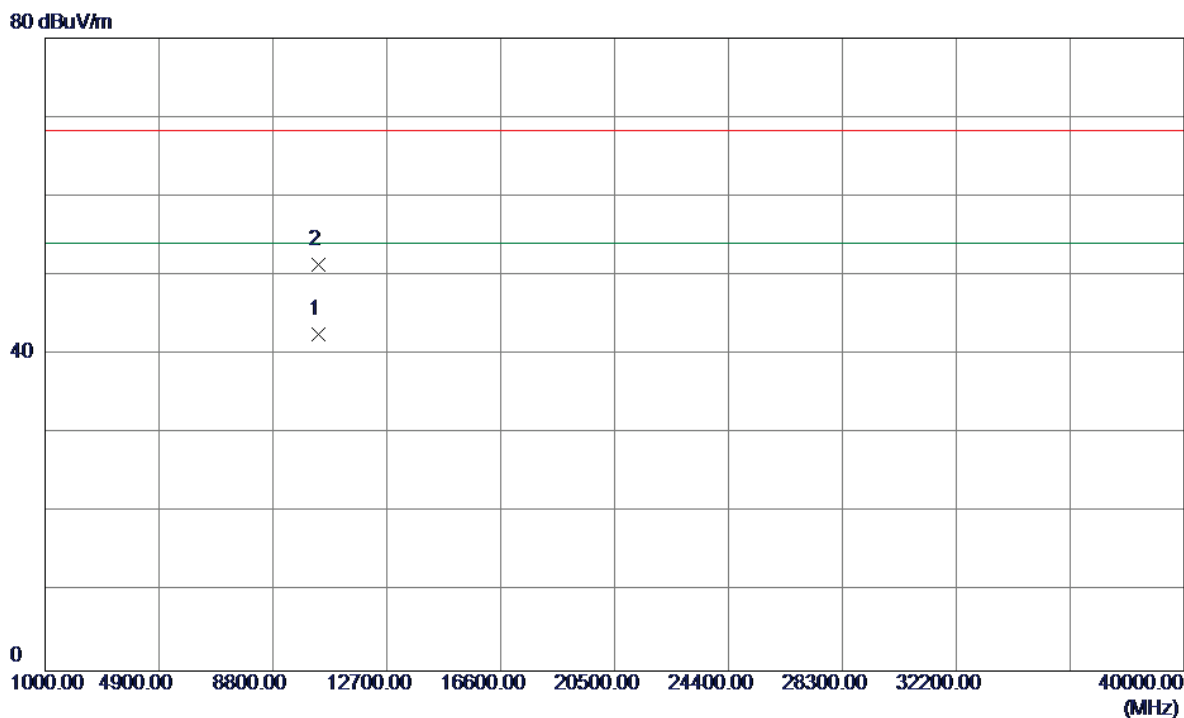

No.	Freq. MHz	Reading Level dBuV/m	Correct Factor dB	Measure ment dBuV/m	Limit dBuV/m	Over dB	Detector	Comment
1	10380.1800	28.66	13.83	42.49	54.00	-11.51	AVG	
2	10380.2000	37.54	13.83	51.37	68.30	-16.93	Peak	

Orthogonal Axis:	X
Test Mode:	UNII-1/ TX N40 Mode 5230MHz- Internal antenna

Vertical

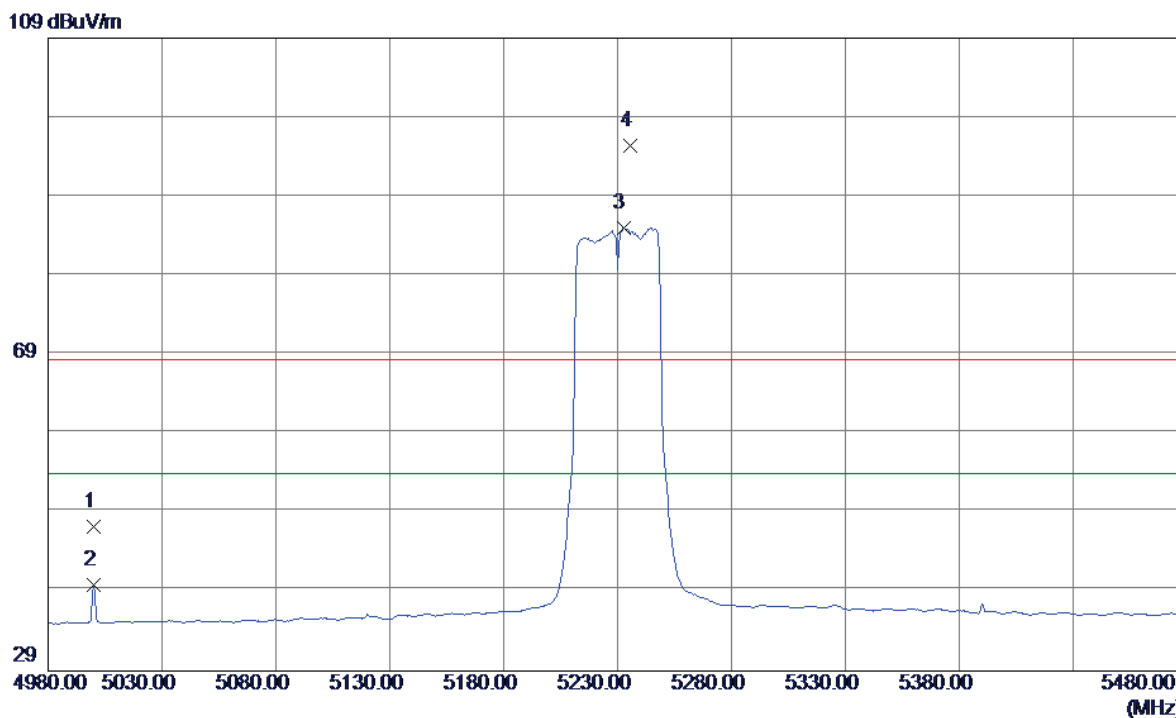

No.	Freq. MHz	Reading Level dBuV/m	Correct Factor dB	Measure ment dBuV/m	Limit dBuV/m	Over dB	Detector	Comment
1	5000.0000	7.34	39.90	47.24	68.30	-21.06	Peak	
2	5000.0000	0.00	39.90	39.90	54.00	-14.10	AVG	
3	5232.5000	44.64	40.39	85.03	54.00	31.03	AVG	No Limit
4	5235.5000	55.07	40.40	95.47	68.30	27.17	Peak	No Limit

Orthogonal Axis:	X
Test Mode:	UNII-1/ TX N40 Mode 5230MHz- Internal antenna

Vertical

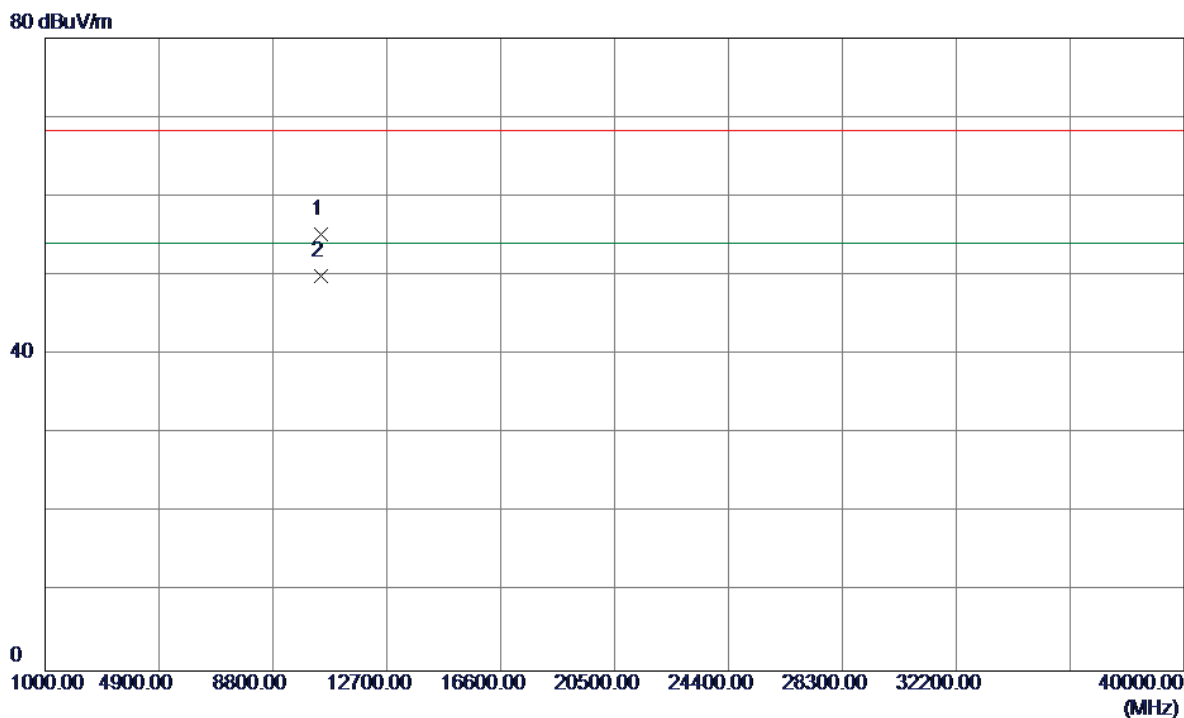

No.	Freq. MHz	Reading Level dBuV/m	Correct Factor dB	Measure ment dBuV/m	Limit dBuV/m	Over dB	Detector	Comment
1	10460.0500	41.46	13.72	55.18	68.30	-13.12	Peak	
2	10460.1200	36.22	13.72	49.94	54.00	-4.06	AVG	

Orthogonal Axis:	X
Test Mode:	UNII-1/ TX N40 Mode 5230MHz- Internal antenna

Horizontal

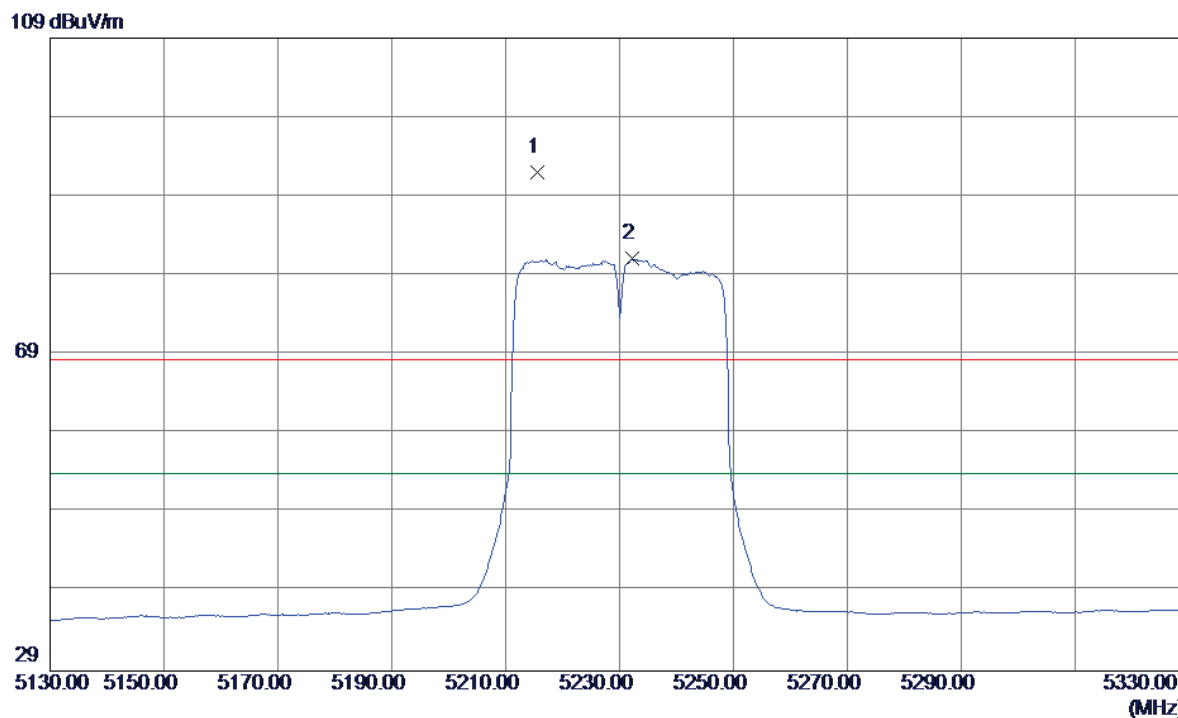

No.	Freq. MHz	Reading Level dBuV/m	Correct Factor dB	Measure ment dBuV/m	Limit dBuV/m	Over dB	Detector	Comment
1	5215.6000	51.63	40.36	91.99	68.30	23.69	Peak	No Limit
2	5232.2000	40.70	40.39	81.09	54.00	27.09	AVG	No Limit

Orthogonal Axis:	X
Test Mode:	UNII-1/ TX N40 Mode 5230MHz- Internal antenna

Horizontal

80 dBuV/m

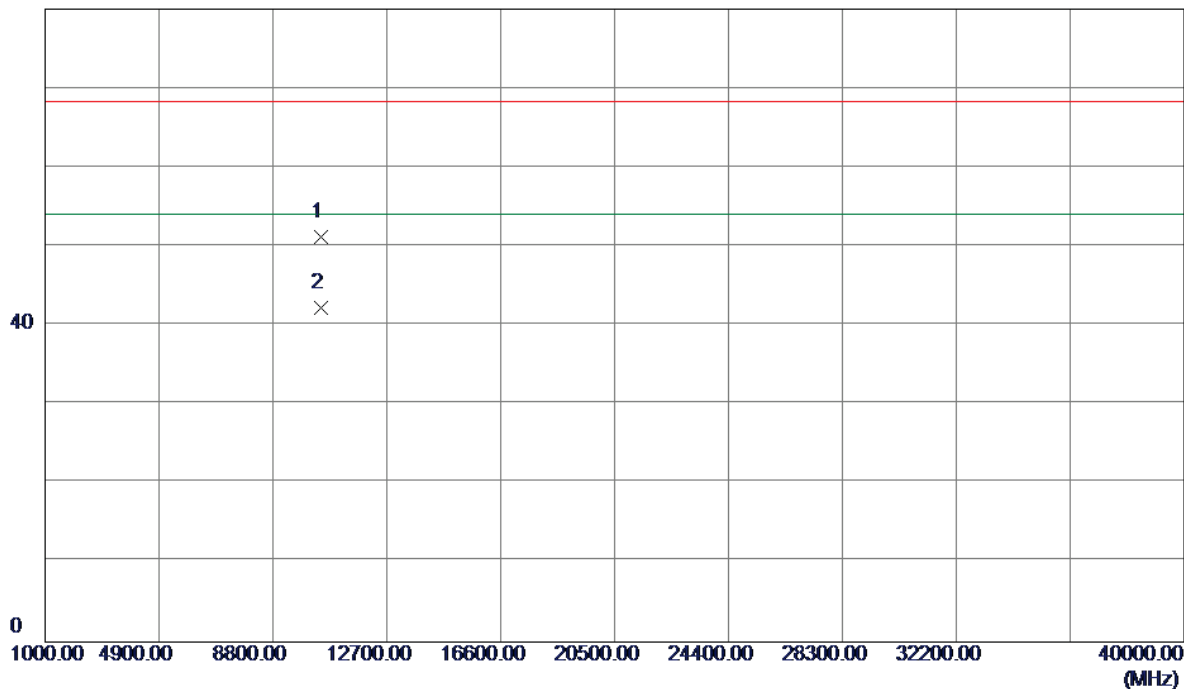

No.	Freq. MHz	Reading Level dBuV/m	Correct Factor dB	Measure ment dBuV/m	Limit dBuV/m	Over dB	Detector	Comment
1	10460.0000	37.50	13.72	51.22	68.30	-17.08	Peak	
2	10460.1500	28.51	13.72	42.23	54.00	-11.77	AVG	

Orthogonal Axis:	X
Test Mode:	UNII-3/TX A Mode 5745MHz- Internal antenna

Vertical

109 dBuV/m

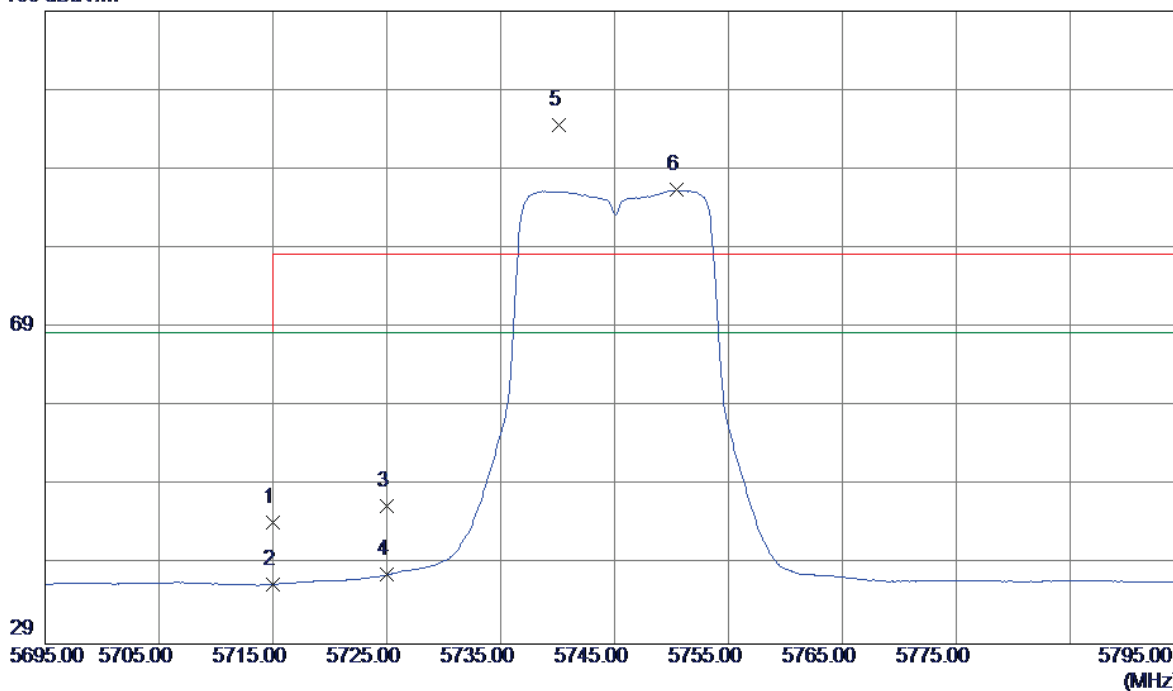

No.	Freq. MHz	Reading Level dBuV/m	Correct Factor dB	Measure ment dBuV/m	Limit dBuV/m	Over dB	Detector	Comment
1	5715.0000	3.09	41.25	44.34	68.30	-23.96	Peak	
2	5715.0000	-4.73	41.25	36.52	68.30	-31.78	AVG	
3	5725.0000	5.14	41.27	46.41	78.30	-31.89	Peak	
4	5725.0000	-3.53	41.27	37.74	68.30	-30.56	AVG	
5	5740.1000	53.31	41.29	94.60	78.30	16.30	Peak	No Limit
6	5750.4000	45.07	41.30	86.37	68.30	18.07	AVG	No Limit

Orthogonal Axis:	X
Test Mode:	UNII-3/TX A Mode 5745MHz- Internal antenna

Vertical

80 dBuV/m

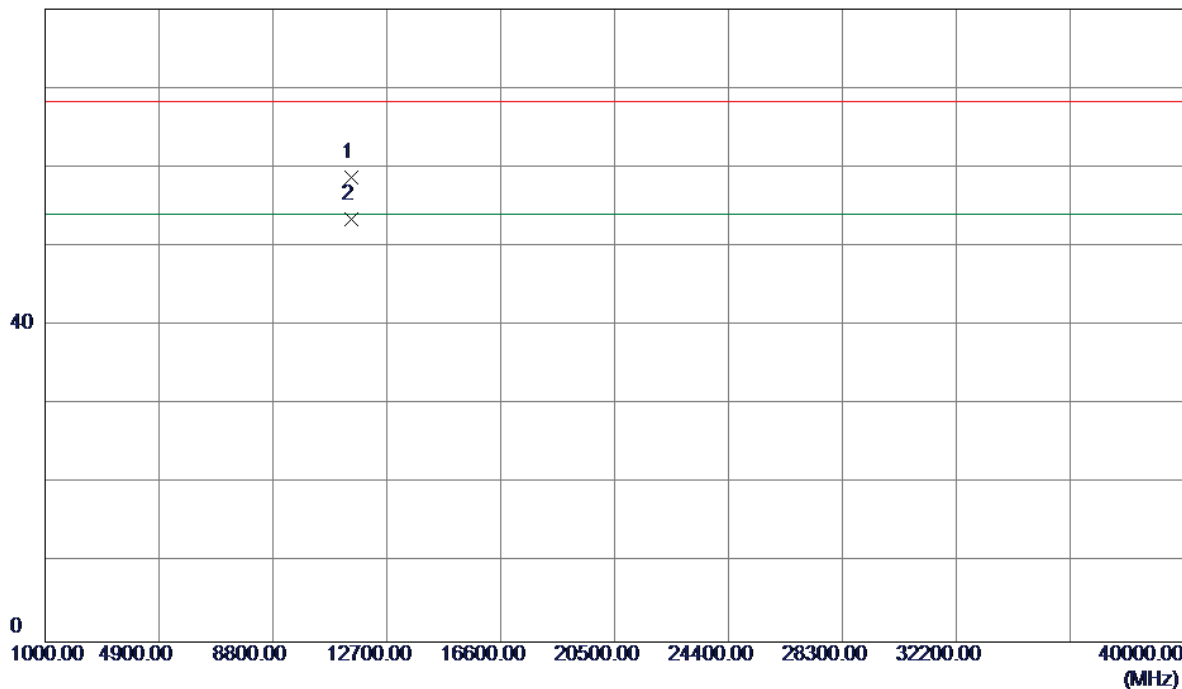

No.	Freq. MHz	Reading Level dBuV/m	Correct Factor dB	Measure ment dBuV/m	Limit dBuV/m	Over dB	Detector	Comment
1	11490.1500	41.87	16.91	58.78	68.30	-9.52	Peak	
2	11490.1500	36.49	16.91	53.40	54.00	-0.60	AVG	

Orthogonal Axis:	X
Test Mode:	UNII-3/TX A Mode 5745MHz- Internal antenna

Horizontal

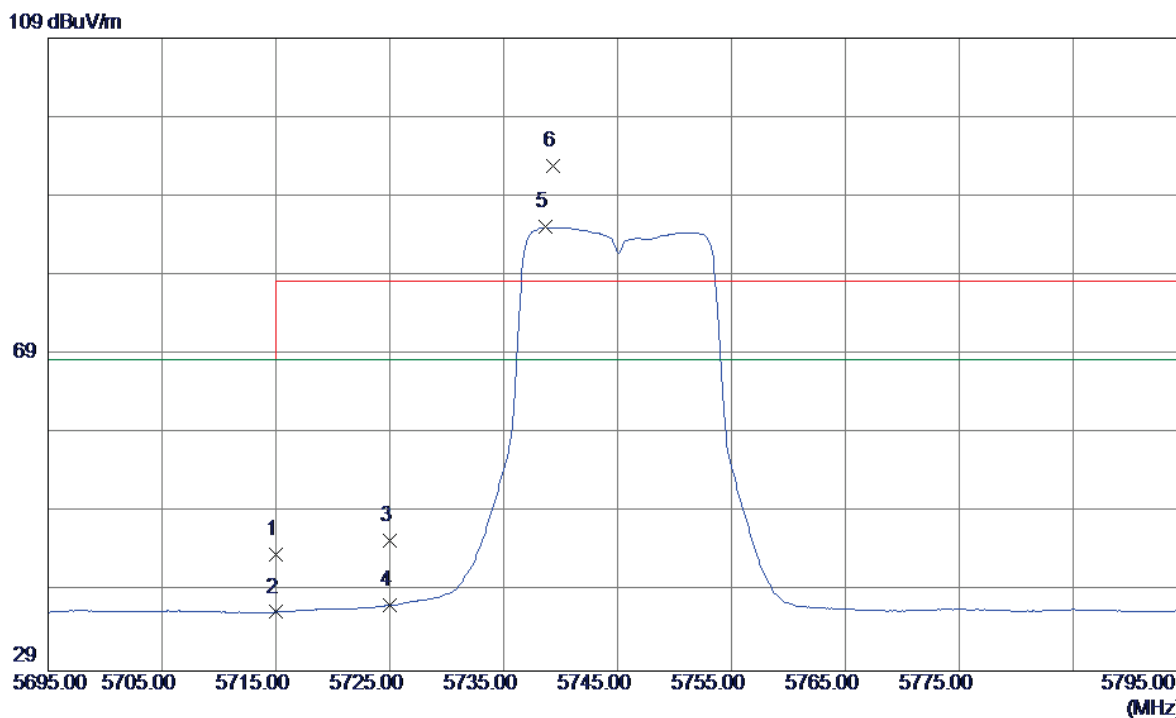

No.	Freq. MHz	Reading Level dBuV/m	Correct Factor dB	Measure ment dBuV/m	Limit dBuV/m	Over dB	Detector	Comment
1	5715.0000	2.40	41.25	43.65	68.30	-24.65	Peak	
2	5715.0000	-4.81	41.25	36.44	68.30	-31.86	AVG	
3	5725.0000	4.16	41.27	45.43	78.30	-32.87	Peak	
4	5725.0000	-3.94	41.27	37.33	68.30	-30.97	AVG	
5	5738.7000	43.81	41.28	85.09	68.30	16.79	AVG	No Limit
6	5739.3000	51.57	41.29	92.86	78.30	14.56	Peak	No Limit

Orthogonal Axis:	X
Test Mode:	UNII-3/TX A Mode 5745MHz- Internal antenna

Horizontal

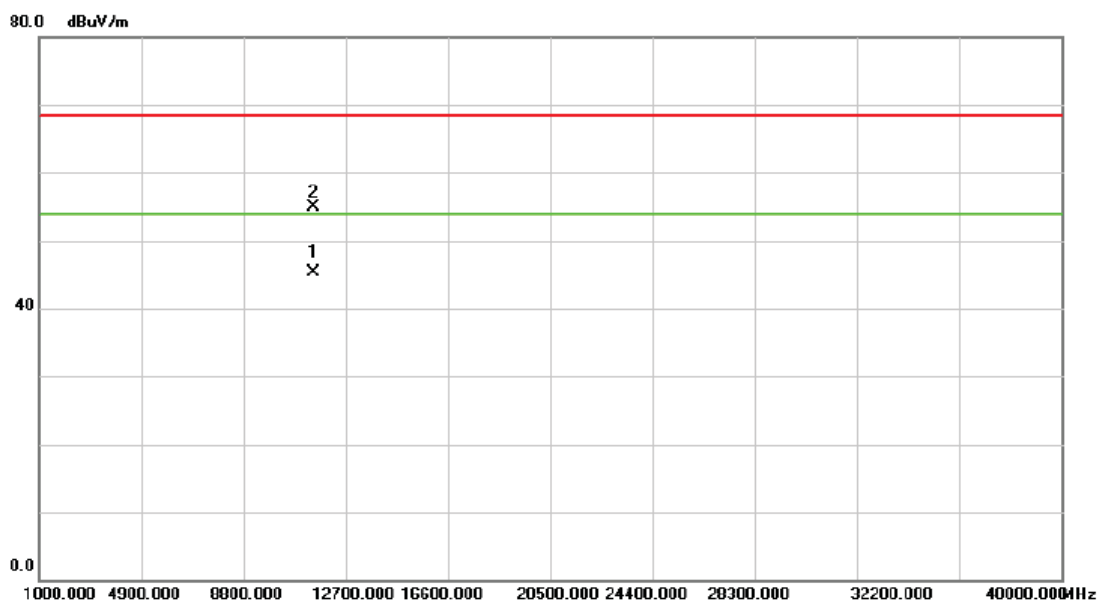

No.	Mk.	Freq. MHz	Reading Level dBuV	Correct Factor dB	Measure- ment dBuV/m	Limit dBuV/m	Margin dB	Detector	Comment
1	*	11490.12	28.32	16.91	45.23	54.00	-8.77	AVG	
2		11490.22	37.97	16.91	54.88	68.30	-13.42	peak	

Orthogonal Axis:	X
Test Mode:	UNII-3/TX A Mode 5785MHz - Internal antenna

Vertical

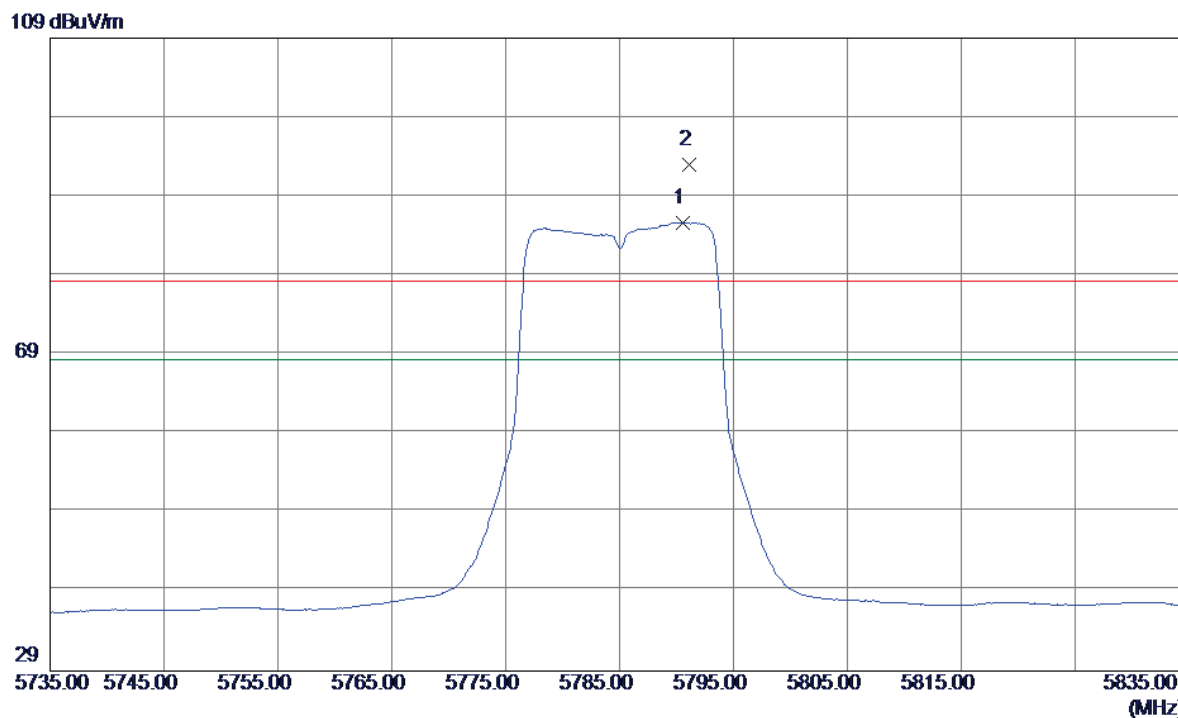

No.	Freq. MHz	Reading Level dBuV/m	Correct Factor dB	Measure ment dBuV/m	Limit dBuV/m	Over dB	Detector	Comment
1	5790.6000	44.33	41.36	85.69	68.30	17.39	AVG	No Limit
2	5791.1000	51.71	41.36	93.07	78.30	14.77	Peak	No Limit

Orthogonal Axis:	X
Test Mode:	UNII-3/TX A Mode 5785MHz - Internal antenna

Vertical

80 dBuV/m

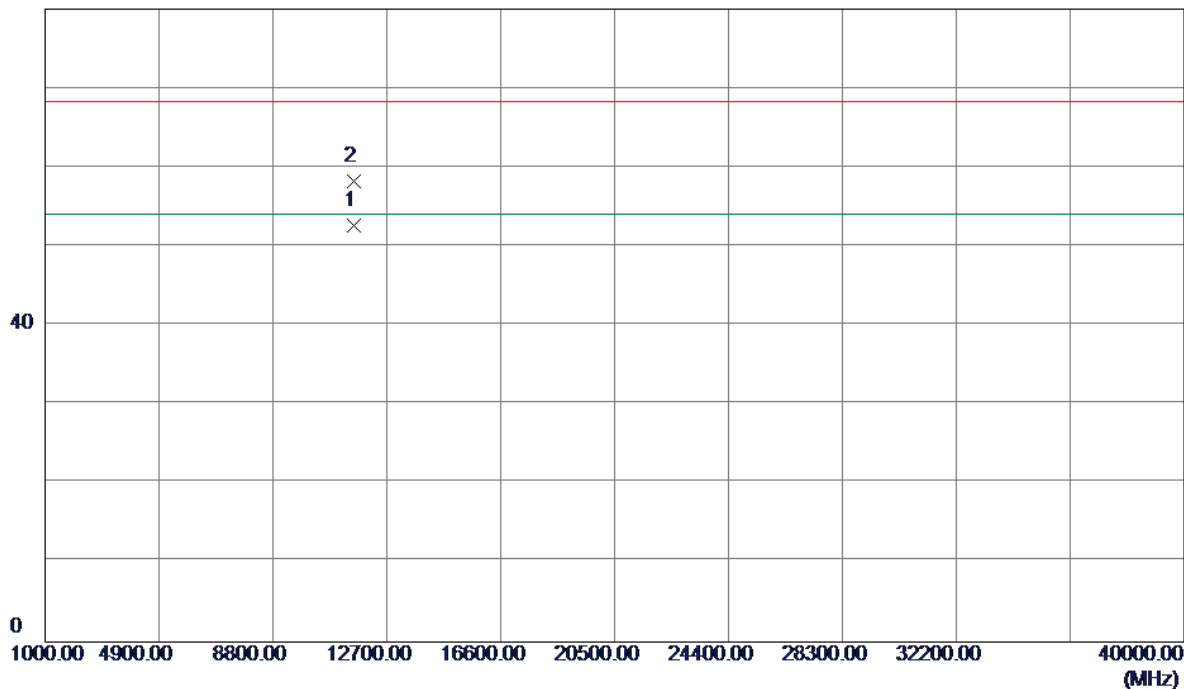

No.	Freq. MHz	Reading Level dBuV/m	Correct Factor dB	Measure ment dBuV/m	Limit dBuV/m	Over dB	Detector	Comment
1	11570.1400	35.65	17.05	52.70	54.00	-1.30	AVG	
2	11570.1600	41.26	17.05	58.31	68.30	-9.99	Peak	

Orthogonal Axis:	X
Test Mode:	UNII-3/TX A Mode 5785MHz - Internal antenna

Horizontal

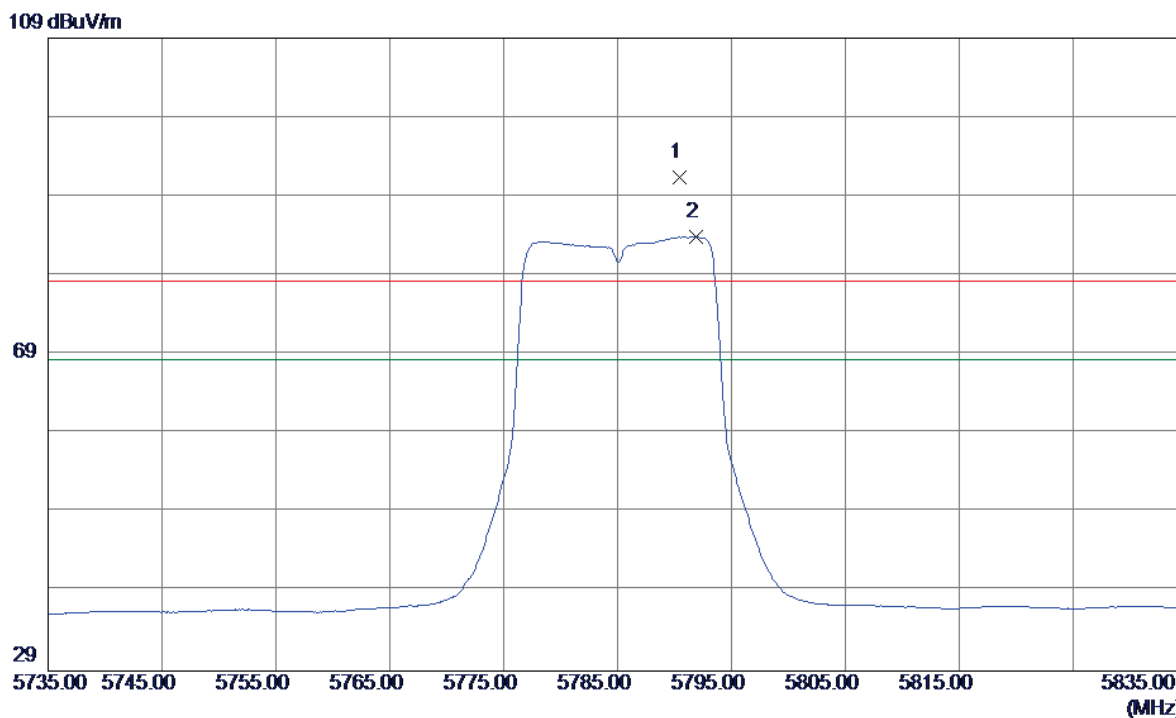

No.	Freq. MHz	Reading Level dBuV/m	Correct Factor dB	Measure ment dBuV/m	Limit dBuV/m	Over dB	Detector	Comment
1	5790.4000	49.98	41.35	91.33	78.30	13.03	Peak	No Limit
2	5791.9000	42.52	41.36	83.88	68.30	15.58	AVG	No Limit

Orthogonal Axis:	X
Test Mode:	UNII-3/TX A Mode 5785MHz - Internal antenna

Horizontal

80 dBuV/m

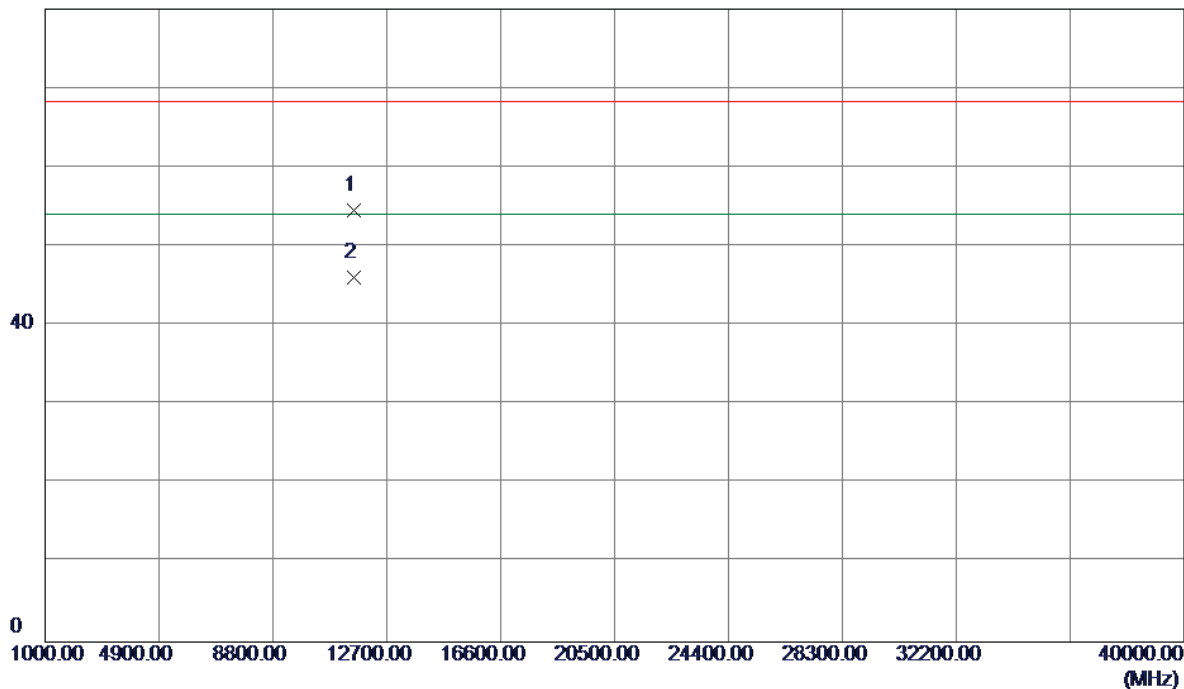

No.	Freq. MHz	Reading Level dBuV/m	Correct Factor dB	Measure ment dBuV/m	Limit dBuV/m	Over dB	Detector	Comment
1	11570.0800	37.55	17.05	54.60	68.30	-13.70	Peak	
2	11570.1300	29.09	17.05	46.14	54.00	-7.86	AVG	

Orthogonal Axis:	X
Test Mode:	UNII-3/TX A Mode 5825MHz - Internal antenna

Vertical

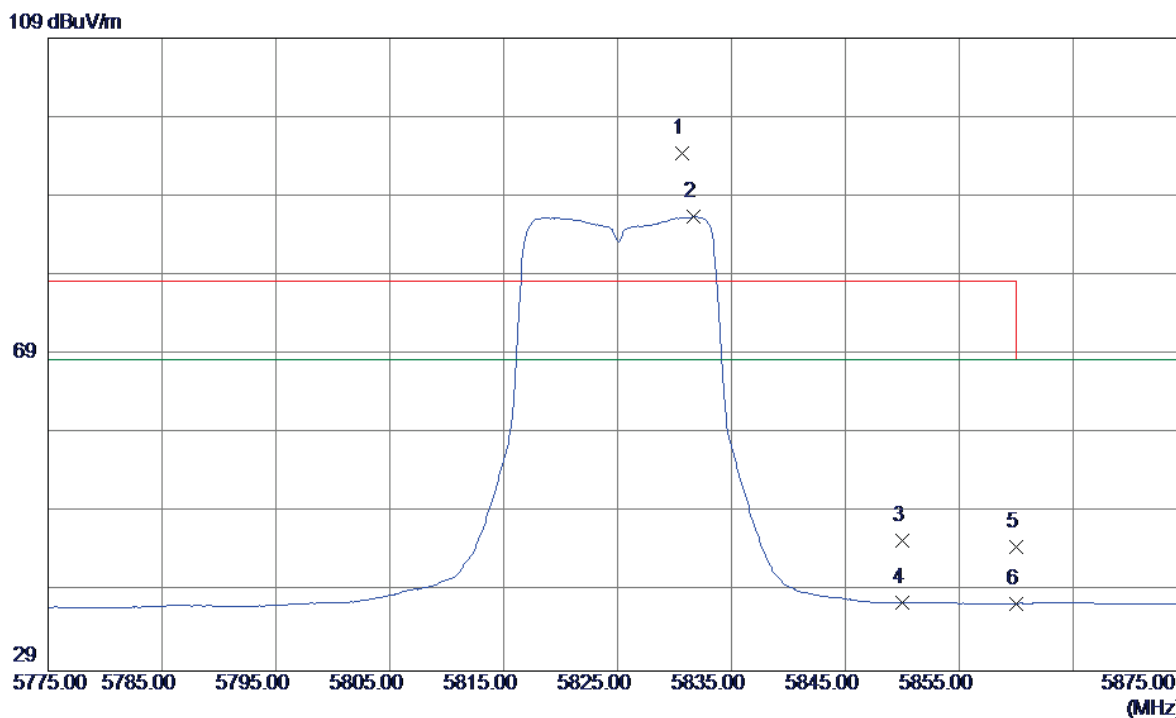

No.	Freq. MHz	Reading Level dBuV/m	Correct Factor dB	Measure ment dBuV/m	Limit dBuV/m	Over dB	Detector	Comment
1	5830.7000	52.97	41.41	94.38	78.30	16.08	Peak	No Limit
2	5831.7000	44.98	41.41	86.39	68.30	18.09	AVG	No Limit
3	5850.0000	4.11	41.44	45.55	78.30	-32.75	Peak	
4	5850.0000	-3.82	41.44	37.62	68.30	-30.68	AVG	
5	5860.0000	3.22	41.45	44.67	78.30	-33.63	Peak	
6	5860.0000	-3.91	41.45	37.54	68.30	-30.76	AVG	

Orthogonal Axis:	X
Test Mode:	UNII-3/TX A Mode 5825MHz - Internal antenna

Vertical

80 dBuV/m

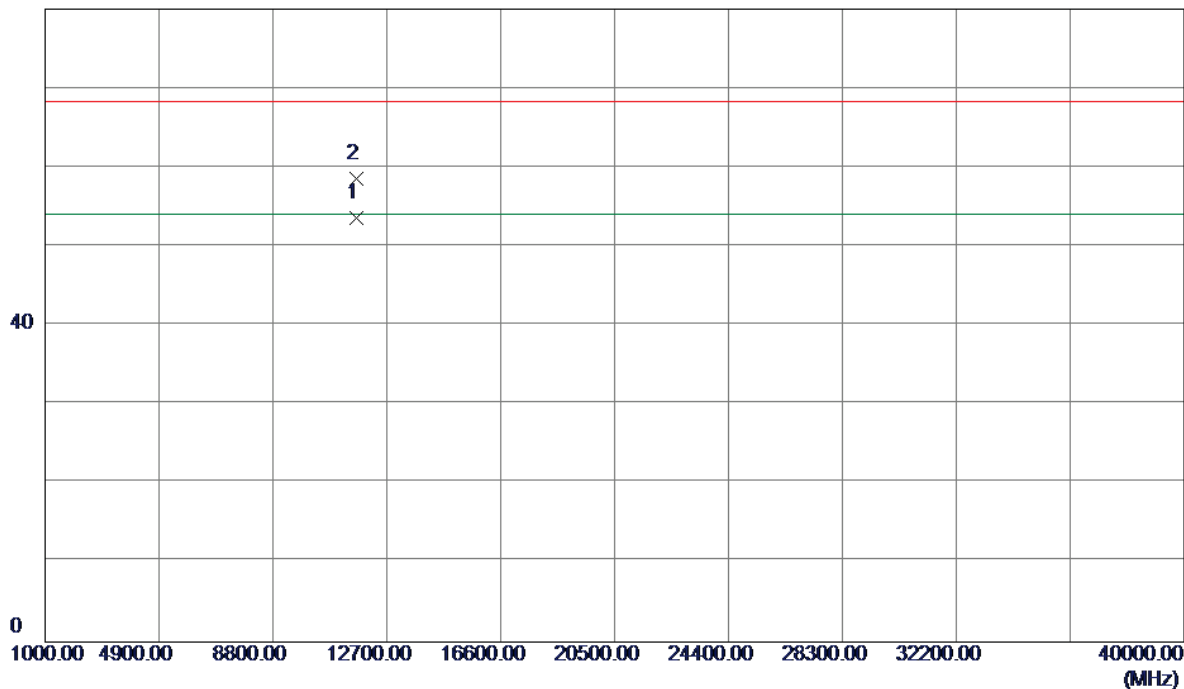

No.	Freq. MHz	Reading Level dBuV/m	Correct Factor dB	Measure ment dBuV/m	Limit dBuV/m	Over dB	Detector	Comment
1	11650.1300	36.38	17.17	53.55	54.00	-0.45	AVG	
2	11650.3600	41.40	17.17	58.57	68.30	-9.73	Peak	

Orthogonal Axis:	X
Test Mode:	UNII-3/TX A Mode 5825MHz - Internal antenna

Horizontal

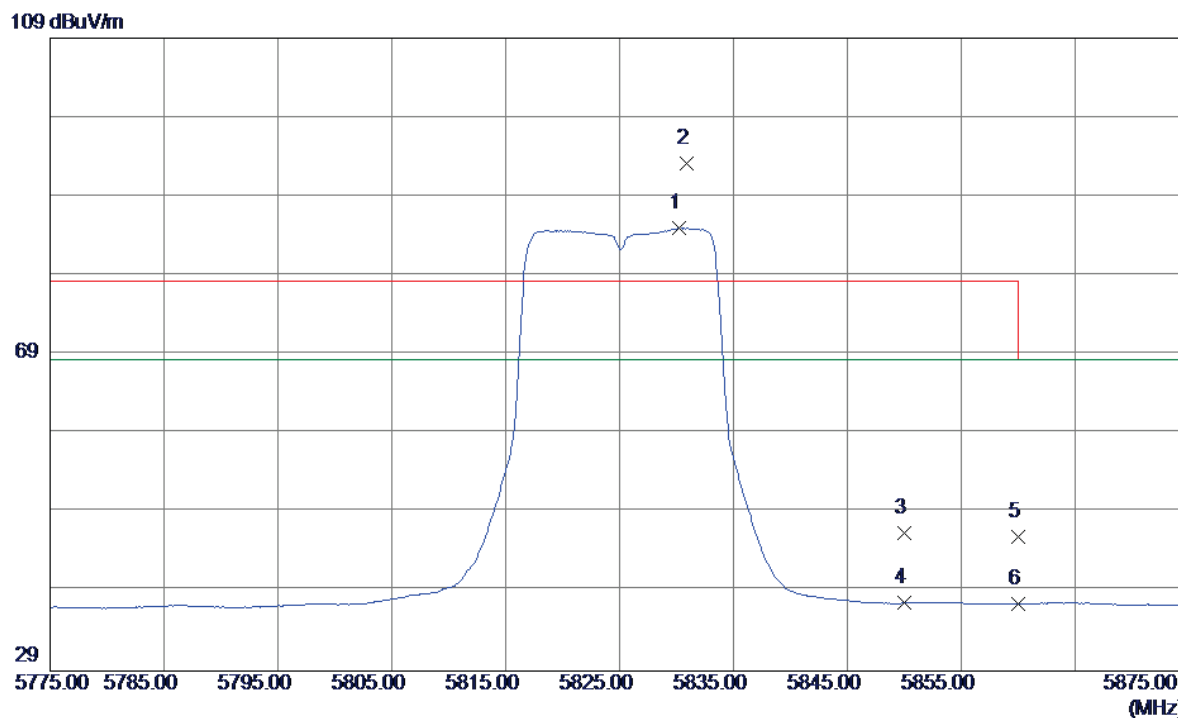

No.	Freq. MHz	Reading Level dBuV/m	Correct Factor dB	Measure ment dBuV/m	Limit dBuV/m	Over dB	Detector	Comment
1	5830.2000	43.55	41.41	84.96	68.30	16.66	AVG	No Limit
2	5830.9000	51.72	41.41	93.13	78.30	14.83	Peak	No Limit
3	5850.0000	4.96	41.44	46.40	78.30	-31.90	Peak	
4	5850.0000	-3.84	41.44	37.60	68.30	-30.70	AVG	
5	5860.0000	4.52	41.45	45.97	78.30	-32.33	Peak	
6	5860.0000	-3.99	41.45	37.46	68.30	-30.84	AVG	

Orthogonal Axis:	X
Test Mode:	UNII-3/TX A Mode 5825MHz - Internal antenna

Horizontal

80 dBuV/m

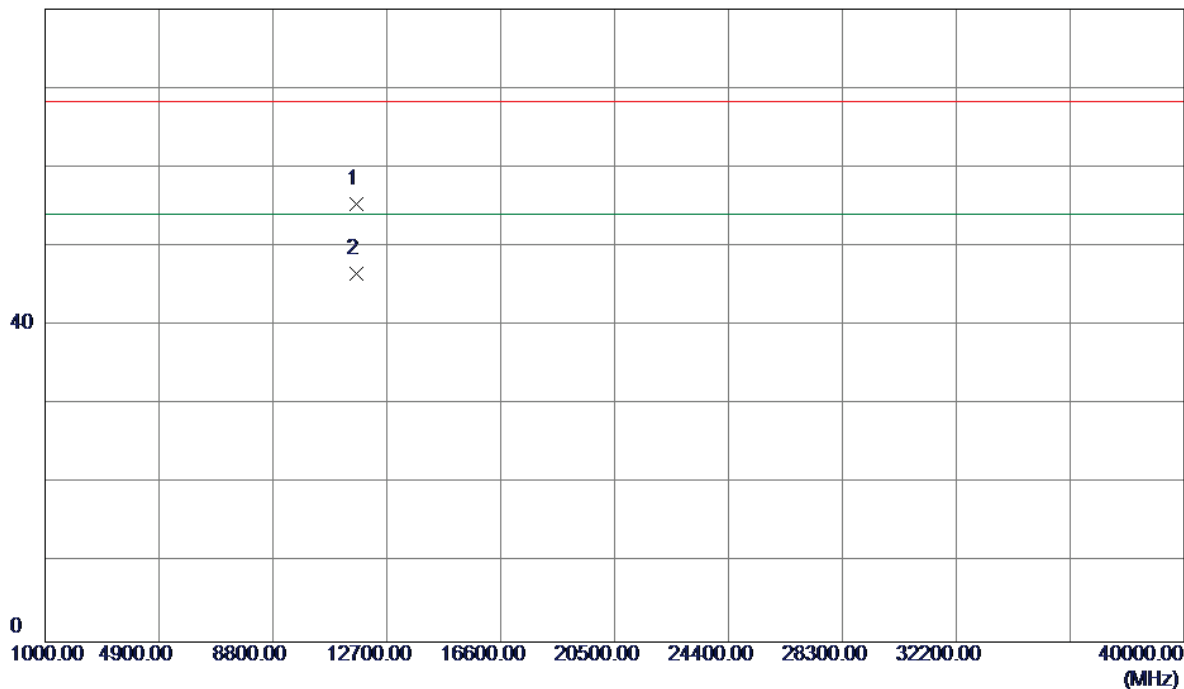

No.	Freq. MHz	Reading Level dBuV/m	Correct Factor dB	Measure ment dBuV/m	Limit dBuV/m	Over dB	Detector	Comment
1	11650.1300	38.18	17.17	55.35	68.30	-12.95	Peak	
2	11650.1500	29.45	17.17	46.62	54.00	-7.38	AVG	

Orthogonal Axis:	X
Test Mode:	UNII-3/TX N20 Mode 5745MHz- Internal antenna

Vertical

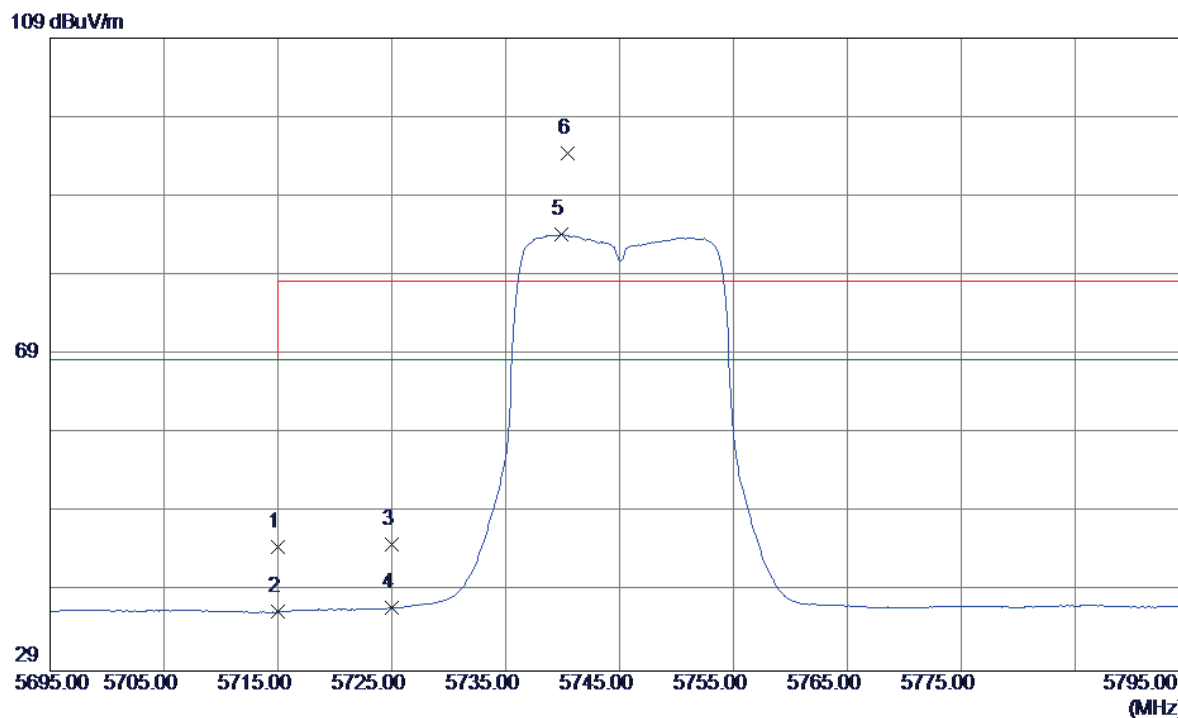

No.	Freq. MHz	Reading Level dBuV/m	Correct Factor dB	Measure ment dBuV/m	Limit dBuV/m	Over dB	Detector	Comment
1	5715.0000	3.39	41.25	44.64	68.30	-23.66	Peak	
2	5715.0000	-4.80	41.25	36.45	68.30	-31.85	AVG	
3	5725.0000	3.68	41.27	44.95	78.30	-33.35	Peak	
4	5725.0000	-4.30	41.27	36.97	68.30	-31.33	AVG	
5	5739.9000	42.90	41.29	84.19	68.30	15.89	AVG	No Limit
6	5740.4000	53.16	41.29	94.45	78.30	16.15	Peak	No Limit

Orthogonal Axis:	X
Test Mode:	UNII-3/TX N20 Mode 5745MHz- Internal antenna

Vertical

80 dBuV/m

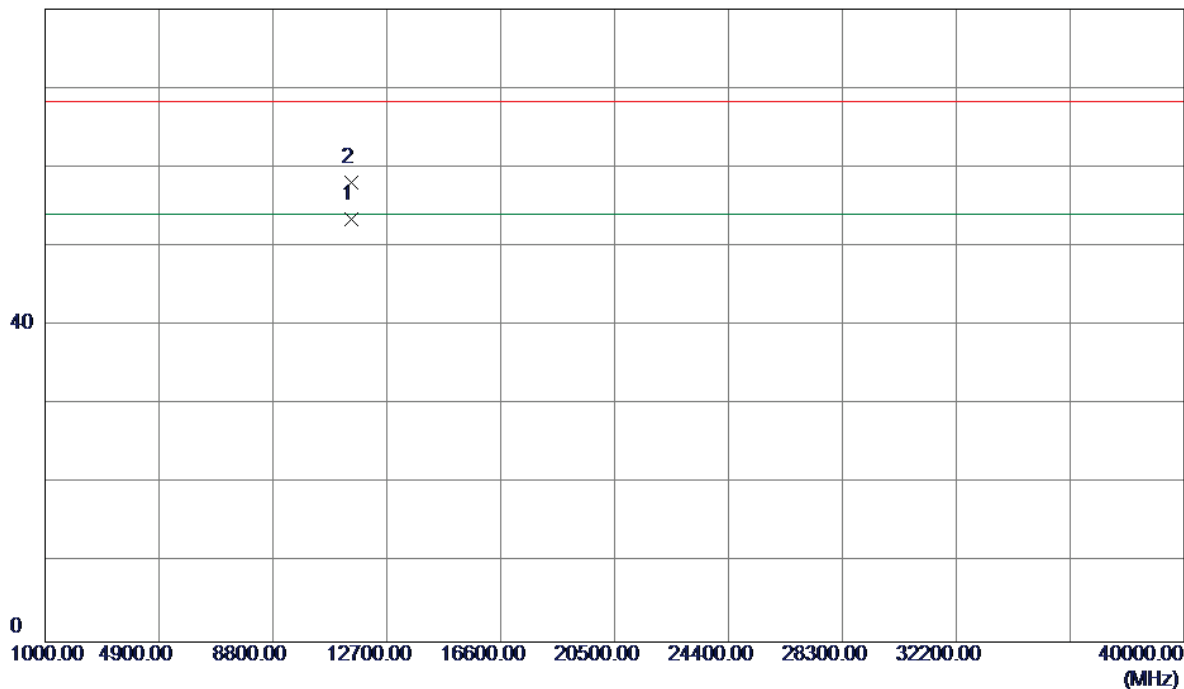

No.	Freq. MHz	Reading Level dBuV/m	Correct Factor dB	Measure ment dBuV/m	Limit dBuV/m	Over dB	Detector	Comment
1	11490.1300	36.60	16.91	53.51	54.00	-0.49	AVG	
2	11490.1700	41.11	16.91	58.02	68.30	-10.28	Peak	

Orthogonal Axis:	X
Test Mode:	UNII-3/TX N20 Mode 5745MHz- Internal antenna

Horizontal

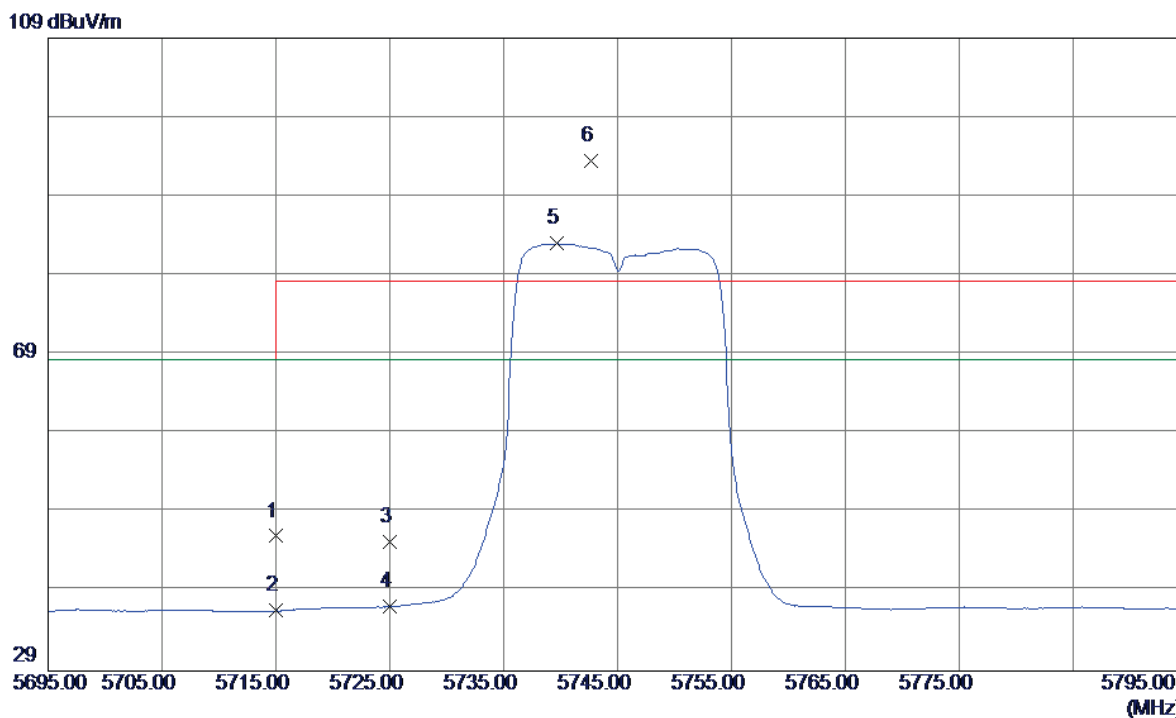

No.	Freq. MHz	Reading Level dBuV/m	Correct Factor dB	Measure ment dBuV/m	Limit dBuV/m	Over dB	Detector	Comment
1	5715.0000	4.79	41.25	46.04	68.30	-22.26	Peak	
2	5715.0000	-4.63	41.25	36.62	68.30	-31.68	AVG	
3	5725.0000	4.06	41.27	45.33	78.30	-32.97	Peak	
4	5725.0000	-4.11	41.27	37.16	68.30	-31.14	AVG	
5	5739.7000	41.73	41.29	83.02	68.30	14.72	AVG	No Limit
6	5742.7000	52.11	41.29	93.40	78.30	15.10	Peak	No Limit

Orthogonal Axis:	X
Test Mode:	UNII-3/TX N20 Mode 5745MHz- Internal antenna

Horizontal

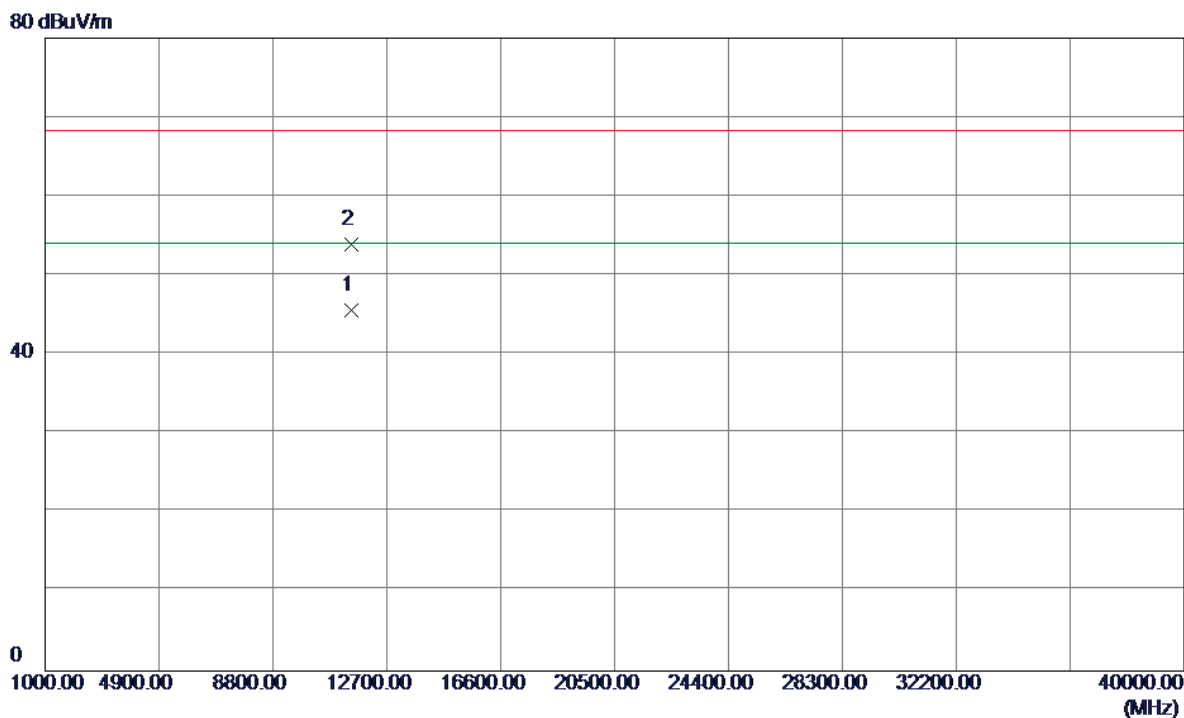

No.	Freq. MHz	Reading Level dBuV/m	Correct Factor dB	Measure ment dBuV/m	Limit dBuV/m	Over dB	Detector	Comment
1	11490.1400	28.75	16.91	45.66	54.00	-8.34	AVG	
2	11490.1600	37.01	16.91	53.92	68.30	-14.38	Peak	

Orthogonal Axis:	X
Test Mode:	UNII-3/TX N20 Mode 5785MHz - Internal antenna

Vertical

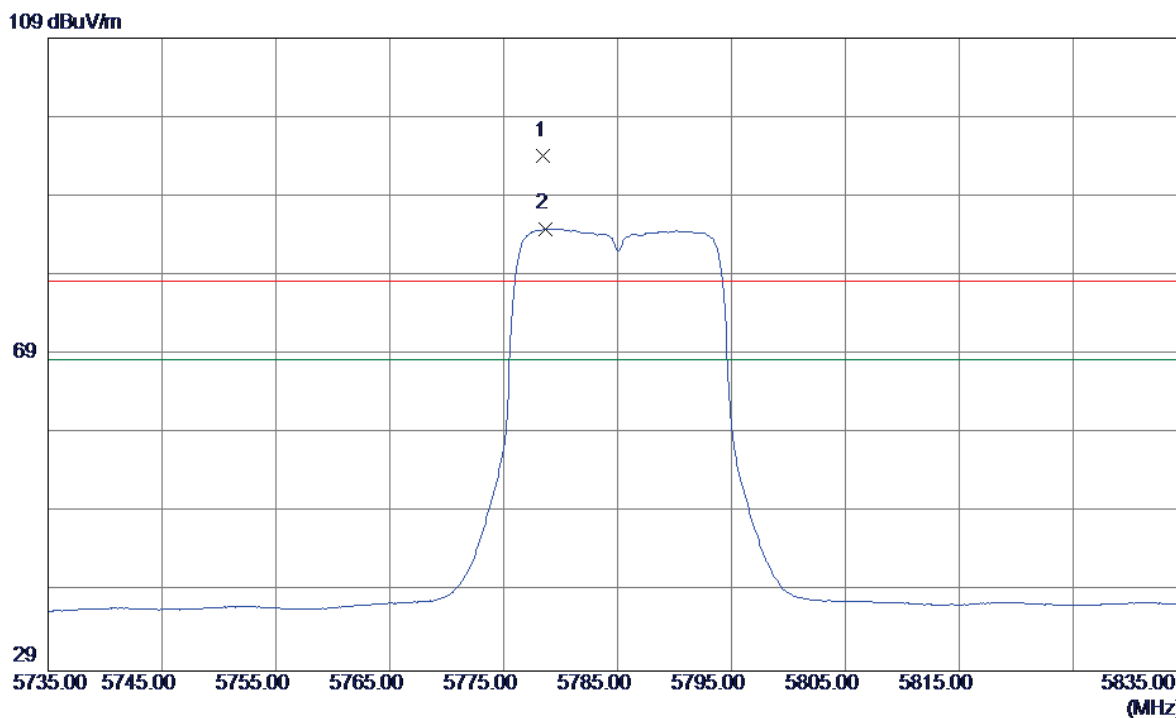

No.	Freq. MHz	Reading Level dBuV/m	Correct Factor dB	Measure ment dBuV/m	Limit dBuV/m	Over dB	Detector	Comment
1	5778.5000	52.70	41.34	94.04	78.30	15.74	Peak	No Limit
2	5778.7000	43.58	41.34	84.92	68.30	16.62	AVG	No Limit

Orthogonal Axis:	X
Test Mode:	UNII-3/TX N20 Mode 5785MHz - Internal antenna

Vertical

80 dBuV/m

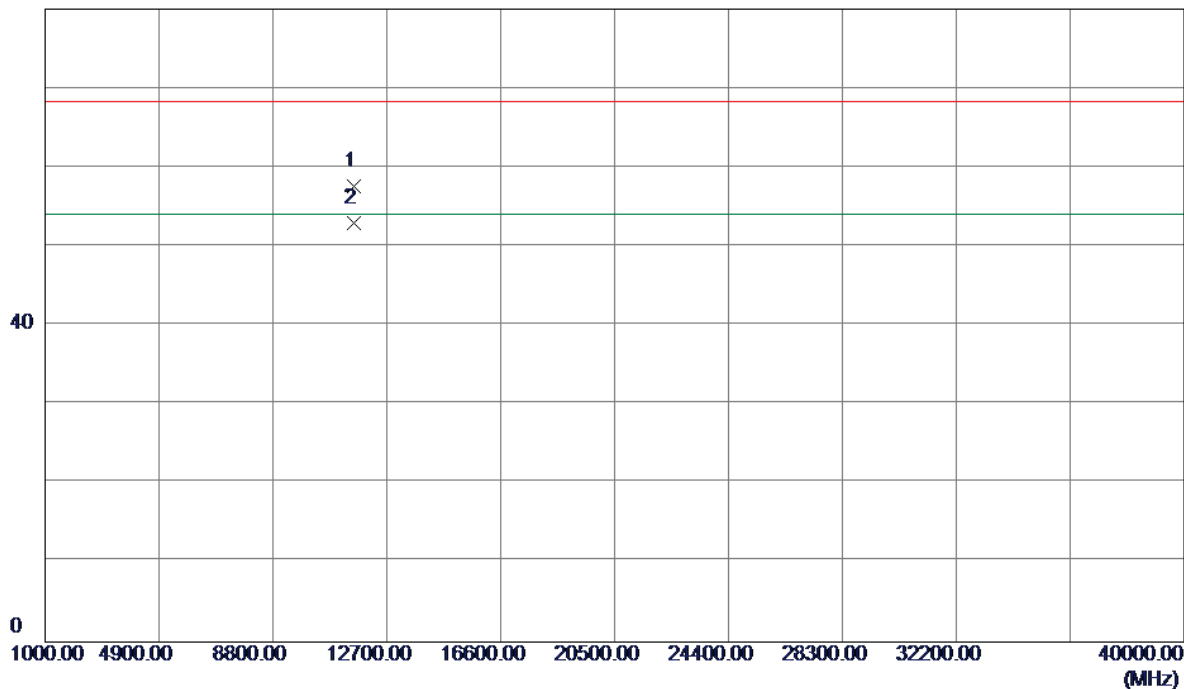

No.	Freq. MHz	Reading Level dBuV/m	Correct Factor dB	Measure ment dBuV/m	Limit dBuV/m	Over dB	Detector	Comment
1	11570.0800	40.50	17.05	57.55	68.30	-10.75	Peak	
2	11570.1300	35.84	17.05	52.89	54.00	-1.11	AVG	

Orthogonal Axis:	X
Test Mode:	UNII-3/TX N20 Mode 5785MHz - Internal antenna

Horizontal

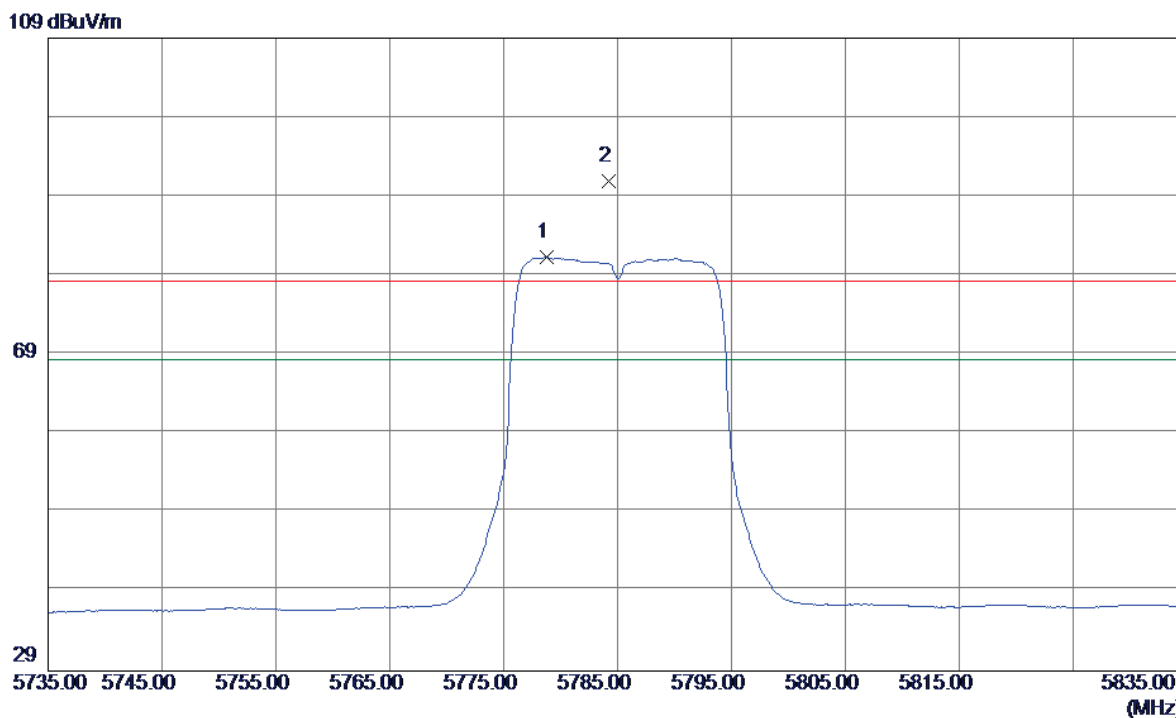

No.	Freq. MHz	Reading Level dBuV/m	Correct Factor dB	Measure ment dBuV/m	Limit dBuV/m	Over dB	Detector	Comment
1	5778.8000	39.99	41.34	81.33	68.30	13.03	AVG	No Limit
2	5784.2000	49.54	41.35	90.89	78.30	12.59	Peak	No Limit

Orthogonal Axis:	X
Test Mode:	UNII-3/TX N20 Mode 5785MHz - Internal antenna

Horizontal

80 dBuV/m

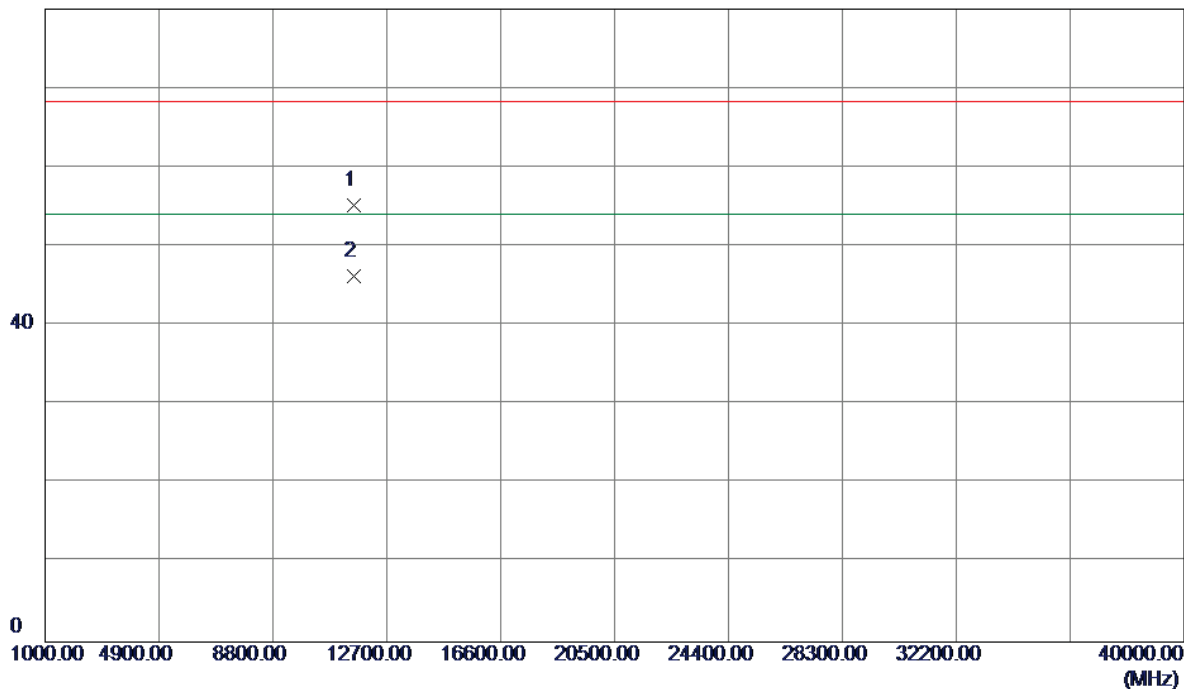

No.	Freq. MHz	Reading Level dBuV/m	Correct Factor dB	Measure ment dBuV/m	Limit dBuV/m	Over dB	Detector	Comment
1	11570.1000	38.10	17.05	55.15	68.30	-13.15	Peak	
2	11570.1400	29.24	17.05	46.29	54.00	-7.71	AVG	

Orthogonal Axis:	X
Test Mode:	UNII-3/TX N20 Mode 5825MHz - Internal antenna

Vertical

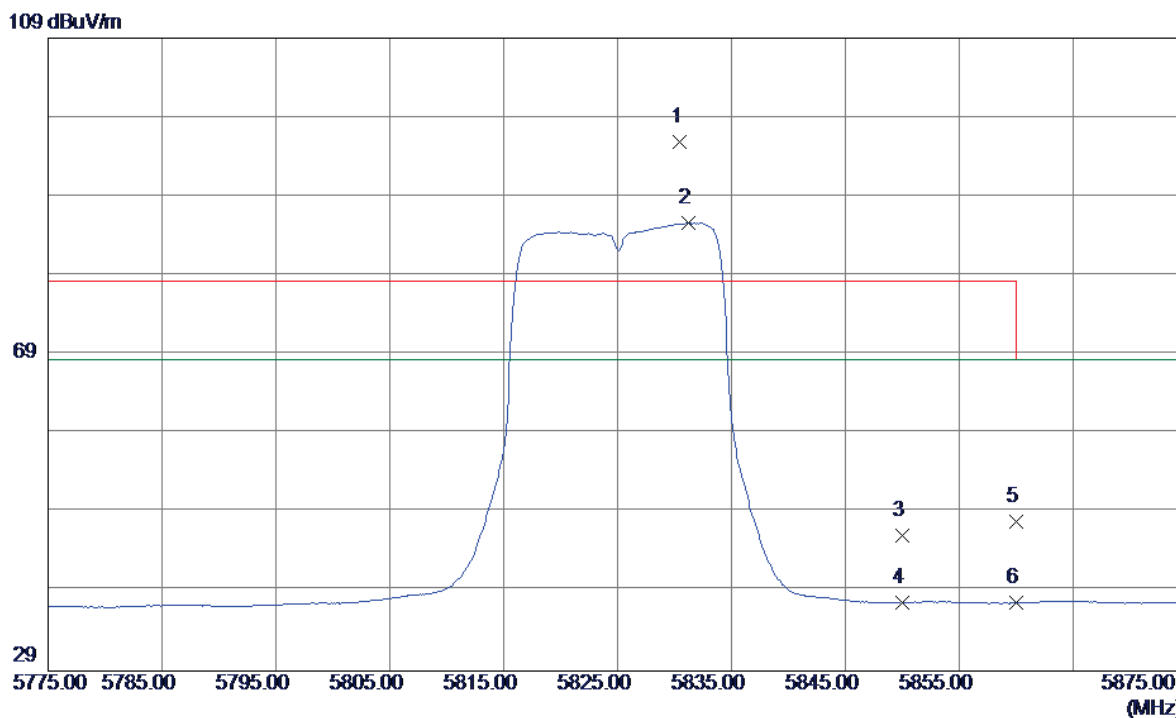

No.	Freq. MHz	Reading Level dBuV/m	Correct Factor dB	Measure ment dBuV/m	Limit dBuV/m	Over dB	Detector	Comment
1	5830.5000	54.54	41.41	95.95	78.30	17.65	Peak	No Limit
2	5831.2000	44.25	41.41	85.66	68.30	17.36	AVG	No Limit
3	5850.0000	4.74	41.44	46.18	78.30	-32.12	Peak	
4	5850.0000	-3.73	41.44	37.71	68.30	-30.59	AVG	
5	5860.0000	6.40	41.45	47.85	78.30	-30.45	Peak	
6	5860.0000	-3.82	41.45	37.63	68.30	-30.67	AVG	

Orthogonal Axis:	X
Test Mode:	UNII-3/TX N20 Mode 5825MHz - Internal antenna

Vertical

80 dBuV/m

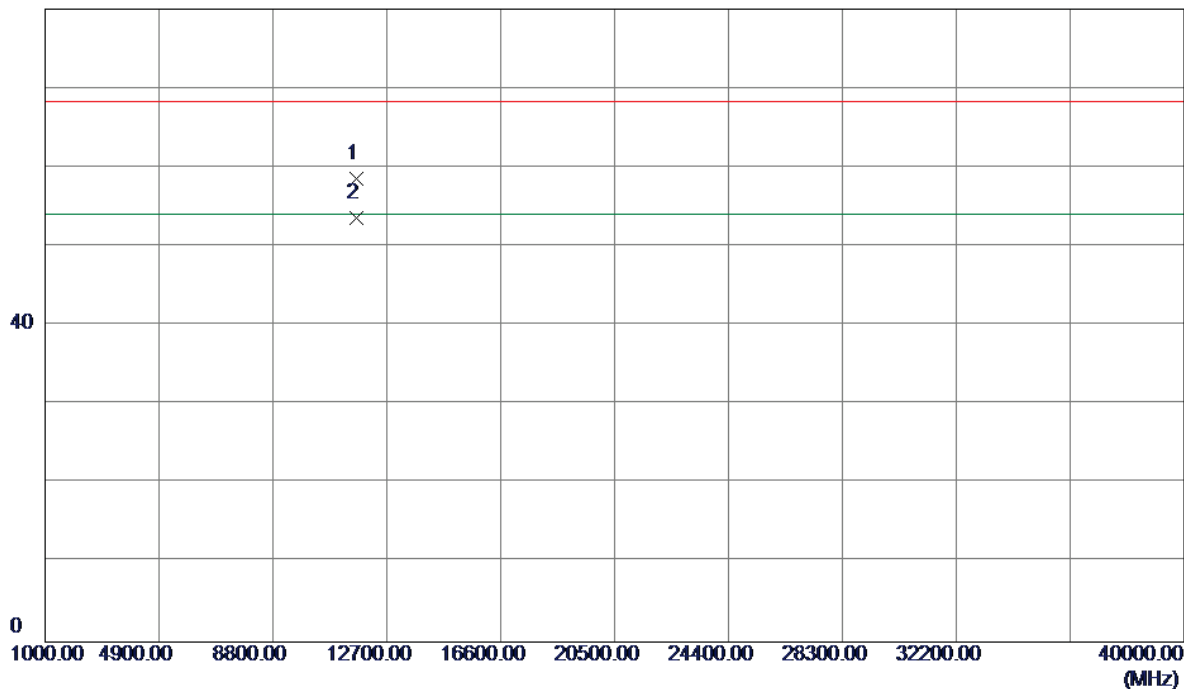

No.	Freq. MHz	Reading Level dBuV/m	Correct Factor dB	Measure ment dBuV/m	Limit dBuV/m	Over dB	Detector	Comment
1	11650.0599	41.32	17.17	58.49	68.30	-9.81	Peak	
2	11650.1500	36.48	17.17	53.65	54.00	-0.35	AVG	

Orthogonal Axis:	X
Test Mode:	UNII-3/TX N20 Mode 5825MHz - Internal antenna

Horizontal

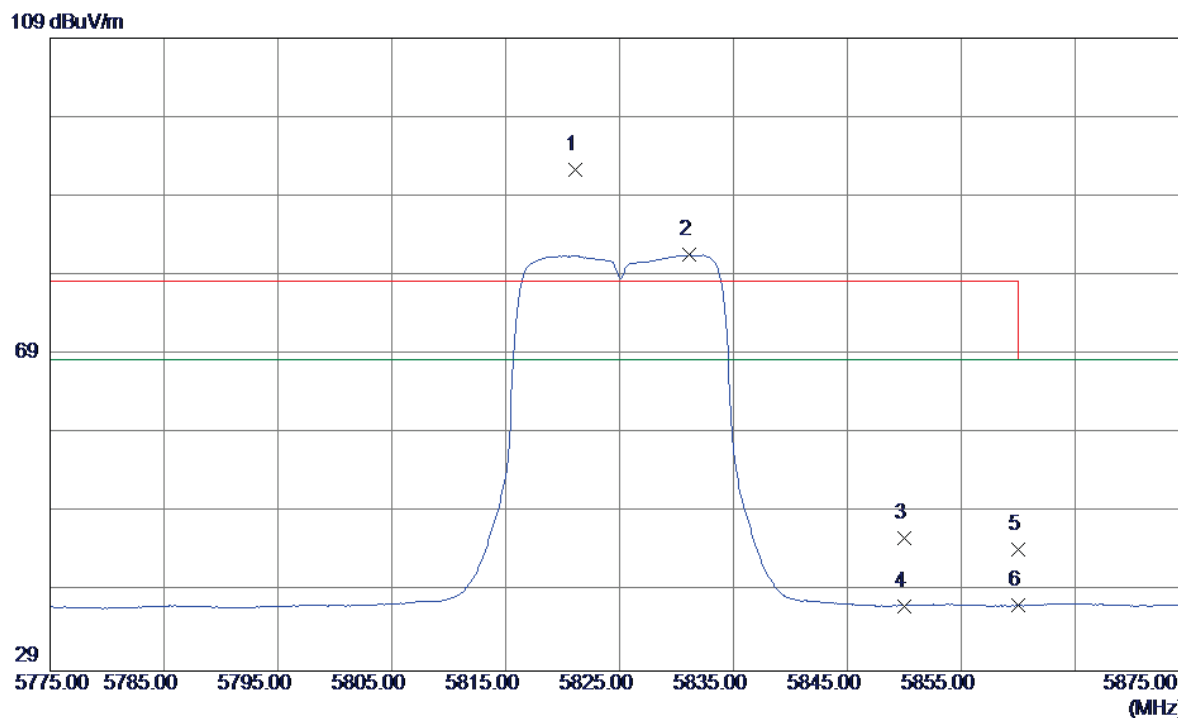

No.	Freq. MHz	Reading Level dBuV/m	Correct Factor dB	Measure ment dBuV/m	Limit dBuV/m	Over dB	Detector	Comment
1	5821.1000	50.92	41.40	92.32	78.30	14.02	Peak	No Limit
2	5831.1000	40.18	41.41	81.59	68.30	13.29	AVG	No Limit
3	5850.0000	4.29	41.44	45.73	78.30	-32.57	Peak	
4	5850.0000	-4.23	41.44	37.21	68.30	-31.09	AVG	
5	5860.0000	2.93	41.45	44.38	78.30	-33.92	Peak	
6	5860.0000	-4.15	41.45	37.30	68.30	-31.00	AVG	

Orthogonal Axis:	X
Test Mode:	UNII-3/TX N20 Mode 5825MHz - Internal antenna

Horizontal

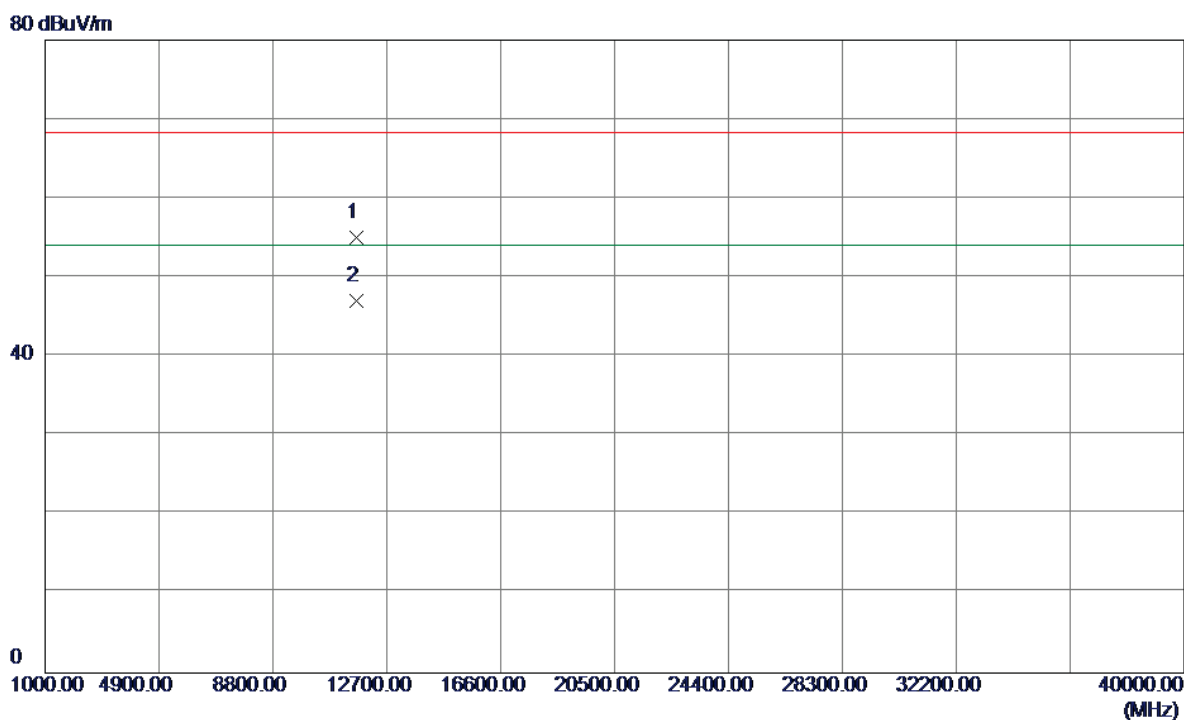

No.	Freq. MHz	Reading Level dBuV/m	Correct Factor dB	Measure ment dBuV/m	Limit dBuV/m	Over dB	Detector	Comment
1	11649.9600	37.87	17.17	55.04	68.30	-13.26	Peak	
2	11650.1500	29.88	17.17	47.05	54.00	-6.95	AVG	

Orthogonal Axis:	X
Test Mode:	UNII-3/TX N40 Mode 5755MHz - Internal antenna

Vertical

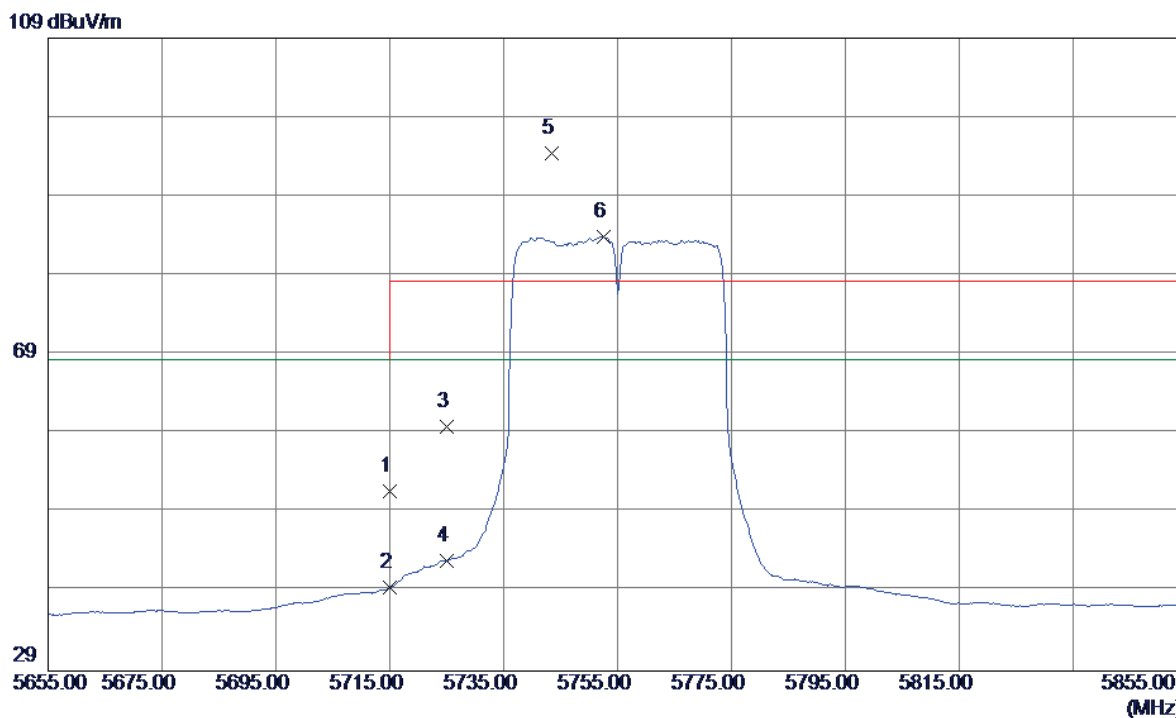

No.	Freq. MHz	Reading Level dBuV/m	Correct Factor dB	Measure ment dBuV/m	Limit dBuV/m	Over dB	Detector	Comment
1	5715.0000	10.49	41.25	51.74	68.30	-16.56	Peak	
2	5715.0000	-1.76	41.25	39.49	68.30	-28.81	AVG	
3	5725.0000	18.66	41.27	59.93	78.30	-18.37	Peak	
4	5725.0000	1.58	41.27	42.85	68.30	-25.45	AVG	
5	5743.4000	53.19	41.29	94.48	78.30	16.18	Peak	No Limit
6	5752.6000	42.64	41.30	83.94	68.30	15.64	AVG	No Limit

Orthogonal Axis:	X
Test Mode:	UNII-3/TX N40 Mode 5755MHz- Internal antenna

Vertical

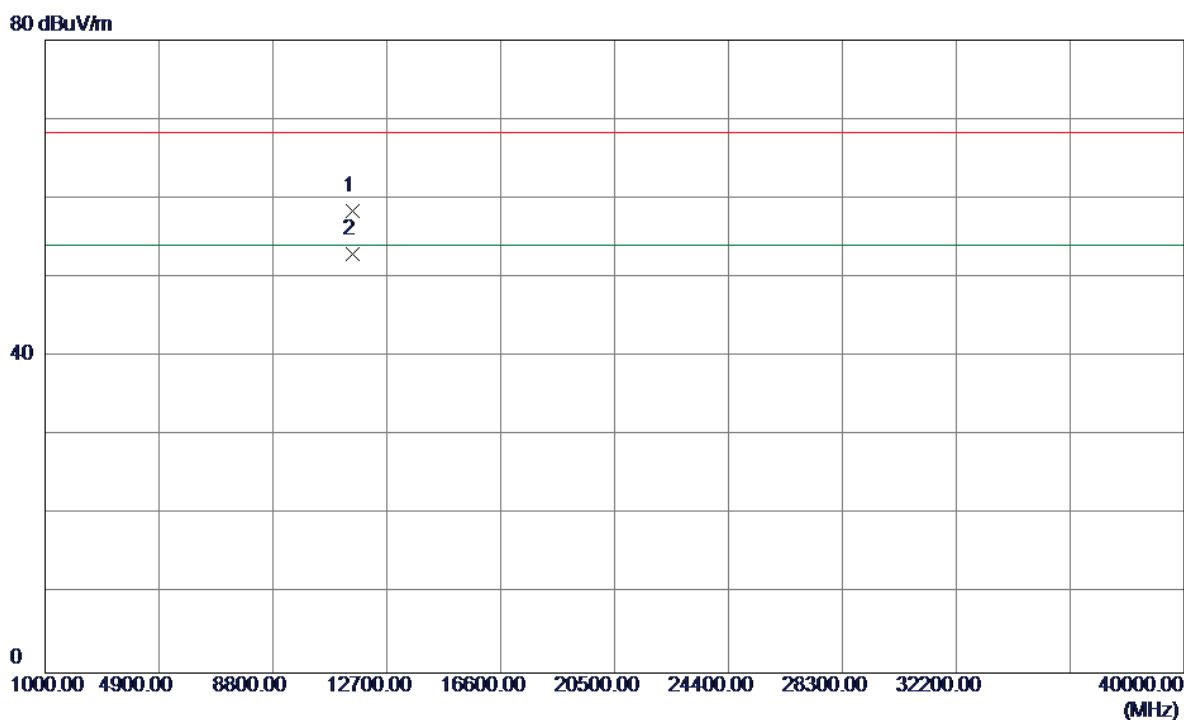

No.	Freq. MHz	Reading Level dBuV/m	Correct Factor dB	Measure ment dBuV/m	Limit dBuV/m	Over dB	Detector	Comment
1	11510.1000	41.45	16.95	58.40	68.30	-9.90	Peak	
2	11510.1400	36.08	16.95	53.03	54.00	-0.97	AVG	

Orthogonal Axis:	X
Test Mode:	UNII-3/TX N40 Mode 5755MHz- Internal antenna

Horizontal

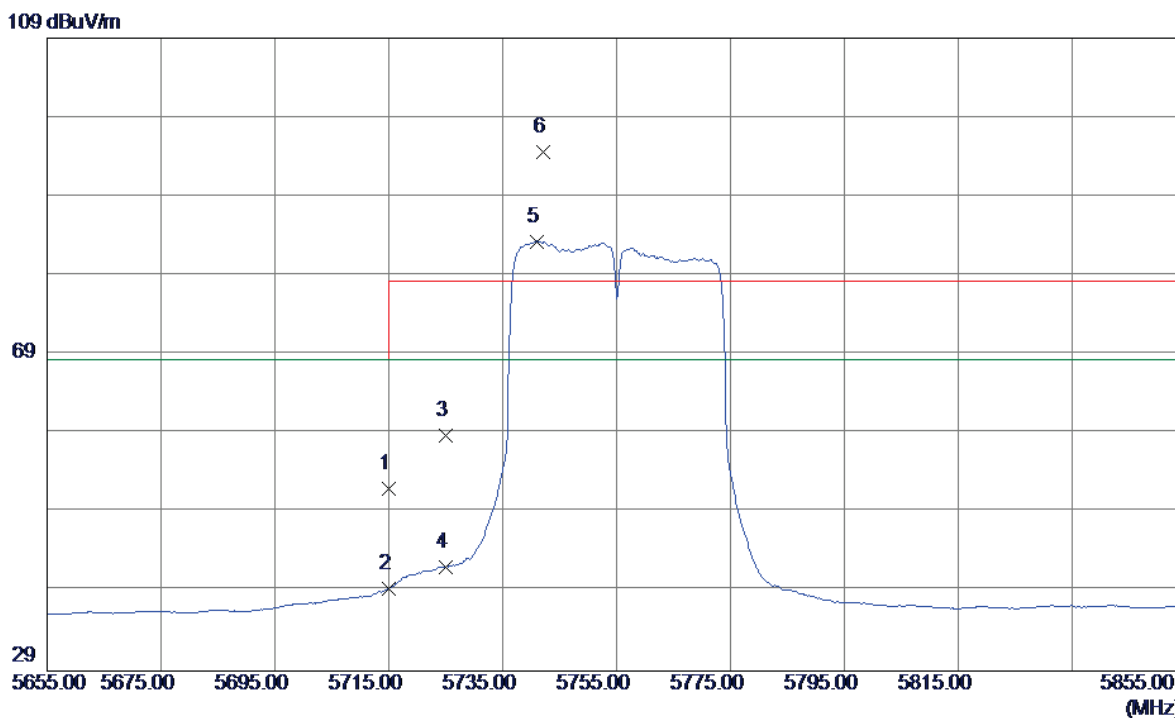

No.	Freq. MHz	Reading Level dBuV/m	Correct Factor dB	Measure ment dBuV/m	Limit dBuV/m	Over dB	Detector	Comment
1	5715.0000	10.80	41.25	52.05	68.30	-16.25	Peak	
2	5715.0000	-1.86	41.25	39.39	68.30	-28.91	AVG	
3	5725.0000	17.55	41.27	58.82	78.30	-19.48	Peak	
4	5725.0000	0.81	41.27	42.08	68.30	-26.22	AVG	
5	5741.0000	42.03	41.29	83.32	68.30	15.02	AVG	No Limit
6	5742.2000	53.29	41.29	94.58	78.30	16.28	Peak	No Limit

Orthogonal Axis:	X
Test Mode:	UNII-3/TX N40 Mode 5755MHz- Internal antenna

Horizontal

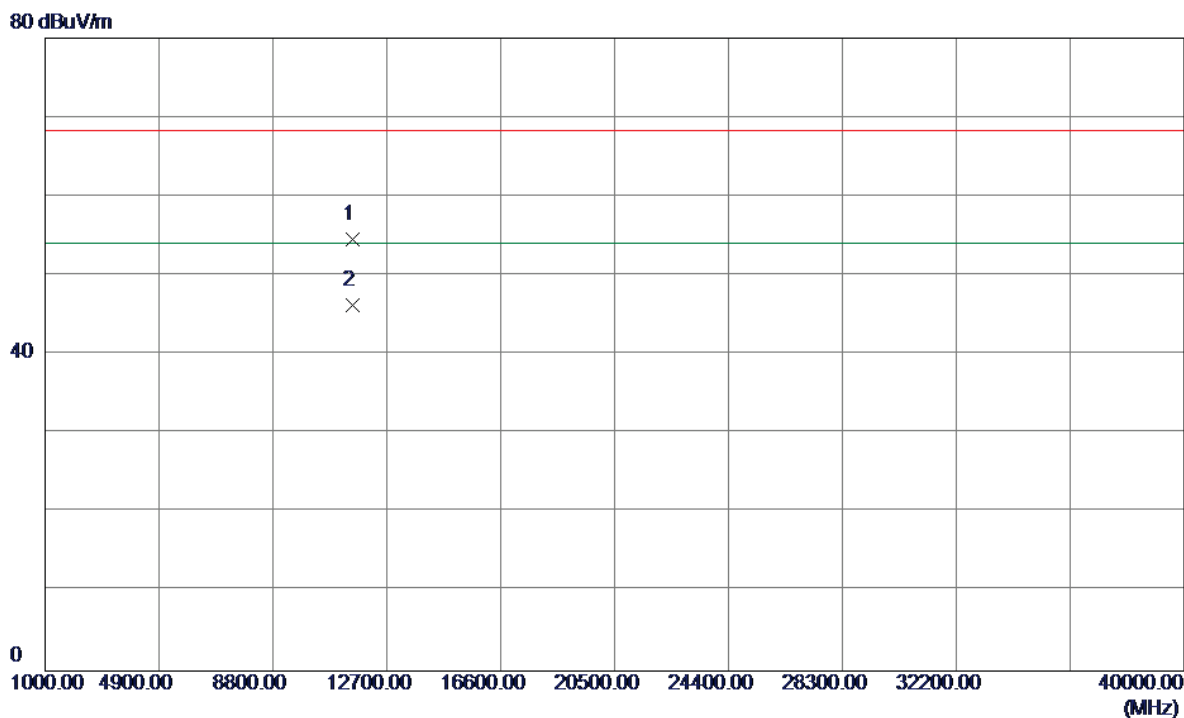

No.	Freq. MHz	Reading Level dBuV/m	Correct Factor dB	Measure ment dBuV/m	Limit dBuV/m	Over dB	Detector	Comment
1	11509.8600	37.68	16.95	54.63	68.30	-13.67	Peak	
2	11510.1300	29.31	16.95	46.26	54.00	-7.74	AVG	

Orthogonal Axis:	X
Test Mode:	UNII-3/TX N40 Mode 5795MHz- Internal antenna

Vertical

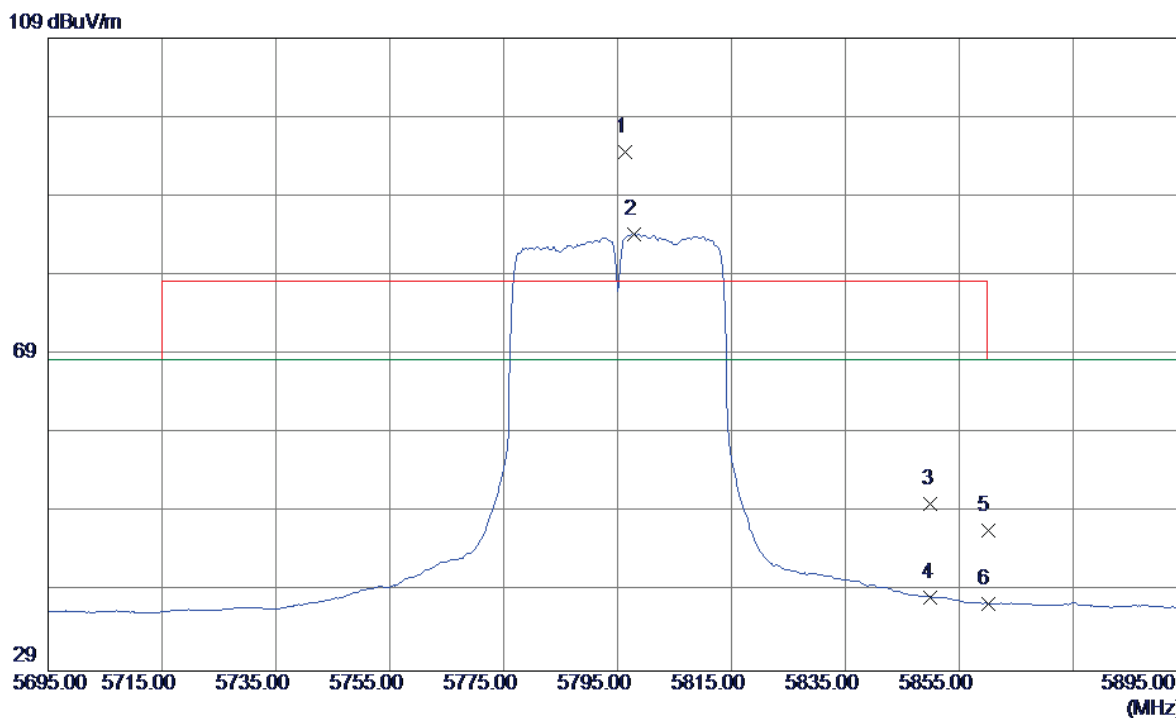

No.	Freq. MHz	Reading Level dBuV/m	Correct Factor dB	Measure ment dBuV/m	Limit dBuV/m	Over dB	Detector	Comment
1	5796.4000	53.17	41.36	94.53	78.30	16.23	Peak	No Limit
2	5797.8000	42.88	41.37	84.25	68.30	15.95	AVG	No Limit
3	5850.0000	8.64	41.44	50.08	78.30	-28.22	Peak	
4	5850.0000	-3.11	41.44	38.33	68.30	-29.97	AVG	
5	5860.0000	5.33	41.45	46.78	78.30	-31.52	Peak	
6	5860.0000	-3.90	41.45	37.55	68.30	-30.75	AVG	

Orthogonal Axis:	X
Test Mode:	UNII-3/TX N40 Mode 5795MHz- Internal antenna

Vertical

80 dBuV/m

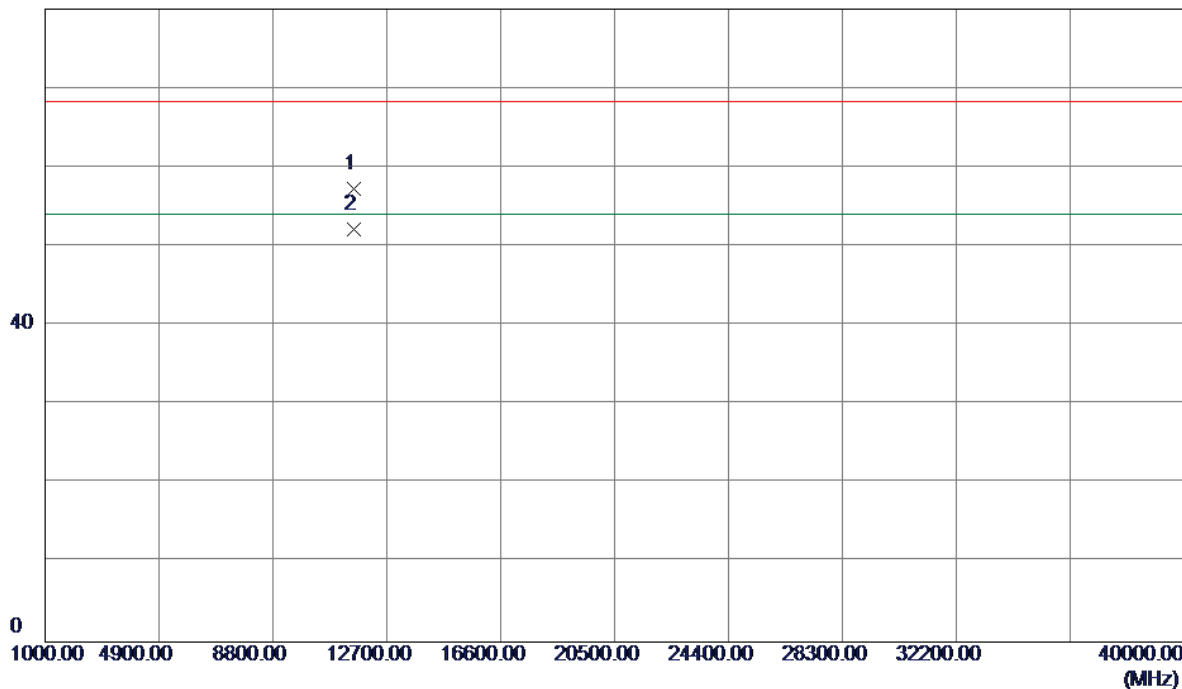

No.	Freq. MHz	Reading Level dBuV/m	Correct Factor dB	Measure ment dBuV/m	Limit dBuV/m	Over dB	Detector	Comment
1	11590.0800	40.26	17.08	57.34	68.30	-10.96	Peak	
2	11590.1400	35.09	17.08	52.17	54.00	-1.83	AVG	

Orthogonal Axis:	X
Test Mode:	UNII-3/TX N40 Mode 5795MHz- Internal antenna

Horizontal

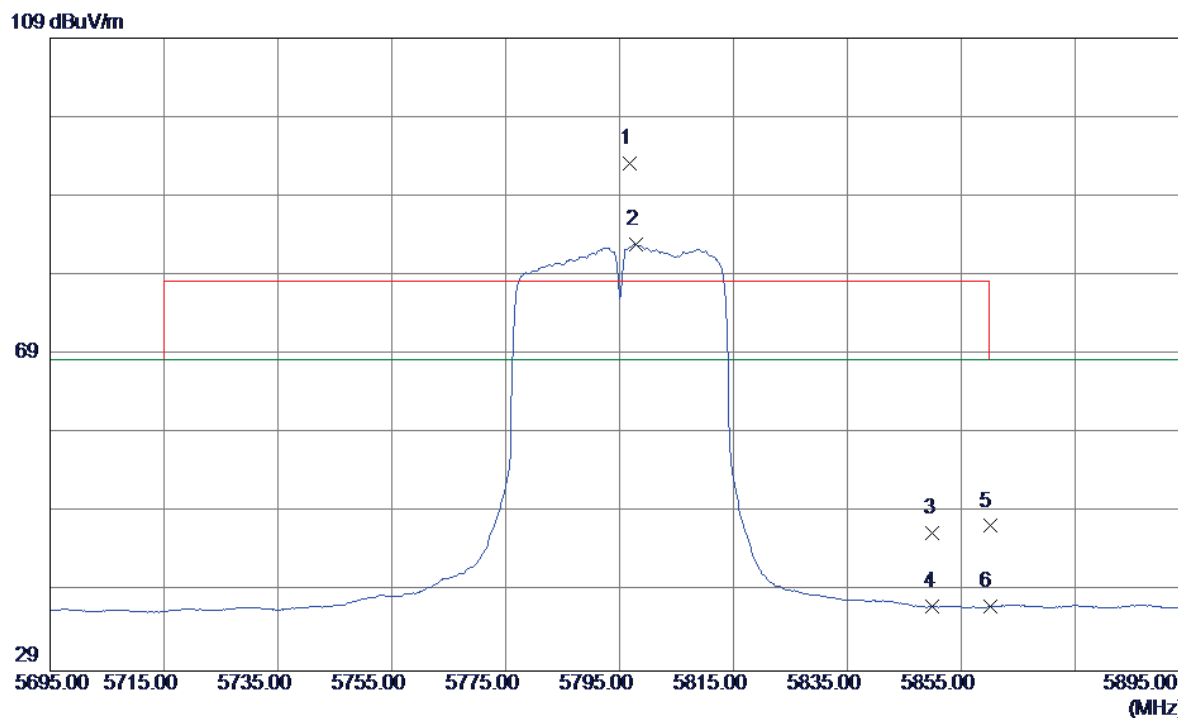

No.	Freq. MHz	Reading Level dBuV/m	Correct Factor dB	Measure ment dBuV/m	Limit dBuV/m	Over dB	Detector	Comment
1	5796.8000	51.76	41.36	93.12	78.30	14.82	Peak	No Limit
2	5797.8000	41.50	41.37	82.87	68.30	14.57	AVG	No Limit
3	5850.0000	4.94	41.44	46.38	78.30	-31.92	Peak	
4	5850.0000	-4.34	41.44	37.10	68.30	-31.20	AVG	
5	5860.0000	5.87	41.45	47.32	78.30	-30.98	Peak	
6	5860.0000	-4.33	41.45	37.12	68.30	-31.18	AVG	

Orthogonal Axis:	X
Test Mode:	UNII-3/TX N40 Mode 5795MHz- Internal antenna

Horizontal

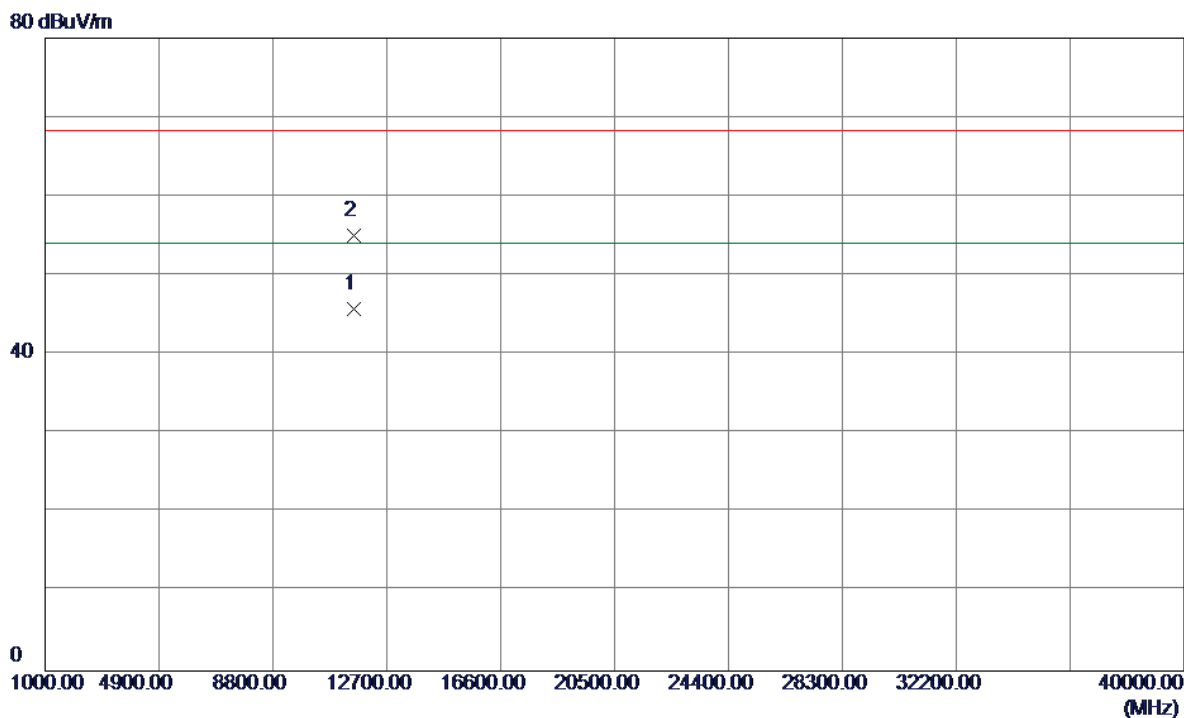

No.	Freq. MHz	Reading Level dBuV/m	Correct Factor dB	Measure ment dBuV/m	Limit dBuV/m	Over dB	Detector	Comment
1	11590.1700	28.72	17.08	45.80	54.00	-8.20	AVG	
2	11590.3000	37.98	17.08	55.06	68.30	-13.24	Peak	

Orthogonal Axis:	X
Test Mode:	UNII-1/ TX AC20 Mode 5180MHz - Internal antenna

Vertical

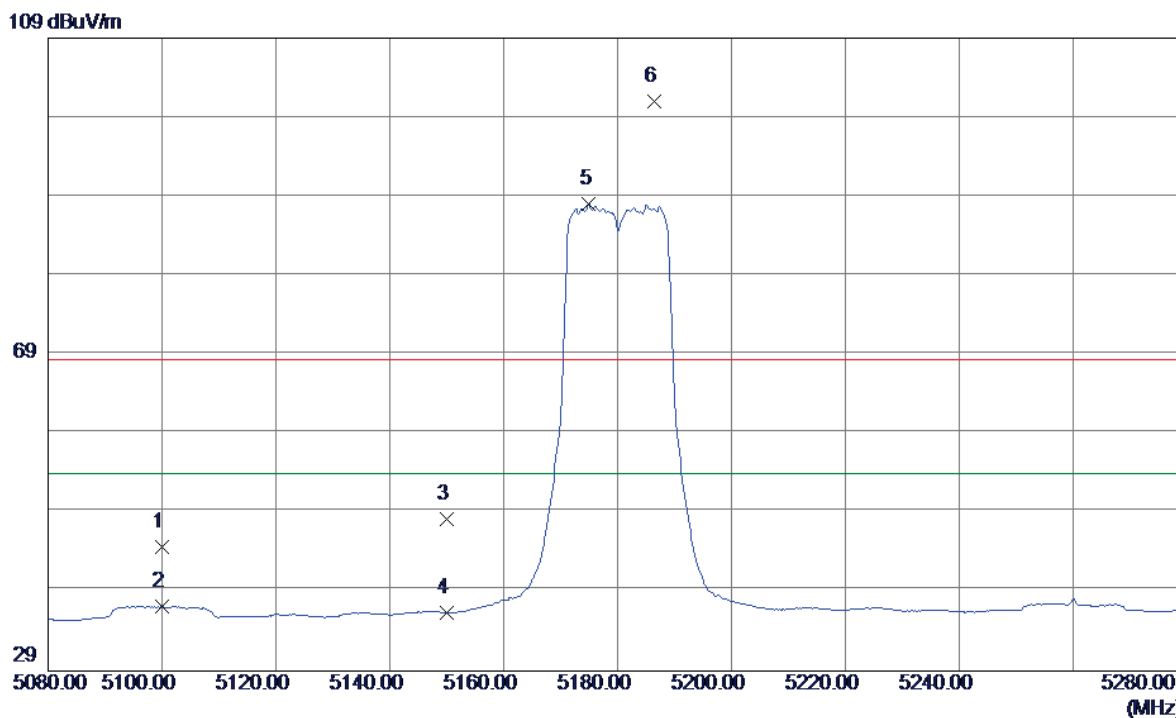

No.	Freq. MHz	Reading Level dBuV/m	Correct Factor dB	Measure ment dBuV/m	Limit dBuV/m	Over dB	Detector	Comment
1	5100.0000	4.58	40.11	44.69	68.30	-23.61	Peak	
2	5100.0000	-2.93	40.11	37.18	54.00	-16.82	AVG	
3	5150.0000	7.98	40.22	48.20	68.30	-20.10	Peak	
4	5150.0000	-3.86	40.22	36.36	54.00	-17.64	AVG	
5	5175.0000	47.70	40.27	87.97	54.00	33.97	AVG	No Limit
6	5186.4000	60.70	40.30	101.00	68.30	32.70	Peak	No Limit

Orthogonal Axis:	X
Test Mode:	UNII-1/ TX AC20 Mode 5180MHz- Internal antenna

Vertical

80 dBuV/m

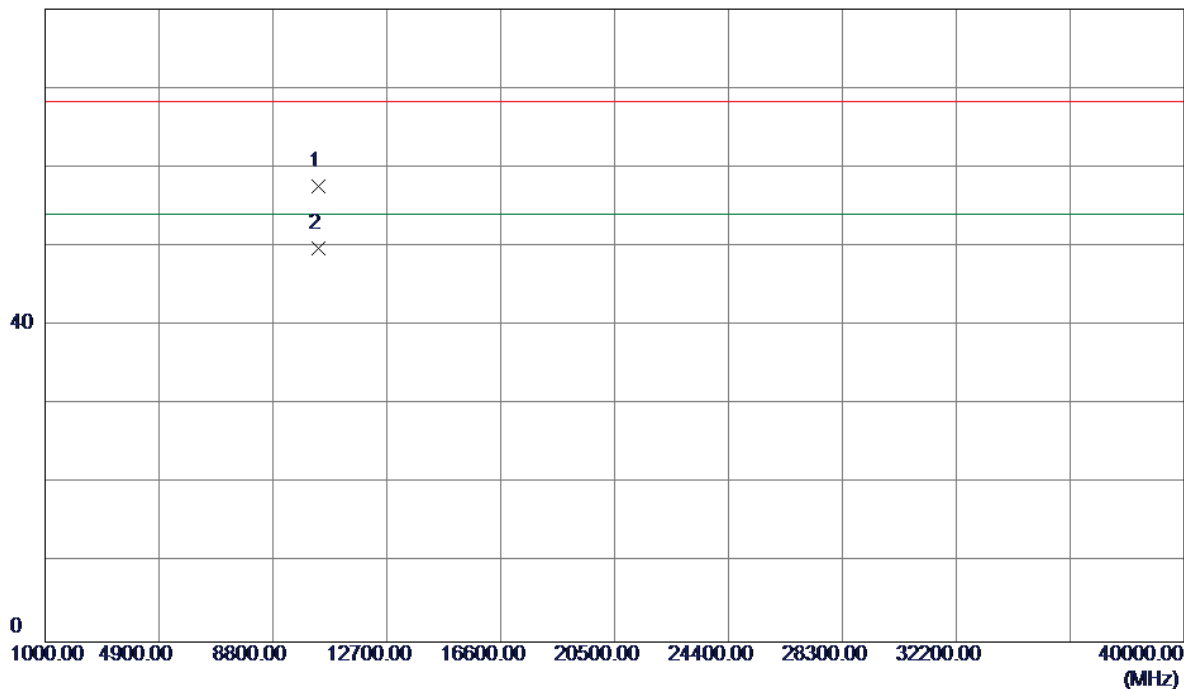

No.	Freq. MHz	Reading Level dBuV/m	Correct Factor dB	Measure ment dBuV/m	Limit dBuV/m	Over dB	Detector	Comment
1	10360.1200	43.79	13.86	57.65	68.30	-10.65	Peak	
2	10360.1200	35.93	13.86	49.79	54.00	-4.21	AVG	

Orthogonal Axis:	X
Test Mode:	UNII-1/ TX AC20 Mode 5180MHz- Internal antenna

Horizontal

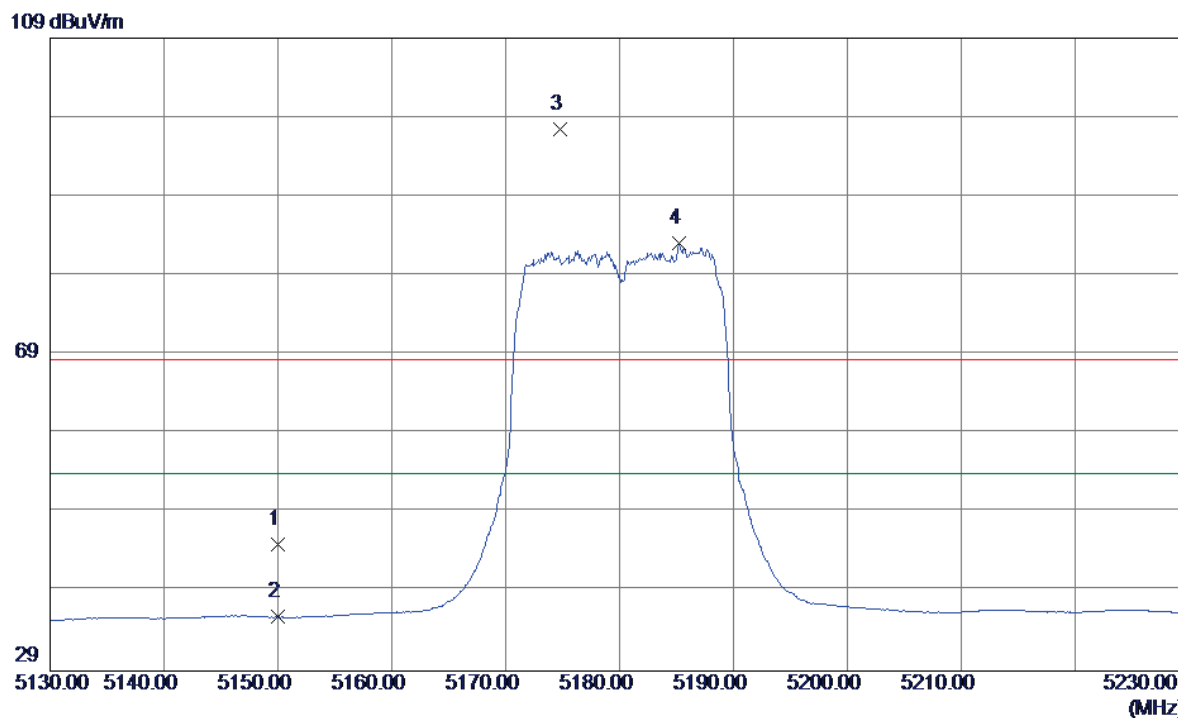

No.	Freq. MHz	Reading Level dBuV/m	Correct Factor dB	Measure ment dBuV/m	Limit dBuV/m	Over dB	Detector	Comment
1	5150.0000	4.79	40.22	45.01	68.30	-23.29	Peak	
2	5150.0000	-4.41	40.22	35.81	54.00	-18.19	AVG	
3	5174.8000	57.14	40.27	97.41	68.30	29.11	Peak	No Limit
4	5185.2000	42.72	40.29	83.01	54.00	29.01	AVG	No Limit

Orthogonal Axis:	X
Test Mode:	UNII-1/ TX AC20 Mode 5180MHz- Internal antenna

Horizontal

80 dBuV/m

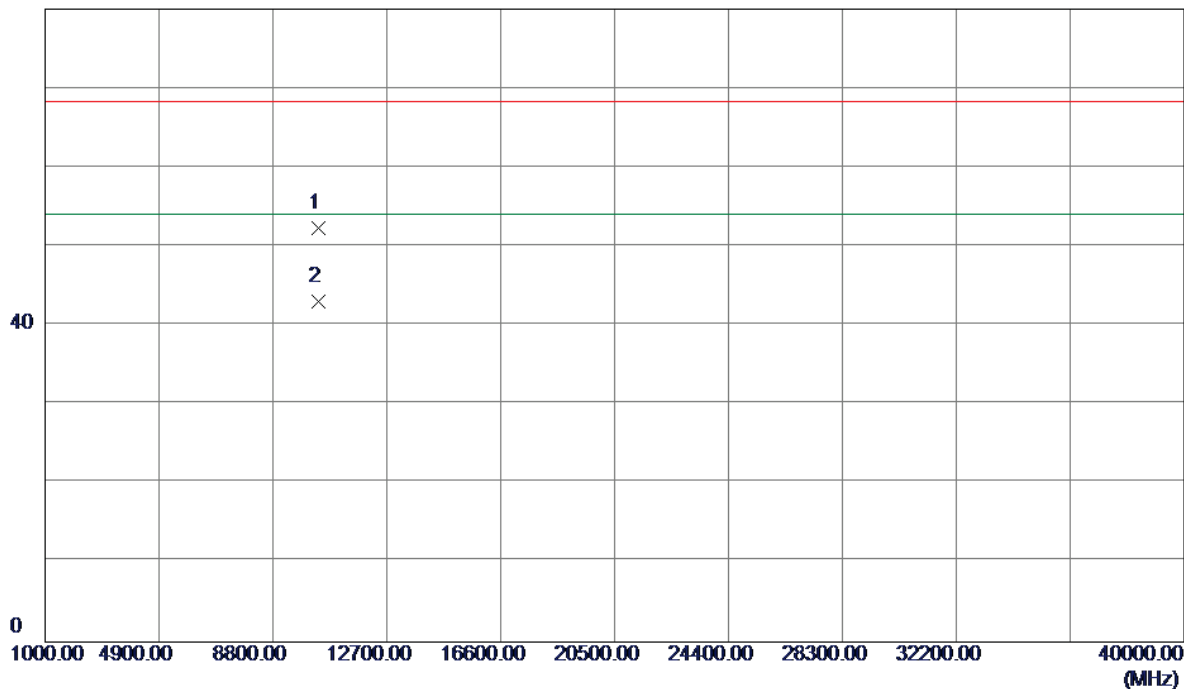

No.	Freq. MHz	Reading Level dBuV/m	Correct Factor dB	Measure ment dBuV/m	Limit dBuV/m	Over dB	Detector	Comment
1	10360.0900	38.40	13.86	52.26	68.30	-16.04	Peak	
2	10360.1300	29.15	13.86	43.01	54.00	-10.99	AVG	

Orthogonal Axis:	X
Test Mode:	UNII-1/ TX AC20 Mode 5200MHz - Internal antenna

Vertical

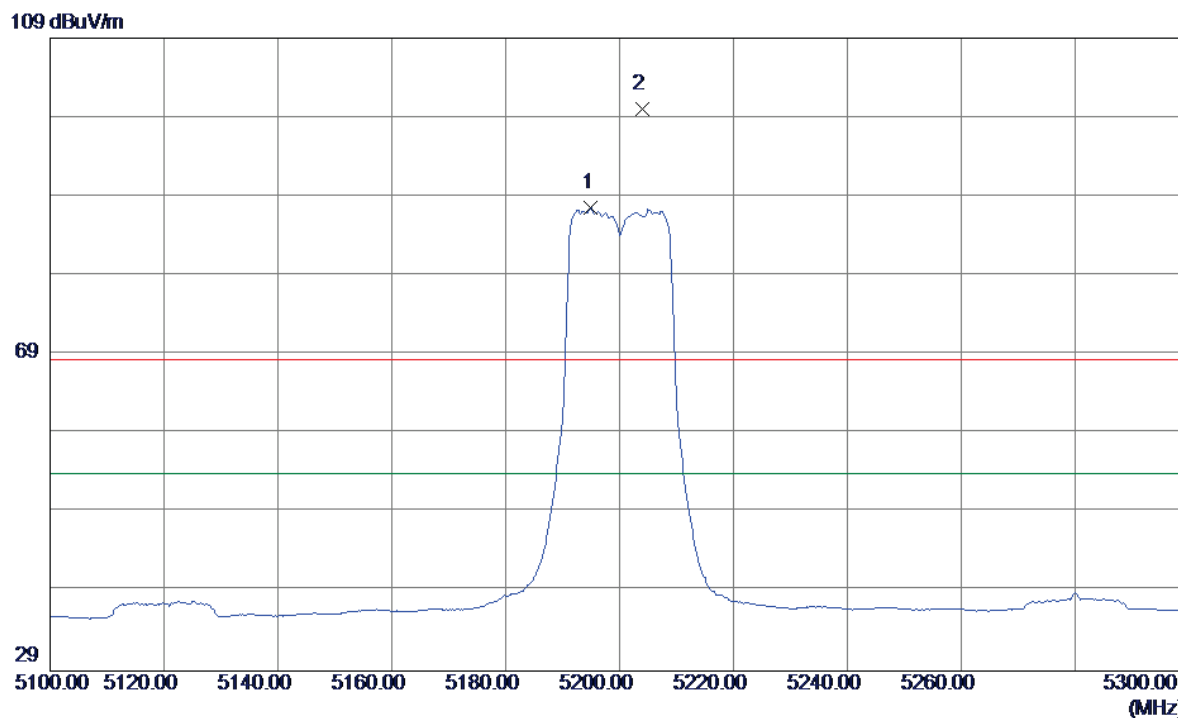

No.	Freq. MHz	Reading Level dBuV/m	Correct Factor dB	Measure ment dBuV/m	Limit dBuV/m	Over dB	Detector	Comment
1	5195.0000	47.20	40.31	87.51	54.00	33.51	AVG	No Limit
2	5204.0000	59.69	40.33	100.02	68.30	31.72	Peak	No Limit

Orthogonal Axis:	X
Test Mode:	UNII-1/ TX AC20 Mode 5200MHz - Internal antenna

Vertical

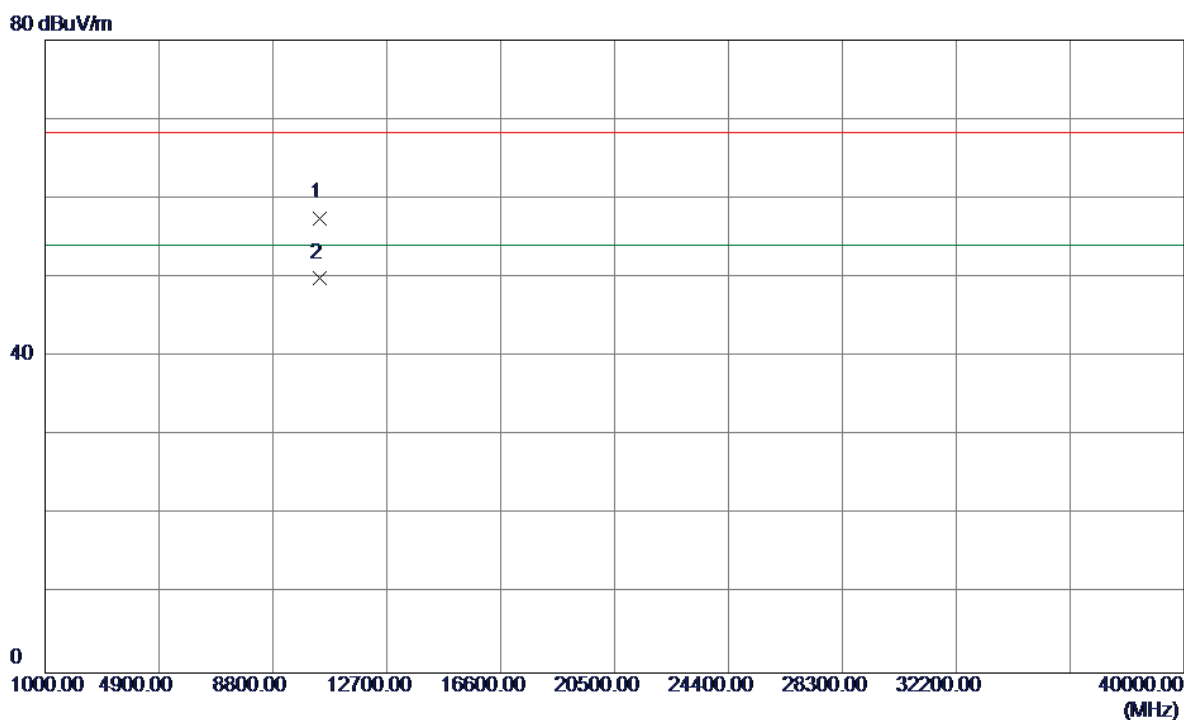

No.	Freq. MHz	Reading Level dBuV/m	Correct Factor dB	Measure ment dBuV/m	Limit dBuV/m	Over dB	Detector	Comment
1	10400.1400	43.72	13.80	57.52	68.30	-10.78	Peak	
2	10400.1400	36.15	13.80	49.95	54.00	-4.05	AVG	

Orthogonal Axis:	X
Test Mode:	UNII-1/ TX AC20 Mode 5200MHz - Internal antenna

Horizontal

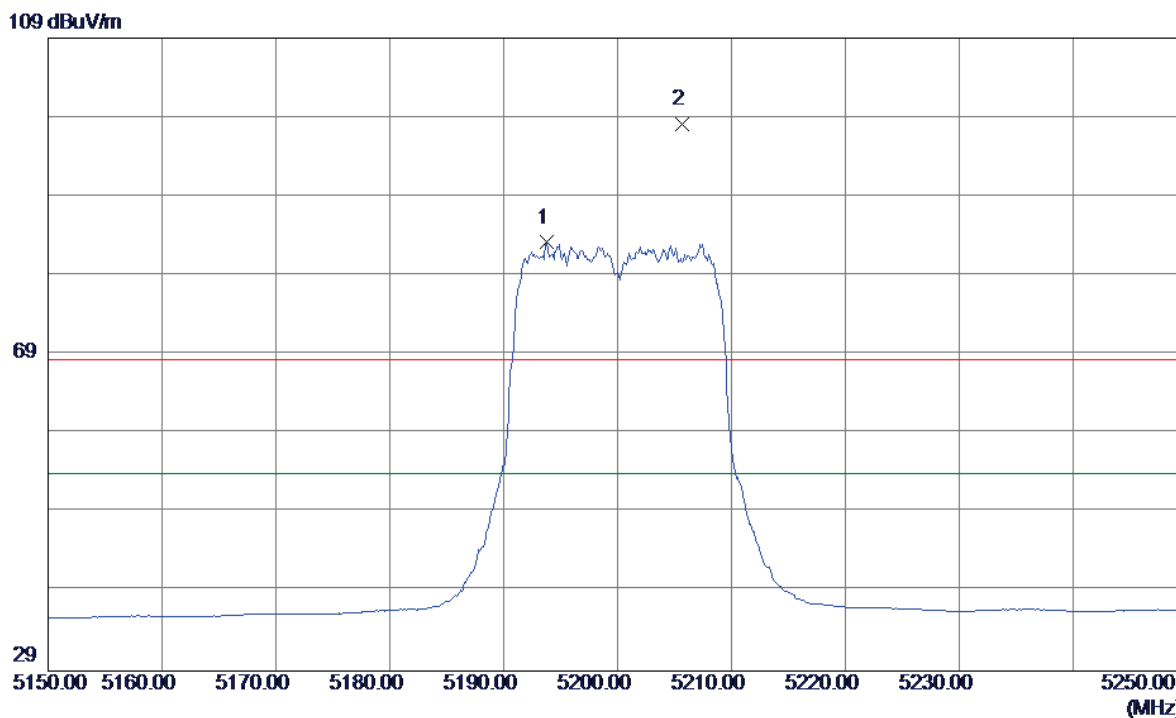

No.	Freq. MHz	Reading Level dBuV/m	Correct Factor dB	Measure ment dBuV/m	Limit dBuV/m	Over dB	Detector	Comment
1	5193.8000	42.85	40.31	83.16	54.00	29.16	AVG	No Limit
2	5205.7000	57.80	40.34	98.14	68.30	29.84	Peak	No Limit

Orthogonal Axis:	X
Test Mode:	UNII-1/ TX AC20 Mode 5200MHz - Internal antenna

Horizontal

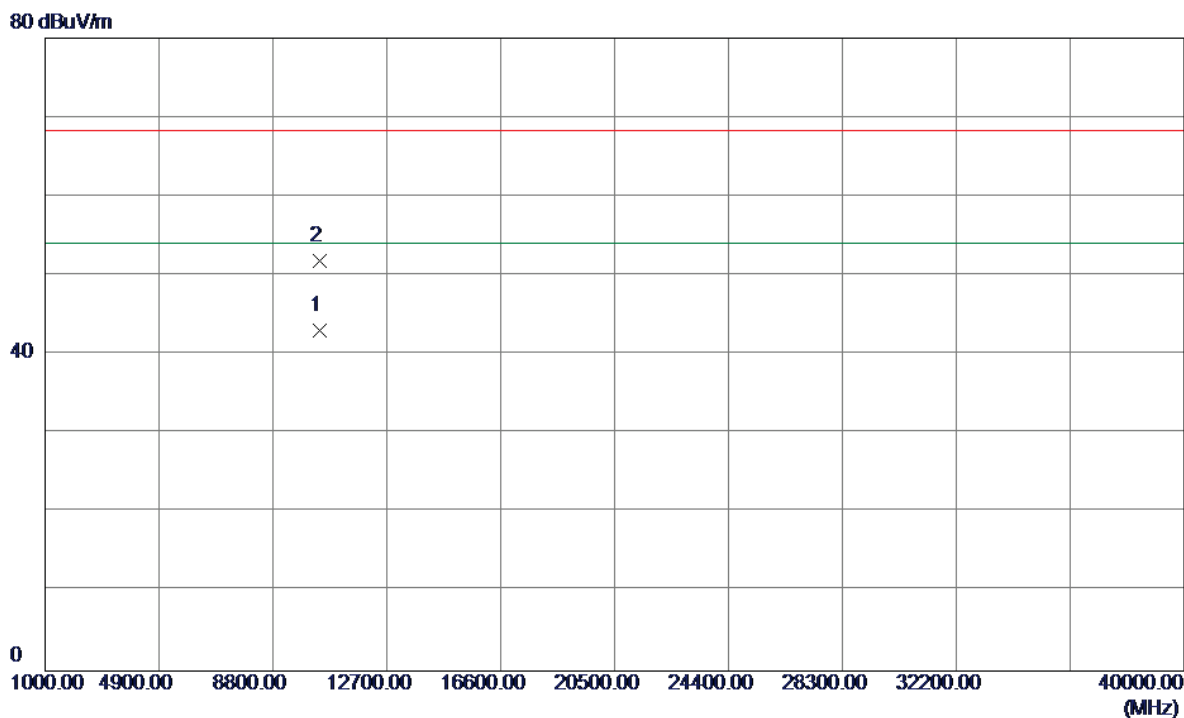

No.	Freq. MHz	Reading Level dBuV/m	Correct Factor dB	Measure ment dBuV/m	Limit dBuV/m	Over dB	Detector	Comment
1	10400.1300	29.20	13.80	43.00	54.00	-11.00	AVG	
2	10400.2000	37.98	13.80	51.78	68.30	-16.52	Peak	

Orthogonal Axis:	X
Test Mode:	UNII-1/ TX AC20 Mode 5240MHz - Internal antenna

Vertical

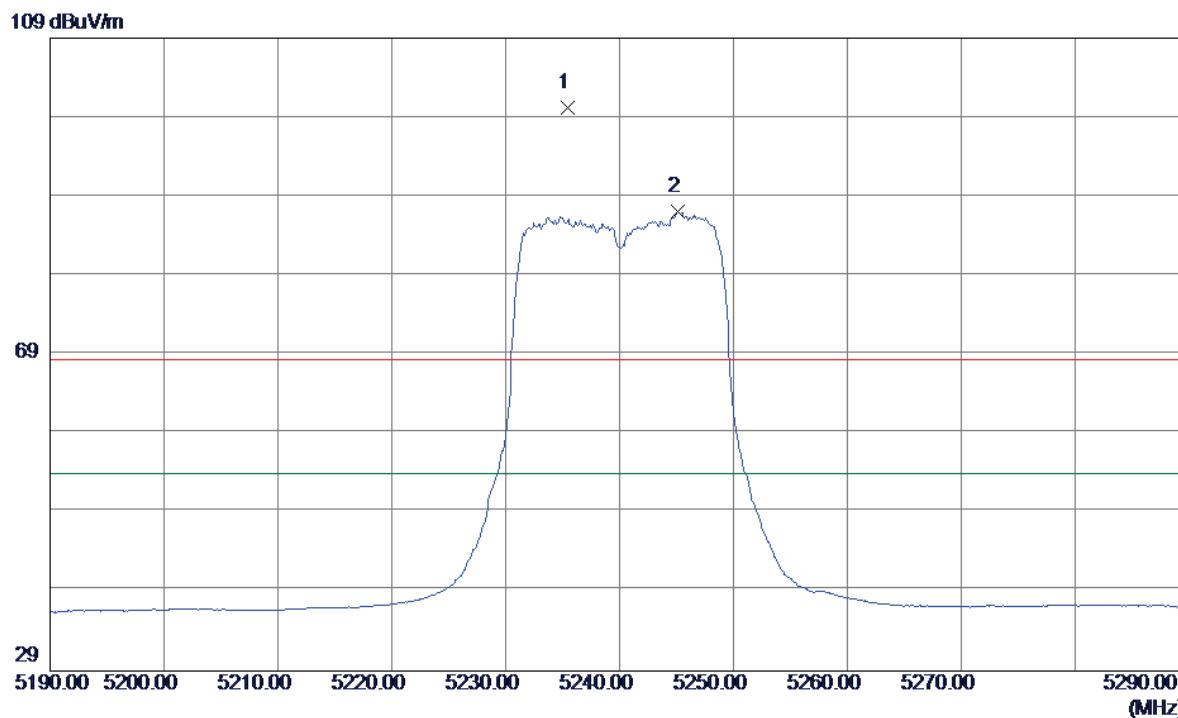

No.	Freq. MHz	Reading Level dBuV/m	Correct Factor dB	Measure ment dBuV/m	Limit dBuV/m	Over dB	Detector	Comment
1	5235.4000	59.87	40.40	100.27	68.30	31.97	Peak	No Limit
2	5245.1000	46.66	40.42	87.08	54.00	33.08	AVG	No Limit

Orthogonal Axis:	X
Test Mode:	UNII-1/ TX AC20 Mode 5240MHz - Internal antenna

Vertical

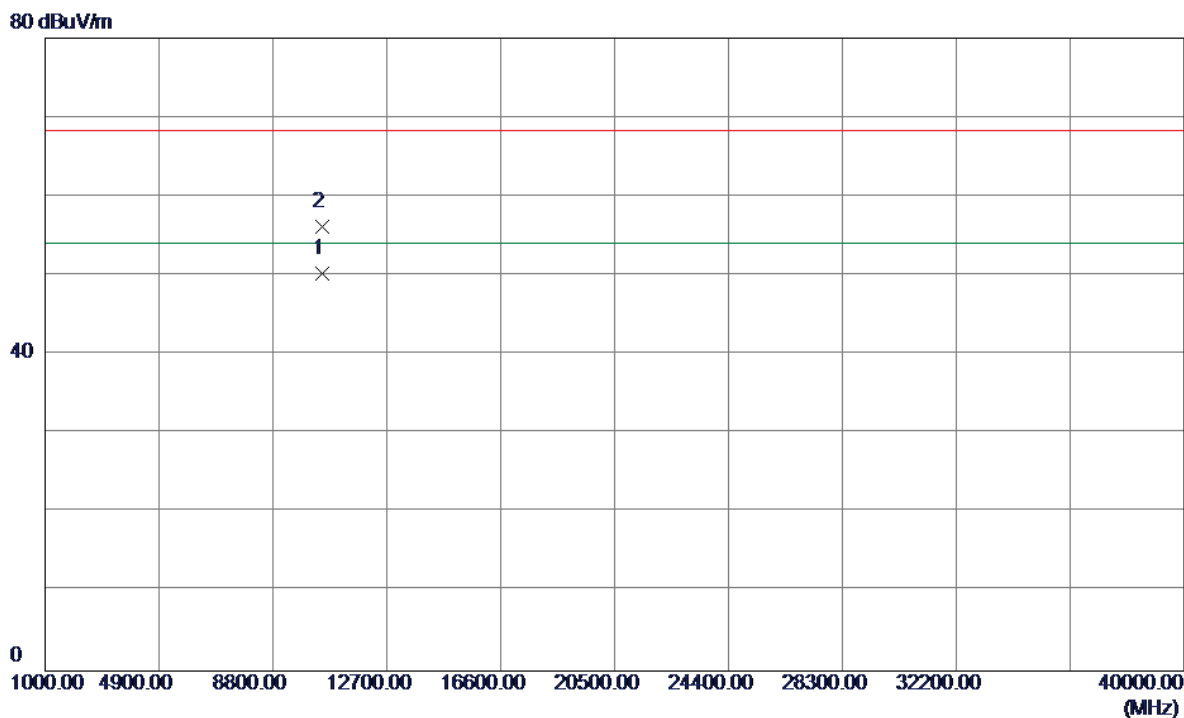

No.	Freq. MHz	Reading Level dBuV/m	Correct Factor dB	Measure ment dBuV/m	Limit dBuV/m	Over dB	Detector	Comment
1	10480.1200	36.52	13.69	50.21	54.00	-3.79	AVG	
2	10480.1700	42.44	13.69	56.13	68.30	-12.17	Peak	

Orthogonal Axis:	X
Test Mode:	UNII-1/ TX AC20 Mode 5240MHz - Internal antenna

Horizontal

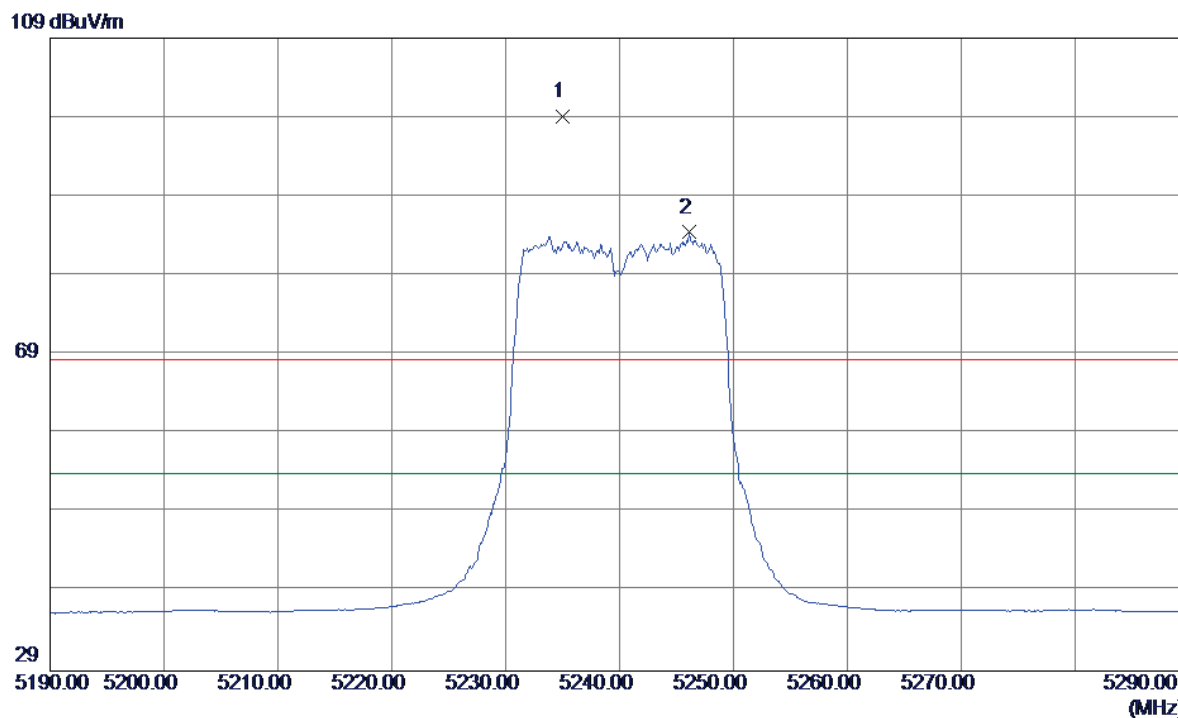

No.	Freq. MHz	Reading Level dBuV/m	Correct Factor dB	Measure ment dBuV/m	Limit dBuV/m	Over dB	Detector	Comment
1	5235.0000	58.69	40.40	99.09	68.30	30.79	Peak	No Limit
2	5246.1000	44.02	40.42	84.44	54.00	30.44	AVG	No Limit

Orthogonal Axis:	X
Test Mode:	UNII-1/ TX AC20 Mode 5240MHz - Internal antenna

Horizontal

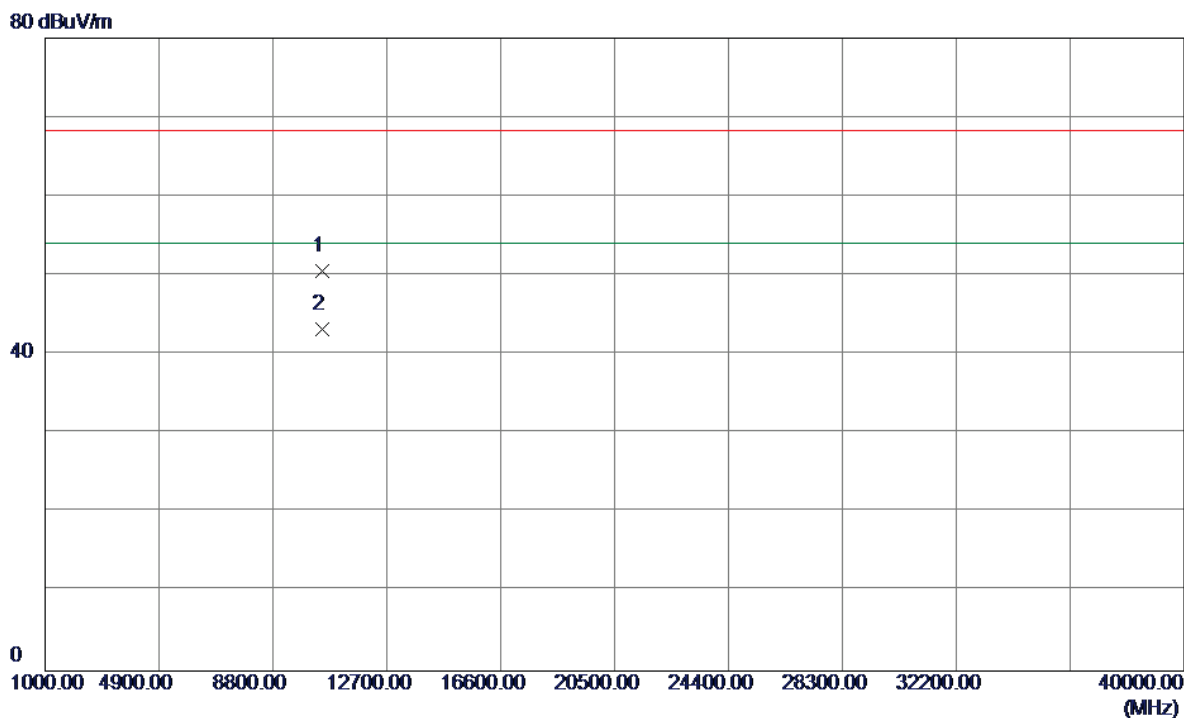

No.	Freq. MHz	Reading Level dBuV/m	Correct Factor dB	Measure ment dBuV/m	Limit dBuV/m	Over dB	Detector	Comment
1	10480.1000	36.89	13.69	50.58	68.30	-17.72	Peak	
2	10480.1700	29.44	13.69	43.13	54.00	-10.87	AVG	

Orthogonal Axis:	X
Test Mode:	UNII-1/ TX AC40 Mode 5190MHz - Internal antenna

Vertical

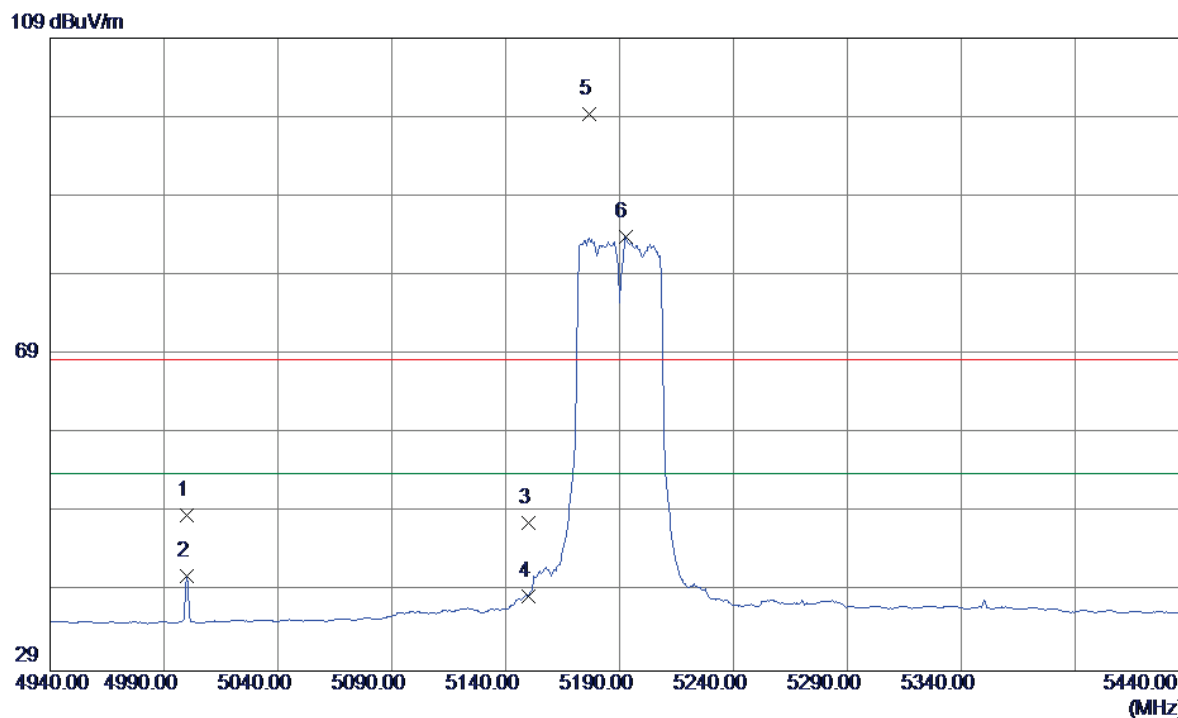

No.	Freq. MHz	Reading Level dBuV/m	Correct Factor dB	Measure ment dBuV/m	Limit dBuV/m	Over dB	Detector	Comment
1	5000.0000	8.71	39.90	48.61	68.30	-19.69	Peak	
2	5000.0000	1.03	39.90	40.93	54.00	-13.07	AVG	
3	5150.0000	7.47	40.22	47.69	68.30	-20.61	Peak	
4	5150.0000	-1.74	40.22	38.48	54.00	-15.52	AVG	
5	5176.5000	59.16	40.27	99.43	68.30	31.13	Peak	No Limit
6	5192.5000	43.56	40.31	83.87	54.00	29.87	AVG	No Limit

Orthogonal Axis:	X
Test Mode:	UNII-1/ TX AC40 Mode 5190MHz- Internal antenna

Vertical

80 dBuV/m

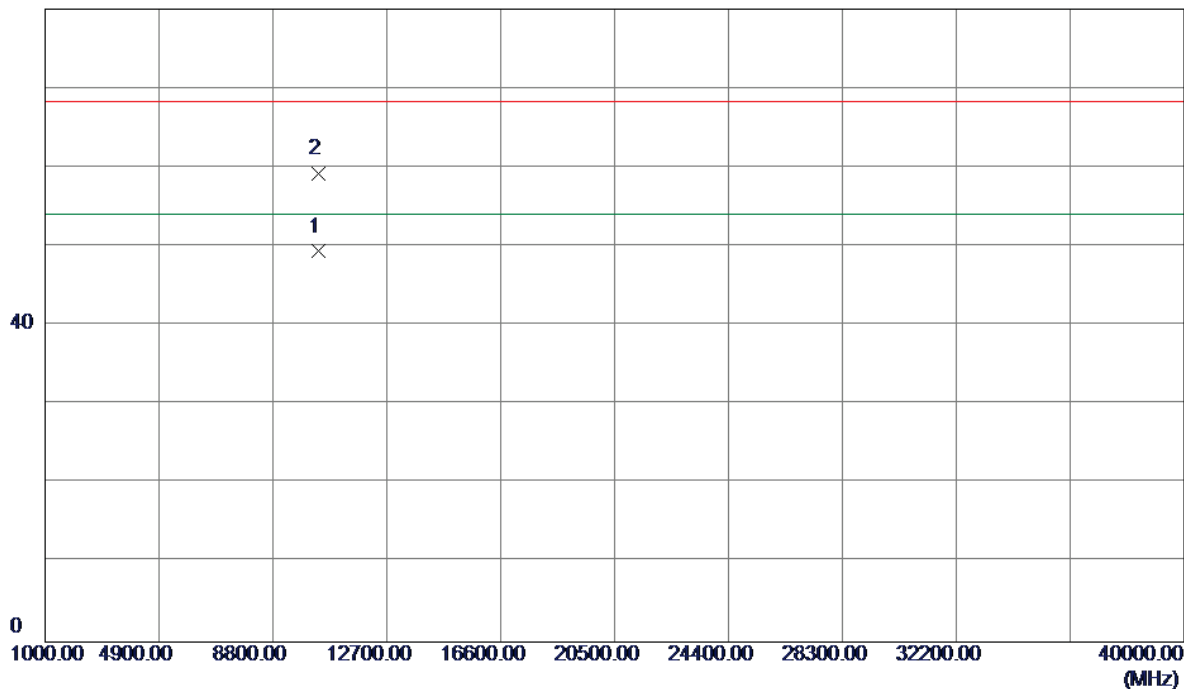

No.	Freq. MHz	Reading Level dBuV/m	Correct Factor dB	Measure ment dBuV/m	Limit dBuV/m	Over dB	Detector	Comment
1	10380.1000	35.53	13.83	49.36	54.00	-4.64	AVG	
2	10380.1600	45.33	13.83	59.16	68.30	-9.14	Peak	

Orthogonal Axis:	X
Test Mode:	UNII-1/ TX AC40 Mode 5190MHz- Internal antenna

Horizontal

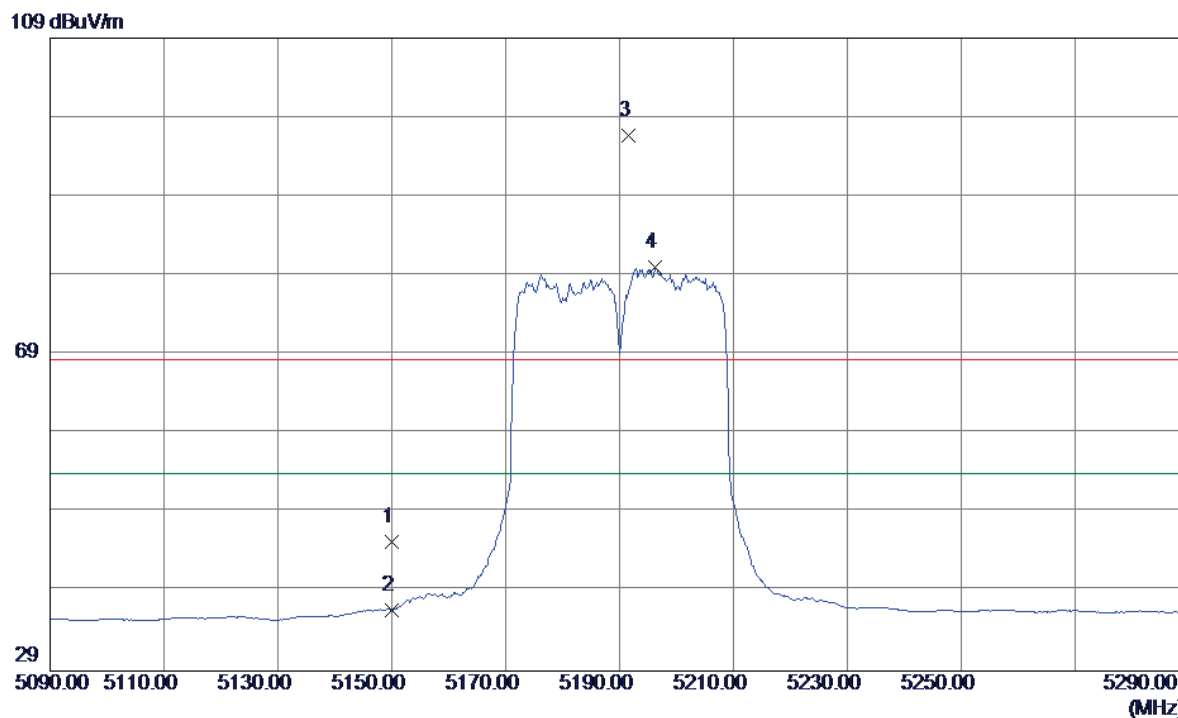

No.	Freq. MHz	Reading Level dBuV/m	Correct Factor dB	Measure ment dBuV/m	Limit dBuV/m	Over dB	Detector	Comment
1	5150.0000	5.17	40.22	45.39	68.30	-22.91	Peak	
2	5150.0000	-3.55	40.22	36.67	54.00	-17.33	AVG	
3	5191.6000	56.34	40.31	96.65	68.30	28.35	Peak	No Limit
4	5196.2000	39.73	40.32	80.05	54.00	26.05	AVG	No Limit

Orthogonal Axis:	X
Test Mode:	UNII-1/ TX AC40 Mode 5190MHz- Internal antenna

Horizontal

80 dBuV/m

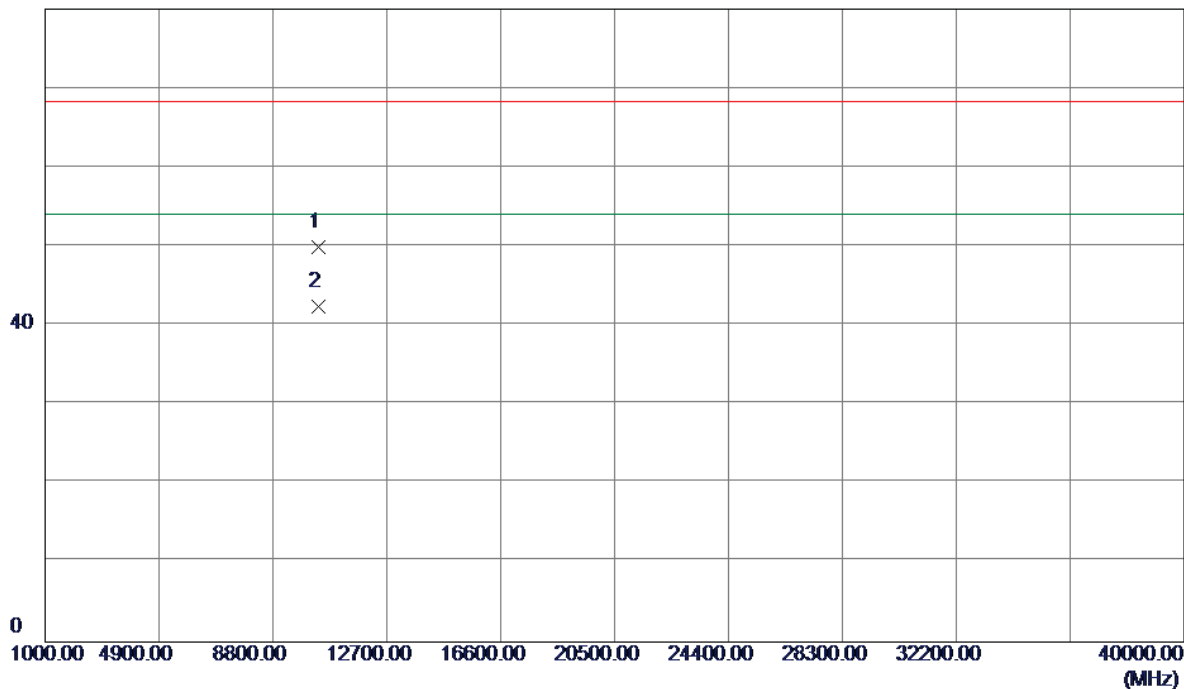

No.	Freq. MHz	Reading Level dBuV/m	Correct Factor dB	Measure ment dBuV/m	Limit dBuV/m	Over dB	Detector	Comment
1	10380.1600	36.10	13.83	49.93	68.30	-18.37	Peak	
2	10380.1600	28.63	13.83	42.46	54.00	-11.54	AVG	

Orthogonal Axis:	X
Test Mode:	UNII-1/ TX AC40 Mode 5230MHz- Internal antenna

Vertical

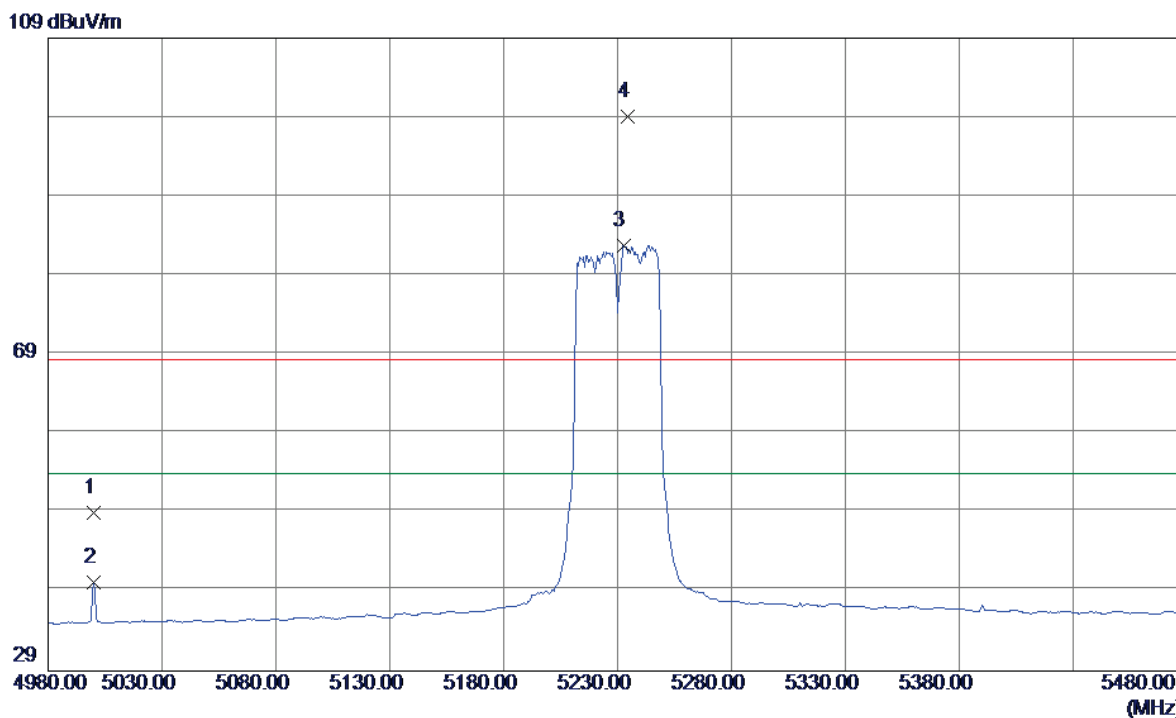

No.	Freq. MHz	Reading Level dBuV/m	Correct Factor dB	Measure ment dBuV/m	Limit dBuV/m	Over dB	Detector	Comment
1	5000.0000	9.15	39.90	49.05	68.30	-19.25	Peak	
2	5000.0000	0.31	39.90	40.21	54.00	-13.79	AVG	
3	5232.5000	42.44	40.39	82.83	54.00	28.83	AVG	No Limit
4	5234.5000	58.68	40.40	99.08	68.30	30.78	Peak	No Limit

Orthogonal Axis:	X
Test Mode:	UNII-1/ TX AC40 Mode 5230MHz- Internal antenna

Vertical

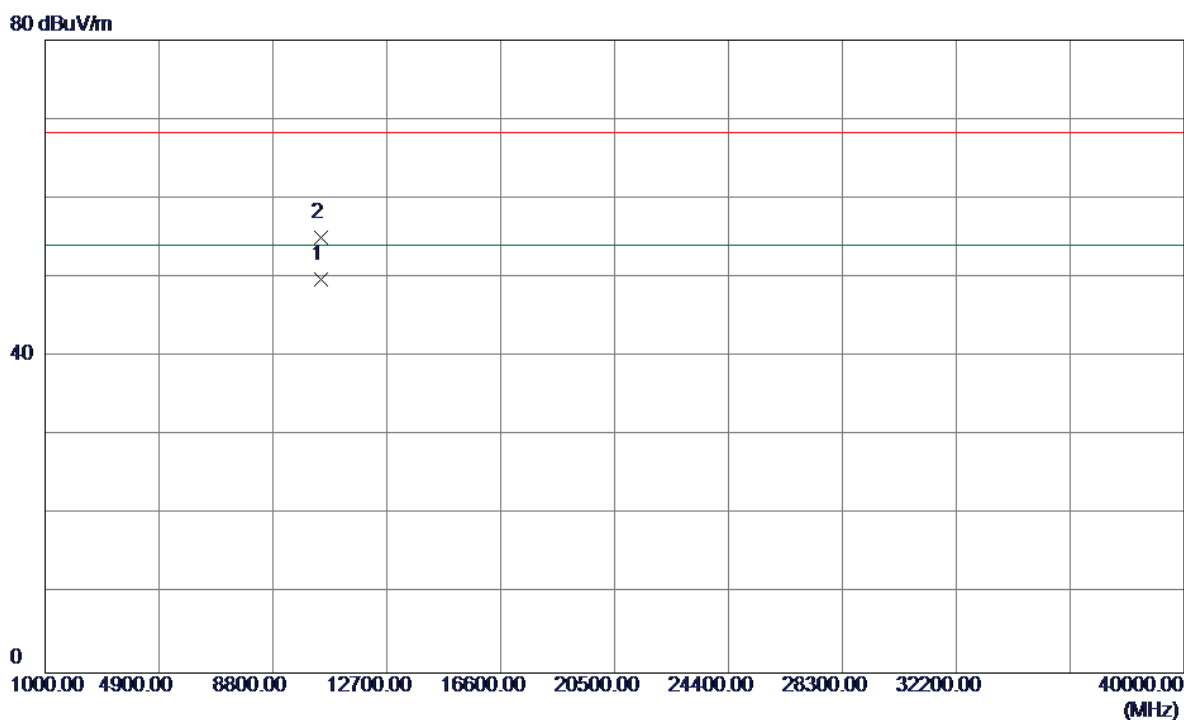

No.	Freq. MHz	Reading Level dBuV/m	Correct Factor dB	Measure ment dBuV/m	Limit dBuV/m	Over dB	Detector	Comment
1	10460.1400	36.07	13.72	49.79	54.00	-4.21	AVG	
2	10460.2500	41.36	13.72	55.08	68.30	-13.22	Peak	

Orthogonal Axis:	X
Test Mode:	UNII-1/ TX AC40 Mode 5230MHz- Internal antenna

Horizontal

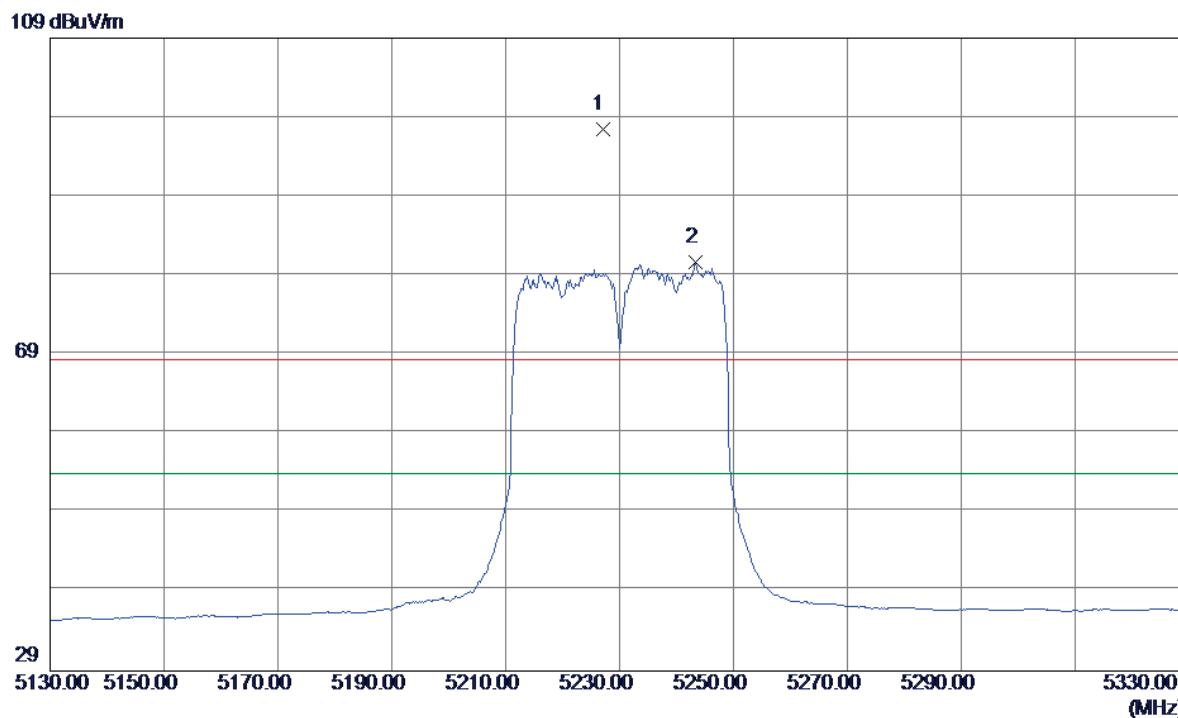

No.	Freq. MHz	Reading Level dBuV/m	Correct Factor dB	Measure ment dBuV/m	Limit dBuV/m	Over dB	Detector	Comment
1	5227.0000	57.16	40.38	97.54	68.30	29.24	Peak	No Limit
2	5243.4000	40.20	40.42	80.62	54.00	26.62	AVG	No Limit

Orthogonal Axis:	X
Test Mode:	UNII-1/ TX AC40 Mode 5230MHz- Internal antenna

Horizontal

80 dBuV/m

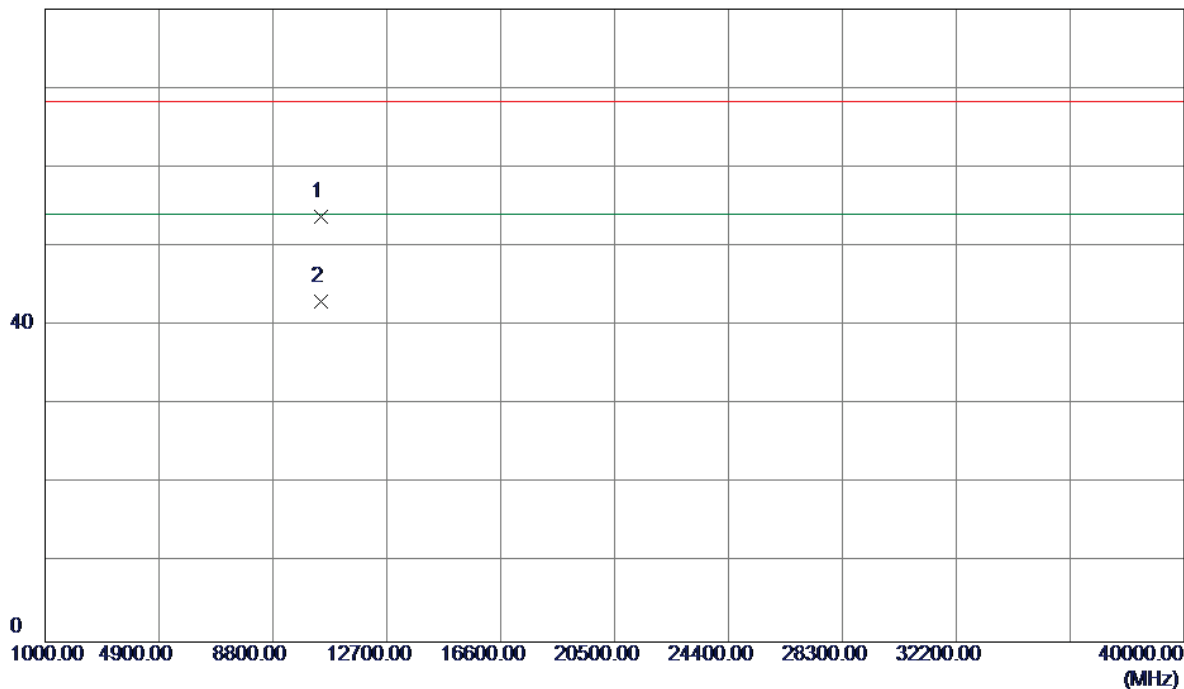

No.	Freq. MHz	Reading Level dBuV/m	Correct Factor dB	Measure ment dBuV/m	Limit dBuV/m	Over dB	Detector	Comment
1	10459.8000	40.03	13.72	53.75	68.30	-14.55	Peak	
2	10460.0900	29.28	13.72	43.00	54.00	-11.00	AVG	

Orthogonal Axis:	X
Test Mode:	UNII-1/ TX AC80 Mode 5210MHz- Internal antenna

Vertical

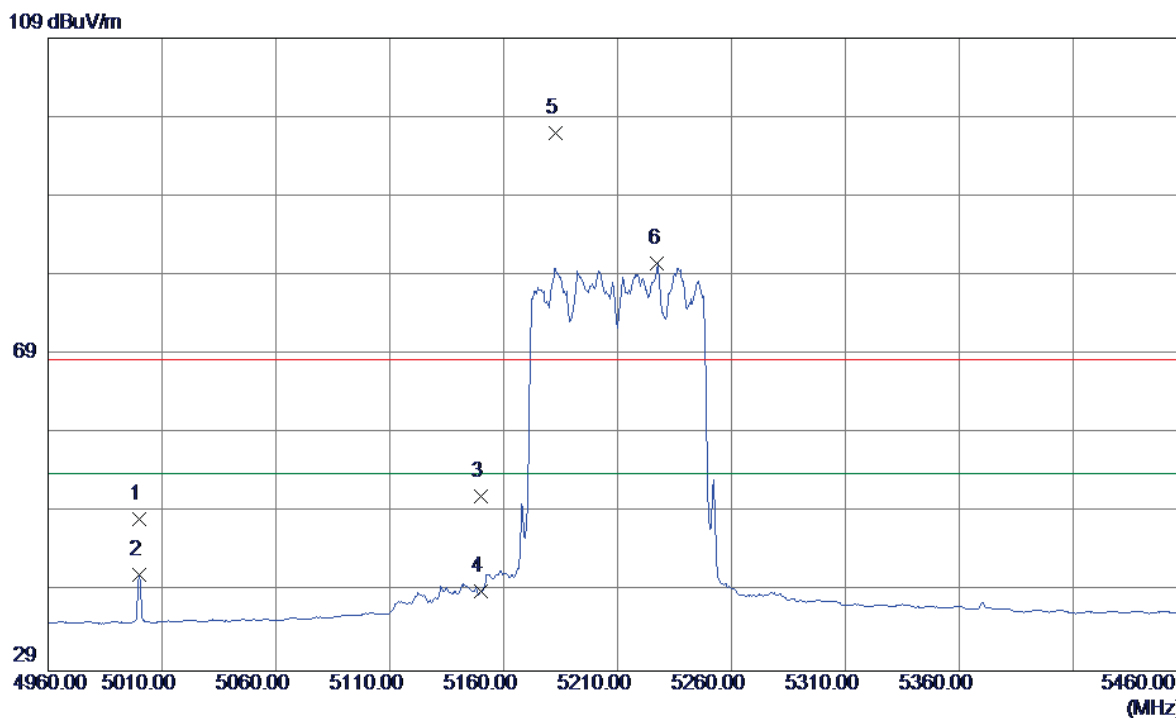

No.	Freq. MHz	Reading Level dBuV/m	Correct Factor dB	Measure ment dBuV/m	Limit dBuV/m	Over dB	Detector	Comment
1	5000.0000	8.31	39.90	48.21	68.30	-20.09	Peak	
2	5000.0000	1.25	39.90	41.15	54.00	-12.85	AVG	
3	5150.0000	10.88	40.22	51.10	68.30	-17.20	Peak	
4	5150.0000	-1.15	40.22	39.07	54.00	-14.93	AVG	
5	5183.0000	56.74	40.29	97.03	68.30	28.73	Peak	No Limit
6	5227.5000	40.16	40.38	80.54	54.00	26.54	AVG	No Limit

Orthogonal Axis:	X
Test Mode:	UNII-1/ TX AC80 Mode 5210MHz- Internal antenna

Vertical

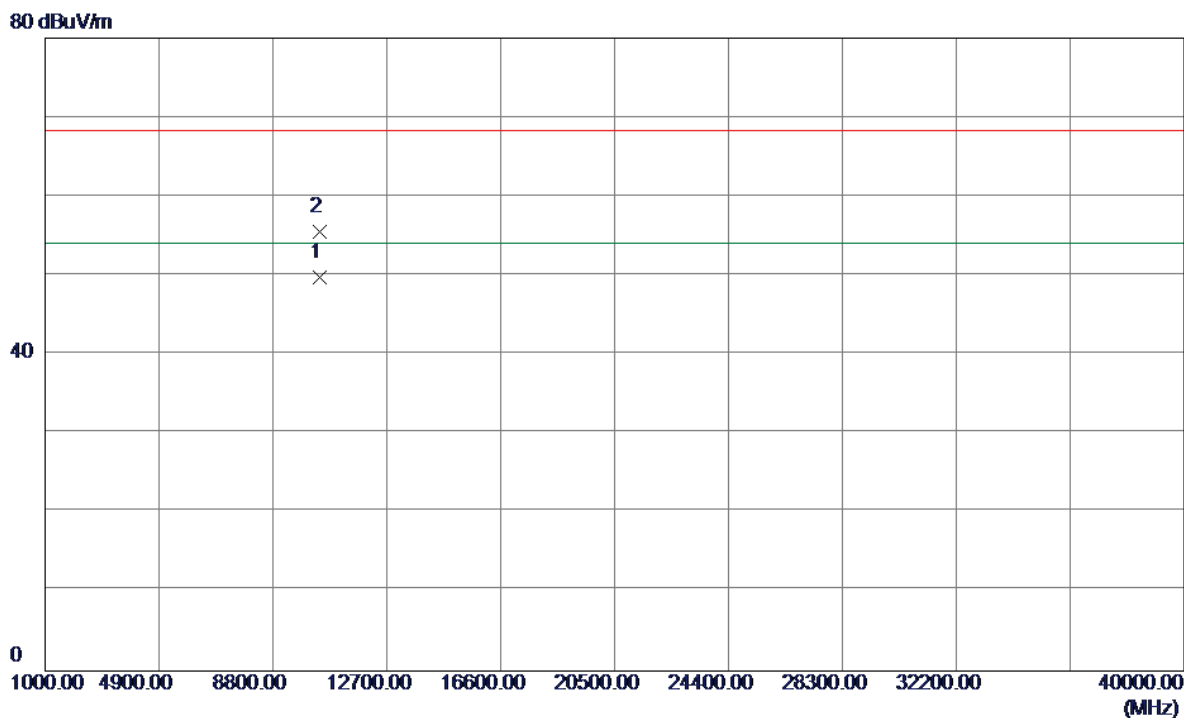

No.	Freq. MHz	Reading Level dBuV/m	Correct Factor dB	Measure ment dBuV/m	Limit dBuV/m	Over dB	Detector	Comment
1	10420.1300	35.93	13.77	49.70	54.00	-4.30	AVG	
2	10420.2100	41.69	13.77	55.46	68.30	-12.84	Peak	

Orthogonal Axis:	X
Test Mode:	UNII-1/ TX AC80 Mode 5210MHz- Internal antenna

Horizontal

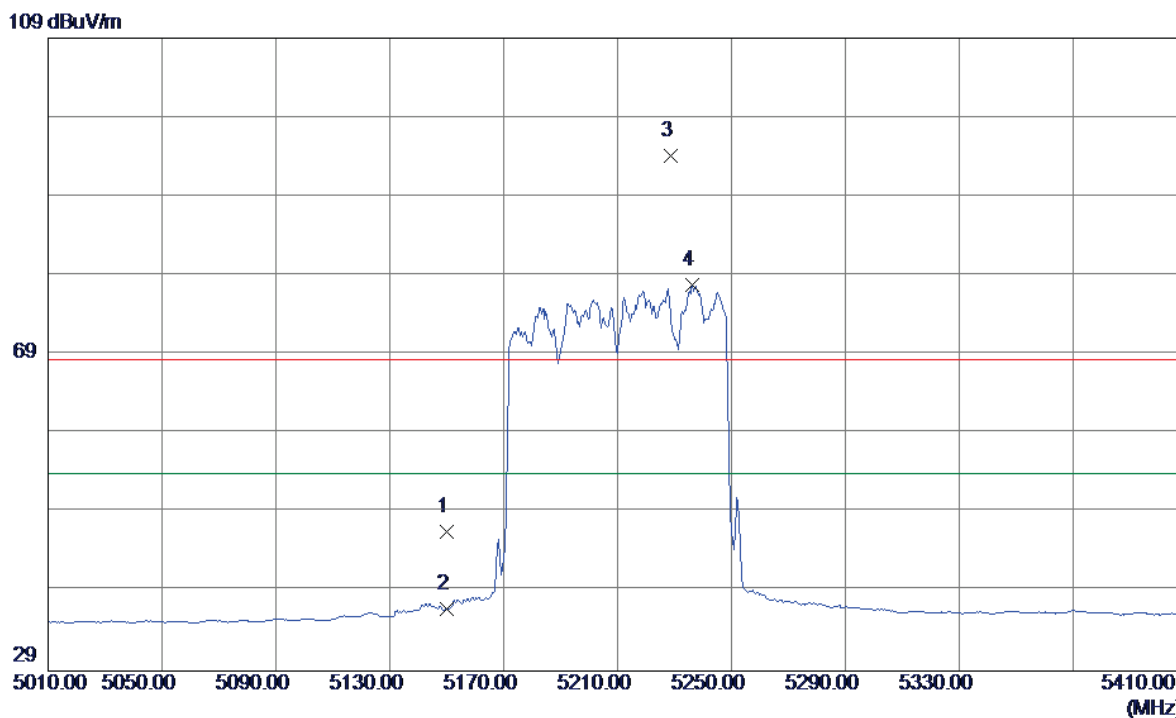

No.	Freq. MHz	Reading Level dBuV/m	Correct Factor dB	Measure ment dBuV/m	Limit dBuV/m	Over dB	Detector	Comment
1	5150.0000	6.43	40.22	46.65	68.30	-21.65	Peak	
2	5150.0000	-3.39	40.22	36.83	54.00	-17.17	AVG	
3	5228.8000	53.75	40.39	94.14	68.30	25.84	Peak	No Limit
4	5236.4000	37.47	40.40	77.87	54.00	23.87	AVG	No Limit

Orthogonal Axis:	X
Test Mode:	UNII-1/ TX AC80 Mode 5210MHz- Internal antenna

Horizontal

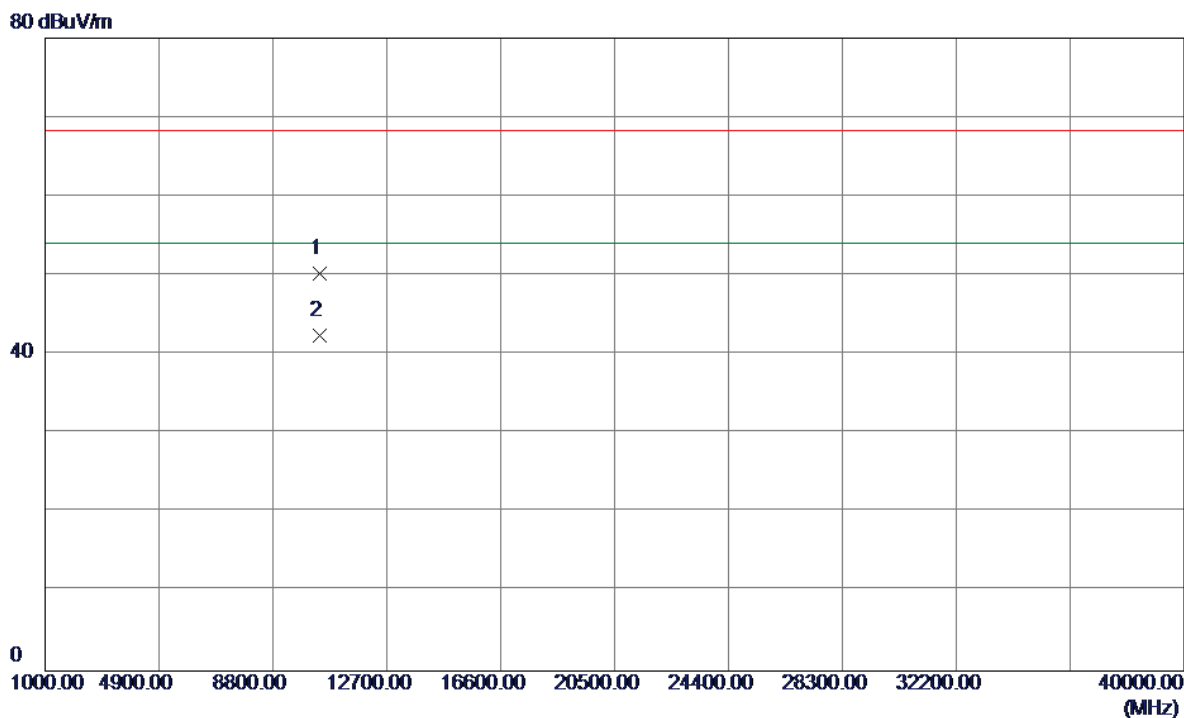

No.	Freq. MHz	Reading Level dBuV/m	Correct Factor dB	Measure ment dBuV/m	Limit dBuV/m	Over dB	Detector	Comment
1	10420.0900	36.43	13.77	50.20	68.30	-18.10	Peak	
2	10420.0900	28.70	13.77	42.47	54.00	-11.53	AVG	

Orthogonal Axis:	X
Test Mode:	UNII-3/TX AC20 Mode 5745MHz- Internal antenna

Vertical

109 dBuV/m

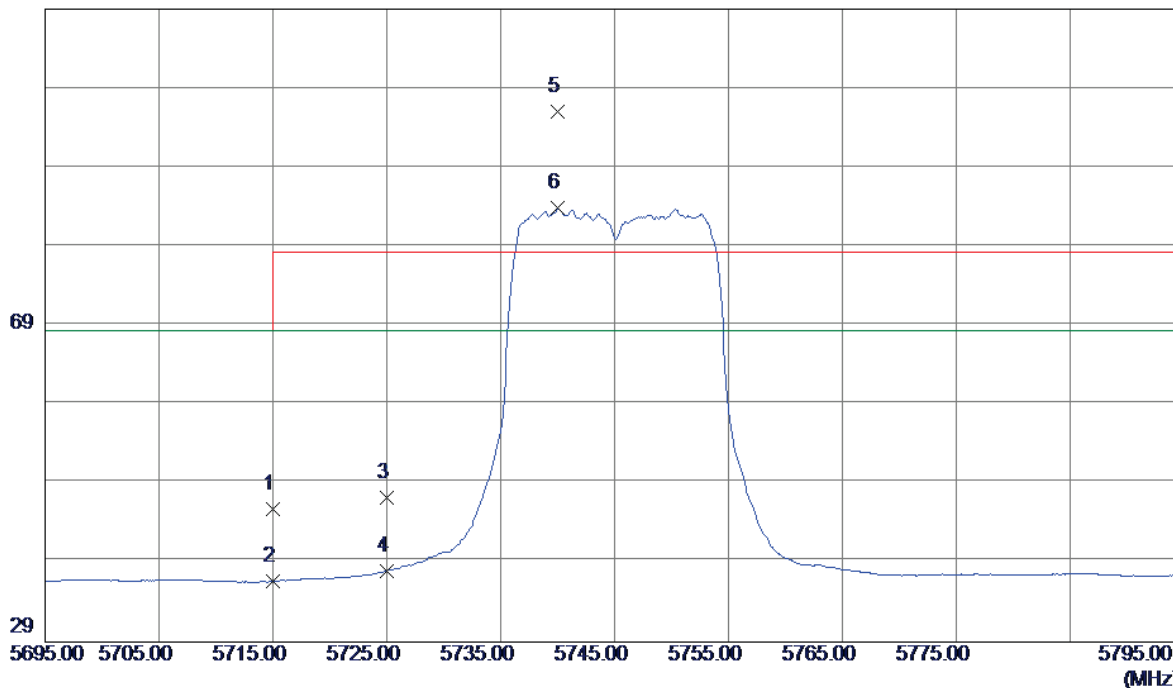

No.	Freq. MHz	Reading Level dBuV/m	Correct Factor dB	Measure ment dBuV/m	Limit dBuV/m	Over dB	Detector	Comment
1	5715.0000	4.59	41.25	45.84	68.30	-22.46	Peak	
2	5715.0000	-4.57	41.25	36.68	68.30	-31.62	AVG	
3	5725.0000	5.99	41.27	47.26	78.30	-31.04	Peak	
4	5725.0000	-3.25	41.27	38.02	68.30	-30.28	AVG	
5	5740.0000	54.79	41.29	96.08	78.30	17.78	Peak	No Limit
6	5740.0000	42.57	41.29	83.86	68.30	15.56	AVG	No Limit

Orthogonal Axis:	X
Test Mode:	UNII-3/TX AC20 Mode 5745MHz- Internal antenna

Vertical

80 dBuV/m

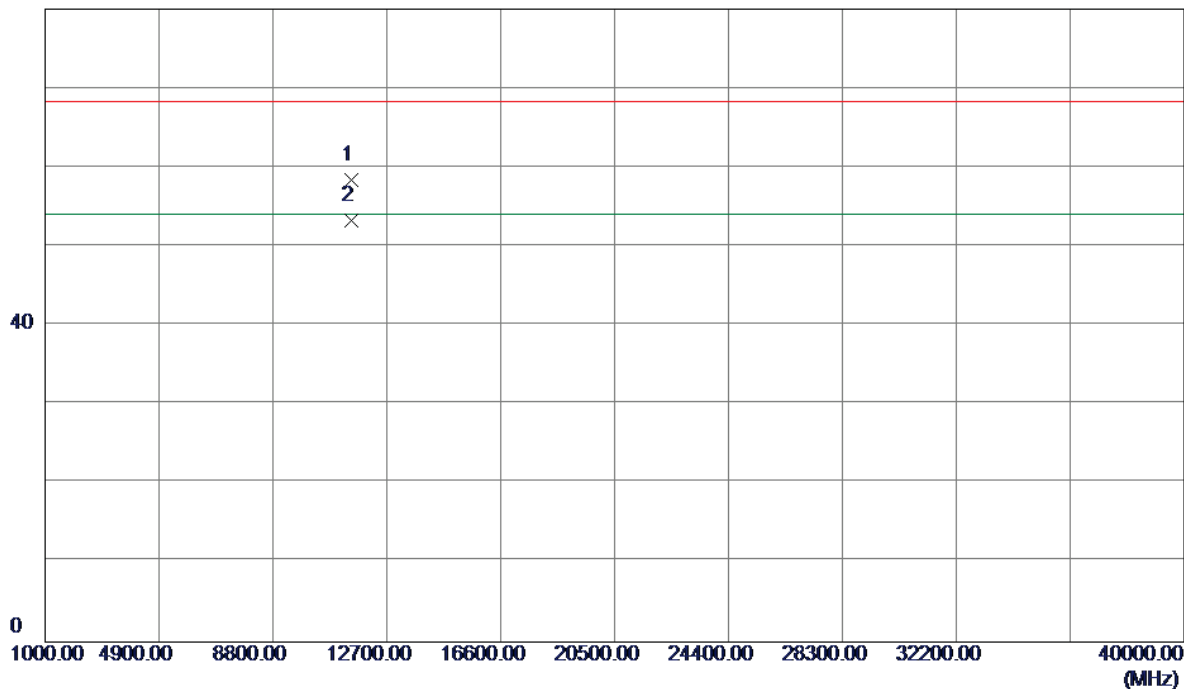

No.	Freq. MHz	Reading Level dBuV/m	Correct Factor dB	Measure ment dBuV/m	Limit dBuV/m	Over dB	Detector	Comment
1	11490.1100	41.56	16.91	58.47	68.30	-9.83	Peak	
2	11490.1500	36.42	16.91	53.33	54.00	-0.67	AVG	

Orthogonal Axis:	X
Test Mode:	UNII-3/TX AC20 Mode 5745MHz- Internal antenna

Horizontal

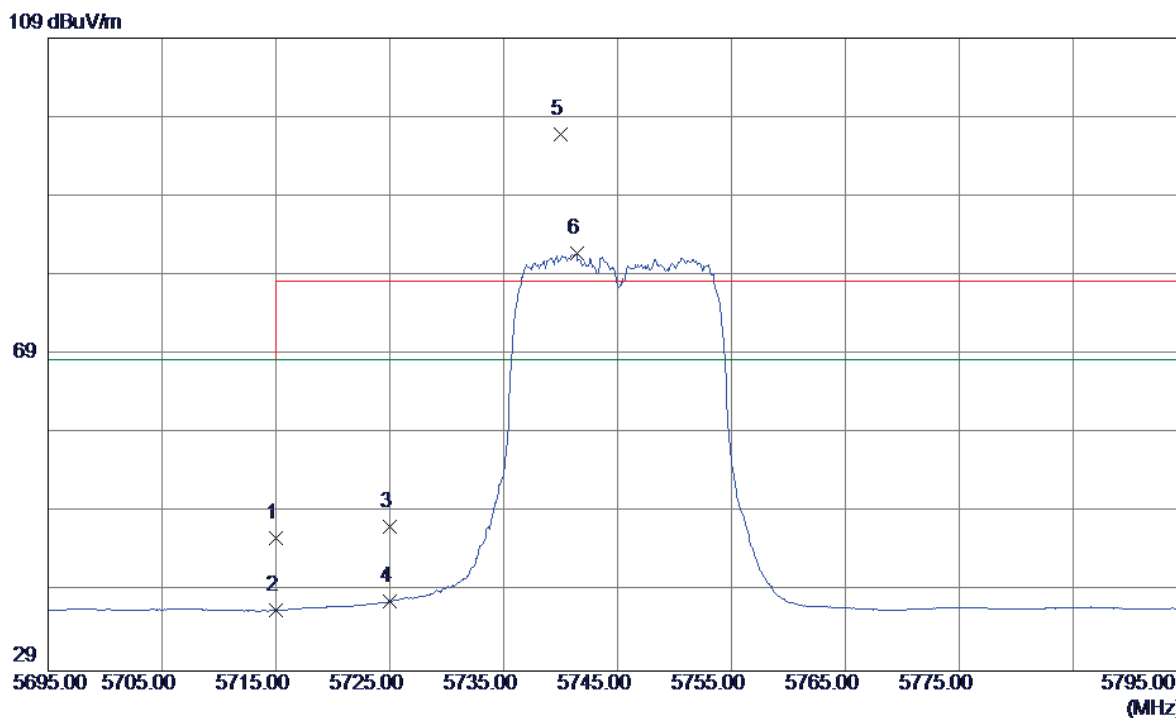

No.	Freq. MHz	Reading Level dBuV/m	Correct Factor dB	Measure ment dBuV/m	Limit dBuV/m	Over dB	Detector	Comment
1	5715.0000	4.58	41.25	45.83	68.30	-22.47	Peak	
2	5715.0000	-4.58	41.25	36.67	68.30	-31.63	AVG	
3	5725.0000	5.95	41.27	47.22	78.30	-31.08	Peak	
4	5725.0000	-3.53	41.27	37.74	68.30	-30.56	AVG	
5	5740.0000	55.62	41.29	96.91	78.30	18.61	Peak	No Limit
6	5741.4000	40.48	41.29	81.77	68.30	13.47	AVG	No Limit

Orthogonal Axis:	X
Test Mode:	UNII-3/TX AC20 Mode 5745MHz- Internal antenna

Horizontal

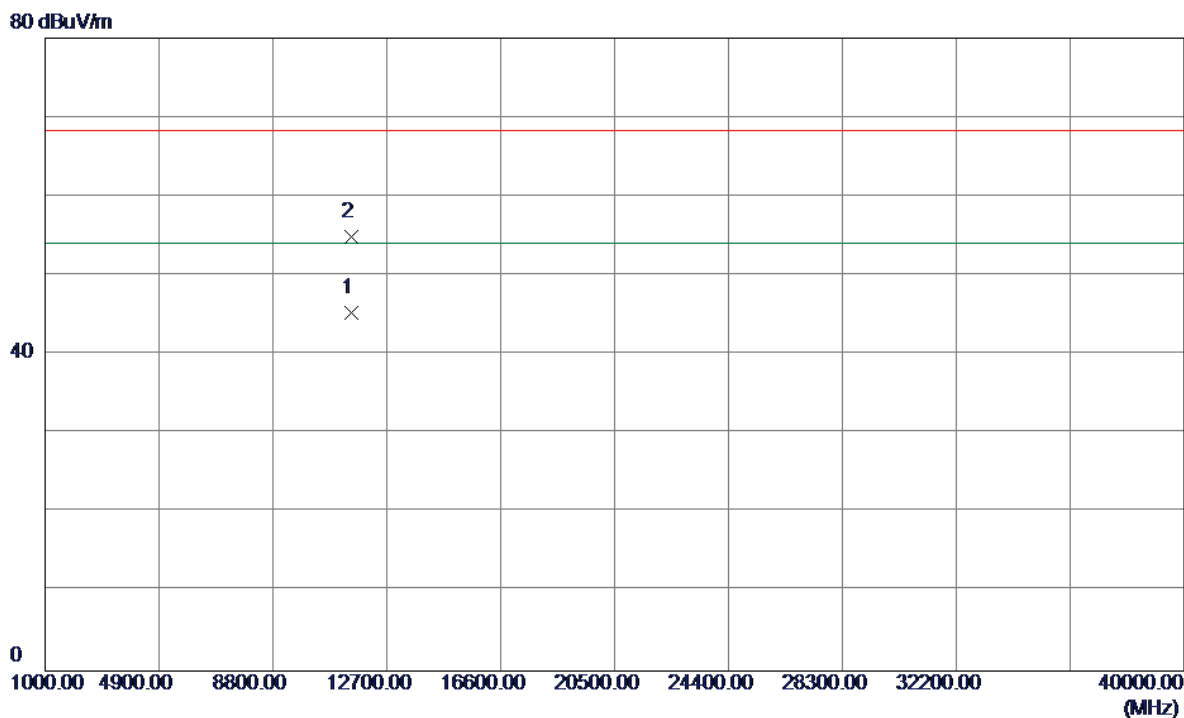

No.	Freq. MHz	Reading Level dBuV/m	Correct Factor dB	Measure ment dBuV/m	Limit dBuV/m	Over dB	Detector	Comment
1	11490.1200	28.32	16.91	45.23	54.00	-8.77	AVG	
2	11490.2200	37.97	16.91	54.88	68.30	-13.42	Peak	

Orthogonal Axis:	X
Test Mode:	UNII-3/TX AC20 Mode 5785MHz - Internal antenna

Vertical

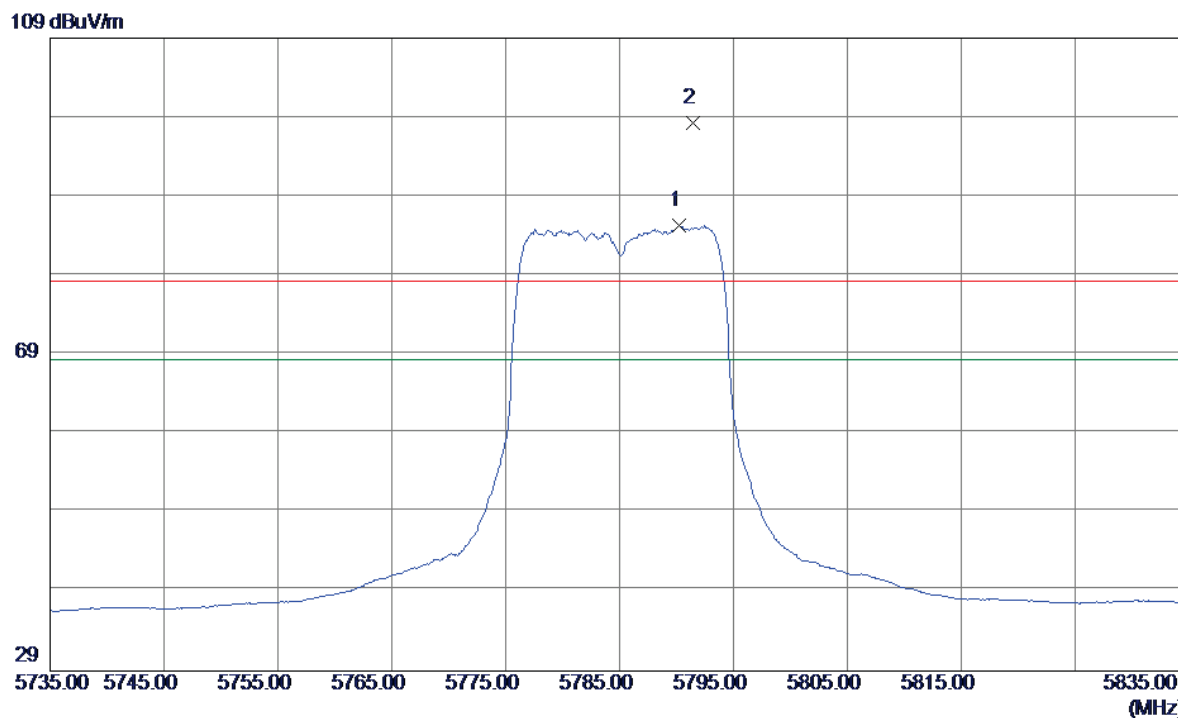

No.	Freq. MHz	Reading Level dBuV/m	Correct Factor dB	Measure ment dBuV/m	Limit dBuV/m	Over dB	Detector	Comment
1	5790.2000	44.01	41.35	85.36	68.30	17.06	AVG	No Limit
2	5791.4000	56.85	41.36	98.21	78.30	19.91	Peak	No Limit

Orthogonal Axis:	X
Test Mode:	UNII-3/TX AC20 Mode 5785MHz - Internal antenna

Vertical

80 dBuV/m

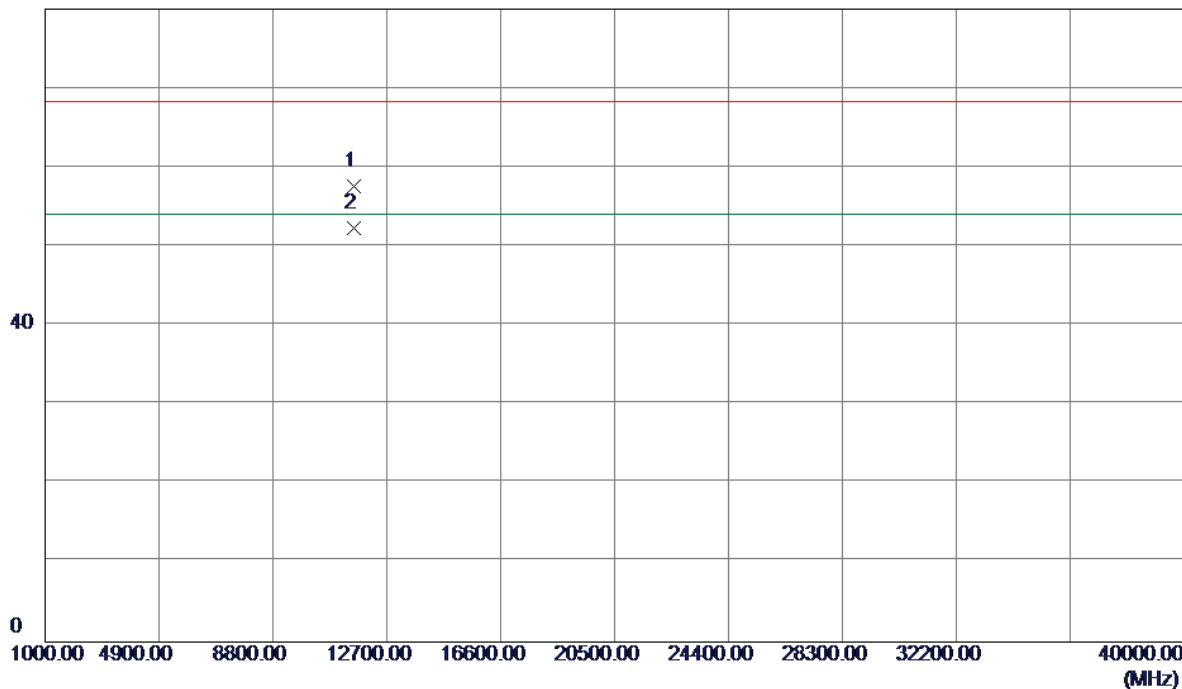

No.	Freq. MHz	Reading Level dBuV/m	Correct Factor dB	Measure ment dBuV/m	Limit dBuV/m	Over dB	Detector	Comment
1	11570.1200	40.52	17.05	57.57	68.30	-10.73	Peak	
2	11570.1200	35.27	17.05	52.32	54.00	-1.68	AVG	

Orthogonal Axis:	X
Test Mode:	UNII-3/TX AC20 Mode 5785MHz - Internal antenna

Horizontal

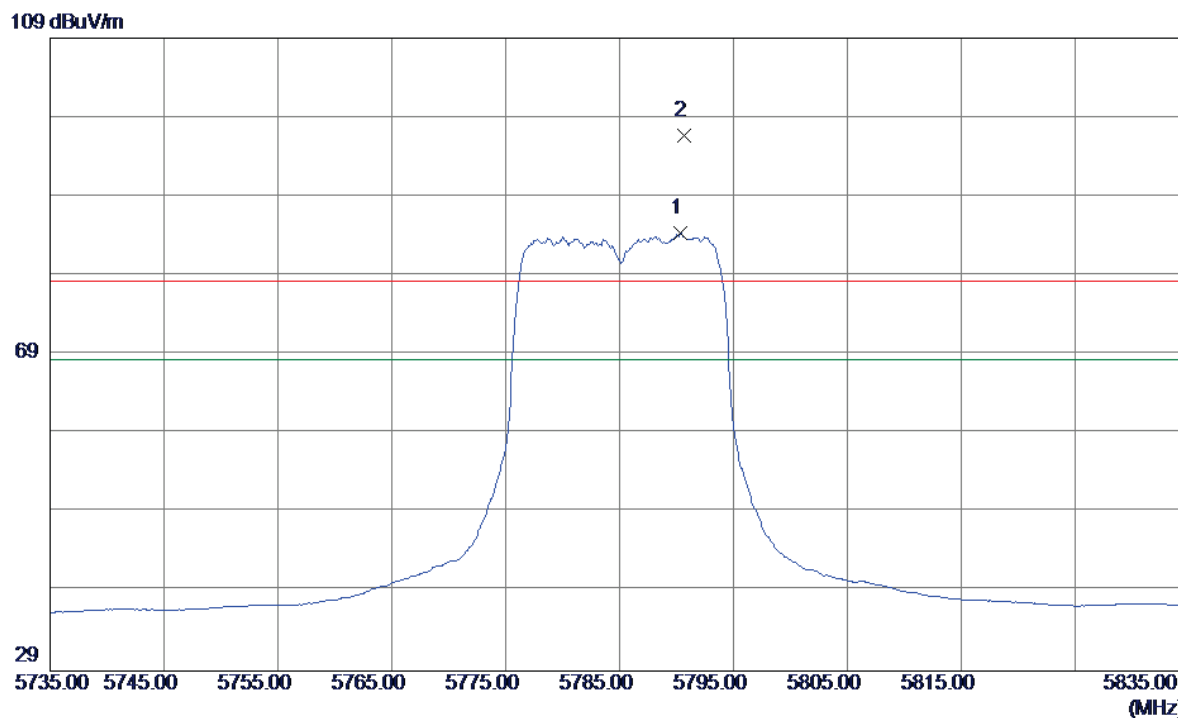

No.	Freq. MHz	Reading Level dBuV/m	Correct Factor dB	Measure ment dBuV/m	Limit dBuV/m	Over dB	Detector	Comment
1	5790.3000	42.98	41.35	84.33	68.30	16.03	AVG	No Limit
2	5790.7000	55.39	41.36	96.75	78.30	18.45	Peak	No Limit

Orthogonal Axis:	X
Test Mode:	UNII-3/TX AC20 Mode 5785MHz - Internal antenna

Horizontal

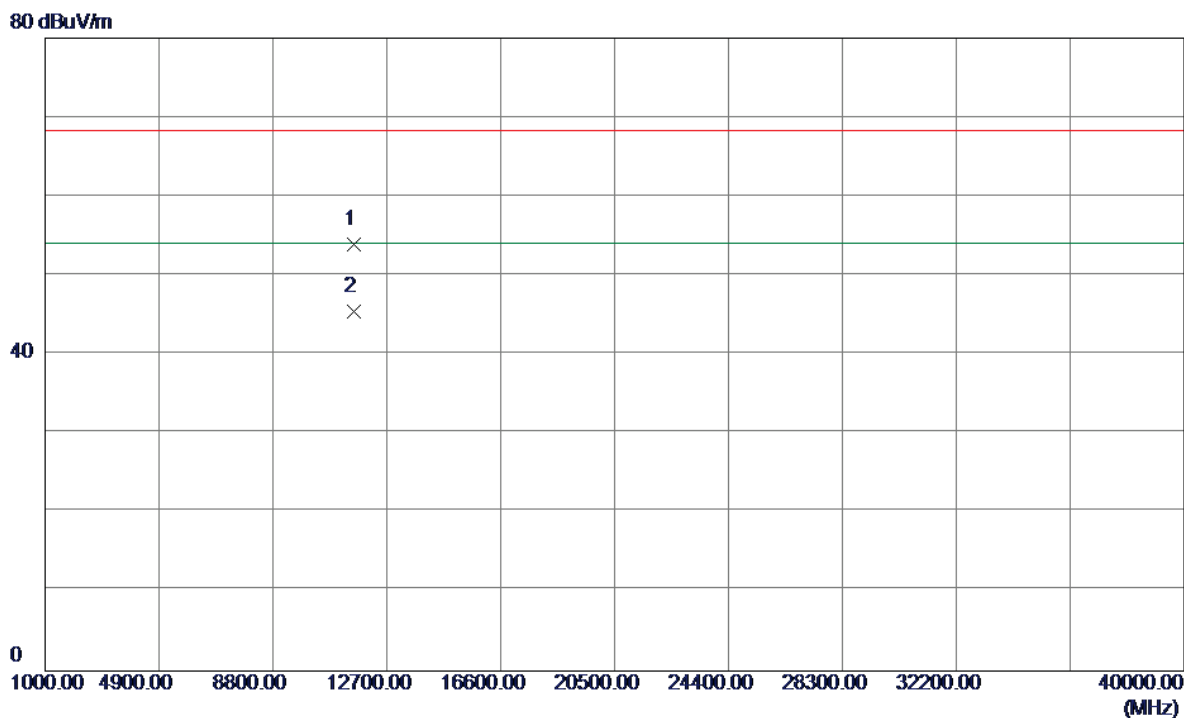

No.	Freq. MHz	Reading Level dBuV/m	Correct Factor dB	Measure ment dBuV/m	Limit dBuV/m	Over dB	Detector	Comment
1	11570.1200	36.90	17.05	53.95	68.30	-14.35	Peak	
2	11570.1200	28.34	17.05	45.39	54.00	-8.61	AVG	

Orthogonal Axis:	X
Test Mode:	UNII-3/TX AC20 Mode 5825MHz - Internal antenna

Vertical

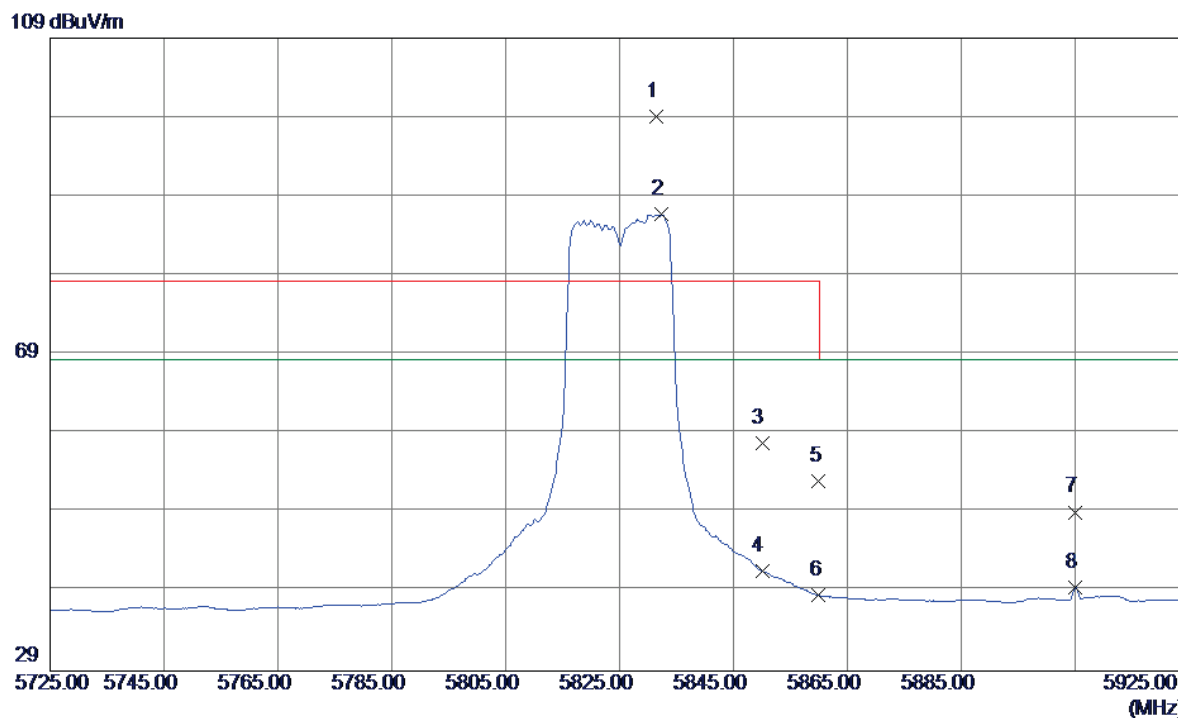

No.	Freq. MHz	Reading Level dBuV/m	Correct Factor dB	Measure ment dBuV/m	Limit dBuV/m	Over dB	Detector	Comment
1	5831.4000	57.70	41.41	99.11	78.30	20.81	Peak	No Limit
2	5832.4000	45.38	41.41	86.79	68.30	18.49	AVG	No Limit
3	5850.0000	16.30	41.44	57.74	78.30	-20.56	Peak	
4	5850.0000	0.27	41.44	41.71	68.30	-26.59	AVG	
5	5860.0000	11.59	41.45	53.04	78.30	-25.26	Peak	
6	5860.0000	-2.87	41.45	38.58	68.30	-29.72	AVG	
7	5905.0000	7.57	41.51	49.08	68.30	-19.22	Peak	
8	5905.0000	-1.95	41.51	39.56	68.30	-28.74	AVG	

Orthogonal Axis:	X
Test Mode:	UNII-3/TX AC20 Mode 5825MHz - Internal antenna

Vertical

80 dBuV/m

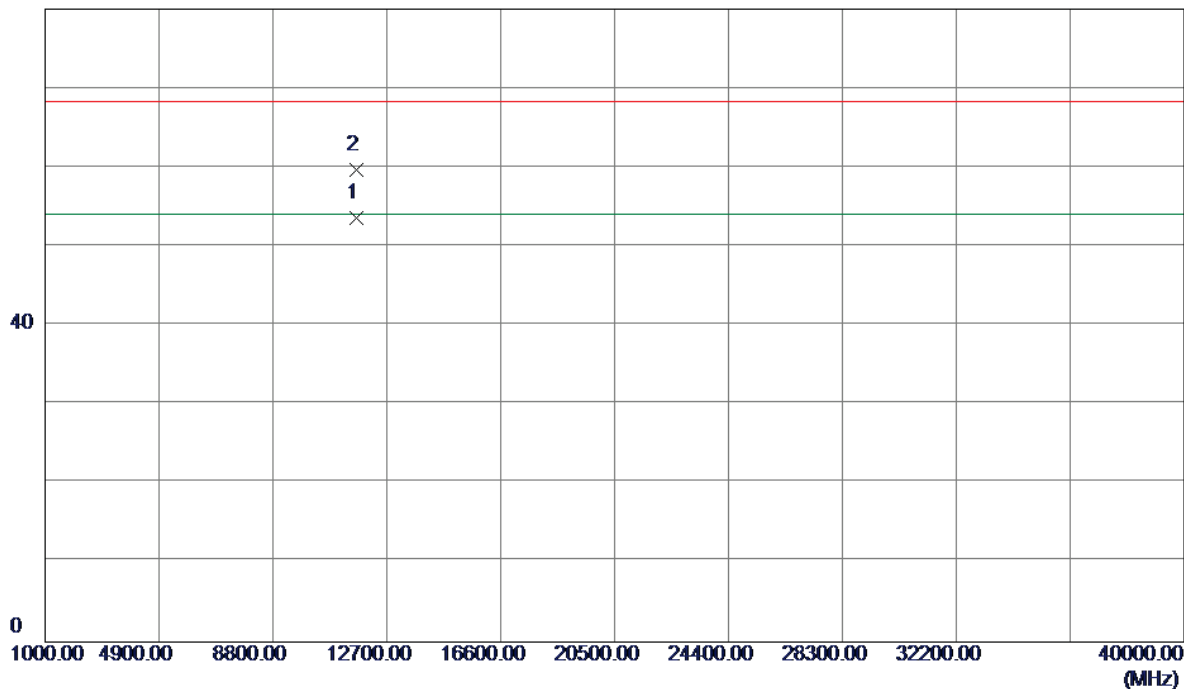

No.	Freq. MHz	Reading Level dBuV/m	Correct Factor dB	Measure ment dBuV/m	Limit dBuV/m	Over dB	Detector	Comment
1	11650.1700	36.42	17.17	53.59	54.00	-0.41	AVG	
2	11650.2500	42.58	17.17	59.75	68.30	-8.55	Peak	

Orthogonal Axis:	X
Test Mode:	UNII-3/TX AC20 Mode 5825MHz - Internal antenna

Horizontal

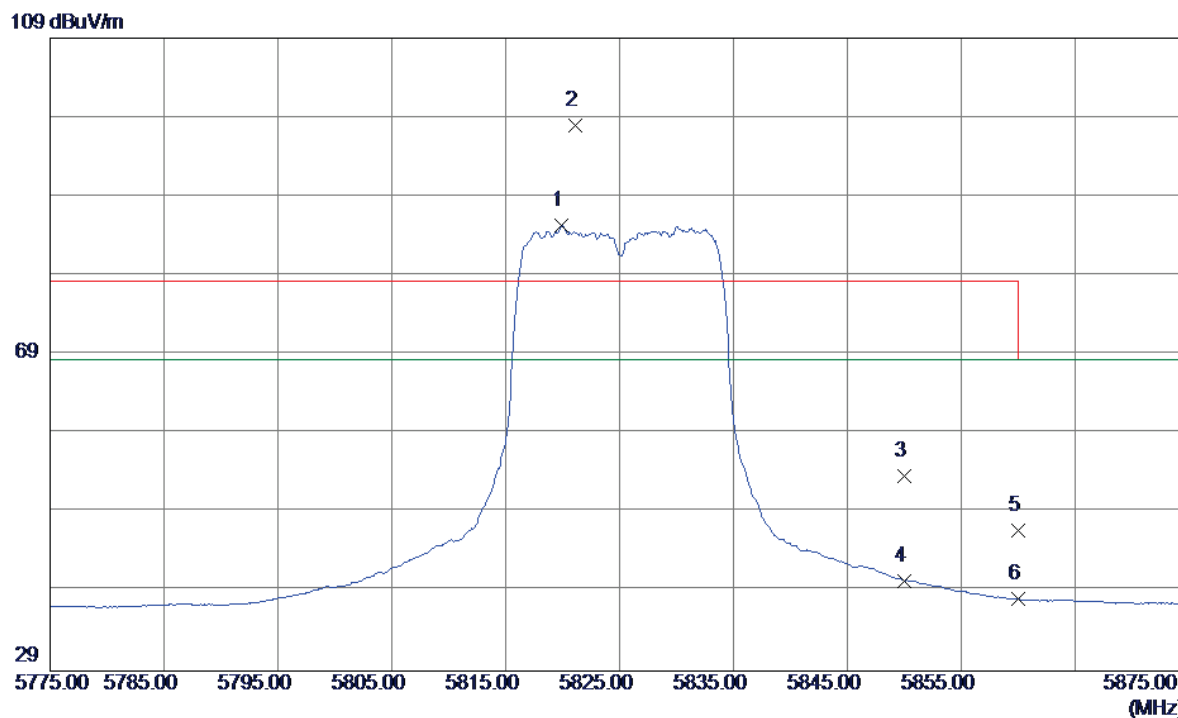

No.	Freq. MHz	Reading Level dBuV/m	Correct Factor dB	Measure ment dBuV/m	Limit dBuV/m	Over dB	Detector	Comment
1	5819.9000	43.86	41.40	85.26	68.30	16.96	AVG	No Limit
2	5821.1000	56.52	41.40	97.92	78.30	19.62	Peak	No Limit
3	5850.0000	12.23	41.44	53.67	78.30	-24.63	Peak	
4	5850.0000	-1.03	41.44	40.41	68.30	-27.89	AVG	
5	5860.0000	5.26	41.45	46.71	78.30	-31.59	Peak	
6	5860.0000	-3.36	41.45	38.09	68.30	-30.21	AVG	

Orthogonal Axis:	X
Test Mode:	UNII-3/TX AC20 Mode 5825MHz - Internal antenna

Horizontal

80 dBuV/m

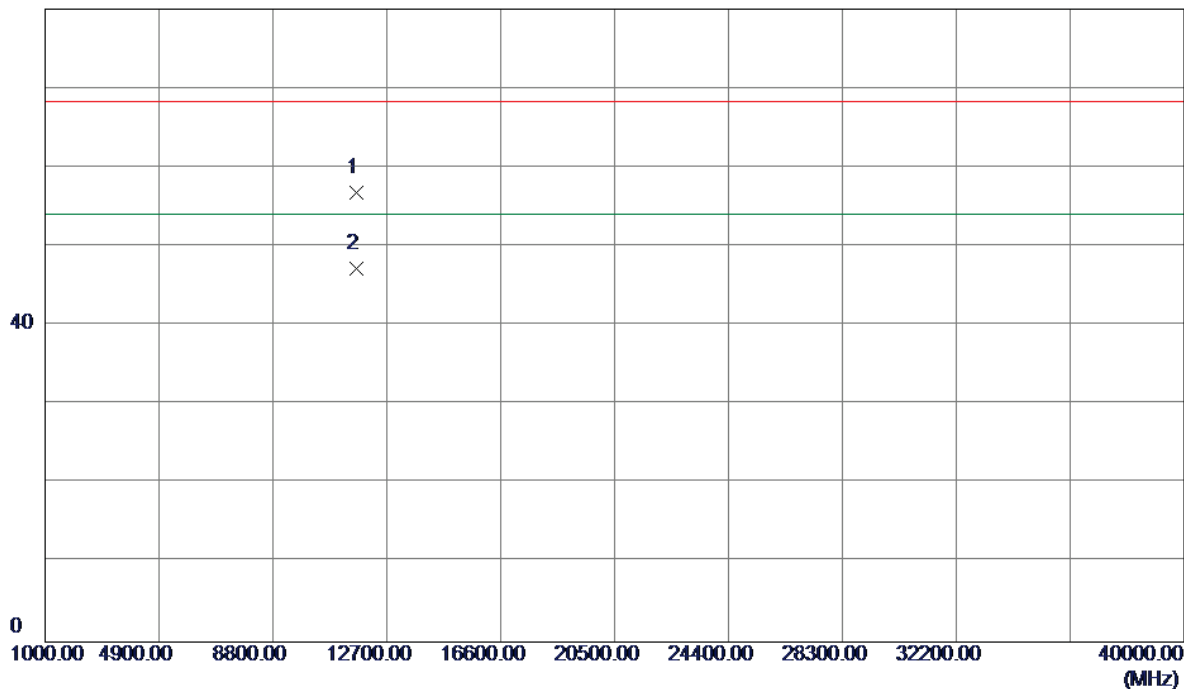

No.	Freq. MHz	Reading Level dBuV/m	Correct Factor dB	Measure ment dBuV/m	Limit dBuV/m	Over dB	Detector	Comment
1	11650.1800	39.57	17.17	56.74	68.30	-11.56	Peak	
2	11650.1800	30.04	17.17	47.21	54.00	-6.79	AVG	

Orthogonal Axis:	X
Test Mode:	UNII-3/TX AC40 Mode 5755MHz - Internal antenna

Vertical

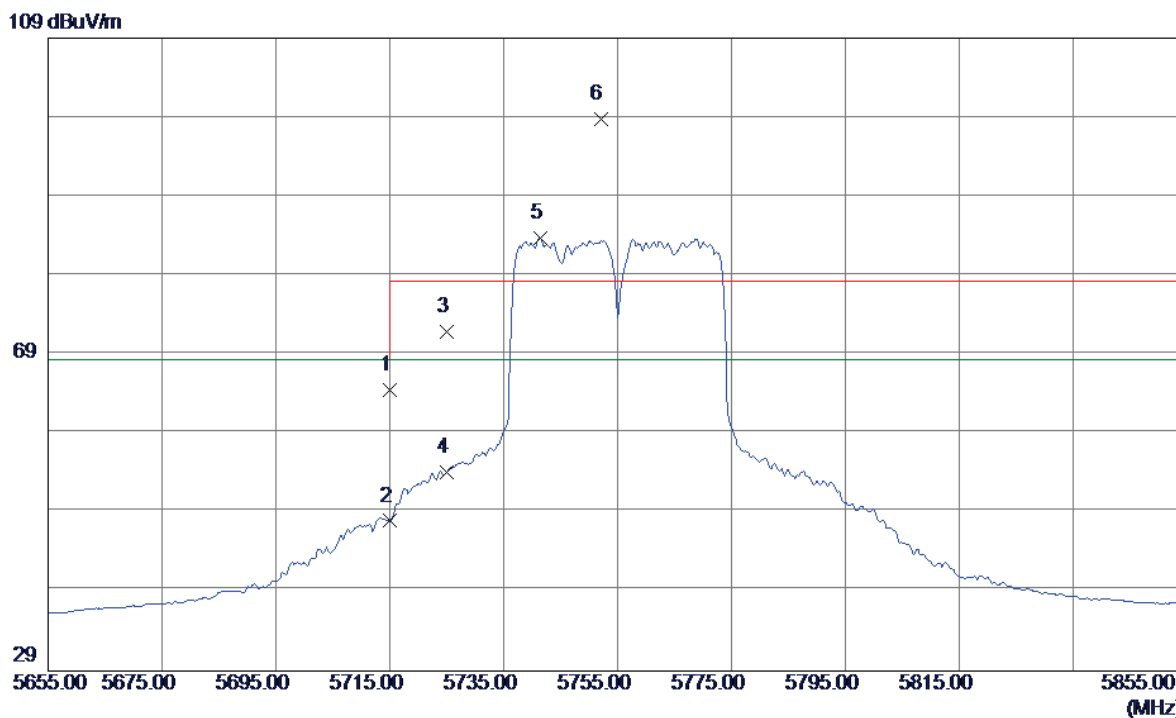

No.	Freq. MHz	Reading Level dBuV/m	Correct Factor dB	Measure ment dBuV/m	Limit dBuV/m	Over dB	Detector	Comment
1	5715.0000	23.20	41.25	64.45	68.30	-3.85	Peak	
2	5715.0000	6.71	41.25	47.96	68.30	-20.34	AVG	
3	5725.0000	30.61	41.27	71.88	78.30	-6.42	Peak	
4	5725.0000	12.88	41.27	54.15	68.30	-14.15	AVG	
5	5741.4000	42.50	41.29	83.79	68.30	15.49	AVG	No Limit
6	5752.0000	57.53	41.30	98.83	78.30	20.53	Peak	No Limit

Orthogonal Axis:	X
Test Mode:	UNII-3/TX AC40 Mode 5755MHz- Internal antenna

Vertical

80 dBuV/m

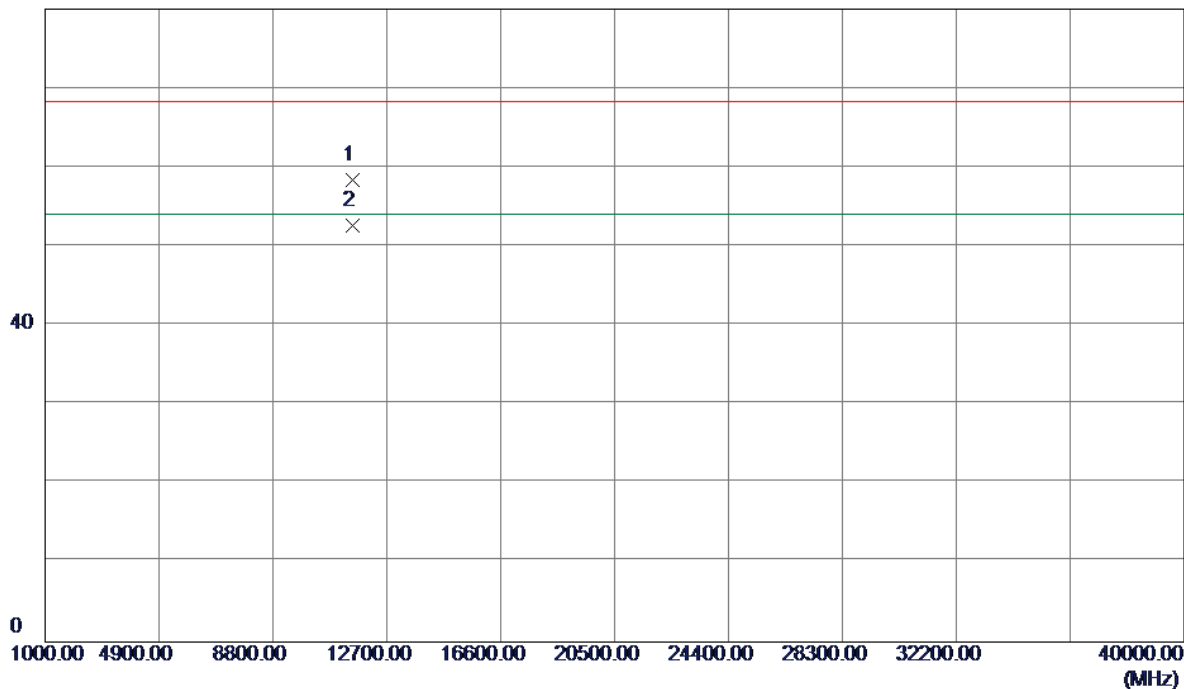

No.	Freq. MHz	Reading Level dBuV/m	Correct Factor dB	Measure ment dBuV/m	Limit dBuV/m	Over dB	Detector	Comment
1	11510.0550	41.42	16.95	58.37	68.30	-9.93	Peak	
2	11510.1600	35.73	16.95	52.68	54.00	-1.32	AVG	

Orthogonal Axis:	X
Test Mode:	UNII-3/TX AC40 Mode 5755MHz- Internal antenna

Horizontal

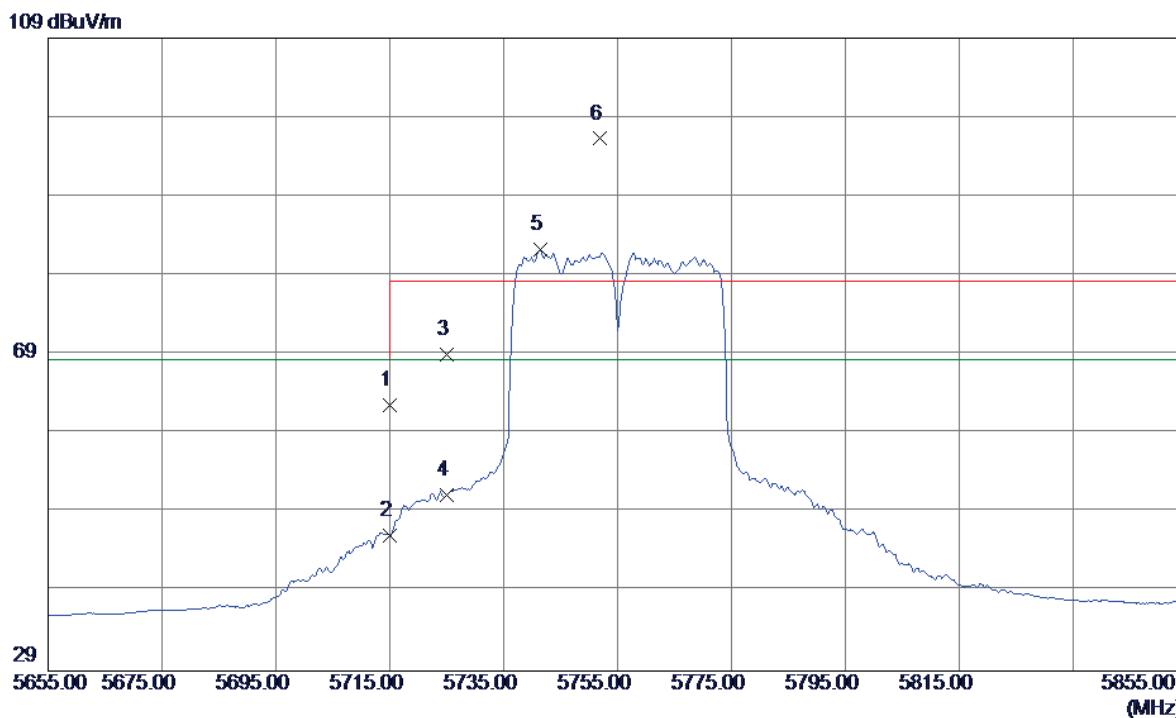

No.	Freq. MHz	Reading Level dBuV/m	Correct Factor dB	Measure ment dBuV/m	Limit dBuV/m	Over dB	Detector	Comment
1	5715.0000	21.35	41.25	62.60	68.30	-5.70	Peak	
2	5715.0000	4.91	41.25	46.16	68.30	-22.14	AVG	
3	5725.0000	27.72	41.27	68.99	78.30	-9.31	Peak	
4	5725.0000	9.95	41.27	51.22	68.30	-17.08	AVG	
5	5741.4000	40.92	41.29	82.21	68.30	13.91	AVG	No Limit
6	5751.8000	54.98	41.30	96.28	78.30	17.98	Peak	No Limit

Orthogonal Axis:	X
Test Mode:	UNII-3/TX AC40 Mode 5755MHz- Internal antenna

Horizontal

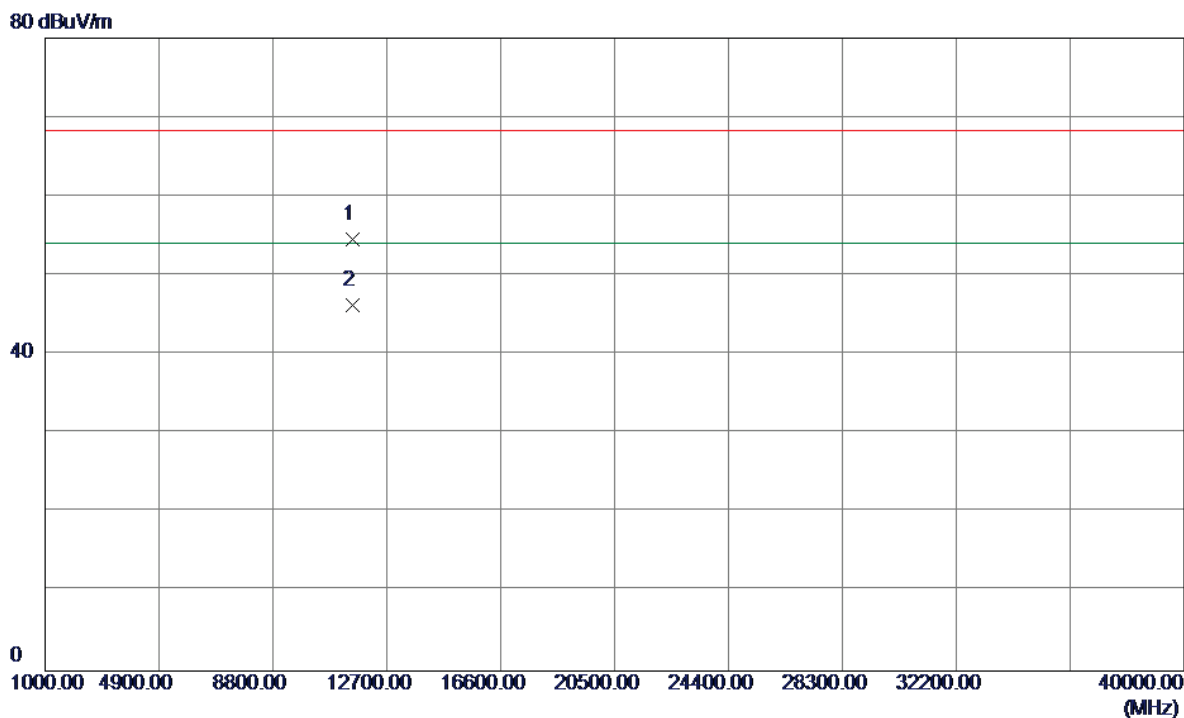

No.	Freq. MHz	Reading Level dBuV/m	Correct Factor dB	Measure ment dBuV/m	Limit dBuV/m	Over dB	Detector	Comment
1	11510.0000	37.62	16.95	54.57	68.30	-13.73	Peak	
2	11510.1400	29.32	16.95	46.27	54.00	-7.73	AVG	

Orthogonal Axis:	X
Test Mode:	UNII-3/TX AC40 Mode 5795MHz- Internal antenna

Vertical

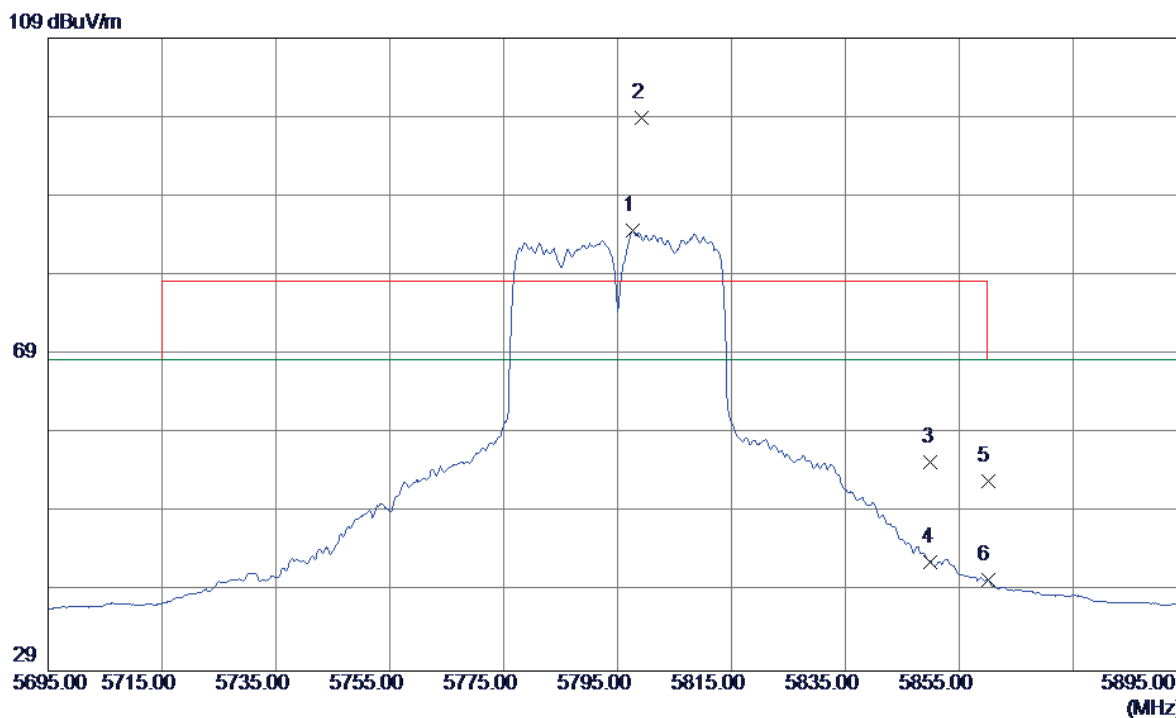

No.	Freq. MHz	Reading Level dBuV/m	Correct Factor dB	Measure ment dBuV/m	Limit dBuV/m	Over dB	Detector	Comment
1	5797.6000	43.28	41.36	84.64	68.30	16.34	AVG	No Limit
2	5799.2000	57.59	41.37	98.96	78.30	20.66	Peak	No Limit
3	5850.0000	13.99	41.44	55.43	78.30	-22.87	Peak	
4	5850.0000	1.30	41.44	42.74	68.30	-25.56	AVG	
5	5860.0000	11.55	41.45	53.00	78.30	-25.30	Peak	
6	5860.0000	-0.88	41.45	40.57	68.30	-27.73	AVG	

Orthogonal Axis:	X
Test Mode:	UNII-3/TX AC40 Mode 5795MHz- Internal antenna

Vertical

80 dBuV/m

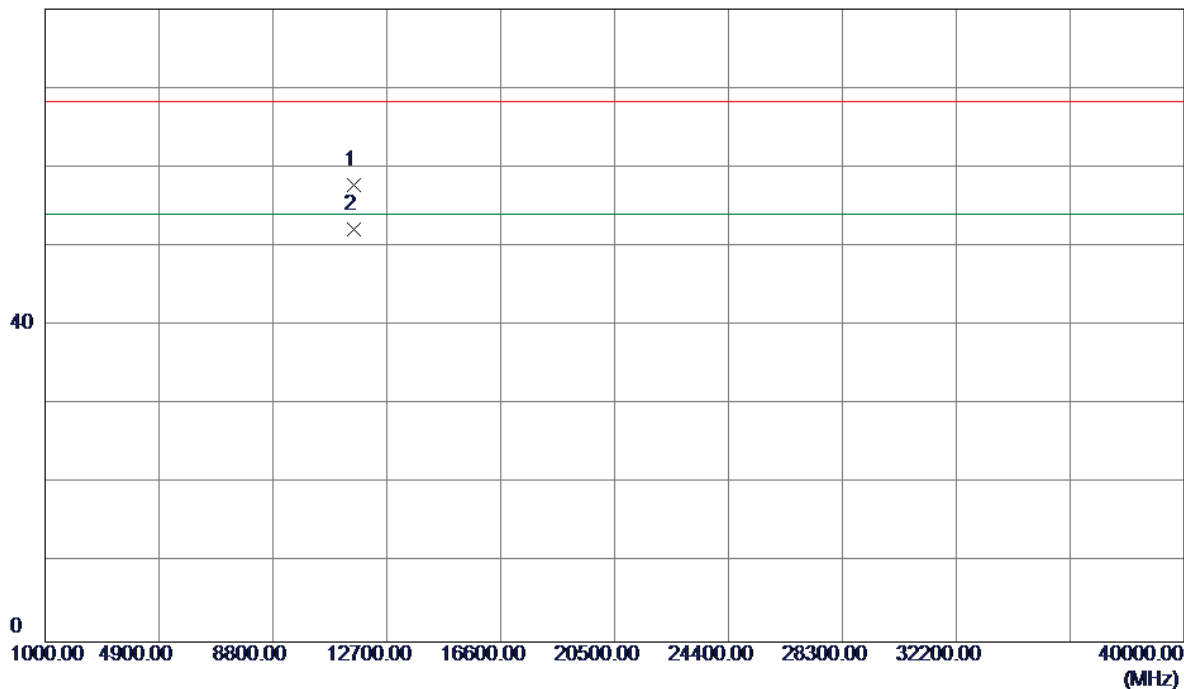

No.	Freq. MHz	Reading Level dBuV/m	Correct Factor dB	Measure ment dBuV/m	Limit dBuV/m	Over dB	Detector	Comment
1	11590.0700	40.74	17.08	57.82	68.30	-10.48	Peak	
2	11590.1600	35.07	17.08	52.15	54.00	-1.85	AVG	

Orthogonal Axis:	X
Test Mode:	UNII-3/TX AC40 Mode 5795MHz- Internal antenna

Horizontal

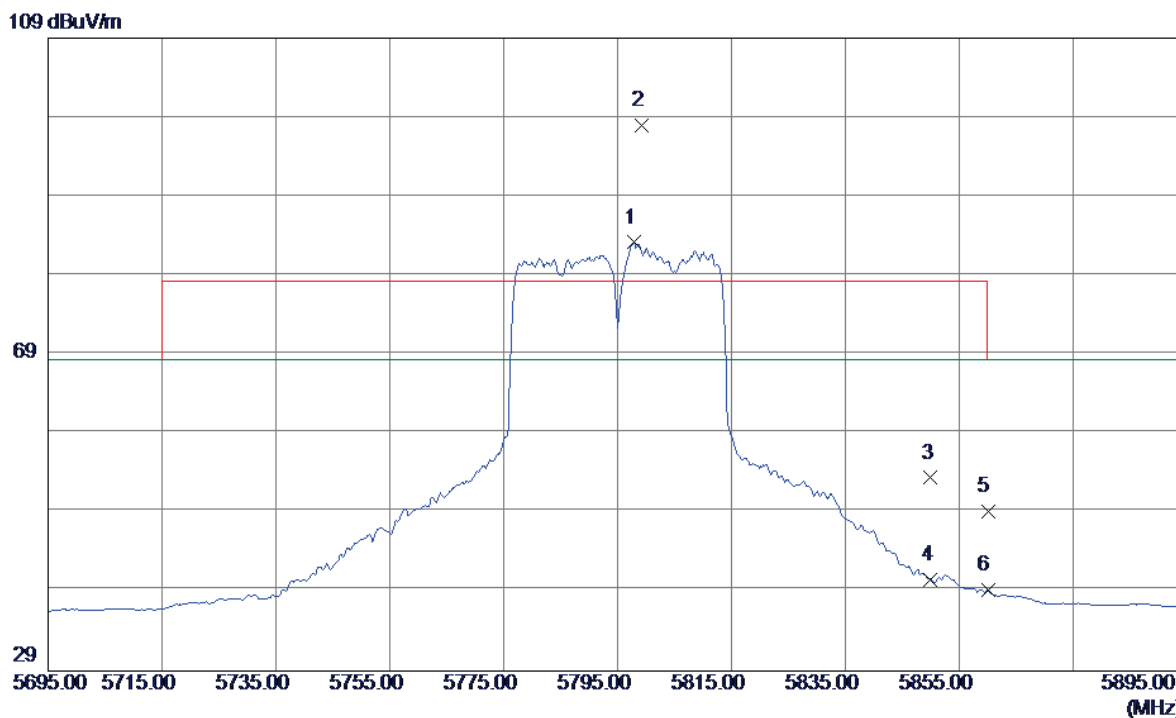

No.	Freq. MHz	Reading Level dBuV/m	Correct Factor dB	Measure ment dBuV/m	Limit dBuV/m	Over dB	Detector	Comment
1	5797.8000	41.79	41.37	83.16	68.30	14.86	AVG	No Limit
2	5799.2000	56.60	41.37	97.97	78.30	19.67	Peak	No Limit
3	5850.0000	11.96	41.44	53.40	78.30	-24.90	Peak	
4	5850.0000	-0.88	41.44	40.56	68.30	-27.74	AVG	
5	5860.0000	7.76	41.45	49.21	78.30	-29.09	Peak	
6	5860.0000	-2.23	41.45	39.22	68.30	-29.08	AVG	

Orthogonal Axis:	X
Test Mode:	UNII-3/TX AC40 Mode 5795MHz- Internal antenna

Horizontal

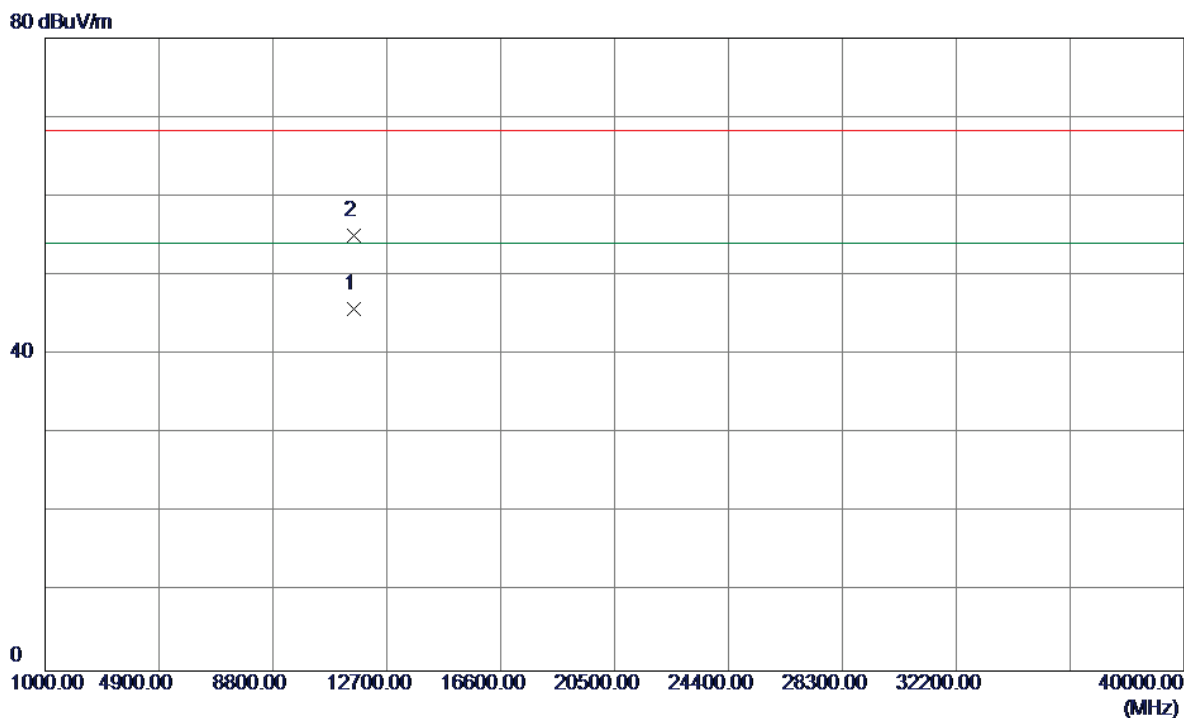

No.	Freq. MHz	Reading Level dBuV/m	Correct Factor dB	Measure ment dBuV/m	Limit dBuV/m	Over dB	Detector	Comment
1	11590.1600	28.74	17.08	45.82	54.00	-8.18	AVG	
2	11590.2500	37.92	17.08	55.00	68.30	-13.30	Peak	

Orthogonal Axis:	X
Test Mode:	UNII-3/TX AC80 Mode 5775MHz- Internal antenna

Vertical

109 dBuV/m

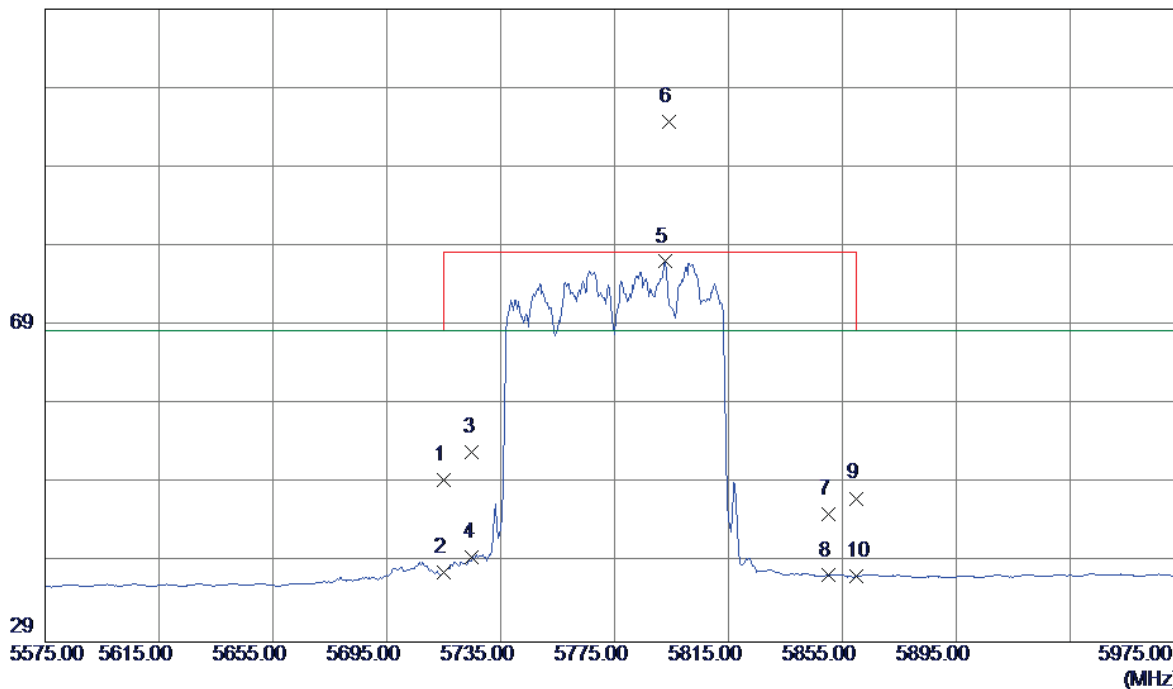

No.	Freq. MHz	Reading Level dBuV/m	Correct Factor dB	Measure ment dBuV/m	Limit dBuV/m	Over dB	Detector	Comment
1	5715.0000	8.17	41.25	49.42	68.30	-18.88	Peak	
2	5715.0000	-3.41	41.25	37.84	68.30	-30.46	AVG	
3	5725.0000	11.77	41.27	53.04	78.30	-25.26	Peak	
4	5725.0000	-1.50	41.27	39.77	68.30	-28.53	AVG	
5	5792.6000	35.72	41.36	77.08	68.30	8.78	AVG	No Limit
6	5794.2000	53.33	41.36	94.69	78.30	16.39	Peak	No Limit
7	5850.0000	3.73	41.44	45.17	78.30	-33.13	Peak	
8	5850.0000	-4.04	41.44	37.40	68.30	-30.90	AVG	
9	5860.0000	5.71	41.45	47.16	78.30	-31.14	Peak	
10	5860.0000	-4.20	41.45	37.25	68.30	-31.05	AVG	

Orthogonal Axis:	X
Test Mode:	UNII-3/TX AC80 Mode 5775MHz- Internal antenna

Vertical

80 dBuV/m

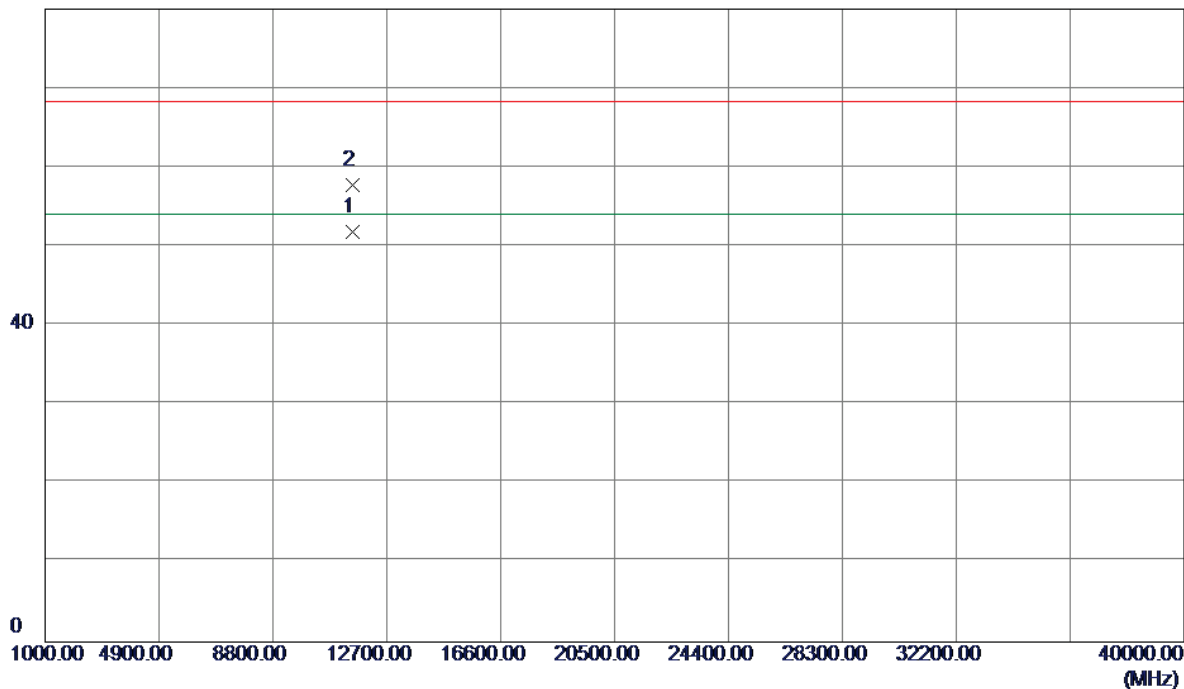

No.	Freq. MHz	Reading Level dBuV/m	Correct Factor dB	Measure ment dBuV/m	Limit dBuV/m	Over dB	Detector	Comment
1	11550.1449	34.85	17.01	51.86	54.00	-2.14	AVG	
2	11550.2699	40.79	17.01	57.80	68.30	-10.50	Peak	

Orthogonal Axis:	X
Test Mode:	UNII-3/TX AC80 Mode 5775MHz- Internal antenna

Horizontal

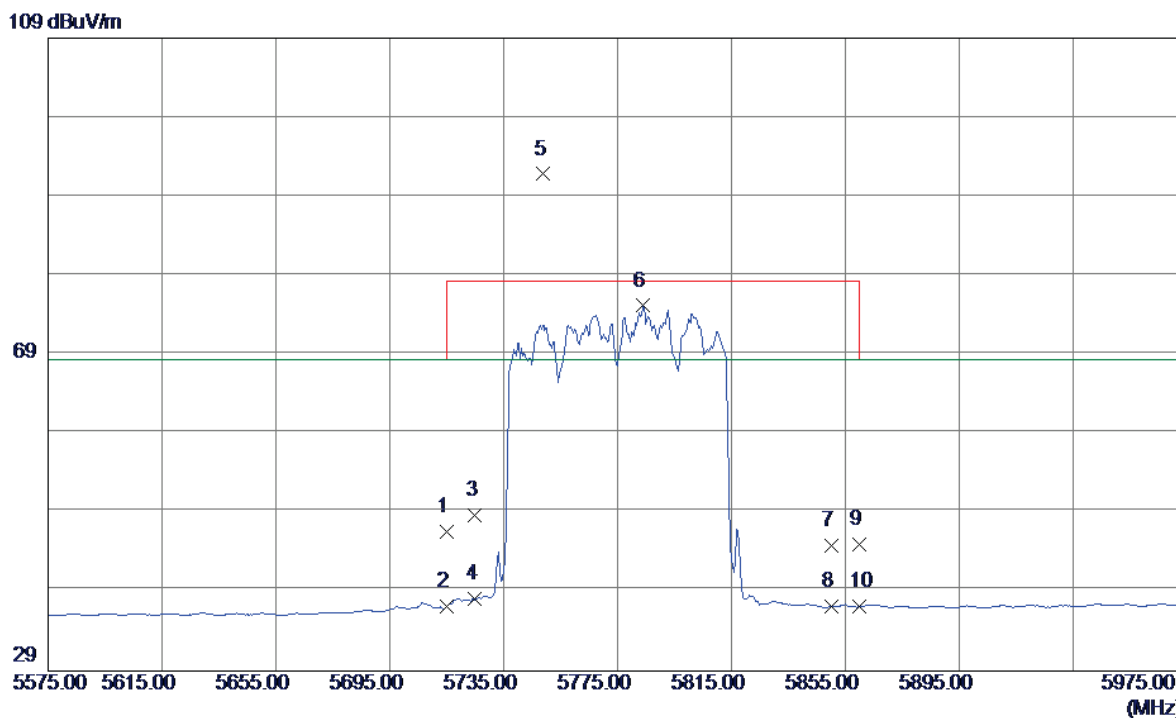

No.	Freq. MHz	Reading Level dBuV/m	Correct Factor dB	Measure ment dBuV/m	Limit dBuV/m	Over dB	Detector	Comment
1	5715.0000	5.38	41.25	46.63	68.30	-21.67	Peak	
2	5715.0000	-4.12	41.25	37.13	68.30	-31.17	AVG	
3	5725.0000	7.39	41.27	48.66	78.30	-29.64	Peak	
4	5725.0000	-3.09	41.27	38.18	68.30	-30.12	AVG	
5	5749.0000	50.50	41.30	91.80	78.30	13.50	Peak	No Limit
6	5783.8000	33.81	41.35	75.16	68.30	6.86	AVG	No Limit
7	5850.0000	3.36	41.44	44.80	78.30	-33.50	Peak	
8	5850.0000	-4.34	41.44	37.10	68.30	-31.20	AVG	
9	5860.0000	3.61	41.45	45.06	78.30	-33.24	Peak	
10	5860.0000	-4.26	41.45	37.19	68.30	-31.11	AVG	

Orthogonal Axis:	X
Test Mode:	UNII-3/TX AC80 Mode 5775MHz- Internal antenna

Horizontal

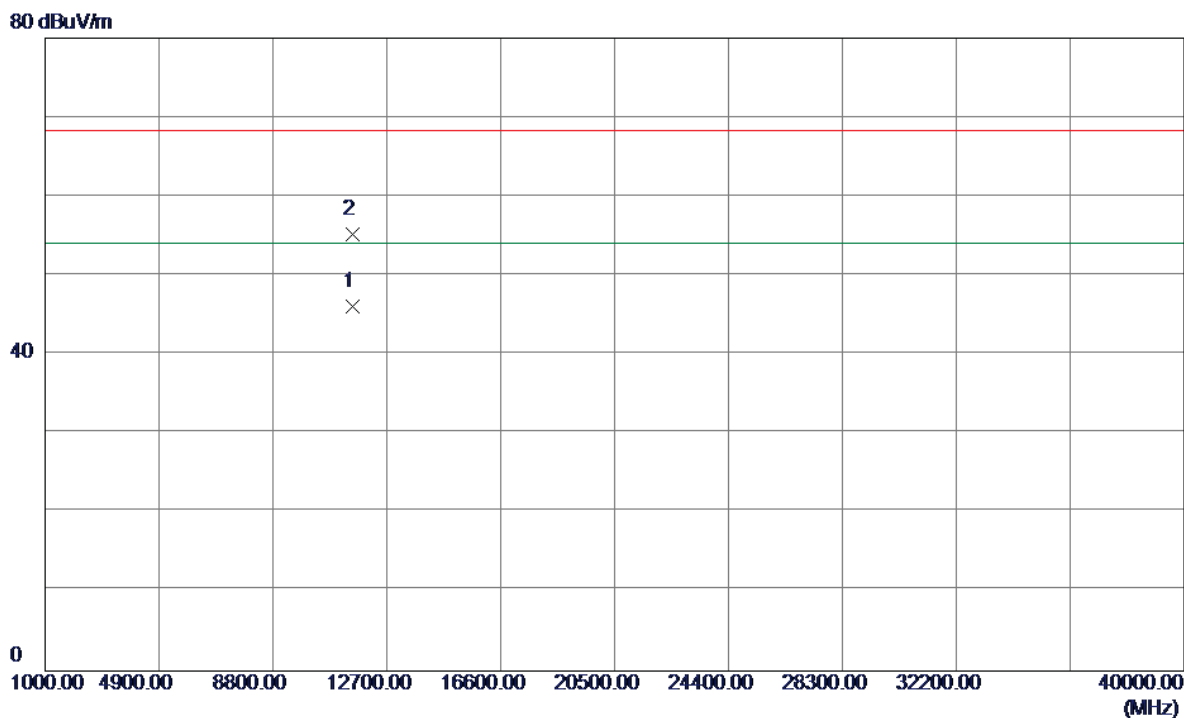

No.	Freq. MHz	Reading Level dBuV/m	Correct Factor dB	Measure ment dBuV/m	Limit dBuV/m	Over dB	Detector	Comment
1	11550.1300	29.05	17.01	46.06	54.00	-7.94	AVG	
2	11550.1650	38.21	17.01	55.22	68.30	-13.08	Peak	

Orthogonal Axis:	X
Test Mode:	UNII-1/ TX A Mode 5180MHz - External antenna

Vertical

112 dBuV/m

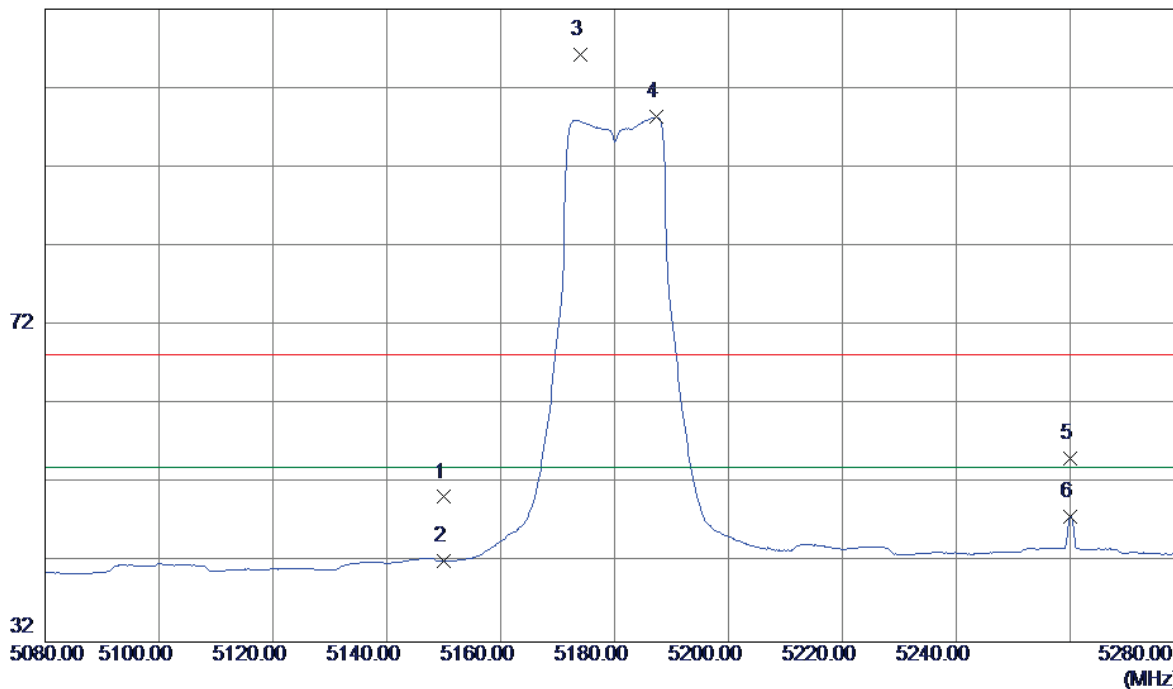

No.	Freq. MHz	Reading Level dBuV/m	Correct Factor dB	Measure ment dBuV/m	Limit dBuV/m	Over dB	Detector	Comment
1	5150.0000	10.10	40.22	50.32	68.30	-17.98	Peak	
2	5150.0000	2.02	40.22	42.24	54.00	-11.76	AVG	
3	5174.0000	65.99	40.27	106.26	68.30	37.96	Peak	No Limit
4	5187.4000	58.05	40.30	98.35	54.00	44.35	AVG	No Limit
5	5260.0000	14.75	40.45	55.20	68.30	-13.10	Peak	
6	5260.0000	7.45	40.45	47.90	54.00	-6.10	AVG	

Orthogonal Axis:	X
Test Mode:	UNII-1/ TX A Mode 5180MHz - External antenna

Vertical

80 dBuV/m

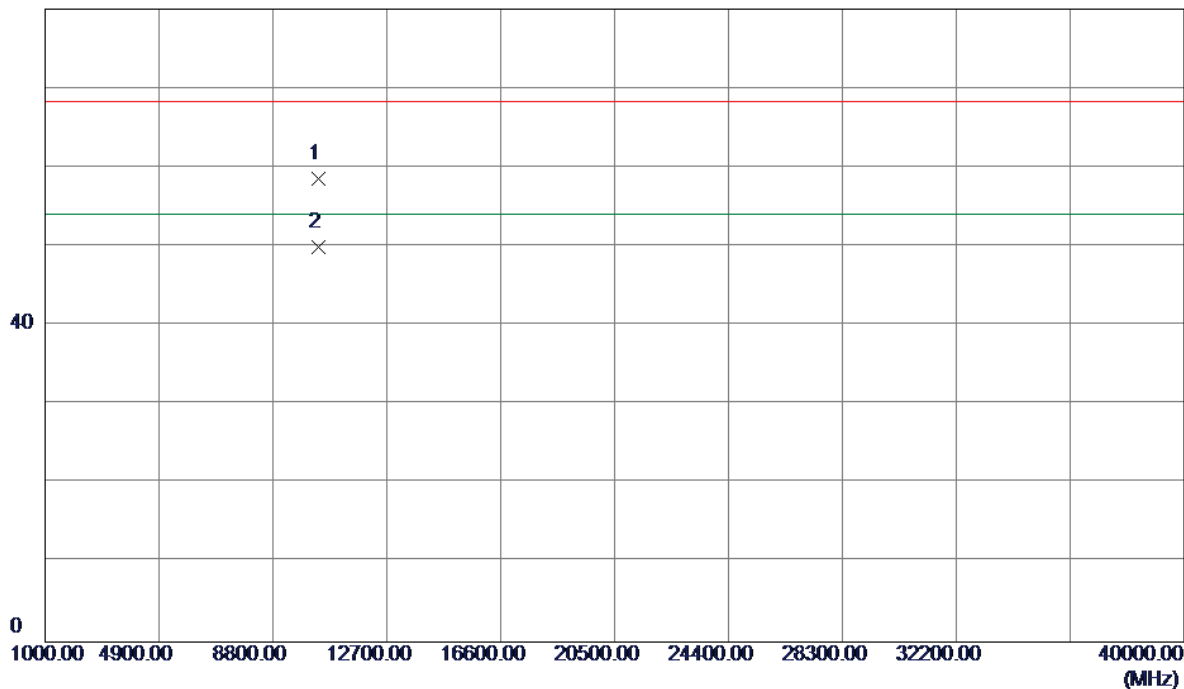

No.	Freq. MHz	Reading Level dBuV/m	Correct Factor dB	Measure ment dBuV/m	Limit dBuV/m	Over dB	Detector	Comment
1	10360.1900	44.71	13.86	58.57	68.30	-9.73	Peak	
2	10360.2000	36.02	13.86	49.88	54.00	-4.12	AVG	

Orthogonal Axis:	X
Test Mode:	UNII-1/ TX A Mode 5180MHz - External antenna

Horizontal

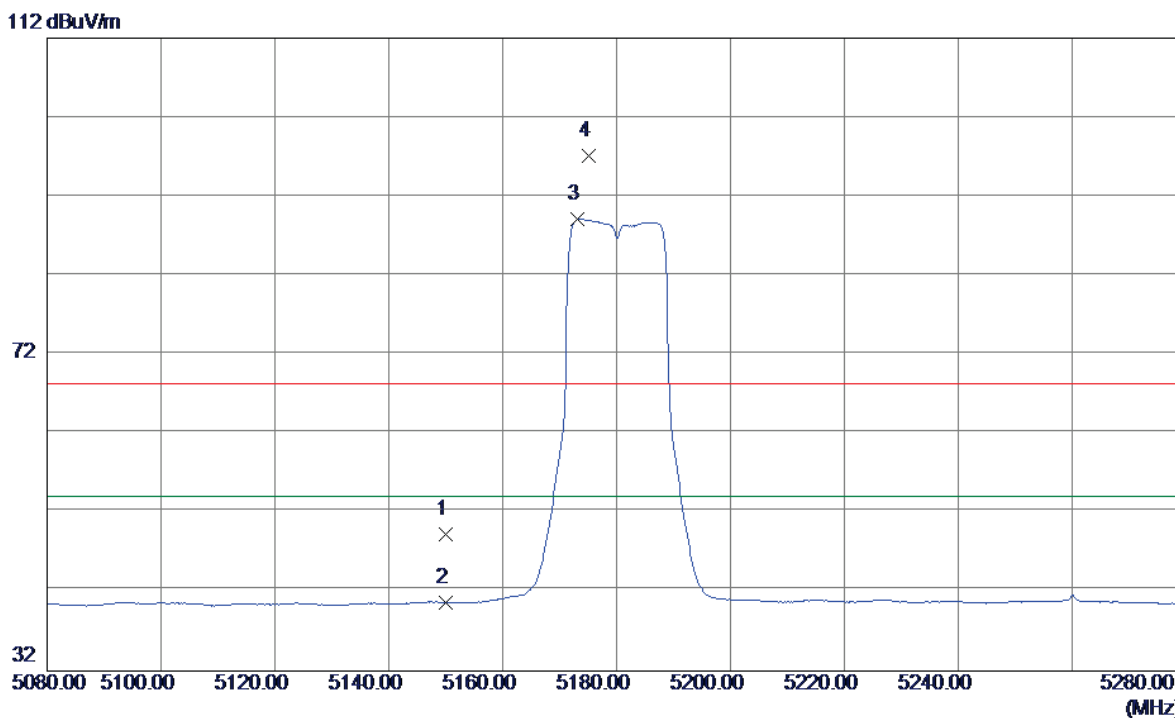

No.	Freq. MHz	Reading Level dBuV/m	Correct Factor dB	Measure ment dBuV/m	Limit dBuV/m	Over dB	Detector	Comment
1	5150.0000	9.03	40.22	49.25	68.30	-19.05	Peak	
2	5150.0000	0.42	40.22	40.64	54.00	-13.36	AVG	
3	5173.2000	48.83	40.27	89.10	54.00	35.10	AVG	No Limit
4	5175.2000	56.81	40.27	97.08	68.30	28.78	Peak	No Limit

Orthogonal Axis:	X
Test Mode:	UNII-1/ TX A Mode 5180MHz - External antenna

Horizontal

80 dBuV/m

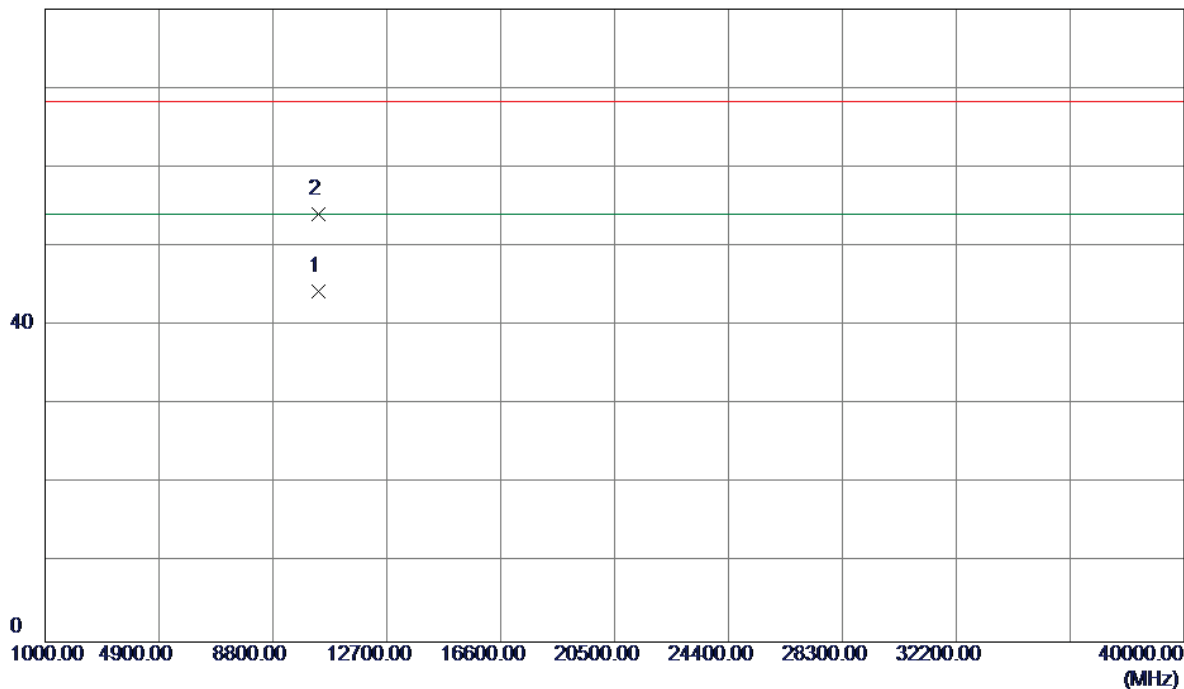

No.	Freq. MHz	Reading Level dBuV/m	Correct Factor dB	Measure ment dBuV/m	Limit dBuV/m	Over dB	Detector	Comment
1	10360.1900	30.41	13.86	44.27	54.00	-9.73	AVG	
2	10360.2699	40.18	13.86	54.04	68.30	-14.26	Peak	

Orthogonal Axis:	X
Test Mode:	UNII-1/ TX A Mode 5200MHz - External antenna

Vertical

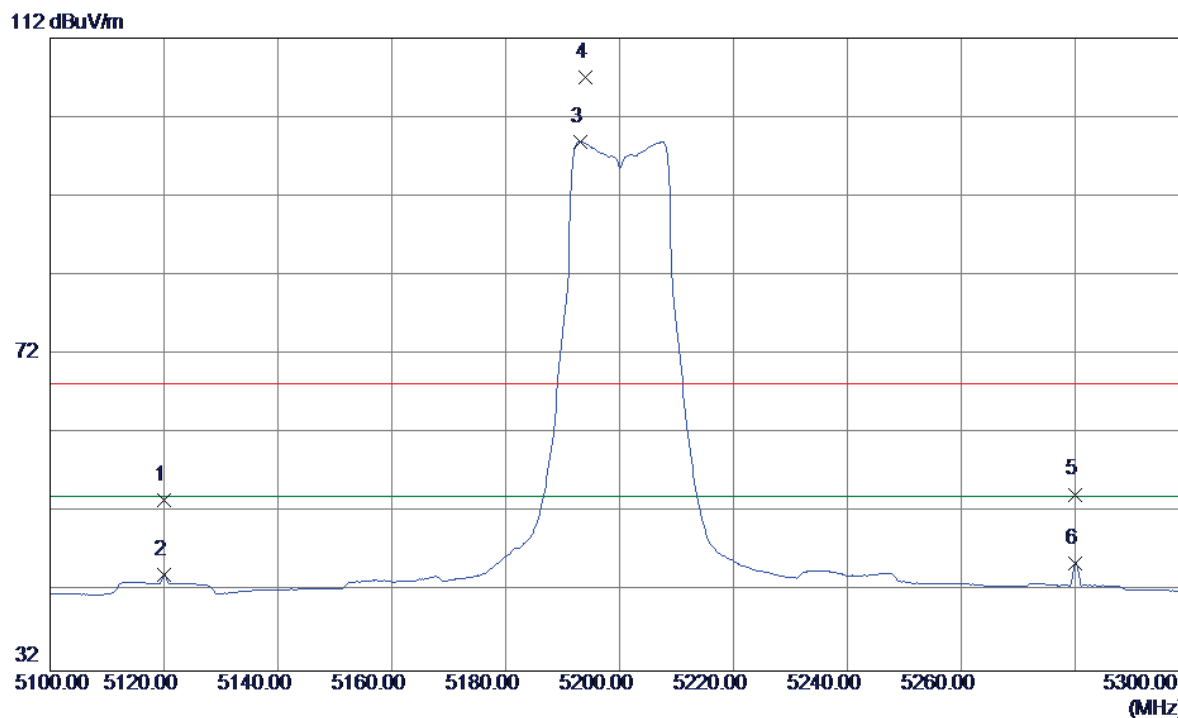

No.	Freq. MHz	Reading Level dBuV/m	Correct Factor dB	Measure ment dBuV/m	Limit dBuV/m	Over dB	Detector	Comment
1	5120.0000	13.44	40.15	53.59	68.30	-14.71	Peak	
2	5120.0000	4.04	40.15	44.19	54.00	-9.81	AVG	
3	5193.2000	58.56	40.31	98.87	54.00	44.87	AVG	No Limit
4	5194.0000	66.66	40.31	106.97	68.30	38.67	Peak	No Limit
5	5280.0000	13.83	40.49	54.32	68.30	-13.98	Peak	
6	5280.0000	5.12	40.49	45.61	54.00	-8.39	AVG	

Orthogonal Axis:	X
Test Mode:	UNII-1/ TX A Mode 5200MHz - External antenna

Vertical

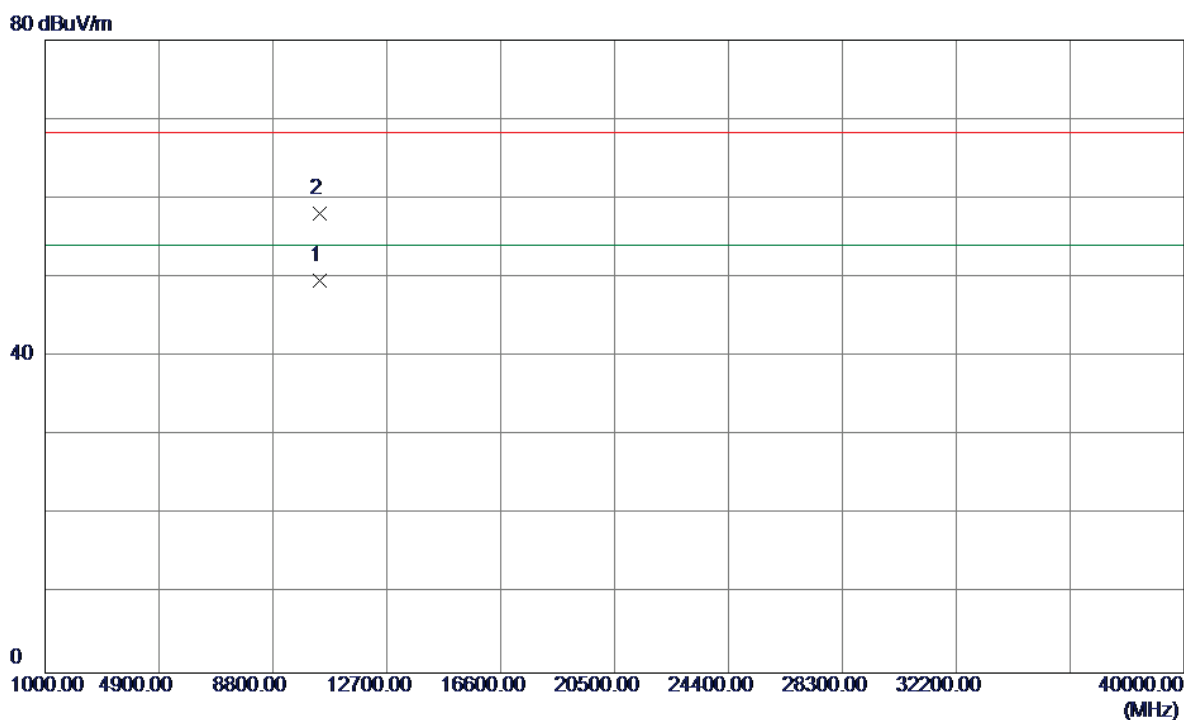

No.	Freq. MHz	Reading Level dBuV/m	Correct Factor dB	Measure ment dBuV/m	Limit dBuV/m	Over dB	Detector	Comment
1	10400.2200	35.86	13.80	49.66	54.00	-4.34	AVG	
2	10400.2400	44.26	13.80	58.06	68.30	-10.24	Peak	

Orthogonal Axis:	X
Test Mode:	UNII-1/ TX A Mode 5200MHz - External antenna

Horizontal

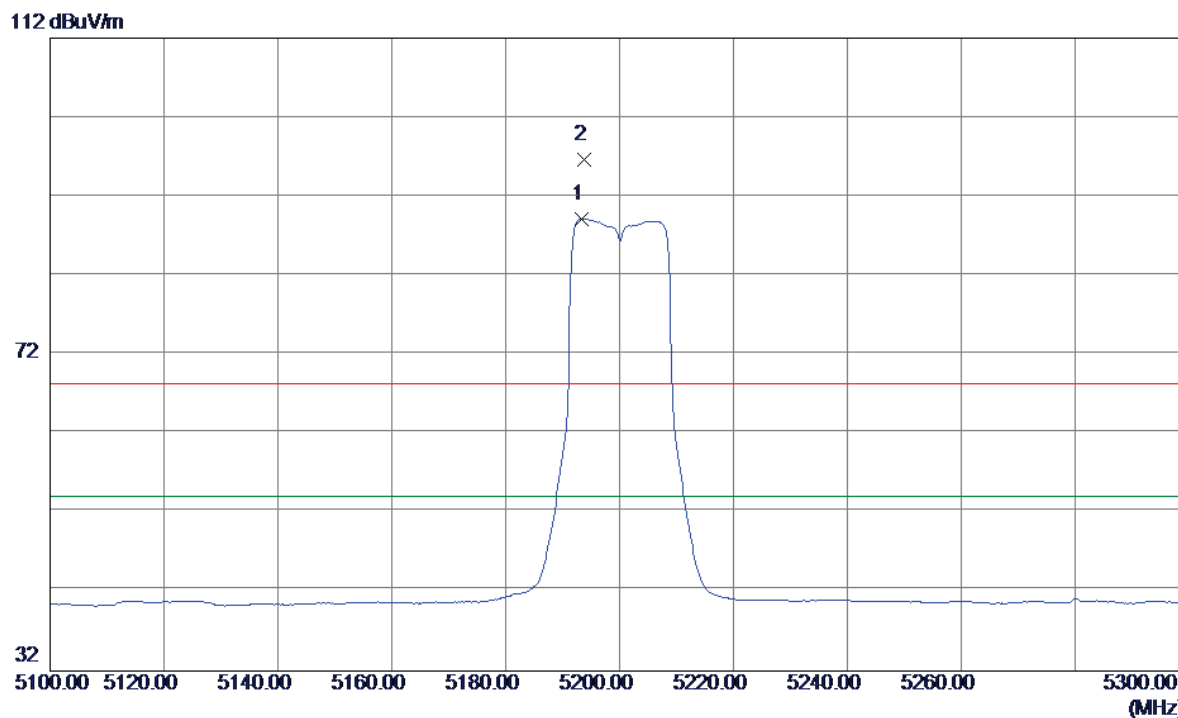

No.	Freq. MHz	Reading Level dBuV/m	Correct Factor dB	Measure ment dBuV/m	Limit dBuV/m	Over dB	Detector	Comment
1	5193.4000	48.88	40.31	89.19	54.00	35.19	AVG	No Limit
2	5193.8000	56.33	40.31	96.64	68.30	28.34	Peak	No Limit

Orthogonal Axis:	X
Test Mode:	UNII-1/ TX A Mode 5200MHz - External antenna

Horizontal

80 dBuV/m

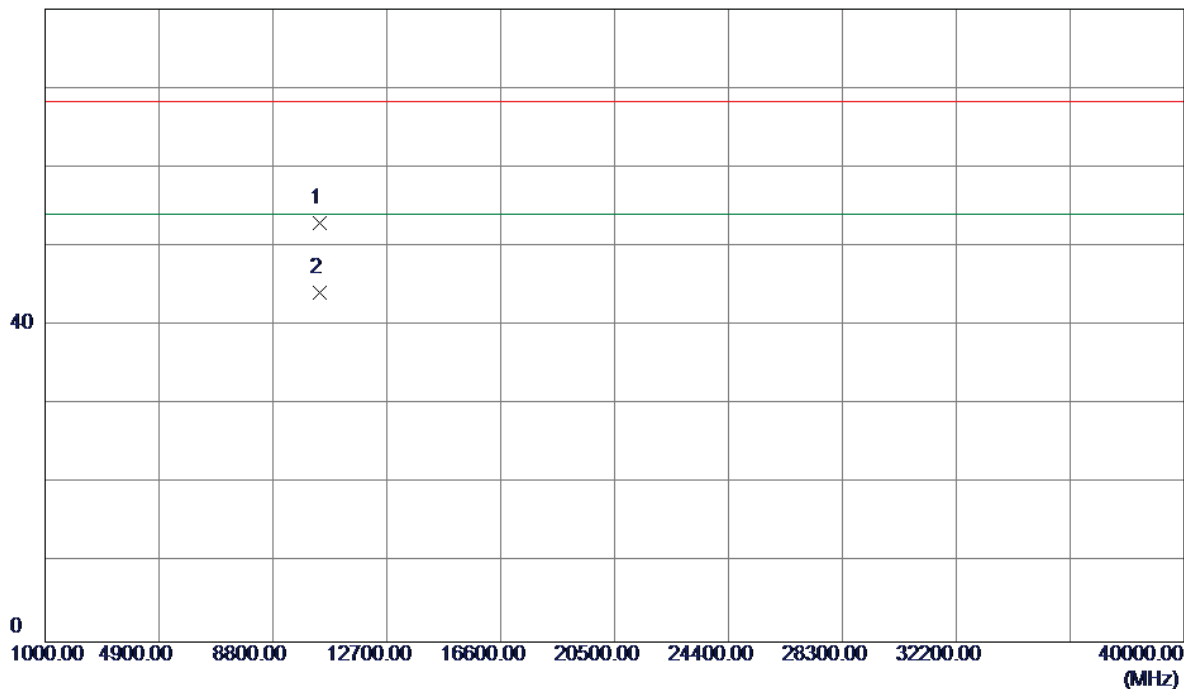

No.	Freq. MHz	Reading Level dBuV/m	Correct Factor dB	Measure ment dBuV/m	Limit dBuV/m	Over dB	Detector	Comment
1	10400.1900	39.12	13.80	52.92	68.30	-15.38	Peak	
2	10400.2200	30.36	13.80	44.16	54.00	-9.84	AVG	

Orthogonal Axis:	X
Test Mode:	UNII-1/ TX A Mode 5240MHz - External antenna

Vertical

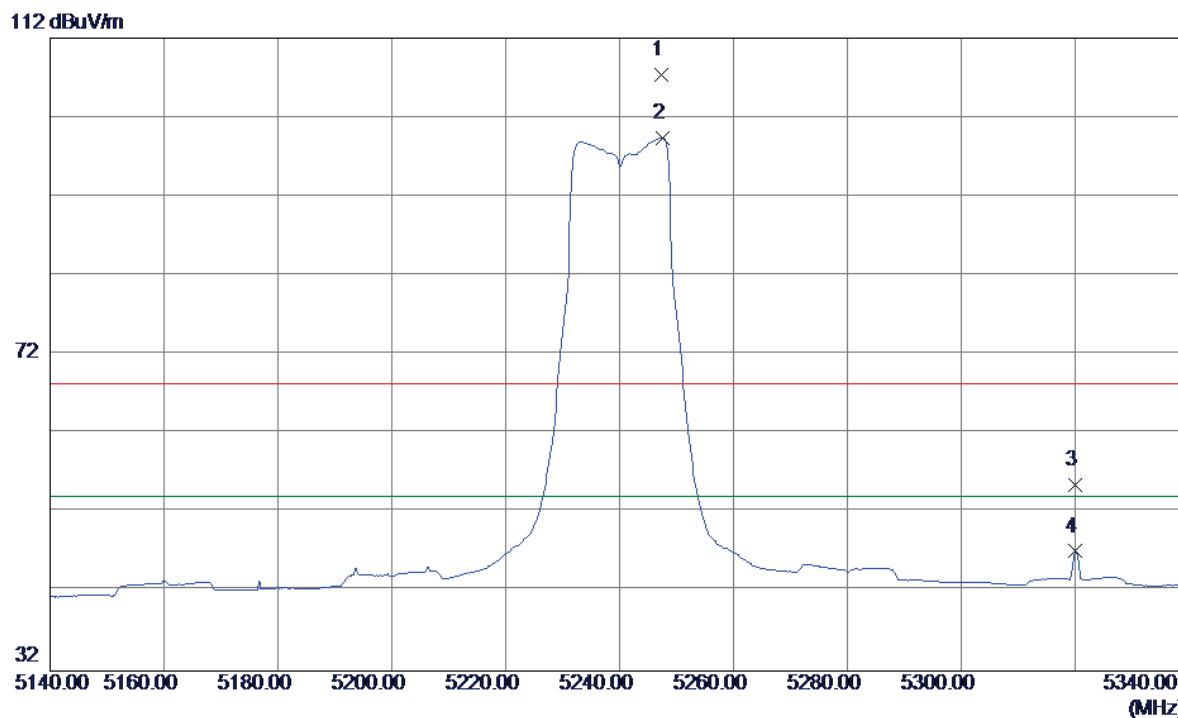

No.	Freq. MHz	Reading Level dBuV/m	Correct Factor dB	Measure ment dBuV/m	Limit dBuV/m	Over dB	Detector	Comment
1	5247.4000	66.99	40.42	107.41	68.30	39.11	Peak	No Limit
2	5247.6000	58.96	40.42	99.38	54.00	45.38	AVG	No Limit
3	5320.0000	14.95	40.58	55.53	68.30	-12.77	Peak	
4	5320.0000	6.54	40.58	47.12	54.00	-6.88	AVG	

Orthogonal Axis:	X
Test Mode:	UNII-1/ TX A Mode 5240MHz - External antenna

Vertical

80 dBuV/m

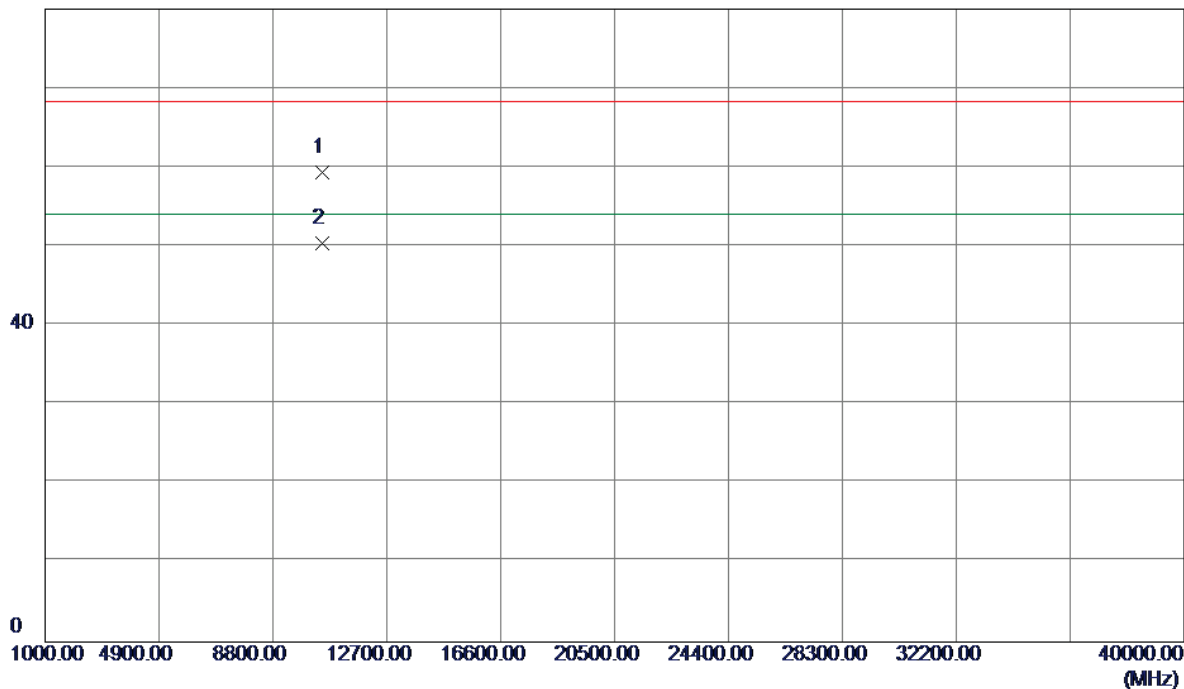

No.	Freq. MHz	Reading Level dBuV/m	Correct Factor dB	Measure ment dBuV/m	Limit dBuV/m	Over dB	Detector	Comment
1	10480.1200	45.73	13.69	59.42	68.30	-8.88	Peak	
2	10480.2000	36.73	13.69	50.42	54.00	-3.58	AVG	

Orthogonal Axis:	X
Test Mode:	UNII-1/ TX A Mode 5240MHz - External antenna

Horizontal

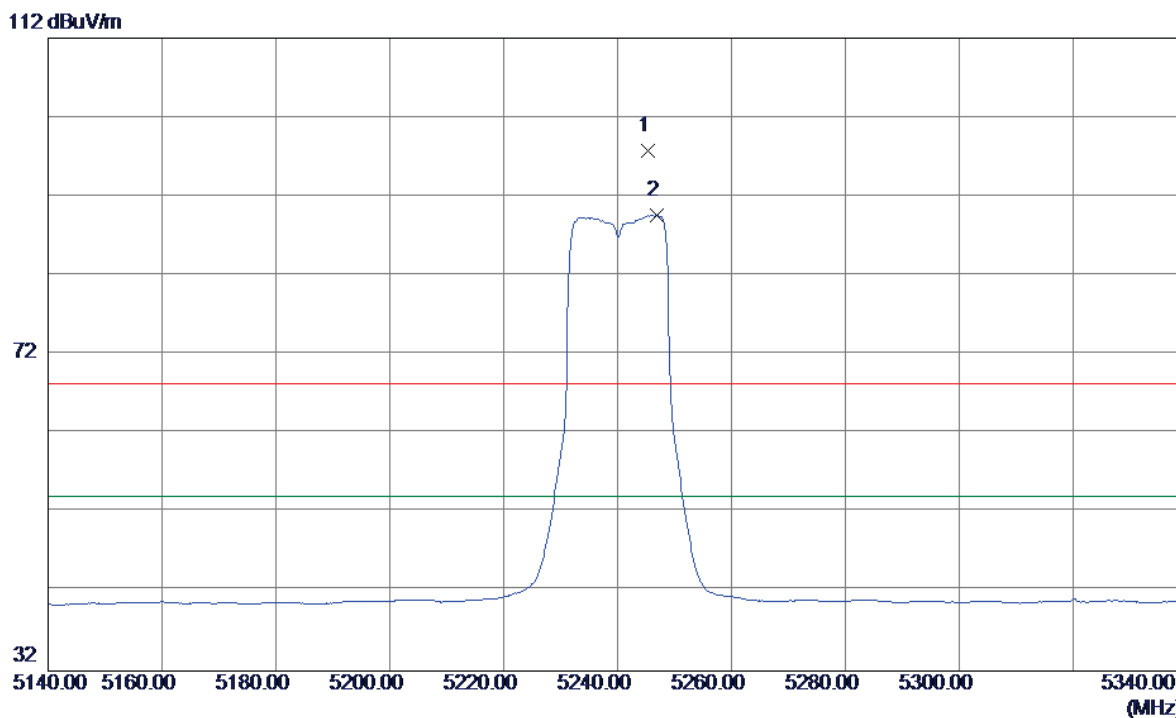

No.	Freq. MHz	Reading Level dBuV/m	Correct Factor dB	Measure ment dBuV/m	Limit dBuV/m	Over dB	Detector	Comment
1	5245.4000	57.35	40.42	97.77	68.30	29.47	Peak	No Limit
2	5246.8000	49.17	40.42	89.59	54.00	35.59	AVG	No Limit

Orthogonal Axis:	X
Test Mode:	UNII-1/ TX A Mode 5240MHz - External antenna

Horizontal

80 dBuV/m

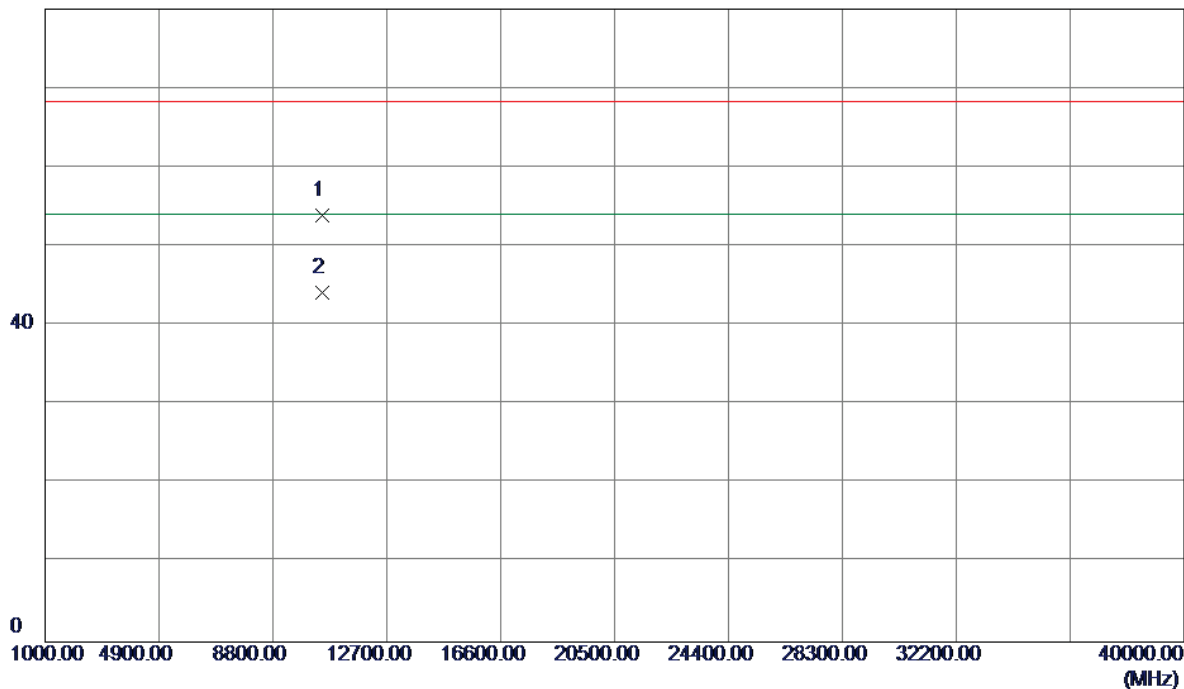

No.	Freq. MHz	Reading Level dBuV/m	Correct Factor dB	Measure ment dBuV/m	Limit dBuV/m	Over dB	Detector	Comment
1	10480.0400	40.29	13.69	53.98	68.30	-14.32	Peak	
2	10480.2000	30.54	13.69	44.23	54.00	-9.77	AVG	

Orthogonal Axis:	X
Test Mode:	UNII-1/ TX N20 Mode 5180MHz - External antenna

Vertical

112 dBuV/m

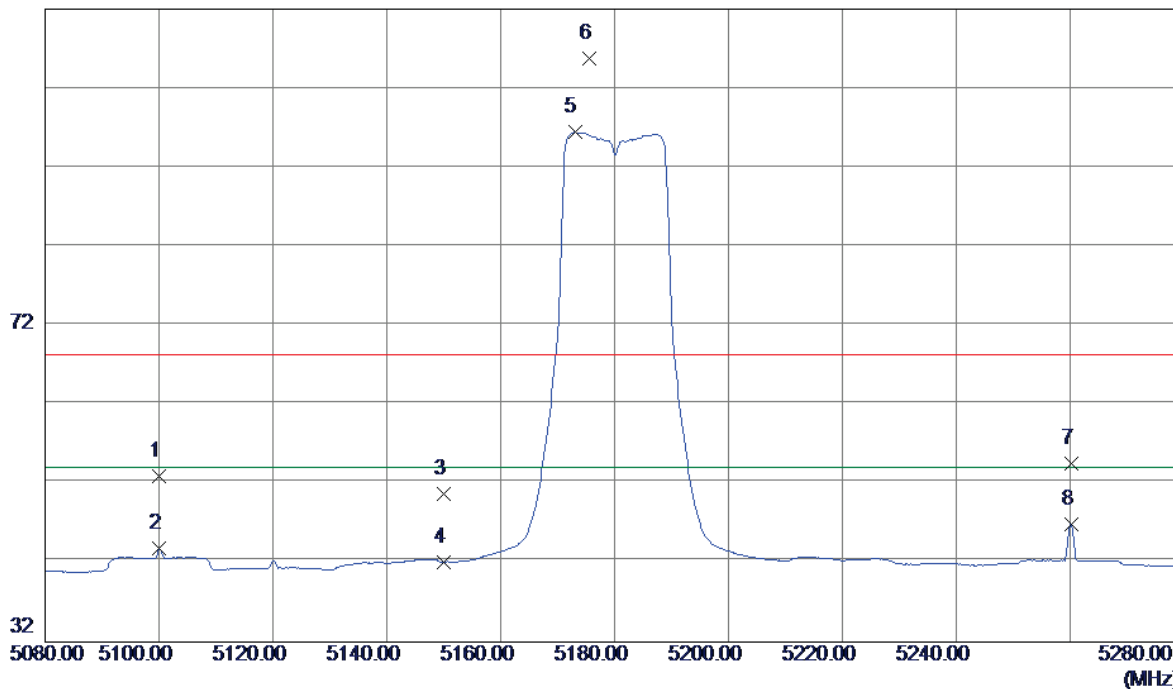

No.	Freq. MHz	Reading Level dBuV/m	Correct Factor dB	Measure ment dBuV/m	Limit dBuV/m	Over dB	Detector	Comment
1	5100.0000	12.91	40.11	53.02	68.30	-15.28	Peak	
2	5100.0000	3.66	40.11	43.77	54.00	-10.23	AVG	
3	5150.0000	10.47	40.22	50.69	68.30	-17.61	Peak	
4	5150.0000	1.86	40.22	42.08	54.00	-11.92	AVG	
5	5173.0000	56.22	40.27	96.49	54.00	42.49	AVG	No Limit
6	5175.6000	65.45	40.27	105.72	68.30	37.42	Peak	No Limit
7	5260.2000	14.08	40.45	54.53	68.30	-13.77	Peak	
8	5260.2000	6.41	40.45	46.86	54.00	-7.14	AVG	

Orthogonal Axis:	X
Test Mode:	UNII-1/ TX N20 Mode 5180MHz - External antenna

Vertical

80 dBuV/m

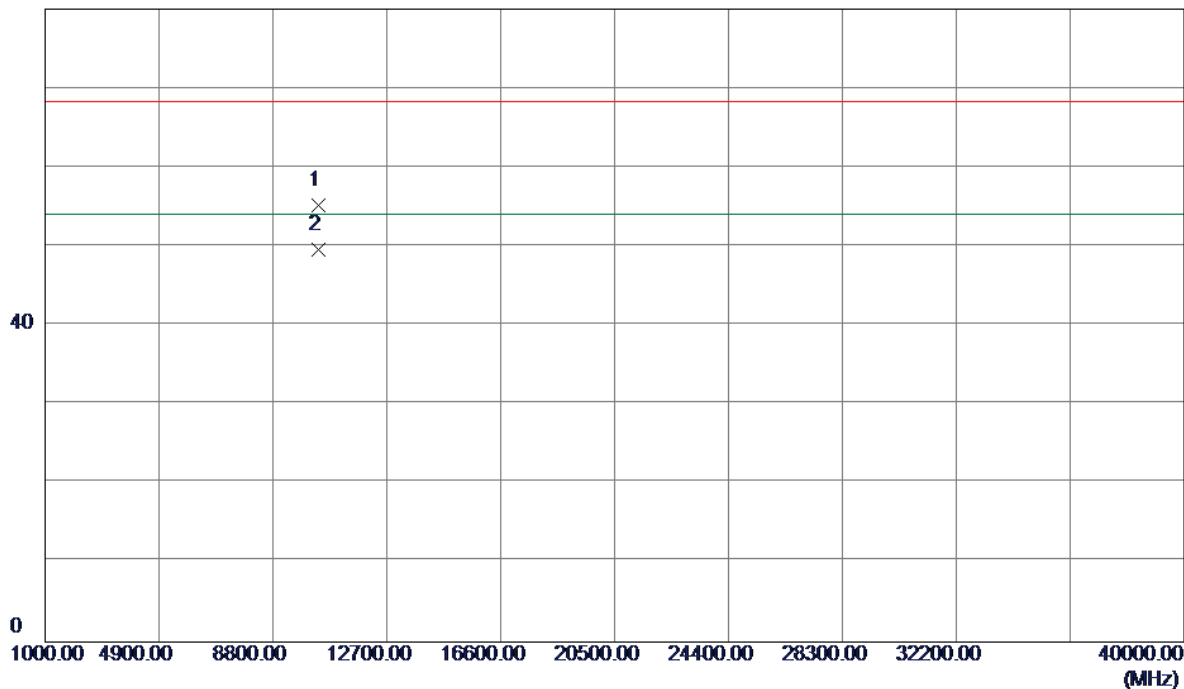

No.	Freq. MHz	Reading Level dBuV/m	Correct Factor dB	Measure ment dBuV/m	Limit dBuV/m	Over dB	Detector	Comment
1	10360.1500	41.31	13.86	55.17	68.30	-13.13	Peak	
2	10360.1900	35.67	13.86	49.53	54.00	-4.47	AVG	

Orthogonal Axis:	X
Test Mode:	UNII-1/ TX N20 Mode 5180MHz - External antenna

Horizontal

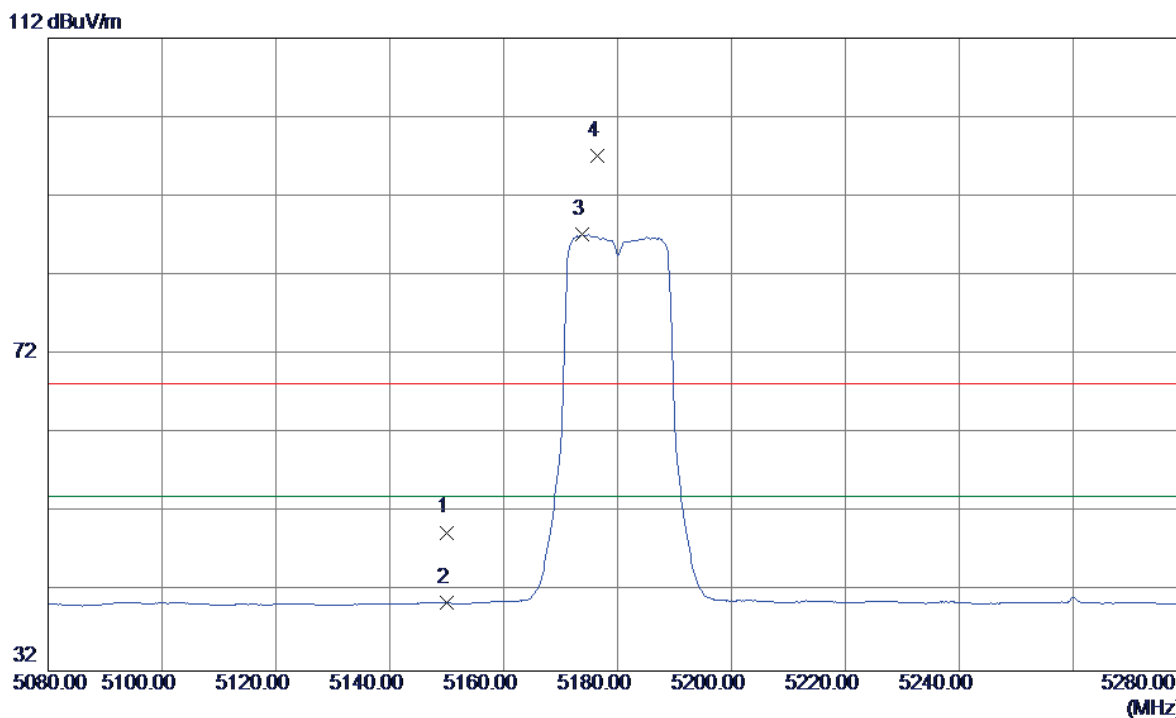

No.	Freq. MHz	Reading Level dBuV/m	Correct Factor dB	Measure ment dBuV/m	Limit dBuV/m	Over dB	Detector	Comment
1	5150.0000	9.30	40.22	49.52	68.30	-18.78	Peak	
2	5150.0000	0.37	40.22	40.59	54.00	-13.41	AVG	
3	5173.8000	46.93	40.27	87.20	54.00	33.20	AVG	No Limit
4	5176.4000	56.87	40.27	97.14	68.30	28.84	Peak	No Limit

Orthogonal Axis:	X
Test Mode:	UNII-1/ TX N20 Mode 5180MHz - External antenna

Horizontal

80 dBuV/m

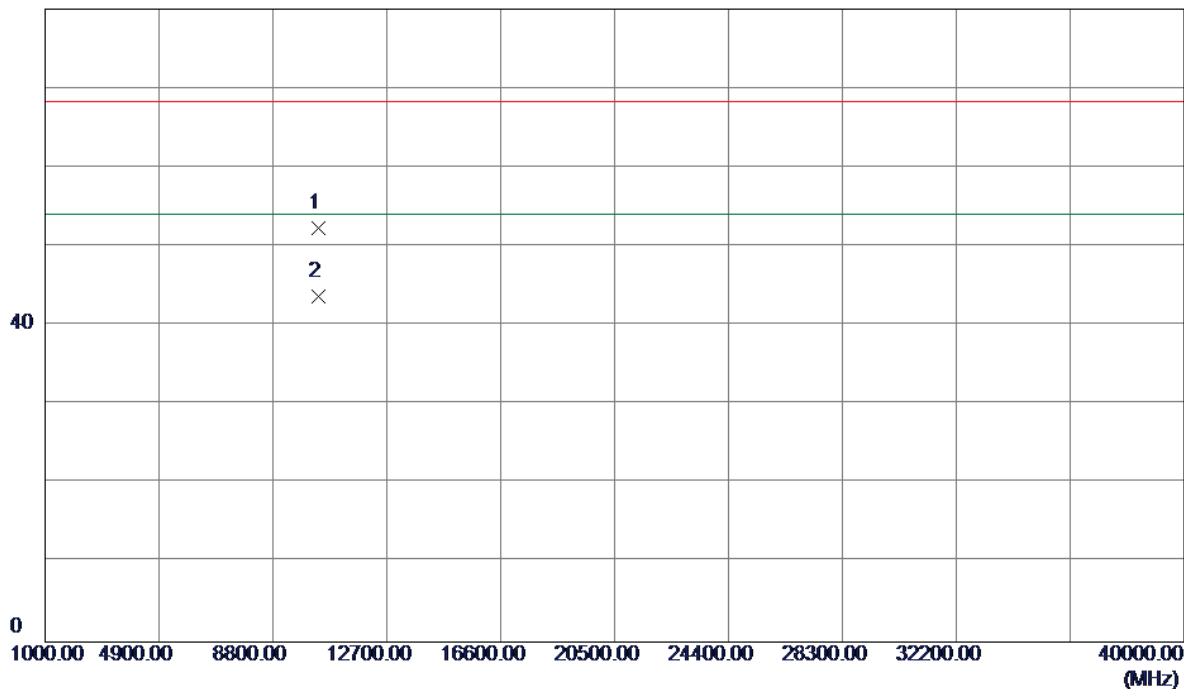

No.	Freq. MHz	Reading Level dBuV/m	Correct Factor dB	Measure ment dBuV/m	Limit dBuV/m	Over dB	Detector	Comment
1	10360.1200	38.40	13.86	52.26	68.30	-16.04	Peak	
2	10360.2000	29.79	13.86	43.65	54.00	-10.35	AVG	

Orthogonal Axis:	X
Test Mode:	UNII-1/ TX N20 Mode 5200MHz - External antenna

Vertical

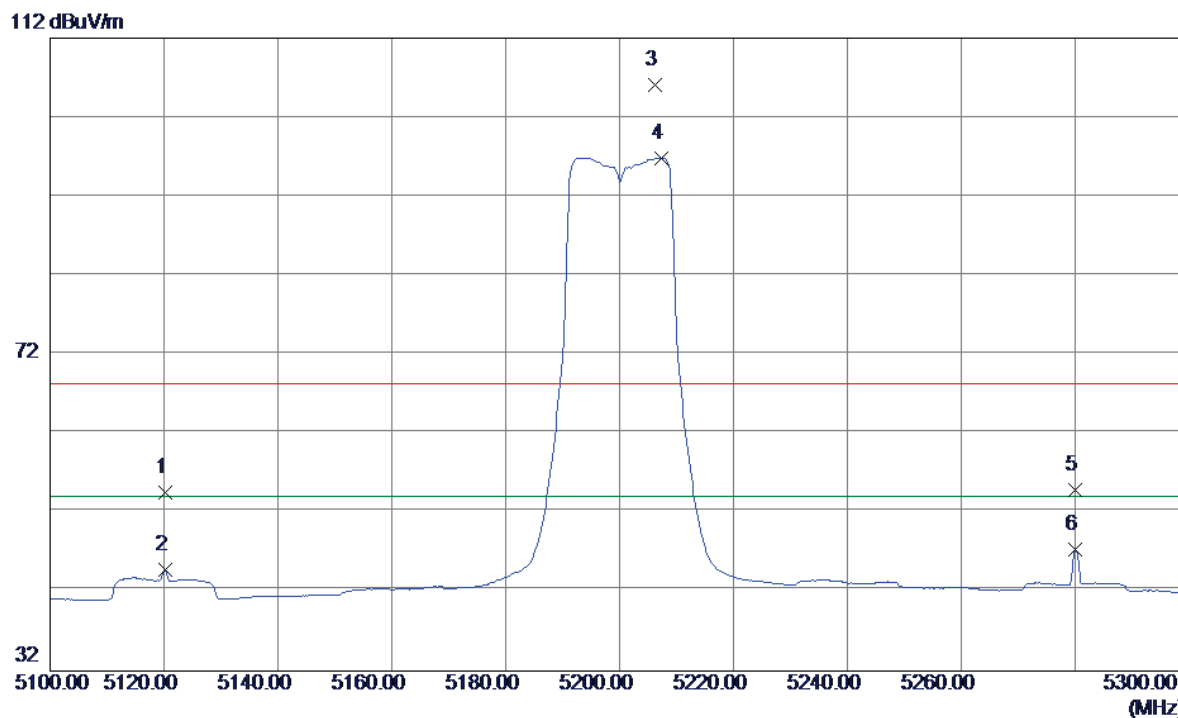

No.	Freq. MHz	Reading Level dBuV/m	Correct Factor dB	Measure ment dBuV/m	Limit dBuV/m	Over dB	Detector	Comment
1	5120.2000	14.41	40.15	54.56	68.30	-13.74	Peak	
2	5120.2000	4.62	40.15	44.77	54.00	-9.23	AVG	
3	5206.2000	65.69	40.34	106.03	68.30	37.73	Peak	No Limit
4	5207.4000	56.52	40.34	96.86	54.00	42.86	AVG	No Limit
5	5280.0000	14.36	40.49	54.85	68.30	-13.45	Peak	
6	5280.0000	6.86	40.49	47.35	54.00	-6.65	AVG	

Orthogonal Axis:	X
Test Mode:	UNII-1/ TX N20 Mode 5200MHz - External antenna

Vertical

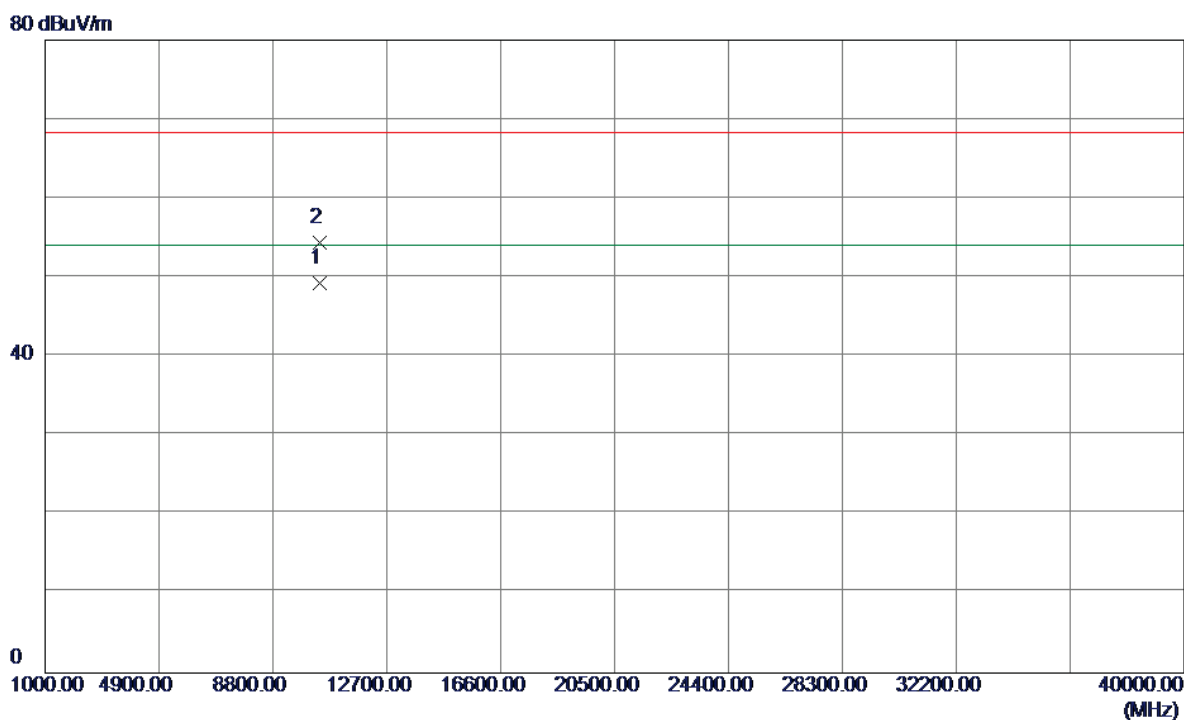

No.	Freq. MHz	Reading Level dBuV/m	Correct Factor dB	Measure ment dBuV/m	Limit dBuV/m	Over dB	Detector	Comment
1	10400.2000	35.54	13.80	49.34	54.00	-4.66	AVG	
2	10400.2900	40.66	13.80	54.46	68.30	-13.84	Peak	

Orthogonal Axis:	X
Test Mode:	UNII-1/ TX N20 Mode 5200MHz - External antenna

Horizontal

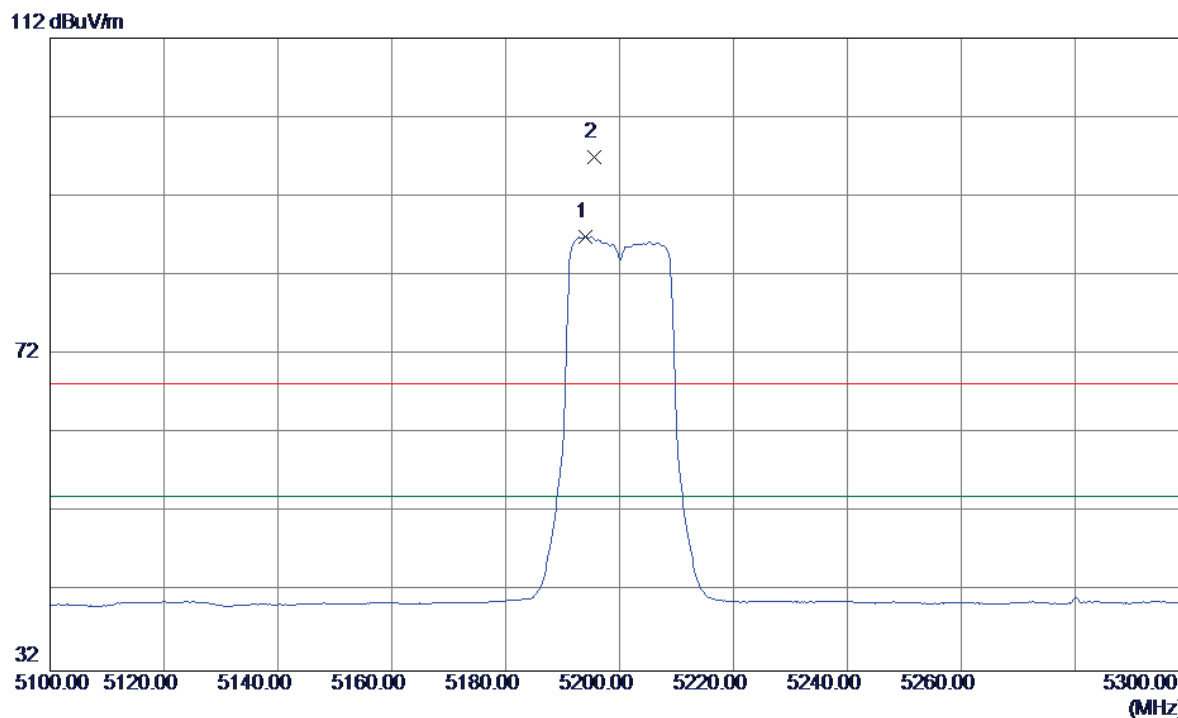

No.	Freq. MHz	Reading Level dBuV/m	Correct Factor dB	Measure ment dBuV/m	Limit dBuV/m	Over dB	Detector	Comment
1	5194.0000	46.54	40.31	86.85	54.00	32.85	AVG	No Limit
2	5195.6000	56.67	40.31	96.98	68.30	28.68	Peak	No Limit

Orthogonal Axis:	X
Test Mode:	UNII-1/ TX N20 Mode 5200MHz - External antenna

Horizontal

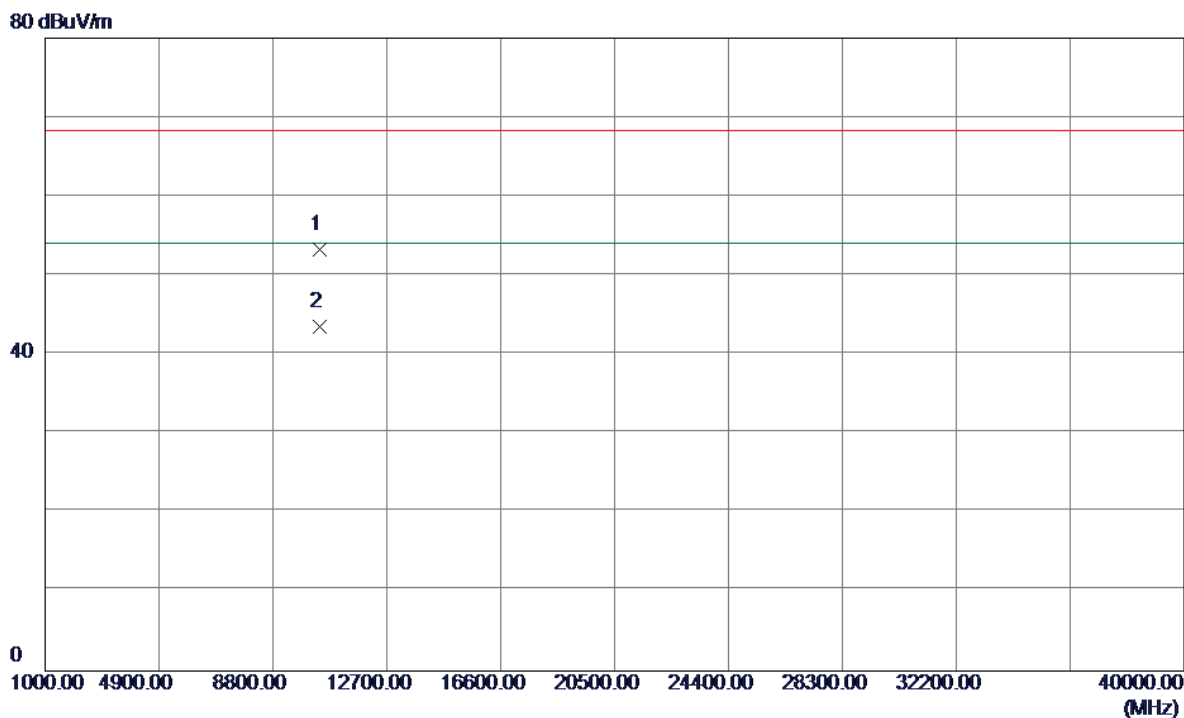

No.	Freq. MHz	Reading Level dBuV/m	Correct Factor dB	Measure ment dBuV/m	Limit dBuV/m	Over dB	Detector	Comment
1	10399.9000	39.44	13.80	53.24	68.30	-15.06	Peak	
2	10400.1900	29.77	13.80	43.57	54.00	-10.43	AVG	

Orthogonal Axis:	X
Test Mode:	UNII-1/ TX N20 Mode 5240MHz - External antenna

Vertical

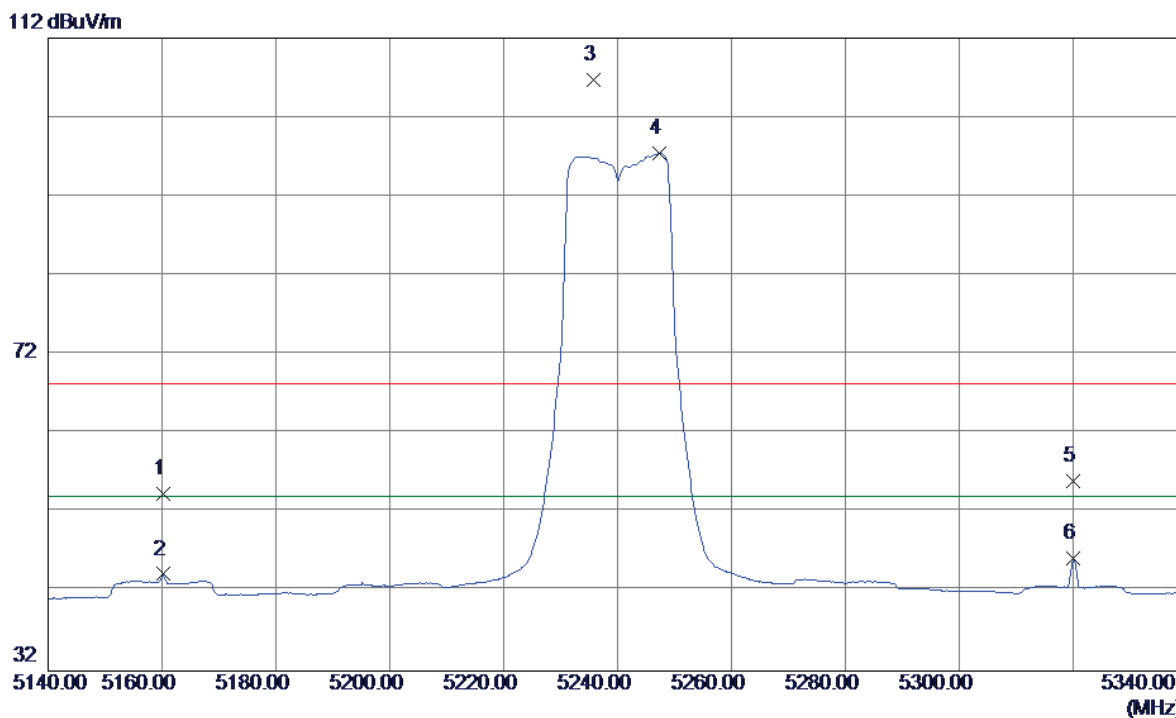

No.	Freq. MHz	Reading Level dBuV/m	Correct Factor dB	Measure ment dBuV/m	Limit dBuV/m	Over dB	Detector	Comment
1	5160.2000	14.22	40.24	54.46	68.30	-13.84	Peak	
2	5160.2000	4.00	40.24	44.24	54.00	-9.76	AVG	
3	5235.8000	66.33	40.40	106.73	68.30	38.43	Peak	No Limit
4	5247.4000	57.06	40.42	97.48	54.00	43.48	AVG	No Limit
5	5320.0000	15.49	40.58	56.07	68.30	-12.23	Peak	
6	5320.0000	5.63	40.58	46.21	54.00	-7.79	AVG	

Orthogonal Axis:	X
Test Mode:	UNII-1/ TX N20 Mode 5240MHz - External antenna

Vertical

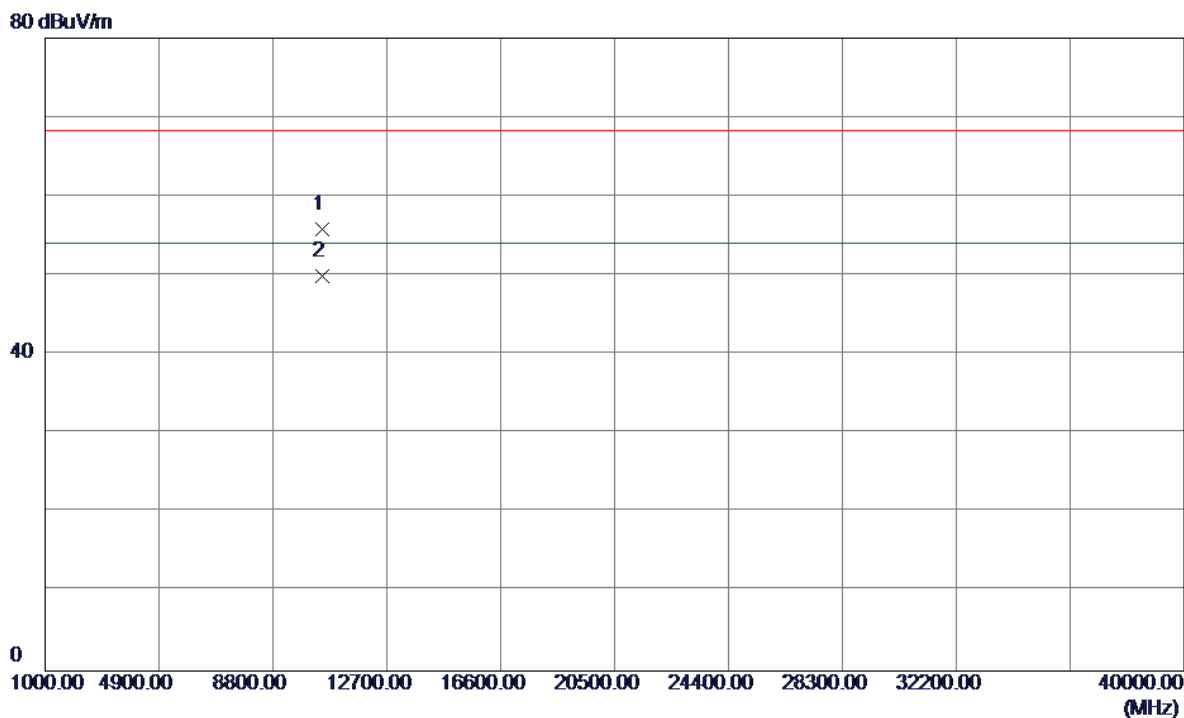

No.	Freq. MHz	Reading Level dBuV/m	Correct Factor dB	Measure ment dBuV/m	Limit dBuV/m	Over dB	Detector	Comment
1	10480.1900	42.20	13.69	55.89	68.30	-12.41	Peak	
2	10480.2000	36.18	13.69	49.87	54.00	-4.13	AVG	

Orthogonal Axis:	X
Test Mode:	UNII-1/ TX N20 Mode 5240MHz - External antenna

Horizontal

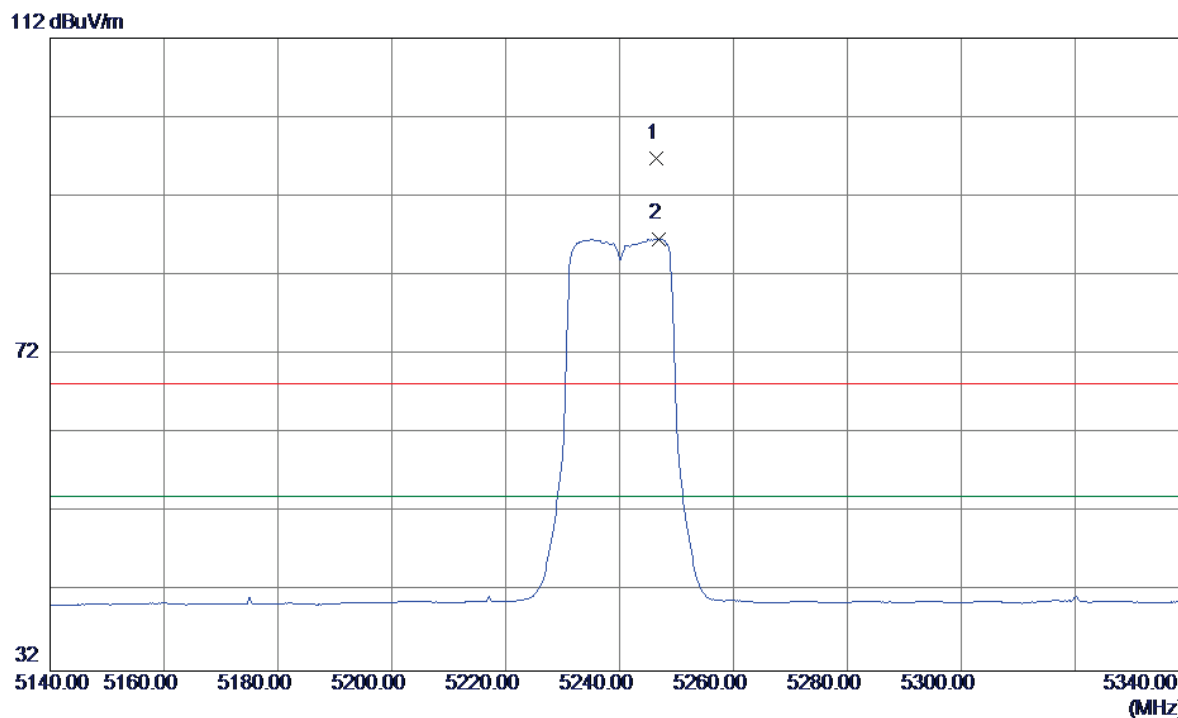

No.	Freq. MHz	Reading Level dBuV/m	Correct Factor dB	Measure ment dBuV/m	Limit dBuV/m	Over dB	Detector	Comment
1	5246.4000	56.41	40.42	96.83	68.30	28.53	Peak	No Limit
2	5246.8000	46.22	40.42	86.64	54.00	32.64	AVG	No Limit

Orthogonal Axis:	X
Test Mode:	UNII-1/ TX N20 Mode 5240MHz - External antenna

Horizontal

80 dBuV/m

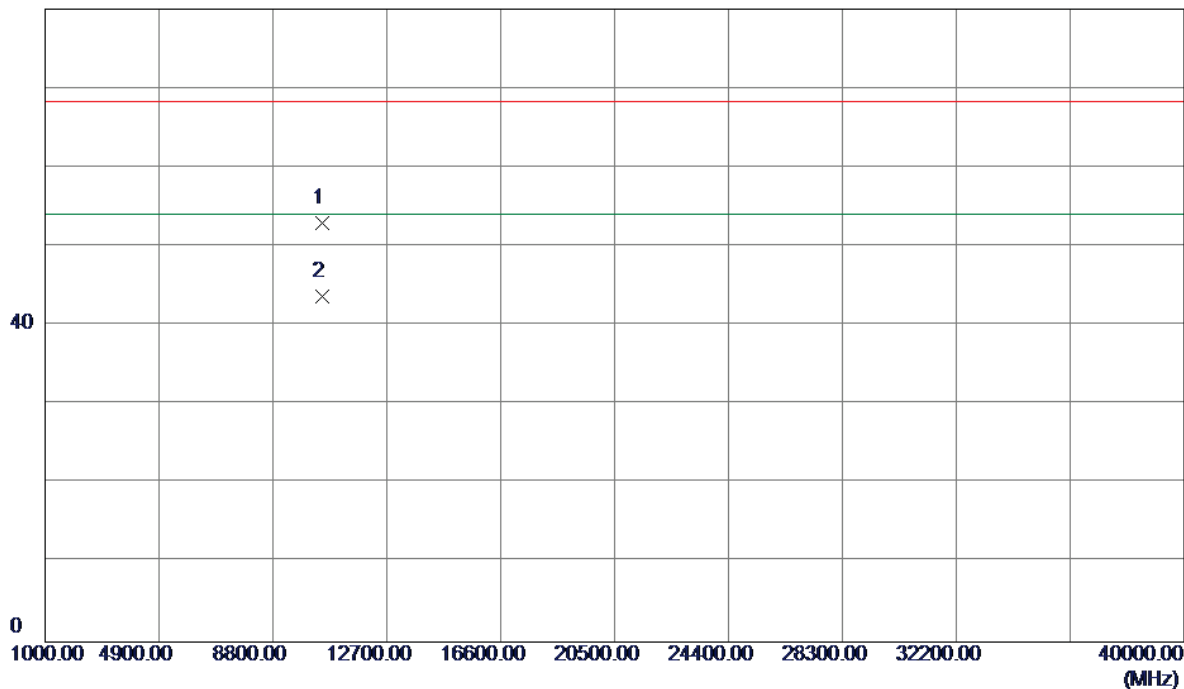

No.	Freq. MHz	Reading Level dBuV/m	Correct Factor dB	Measure ment dBuV/m	Limit dBuV/m	Over dB	Detector	Comment
1	10480.0900	39.21	13.69	52.90	68.30	-15.40	Peak	
2	10480.1800	29.99	13.69	43.68	54.00	-10.32	AVG	

Orthogonal Axis:	X
Test Mode:	UNII-1/ TX N40 Mode 5190MHz - External antenna

Vertical

112 dBuV/m

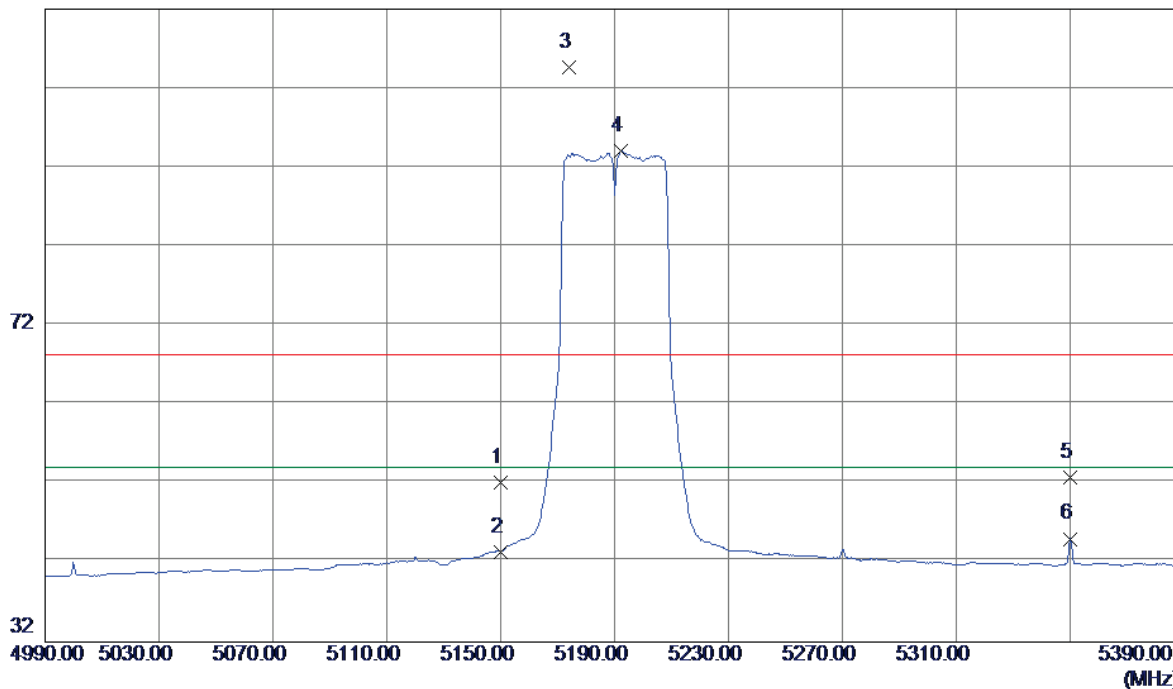

No.	Freq. MHz	Reading Level dBuV/m	Correct Factor dB	Measure ment dBuV/m	Limit dBuV/m	Over dB	Detector	Comment
1	5150.0000	11.96	40.22	52.18	68.30	-16.12	Peak	
2	5150.0000	3.20	40.22	43.42	54.00	-10.58	AVG	
3	5174.0000	64.30	40.27	104.57	68.30	36.27	Peak	No Limit
4	5192.4000	53.83	40.31	94.14	54.00	40.14	AVG	No Limit
5	5350.0000	12.16	40.64	52.80	68.30	-15.50	Peak	
6	5350.0000	4.40	40.64	45.04	54.00	-8.96	AVG	

Orthogonal Axis:	X
Test Mode:	UNII-1/ TX N40 Mode 5190MHz - External antenna

Vertical

80 dBuV/m

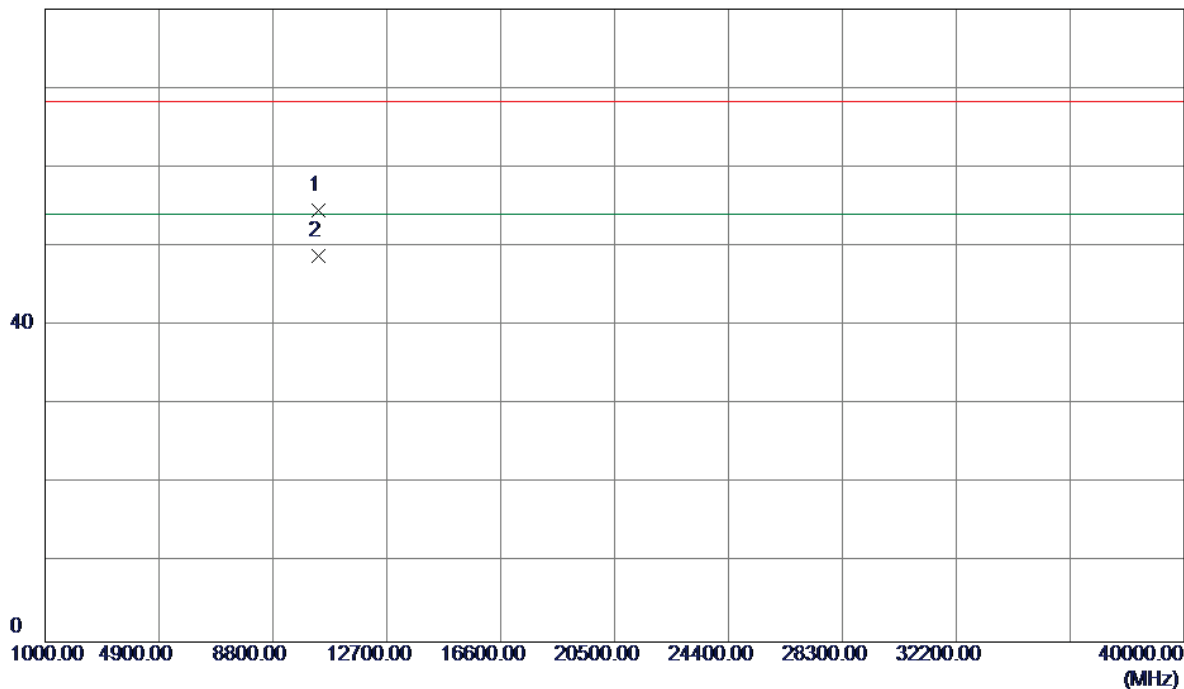

No.	Freq. MHz	Reading Level dBuV/m	Correct Factor dB	Measure ment dBuV/m	Limit dBuV/m	Over dB	Detector	Comment
1	10380.2000	40.73	13.83	54.56	68.30	-13.74	Peak	
2	10380.2000	34.96	13.83	48.79	54.00	-5.21	AVG	

Orthogonal Axis:	X
Test Mode:	UNII-1/ TX N40 Mode 5190MHz - External antenna

Horizontal

112 dBuV/m

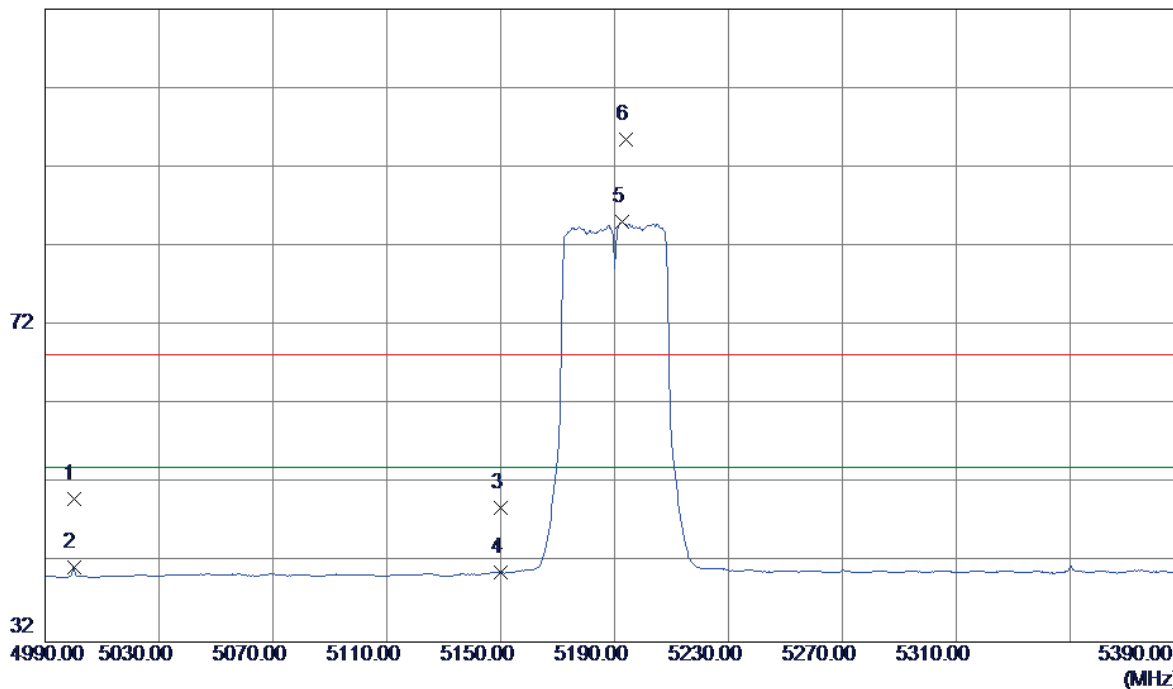

No.	Freq. MHz	Reading Level dBuV/m	Correct Factor dB	Measure ment dBuV/m	Limit dBuV/m	Over dB	Detector	Comment
1	5000.0000	10.17	39.90	50.07	68.30	-18.23	Peak	
2	5000.0000	1.56	39.90	41.46	54.00	-12.54	AVG	
3	5150.0000	8.70	40.22	48.92	68.30	-19.38	Peak	
4	5150.0000	0.55	40.22	40.77	54.00	-13.23	AVG	
5	5192.8000	44.75	40.31	85.06	54.00	31.06	AVG	No Limit
6	5194.0000	55.24	40.31	95.55	68.30	27.25	Peak	No Limit

Orthogonal Axis:	X
Test Mode:	UNII-1/ TX N40 Mode 5190MHz - External antenna

Horizontal

80 dBuV/m

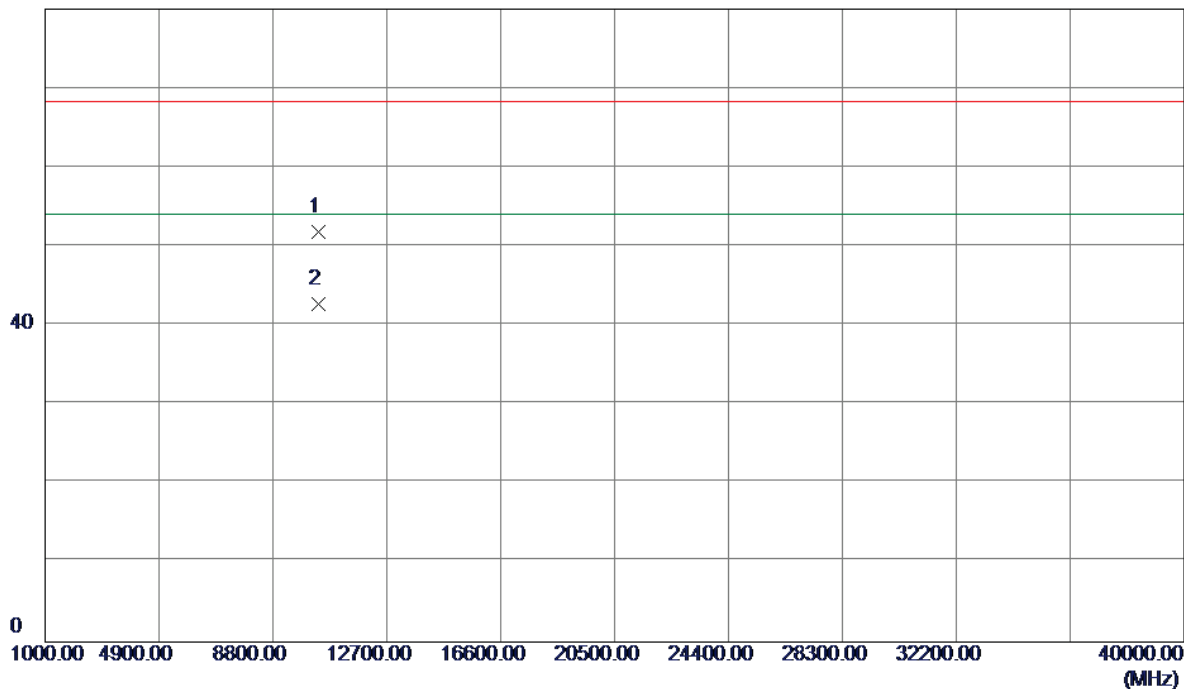

No.	Freq. MHz	Reading Level dBuV/m	Correct Factor dB	Measure ment dBuV/m	Limit dBuV/m	Over dB	Detector	Comment
1	10380.0300	37.97	13.83	51.80	68.30	-16.50	Peak	
2	10380.1700	28.86	13.83	42.69	54.00	-11.31	AVG	

Orthogonal Axis:	X
Test Mode:	UNII-1/ TX N40 Mode 5230MHz - External antenna

Vertical

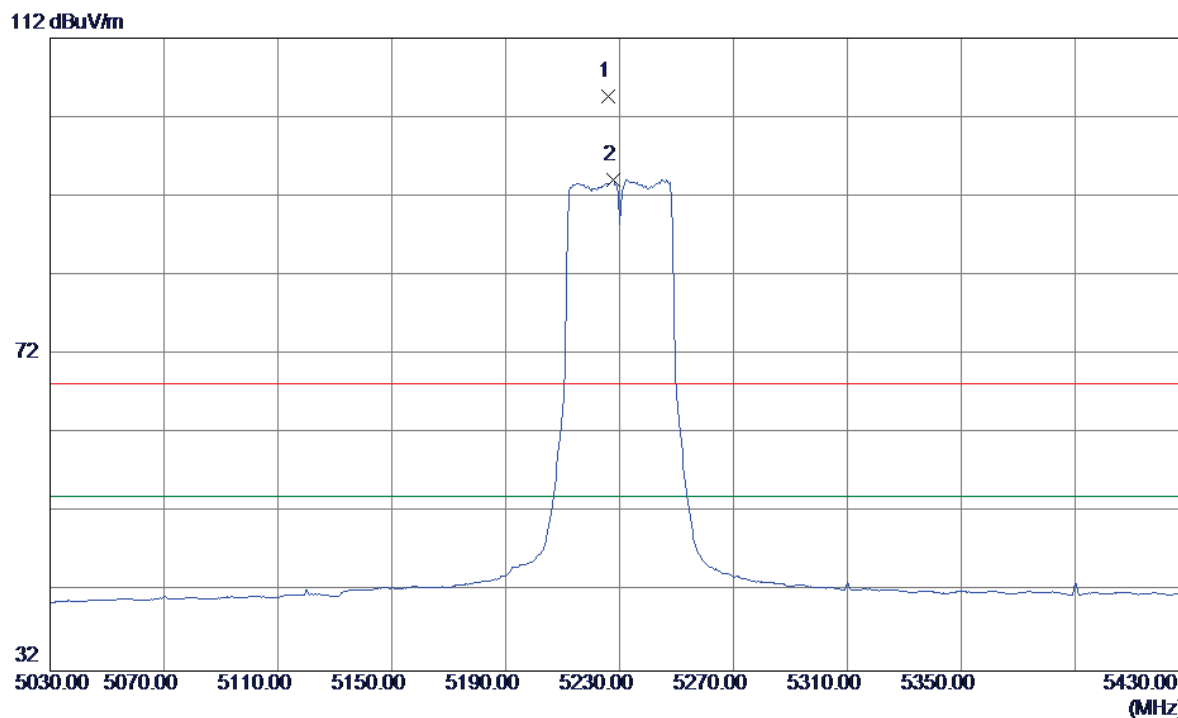

No.	Freq. MHz	Reading Level dBuV/m	Correct Factor dB	Measure ment dBuV/m	Limit dBuV/m	Over dB	Detector	Comment
1	5226.0000	64.29	40.38	104.67	68.30	36.37	Peak	No Limit
2	5227.6000	53.72	40.38	94.10	54.00	40.10	AVG	No Limit

Orthogonal Axis:	X
Test Mode:	UNII-1/ TX N40 Mode 5230MHz - External antenna

Vertical

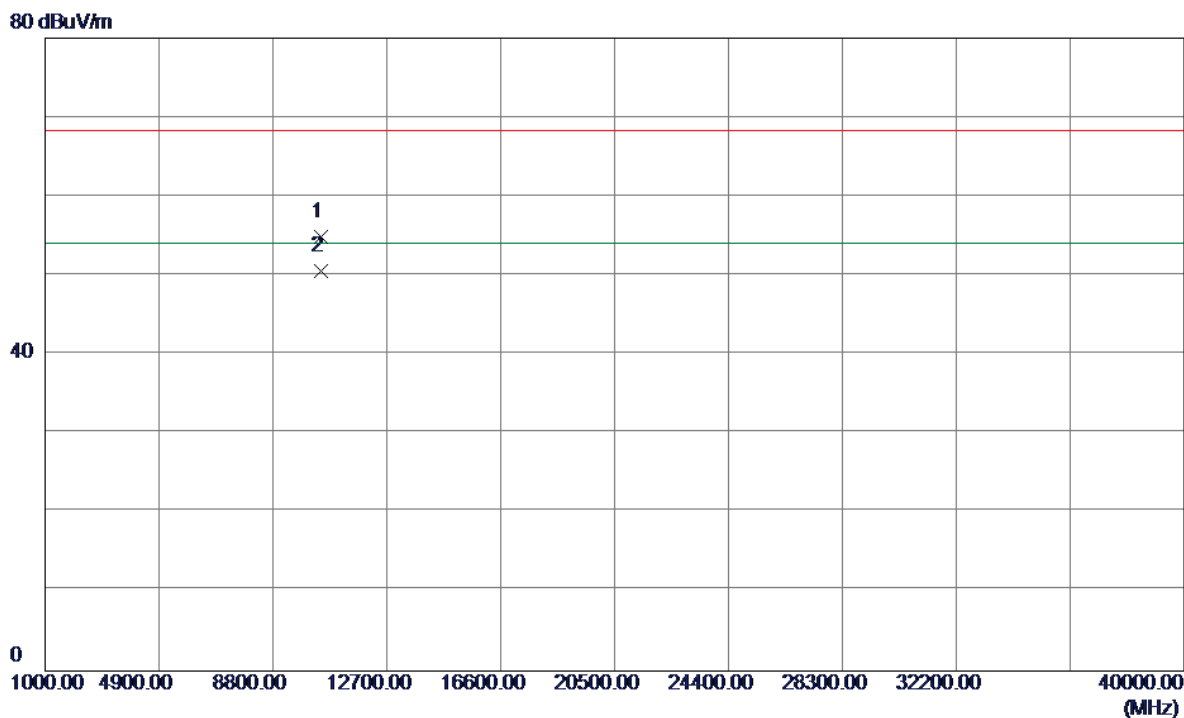

No.	Freq. MHz	Reading Level dBuV/m	Correct Factor dB	Measure ment dBuV/m	Limit dBuV/m	Over dB	Detector	Comment
1	10460.1700	41.10	13.72	54.82	68.30	-13.48	Peak	
2	10460.1900	36.88	13.72	50.60	54.00	-3.40	AVG	

Orthogonal Axis:	X
Test Mode:	UNII-1/ TX N40 Mode 5230MHz - External antenna

Horizontal

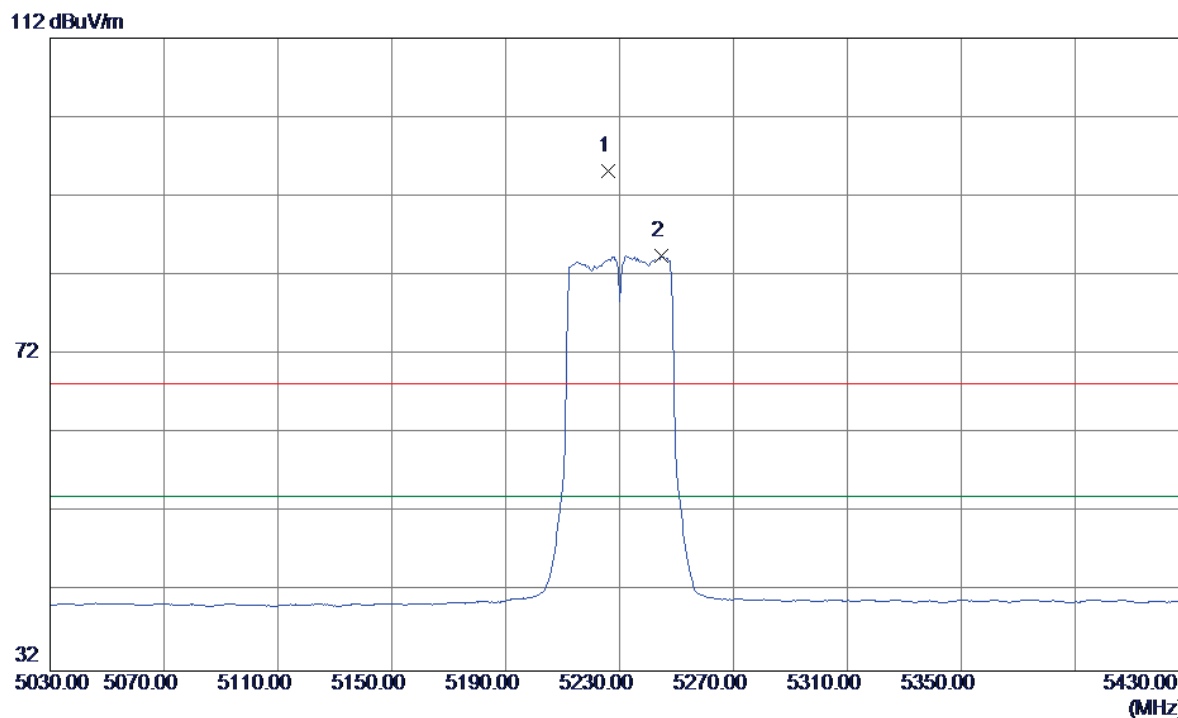

No.	Freq. MHz	Reading Level dBuV/m	Correct Factor dB	Measure ment dBuV/m	Limit dBuV/m	Over dB	Detector	Comment
1	5226.0000	54.75	40.38	95.13	68.30	26.83	Peak	No Limit
2	5244.8000	43.99	40.42	84.41	54.00	30.41	AVG	No Limit

Orthogonal Axis:	X
Test Mode:	UNII-1/ TX N40 Mode 5230MHz - External antenna

Horizontal

80 dBuV/m

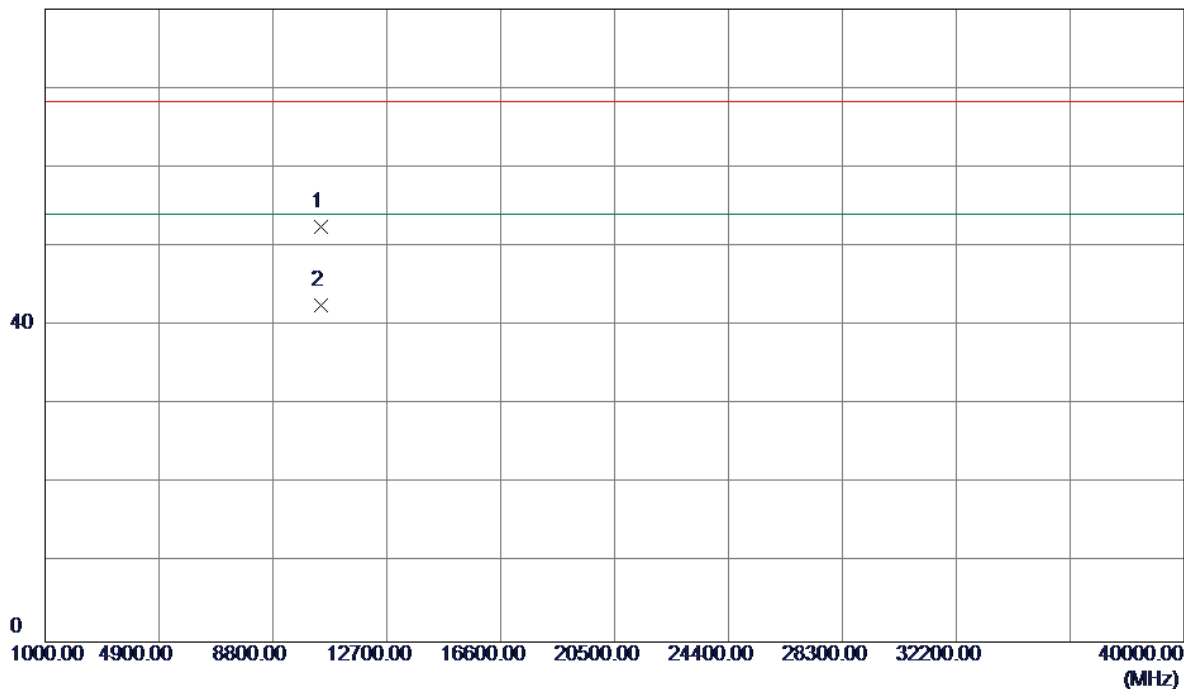

No.	Freq. MHz	Reading Level dBuV/m	Correct Factor dB	Measure ment dBuV/m	Limit dBuV/m	Over dB	Detector	Comment
1	10460.0800	38.82	13.72	52.54	68.30	-15.76	Peak	
2	10460.1800	28.78	13.72	42.50	54.00	-11.50	AVG	

Orthogonal Axis:	X
Test Mode:	UNII-3/TX A Mode 5745MHz - External antenna

Vertical

112 dBuV/m

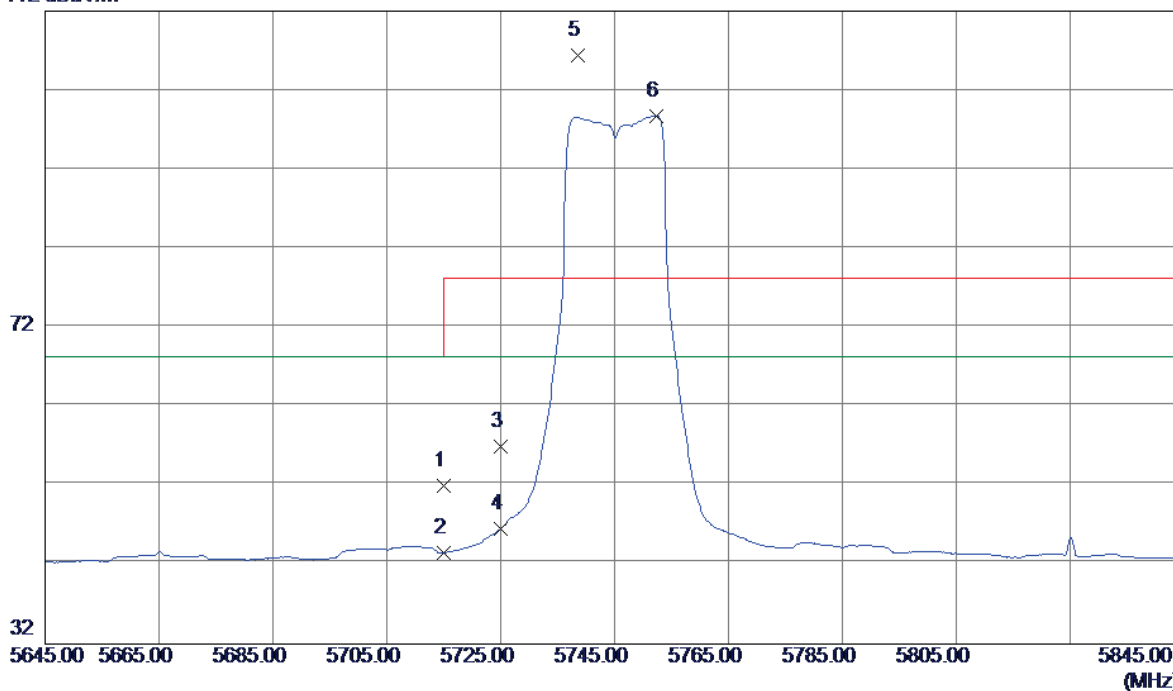

No.	Freq. MHz	Reading Level dBuV/m	Correct Factor dB	Measure ment dBuV/m	Limit dBuV/m	Over dB	Detector	Comment
1	5715.0000	10.78	41.25	52.03	68.30	-16.27	Peak	
2	5715.0000	2.30	41.25	43.55	68.30	-24.75	AVG	
3	5725.0000	15.64	41.27	56.91	78.30	-21.39	Peak	
4	5725.0000	5.30	41.27	46.57	68.30	-21.73	AVG	
5	5738.6000	65.10	41.28	106.38	78.30	28.08	Peak	No Limit
6	5752.4000	57.46	41.30	98.76	68.30	30.46	AVG	No Limit

Orthogonal Axis:	X
Test Mode:	UNII-3/TX A Mode 5745MHz - External antenna

Vertical

80 dBuV/m

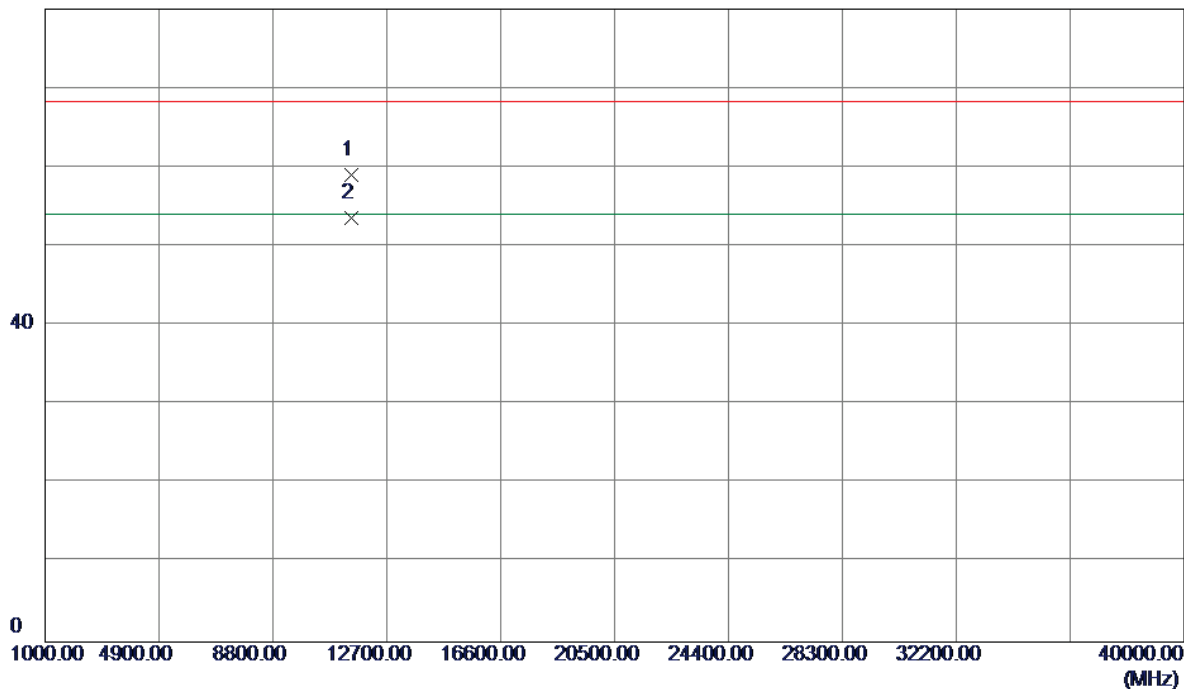

No.	Freq. MHz	Reading Level dBuV/m	Correct Factor dB	Measure ment dBuV/m	Limit dBuV/m	Over dB	Detector	Comment
1	11490.2200	42.11	16.91	59.02	68.30	-9.28	Peak	
2	11490.2200	36.74	16.91	53.65	54.00	-0.35	AVG	

Orthogonal Axis:	X
Test Mode:	UNII-3/TX A Mode 5745MHz - External antenna

Horizontal

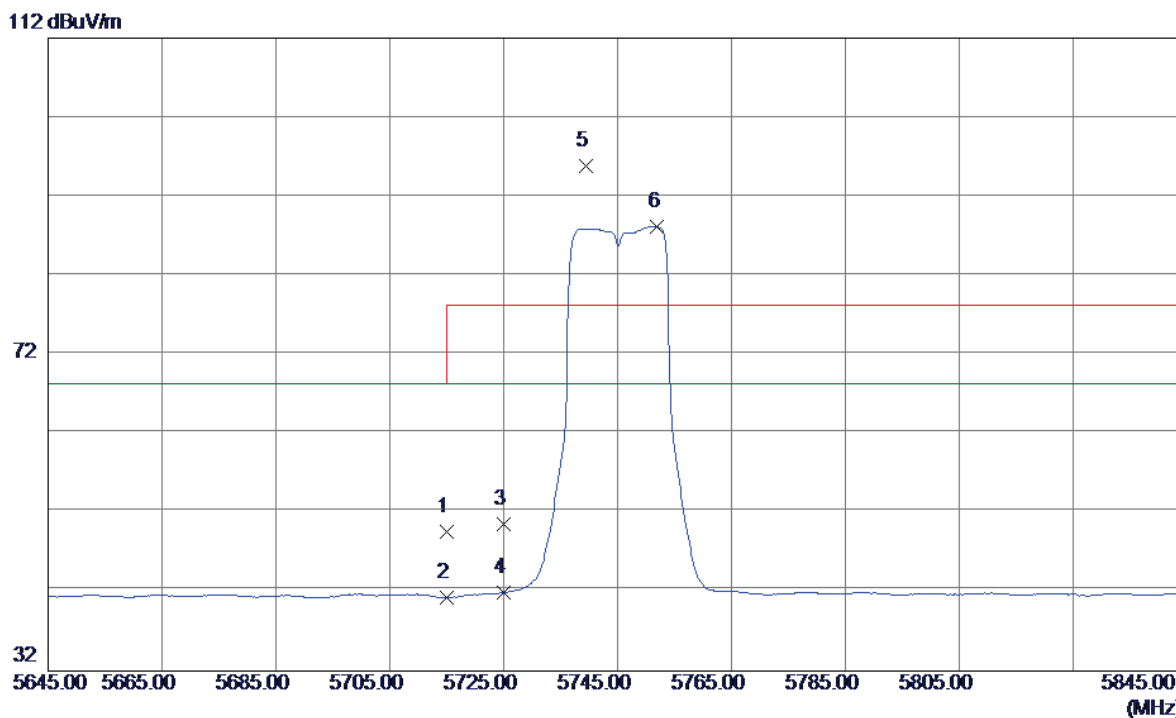

No.	Freq. MHz	Reading Level dBuV/m	Correct Factor dB	Measure ment dBuV/m	Limit dBuV/m	Over dB	Detector	Comment
1	5715.0000	8.36	41.25	49.61	68.30	-18.69	Peak	
2	5715.0000	0.06	41.25	41.31	68.30	-26.99	AVG	
3	5725.0000	9.24	41.27	50.51	78.30	-27.79	Peak	
4	5725.0000	0.59	41.27	41.86	68.30	-26.44	AVG	
5	5739.4000	54.47	41.29	95.76	78.30	17.46	Peak	No Limit
6	5752.0000	46.89	41.30	88.19	68.30	19.89	AVG	No Limit

Orthogonal Axis:	X
Test Mode:	UNII-3/TX A Mode 5745MHz - External antenna

Horizontal

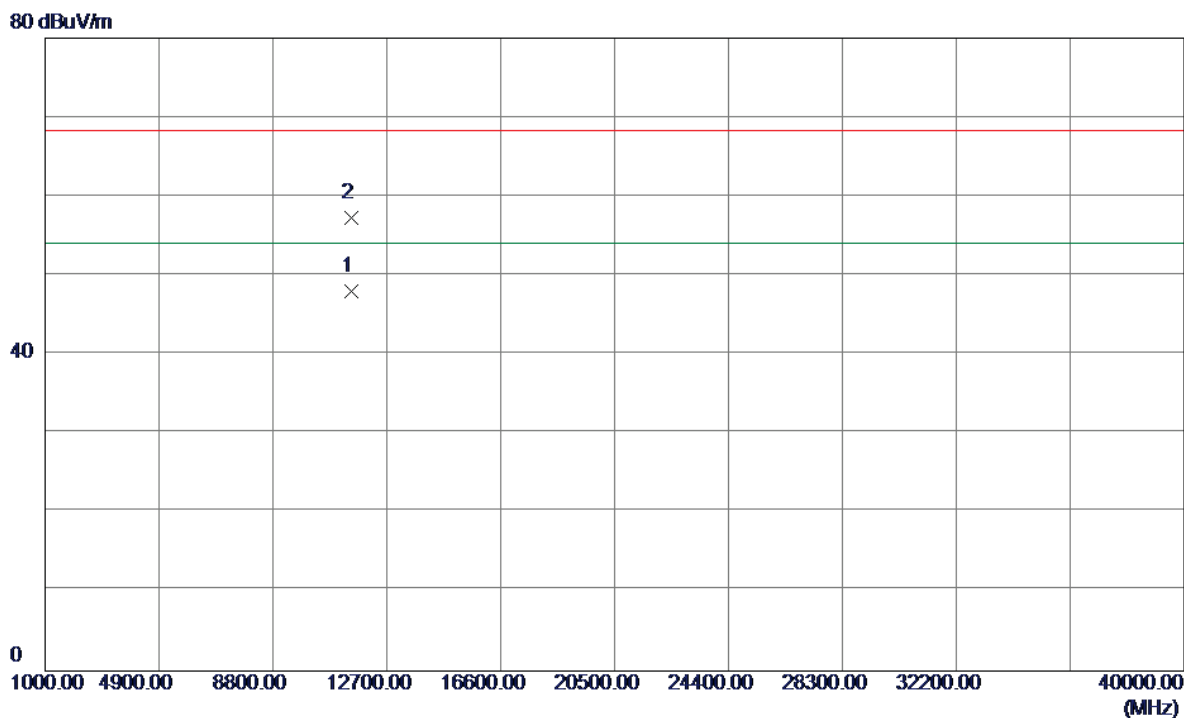

No.	Freq. MHz	Reading Level dBuV/m	Correct Factor dB	Measure ment dBuV/m	Limit dBuV/m	Over dB	Detector	Comment
1	11490.2100	31.10	16.91	48.01	54.00	-5.99	AVG	
2	11490.3000	40.42	16.91	57.33	68.30	-10.97	Peak	

Orthogonal Axis:	X
Test Mode:	UNII-3/TX A Mode 5785MHz - External antenna

Vertical

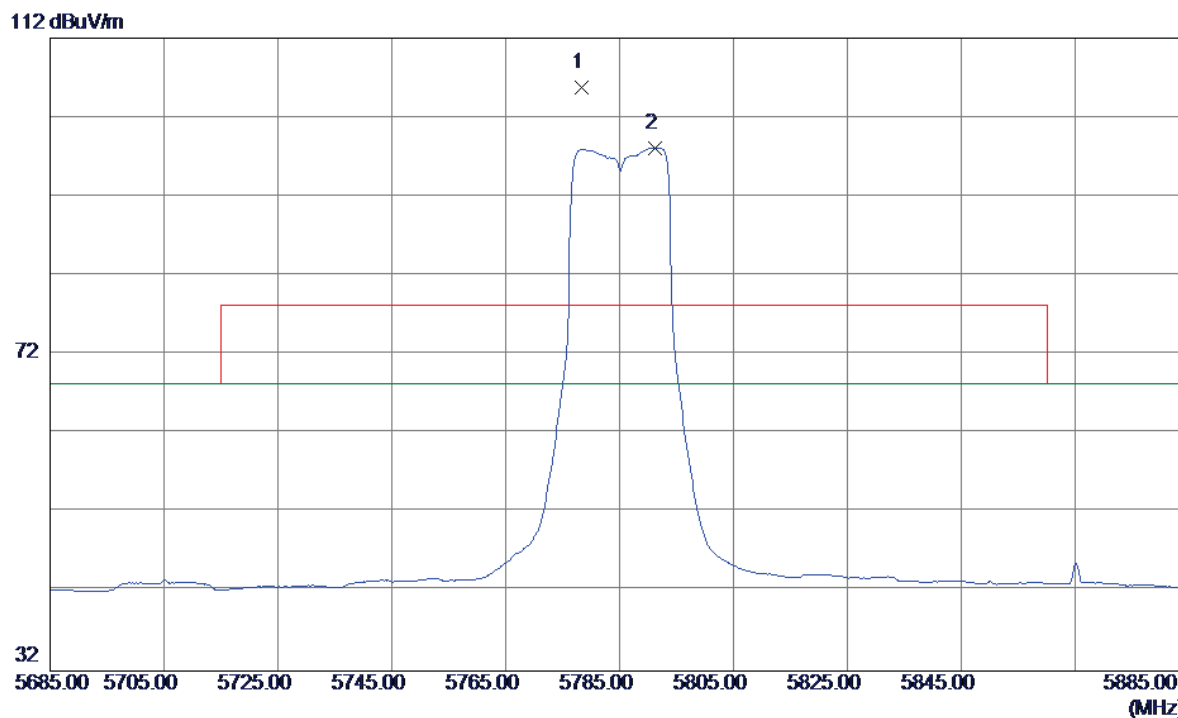

No.	Freq. MHz	Reading Level dBuV/m	Correct Factor dB	Measure ment dBuV/m	Limit dBuV/m	Over dB	Detector	Comment
1	5778.4000	64.41	41.34	105.75	78.30	27.45	Peak	No Limit
2	5791.2000	56.77	41.36	98.13	68.30	29.83	AVG	No Limit

Orthogonal Axis:	X
Test Mode:	UNII-3/TX A Mode 5785MHz - External antenna

Vertical

80 dBuV/m

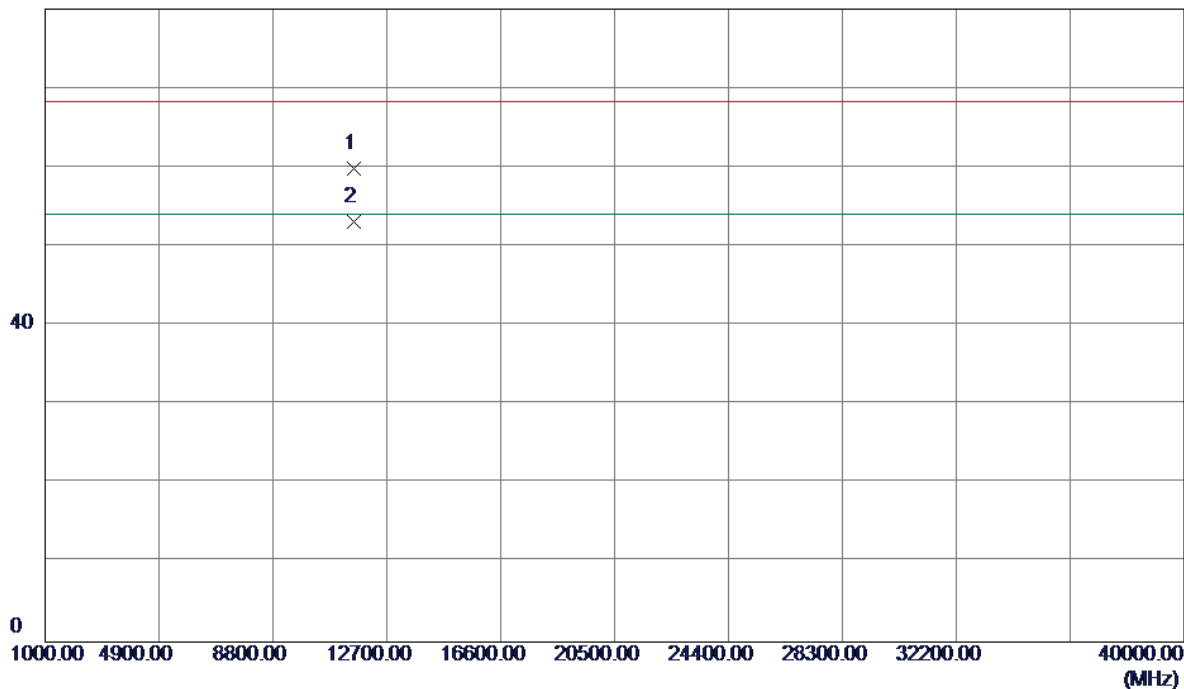

No.	Freq. MHz	Reading Level dBuV/m	Correct Factor dB	Measure ment dBuV/m	Limit dBuV/m	Over dB	Detector	Comment
1	11570.1300	42.75	17.05	59.80	68.30	-8.50	Peak	
2	11570.2200	36.08	17.05	53.13	54.00	-0.87	AVG	

Orthogonal Axis:	X
Test Mode:	UNII-3/TX A Mode 5785MHz - External antenna

Horizontal

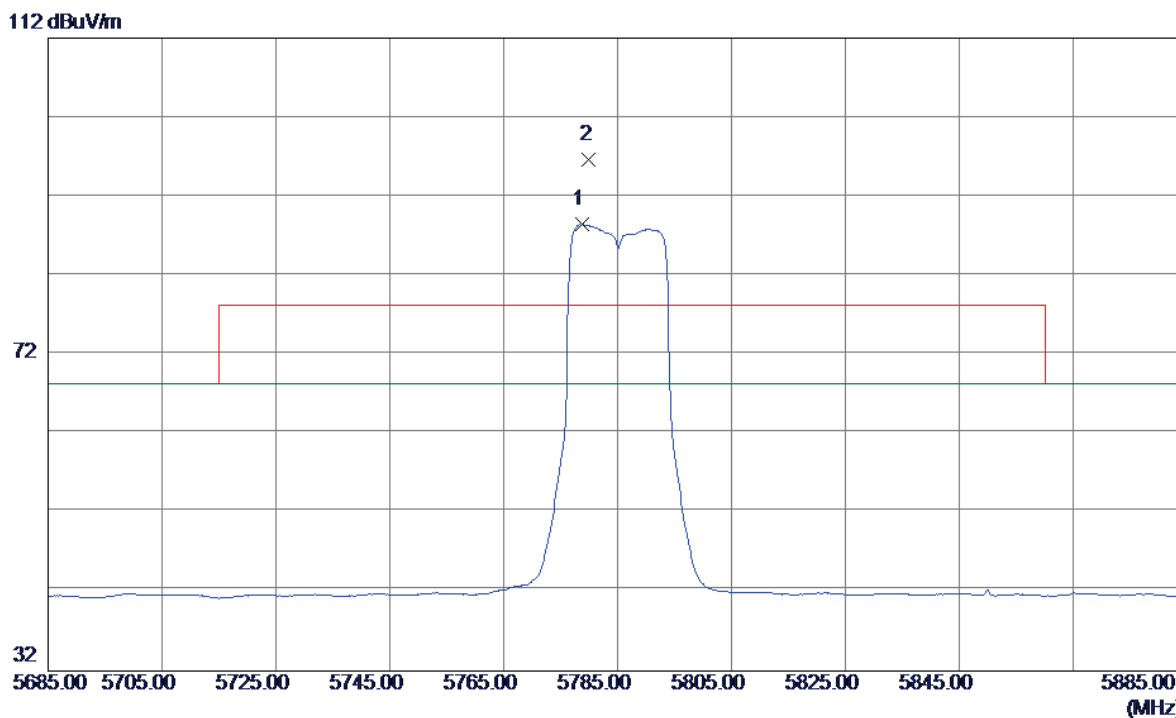

No.	Freq. MHz	Reading Level dBuV/m	Correct Factor dB	Measure ment dBuV/m	Limit dBuV/m	Over dB	Detector	Comment
1	5778.8000	47.12	41.34	88.46	68.30	20.16	AVG	No Limit
2	5780.0000	55.31	41.34	96.65	78.30	18.35	Peak	No Limit

Orthogonal Axis:	X
Test Mode:	UNII-3/TX A Mode 5785MHz - External antenna

Horizontal

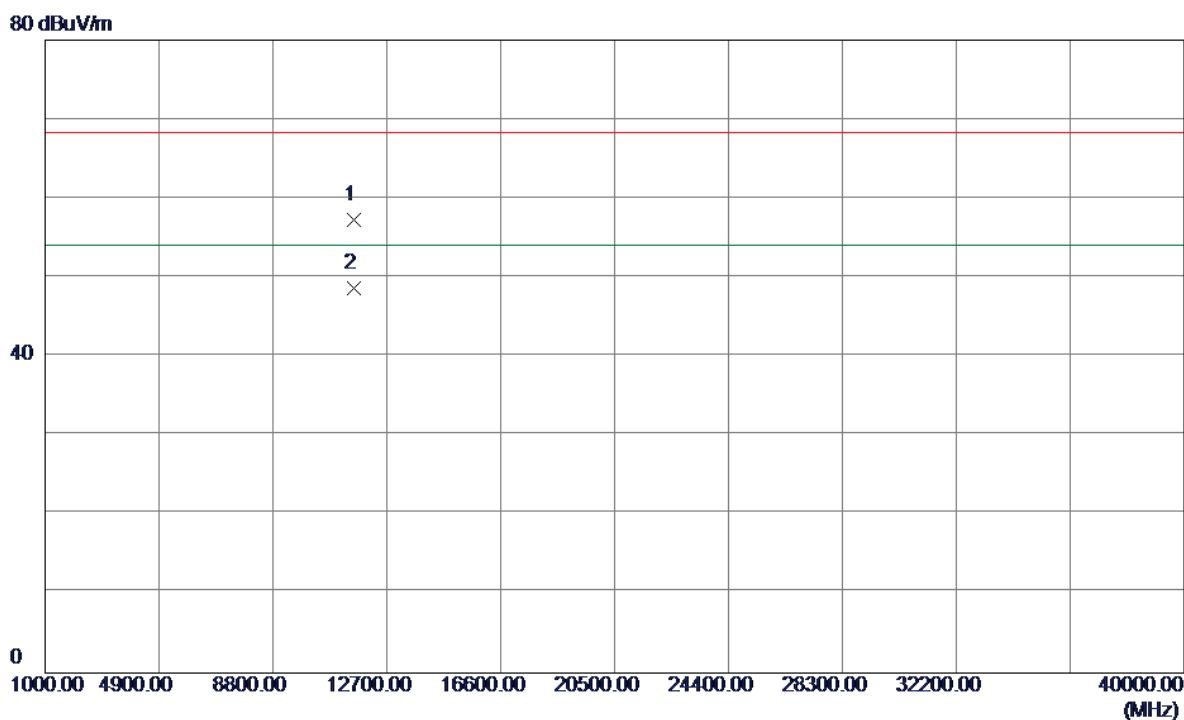

No.	Freq. MHz	Reading Level dBuV/m	Correct Factor dB	Measure ment dBuV/m	Limit dBuV/m	Over dB	Detector	Comment
1	11570.1000	40.28	17.05	57.33	68.30	-10.97	Peak	
2	11570.2300	31.58	17.05	48.63	54.00	-5.37	AVG	

Orthogonal Axis:	X
Test Mode:	UNII-3/TX A Mode 5825MHz - External antenna

Vertical

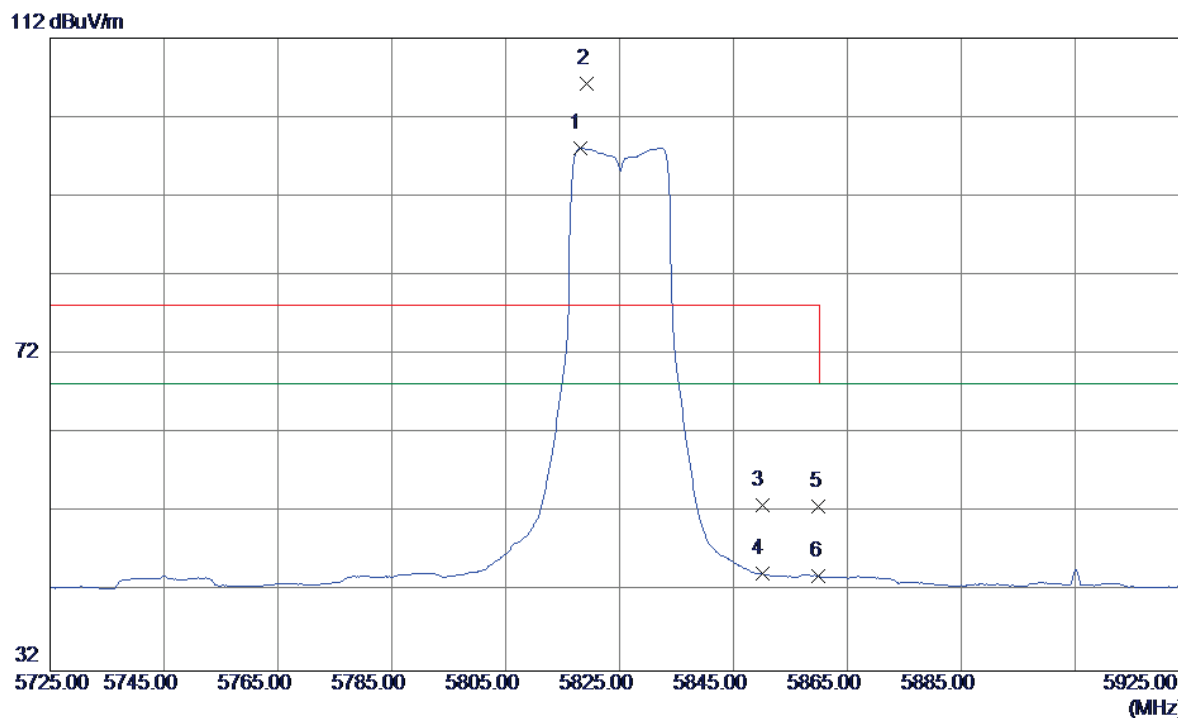

No.	Freq. MHz	Reading Level dBuV/m	Correct Factor dB	Measure ment dBuV/m	Limit dBuV/m	Over dB	Detector	Comment
1	5818.0000	56.73	41.39	98.12	68.30	29.82	AVG	No Limit
2	5819.2000	64.89	41.39	106.28	78.30	27.98	Peak	No Limit
3	5850.0000	11.57	41.44	53.01	78.30	-25.29	Peak	
4	5850.0000	2.88	41.44	44.32	68.30	-23.98	AVG	
5	5860.0000	11.38	41.45	52.83	78.30	-25.47	Peak	
6	5860.0000	2.55	41.45	44.00	68.30	-24.30	AVG	

Orthogonal Axis:	X
Test Mode:	UNII-3/TX A Mode 5825MHz - External antenna

Vertical

80 dBuV/m

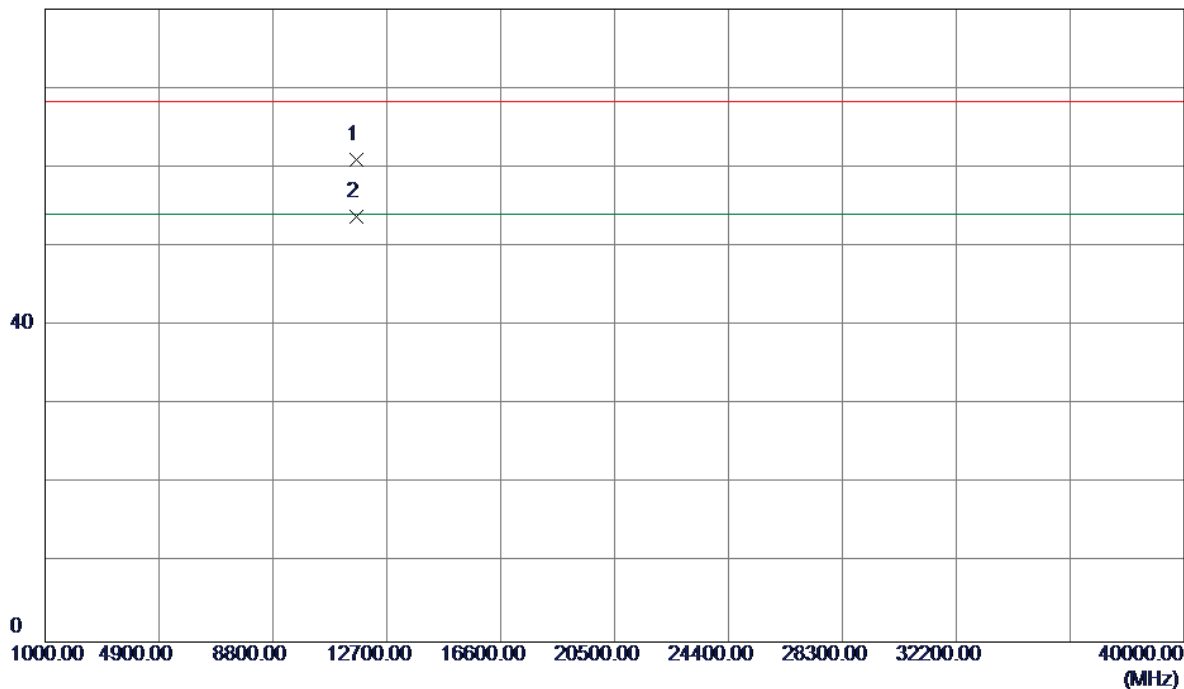

No.	Freq. MHz	Reading Level dBuV/m	Correct Factor dB	Measure ment dBuV/m	Limit dBuV/m	Over dB	Detector	Comment
1	11650.1300	43.72	17.17	60.89	68.30	-7.41	Peak	
2	11650.2200	36.52	17.17	53.69	54.00	-0.31	AVG	

Orthogonal Axis:	X
Test Mode:	UNII-3/TX A Mode 5825MHz - External antenna

Horizontal

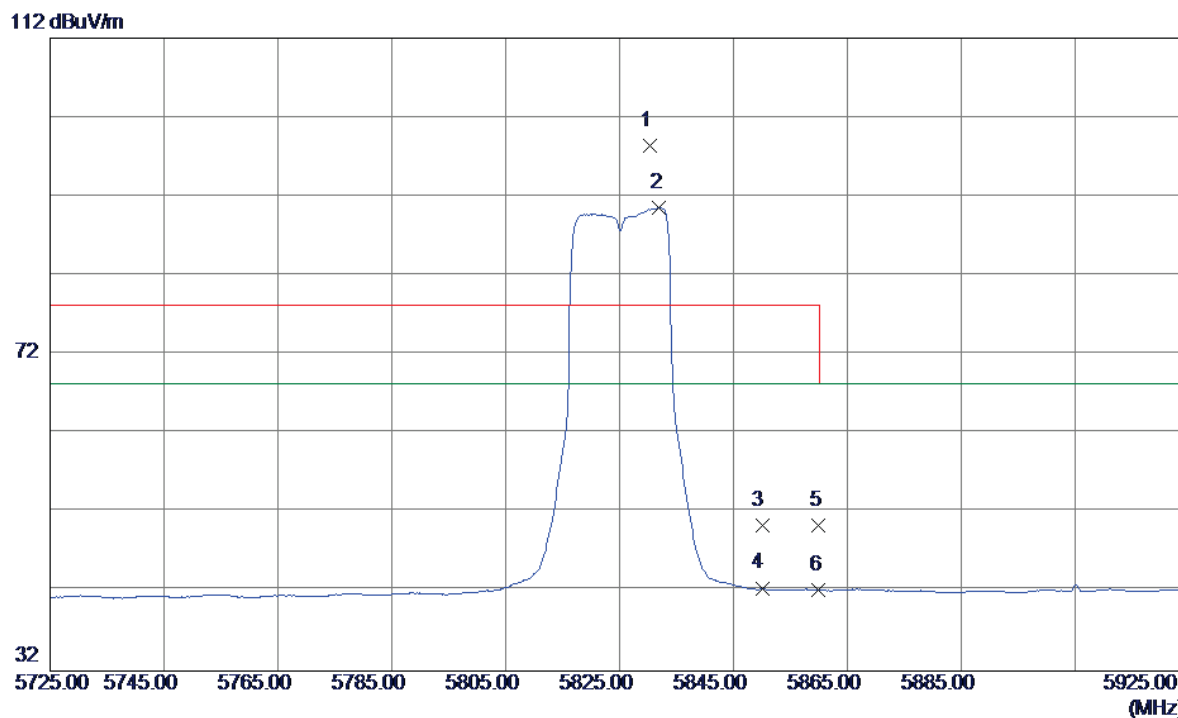

No.	Freq. MHz	Reading Level dBuV/m	Correct Factor dB	Measure ment dBuV/m	Limit dBuV/m	Over dB	Detector	Comment
1	5830.4000	56.95	41.41	98.36	78.30	20.06	Peak	No Limit
2	5832.0000	49.17	41.41	90.58	68.30	22.28	AVG	No Limit
3	5850.0000	8.90	41.44	50.34	78.30	-27.96	Peak	
4	5850.0000	1.04	41.44	42.48	68.30	-25.82	AVG	
5	5860.0000	8.89	41.45	50.34	78.30	-27.96	Peak	
6	5860.0000	0.76	41.45	42.21	68.30	-26.09	AVG	

Orthogonal Axis:	X
Test Mode:	UNII-3/TX A Mode 5825MHz - External antenna

Horizontal

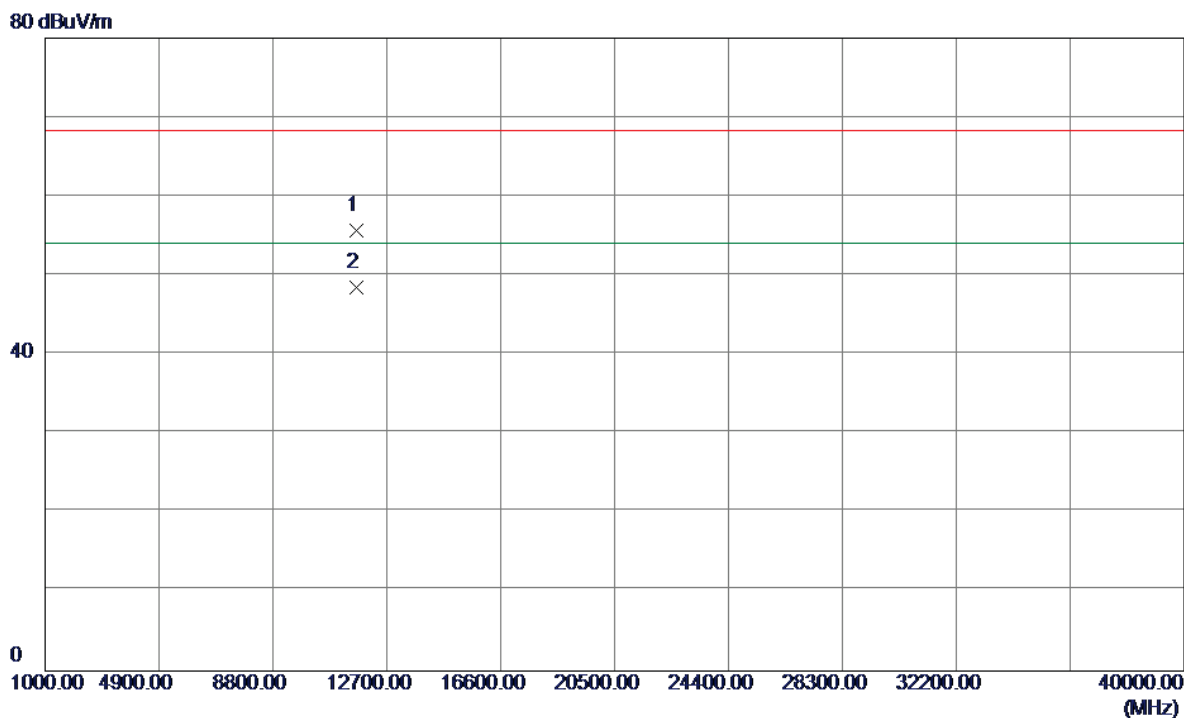

No.	Freq. MHz	Reading Level dBuV/m	Correct Factor dB	Measure ment dBuV/m	Limit dBuV/m	Over dB	Detector	Comment
1	11649.9800	38.58	17.17	55.75	68.30	-12.55	Peak	
2	11650.2400	31.31	17.17	48.48	54.00	-5.52	AVG	

Orthogonal Axis:	X
Test Mode:	UNII-3/TX N20 Mode 5745MHz - External antenna

Vertical

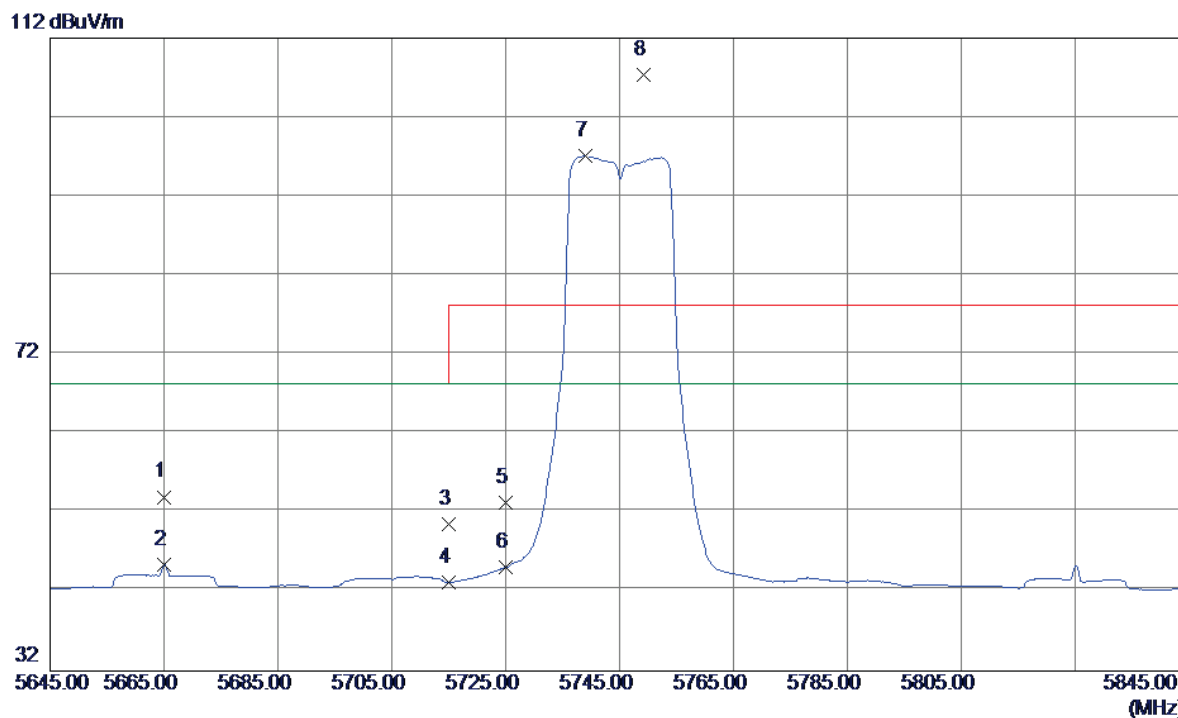

No.	Freq. MHz	Reading Level dBuV/m	Correct Factor dB	Measure ment dBuV/m	Limit dBuV/m	Over dB	Detector	Comment
1	5665.0000	12.82	41.18	54.00	68.30	-14.30	Peak	
2	5665.0000	4.21	41.18	45.39	68.30	-22.91	AVG	
3	5715.0000	9.31	41.25	50.56	68.30	-17.74	Peak	
4	5715.0000	1.96	41.25	43.21	68.30	-25.09	AVG	
5	5725.0000	12.02	41.27	53.29	78.30	-25.01	Peak	
6	5725.0000	3.84	41.27	45.11	68.30	-23.19	AVG	
7	5739.0000	55.79	41.28	97.07	68.30	28.77	AVG	No Limit
8	5749.2000	66.05	41.30	107.35	78.30	29.05	Peak	No Limit

Orthogonal Axis:	X
Test Mode:	UNII-3/TX N20 Mode 5745MHz - External antenna

Vertical

80 dBuV/m

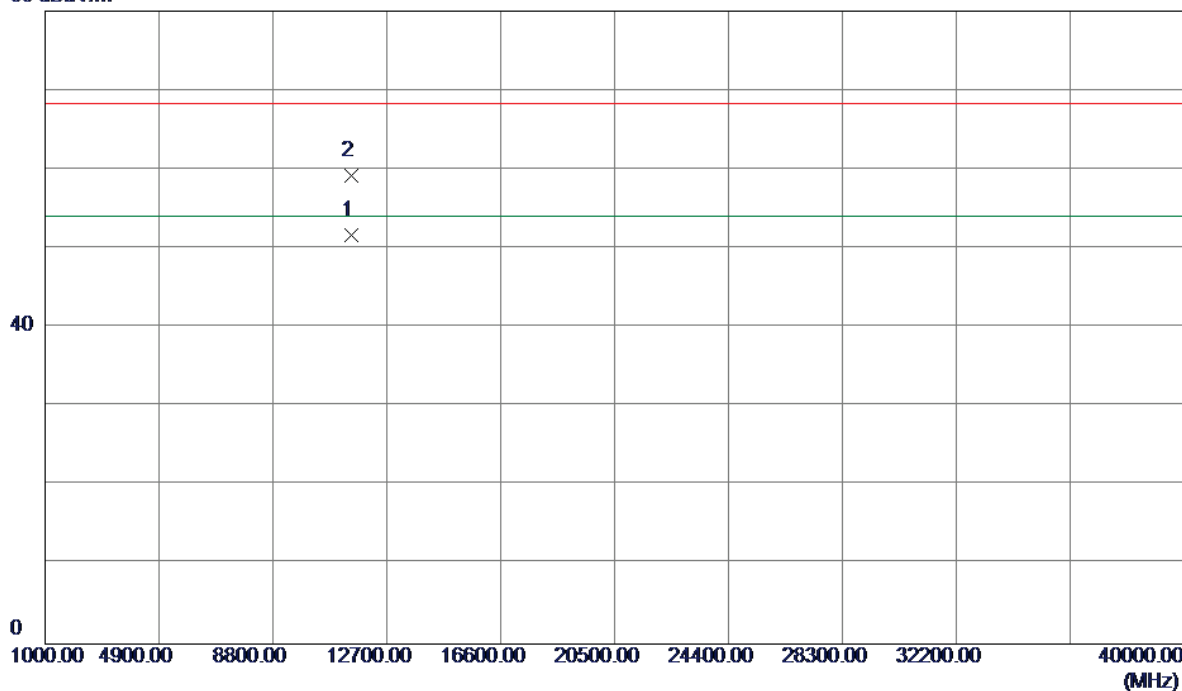

No.	Freq. MHz	Reading Level dBuV/m	Correct Factor dB	Measure ment dBuV/m	Limit dBuV/m	Over dB	Detector	Comment
1	11490.2200	34.81	16.91	51.72	54.00	-2.28	AVG	
2	11490.3300	42.34	16.91	59.25	68.30	-9.05	Peak	

Orthogonal Axis:	X
Test Mode:	UNII-3/TX N20 Mode 5745MHz - External antenna

Horizontal

112 dBuV/m

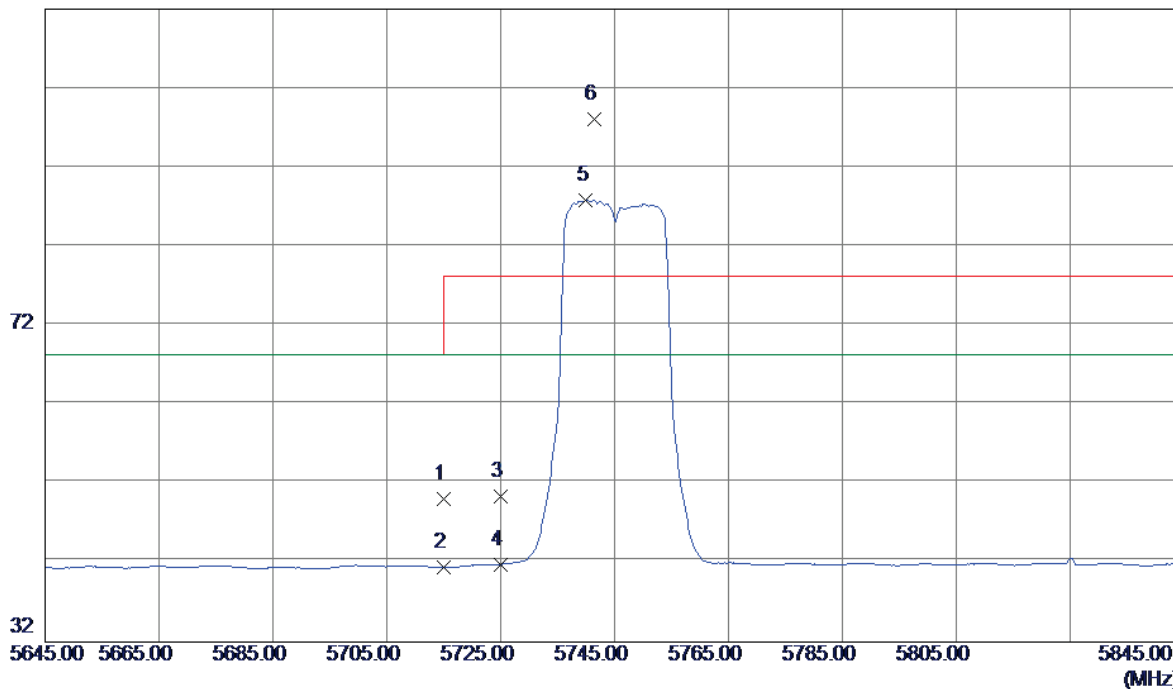

No.	Freq. MHz	Reading Level dBuV/m	Correct Factor dB	Measure ment dBuV/m	Limit dBuV/m	Over dB	Detector	Comment
1	5715.0000	8.81	41.25	50.06	68.30	-18.24	Peak	
2	5715.0000	0.15	41.25	41.40	68.30	-26.90	AVG	
3	5725.0000	9.17	41.27	50.44	78.30	-27.86	Peak	
4	5725.0000	0.54	41.27	41.81	68.30	-26.49	AVG	
5	5740.0000	46.60	41.29	87.89	68.30	19.59	AVG	No Limit
6	5741.4000	56.83	41.29	98.12	78.30	19.82	Peak	No Limit

Orthogonal Axis:	X
Test Mode:	UNII-3/TX N20 Mode 5745MHz - External antenna

Horizontal

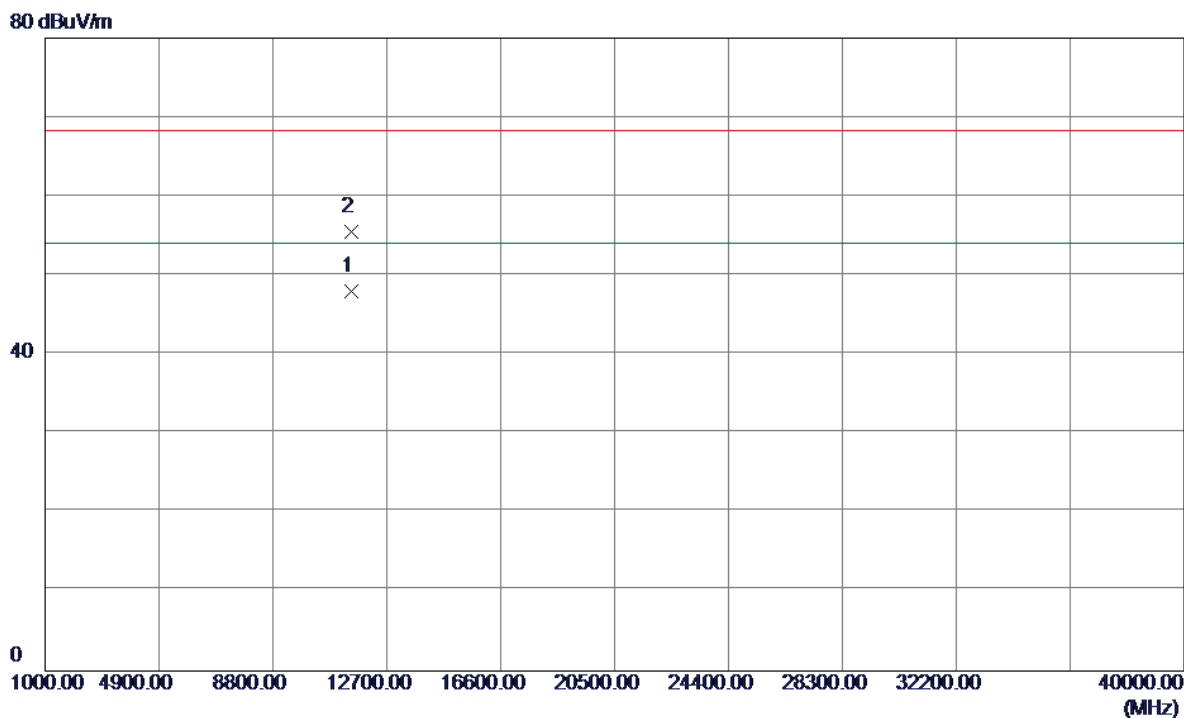

No.	Freq. MHz	Reading Level dBuV/m	Correct Factor dB	Measure ment dBuV/m	Limit dBuV/m	Over dB	Detector	Comment
1	11490.2300	31.08	16.91	47.99	54.00	-6.01	AVG	
2	11490.2699	38.61	16.91	55.52	68.30	-12.78	Peak	

Orthogonal Axis:	X
Test Mode:	UNII-3/TX N20 Mode 5785MHz - External antenna

Vertical

112 dBuV/m

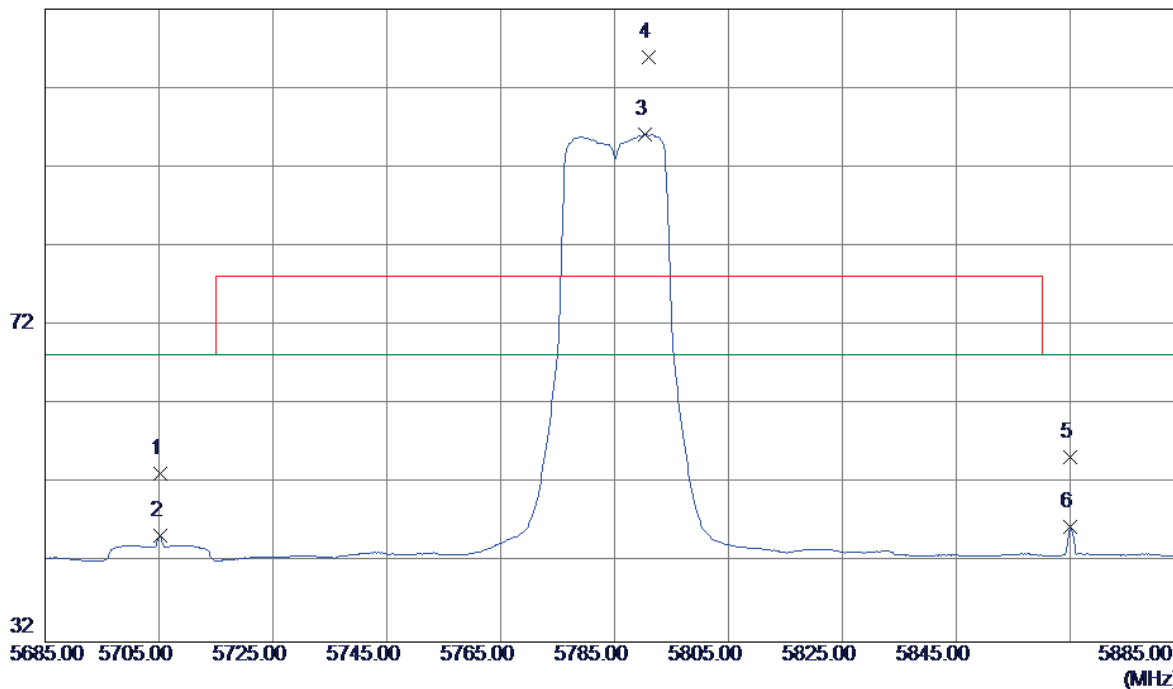

No.	Freq. MHz	Reading Level dBuV/m	Correct Factor dB	Measure ment dBuV/m	Limit dBuV/m	Over dB	Detector	Comment
1	5705.2000	12.11	41.24	53.35	68.30	-14.95	Peak	
2	5705.2000	4.25	41.24	45.49	68.30	-22.81	AVG	
3	5790.4000	54.83	41.35	96.18	68.30	27.88	AVG	No Limit
4	5791.0000	64.54	41.36	105.90	78.30	27.60	Peak	No Limit
5	5865.0000	13.85	41.46	55.31	68.30	-12.99	Peak	
6	5865.0000	5.04	41.46	46.50	68.30	-21.80	AVG	

Orthogonal Axis:	X
Test Mode:	UNII-3/TX N20 Mode 5785MHz - External antenna

Vertical

80 dBuV/m

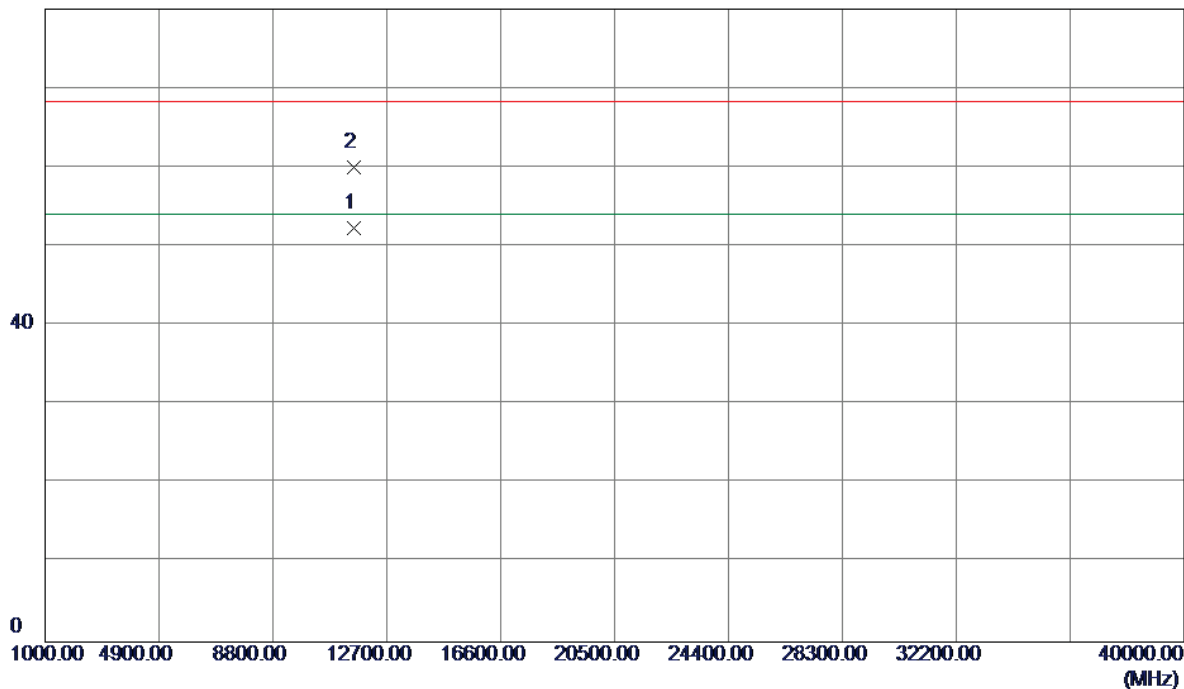

No.	Freq. MHz	Reading Level dBuV/m	Correct Factor dB	Measure ment dBuV/m	Limit dBuV/m	Over dB	Detector	Comment
1	11570.2300	35.20	17.05	52.25	54.00	-1.75	AVG	
2	11570.2500	42.91	17.05	59.96	68.30	-8.34	Peak	

Orthogonal Axis:	X
Test Mode:	UNII-3/TX N20 Mode 5785MHz - External antenna

Horizontal

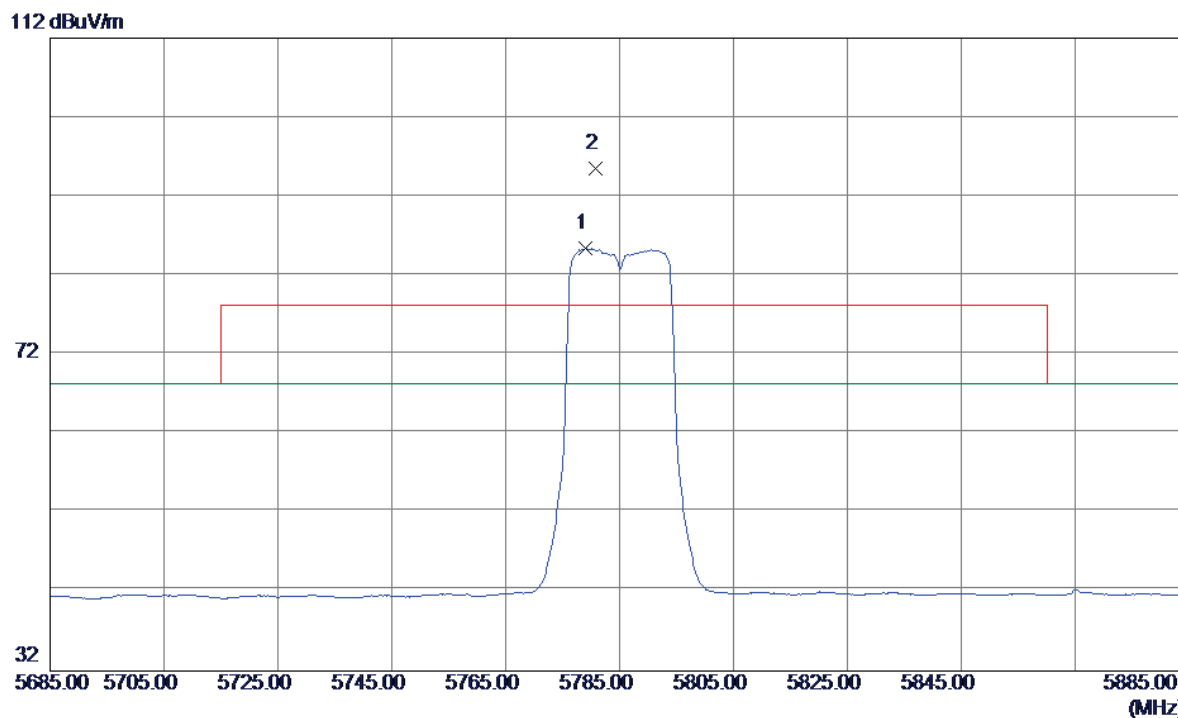

No.	Freq. MHz	Reading Level dBuV/m	Correct Factor dB	Measure ment dBuV/m	Limit dBuV/m	Over dB	Detector	Comment
1	5779.0000	44.07	41.34	85.41	68.30	17.11	AVG	No Limit
2	5780.8000	54.15	41.34	95.49	78.30	17.19	Peak	No Limit

Orthogonal Axis:	X
Test Mode:	UNII-3/TX N20 Mode 5785MHz - External antenna

Horizontal

80 dBuV/m

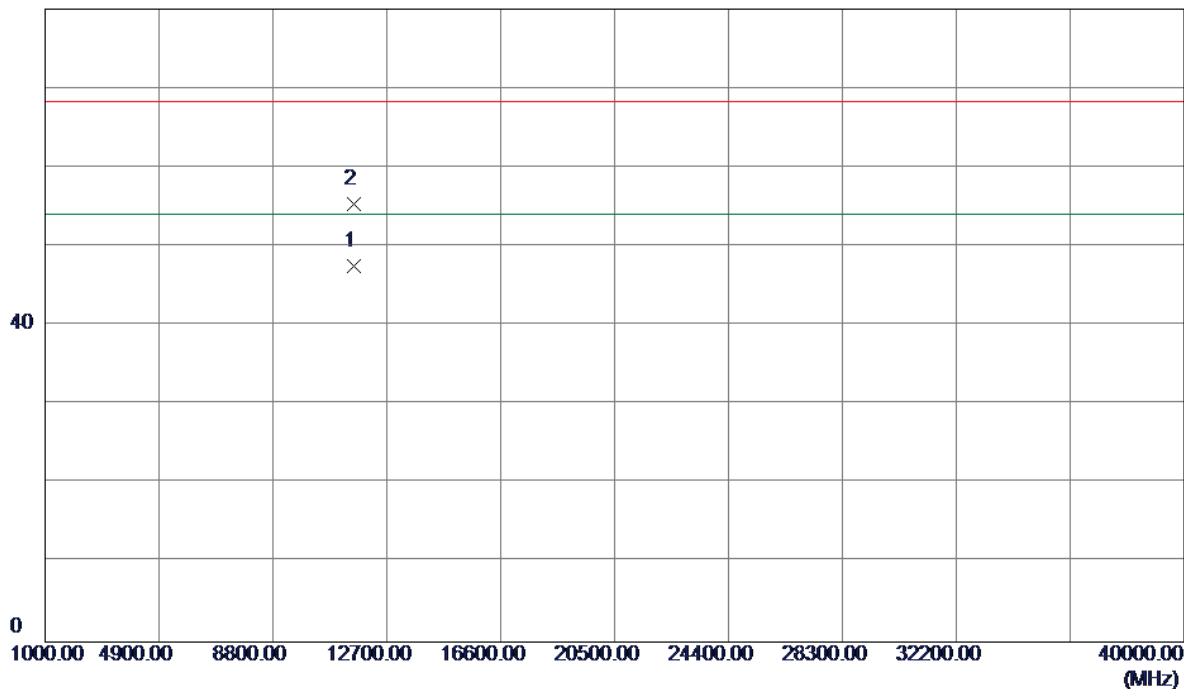

No.	Freq. MHz	Reading Level dBuV/m	Correct Factor dB	Measure ment dBuV/m	Limit dBuV/m	Over dB	Detector	Comment
1	11570.2300	30.47	17.05	47.52	54.00	-6.48	AVG	
2	11570.2600	38.32	17.05	55.37	68.30	-12.93	Peak	

Orthogonal Axis:	X
Test Mode:	UNII-3/TX N20 Mode 5825MHz - External antenna

Vertical

112 dBuV/m

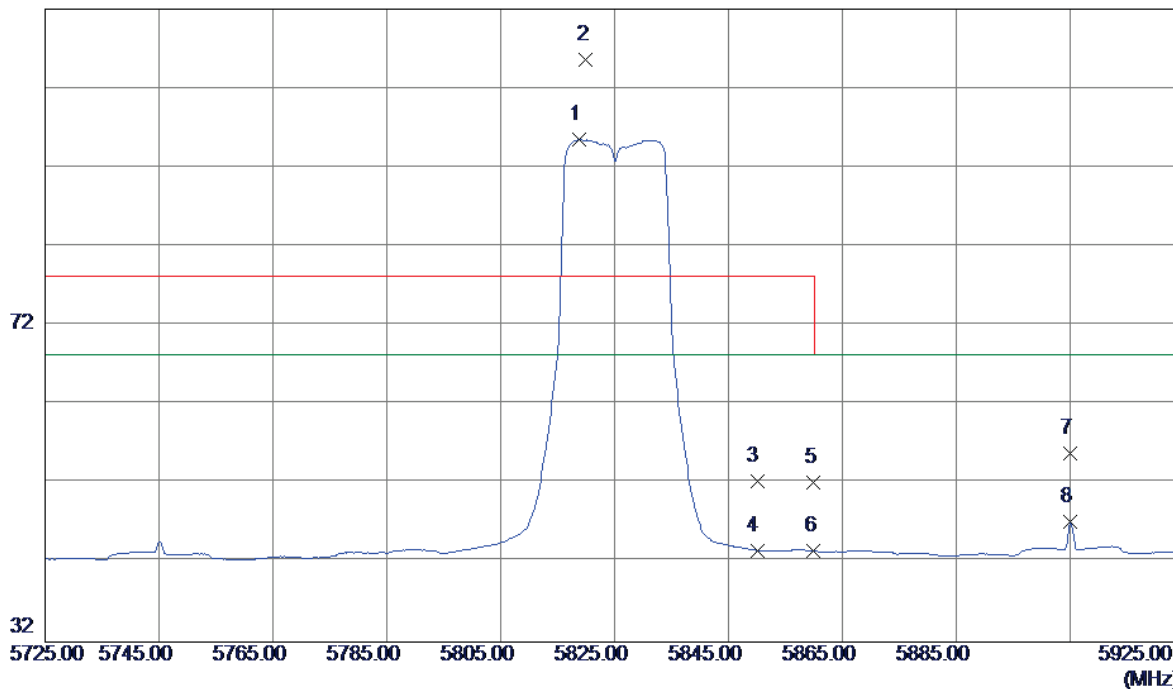

No.	Freq. MHz	Reading Level dBuV/m	Correct Factor dB	Measure ment dBuV/m	Limit dBuV/m	Over dB	Detector	Comment
1	5818.8000	54.09	41.39	95.48	68.30	27.18	AVG	No Limit
2	5820.0000	64.18	41.40	105.58	78.30	27.28	Peak	No Limit
3	5850.0000	10.85	41.44	52.29	78.30	-26.01	Peak	
4	5850.0000	2.15	41.44	43.59	68.30	-24.71	AVG	
5	5860.0000	10.69	41.45	52.14	78.30	-26.16	Peak	
6	5860.0000	2.01	41.45	43.46	68.30	-24.84	AVG	
7	5905.0000	14.35	41.51	55.86	68.30	-12.44	Peak	
8	5905.0000	5.76	41.51	47.27	68.30	-21.03	AVG	

Orthogonal Axis:	X
Test Mode:	UNII-3/TX N20 Mode 5825MHz - External antenna

Vertical

80 dBuV/m

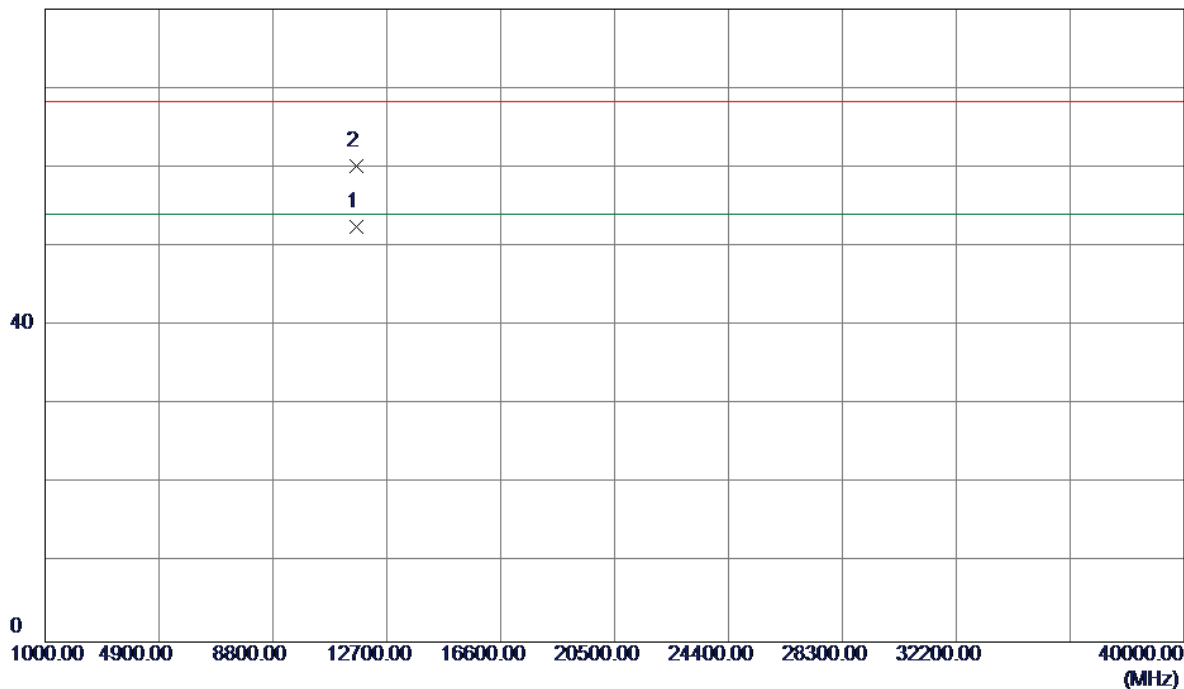

No.	Freq. MHz	Reading Level dBuV/m	Correct Factor dB	Measure ment dBuV/m	Limit dBuV/m	Over dB	Detector	Comment
1	11650.2300	35.28	17.17	52.45	54.00	-1.55	AVG	
2	11650.2500	43.04	17.17	60.21	68.30	-8.09	Peak	

Orthogonal Axis:	X
Test Mode:	UNII-3/TX N20 Mode 5825MHz - External antenna

Horizontal

112 dBuV/m

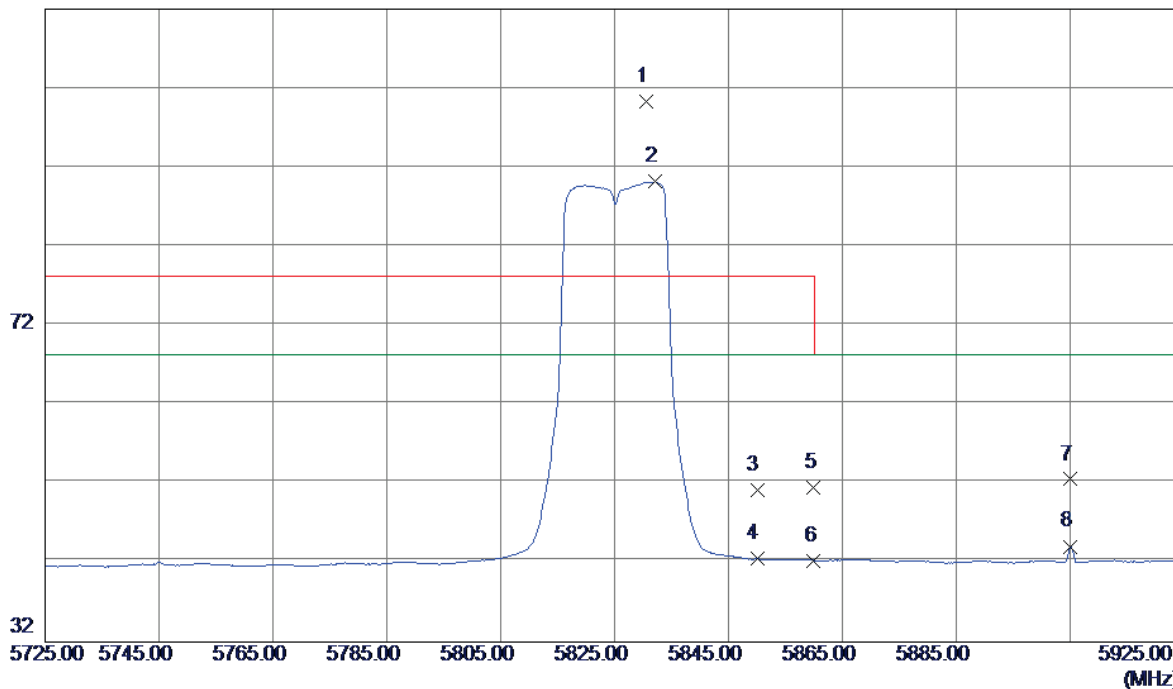

No.	Freq. MHz	Reading Level dBuV/m	Correct Factor dB	Measure ment dBuV/m	Limit dBuV/m	Over dB	Detector	Comment
1	5830.6000	58.88	41.41	100.29	78.30	21.99	Peak	No Limit
2	5832.2000	48.80	41.41	90.21	68.30	21.91	AVG	No Limit
3	5850.0000	9.82	41.44	51.26	78.30	-27.04	Peak	
4	5850.0000	1.15	41.44	42.59	68.30	-25.71	AVG	
5	5860.0000	10.08	41.45	51.53	78.30	-26.77	Peak	
6	5860.0000	0.84	41.45	42.29	68.30	-26.01	AVG	
7	5905.0000	11.05	41.51	52.56	68.30	-15.74	Peak	
8	5905.0000	2.57	41.51	44.08	68.30	-24.22	AVG	

Orthogonal Axis:	X
Test Mode:	UNII-3/TX N20 Mode 5825MHz - External antenna

Horizontal

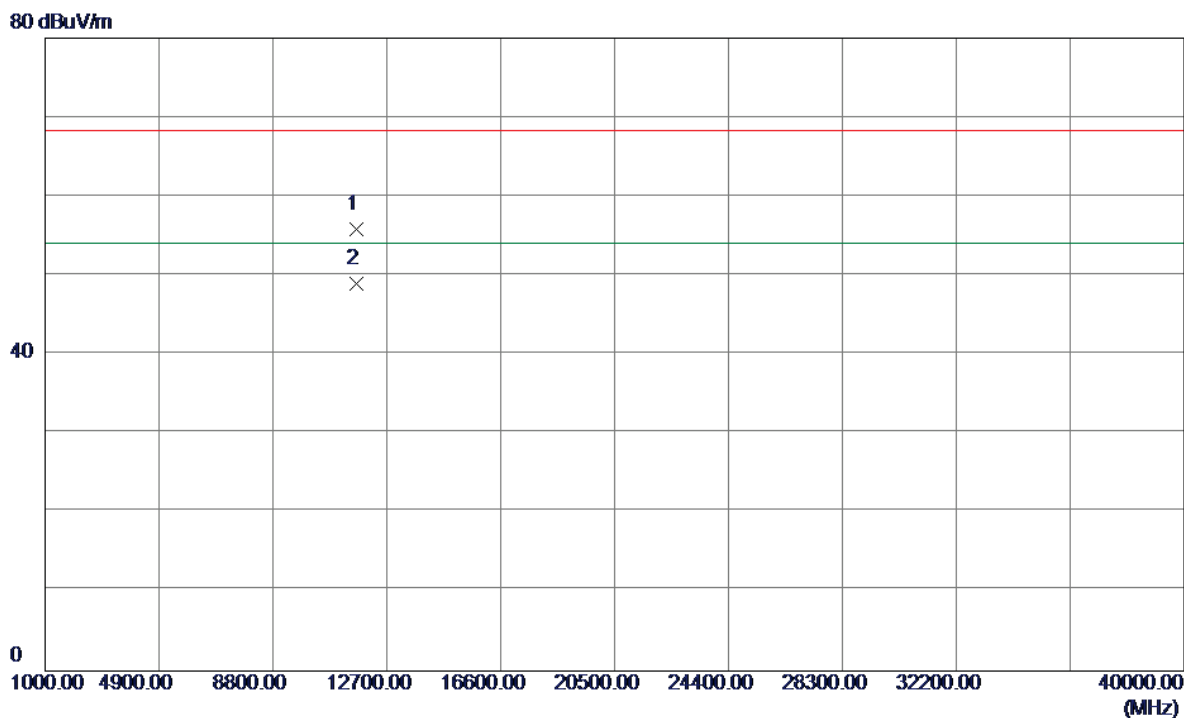

No.	Freq. MHz	Reading Level dBuV/m	Correct Factor dB	Measure ment dBuV/m	Limit dBuV/m	Over dB	Detector	Comment
1	11650.1100	38.66	17.17	55.83	68.30	-12.47	Peak	
2	11650.2300	31.77	17.17	48.94	54.00	-5.06	AVG	

Orthogonal Axis:	X
Test Mode:	UNII-3/TX N40 Mode 5755MHz - External antenna

Vertical

112 dBuV/m

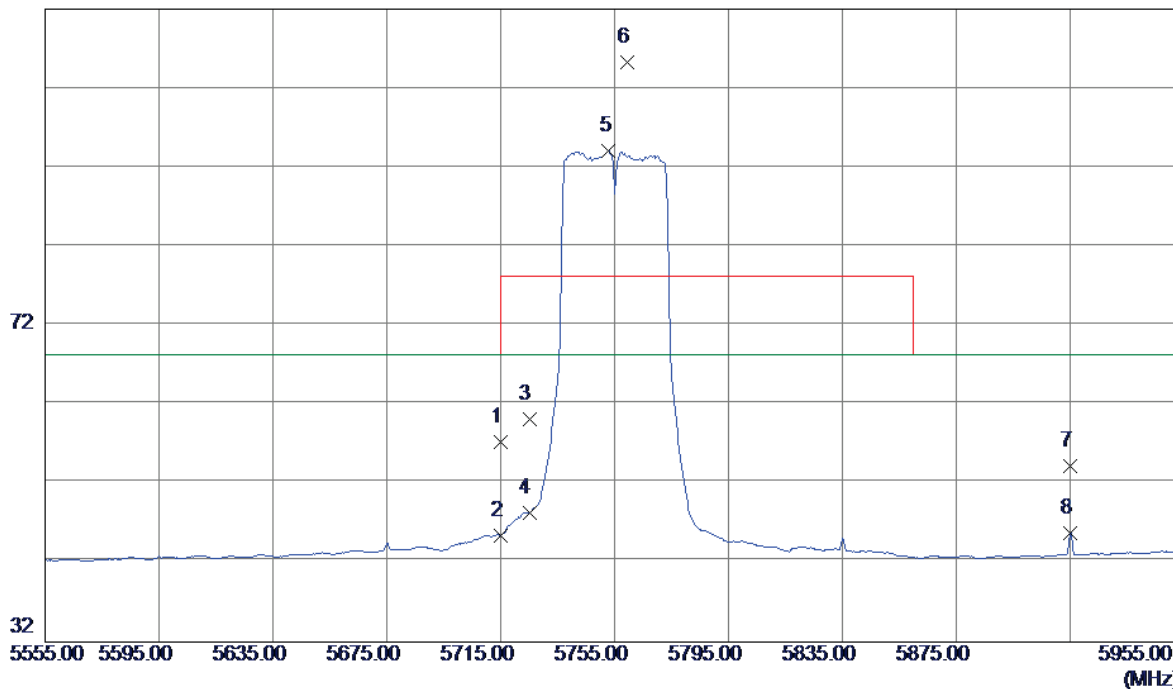

No.	Freq. MHz	Reading Level dBuV/m	Correct Factor dB	Measure ment dBuV/m	Limit dBuV/m	Over dB	Detector	Comment
1	5715.0000	16.04	41.25	57.29	68.30	-11.01	Peak	
2	5715.0000	4.18	41.25	45.43	68.30	-22.87	AVG	
3	5725.0000	18.92	41.27	60.19	78.30	-18.11	Peak	
4	5725.0000	7.02	41.27	48.29	68.30	-20.01	AVG	
5	5753.0000	52.80	41.30	94.10	68.30	25.80	AVG	No Limit
6	5759.4000	63.93	41.31	105.24	78.30	26.94	Peak	No Limit
7	5915.0000	12.67	41.52	54.19	68.30	-14.11	Peak	
8	5915.0000	4.27	41.52	45.79	68.30	-22.51	AVG	

Orthogonal Axis:	X
Test Mode:	UNII-3/TX N40 Mode 5755MHz - External antenna

Vertical

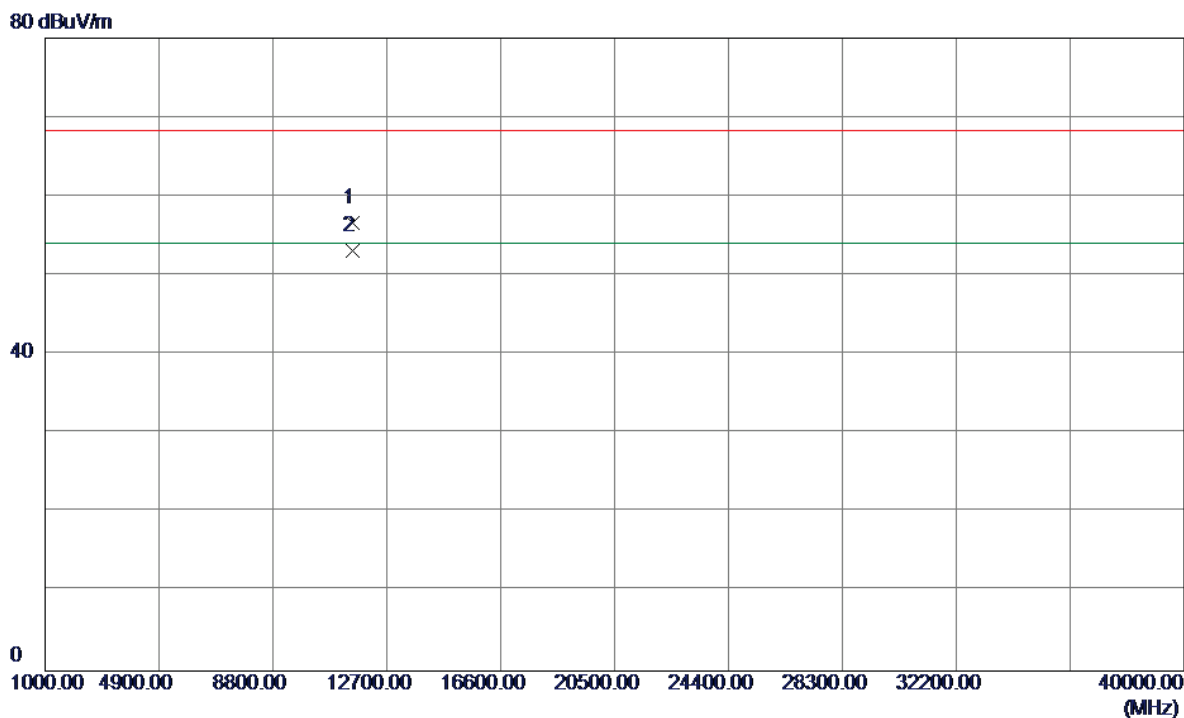

No.	Freq. MHz	Reading Level dBuV/m	Correct Factor dB	Measure ment dBuV/m	Limit dBuV/m	Over dB	Detector	Comment
1	11510.2000	39.69	16.95	56.64	68.30	-11.66	Peak	
2	11510.2300	36.18	16.95	53.13	54.00	-0.87	AVG	

Orthogonal Axis:	X
Test Mode:	UNII-3/TX N40 Mode 5755MHz - External antenna

Horizontal

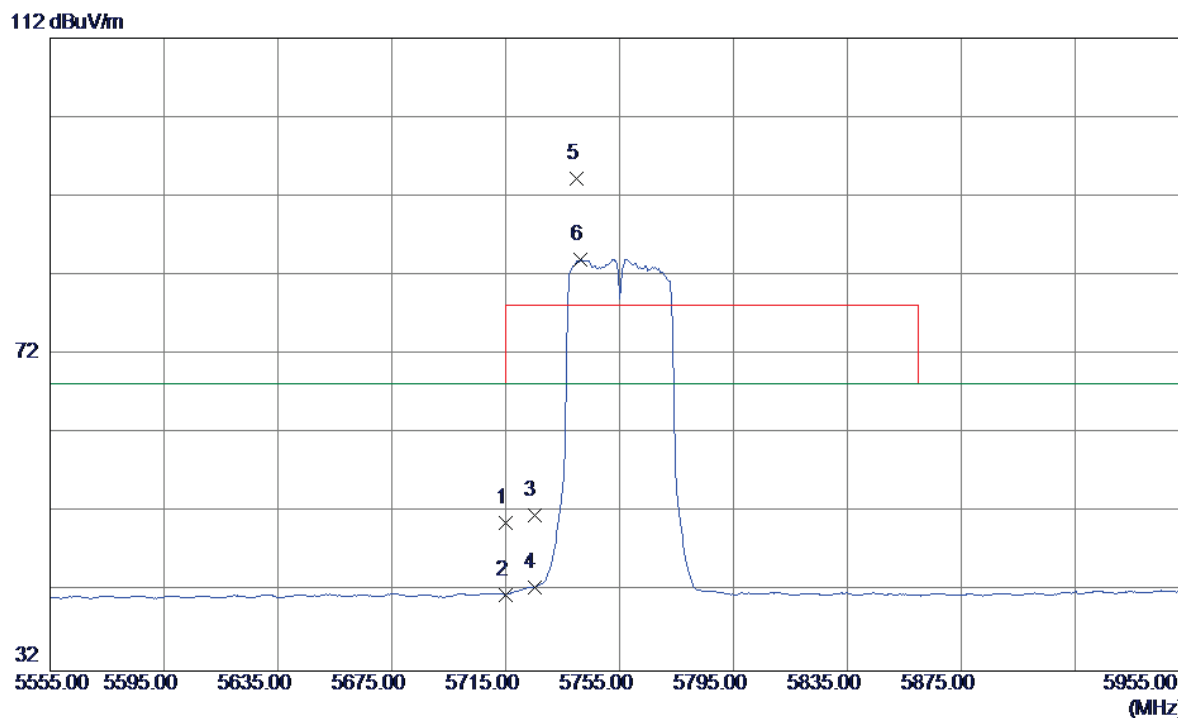

No.	Freq. MHz	Reading Level dBuV/m	Correct Factor dB	Measure ment dBuV/m	Limit dBuV/m	Over dB	Detector	Comment
1	5715.0000	9.51	41.25	50.76	68.30	-17.54	Peak	
2	5715.0000	0.42	41.25	41.67	68.30	-26.63	AVG	
3	5725.0000	10.38	41.27	51.65	78.30	-26.65	Peak	
4	5725.0000	1.28	41.27	42.55	68.30	-25.75	AVG	
5	5739.8000	52.94	41.29	94.23	78.30	15.93	Peak	No Limit
6	5741.4000	42.76	41.29	84.05	68.30	15.75	AVG	No Limit

Orthogonal Axis:	X
Test Mode:	UNII-3/TX N40 Mode 5755MHz - External antenna

Horizontal

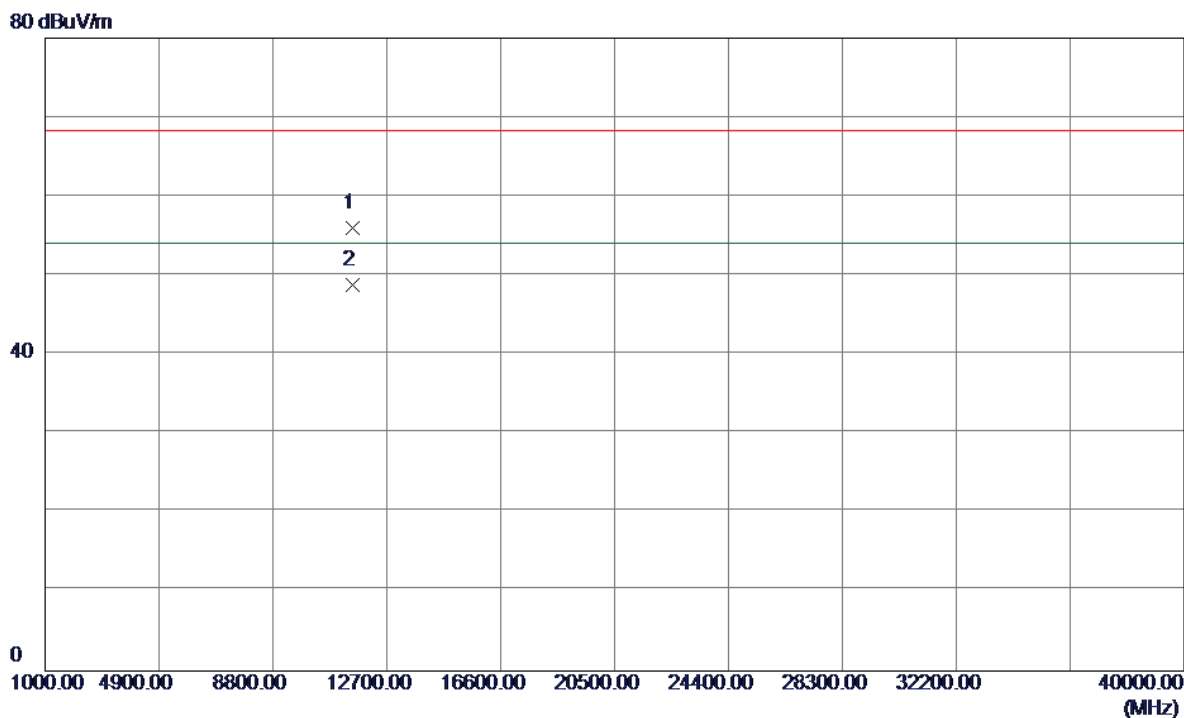

No.	Freq. MHz	Reading Level dBuV/m	Correct Factor dB	Measure ment dBuV/m	Limit dBuV/m	Over dB	Detector	Comment
1	11510.1500	39.05	16.95	56.00	68.30	-12.30	Peak	
2	11510.2200	31.85	16.95	48.80	54.00	-5.20	AVG	

Orthogonal Axis:	X
Test Mode:	UNII-3/TX N40 Mode 5795MHz - External antenna

Vertical

112 dBuV/m

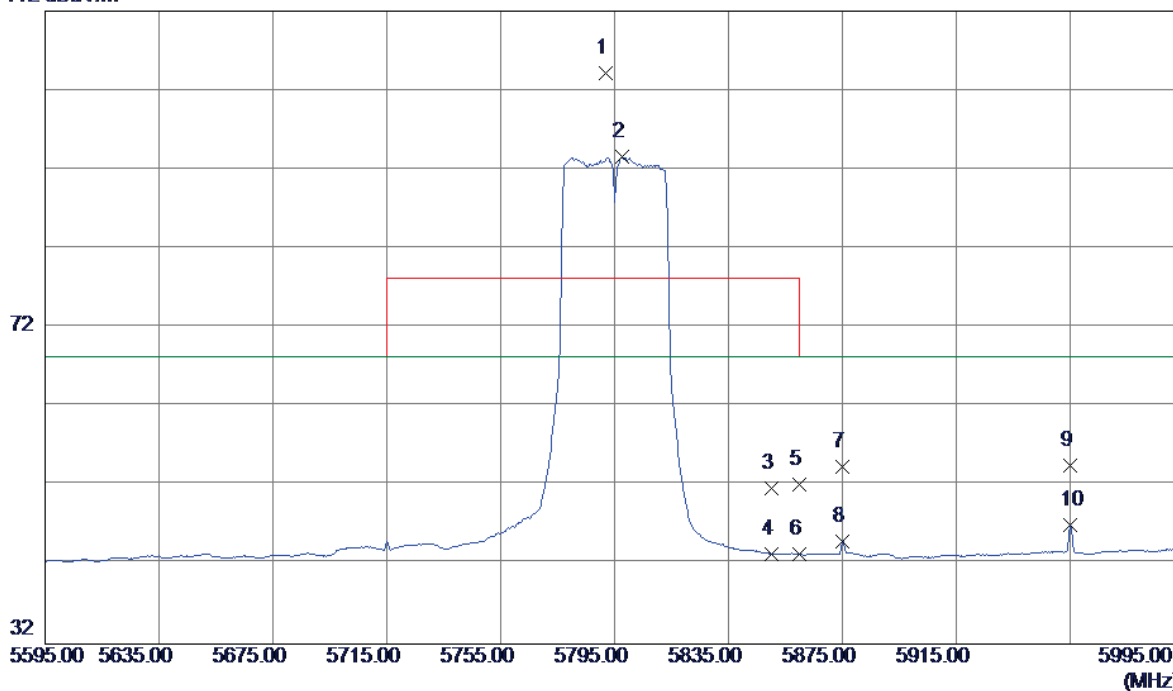

No.	Freq. MHz	Reading Level dBuV/m	Correct Factor dB	Measure ment dBuV/m	Limit dBuV/m	Over dB	Detector	Comment
1	5791.8000	62.78	41.36	104.14	78.30	25.84	Peak	No Limit
2	5797.8000	52.18	41.36	93.54	68.30	25.24	AVG	No Limit
3	5850.0000	10.29	41.44	51.73	78.30	-26.57	Peak	
4	5850.0000	1.95	41.44	43.39	68.30	-24.91	AVG	
5	5860.0000	10.71	41.45	52.16	78.30	-26.14	Peak	
6	5860.0000	1.89	41.45	43.34	68.30	-24.96	AVG	
7	5875.0000	12.91	41.47	54.38	68.30	-13.92	Peak	
8	5875.0000	3.51	41.47	44.98	68.30	-23.32	AVG	
9	5955.0000	12.92	41.58	54.50	68.30	-13.80	Peak	
10	5955.0000	5.51	41.58	47.09	68.30	-21.21	AVG	

Orthogonal Axis:	X
Test Mode:	UNII-3/TX N40 Mode 5795MHz - External antenna

Vertical

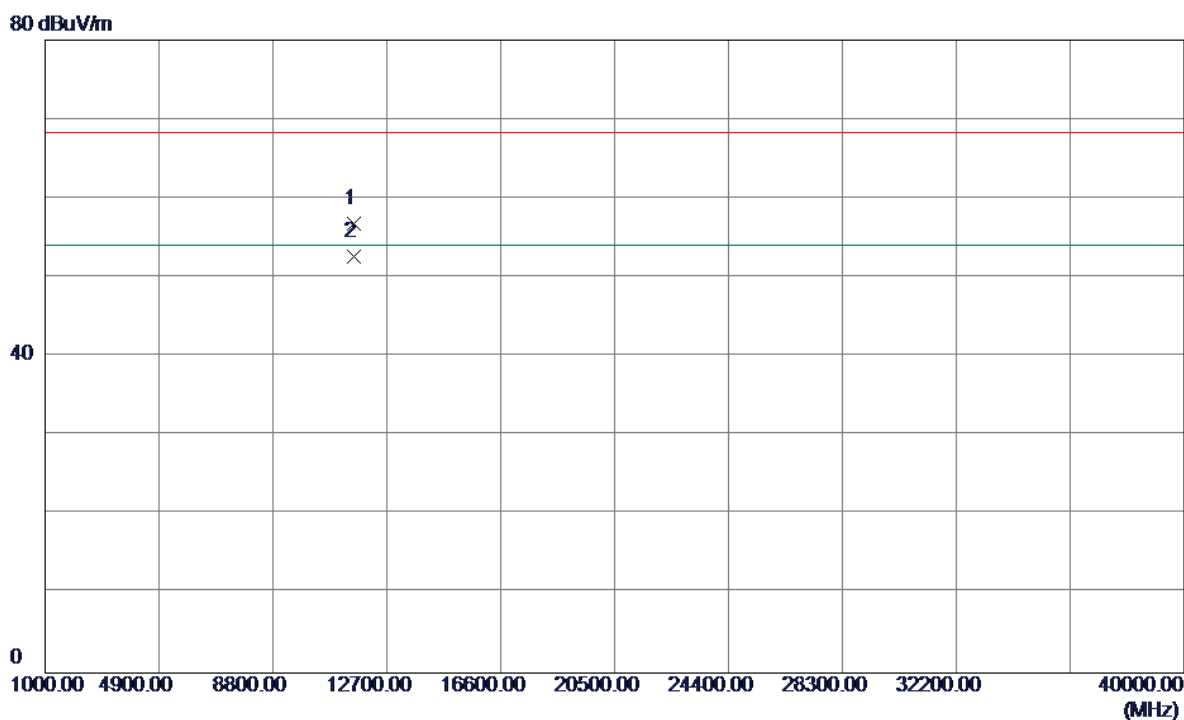

No.	Freq. MHz	Reading Level dBuV/m	Correct Factor dB	Measure ment dBuV/m	Limit dBuV/m	Over dB	Detector	Comment
1	11590.1000	39.76	17.08	56.84	68.30	-11.46	Peak	
2	11590.2100	35.56	17.08	52.64	54.00	-1.36	AVG	

Orthogonal Axis:	X
Test Mode:	UNII-3/TX N40 Mode 5795MHz - External antenna

Horizontal

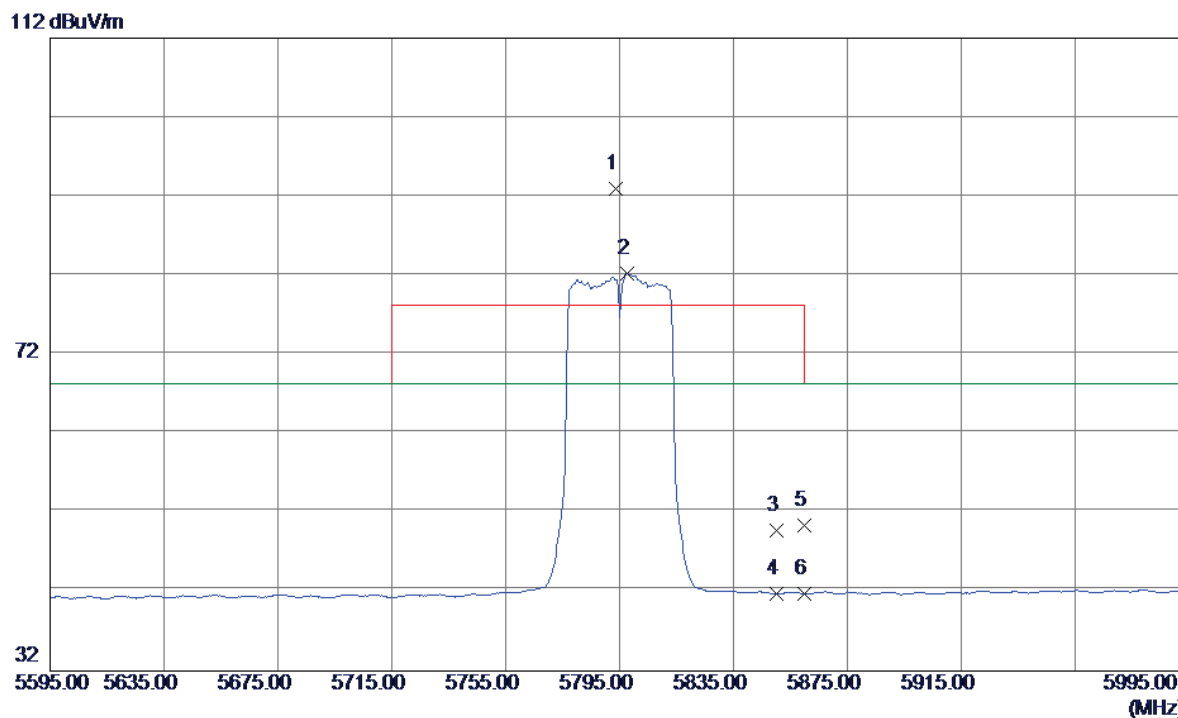

No.	Freq. MHz	Reading Level dBuV/m	Correct Factor dB	Measure ment dBuV/m	Limit dBuV/m	Over dB	Detector	Comment
1	5793.8000	51.53	41.36	92.89	78.30	14.59	Peak	No Limit
2	5797.8000	40.94	41.36	82.30	68.30	14.00	AVG	No Limit
3	5850.0000	8.32	41.44	49.76	78.30	-28.54	Peak	
4	5850.0000	0.32	41.44	41.76	68.30	-26.54	AVG	
5	5860.0000	8.94	41.45	50.39	78.30	-27.91	Peak	
6	5860.0000	0.27	41.45	41.72	68.30	-26.58	AVG	

Orthogonal Axis:	X
Test Mode:	UNII-3/TX N40 Mode 5795MHz - External antenna

Horizontal

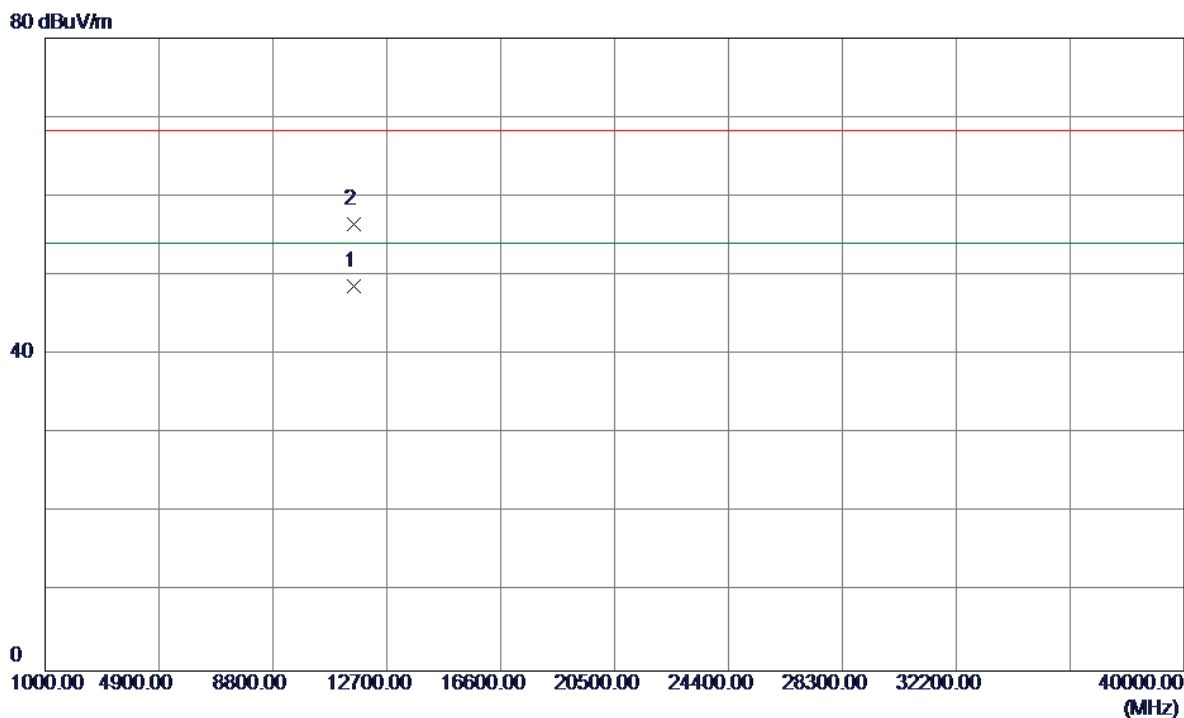

No.	Freq. MHz	Reading Level dBuV/m	Correct Factor dB	Measure ment dBuV/m	Limit dBuV/m	Over dB	Detector	Comment
1	11590.2100	31.63	17.08	48.71	54.00	-5.29	AVG	
2	11590.3800	39.39	17.08	56.47	68.30	-11.83	Peak	

Orthogonal Axis:	X
Test Mode:	UNII-1/ TX AC20 Mode 5180MHz - External antenna

Vertical

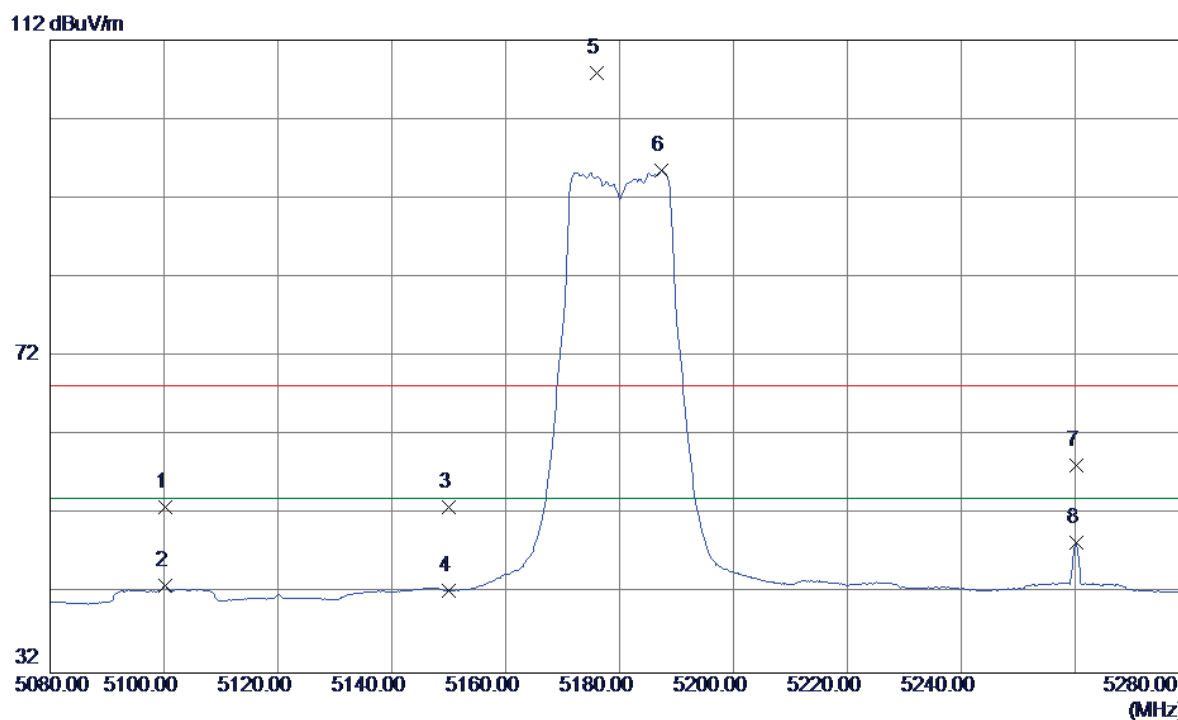

No.	Freq. MHz	Reading Level dBuV/m	Correct Factor dB	Measure ment dBuV/m	Limit dBuV/m	Over dB	Detector	Comment
1	5100.2000	12.81	40.11	52.92	68.30	-15.38	Peak	
2	5100.2000	2.98	40.11	43.09	54.00	-10.91	AVG	
3	5150.0000	12.78	40.22	53.00	68.30	-15.30	Peak	
4	5150.0000	2.15	40.22	42.37	54.00	-11.63	AVG	
5	5176.0000	67.53	40.27	107.80	68.30	39.50	Peak	No Limit
6	5187.4000	55.18	40.30	95.48	54.00	41.48	AVG	No Limit
7	5260.2000	17.85	40.45	58.30	68.30	-10.00	Peak	
8	5260.2000	7.96	40.45	48.41	54.00	-5.59	AVG	

Orthogonal Axis:	X
Test Mode:	UNII-1/ TX AC20 Mode 5180MHz - External antenna

Vertical

80 dBuV/m

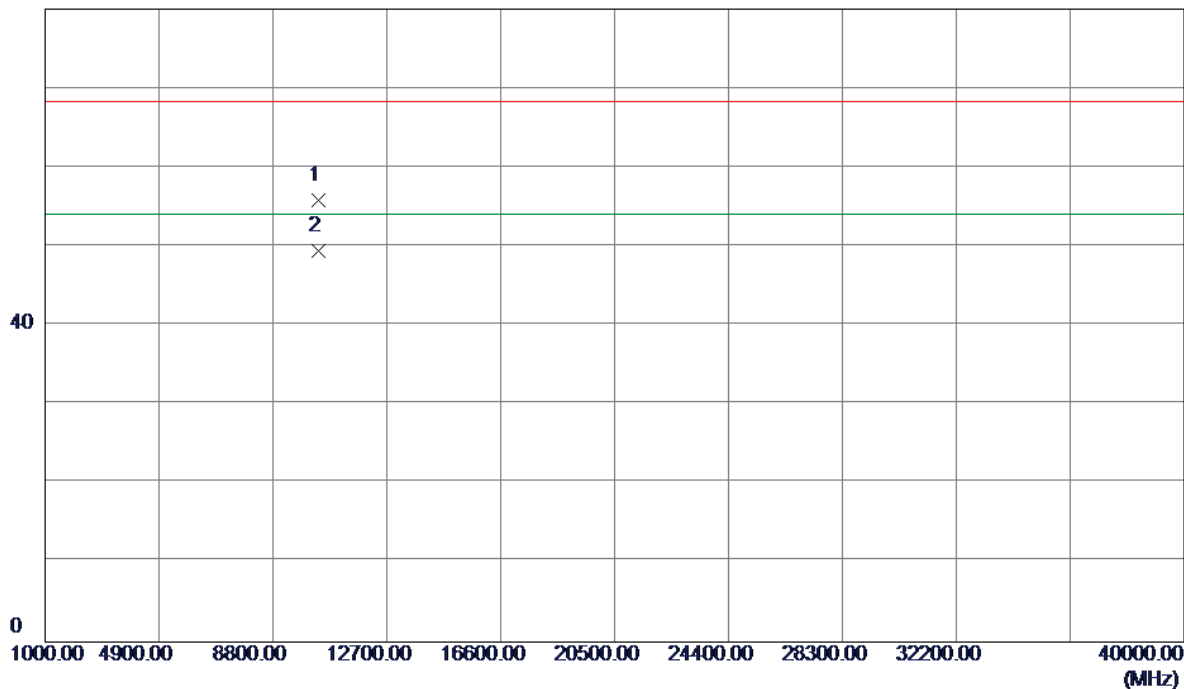

No.	Freq. MHz	Reading Level dBuV/m	Correct Factor dB	Measure ment dBuV/m	Limit dBuV/m	Over dB	Detector	Comment
1	10360.1000	41.93	13.86	55.79	68.30	-12.51	Peak	
2	10360.1900	35.53	13.86	49.39	54.00	-4.61	AVG	

Orthogonal Axis:	X
Test Mode:	UNII-1/ TX AC20 Mode 5180MHz - External antenna

Horizontal

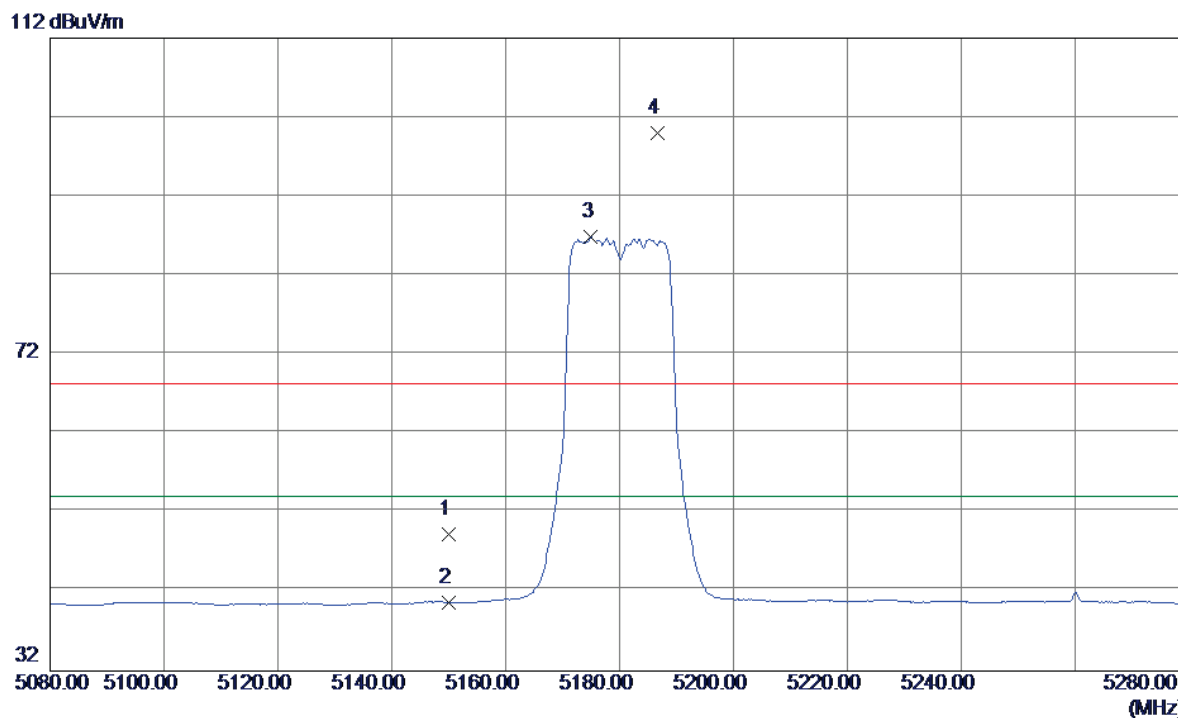

No.	Freq. MHz	Reading Level dBuV/m	Correct Factor dB	Measure ment dBuV/m	Limit dBuV/m	Over dB	Detector	Comment
1	5150.0000	9.07	40.22	49.29	68.30	-19.01	Peak	
2	5150.0000	0.47	40.22	40.69	54.00	-13.31	AVG	
3	5175.0000	46.66	40.27	86.93	54.00	32.93	AVG	No Limit
4	5186.6000	59.66	40.30	99.96	68.30	31.66	Peak	No Limit

Orthogonal Axis:	X
Test Mode:	UNII-1/ TX AC20 Mode 5180MHz - External antenna

Horizontal

80 dBuV/m

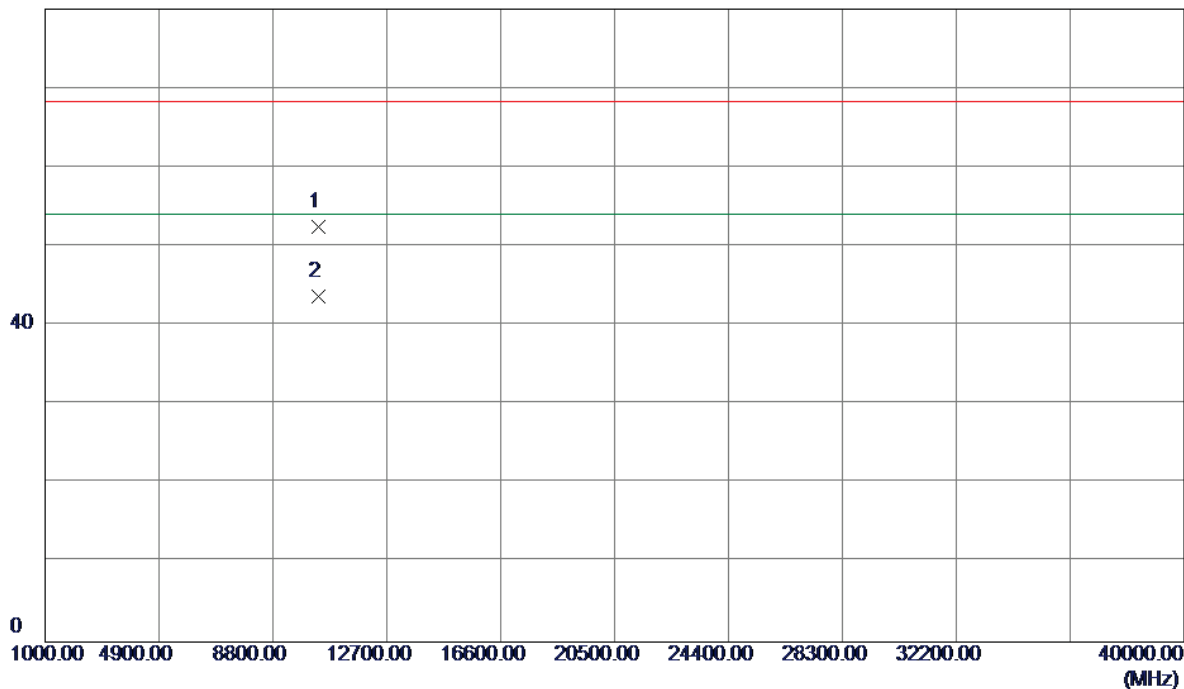

No.	Freq. MHz	Reading Level dBuV/m	Correct Factor dB	Measure ment dBuV/m	Limit dBuV/m	Over dB	Detector	Comment
1	10360.1600	38.64	13.86	52.50	68.30	-15.80	Peak	
2	10360.1800	29.83	13.86	43.69	54.00	-10.31	AVG	

Orthogonal Axis:	X
Test Mode:	UNII-1/ TX AC20 Mode 5200MHz - External antenna

Vertical

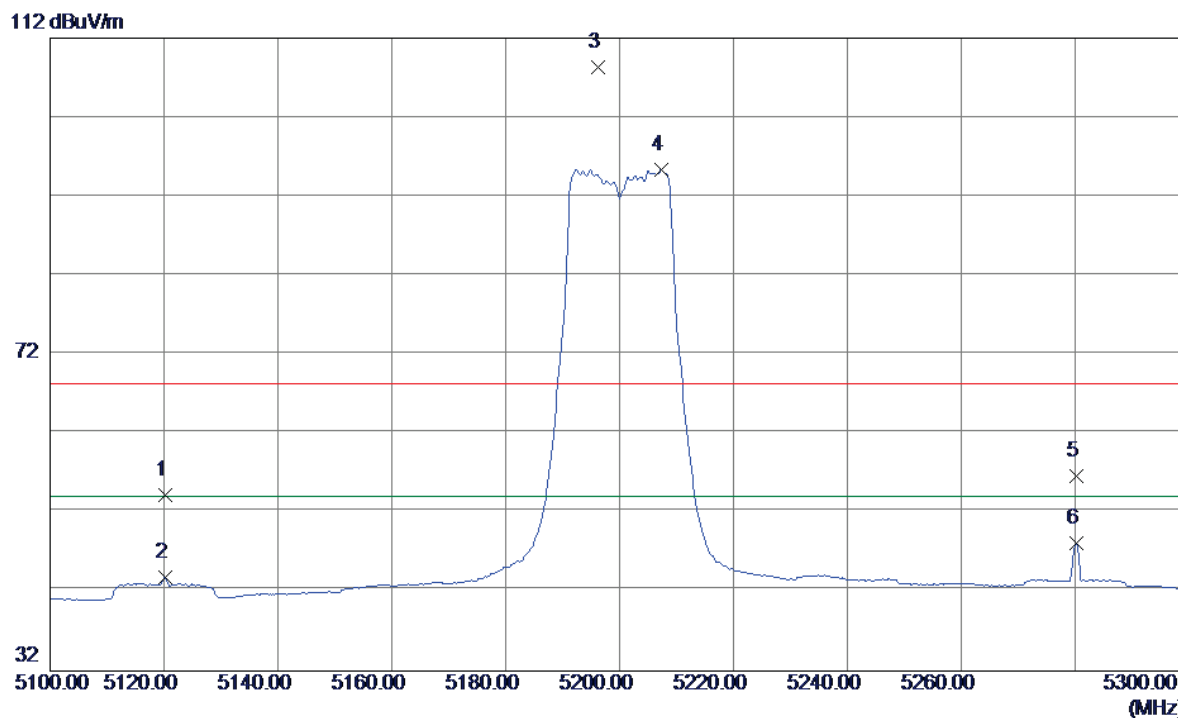

No.	Freq. MHz	Reading Level dBuV/m	Correct Factor dB	Measure ment dBuV/m	Limit dBuV/m	Over dB	Detector	Comment
1	5120.2000	14.15	40.15	54.30	68.30	-14.00	Peak	
2	5120.2000	3.68	40.15	43.83	54.00	-10.17	AVG	
3	5196.2000	68.05	40.32	108.37	68.30	40.07	Peak	No Limit
4	5207.4000	55.05	40.34	95.39	54.00	41.39	AVG	No Limit
5	5280.2000	16.08	40.49	56.57	68.30	-11.73	Peak	
6	5280.2000	7.68	40.49	48.17	54.00	-5.83	AVG	

Orthogonal Axis:	X
Test Mode:	UNII-1/ TX AC20 Mode 5200MHz - External antenna

Vertical

80 dBuV/m

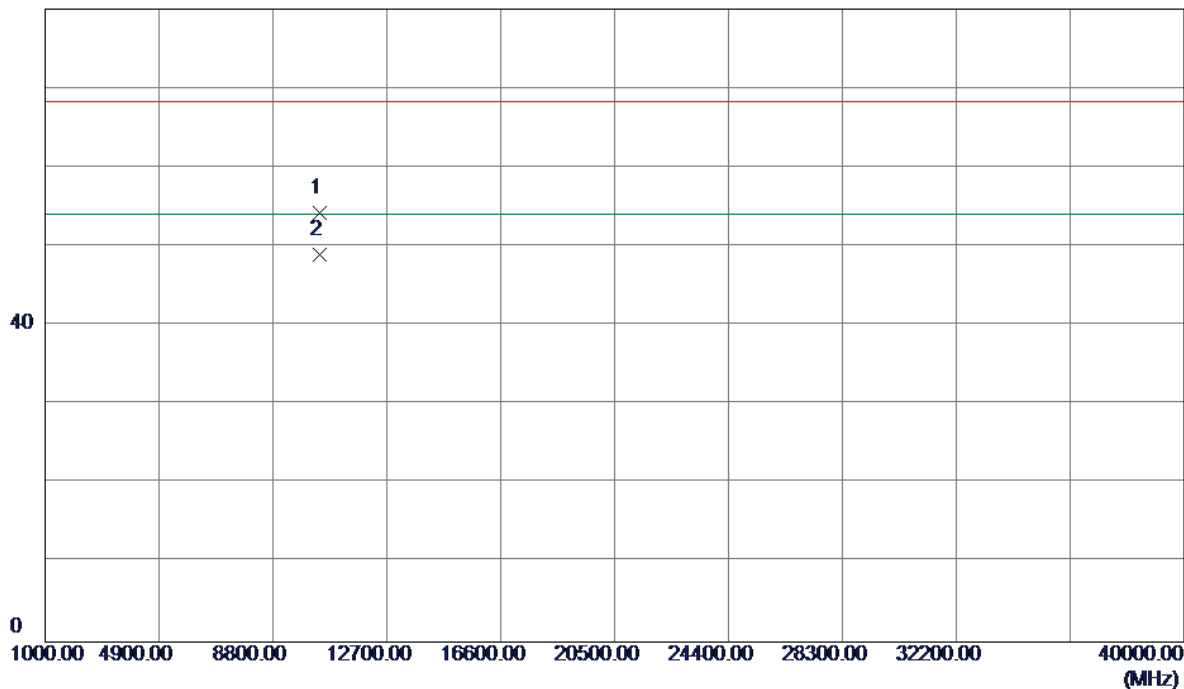

No.	Freq. MHz	Reading Level dBuV/m	Correct Factor dB	Measure ment dBuV/m	Limit dBuV/m	Over dB	Detector	Comment
1	10400.0500	40.47	13.80	54.27	68.30	-14.03	Peak	
2	10400.2000	35.23	13.80	49.03	54.00	-4.97	AVG	

Orthogonal Axis:	X
Test Mode:	UNII-1/ TX AC20 Mode 5200MHz - External antenna

Horizontal

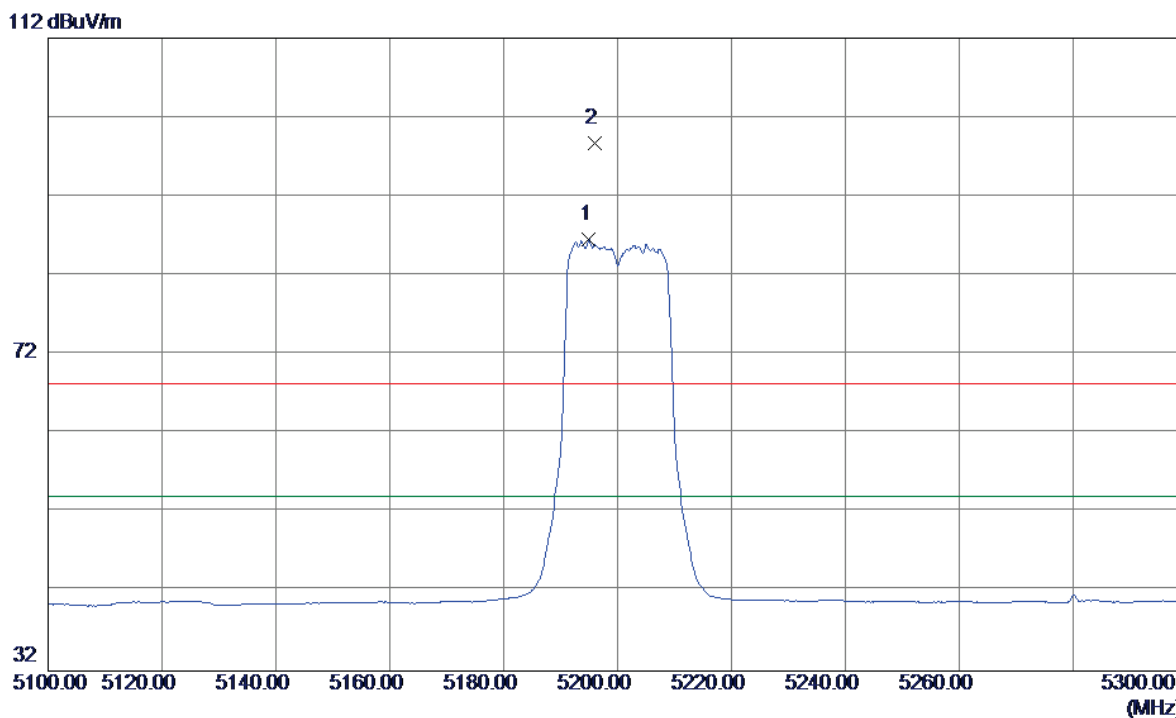

No.	Freq. MHz	Reading Level dBuV/m	Correct Factor dB	Measure ment dBuV/m	Limit dBuV/m	Over dB	Detector	Comment
1	5195.0000	46.18	40.31	86.49	54.00	32.49	AVG	No Limit
2	5196.0000	58.36	40.32	98.68	68.30	30.38	Peak	No Limit

Orthogonal Axis:	X
Test Mode:	UNII-1/ TX AC20 Mode 5200MHz - External antenna

Horizontal

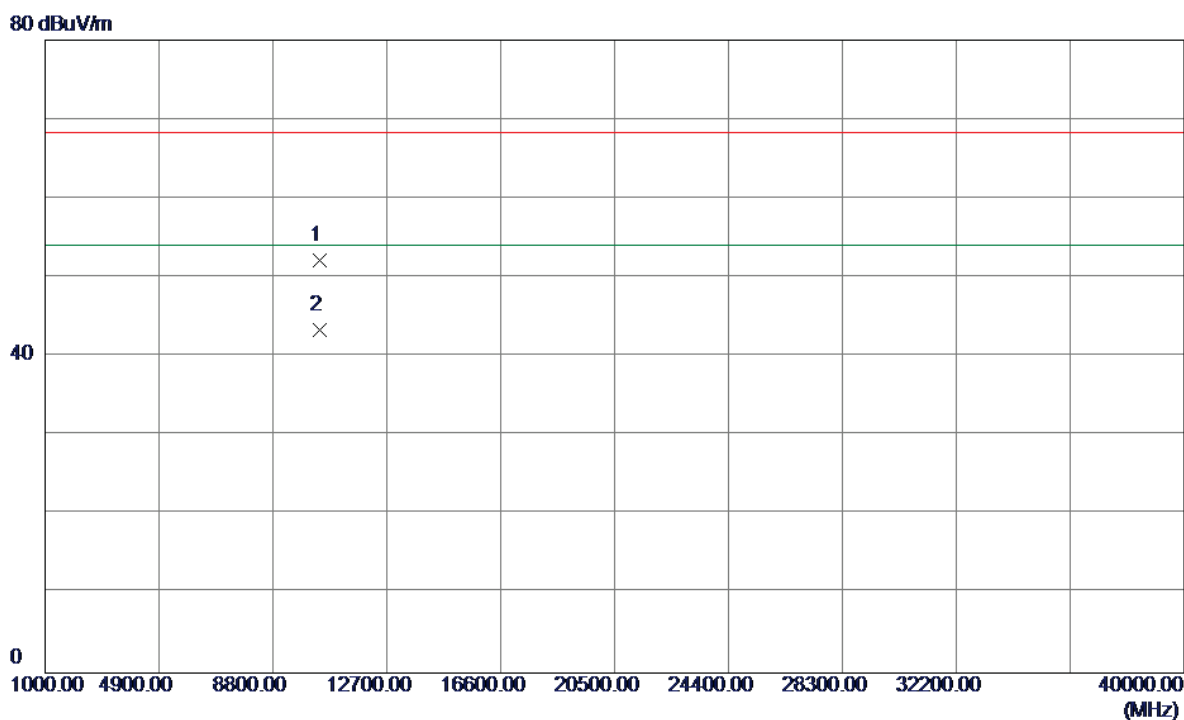

No.	Freq. MHz	Reading Level dBuV/m	Correct Factor dB	Measure ment dBuV/m	Limit dBuV/m	Over dB	Detector	Comment
1	10400.1500	38.29	13.80	52.09	68.30	-16.21	Peak	
2	10400.1900	29.62	13.80	43.42	54.00	-10.58	AVG	

Orthogonal Axis:	X
Test Mode:	UNII-1/ TX AC20 Mode 5240MHz - External antenna

Vertical

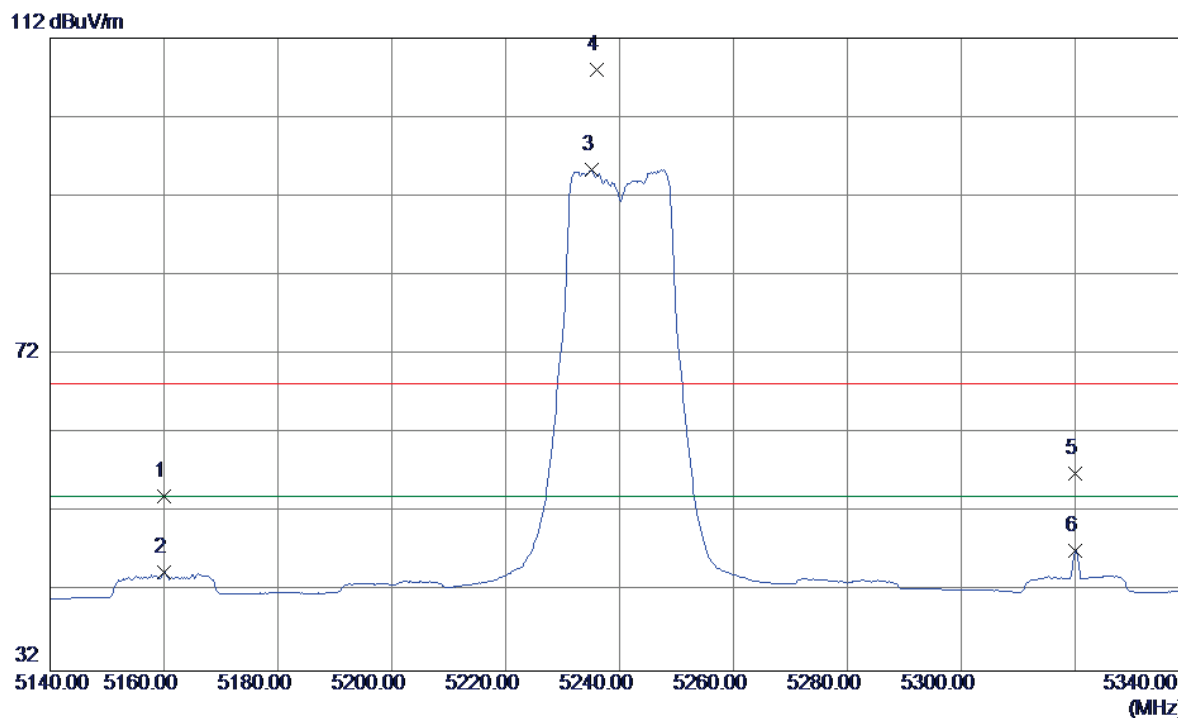

No.	Freq. MHz	Reading Level dBuV/m	Correct Factor dB	Measure ment dBuV/m	Limit dBuV/m	Over dB	Detector	Comment
1	5160.0000	13.85	40.24	54.09	68.30	-14.21	Peak	
2	5160.0000	4.30	40.24	44.54	54.00	-9.46	AVG	
3	5235.2000	54.95	40.40	95.35	54.00	41.35	AVG	No Limit
4	5236.0000	67.65	40.40	108.05	68.30	39.75	Peak	No Limit
5	5320.0000	16.36	40.58	56.94	68.30	-11.36	Peak	
6	5320.0000	6.62	40.58	47.20	54.00	-6.80	AVG	

Orthogonal Axis:	X
Test Mode:	UNII-1/ TX AC20 Mode 5240MHz - External antenna

Vertical

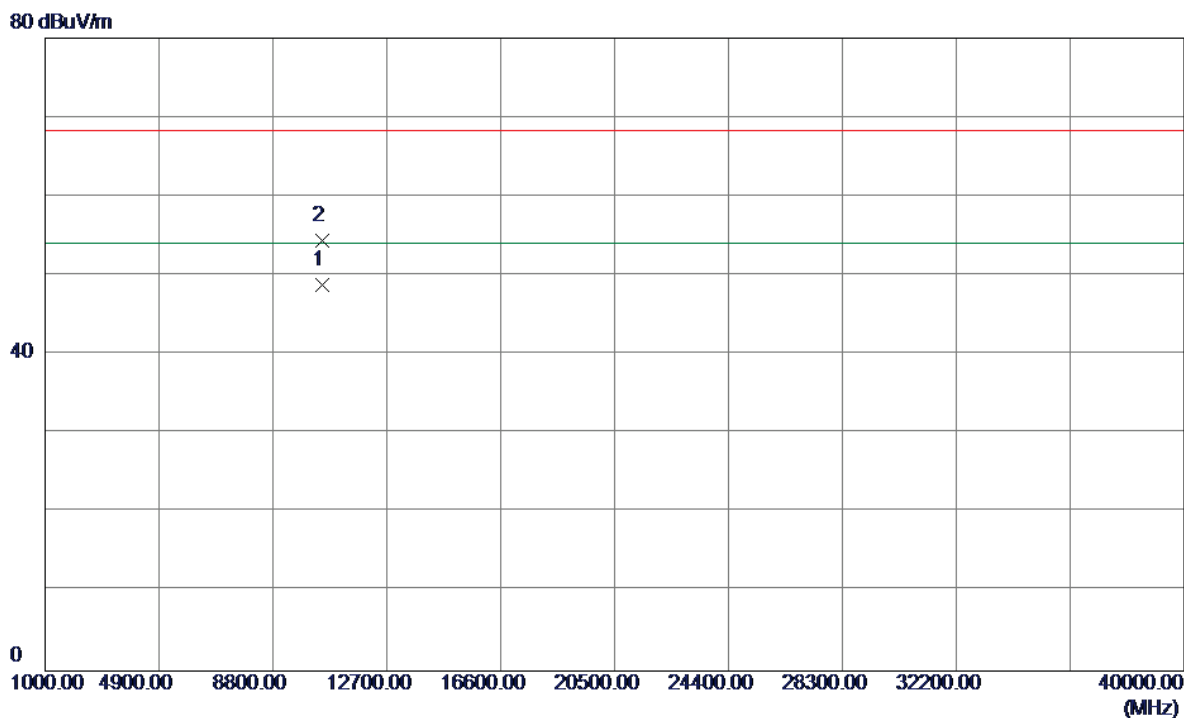

No.	Freq. MHz	Reading Level dBuV/m	Correct Factor dB	Measure ment dBuV/m	Limit dBuV/m	Over dB	Detector	Comment
1	10480.1900	35.17	13.69	48.86	54.00	-5.14	AVG	
2	10480.2800	40.71	13.69	54.40	68.30	-13.90	Peak	

Orthogonal Axis:	X
Test Mode:	UNII-1/ TX AC20 Mode 5240MHz - External antenna

Horizontal

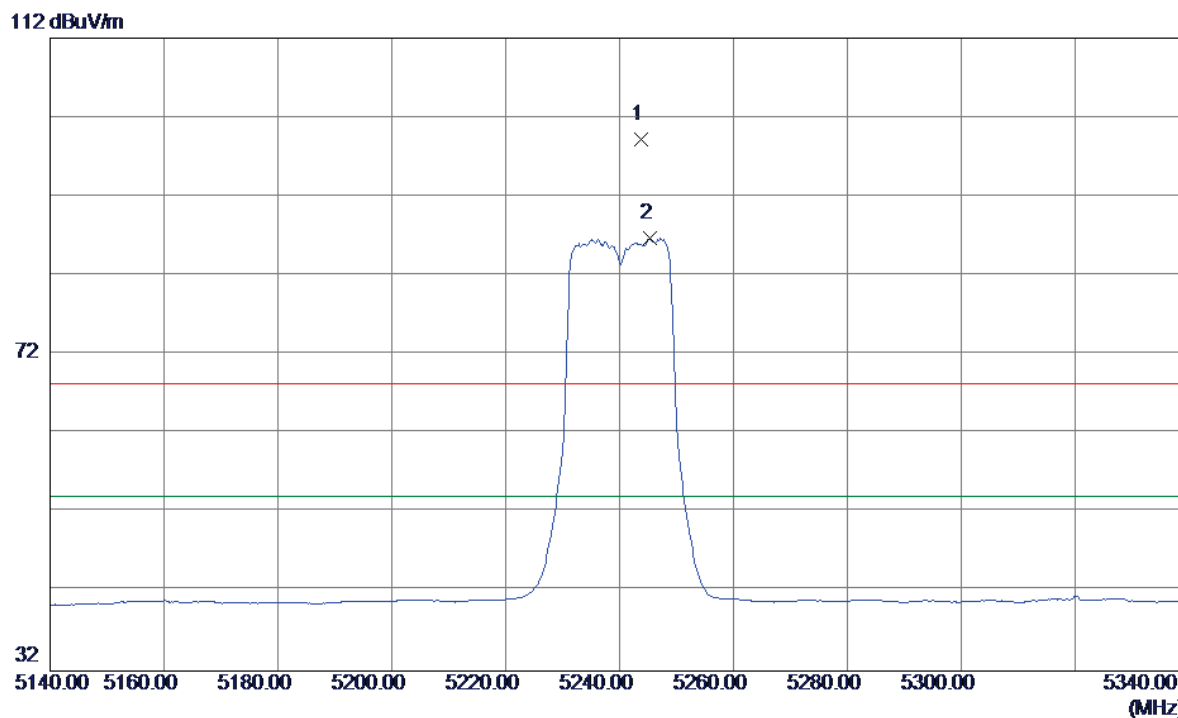

No.	Freq. MHz	Reading Level dBuV/m	Correct Factor dB	Measure ment dBuV/m	Limit dBuV/m	Over dB	Detector	Comment
1	5243.8000	58.73	40.42	99.15	68.30	30.85	Peak	No Limit
2	5245.4000	46.33	40.42	86.75	54.00	32.75	AVG	No Limit

Orthogonal Axis:	X
Test Mode:	UNII-1/ TX AC20 Mode 5240MHz - External antenna

Horizontal

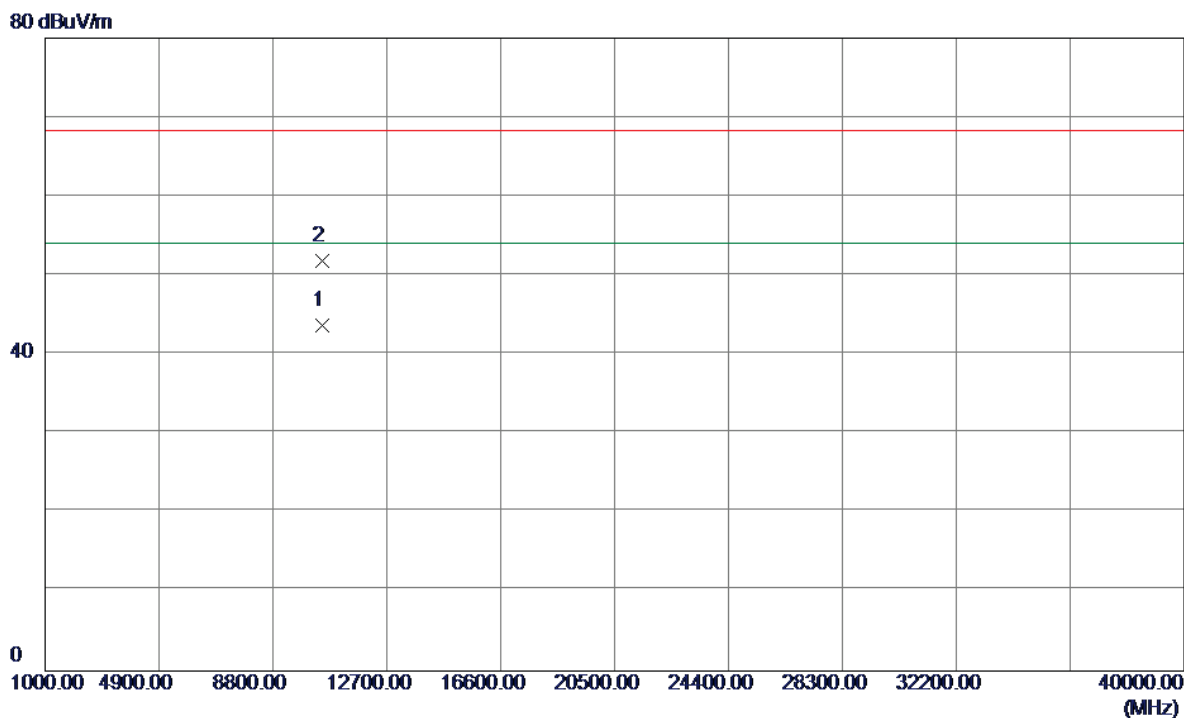

No.	Freq. MHz	Reading Level dBuV/m	Correct Factor dB	Measure ment dBuV/m	Limit dBuV/m	Over dB	Detector	Comment
1	10480.1800	29.98	13.69	43.67	54.00	-10.33	AVG	
2	10480.2699	38.17	13.69	51.86	68.30	-16.44	Peak	

Orthogonal Axis:	X
Test Mode:	UNII-1/ TX AC40 Mode 5190MHz - External antenna

Vertical

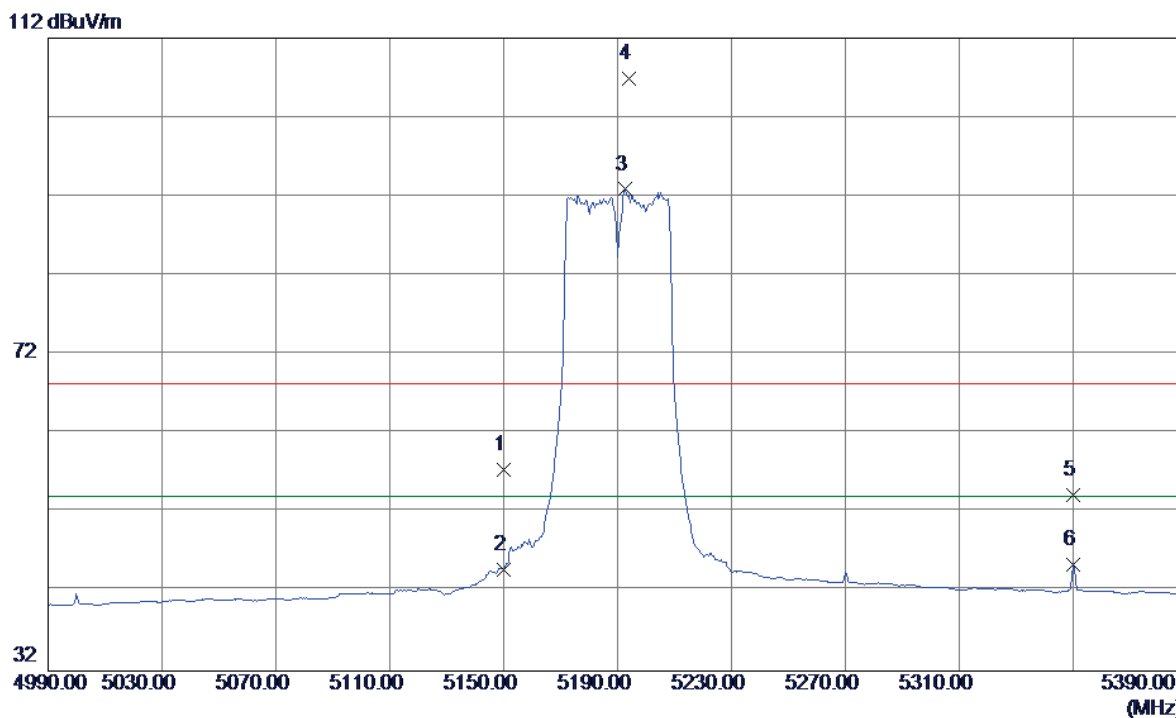

No.	Freq. MHz	Reading Level dBuV/m	Correct Factor dB	Measure ment dBuV/m	Limit dBuV/m	Over dB	Detector	Comment
1	5150.0000	17.28	40.22	57.50	68.30	-10.80	Peak	
2	5150.0000	4.62	40.22	44.84	54.00	-9.16	AVG	
3	5192.8000	52.57	40.31	92.88	54.00	38.88	AVG	No Limit
4	5194.0000	66.59	40.31	106.90	68.30	38.60	Peak	No Limit
5	5350.0000	13.63	40.64	54.27	68.30	-14.03	Peak	
6	5350.0000	4.76	40.64	45.40	54.00	-8.60	AVG	

Orthogonal Axis:	X
Test Mode:	UNII-1/ TX AC40 Mode 5190MHz - External antenna

Vertical

80 dBuV/m

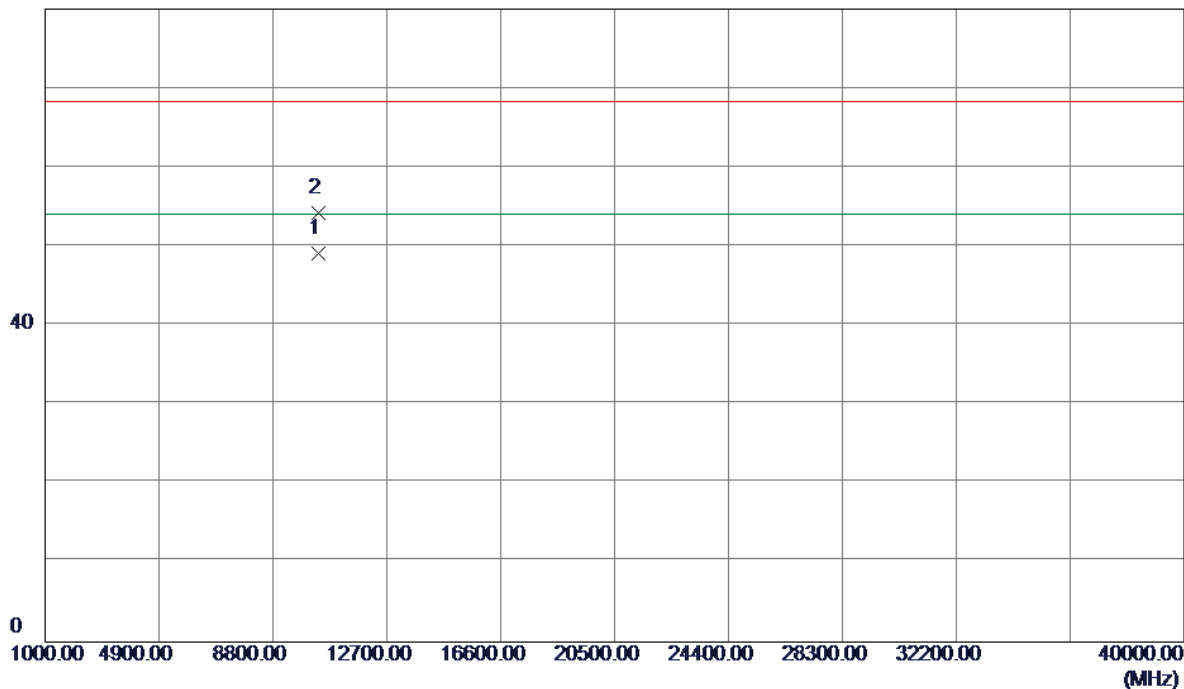

No.	Freq. MHz	Reading Level dBuV/m	Correct Factor dB	Measure ment dBuV/m	Limit dBuV/m	Over dB	Detector	Comment
1	10380.1900	35.31	13.83	49.14	54.00	-4.86	AVG	
2	10380.2000	40.48	13.83	54.31	68.30	-13.99	Peak	

Orthogonal Axis:	X
Test Mode:	UNII-1/ TX AC40 Mode 5190MHz - External antenna

Horizontal

112 dBuV/m

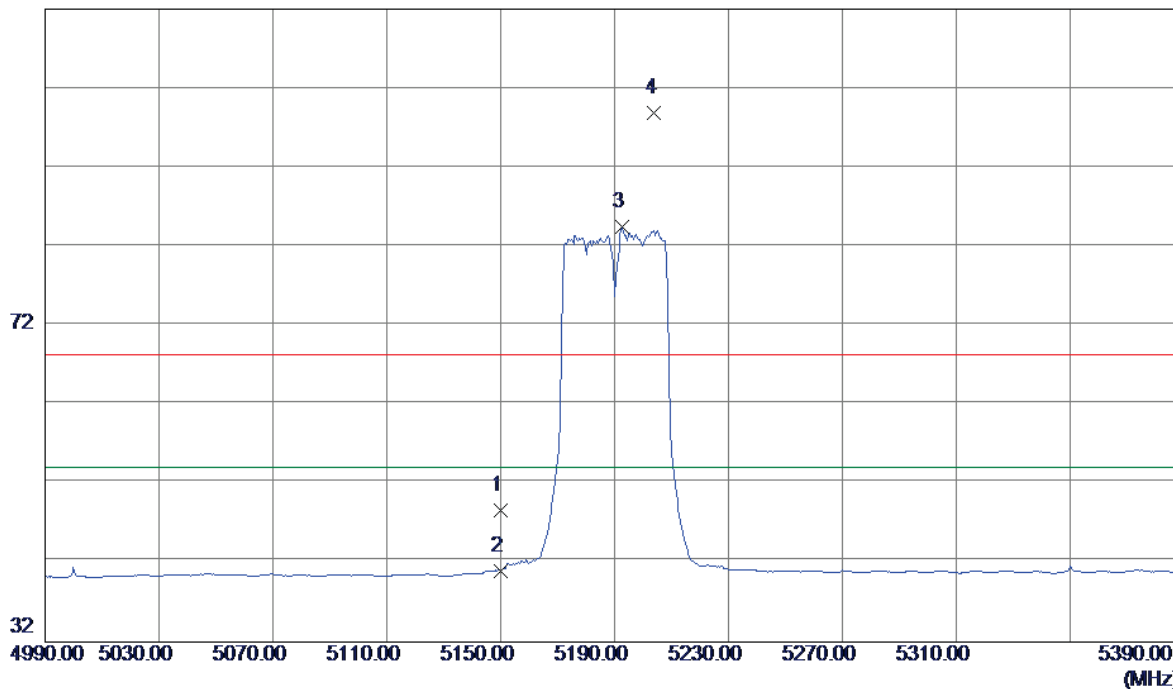

No.	Freq. MHz	Reading Level dBuV/m	Correct Factor dB	Measure ment dBuV/m	Limit dBuV/m	Over dB	Detector	Comment
1	5150.0000	8.39	40.22	48.61	68.30	-19.69	Peak	
2	5150.0000	0.77	40.22	40.99	54.00	-13.01	AVG	
3	5192.8000	44.14	40.31	84.45	54.00	30.45	AVG	No Limit
4	5204.0000	58.55	40.33	98.88	68.30	30.58	Peak	No Limit

Orthogonal Axis:	X
Test Mode:	UNII-1/ TX AC40 Mode 5190MHz - External antenna

Horizontal

80 dBuV/m

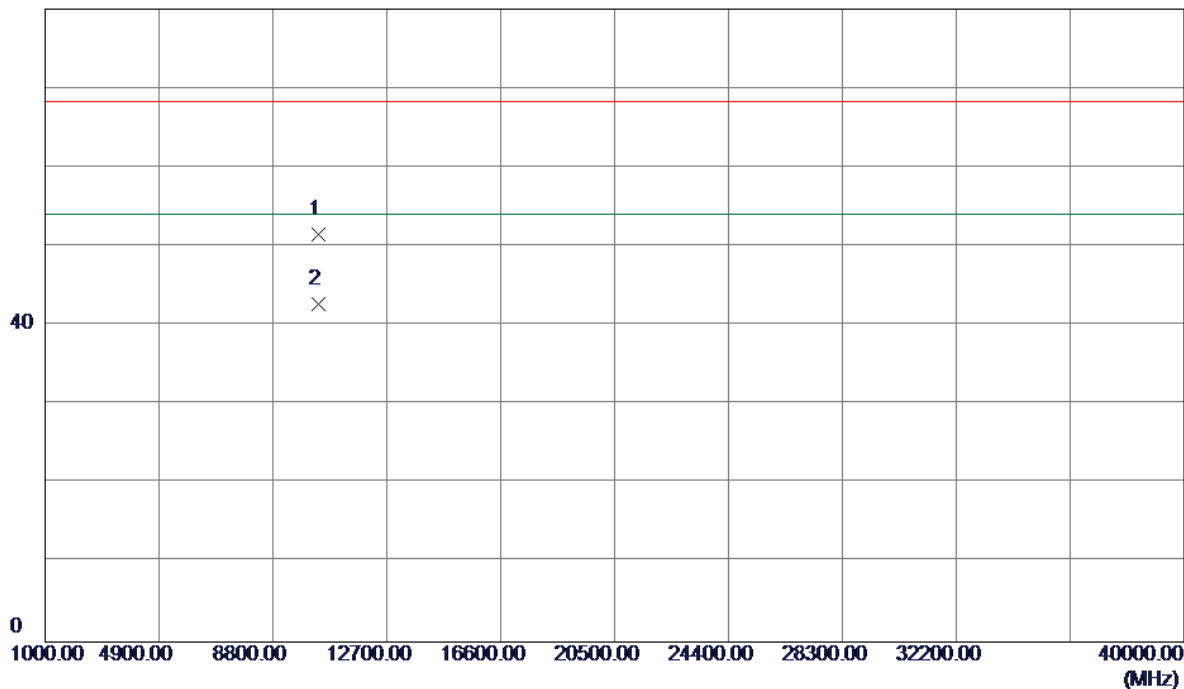

No.	Freq. MHz	Reading Level dBuV/m	Correct Factor dB	Measure ment dBuV/m	Limit dBuV/m	Over dB	Detector	Comment
1	10380.1200	37.65	13.83	51.48	68.30	-16.82	Peak	
2	10380.1900	28.90	13.83	42.73	54.00	-11.27	AVG	

Orthogonal Axis:	X
Test Mode:	UNII-1/ TX AC40 Mode 5230MHz - External antenna

Vertical

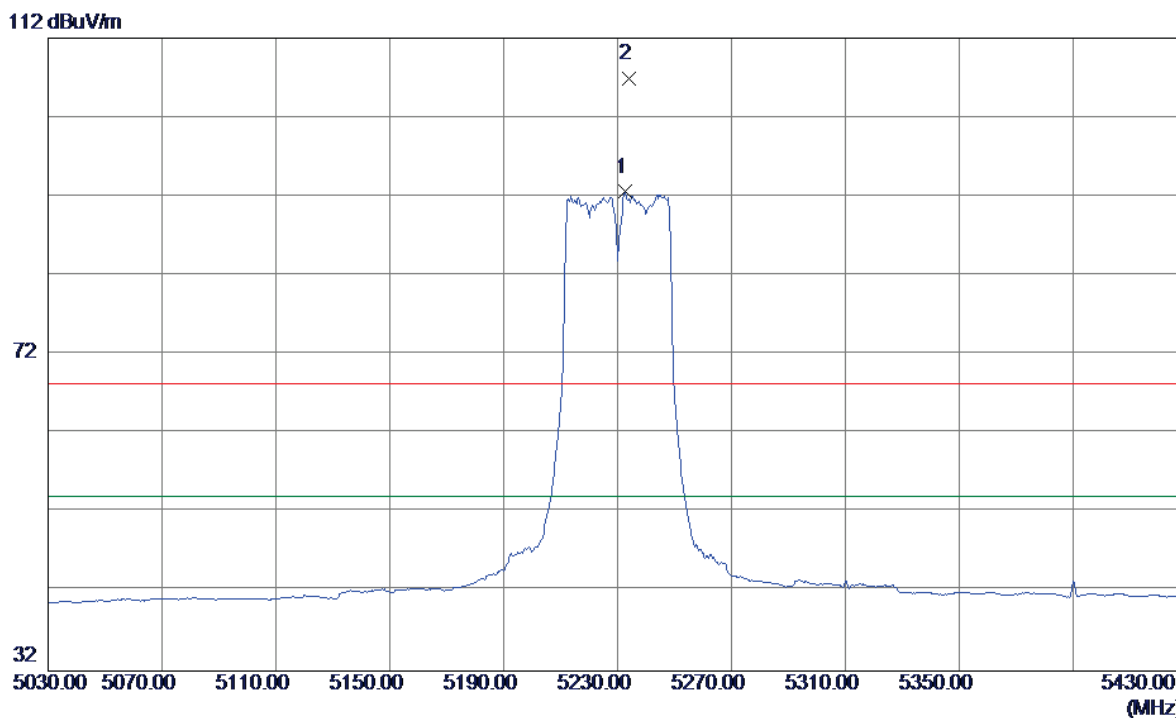

No.	Freq. MHz	Reading Level dBuV/m	Correct Factor dB	Measure ment dBuV/m	Limit dBuV/m	Over dB	Detector	Comment
1	5232.8000	52.17	40.39	92.56	54.00	38.56	AVG	No Limit
2	5234.0000	66.55	40.40	106.95	68.30	38.65	Peak	No Limit

Orthogonal Axis:	X
Test Mode:	UNII-1/ TX AC40 Mode 5230MHz - External antenna

Vertical

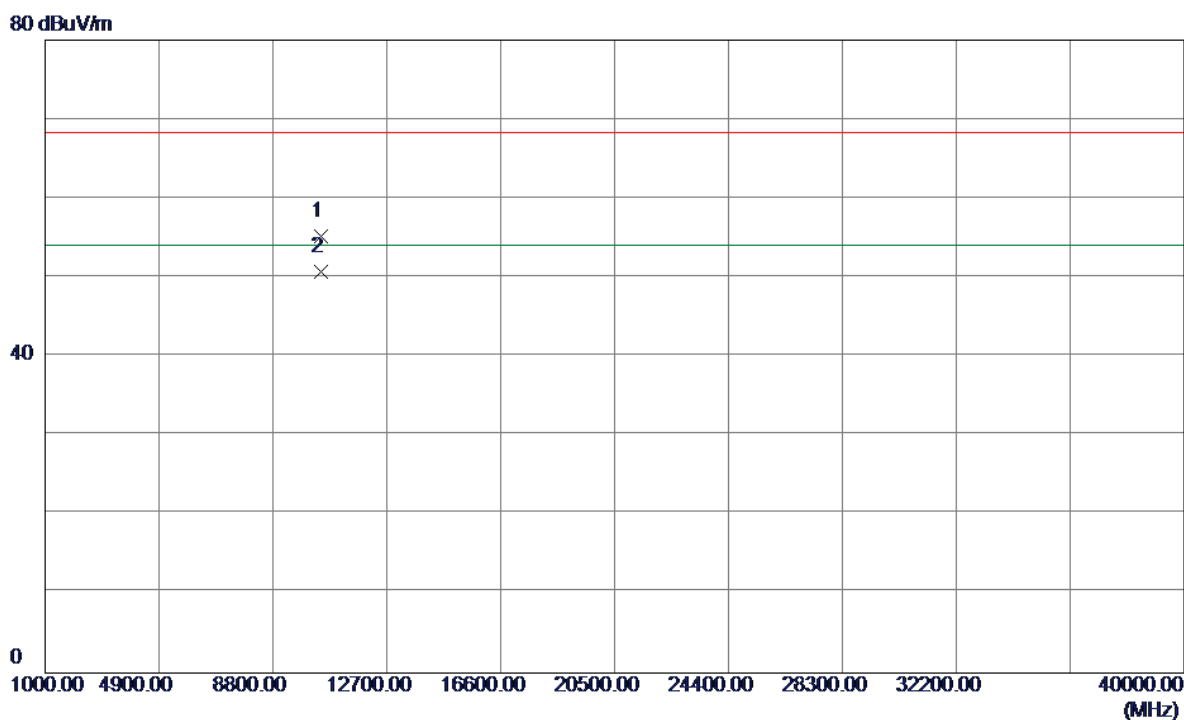

No.	Freq. MHz	Reading Level dBuV/m	Correct Factor dB	Measure ment dBuV/m	Limit dBuV/m	Over dB	Detector	Comment
1	10460.1000	41.54	13.72	55.26	68.30	-13.04	Peak	
2	10460.2000	36.98	13.72	50.70	54.00	-3.30	AVG	

Orthogonal Axis:	X
Test Mode:	UNII-1/ TX AC40 Mode 5230MHz - External antenna

Horizontal

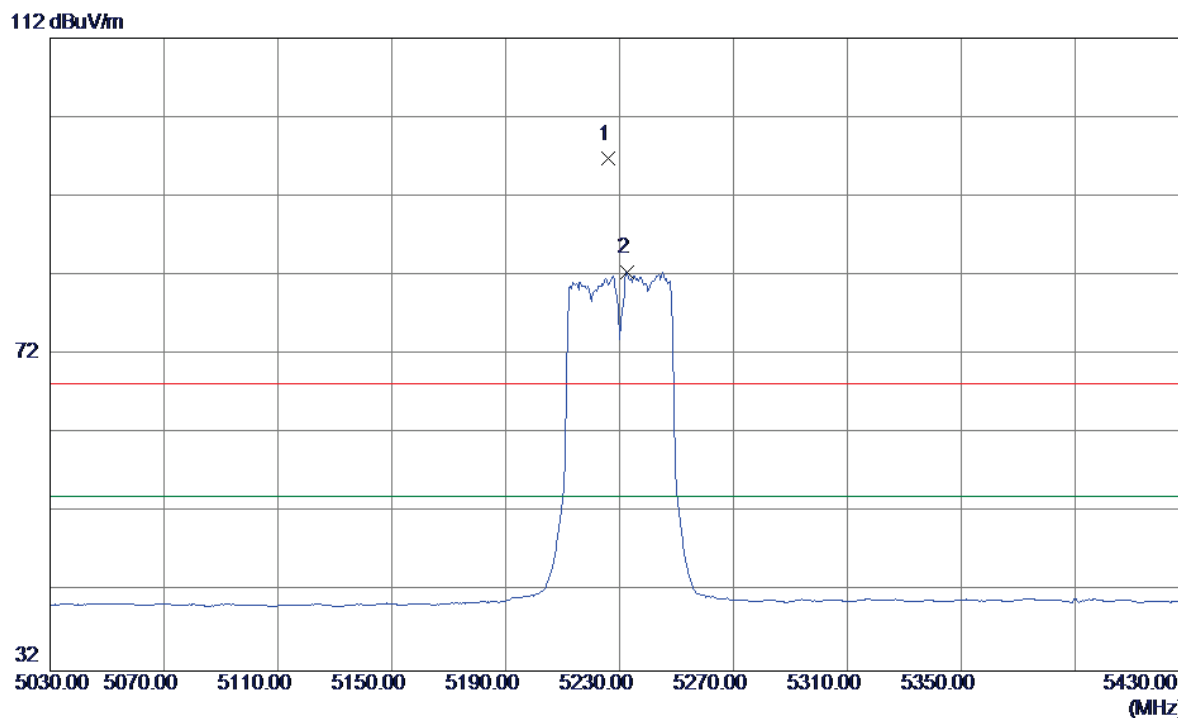

No.	Freq. MHz	Reading Level dBuV/m	Correct Factor dB	Measure ment dBuV/m	Limit dBuV/m	Over dB	Detector	Comment
1	5226.0000	56.34	40.38	96.72	68.30	28.42	Peak	No Limit
2	5232.8000	41.99	40.39	82.38	54.00	28.38	AVG	No Limit

Orthogonal Axis:	X
Test Mode:	UNII-1/ TX AC40 Mode 5230MHz - External antenna

Horizontal

80 dBuV/m

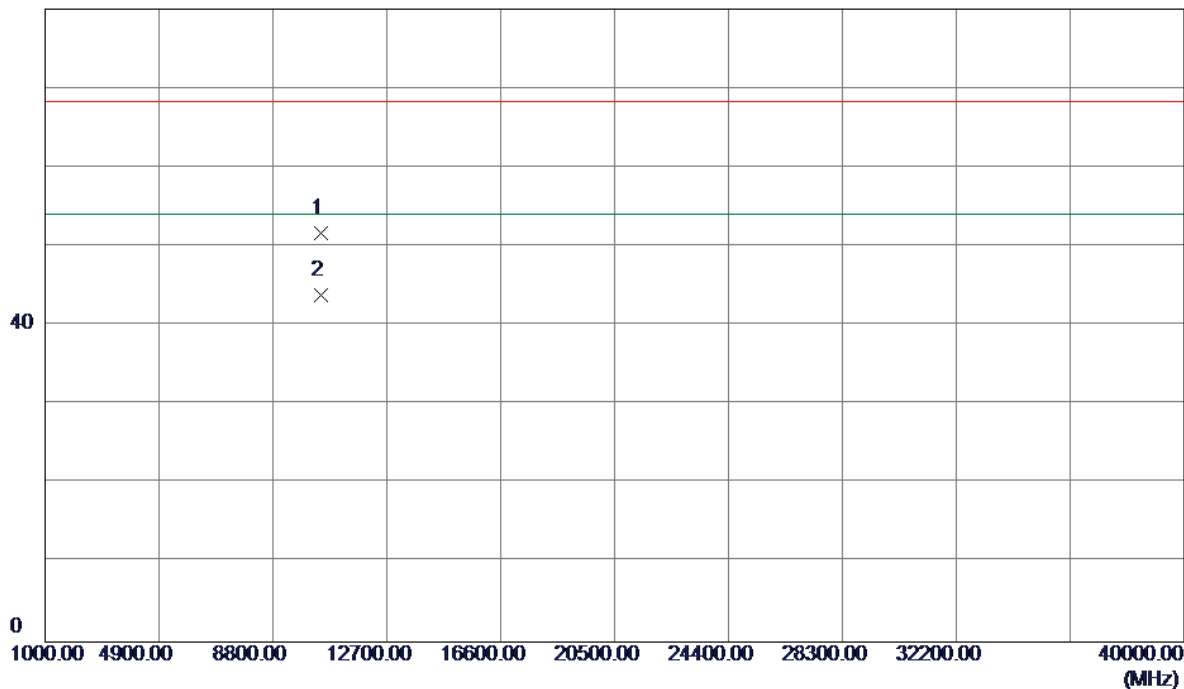

No.	Freq. MHz	Reading Level dBuV/m	Correct Factor dB	Measure ment dBuV/m	Limit dBuV/m	Over dB	Detector	Comment
1	10460.0900	37.90	13.72	51.62	68.30	-16.68	Peak	
2	10460.2100	30.06	13.72	43.78	54.00	-10.22	AVG	

Orthogonal Axis:	X
Test Mode:	UNII-1/ TX AC80 Mode 5210MHz - External antenna

Vertical

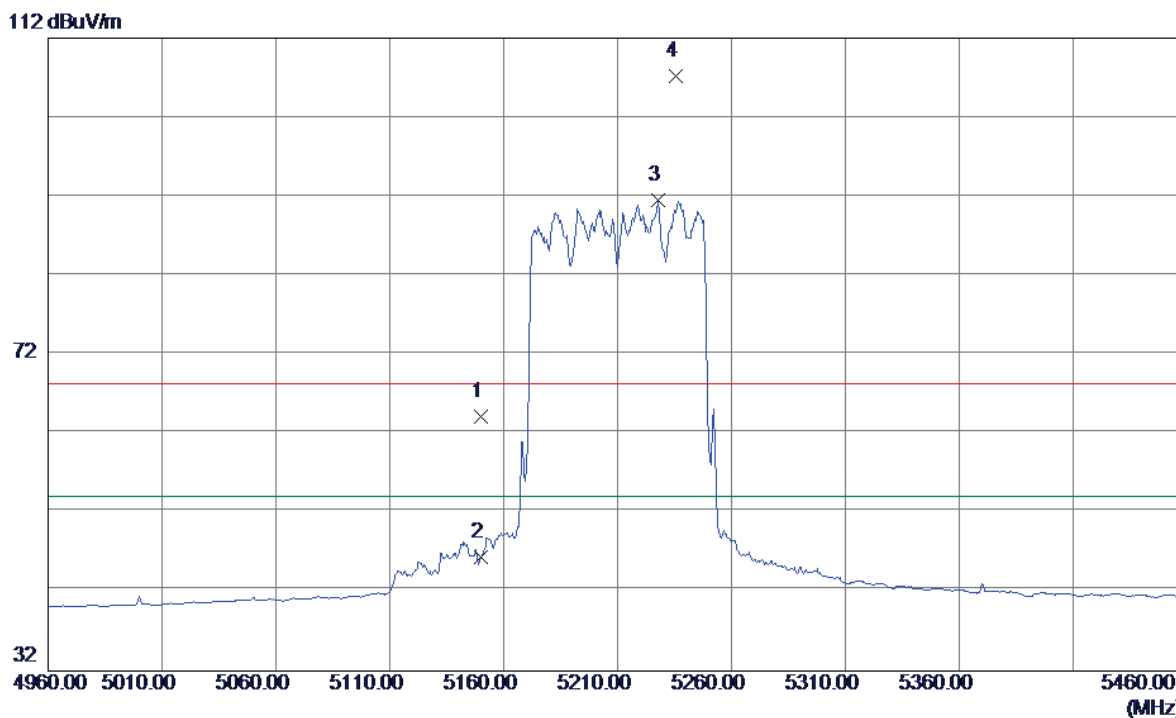

No.	Freq. MHz	Reading Level dBuV/m	Correct Factor dB	Measure ment dBuV/m	Limit dBuV/m	Over dB	Detector	Comment
1	5150.0000	23.91	40.22	64.13	68.30	-4.17	Peak	
2	5150.0000	6.14	40.22	46.36	54.00	-7.64	AVG	
3	5228.0000	51.07	40.38	91.45	54.00	37.45	AVG	No Limit
4	5235.5000	66.75	40.40	107.15	68.30	38.85	Peak	No Limit

Orthogonal Axis:	X
Test Mode:	UNII-1/ TX AC80 Mode 5210MHz - External antenna

Vertical

80 dBuV/m

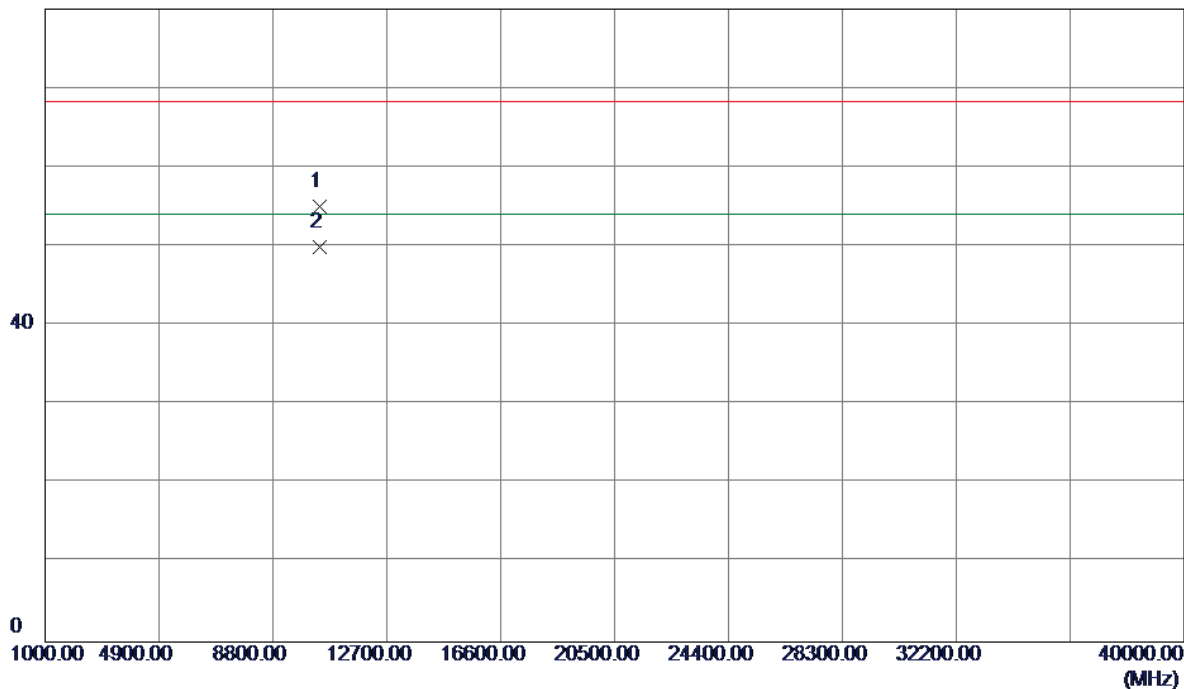

No.	Freq. MHz	Reading Level dBuV/m	Correct Factor dB	Measure ment dBuV/m	Limit dBuV/m	Over dB	Detector	Comment
1	10420.1200	41.31	13.77	55.08	68.30	-13.22	Peak	
2	10420.1900	36.18	13.77	49.95	54.00	-4.05	AVG	

Orthogonal Axis:	X
Test Mode:	UNII-1/ TX AC80 Mode 5210MHz - External antenna

Horizontal

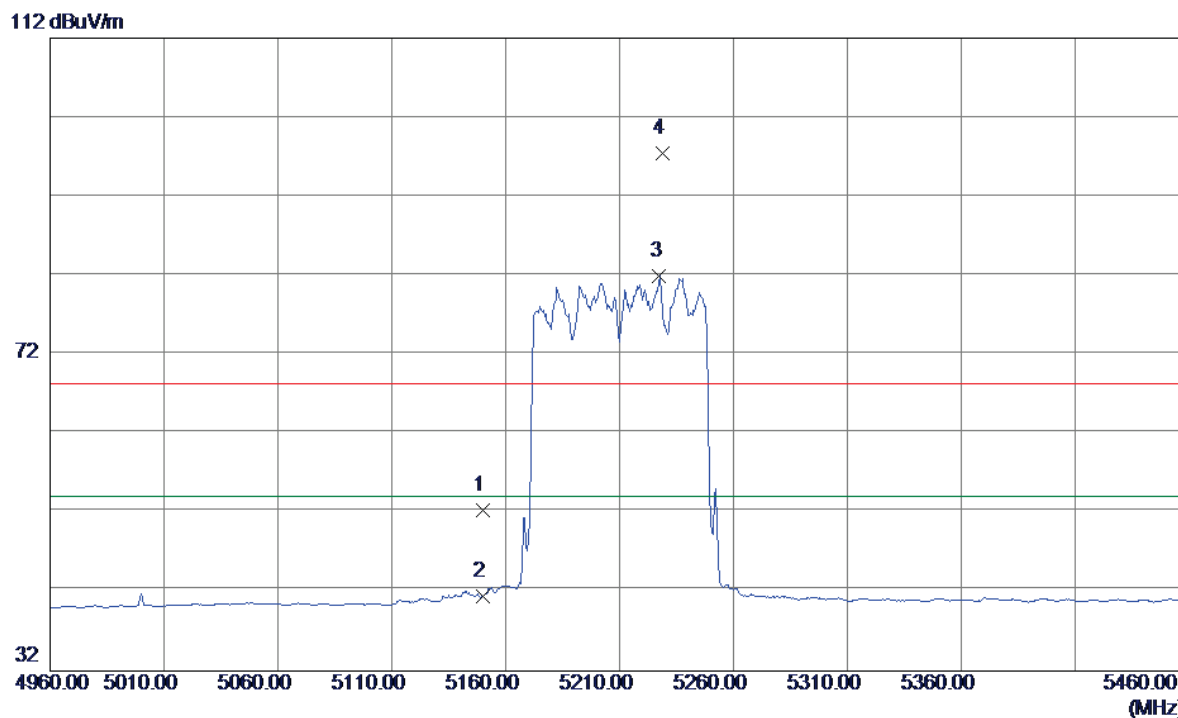

No.	Freq. MHz	Reading Level dBuV/m	Correct Factor dB	Measure ment dBuV/m	Limit dBuV/m	Over dB	Detector	Comment
1	5150.0000	12.05	40.22	52.27	68.30	-16.03	Peak	
2	5150.0000	1.24	40.22	41.46	54.00	-12.54	AVG	
3	5227.5000	41.51	40.38	81.89	54.00	27.89	AVG	No Limit
4	5229.0000	57.13	40.39	97.52	68.30	29.22	Peak	No Limit

Orthogonal Axis:	X
Test Mode:	UNII-1/ TX AC80 Mode 5210MHz - External antenna

Horizontal

80 dBuV/m

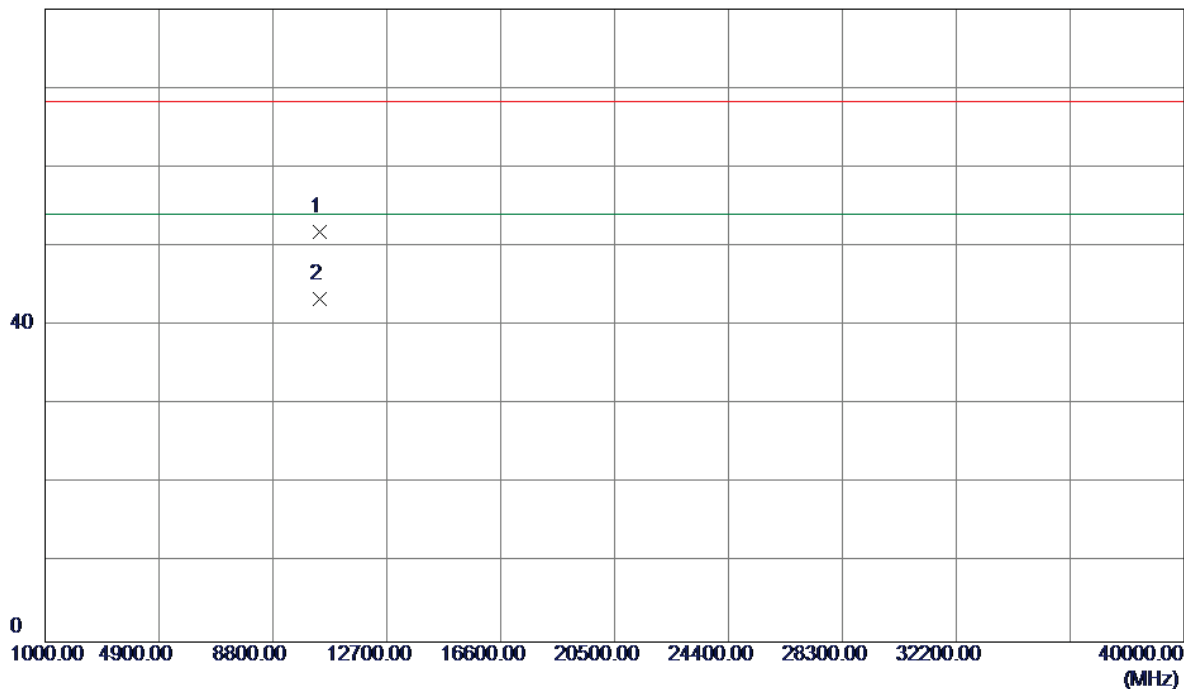

No.	Freq. MHz	Reading Level dBuV/m	Correct Factor dB	Measure ment dBuV/m	Limit dBuV/m	Over dB	Detector	Comment
1	10420.0500	38.02	13.77	51.79	68.30	-16.51	Peak	
2	10420.1900	29.59	13.77	43.36	54.00	-10.64	AVG	

Orthogonal Axis:	X
Test Mode:	UNII-3/TX AC20 Mode 5745MHz - External antenna

Vertical

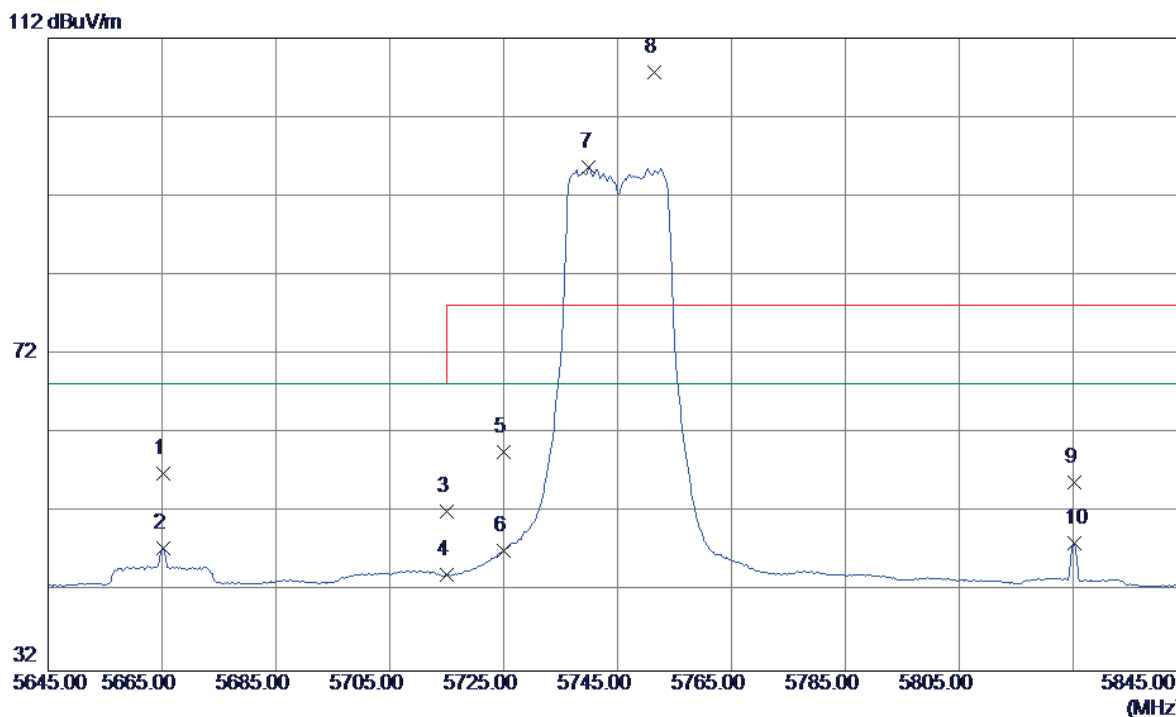

No.	Freq. MHz	Reading Level dBuV/m	Correct Factor dB	Measure ment dBuV/m	Limit dBuV/m	Over dB	Detector	Comment
1	5665.2000	15.78	41.18	56.96	68.30	-11.34	Peak	
2	5665.2000	6.39	41.18	47.57	68.30	-20.73	AVG	
3	5715.0000	10.94	41.25	52.19	68.30	-16.11	Peak	
4	5715.0000	2.90	41.25	44.15	68.30	-24.15	AVG	
5	5725.0000	18.42	41.27	59.69	78.30	-18.61	Peak	
6	5725.0000	5.96	41.27	47.23	68.30	-21.07	AVG	
7	5740.0000	54.40	41.29	95.69	68.30	27.39	AVG	No Limit
8	5751.4000	66.42	41.30	107.72	78.30	29.42	Peak	No Limit
9	5825.2000	14.47	41.40	55.87	78.30	-22.43	Peak	
10	5825.2000	6.69	41.40	48.09	68.30	-20.21	AVG	

Orthogonal Axis:	X
Test Mode:	UNII-3/TX AC20 Mode 5745MHz - External antenna

Vertical

80 dBuV/m

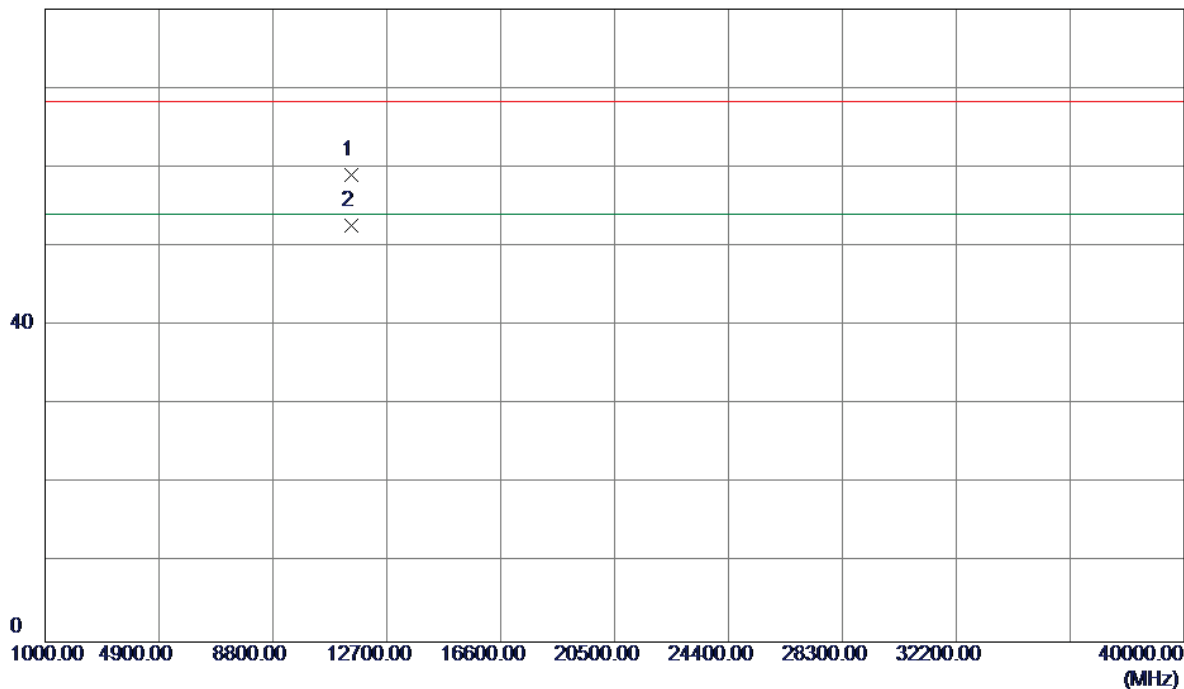

No.	Freq. MHz	Reading Level dBuV/m	Correct Factor dB	Measure ment dBuV/m	Limit dBuV/m	Over dB	Detector	Comment
1	11490.1700	42.16	16.91	59.07	68.30	-9.23	Peak	
2	11490.3300	35.76	16.91	52.67	54.00	-1.33	AVG	

Orthogonal Axis:	X
Test Mode:	UNII-3/TX AC20 Mode 5745MHz - External antenna

Horizontal

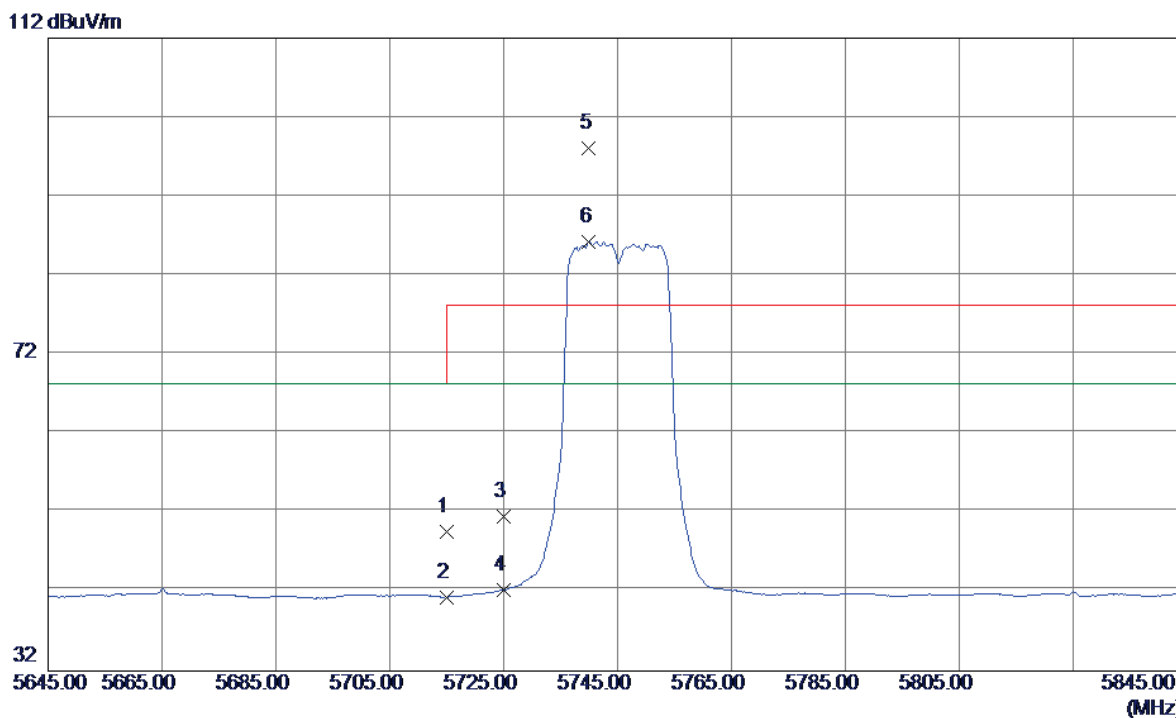

No.	Freq. MHz	Reading Level dBuV/m	Correct Factor dB	Measure ment dBuV/m	Limit dBuV/m	Over dB	Detector	Comment
1	5715.0000	8.37	41.25	49.62	68.30	-18.68	Peak	
2	5715.0000	0.09	41.25	41.34	68.30	-26.96	AVG	
3	5725.0000	10.18	41.27	51.45	78.30	-26.85	Peak	
4	5725.0000	0.98	41.27	42.25	68.30	-26.05	AVG	
5	5740.0000	56.79	41.29	98.08	78.30	19.78	Peak	No Limit
6	5740.0000	45.02	41.29	86.31	68.30	18.01	AVG	No Limit

Orthogonal Axis:	X
Test Mode:	UNII-3/TX AC20 Mode 5745MHz - External antenna

Horizontal

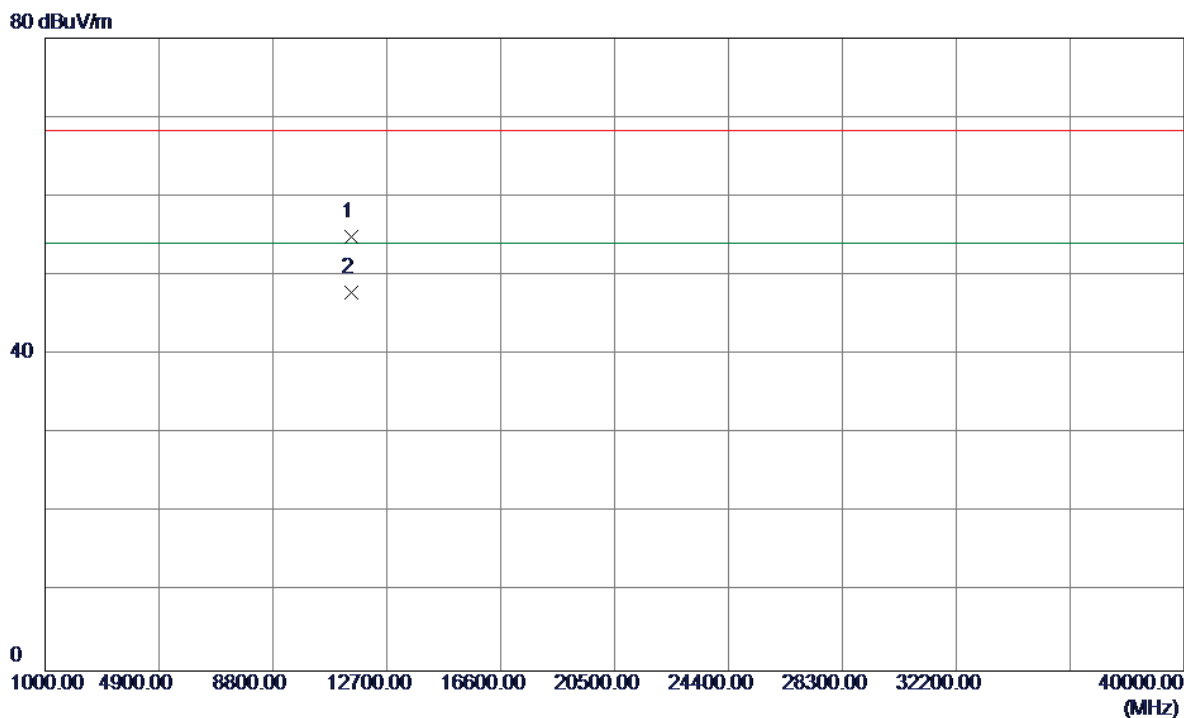

No.	Freq. MHz	Reading Level dBuV/m	Correct Factor dB	Measure ment dBuV/m	Limit dBuV/m	Over dB	Detector	Comment
1	11490.1300	37.96	16.91	54.87	68.30	-13.43	Peak	
2	11490.2100	31.00	16.91	47.91	54.00	-6.09	AVG	

Orthogonal Axis:	X
Test Mode:	UNII-3/TX AC20 Mode 5785MHz - External antenna

Vertical

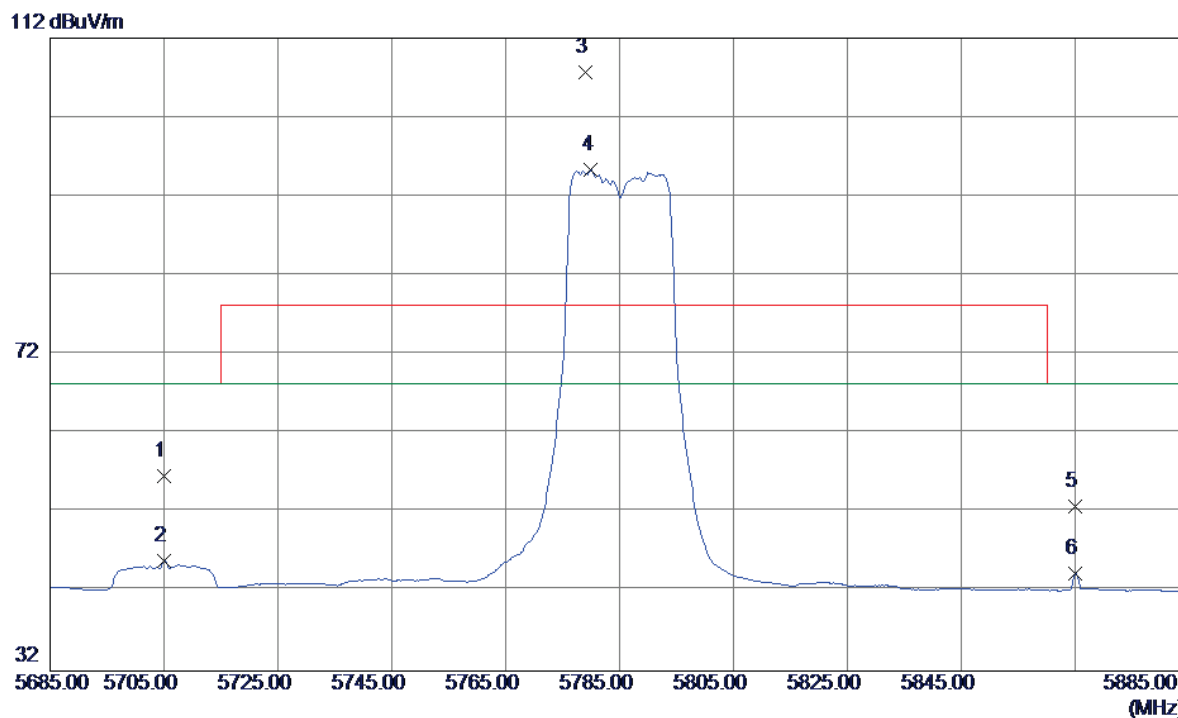

No.	Freq. MHz	Reading Level dBuV/m	Correct Factor dB	Measure ment dBuV/m	Limit dBuV/m	Over dB	Detector	Comment
1	5705.0000	15.39	41.24	56.63	68.30	-11.67	Peak	
2	5705.0000	4.68	41.24	45.92	68.30	-22.38	AVG	
3	5779.0000	66.35	41.34	107.69	78.30	29.39	Peak	No Limit
4	5780.0000	53.95	41.34	95.29	68.30	26.99	AVG	No Limit
5	5865.0000	11.41	41.46	52.87	68.30	-15.43	Peak	
6	5865.0000	2.86	41.46	44.32	68.30	-23.98	AVG	

Orthogonal Axis:	X
Test Mode:	UNII-3/TX AC20 Mode 5785MHz - External antenna

Vertical

80 dBuV/m

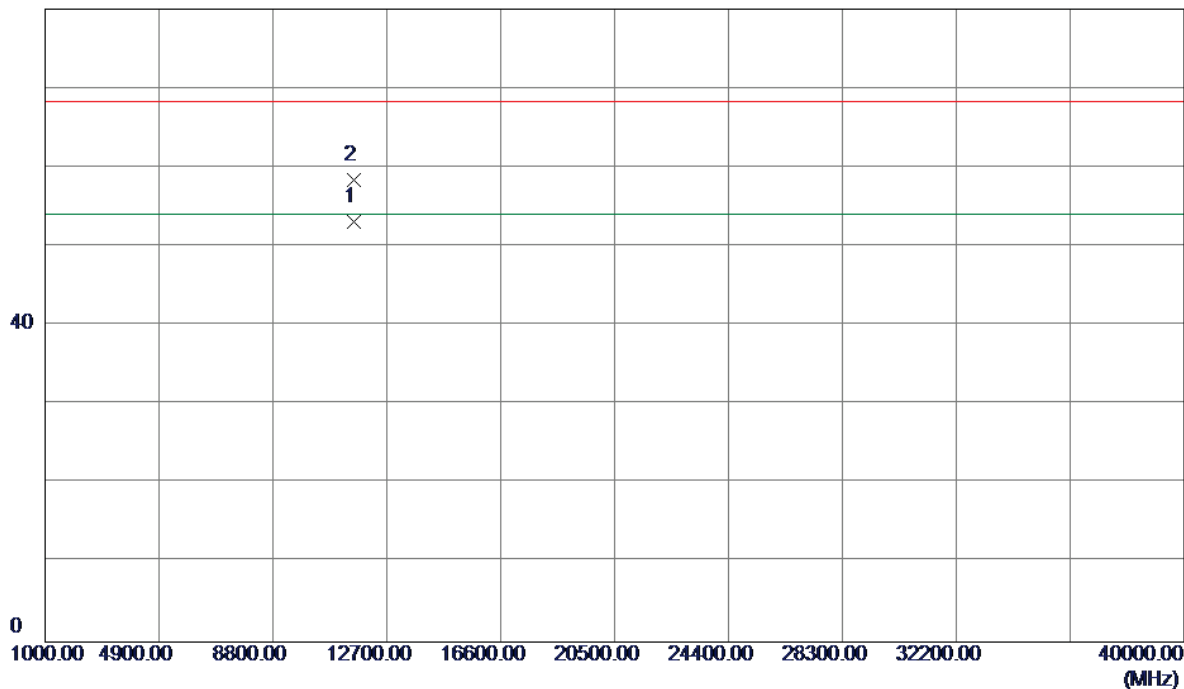

No.	Freq. MHz	Reading Level dBuV/m	Correct Factor dB	Measure ment dBuV/m	Limit dBuV/m	Over dB	Detector	Comment
1	11570.2200	36.09	17.05	53.14	54.00	-0.86	AVG	
2	11570.3000	41.32	17.05	58.37	68.30	-9.93	Peak	

Orthogonal Axis:	X
Test Mode:	UNII-3/TX AC20 Mode 5785MHz - External antenna

Horizontal

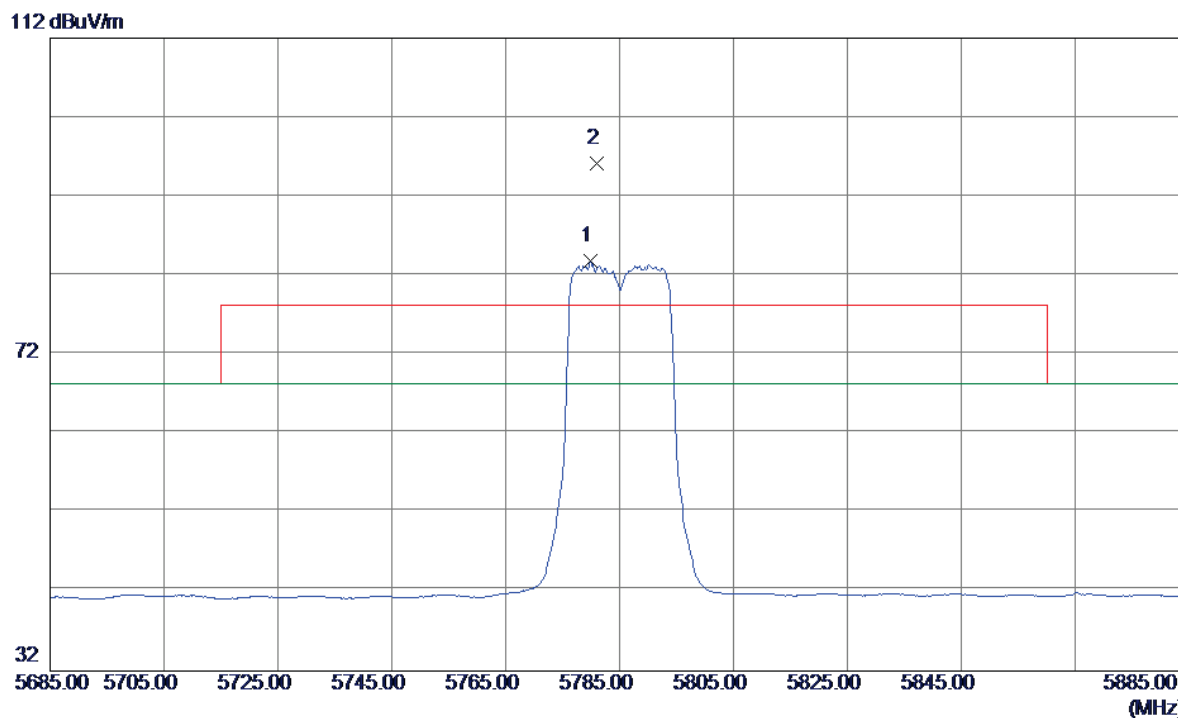

No.	Freq. MHz	Reading Level dBuV/m	Correct Factor dB	Measure ment dBuV/m	Limit dBuV/m	Over dB	Detector	Comment
1	5779.8000	42.48	41.34	83.82	68.30	15.52	AVG	No Limit
2	5781.0000	54.75	41.34	96.09	78.30	17.79	Peak	No Limit

Orthogonal Axis:	X
Test Mode:	UNII-3/TX AC20 Mode 5785MHz - External antenna

Horizontal

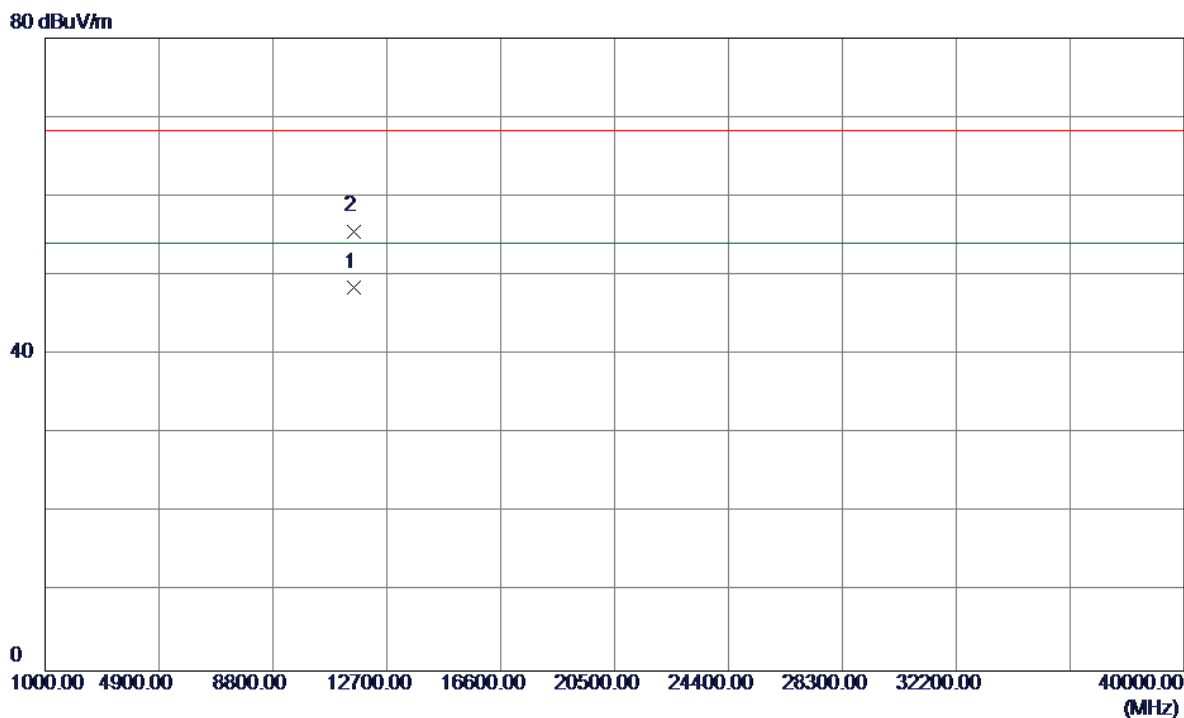

No.	Freq. MHz	Reading Level dBuV/m	Correct Factor dB	Measure ment dBuV/m	Limit dBuV/m	Over dB	Detector	Comment
1	11570.2200	31.46	17.05	48.51	54.00	-5.49	AVG	
2	11570.2500	38.55	17.05	55.60	68.30	-12.70	Peak	

Orthogonal Axis:	X
Test Mode:	UNII-3/TX AC20 Mode 5825MHz - External antenna

Vertical

112 dBuV/m

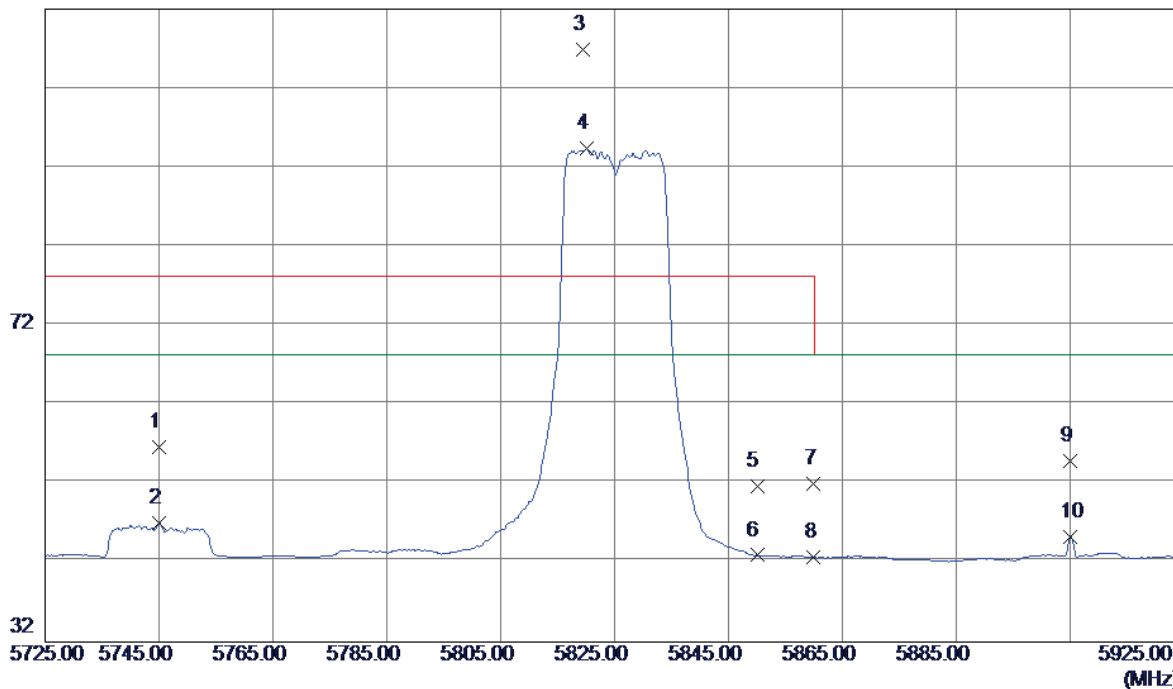

No.	Freq. MHz	Reading Level dBuV/m	Correct Factor dB	Measure ment dBuV/m	Limit dBuV/m	Over dB	Detector	Comment
1	5745.0000	15.40	41.29	56.69	78.30	-21.61	Peak	
2	5745.0000	5.81	41.29	47.10	68.30	-21.20	AVG	
3	5819.4000	65.47	41.39	106.86	78.30	28.56	Peak	No Limit
4	5820.2000	52.99	41.40	94.39	68.30	26.09	AVG	No Limit
5	5850.0000	10.23	41.44	51.67	78.30	-26.63	Peak	
6	5850.0000	1.52	41.44	42.96	68.30	-25.34	AVG	
7	5860.0000	10.58	41.45	52.03	78.30	-26.27	Peak	
8	5860.0000	1.25	41.45	42.70	68.30	-25.60	AVG	
9	5905.0000	13.37	41.51	54.88	68.30	-13.42	Peak	
10	5905.0000	3.74	41.51	45.25	68.30	-23.05	AVG	

Orthogonal Axis:	X
Test Mode:	UNII-3/TX AC20 Mode 5825MHz - External antenna

Vertical

80 dBuV/m

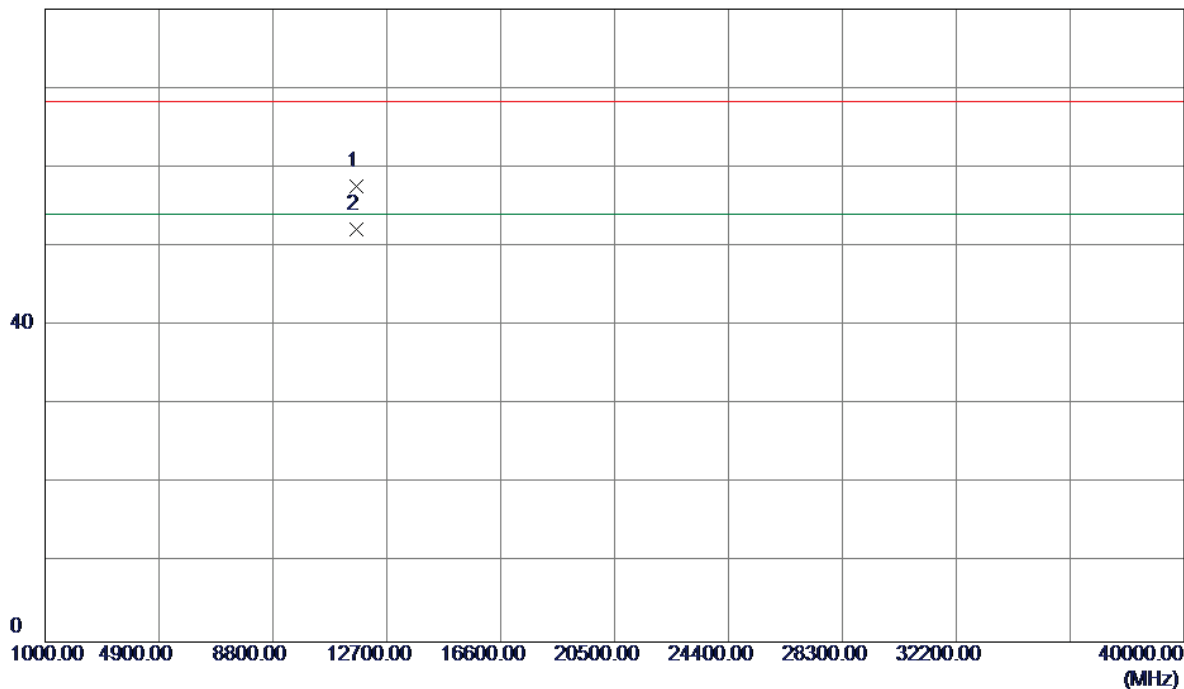

No.	Freq. MHz	Reading Level dBuV/m	Correct Factor dB	Measure ment dBuV/m	Limit dBuV/m	Over dB	Detector	Comment
1	11650.1100	40.48	17.17	57.65	68.30	-10.65	Peak	
2	11650.2300	35.06	17.17	52.23	54.00	-1.77	AVG	

Orthogonal Axis:	X
Test Mode:	UNII-3/TX AC20 Mode 5825MHz - External antenna

Horizontal

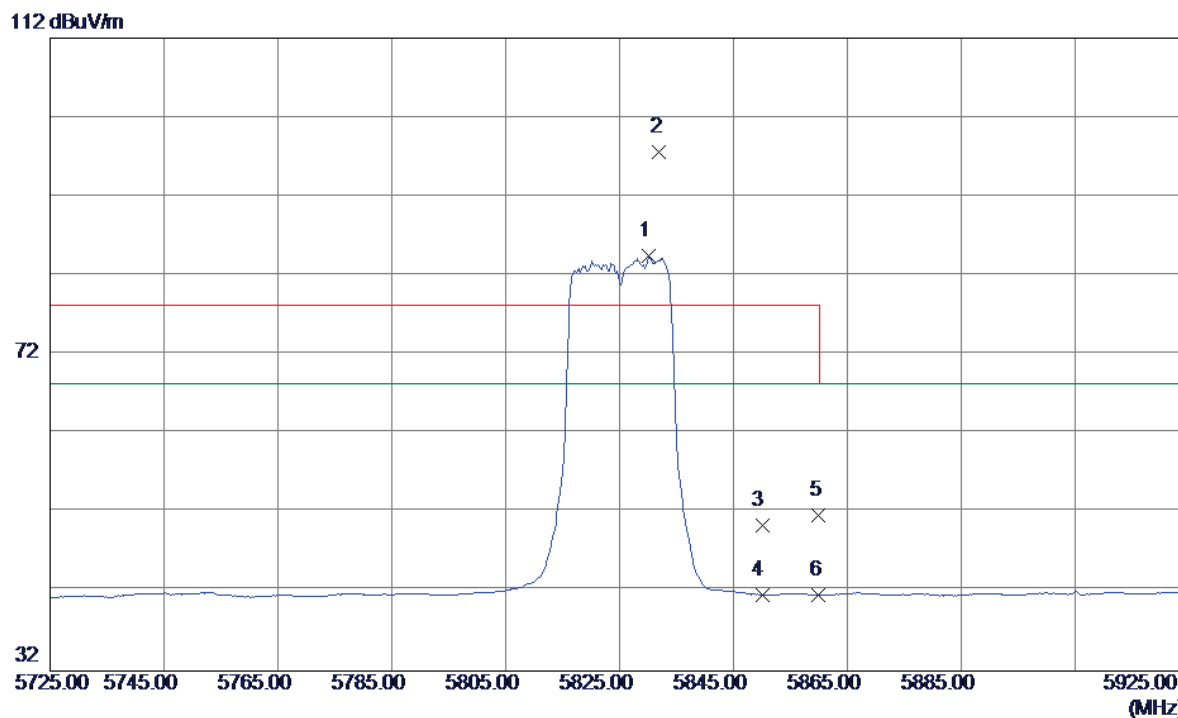

No.	Freq. MHz	Reading Level dBuV/m	Correct Factor dB	Measure ment dBuV/m	Limit dBuV/m	Over dB	Detector	Comment
1	5830.2000	43.08	41.41	84.49	68.30	16.19	AVG	No Limit
2	5832.0000	56.17	41.41	97.58	78.30	19.28	Peak	No Limit
3	5850.0000	8.97	41.44	50.41	78.30	-27.89	Peak	
4	5850.0000	0.23	41.44	41.67	68.30	-26.63	AVG	
5	5860.0000	10.17	41.45	51.62	78.30	-26.68	Peak	
6	5860.0000	0.16	41.45	41.61	68.30	-26.69	AVG	

Orthogonal Axis:	X
Test Mode:	UNII-3/TX AC20 Mode 5825MHz - External antenna

Horizontal

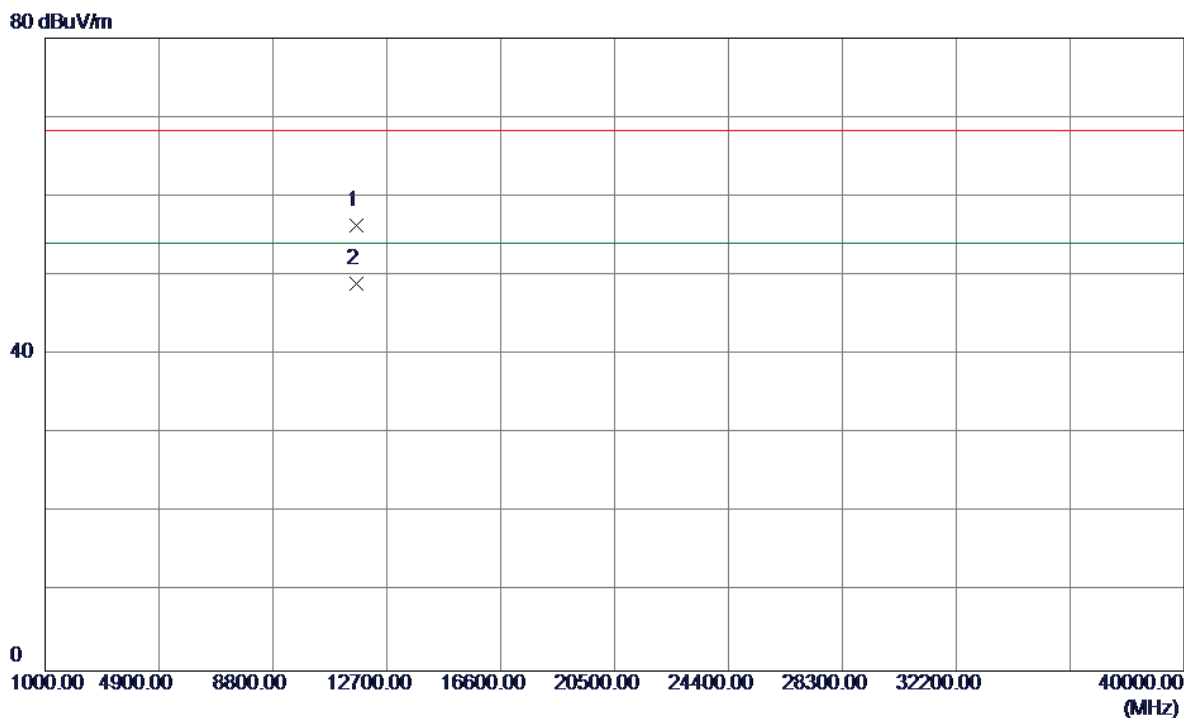

No.	Freq. MHz	Reading Level dBuV/m	Correct Factor dB	Measure ment dBuV/m	Limit dBuV/m	Over dB	Detector	Comment
1	11650.0700	39.17	17.17	56.34	68.30	-11.96	Peak	
2	11650.2100	31.74	17.17	48.91	54.00	-5.09	AVG	

Orthogonal Axis:	X
Test Mode:	UNII-3/TX AC40 Mode 5755MHz - External antenna

Vertical

112 dBuV/m

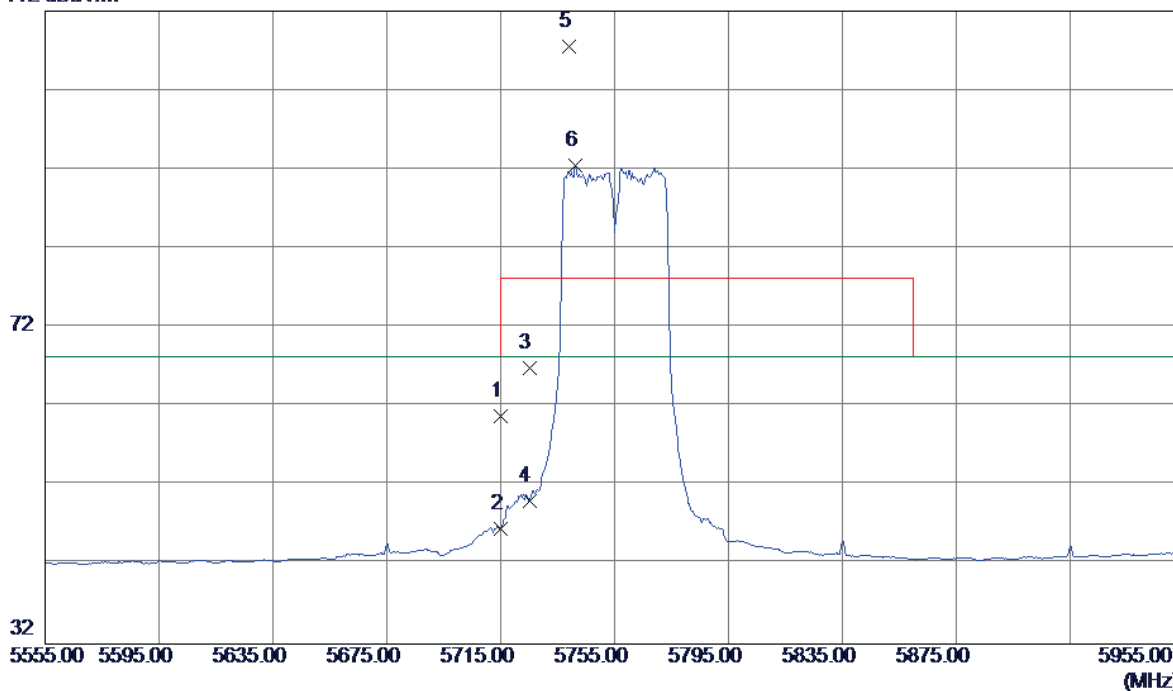

No.	Freq. MHz	Reading Level dBuV/m	Correct Factor dB	Measure ment dBuV/m	Limit dBuV/m	Over dB	Detector	Comment
1	5715.0000	19.56	41.25	60.81	68.30	-7.49	Peak	
2	5715.0000	5.34	41.25	46.59	68.30	-21.71	AVG	
3	5725.0000	25.57	41.27	66.84	78.30	-11.46	Peak	
4	5725.0000	8.79	41.27	50.06	68.30	-18.24	AVG	
5	5739.0000	66.20	41.28	107.48	78.30	29.18	Peak	No Limit
6	5741.4000	51.13	41.29	92.42	68.30	24.12	AVG	No Limit

Orthogonal Axis:	X
Test Mode:	UNII-3/TX AC40 Mode 5755MHz - External antenna

Vertical

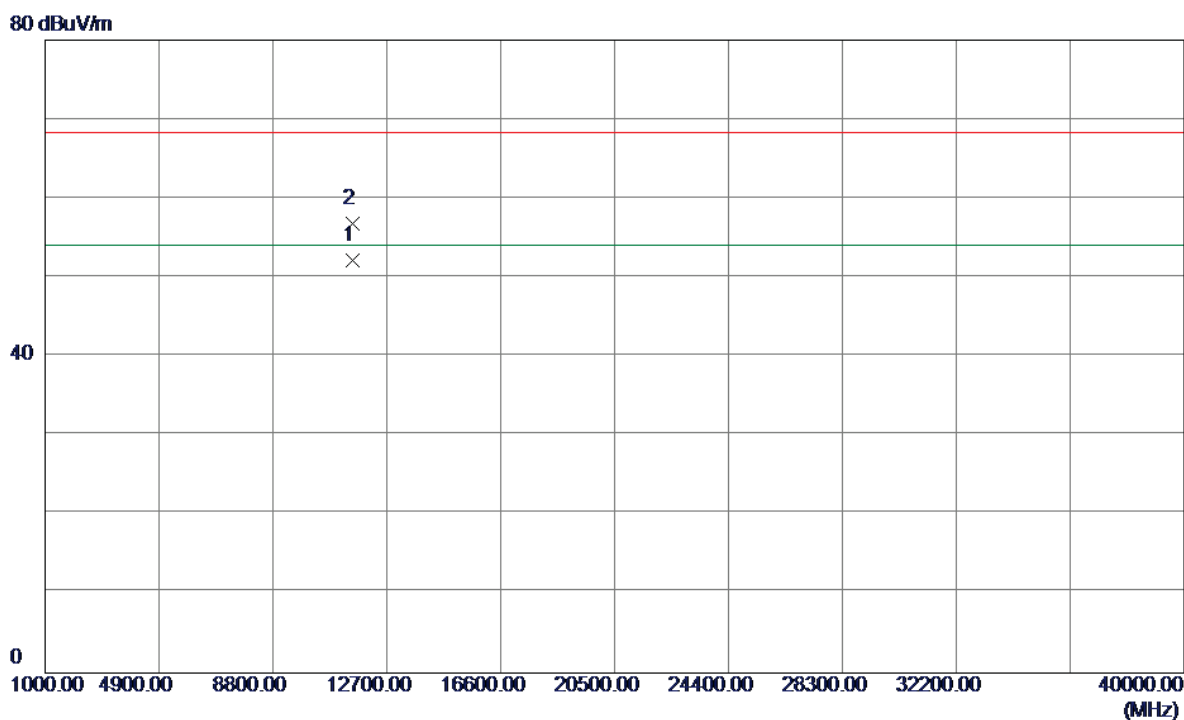

No.	Freq. MHz	Reading Level dBuV/m	Correct Factor dB	Measure ment dBuV/m	Limit dBuV/m	Over dB	Detector	Comment
1	11510.2200	35.19	16.95	52.14	54.00	-1.86	AVG	
2	11510.2300	39.91	16.95	56.86	68.30	-11.44	Peak	

Orthogonal Axis:	X
Test Mode:	UNII-3/TX AC40 Mode 5755MHz - External antenna

Horizontal

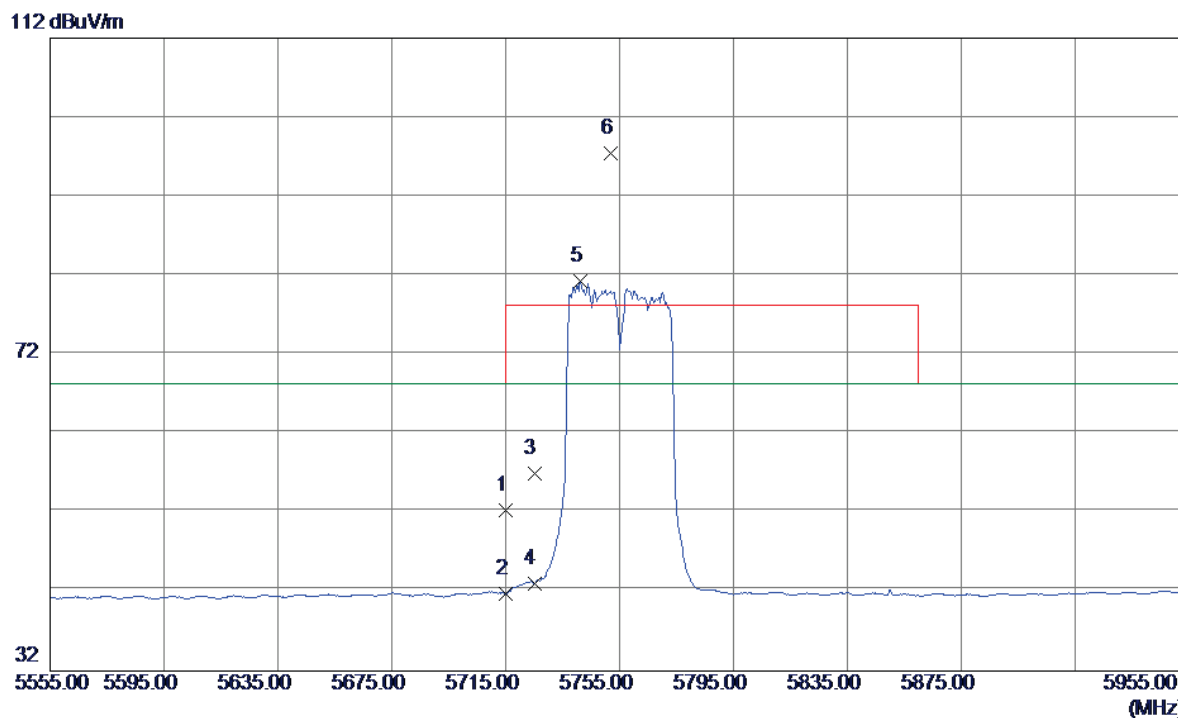

No.	Freq. MHz	Reading Level dBuV/m	Correct Factor dB	Measure ment dBuV/m	Limit dBuV/m	Over dB	Detector	Comment
1	5715.0000	11.04	41.25	52.29	68.30	-16.01	Peak	
2	5715.0000	0.58	41.25	41.83	68.30	-26.47	AVG	
3	5725.0000	15.64	41.27	56.91	78.30	-21.39	Peak	
4	5725.0000	1.81	41.27	43.08	68.30	-25.22	AVG	
5	5741.4000	39.95	41.29	81.24	68.30	12.94	AVG	No Limit
6	5751.8000	56.12	41.30	97.42	78.30	19.12	Peak	No Limit

Orthogonal Axis:	X
Test Mode:	UNII-3/TX AC40 Mode 5755MHz - External antenna

Horizontal

80 dBuV/m

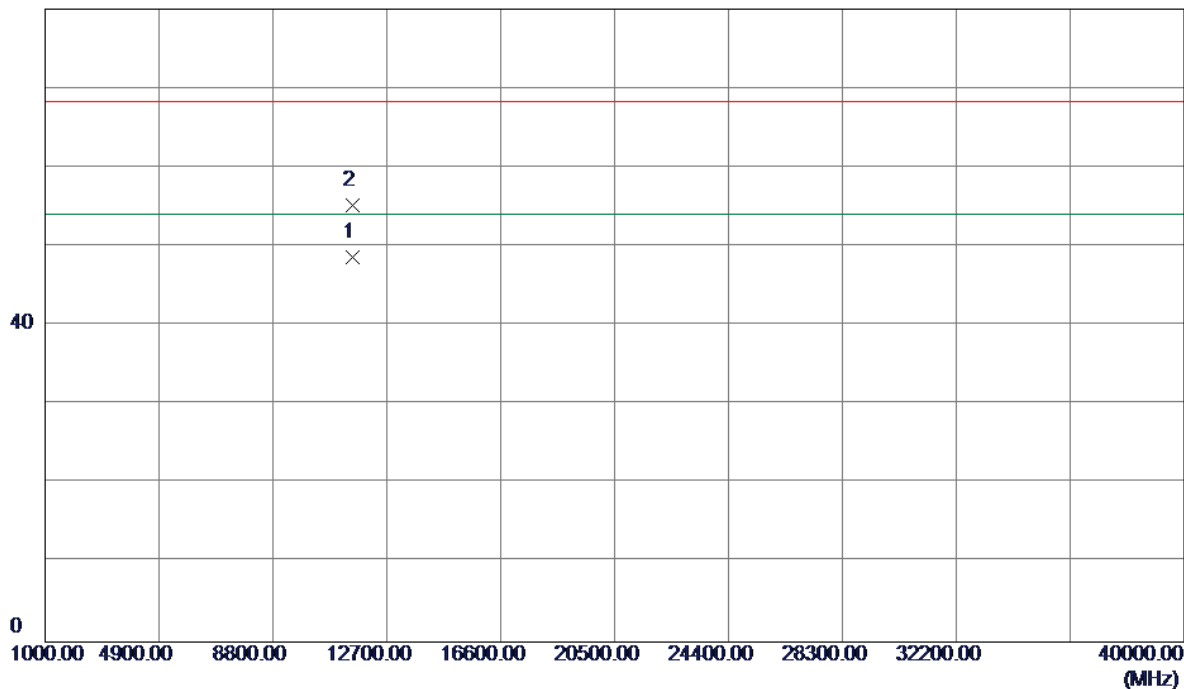

No.	Freq. MHz	Reading Level dBuV/m	Correct Factor dB	Measure ment dBuV/m	Limit dBuV/m	Over dB	Detector	Comment
1	11510.2100	31.65	16.95	48.60	54.00	-5.40	AVG	
2	11510.2300	38.29	16.95	55.24	68.30	-13.06	Peak	

Orthogonal Axis:	X
Test Mode:	UNII-3/TX AC40 Mode 5795MHz - External antenna

Vertical

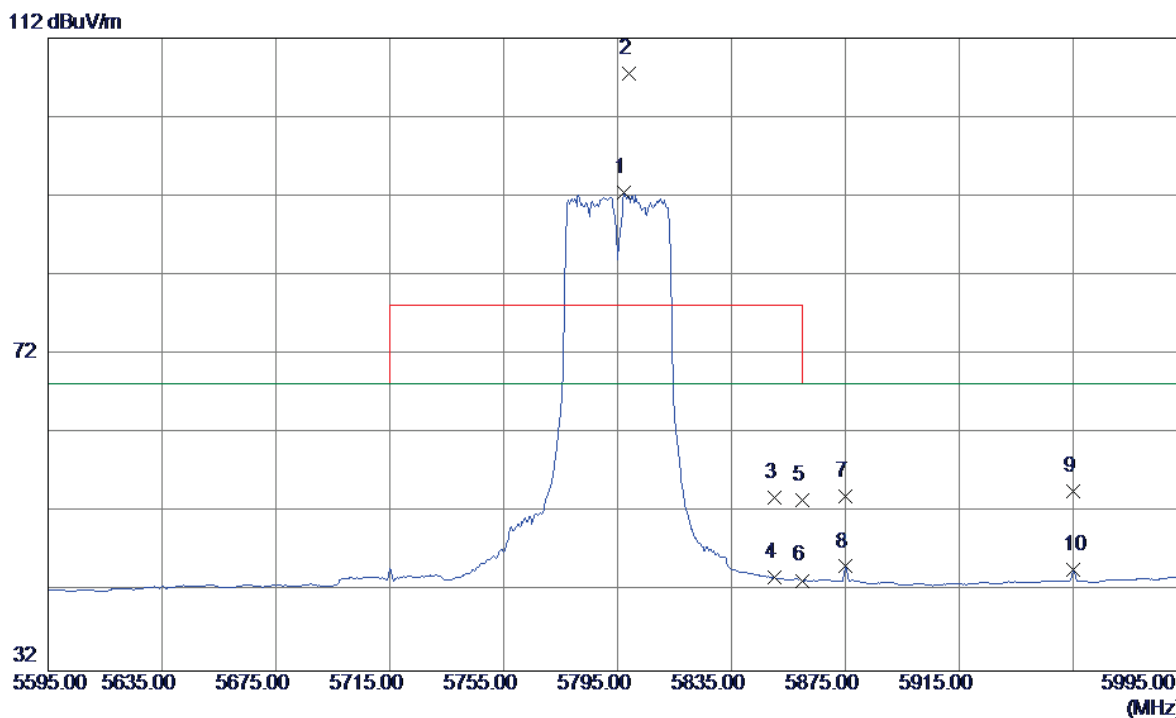

No.	Freq. MHz	Reading Level dBuV/m	Correct Factor dB	Measure ment dBuV/m	Limit dBuV/m	Over dB	Detector	Comment
1	5797.4000	51.08	41.36	92.44	68.30	24.14	AVG	No Limit
2	5799.0000	66.11	41.37	107.48	78.30	29.18	Peak	No Limit
3	5850.0000	12.41	41.44	53.85	78.30	-24.45	Peak	
4	5850.0000	2.39	41.44	43.83	68.30	-24.47	AVG	
5	5860.0000	12.14	41.45	53.59	78.30	-24.71	Peak	
6	5860.0000	1.99	41.45	43.44	68.30	-24.86	AVG	
7	5875.0000	12.59	41.47	54.06	68.30	-14.24	Peak	
8	5875.0000	3.73	41.47	45.20	68.30	-23.10	AVG	
9	5955.0000	13.16	41.58	54.74	68.30	-13.56	Peak	
10	5955.0000	3.19	41.58	44.77	68.30	-23.53	AVG	

Orthogonal Axis:	X
Test Mode:	UNII-3/TX AC40 Mode 5795MHz - External antenna

Vertical

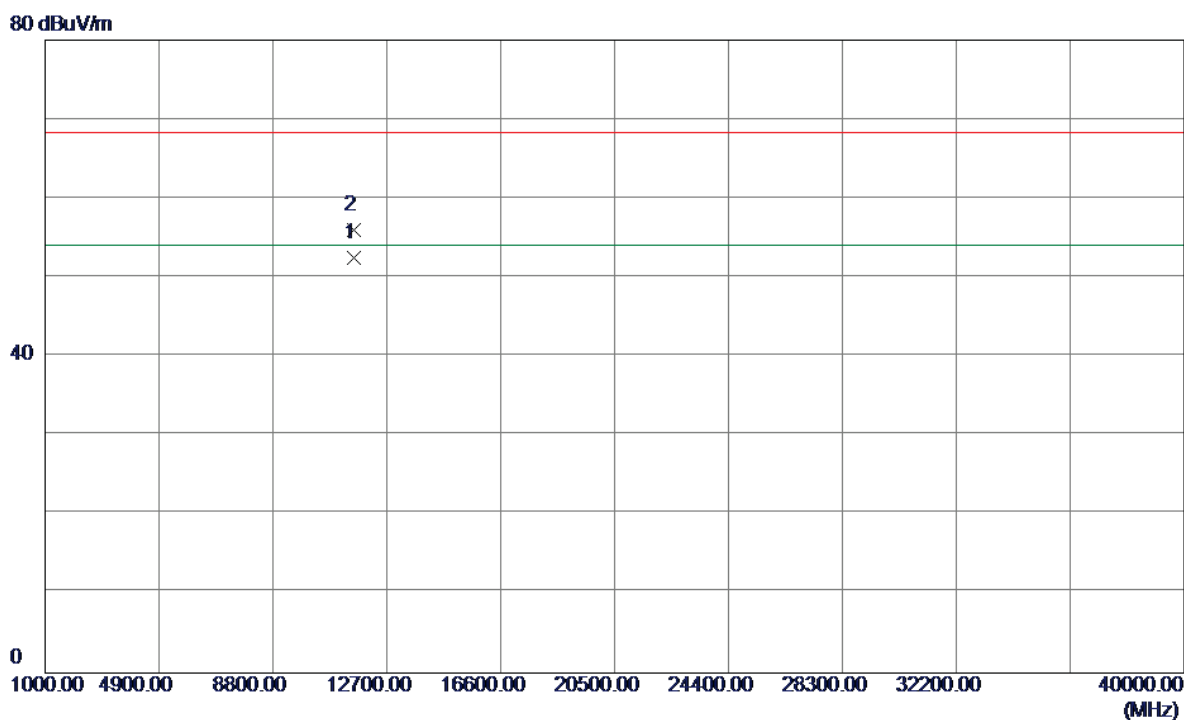

No.	Freq. MHz	Reading Level dBuV/m	Correct Factor dB	Measure ment dBuV/m	Limit dBuV/m	Over dB	Detector	Comment
1	11590.2200	35.39	17.08	52.47	54.00	-1.53	AVG	
2	11590.2000	38.87	17.08	55.95	68.30	-12.35	Peak	

Orthogonal Axis:	X
Test Mode:	UNII-3/TX AC40 Mode 5795MHz - External antenna

Horizontal

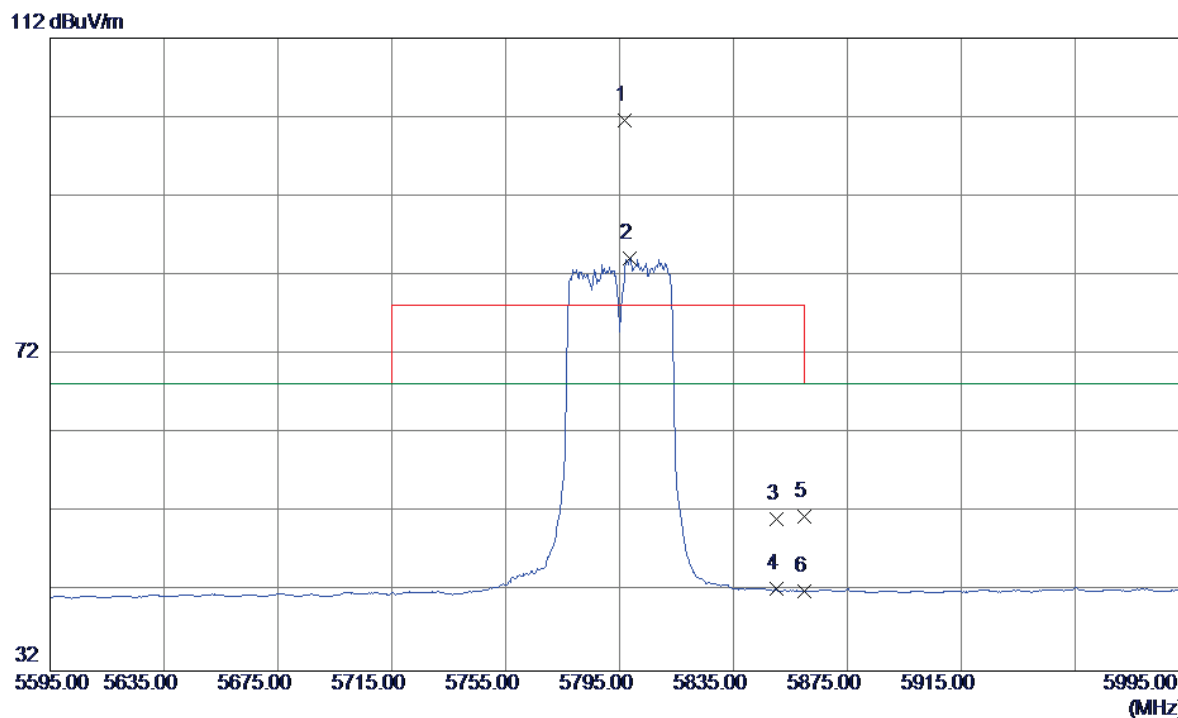

No.	Freq. MHz	Reading Level dBuV/m	Correct Factor dB	Measure ment dBuV/m	Limit dBuV/m	Over dB	Detector	Comment
1	5796.6000	60.17	41.36	101.53	78.30	23.23	Peak	No Limit
2	5798.6000	42.72	41.37	84.09	68.30	15.79	AVG	No Limit
3	5850.0000	9.69	41.44	51.13	78.30	-27.17	Peak	
4	5850.0000	0.93	41.44	42.37	68.30	-25.93	AVG	
5	5860.0000	10.09	41.45	51.54	78.30	-26.76	Peak	
6	5860.0000	0.58	41.45	42.03	68.30	-26.27	AVG	

Orthogonal Axis:	X
Test Mode:	UNII-3/TX AC40 Mode 5795MHz - External antenna

Horizontal

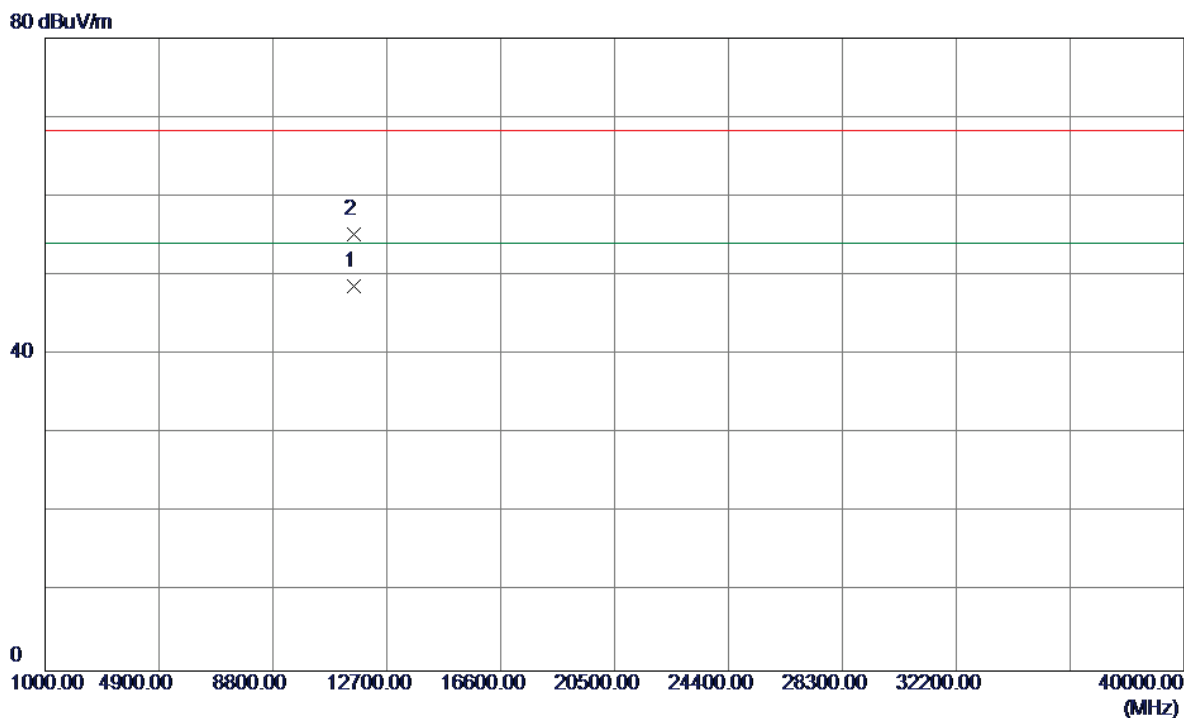

No.	Freq. MHz	Reading Level dBuV/m	Correct Factor dB	Measure ment dBuV/m	Limit dBuV/m	Over dB	Detector	Comment
1	11590.2100	31.49	17.08	48.57	54.00	-5.43	AVG	
2	11590.2200	38.14	17.08	55.22	68.30	-13.08	Peak	

Orthogonal Axis:	X
Test Mode:	UNII-3/TX AC80 Mode 5775MHz - External antenna

Vertical

112 dBuV/m

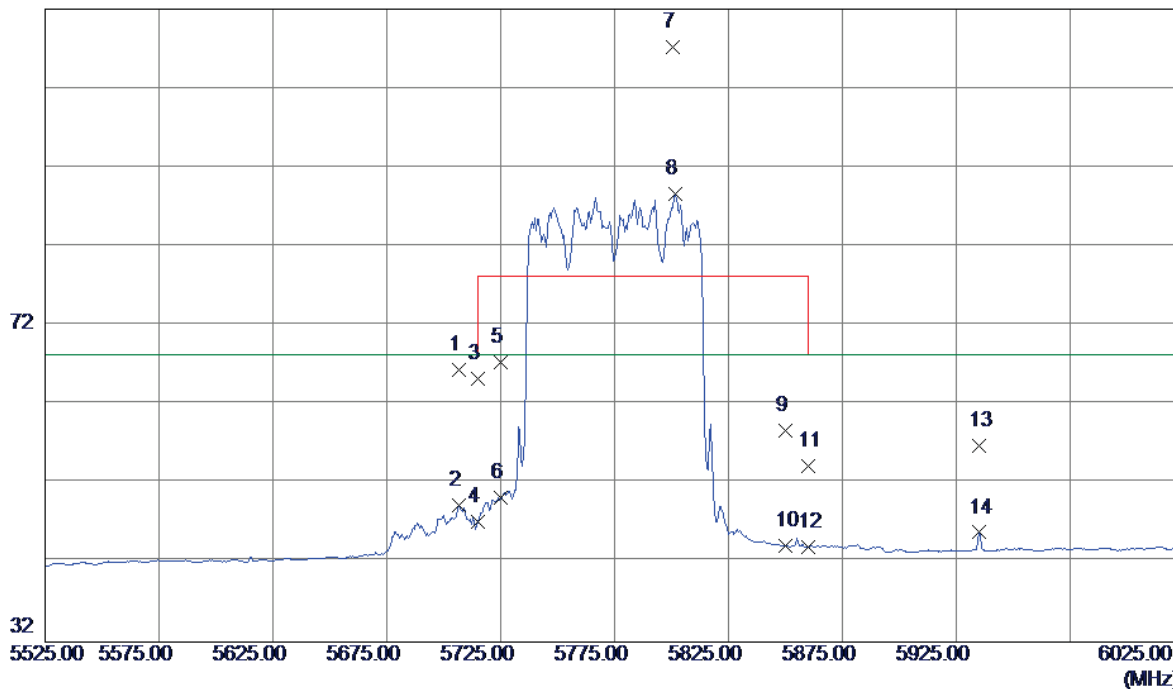

No.	Freq. MHz	Reading Level dBuV/m	Correct Factor dB	Measure ment dBuV/m	Limit dBuV/m	Over dB	Detector	Comment
1	5706.5000	25.12	41.24	66.36	68.30	-1.94	Peak	
2	5706.5000	8.10	41.24	49.34	68.30	-18.96	AVG	
3	5715.0000	23.99	41.25	65.24	68.30	-3.06	Peak	
4	5715.0000	5.90	41.25	47.15	68.30	-21.15	AVG	
5	5725.0000	26.11	41.27	67.38	78.30	-10.92	Peak	
6	5725.0000	9.03	41.27	50.30	68.30	-18.00	AVG	
7	5800.5000	65.86	41.37	107.23	78.30	28.93	Peak	No Limit
8	5801.5000	47.20	41.37	88.57	68.30	20.27	AVG	No Limit
9	5850.0000	17.32	41.44	58.76	78.30	-19.54	Peak	
10	5850.0000	2.67	41.44	44.11	68.30	-24.19	AVG	
11	5860.0000	12.73	41.45	54.18	78.30	-24.12	Peak	
12	5860.0000	2.59	41.45	44.04	68.30	-24.26	AVG	
13	5935.0000	15.25	41.55	56.80	68.30	-11.50	Peak	
14	5935.0000	4.29	41.55	45.84	68.30	-22.46	AVG	

Orthogonal Axis:	X
Test Mode:	UNII-3/TX AC80 Mode 5775MHz - External antenna

Vertical

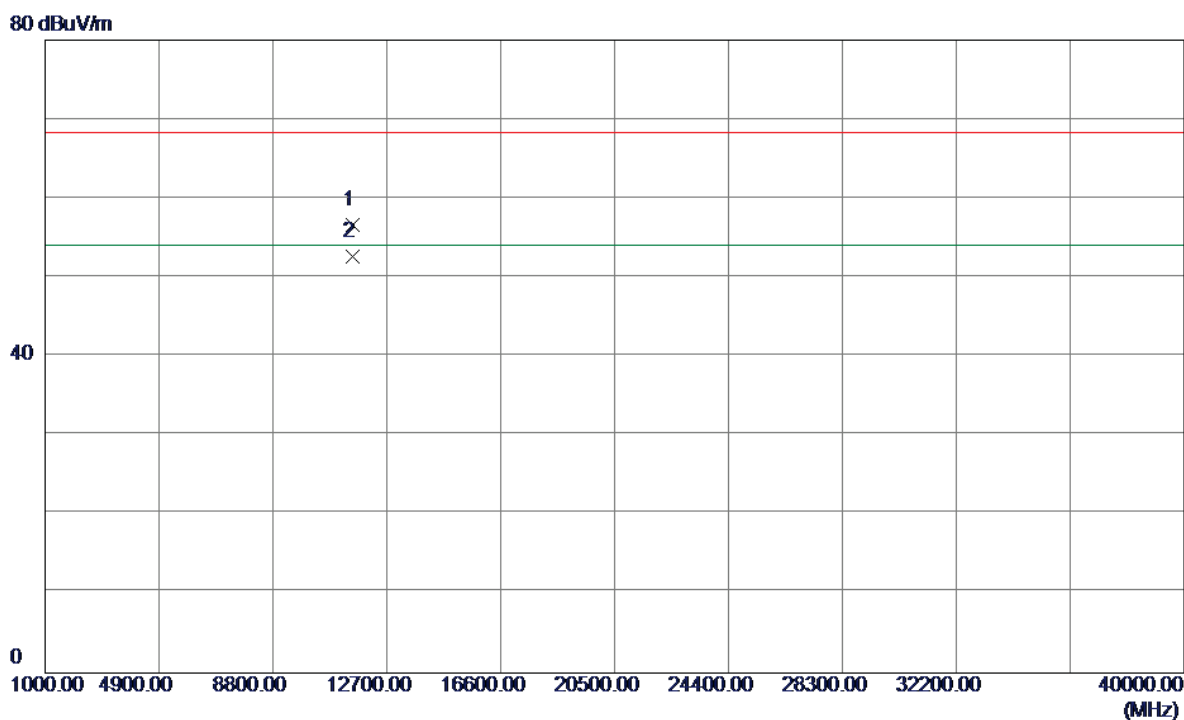

No.	Freq. MHz	Reading Level dBuV/m	Correct Factor dB	Measure ment dBuV/m	Limit dBuV/m	Over dB	Detector	Comment
1	11550.1900	39.62	17.01	56.63	68.30	-11.67	Peak	
2	11550.2200	35.64	17.01	52.65	54.00	-1.35	AVG	

Orthogonal Axis:	X
Test Mode:	UNII-3/TX AC80 Mode 5775MHz - External antenna

Horizontal

112 dBuV/m

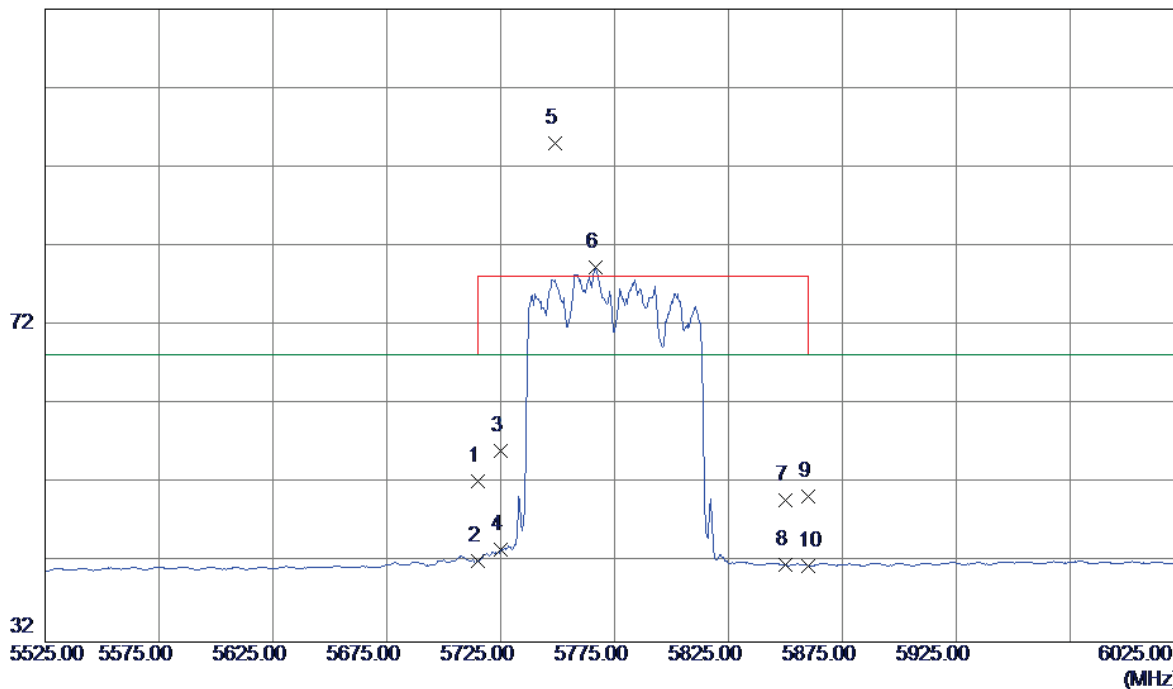

No.	Freq. MHz	Reading Level dBuV/m	Correct Factor dB	Measure ment dBuV/m	Limit dBuV/m	Over dB	Detector	Comment
1	5715.0000	11.02	41.25	52.27	68.30	-16.03	Peak	
2	5715.0000	0.97	41.25	42.22	68.30	-26.08	AVG	
3	5725.0000	14.84	41.27	56.11	78.30	-22.19	Peak	
4	5725.0000	2.39	41.27	43.66	68.30	-24.64	AVG	
5	5749.0000	53.78	41.30	95.08	78.30	16.78	Peak	No Limit
6	5766.5000	37.97	41.32	79.29	68.30	10.99	AVG	No Limit
7	5850.0000	8.51	41.44	49.95	78.30	-28.35	Peak	
8	5850.0000	0.30	41.44	41.74	68.30	-26.56	AVG	
9	5860.0000	9.00	41.45	50.45	78.30	-27.85	Peak	
10	5860.0000	0.21	41.45	41.66	68.30	-26.64	AVG	

Orthogonal Axis:	X
Test Mode:	UNII-3/TX AC80 Mode 5775MHz - External antenna

Horizontal

80 dBuV/m

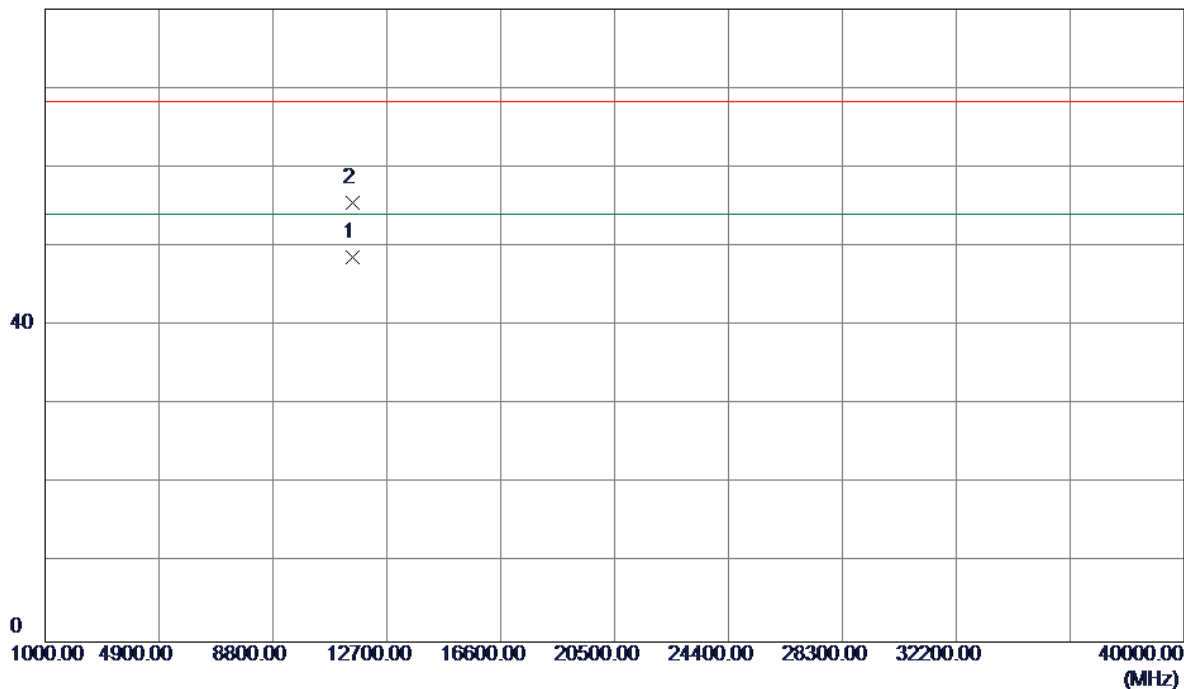

No.	Freq. MHz	Reading Level dBuV/m	Correct Factor dB	Measure ment dBuV/m	Limit dBuV/m	Over dB	Detector	Comment
1	11550.2000	31.69	17.01	48.70	54.00	-5.30	AVG	
2	11550.3099	38.51	17.01	55.52	68.30	-12.78	Peak	

Internal antenna

TX A Mode_DUTY CYCLE

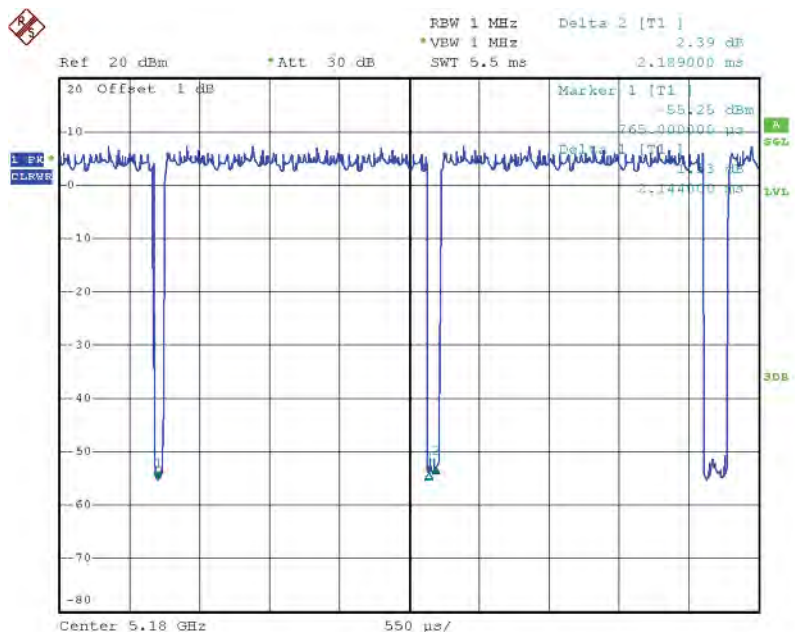

Date: 8.JUN.2015 16:58:34

Duty cycle: TX DUTYMHZ

$$\text{Duty cycle} = T_{\text{ON}} / T_{\text{Total}}$$

T_{ON} : 2.14 msec

T_{Total} : 2.19 msec

Duty cycle: 97.72%

$$\text{Duty Factor} = 10 \log(1/\text{Duty cycle})$$

Duty Factor = 0.10

Note: The EUT was programmed to be in continuously transmitting mode and the transmit duty cycle is less than 98 %, so, the output power and power density should be calculated as

$$\text{Output Power} = \text{Measured power} + \text{Duty factor}$$

$$\text{Power Spectral Density} = \text{Measured density} + \text{Duty factor}$$

TX N20 Mode_DUTY CYCLE

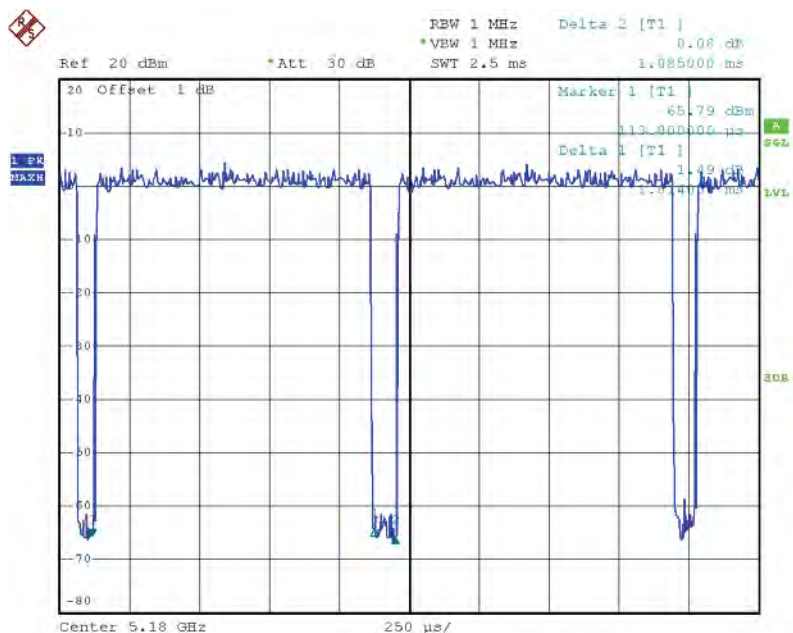

Date: 8.JUN.2015 17:01:39

Duty cycle: TX DUTYMHZ

$$\text{Duty cycle} = T_{\text{ON}} / T_{\text{Total}}$$

T_{ON} : 1.01 msec

T_{Total} : 1.08 msec

Duty cycle: 93.52%

$$\text{Duty Factor} = 10 \log(1/\text{Duty cycle})$$

Duty Factor = 0.29

Note: The EUT was programmed to be in continuously transmitting mode and the transmit duty cycle is less than 98 %, so, the output power and power density should be calculated as

$$\text{Output Power} = \text{Measured power} + \text{Duty factor}$$

$$\text{Power Spectral Density} = \text{Measured density} + \text{Duty factor}$$

TX N40 Mode_DUTY CYCLE

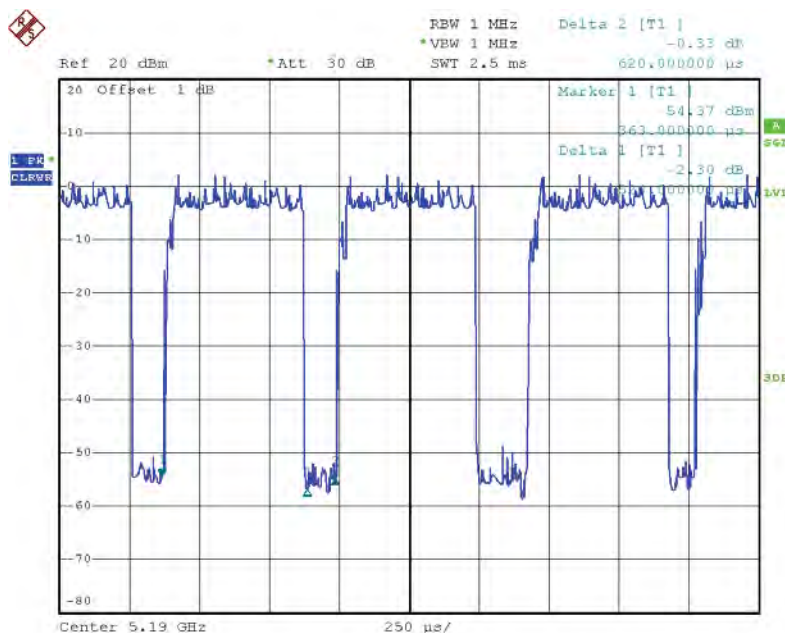

Date: 8.JUN.2015 17:48:06

Duty cycle: TX DUTYMHZ

$$\text{Duty cycle} = T_{\text{ON}} / T_{\text{Total}}$$

T_{ON} : 0.52 msec

T_{Total} : 0.62 msec

Duty cycle: 83.87%

$$\text{Duty Factor} = 10 \log(1/\text{Duty cycle})$$

Duty Factor = 0.76

Note: The EUT was programmed to be in continuously transmitting mode and the transmit duty cycle is less than 98 %, so, the output power and power density should be calculated as

$$\text{Output Power} = \text{Measured power} + \text{Duty factor}$$

$$\text{Power Spectral Density} = \text{Measured density} + \text{Duty factor}$$

TX AC20 Mode_DUTY CYCLE

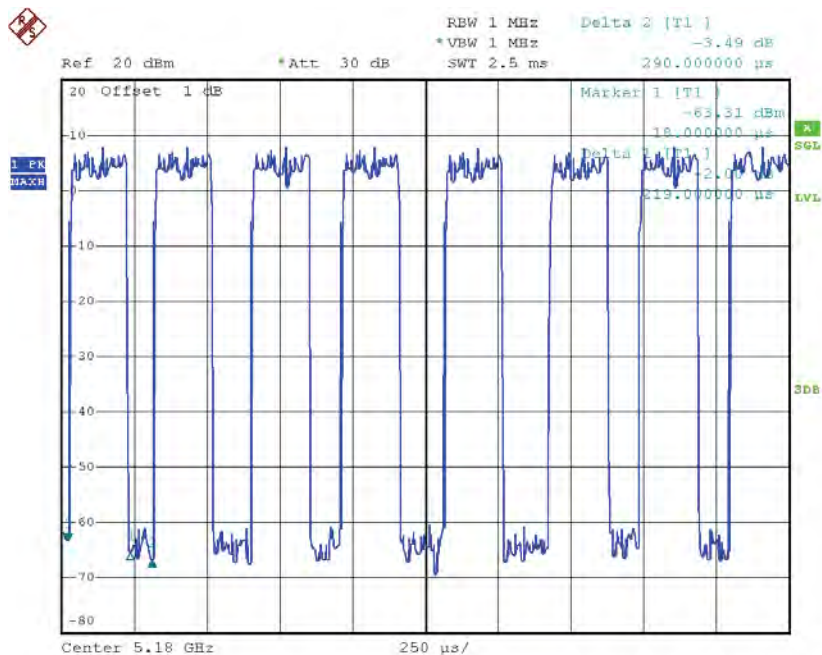

Date: 8.JUN.2015 17:22:28

Duty cycle: TX DUTYMHZ

$$\text{Duty cycle} = T_{\text{ON}} / T_{\text{Total}}$$

T_{ON} : 0.22 msec

T_{Total} : 0.29 msec

Duty cycle: 75.86%

$$\text{Duty Factor} = 10 \log(1/\text{Duty cycle})$$

Duty Factor = 1.20

Note: The EUT was programmed to be in continuously transmitting mode and the transmit duty cycle is less than 98 %, so, the output power and power density should be calculated as

$$\text{Output Power} = \text{Measured power} + \text{Duty factor}$$

$$\text{Power Spectral Density} = \text{Measured density} + \text{Duty factor}$$

TX AC40 Mode_DUTY CYCLE

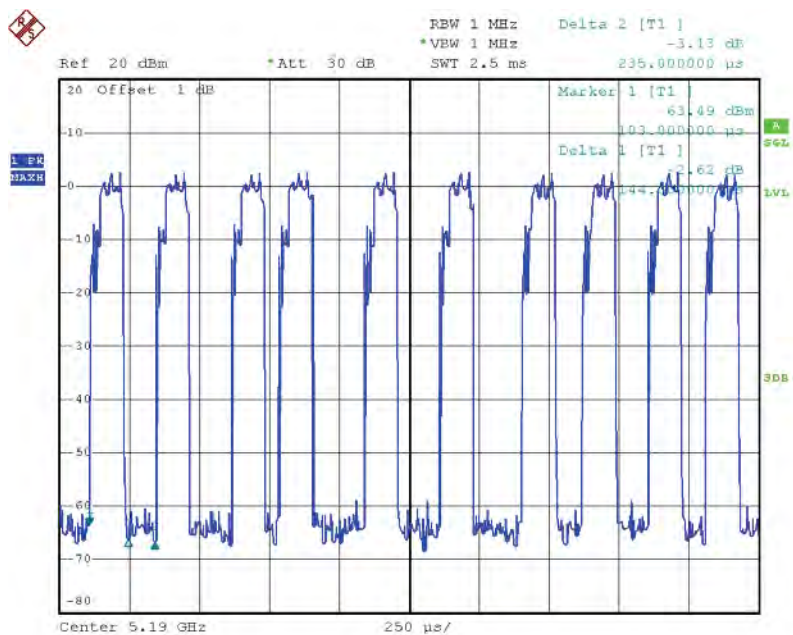

Date: 8.JUN.2015 18:54:03

Duty cycle: TX DUTYMHZ

$$\text{Duty cycle} = T_{\text{ON}} / T_{\text{Total}}$$

T_{ON} : 0.14 msec

T_{Total} : 0.24 msec

Duty cycle: 58.33%

$$\text{Duty Factor} = 10 \log(1/\text{Duty cycle})$$

Duty Factor = 2.34

Note: The EUT was programmed to be in continuously transmitting mode and the transmit duty cycle is less than 98 %, so, the output power and power density should be calculated as

Output Power = Measured power + Ducus factor

Power Spectral Density = Measured density + Duty factor

TX AC80 Mode_DUTY CYCLE

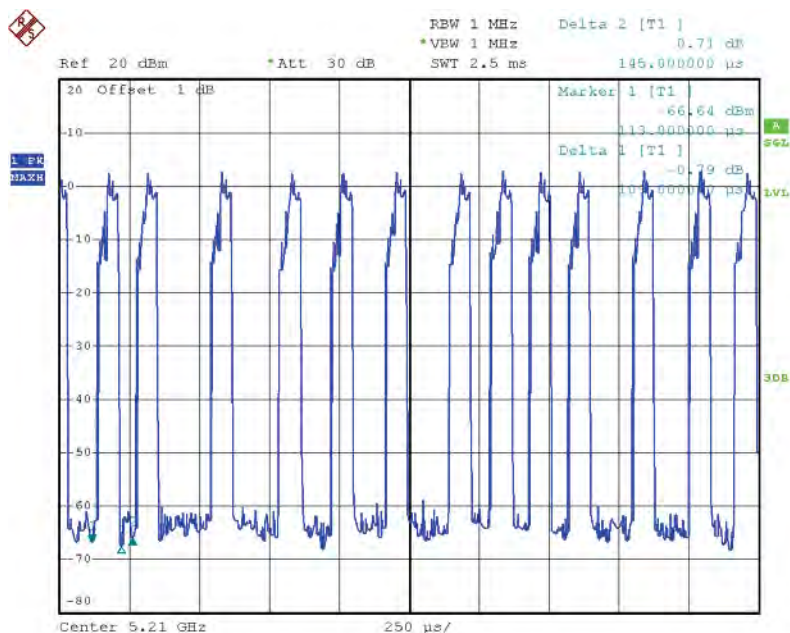

Date: 8.JUN.2015 19:37:38

Duty cycle: TX DUTYMHZ

$$\text{Duty cycle} = T_{\text{ON}} / T_{\text{Total}}$$

T_{ON} : 0.11 msec

T_{Total} : 0.14 msec

Duty cycle: 78.57%

$$\text{Duty Factor} = 10 \log(1/\text{Duty cycle})$$

Duty Factor = 1.05

Note: The EUT was programmed to be in continuously transmitting mode and the transmit duty cycle is less than 98 %, so, the output power and power density should be calculated as

$$\text{Output Power} = \text{Measured power} + \text{Duty factor}$$

$$\text{Power Spectral Density} = \text{Measured density} + \text{Duty factor}$$

TX N20 Mode_DUTY CYCLE

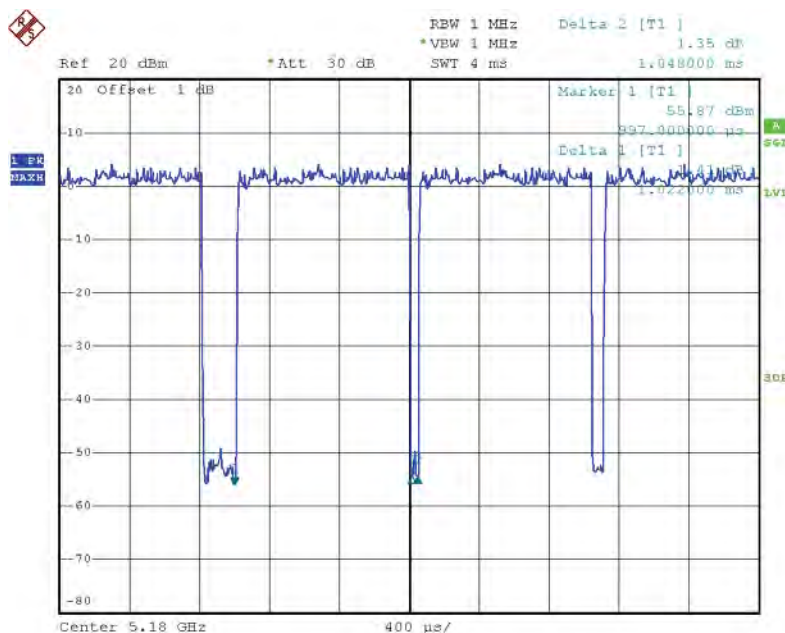

Date: 10.JUN.2015 17:29:50

Duty cycle: TX DUTYMHZ

$$\text{Duty cycle} = T_{\text{ON}} / T_{\text{Total}}$$

T_{ON} : 1.02 msec

T_{Total} : 1.05 msec

Duty cycle: 97.14%

$$\text{Duty Factor} = 10 \log(1/\text{Duty cycle})$$

Duty Factor = 0.13

Note: The EUT was programmed to be in continuously transmitting mode and the transmit duty cycle is less than 98 %, so, the output power and power density should be calculated as

Output Power = Measured power + Ducus factor

Power Spectral Density = Measured density + Duty factor

TX N40 Mode_DUTY CYCLE

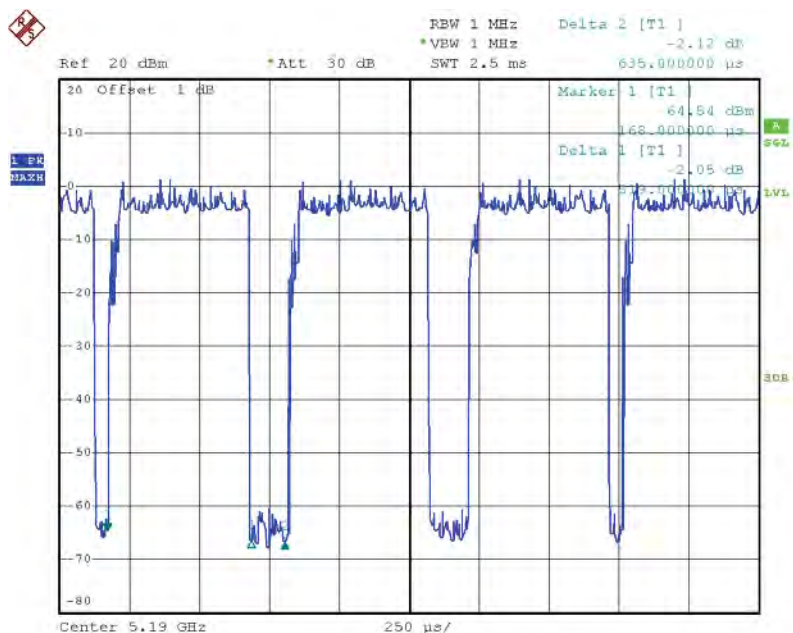

Date: 10.JUN.2015 18:08:32

Duty cycle: TX DUTYMHZ

$$\text{Duty cycle} = T_{\text{ON}} / T_{\text{Total}}$$

T_{ON} : 0.52 msec

T_{Total} : 0.64 msec

Duty cycle: 81.25%

$$\text{Duty Factor} = 10 \log(1/\text{Duty cycle})$$

Duty Factor = 0.90

Note: The EUT was programmed to be in continuously transmitting mode and the transmit duty cycle is less than 98 %, so, the output power and power density should be calculated as

Output Power = Measured power + Ducus factor

Power Spectral Density = Measured density + Duty factor

TX AC20 Mode_DUTY CYCLE

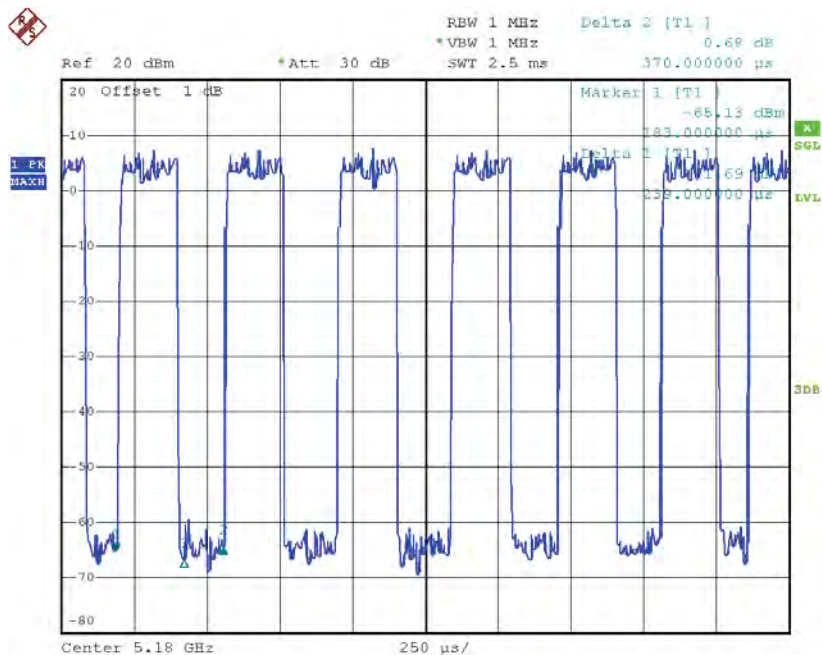

Date: 10.JUN.2015 17:48:29

Duty cycle: TX DUTYMHZ

$$\text{Duty cycle} = T_{\text{ON}} / T_{\text{Total}}$$

T_{ON} : 0.24 msec

T_{Total} : 0.37 msec

Duty cycle: 64.86%

$$\text{Duty Factor} = 10 \log(1/\text{Duty cycle})$$

Duty Factor = 1.88

Note: The EUT was programmed to be in continuously transmitting mode and the transmit duty cycle is less than 98 %, so, the output power and power density should be calculated as

$$\text{Output Power} = \text{Measured power} + \text{Duty factor}$$

$$\text{Power Spectral Density} = \text{Measured density} + \text{Duty factor}$$

TX AC40 Mode_DUTY CYCLE

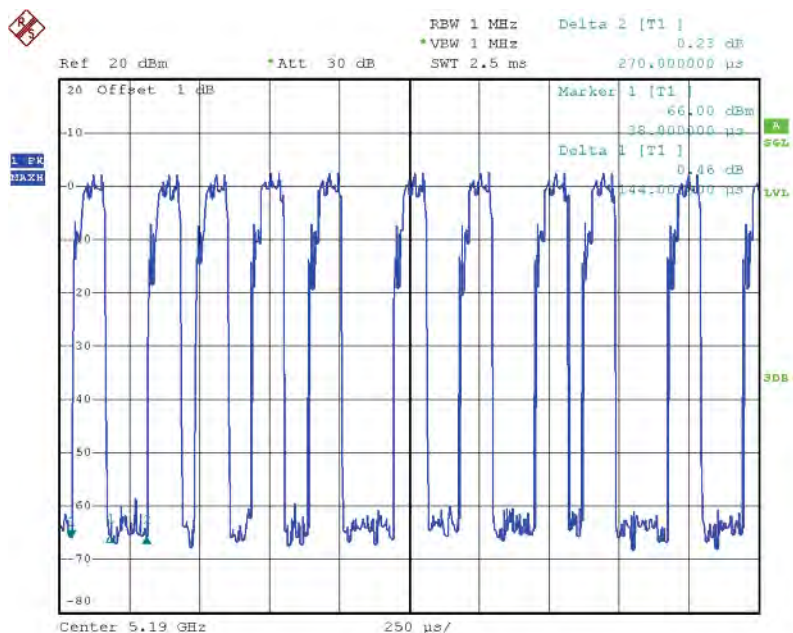

Date: 10.JUN.2015 18:51:24

Duty cycle: TX DUTYMHZ

$$\text{Duty cycle} = T_{\text{ON}} / T_{\text{Total}}$$

T_{ON} : 0.14 msec

T_{Total} : 0.27 msec

Duty cycle: 51.85%

$$\text{Duty Factor} = 10 \log(1/\text{Duty cycle})$$

Duty Factor = 2.85

Note: The EUT was programmed to be in continuously transmitting mode and the transmit duty cycle is less than 98 %, so, the output power and power density should be calculated as

$$\text{Output Power} = \text{Measured power} + \text{Duty factor}$$

$$\text{Power Spectral Density} = \text{Measured density} + \text{Duty factor}$$

ATTACHMENT E - BANDWIDTH

Internal antenna

Test Mode: UNII-1/TX A Mode_CH36/CH40/CH48

Channel	Frequency (MHz)	26dB Bandwidth (MHz)	99% Occupied Bandwidth (MHz)
CH36	5180	21.29	16.90
CH40	5200	21.09	16.90
CH48	5240	21.10	16.90

TX CH36

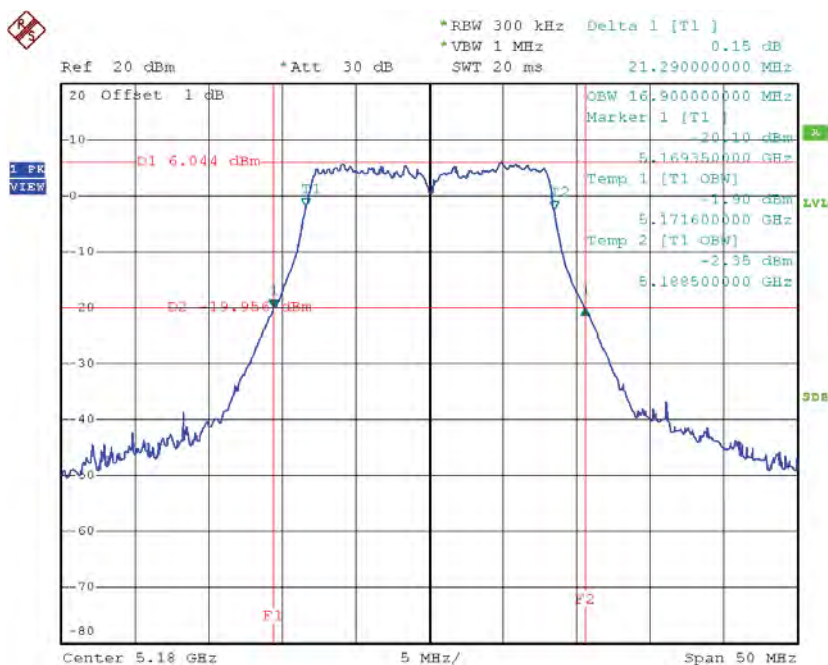

Date: 8.JUN.2015 16:44:18

TX CH40

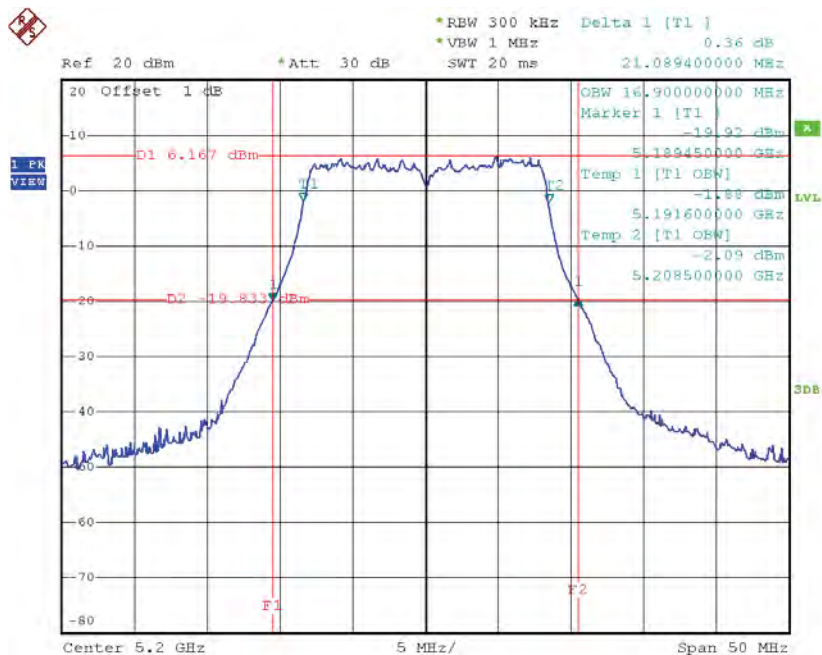

Date: 8.JUN.2015 16:45:53

TX CH48

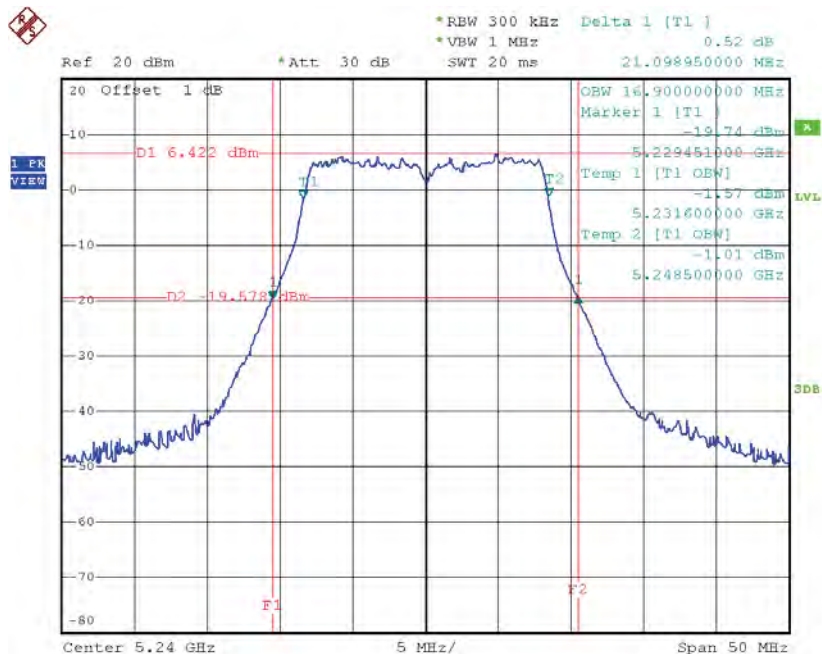

Date: 8.JUN.2015 16:47:26

Test Mode: UNII-1/TX N20 Mode_CH36/CH40/CH48

Channel	Frequency (MHz)	26dB Bandwidth (MHz)	99% Occupied Bandwidth (MHz)
CH36	5180	22.20	18.10
CH40	5200	22.09	18.00
CH48	5240	22.10	18.00

TX CH36

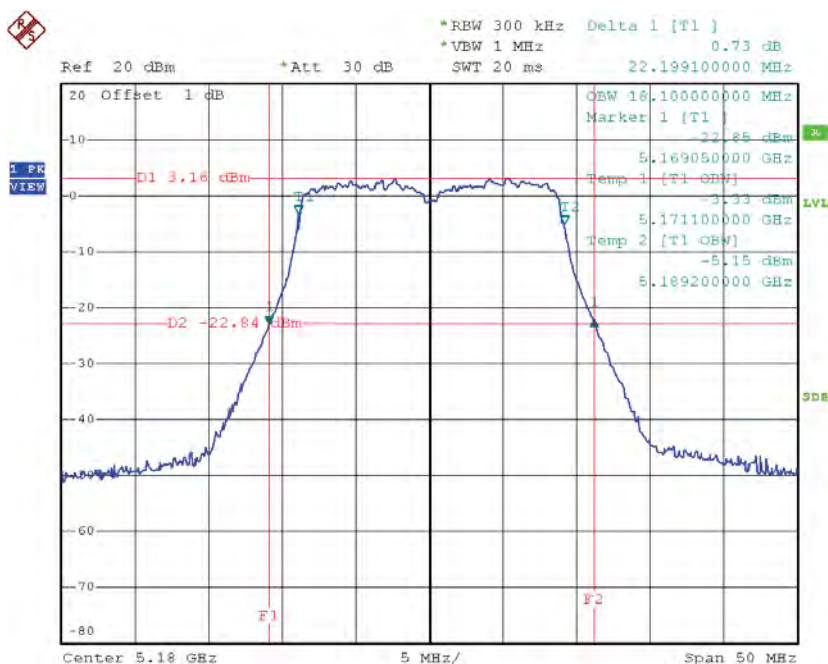

Date: 8.JUN.2015 17:01:11

TX CH40

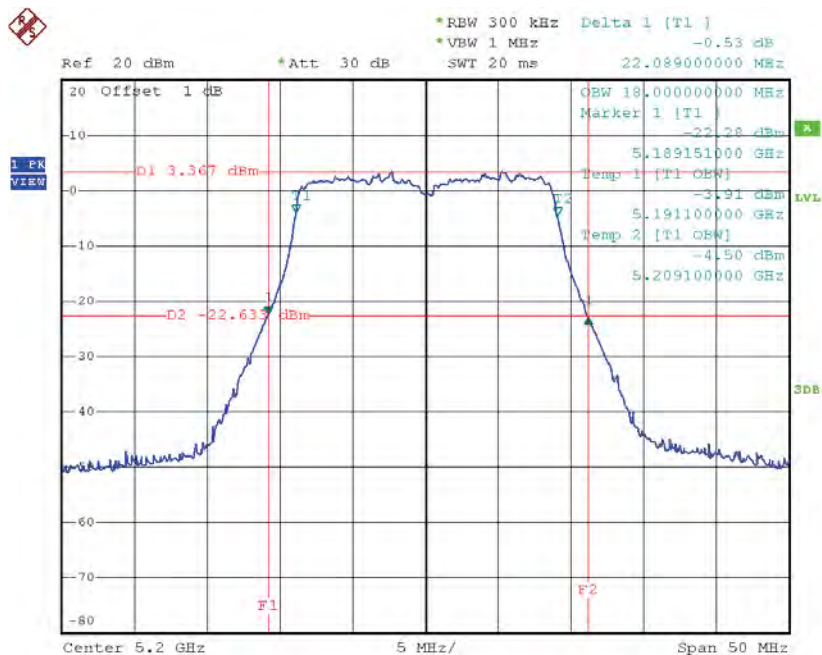

Date: 8.JUN.2015 17:03:04

TX CH48

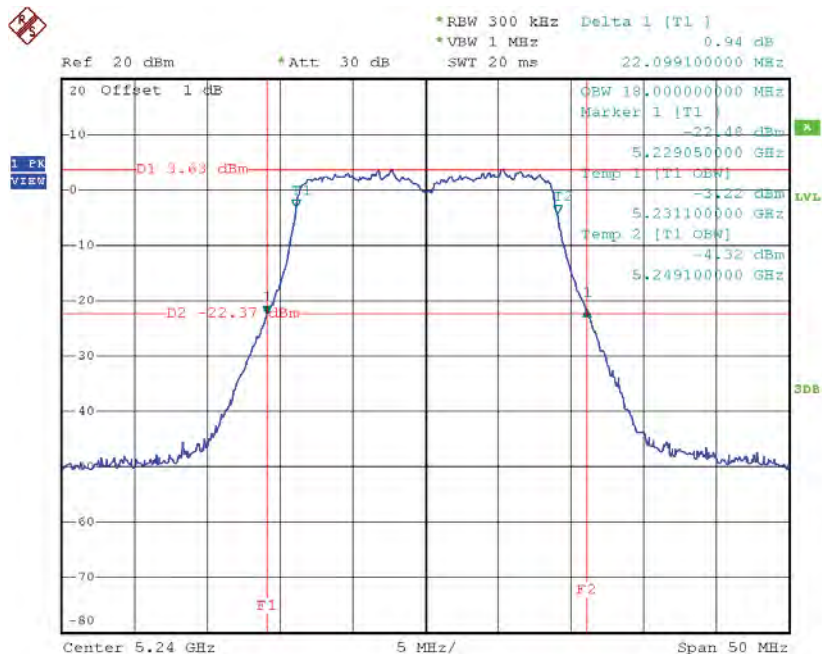

Date: 8.JUN.2015 17:04:17

Test Mode: UNII-1/TX N40 Mode_CH38/CH46

Channel	Frequency (MHz)	26dB Bandwidth (MHz)	99% Occupied Bandwidth (MHz)
CH38	5190	42.50	36.40
CH46	5230	42.39	36.40

TX CH38

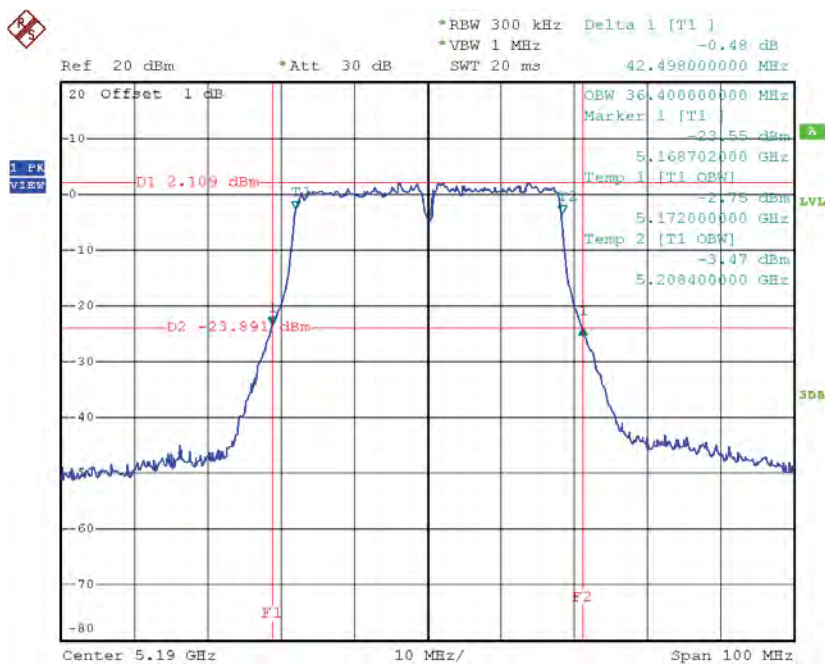

Date: 8.JUN.2015 17:47:25

TX CH46

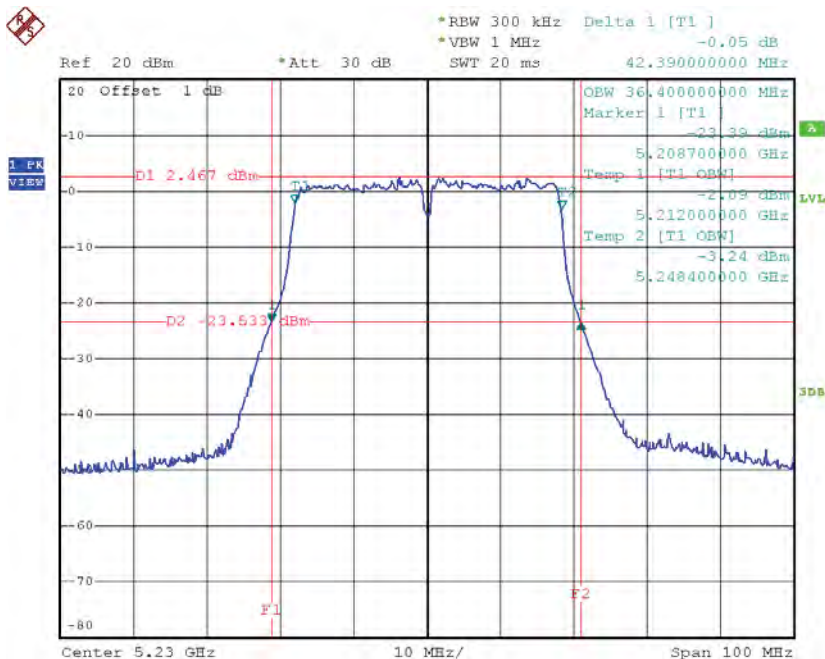

Date: 8.JUN.2015 17:49:01

Test Mode: UNII-3/ TX A Mode_CH149/CH157/CH165

Channel	Frequency (MHz)	6dB Bandwidth (MHz)	99% Occupied Bandwidth (MHz)	Limit (kHz)
CH149	5745	16.65	16.90	>=500
CH157	5785	16.65	16.90	>=500
CH165	5825	16.61	16.90	>=500

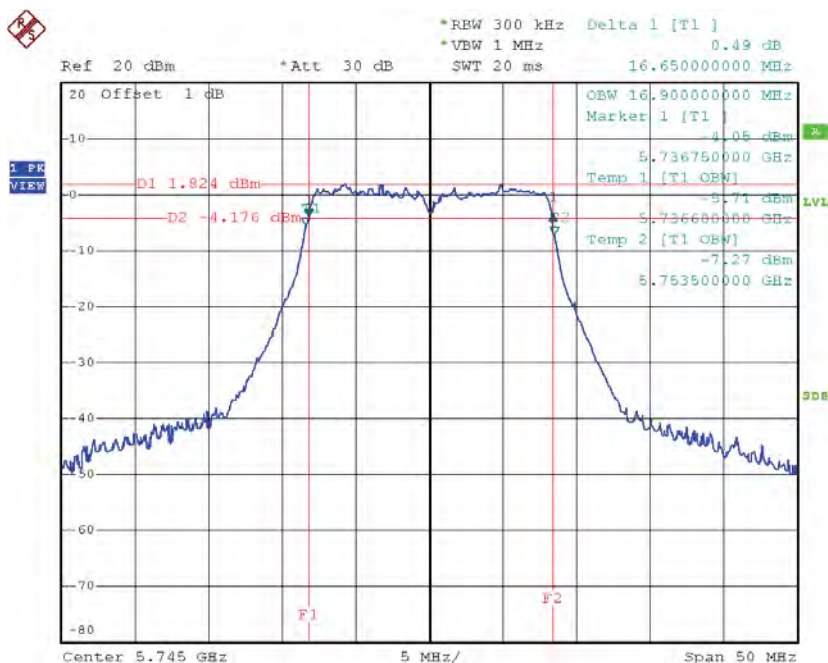
TX CH 149

Date: 8.JUN.2015 16:52:45

TX CH 157

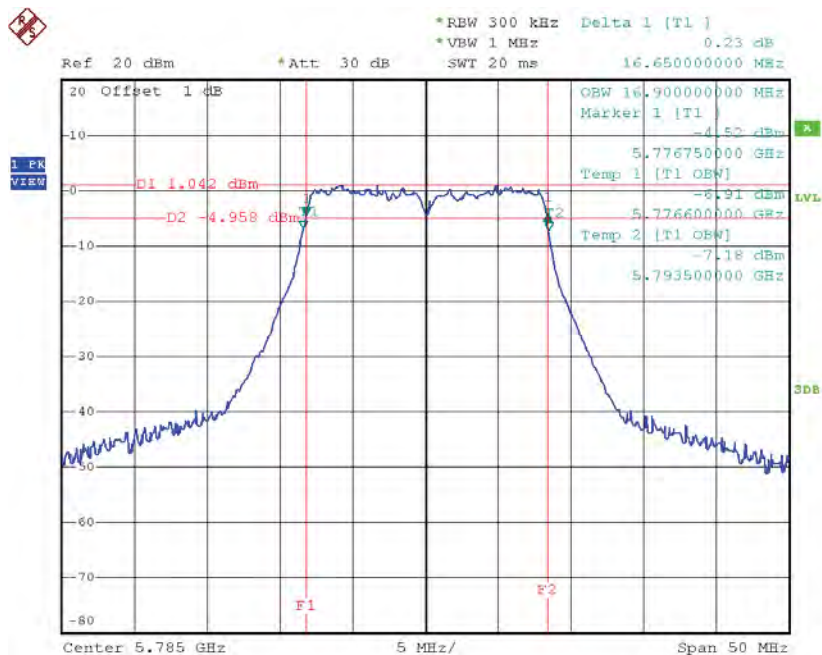

Date: 8.JUN.2015 16:54:36

TX CH 165

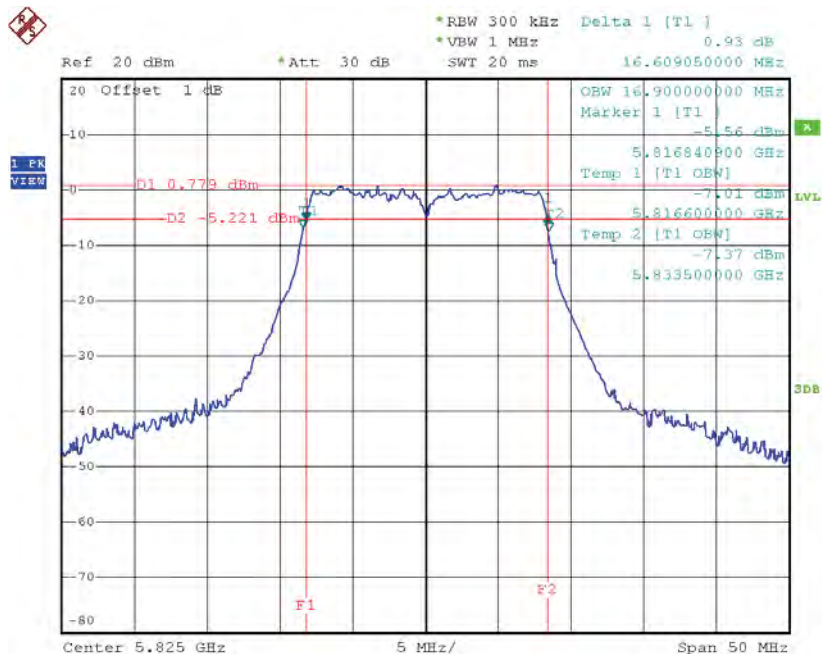

Date: 8.JUN.2015 16:56:07

TX CH 157

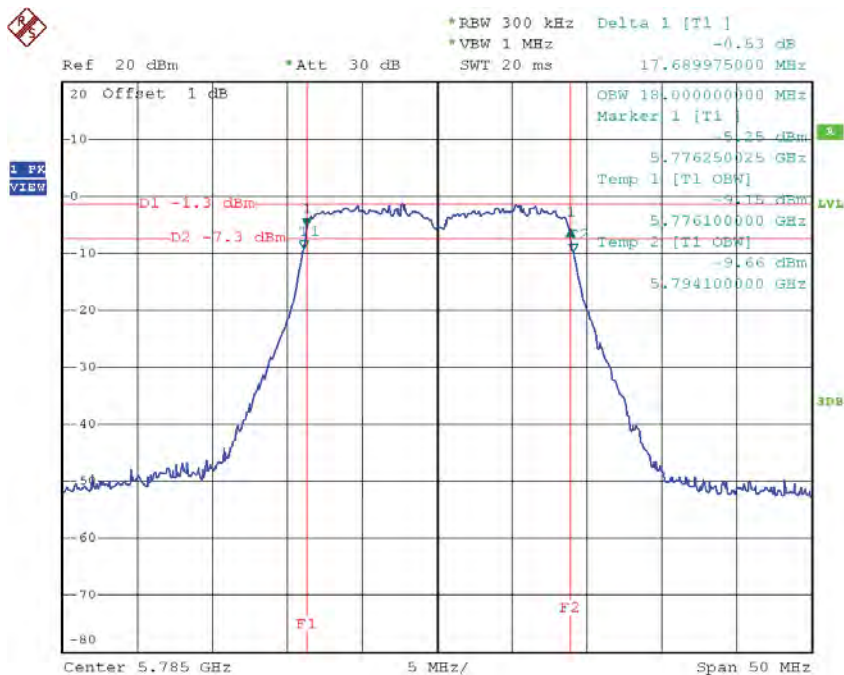

Date: 8.JUN.2015 17:07:50

TX CH 165

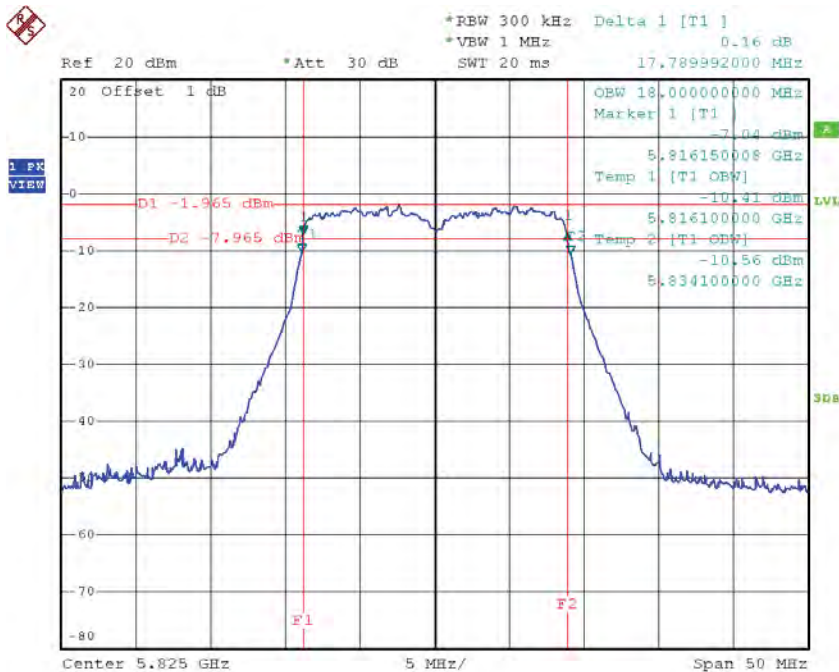

Date: 8.JUN.2015 17:08:56

Test Mode: UNII-3/ TX N40 Mode_CH151/CH159

Channel	Frequency (MHz)	6dB Bandwidth (MHz)	99% Occupied Bandwidth (MHz)	Limit (kHz)
CH151	5755	36.50	36.60	>=500
CH159	5795	36.50	36.60	>=500

TX CH 151

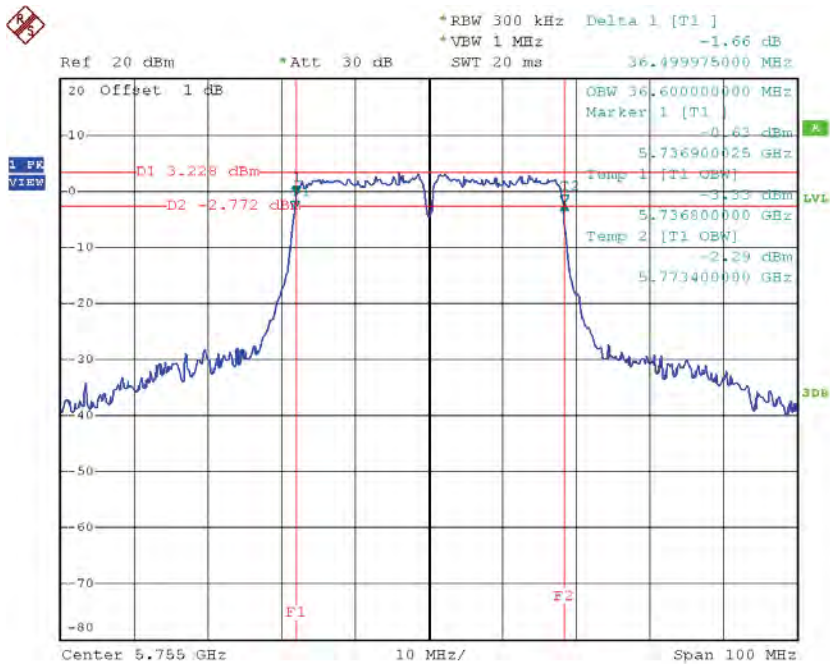

Date: 8.JUN.2015 17:55:16

TX CH 159

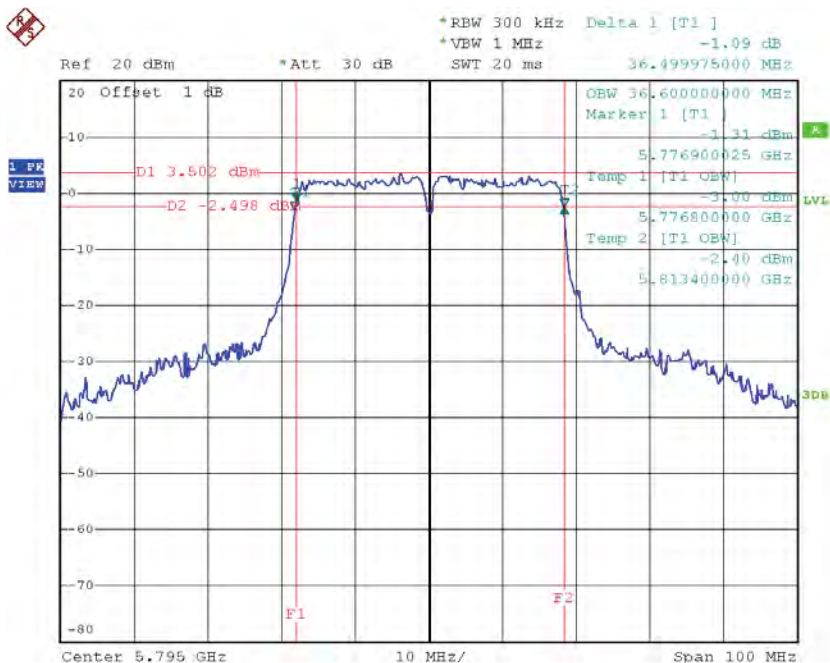

Date: 8.JUN.2015 18:04:25

Test Mode: UNII-1/TX AC20 Mode_CH36/CH40/CH48

Channel	Frequency (MHz)	26dB Bandwidth (MHz)	99% Occupied Bandwidth (MHz)
CH36	5180	21.85	18.20
CH40	5200	21.80	18.20
CH48	5240	21.80	18.20

TX CH36

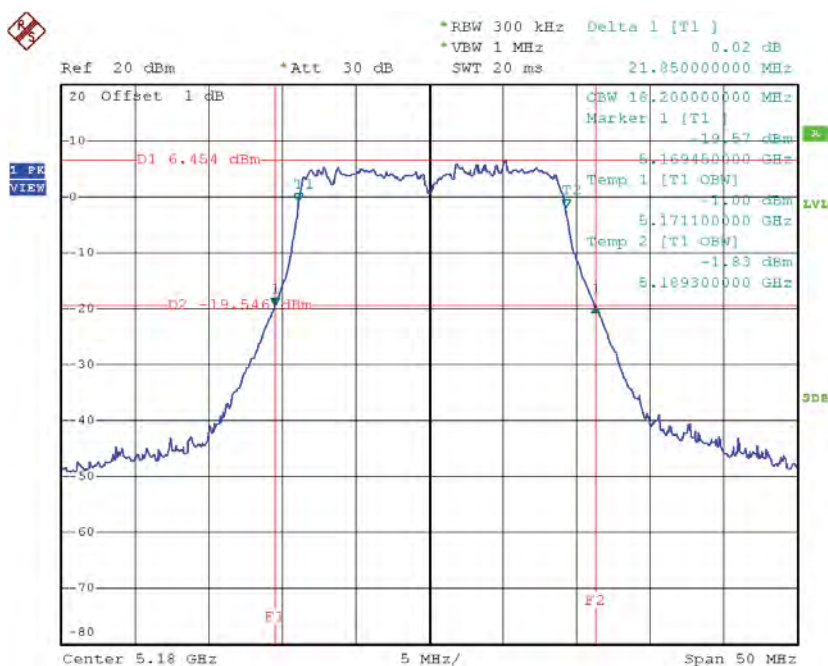

Date: 8.JUN.2015 17:22:04

TX CH40

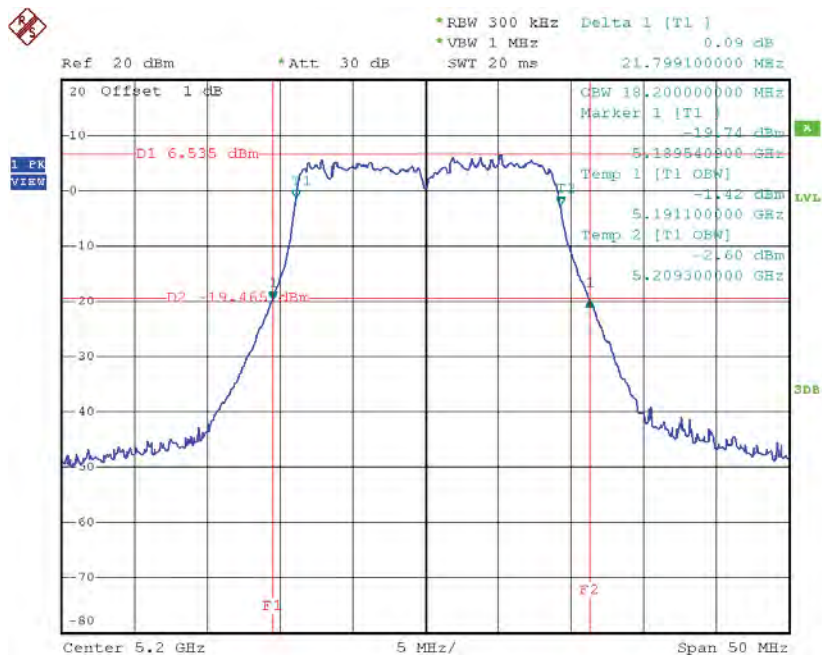

Date: 8.JUN.2015 17:25:10

TX CH48

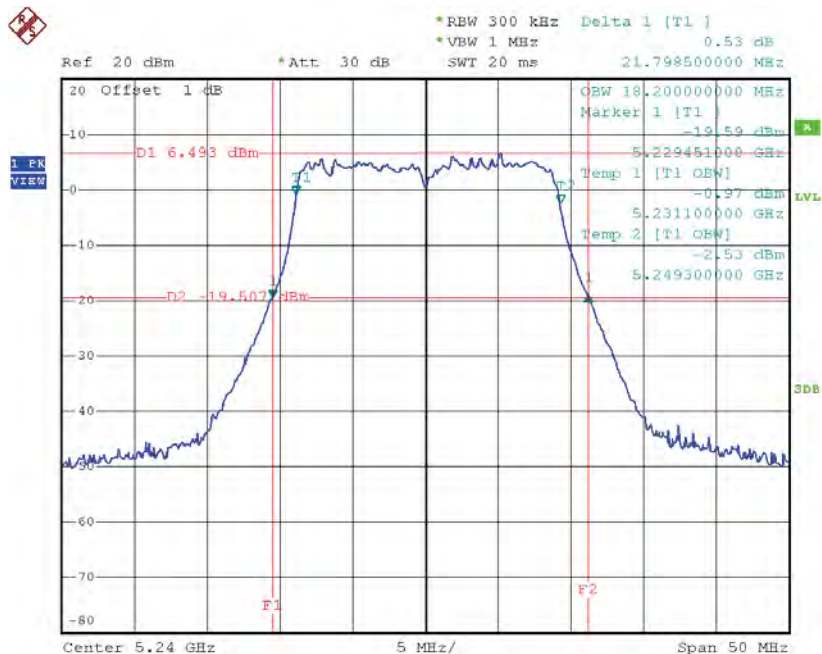

Date: 8.JUN.2015 17:26:36

Test Mode: UNII-1/TX AC40 Mode_CH38/CH46

Channel	Frequency (MHz)	26dB Bandwidth (MHz)	99% Occupied Bandwidth (MHz)
CH38	5190	41.39	36.60
CH46	5230	41.21	36.40

TX CH38

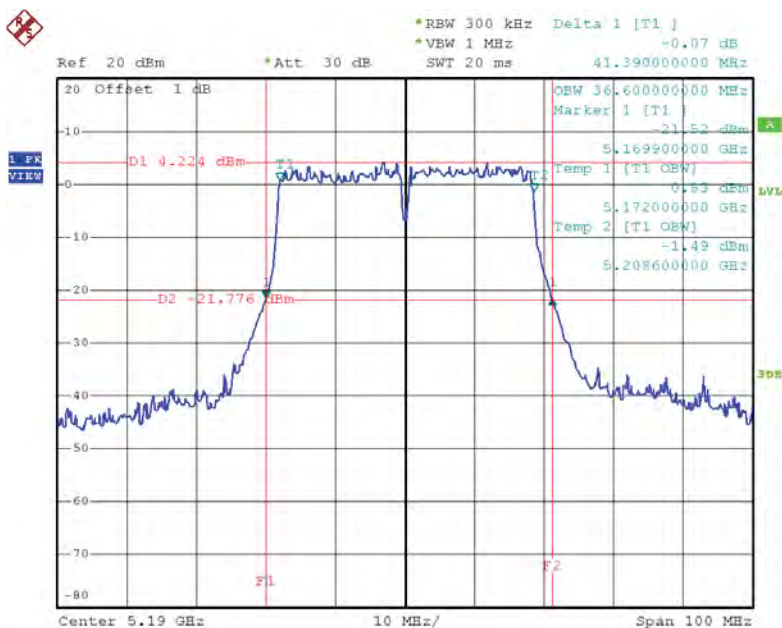

Date: 8.JUN.2015 18:53:38

TX CH46

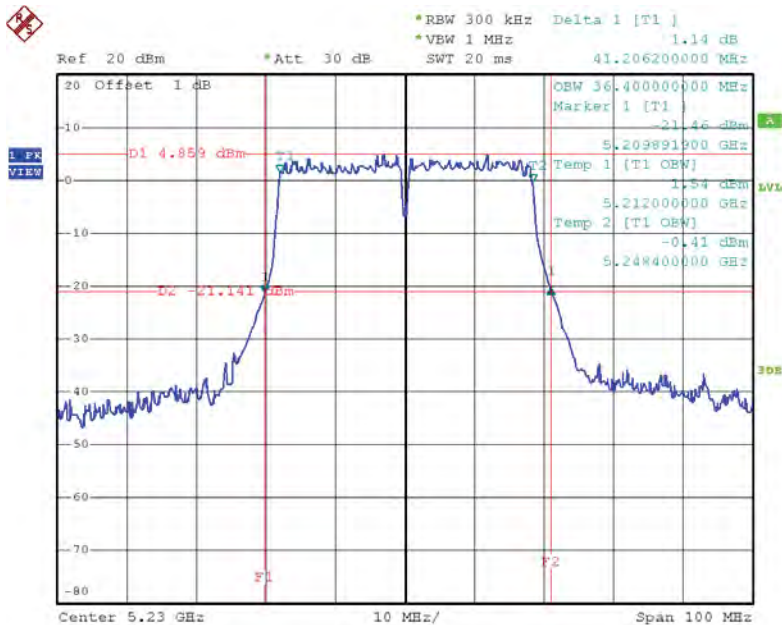

Date: 8.JUN.2015 18:55:44

Test Mode: UNII-1/TX AC80 Mode_CH42

Channel	Frequency (MHz)	26dB Bandwidth (MHz)	99% Occupied Bandwidth (MHz)
CH42	5210	79.20	75.60

TX CH42

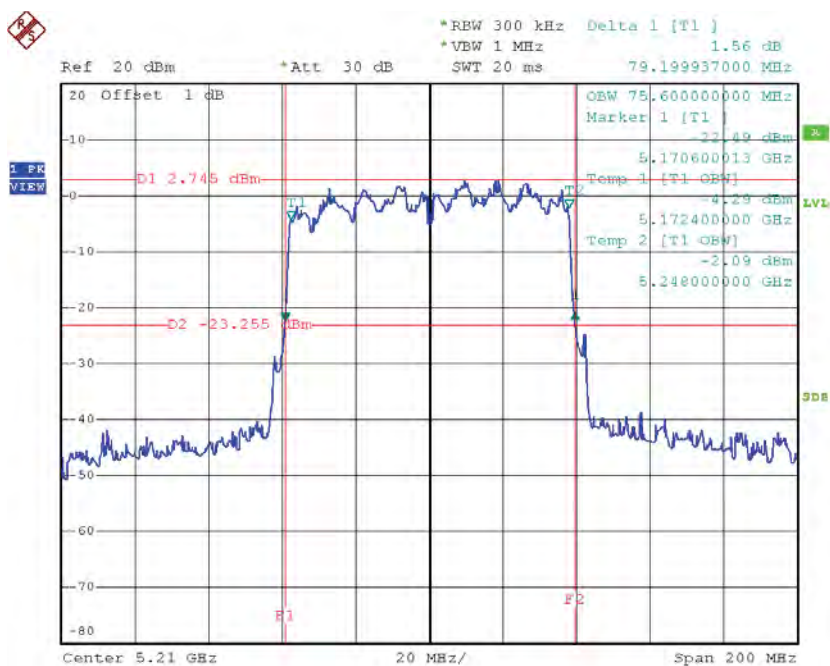

Date: 8.JUN.2015 19:37:18

TX CH 157

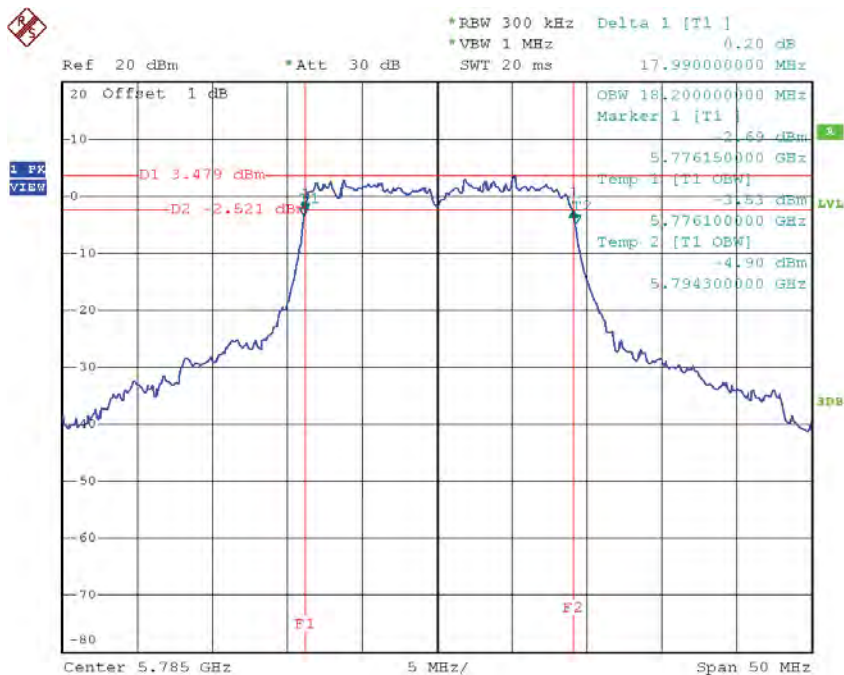

Date: 8.JUN.2015 17:29:39

TX CH 165

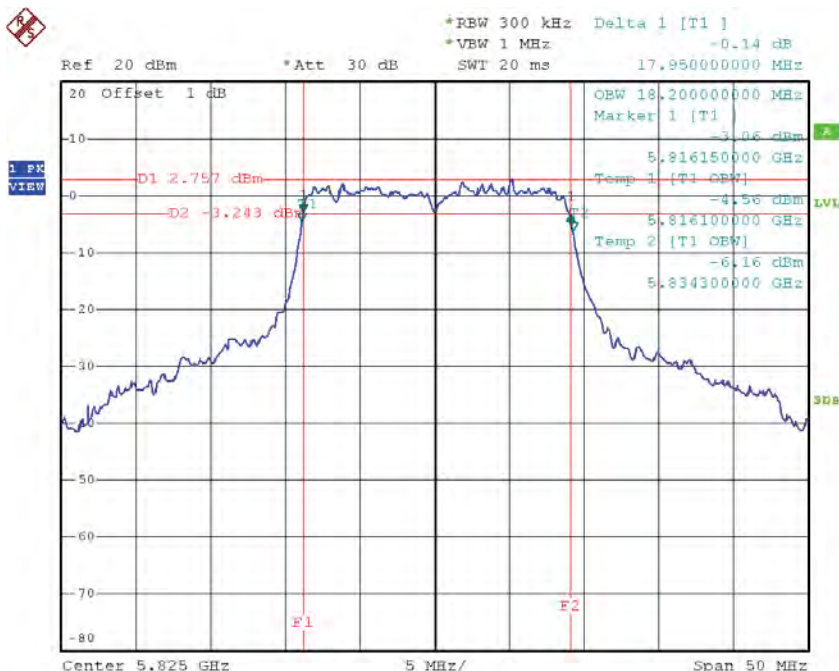

Date: 8.JUN.2015 17:30:58

Test Mode: UNII-3/ TX AC40 Mode_CH151/CH159

Channel	Frequency (MHz)	6dB Bandwidth (MHz)	99% Occupied Bandwidth (MHz)	Limit (kHz)
CH151	5755	36.80	36.40	>=500
CH159	5795	36.59	38.00	>=500

TX CH 151

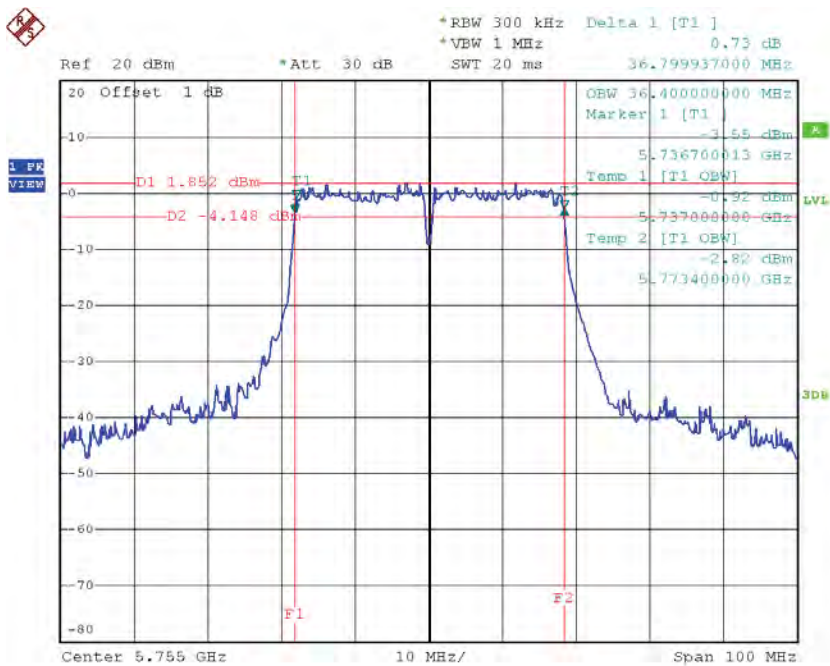

Date: 8.JUN.2015 19:17:15

TX CH 159

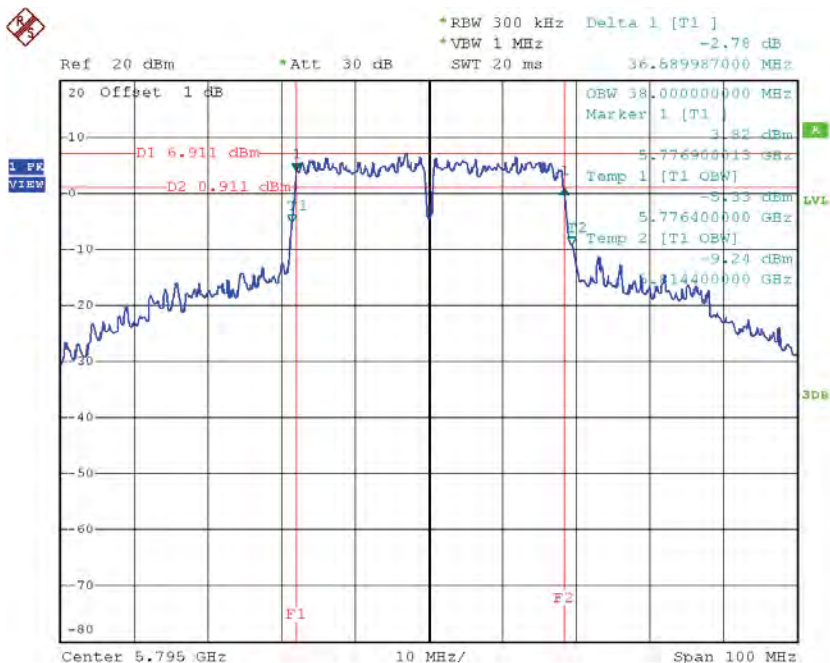

Date: 8.JUN.2015 19:21:17

Test Mode: UNII-3/ TX AC80 Mode_CH155

Channel	Frequency (MHz)	6dB Bandwidth (MHz)	99% Occupied Bandwidth (MHz)	Limit (kHz)
CH155	5775	76.00	75.60	>=500

TX CH 155

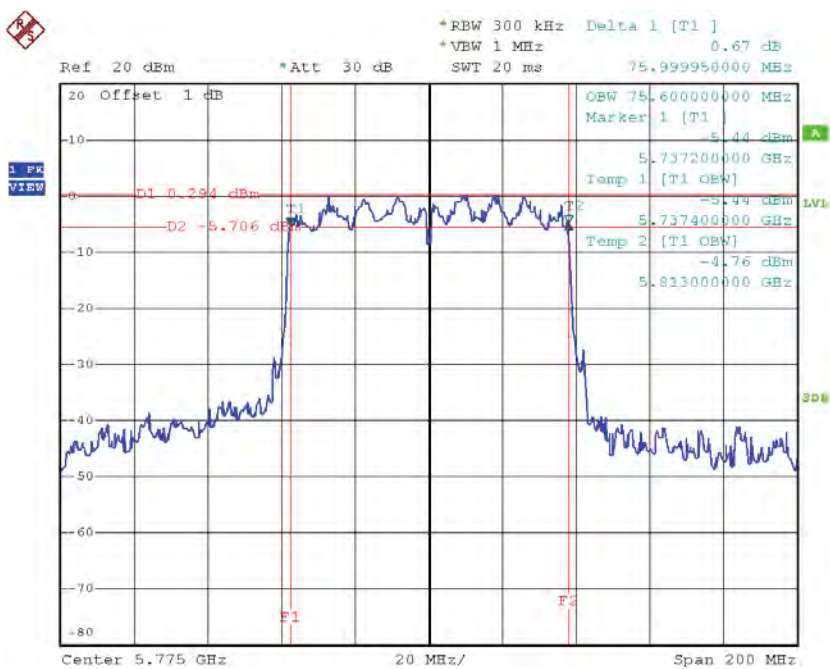

Date: 8.JUN.2015 19:39:41

External antenna

Test Mode: UNII-1/TX A Mode_CH36/CH40/CH48

Channel	Frequency (MHz)	26dB Bandwidth (MHz)	99% Occupied Bandwidth (MHz)
CH36	5180	21.39	17.00
CH40	5200	21.29	16.90
CH48	5240	21.29	16.90

TX CH36

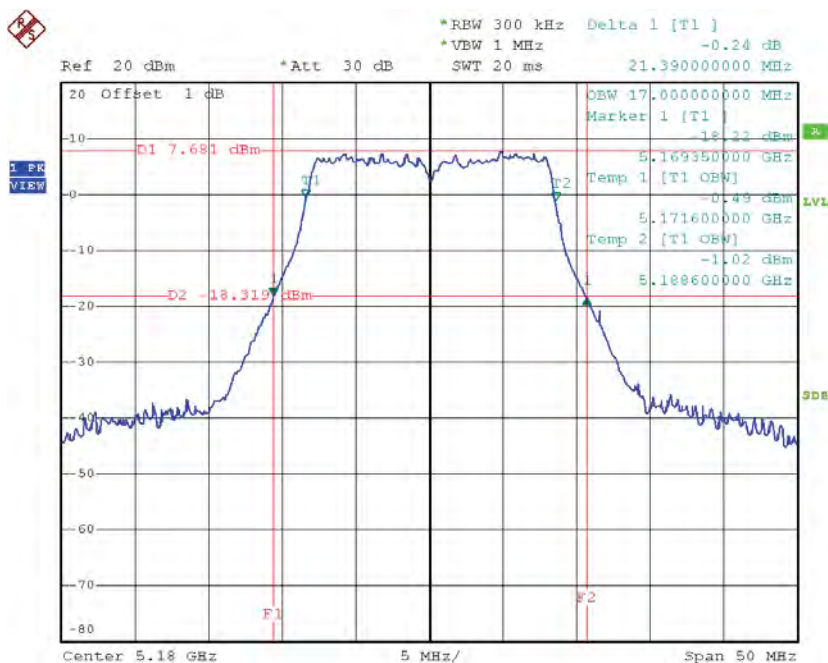

Date: 10.JUN.2015 17:18:31

TX CH40

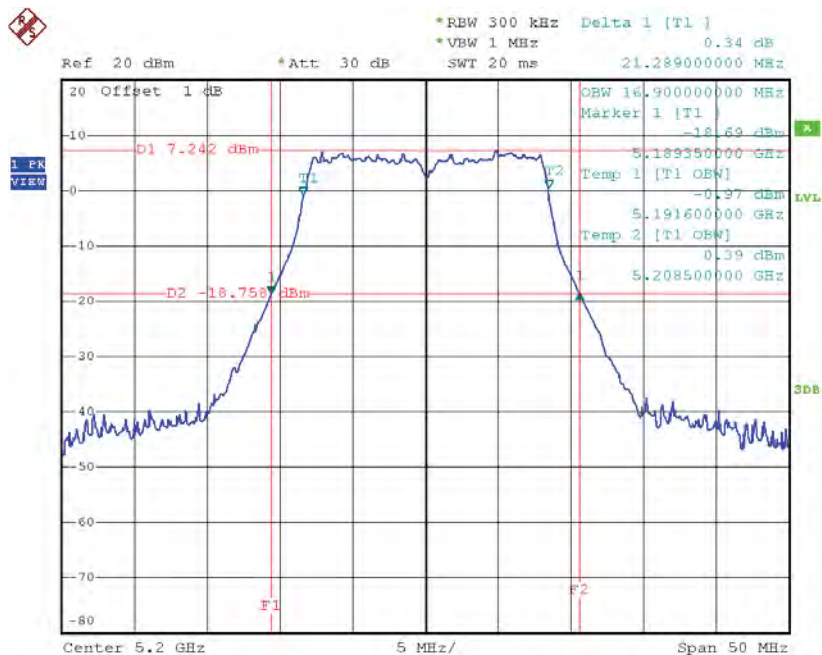

Date: 10.JUN.2015 17:20:24

TX CH48

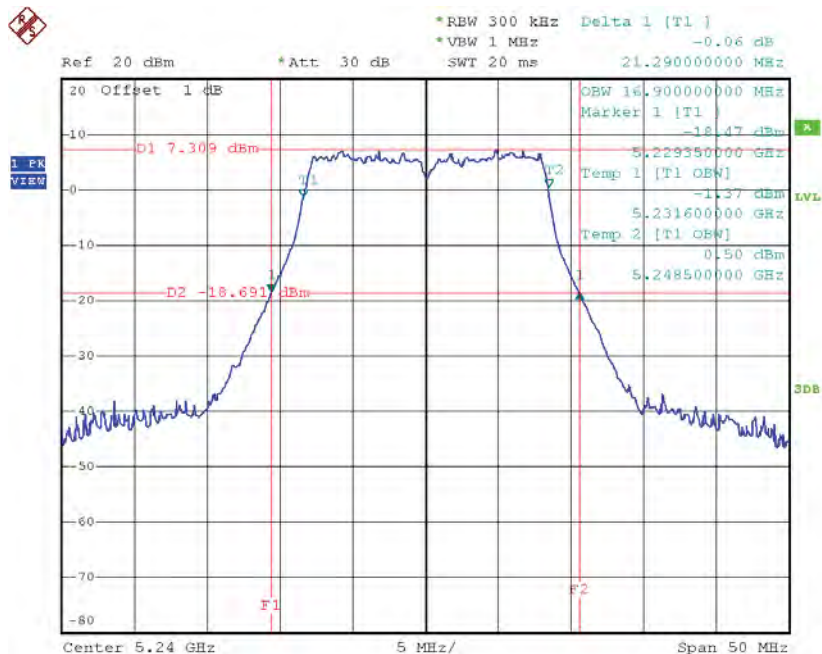

Date: 10.JUN.2015 17:21:50

Test Mode: UNII-1/TX N20 Mode_CH36/CH40/CH48

Channel	Frequency (MHz)	26dB Bandwidth (MHz)	99% Occupied Bandwidth (MHz)
CH36	5180	22.39	18.00
CH40	5200	22.21	18.10
CH48	5240	22.35	18.10

TX CH36

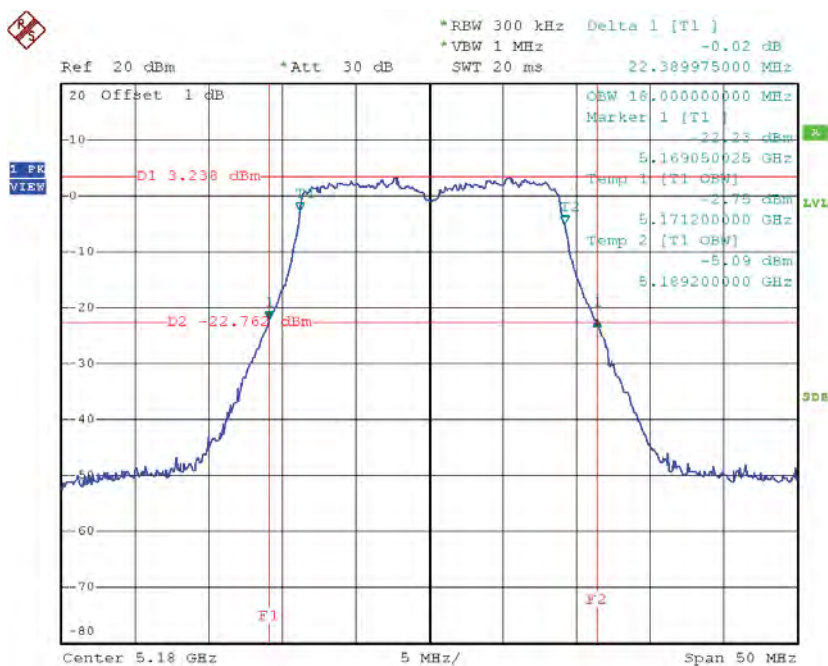

Date: 10.JUN.2015 17:29:17

TX CH40

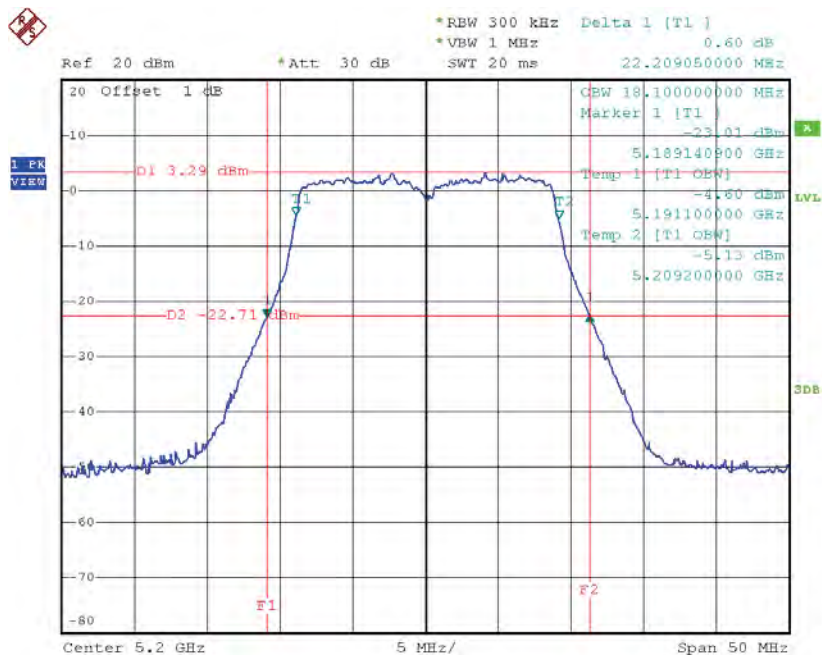

Date: 10.JUN.2015 17:30:41

TX CH48

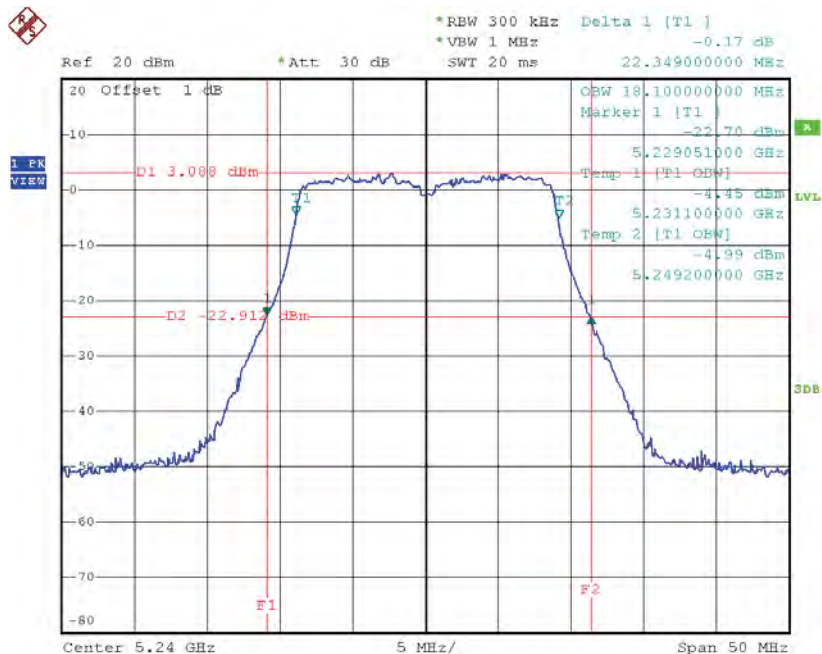

Date: 10.JUN.2015 17:31:46

Test Mode: UNII-1/TX N40 Mode_CH38/CH46

Channel	Frequency (MHz)	26dB Bandwidth (MHz)	99% Occupied Bandwidth (MHz)
CH38	5190	42.59	36.40
CH46	5230	42.42	36.40

TX CH38

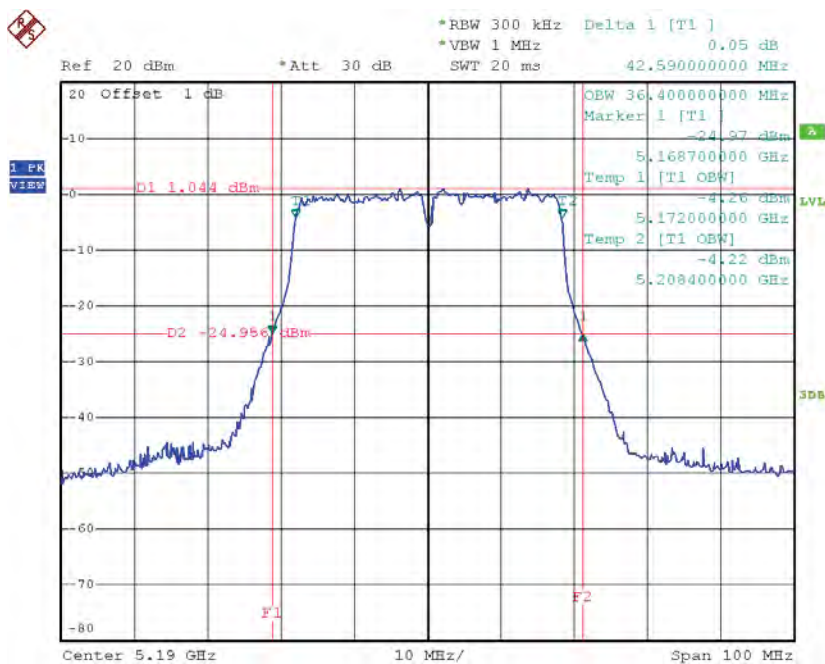

Date: 10.JUN.2015 18:08:05

TX CH46

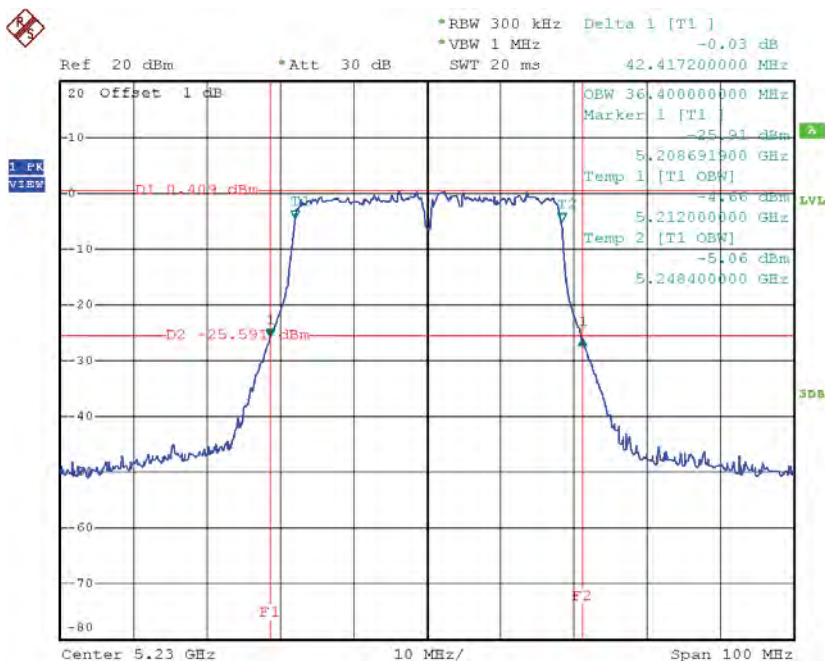

Date: 10.JUN.2015 18:09:46

Test Mode: UNII-3/ TX A Mode_CH149/CH157/CH165

Channel	Frequency (MHz)	6dB Bandwidth (MHz)	99% Occupied Bandwidth (MHz)	Limit (kHz)
CH149	5745	16.55	16.90	>=500
CH157	5785	16.60	16.90	>=500
CH165	5825	16.55	16.90	>=500

TX CH 149

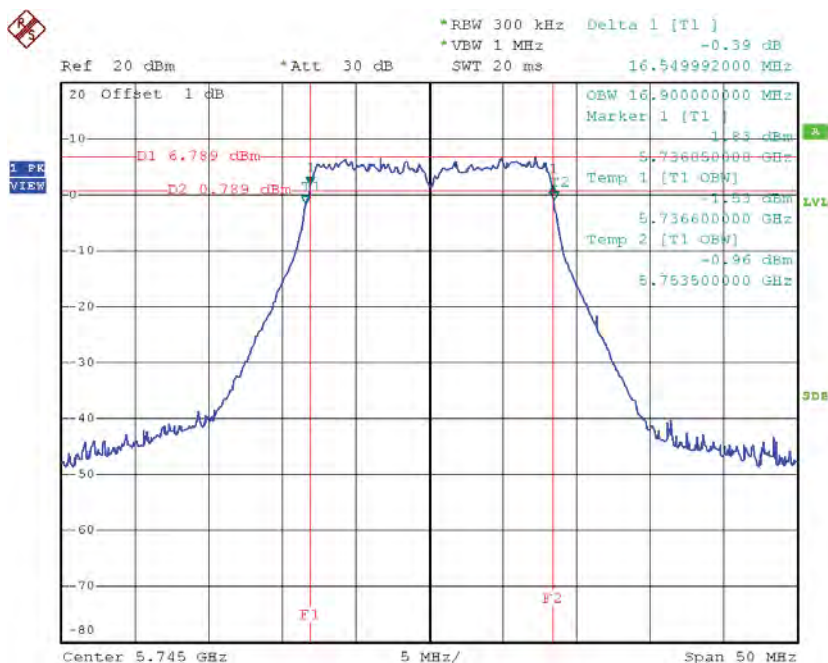

Date: 10.JUN.2015 17:23:57

TX CH 157

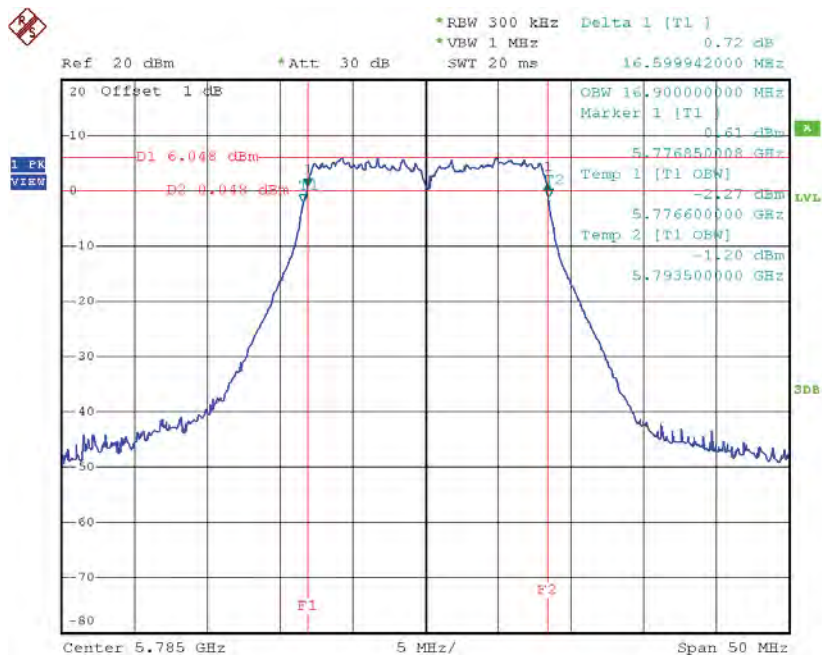

Date: 10.JUN.2015 17:25:37

TX CH 165

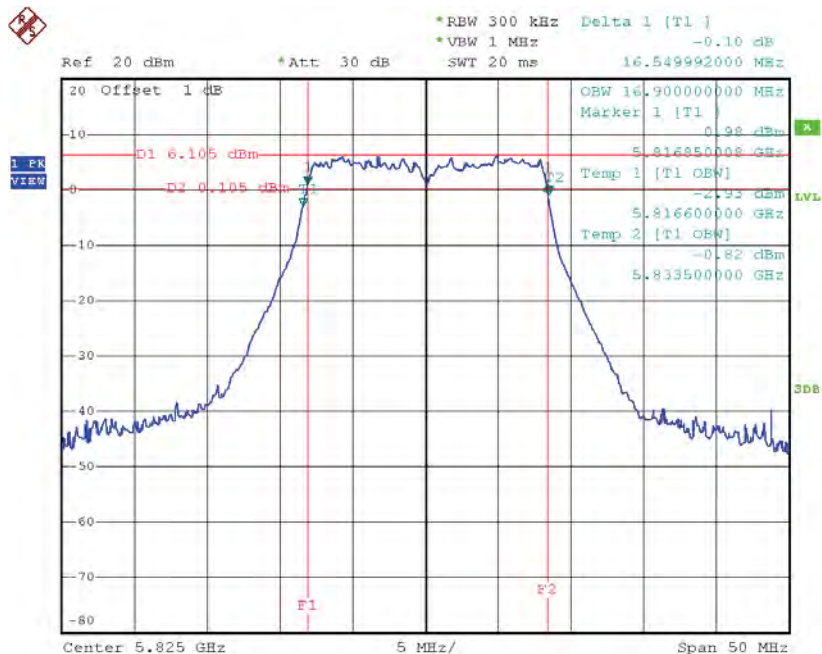

Date: 10.JUN.2015 17:27:01

Test Mode: UNII-3/ TX N20 Mode_CH149/CH157/CH165

Channel	Frequency (MHz)	6dB Bandwidth (MHz)	99% Occupied Bandwidth (MHz)	Limit (kHz)
CH149	5745	17.76	18.10	>=500
CH157	5785	17.85	18.10	>=500
CH165	5825	17.69	18.00	>=500

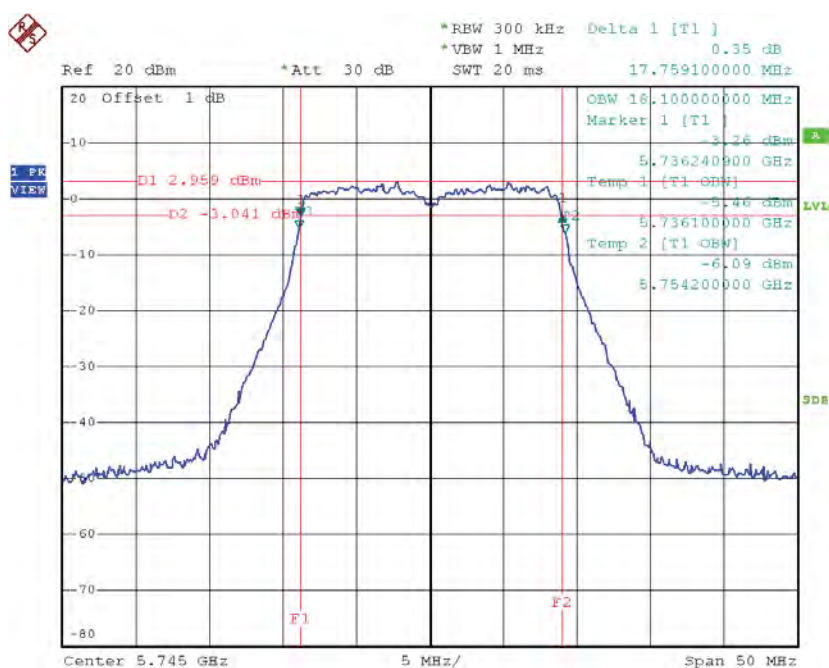
TX CH 149

Date: 10.JUN.2015 17:33:54

TX CH 157

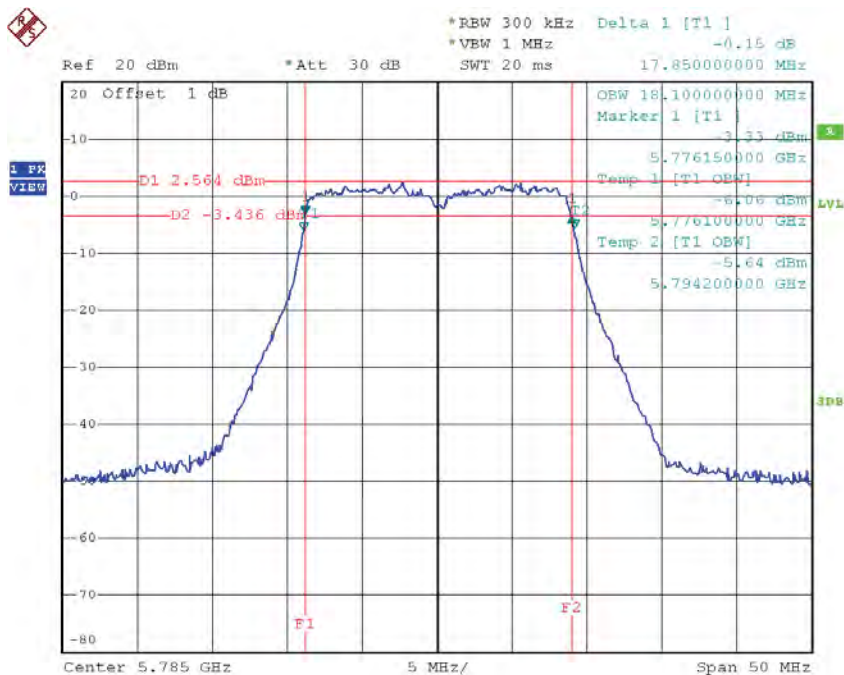

Date: 10.JUN.2015 17:35:06

TX CH 165

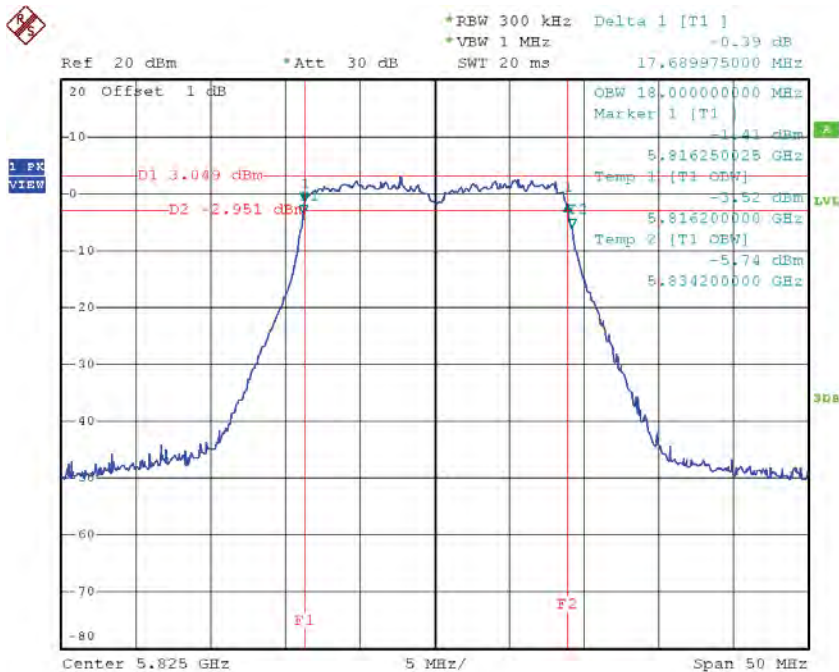

Date: 10.JUN.2015 17:36:10

Test Mode: UNII-3/ TX N40 Mode_CH151/CH159

Channel	Frequency (MHz)	6dB Bandwidth (MHz)	99% Occupied Bandwidth (MHz)	Limit (kHz)
CH151	5755	36.50	36.40	>=500
CH159	5795	36.50	36.40	>=500

TX CH 151

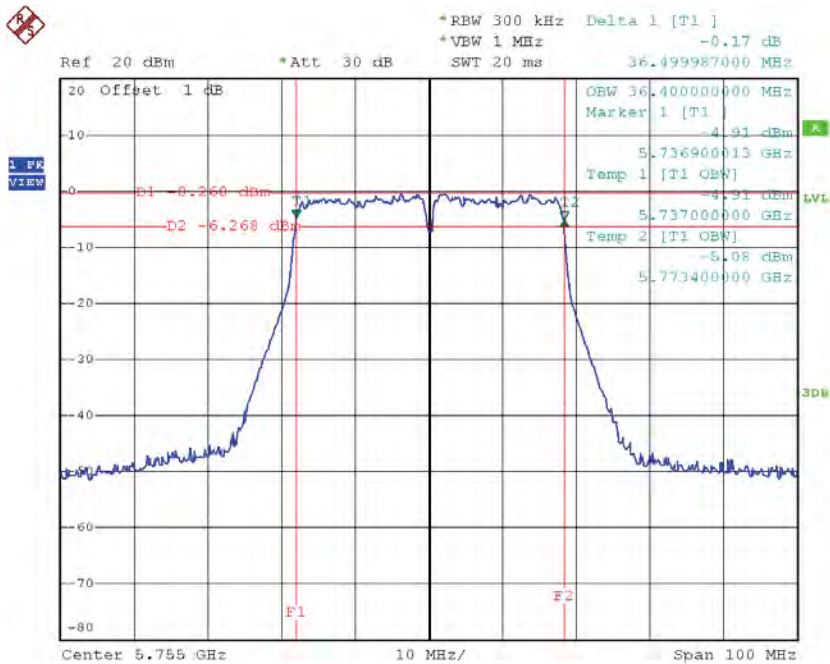

Date: 10.JUN.2015 18:11:38

TX CH 159

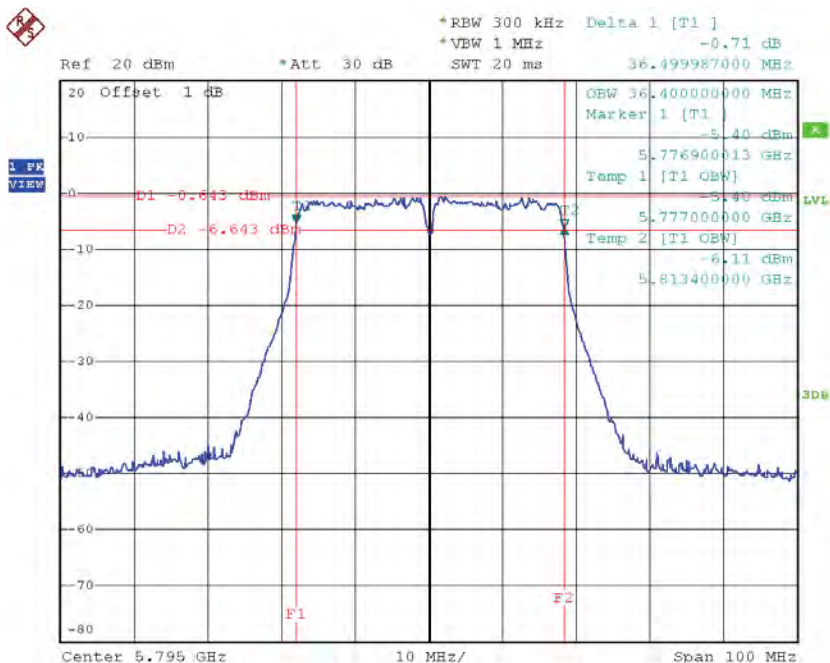

Date: 10.JUN.2015 18:12:47

Test Mode: UNII-1/TX AC20 Mode_CH36/CH40/CH48

Channel	Frequency (MHz)	26dB Bandwidth (MHz)	99% Occupied Bandwidth (MHz)
CH36	5180	22.00	18.10
CH40	5200	22.09	18.10
CH48	5240	22.09	18.10

TX CH36

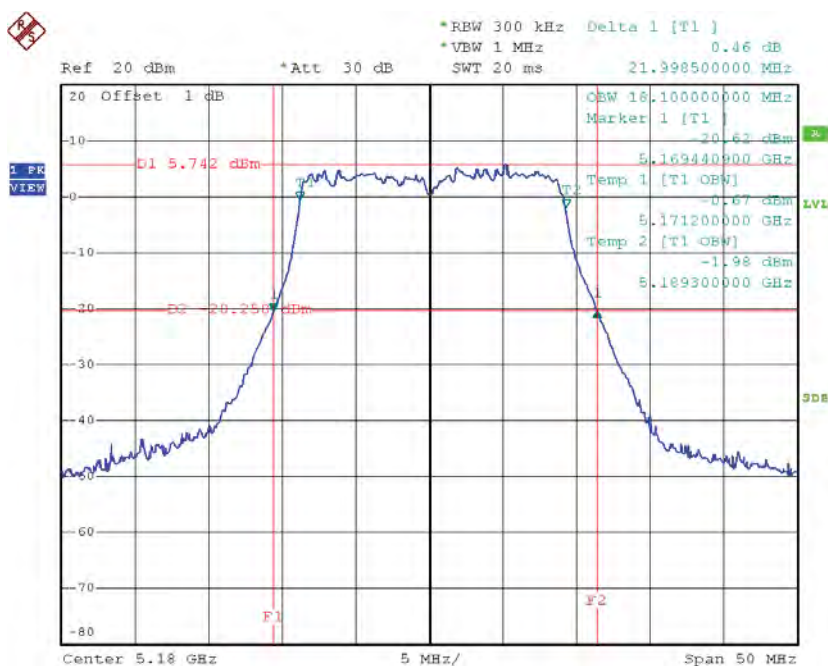

Date: 10.JUN.2015 17:48:04

TX CH40

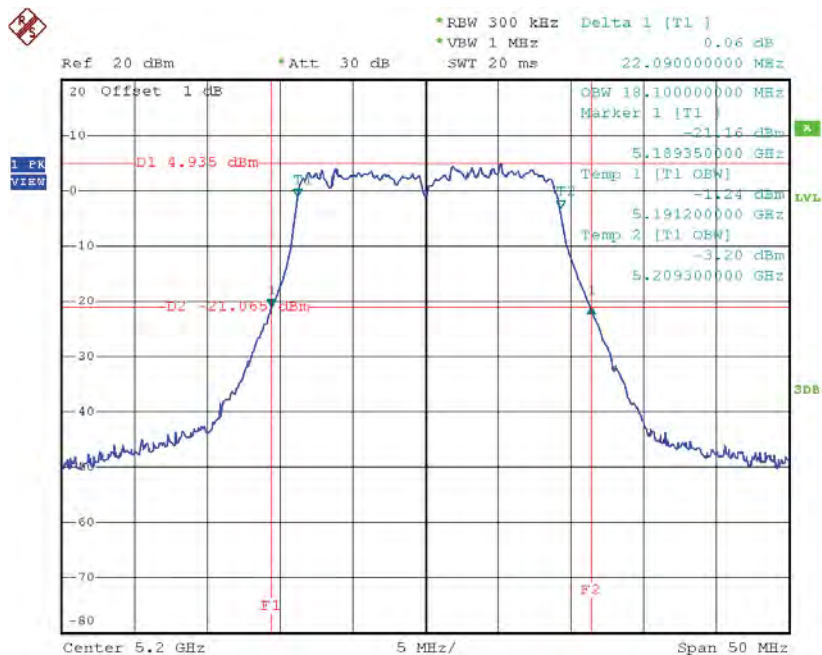

Date: 10.JUN.2015 17:49:27

TX CH48

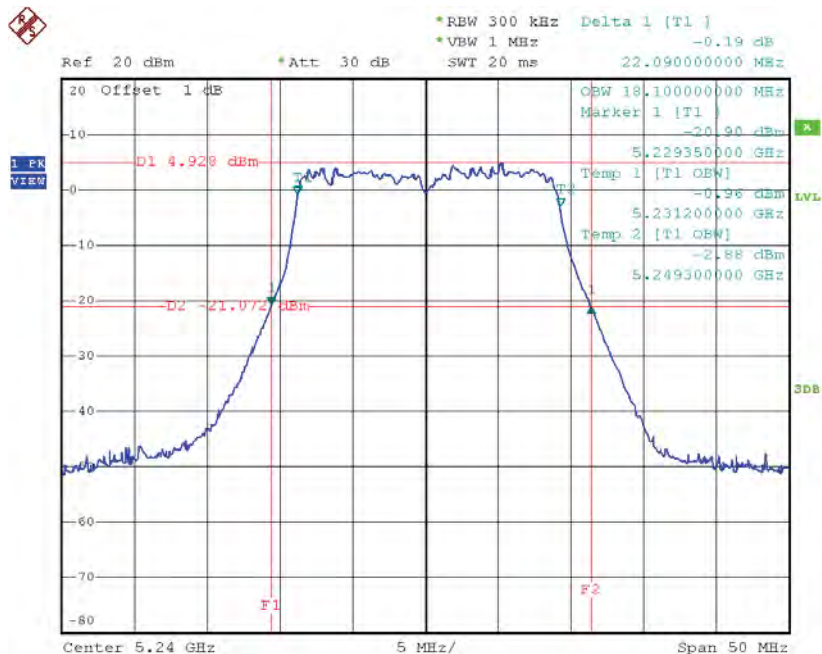

Date: 10.JUN.2015 17:50:26

Test Mode: UNII-1/TX AC40 Mode_CH38/CH46

Channel	Frequency (MHz)	26dB Bandwidth (MHz)	99% Occupied Bandwidth (MHz)
CH38	5190	41.39	36.60
CH46	5230	41.60	36.60

TX CH38

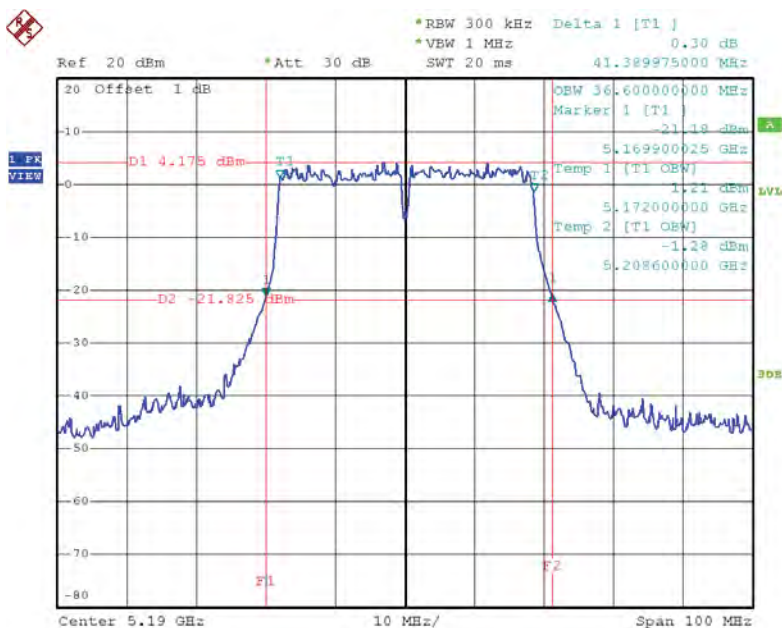

Date: 10.JUN.2015 18:51:00

TX CH46

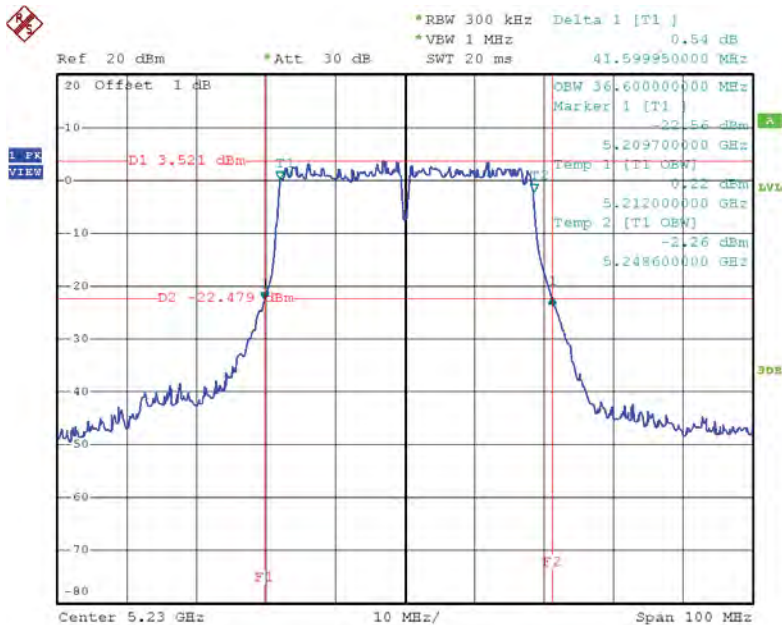

Date: 10.JUN.2015 18:52:30

Test Mode: UNII-1/TX AC80 Mode_CH42

Channel	Frequency (MHz)	26dB Bandwidth (MHz)	99% Occupied Bandwidth (MHz)
CH42	5210	79.80	75.60

TX CH42

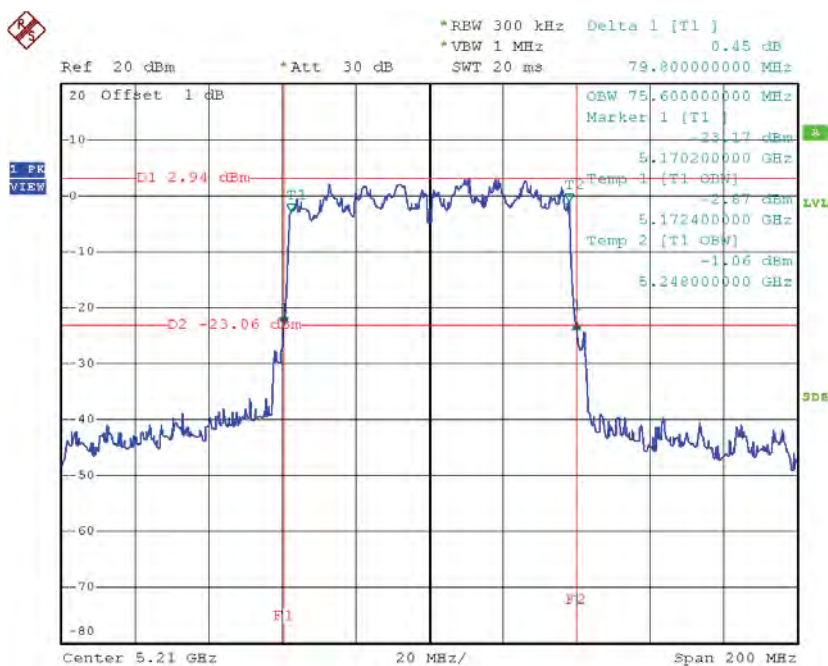

Date: 10.JUN.2015 19:08:49

Test Mode: UNII-3/ TX AC20 Mode_CH149/CH157/CH165

Channel	Frequency (MHz)	6dB Bandwidth (MHz)	99% Occupied Bandwidth (MHz)	Limit (kHz)
CH149	5745	17.89	18.10	>=500
CH157	5785	17.99	18.10	>=500
CH165	5825	17.91	18.10	>=500

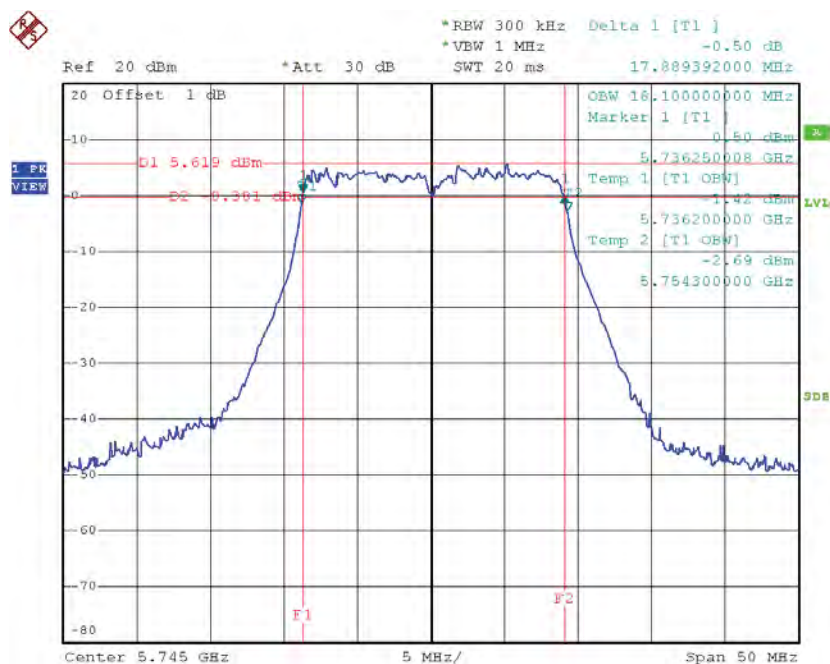
TX CH 149

Date: 10.JUN.2015 17:52:16

TX CH 157

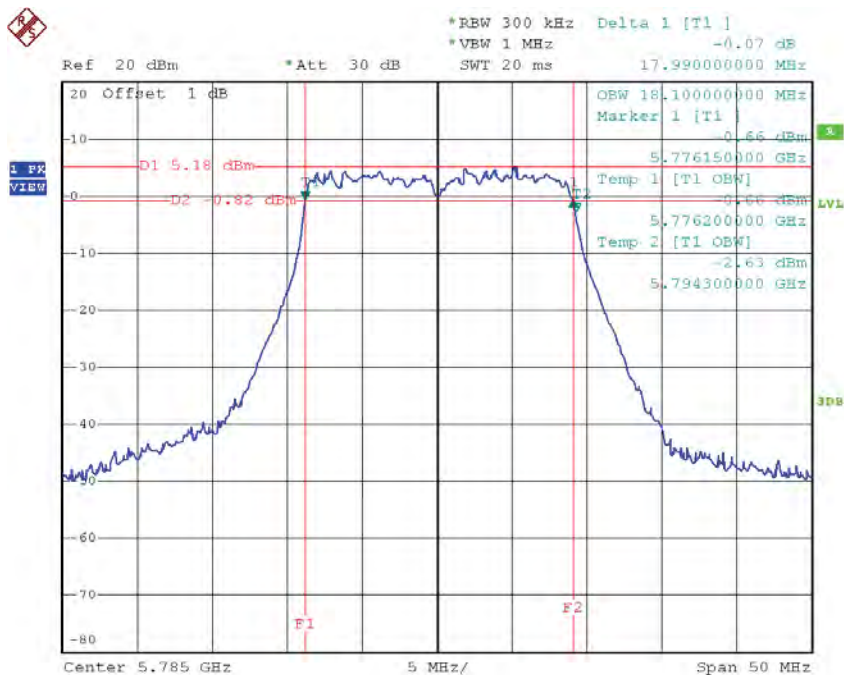

Date: 10.JUN.2015 17:53:26

TX CH 165

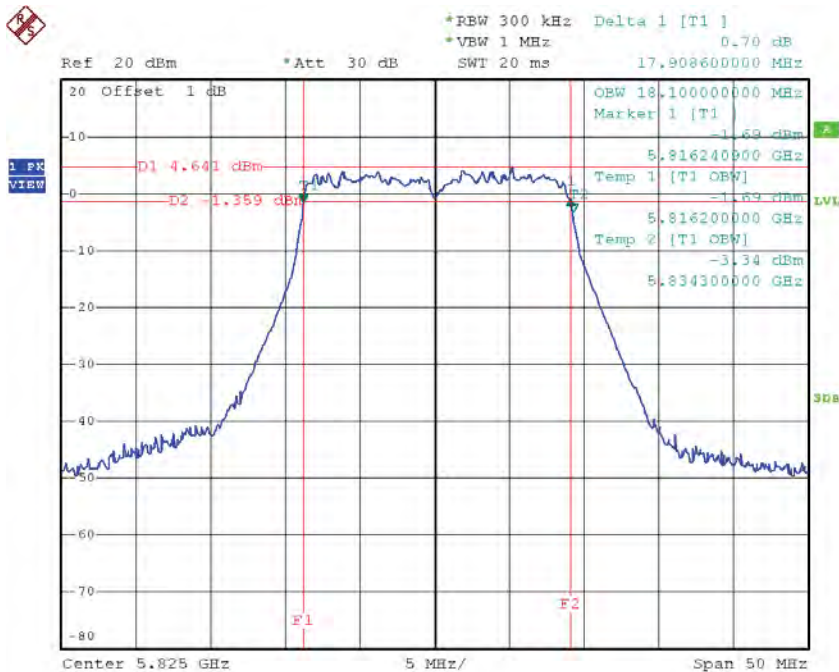

Date: 10.JUN.2015 17:54:38

Test Mode: UNII-3/ TX AC40 Mode_CH151/CH159

Channel	Frequency (MHz)	6dB Bandwidth (MHz)	99% Occupied Bandwidth (MHz)	Limit (kHz)
CH151	5755	36.59	36.40	>=500
CH159	5795	36.60	36.40	>=500

TX CH 151

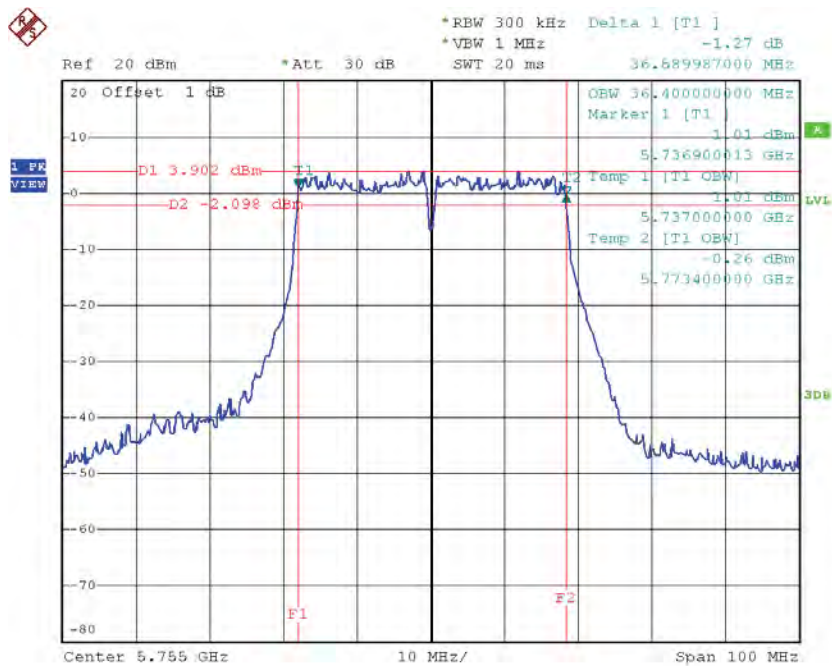

Date: 10.JUN.2015 18:54:36

TX CH 159

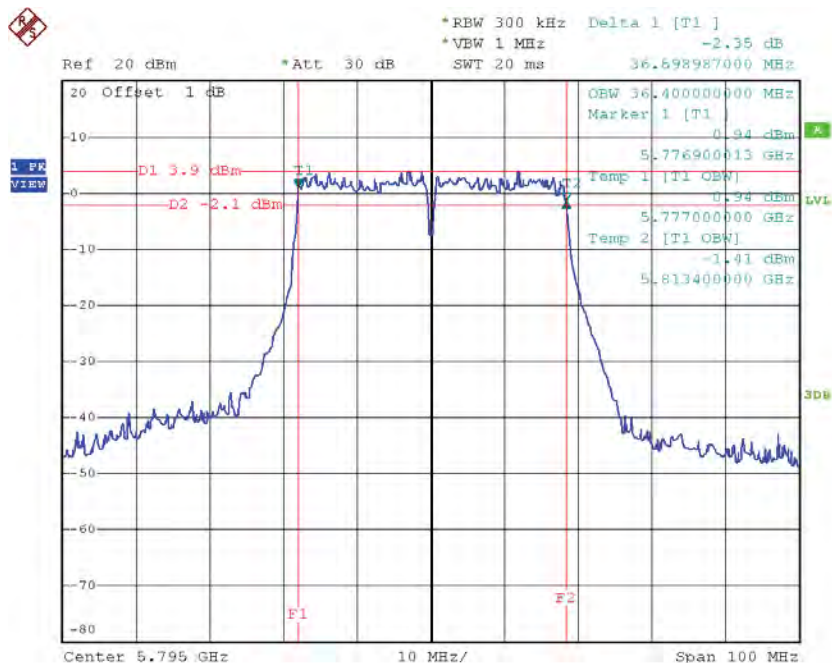

Date: 10.JUN.2015 18:56:59

Test Mode: UNII-3/ TX AC80 Mode_CH155

Channel	Frequency (MHz)	6dB Bandwidth (MHz)	99% Occupied Bandwidth (MHz)	Limit (kHz)
CH155	5775	76.40	75.60	>=500

TX CH 155

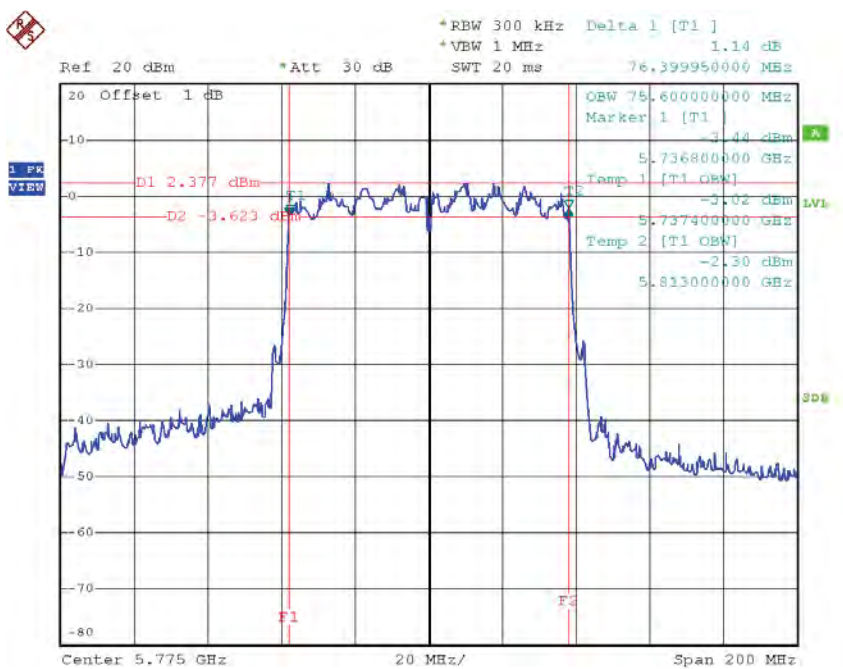

Date: 10.JUN.2015 19:10:51

ATTACHMENT F - MAXIMUM OUTPUT POWER

Internal antenna

Test Mode: UNII-1/TX A Mode						
Channel	Frequency (MHz)	FCC Part 15E Conducted Output Power (dBm)	Duty Factor (dBm)	FCC Part 15E Conducted Output Power + Duty Factor (dBm)	Limit (dBm)	Limit (Watt)
CH36	5180	14.87	0.10	14.97	30.00	1.00
CH40	5200	14.85	0.10	14.95	30.00	1.00
CH48	5240	14.92	0.10	15.02	30.00	1.00

Test Mode: UNII-1/TX A Mode					
Channel	Frequency (MHz)	RSS-247 E.I.R.P Output Power (dBm)		Limit (dBm)	Limit (Watt)
CH36	5180	18.25		23.00	0.20
CH40	5200	18.23		23.00	0.20
CH48	5240	18.30		23.00	0.20

Test Mode: UNII-1/TX N20 Mode_ANT 3						
Channel	Frequency (MHz)	FCC Part 15E Conducted Output Power (dBm)	Duty Factor (dBm)	FCC Part 15E Conducted Output Power + Duty Factor (dBm)	Limit (dBm)	Limit (Watt)
CH36	5180	11.86	0.29	12.15	30.00	1.00
CH40	5200	11.98	0.29	12.27	30.00	1.00
CH48	5240	11.97	0.29	12.26	30.00	1.00

Test Mode: UNII-1/TX N20 Mode_ANT 4						
Channel	Frequency (MHz)	FCC Part 15E Conducted Output Power (dBm)	Duty Factor (dBm)	FCC Part 15E Conducted Output Power + Duty Factor (dBm)	Limit (dBm)	Limit (Watt)
CH36	5180	11.94	0.29	12.23	30.00	1.00
CH40	5200	11.87	0.29	12.16	30.00	1.00
CH48	5240	11.97	0.29	12.26	30.00	1.00

Test Mode: UNII-1/TX N20 Mode_Total					
Channel	Frequency (MHz)	FCC Part 15E Conducted Output Power (dBm)		Limit (dBm)	Limit (Watt)
CH36	5180	15.20		30.00	1.00
CH40	5200	15.23		30.00	1.00
CH48	5240	15.27		30.00	1.00

Test Mode: UNII-1/TX N20 Mode_ANT 3				
Channel	Frequency (MHz)	RSS-247 E.I.R.P Output Power (dBm)	Limit (dBm)	Limit (Watt)
CH36	5180	15.24	23.00	0.20
CH40	5200	15.36	23.00	0.20
CH48	5240	15.35	23.00	0.20

Test Mode: UNII-1/TX N20 Mode_ANT 4				
Channel	Frequency (MHz)	RSS-247 E.I.R.P Output Power (dBm)	Limit (dBm)	Limit (Watt)
CH36	5180	15.02	23.00	0.20
CH40	5200	14.95	23.00	0.20
CH48	5240	15.05	23.00	0.20

Test Mode: UNII-1/TX N20 Mode_Total				
Channel	Frequency (MHz)	RSS-247 E.I.R.P Output Power (dBm)	Limit (dBm)	Limit (Watt)
CH36	5180	18.14	23.00	0.20
CH40	5200	18.17	23.00	0.20
CH48	5240	18.21	23.00	0.20

Test Mode: UNII-1/TX N40 Mode_ANT 3						
Channel	Frequency (MHz)	FCC Part 15E Conducted Output Power (dBm)	Duty Factor (dBm)	FCC Part 15E Conducted Output Power + Duty Factor (dBm)	Limit (dBm)	Limit (Watt)
CH38	5190	11.93	0.76	12.69	30.00	1.00
CH46	5230	11.97	0.76	12.73	30.00	1.00

Test Mode: UNII-1/TX N40 Mode_ANT 4						
Channel	Frequency (MHz)	FCC Part 15E Conducted Output Power (dBm)	Duty Factor (dBm)	FCC Part 15E Conducted Output Power + Duty Factor (dBm)	Limit (dBm)	Limit (Watt)
CH38	5190	11.94	0.76	12.70	30.00	1.00
CH46	5230	11.85	0.76	12.61	30.00	1.00

Test Mode: UNII-1/TX N40 Mode_Total					
Channel	Frequency (MHz)	FCC Part 15E Conducted Output Power (dBm)		Limit (dBm)	Limit (Watt)
CH38	5190	15.71		30.00	1.00
CH46	5230	15.68		30.00	1.00

Test Mode: UNII-1/TX N40 Mode_ANT 3				
Channel	Frequency (MHz)	RSS-247 E.I.R.P Output Power (dBm)	Limit (dBm)	Limit (Watt)
CH38	5190	15.31	23.00	0.20
CH46	5230	15.35	23.00	0.20

Test Mode: UNII-1/TX N40 Mode_ANT 4				
Channel	Frequency (MHz)	RSS-247 E.I.R.P Output Power (dBm)	Limit (dBm)	Limit (Watt)
CH38	5190	15.02	23.00	0.20
CH46	5230	14.93	23.00	0.20

Test Mode: UNII-1/TX N40 Mode_Total				
Channel	Frequency (MHz)	RSS-247 E.I.R.P Output Power (dBm)	Limit (dBm)	Limit (Watt)
CH38	5190	18.18	23.00	0.20
CH46	5230	18.16	23.00	0.20

Test Mode: UNII-3/ TX A Mode

Channel	Frequency (MHz)	Output Power (dBm)	Duty Factor (dBm)	Output Power + Duty Factor (dBm)	Limit (dBm)	Limit (Watt)
CH149	5745	14.84	0.10	14.94	30.00	1.00
CH157	5785	14.82	0.10	14.92	30.00	1.00
CH165	5825	14.95	0.10	15.05	30.00	1.00

Test Mode: UNII-3/TX N20 Mode_ANT 3

Channel	Frequency (MHz)	Output Power (dBm)	Duty Factor (dBm)	Output Power + Duty Factor (dBm)	Limit (dBm)	Limit (Watt)
CH149	5745	11.95	0.29	12.24	30.00	1.00
CH157	5785	11.77	0.29	12.06	30.00	1.00
CH165	5825	11.92	0.29	12.21	30.00	1.00

Test Mode: UNII-3/TX N20 Mode_ANT 4

Channel	Frequency (MHz)	Output Power (dBm)	Duty Factor (dBm)	Output Power + Duty Factor (dBm)	Limit (dBm)	Limit (Watt)
CH149	5745	11.93	0.29	12.22	30.00	1.00
CH157	5785	11.84	0.29	12.13	30.00	1.00
CH165	5825	11.91	0.29	12.20	30.00	1.00

Test Mode: UNII-3/TX N20 Mode_Total

Channel	Frequency (MHz)	Output Power (dBm)	Limit (dBm)	Limit (Watt)
CH149	5745	15.24	30.00	1.00
CH157	5785	15.11	30.00	1.00
CH165	5825	15.22	30.00	1.00

Test Mode: UNII-3/ TX N40 Mode_ANT 3						
Channel	Frequency (MHz)	Output Power (dBm)	Duty Factor (dBm)	Output Power + Duty Factor (dBm)	Limit (dBm)	Limit (Watt)
CH151	5755	11.92	0.76	12.68	30.00	1.00
CH159	5795	11.85	0.76	12.61	30.00	1.00

Test Mode: UNII-3/ TX N40 Mode_ANT 4						
Channel	Frequency (MHz)	Output Power (dBm)	Duty Factor (dBm)	Output Power + Duty Factor (dBm)	Limit (dBm)	Limit (Watt)
CH151	5755	11.96	0.76	12.72	30.00	1.00
CH159	5795	11.93	0.76	12.69	30.00	1.00

Test Mode: UNII-3/ TX N40 Mode_Total					
Channel	Frequency (MHz)	Output Power (dBm)		Limit (dBm)	Limit (Watt)
CH151	5755	15.71		30.00	1.00
CH159	5795	15.66		30.00	1.00

Test Mode: UNII-1/TX AC20 Mode_ANT 3

Channel	Frequency (MHz)	Output Power (dBm)	Duty Factor (dBm)	Output Power + Duty Factor (dBm)	Limit (dBm)	Limit (Watt)
CH36	5180	11.98	1.20	13.18	30.00	1.00
CH40	5200	11.91	1.20	13.11	30.00	1.00
CH48	5240	11.93	1.20	13.13	30.00	1.00

Test Mode: UNII-1/TX AC20 Mode_ANT 4

Channel	Frequency (MHz)	Output Power (dBm)	Duty Factor (dBm)	Output Power + Duty Factor (dBm)	Limit (dBm)	Limit (Watt)
CH36	5180	11.95	1.20	13.15	30.00	1.00
CH40	5200	11.98	1.20	13.18	30.00	1.00
CH48	5240	11.89	1.20	13.09	30.00	1.00

Test Mode: UNII-1/TX AC20 Mode_Total

Channel	Frequency (MHz)	Output Power (dBm)	Limit (dBm)	Limit (Watt)
CH36	5180	16.18	30.00	1.00
CH40	5200	16.16	30.00	1.00
CH48	5240	16.12	30.00	1.00

Test Mode: UNII-1/TX AC20 Mode_ANT 3				
Channel	Frequency (MHz)	RSS-247 E.I.R.P Output Power (dBm)	Limit (dBm)	Limit (Watt)
CH36	5180	15.36	23.00	0.20
CH40	5200	15.29	23.00	0.20
CH48	5240	15.31	23.00	0.20

Test Mode: UNII-1/TX AC20 Mode_ANT 4				
Channel	Frequency (MHz)	RSS-247 E.I.R.P Output Power (dBm)	Limit (dBm)	Limit (Watt)
CH36	5180	15.03	23.00	0.20
CH40	5200	15.06	23.00	0.20
CH48	5240	14.97	23.00	0.20

Test Mode: UNII-1/TX AC20 Mode_Total				
Channel	Frequency (MHz)	RSS-247 E.I.R.P Output Power (dBm)	Limit (dBm)	Limit (Watt)
CH36	5180	18.21	23.00	0.20
CH40	5200	18.19	23.00	0.20
CH48	5240	18.15	23.00	0.20

Test Mode: UNII-1/TX AC40 Mode_ANT 3						
Channel	Frequency (MHz)	FCC Part 15E Conducted Output Power (dBm)	Duty Factor (dBm)	FCC Part 15E Conducted Output Power + Duty Factor (dBm)	Limit (dBm)	Limit (Watt)
CH38	5190	11.82	2.34	14.16	30.00	1.00
CH46	5230	11.98	2.34	14.32	30.00	1.00

Test Mode: UNII-1/TX AC40 Mode_ANT 4						
Channel	Frequency (MHz)	FCC Part 15E Conducted Output Power (dBm)	Duty Factor (dBm)	FCC Part 15E Conducted Output Power + Duty Factor (dBm)	Limit (dBm)	Limit (Watt)
CH38	5190	11.96	2.34	14.30	30.00	1.00
CH46	5230	11.92	2.34	14.26	30.00	1.00

Test Mode: UNII-1/TX AC40 Mode_Total					
Channel	Frequency (MHz)	FCC Part 15E Conducted Output Power (dBm)		Limit (dBm)	Limit (Watt)
CH38	5190	17.24		30.00	1.00
CH46	5230	17.30		30.00	1.00

Test Mode: UNII-1/TX AC40 Mode_ANT 3

Channel	Frequency (MHz)	RSS-247 E.I.R.P Output Power (dBm)	Limit (dBm)	Limit (Watt)
CH38	5190	15.20	23.00	0.20
CH46	5230	15.36	23.00	0.20

Test Mode: UNII-1/TX AC40 Mode_ANT 4

Channel	Frequency (MHz)	RSS-247 E.I.R.P Output Power (dBm)	Limit (dBm)	Limit (Watt)
CH38	5190	15.04	23.00	0.20
CH46	5230	15.00	23.00	0.20

Test Mode: UNII-1/TX AC40 Mode_Total

Channel	Frequency (MHz)	RSS-247 E.I.R.P Output Power (dBm)	Limit (dBm)	Limit (Watt)
CH38	5190	18.13	23.00	0.20
CH46	5230	18.19	23.00	0.20

Test Mode: UNII-1/TX AC80 Mode_ANT 3						
Channel	Frequency (MHz)	Output Power (dBm)	Duty Factor (dBm)	Output Power + Duty Factor (dBm)	Limit (dBm)	Limit (Watt)
CH42	5210	11.91	1.05	12.96	30.00	1.00

Test Mode: UNII-1/TX AC80 Mode_ANT 4						
Channel	Frequency (MHz)	Output Power (dBm)	Duty Factor (dBm)	Output Power + Duty Factor (dBm)	Limit (dBm)	Limit (Watt)
CH42	5210	11.75	1.05	12.80	30.00	1.00

Test Mode: UNII-1/TX AC80 Mode_Total						
Channel	Frequency (MHz)	Output Power (dBm)			Limit (dBm)	Limit (Watt)
CH42	5210	15.89			30.00	1.00

Test Mode: UNII-1/TX AC80 Mode_ANT 3				
Channel	Frequency (MHz)	RSS-247 E.I.R.P Output Power (dBm)	Limit (dBm)	Limit (Watt)
CH42	5210	15.29	23.00	0.20

Test Mode: UNII-1/TX AC80 Mode_ANT 4				
Channel	Frequency (MHz)	RSS-247 E.I.R.P Output Power (dBm)	Limit (dBm)	Limit (Watt)
CH42	5210	14.83	23.00	0.20

Test Mode: UNII-1/TX AC80 Mode_Total				
Channel	Frequency (MHz)	RSS-247 E.I.R.P Output Power (dBm)	Limit (dBm)	Limit (Watt)
CH42	5210	18.08	23.00	0.20

Test Mode: UNII-3/TX AC20 Mode_ANT 3

Channel	Frequency (MHz)	Output Power (dBm)	Duty Factor (dBm)	Output Power + Duty Factor (dBm)	Limit (dBm)	Limit (Watt)
CH149	5745	11.84	1.20	13.04	30.00	1.00
CH157	5785	11.76	1.20	12.96	30.00	1.00
CH165	5825	11.91	1.20	13.11	30.00	1.00

Test Mode: UNII-3/TX AC20 Mode_ANT 4

Channel	Frequency (MHz)	Output Power (dBm)	Duty Factor (dBm)	Output Power + Duty Factor (dBm)	Limit (dBm)	Limit (Watt)
CH149	5745	11.96	1.20	13.16	30.00	1.00
CH157	5785	11.94	1.20	13.14	30.00	1.00
CH165	5825	11.88	1.20	13.08	30.00	1.00

Test Mode: UNII-3/TX AC20 Mode_Total

Channel	Frequency (MHz)	Output Power (dBm)	Limit (dBm)	Limit (Watt)
CH149	5745	16.11	30.00	1.00
CH157	5785	16.06	30.00	1.00
CH165	5825	16.11	30.00	1.00

Test Mode: UNII-3/TX AC40 Mode_ANT 3						
Channel	Frequency (MHz)	Output Power (dBm)	Duty Factor (dBm)	Output Power + Duty Factor (dBm)	Limit (dBm)	Limit (Watt)
CH151	5755	11.82	2.34	14.16	30.00	1.00
CH159	5795	11.98	2.34	14.32	30.00	1.00

Test Mode: UNII-3/TX AC40 Mode_ANT 4						
Channel	Frequency (MHz)	Output Power (dBm)	Duty Factor (dBm)	Output Power + Duty Factor (dBm)	Limit (dBm)	Limit (Watt)
CH151	5755	11.76	2.34	14.10	30.00	1.00
CH159	5795	11.95	2.34	14.29	30.00	1.00

Test Mode: UNII-3/TX AC40 Mode_Total					
Channel	Frequency (MHz)	Output Power (dBm)		Limit (dBm)	Limit (Watt)
CH151	5755	17.14		30.00	1.00
CH159	5795	17.32		30.00	1.00

Test Mode: UNII-3/TX AC80 Mode_ANT 3						
Channel	Frequency (MHz)	Output Power (dBm)	Duty Factor (dBm)	Output Power + Duty Factor (dBm)	Limit (dBm)	Limit (Watt)
CH155	5775	11.82	1.05	12.87	30.00	1.00

Test Mode: UNII-3/TX AC80 Mode_ANT 4						
Channel	Frequency (MHz)	Output Power (dBm)	Duty Factor (dBm)	Output Power + Duty Factor (dBm)	Limit (dBm)	Limit (Watt)
CH155	5775	11.88	1.05	12.93	30.00	1.00

Test Mode: UNII-3/TX AC80 Mode_Total						
Channel	Frequency (MHz)	Output Power (dBm)			Limit (dBm)	Limit (Watt)
CH155	5775	15.91			30.00	1.00

External antenna

Test Mode: UNII-1/TX A Mode						
Channel	Frequency (MHz)	FCC Part 15E Conducted Output Power (dBm)	Duty Factor (dBm)	FCC Part 15E Conducted Output Power + Duty Factor (dBm)	Limit (dBm)	Limit (Watt)
CH36	5180	14.85	0.18	15.03	30.00	1.00
CH40	5200	14.92	0.18	15.10	30.00	1.00
CH48	5240	14.92	0.18	15.10	30.00	1.00

Test Mode: UNII-1/TX A Mode					
Channel	Frequency (MHz)	RSS-247 E.I.R.P Output Power (dBm)		Limit (dBm)	Limit (Watt)
CH36	5180	19.49		23.00	0.20
CH40	5200	19.56		23.00	0.20
CH48	5240	19.56		23.00	0.20

Test Mode: UNII-1/TX N20 Mode_ANT 3						
Channel	Frequency (MHz)	FCC Part 15E Conducted Output Power (dBm)	Duty Factor (dBm)	FCC Part 15E Conducted Output Power + Duty Factor (dBm)	Limit (dBm)	Limit (Watt)
CH36	5180	11.83	0.13	11.96	30.00	1.00
CH40	5200	11.92	0.13	12.05	30.00	1.00
CH48	5240	11.96	0.13	12.09	30.00	1.00

Test Mode: UNII-1/TX N20 Mode_ANT 4						
Channel	Frequency (MHz)	FCC Part 15E Conducted Output Power (dBm)	Duty Factor (dBm)	FCC Part 15E Conducted Output Power + Duty Factor (dBm)	Limit (dBm)	Limit (Watt)
CH36	5180	11.68	0.13	11.81	30.00	1.00
CH40	5200	11.85	0.13	11.98	30.00	1.00
CH48	5240	11.94	0.13	12.07	30.00	1.00

Test Mode: UNII-1/TX N20 Mode_Total					
Channel	Frequency (MHz)	FCC Part 15E Conducted Output Power (dBm)		Limit (dBm)	Limit (Watt)
CH36	5180	14.90		30.00	1.00
CH40	5200	15.03		30.00	1.00
CH48	5240	15.09		30.00	1.00

Test Mode: UNII-1/TX N20 Mode_ANT 3				
Channel	Frequency (MHz)	RSS-247 E.I.R.P Output Power (dBm)	Limit (dBm)	Limit (Watt)
CH36	5180	16.47	23.00	0.20
CH40	5200	16.56	23.00	0.20
CH48	5240	16.60	23.00	0.20

Test Mode: UNII-1/TX N20 Mode_ANT 4				
Channel	Frequency (MHz)	RSS-247 E.I.R.P Output Power (dBm)	Limit (dBm)	Limit (Watt)
CH36	5180	16.32	23.00	0.20
CH40	5200	16.49	23.00	0.20
CH48	5240	16.58	23.00	0.20

Test Mode: UNII-1/TX N20 Mode_Total				
Channel	Frequency (MHz)	RSS-247 E.I.R.P Output Power (dBm)	Limit (dBm)	Limit (Watt)
CH36	5180	19.41	23.00	0.20
CH40	5200	19.54	23.00	0.20
CH48	5240	19.60	23.00	0.20

Test Mode: UNII-1/TX N40 Mode_ANT 3						
Channel	Frequency (MHz)	FCC Part 15E Conducted Output Power (dBm)	Duty Factor (dBm)	FCC Part 15E Conducted Output Power + Duty Factor (dBm)	Limit (dBm)	Limit (Watt)
CH38	5190	11.85	0.90	12.75	30.00	1.00
CH46	5230	11.92	0.90	12.82	30.00	1.00

Test Mode: UNII-1/TX N40 Mode_ANT 4						
Channel	Frequency (MHz)	FCC Part 15E Conducted Output Power (dBm)	Duty Factor (dBm)	FCC Part 15E Conducted Output Power + Duty Factor (dBm)	Limit (dBm)	Limit (Watt)
CH38	5190	11.84	0.90	12.74	30.00	1.00
CH46	5230	11.78	0.90	12.68	30.00	1.00

Test Mode: UNII-1/TX N40 Mode_Total					
Channel	Frequency (MHz)	FCC Part 15E Conducted Output Power (dBm)		Limit (dBm)	Limit (Watt)
CH38	5190	15.76		30.00	1.00
CH46	5230	15.76		30.00	1.00

Test Mode: UNII-1/TX N40 Mode_ANT 3				
Channel	Frequency (MHz)	RSS-247 E.I.R.P Output Power (dBm)	Limit (dBm)	Limit (Watt)
CH38	5190	16.49	23.00	0.20
CH46	5230	16.56	23.00	0.20

Test Mode: UNII-1/TX N40 Mode_ANT 4				
Channel	Frequency (MHz)	RSS-247 E.I.R.P Output Power (dBm)	Limit (dBm)	Limit (Watt)
CH38	5190	16.48	23.00	0.20
CH46	5230	16.42	23.00	0.20

Test Mode: UNII-1/TX N40 Mode_Total				
Channel	Frequency (MHz)	RSS-247 E.I.R.P Output Power (dBm)	Limit (dBm)	Limit (Watt)
CH38	5190	19.50	23.00	0.20
CH46	5230	19.50	23.00	0.20

Test Mode: UNII-3/ TX A Mode

Channel	Frequency (MHz)	Output Power (dBm)	Duty Factor (dBm)	Output Power + Duty Factor (dBm)	Limit (dBm)	Limit (Watt)
CH149	5745	14.89	0.18	15.07	30.00	1.00
CH157	5785	14.74	0.18	14.92	30.00	1.00
CH165	5825	14.88	0.18	15.06	30.00	1.00

Test Mode: UNII-3/TX N20 Mode_ANT 3

Channel	Frequency (MHz)	Output Power (dBm)	Duty Factor (dBm)	Output Power + Duty Factor (dBm)	Limit (dBm)	Limit (Watt)
CH149	5745	11.95	0.13	12.08	30.00	1.00
CH157	5785	11.93	0.13	12.06	30.00	1.00
CH165	5825	11.85	0.13	11.98	30.00	1.00

Test Mode: UNII-3/TX N20 Mode_ANT 4

Channel	Frequency (MHz)	Output Power (dBm)	Duty Factor (dBm)	Output Power + Duty Factor (dBm)	Limit (dBm)	Limit (Watt)
CH149	5745	11.83	0.13	11.96	30.00	1.00
CH157	5785	11.92	0.13	12.05	30.00	1.00
CH165	5825	11.81	0.13	11.94	30.00	1.00

Test Mode: UNII-3/TX N20 Mode_Total

Channel	Frequency (MHz)	Output Power (dBm)	Limit (dBm)	Limit (Watt)
CH149	5745	15.03	30.00	1.00
CH157	5785	15.07	30.00	1.00
CH165	5825	14.97	30.00	1.00

Test Mode: UNII-3/ TX N40 Mode_ANT 3						
Channel	Frequency (MHz)	Output Power (dBm)	Duty Factor (dBm)	Output Power + Duty Factor (dBm)	Limit (dBm)	Limit (Watt)
CH151	5755	11.74	0.90	12.64	30.00	1.00
CH159	5795	11.71	0.90	12.61	30.00	1.00

Test Mode: UNII-3/ TX N40 Mode_ANT 4						
Channel	Frequency (MHz)	Output Power (dBm)	Duty Factor (dBm)	Output Power + Duty Factor (dBm)	Limit (dBm)	Limit (Watt)
CH151	5755	11.87	0.90	12.77	30.00	1.00
CH159	5795	11.91	0.90	12.81	30.00	1.00

Test Mode: UNII-3/ TX N40 Mode_Total					
Channel	Frequency (MHz)	Output Power (dBm)		Limit (dBm)	Limit (Watt)
CH151	5755	15.72		30.00	1.00
CH159	5795	15.72		30.00	1.00

Test Mode: UNII-1/TX AC20 Mode_ANT 3						
Channel	Frequency (MHz)	FCC Part 15E Conducted Output Power (dBm)	Duty Factor (dBm)	FCC Part 15E Conducted Output Power + Duty Factor (dBm)	Limit (dBm)	Limit (Watt)
CH36	5180	11.96	1.88	13.84	30.00	1.00
CH40	5200	11.91	1.88	13.79	30.00	1.00
CH48	5240	11.87	1.88	13.75	30.00	1.00

Test Mode: UNII-1/TX AC20 Mode_ANT 4						
Channel	Frequency (MHz)	FCC Part 15E Conducted Output Power (dBm)	Duty Factor (dBm)	FCC Part 15E Conducted Output Power + Duty Factor (dBm)	Limit (dBm)	Limit (Watt)
CH36	5180	11.96	1.88	13.84	30.00	1.00
CH40	5200	11.94	1.88	13.82	30.00	1.00
CH48	5240	11.85	1.88	13.73	30.00	1.00

Test Mode: UNII-1/TX AC20 Mode_Total					
Channel	Frequency (MHz)	FCC Part 15E Conducted Output Power (dBm)		Limit (dBm)	Limit (Watt)
CH36	5180	16.85		30.00	1.00
CH40	5200	16.82		30.00	1.00
CH48	5240	16.75		30.00	1.00

Test Mode: UNII-1/TX AC20 Mode_ANT 3				
Channel	Frequency (MHz)	RSS-247 E.I.R.P Output Power (dBm)	Limit (dBm)	Limit (Watt)
CH36	5180	16.60	23.00	0.20
CH40	5200	16.55	23.00	0.20
CH48	5240	16.51	23.00	0.20

Test Mode: UNII-1/TX AC20 Mode_ANT 4				
Channel	Frequency (MHz)	RSS-247 E.I.R.P Output Power (dBm)	Limit (dBm)	Limit (Watt)
CH36	5180	16.60	23.00	0.20
CH40	5200	16.58	23.00	0.20
CH48	5240	16.49	23.00	0.20

Test Mode: UNII-1/TX AC20 Mode_Total				
Channel	Frequency (MHz)	RSS-247 E.I.R.P Output Power (dBm)	Limit (dBm)	Limit (Watt)
CH36	5180	19.61	23.00	0.20
CH40	5200	19.58	23.00	0.20
CH48	5240	19.51	23.00	0.20

Test Mode: UNII-1/TX AC40 Mode_ANT 3						
Channel	Frequency (MHz)	FCC Part 15E Conducted Output Power (dBm)	Duty Factor (dBm)	FCC Part 15E Conducted Output Power + Duty Factor (dBm)	Limit (dBm)	Limit (Watt)
CH38	5190	11.83	2.85	14.68	30.00	1.00
CH46	5230	11.75	2.85	14.60	30.00	1.00

Test Mode: UNII-1/TX AC40 Mode_ANT 4						
Channel	Frequency (MHz)	FCC Part 15E Conducted Output Power (dBm)	Duty Factor (dBm)	FCC Part 15E Conducted Output Power + Duty Factor (dBm)	Limit (dBm)	Limit (Watt)
CH38	5190	11.94	2.85	14.79	30.00	1.00
CH46	5230	11.79	2.85	14.64	30.00	1.00

Test Mode: UNII-1/TX AC40 Mode_Total					
Channel	Frequency (MHz)	FCC Part 15E Conducted Output Power (dBm)		Limit (dBm)	Limit (Watt)
CH38	5190	17.75		30.00	1.00
CH46	5230	17.63		30.00	1.00

Test Mode: UNII-1/TX AC40 Mode_ANT 3

Channel	Frequency (MHz)	RSS-247 E.I.R.P Output Power (dBm)	Limit (dBm)	Limit (Watt)
CH38	5190	16.47	23.00	0.20
CH46	5230	16.39	23.00	0.20

Test Mode: UNII-1/TX AC40 Mode_ANT 4

Channel	Frequency (MHz)	RSS-247 E.I.R.P Output Power (dBm)	Limit (dBm)	Limit (Watt)
CH38	5190	16.58	23.00	0.20
CH46	5230	16.43	23.00	0.20

Test Mode: UNII-1/TX AC40 Mode_Total

Channel	Frequency (MHz)	RSS-247 E.I.R.P Output Power (dBm)	Limit (dBm)	Limit (Watt)
CH38	5190	19.54	23.00	0.20
CH46	5230	19.42	23.00	0.20

Test Mode: UNII-1/TX AC80 Mode_ANT 3						
Channel	Frequency (MHz)	FCC Part 15E Conducted Output Power (dBm)	Duty Factor (dBm)	FCC Part 15E Conducted Output Power + Duty Factor (dBm)	Limit (dBm)	Limit (Watt)
CH42	5210	11.93	0.67	12.60	30.00	1.00

Test Mode: UNII-1/TX AC80 Mode_ANT 4						
Channel	Frequency (MHz)	FCC Part 15E Conducted Output Power (dBm)	Duty Factor (dBm)	FCC Part 15E Conducted Output Power + Duty Factor (dBm)	Limit (dBm)	Limit (Watt)
CH42	5210	11.82	0.67	12.49	30.00	1.00

Test Mode: UNII-1/TX AC80 Mode_Total					
Channel	Frequency (MHz)	FCC Part 15E Conducted Output Power (dBm)		Limit (dBm)	Limit (Watt)
CH42	5210	15.56		30.00	1.00

Test Mode: UNII-1/TX AC80 Mode_ANT 3

Channel	Frequency (MHz)	RSS-247 E.I.R.P Output Power (dBm)	Limit (dBm)	Limit (Watt)
CH42	5210	16.57	23.00	0.20

Test Mode: UNII-1/TX AC80 Mode_ANT 4

Channel	Frequency (MHz)	RSS-247 E.I.R.P Output Power (dBm)	Limit (dBm)	Limit (Watt)
CH42	5210	16.46	23.00	0.20

Test Mode: UNII-1/TX AC80 Mode_Total

Channel	Frequency (MHz)	RSS-247 E.I.R.P Output Power (dBm)	Limit (dBm)	Limit (Watt)
CH42	5210	19.53	23.00	0.20

Test Mode: UNII-3/TX AC20 Mode_ANT 3

Channel	Frequency (MHz)	Output Power (dBm)	Duty Factor (dBm)	Output Power + Duty Factor (dBm)	Limit (dBm)	Limit (Watt)
CH149	5745	11.93	1.88	13.81	30.00	1.00
CH157	5785	11.89	1.88	13.77	30.00	1.00
CH165	5825	11.74	1.88	13.62	30.00	1.00

Test Mode: UNII-3/TX AC20 Mode_ANT 4

Channel	Frequency (MHz)	Output Power (dBm)	Duty Factor (dBm)	Output Power + Duty Factor (dBm)	Limit (dBm)	Limit (Watt)
CH149	5745	11.84	1.88	13.72	30.00	1.00
CH157	5785	11.93	1.88	13.81	30.00	1.00
CH165	5825	11.88	1.88	13.76	30.00	1.00

Test Mode: UNII-3/TX AC20 Mode_Total

Channel	Frequency (MHz)	Output Power (dBm)	Limit (dBm)	Limit (Watt)
CH149	5745	16.78	30.00	1.00
CH157	5785	16.80	30.00	1.00
CH165	5825	16.70	30.00	1.00

Test Mode: UNII-3/TX AC40 Mode_ANT 3

Channel	Frequency (MHz)	Output Power (dBm)	Duty Factor (dBm)	Output Power + Duty Factor (dBm)	Limit (dBm)	Limit (Watt)
CH151	5755	11.94	2.85	14.79	30.00	1.00
CH159	5795	11.87	2.85	14.72	30.00	1.00

Test Mode: UNII-3/TX AC40 Mode_ANT 4

Channel	Frequency (MHz)	Output Power (dBm)	Duty Factor (dBm)	Output Power + Duty Factor (dBm)	Limit (dBm)	Limit (Watt)
CH151	5755	11.72	2.85	14.57	30.00	1.00
CH159	5795	11.86	2.85	14.71	30.00	1.00

Test Mode: UNII-3/TX AC40 Mode_Total

Channel	Frequency (MHz)	Output Power (dBm)	Limit (dBm)	Limit (Watt)
CH151	5755	17.69	30.00	1.00
CH159	5795	17.73	30.00	1.00

Test Mode: UNII-3/TX AC80 Mode_ANT 3						
Channel	Frequency (MHz)	Output Power (dBm)	Duty Factor (dBm)	Output Power + Duty Factor (dBm)	Limit (dBm)	Limit (Watt)
CH155	5775	11.76	0.67	12.43	30.00	1.00

Test Mode: UNII-3/TX AC80 Mode_ANT 4						
Channel	Frequency (MHz)	Output Power (dBm)	Duty Factor (dBm)	Output Power + Duty Factor (dBm)	Limit (dBm)	Limit (Watt)
CH155	5775	11.96	0.67	12.63	30.00	1.00

Test Mode: UNII-3/TX AC80 Mode_Total						
Channel	Frequency (MHz)	Output Power (dBm)			Limit (dBm)	Limit (Watt)
CH155	5775	15.54			30.00	1.00

ATTACHMENT G - ANTENNA CONDUCTED SPURIOUS EMISSION

Internal antenna

Test Mode: UNII-1/TX A Mode

TX mode CH36

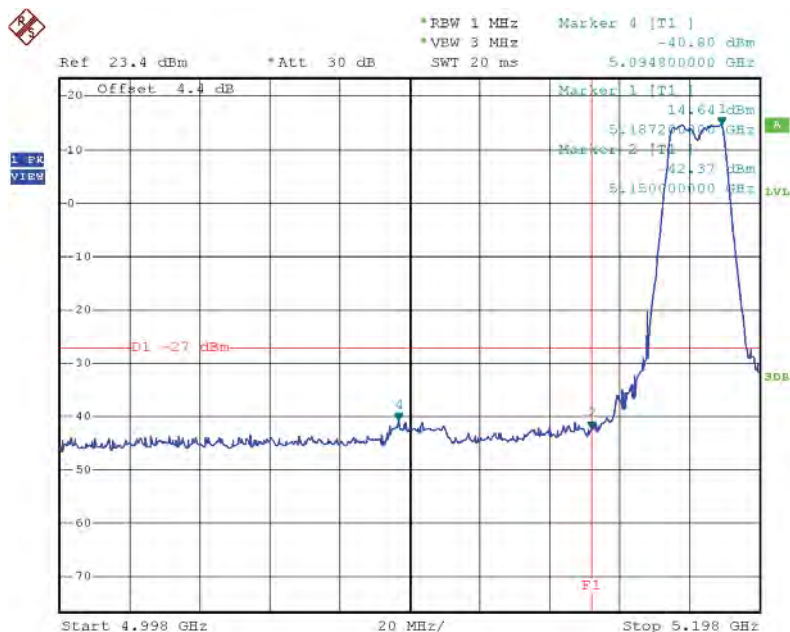

Date: 8.JUN.2015 16:44:35

TX mode CH48

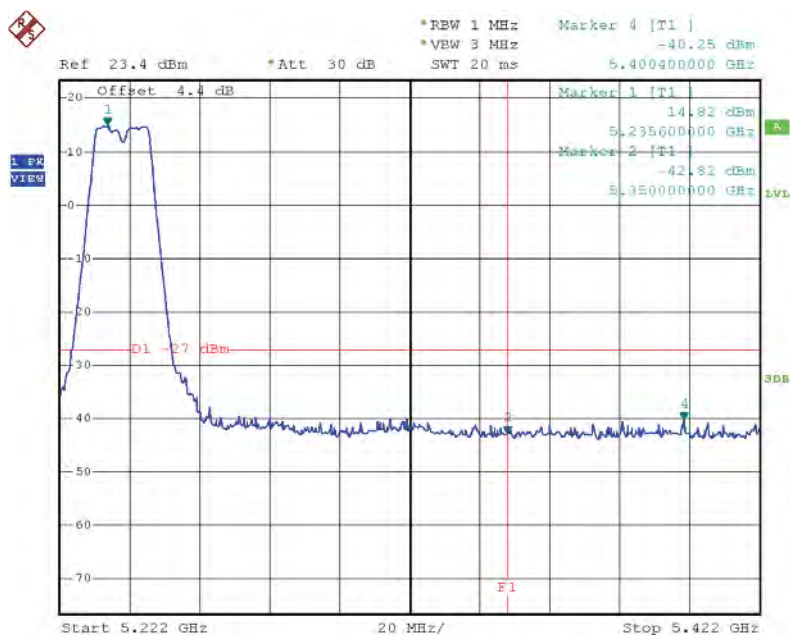

Date: 8.JUN.2015 16:47:43

Test Mode: UNII-1/TX N20 Mode_ANT 3

TX mode CH36

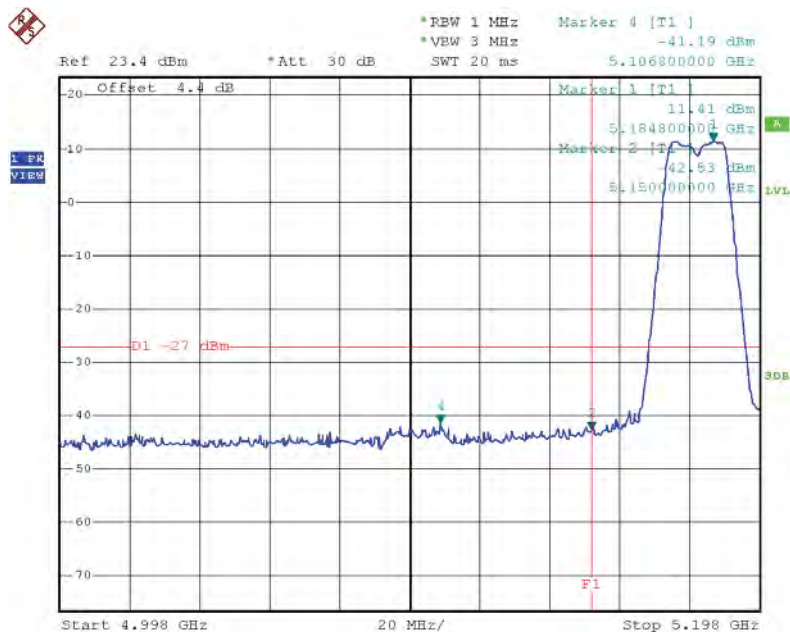

Date: 8.JUN.2015 17:01:28

TX mode CH48

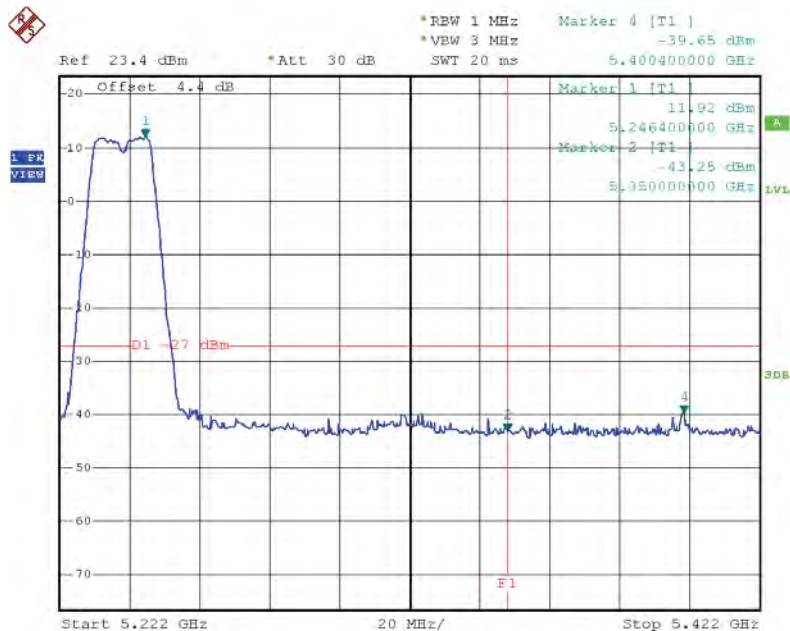

Date: 8.JUN.2015 17:04:34

Test Mode: UNII-1/TX N20 Mode_ANT 4

TX mode CH36

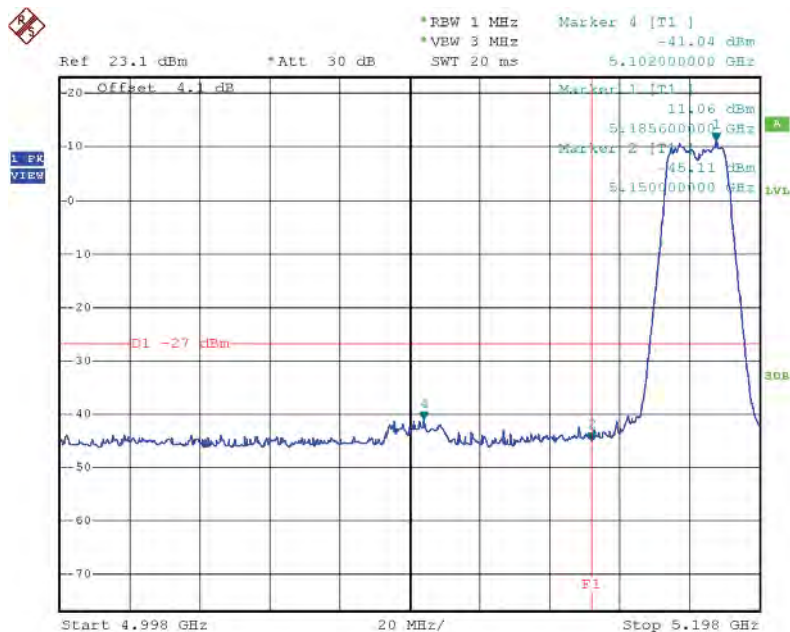

Date: 8.JUN.2015 17:11:33

TX mode CH48

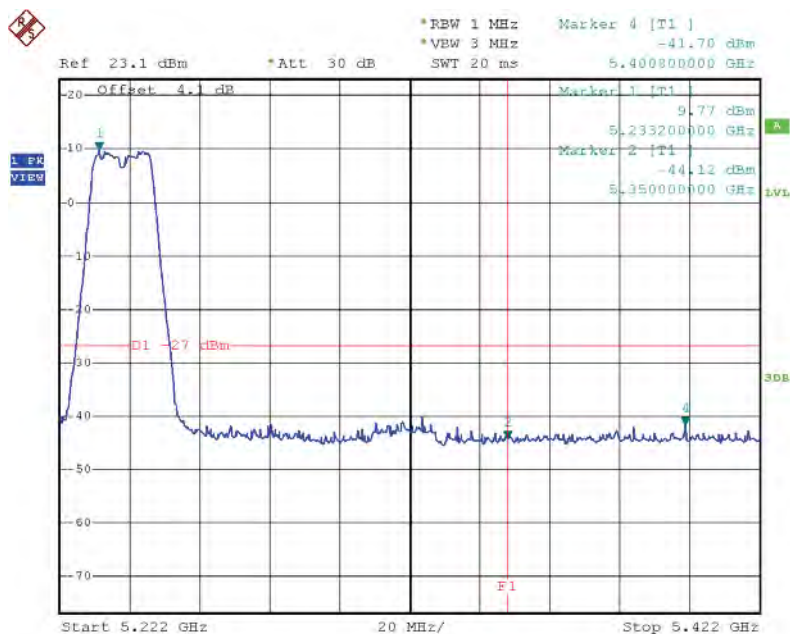

Date: 8.JUN.2015 17:14:01

Test Mode: UNII-1/TX N40 Mode_ANT 3

TX mode CH38

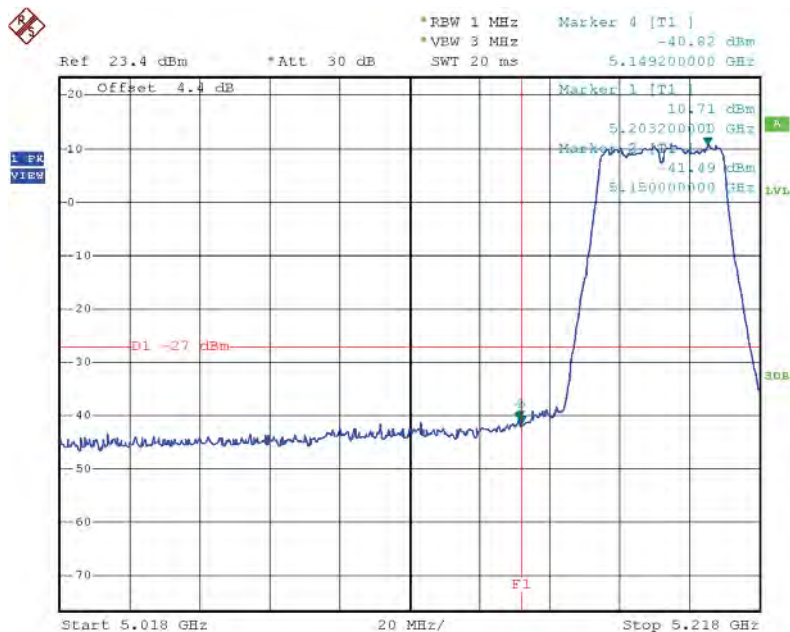

Date: 8.JUN.2015 17:47:42

TX mode CH46

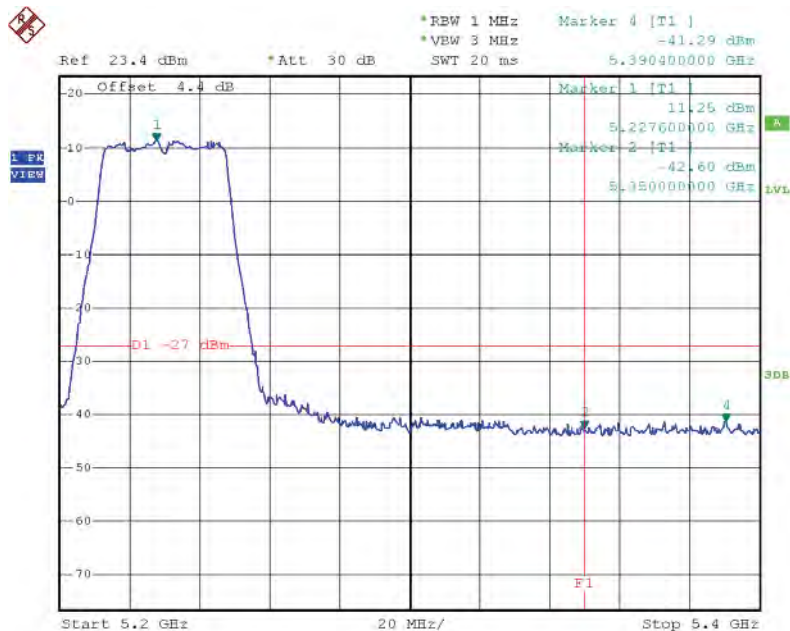

Date: 8.JUN.2015 17:49:17