



# FCC DFS TEST REPORT

**FCC ID** : TVE-3417T0696  
**Equipment** : Secured Wireless Access Point  
**Brand Name** : FORTINET  
**Model Name** : FortiAP 231Fxxxxxx, FAP-231Fxxxxxx, FORTIAP-231Fxxxxxx  
(Where "x" can be used as "A-Z", or "0-9", or "-", or blank for software changes or marketing purposes only)  
**Applicant** : Fortinet, Inc.  
899 Kifer Road, Sunnyvale, CA 94086, USA  
**Manufacturer** : Senao Networks Inc.  
500 Fusing 3rd Rd Hwa-YA Technology Park, Kuei-Shan  
District Taoyuan 333  
**Standard** : FCC Part 15 Subpart E

The product was received on Oct. 12, 2020 and testing was started from Oct. 22, 2020 and completed on Nov. 24, 2020. We, SPORTON INTERNATIONAL INC. EMC & Wireless Communications Laboratory, would like to declare that the tested sample has been evaluated in accordance with the procedures given in FCC Part 15 Subpart E and shown compliance with the applicable technical standards.

The test results in this report apply exclusively to the tested model / sample. Without written approval of SPORTON INTERNATIONAL INC. EMC & Wireless Communications Laboratory, the test report shall not be reproduced except in full.

*Louis Wu*

Approved by: Louis Wu

**SPORTON INTERNATIONAL INC. EMC & Wireless Communications Laboratory**

No. 52, Huaya 1st Rd., Guishan Dist., Taoyuan City, Taiwan (R.O.C.)



# Table of Contents

**History of this test report.....3**

**Summary of Test Result.....4**

**1 General Description .....5**

    1.1 Feature of Equipment Under Test .....5

    1.2 Product Specification of Equipment Under Test.....5

    1.3 Modification of EUT .....5

    1.4 Testing Site .....5

    1.5 Applied Standards .....6

    1.6 Support Unit used in test configuration and system .....6

**2 Requirements and Parameters for DFS Test.....7**

    2.1 Summary of Dynamic Frequency Selection Test .....7

    2.2 Applicability of DFS Requirements .....8

    2.3 DFS Detection Thresholds.....10

    2.4 DFS Response requirement values.....11

    2.5 Short Pulse Radar Test Waveforms .....12

    2.6 Long Pulse Radar Test Waveform .....14

    2.7 Frequency Hopping Radar Test Waveform .....16

**3 Calibration Setup and DFS Test Results .....17**

    3.1 Calibration of Radar Waveform .....17

    3.2 U-NII Detection Bandwidth .....30

    3.3 Channel Availability Check .....38

    3.4 In-Service Monitoring: Channel Move Time, Channel Closing Transmission Time and  
    Non-Occupancy Period.....44

    3.5 Statistical Performance Check .....52

**4 List of Measuring Equipment.....66**

**Appendix A. Radar Parameters**





## Summary of Test Result

Report Clause	Ref Std. Clause	Test Items	Result (PASS/FAIL)	Remark
3.2	7.8.1	U-NII Detection Bandwidth	Pass	-
3.3	7.8.2	Channel Availability Check Time	Pass	-
3.4	7.8.3	Channel Move Time	Pass	-
		Channel Closing Transmission Time	Pass	-
		Non-Occupancy Period Test	Pass	-
3.5	7.8.4	Statistical Performance Check	Pass	-

**Declaration of Conformity:**

The test results with all measurement uncertainty excluded are presented in accordance with the regulation limits or requirements declared by manufacturers.

**Comments and Explanations:**

The declared of product specification for EUT presented in the report are provided by the manufacturer, and the manufacturer takes all the responsibilities for the accuracy of product specification.

**Reviewed by: Wii Chang**

**Report Producer: Dara Chiu**



# 1 General Description

## 1.1 Feature of Equipment Under Test

Product Specification subjective to this standard	
Equipment	Secured Wireless Access Point
Model Name	FortiAP 231Fxxxxxx, FAP-231Fxxxxxx, FORTIAP-231Fxxxxxx (Where "x" can be used as "A-Z", or "0-9", or "-", or blank for software changes or marketing purposes only)

## 1.2 Product Specification of Equipment Under Test

Product Specification subjective to this standard	
Tx/Rx Channel Frequency Range	5260 MHz ~ 5320 MHz 5500 MHz ~ 5720 MHz
EUT support WLAN function	802.11a 802.11n HT20 802.11n HT40 802.11ac VHT20 802.11ac VHT40 802.11ac VHT80 802.11ax HE20 802.11ax HE40 802.11ax HE80
Type of Modulation	802.11a/n: OFDM (BPSK/QPSK/16QAM/64QAM) 802.11ac: OFDM (BPSK/QPSK/16QAM/64QAM/256QAM) 802.11ax: OFDM (BPSK/QPSK/16QAM/64QAM/256QAM/1024QAM)

## 1.3 Modification of EUT

No modifications are made to the EUT during all test items.

## 1.4 Testing Site

Test Site	SPORTON INTERNATIONAL INC. EMC & Wireless Communications Laboratory
Test Site Location	No.52, Huaya 1st Rd., Guishan Dist., Taoyuan City, Taiwan (R.O.C.) TEL: +886-3-327-3456 FAX: +886-3-328-4978
Test Site No.	<b>Sporton Site No.</b> DFS02-HY



### 1.5 Applied Standards

According to the specifications of the manufacturer, the EUT must comply with the requirements of the following standards:

- ♦ FCC Part 15 Subpart E
- ♦ FCC KDB 905462 D02 UNII DFS Compliance Procedures New Rules v02
- ♦ FCC KDB 905462 D03 UNII Clients Without Radar Detection New Rules v01r02

**Remark:** All test items were verified and recorded according to the standards and without any deviation during the test.

### 1.6 Support Unit used in test configuration and system

Item	Equipment	Brand Name	Model Name	FCC ID	HW / FW Version	Power Cord
1.	Notebook	Lenovo	Edge E335	PPD-AR5B95	N/A	AC I/P: Unshielded, 1.2 m DC O/P: Shielded, 1.8 m



## 2 Requirements and Parameters for DFS Test

### 2.1 Summary of Dynamic Frequency Selection Test

UNII	Description	Limit
U-NII Band 2-A 5250-5350 MHz	Channel Availability Check Time	> 60sec
	U-NII Detection Bandwidth	> 100% of the U-NII 99% transmission power bandwidth
	Statistical Performance Check	Type 1,2,3,4 >= 60% Type 1~4 and 5 >= 80% Type 6 >= 70%
	Channel Move Time	< 10 sec
	Channel Closing Transmission Time	< 200 ms + aggregate of 60 ms over remaining 10 s period
	Non-Occupancy Period Test	> 30 minutes
U-NII Band 2-C 5470-5725 MHz	Channel Availability Check Time	> 60sec
	U-NII Detection Bandwidth	> 100% of the U-NII 99% transmission power bandwidth
	Statistical Performance Check	Type 1,2,3,4 >= 60% Type 1~4 and 5 >= 80% Type 6 >= 70%
	Channel Move Time	< 10 sec
	Channel Closing Transmission Time	< 200 ms + aggregate of 60 ms over remaining 10 s period
	Non-Occupancy Period Test	> 30 minutes



## 2.2 Applicability of DFS Requirements

EUT is considered as a master device.

**Table 1: Applicability of DFS Requirements Prior to Use of a Channel**

Requirement	Operational Mode		
	Master	Client Without Radar Detection	Client With Radar Detection
Non-Occupancy Period	Yes	Not required	Yes
DFS Detection Threshold	Yes	Not required	Yes
Channel Availability Check Time	Yes	Not required	Not required
U-NII Detection Bandwidth	Yes	Not required	Yes





**Table 2: Applicability of DFS requirements during normal operation**

Requirement	Operational Mode		
	Master	Client Without Radar Detection	Client With Radar Detection
DFS Detection Threshold	Yes	Not required	Yes
Channel Closing Transmission Time	Yes	Yes	Yes
Channel Move Time	Yes	Yes	Yes
U-NII Detection Bandwidth	Yes	Not required	Yes
Client Beacon Test	N/A	Yes	Yes

Additional requirements for devices with multiple bandwidth modes	Operational Mode	
	Master or Client With Radar Detection	Client Without Radar Detection
U-NII Detection Bandwidth and Statistical Performance Check	All BW modes must be tested	Not required
Channel Move Time and Channel Closing Transmission Time	Test using widest BW mode available	Test using the widest BW mode available for the link
All other tests	Any single BW mode	Not required

**Note**

Frequencies selected for statistical performance check (Section 7.8.4) should include several frequencies within the radar detection bandwidth and frequencies near the edge of the radar detection bandwidth. For 802.11 devices it is suggested to select frequencies in each of the bonded 20 MHz channels and the channel center frequency.



### 2.3 DFS Detection Thresholds

Table 3 below provides the DFS Detection Thresholds for Master Devices as well as Client Devices incorporating In-Service Monitoring.

**Table 3: DFS Detection Thresholds for Master Devices**

Maximum Transmit Power	Value (see notes 1, 2, and 3)
EIRP ≥ 200 milliwatt	-64 dBm
EIRP < 200 milliwatt and power spectral density < 10 dBm/MHz	-62 dBm
EIRP < 200 milliwatt that do not meet the power spectral density requirement	-64 dBm

**Note 1:** This is the level at the input of the receiver assuming a 0 dBi receive antenna.

**Note 2:** Throughout these test procedures an additional 1 dB has been added to the amplitude of the test transmission waveforms to account for variations in measurement equipment. This will ensure that the test signal is at or above the detection threshold level to trigger a DFS response.

**Note 3:** EIRP is based on the highest antenna gain. For MIMO devices refer to KDB Publication 662911 D01.

The radar *Detection Threshold* is  $(-64\text{dBm}) + 1\text{ dB} = -63\text{ dBm}$



## 2.4 DFS Response requirement values

Table 4 provides the response requirements for Master and Client Devices incorporating DFS.

**Table 4: DFS Response Requirement Values**

Parameter	Value
<i>Non-occupancy period</i>	Minimum 30 minutes
<i>Channel Availability Check Time</i>	60 seconds
<i>Channel Move Time</i>	10 seconds See Note 1.
<i>Channel Closing Transmission Time</i>	200 milliseconds + an aggregate of 60 milliseconds over remaining 10 second period. See Notes 1 and 2.
<i>U-NII Detection Bandwidth</i>	Minimum 100% of the 99% power bandwidth See Note 3.
<p><b>Note 1:</b> <i>Channel Move Time</i> and the <i>Channel Closing Transmission Time</i> should be performed with Radar Type 0. The measurement timing begins at the end of the Radar Type 0 burst.</p> <p><b>Note 2:</b> The <i>Channel Closing Transmission Time</i> is comprised of 200 milliseconds starting at the beginning of the <i>Channel Move Time</i> plus any additional intermittent control signals required to facilitate <i>Channel</i> changes (an aggregate of 60 milliseconds) during the remainder of the 10 second period. The aggregate duration of control signals will not count quiet periods in between transmissions.</p> <p><b>Note 3:</b> During the <i>U-NII Detection Bandwidth</i> detection test, radar type 0 is used and for each frequency step the minimum percentage of detection is 90%. Measurements are performed with no data traffic.</p>	



### 2.5 Short Pulse Radar Test Waveforms

Radar Type 0 was used in the evaluation of the Client device for the purpose of measuring the Channel Move Time and the Channel Closing Transmission Time.

Radar Type	Pulse Width (μsec)	PRI (μsec)	Number of Pulses	Minimum Percentage of Successful Detection	Minimum Trials
0	1	1428	18	See Note 1.	See Note 1.
1	1	Test A Test B	Roundup $\left\{ \begin{matrix} \left( \frac{1}{360} \right) \cdot \\ \left( \frac{19 \cdot 10^6}{PRI_{\mu sec}} \right) \end{matrix} \right\}$	60%	30
2	1-5	150-230	23-29	60%	30
3	6-10	200-500	16-18	60%	30
4	11-20	200-500	12-16	60%	30
Aggregate (Radar Types 1-4)				80%	120
<b>Note 1:</b> Short Pulse Radar Type 0 should be used for the detection bandwidth test, channel move time, and channel closing time tests.					

Test A: 15 unique PRI values randomly selected from the list of 23 PRI values in Table 5a  
Test B: 15 unique PRI values randomly selected within the range of 518-3066 μsec, with a minimum increment of 1 μsec, excluding PRI values selected in Test A

A minimum of 30 unique waveforms are required for each of the Short Pulse Radar Types 2 through 4. If more than 30 waveforms are used for Short Pulse Radar Types 2 through 4, then each additional waveform must also be unique and not repeated from the previous waveforms.

If more than 30 waveforms are used for Short Pulse Radar Type 1, then each additional waveform is generated with Test B and must also be unique and not repeated from the previous waveforms in Tests A or B.

The aggregate is the average of the percentage of successful detections of short pulse radar types 1-4.



Table 5a - Pulse Repetition Intervals Values for Test A

Pulse Repetition Frequency Number (1 to 23)	Pulse Repetition Frequency (Pulses Per Second)	Pulse Repetition Interval (Microseconds)
1	1930.5	518
2	1858.7	538
3	1792.1	558
4	1730.1	578
5	1672.2	598
6	1618.1	618
7	1567.4	638
8	1519.8	658
9	1474.9	678
10	1432.7	698
11	1392.8	718
12	1355.0	738
13	1319.3	758
14	1285.3	778
15	1253.1	798
16	1222.5	818
17	1193.3	838
18	1165.5	858
19	1139.0	878
20	1113.6	898
21	1089.3	918
22	1066.1	938
23	326.2	3066



## 2.6 Long Pulse Radar Test Waveform

Radar Type	Pulse Width (µsec)	Chirp Width (MHz)	PRI (µsec)	Number of Pulses per Burst	Number of Bursts	Minimum Percentage of Successful Detection	Minimum Trials
5	50-100	5-20	1000-2000	1-3	8-20	80%	30

The parameters for this waveform are randomly chosen. Thirty unique waveforms are required for the Long Pulse radar test signal. If more than 30 waveforms are used for the Long Pulse radar test signal, then each additional waveform must also be unique and not repeated from the previous waveforms. Each waveform is defined as follows:

Note: The center frequency for each of the 30 trials of the Bin 5 radar shall be randomly selected within 80% of the Occupied Bandwidth.

- (1) The transmission period for the Long Pulse Radar test signal is 12 seconds.
- (2) There are a total of 8 to 20 Bursts in the 12 second period, with the number of Bursts being randomly chosen. This number is Burst\_Count.
- (3) Each Burst consists of 1 to 3 pulses, with the number of pulses being randomly chosen. Each Burst within the 12 second sequence may have a different number of pulses.
- (4) The pulse width is between 50 and 100 microseconds, with the pulse width being randomly chosen. Each pulse within a Burst will have the same pulse width. Pulses in different Bursts may have different pulse widths.
- (5) Each pulse has a linear frequency modulated chirp between 5 and 20 MHz, with the chirp width being randomly chosen. Each pulse within a **transmission period** will have the same chirp width. The chirp is centered on the pulse. For example, with a radar frequency of 5300 MHz and a 20 MHz chirped signal, the chirp starts at 5290 MHz and ends at 5310 MHz
- (6) If more than one pulse is present in a Burst, the time between the pulses will be between 1000 and 2000 microseconds, with the time being randomly chosen. If three pulses are present in a Burst, the time between the first and second pulses is chosen independently of the time between the second and third pulses.
- (7) The 12 second transmission period is divided into even intervals. The number of intervals is equal to Burst\_Count. Each interval is of length  $(12,000,000 / \text{Burst\_Count})$  microseconds. Each interval contains one Burst. The start time for the Burst, relative to the beginning of the interval, is between 1 and  $[(12,000,000 / \text{Burst\_Count}) - (\text{Total Burst Length}) + (\text{One Random PRI Interval})]$  microseconds, with the start time being randomly chosen. The step interval for the start time is 1 microsecond. The start time for each Burst is chosen independently.

**A representative example of a Long Pulse radar test waveform:**

- (1) The total test signal length is 12 seconds.
- (2) 8 Bursts are randomly generated for the Burst\_Count.
- (3) Burst 1 has 2 randomly generated pulses.
- (4) The pulse width (for both pulses) is randomly selected to be 75 microseconds.
- (5) The PRI is randomly selected to be at 1213 microseconds.
- (6) Bursts 2 through 8 are generated using steps 3 – 5.
- (7) Each Burst is contained in even intervals of 1,500,000 microseconds. The starting location for Pulse 1, Burst 1 is randomly generated (1 to 1,500,000 minus the total Burst 1 length + 1 random PRI interval) at the 325,001 microsecond step. Bursts 2 through 8 randomly fall in successive 1,500,000 microsecond intervals (i.e. Burst 2 falls in the 1,500,001 – 3,000,000 microsecond range).

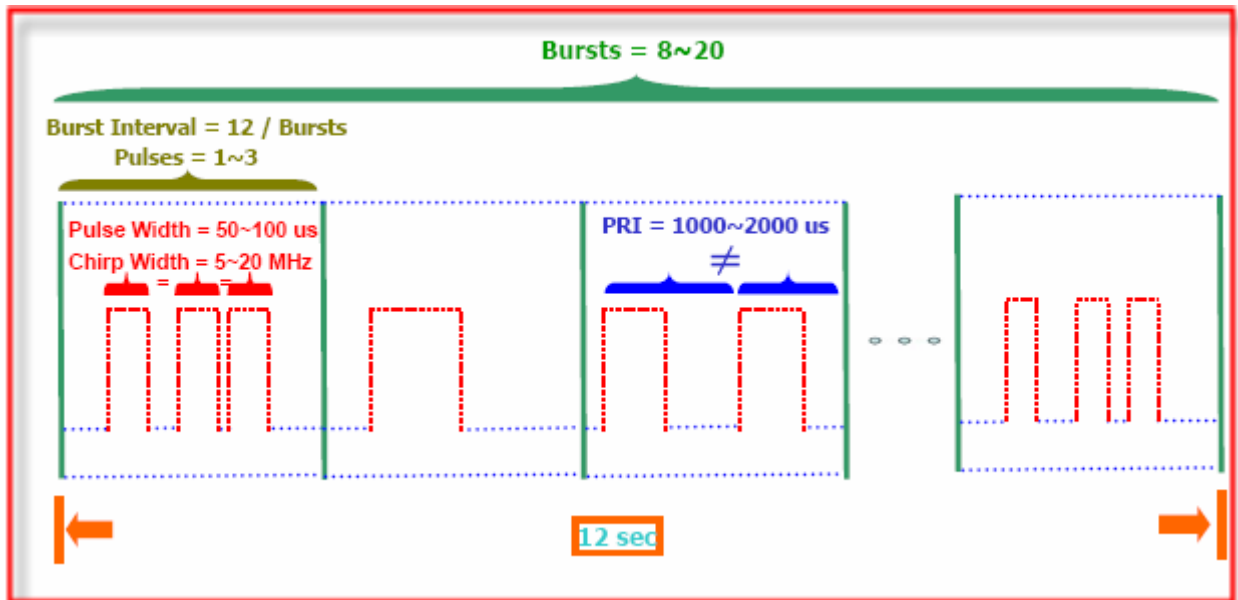

## 2.7 Frequency Hopping Radar Test Waveform

Radar Type	Pulse Width (µsec)	PRI (µsec)	Pulses per Hop	Hopping Rate (kHz)	Hopping Sequence Length (msec)	Minimum Percentage of Successful Detection	Minimum Trials
6	1	333	9	0.333	300	70%	30

For the Frequency Hopping Radar Type, the same Burst parameters are used for each waveform. The hopping sequence is different for each waveform and a 100-length segment is selected from the hopping sequence defined by the following algorithm:

The first frequency in a hopping sequence is selected randomly from the group of 475 integer frequencies from 5250 – 5724 MHz. Next, the frequency that was just chosen is removed from the group and a frequency is randomly selected from the remaining 474 frequencies in the group. This process continues until all 475 frequencies are chosen for the set. For selection of a random frequency, the frequencies remaining within the group are always treated as equally likely.

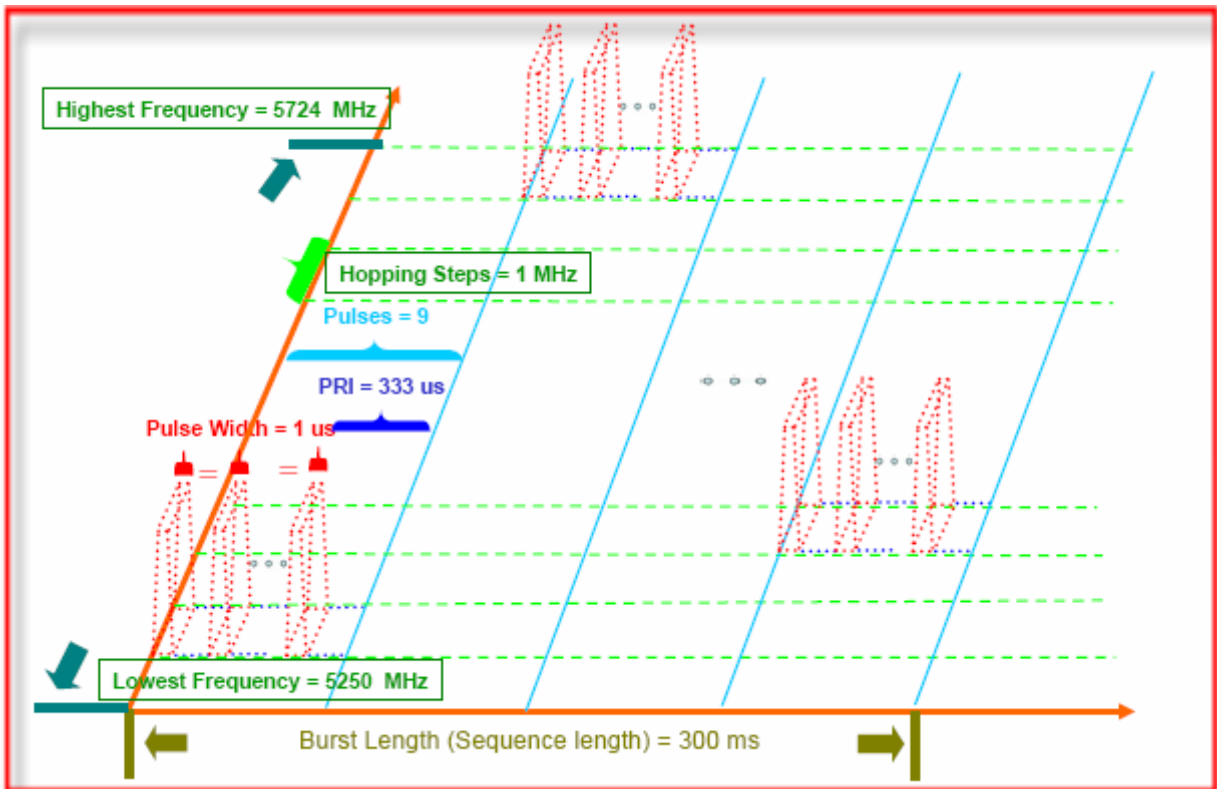



## 3 Calibration Setup and DFS Test Results

### 3.1 Calibration of Radar Waveform

#### 3.1.1 Radar Waveform Calibration Procedure

The Interference Radar Detection Threshold Level is  $(-64\text{dBm}) + 1\text{ dB} = -63\text{ dBm}$ . The following equipment setup was used to calibrate the radiated radar waveform. A vector signal generator was utilized to establish the test signal level for radar type 0-6. During this process there were no transmissions by either the Master or Client Device. The spectrum analyzer was switched to the zero span (Time Domain) at the frequency of the Radar Waveform generator. Peak detection was used. The spectrum analyzer resolution bandwidth (RBW) and video bandwidth (VBW) were set to 3 MHz to measure the radar waveform. The vector signal generator amplitude was set so that the power level measured at the spectrum analyzer was  $(-64\text{dBm}) + 1\text{ dB} = -63\text{ dBm}$ . Capture the spectrum analyzer plots on radar waveform. The spectrum offset has included the monitor antenna gain and path loss between monitor antenna and spectrum analyzer.

#### 3.1.2 Radiated Calibration Setup

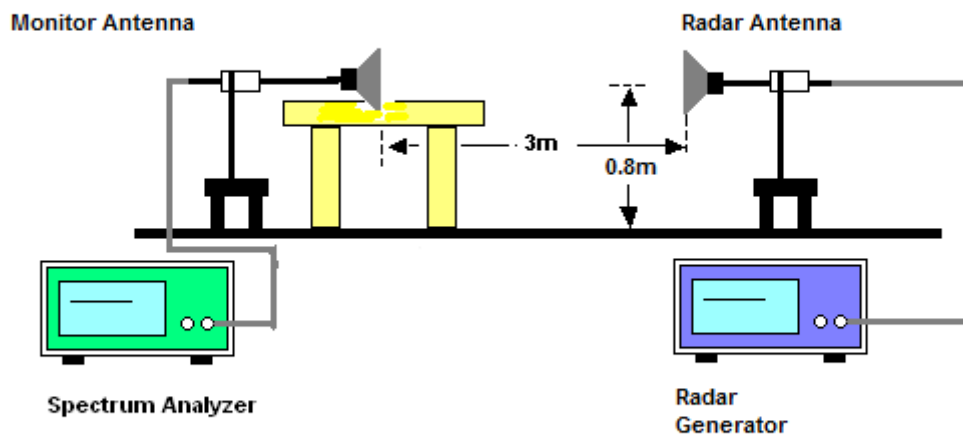

#### 3.1.3 Calibration Deviation

There is no deviation with the original standard.



### 3.1.4 Radar Waveform Calibration Result

<20MHz / 5300MHz>

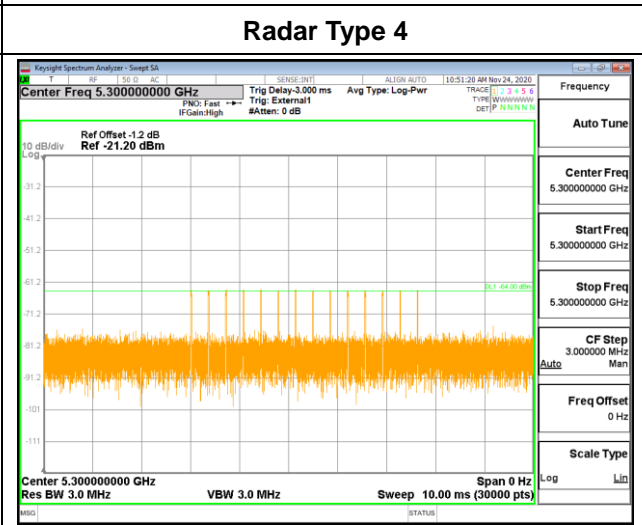
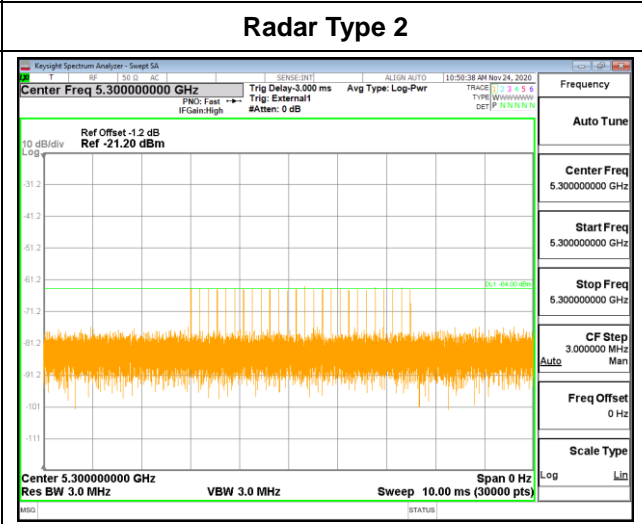
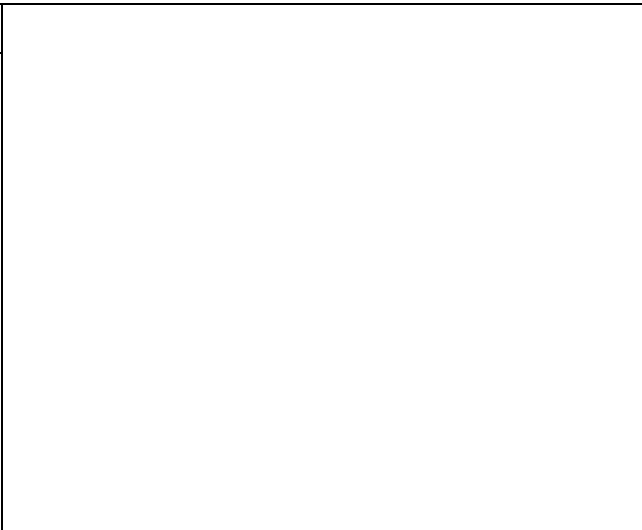
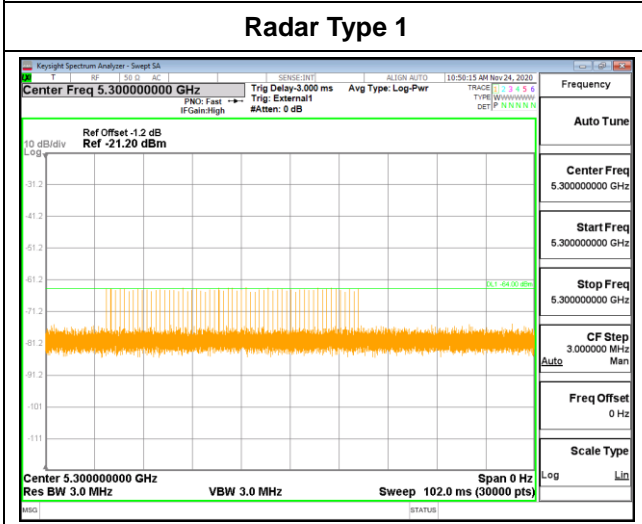
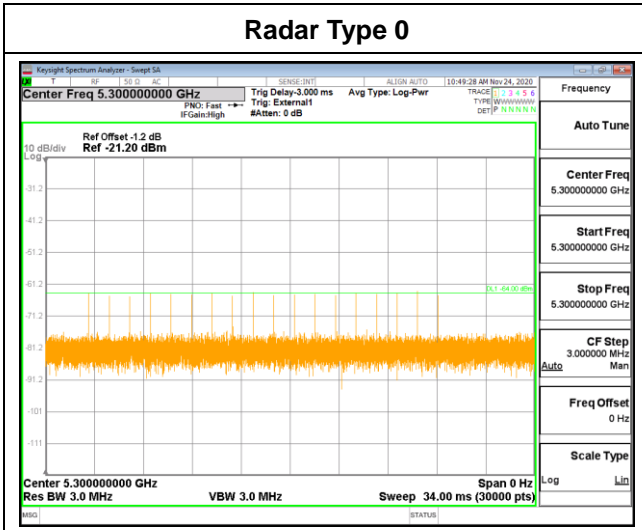



Single Burst of Radar Type 5

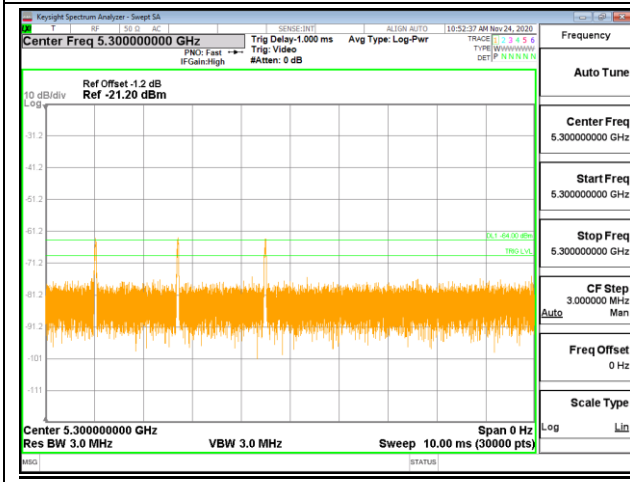

Single Burst of Radar Type 6

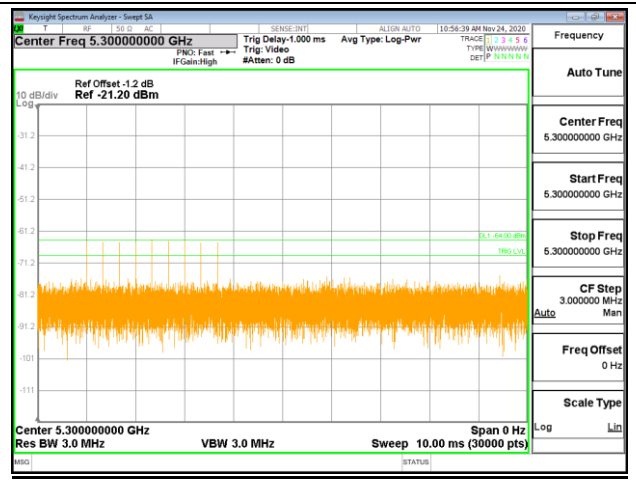



<40MHz / 5310MHz>

Radars Type 0

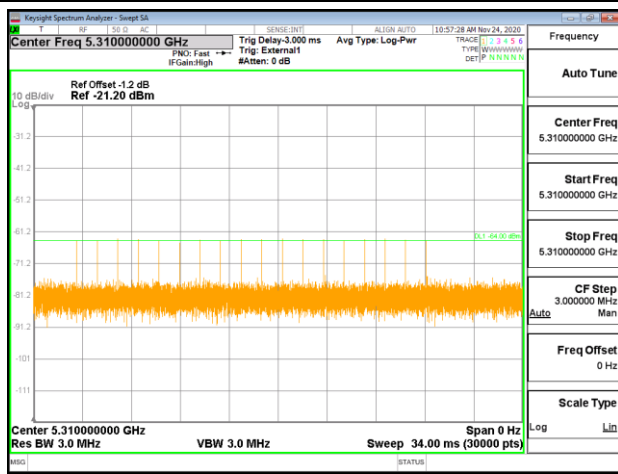

Radars Type 1

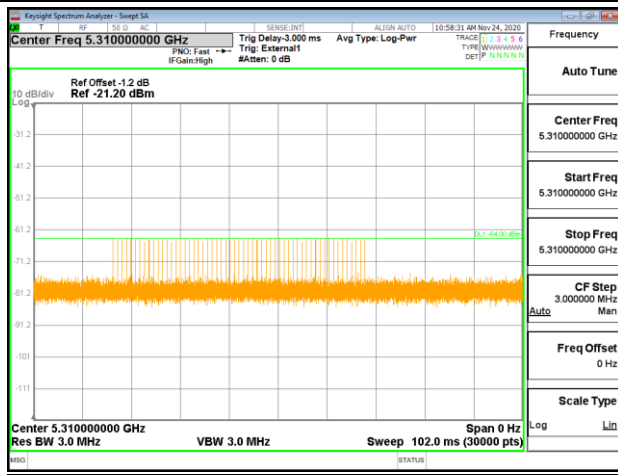

Radars Type 2

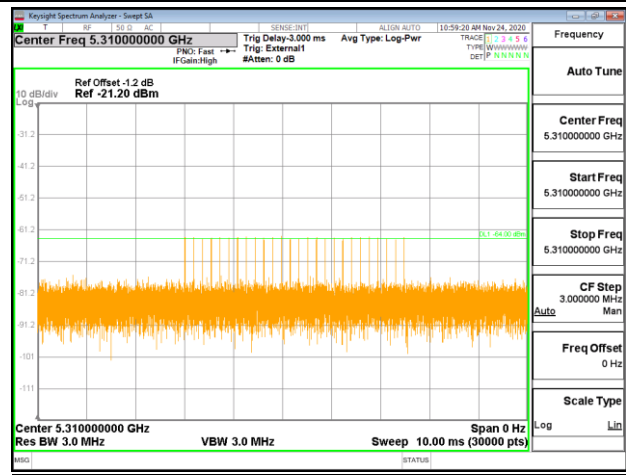

Radars Type 3

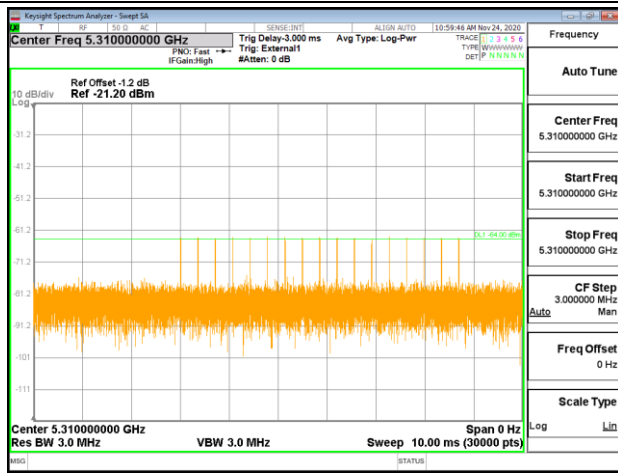

Radars Type 4

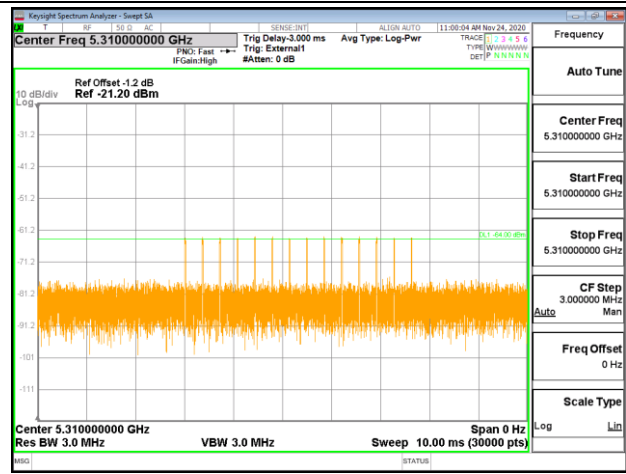



Single Burst of Radar Type 5

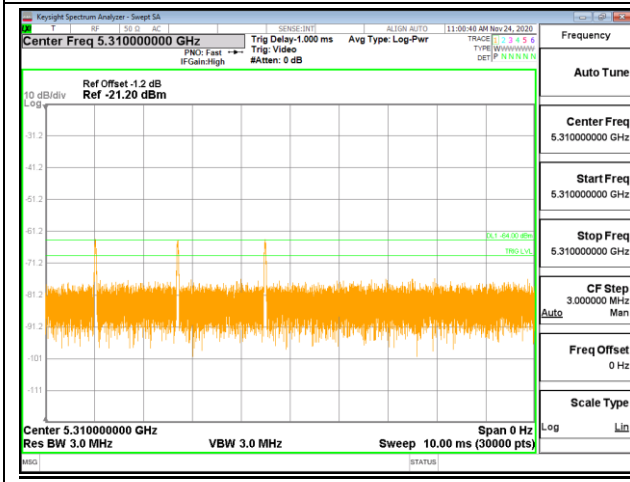

Single Burst of Radar Type 6

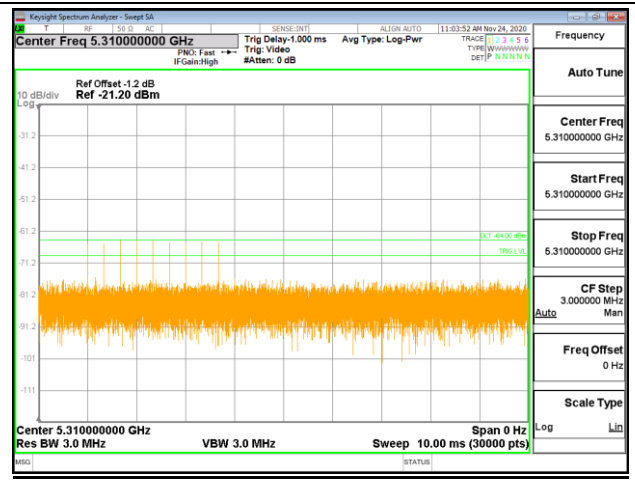



<80MHz / 5290MHz>

Radars Type 0

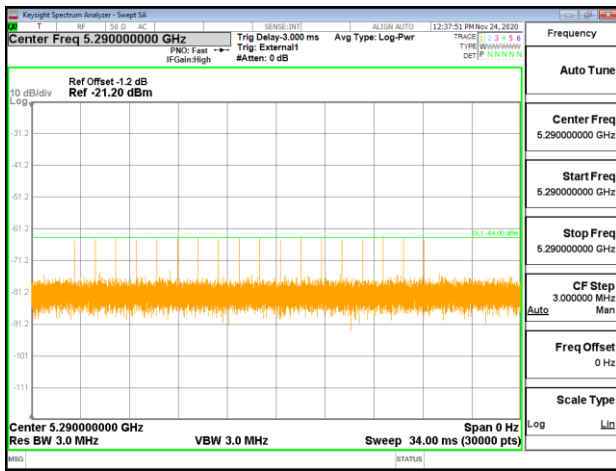

Radars Type 1

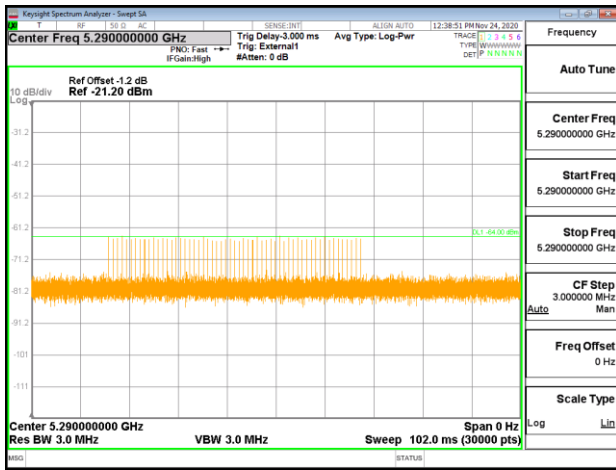

Radars Type 2

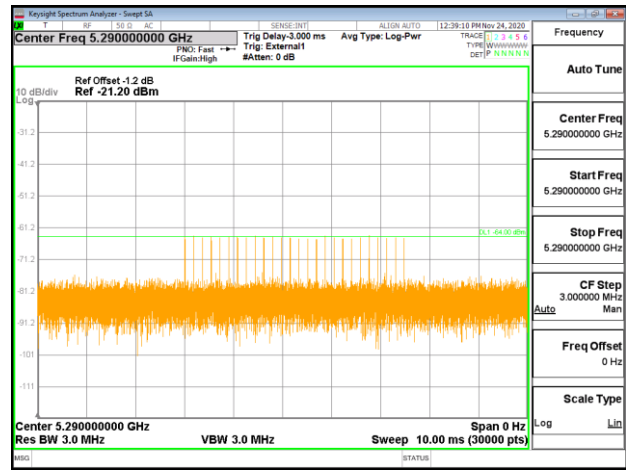

Radars Type 3

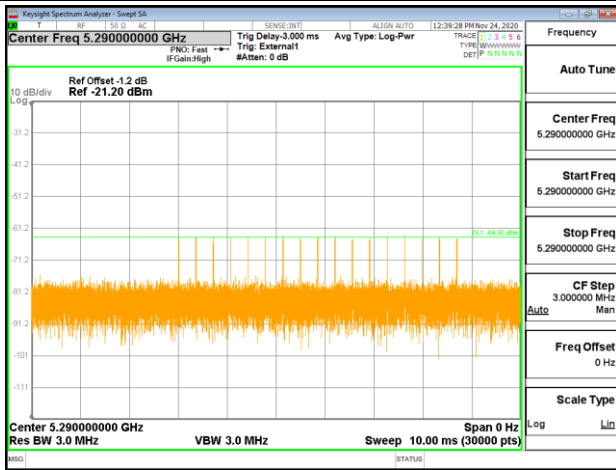

Radars Type 4

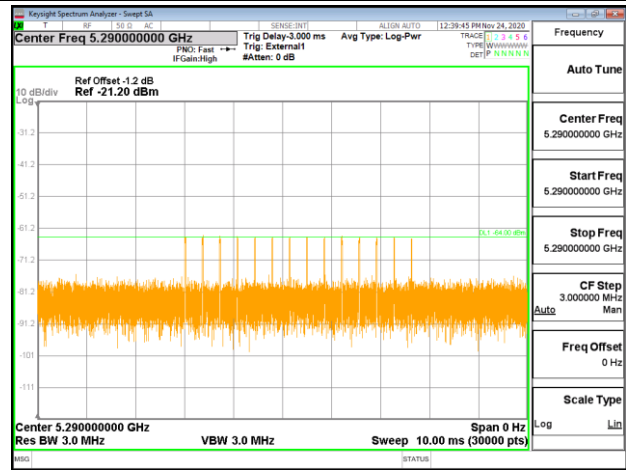



Single Burst of Radar Type 5

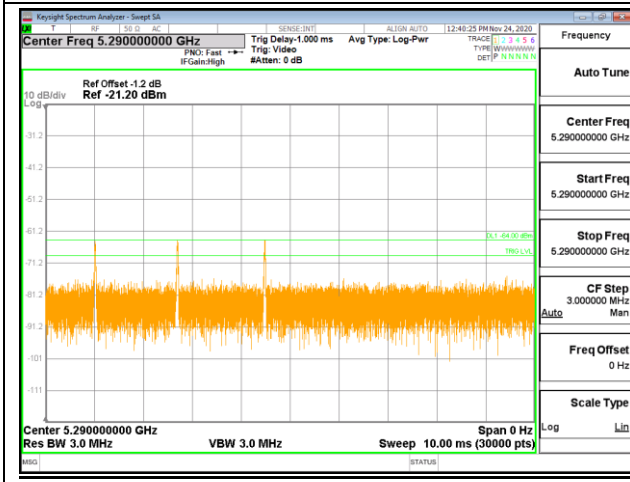

Single Burst of Radar Type 6

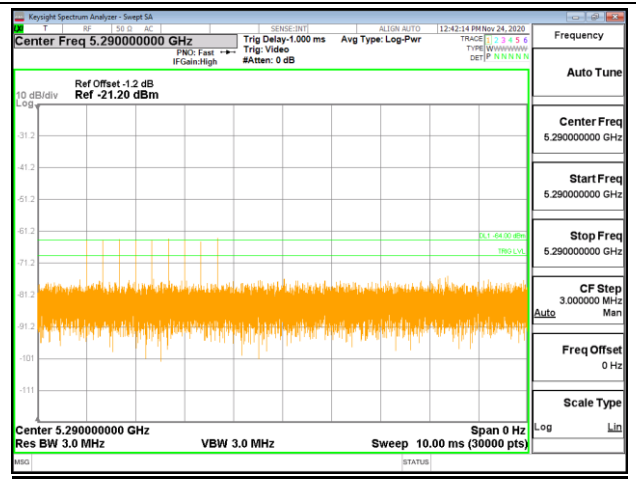



<20MHz / 5500MHz>

Radars Type 0

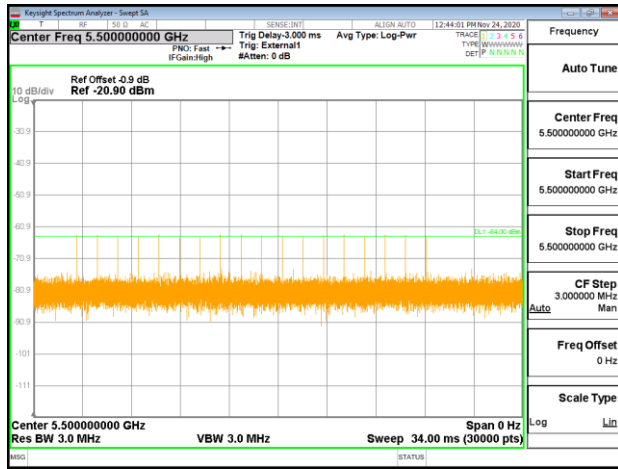

Radars Type 1

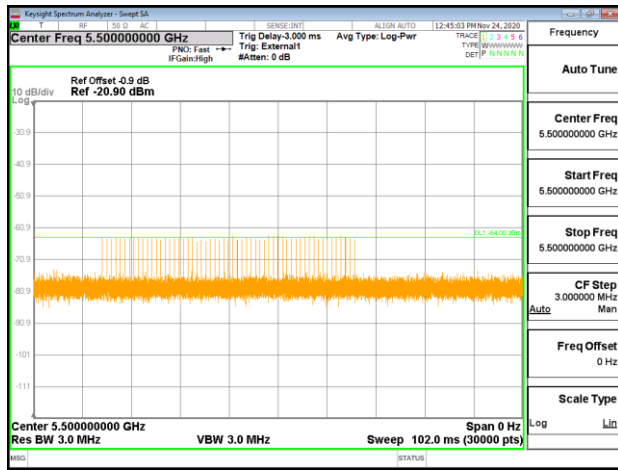

Radars Type 2

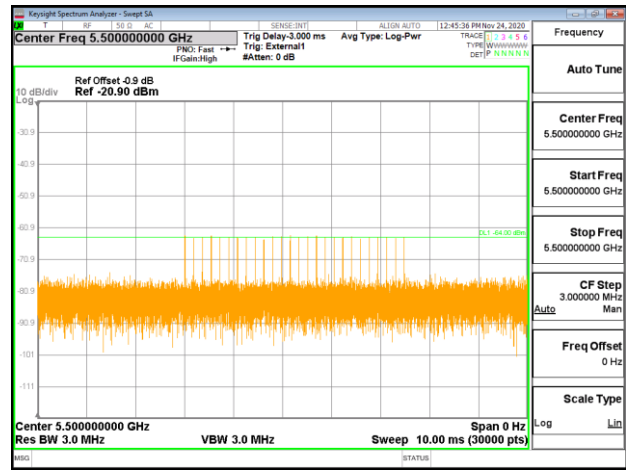

Radars Type 3

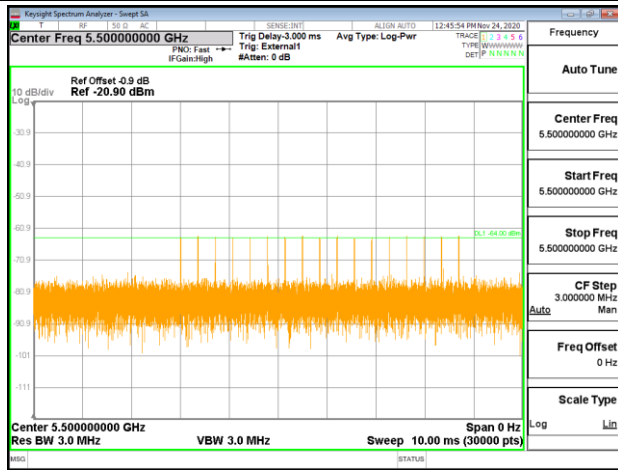

Radars Type 4

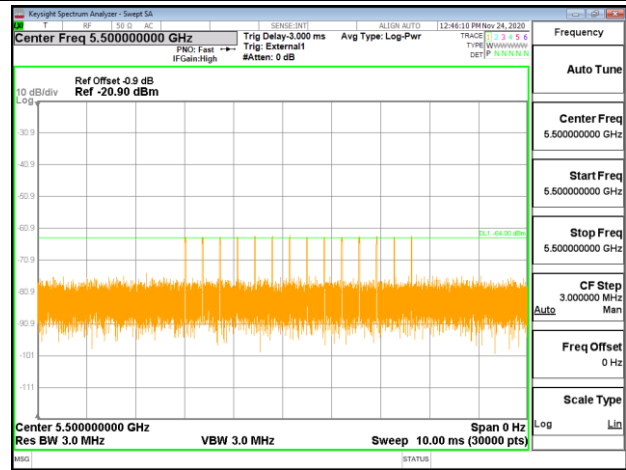





Single Burst of Radar Type 5

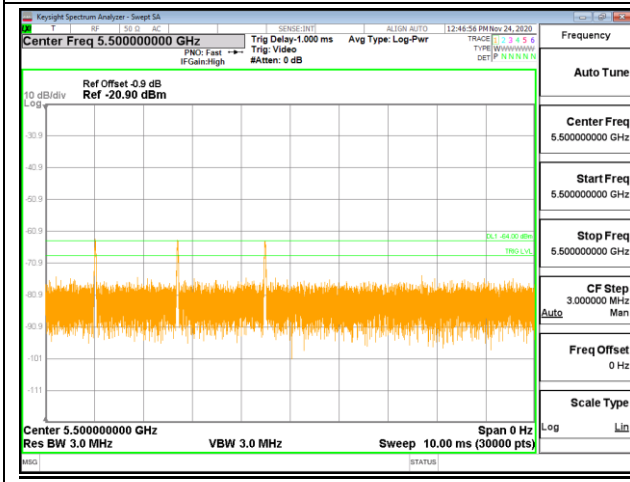

Single Burst of Radar Type 6

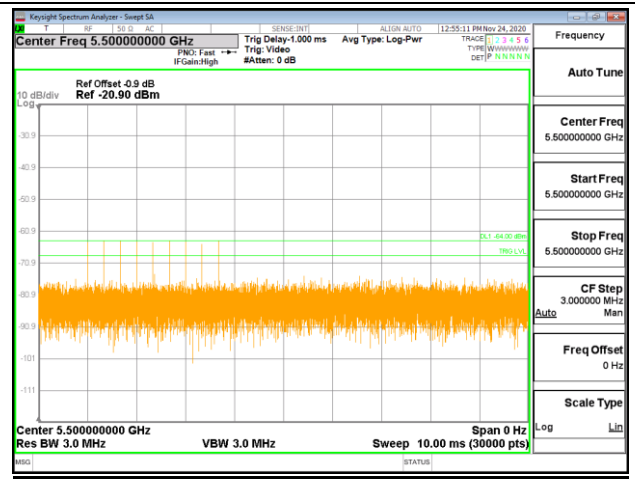



<40MHz / 5510MHz>

Radars Type 0

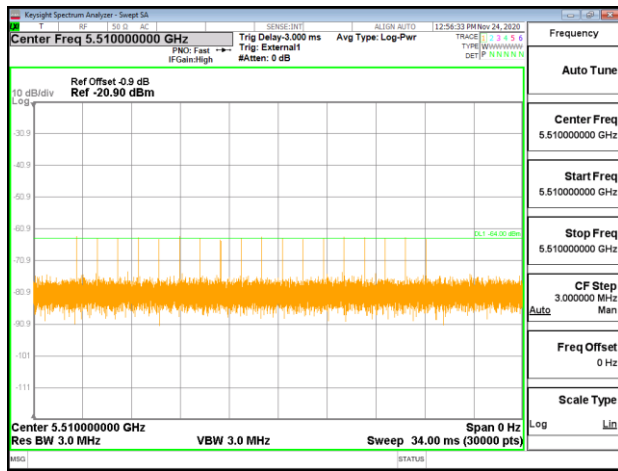

Radars Type 1

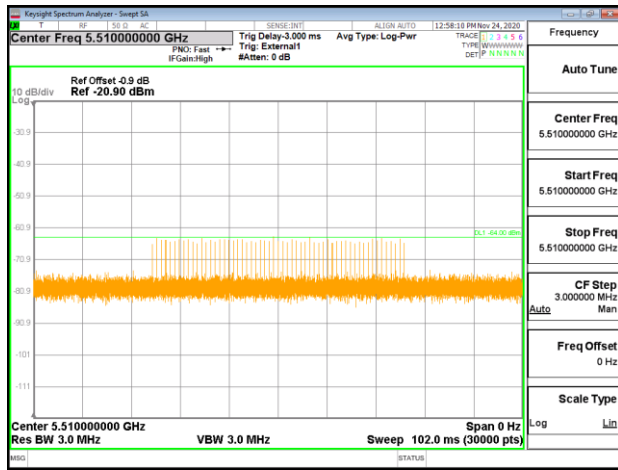

Radars Type 2

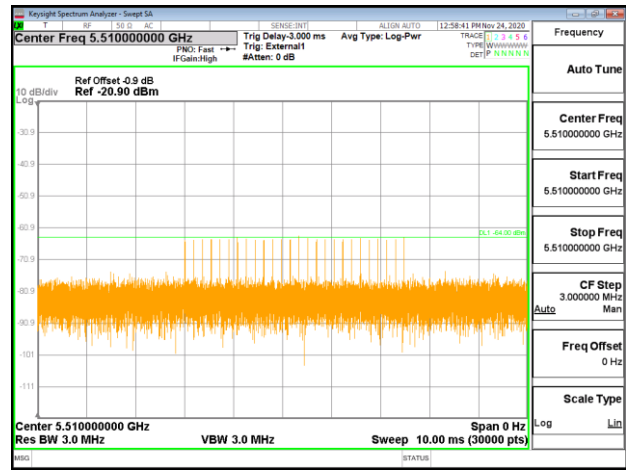

Radars Type 3

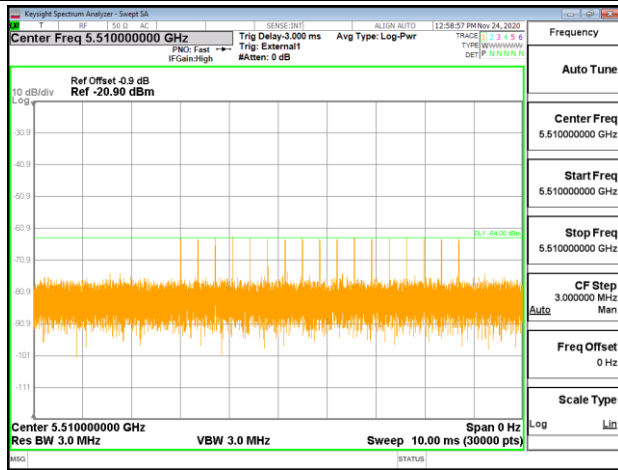

Radars Type 4

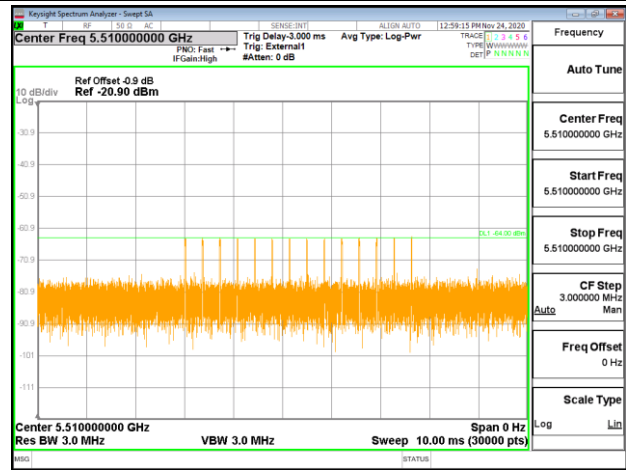



Single Burst of Radar Type 5

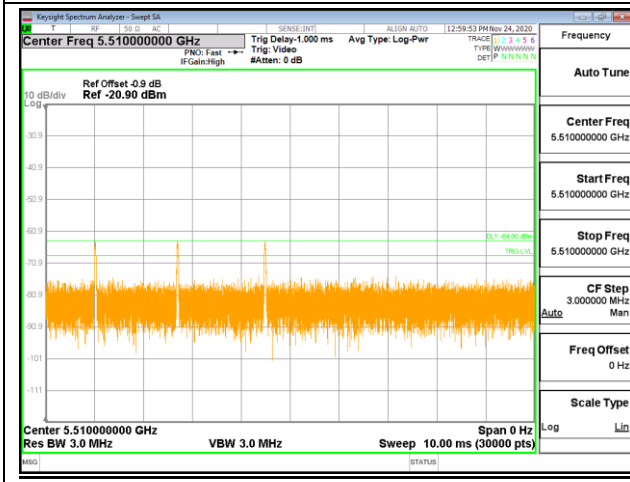

Single Burst of Radar Type 6

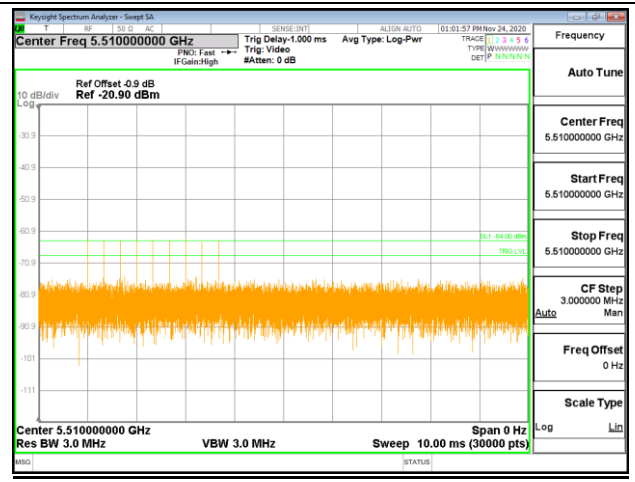



<80MHz / 5530MHz>

Radars Type 0

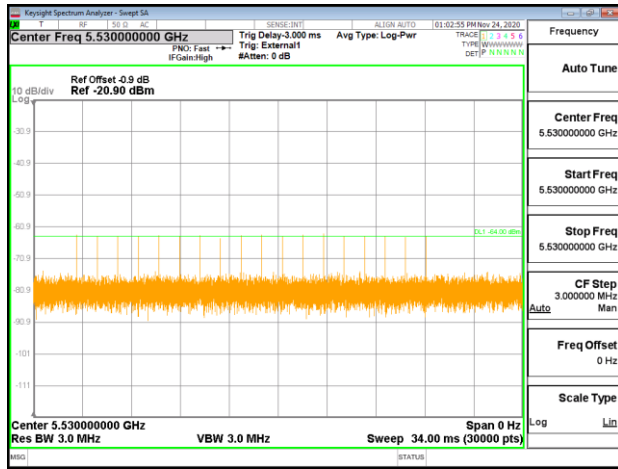

Radars Type 1

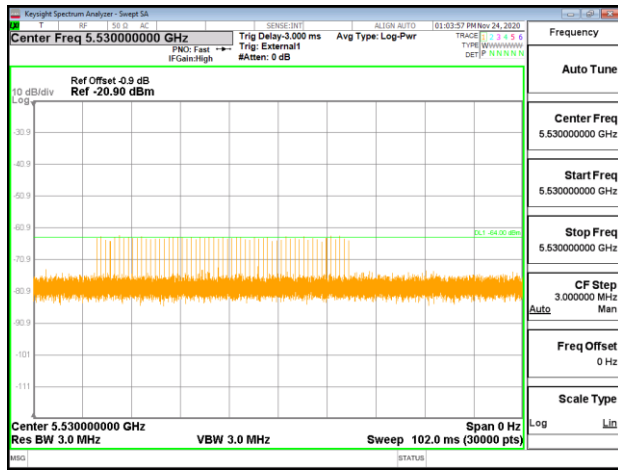

Radars Type 2

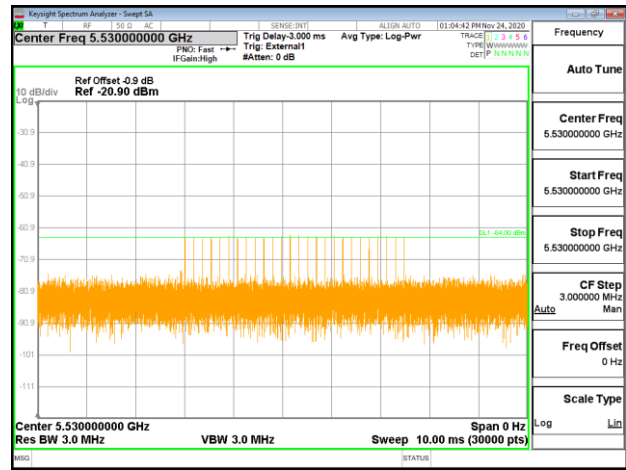

Radars Type 3

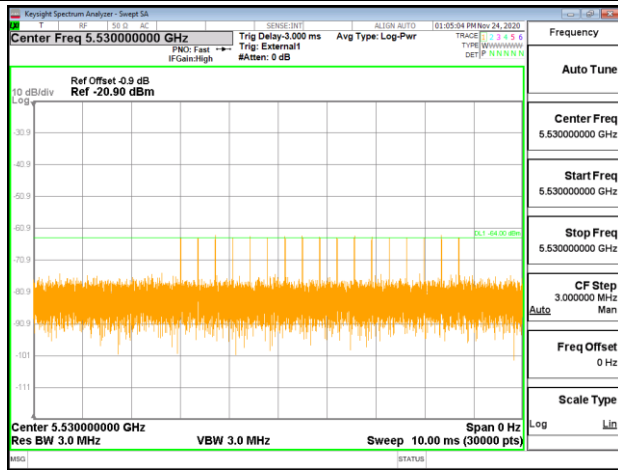

Radars Type 4

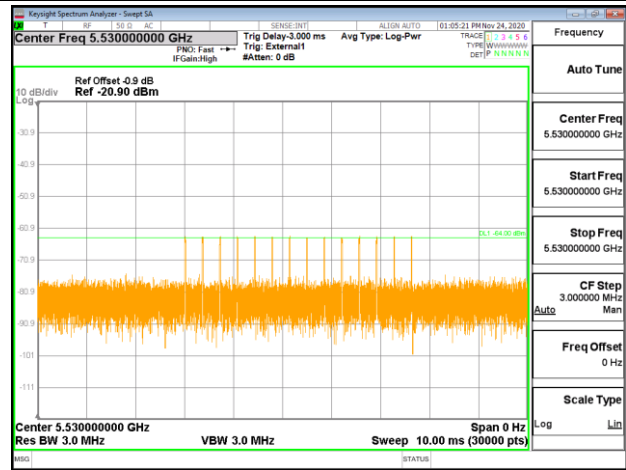



Single Burst of Radar Type 5

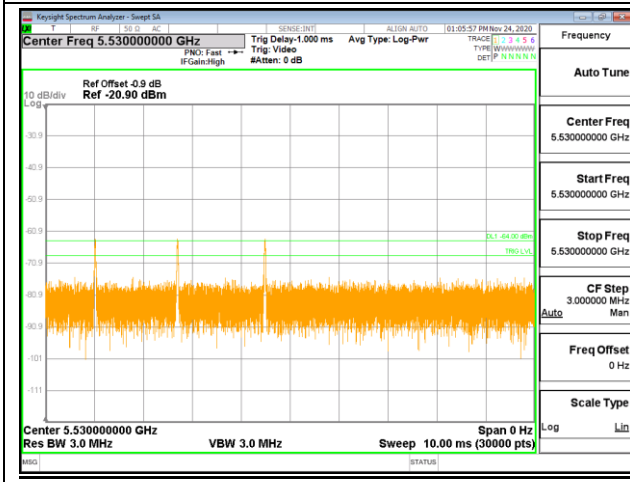

Single Burst of Radar Type 6

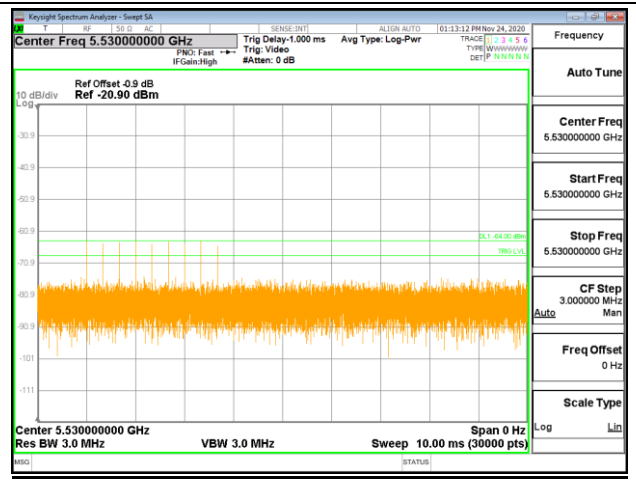



## 3.2 U-NII Detection Bandwidth

### 3.2.1 Limit of U-NII Detection Bandwidth

The U-NII Detection Bandwidth shall contain minimum 100% of the 99% power bandwidth. During the U-NII Detection Bandwidth detection test, radar type 0 is used and for each frequency step the minimum percentage of detection is 90%. Measurements are performed with no data traffic.

### 3.2.2 Test Procedures

- (1) Adjust the equipment to produce a single burst of the Short Pulse Radar Type 0 at the center frequency of the EUT Operating Channel at the specified DFS Detection Threshold level.
- (2) Set the EUT up as a standalone device (no associated Client or Master, as appropriate) and no traffic. Frame based systems will be set to a talk/listen ratio of 0%/100% during this test.
- (3) Generate a single radar burst, and note the response of the EUT. Repeat for a minimum of 10 trials. The EUT must detect the Radar Waveform using the specified U-NII Detection Bandwidth criterion.
- (4) Starting at the center frequency of the EUT operating Channel, increase the radar frequency in 5 MHz steps, repeating the above test sequence, until the detection rate falls below the U-NII Detection Bandwidth criterion specified in report clause 2.3. Repeat this measurement in 1MHz steps at frequencies 5 MHz below where the detection rate begins to fall. Record the highest frequency (denote as  $F_H$ ) at which detection is greater than or equal to the U-NII Detection Bandwidth criterion. Recording the detection rate at frequencies above  $F_H$  is not required to demonstrate compliance.
- (5) Starting at the center frequency of the EUT operating Channel, decrease the radar frequency in 5 MHz steps, repeating the above test sequence, until the detection rate falls below the U-NII Detection Bandwidth criterion specified in report clause 2.3. Repeat this measurement in 1MHz steps at frequencies 5 MHz above where the detection rate begins to fall. Record the lowest frequency (denote as  $F_L$ ) at which detection is greater than or equal to the U-NII Detection Bandwidth criterion. Recording the detection rate at frequencies below  $F_L$  is not required to demonstrate compliance.
- (6) The U-NII Detection Bandwidth is calculated as follows:  
*U-NII Detection Bandwidth* =  $F_H - F_L$

### 3.2.3 Test Setup

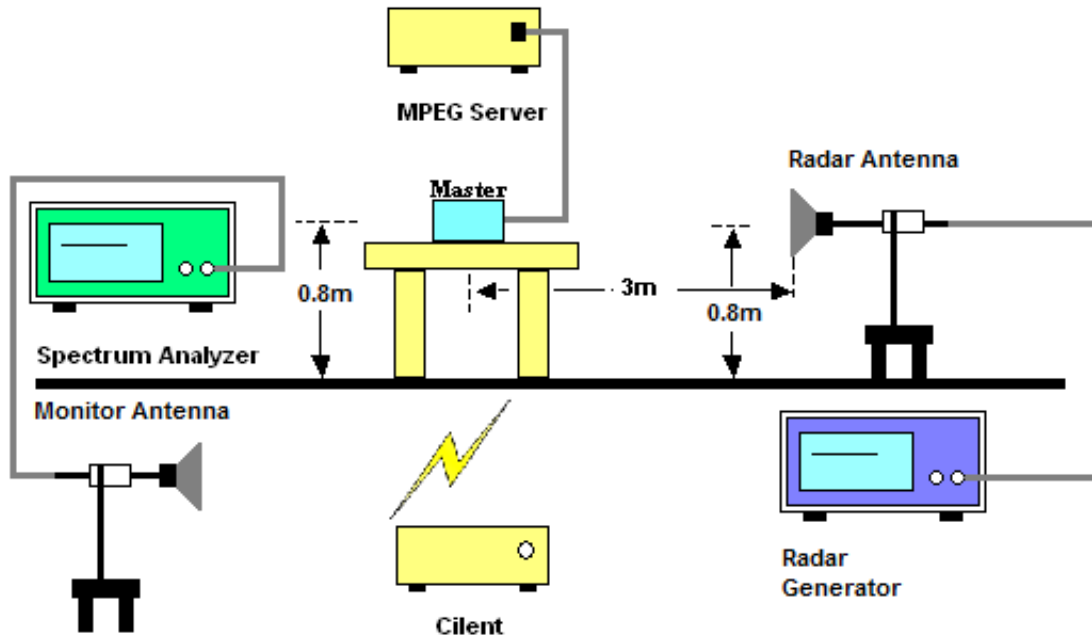

### 3.2.4 Test Deviation

There is no deviation with the original standard.



3.2.5 Result of U-NII Detection Bandwidth

<20MHz / 5300MHz>

Frequency (MHz)	Fc	Trial Number (Detection = Y, No Detection = N)										Rate (%)	F <sub>H</sub> /F <sub>L</sub>	
		1	2	3	4	5	6	7	8	9	10			
5289	-11	N	N	N	N	N	N	N	N	N	N	N	0%	
5290	-10	Y	Y	Y	Y	Y	Y	Y	Y	Y	Y	Y	100%	F <sub>L</sub>
5291	-9	Y	Y	Y	Y	Y	Y	Y	Y	Y	Y	Y	100%	
5292	-8	Y	Y	Y	Y	Y	Y	Y	Y	Y	Y	Y	100%	
5293	-7	Y	Y	Y	Y	Y	Y	Y	Y	Y	Y	Y	100%	
5294	-6	Y	Y	Y	Y	Y	Y	Y	Y	Y	Y	Y	100%	
5295	-5	Y	Y	Y	Y	Y	Y	Y	Y	Y	Y	Y	100%	
5300	0	Y	Y	Y	Y	Y	Y	Y	Y	Y	Y	Y	100%	
5305	+5	Y	Y	Y	Y	Y	Y	Y	Y	Y	Y	Y	100%	
5306	+6	Y	Y	Y	Y	Y	Y	Y	Y	Y	Y	Y	100%	
5307	+7	Y	Y	Y	Y	Y	Y	Y	Y	Y	Y	Y	100%	
5308	+8	Y	Y	Y	Y	Y	Y	Y	Y	Y	Y	Y	100%	
5309	+9	Y	Y	Y	Y	Y	Y	Y	Y	Y	Y	Y	100%	
5310	+10	Y	Y	Y	Y	Y	Y	Y	Y	Y	Y	Y	100%	F <sub>H</sub>
5311	+11	N	N	N	N	N	N	N	N	N	N	N	0%	

Detection Bandwidth = F<sub>H</sub> – F<sub>L</sub> = 5310 – 5290 = 20 MHz  
 EUT 99% Bandwidth = 18.259 MHz (Refer to channel 60)





<40MHz / 5310MHz>

Frequency (MHz)	Fc	Trial Number (Detection = Y, No Detection = N)										Rate (%)	F <sub>H</sub> /F <sub>L</sub>
		1	2	3	4	5	6	7	8	9	10		
5289	-21	N	N	N	N	N	N	N	N	N	N	0%	
5290	-20	Y	Y	Y	Y	Y	Y	Y	Y	Y	Y	100%	F <sub>L</sub>
5291	-19	Y	Y	Y	Y	Y	Y	Y	Y	Y	Y	100%	
5292	-18	Y	Y	Y	Y	Y	Y	Y	Y	Y	Y	100%	
5293	-17	Y	Y	Y	Y	Y	Y	Y	Y	Y	Y	100%	
5294	-16	Y	Y	Y	Y	Y	Y	Y	Y	Y	Y	100%	
5295	-15	Y	Y	Y	Y	Y	Y	Y	Y	Y	Y	100%	
5300	-10	Y	Y	Y	Y	Y	Y	Y	Y	Y	Y	100%	
5305	-5	Y	Y	Y	Y	Y	Y	Y	Y	Y	Y	100%	
5310	0	Y	Y	Y	Y	Y	Y	Y	Y	Y	Y	100%	
5315	+5	Y	Y	Y	Y	Y	Y	Y	Y	Y	Y	100%	
5320	+10	Y	Y	Y	Y	Y	Y	Y	Y	Y	Y	100%	
5325	+15	Y	Y	Y	Y	Y	Y	Y	Y	Y	Y	100%	
5326	+16	Y	Y	Y	Y	Y	Y	Y	Y	Y	Y	100%	
5327	+17	Y	Y	Y	Y	Y	Y	Y	Y	Y	Y	100%	
5328	+18	Y	Y	Y	Y	Y	Y	Y	Y	Y	Y	100%	
5329	+19	Y	Y	Y	Y	Y	Y	Y	Y	Y	Y	100%	
5330	+20	Y	Y	Y	Y	Y	Y	Y	Y	Y	Y	100%	F <sub>H</sub>
5331	+21	N	N	N	N	N	N	N	N	N	N	0%	

Detection Bandwidth = F<sub>H</sub> – F<sub>L</sub> = 5330 – 5290 = 40 MHz  
EUT 99% Bandwidth = 36.466 MHz (Refer to channel 62)



<80MHz / 5290MHz>

Frequency (MHz)	Fc	Trial Number (Detection = Y, No Detection = N)										Rate (%)	F <sub>H</sub> /F <sub>L</sub>
		1	2	3	4	5	6	7	8	9	10		
5249	-41	N	N	N	N	N	N	N	N	N	N	0%	
5250	-40	Y	Y	Y	Y	Y	Y	Y	Y	Y	Y	100%	F <sub>L</sub>
5251	-39	Y	Y	Y	Y	Y	Y	Y	Y	Y	Y	100%	
5252	-38	Y	Y	Y	Y	Y	Y	Y	Y	Y	Y	100%	
5253	-37	Y	Y	Y	Y	Y	Y	Y	Y	Y	Y	100%	
5254	-36	Y	Y	Y	Y	Y	Y	Y	Y	Y	Y	100%	
5255	-35	Y	Y	Y	Y	Y	Y	Y	Y	Y	Y	100%	
5260	-30	Y	Y	Y	Y	Y	Y	Y	Y	Y	Y	100%	
5265	-25	Y	Y	Y	Y	Y	Y	Y	Y	Y	Y	100%	
5270	-20	Y	Y	Y	Y	Y	Y	Y	Y	Y	Y	100%	
5275	-15	Y	Y	Y	Y	Y	Y	Y	Y	Y	Y	100%	
5380	-10	Y	Y	Y	Y	Y	Y	Y	Y	Y	Y	100%	
5285	-5	Y	Y	Y	Y	Y	Y	Y	Y	Y	Y	100%	
5290	0	Y	Y	Y	Y	Y	Y	Y	Y	Y	Y	100%	
5295	+5	Y	Y	Y	Y	Y	Y	Y	Y	Y	Y	100%	
5300	+10	Y	Y	Y	Y	Y	Y	Y	Y	Y	Y	100%	
5305	+15	Y	Y	Y	Y	Y	Y	Y	Y	Y	Y	100%	
5310	+20	Y	Y	Y	Y	Y	Y	Y	Y	Y	Y	100%	
5315	+25	Y	Y	Y	Y	Y	Y	Y	Y	Y	Y	100%	
5320	+30	Y	Y	Y	Y	Y	Y	Y	Y	Y	Y	100%	
5325	+35	Y	Y	Y	Y	Y	Y	Y	Y	Y	Y	100%	
5326	+36	Y	Y	Y	Y	Y	Y	Y	Y	Y	Y	100%	
5327	+37	Y	Y	Y	Y	Y	Y	Y	Y	Y	Y	100%	
5328	+38	Y	Y	Y	Y	Y	Y	Y	Y	Y	Y	100%	
5329	+39	Y	Y	Y	Y	Y	Y	Y	Y	Y	Y	100%	
5330	+40	Y	Y	Y	Y	Y	Y	Y	Y	Y	Y	100%	F <sub>H</sub>
5331	+41	N	N	N	N	N	N	N	N	N	N	0%	

Detection Bandwidth = F<sub>H</sub> – F<sub>L</sub> = 5330 – 5250 = 80 MHz  
EUT 99% Bandwidth = 76.048 MHz (Refer to channel 58)



<20MHz / 5500MHz>

Frequency (MHz)	Fc	Trial Number (Detection = Y, No Detection = N)										Rate (%)	F <sub>H</sub> /F <sub>L</sub>	
		1	2	3	4	5	6	7	8	9	10			
5489	-11	N	N	N	N	N	N	N	N	N	N	N	0%	
5490	-10	Y	Y	Y	Y	Y	Y	Y	Y	Y	Y	Y	100%	F <sub>L</sub>
5491	-9	Y	Y	Y	Y	Y	Y	Y	Y	Y	Y	Y	100%	
5492	-8	Y	Y	Y	Y	Y	Y	Y	Y	Y	Y	Y	100%	
5493	-7	Y	Y	Y	Y	Y	Y	Y	Y	Y	Y	Y	100%	
5494	-6	Y	Y	Y	Y	Y	Y	Y	Y	Y	Y	Y	100%	
5495	-5	Y	Y	Y	Y	Y	Y	Y	Y	Y	Y	Y	100%	
5500	0	Y	Y	Y	Y	Y	Y	Y	Y	Y	Y	Y	100%	
5505	+5	Y	Y	Y	Y	Y	Y	Y	Y	Y	Y	Y	100%	
5506	+6	Y	Y	Y	Y	Y	Y	Y	Y	Y	Y	Y	100%	
5507	+7	Y	Y	Y	Y	Y	Y	Y	Y	Y	Y	Y	100%	
5508	+8	Y	Y	Y	Y	Y	Y	Y	Y	Y	Y	Y	100%	
5509	+9	Y	Y	Y	Y	Y	Y	Y	Y	Y	Y	Y	100%	
5510	+10	Y	Y	Y	Y	Y	Y	Y	Y	Y	Y	Y	100%	F <sub>H</sub>
5511	+11	N	N	N	N	N	N	N	N	N	N	N	0%	

Detection Bandwidth = F<sub>H</sub> - F<sub>L</sub> = 5510 - 5490 = 20 MHz  
 EUT 99% Bandwidth = 17.726MHz (Refer to channel 100)



<40MHz / 5510MHz>

Frequency (MHz)	Fc	Trial Number (Detection = Y, No Detection = N)										Rate (%)	F <sub>H</sub> /F <sub>L</sub>
		1	2	3	4	5	6	7	8	9	10		
5489	-21	N	N	N	N	N	N	N	N	N	N	0%	
5490	-20	Y	Y	Y	Y	Y	Y	Y	Y	Y	Y	100%	F <sub>L</sub>
5491	-19	Y	Y	Y	Y	Y	Y	Y	Y	Y	Y	100%	
5492	-18	Y	Y	Y	Y	Y	Y	Y	Y	Y	Y	100%	
5493	-17	Y	Y	Y	Y	Y	Y	Y	Y	Y	Y	100%	
5494	-16	Y	Y	Y	Y	Y	Y	Y	Y	Y	Y	100%	
5495	-15	Y	Y	Y	Y	Y	Y	Y	Y	Y	Y	100%	
5500	-10	Y	Y	Y	Y	Y	Y	Y	Y	Y	Y	100%	
5505	-5	Y	Y	Y	Y	Y	Y	Y	Y	Y	Y	100%	
5510	0	Y	Y	Y	Y	Y	Y	Y	Y	Y	Y	100%	
5515	+5	Y	Y	Y	Y	Y	Y	Y	Y	Y	Y	100%	
5520	+10	Y	Y	Y	Y	Y	Y	Y	Y	Y	Y	100%	
5525	+15	Y	Y	Y	Y	Y	Y	Y	Y	Y	Y	100%	
5526	+16	Y	Y	Y	Y	Y	Y	Y	Y	Y	Y	100%	
5527	+17	Y	Y	Y	Y	Y	Y	Y	Y	Y	Y	100%	
5528	+18	Y	Y	Y	Y	Y	Y	Y	Y	Y	Y	100%	
5529	+19	Y	Y	Y	Y	Y	Y	Y	Y	Y	Y	100%	
5530	+20	Y	Y	Y	Y	Y	Y	Y	Y	Y	Y	100%	F <sub>H</sub>
5531	+21	N	N	N	N	N	N	N	N	N	N	0%	

Detection Bandwidth = F<sub>H</sub> – F<sub>L</sub> = 5530 – 5490 = 40 MHz  
EUT 99% Bandwidth = 36.848 MHz (Refer to channel 102)



<80MHz / 5530MHz>

Frequency (MHz)	Fc	Trial Number (Detection = Y, No Detection = N)										Rate (%)	F <sub>H</sub> /F <sub>L</sub>
		1	2	3	4	5	6	7	8	9	10		
5489	-41	N	N	N	N	N	N	N	N	N	N	0%	
5490	-40	Y	Y	Y	Y	Y	Y	Y	Y	Y	Y	100%	F <sub>L</sub>
5491	-39	Y	Y	Y	Y	Y	Y	Y	Y	Y	Y	100%	
5492	-38	Y	Y	Y	Y	Y	Y	Y	Y	Y	Y	100%	
5493	-37	Y	Y	Y	Y	Y	Y	Y	Y	Y	Y	100%	
5494	-36	Y	Y	Y	Y	Y	Y	Y	Y	Y	Y	100%	
5495	-35	Y	Y	Y	Y	Y	Y	Y	Y	Y	Y	100%	
5500	-30	Y	Y	Y	Y	Y	Y	Y	Y	Y	Y	100%	
5505	-25	Y	Y	Y	Y	Y	Y	Y	Y	Y	Y	100%	
5510	-20	Y	Y	Y	Y	Y	Y	Y	Y	Y	Y	100%	
5515	-15	Y	Y	Y	Y	Y	Y	Y	Y	Y	Y	100%	
5520	-10	Y	Y	Y	Y	Y	Y	Y	Y	Y	Y	100%	
5525	-5	Y	Y	Y	Y	Y	Y	Y	Y	Y	Y	100%	
5530	0	Y	Y	Y	Y	Y	Y	Y	Y	Y	Y	100%	
5535	+5	Y	Y	Y	Y	Y	Y	Y	Y	Y	Y	100%	
5540	+10	Y	Y	Y	Y	Y	Y	Y	Y	Y	Y	100%	
5545	+15	Y	Y	Y	Y	Y	Y	Y	Y	Y	Y	100%	
5550	+20	Y	Y	Y	Y	Y	Y	Y	Y	Y	Y	100%	
5555	+25	Y	Y	Y	Y	Y	Y	Y	Y	Y	Y	100%	
5560	+30	Y	Y	Y	Y	Y	Y	Y	Y	Y	Y	100%	
5565	+35	Y	Y	Y	Y	Y	Y	Y	Y	Y	Y	100%	
5566	+36	Y	Y	Y	Y	Y	Y	Y	Y	Y	Y	100%	
5567	+37	Y	Y	Y	Y	Y	Y	Y	Y	Y	Y	100%	
5568	+38	Y	Y	Y	Y	Y	Y	Y	Y	Y	Y	100%	
5569	+39	Y	Y	Y	Y	Y	Y	Y	Y	Y	Y	100%	
5570	+40	Y	Y	Y	Y	Y	Y	Y	Y	Y	Y	100%	F <sub>H</sub>
5571	+41	N	N	N	N	N	N	N	N	N	N	0%	

Detection Bandwidth = F<sub>H</sub> – F<sub>L</sub> = 5570 – 5490 = 80 MHz  
EUT 99% Bandwidth = 77.997MHz (Refer to channel 106)



### 3.3 Channel Availability Check

#### 3.3.1 Limit of Channel Availability Check

The Initial Channel Availability Check Time tests that the EUT does not emit beacon, control, or data signals on the test Channel until the power-up sequence has been completed and the U-NII device checks for radar waveforms for **one minute** on the test Channel.

#### 3.3.2 Test Procedures of Initial Channel Availability Check Time

This test does not use any radar waveforms and only needs to be performed one time.

- (1) The U-NII devices will be powered on and be instructed to operate on the appropriate U-NII Channel that must incorporate DFS functions. At the same time the EUT is powered on, the spectrum analyzer will be set to zero span mode with a 3 MHz RBW and 3 MHz VBW on the Channel occupied by the radar (Chr) with a 2.5 minute sweep time. The spectrum analyzer's sweep will be started at the same time power is applied to the U-NII device.
- (2) The EUT should not transmit any beacon or data transmissions until at least 1 minute after the completion of the power-on cycle.

### 3.3.3 Radar Burst at the Beginning of the Channel Availability Check Time

The steps below define the procedure to verify successful radar detection on the test Channel during a period equal to the Channel Availability Check Time and avoidance of operation on that Channel when a radar Burst with a level equal to the DFS Detection Threshold + 1 dB occurs at the beginning of the Channel Availability Check Time. This is illustrated in Figure 15.

- (1) The Radar Waveform generator and EUT are connected using the applicable test setup and the power of the EUT is switched off.
- (2) The EUT is powered on at  $T_0$ .  $T_1$  denotes the instant when the EUT has completed its power-up sequence ( $T_{power\_up}$ ). The Channel Availability Check Time commences on Chr at instant  $T_1$  and will end no sooner than  $T_1 + T_{ch\_avail\_check}$ .
- (3) A single Burst of one of the Short Pulse Radar Types 1-4 will commence within a 6 second window starting at  $T_1$ . An additional 1 dB is added to the radar test signal to ensure it is at or above the DFS Detection Threshold, accounting for equipment variations/errors.
- (4) Visual indication or measured results on the EUT of successful detection of the radar Burst will be recorded and reported. Observation of Chr for EUT emissions will continue for 2.5 minutes after the radar Burst has been generated.
- (5) Verify that during the 2.5 minute measurement window no EUT transmissions occurred on Chr. The Channel Availability Check results will be recorded.

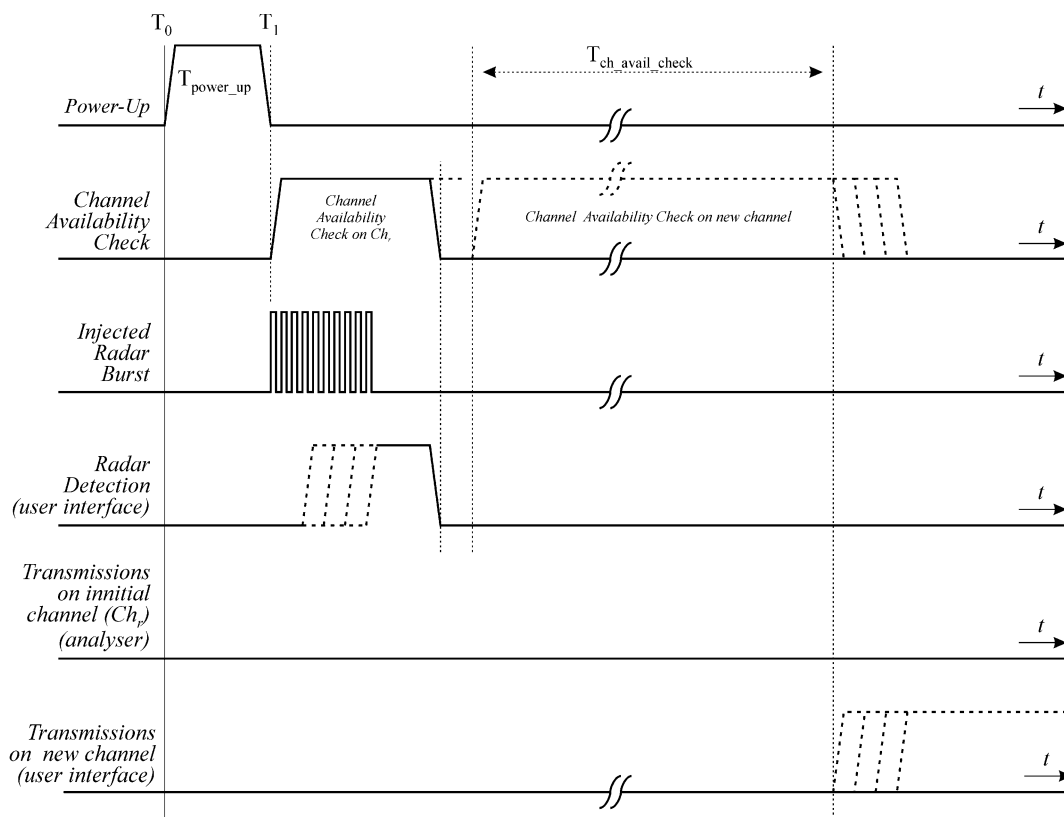

Figure 15: Example of timing for radar testing at the beginning of the Channel Availability Check Time

### 3.3.4 Radar Burst at the End of the Channel Availability Check Time

The steps below define the procedure to verify successful radar detection on the test Channel during a period equal to the Channel Availability Check Time and avoidance of operation on that Channel when a radar Burst with a level equal to the DFS Detection Threshold + 1dB occurs at the end of the Channel Availability Check Time. This is illustrated in Figure 16.

- (1) The Radar Waveform generator and EUT are connected using the applicable test setup and the power of the EUT is switched off.
- (2) The EUT is powered on at  $T_0$ .  $T_1$  denotes the instant when the EUT has completed its power-up sequence ( $T_{power\_up}$ ). The Channel Availability Check Time commences on Chr at instant  $T_1$  and will end no sooner than  $T_1 + T_{ch\_avail\_check}$ .
- (3) A single Burst of one of the Short Pulse Radar Types 1-4 will commence within a 6 second window starting at  $T_1 + 54$  seconds. An additional 1 dB is added to the radar test signal to ensure it is at or above the DFS Detection Threshold, accounting for equipment variations/errors.
- (4) Visual indication or measured results on the EUT of successful detection of the radar Burst will be recorded and reported. Observation of Chr for EUT emissions will continue for 2.5 minutes after the radar Burst has been generated.
- (5) Verify that during the 2.5 minute measurement window no EUT transmissions occurred on Chr. The Channel Availability Check results will be recorded.

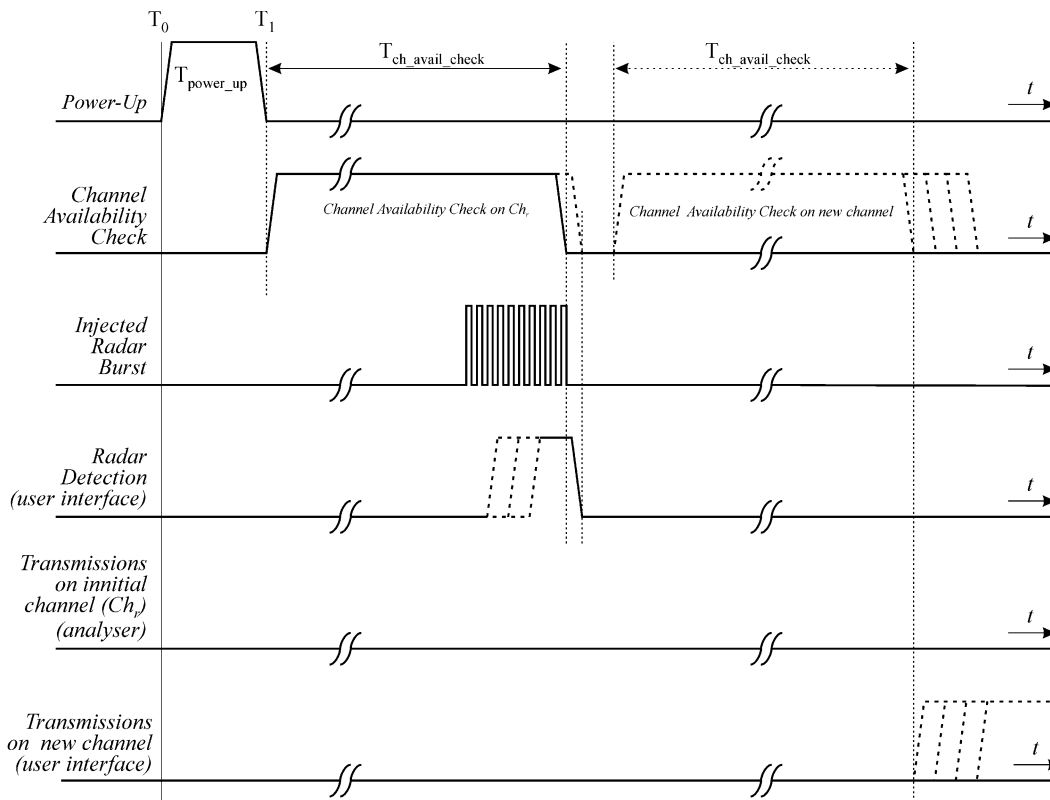
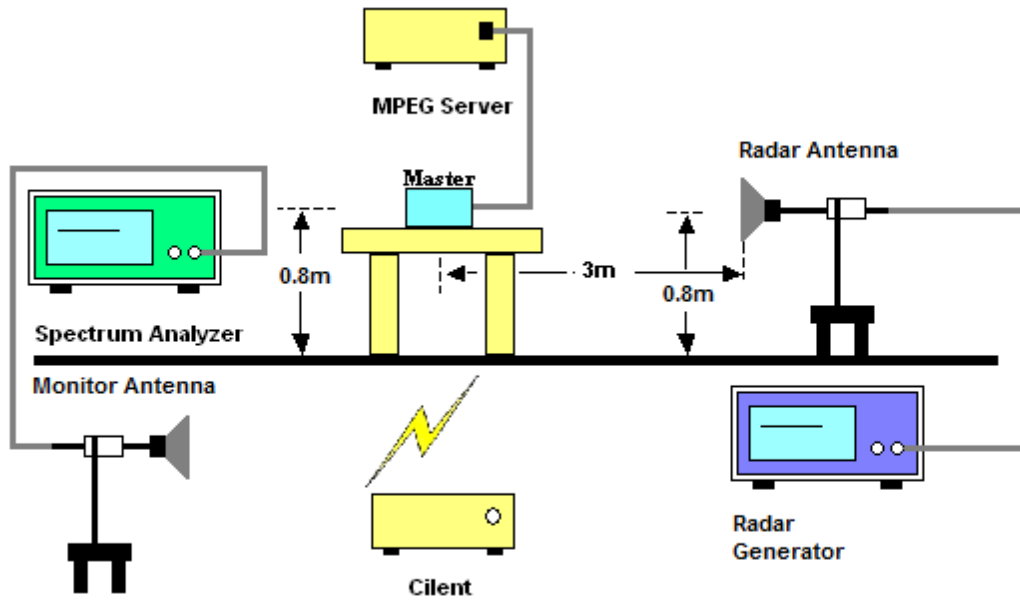

Figure 16: Example of timing for radar testing towards the end of the Channel Availability Check Time



### 3.3.5 Test Setup



### 3.3.6 Test Deviation

There is no deviation with the original standard.



### 3.3.7 Result of Channel Availability Check Time

<80MHz / 5290MHz>



- Marker 1 (Delta2): 60 seconds before End of Channel Availability Check
- Marker 2: End of Channel Availability Check
- Marker 3: 54 seconds or 6 seconds before End of Channel Availability Check



<80MHz / 5530MHz>

EUT Power up and Initial Channel Availability Check Time



Radar Burst at the Beginning of the Channel Availability Check Time



Radar Burst at the End of the Channel Availability Check Time

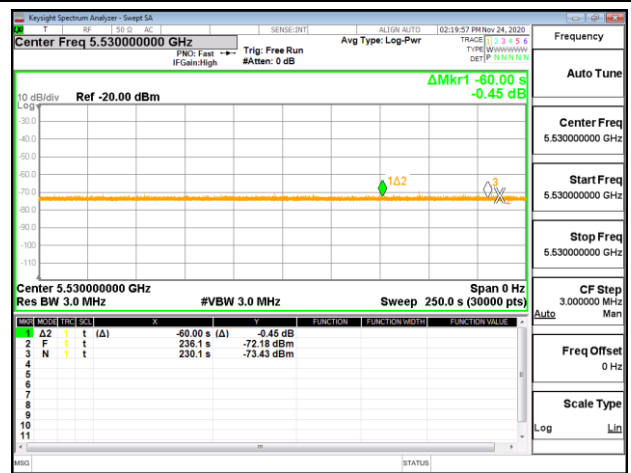

- Marker 1 (Delta2): 60 seconds before End of Channel Availability Check
- Marker 2: End of Channel Availability Check
- Marker 3: 54 seconds or 6 seconds before End of Channel Availability Check



### **3.4 In-Service Monitoring: Channel Move Time, Channel Closing Transmission Time and Non-Occupancy Period**

#### **3.4.1 Limit of In-Service Monitoring**

The EUT has In-Service Monitoring function to continuously monitor the radar signals, If radar is detected, it must leave the channel (Shutdown). The Channel Move Time to cease all transmissions on the current Channel upon detection of a Radar Waveform above the DFS Detection Threshold within 10 sec. The total duration of Channel Closing Transmission Time is comprised of 200 milliseconds starting at the beginning of the Channel Move Time plus any additional intermittent control signals required to facilitate Channel changes (an aggregate of 60 milliseconds) during the remainder of the 10 second period. The aggregate duration of control signals will not count quiet periods in between transmissions.

Non-Occupancy Period time is 30 minute during which a Channel will not be utilized after a Radar Waveform is detected on that Channel.

#### **3.4.2 Test Procedures**

- (1) One frequency will be chosen from the Operating Channels of the EUT within the 5250-5350 MHz or 5470-5725 MHz bands. For 802.11 devices, the test frequency must contain control signals. This can be verified by disabling channel loading and monitoring the spectrum analyzer. If no control signals are detected, another frequency must be selected within the emission bandwidth where control signals are detected.
- (2) In case the EUT is a Master Device, a U-NII device operating as a Client Device will be used and it is assumed that the Client will associate with the EUT (Master). For radiated tests, the emissions of the Radar Waveform generator will be directed towards the Master Device. If the Master Device has antenna gain, the main beam of the antenna will be directed toward the radar emitter. Vertical polarization is used for testing.
- (3) The TCP protocol unicast data stream was generated by the iperf software command line with at least 17% activity ratio over any 100ms period.
- (4) Timing plots are reported with calculations demonstrating a minimum channel loading of approximately 17% or greater. For example, channel loading can be estimated by setting the spectrum analyzer for zero span and approximate the Time On/ (Time On + Off Time).
- (5) At time T0 the Radar Waveform generator sends a Burst of pulses for one of the Short Pulse Radar Types 1-4 at DFS Detection Threshold levels on the Operating Channel. An additional 1 dB is added to the radar test signal to ensure it is at or above the DFS Detection Threshold, accounting for equipment variations/errors.
- (6) Observe the transmissions of the EUT at the end of the radar Burst on the Operating Channel for duration greater than 10 seconds. Measure and record the transmissions from the EUT during the observation time (Channel Move Time). Measure and record the Channel Move Time and Channel Closing Transmission Time if radar detection occurs.

- (7) When operating as a Master Device, monitor the EUT for more than 30 minutes following instant T2 to verify that the EUT does not resume any transmissions on this Channel. Perform this test once and record the measurement result.

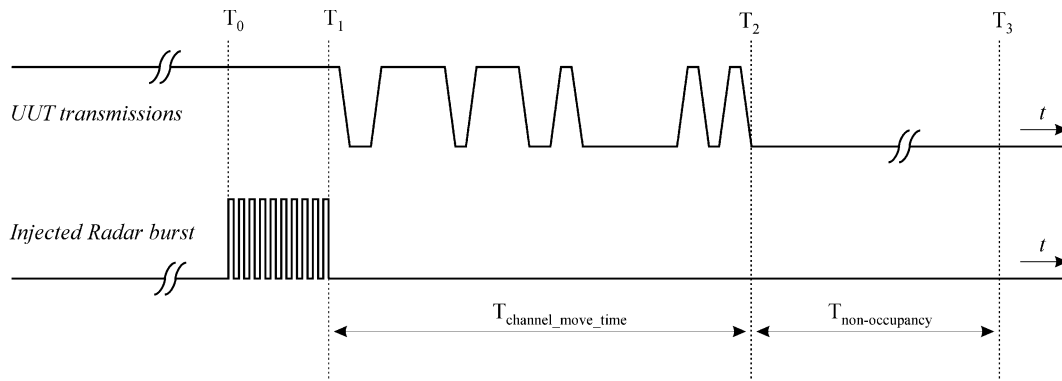

- (8) One 12 seconds plot is reported for the Short Pulse Radar Type 0.
- (9) Measurement of the aggregate duration of the Channel Closing Transmission Time method. With the spectrum analyzer set to zero span tuned to the center frequency of the EUT operating channel at the radar simulated frequency, peak detection, and max hold, the dwell time per bin is given by:  $Dwell (0.4ms) = S (12000ms) / B (30000)$ ; where Dwell is the dwell time per spectrum analyzer sampling bin, S is the sweep time and B is the number of spectrum analyzer sampling bins. An upper bound of the aggregate duration of the intermittent control signals of Channel Closing Transmission Time is calculated by:  $C (ms) = N \times Dwell (0.4 ms)$ ; where C is the Closing Time, N is the number of spectrum analyzer sampling bins (intermittent control signals) showing a U-NII transmission and Dwell is the dwell time per bin.

### 3.4.3 Test Setup

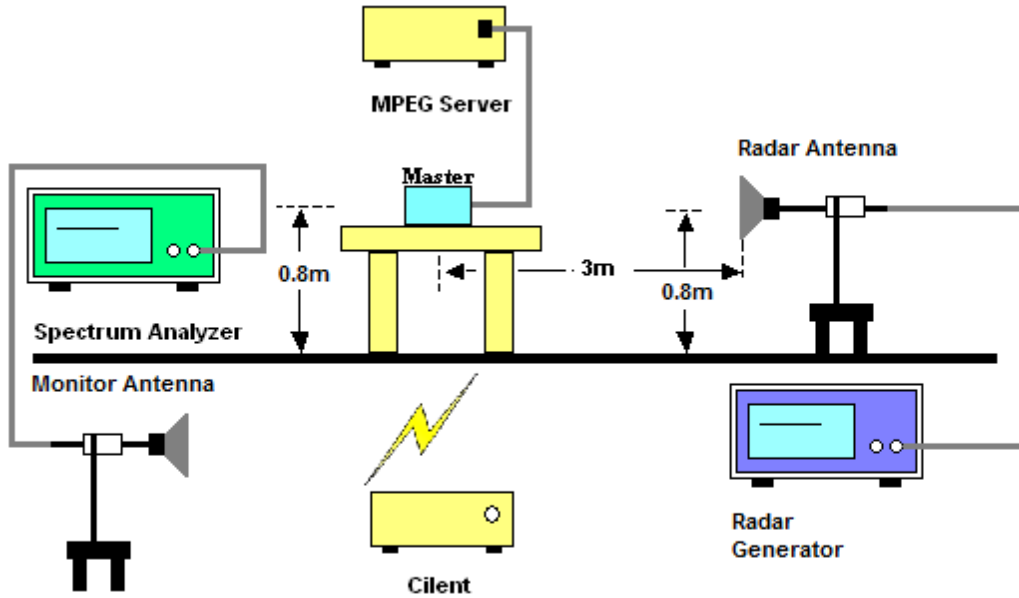

### 3.4.4 Test Deviation

There is no deviation with the original standard.



**3.4.5 Result of Channel Move Time, Channel Closing Transmission Time and Non-Occupancy Period for Client Beacon Test**

<b>Test Mode :</b>	Master	<b>Temperature :</b>	24~26°C
<b>Test Engineer :</b>	PH Yang / AnAn Wu	<b>Relative Humidity :</b>	45~50%

BW / Channel	Test Item	Test Result	Limit	Pass/Fail
<b>80MHz / 5290MHz</b>	Channel Move Time	<b>0.008368 s</b>	< 10s	<b>Pass</b>
	Channel Closing Transmission Time	<b>200ms + 0 ms</b>	< 260ms	<b>Pass</b>
	Non-Occupancy Period	<b>≥ 30</b>	≥ 30 min	<b>Pass</b>
<b>80MHz / 5530MHz</b>	Channel Move Time	<b>0.4604 s</b>	< 10s	<b>Pass</b>
	Channel Closing Transmission Time	<b>200ms + 1.2 ms</b>	< 260ms	<b>Pass</b>
	Non-Occupancy Period	<b>≥ 30</b>	≥ 30 min	<b>Pass</b>

**Note:** The Channel Closing Transmission Time is comprised of 200 milliseconds starting at the beginning of the Channel Move Time plus any additional intermittent control signals required to facilitate a Channel move (an aggregate of 60 milliseconds) during the remainder of the 10 seconds period. The aggregate duration of control signals will not count quiet periods in between transmissions.



### 3.4.6 Channel Move Time, Channel Closing Transmission Time and Non-Occupancy Period Test Plots

#### <80MHz / 5290MHz> In-Service Monitoring

#### Channel Move Time & Channel Closing Transmission Time

Marker 1: signal found within channel moving time.

Marker 2: 200ms after radar injected. ; Marker 3: 10 s after radar injected



#### Non-Occupancy Period

Marker 1 (Delta2) : 30 minutes (1.8ks) after radar injected ; Marker 2: radar injected at 141.1s

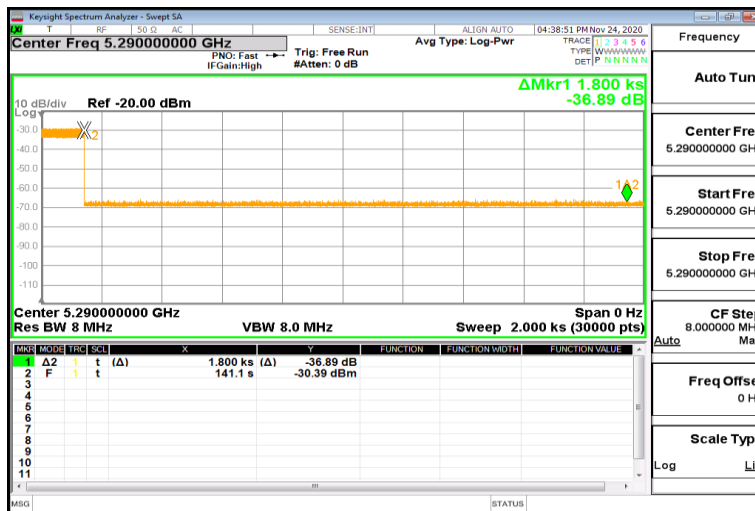

**Note:**

Dwell (0.4 ms)= Sweep Time (12000 ms) / Sweep Point Bins (30000)

Channel Closing Transmission Time ( 200 + 0 ms) = 200 + Number (0) X Dwell (0.4 ms) < 260ms





<80MHz / 5530MHz> In-Service Monitoring

Channel Move Time & Channel Closing Transmission Time

Marker 1: signal found within channel moving time.

Marker 2: 200ms after radar injected. ; Marker 3: 10 s after radar injected



Non-Occupancy Period

Marker 1 (Delta2) : 30 minutes (1.8ks) after radar injected ; Marker 2: radar injected at 32.67s

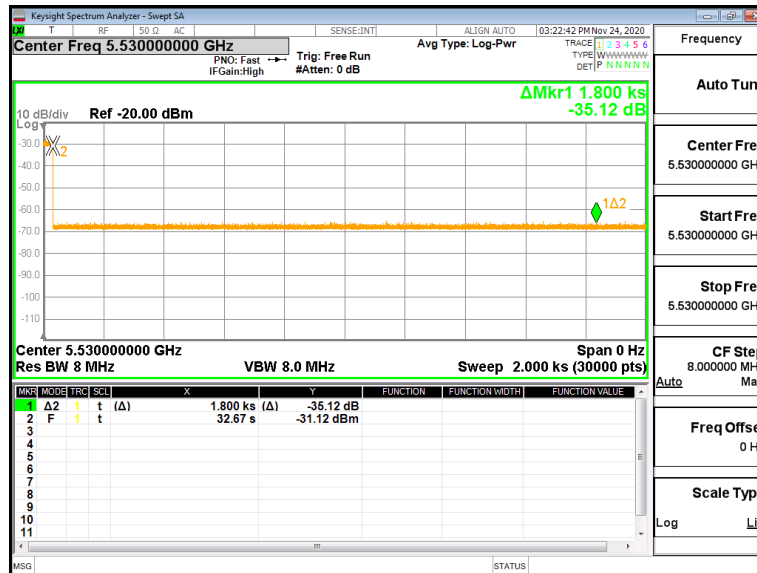

Note:

Dwell (0.4 ms)= Sweep Time (12000 ms) / Sweep Point Bins (30000)

Channel Closing Transmission Time ( 200 + 1.2ms) = 200 + Number (0) X Dwell (0.4 ms) < 260ms



### 3.4.7 Long Pulsed Radar Type Channel Move Time Test Plots (22second)

#### <80MHz / 5290MHz> Radar Type 5

Channel Move Time Marker 1: End of transmission time ; Marker 2: 22seconds after radar injected

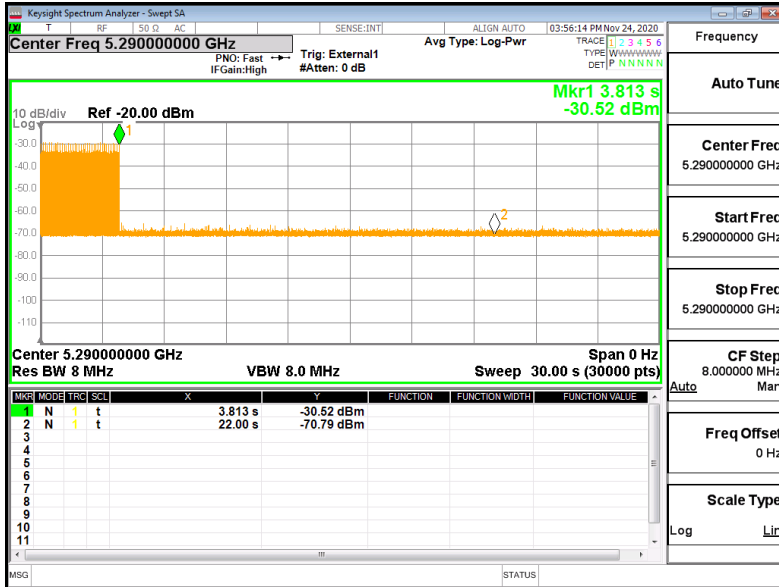

#### <80MHz / 5530MHz> Radar Type 5

Channel Move Time Marker 1: End of transmission time ; Marker 2: 22seconds after radar injected





### 3.4.8 Data Traffic Channel Loading and Noise Floor Plots

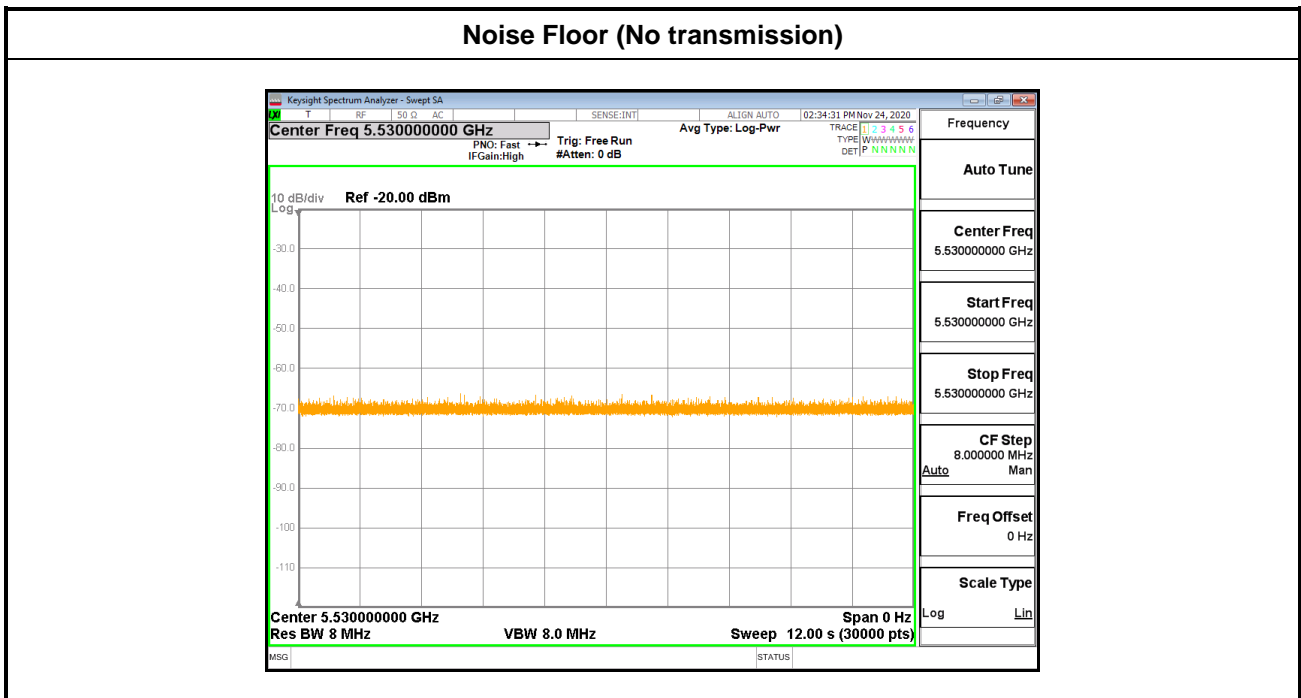
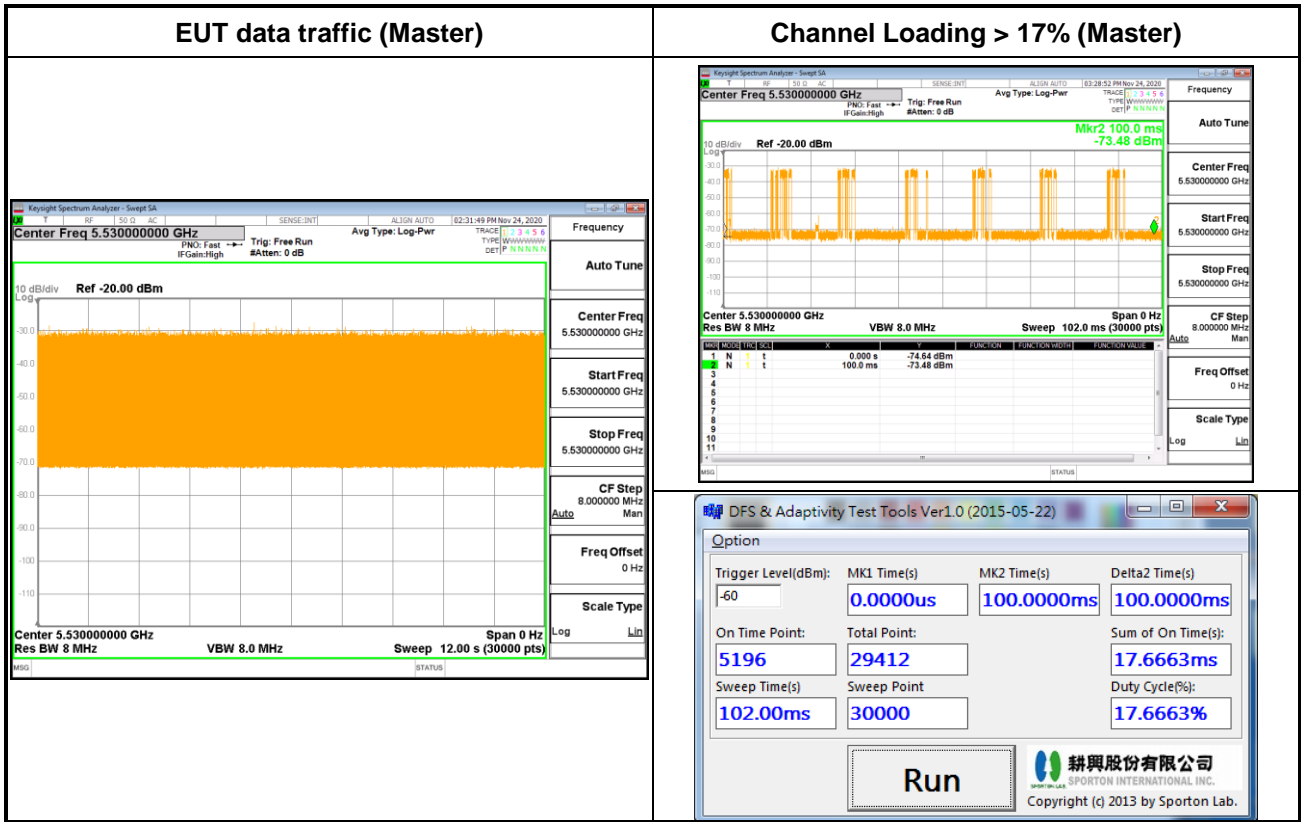



### 3.5 Statistical Performance Check

#### 3.5.1 Limit of Statistical Performance Check

##### Short Pulse Radar Test

Once the performance requirements check is complete, statistical data will be gathered, to determine the ability of the device to detect the radar test waveforms (Short Pulse Radar Types 1-4) found in **Table 5**. The device can utilize a test mode to demonstrate when detection occurs to prevent the need to reset the device between trials. The percentage of successful detection is calculated by:

$$\frac{\text{TotalWaveformDetections}}{\text{TotalWaveformTrials}} \times 100 = \text{Percentage of Successful Detection Radar Waveform } N = P_d N$$

In addition an aggregate minimum percentage of successful detection across all Short Pulse Radar Types 1-4 is required and is calculated as follows:

$$\frac{P_d 1 + P_d 2 + P_d 3 + P_d 4}{4}$$

The minimum number of trails, minimum percentage of successful detection and the aggregate minimum percentage of successful detection are found in **Table 5**.

**Table 5 – Short Pulse Radar Test Waveforms**

Radar Type	Pulse Width (µsec)	PRI (µsec)	Number of Pulses	Minimum Percentage of Successful Detection	Minimum Number of Trials
1	1	1428	18	60%	30
2	1-5	150-230	23-29	60%	30
3	6-10	200-500	16-18	60%	30
4	11-20	200-500	12-16	60%	30
Aggregate (Radar Types 1-4)				80%	120



A minimum of 30 unique waveforms are required for each of the Short Pulse Radar Types 1 through 4. For Short Pulse Radar Type 0, the same waveform is used a minimum of 30 times. If more than 30 waveforms are used for Short Pulse Radar Types 1 through 4, then each additional waveform must also be unique and not repeated from the previous waveforms.

Radar Type	Number of Trials	Number of Successful Detections	Minimum Percentage of Successful Detection
1	35	29	82.9%
2	30	18	60%
3	30	27	90%
4	50	44	88%
Aggregate $(82.9\% + 60\% + 90\% + 88\%)/4 = 80.2\%$			



**Long Pulse Radar Test**

Statistical data will be gathered to determine the ability of the device to detect the Long Pulse Radar Type 5 found in **Table 6**. The device can utilize a test mode to demonstrate when detection occurs to prevent the need to reset the device between trials.

**Table 6 – Long Pulse Radar Test Waveform**

Radar Type	Pulse Width (μsec)	Chirp Width (MHz)	PRI (μsec)	Number of Pulses per Burst	Number of Bursts	Minimum Percentage of Successful Detection	Minimum Number of Trials
5	50-100	5-20	1000-2000	1-3	8-20	80%	30

The parameters for this waveform are randomly chosen. Thirty unique waveforms are required for the Long Pulse Radar Type waveforms. If more than 30 waveforms are used for the Long Pulse Radar Type waveforms, then each additional waveform must also be unique and not repeated from the previous waveforms.

Three subsets of trials will be performed with a minimum of ten trials per subset.

The subset of trials differs in where the Long Pulse Type 5 Signal is tuned in frequency:

- a) The Channel center frequency (subset case 1).
- b) Tuned frequencies such that 90% of the Long Pulse Type 5 frequency modulation is within the low edge of the UUT Occupied Bandwidth (subset case 2).
- c) Tuned frequencies such that 90% of the Long Pulse Type 5 frequency modulation is within the high edge of the UUT Occupied Bandwidth (subset case 3).

For subset case 1: the center frequency of the signal generator will remain fixed at the center of the UUT Channel.

For subset case 2: to retain 90% frequency overlap between the radar signal and the UUT Occupied Bandwidth, the center frequency of the signal generator will vary for each of the ten trials in subset case 2.

The center frequency of the signal generator for each trial is calculated by:  $FL + (0.4 * Chirp\ Width\ [in\ MHz])$

For subset case 3: to retain 90% frequency overlap between the radar signal and the UUT Occupied Bandwidth, the center frequency of the signal generator will vary for each of the ten trials in subset case 3.

The center frequency of the signal generator for each trial is calculated by:  $FH - (0.4 * Chirp\ Width\ [in\ MHz])$

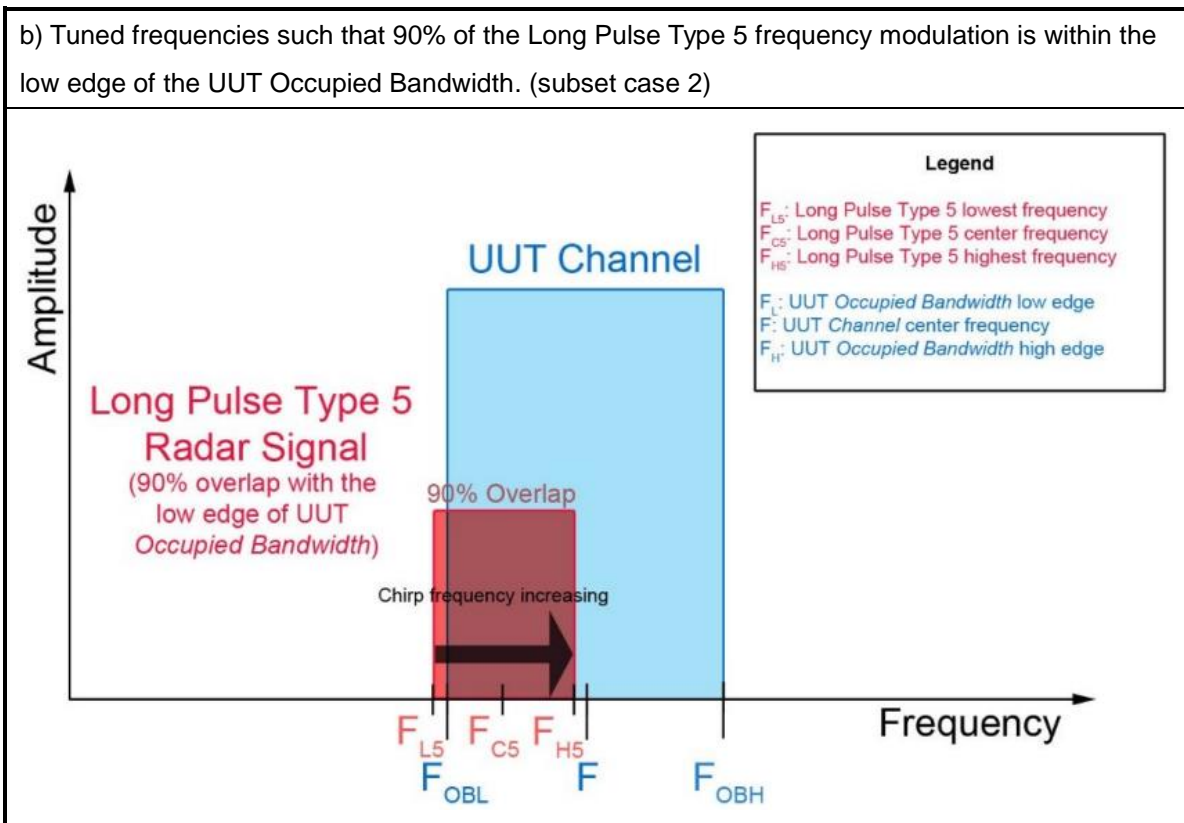
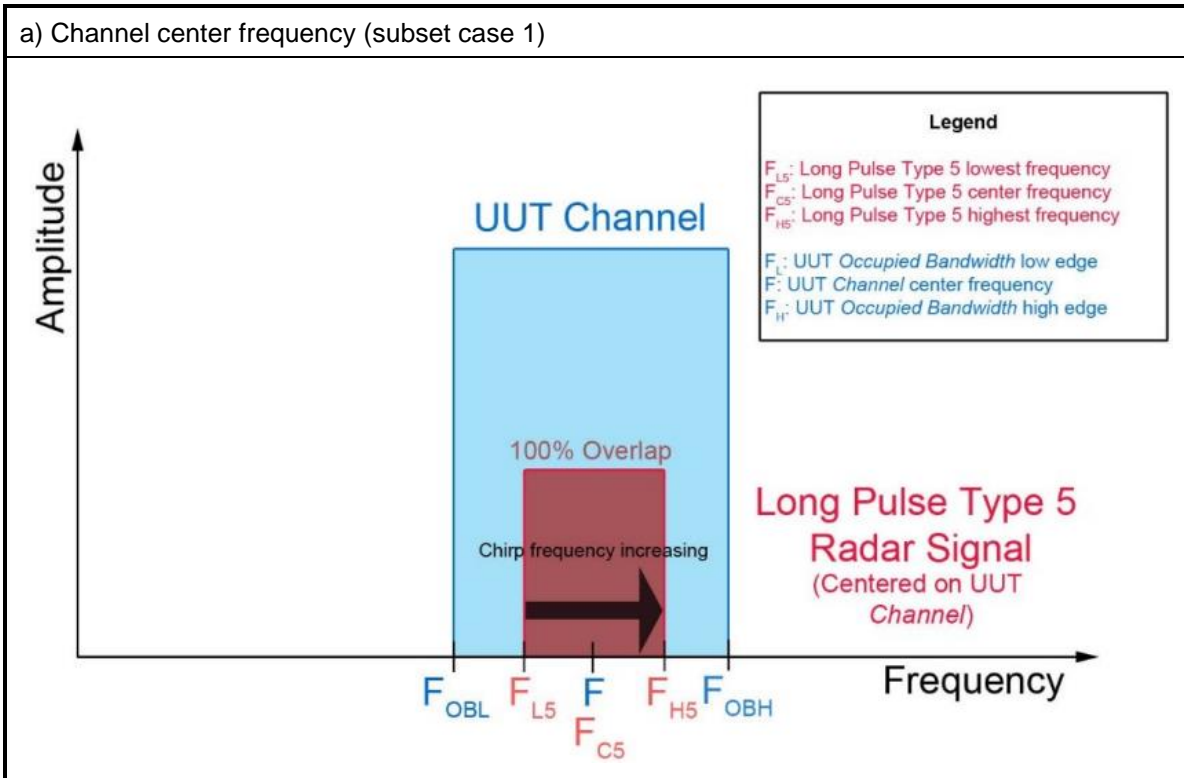

c) Tuned frequencies such that 90% of the Long Pulse Type 5 frequency modulation is within the high edge of the UUT Occupied Bandwidth. (subset case 3)

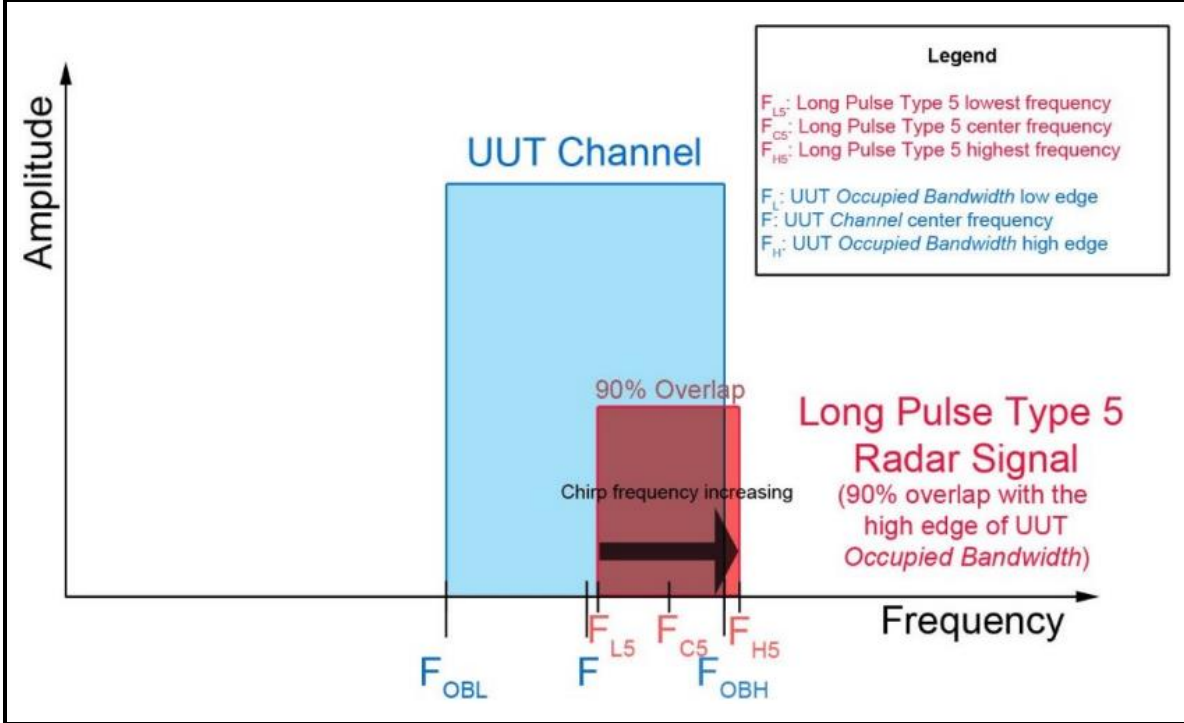

The percentage of successful detection is calculated by:

$$\frac{\text{TotalWaveformDetections}}{\text{TotalWaveformTrials}} \times 100$$





**Frequency Hopping Radar Test**

Statistical data will be gathered to determine the ability of the device to detect the Frequency Hopping radar test signal (radar type 6) found in **Table 7**. The device can utilize a test mode to demonstrate when detection occurs to prevent the need to reset the device between trial runs. The probability of successful detection is calculated by:

$$\frac{TotalWaveformDetections}{TotalWaveformTrials} \times 100$$

**Table 7 – Frequency Hopping Radar Test Waveform**

Radar Type	Pulse Width (µsec)	PRI (µsec)	Pulses per Hop	Hopping Rate (kHz)	Hopping Sequence Length (msec)	Minimum Percentage of Successful Detection	Minimum Number of Trials
6	1	333	9	0.333	300	70%	30

For the Frequency Hopping Radar Type, the same *Burst* parameters are used for each waveform. The hopping sequence is different for each waveform and a 100-length segment is selected from the hopping sequence defined by the following algorithm:

The first frequency in a hopping sequence is selected randomly from the group of 475 integer frequencies from 5250 – 5724 MHz. Next, the frequency that was just chosen is removed from the group and a frequency is randomly selected from the remaining 474 frequencies in the group. This process continues until all 475 frequencies are chosen for the set. For selection of a random frequency, the frequencies remaining within the group are always treated as equally likely.

### 3.5.2 Test Procedures

- (1) One frequency will be chosen from the Operating Channels of the EUT within the 5250-5350 MHz or 5470-5725 MHz bands.
- (2) In case the EUT is a Master Device, a U-NII device operating as a Client Device will be used and it is assumed that the Client will associate with the EUT (Master). If the Master Device has antenna gain, the main beam of the antenna will be directed toward the radar emitter. Vertical polarization is used for testing.
- (3) The TCP protocol unicast data stream was generated by the iperf software command line with at least 17% activity ratio over any 100ms period.
- (4) At time  $T_0$  the Radar Waveform generator sends a Burst of pulses for each of the Radar Types 1-6 at DFS Detection Threshold levels on the Operating Channel. An additional 1 dB is added to the radar test signal to ensure it is at or above the DFS Detection Threshold, accounting for equipment variations/errors.
- (5) Observe the transmissions of the EUT at the end of the Burst on the Operating Channel for duration greater than 10 seconds for Short Pulse Radar Types 1-4 and 6 to ensure detection occurs.
- (6) Observe the transmissions of the EUT at the end of the Burst on the Operating Channel for duration greater than 22 seconds for Long Pulse Radar Type 5 to ensure detection occurs.

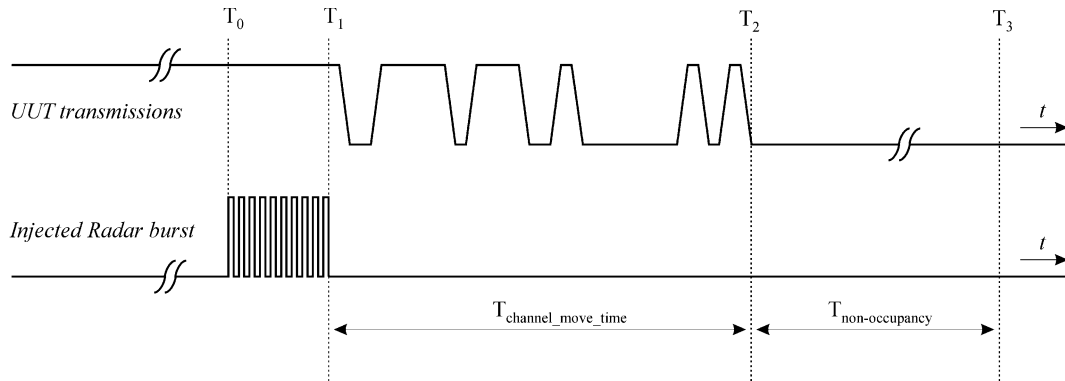

### 3.5.3 Test Setup

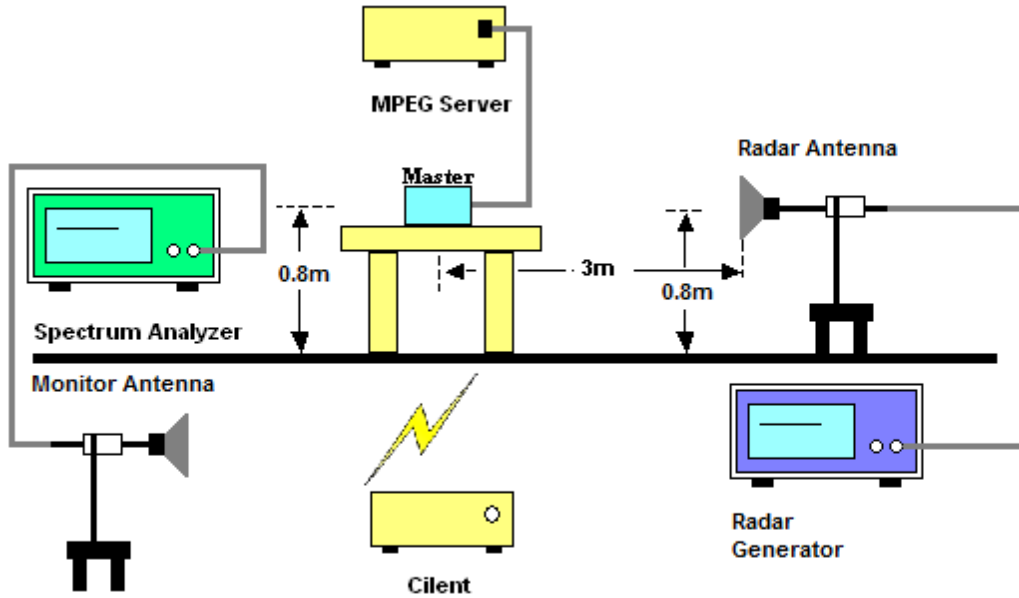

### 3.5.4 Test Deviation

There is no deviation with the original standard.



3.5.5 Result of Statistical Performance Check

<20MHz / 5300MHz>

(Detection = Y, No Detection = N)						
Trial Number	Type 1	Type 2	Type 3	Type 4	Type 5	Type 6
1	Y	Y	Y	Y	Y	Y
2	Y	Y	Y	Y	Y	Y
3	Y	Y	Y	Y	Y	Y
4	Y	Y	Y	Y	Y	Y
5	Y	Y	Y	Y	Y	Y
6	Y	Y	Y	Y	Y	Y
7	Y	Y	Y	Y	Y	Y
8	Y	Y	Y	Y	Y	Y
9	Y	Y	Y	Y	Y	Y
10	Y	Y	Y	Y	Y	Y
11	Y	Y	Y	Y	Y	Y
12	Y	Y	Y	Y	Y	Y
13	Y	Y	Y	Y	Y	Y
14	Y	Y	Y	Y	Y	Y
15	Y	Y	Y	Y	Y	Y
16	Y	Y	Y	Y	Y	Y
17	Y	Y	Y	Y	Y	Y
18	Y	Y	Y	Y	Y	Y
19	Y	Y	Y	Y	Y	Y
20	Y	Y	Y	Y	Y	Y
21	Y	Y	Y	Y	Y	Y
22	Y	Y	Y	Y	Y	Y
23	Y	Y	Y	Y	Y	Y
24	Y	Y	Y	Y	Y	Y
25	Y	Y	Y	Y	Y	Y
26	Y	Y	Y	Y	Y	Y
27	Y	Y	Y	Y	Y	Y
28	Y	Y	Y	Y	Y	Y
29	Y	Y	Y	Y	Y	Y
30	Y	Y	Y	Y	Y	Y
<b>Trial of Detection</b>	<b>30/30</b>	<b>30/30</b>	<b>30/30</b>	<b>30/30</b>	<b>30/30</b>	<b>30/30</b>
<b>Probability (%)</b>	<b>100%</b>	<b>100%</b>	<b>100%</b>	<b>100%</b>	<b>100%</b>	<b>100%</b>
<b>Limit (%)</b>	<b>&gt;= 60%</b>	<b>&gt;= 60%</b>	<b>&gt;= 60%</b>	<b>&gt;= 60%</b>	<b>&gt;= 80%</b>	<b>&gt;= 70%</b>
<b>Average Probability of Radar Type 1~4 (%)</b>	<b>100% ( &gt;=80% )</b>					



<40MHz /5310MHz>

(Detection = Y, No Detection = N)						
Trial Number	Type 1	Type 2	Type 3	Type 4	Type 5	Type 6
1	Y	Y	Y	Y	Y	Y
2	Y	Y	Y	Y	Y	Y
3	Y	Y	Y	Y	Y	Y
4	Y	Y	Y	Y	Y	Y
5	Y	Y	Y	Y	Y	Y
6	Y	Y	Y	Y	Y	Y
7	Y	Y	Y	Y	Y	Y
8	Y	Y	Y	Y	Y	Y
9	Y	Y	Y	Y	Y	Y
10	Y	Y	Y	Y	Y	Y
11	Y	Y	Y	Y	Y	Y
12	Y	Y	Y	Y	Y	Y
13	Y	Y	Y	Y	Y	Y
14	Y	Y	Y	Y	Y	Y
15	Y	Y	Y	Y	Y	Y
16	Y	Y	Y	Y	Y	Y
17	Y	Y	Y	Y	Y	Y
18	Y	Y	Y	Y	Y	Y
19	Y	Y	Y	Y	Y	Y
20	Y	Y	Y	Y	Y	Y
21	Y	Y	Y	Y	Y	Y
22	Y	Y	Y	Y	Y	Y
23	Y	Y	Y	Y	Y	Y
24	Y	Y	Y	Y	Y	Y
25	Y	Y	Y	Y	Y	Y
26	Y	Y	Y	Y	Y	Y
27	Y	Y	Y	Y	Y	Y
28	Y	Y	Y	Y	Y	Y
29	Y	Y	Y	Y	Y	Y
30	Y	Y	Y	Y	Y	Y
<b>Trial of Detection</b>	<b>30/30</b>	<b>30/30</b>	<b>30/30</b>	<b>30/30</b>	<b>30/30</b>	<b>30/30</b>
<b>Probability (%)</b>	<b>100%</b>	<b>100%</b>	<b>100%</b>	<b>100%</b>	<b>100%</b>	<b>100%</b>
<b>Limit (%)</b>	<b>&gt;= 60%</b>	<b>&gt;= 60%</b>	<b>&gt;= 60%</b>	<b>&gt;= 60%</b>	<b>&gt;= 80%</b>	<b>&gt;= 70%</b>
<b>Average Probability of Radar Type 1~4 (%)</b>				<b>100% ( &gt;=80% )</b>		



<80MHz / 5290MHz>

(Detection = Y, No Detection = N)						
Trial Number	Type 1	Type 2	Type 3	Type 4	Type 5	Type 6
1	Y	Y	Y	Y	Y	Y
2	Y	Y	Y	Y	Y	Y
3	Y	Y	Y	Y	Y	Y
4	Y	Y	Y	Y	Y	Y
5	Y	Y	Y	Y	Y	Y
6	Y	Y	Y	Y	Y	Y
7	Y	Y	Y	Y	Y	Y
8	Y	Y	Y	Y	Y	Y
9	Y	Y	Y	Y	Y	Y
10	Y	Y	Y	Y	Y	Y
11	Y	Y	Y	Y	Y	Y
12	Y	Y	Y	Y	Y	Y
13	Y	Y	Y	Y	Y	Y
14	Y	Y	Y	Y	Y	Y
15	Y	Y	Y	Y	Y	Y
16	Y	Y	Y	Y	Y	Y
17	Y	Y	Y	Y	Y	Y
18	Y	Y	Y	Y	Y	Y
19	Y	Y	Y	Y	Y	Y
20	Y	Y	Y	Y	Y	Y
21	Y	Y	Y	Y	Y	Y
22	Y	Y	Y	Y	Y	Y
23	Y	Y	Y	Y	Y	Y
24	Y	Y	Y	Y	Y	Y
25	Y	Y	Y	Y	Y	Y
26	Y	Y	Y	Y	Y	Y
27	Y	Y	Y	Y	Y	Y
28	Y	Y	Y	Y	Y	Y
29	Y	Y	Y	Y	Y	Y
30	Y	Y	Y	Y	Y	Y
<b>Trial of Detection</b>	<b>30/30</b>	<b>30/30</b>	<b>30/30</b>	<b>30/30</b>	<b>30/30</b>	<b>30/30</b>
<b>Probability (%)</b>	<b>100%</b>	<b>100%</b>	<b>100%</b>	<b>100%</b>	<b>100%</b>	<b>100%</b>
<b>Limit (%)</b>	<b>&gt;= 60%</b>	<b>&gt;= 60%</b>	<b>&gt;= 60%</b>	<b>&gt;= 60%</b>	<b>&gt;= 80%</b>	<b>&gt;= 70%</b>
<b>Average Probability of Radar Type 1~4 (%)</b>				<b>100% ( &gt;=80% )</b>		



<20MHz / 5500MHz>

(Detection = Y, No Detection = N)						
Trial Number	Type 1	Type 2	Type 3	Type 4	Type 5	Type 6
1	Y	Y	Y	Y	Y	Y
2	Y	Y	Y	Y	Y	Y
3	Y	Y	Y	Y	Y	Y
4	Y	Y	Y	Y	Y	Y
5	Y	Y	Y	Y	Y	Y
6	Y	Y	Y	Y	Y	Y
7	Y	Y	Y	Y	Y	Y
8	Y	Y	Y	Y	Y	Y
9	Y	Y	Y	Y	Y	Y
10	Y	Y	Y	Y	Y	Y
11	Y	Y	Y	Y	Y	Y
12	Y	Y	Y	Y	Y	Y
13	Y	Y	Y	Y	Y	Y
14	Y	Y	Y	Y	Y	Y
15	Y	Y	Y	Y	Y	Y
16	Y	Y	Y	Y	Y	Y
17	Y	Y	Y	Y	Y	Y
18	Y	Y	Y	Y	Y	Y
19	Y	Y	Y	Y	Y	Y
20	Y	Y	Y	Y	Y	Y
21	Y	Y	Y	Y	Y	Y
22	Y	Y	Y	Y	Y	Y
23	Y	Y	Y	Y	Y	Y
24	Y	Y	Y	Y	Y	Y
25	Y	Y	Y	Y	Y	Y
26	Y	Y	Y	Y	Y	Y
27	Y	Y	Y	Y	Y	Y
28	Y	Y	Y	Y	Y	Y
29	Y	Y	Y	Y	Y	Y
30	Y	Y	Y	Y	Y	Y
<b>Trial of Detection</b>	<b>30/30</b>	<b>30/30</b>	<b>30/30</b>	<b>30/30</b>	<b>30/30</b>	<b>30/30</b>
<b>Probability (%)</b>	<b>100%</b>	<b>100%</b>	<b>100%</b>	<b>100%</b>	<b>100%</b>	<b>100%</b>
<b>Limit (%)</b>	<b>&gt;= 60%</b>	<b>&gt;= 60%</b>	<b>&gt;= 60%</b>	<b>&gt;= 60%</b>	<b>&gt;= 80%</b>	<b>&gt;= 70%</b>
<b>Average Probability of Radar Type 1~4 (%)</b>				<b>100% ( &gt;=80% )</b>		



<40MHz / 5510MHz>

(Detection = Y, No Detection = N)						
Trial Number	Type 1	Type 2	Type 3	Type 4	Type 5	Type 6
1	Y	Y	Y	Y	Y	Y
2	Y	Y	Y	Y	Y	Y
3	Y	Y	Y	Y	Y	Y
4	Y	Y	Y	Y	Y	Y
5	Y	Y	Y	Y	Y	Y
6	Y	Y	Y	Y	Y	Y
7	Y	Y	Y	Y	Y	Y
8	Y	Y	Y	Y	Y	Y
9	Y	Y	Y	Y	Y	Y
10	Y	Y	Y	Y	Y	Y
11	Y	Y	Y	Y	Y	Y
12	Y	Y	Y	Y	Y	Y
13	Y	Y	Y	Y	Y	Y
14	Y	Y	Y	Y	Y	Y
15	Y	Y	Y	Y	Y	Y
16	Y	Y	Y	Y	Y	Y
17	Y	Y	Y	Y	Y	Y
18	Y	Y	Y	Y	Y	Y
19	Y	Y	Y	Y	Y	Y
20	Y	Y	Y	Y	Y	Y
21	Y	Y	Y	Y	Y	Y
22	Y	Y	Y	Y	Y	Y
23	Y	Y	Y	Y	Y	Y
24	Y	Y	Y	Y	Y	Y
25	Y	Y	Y	Y	Y	Y
26	Y	Y	Y	Y	Y	Y
27	Y	Y	Y	Y	Y	Y
28	Y	Y	Y	Y	Y	Y
29	Y	Y	Y	Y	Y	Y
30	Y	Y	Y	Y	Y	Y
<b>Trial of Detection</b>	<b>30/30</b>	<b>30/30</b>	<b>30/30</b>	<b>30/30</b>	<b>30/30</b>	<b>30/30</b>
<b>Probability (%)</b>	<b>100%</b>	<b>100%</b>	<b>100%</b>	<b>100%</b>	<b>100%</b>	<b>100%</b>
<b>Limit (%)</b>	<b>&gt;= 60%</b>	<b>&gt;= 60%</b>	<b>&gt;= 60%</b>	<b>&gt;= 60%</b>	<b>&gt;= 80%</b>	<b>&gt;= 70%</b>
<b>Average Probability of Radar Type 1~4 (%)</b>				<b>100% ( &gt;=80% )</b>		





<80MHz / 5530MHz>

(Detection = Y, No Detection = N)						
Trial Number	Type 1	Type 2	Type 3	Type 4	Type 5	Type 6
1	Y	Y	Y	Y	Y	Y
2	Y	Y	Y	Y	Y	Y
3	Y	Y	Y	Y	Y	Y
4	Y	Y	Y	Y	Y	Y
5	Y	Y	Y	Y	Y	Y
6	Y	Y	Y	Y	Y	Y
7	Y	Y	Y	Y	Y	Y
8	Y	Y	Y	Y	Y	Y
9	Y	Y	Y	Y	Y	Y
10	Y	Y	Y	Y	Y	Y
11	Y	Y	Y	Y	Y	Y
12	Y	Y	Y	Y	Y	Y
13	Y	Y	Y	Y	Y	Y
14	Y	Y	Y	Y	Y	Y
15	Y	Y	Y	Y	Y	Y
16	Y	Y	Y	Y	Y	Y
17	Y	Y	Y	Y	Y	Y
18	Y	Y	Y	Y	Y	Y
19	Y	Y	Y	Y	Y	Y
20	Y	Y	Y	Y	Y	Y
21	Y	Y	Y	Y	Y	Y
22	Y	Y	Y	Y	Y	Y
23	Y	Y	Y	Y	Y	Y
24	Y	Y	Y	Y	Y	Y
25	Y	Y	Y	Y	Y	Y
26	Y	Y	Y	Y	Y	Y
27	Y	Y	Y	Y	Y	Y
28	Y	Y	Y	Y	Y	Y
29	Y	Y	Y	Y	Y	Y
30	Y	Y	Y	Y	Y	Y
<b>Trial of Detection</b>	<b>30/30</b>	<b>30/30</b>	<b>30/30</b>	<b>30/30</b>	<b>30/30</b>	<b>30/30</b>
<b>Probability (%)</b>	<b>100%</b>	<b>100%</b>	<b>100%</b>	<b>100%</b>	<b>100%</b>	<b>100%</b>
<b>Limit (%)</b>	<b>&gt;= 60%</b>	<b>&gt;= 60%</b>	<b>&gt;= 60%</b>	<b>&gt;= 60%</b>	<b>&gt;= 80%</b>	<b>&gt;= 70%</b>
<b>Average Probability of Radar Type 1~4 (%)</b>				<b>100% ( &gt;=80% )</b>		



## 4 List of Measuring Equipment

Instrument	Brand Name	Model No.	Serial No.	Characteristics	Calibration Date	Test Date	Due Date	Remark
Signal Generator	Keysight	N5182B	MY56200377	9kHz~6GHz	Apr. 22, 2020	Oct. 22, 2020~ Nov. 24, 2020	Apr. 21, 2021	DFS (DFS02-HY)
Spectrum Analyzer	Keysight	N9010A	MY56070412	10Hz~7GHz	Aug. 27, 2020	Oct. 22, 2020~ Nov. 24, 2020	Aug. 26, 2021	DFS (DFS02-HY)
Horn Antenna	COM-POWER	AH-118	071025	1GHz~18GHz	Sep. 25, 2020	Oct. 22, 2020~ Nov. 24, 2020	Sep. 24, 2021	DFS (DFS02-HY)
Horn Antenna	COM-POWER	AH-118	071027	1GHz~18GHz	Sep. 25, 2020	Oct. 22, 2020~ Nov. 24, 2020	Sep. 24, 2021	DFS (DFS02-HY)

## Appendix A. DFS Radar Parameters

**DFS Radar Parameters**  
**FCC Radar Type 1**  
**Channel 60 Bandwidth 20MHz**

Trial #	Pulse Repetition Frequency Number (1 to 23)	Pulse Repetition Frequency (Pulses Per Second)	Pulse Repetition Interval (Microseconds)	Detection (Yes / No)
1	22	1066.10	938	Yes
2	10	1432.66	698	Yes
3	6	1618.12	618	Yes
4	2	1858.74	538	Yes
5	19	1138.95	878	Yes
6	12	326.16	3066	Yes
7	7	1567.40	638	Yes
8	21	1089.32	918	Yes
9	17	1193.32	838	Yes
10	18	1165.50	858	Yes
11	15	1253.13	798	Yes
12	11	1392.76	718	Yes
13	4	1730.10	578	Yes
14	5	1672.24	598	Yes
15	3	1792.11	558	Yes
16		394.32	2536	Yes
17		1035.20	966	Yes
18		1209.19	827	Yes
19		399.84	2501	Yes
20		385.36	2595	Yes
21		897.67	1114	Yes
22		768.05	1302	Yes
23		328.41	3045	Yes
24		615.76	1624	Yes
25		347.46	2878	Yes
26		973.71	1027	Yes
27		402.41	2485	Yes
28		625.00	1600	Yes
29		853.24	1172	Yes
30		849.62	1177	Yes

**DFS Radar Parameters**  
**FCC Radar Type 2**  
**Channel 60 Bandwidth 20MHz**

Trial #	Number Pulses per Burst	Pulse Width (Microseconds)	Pulse Repetition Interval (Microseconds)	Detection (Yes / No)
1	26	3.20	179	Yes
2	23	1.10	207	Yes
3	24	2.10	230	Yes
4	29	4.80	200	Yes
5	28	3.90	214	Yes
6	26	2.90	222	Yes
7	26	3.20	204	Yes
8	25	2.50	192	Yes
9	26	3.10	164	Yes
10	23	1.20	156	Yes
11	27	3.90	210	Yes
12	29	4.60	201	Yes
13	26	3.20	162	Yes
14	25	2.20	197	Yes
15	29	4.50	163	Yes
16	26	3.00	203	Yes
17	29	5.00	168	Yes
18	25	2.40	217	Yes
19	26	2.90	191	Yes
20	25	2.30	166	Yes
21	27	3.70	150	Yes
22	25	2.20	176	Yes
23	29	4.90	195	Yes
24	26	2.90	202	Yes
25	25	2.50	178	Yes
26	23	1.10	206	Yes
27	27	3.80	155	Yes
28	29	4.70	157	Yes
29	25	2.40	224	Yes
30	28	4.20	159	Yes

**DFS Radar Parameters**  
**FCC Radar Type 3**  
**Channel 60 Bandwidth 20MHz**

Trial #	Number Pulses per Burst	Pulse Width (Microseconds)	Pulse Repetition Interval (Microseconds)	Detection (Yes / No)
1	17	8.20	355	Yes
2	16	6.10	487	Yes
3	16	7.10	344	Yes
4	18	9.80	288	Yes
5	18	8.90	230	Yes
6	17	7.90	432	Yes
7	17	8.20	207	Yes
8	17	7.50	443	Yes
9	17	8.10	439	Yes
10	16	6.20	223	Yes
11	18	8.90	208	Yes
12	18	9.60	463	Yes
13	17	8.20	441	Yes
14	16	7.20	323	Yes
15	18	9.50	297	Yes
16	17	8.00	412	Yes
17	18	10.00	324	Yes
18	17	7.40	271	Yes
19	17	7.90	349	Yes
20	16	7.30	409	Yes
21	18	8.70	373	Yes
22	16	7.20	254	Yes
23	18	9.90	274	Yes
24	17	7.90	278	Yes
25	17	7.50	317	Yes
26	16	6.10	260	Yes
27	18	8.80	211	Yes
28	18	9.70	272	Yes
29	17	7.40	264	Yes
30	18	9.20	284	Yes

**DFS Radar Parameters**  
**FCC Radar Type 4**  
**Channel 60 Bandwidth 20MHz**

Trial #	Number Pulses per Burst	Pulse Width (Microseconds)	Pulse Repetition Interval (Microseconds)	Detection (Yes / No)
1	14	16.00	355	Yes
2	12	11.30	487	Yes
3	13	13.50	344	Yes
4	16	19.40	288	Yes
5	15	17.50	230	Yes
6	14	15.30	432	Yes
7	14	15.90	207	Yes
8	13	14.30	443	Yes
9	14	15.80	439	Yes
10	12	11.50	223	Yes
11	15	17.40	208	Yes
12	16	19.00	463	Yes
13	14	16.00	441	Yes
14	13	13.80	323	Yes
15	16	18.90	297	Yes
16	14	15.50	412	Yes
17	16	19.90	324	Yes
18	13	14.10	271	Yes
19	14	15.20	349	Yes
20	13	13.80	409	Yes
21	15	17.10	373	Yes
22	13	13.80	254	Yes
23	16	19.80	274	Yes
24	14	15.30	278	Yes
25	13	14.50	317	Yes
26	12	11.30	260	Yes
27	15	17.30	211	Yes
28	16	19.20	272	Yes
29	13	14.20	264	Yes
30	15	18.20	284	Yes

**DFS Radar Parameters**  
**FCC Radar Type 5**  
**Channel 60 Bandwidth 20MHz**

Trial Number:			1			Detection (Yes/No) Yes
Number of Bursts in Trial:			15			
Chirp Center Frequency:			5300			
Burst	Number of Pulses	Pulse Width (Microseconds)	Chirp Width (MHz)	Pulse 1-to-2 Spacing (µsec)	Pulse 2-to-3 Spacing (µsec)	Starting Location Within Interval (µsec)
1	2	77.8	13	1477	-	636185
2	1	51.9	13	-	-	32674
3	1	63.8	13	-	-	226294
4	3	96.6	13	1786	1843	417976
5	3	85.9	13	1215	1729	611152
6	2	73.7	13	1549	-	8789
7	2	77.2	13	1819	-	201917
8	2	68.4	13	1114	-	395530
9	2	76.7	13	1155	-	588564
10	1	53.2	13	-	-	783794
11	3	85.7	13	1695	1394	177933
12	3	94.3	13	1426	1935	370624
13	2	77.6	13	1671	-	564893
14	1	65.7	13	-	-	759583
15	3	93.5	13	1130	1468	154262
16						
17						
18						
19						
20						

Trial Number:			2			Detection (Yes/No) Yes
Number of Bursts in Trial:			8			
Chirp Center Frequency:			5300			
Burst	Number of Pulses	Pulse Width (Microseconds)	Chirp Width (MHz)	Pulse 1-to-2 Spacing (µsec)	Pulse 2-to-3 Spacing (µsec)	Starting Location Within Interval (µsec)
1	2	75	5	1527	-	653020
2	3	99.4	5	1262	1257	1015643
3	2	67.4	5	1403	-	1379398
4	2	73.6	5	1041	-	245489
5	1	65.9	5	-	-	609113
6	3	83.8	5	1292	1419	970852
7	1	65.5	5	-	-	1335913
8	3	98.6	5	1796	1728	200406
9						
10						
11						
12						
13						
14						
15						
16						
17						
18						
19						
20						



**DFS Radar Parameters**  
**FCC Radar Type 5**  
**Channel 60 Bandwidth 20MHz**

Trial Number:			3			Detection (Yes/No)
Number of Bursts in Trial:			11			
Chirp Center Frequency:			5300			Yes
Burst	Number of Pulses	Pulse Width (Microseconds)	Chirp Width (MHz)	Pulse 1-to-2 Spacing (µsec)	Pulse 2-to-3 Spacing (µsec)	Starting Location Within Interval (µsec)
1	2	73.8	9	1538	-	409565
2	2	69.5	9	1649	-	673692
3	1	51.9	9	-	-	938562
4	3	84.6	9	1032	1271	113209
5	3	95.4	9	1903	1388	376726
6	2	68	9	1351	-	641212
7	3	89.6	9	1514	1573	903714
8	2	81.9	9	1689	-	80863
9	3	88.3	9	1330	1838	344067
10	1	53.7	9	-	-	609331
11	3	91.3	9	1106	1001	871542
12						
13						
14						
15						
16						
17						
18						
19						
20						

Trial Number:			4			Detection (Yes/No)
Number of Bursts in Trial:			11			
Chirp Center Frequency:			5300			Yes
Burst	Number of Pulses	Pulse Width (Microseconds)	Chirp Width (MHz)	Pulse 1-to-2 Spacing (µsec)	Pulse 2-to-3 Spacing (µsec)	Starting Location Within Interval (µsec)
1	2	68.1	19	1355	-	26541
2	1	58.7	19	-	-	171821
3	2	75.3	19	1640	-	316229
4	1	56.4	19	-	-	461864
5	3	99.7	19	1708	1159	8677
6	1	57.7	19	-	-	153995
7	1	59.5	19	-	-	299238
8	2	80	19	1369	-	443177
9	2	82	19	1197	-	587671
10	2	82.8	19	1005	-	135674
11	3	88	19	1928	1101	279928
12	3	93.2	19	1907	1223	424279
13	2	70.4	19	1360	-	570132
14	3	95.3	19	1955	1775	117439
15	2	81.9	19	1545	-	262502
16	3	98.5	19	1169	1062	406573
17	1	65	19	-	-	553328
18	3	85.4	19	1637	1425	99799
19	3	91.6	19	1445	1325	244095
20	2	67.3	19	1218	-	390012

**DFS Radar Parameters**  
**FCC Radar Type 5**  
**Channel 60 Bandwidth 20MHz**

Trial Number:		5				Detection (Yes/No)
Number of Bursts in Trial:		17				
Chirp Center Frequency:		5300				Yes
Burst	Number of Pulses	Pulse Width (Microseconds)	Chirp Width (MHz)	Pulse 1-to-2 Spacing (µsec)	Pulse 2-to-3 Spacing (µsec)	Starting Location Within Interval (µsec)
1	2	67.9	16	1133	-	629614
2	1	62.3	16	-	-	96856
3	1	53.3	16	-	-	267719
4	3	90	16	1153	1346	436784
5	2	77.1	16	1646	-	608289
6	3	83.9	16	1232	1459	75610
7	3	89.1	16	1384	1939	245638
8	2	81.8	16	1676	-	416355
9	1	50.3	16	-	-	588736
10	3	87.1	16	1996	1756	54571
11	2	71.3	16	1815	-	225175
12	3	97.5	16	1465	1132	394825
13	3	90.6	16	1040	1354	565361
14	3	86.3	16	1183	1792	33643
15	3	97.6	16	1073	1361	203957
16	3	84.7	16	1718	1854	373812
17	3	99.7	16	1244	1988	544060
18						
19						
20						

Trial Number:		6				Detection (Yes/No)
Number of Bursts in Trial:		14				
Chirp Center Frequency:		5300				Yes
Burst	Number of Pulses	Pulse Width (Microseconds)	Chirp Width (MHz)	Pulse 1-to-2 Spacing (µsec)	Pulse 2-to-3 Spacing (µsec)	Starting Location Within Interval (µsec)
1	3	92.9	12	1564	1407	15438
2	2	67.7	12	1747	-	222486
3	1	65.8	12	-	-	430731
4	1	56.3	12	-	-	637784
5	1	53.7	12	-	-	845342
6	3	83.5	12	1930	1025	196720
7	1	65.8	12	-	-	404955
8	3	85.9	12	1034	1808	610711
9	2	76.3	12	1926	-	818057
10	2	81.5	12	1714	-	171459
11	3	89.4	12	1594	1827	377969
12	1	63.4	12	-	-	586875
13	2	69.6	12	1925	-	792834
14	2	74.5	12	1846	-	146044
15						
16						
17						
18						
19						
20						

**DFS Radar Parameters**  
**FCC Radar Type 5**  
**Channel 60 Bandwidth 20MHz**

Trial Number:		7				Detection (Yes/No)
Number of Bursts in Trial:		15				Yes
Chirp Center Frequency:		5300				Yes
Burst	Number of Pulses	Pulse Width (Microseconds)	Chirp Width (MHz)	Pulse 1-to-2 Spacing (µsec)	Pulse 2-to-3 Spacing (µsec)	Starting Location Within Interval (µsec)
1	1	52.6	10	-	-	51446
2	3	84.1	10	1725	1529	292696
3	3	97.7	10	1868	1805	533989
4	3	97.3	10	1446	1755	775564
5	3	98.8	10	1386	1302	21542
6	2	72.2	10	1184	-	263385
7	2	67.6	10	1027	-	505581
8	2	75.7	10	1871	-	747058
9	1	60.9	10	-	-	989976
10	1	64.2	10	-	-	234024
11	2	78.8	10	1604	-	475207
12	3	87.5	10	1712	1683	715825
13						
14						
15						
16						
17						
18						
19						
20						

Trial Number:		8				Detection (Yes/No)
Number of Bursts in Trial:		12				Yes
Chirp Center Frequency:		5300				Yes
Burst	Number of Pulses	Pulse Width (Microseconds)	Chirp Width (MHz)	Pulse 1-to-2 Spacing (µsec)	Pulse 2-to-3 Spacing (µsec)	Starting Location Within Interval (µsec)
1	1	52.6	10	-	-	51446
2	3	84.1	10	1725	1529	292696
3	3	97.7	10	1868	1805	533989
4	3	97.3	10	1446	1755	775564
5	3	98.8	10	1386	1302	21542
6	2	72.2	10	1184	-	263385
7	2	67.6	10	1027	-	505581
8	2	75.7	10	1871	-	747058
9	1	60.9	10	-	-	989976
10	1	64.2	10	-	-	234024
11	2	78.8	10	1604	-	475207
12	3	87.5	10	1712	1683	715825
13						
14						
15						
16						
17						
18						
19						
20						

**DFS Radar Parameters**  
**FCC Radar Type 5**  
**Channel 60 Bandwidth 20MHz**

Trial Number:		9				Detection (Yes/No)
Number of Bursts in Trial:		14				Yes
Chirp Center Frequency:		5300				Yes
Burst	Number of Pulses	Pulse Width (Microseconds)	Chirp Width (MHz)	Pulse 1-to-2 Spacing (µsec)	Pulse 2-to-3 Spacing (µsec)	Starting Location Within Interval (µsec)
1	1	54.1	13	-	-	823112
2	1	50.7	13	-	-	174965
3	1	52.3	13	-	-	382216
4	3	99.8	13	1696	1949	587395
5	2	68.4	13	1099	-	796897
6	2	80.8	13	1505	-	149042
7	1	62.5	13	-	-	356750
8	2	74.8	13	1204	-	563824
9	1	50.8	13	-	-	772314
10	1	54	13	-	-	123796
11	1	63	13	-	-	331215
12	3	91.8	13	1270	1347	537402
13	2	79.3	13	1992	-	744805
14	1	64.3	13	-	-	98172
15						
16						
17						
18						
19						
20						

Trial Number:		10				Detection (Yes/No)
Number of Bursts in Trial:		8				Yes
Chirp Center Frequency:		5300				Yes
Burst	Number of Pulses	Pulse Width (Microseconds)	Chirp Width (MHz)	Pulse 1-to-2 Spacing (µsec)	Pulse 2-to-3 Spacing (µsec)	Starting Location Within Interval (µsec)
1	1	63.4	6	-	-	535615
2	1	52	6	-	-	898668
3	3	97.2	6	1605	1583	1259235
4	2	78.7	6	1743	-	127106
5	2	74.2	6	1219	-	490358
6	3	88.7	6	1934	1273	852409
7	1	54.3	6	-	-	1217152
8	3	95.4	6	1555	1791	82296
9						
10						
11						
12						
13						
14						
15						
16						
17						
18						
19						
20						

**DFS Radar Parameters**  
**FCC Radar Type 5**  
**Channel 60 Bandwidth 20MHz**

Trial Number:			11			Detection (Yes/No)
Number of Bursts in Trial:			17			
Chirp Center Frequency:			5297			Yes
Burst	Number of Pulses	Pulse Width (Microseconds)	Chirp Width (MHz)	Pulse 1-to-2 Spacing (µsec)	Pulse 2-to-3 Spacing (µsec)	Starting Location Within Interval (µsec)
1	2	73.7	16	1497	-	209249
2	3	97.4	16	1754	1613	378386
3	3	91.7	16	1702	1462	548411
4	1	66.2	16	-	-	17733
5	2	70.8	16	1821	-	187952
6	1	52.3	16	-	-	359277
7	2	78.9	16	1984	-	528886
8	2	70.9	16	1358	-	700166
9	2	75.6	16	1430	-	167197
10	1	59.1	16	-	-	338262
11	2	77	16	1304	-	508324
12	2	67.9	16	1083	-	678689
13	2	81.2	16	1932	-	146031
14	2	78.7	16	1121	-	316923
15	1	63.3	16	-	-	488056
16	2	68.9	16	1423	-	657326
17	1	59.3	16	-	-	125509
18						
19						
20						

Trial Number:			12			Detection (Yes/No)
Number of Bursts in Trial:			19			
Chirp Center Frequency:			5298			Yes
Burst	Number of Pulses	Pulse Width (Microseconds)	Chirp Width (MHz)	Pulse 1-to-2 Spacing (µsec)	Pulse 2-to-3 Spacing (µsec)	Starting Location Within Interval (µsec)
1	3	98.9	19	1680	1488	263736
2	2	82.3	19	1855	-	416459
3	3	86.7	19	1400	1919	567902
4	3	89.7	19	1068	1282	92979
5	3	98.6	19	1194	1461	245155
6	2	71.1	19	1789	-	397609
7	1	55.9	19	-	-	551431
8	2	67.9	19	1372	-	74413
9	3	84.4	19	1107	1443	226559
10	1	58.8	19	-	-	380056
11	1	65.6	19	-	-	533408
12	2	78.5	19	1704	-	55547
13	2	82.3	19	1686	-	207876
14	3	90.1	19	1071	1266	359771
15	3	90.2	19	1089	1950	511297
16	2	83.1	19	1406	-	36803
17	1	58.8	19	-	-	189652
18	2	77	19	1657	-	341809
19	1	55	19	-	-	495737
20						

**DFS Radar Parameters**  
**FCC Radar Type 5**  
**Channel 60 Bandwidth 20MHz**

Trial Number:		13				Detection (Yes/No)
Number of Bursts in Trial:		15				
Chirp Center Frequency:		5296				Yes
Burst	Number of Pulses	Pulse Width (Microseconds)	Chirp Width (MHz)	Pulse 1-to-2 Spacing (µsec)	Pulse 2-to-3 Spacing (µsec)	Starting Location Within Interval (µsec)
1	1	58.1	13	-	-	22911
2	1	52.1	13	-	-	216473
3	1	59.9	13	-	-	410004
4	1	60.2	13	-	-	603671
5	3	95.9	13	1906	1608	794160
6	2	79.9	13	1859	-	192251
7	2	78.5	13	1917	-	385590
8	1	53.8	13	-	-	579862
9	1	64.7	13	-	-	773423
10	1	61.4	13	-	-	168898
11	2	83.2	13	1858	-	361606
12	3	84.7	13	1677	1638	553866
13	3	88.7	13	1528	1058	747241
14	2	78.3	13	1951	-	144710
15	2	69.3	13	1717	-	337856
16						
17						
18						
19						
20						

Trial Number:		14				Detection (Yes/No)
Number of Bursts in Trial:		12				
Chirp Center Frequency:		5295				Yes
Burst	Number of Pulses	Pulse Width (Microseconds)	Chirp Width (MHz)	Pulse 1-to-2 Spacing (µsec)	Pulse 2-to-3 Spacing (µsec)	Starting Location Within Interval (µsec)
1	2	75.3	10	1612	-	664275
2	1	56.3	10	-	-	907886
3	2	67.7	10	1185	-	151316
4	1	55.6	10	-	-	393746
5	2	75.2	10	1267	-	635093
6	2	76.3	10	1305	-	876993
7	3	85.7	10	1362	1924	121278
8	3	98.4	10	1550	1249	362696
9	3	86.4	10	1439	1046	604342
10	3	93.6	10	1031	1452	846453
11	1	63.3	10	-	-	91871
12	3	92.4	10	1673	1322	333050
13						
14						
15						
16						
17						
18						
19						
20						

**DFS Radar Parameters**  
**FCC Radar Type 5**  
**Channel 60 Bandwidth 20MHz**

Trial Number:		15				Detection (Yes/No)
Number of Bursts in Trial:		19				
Chirp Center Frequency:		5298				Yes
Burst	Number of Pulses	Pulse Width (Microseconds)	Chirp Width (MHz)	Pulse 1-to-2 Spacing (µsec)	Pulse 2-to-3 Spacing (µsec)	Starting Location Within Interval (µsec)
1	3	93.3	18	1912	1535	361323
2	2	69.1	18	1794	-	515261
3	3	86.9	18	1152	1148	39025
4	3	84.9	18	1948	1118	190900
5	2	72.3	18	1916	-	343941
6	1	51.7	18	-	-	497624
7	1	58.3	18	-	-	20319
8	1	60.8	18	-	-	172999
9	1	57.1	18	-	-	325872
10	3	88.9	18	1964	1489	475841
11	2	72	18	1297	-	1489
12	3	90.9	18	1566	1370	153647
13	1	59.8	18	-	-	307096
14	2	70	18	1291	-	458804
15	2	67.2	18	1881	-	610798
16	3	91.2	18	1832	1661	134759
17	1	56.5	18	-	-	288306
18	1	51.2	18	-	-	441296
19	2	74.1	18	1245	-	592780
20						

Trial Number:		16				Detection (Yes/No)
Number of Bursts in Trial:		14				
Chirp Center Frequency:		5296				Yes
Burst	Number of Pulses	Pulse Width (Microseconds)	Chirp Width (MHz)	Pulse 1-to-2 Spacing (µsec)	Pulse 2-to-3 Spacing (µsec)	Starting Location Within Interval (µsec)
1	2	76.9	12	1140	-	158286
2	1	50.2	12	-	-	366024
3	1	62.9	12	-	-	573452
4	1	64.7	12	-	-	780619
5	3	83.8	12	1097	1621	132455
6	1	65.4	12	-	-	340207
7	1	53.2	12	-	-	548208
8	1	51.7	12	-	-	755333
9	2	78.7	12	1168	-	107117
10	2	72.4	12	1343	-	314500
11	1	53.8	12	-	-	522447
12	2	73.6	12	1553	-	728517
13	2	66.7	12	1122	-	81611
14	2	82.5	12	1019	-	288948
15						
16						
17						
18						
19						
20						

**DFS Radar Parameters**  
**FCC Radar Type 5**  
**Channel 60 Bandwidth 20MHz**

Trial Number:		17				Detection (Yes/No)
Number of Bursts in Trial:		20				Yes
Chirp Center Frequency:		5299				Yes
Burst	Number of Pulses	Pulse Width (Microseconds)	Chirp Width (MHz)	Pulse 1-to-2 Spacing (µsec)	Pulse 2-to-3 Spacing (µsec)	Starting Location Within Interval (µsec)
1	3	87.6	20	1055	1840	345766
2	3	85.2	20	1541	1408	490019
3	3	84.8	20	1889	1463	39073
4	2	77.9	20	1460	-	183923
5	2	76.5	20	1485	-	328777
6	1	60.9	20	-	-	474728
7	2	83	20	1010	-	21394
8	2	80.4	20	1752	-	165992
9	2	67.5	20	1181	-	310973
10	1	62.1	20	-	-	456884
11	3	86.4	20	1966	1263	3515
12	3	84.3	20	1188	1788	147928
13	2	76.9	20	1537	-	293225
14	3	95.8	20	1298	1844	436922
15	1	55.2	20	-	-	584015
16	1	59	20	-	-	130832
17	3	94.5	20	1700	1283	274684
18	3	91.9	20	1978	1165	418579
19	3	85.2	20	1551	1189	563464
20	2	69.5	20	1224	-	112787

Trial Number:		18				Detection (Yes/No)
Number of Bursts in Trial:		12				Yes
Chirp Center Frequency:		5295				Yes
Burst	Number of Pulses	Pulse Width (Microseconds)	Chirp Width (MHz)	Pulse 1-to-2 Spacing (µsec)	Pulse 2-to-3 Spacing (µsec)	Starting Location Within Interval (µsec)
1	3	86.4	10	1918	1455	429224
2	3	92.2	10	1719	1895	670241
3	2	80.4	10	1899	-	912880
4	1	54.3	10	-	-	158603
5	1	53.1	10	-	-	400824
6	2	69.4	10	1546	-	641915
7	2	69.1	10	1639	-	883823
8	3	100	10	1438	1595	128373
9	2	79.6	10	1705	-	370379
10	3	88.4	10	1579	1623	611194
11	1	53.3	10	-	-	855665
12	1	65.3	10	-	-	98897
13						
14						
15						
16						
17						
18						
19						
20						



**DFS Radar Parameters**  
**FCC Radar Type 5**  
**Channel 60 Bandwidth 20MHz**

Trial Number:		19				Detection (Yes/No)
Number of Bursts in Trial:		14				Yes
Chirp Center Frequency:		5296				Yes
Burst	Number of Pulses	Pulse Width (Microseconds)	Chirp Width (MHz)	Pulse 1-to-2 Spacing (µsec)	Pulse 2-to-3 Spacing (µsec)	Starting Location Within Interval (µsec)
1	1	55.3	12	-	-	292143
2	1	58.3	12	-	-	499633
3	2	72.3	12	1039.000	-	706377
4	3	84.8	12	1761.000	1721.000	58989
5	2	82.5	12	1431.000	-	266161
6	1	63.3	12	-	-	474469
7	2	80	12	1913.000	-	680544
8	3	90.3	12	1853.000	1123.000	33519
9	3	91.1	12	1783.000	1172.000	240319
10	3	96.6	12	1036.000	1385.000	447400
11	2	82.7	12	1990.000	-	654516
12	1	50.7	12	-	-	8083
13	2	78.4	12	1109.000	-	215435
14	3	99.5	12	1965.000	1869.000	421325
15						
16						
17						
18						
19						
20						

Trial Number:		20				Detection (Yes/No)
Number of Bursts in Trial:		12				Yes
Chirp Center Frequency:		5295				Yes
Burst	Number of Pulses	Pulse Width (Microseconds)	Chirp Width (MHz)	Pulse 1-to-2 Spacing (µsec)	Pulse 2-to-3 Spacing (µsec)	Starting Location Within Interval (µsec)
1	3	88.6	10	1067	1927	733725
2	1	57.4	10	-	-	977882
3	3	96.6	10	1658	1324	221197
4	2	69.7	10	1945	-	462915
5	2	77.9	10	1317	-	705071
6	1	62	10	-	-	947923
7	3	88.4	10	1077	1366	191373
8	3	97.3	10	1896	1367	432561
9	3	96.2	10	1787	1672	674004
10	3	95.4	10	1892	1414	915842
11	1	54.8	10	-	-	162176
12	2	80.4	10	1436	-	403553
13						
14						
15						
16						
17						
18						
19						
20						

**DFS Radar Parameters**  
**FCC Radar Type 5**  
**Channel 60 Bandwidth 20MHz**

Trial Number:		21				Detection (Yes/No)
Number of Bursts in Trial:		16				Yes
Chirp Center Frequency:		5303				Yes
Burst	Number of Pulses	Pulse Width (Microseconds)	Chirp Width (MHz)	Pulse 1-to-2 Spacing (µsec)	Pulse 2-to-3 Spacing (µsec)	Starting Location Within Interval (µsec)
1	2	74.7	15	1611	-	483470
2	1	57.1	15	-	-	666072
3	3	91.9	15	1475	1276	98810
4	2	83.1	15	1772	-	279914
5	1	50.7	15	-	-	462536
6	2	79.2	15	1600	-	642324
7	1	58.7	15	-	-	76831
8	2	71	15	1567	-	257785
9	2	79	15	1960	-	438554
10	2	68.5	15	1428	-	620397
11	2	73.5	15	1352	-	54310
12	2	70.5	15	1115	-	235506
13	2	76.6	15	1300	-	417036
14	2	81.2	15	1675	-	597974
15	1	61.8	15	-	-	32086
16	3	94.9	15	1206	1860	212751
17						
18						
19						
20						

Trial Number:		22				Detection (Yes/No)
Number of Bursts in Trial:		12				Yes
Chirp Center Frequency:		5306				Yes
Burst	Number of Pulses	Pulse Width (Microseconds)	Chirp Width (MHz)	Pulse 1-to-2 Spacing (µsec)	Pulse 2-to-3 Spacing (µsec)	Starting Location Within Interval (µsec)
1	2	78.5	9	1698	-	526149
2	3	89.8	9	1962	1167	767135
3	1	59.4	9	-	-	12955
4	2	79.6	9	1890	-	254612
5	2	76	9	1811	-	496588
6	1	53.6	9	-	-	739728
7	2	80.9	9	1053	-	980872
8	1	61.6	9	-	-	225249
9	1	53.4	9	-	-	467279
10	1	59.9	9	-	-	709720
11	1	60.4	9	-	-	951847
12	3	91.4	9	1726	1227	194839
13						
14						
15						
16						
17						
18						
19						
20						

**DFS Radar Parameters**  
**FCC Radar Type 5**  
**Channel 60 Bandwidth 20MHz**

Trial Number:		23				Detection (Yes/No)
Number of Bursts in Trial:		20				Yes
Chirp Center Frequency:		5301				Yes
Burst	Number of Pulses	Pulse Width (Microseconds)	Chirp Width (MHz)	Pulse 1-to-2 Spacing (µsec)	Pulse 2-to-3 Spacing (µsec)	Starting Location Within Interval (µsec)
1	2	77	20	1363	-	261858
2	1	58.1	20	-	-	407646
3	1	62.1	20	-	-	552319
4	2	76.9	20	1236	-	99107
5	2	80	20	1852	-	243514
6	1	52	20	-	-	389464
7	3	88.6	20	1995	1905	531093
8	2	72.9	20	1387	-	81159
9	3	98.5	20	1746	1389	225245
10	1	57.9	20	-	-	371906
11	3	95.9	20	1870	1066	514197
12	1	53.5	20	-	-	63561
13	3	92	20	1654	1458	207510
14	1	57.3	20	-	-	353638
15	2	70.5	20	1586	-	497515
16	2	70	20	1664	-	45553
17	3	84	20	1630	1176	189821
18	2	76.1	20	1057	-	335330
19	3	93.2	20	1018	1340	478825
20	3	96.8	20	1614	1817	27594

Trial Number:		24				Detection (Yes/No)
Number of Bursts in Trial:		16				Yes
Chirp Center Frequency:		0				Yes
Burst	Number of Pulses	Pulse Width (Microseconds)	Chirp Width (MHz)	Pulse 1-to-2 Spacing (µsec)	Pulse 2-to-3 Spacing (µsec)	Starting Location Within Interval (µsec)
1	5.304	0.857143	12			14
2	of Pulses p	Pulse Width (us)	chirp Width (MH	PRI-2 (us)	PRI-3 (us)	Burst Offset (us)
3	1	50.1	12	-	-	247117
4	3	93.5	12	1081	1413	453362
5	2	68.8	12	1577	-	660875
6	1	56.3	12	-	-	14140
7	3	86	12	1108	1987	220734
8	2	75.2	12	1536	-	428367
9	1	54.4	12	-	-	636681
10	2	71.1	12	1243	-	843157
11	2	76.2	12	1770	-	195585
12	2	80.2	12	1209	-	403231
13	2	79.7	12	1214	-	610202
14	3	90.9	12	1862	1601	815229
15	2	68.7	12	1441	-	170267
16	2	67.4	12	1313	-	377306
17						
18						
19						
20						

**DFS Radar Parameters**  
**FCC Radar Type 5**  
**Channel 60 Bandwidth 20MHz**

Trial Number:		25				Detection (Yes/No)
Number of Bursts in Trial:		13				Yes
Chirp Center Frequency:		5305				Yes
Burst	Number of Pulses	Pulse Width (Microseconds)	Chirp Width (MHz)	Pulse 1-to-2 Spacing (µsec)	Pulse 2-to-3 Spacing (µsec)	Starting Location Within Interval (µsec)
1	3	94	11	1748	1941	628071
2	2	70.8	11	1201	-	853391
3	1	56.3	11	-	-	156223
4	3	96.7	11	1163	1332	378734
5	3	90.6	11	1582	1498	601331
6	2	74.5	11	1281	-	825462
7	3	92.6	11	1669	1222	128265
8	3	89	11	1135	1380	351161
9	3	96.5	11	1822	1602	573425
10	2	70.5	11	1178	-	798431
11	3	94	11	1629	1956	100737
12	1	55.8	11	-	-	324661
13	3	87.7	11	1963	1164	546278
14						
15						
16						
17						
18						
19						
20						

Trial Number:		26				Detection (Yes/No)
Number of Bursts in Trial:		8				Yes
Chirp Center Frequency:		5307				Yes
Burst	Number of Pulses	Pulse Width (Microseconds)	Chirp Width (MHz)	Pulse 1-to-2 Spacing (µsec)	Pulse 2-to-3 Spacing (µsec)	Starting Location Within Interval (µsec)
1	2	68.6	5	1161	-	1253842
2	2	83.1	5	1315	-	119486
3	1	60.9	5	-	-	482958
4	2	77.7	5	1158	-	845641
5	2	77.4	5	1510	-	1208428
6	2	66.8	5	1323	-	74748
7	1	63.7	5	-	-	438300
8	3	91.2	5	1681	1275	800152
9						
10						
11						
12						
13						
14						
15						
16						
17						
18						
19						
20						

**DFS Radar Parameters**  
**FCC Radar Type 5**  
**Channel 60 Bandwidth 20MHz**

Trial Number:		27				Detection (Yes/No)
Number of Bursts in Trial:		17				Yes
Chirp Center Frequency:		5303				Yes
Burst	Number of Pulses	Pulse Width (Microseconds)	Chirp Width (MHz)	Pulse 1-to-2 Spacing (µsec)	Pulse 2-to-3 Spacing (µsec)	Starting Location Within Interval (µsec)
1	3	83.6	16	1195	1000	545865
2	3	89.4	16	1627	1656	14067
3	1	55.8	16	-	-	184953
4	3	90.9	16	1554	1998	353759
5	1	54.7	16	-	-	526388
6	3	97.7	16	1202	1250	694806
7	2	67.5	16	1434	-	163568
8	3	96.7	16	1469	1268	333410
9	2	68.3	16	1954	-	504006
10	2	78.3	16	1082	-	675297
11	1	55	16	-	-	142890
12	3	84.9	16	1936	1199	312479
13	2	74.6	16	1856	-	482953
14	1	63.3	16	-	-	655022
15	3	99.8	16	1515	1120	121457
16	1	63.6	16	-	-	292606
17	3	87.3	16	1051	1831	461322
18						
19						
20						

Trial Number:		28				Detection (Yes/No)
Number of Bursts in Trial:		19				Yes
Chirp Center Frequency:		5302				Yes
Burst	Number of Pulses	Pulse Width (Microseconds)	Chirp Width (MHz)	Pulse 1-to-2 Spacing (µsec)	Pulse 2-to-3 Spacing (µsec)	Starting Location Within Interval (µsec)
1	3	85.6	19	1078	1015	565136
2	2	68.6	19	1780	-	89970
3	1	54.2	19	-	-	243121
4	1	61.2	19	-	-	396034
5	3	97.1	19	1969	1100	546225
6	3	98.3	19	1699	1622	70998
7	1	62.4	19	-	-	224093
8	2	80.2	19	1769	-	376127
9	3	87.5	19	1448	1179	527806
10	3	85.8	19	1348	1472	52247
11	3	88.1	19	1124	1631	204582
12	1	65.3	19	-	-	357941
13	1	52.5	19	-	-	510977
14	1	52.3	19	-	-	33698
15	2	74.1	19	1200	-	186023
16	1	54.9	19	-	-	339327
17	2	76.2	19	1502	-	491053
18	1	60.4	19	-	-	14858
19	2	81.5	19	1103	-	167387
20						

**DFS Radar Parameters**  
**FCC Radar Type 5**  
**Channel 60 Bandwidth 20MHz**

Trial Number:		29				Detection (Yes/No)
Number of Bursts in Trial:		12				Yes
Chirp Center Frequency:		5305				Yes
Burst	Number of Pulses	Pulse Width (Microseconds)	Chirp Width (MHz)	Pulse 1-to-2 Spacing (µsec)	Pulse 2-to-3 Spacing (µsec)	Starting Location Within Interval (µsec)
1	1	50.5	10	-	-	507709
2	1	55.7	10	-	-	750249
3	3	85.8	10	1002	1967	989003
4	2	76.9	10	1474	-	235634
5	2	75.1	10	1052	-	477675
6	3	92.3	10	1486	1492	718312
7	2	78.1	10	1757	-	960895
8	3	92.2	10	1252	1713	205370
9	3	89	10	1706	1411	446940
10	2	70.9	10	1620	-	689225
11	1	63.1	10	-	-	932305
12	1	55.3	10	-	-	176231
13						
14						
15						
16						
17						
18						
19						
20						

Trial Number:		30				Detection (Yes/No)
Number of Bursts in Trial:		18				Yes
Chirp Center Frequency:		5302				Yes
Burst	Number of Pulses	Pulse Width (Microseconds)	Chirp Width (MHz)	Pulse 1-to-2 Spacing (µsec)	Pulse 2-to-3 Spacing (µsec)	Starting Location Within Interval (µsec)
1	3	83.4	17	1205	1801	277485
2	3	97.3	17	1826	1635	437880
3	3	90.4	17	1986	1674	598445
4	3	91.8	17	1151	1802	97088
5	3	98.2	17	1977	1766	257251
6	1	59.5	17	-	-	419893
7	2	80	17	1137	-	580724
8	3	86.5	17	1128	1828	77366
9	3	91.1	17	1599	1442	238032
10	3	93.5	17	1373	1087	398605
11	1	60.7	17	-	-	562025
12	2	67.2	17	1405	-	57684
13	1	61.8	17	-	-	219083
14	2	79.4	17	1667	-	379234
15	2	81.4	17	1464	-	540896
16	1	65.7	17	-	-	37916
17	2	76	17	1255	-	198794
18	2	81	17	1668	-	359754
19						
20						

**DFS Radar Parameters**  
**FCC Radar Type 1**  
**Channel 62 Bandwidth 40MHz**

Trial #	Pulse Repetition Frequency Number (1 to 23)	Pulse Repetition Frequency (Pulses Per Second)	Pulse Repetition Interval (Microseconds)	Detection (Yes / No)
1	22	1066.10	938	Yes
2	10	1432.66	698	Yes
3	6	1618.12	618	Yes
4	2	1858.74	538	Yes
5	19	1138.95	878	Yes
6	12	326.16	3066	Yes
7	7	1567.40	638	Yes
8	21	1089.32	918	Yes
9	17	1193.32	838	Yes
10	18	1165.50	858	Yes
11	15	1253.13	798	Yes
12	11	1392.76	718	Yes
13	4	1730.10	578	Yes
14	5	1672.24	598	Yes
15	3	1792.11	558	Yes
16		394.32	2536	Yes
17		1035.20	966	Yes
18		1209.19	827	Yes
19		399.84	2501	Yes
20		385.36	2595	Yes
21		897.67	1114	Yes
22		768.05	1302	Yes
23		328.41	3045	Yes
24		615.76	1624	Yes
25		347.46	2878	Yes
26		973.71	1027	Yes
27		402.41	2485	Yes
28		625.00	1600	Yes
29		853.24	1172	Yes
30		849.62	1177	Yes

**DFS Radar Parameters**  
**FCC Radar Type 2**  
**Channel 62 Bandwidth 40MHz**

Trial #	Number Pulses per Burst	Pulse Width (Microseconds)	Pulse Repetition Interval (Microseconds)	Detection (Yes / No)
1	26	3.20	179	Yes
2	23	1.10	207	Yes
3	24	2.10	230	Yes
4	29	4.80	200	Yes
5	28	3.90	214	Yes
6	26	2.90	222	Yes
7	26	3.20	204	Yes
8	25	2.50	192	Yes
9	26	3.10	164	Yes
10	23	1.20	156	Yes
11	27	3.90	210	Yes
12	29	4.60	201	Yes
13	26	3.20	162	Yes
14	25	2.20	197	Yes
15	29	4.50	163	Yes
16	26	3.00	203	Yes
17	29	5.00	168	Yes
18	25	2.40	217	Yes
19	26	2.90	191	Yes
20	25	2.30	166	Yes
21	27	3.70	150	Yes
22	25	2.20	176	Yes
23	29	4.90	195	Yes
24	26	2.90	202	Yes
25	25	2.50	178	Yes
26	23	1.10	206	Yes
27	27	3.80	155	Yes
28	29	4.70	157	Yes
29	25	2.40	224	Yes
30	28	4.20	159	Yes



**DFS Radar Parameters**  
**FCC Radar Type 3**  
**Channel 62 Bandwidth 40MHz**

Trial #	Number Pulses per Burst	Pulse Width (Microseconds)	Pulse Repetition Interval (Microseconds)	Detection (Yes / No)
1	17	8.20	355	Yes
2	16	6.10	487	Yes
3	16	7.10	344	Yes
4	18	9.80	288	Yes
5	18	8.90	230	Yes
6	17	7.90	432	Yes
7	17	8.20	207	Yes
8	17	7.50	443	Yes
9	17	8.10	439	Yes
10	16	6.20	223	Yes
11	18	8.90	208	Yes
12	18	9.60	463	Yes
13	17	8.20	441	Yes
14	16	7.20	323	Yes
15	18	9.50	297	Yes
16	17	8.00	412	Yes
17	18	10.00	324	Yes
18	17	7.40	271	Yes
19	17	7.90	349	Yes
20	16	7.30	409	Yes
21	18	8.70	373	Yes
22	16	7.20	254	Yes
23	18	9.90	274	Yes
24	17	7.90	278	Yes
25	17	7.50	317	Yes
26	16	6.10	260	Yes
27	18	8.80	211	Yes
28	18	9.70	272	Yes
29	17	7.40	264	Yes
30	18	9.20	284	Yes

**DFS Radar Parameters**  
**FCC Radar Type 4**  
**Channel 62 Bandwidth 40MHz**

Trial #	Number Pulses per Burst	Pulse Width (Microseconds)	Pulse Repetition Interval (Microseconds)	Detection (Yes / No)
1	14	16.00	355	Yes
2	12	11.30	487	Yes
3	13	13.50	344	Yes
4	16	19.40	288	Yes
5	15	17.50	230	Yes
6	14	15.30	432	Yes
7	14	15.90	207	Yes
8	13	14.30	443	Yes
9	14	15.80	439	Yes
10	12	11.50	223	Yes
11	15	17.40	208	Yes
12	16	19.00	463	Yes
13	14	16.00	441	Yes
14	13	13.80	323	Yes
15	16	18.90	297	Yes
16	14	15.50	412	Yes
17	16	19.90	324	Yes
18	13	14.10	271	Yes
19	14	15.20	349	Yes
20	13	13.80	409	Yes
21	15	17.10	373	Yes
22	13	13.80	254	Yes
23	16	19.80	274	Yes
24	14	15.30	278	Yes
25	13	14.50	317	Yes
26	12	11.30	260	Yes
27	15	17.30	211	Yes
28	16	19.20	272	Yes
29	13	14.20	264	Yes
30	15	18.20	284	Yes

**DFS Radar Parameters**  
**FCC Radar Type 5**  
**Channel 62 Bandwidth 40MHz**

Trial Number:			1			Detection (Yes/No) Yes
Number of Bursts in Trial:			15			
Chirp Center Frequency:			5310			
Burst	Number of Pulses	Pulse Width (Microseconds)	Chirp Width (MHz)	Pulse 1-to-2 Spacing (µsec)	Pulse 2-to-3 Spacing (µsec)	Starting Location Within Interval (µsec)
1	2	77.8	13	1477	-	636185
2	1	51.9	13	-	-	32674
3	1	63.8	13	-	-	226294
4	3	96.6	13	1786	1843	417976
5	3	85.9	13	1215	1729	611152
6	2	73.7	13	1549	-	8789
7	2	77.2	13	1819	-	201917
8	2	68.4	13	1114	-	395530
9	2	76.7	13	1155	-	588564
10	1	53.2	13	-	-	783794
11	3	85.7	13	1695	1394	177933
12	3	94.3	13	1426	1935	370624
13	2	77.6	13	1671	-	564893
14	1	65.7	13	-	-	759583
15	3	93.5	13	1130	1468	154262
16						
17						
18						
19						
20						

Trial Number:			2			Detection (Yes/No) Yes
Number of Bursts in Trial:			8			
Chirp Center Frequency:			5310			
Burst	Number of Pulses	Pulse Width (Microseconds)	Chirp Width (MHz)	Pulse 1-to-2 Spacing (µsec)	Pulse 2-to-3 Spacing (µsec)	Starting Location Within Interval (µsec)
1	2	75	5	1527	-	653020
2	3	99.4	5	1262	1257	1015643
3	2	67.4	5	1403	-	1379398
4	2	73.6	5	1041	-	245489
5	1	65.9	5	-	-	609113
6	3	83.8	5	1292	1419	970852
7	1	65.5	5	-	-	1335913
8	3	98.6	5	1796	1728	200406
9						
10						
11						
12						
13						
14						
15						
16						
17						
18						
19						
20						

**DFS Radar Parameters**  
**FCC Radar Type 5**  
**Channel 62 Bandwidth 40MHz**

Trial Number:			3			Detection (Yes/No)
Number of Bursts in Trial:			11			
Chirp Center Frequency:			5310			Yes
Burst	Number of Pulses	Pulse Width (Microseconds)	Chirp Width (MHz)	Pulse 1-to-2 Spacing (µsec)	Pulse 2-to-3 Spacing (µsec)	Starting Location Within Interval (µsec)
1	2	73.8	9	1538	-	409565
2	2	69.5	9	1649	-	673692
3	1	51.9	9	-	-	938562
4	3	84.6	9	1032	1271	113209
5	3	95.4	9	1903	1388	376726
6	2	68	9	1351	-	641212
7	3	89.6	9	1514	1573	903714
8	2	81.9	9	1689	-	80863
9	3	88.3	9	1330	1838	344067
10	1	53.7	9	-	-	609331
11	3	91.3	9	1106	1001	871542
12						
13						
14						
15						
16						
17						
18						
19						
20						

Trial Number:			4			Detection (Yes/No)
Number of Bursts in Trial:			11			
Chirp Center Frequency:			5310			Yes
Burst	Number of Pulses	Pulse Width (Microseconds)	Chirp Width (MHz)	Pulse 1-to-2 Spacing (µsec)	Pulse 2-to-3 Spacing (µsec)	Starting Location Within Interval (µsec)
1	2	68.1	19	1355	-	26541
2	1	58.7	19	-	-	171821
3	2	75.3	19	1640	-	316229
4	1	56.4	19	-	-	461864
5	3	99.7	19	1708	1159	8677
6	1	57.7	19	-	-	153995
7	1	59.5	19	-	-	299238
8	2	80	19	1369	-	443177
9	2	82	19	1197	-	587671
10	2	82.8	19	1005	-	135674
11	3	88	19	1928	1101	279928
12	3	93.2	19	1907	1223	424279
13	2	70.4	19	1360	-	570132
14	3	95.3	19	1955	1775	117439
15	2	81.9	19	1545	-	262502
16	3	98.5	19	1169	1062	406573
17	1	65	19	-	-	553328
18	3	85.4	19	1637	1425	99799
19	3	91.6	19	1445	1325	244095
20	2	67.3	19	1218	-	390012

**DFS Radar Parameters**  
**FCC Radar Type 5**  
**Channel 62 Bandwidth 40MHz**

Trial Number:		5				Detection (Yes/No)
Number of Bursts in Trial:		17				
Chirp Center Frequency:		5310				Yes
Burst	Number of Pulses	Pulse Width (Microseconds)	Chirp Width (MHz)	Pulse 1-to-2 Spacing (µsec)	Pulse 2-to-3 Spacing (µsec)	Starting Location Within Interval (µsec)
1	2	67.9	16	1133	-	629614
2	1	62.3	16	-	-	96856
3	1	53.3	16	-	-	267719
4	3	90	16	1153	1346	436784
5	2	77.1	16	1646	-	608289
6	3	83.9	16	1232	1459	75610
7	3	89.1	16	1384	1939	245638
8	2	81.8	16	1676	-	416355
9	1	50.3	16	-	-	588736
10	3	87.1	16	1996	1756	54571
11	2	71.3	16	1815	-	225175
12	3	97.5	16	1465	1132	394825
13	3	90.6	16	1040	1354	565361
14	3	86.3	16	1183	1792	33643
15	3	97.6	16	1073	1361	203957
16	3	84.7	16	1718	1854	373812
17	3	99.7	16	1244	1988	544060
18						
19						
20						

Trial Number:		6				Detection (Yes/No)
Number of Bursts in Trial:		14				
Chirp Center Frequency:		5310				Yes
Burst	Number of Pulses	Pulse Width (Microseconds)	Chirp Width (MHz)	Pulse 1-to-2 Spacing (µsec)	Pulse 2-to-3 Spacing (µsec)	Starting Location Within Interval (µsec)
1	3	92.9	12	1564	1407	15438
2	2	67.7	12	1747	-	222486
3	1	65.8	12	-	-	430731
4	1	56.3	12	-	-	637784
5	1	53.7	12	-	-	845342
6	3	83.5	12	1930	1025	196720
7	1	65.8	12	-	-	404955
8	3	85.9	12	1034	1808	610711
9	2	76.3	12	1926	-	818057
10	2	81.5	12	1714	-	171459
11	3	89.4	12	1594	1827	377969
12	1	63.4	12	-	-	586875
13	2	69.6	12	1925	-	792834
14	2	74.5	12	1846	-	146044
15						
16						
17						
18						
19						
20						

**DFS Radar Parameters**  
**FCC Radar Type 5**  
**Channel 62 Bandwidth 40MHz**

Trial Number:		7				Detection (Yes/No)
Number of Bursts in Trial:		15				
Chirp Center Frequency:		5310				Yes
Burst	Number of Pulses	Pulse Width (Microseconds)	Chirp Width (MHz)	Pulse 1-to-2 Spacing (µsec)	Pulse 2-to-3 Spacing (µsec)	Starting Location Within Interval (µsec)
1	1	52.6	10	-	-	51446
2	3	84.1	10	1725	1529	292696
3	3	97.7	10	1868	1805	533989
4	3	97.3	10	1446	1755	775564
5	3	98.8	10	1386	1302	21542
6	2	72.2	10	1184	-	263385
7	2	67.6	10	1027	-	505581
8	2	75.7	10	1871	-	747058
9	1	60.9	10	-	-	989976
10	1	64.2	10	-	-	234024
11	2	78.8	10	1604	-	475207
12	3	87.5	10	1712	1683	715825
13						
14						
15						
16						
17						
18						
19						
20						

Trial Number:		8				Detection (Yes/No)
Number of Bursts in Trial:		12				
Chirp Center Frequency:		5310				Yes
Burst	Number of Pulses	Pulse Width (Microseconds)	Chirp Width (MHz)	Pulse 1-to-2 Spacing (µsec)	Pulse 2-to-3 Spacing (µsec)	Starting Location Within Interval (µsec)
1	1	52.6	10	-	-	51446
2	3	84.1	10	1725	1529	292696
3	3	97.7	10	1868	1805	533989
4	3	97.3	10	1446	1755	775564
5	3	98.8	10	1386	1302	21542
6	2	72.2	10	1184	-	263385
7	2	67.6	10	1027	-	505581
8	2	75.7	10	1871	-	747058
9	1	60.9	10	-	-	989976
10	1	64.2	10	-	-	234024
11	2	78.8	10	1604	-	475207
12	3	87.5	10	1712	1683	715825
13						
14						
15						
16						
17						
18						
19						
20						

**DFS Radar Parameters**  
**FCC Radar Type 5**  
**Channel 62 Bandwidth 40MHz**

Trial Number:		9				Detection (Yes/No)
Number of Bursts in Trial:		14				Yes
Chirp Center Frequency:		5310				Yes
Burst	Number of Pulses	Pulse Width (Microseconds)	Chirp Width (MHz)	Pulse 1-to-2 Spacing (µsec)	Pulse 2-to-3 Spacing (µsec)	Starting Location Within Interval (µsec)
1	1	54.1	13	-	-	823112
2	1	50.7	13	-	-	174965
3	1	52.3	13	-	-	382216
4	3	99.8	13	1696	1949	587395
5	2	68.4	13	1099	-	796897
6	2	80.8	13	1505	-	149042
7	1	62.5	13	-	-	356750
8	2	74.8	13	1204	-	563824
9	1	50.8	13	-	-	772314
10	1	54	13	-	-	123796
11	1	63	13	-	-	331215
12	3	91.8	13	1270	1347	537402
13	2	79.3	13	1992	-	744805
14	1	64.3	13	-	-	98172
15						
16						
17						
18						
19						
20						

Trial Number:		10				Detection (Yes/No)
Number of Bursts in Trial:		8				Yes
Chirp Center Frequency:		5310				Yes
Burst	Number of Pulses	Pulse Width (Microseconds)	Chirp Width (MHz)	Pulse 1-to-2 Spacing (µsec)	Pulse 2-to-3 Spacing (µsec)	Starting Location Within Interval (µsec)
1	1	63.4	6	-	-	535615
2	1	52	6	-	-	898668
3	3	97.2	6	1605	1583	1259235
4	2	78.7	6	1743	-	127106
5	2	74.2	6	1219	-	490358
6	3	88.7	6	1934	1273	852409
7	1	54.3	6	-	-	1217152
8	3	95.4	6	1555	1791	82296
9						
10						
11						
12						
13						
14						
15						
16						
17						
18						
19						
20						

**DFS Radar Parameters**  
**FCC Radar Type 5**  
**Channel 62 Bandwidth 40MHz**

Trial Number:			11			Detection (Yes/No)
Number of Bursts in Trial:			17			
Chirp Center Frequency:			5298			Yes
Burst	Number of Pulses	Pulse Width (Microseconds)	Chirp Width (MHz)	Pulse 1-to-2 Spacing (µsec)	Pulse 2-to-3 Spacing (µsec)	Starting Location Within Interval (µsec)
1	2	73.7	16	1497	-	209249
2	3	97.4	16	1754	1613	378386
3	3	91.7	16	1702	1462	548411
4	1	66.2	16	-	-	17733
5	2	70.8	16	1821	-	187952
6	1	52.3	16	-	-	359277
7	2	78.9	16	1984	-	528886
8	2	70.9	16	1358	-	700166
9	2	75.6	16	1430	-	167197
10	1	59.1	16	-	-	338262
11	2	77	16	1304	-	508324
12	2	67.9	16	1083	-	678689
13	2	81.2	16	1932	-	146031
14	2	78.7	16	1121	-	316923
15	1	63.3	16	-	-	488056
16	2	68.9	16	1423	-	657326
17	1	59.3	16	-	-	125509
18						
19						
20						

Trial Number:			12			Detection (Yes/No)
Number of Bursts in Trial:			19			
Chirp Center Frequency:			5299			Yes
Burst	Number of Pulses	Pulse Width (Microseconds)	Chirp Width (MHz)	Pulse 1-to-2 Spacing (µsec)	Pulse 2-to-3 Spacing (µsec)	Starting Location Within Interval (µsec)
1	3	98.9	19	1680	1488	263736
2	2	82.3	19	1855	-	416459
3	3	86.7	19	1400	1919	567902
4	3	89.7	19	1068	1282	92979
5	3	98.6	19	1194	1461	245155
6	2	71.1	19	1789	-	397609
7	1	55.9	19	-	-	551431
8	2	67.9	19	1372	-	74413
9	3	84.4	19	1107	1443	226559
10	1	58.8	19	-	-	380056
11	1	65.6	19	-	-	533408
12	2	78.5	19	1704	-	55547
13	2	82.3	19	1686	-	207876
14	3	90.1	19	1071	1266	359771
15	3	90.2	19	1089	1950	511297
16	2	83.1	19	1406	-	36803
17	1	58.8	19	-	-	189652
18	2	77	19	1657	-	341809
19	1	55	19	-	-	495737
20						



**DFS Radar Parameters**  
**FCC Radar Type 5**  
**Channel 62 Bandwidth 40MHz**

Trial Number:		13				Detection (Yes/No)
Number of Bursts in Trial:		15				
Chirp Center Frequency:		5297				Yes
Burst	Number of Pulses	Pulse Width (Microseconds)	Chirp Width (MHz)	Pulse 1-to-2 Spacing (µsec)	Pulse 2-to-3 Spacing (µsec)	Starting Location Within Interval (µsec)
1	1	58.1	13	-	-	22911
2	1	52.1	13	-	-	216473
3	1	59.9	13	-	-	410004
4	1	60.2	13	-	-	603671
5	3	95.9	13	1906	1608	794160
6	2	79.9	13	1859	-	192251
7	2	78.5	13	1917	-	385590
8	1	53.8	13	-	-	579862
9	1	64.7	13	-	-	773423
10	1	61.4	13	-	-	168898
11	2	83.2	13	1858	-	361606
12	3	84.7	13	1677	1638	553866
13	3	88.7	13	1528	1058	747241
14	2	78.3	13	1951	-	144710
15	2	69.3	13	1717	-	337856
16						
17						
18						
19						
20						

Trial Number:		14				Detection (Yes/No)
Number of Bursts in Trial:		12				
Chirp Center Frequency:		5296				Yes
Burst	Number of Pulses	Pulse Width (Microseconds)	Chirp Width (MHz)	Pulse 1-to-2 Spacing (µsec)	Pulse 2-to-3 Spacing (µsec)	Starting Location Within Interval (µsec)
1	2	75.3	10	1612	-	664275
2	1	56.3	10	-	-	907886
3	2	67.7	10	1185	-	151316
4	1	55.6	10	-	-	393746
5	2	75.2	10	1267	-	635093
6	2	76.3	10	1305	-	876993
7	3	85.7	10	1362	1924	121278
8	3	98.4	10	1550	1249	362696
9	3	86.4	10	1439	1046	604342
10	3	93.6	10	1031	1452	846453
11	1	63.3	10	-	-	91871
12	3	92.4	10	1673	1322	333050
13						
14						
15						
16						
17						
18						
19						
20						

**DFS Radar Parameters**  
**FCC Radar Type 5**  
**Channel 62 Bandwidth 40MHz**

Trial Number:		15				Detection (Yes/No)
Number of Bursts in Trial:		19				
Chirp Center Frequency:		5299				Yes
Burst	Number of Pulses	Pulse Width (Microseconds)	Chirp Width (MHz)	Pulse 1-to-2 Spacing (µsec)	Pulse 2-to-3 Spacing (µsec)	Starting Location Within Interval (µsec)
1	3	93.3	18	1912	1535	361323
2	2	69.1	18	1794	-	515261
3	3	86.9	18	1152	1148	39025
4	3	84.9	18	1948	1118	190900
5	2	72.3	18	1916	-	343941
6	1	51.7	18	-	-	497624
7	1	58.3	18	-	-	20319
8	1	60.8	18	-	-	172999
9	1	57.1	18	-	-	325872
10	3	88.9	18	1964	1489	475841
11	2	72	18	1297	-	1489
12	3	90.9	18	1566	1370	153647
13	1	59.8	18	-	-	307096
14	2	70	18	1291	-	458804
15	2	67.2	18	1881	-	610798
16	3	91.2	18	1832	1661	134759
17	1	56.5	18	-	-	288306
18	1	51.2	18	-	-	441296
19	2	74.1	18	1245	-	592780
20						

Trial Number:		16				Detection (Yes/No)
Number of Bursts in Trial:		14				
Chirp Center Frequency:		5297				Yes
Burst	Number of Pulses	Pulse Width (Microseconds)	Chirp Width (MHz)	Pulse 1-to-2 Spacing (µsec)	Pulse 2-to-3 Spacing (µsec)	Starting Location Within Interval (µsec)
1	2	76.9	12	1140	-	158286
2	1	50.2	12	-	-	366024
3	1	62.9	12	-	-	573452
4	1	64.7	12	-	-	780619
5	3	83.8	12	1097	1621	132455
6	1	65.4	12	-	-	340207
7	1	53.2	12	-	-	548208
8	1	51.7	12	-	-	755333
9	2	78.7	12	1168	-	107117
10	2	72.4	12	1343	-	314500
11	1	53.8	12	-	-	522447
12	2	73.6	12	1553	-	728517
13	2	66.7	12	1122	-	81611
14	2	82.5	12	1019	-	288948
15						
16						
17						
18						
19						
20						

**DFS Radar Parameters**  
**FCC Radar Type 5**  
**Channel 62 Bandwidth 40MHz**

Trial Number:		17				Detection (Yes/No)
Number of Bursts in Trial:		20				Yes
Chirp Center Frequency:		5300				Starting Location Within Interval (µsec)
Burst	Number of Pulses	Pulse Width (Microseconds)	Chirp Width (MHz)	Pulse 1-to-2 Spacing (µsec)	Pulse 2-to-3 Spacing (µsec)	
1	3	87.6	20	1055	1840	345766
2	3	85.2	20	1541	1408	490019
3	3	84.8	20	1889	1463	39073
4	2	77.9	20	1460	-	183923
5	2	76.5	20	1485	-	328777
6	1	60.9	20	-	-	474728
7	2	83	20	1010	-	21394
8	2	80.4	20	1752	-	165992
9	2	67.5	20	1181	-	310973
10	1	62.1	20	-	-	456884
11	3	86.4	20	1966	1263	3515
12	3	84.3	20	1188	1788	147928
13	2	76.9	20	1537	-	293225
14	3	95.8	20	1298	1844	436922
15	1	55.2	20	-	-	584015
16	1	59	20	-	-	130832
17	3	94.5	20	1700	1283	274684
18	3	91.9	20	1978	1165	418579
19	3	85.2	20	1551	1189	563464
20	2	69.5	20	1224	-	112787

Trial Number:		18				Detection (Yes/No)
Number of Bursts in Trial:		12				Yes
Chirp Center Frequency:		5296				Starting Location Within Interval (µsec)
Burst	Number of Pulses	Pulse Width (Microseconds)	Chirp Width (MHz)	Pulse 1-to-2 Spacing (µsec)	Pulse 2-to-3 Spacing (µsec)	
1	3	86.4	10	1918	1455	429224
2	3	92.2	10	1719	1895	670241
3	2	80.4	10	1899	-	912880
4	1	54.3	10	-	-	158603
5	1	53.1	10	-	-	400824
6	2	69.4	10	1546	-	641915
7	2	69.1	10	1639	-	883823
8	3	100	10	1438	1595	128373
9	2	79.6	10	1705	-	370379
10	3	88.4	10	1579	1623	611194
11	1	53.3	10	-	-	855665
12	1	65.3	10	-	-	98897
13						
14						
15						
16						
17						
18						
19						
20						

**DFS Radar Parameters**  
**FCC Radar Type 5**  
**Channel 62 Bandwidth 40MHz**

Trial Number:		19				Detection (Yes/No)
Number of Bursts in Trial:		14				Yes
Chirp Center Frequency:		5297				Yes
Burst	Number of Pulses	Pulse Width (Microseconds)	Chirp Width (MHz)	Pulse 1-to-2 Spacing (µsec)	Pulse 2-to-3 Spacing (µsec)	Starting Location Within Interval (µsec)
1	1	55.3	12	-	-	292143
2	1	58.3	12	-	-	499633
3	2	72.3	12	1039.000	-	706377
4	3	84.8	12	1761.000	1721.000	58989
5	2	82.5	12	1431.000	-	266161
6	1	63.3	12	-	-	474469
7	2	80	12	1913.000	-	680544
8	3	90.3	12	1853.000	1123.000	33519
9	3	91.1	12	1783.000	1172.000	240319
10	3	96.6	12	1036.000	1385.000	447400
11	2	82.7	12	1990.000	-	654516
12	1	50.7	12	-	-	8083
13	2	78.4	12	1109.000	-	215435
14	3	99.5	12	1965.000	1869.000	421325
15						
16						
17						
18						
19						
20						

Trial Number:		20				Detection (Yes/No)
Number of Bursts in Trial:		12				Yes
Chirp Center Frequency:		5296				Yes
Burst	Number of Pulses	Pulse Width (Microseconds)	Chirp Width (MHz)	Pulse 1-to-2 Spacing (µsec)	Pulse 2-to-3 Spacing (µsec)	Starting Location Within Interval (µsec)
1	3	88.6	10	1067	1927	733725
2	1	57.4	10	-	-	977882
3	3	96.6	10	1658	1324	221197
4	2	69.7	10	1945	-	462915
5	2	77.9	10	1317	-	705071
6	1	62	10	-	-	947923
7	3	88.4	10	1077	1366	191373
8	3	97.3	10	1896	1367	432561
9	3	96.2	10	1787	1672	674004
10	3	95.4	10	1892	1414	915842
11	1	54.8	10	-	-	162176
12	2	80.4	10	1436	-	403553
13						
14						
15						
16						
17						
18						
19						
20						

**DFS Radar Parameters**  
**FCC Radar Type 5**  
**Channel 62 Bandwidth 40MHz**

Trial Number:		21				Detection (Yes/No)
Number of Bursts in Trial:		16				Yes
Chirp Center Frequency:		5322				Yes
Burst	Number of Pulses	Pulse Width (Microseconds)	Chirp Width (MHz)	Pulse 1-to-2 Spacing (µsec)	Pulse 2-to-3 Spacing (µsec)	Starting Location Within Interval (µsec)
1	2	74.7	15	1611	-	483470
2	1	57.1	15	-	-	666072
3	3	91.9	15	1475	1276	98810
4	2	83.1	15	1772	-	279914
5	1	50.7	15	-	-	462536
6	2	79.2	15	1600	-	642324
7	1	58.7	15	-	-	76831
8	2	71	15	1567	-	257785
9	2	79	15	1960	-	438554
10	2	68.5	15	1428	-	620397
11	2	73.5	15	1352	-	54310
12	2	70.5	15	1115	-	235506
13	2	76.6	15	1300	-	417036
14	2	81.2	15	1675	-	597974
15	1	61.8	15	-	-	32086
16	3	94.9	15	1206	1860	212751
17						
18						
19						
20						

Trial Number:		22				Detection (Yes/No)
Number of Bursts in Trial:		12				Yes
Chirp Center Frequency:		5325				Yes
Burst	Number of Pulses	Pulse Width (Microseconds)	Chirp Width (MHz)	Pulse 1-to-2 Spacing (µsec)	Pulse 2-to-3 Spacing (µsec)	Starting Location Within Interval (µsec)
1	2	78.5	9	1698	-	526149
2	3	89.8	9	1962	1167	767135
3	1	59.4	9	-	-	12955
4	2	79.6	9	1890	-	254612
5	2	76	9	1811	-	496588
6	1	53.6	9	-	-	739728
7	2	80.9	9	1053	-	980872
8	1	61.6	9	-	-	225249
9	1	53.4	9	-	-	467279
10	1	59.9	9	-	-	709720
11	1	60.4	9	-	-	951847
12	3	91.4	9	1726	1227	194839
13						
14						
15						
16						
17						
18						
19						
20						

**DFS Radar Parameters**  
**FCC Radar Type 5**  
**Channel 62 Bandwidth 40MHz**

Trial Number:		23				Detection (Yes/No)
Number of Bursts in Trial:		20				Yes
Chirp Center Frequency:		5320				Yes
Burst	Number of Pulses	Pulse Width (Microseconds)	Chirp Width (MHz)	Pulse 1-to-2 Spacing (µsec)	Pulse 2-to-3 Spacing (µsec)	Starting Location Within Interval (µsec)
1	2	77	20	1363	-	261858
2	1	58.1	20	-	-	407646
3	1	62.1	20	-	-	552319
4	2	76.9	20	1236	-	99107
5	2	80	20	1852	-	243514
6	1	52	20	-	-	389464
7	3	88.6	20	1995	1905	531093
8	2	72.9	20	1387	-	81159
9	3	98.5	20	1746	1389	225245
10	1	57.9	20	-	-	371906
11	3	95.9	20	1870	1066	514197
12	1	53.5	20	-	-	63561
13	3	92	20	1654	1458	207510
14	1	57.3	20	-	-	353638
15	2	70.5	20	1586	-	497515
16	2	70	20	1664	-	45553
17	3	84	20	1630	1176	189821
18	2	76.1	20	1057	-	335330
19	3	93.2	20	1018	1340	478825
20	3	96.8	20	1614	1817	27594

Trial Number:		24				Detection (Yes/No)
Number of Bursts in Trial:		14				Yes
Chirp Center Frequency:		5323				Yes
Burst	Number of Pulses	Pulse Width (Microseconds)	Chirp Width (MHz)	Pulse 1-to-2 Spacing (µsec)	Pulse 2-to-3 Spacing (µsec)	Starting Location Within Interval (µsec)
1	1	50.1	12	-	-	247117
2	3	93.5	12	1081	1413	453362
3	2	68.8	12	1577	-	660875
4	1	56.3	12	-	-	14140
5	3	86	12	1108	1987	220734
6	2	75.2	12	1536	-	428367
7	1	54.4	12	-	-	636681
8	2	71.1	12	1243	-	843157
9	2	76.2	12	1770	-	195585
10	2	80.2	12	1209	-	403231
11	2	79.7	12	1214	-	610202
12	3	90.9	12	1862	1601	815229
13	2	68.7	12	1441	-	170267
14	2	67.4	12	1313	-	377306
15						
16						
17						
18						
19						
20						

**DFS Radar Parameters**  
**FCC Radar Type 5**  
**Channel 62 Bandwidth 40MHz**

Trial Number:		25				Detection (Yes/No)
Number of Bursts in Trial:		13				Yes
Chirp Center Frequency:		5324				Yes
Burst	Number of Pulses	Pulse Width (Microseconds)	Chirp Width (MHz)	Pulse 1-to-2 Spacing (µsec)	Pulse 2-to-3 Spacing (µsec)	Starting Location Within Interval (µsec)
1	3	94	11	1748	1941	628071
2	2	70.8	11	1201	-	853391
3	1	56.3	11	-	-	156223
4	3	96.7	11	1163	1332	378734
5	3	90.6	11	1582	1498	601331
6	2	74.5	11	1281	-	825462
7	3	92.6	11	1669	1222	128265
8	3	89	11	1135	1380	351161
9	3	96.5	11	1822	1602	573425
10	2	70.5	11	1178	-	798431
11	3	94	11	1629	1956	100737
12	1	55.8	11	-	-	324661
13	3	87.7	11	1963	1164	546278
14						
15						
16						
17						
18						
19						
20						

Trial Number:		26				Detection (Yes/No)
Number of Bursts in Trial:		8				Yes
Chirp Center Frequency:		5326				Yes
Burst	Number of Pulses	Pulse Width (Microseconds)	Chirp Width (MHz)	Pulse 1-to-2 Spacing (µsec)	Pulse 2-to-3 Spacing (µsec)	Starting Location Within Interval (µsec)
1	2	68.6	5	1161	-	1253842
2	2	83.1	5	1315	-	119486
3	1	60.9	5	-	-	482958
4	2	77.7	5	1158	-	845641
5	2	77.4	5	1510	-	1208428
6	2	66.8	5	1323	-	74748
7	1	63.7	5	-	-	438300
8	3	91.2	5	1681	1275	800152
9						
10						
11						
12						
13						
14						
15						
16						
17						
18						
19						
20						

**DFS Radar Parameters**  
**FCC Radar Type 5**  
**Channel 62 Bandwidth 40MHz**

Trial Number:		27				Detection (Yes/No)
Number of Bursts in Trial:		17				Yes
Chirp Center Frequency:		5322				Yes
Burst	Number of Pulses	Pulse Width (Microseconds)	Chirp Width (MHz)	Pulse 1-to-2 Spacing (µsec)	Pulse 2-to-3 Spacing (µsec)	Starting Location Within Interval (µsec)
1	3	83.6	16	1195	1000	545865
2	3	89.4	16	1627	1656	14067
3	1	55.8	16	-	-	184953
4	3	90.9	16	1554	1998	353759
5	1	54.7	16	-	-	526388
6	3	97.7	16	1202	1250	694806
7	2	67.5	16	1434	-	163568
8	3	96.7	16	1469	1268	333410
9	2	68.3	16	1954	-	504006
10	2	78.3	16	1082	-	675297
11	1	55	16	-	-	142890
12	3	84.9	16	1936	1199	312479
13	2	74.6	16	1856	-	482953
14	1	63.3	16	-	-	655022
15	3	99.8	16	1515	1120	121457
16	1	63.6	16	-	-	292606
17	3	87.3	16	1051	1831	461322
18						
19						
20						

Trial Number:		28				Detection (Yes/No)
Number of Bursts in Trial:		19				Yes
Chirp Center Frequency:		5321				Yes
Burst	Number of Pulses	Pulse Width (Microseconds)	Chirp Width (MHz)	Pulse 1-to-2 Spacing (µsec)	Pulse 2-to-3 Spacing (µsec)	Starting Location Within Interval (µsec)
1	3	85.6	19	1078	1015	565136
2	2	68.6	19	1780	-	89970
3	1	54.2	19	-	-	243121
4	1	61.2	19	-	-	396034
5	3	97.1	19	1969	1100	546225
6	3	98.3	19	1699	1622	70998
7	1	62.4	19	-	-	224093
8	2	80.2	19	1769	-	376127
9	3	87.5	19	1448	1179	527806
10	3	85.8	19	1348	1472	52247
11	3	88.1	19	1124	1631	204582
12	1	65.3	19	-	-	357941
13	1	52.5	19	-	-	510977
14	1	52.3	19	-	-	33698
15	2	74.1	19	1200	-	186023
16	1	54.9	19	-	-	339327
17	2	76.2	19	1502	-	491053
18	1	60.4	19	-	-	14858
19	2	81.5	19	1103	-	167387
20						



**DFS Radar Parameters**  
**FCC Radar Type 5**  
**Channel 62 Bandwidth 40MHz**

Trial Number:		29				Detection (Yes/No)
Number of Bursts in Trial:		12				Yes
Chirp Center Frequency:		5324				Yes
Burst	Number of Pulses	Pulse Width (Microseconds)	Chirp Width (MHz)	Pulse 1-to-2 Spacing (µsec)	Pulse 2-to-3 Spacing (µsec)	Starting Location Within Interval (µsec)
1	1	50.5	10	-	-	507709
2	1	55.7	10	-	-	750249
3	3	85.8	10	1002	1967	989003
4	2	76.9	10	1474	-	235634
5	2	75.1	10	1052	-	477675
6	3	92.3	10	1486	1492	718312
7	2	78.1	10	1757	-	960895
8	3	92.2	10	1252	1713	205370
9	3	89	10	1706	1411	446940
10	2	70.9	10	1620	-	689225
11	1	63.1	10	-	-	932305
12	1	55.3	10	-	-	176231
13						
14						
15						
16						
17						
18						
19						
20						

Trial Number:		30				Detection (Yes/No)
Number of Bursts in Trial:		18				Yes
Chirp Center Frequency:		5321				Yes
Burst	Number of Pulses	Pulse Width (Microseconds)	Chirp Width (MHz)	Pulse 1-to-2 Spacing (µsec)	Pulse 2-to-3 Spacing (µsec)	Starting Location Within Interval (µsec)
1	3	83.4	17	1205	1801	277485
2	3	97.3	17	1826	1635	437880
3	3	90.4	17	1986	1674	598445
4	3	91.8	17	1151	1802	97088
5	3	98.2	17	1977	1766	257251
6	1	59.5	17	-	-	419893
7	2	80	17	1137	-	580724
8	3	86.5	17	1128	1828	77366
9	3	91.1	17	1599	1442	238032
10	3	93.5	17	1373	1087	398605
11	1	60.7	17	-	-	562025
12	2	67.2	17	1405	-	57684
13	1	61.8	17	-	-	219083
14	2	79.4	17	1667	-	379234
15	2	81.4	17	1464	-	540896
16	1	65.7	17	-	-	37916
17	2	76	17	1255	-	198794
18	2	81	17	1668	-	359754
19						
20						

**DFS Radar Parameters**  
**FCC Radar Type 1**  
**Channel 58 Bandwidth 80MHz**

Trial #	Pulse Repetition Frequency Number (1 to 23)	Pulse Repetition Frequency (Pulses Per Second)	Pulse Repetition Interval (Microseconds)	Detection (Yes / No)
1	22	1066.10	938	Yes
2	10	1432.66	698	Yes
3	6	1618.12	618	Yes
4	2	1858.74	538	Yes
5	19	1138.95	878	Yes
6	12	326.16	3066	Yes
7	7	1567.40	638	Yes
8	21	1089.32	918	Yes
9	17	1193.32	838	Yes
10	18	1165.50	858	Yes
11	15	1253.13	798	Yes
12	11	1392.76	718	Yes
13	4	1730.10	578	Yes
14	5	1672.24	598	Yes
15	3	1792.11	558	Yes
16		394.32	2536	Yes
17		1035.20	966	Yes
18		1209.19	827	Yes
19		399.84	2501	Yes
20		385.36	2595	Yes
21		897.67	1114	Yes
22		768.05	1302	Yes
23		328.41	3045	Yes
24		615.76	1624	Yes
25		347.46	2878	Yes
26		973.71	1027	Yes
27		402.41	2485	Yes
28		625.00	1600	Yes
29		853.24	1172	Yes
30		849.62	1177	Yes

**DFS Radar Parameters**  
**FCC Radar Type 2**  
**Channel 58 Bandwidth 80MHz**

Trial #	Number Pulses per Burst	Pulse Width (Microseconds)	Pulse Repetition Interval (Microseconds)	Detection (Yes / No)
1	26	3.20	179	Yes
2	23	1.10	207	Yes
3	24	2.10	230	Yes
4	29	4.80	200	Yes
5	28	3.90	214	Yes
6	26	2.90	222	Yes
7	26	3.20	204	Yes
8	25	2.50	192	Yes
9	26	3.10	164	Yes
10	23	1.20	156	Yes
11	27	3.90	210	Yes
12	29	4.60	201	Yes
13	26	3.20	162	Yes
14	25	2.20	197	Yes
15	29	4.50	163	Yes
16	26	3.00	203	Yes
17	29	5.00	168	Yes
18	25	2.40	217	Yes
19	26	2.90	191	Yes
20	25	2.30	166	Yes
21	27	3.70	150	Yes
22	25	2.20	176	Yes
23	29	4.90	195	Yes
24	26	2.90	202	Yes
25	25	2.50	178	Yes
26	23	1.10	206	Yes
27	27	3.80	155	Yes
28	29	4.70	157	Yes
29	25	2.40	224	Yes
30	28	4.20	159	Yes

**DFS Radar Parameters**  
**FCC Radar Type 3**  
**Channel 58 Bandwidth 80MHz**

Trial #	Number Pulses per Burst	Pulse Width (Microseconds)	Pulse Repetition Interval (Microseconds)	Detection (Yes / No)
1	17	8.20	355	Yes
2	16	6.10	487	Yes
3	16	7.10	344	Yes
4	18	9.80	288	Yes
5	18	8.90	230	Yes
6	17	7.90	432	Yes
7	17	8.20	207	Yes
8	17	7.50	443	Yes
9	17	8.10	439	Yes
10	16	6.20	223	Yes
11	18	8.90	208	Yes
12	18	9.60	463	Yes
13	17	8.20	441	Yes
14	16	7.20	323	Yes
15	18	9.50	297	Yes
16	17	8.00	412	Yes
17	18	10.00	324	Yes
18	17	7.40	271	Yes
19	17	7.90	349	Yes
20	16	7.30	409	Yes
21	18	8.70	373	Yes
22	16	7.20	254	Yes
23	18	9.90	274	Yes
24	17	7.90	278	Yes
25	17	7.50	317	Yes
26	16	6.10	260	Yes
27	18	8.80	211	Yes
28	18	9.70	272	Yes
29	17	7.40	264	Yes
30	18	9.20	284	Yes

**DFS Radar Parameters**  
**FCC Radar Type 4**  
**Channel 58 Bandwidth 80MHz**

Trial #	Number Pulses per Burst	Pulse Width (Microseconds)	Pulse Repetition Interval (Microseconds)	Detection (Yes / No)
1	14	16.00	355	Yes
2	12	11.30	487	Yes
3	13	13.50	344	Yes
4	16	19.40	288	Yes
5	15	17.50	230	Yes
6	14	15.30	432	Yes
7	14	15.90	207	Yes
8	13	14.30	443	Yes
9	14	15.80	439	Yes
10	12	11.50	223	Yes
11	15	17.40	208	Yes
12	16	19.00	463	Yes
13	14	16.00	441	Yes
14	13	13.80	323	Yes
15	16	18.90	297	Yes
16	14	15.50	412	Yes
17	16	19.90	324	Yes
18	13	14.10	271	Yes
19	14	15.20	349	Yes
20	13	13.80	409	Yes
21	15	17.10	373	Yes
22	13	13.80	254	Yes
23	16	19.80	274	Yes
24	14	15.30	278	Yes
25	13	14.50	317	Yes
26	12	11.30	260	Yes
27	15	17.30	211	Yes
28	16	19.20	272	Yes
29	13	14.20	264	Yes
30	15	18.20	284	Yes

**DFS Radar Parameters**  
**FCC Radar Type 5**  
**Channel 58 Bandwidth 80MHz**

Trial Number:			1			Detection (Yes/No)
Number of Bursts in Trial:			15			
Chirp Center Frequency:			5290			
Burst	Number of Pulses	Pulse Width (Microseconds)	Chirp Width (MHz)	Pulse 1-to-2 Spacing (µsec)	Pulse 2-to-3 Spacing (µsec)	Starting Location Within Interval (µsec)
1	2	77.8	13	1477	-	636185
2	1	51.9	13	-	-	32674
3	1	63.8	13	-	-	226294
4	3	96.6	13	1786	1843	417976
5	3	85.9	13	1215	1729	611152
6	2	73.7	13	1549	-	8789
7	2	77.2	13	1819	-	201917
8	2	68.4	13	1114	-	395530
9	2	76.7	13	1155	-	588564
10	1	53.2	13	-	-	783794
11	3	85.7	13	1695	1394	177933
12	3	94.3	13	1426	1935	370624
13	2	77.6	13	1671	-	564893
14	1	65.7	13	-	-	759583
15	3	93.5	13	1130	1468	154262
16						
17						
18						
19						
20						

Trial Number:			2			Detection (Yes/No)
Number of Bursts in Trial:			8			
Chirp Center Frequency:			5290			
Burst	Number of Pulses	Pulse Width (Microseconds)	Chirp Width (MHz)	Pulse 1-to-2 Spacing (µsec)	Pulse 2-to-3 Spacing (µsec)	Starting Location Within Interval (µsec)
1	2	75	5	1527	-	653020
2	3	99.4	5	1262	1257	1015643
3	2	67.4	5	1403	-	1379398
4	2	73.6	5	1041	-	245489
5	1	65.9	5	-	-	609113
6	3	83.8	5	1292	1419	970852
7	1	65.5	5	-	-	1335913
8	3	98.6	5	1796	1728	200406
9						
10						
11						
12						
13						
14						
15						
16						
17						
18						
19						
20						

**DFS Radar Parameters**  
**FCC Radar Type 5**  
**Channel 58 Bandwidth 80MHz**

Trial Number:			3			Detection (Yes/No) Yes
Number of Bursts in Trial:			11			
Chirp Center Frequency:			5290			
Burst	Number of Pulses	Pulse Width (Microseconds)	Chirp Width (MHz)	Pulse 1-to-2 Spacing ( $\mu$ sec)	Pulse 2-to-3 Spacing ( $\mu$ sec)	Starting Location Within Interval ( $\mu$ sec)
1	2	73.8	9	1538	-	409565
2	2	69.5	9	1649	-	673692
3	1	51.9	9	-	-	938562
4	3	84.6	9	1032	1271	113209
5	3	95.4	9	1903	1388	376726
6	2	68	9	1351	-	641212
7	3	89.6	9	1514	1573	903714
8	2	81.9	9	1689	-	80863
9	3	88.3	9	1330	1838	344067
10	1	53.7	9	-	-	609331
11	3	91.3	9	1106	1001	871542
12						
13						
14						
15						
16						
17						
18						
19						
20						

Trial Number:			4			Detection (Yes/No) Yes
Number of Bursts in Trial:			11			
Chirp Center Frequency:			5290			
Burst	Number of Pulses	Pulse Width (Microseconds)	Chirp Width (MHz)	Pulse 1-to-2 Spacing ( $\mu$ sec)	Pulse 2-to-3 Spacing ( $\mu$ sec)	Starting Location Within Interval ( $\mu$ sec)
1	2	68.1	19	1355	-	26541
2	1	58.7	19	-	-	171821
3	2	75.3	19	1640	-	316229
4	1	56.4	19	-	-	461864
5	3	99.7	19	1708	1159	8677
6	1	57.7	19	-	-	153995
7	1	59.5	19	-	-	299238
8	2	80	19	1369	-	443177
9	2	82	19	1197	-	587671
10	2	82.8	19	1005	-	135674
11	3	88	19	1928	1101	279928
12	3	93.2	19	1907	1223	424279
13	2	70.4	19	1360	-	570132
14	3	95.3	19	1955	1775	117439
15	2	81.9	19	1545	-	262502
16	3	98.5	19	1169	1062	406573
17	1	65	19	-	-	553328
18	3	85.4	19	1637	1425	99799
19	3	91.6	19	1445	1325	244095
20	2	67.3	19	1218	-	390012

**DFS Radar Parameters**  
**FCC Radar Type 5**  
**Channel 58 Bandwidth 80MHz**

Trial Number:			5			Detection (Yes/No)
Number of Bursts in Trial:			17			
Chirp Center Frequency:			5290			Yes
Burst	Number of Pulses	Pulse Width (Microseconds)	Chirp Width (MHz)	Pulse 1-to-2 Spacing ( $\mu$ sec)	Pulse 2-to-3 Spacing ( $\mu$ sec)	Starting Location Within Interval ( $\mu$ sec)
1	2	67.9	16	1133	-	629614
2	1	62.3	16	-	-	96856
3	1	53.3	16	-	-	267719
4	3	90	16	1153	1346	436784
5	2	77.1	16	1646	-	608289
6	3	83.9	16	1232	1459	75610
7	3	89.1	16	1384	1939	245638
8	2	81.8	16	1676	-	416355
9	1	50.3	16	-	-	588736
10	3	87.1	16	1996	1756	54571
11	2	71.3	16	1815	-	225175
12	3	97.5	16	1465	1132	394825
13	3	90.6	16	1040	1354	565361
14	3	86.3	16	1183	1792	33643
15	3	97.6	16	1073	1361	203957
16	3	84.7	16	1718	1854	373812
17	3	99.7	16	1244	1988	544060
18						
19						
20						

Trial Number:			6			Detection (Yes/No)
Number of Bursts in Trial:			14			
Chirp Center Frequency:			5290			Yes
Burst	Number of Pulses	Pulse Width (Microseconds)	Chirp Width (MHz)	Pulse 1-to-2 Spacing ( $\mu$ sec)	Pulse 2-to-3 Spacing ( $\mu$ sec)	Starting Location Within Interval ( $\mu$ sec)
1	3	92.9	12	1564	1407	15438
2	2	67.7	12	1747	-	222486
3	1	65.8	12	-	-	430731
4	1	56.3	12	-	-	637784
5	1	53.7	12	-	-	845342
6	3	83.5	12	1930	1025	196720
7	1	65.8	12	-	-	404955
8	3	85.9	12	1034	1808	610711
9	2	76.3	12	1926	-	818057
10	2	81.5	12	1714	-	171459
11	3	89.4	12	1594	1827	377969
12	1	63.4	12	-	-	586875
13	2	69.6	12	1925	-	792834
14	2	74.5	12	1846	-	146044
15						
16						
17						
18						
19						
20						



**DFS Radar Parameters**  
**FCC Radar Type 5**  
**Channel 58 Bandwidth 80MHz**

Trial Number:			7			Detection (Yes/No)
Number of Bursts in Trial:			15			
Chirp Center Frequency:			5290			
Burst	Number of Pulses	Pulse Width (Microseconds)	Chirp Width (MHz)	Pulse 1-to-2 Spacing (µsec)	Pulse 2-to-3 Spacing (µsec)	Starting Location Within Interval (µsec)
1	1	52.6	10	-	-	51446
2	3	84.1	10	1725	1529	292696
3	3	97.7	10	1868	1805	533989
4	3	97.3	10	1446	1755	775564
5	3	98.8	10	1386	1302	21542
6	2	72.2	10	1184	-	263385
7	2	67.6	10	1027	-	505581
8	2	75.7	10	1871	-	747058
9	1	60.9	10	-	-	989976
10	1	64.2	10	-	-	234024
11	2	78.8	10	1604	-	475207
12	3	87.5	10	1712	1683	715825
13						
14						
15						
16						
17						
18						
19						
20						

Trial Number:			8			Detection (Yes/No)
Number of Bursts in Trial:			12			
Chirp Center Frequency:			5290			
Burst	Number of Pulses	Pulse Width (Microseconds)	Chirp Width (MHz)	Pulse 1-to-2 Spacing (µsec)	Pulse 2-to-3 Spacing (µsec)	Starting Location Within Interval (µsec)
1	1	52.6	10	-	-	51446
2	3	84.1	10	1725	1529	292696
3	3	97.7	10	1868	1805	533989
4	3	97.3	10	1446	1755	775564
5	3	98.8	10	1386	1302	21542
6	2	72.2	10	1184	-	263385
7	2	67.6	10	1027	-	505581
8	2	75.7	10	1871	-	747058
9	1	60.9	10	-	-	989976
10	1	64.2	10	-	-	234024
11	2	78.8	10	1604	-	475207
12	3	87.5	10	1712	1683	715825
13						
14						
15						
16						
17						
18						
19						
20						

**DFS Radar Parameters**  
**FCC Radar Type 5**  
**Channel 58 Bandwidth 80MHz**

Trial Number:			9			Detection (Yes/No)
Number of Bursts in Trial:			14			
Chirp Center Frequency:			5290			
Burst	Number of Pulses	Pulse Width (Microseconds)	Chirp Width (MHz)	Pulse 1-to-2 Spacing (µsec)	Pulse 2-to-3 Spacing (µsec)	Starting Location Within Interval (µsec)
1	1	54.1	13	-	-	823112
2	1	50.7	13	-	-	174965
3	1	52.3	13	-	-	382216
4	3	99.8	13	1696	1949	587395
5	2	68.4	13	1099	-	796897
6	2	80.8	13	1505	-	149042
7	1	62.5	13	-	-	356750
8	2	74.8	13	1204	-	563824
9	1	50.8	13	-	-	772314
10	1	54	13	-	-	123796
11	1	63	13	-	-	331215
12	3	91.8	13	1270	1347	537402
13	2	79.3	13	1992	-	744805
14	1	64.3	13	-	-	98172
15						
16						
17						
18						
19						
20						

Trial Number:			10			Detection (Yes/No)
Number of Bursts in Trial:			8			
Chirp Center Frequency:			5290			
Burst	Number of Pulses	Pulse Width (Microseconds)	Chirp Width (MHz)	Pulse 1-to-2 Spacing (µsec)	Pulse 2-to-3 Spacing (µsec)	Starting Location Within Interval (µsec)
1	1	63.4	6	-	-	535615
2	1	52	6	-	-	898668
3	3	97.2	6	1605	1583	1259235
4	2	78.7	6	1743	-	127106
5	2	74.2	6	1219	-	490358
6	3	88.7	6	1934	1273	852409
7	1	54.3	6	-	-	1217152
8	3	95.4	6	1555	1791	82296
9						
10						
11						
12						
13						
14						
15						
16						
17						
18						
19						
20						

**DFS Radar Parameters**  
**FCC Radar Type 5**  
**Channel 58 Bandwidth 80MHz**

Trial Number:			11			Detection (Yes/No)
Number of Bursts in Trial:			17			
Chirp Center Frequency:			5258			
Burst	Number of Pulses	Pulse Width (Microseconds)	Chirp Width (MHz)	Pulse 1-to-2 Spacing (µsec)	Pulse 2-to-3 Spacing (µsec)	Starting Location Within Interval (µsec)
1	2	73.7	16	1497	-	209249
2	3	97.4	16	1754	1613	378386
3	3	91.7	16	1702	1462	548411
4	1	66.2	16	-	-	17733
5	2	70.8	16	1821	-	187952
6	1	52.3	16	-	-	359277
7	2	78.9	16	1984	-	528886
8	2	70.9	16	1358	-	700166
9	2	75.6	16	1430	-	167197
10	1	59.1	16	-	-	338262
11	2	77	16	1304	-	508324
12	2	67.9	16	1083	-	678689
13	2	81.2	16	1932	-	146031
14	2	78.7	16	1121	-	316923
15	1	63.3	16	-	-	488056
16	2	68.9	16	1423	-	657326
17	1	59.3	16	-	-	125509
18						
19						
20						

Trial Number:			12			Detection (Yes/No)
Number of Bursts in Trial:			19			
Chirp Center Frequency:			5260			
Burst	Number of Pulses	Pulse Width (Microseconds)	Chirp Width (MHz)	Pulse 1-to-2 Spacing (µsec)	Pulse 2-to-3 Spacing (µsec)	Starting Location Within Interval (µsec)
1	3	98.9	19	1680	1488	263736
2	2	82.3	19	1855	-	416459
3	3	86.7	19	1400	1919	567902
4	3	89.7	19	1068	1282	92979
5	3	98.6	19	1194	1461	245155
6	2	71.1	19	1789	-	397609
7	1	55.9	19	-	-	551431
8	2	67.9	19	1372	-	74413
9	3	84.4	19	1107	1443	226559
10	1	58.8	19	-	-	380056
11	1	65.6	19	-	-	533408
12	2	78.5	19	1704	-	55547
13	2	82.3	19	1686	-	207876
14	3	90.1	19	1071	1266	359771
15	3	90.2	19	1089	1950	511297
16	2	83.1	19	1406	-	36803
17	1	58.8	19	-	-	189652
18	2	77	19	1657	-	341809
19	1	55	19	-	-	495737
20						

**DFS Radar Parameters**  
**FCC Radar Type 5**  
**Channel 58 Bandwidth 80MHz**

Trial Number:			13			Detection (Yes/No)
Number of Bursts in Trial:			15			
Chirp Center Frequency:			5257			
Burst	Number of Pulses	Pulse Width (Microseconds)	Chirp Width (MHz)	Pulse 1-to-2 Spacing ( $\mu$ sec)	Pulse 2-to-3 Spacing ( $\mu$ sec)	Starting Location Within Interval ( $\mu$ sec)
1	1	58.1	13	-	-	22911
2	1	52.1	13	-	-	216473
3	1	59.9	13	-	-	410004
4	1	60.2	13	-	-	603671
5	3	95.9	13	1906	1608	794160
6	2	79.9	13	1859	-	192251
7	2	78.5	13	1917	-	385590
8	1	53.8	13	-	-	579862
9	1	64.7	13	-	-	773423
10	1	61.4	13	-	-	168898
11	2	83.2	13	1858	-	361606
12	3	84.7	13	1677	1638	553866
13	3	88.7	13	1528	1058	747241
14	2	78.3	13	1951	-	144710
15	2	69.3	13	1717	-	337856
16						
17						
18						
19						
20						

Trial Number:			14			Detection (Yes/No)
Number of Bursts in Trial:			12			
Chirp Center Frequency:			5256			
Burst	Number of Pulses	Pulse Width (Microseconds)	Chirp Width (MHz)	Pulse 1-to-2 Spacing ( $\mu$ sec)	Pulse 2-to-3 Spacing ( $\mu$ sec)	Starting Location Within Interval ( $\mu$ sec)
1	2	75.3	10	1612	-	664275
2	1	56.3	10	-	-	907886
3	2	67.7	10	1185	-	151316
4	1	55.6	10	-	-	393746
5	2	75.2	10	1267	-	635093
6	2	76.3	10	1305	-	876993
7	3	85.7	10	1362	1924	121278
8	3	98.4	10	1550	1249	362696
9	3	86.4	10	1439	1046	604342
10	3	93.6	10	1031	1452	846453
11	1	63.3	10	-	-	91871
12	3	92.4	10	1673	1322	333050
13						
14						
15						
16						
17						
18						
19						
20						

**DFS Radar Parameters**  
**FCC Radar Type 5**  
**Channel 58 Bandwidth 80MHz**

Trial Number:		15				Detection (Yes/No)
Number of Bursts in Trial:		19				
Chirp Center Frequency:		5259				
Burst	Number of Pulses	Pulse Width (Microseconds )	Chirp Width (MHz)	Pulse 1-to-2 Spacing (µsec)	Pulse 2-to-3 Spacing (µsec)	Starting Location Within Interval (µsec)
1	3	93.3	18	1912	1535	361323
2	2	69.1	18	1794	-	515261
3	3	86.9	18	1152	1148	39025
4	3	84.9	18	1948	1118	190900
5	2	72.3	18	1916	-	343941
6	1	51.7	18	-	-	497624
7	1	58.3	18	-	-	20319
8	1	60.8	18	-	-	172999
9	1	57.1	18	-	-	325872
10	3	88.9	18	1964	1489	475841
11	2	72	18	1297	-	1489
12	3	90.9	18	1566	1370	153647
13	1	59.8	18	-	-	307096
14	2	70	18	1291	-	458804
15	2	67.2	18	1881	-	610798
16	3	91.2	18	1832	1661	134759
17	1	56.5	18	-	-	288306
18	1	51.2	18	-	-	441296
19	2	74.1	18	1245	-	592780
20						

Trial Number:		16				Detection (Yes/No)
Number of Bursts in Trial:		14				
Chirp Center Frequency:		5257				
Burst	Number of Pulses	Pulse Width (Microseconds )	Chirp Width (MHz)	Pulse 1-to-2 Spacing (µsec)	Pulse 2-to-3 Spacing (µsec)	Starting Location Within Interval (µsec)
1	2	76.9	12	1140	-	158286
2	1	50.2	12	-	-	366024
3	1	62.9	12	-	-	573452
4	1	64.7	12	-	-	780619
5	3	83.8	12	1097	1621	132455
6	1	65.4	12	-	-	340207
7	1	53.2	12	-	-	548208
8	1	51.7	12	-	-	755333
9	2	78.7	12	1168	-	107117
10	2	72.4	12	1343	-	314500
11	1	53.8	12	-	-	522447
12	2	73.6	12	1553	-	728517
13	2	66.7	12	1122	-	81611
14	2	82.5	12	1019	-	288948
15						
16						
17						
18						
19						
20						

**DFS Radar Parameters**  
**FCC Radar Type 5**  
**Channel 58 Bandwidth 80MHz**

Trial Number:			17			Detection (Yes/No)
Number of Bursts in Trial:			20			
Chirp Center Frequency:			5260			
Burst	Number of Pulses	Pulse Width (Microseconds)	Chirp Width (MHz)	Pulse 1-to-2 Spacing (µsec)	Pulse 2-to-3 Spacing (µsec)	Starting Location Within Interval (µsec)
1	3	87.6	20	1055	1840	345766
2	3	85.2	20	1541	1408	490019
3	3	84.8	20	1889	1463	39073
4	2	77.9	20	1460	-	183923
5	2	76.5	20	1485	-	328777
6	1	60.9	20	-	-	474728
7	2	83	20	1010	-	21394
8	2	80.4	20	1752	-	165992
9	2	67.5	20	1181	-	310973
10	1	62.1	20	-	-	456884
11	3	86.4	20	1966	1263	3515
12	3	84.3	20	1188	1788	147928
13	2	76.9	20	1537	-	293225
14	3	95.8	20	1298	1844	436922
15	1	55.2	20	-	-	584015
16	1	59	20	-	-	130832
17	3	94.5	20	1700	1283	274684
18	3	91.9	20	1978	1165	418579
19	3	85.2	20	1551	1189	563464
20	2	69.5	20	1224	-	112787

Trial Number:			18			Detection (Yes/No)
Number of Bursts in Trial:			12			
Chirp Center Frequency:			5256			
Burst	Number of Pulses	Pulse Width (Microseconds)	Chirp Width (MHz)	Pulse 1-to-2 Spacing (µsec)	Pulse 2-to-3 Spacing (µsec)	Starting Location Within Interval (µsec)
1	3	86.4	10	1918	1455	429224
2	3	92.2	10	1719	1895	670241
3	2	80.4	10	1899	-	912880
4	1	54.3	10	-	-	158603
5	1	53.1	10	-	-	400824
6	2	69.4	10	1546	-	641915
7	2	69.1	10	1639	-	883823
8	3	100	10	1438	1595	128373
9	2	79.6	10	1705	-	370379
10	3	88.4	10	1579	1623	611194
11	1	53.3	10	-	-	855665
12	1	65.3	10	-	-	98897
13						
14						
15						
16						
17						
18						
19						
20						

**DFS Radar Parameters**  
**FCC Radar Type 5**  
**Channel 58 Bandwidth 80MHz**

Trial Number:		19				Detection (Yes/No)
Number of Bursts in Trial:		14				
Chirp Center Frequency:		5257				
Burst	Number of Pulses	Pulse Width (Microseconds)	Chirp Width (MHz)	Pulse 1-to-2 Spacing (µsec)	Pulse 2-to-3 Spacing (µsec)	Starting Location Within Interval (µsec)
1	1	55.3	12	-	-	292143
2	1	58.3	12	-	-	499633
3	2	72.3	12	1039.000	-	706377
4	3	84.8	12	1761.000	1721.000	58989
5	2	82.5	12	1431.000	-	266161
6	1	63.3	12	-	-	474469
7	2	80	12	1913.000	-	680544
8	3	90.3	12	1853.000	1123.000	33519
9	3	91.1	12	1783.000	1172.000	240319
10	3	96.6	12	1036.000	1385.000	447400
11	2	82.7	12	1990.000	-	654516
12	1	50.7	12	-	-	8083
13	2	78.4	12	1109.000	-	215435
14	3	99.5	12	1965.000	1869.000	421325
15						
16						
17						
18						
19						
20						

Trial Number:		20				Detection (Yes/No)
Number of Bursts in Trial:		12				
Chirp Center Frequency:		5256				
Burst	Number of Pulses	Pulse Width (Microseconds)	Chirp Width (MHz)	Pulse 1-to-2 Spacing (µsec)	Pulse 2-to-3 Spacing (µsec)	Starting Location Within Interval (µsec)
1	3	88.6	10	1067	1927	733725
2	1	57.4	10	-	-	977882
3	3	96.6	10	1658	1324	221197
4	2	69.7	10	1945	-	462915
5	2	77.9	10	1317	-	705071
6	1	62	10	-	-	947923
7	3	88.4	10	1077	1366	191373
8	3	97.3	10	1896	1367	432561
9	3	96.2	10	1787	1672	674004
10	3	95.4	10	1892	1414	915842
11	1	54.8	10	-	-	162176
12	2	80.4	10	1436	-	403553
13						
14						
15						
16						
17						
18						
19						
20						

**DFS Radar Parameters**  
**FCC Radar Type 5**  
**Channel 58 Bandwidth 80MHz**

Trial Number:			21			Detection (Yes/No)
Number of Bursts in Trial:			16			
Chirp Center Frequency:			5322			
Burst	Number of Pulses	Pulse Width (Microseconds)	Chirp Width (MHz)	Pulse 1-to-2 Spacing (µsec)	Pulse 2-to-3 Spacing (µsec)	Starting Location Within Interval (µsec)
1	2	74.7	15	1611	-	483470
2	1	57.1	15	-	-	666072
3	3	91.9	15	1475	1276	98810
4	2	83.1	15	1772	-	279914
5	1	50.7	15	-	-	462536
6	2	79.2	15	1600	-	642324
7	1	58.7	15	-	-	76831
8	2	71	15	1567	-	257785
9	2	79	15	1960	-	438554
10	2	68.5	15	1428	-	620397
11	2	73.5	15	1352	-	54310
12	2	70.5	15	1115	-	235506
13	2	76.6	15	1300	-	417036
14	2	81.2	15	1675	-	597974
15	1	61.8	15	-	-	32086
16	3	94.9	15	1206	1860	212751
17						
18						
19						
20						

Trial Number:			22			Detection (Yes/No)
Number of Bursts in Trial:			12			
Chirp Center Frequency:			5324			
Burst	Number of Pulses	Pulse Width (Microseconds)	Chirp Width (MHz)	Pulse 1-to-2 Spacing (µsec)	Pulse 2-to-3 Spacing (µsec)	Starting Location Within Interval (µsec)
1	2	78.5	9	1698	-	526149
2	3	89.8	9	1962	1167	767135
3	1	59.4	9	-	-	12955
4	2	79.6	9	1890	-	254612
5	2	76	9	1811	-	496588
6	1	53.6	9	-	-	739728
7	2	80.9	9	1053	-	980872
8	1	61.6	9	-	-	225249
9	1	53.4	9	-	-	467279
10	1	59.9	9	-	-	709720
11	1	60.4	9	-	-	951847
12	3	91.4	9	1726	1227	194839
13						
14						
15						
16						
17						
18						
19						
20						



**DFS Radar Parameters**  
**FCC Radar Type 5**  
**Channel 58 Bandwidth 80MHz**

Trial Number:		23				Detection (Yes/No)
Number of Bursts in Trial:		20				
Chirp Center Frequency:		5320				
Burst	Number of Pulses	Pulse Width (Microseconds)	Chirp Width (MHz)	Pulse 1-to-2 Spacing (µsec)	Pulse 2-to-3 Spacing (µsec)	Starting Location Within Interval (µsec)
1	2	77	20	1363	-	261858
2	1	58.1	20	-	-	407646
3	1	62.1	20	-	-	552319
4	2	76.9	20	1236	-	99107
5	2	80	20	1852	-	243514
6	1	52	20	-	-	389464
7	3	88.6	20	1995	1905	531093
8	2	72.9	20	1387	-	81159
9	3	98.5	20	1746	1389	225245
10	1	57.9	20	-	-	371906
11	3	95.9	20	1870	1066	514197
12	1	53.5	20	-	-	63561
13	3	92	20	1654	1458	207510
14	1	57.3	20	-	-	353638
15	2	70.5	20	1586	-	497515
16	2	70	20	1664	-	45553
17	3	84	20	1630	1176	189821
18	2	76.1	20	1057	-	335330
19	3	93.2	20	1018	1340	478825
20	3	96.8	20	1614	1817	27594

Trial Number:		24				Detection (Yes/No)
Number of Bursts in Trial:		14				
Chirp Center Frequency:		5323				
Burst	Number of Pulses	Pulse Width (Microseconds)	Chirp Width (MHz)	Pulse 1-to-2 Spacing (µsec)	Pulse 2-to-3 Spacing (µsec)	Starting Location Within Interval (µsec)
1	1	50.1	12	-	-	247117
2	3	93.5	12	1081	1413	453362
3	2	68.8	12	1577	-	660875
4	1	56.3	12	-	-	14140
5	3	86	12	1108	1987	220734
6	2	75.2	12	1536	-	428367
7	1	54.4	12	-	-	636681
8	2	71.1	12	1243	-	843157
9	2	76.2	12	1770	-	195585
10	2	80.2	12	1209	-	403231
11	2	79.7	12	1214	-	610202
12	3	90.9	12	1862	1601	815229
13	2	68.7	12	1441	-	170267
14	2	67.4	12	1313	-	377306
15						
16						
17						
18						
19						
20						

**DFS Radar Parameters**  
**FCC Radar Type 5**  
**Channel 58 Bandwidth 80MHz**

Trial Number:			25			Detection (Yes/No)
Number of Bursts in Trial:			13			
Chirp Center Frequency:			5324			
Burst	Number of Pulses	Pulse Width (Microseconds)	Chirp Width (MHz)	Pulse 1-to-2 Spacing (µsec)	Pulse 2-to-3 Spacing (µsec)	Starting Location Within Interval (µsec)
1	3	94	11	1748	1941	628071
2	2	70.8	11	1201	-	853391
3	1	56.3	11	-	-	156223
4	3	96.7	11	1163	1332	378734
5	3	90.6	11	1582	1498	601331
6	2	74.5	11	1281	-	825462
7	3	92.6	11	1669	1222	128265
8	3	89	11	1135	1380	351161
9	3	96.5	11	1822	1602	573425
10	2	70.5	11	1178	-	798431
11	3	94	11	1629	1956	100737
12	1	55.8	11	-	-	324661
13	3	87.7	11	1963	1164	546278
14						
15						
16						
17						
18						
19						
20						

Trial Number:			26			Detection (Yes/No)
Number of Bursts in Trial:			8			
Chirp Center Frequency:			5326			
Burst	Number of Pulses	Pulse Width (Microseconds)	Chirp Width (MHz)	Pulse 1-to-2 Spacing (µsec)	Pulse 2-to-3 Spacing (µsec)	Starting Location Within Interval (µsec)
1	2	68.6	5	1161	-	1253842
2	2	83.1	5	1315	-	119486
3	1	60.9	5	-	-	482958
4	2	77.7	5	1158	-	845641
5	2	77.4	5	1510	-	1208428
6	2	66.8	5	1323	-	74748
7	1	63.7	5	-	-	438300
8	3	91.2	5	1681	1275	800152
9						
10						
11						
12						
13						
14						
15						
16						
17						
18						
19						
20						

**DFS Radar Parameters**  
**FCC Radar Type 5**  
**Channel 58 Bandwidth 80MHz**

Trial Number:		27				Detection (Yes/No)
Number of Bursts in Trial:		17				
Chirp Center Frequency:		5322				
Burst	Number of Pulses	Pulse Width (Microseconds )	Chirp Width (MHz)	Pulse 1-to-2 Spacing (µsec)	Pulse 2-to-3 Spacing (µsec)	Starting Location Within Interval (µsec)
1	3	83.6	16	1195	1000	545865
2	3	89.4	16	1627	1656	14067
3	1	55.8	16	-	-	184953
4	3	90.9	16	1554	1998	353759
5	1	54.7	16	-	-	526388
6	3	97.7	16	1202	1250	694806
7	2	67.5	16	1434	-	163568
8	3	96.7	16	1469	1268	333410
9	2	68.3	16	1954	-	504006
10	2	78.3	16	1082	-	675297
11	1	55	16	-	-	142890
12	3	84.9	16	1936	1199	312479
13	2	74.6	16	1856	-	482953
14	1	63.3	16	-	-	655022
15	3	99.8	16	1515	1120	121457
16	1	63.6	16	-	-	292606
17	3	87.3	16	1051	1831	461322
18						
19						
20						

Trial Number:		28				Detection (Yes/No)
Number of Bursts in Trial:		19				
Chirp Center Frequency:		5320				
Burst	Number of Pulses	Pulse Width (Microseconds )	Chirp Width (MHz)	Pulse 1-to-2 Spacing (µsec)	Pulse 2-to-3 Spacing (µsec)	Starting Location Within Interval (µsec)
1	3	85.6	19	1078	1015	565136
2	2	68.6	19	1780	-	89970
3	1	54.2	19	-	-	243121
4	1	61.2	19	-	-	396034
5	3	97.1	19	1969	1100	546225
6	3	98.3	19	1699	1622	70998
7	1	62.4	19	-	-	224093
8	2	80.2	19	1769	-	376127
9	3	87.5	19	1448	1179	527806
10	3	85.8	19	1348	1472	52247
11	3	88.1	19	1124	1631	204582
12	1	65.3	19	-	-	357941
13	1	52.5	19	-	-	510977
14	1	52.3	19	-	-	33698
15	2	74.1	19	1200	-	186023
16	1	54.9	19	-	-	339327
17	2	76.2	19	1502	-	491053
18	1	60.4	19	-	-	14858
19	2	81.5	19	1103	-	167387
20						

**DFS Radar Parameters**  
**FCC Radar Type 5**  
**Channel 58 Bandwidth 80MHz**

Trial Number:			29			Detection (Yes/No)
Number of Bursts in Trial:			12			
Chirp Center Frequency:			5324			
Burst	Number of Pulses	Pulse Width (Microseconds)	Chirp Width (MHz)	Pulse 1-to-2 Spacing (µsec)	Pulse 2-to-3 Spacing (µsec)	Starting Location Within Interval (µsec)
1	1	50.5	10	-	-	507709
2	1	55.7	10	-	-	750249
3	3	85.8	10	1002	1967	989003
4	2	76.9	10	1474	-	235634
5	2	75.1	10	1052	-	477675
6	3	92.3	10	1486	1492	718312
7	2	78.1	10	1757	-	960895
8	3	92.2	10	1252	1713	205370
9	3	89	10	1706	1411	446940
10	2	70.9	10	1620	-	689225
11	1	63.1	10	-	-	932305
12	1	55.3	10	-	-	176231
13						
14						
15						
16						
17						
18						
19						
20						

Trial Number:			30			Detection (Yes/No)
Number of Bursts in Trial:			18			
Chirp Center Frequency:			5321			
Burst	Number of Pulses	Pulse Width (Microseconds)	Chirp Width (MHz)	Pulse 1-to-2 Spacing (µsec)	Pulse 2-to-3 Spacing (µsec)	Starting Location Within Interval (µsec)
1	3	83.4	17	1205	1801	277485
2	3	97.3	17	1826	1635	437880
3	3	90.4	17	1986	1674	598445
4	3	91.8	17	1151	1802	97088
5	3	98.2	17	1977	1766	257251
6	1	59.5	17	-	-	419893
7	2	80	17	1137	-	580724
8	3	86.5	17	1128	1828	77366
9	3	91.1	17	1599	1442	238032
10	3	93.5	17	1373	1087	398605
11	1	60.7	17	-	-	562025
12	2	67.2	17	1405	-	57684
13	1	61.8	17	-	-	219083
14	2	79.4	17	1667	-	379234
15	2	81.4	17	1464	-	540896
16	1	65.7	17	-	-	37916
17	2	76	17	1255	-	198794
18	2	81	17	1668	-	359754
19						
20						

**DFS Radar Parameters**  
**FCC Radar Type 1**  
**Channel 100 Bandwidth 20MHz**

Trial #	Pulse Repetition Frequency Number (1 to 23)	Pulse Repetition Frequency (Pulses Per Second)	Pulse Repetition Interval (Microseconds)	Detection (Yes / No)
1	22	1066.10	938	Yes
2	10	1432.66	698	Yes
3	6	1618.12	618	Yes
4	2	1858.74	538	Yes
5	19	1138.95	878	Yes
6	12	326.16	3066	Yes
7	7	1567.40	638	Yes
8	21	1089.32	918	Yes
9	17	1193.32	838	Yes
10	18	1165.50	858	Yes
11	15	1253.13	798	Yes
12	11	1392.76	718	Yes
13	4	1730.10	578	Yes
14	5	1672.24	598	Yes
15	3	1792.11	558	Yes
16		394.32	2536	Yes
17		1035.20	966	Yes
18		1209.19	827	Yes
19		399.84	2501	Yes
20		385.36	2595	Yes
21		897.67	1114	Yes
22		768.05	1302	Yes
23		328.41	3045	Yes
24		615.76	1624	Yes
25		347.46	2878	Yes
26		973.71	1027	Yes
27		402.41	2485	Yes
28		625.00	1600	Yes
29		853.24	1172	Yes
30		849.62	1177	Yes

**DFS Radar Parameters**  
**FCC Radar Type 2**  
**Channel 100 Bandwidth 20MHz**

Trial #	Number Pulses per Burst	Pulse Width (Microseconds)	Pulse Repetition Interval (Microseconds)	Detection (Yes / No)
1	26	3.20	179	Yes
2	23	1.10	207	Yes
3	24	2.10	230	Yes
4	29	4.80	200	Yes
5	28	3.90	214	Yes
6	26	2.90	222	Yes
7	26	3.20	204	Yes
8	25	2.50	192	Yes
9	26	3.10	164	Yes
10	23	1.20	156	Yes
11	27	3.90	210	Yes
12	29	4.60	201	Yes
13	26	3.20	162	Yes
14	25	2.20	197	Yes
15	29	4.50	163	Yes
16	26	3.00	203	Yes
17	29	5.00	168	Yes
18	25	2.40	217	Yes
19	26	2.90	191	Yes
20	25	2.30	166	Yes
21	27	3.70	150	Yes
22	25	2.20	176	Yes
23	29	4.90	195	Yes
24	26	2.90	202	Yes
25	25	2.50	178	Yes
26	23	1.10	206	Yes
27	27	3.80	155	Yes
28	29	4.70	157	Yes
29	25	2.40	224	Yes
30	28	4.20	159	Yes

**DFS Radar Parameters**  
**FCC Radar Type 3**  
**Channel 100 Bandwidth 20MHz**

Trial #	Number Pulses per Burst	Pulse Width (Microseconds)	Pulse Repetition Interval (Microseconds)	Detection (Yes / No)
1	17	8.20	355	Yes
2	16	6.10	487	Yes
3	16	7.10	344	Yes
4	18	9.80	288	Yes
5	18	8.90	230	Yes
6	17	7.90	432	Yes
7	17	8.20	207	Yes
8	17	7.50	443	Yes
9	17	8.10	439	Yes
10	16	6.20	223	Yes
11	18	8.90	208	Yes
12	18	9.60	463	Yes
13	17	8.20	441	Yes
14	16	7.20	323	Yes
15	18	9.50	297	Yes
16	17	8.00	412	Yes
17	18	10.00	324	Yes
18	17	7.40	271	Yes
19	17	7.90	349	Yes
20	16	7.30	409	Yes
21	18	8.70	373	Yes
22	16	7.20	254	Yes
23	18	9.90	274	Yes
24	17	7.90	278	Yes
25	17	7.50	317	Yes
26	16	6.10	260	Yes
27	18	8.80	211	Yes
28	18	9.70	272	Yes
29	17	7.40	264	Yes
30	18	9.20	284	Yes

**DFS Radar Parameters**  
**FCC Radar Type 4**  
**Channel 100 Bandwidth 20MHz**

Trial #	Number Pulses per Burst	Pulse Width (Microseconds)	Pulse Repetition Interval (Microseconds)	Detection (Yes / No)
1	14	16.00	355	Yes
2	12	11.30	487	Yes
3	13	13.50	344	Yes
4	16	19.40	288	Yes
5	15	17.50	230	Yes
6	14	15.30	432	Yes
7	14	15.90	207	Yes
8	13	14.30	443	Yes
9	14	15.80	439	Yes
10	12	11.50	223	Yes
11	15	17.40	208	Yes
12	16	19.00	463	Yes
13	14	16.00	441	Yes
14	13	13.80	323	Yes
15	16	18.90	297	Yes
16	14	15.50	412	Yes
17	16	19.90	324	Yes
18	13	14.10	271	Yes
19	14	15.20	349	Yes
20	13	13.80	409	Yes
21	15	17.10	373	Yes
22	13	13.80	254	Yes
23	16	19.80	274	Yes
24	14	15.30	278	Yes
25	13	14.50	317	Yes
26	12	11.30	260	Yes
27	15	17.30	211	Yes
28	16	19.20	272	Yes
29	13	14.20	264	Yes
30	15	18.20	284	Yes



**DFS Radar Parameters**  
**FCC Radar Type 5**  
**Channel 100 Bandwidth 20MHz**

Trial Number:			1			Detection (Yes/No)
Number of Bursts in Trial:			15			
Chirp Center Frequency:			5500			
Burst	Number of Pulses	Pulse Width (Microseconds)	Chirp Width (MHz)	Pulse 1-to-2 Spacing (µsec)	Pulse 2-to-3 Spacing (µsec)	Starting Location Within Interval (µsec)
1	2	77.8	13	1477	-	636185
2	1	51.9	13	-	-	32674
3	1	63.8	13	-	-	226294
4	3	96.6	13	1786	1843	417976
5	3	85.9	13	1215	1729	611152
6	2	73.7	13	1549	-	8789
7	2	77.2	13	1819	-	201917
8	2	68.4	13	1114	-	395530
9	2	76.7	13	1155	-	588564
10	1	53.2	13	-	-	783794
11	3	85.7	13	1695	1394	177933
12	3	94.3	13	1426	1935	370624
13	2	77.6	13	1671	-	564893
14	1	65.7	13	-	-	759583
15	3	93.5	13	1130	1468	154262
16						
17						
18						
19						
20						

Trial Number:			2			Detection (Yes/No)
Number of Bursts in Trial:			8			
Chirp Center Frequency:			5500			
Burst	Number of Pulses	Pulse Width (Microseconds)	Chirp Width (MHz)	Pulse 1-to-2 Spacing (µsec)	Pulse 2-to-3 Spacing (µsec)	Starting Location Within Interval (µsec)
1	2	75	5	1527	-	653020
2	3	99.4	5	1262	1257	1015643
3	2	67.4	5	1403	-	1379398
4	2	73.6	5	1041	-	245489
5	1	65.9	5	-	-	609113
6	3	83.8	5	1292	1419	970852
7	1	65.5	5	-	-	1335913
8	3	98.6	5	1796	1728	200406
9						
10						
11						
12						
13						
14						
15						
16						
17						
18						
19						
20						

**DFS Radar Parameters**  
**FCC Radar Type 5**  
**Channel 100 Bandwidth 20MHz**

Trial Number:			3			Detection (Yes/No) Yes
Number of Bursts in Trial:			11			
Chirp Center Frequency:			5500			
Burst	Number of Pulses	Pulse Width (Microseconds)	Chirp Width (MHz)	Pulse 1-to-2 Spacing (µsec)	Pulse 2-to-3 Spacing (µsec)	Starting Location Within Interval (µsec)
1	2	73.8	9	1538	-	409565
2	2	69.5	9	1649	-	673692
3	1	51.9	9	-	-	938562
4	3	84.6	9	1032	1271	113209
5	3	95.4	9	1903	1388	376726
6	2	68	9	1351	-	641212
7	3	89.6	9	1514	1573	903714
8	2	81.9	9	1689	-	80863
9	3	88.3	9	1330	1838	344067
10	1	53.7	9	-	-	609331
11	3	91.3	9	1106	1001	871542
12						
13						
14						
15						
16						
17						
18						
19						
20						

Trial Number:			4			Detection (Yes/No) Yes
Number of Bursts in Trial:			11			
Chirp Center Frequency:			5500			
Burst	Number of Pulses	Pulse Width (Microseconds)	Chirp Width (MHz)	Pulse 1-to-2 Spacing (µsec)	Pulse 2-to-3 Spacing (µsec)	Starting Location Within Interval (µsec)
1	2	68.1	19	1355	-	26541
2	1	58.7	19	-	-	171821
3	2	75.3	19	1640	-	316229
4	1	56.4	19	-	-	461864
5	3	99.7	19	1708	1159	8677
6	1	57.7	19	-	-	153995
7	1	59.5	19	-	-	299238
8	2	80	19	1369	-	443177
9	2	82	19	1197	-	587671
10	2	82.8	19	1005	-	135674
11	3	88	19	1928	1101	279928
12	3	93.2	19	1907	1223	424279
13	2	70.4	19	1360	-	570132
14	3	95.3	19	1955	1775	117439
15	2	81.9	19	1545	-	262502
16	3	98.5	19	1169	1062	406573
17	1	65	19	-	-	553328
18	3	85.4	19	1637	1425	99799
19	3	91.6	19	1445	1325	244095
20	2	67.3	19	1218	-	390012

**DFS Radar Parameters**  
**FCC Radar Type 5**  
**Channel 100 Bandwidth 20MHz**

Trial Number:			5			Detection (Yes/No)
Number of Bursts in Trial:			17			
Chirp Center Frequency:			5500			Yes
Burst	Number of Pulses	Pulse Width (Microseconds)	Chirp Width (MHz)	Pulse 1-to-2 Spacing (µsec)	Pulse 2-to-3 Spacing (µsec)	Starting Location Within Interval (µsec)
1	2	67.9	16	1133	-	629614
2	1	62.3	16	-	-	96856
3	1	53.3	16	-	-	267719
4	3	90	16	1153	1346	436784
5	2	77.1	16	1646	-	608289
6	3	83.9	16	1232	1459	75610
7	3	89.1	16	1384	1939	245638
8	2	81.8	16	1676	-	416355
9	1	50.3	16	-	-	588736
10	3	87.1	16	1996	1756	54571
11	2	71.3	16	1815	-	225175
12	3	97.5	16	1465	1132	394825
13	3	90.6	16	1040	1354	565361
14	3	86.3	16	1183	1792	33643
15	3	97.6	16	1073	1361	203957
16	3	84.7	16	1718	1854	373812
17	3	99.7	16	1244	1988	544060
18						
19						
20						

Trial Number:			6			Detection (Yes/No)
Number of Bursts in Trial:			14			
Chirp Center Frequency:			5500			Yes
Burst	Number of Pulses	Pulse Width (Microseconds)	Chirp Width (MHz)	Pulse 1-to-2 Spacing (µsec)	Pulse 2-to-3 Spacing (µsec)	Starting Location Within Interval (µsec)
1	3	92.9	12	1564	1407	15438
2	2	67.7	12	1747	-	222486
3	1	65.8	12	-	-	430731
4	1	56.3	12	-	-	637784
5	1	53.7	12	-	-	845342
6	3	83.5	12	1930	1025	196720
7	1	65.8	12	-	-	404955
8	3	85.9	12	1034	1808	610711
9	2	76.3	12	1926	-	818057
10	2	81.5	12	1714	-	171459
11	3	89.4	12	1594	1827	377969
12	1	63.4	12	-	-	586875
13	2	69.6	12	1925	-	792834
14	2	74.5	12	1846	-	146044
15						
16						
17						
18						
19						
20						

**DFS Radar Parameters**  
**FCC Radar Type 5**  
**Channel 100 Bandwidth 20MHz**

Trial Number:			7			Detection (Yes/No)
Number of Bursts in Trial:			15			
Chirp Center Frequency:			5500			
Burst	Number of Pulses	Pulse Width (Microseconds)	Chirp Width (MHz)	Pulse 1-to-2 Spacing (µsec)	Pulse 2-to-3 Spacing (µsec)	Starting Location Within Interval (µsec)
1	1	52.6	10	-	-	51446
2	3	84.1	10	1725	1529	292696
3	3	97.7	10	1868	1805	533989
4	3	97.3	10	1446	1755	775564
5	3	98.8	10	1386	1302	21542
6	2	72.2	10	1184	-	263385
7	2	67.6	10	1027	-	505581
8	2	75.7	10	1871	-	747058
9	1	60.9	10	-	-	989976
10	1	64.2	10	-	-	234024
11	2	78.8	10	1604	-	475207
12	3	87.5	10	1712	1683	715825
13						
14						
15						
16						
17						
18						
19						
20						

Trial Number:			8			Detection (Yes/No)
Number of Bursts in Trial:			12			
Chirp Center Frequency:			5500			
Burst	Number of Pulses	Pulse Width (Microseconds)	Chirp Width (MHz)	Pulse 1-to-2 Spacing (µsec)	Pulse 2-to-3 Spacing (µsec)	Starting Location Within Interval (µsec)
1	1	52.6	10	-	-	51446
2	3	84.1	10	1725	1529	292696
3	3	97.7	10	1868	1805	533989
4	3	97.3	10	1446	1755	775564
5	3	98.8	10	1386	1302	21542
6	2	72.2	10	1184	-	263385
7	2	67.6	10	1027	-	505581
8	2	75.7	10	1871	-	747058
9	1	60.9	10	-	-	989976
10	1	64.2	10	-	-	234024
11	2	78.8	10	1604	-	475207
12	3	87.5	10	1712	1683	715825
13						
14						
15						
16						
17						
18						
19						
20						

**DFS Radar Parameters**  
**FCC Radar Type 5**  
**Channel 100 Bandwidth 20MHz**

Trial Number:			9			Detection (Yes/No)
Number of Bursts in Trial:			14			
Chirp Center Frequency:			5500			
Burst	Number of Pulses	Pulse Width (Microseconds)	Chirp Width (MHz)	Pulse 1-to-2 Spacing (µsec)	Pulse 2-to-3 Spacing (µsec)	Starting Location Within Interval (µsec)
1	1	54.1	13	-	-	823112
2	1	50.7	13	-	-	174965
3	1	52.3	13	-	-	382216
4	3	99.8	13	1696	1949	587395
5	2	68.4	13	1099	-	796897
6	2	80.8	13	1505	-	149042
7	1	62.5	13	-	-	356750
8	2	74.8	13	1204	-	563824
9	1	50.8	13	-	-	772314
10	1	54	13	-	-	123796
11	1	63	13	-	-	331215
12	3	91.8	13	1270	1347	537402
13	2	79.3	13	1992	-	744805
14	1	64.3	13	-	-	98172
15						
16						
17						
18						
19						
20						

Trial Number:			10			Detection (Yes/No)
Number of Bursts in Trial:			8			
Chirp Center Frequency:			5500			
Burst	Number of Pulses	Pulse Width (Microseconds)	Chirp Width (MHz)	Pulse 1-to-2 Spacing (µsec)	Pulse 2-to-3 Spacing (µsec)	Starting Location Within Interval (µsec)
1	1	63.4	6	-	-	535615
2	1	52	6	-	-	898668
3	3	97.2	6	1605	1583	1259235
4	2	78.7	6	1743	-	127106
5	2	74.2	6	1219	-	490358
6	3	88.7	6	1934	1273	852409
7	1	54.3	6	-	-	1217152
8	3	95.4	6	1555	1791	82296
9						
10						
11						
12						
13						
14						
15						
16						
17						
18						
19						
20						

**DFS Radar Parameters**  
**FCC Radar Type 5**  
**Channel 100 Bandwidth 20MHz**

Trial Number:			11			Detection (Yes/No)
Number of Bursts in Trial:			17			
Chirp Center Frequency:			5498			
Burst	Number of Pulses	Pulse Width (Microseconds)	Chirp Width (MHz)	Pulse 1-to-2 Spacing (µsec)	Pulse 2-to-3 Spacing (µsec)	Starting Location Within Interval (µsec)
1	2	73.7	16	1497	-	209249
2	3	97.4	16	1754	1613	378386
3	3	91.7	16	1702	1462	548411
4	1	66.2	16	-	-	17733
5	2	70.8	16	1821	-	187952
6	1	52.3	16	-	-	359277
7	2	78.9	16	1984	-	528886
8	2	70.9	16	1358	-	700166
9	2	75.6	16	1430	-	167197
10	1	59.1	16	-	-	338262
11	2	77	16	1304	-	508324
12	2	67.9	16	1083	-	678689
13	2	81.2	16	1932	-	146031
14	2	78.7	16	1121	-	316923
15	1	63.3	16	-	-	488056
16	2	68.9	16	1423	-	657326
17	1	59.3	16	-	-	125509
18						
19						
20						

Trial Number:			12			Detection (Yes/No)
Number of Bursts in Trial:			19			
Chirp Center Frequency:			5499			
Burst	Number of Pulses	Pulse Width (Microseconds)	Chirp Width (MHz)	Pulse 1-to-2 Spacing (µsec)	Pulse 2-to-3 Spacing (µsec)	Starting Location Within Interval (µsec)
1	3	98.9	19	1680	1488	263736
2	2	82.3	19	1855	-	416459
3	3	86.7	19	1400	1919	567902
4	3	89.7	19	1068	1282	92979
5	3	98.6	19	1194	1461	245155
6	2	71.1	19	1789	-	397609
7	1	55.9	19	-	-	551431
8	2	67.9	19	1372	-	74413
9	3	84.4	19	1107	1443	226559
10	1	58.8	19	-	-	380056
11	1	65.6	19	-	-	533408
12	2	78.5	19	1704	-	55547
13	2	82.3	19	1686	-	207876
14	3	90.1	19	1071	1266	359771
15	3	90.2	19	1089	1950	511297
16	2	83.1	19	1406	-	36803
17	1	58.8	19	-	-	189652
18	2	77	19	1657	-	341809
19	1	55	19	-	-	495737
20						

**DFS Radar Parameters**  
**FCC Radar Type 5**  
**Channel 100 Bandwidth 20MHz**

Trial Number:			13			Detection (Yes/No)
Number of Bursts in Trial:			15			
Chirp Center Frequency:			5496			
Burst	Number of Pulses	Pulse Width (Microseconds)	Chirp Width (MHz)	Pulse 1-to-2 Spacing (µsec)	Pulse 2-to-3 Spacing (µsec)	Starting Location Within Interval (µsec)
1	1	58.1	13	-	-	22911
2	1	52.1	13	-	-	216473
3	1	59.9	13	-	-	410004
4	1	60.2	13	-	-	603671
5	3	95.9	13	1906	1608	794160
6	2	79.9	13	1859	-	192251
7	2	78.5	13	1917	-	385590
8	1	53.8	13	-	-	579862
9	1	64.7	13	-	-	773423
10	1	61.4	13	-	-	168898
11	2	83.2	13	1858	-	361606
12	3	84.7	13	1677	1638	553866
13	3	88.7	13	1528	1058	747241
14	2	78.3	13	1951	-	144710
15	2	69.3	13	1717	-	337856
16						
17						
18						
19						
20						

Trial Number:			14			Detection (Yes/No)
Number of Bursts in Trial:			12			
Chirp Center Frequency:			5495			
Burst	Number of Pulses	Pulse Width (Microseconds)	Chirp Width (MHz)	Pulse 1-to-2 Spacing (µsec)	Pulse 2-to-3 Spacing (µsec)	Starting Location Within Interval (µsec)
1	2	75.3	10	1612	-	664275
2	1	56.3	10	-	-	907886
3	2	67.7	10	1185	-	151316
4	1	55.6	10	-	-	393746
5	2	75.2	10	1267	-	635093
6	2	76.3	10	1305	-	876993
7	3	85.7	10	1362	1924	121278
8	3	98.4	10	1550	1249	362696
9	3	86.4	10	1439	1046	604342
10	3	93.6	10	1031	1452	846453
11	1	63.3	10	-	-	91871
12	3	92.4	10	1673	1322	333050
13						
14						
15						
16						
17						
18						
19						
20						

**DFS Radar Parameters**  
**FCC Radar Type 5**  
**Channel 100 Bandwidth 20MHz**

Trial Number:		15				Detection (Yes/No)
Number of Bursts in Trial:		19				
Chirp Center Frequency:		5498				
Burst	Number of Pulses	Pulse Width (Microseconds)	Chirp Width (MHz)	Pulse 1-to-2 Spacing (µsec)	Pulse 2-to-3 Spacing (µsec)	Starting Location Within Interval (µsec)
1	3	93.3	18	1912	1535	361323
2	2	69.1	18	1794	-	515261
3	3	86.9	18	1152	1148	39025
4	3	84.9	18	1948	1118	190900
5	2	72.3	18	1916	-	343941
6	1	51.7	18	-	-	497624
7	1	58.3	18	-	-	20319
8	1	60.8	18	-	-	172999
9	1	57.1	18	-	-	325872
10	3	88.9	18	1964	1489	475841
11	2	72	18	1297	-	1489
12	3	90.9	18	1566	1370	153647
13	1	59.8	18	-	-	307096
14	2	70	18	1291	-	458804
15	2	67.2	18	1881	-	610798
16	3	91.2	18	1832	1661	134759
17	1	56.5	18	-	-	288306
18	1	51.2	18	-	-	441296
19	2	74.1	18	1245	-	592780
20						

Trial Number:		16				Detection (Yes/No)
Number of Bursts in Trial:		14				
Chirp Center Frequency:		5496				
Burst	Number of Pulses	Pulse Width (Microseconds)	Chirp Width (MHz)	Pulse 1-to-2 Spacing (µsec)	Pulse 2-to-3 Spacing (µsec)	Starting Location Within Interval (µsec)
1	2	76.9	12	1140	-	158286
2	1	50.2	12	-	-	366024
3	1	62.9	12	-	-	573452
4	1	64.7	12	-	-	780619
5	3	83.8	12	1097	1621	132455
6	1	65.4	12	-	-	340207
7	1	53.2	12	-	-	548208
8	1	51.7	12	-	-	755333
9	2	78.7	12	1168	-	107117
10	2	72.4	12	1343	-	314500
11	1	53.8	12	-	-	522447
12	2	73.6	12	1553	-	728517
13	2	66.7	12	1122	-	81611
14	2	82.5	12	1019	-	288948
15						
16						
17						
18						
19						
20						



**DFS Radar Parameters**  
**FCC Radar Type 5**  
**Channel 100 Bandwidth 20MHz**

Trial Number:			17			Detection (Yes/No)
Number of Bursts in Trial:			20			
Chirp Center Frequency:			5499			
Burst	Number of Pulses	Pulse Width (Microseconds)	Chirp Width (MHz)	Pulse 1-to-2 Spacing (µsec)	Pulse 2-to-3 Spacing (µsec)	Starting Location Within Interval (µsec)
1	3	87.6	20	1055	1840	345766
2	3	85.2	20	1541	1408	490019
3	3	84.8	20	1889	1463	39073
4	2	77.9	20	1460	-	183923
5	2	76.5	20	1485	-	328777
6	1	60.9	20	-	-	474728
7	2	83	20	1010	-	21394
8	2	80.4	20	1752	-	165992
9	2	67.5	20	1181	-	310973
10	1	62.1	20	-	-	456884
11	3	86.4	20	1966	1263	3515
12	3	84.3	20	1188	1788	147928
13	2	76.9	20	1537	-	293225
14	3	95.8	20	1298	1844	436922
15	1	55.2	20	-	-	584015
16	1	59	20	-	-	130832
17	3	94.5	20	1700	1283	274684
18	3	91.9	20	1978	1165	418579
19	3	85.2	20	1551	1189	563464
20	2	69.5	20	1224	-	112787

Trial Number:			18			Detection (Yes/No)
Number of Bursts in Trial:			12			
Chirp Center Frequency:			5495			
Burst	Number of Pulses	Pulse Width (Microseconds)	Chirp Width (MHz)	Pulse 1-to-2 Spacing (µsec)	Pulse 2-to-3 Spacing (µsec)	Starting Location Within Interval (µsec)
1	3	86.4	10	1918	1455	429224
2	3	92.2	10	1719	1895	670241
3	2	80.4	10	1899	-	912880
4	1	54.3	10	-	-	158603
5	1	53.1	10	-	-	400824
6	2	69.4	10	1546	-	641915
7	2	69.1	10	1639	-	883823
8	3	100	10	1438	1595	128373
9	2	79.6	10	1705	-	370379
10	3	88.4	10	1579	1623	611194
11	1	53.3	10	-	-	855665
12	1	65.3	10	-	-	98897
13						
14						
15						
16						
17						
18						
19						
20						

**DFS Radar Parameters**  
**FCC Radar Type 5**  
**Channel 100 Bandwidth 20MHz**

Trial Number:			19			Detection (Yes/No)
Number of Bursts in Trial:			14			
Chirp Center Frequency:			5496			
Burst	Number of Pulses	Pulse Width (Microseconds)	Chirp Width (MHz)	Pulse 1-to-2 Spacing (µsec)	Pulse 2-to-3 Spacing (µsec)	Starting Location Within Interval (µsec)
1	1	55.3	12	-	-	292143
2	1	58.3	12	-	-	499633
3	2	72.3	12	1039.000	-	706377
4	3	84.8	12	1761.000	1721.000	58989
5	2	82.5	12	1431.000	-	266161
6	1	63.3	12	-	-	474469
7	2	80	12	1913.000	-	680544
8	3	90.3	12	1853.000	1123.000	33519
9	3	91.1	12	1783.000	1172.000	240319
10	3	96.6	12	1036.000	1385.000	447400
11	2	82.7	12	1990.000	-	654516
12	1	50.7	12	-	-	8083
13	2	78.4	12	1109.000	-	215435
14	3	99.5	12	1965.000	1869.000	421325
15						
16						
17						
18						
19						
20						

Trial Number:			20			Detection (Yes/No)
Number of Bursts in Trial:			12			
Chirp Center Frequency:			5495			
Burst	Number of Pulses	Pulse Width (Microseconds)	Chirp Width (MHz)	Pulse 1-to-2 Spacing (µsec)	Pulse 2-to-3 Spacing (µsec)	Starting Location Within Interval (µsec)
1	3	88.6	10	1067	1927	733725
2	1	57.4	10	-	-	977882
3	3	96.6	10	1658	1324	221197
4	2	69.7	10	1945	-	462915
5	2	77.9	10	1317	-	705071
6	1	62	10	-	-	947923
7	3	88.4	10	1077	1366	191373
8	3	97.3	10	1896	1367	432561
9	3	96.2	10	1787	1672	674004
10	3	95.4	10	1892	1414	915842
11	1	54.8	10	-	-	162176
12	2	80.4	10	1436	-	403553
13						
14						
15						
16						
17						
18						
19						
20						

**DFS Radar Parameters**  
**FCC Radar Type 5**  
**Channel 100 Bandwidth 20MHz**

Trial Number:			21			Detection (Yes/No)
Number of Bursts in Trial:			16			
Chirp Center Frequency:			5503			
Burst	Number of Pulses	Pulse Width (Microseconds )	Chirp Width (MHz)	Pulse 1-to-2 Spacing (µsec)	Pulse 2-to-3 Spacing (µsec)	Starting Location Within Interval (µsec)
1	2	74.7	15	1611	-	483470
2	1	57.1	15	-	-	666072
3	3	91.9	15	1475	1276	98810
4	2	83.1	15	1772	-	279914
5	1	50.7	15	-	-	462536
6	2	79.2	15	1600	-	642324
7	1	58.7	15	-	-	76831
8	2	71	15	1567	-	257785
9	2	79	15	1960	-	438554
10	2	68.5	15	1428	-	620397
11	2	73.5	15	1352	-	54310
12	2	70.5	15	1115	-	235506
13	2	76.6	15	1300	-	417036
14	2	81.2	15	1675	-	597974
15	1	61.8	15	-	-	32086
16	3	94.9	15	1206	1860	212751
17						
18						
19						
20						

Trial Number:			22			Detection (Yes/No)
Number of Bursts in Trial:			12			
Chirp Center Frequency:			5505			
Burst	Number of Pulses	Pulse Width (Microseconds )	Chirp Width (MHz)	Pulse 1-to-2 Spacing (µsec)	Pulse 2-to-3 Spacing (µsec)	Starting Location Within Interval (µsec)
1	2	78.5	9	1698	-	526149
2	3	89.8	9	1962	1167	767135
3	1	59.4	9	-	-	12955
4	2	79.6	9	1890	-	254612
5	2	76	9	1811	-	496588
6	1	53.6	9	-	-	739728
7	2	80.9	9	1053	-	980872
8	1	61.6	9	-	-	225249
9	1	53.4	9	-	-	467279
10	1	59.9	9	-	-	709720
11	1	60.4	9	-	-	951847
12	3	91.4	9	1726	1227	194839
13						
14						
15						
16						
17						
18						
19						
20						

**DFS Radar Parameters**  
**FCC Radar Type 5**  
**Channel 100 Bandwidth 20MHz**

Trial Number:			23			Detection (Yes/No)
Number of Bursts in Trial:			20			
Chirp Center Frequency:			5501			
Burst	Number of Pulses	Pulse Width (Microseconds )	Chirp Width (MHz)	Pulse 1-to-2 Spacing (µsec)	Pulse 2-to-3 Spacing (µsec)	Starting Location Within Interval (µsec)
1	2	77	20	1363	-	261858
2	1	58.1	20	-	-	407646
3	1	62.1	20	-	-	552319
4	2	76.9	20	1236	-	99107
5	2	80	20	1852	-	243514
6	1	52	20	-	-	389464
7	3	88.6	20	1995	1905	531093
8	2	72.9	20	1387	-	81159
9	3	98.5	20	1746	1389	225245
10	1	57.9	20	-	-	371906
11	3	95.9	20	1870	1066	514197
12	1	53.5	20	-	-	63561
13	3	92	20	1654	1458	207510
14	1	57.3	20	-	-	353638
15	2	70.5	20	1586	-	497515
16	2	70	20	1664	-	45553
17	3	84	20	1630	1176	189821
18	2	76.1	20	1057	-	335330
19	3	93.2	20	1018	1340	478825
20	3	96.8	20	1614	1817	27594

Trial Number:			24			Detection (Yes/No)
Number of Bursts in Trial:			14			
Chirp Center Frequency:			5504			
Burst	Number of Pulses	Pulse Width (Microseconds )	Chirp Width (MHz)	Pulse 1-to-2 Spacing (µsec)	Pulse 2-to-3 Spacing (µsec)	Starting Location Within Interval (µsec)
1	1	50.1	12	-	-	247117
2	3	93.5	12	1081	1413	453362
3	2	68.8	12	1577	-	660875
4	1	56.3	12	-	-	14140
5	3	86	12	1108	1987	220734
6	2	75.2	12	1536	-	428367
7	1	54.4	12	-	-	636681
8	2	71.1	12	1243	-	843157
9	2	76.2	12	1770	-	195585
10	2	80.2	12	1209	-	403231
11	2	79.7	12	1214	-	610202
12	3	90.9	12	1862	1601	815229
13	2	68.7	12	1441	-	170267
14	2	67.4	12	1313	-	377306
15						
16						
17						
18						
19						
20						

**DFS Radar Parameters**  
**FCC Radar Type 5**  
**Channel 100 Bandwidth 20MHz**

Trial Number:			25			Detection (Yes/No)
Number of Bursts in Trial:			13			
Chirp Center Frequency:			5504			
Burst	Number of Pulses	Pulse Width (Microseconds)	Chirp Width (MHz)	Pulse 1-to-2 Spacing (µsec)	Pulse 2-to-3 Spacing (µsec)	Starting Location Within Interval (µsec)
1	3	94	11	1748	1941	628071
2	2	70.8	11	1201	-	853391
3	1	56.3	11	-	-	156223
4	3	96.7	11	1163	1332	378734
5	3	90.6	11	1582	1498	601331
6	2	74.5	11	1281	-	825462
7	3	92.6	11	1669	1222	128265
8	3	89	11	1135	1380	351161
9	3	96.5	11	1822	1602	573425
10	2	70.5	11	1178	-	798431
11	3	94	11	1629	1956	100737
12	1	55.8	11	-	-	324661
13	3	87.7	11	1963	1164	546278
14						
15						
16						
17						
18						
19						
20						

Trial Number:			26			Detection (Yes/No)
Number of Bursts in Trial:			8			
Chirp Center Frequency:			5507			
Burst	Number of Pulses	Pulse Width (Microseconds)	Chirp Width (MHz)	Pulse 1-to-2 Spacing (µsec)	Pulse 2-to-3 Spacing (µsec)	Starting Location Within Interval (µsec)
1	2	68.6	5	1161	-	1253842
2	2	83.1	5	1315	-	119486
3	1	60.9	5	-	-	482958
4	2	77.7	5	1158	-	845641
5	2	77.4	5	1510	-	1208428
6	2	66.8	5	1323	-	74748
7	1	63.7	5	-	-	438300
8	3	91.2	5	1681	1275	800152
9						
10						
11						
12						
13						
14						
15						
16						
17						
18						
19						
20						

**DFS Radar Parameters**  
**FCC Radar Type 5**  
**Channel 100 Bandwidth 20MHz**

Trial Number:		27				Detection (Yes/No)
Number of Bursts in Trial:		17				
Chirp Center Frequency:		5502				
Burst	Number of Pulses	Pulse Width (Microseconds )	Chirp Width (MHz)	Pulse 1-to-2 Spacing (µsec)	Pulse 2-to-3 Spacing (µsec)	Starting Location Within Interval (µsec)
1	3	83.6	16	1195	1000	545865
2	3	89.4	16	1627	1656	14067
3	1	55.8	16	-	-	184953
4	3	90.9	16	1554	1998	353759
5	1	54.7	16	-	-	526388
6	3	97.7	16	1202	1250	694806
7	2	67.5	16	1434	-	163568
8	3	96.7	16	1469	1268	333410
9	2	68.3	16	1954	-	504006
10	2	78.3	16	1082	-	675297
11	1	55	16	-	-	142890
12	3	84.9	16	1936	1199	312479
13	2	74.6	16	1856	-	482953
14	1	63.3	16	-	-	655022
15	3	99.8	16	1515	1120	121457
16	1	63.6	16	-	-	292606
17	3	87.3	16	1051	1831	461322
18						
19						
20						

Trial Number:		28				Detection (Yes/No)
Number of Bursts in Trial:		19				
Chirp Center Frequency:		5501				
Burst	Number of Pulses	Pulse Width (Microseconds )	Chirp Width (MHz)	Pulse 1-to-2 Spacing (µsec)	Pulse 2-to-3 Spacing (µsec)	Starting Location Within Interval (µsec)
1	3	85.6	19	1078	1015	565136
2	2	68.6	19	1780	-	89970
3	1	54.2	19	-	-	243121
4	1	61.2	19	-	-	396034
5	3	97.1	19	1969	1100	546225
6	3	98.3	19	1699	1622	70998
7	1	62.4	19	-	-	224093
8	2	80.2	19	1769	-	376127
9	3	87.5	19	1448	1179	527806
10	3	85.8	19	1348	1472	52247
11	3	88.1	19	1124	1631	204582
12	1	65.3	19	-	-	357941
13	1	52.5	19	-	-	510977
14	1	52.3	19	-	-	33698
15	2	74.1	19	1200	-	186023
16	1	54.9	19	-	-	339327
17	2	76.2	19	1502	-	491053
18	1	60.4	19	-	-	14858
19	2	81.5	19	1103	-	167387
20						

**DFS Radar Parameters**  
**FCC Radar Type 5**  
**Channel 100 Bandwidth 20MHz**

Trial Number:			29			Detection (Yes/No)
Number of Bursts in Trial:			12			
Chirp Center Frequency:			5505			
Burst	Number of Pulses	Pulse Width (Microseconds)	Chirp Width (MHz)	Pulse 1-to-2 Spacing (µsec)	Pulse 2-to-3 Spacing (µsec)	Starting Location Within Interval (µsec)
1	1	50.5	10	-	-	507709
2	1	55.7	10	-	-	750249
3	3	85.8	10	1002	1967	989003
4	2	76.9	10	1474	-	235634
5	2	75.1	10	1052	-	477675
6	3	92.3	10	1486	1492	718312
7	2	78.1	10	1757	-	960895
8	3	92.2	10	1252	1713	205370
9	3	89	10	1706	1411	446940
10	2	70.9	10	1620	-	689225
11	1	63.1	10	-	-	932305
12	1	55.3	10	-	-	176231
13						
14						
15						
16						
17						
18						
19						
20						

Trial Number:			30			Detection (Yes/No)
Number of Bursts in Trial:			18			
Chirp Center Frequency:			5502			
Burst	Number of Pulses	Pulse Width (Microseconds)	Chirp Width (MHz)	Pulse 1-to-2 Spacing (µsec)	Pulse 2-to-3 Spacing (µsec)	Starting Location Within Interval (µsec)
1	3	83.4	17	1205	1801	277485
2	3	97.3	17	1826	1635	437880
3	3	90.4	17	1986	1674	598445
4	3	91.8	17	1151	1802	97088
5	3	98.2	17	1977	1766	257251
6	1	59.5	17	-	-	419893
7	2	80	17	1137	-	580724
8	3	86.5	17	1128	1828	77366
9	3	91.1	17	1599	1442	238032
10	3	93.5	17	1373	1087	398605
11	1	60.7	17	-	-	562025
12	2	67.2	17	1405	-	57684
13	1	61.8	17	-	-	219083
14	2	79.4	17	1667	-	379234
15	2	81.4	17	1464	-	540896
16	1	65.7	17	-	-	37916
17	2	76	17	1255	-	198794
18	2	81	17	1668	-	359754
19						
20						

**DFS Radar Parameters**  
**FCC Radar Type 1**  
**Channel 102 Bandwidth 40MHz**

Trial #	Pulse Repetition Frequency Number (1 to 23)	Pulse Repetition Frequency (Pulses Per Second)	Pulse Repetition Interval (Microseconds)	Detection (Yes / No)
1	22	1066.10	938	Yes
2	10	1432.66	698	Yes
3	6	1618.12	618	Yes
4	2	1858.74	538	Yes
5	19	1138.95	878	Yes
6	12	326.16	3066	Yes
7	7	1567.40	638	Yes
8	21	1089.32	918	Yes
9	17	1193.32	838	Yes
10	18	1165.50	858	Yes
11	15	1253.13	798	Yes
12	11	1392.76	718	Yes
13	4	1730.10	578	Yes
14	5	1672.24	598	Yes
15	3	1792.11	558	Yes
16		394.32	2536	Yes
17		1035.20	966	Yes
18		1209.19	827	Yes
19		399.84	2501	Yes
20		385.36	2595	Yes
21		897.67	1114	Yes
22		768.05	1302	Yes
23		328.41	3045	Yes
24		615.76	1624	Yes
25		347.46	2878	Yes
26		973.71	1027	Yes
27		402.41	2485	Yes
28		625.00	1600	Yes
29		853.24	1172	Yes
30		849.62	1177	Yes



**DFS Radar Parameters**  
**FCC Radar Type 2**  
**Channel 102 Bandwidth 40MHz**

Trial #	Number Pulses per Burst	Pulse Width (Microseconds)	Pulse Repetition Interval (Microseconds)	Detection (Yes / No)
1	26	3.20	179	Yes
2	23	1.10	207	Yes
3	24	2.10	230	Yes
4	29	4.80	200	Yes
5	28	3.90	214	Yes
6	26	2.90	222	Yes
7	26	3.20	204	Yes
8	25	2.50	192	Yes
9	26	3.10	164	Yes
10	23	1.20	156	Yes
11	27	3.90	210	Yes
12	29	4.60	201	Yes
13	26	3.20	162	Yes
14	25	2.20	197	Yes
15	29	4.50	163	Yes
16	26	3.00	203	Yes
17	29	5.00	168	Yes
18	25	2.40	217	Yes
19	26	2.90	191	Yes
20	25	2.30	166	Yes
21	27	3.70	150	Yes
22	25	2.20	176	Yes
23	29	4.90	195	Yes
24	26	2.90	202	Yes
25	25	2.50	178	Yes
26	23	1.10	206	Yes
27	27	3.80	155	Yes
28	29	4.70	157	Yes
29	25	2.40	224	Yes
30	28	4.20	159	Yes

**DFS Radar Parameters**  
**FCC Radar Type 3**  
**Channel 102 Bandwidth 40MHz**

Trial #	Number Pulses per Burst	Pulse Width (Microseconds)	Pulse Repetition Interval (Microseconds)	Detection (Yes / No)
1	17	8.20	355	Yes
2	16	6.10	487	Yes
3	16	7.10	344	Yes
4	18	9.80	288	Yes
5	18	8.90	230	Yes
6	17	7.90	432	Yes
7	17	8.20	207	Yes
8	17	7.50	443	Yes
9	17	8.10	439	Yes
10	16	6.20	223	Yes
11	18	8.90	208	Yes
12	18	9.60	463	Yes
13	17	8.20	441	Yes
14	16	7.20	323	Yes
15	18	9.50	297	Yes
16	17	8.00	412	Yes
17	18	10.00	324	Yes
18	17	7.40	271	Yes
19	17	7.90	349	Yes
20	16	7.30	409	Yes
21	18	8.70	373	Yes
22	16	7.20	254	Yes
23	18	9.90	274	Yes
24	17	7.90	278	Yes
25	17	7.50	317	Yes
26	16	6.10	260	Yes
27	18	8.80	211	Yes
28	18	9.70	272	Yes
29	17	7.40	264	Yes
30	18	9.20	284	Yes

**DFS Radar Parameters**  
**FCC Radar Type 4**  
**Channel 102 Bandwidth 40MHz**

Trial #	Number Pulses per Burst	Pulse Width (Microseconds)	Pulse Repetition Interval (Microseconds)	Detection (Yes / No)
1	14	16.00	355	Yes
2	12	11.30	487	Yes
3	13	13.50	344	Yes
4	16	19.40	288	Yes
5	15	17.50	230	Yes
6	14	15.30	432	Yes
7	14	15.90	207	Yes
8	13	14.30	443	Yes
9	14	15.80	439	Yes
10	12	11.50	223	Yes
11	15	17.40	208	Yes
12	16	19.00	463	Yes
13	14	16.00	441	Yes
14	13	13.80	323	Yes
15	16	18.90	297	Yes
16	14	15.50	412	Yes
17	16	19.90	324	Yes
18	13	14.10	271	Yes
19	14	15.20	349	Yes
20	13	13.80	409	Yes
21	15	17.10	373	Yes
22	13	13.80	254	Yes
23	16	19.80	274	Yes
24	14	15.30	278	Yes
25	13	14.50	317	Yes
26	12	11.30	260	Yes
27	15	17.30	211	Yes
28	16	19.20	272	Yes
29	13	14.20	264	Yes
30	15	18.20	284	Yes

**DFS Radar Parameters**  
**FCC Radar Type 5**  
**Channel 102 Bandwidth 40MHz**

Trial Number:			1			Detection (Yes/No)
Number of Bursts in Trial:			15			
Chirp Center Frequency:			5510			
Burst	Number of Pulses	Pulse Width (Microseconds)	Chirp Width (MHz)	Pulse 1-to-2 Spacing (µsec)	Pulse 2-to-3 Spacing (µsec)	Starting Location Within Interval (µsec)
1	2	77.8	13	1477	-	636185
2	1	51.9	13	-	-	32674
3	1	63.8	13	-	-	226294
4	3	96.6	13	1786	1843	417976
5	3	85.9	13	1215	1729	611152
6	2	73.7	13	1549	-	8789
7	2	77.2	13	1819	-	201917
8	2	68.4	13	1114	-	395530
9	2	76.7	13	1155	-	588564
10	1	53.2	13	-	-	783794
11	3	85.7	13	1695	1394	177933
12	3	94.3	13	1426	1935	370624
13	2	77.6	13	1671	-	564893
14	1	65.7	13	-	-	759583
15	3	93.5	13	1130	1468	154262
16						
17						
18						
19						
20						

Trial Number:			2			Detection (Yes/No)
Number of Bursts in Trial:			8			
Chirp Center Frequency:			5510			
Burst	Number of Pulses	Pulse Width (Microseconds)	Chirp Width (MHz)	Pulse 1-to-2 Spacing (µsec)	Pulse 2-to-3 Spacing (µsec)	Starting Location Within Interval (µsec)
1	2	75	5	1527	-	653020
2	3	99.4	5	1262	1257	1015643
3	2	67.4	5	1403	-	1379398
4	2	73.6	5	1041	-	245489
5	1	65.9	5	-	-	609113
6	3	83.8	5	1292	1419	970852
7	1	65.5	5	-	-	1335913
8	3	98.6	5	1796	1728	200406
9						
10						
11						
12						
13						
14						
15						
16						
17						
18						
19						
20						

**DFS Radar Parameters**  
**FCC Radar Type 5**  
**Channel 102 Bandwidth 40MHz**

Trial Number:			3			Detection (Yes/No)
Number of Bursts in Trial:			11			
Chirp Center Frequency:			5510			
Burst	Number of Pulses	Pulse Width (Microseconds)	Chirp Width (MHz)	Pulse 1-to-2 Spacing (µsec)	Pulse 2-to-3 Spacing (µsec)	Starting Location Within Interval (µsec)
1	2	73.8	9	1538	-	409565
2	2	69.5	9	1649	-	673692
3	1	51.9	9	-	-	938562
4	3	84.6	9	1032	1271	113209
5	3	95.4	9	1903	1388	376726
6	2	68	9	1351	-	641212
7	3	89.6	9	1514	1573	903714
8	2	81.9	9	1689	-	80863
9	3	88.3	9	1330	1838	344067
10	1	53.7	9	-	-	609331
11	3	91.3	9	1106	1001	871542
12						
13						
14						
15						
16						
17						
18						
19						
20						

Trial Number:			4			Detection (Yes/No)
Number of Bursts in Trial:			11			
Chirp Center Frequency:			5510			
Burst	Number of Pulses	Pulse Width (Microseconds)	Chirp Width (MHz)	Pulse 1-to-2 Spacing (µsec)	Pulse 2-to-3 Spacing (µsec)	Starting Location Within Interval (µsec)
1	2	68.1	19	1355	-	26541
2	1	58.7	19	-	-	171821
3	2	75.3	19	1640	-	316229
4	1	56.4	19	-	-	461864
5	3	99.7	19	1708	1159	8677
6	1	57.7	19	-	-	153995
7	1	59.5	19	-	-	299238
8	2	80	19	1369	-	443177
9	2	82	19	1197	-	587671
10	2	82.8	19	1005	-	135674
11	3	88	19	1928	1101	279928
12	3	93.2	19	1907	1223	424279
13	2	70.4	19	1360	-	570132
14	3	95.3	19	1955	1775	117439
15	2	81.9	19	1545	-	262502
16	3	98.5	19	1169	1062	406573
17	1	65	19	-	-	553328
18	3	85.4	19	1637	1425	99799
19	3	91.6	19	1445	1325	244095
20	2	67.3	19	1218	-	390012

**DFS Radar Parameters**  
**FCC Radar Type 5**  
**Channel 102 Bandwidth 40MHz**

Trial Number:			5			Detection (Yes/No)
Number of Bursts in Trial:			17			
Chirp Center Frequency:			5510			Yes
Burst	Number of Pulses	Pulse Width (Microseconds)	Chirp Width (MHz)	Pulse 1-to-2 Spacing (µsec)	Pulse 2-to-3 Spacing (µsec)	Starting Location Within Interval (µsec)
1	2	67.9	16	1133	-	629614
2	1	62.3	16	-	-	96856
3	1	53.3	16	-	-	267719
4	3	90	16	1153	1346	436784
5	2	77.1	16	1646	-	608289
6	3	83.9	16	1232	1459	75610
7	3	89.1	16	1384	1939	245638
8	2	81.8	16	1676	-	416355
9	1	50.3	16	-	-	588736
10	3	87.1	16	1996	1756	54571
11	2	71.3	16	1815	-	225175
12	3	97.5	16	1465	1132	394825
13	3	90.6	16	1040	1354	565361
14	3	86.3	16	1183	1792	33643
15	3	97.6	16	1073	1361	203957
16	3	84.7	16	1718	1854	373812
17	3	99.7	16	1244	1988	544060
18						
19						
20						

Trial Number:			6			Detection (Yes/No)
Number of Bursts in Trial:			14			
Chirp Center Frequency:			5510			Yes
Burst	Number of Pulses	Pulse Width (Microseconds)	Chirp Width (MHz)	Pulse 1-to-2 Spacing (µsec)	Pulse 2-to-3 Spacing (µsec)	Starting Location Within Interval (µsec)
1	3	92.9	12	1564	1407	15438
2	2	67.7	12	1747	-	222486
3	1	65.8	12	-	-	430731
4	1	56.3	12	-	-	637784
5	1	53.7	12	-	-	845342
6	3	83.5	12	1930	1025	196720
7	1	65.8	12	-	-	404955
8	3	85.9	12	1034	1808	610711
9	2	76.3	12	1926	-	818057
10	2	81.5	12	1714	-	171459
11	3	89.4	12	1594	1827	377969
12	1	63.4	12	-	-	586875
13	2	69.6	12	1925	-	792834
14	2	74.5	12	1846	-	146044
15						
16						
17						
18						
19						
20						

**DFS Radar Parameters**  
**FCC Radar Type 5**  
**Channel 102 Bandwidth 40MHz**

Trial Number:			7			Detection (Yes/No)
Number of Bursts in Trial:			15			
Chirp Center Frequency:			5510			
Burst	Number of Pulses	Pulse Width (Microseconds)	Chirp Width (MHz)	Pulse 1-to-2 Spacing (µsec)	Pulse 2-to-3 Spacing (µsec)	Starting Location Within Interval (µsec)
1	1	52.6	10	-	-	51446
2	3	84.1	10	1725	1529	292696
3	3	97.7	10	1868	1805	533989
4	3	97.3	10	1446	1755	775564
5	3	98.8	10	1386	1302	21542
6	2	72.2	10	1184	-	263385
7	2	67.6	10	1027	-	505581
8	2	75.7	10	1871	-	747058
9	1	60.9	10	-	-	989976
10	1	64.2	10	-	-	234024
11	2	78.8	10	1604	-	475207
12	3	87.5	10	1712	1683	715825
13						
14						
15						
16						
17						
18						
19						
20						

Trial Number:			8			Detection (Yes/No)
Number of Bursts in Trial:			12			
Chirp Center Frequency:			5510			
Burst	Number of Pulses	Pulse Width (Microseconds)	Chirp Width (MHz)	Pulse 1-to-2 Spacing (µsec)	Pulse 2-to-3 Spacing (µsec)	Starting Location Within Interval (µsec)
1	1	52.6	10	-	-	51446
2	3	84.1	10	1725	1529	292696
3	3	97.7	10	1868	1805	533989
4	3	97.3	10	1446	1755	775564
5	3	98.8	10	1386	1302	21542
6	2	72.2	10	1184	-	263385
7	2	67.6	10	1027	-	505581
8	2	75.7	10	1871	-	747058
9	1	60.9	10	-	-	989976
10	1	64.2	10	-	-	234024
11	2	78.8	10	1604	-	475207
12	3	87.5	10	1712	1683	715825
13						
14						
15						
16						
17						
18						
19						
20						

**DFS Radar Parameters**  
**FCC Radar Type 5**  
**Channel 102 Bandwidth 40MHz**

Trial Number:			9			Detection (Yes/No)
Number of Bursts in Trial:			14			
Chirp Center Frequency:			5510			
Burst	Number of Pulses	Pulse Width (Microseconds)	Chirp Width (MHz)	Pulse 1-to-2 Spacing (µsec)	Pulse 2-to-3 Spacing (µsec)	Starting Location Within Interval (µsec)
1	1	54.1	13	-	-	823112
2	1	50.7	13	-	-	174965
3	1	52.3	13	-	-	382216
4	3	99.8	13	1696	1949	587395
5	2	68.4	13	1099	-	796897
6	2	80.8	13	1505	-	149042
7	1	62.5	13	-	-	356750
8	2	74.8	13	1204	-	563824
9	1	50.8	13	-	-	772314
10	1	54	13	-	-	123796
11	1	63	13	-	-	331215
12	3	91.8	13	1270	1347	537402
13	2	79.3	13	1992	-	744805
14	1	64.3	13	-	-	98172
15						
16						
17						
18						
19						
20						

Trial Number:			10			Detection (Yes/No)
Number of Bursts in Trial:			8			
Chirp Center Frequency:			5510			
Burst	Number of Pulses	Pulse Width (Microseconds)	Chirp Width (MHz)	Pulse 1-to-2 Spacing (µsec)	Pulse 2-to-3 Spacing (µsec)	Starting Location Within Interval (µsec)
1	1	63.4	6	-	-	535615
2	1	52	6	-	-	898668
3	3	97.2	6	1605	1583	1259235
4	2	78.7	6	1743	-	127106
5	2	74.2	6	1219	-	490358
6	3	88.7	6	1934	1273	852409
7	1	54.3	6	-	-	1217152
8	3	95.4	6	1555	1791	82296
9						
10						
11						
12						
13						
14						
15						
16						
17						
18						
19						
20						



**DFS Radar Parameters**  
**FCC Radar Type 5**  
**Channel 102 Bandwidth 40MHz**

Trial Number:			11			Detection (Yes/No)
Number of Bursts in Trial:			17			
Chirp Center Frequency:			5498			
Burst	Number of Pulses	Pulse Width (Microseconds)	Chirp Width (MHz)	Pulse 1-to-2 Spacing (µsec)	Pulse 2-to-3 Spacing (µsec)	Starting Location Within Interval (µsec)
1	2	73.7	16	1497	-	209249
2	3	97.4	16	1754	1613	378386
3	3	91.7	16	1702	1462	548411
4	1	66.2	16	-	-	17733
5	2	70.8	16	1821	-	187952
6	1	52.3	16	-	-	359277
7	2	78.9	16	1984	-	528886
8	2	70.9	16	1358	-	700166
9	2	75.6	16	1430	-	167197
10	1	59.1	16	-	-	338262
11	2	77	16	1304	-	508324
12	2	67.9	16	1083	-	678689
13	2	81.2	16	1932	-	146031
14	2	78.7	16	1121	-	316923
15	1	63.3	16	-	-	488056
16	2	68.9	16	1423	-	657326
17	1	59.3	16	-	-	125509
18						
19						
20						

Trial Number:			12			Detection (Yes/No)
Number of Bursts in Trial:			19			
Chirp Center Frequency:			5499			
Burst	Number of Pulses	Pulse Width (Microseconds)	Chirp Width (MHz)	Pulse 1-to-2 Spacing (µsec)	Pulse 2-to-3 Spacing (µsec)	Starting Location Within Interval (µsec)
1	3	98.9	19	1680	1488	263736
2	2	82.3	19	1855	-	416459
3	3	86.7	19	1400	1919	567902
4	3	89.7	19	1068	1282	92979
5	3	98.6	19	1194	1461	245155
6	2	71.1	19	1789	-	397609
7	1	55.9	19	-	-	551431
8	2	67.9	19	1372	-	74413
9	3	84.4	19	1107	1443	226559
10	1	58.8	19	-	-	380056
11	1	65.6	19	-	-	533408
12	2	78.5	19	1704	-	55547
13	2	82.3	19	1686	-	207876
14	3	90.1	19	1071	1266	359771
15	3	90.2	19	1089	1950	511297
16	2	83.1	19	1406	-	36803
17	1	58.8	19	-	-	189652
18	2	77	19	1657	-	341809
19	1	55	19	-	-	495737
20						

**DFS Radar Parameters**  
**FCC Radar Type 5**  
**Channel 102 Bandwidth 40MHz**

Trial Number:			13			Detection (Yes/No)
Number of Bursts in Trial:			15			
Chirp Center Frequency:			5497			
Burst	Number of Pulses	Pulse Width (Microseconds)	Chirp Width (MHz)	Pulse 1-to-2 Spacing (µsec)	Pulse 2-to-3 Spacing (µsec)	Starting Location Within Interval (µsec)
1	1	58.1	13	-	-	22911
2	1	52.1	13	-	-	216473
3	1	59.9	13	-	-	410004
4	1	60.2	13	-	-	603671
5	3	95.9	13	1906	1608	794160
6	2	79.9	13	1859	-	192251
7	2	78.5	13	1917	-	385590
8	1	53.8	13	-	-	579862
9	1	64.7	13	-	-	773423
10	1	61.4	13	-	-	168898
11	2	83.2	13	1858	-	361606
12	3	84.7	13	1677	1638	553866
13	3	88.7	13	1528	1058	747241
14	2	78.3	13	1951	-	144710
15	2	69.3	13	1717	-	337856
16						
17						
18						
19						
20						

Trial Number:			14			Detection (Yes/No)
Number of Bursts in Trial:			12			
Chirp Center Frequency:			5496			
Burst	Number of Pulses	Pulse Width (Microseconds)	Chirp Width (MHz)	Pulse 1-to-2 Spacing (µsec)	Pulse 2-to-3 Spacing (µsec)	Starting Location Within Interval (µsec)
1	2	75.3	10	1612	-	664275
2	1	56.3	10	-	-	907886
3	2	67.7	10	1185	-	151316
4	1	55.6	10	-	-	393746
5	2	75.2	10	1267	-	635093
6	2	76.3	10	1305	-	876993
7	3	85.7	10	1362	1924	121278
8	3	98.4	10	1550	1249	362696
9	3	86.4	10	1439	1046	604342
10	3	93.6	10	1031	1452	846453
11	1	63.3	10	-	-	91871
12	3	92.4	10	1673	1322	333050
13						
14						
15						
16						
17						
18						
19						
20						

**DFS Radar Parameters**  
**FCC Radar Type 5**  
**Channel 102 Bandwidth 40MHz**

Trial Number:			15			Detection (Yes/No)
Number of Bursts in Trial:			19			
Chirp Center Frequency:			5499			
Burst	Number of Pulses	Pulse Width (Microseconds )	Chirp Width (MHz)	Pulse 1-to-2 Spacing (µsec)	Pulse 2-to-3 Spacing (µsec)	Starting Location Within Interval (µsec)
1	3	93.3	18	1912	1535	361323
2	2	69.1	18	1794	-	515261
3	3	86.9	18	1152	1148	39025
4	3	84.9	18	1948	1118	190900
5	2	72.3	18	1916	-	343941
6	1	51.7	18	-	-	497624
7	1	58.3	18	-	-	20319
8	1	60.8	18	-	-	172999
9	1	57.1	18	-	-	325872
10	3	88.9	18	1964	1489	475841
11	2	72	18	1297	-	1489
12	3	90.9	18	1566	1370	153647
13	1	59.8	18	-	-	307096
14	2	70	18	1291	-	458804
15	2	67.2	18	1881	-	610798
16	3	91.2	18	1832	1661	134759
17	1	56.5	18	-	-	288306
18	1	51.2	18	-	-	441296
19	2	74.1	18	1245	-	592780
20						

Trial Number:			16			Detection (Yes/No)
Number of Bursts in Trial:			14			
Chirp Center Frequency:			5496			
Burst	Number of Pulses	Pulse Width (Microseconds )	Chirp Width (MHz)	Pulse 1-to-2 Spacing (µsec)	Pulse 2-to-3 Spacing (µsec)	Starting Location Within Interval (µsec)
1	2	76.9	12	1140	-	158286
2	1	50.2	12	-	-	366024
3	1	62.9	12	-	-	573452
4	1	64.7	12	-	-	780619
5	3	83.8	12	1097	1621	132455
6	1	65.4	12	-	-	340207
7	1	53.2	12	-	-	548208
8	1	51.7	12	-	-	755333
9	2	78.7	12	1168	-	107117
10	2	72.4	12	1343	-	314500
11	1	53.8	12	-	-	522447
12	2	73.6	12	1553	-	728517
13	2	66.7	12	1122	-	81611
14	2	82.5	12	1019	-	288948
15						
16						
17						
18						
19						
20						

**DFS Radar Parameters**  
**FCC Radar Type 5**  
**Channel 102 Bandwidth 40MHz**

Trial Number:			17			Detection (Yes/No)
Number of Bursts in Trial:			20			
Chirp Center Frequency:			5500			
Burst	Number of Pulses	Pulse Width (Microseconds)	Chirp Width (MHz)	Pulse 1-to-2 Spacing (µsec)	Pulse 2-to-3 Spacing (µsec)	Starting Location Within Interval (µsec)
1	3	87.6	20	1055	1840	345766
2	3	85.2	20	1541	1408	490019
3	3	84.8	20	1889	1463	39073
4	2	77.9	20	1460	-	183923
5	2	76.5	20	1485	-	328777
6	1	60.9	20	-	-	474728
7	2	83	20	1010	-	21394
8	2	80.4	20	1752	-	165992
9	2	67.5	20	1181	-	310973
10	1	62.1	20	-	-	456884
11	3	86.4	20	1966	1263	3515
12	3	84.3	20	1188	1788	147928
13	2	76.9	20	1537	-	293225
14	3	95.8	20	1298	1844	436922
15	1	55.2	20	-	-	584015
16	1	59	20	-	-	130832
17	3	94.5	20	1700	1283	274684
18	3	91.9	20	1978	1165	418579
19	3	85.2	20	1551	1189	563464
20	2	69.5	20	1224	-	112787

Trial Number:			18			Detection (Yes/No)
Number of Bursts in Trial:			12			
Chirp Center Frequency:			5496			
Burst	Number of Pulses	Pulse Width (Microseconds)	Chirp Width (MHz)	Pulse 1-to-2 Spacing (µsec)	Pulse 2-to-3 Spacing (µsec)	Starting Location Within Interval (µsec)
1	3	86.4	10	1918	1455	429224
2	3	92.2	10	1719	1895	670241
3	2	80.4	10	1899	-	912880
4	1	54.3	10	-	-	158603
5	1	53.1	10	-	-	400824
6	2	69.4	10	1546	-	641915
7	2	69.1	10	1639	-	883823
8	3	100	10	1438	1595	128373
9	2	79.6	10	1705	-	370379
10	3	88.4	10	1579	1623	611194
11	1	53.3	10	-	-	855665
12	1	65.3	10	-	-	98897
13						
14						
15						
16						
17						
18						
19						
20						

**DFS Radar Parameters**  
**FCC Radar Type 5**  
**Channel 102 Bandwidth 40MHz**

Trial Number:			19			Detection (Yes/No)
Number of Bursts in Trial:			14			
Chirp Center Frequency:			5496			Yes
Burst	Number of Pulses	Pulse Width (Microseconds)	Chirp Width (MHz)	Pulse 1-to-2 Spacing (µsec)	Pulse 2-to-3 Spacing (µsec)	Starting Location Within Interval (µsec)
1	1	55.3	12	-	-	292143
2	1	58.3	12	-	-	499633
3	2	72.3	12	1039.000	-	706377
4	3	84.8	12	1761.000	1721.000	58989
5	2	82.5	12	1431.000	-	266161
6	1	63.3	12	-	-	474469
7	2	80	12	1913.000	-	680544
8	3	90.3	12	1853.000	1123.000	33519
9	3	91.1	12	1783.000	1172.000	240319
10	3	96.6	12	1036.000	1385.000	447400
11	2	82.7	12	1990.000	-	654516
12	1	50.7	12	-	-	8083
13	2	78.4	12	1109.000	-	215435
14	3	99.5	12	1965.000	1869.000	421325
15						
16						
17						
18						
19						
20						

Trial Number:			20			Detection (Yes/No)
Number of Bursts in Trial:			12			
Chirp Center Frequency:			5496			Yes
Burst	Number of Pulses	Pulse Width (Microseconds)	Chirp Width (MHz)	Pulse 1-to-2 Spacing (µsec)	Pulse 2-to-3 Spacing (µsec)	Starting Location Within Interval (µsec)
1	3	88.6	10	1067	1927	733725
2	1	57.4	10	-	-	977882
3	3	96.6	10	1658	1324	221197
4	2	69.7	10	1945	-	462915
5	2	77.9	10	1317	-	705071
6	1	62	10	-	-	947923
7	3	88.4	10	1077	1366	191373
8	3	97.3	10	1896	1367	432561
9	3	96.2	10	1787	1672	674004
10	3	95.4	10	1892	1414	915842
11	1	54.8	10	-	-	162176
12	2	80.4	10	1436	-	403553
13						
14						
15						
16						
17						
18						
19						
20						

**DFS Radar Parameters**  
**FCC Radar Type 5**  
**Channel 102 Bandwidth 40MHz**

Trial Number:			21			Detection (Yes/No)
Number of Bursts in Trial:			16			
Chirp Center Frequency:			5522			
Burst	Number of Pulses	Pulse Width (Microseconds )	Chirp Width (MHz)	Pulse 1-to-2 Spacing (µsec)	Pulse 2-to-3 Spacing (µsec)	Starting Location Within Interval (µsec)
1	2	74.7	15	1611	-	483470
2	1	57.1	15	-	-	666072
3	3	91.9	15	1475	1276	98810
4	2	83.1	15	1772	-	279914
5	1	50.7	15	-	-	462536
6	2	79.2	15	1600	-	642324
7	1	58.7	15	-	-	76831
8	2	71	15	1567	-	257785
9	2	79	15	1960	-	438554
10	2	68.5	15	1428	-	620397
11	2	73.5	15	1352	-	54310
12	2	70.5	15	1115	-	235506
13	2	76.6	15	1300	-	417036
14	2	81.2	15	1675	-	597974
15	1	61.8	15	-	-	32086
16	3	94.9	15	1206	1860	212751
17						
18						
19						
20						

Trial Number:			22			Detection (Yes/No)
Number of Bursts in Trial:			12			
Chirp Center Frequency:			5525			
Burst	Number of Pulses	Pulse Width (Microseconds )	Chirp Width (MHz)	Pulse 1-to-2 Spacing (µsec)	Pulse 2-to-3 Spacing (µsec)	Starting Location Within Interval (µsec)
1	2	78.5	9	1698	-	526149
2	3	89.8	9	1962	1167	767135
3	1	59.4	9	-	-	12955
4	2	79.6	9	1890	-	254612
5	2	76	9	1811	-	496588
6	1	53.6	9	-	-	739728
7	2	80.9	9	1053	-	980872
8	1	61.6	9	-	-	225249
9	1	53.4	9	-	-	467279
10	1	59.9	9	-	-	709720
11	1	60.4	9	-	-	951847
12	3	91.4	9	1726	1227	194839
13						
14						
15						
16						
17						
18						
19						
20						

**DFS Radar Parameters**  
**FCC Radar Type 5**  
**Channel 102 Bandwidth 40MHz**

Trial Number:			23			Detection (Yes/No)
Number of Bursts in Trial:			20			
Chirp Center Frequency:			5520			
Burst	Number of Pulses	Pulse Width (Microseconds)	Chirp Width (MHz)	Pulse 1-to-2 Spacing (µsec)	Pulse 2-to-3 Spacing (µsec)	Starting Location Within Interval (µsec)
1	2	77	20	1363	-	261858
2	1	58.1	20	-	-	407646
3	1	62.1	20	-	-	552319
4	2	76.9	20	1236	-	99107
5	2	80	20	1852	-	243514
6	1	52	20	-	-	389464
7	3	88.6	20	1995	1905	531093
8	2	72.9	20	1387	-	81159
9	3	98.5	20	1746	1389	225245
10	1	57.9	20	-	-	371906
11	3	95.9	20	1870	1066	514197
12	1	53.5	20	-	-	63561
13	3	92	20	1654	1458	207510
14	1	57.3	20	-	-	353638
15	2	70.5	20	1586	-	497515
16	2	70	20	1664	-	45553
17	3	84	20	1630	1176	189821
18	2	76.1	20	1057	-	335330
19	3	93.2	20	1018	1340	478825
20	3	96.8	20	1614	1817	27594

Trial Number:			24			Detection (Yes/No)
Number of Bursts in Trial:			14			
Chirp Center Frequency:			5524			
Burst	Number of Pulses	Pulse Width (Microseconds)	Chirp Width (MHz)	Pulse 1-to-2 Spacing (µsec)	Pulse 2-to-3 Spacing (µsec)	Starting Location Within Interval (µsec)
1	1	50.1	12	-	-	247117
2	3	93.5	12	1081	1413	453362
3	2	68.8	12	1577	-	660875
4	1	56.3	12	-	-	14140
5	3	86	12	1108	1987	220734
6	2	75.2	12	1536	-	428367
7	1	54.4	12	-	-	636681
8	2	71.1	12	1243	-	843157
9	2	76.2	12	1770	-	195585
10	2	80.2	12	1209	-	403231
11	2	79.7	12	1214	-	610202
12	3	90.9	12	1862	1601	815229
13	2	68.7	12	1441	-	170267
14	2	67.4	12	1313	-	377306
15						
16						
17						
18						
19						
20						

**DFS Radar Parameters**  
**FCC Radar Type 5**  
**Channel 102 Bandwidth 40MHz**

Trial Number:			25			Detection (Yes/No)
Number of Bursts in Trial:			13			
Chirp Center Frequency:			5524			
Burst	Number of Pulses	Pulse Width (Microseconds)	Chirp Width (MHz)	Pulse 1-to-2 Spacing (µsec)	Pulse 2-to-3 Spacing (µsec)	Starting Location Within Interval (µsec)
1	3	94	11	1748	1941	628071
2	2	70.8	11	1201	-	853391
3	1	56.3	11	-	-	156223
4	3	96.7	11	1163	1332	378734
5	3	90.6	11	1582	1498	601331
6	2	74.5	11	1281	-	825462
7	3	92.6	11	1669	1222	128265
8	3	89	11	1135	1380	351161
9	3	96.5	11	1822	1602	573425
10	2	70.5	11	1178	-	798431
11	3	94	11	1629	1956	100737
12	1	55.8	11	-	-	324661
13	3	87.7	11	1963	1164	546278
14						
15						
16						
17						
18						
19						
20						

Trial Number:			26			Detection (Yes/No)
Number of Bursts in Trial:			8			
Chirp Center Frequency:			5526			
Burst	Number of Pulses	Pulse Width (Microseconds)	Chirp Width (MHz)	Pulse 1-to-2 Spacing (µsec)	Pulse 2-to-3 Spacing (µsec)	Starting Location Within Interval (µsec)
1	2	68.6	5	1161	-	1253842
2	2	83.1	5	1315	-	119486
3	1	60.9	5	-	-	482958
4	2	77.7	5	1158	-	845641
5	2	77.4	5	1510	-	1208428
6	2	66.8	5	1323	-	74748
7	1	63.7	5	-	-	438300
8	3	91.2	5	1681	1275	800152
9						
10						
11						
12						
13						
14						
15						
16						
17						
18						
19						
20						



**DFS Radar Parameters**  
**FCC Radar Type 5**  
**Channel 102 Bandwidth 40MHz**

Trial Number:			27			Detection (Yes/No)
Number of Bursts in Trial:			17			
Chirp Center Frequency:			5522			
Burst	Number of Pulses	Pulse Width (Microseconds)	Chirp Width (MHz)	Pulse 1-to-2 Spacing (µsec)	Pulse 2-to-3 Spacing (µsec)	Starting Location Within Interval (µsec)
1	3	83.6	16	1195	1000	545865
2	3	89.4	16	1627	1656	14067
3	1	55.8	16	-	-	184953
4	3	90.9	16	1554	1998	353759
5	1	54.7	16	-	-	526388
6	3	97.7	16	1202	1250	694806
7	2	67.5	16	1434	-	163568
8	3	96.7	16	1469	1268	333410
9	2	68.3	16	1954	-	504006
10	2	78.3	16	1082	-	675297
11	1	55	16	-	-	142890
12	3	84.9	16	1936	1199	312479
13	2	74.6	16	1856	-	482953
14	1	63.3	16	-	-	655022
15	3	99.8	16	1515	1120	121457
16	1	63.6	16	-	-	292606
17	3	87.3	16	1051	1831	461322
18						
19						
20						

Trial Number:			28			Detection (Yes/No)
Number of Bursts in Trial:			19			
Chirp Center Frequency:			5521			
Burst	Number of Pulses	Pulse Width (Microseconds)	Chirp Width (MHz)	Pulse 1-to-2 Spacing (µsec)	Pulse 2-to-3 Spacing (µsec)	Starting Location Within Interval (µsec)
1	3	85.6	19	1078	1015	565136
2	2	68.6	19	1780	-	89970
3	1	54.2	19	-	-	243121
4	1	61.2	19	-	-	396034
5	3	97.1	19	1969	1100	546225
6	3	98.3	19	1699	1622	70998
7	1	62.4	19	-	-	224093
8	2	80.2	19	1769	-	376127
9	3	87.5	19	1448	1179	527806
10	3	85.8	19	1348	1472	52247
11	3	88.1	19	1124	1631	204582
12	1	65.3	19	-	-	357941
13	1	52.5	19	-	-	510977
14	1	52.3	19	-	-	33698
15	2	74.1	19	1200	-	186023
16	1	54.9	19	-	-	339327
17	2	76.2	19	1502	-	491053
18	1	60.4	19	-	-	14858
19	2	81.5	19	1103	-	167387
20						

**DFS Radar Parameters**  
**FCC Radar Type 5**  
**Channel 102 Bandwidth 40MHz**

Trial Number:			29			Detection (Yes/No)
Number of Bursts in Trial:			12			
Chirp Center Frequency:			5524			Yes
Burst	Number of Pulses	Pulse Width (Microseconds)	Chirp Width (MHz)	Pulse 1-to-2 Spacing (µsec)	Pulse 2-to-3 Spacing (µsec)	Starting Location Within Interval (µsec)
1	1	50.5	10	-	-	507709
2	1	55.7	10	-	-	750249
3	3	85.8	10	1002	1967	989003
4	2	76.9	10	1474	-	235634
5	2	75.1	10	1052	-	477675
6	3	92.3	10	1486	1492	718312
7	2	78.1	10	1757	-	960895
8	3	92.2	10	1252	1713	205370
9	3	89	10	1706	1411	446940
10	2	70.9	10	1620	-	689225
11	1	63.1	10	-	-	932305
12	1	55.3	10	-	-	176231
13						
14						
15						
16						
17						
18						
19						
20						

Trial Number:			30			Detection (Yes/No)
Number of Bursts in Trial:			18			
Chirp Center Frequency:			5522			Yes
Burst	Number of Pulses	Pulse Width (Microseconds)	Chirp Width (MHz)	Pulse 1-to-2 Spacing (µsec)	Pulse 2-to-3 Spacing (µsec)	Starting Location Within Interval (µsec)
1	3	83.4	17	1205	1801	277485
2	3	97.3	17	1826	1635	437880
3	3	90.4	17	1986	1674	598445
4	3	91.8	17	1151	1802	97088
5	3	98.2	17	1977	1766	257251
6	1	59.5	17	-	-	419893
7	2	80	17	1137	-	580724
8	3	86.5	17	1128	1828	77366
9	3	91.1	17	1599	1442	238032
10	3	93.5	17	1373	1087	398605
11	1	60.7	17	-	-	562025
12	2	67.2	17	1405	-	57684
13	1	61.8	17	-	-	219083
14	2	79.4	17	1667	-	379234
15	2	81.4	17	1464	-	540896
16	1	65.7	17	-	-	37916
17	2	76	17	1255	-	198794
18	2	81	17	1668	-	359754
19						
20						

**DFS Radar Parameters**  
**FCC Radar Type 1**  
**Channel 106 Bandwidth 80MHz**

Trial #	Pulse Repetition Frequency Number (1 to 23)	Pulse Repetition Frequency (Pulses Per Second)	Pulse Repetition Interval (Microseconds)	Detection (Yes / No)
1	22	1066.10	938	Yes
2	10	1432.66	698	Yes
3	6	1618.12	618	Yes
4	2	1858.74	538	Yes
5	19	1138.95	878	Yes
6	12	326.16	3066	Yes
7	7	1567.40	638	Yes
8	21	1089.32	918	Yes
9	17	1193.32	838	Yes
10	18	1165.50	858	Yes
11	15	1253.13	798	Yes
12	11	1392.76	718	Yes
13	4	1730.10	578	Yes
14	5	1672.24	598	Yes
15	3	1792.11	558	Yes
16		394.32	2536	Yes
17		1035.20	966	Yes
18		1209.19	827	Yes
19		399.84	2501	Yes
20		385.36	2595	Yes
21		897.67	1114	Yes
22		768.05	1302	Yes
23		328.41	3045	Yes
24		615.76	1624	Yes
25		347.46	2878	Yes
26		973.71	1027	Yes
27		402.41	2485	Yes
28		625.00	1600	Yes
29		853.24	1172	Yes
30		849.62	1177	Yes

**DFS Radar Parameters**  
**FCC Radar Type 2**  
**Channel 106 Bandwidth 80MHz**

Trial #	Number Pulses per Burst	Pulse Width (Microseconds)	Pulse Repetition Interval (Microseconds)	Detection (Yes / No)
1	26	3.20	179	Yes
2	23	1.10	207	Yes
3	24	2.10	230	Yes
4	29	4.80	200	Yes
5	28	3.90	214	Yes
6	26	2.90	222	Yes
7	26	3.20	204	Yes
8	25	2.50	192	Yes
9	26	3.10	164	Yes
10	23	1.20	156	Yes
11	27	3.90	210	Yes
12	29	4.60	201	Yes
13	26	3.20	162	Yes
14	25	2.20	197	Yes
15	29	4.50	163	Yes
16	26	3.00	203	Yes
17	29	5.00	168	Yes
18	25	2.40	217	Yes
19	26	2.90	191	Yes
20	25	2.30	166	Yes
21	27	3.70	150	Yes
22	25	2.20	176	Yes
23	29	4.90	195	Yes
24	26	2.90	202	Yes
25	25	2.50	178	Yes
26	23	1.10	206	Yes
27	27	3.80	155	Yes
28	29	4.70	157	Yes
29	25	2.40	224	Yes
30	28	4.20	159	Yes

**DFS Radar Parameters**  
**FCC Radar Type 3**  
**Channel 106 Bandwidth 80MHz**

Trial #	Number Pulses per Burst	Pulse Width (Microseconds)	Pulse Repetition Interval (Microseconds)	Detection (Yes / No)
1	17	8.20	355	Yes
2	16	6.10	487	Yes
3	16	7.10	344	Yes
4	18	9.80	288	Yes
5	18	8.90	230	Yes
6	17	7.90	432	Yes
7	17	8.20	207	Yes
8	17	7.50	443	Yes
9	17	8.10	439	Yes
10	16	6.20	223	Yes
11	18	8.90	208	Yes
12	18	9.60	463	Yes
13	17	8.20	441	Yes
14	16	7.20	323	Yes
15	18	9.50	297	Yes
16	17	8.00	412	Yes
17	18	10.00	324	Yes
18	17	7.40	271	Yes
19	17	7.90	349	Yes
20	16	7.30	409	Yes
21	18	8.70	373	Yes
22	16	7.20	254	Yes
23	18	9.90	274	Yes
24	17	7.90	278	Yes
25	17	7.50	317	Yes
26	16	6.10	260	Yes
27	18	8.80	211	Yes
28	18	9.70	272	Yes
29	17	7.40	264	Yes
30	18	9.20	284	Yes

**DFS Radar Parameters**  
**FCC Radar Type 4**  
**Channel 106 Bandwidth 80MHz**

Trial #	Number Pulses per Burst	Pulse Width (Microseconds)	Pulse Repetition Interval (Microseconds)	Detection (Yes / No)
1	14	16.00	355	Yes
2	12	11.30	487	Yes
3	13	13.50	344	Yes
4	16	19.40	288	Yes
5	15	17.50	230	Yes
6	14	15.30	432	Yes
7	14	15.90	207	Yes
8	13	14.30	443	Yes
9	14	15.80	439	Yes
10	12	11.50	223	Yes
11	15	17.40	208	Yes
12	16	19.00	463	Yes
13	14	16.00	441	Yes
14	13	13.80	323	Yes
15	16	18.90	297	Yes
16	14	15.50	412	Yes
17	16	19.90	324	Yes
18	13	14.10	271	Yes
19	14	15.20	349	Yes
20	13	13.80	409	Yes
21	15	17.10	373	Yes
22	13	13.80	254	Yes
23	16	19.80	274	Yes
24	14	15.30	278	Yes
25	13	14.50	317	Yes
26	12	11.30	260	Yes
27	15	17.30	211	Yes
28	16	19.20	272	Yes
29	13	14.20	264	Yes
30	15	18.20	284	Yes

**DFS Radar Parameters**  
**FCC Radar Type 5**  
**Channel 106 Bandwidth 80MHz**

Trial Number:			1			Detection (Yes/No)
Number of Bursts in Trial:			15			
Chirp Center Frequency:			5530			
Burst	Number of Pulses	Pulse Width (Microseconds)	Chirp Width (MHz)	Pulse 1-to-2 Spacing (µsec)	Pulse 2-to-3 Spacing (µsec)	Starting Location Within Interval (µsec)
1	2	77.8	13	1477	-	636185
2	1	51.9	13	-	-	32674
3	1	63.8	13	-	-	226294
4	3	96.6	13	1786	1843	417976
5	3	85.9	13	1215	1729	611152
6	2	73.7	13	1549	-	8789
7	2	77.2	13	1819	-	201917
8	2	68.4	13	1114	-	395530
9	2	76.7	13	1155	-	588564
10	1	53.2	13	-	-	783794
11	3	85.7	13	1695	1394	177933
12	3	94.3	13	1426	1935	370624
13	2	77.6	13	1671	-	564893
14	1	65.7	13	-	-	759583
15	3	93.5	13	1130	1468	154262
16						
17						
18						
19						
20						

Trial Number:			2			Detection (Yes/No)
Number of Bursts in Trial:			8			
Chirp Center Frequency:			5530			
Burst	Number of Pulses	Pulse Width (Microseconds)	Chirp Width (MHz)	Pulse 1-to-2 Spacing (µsec)	Pulse 2-to-3 Spacing (µsec)	Starting Location Within Interval (µsec)
1	2	75	5	1527	-	653020
2	3	99.4	5	1262	1257	1015643
3	2	67.4	5	1403	-	1379398
4	2	73.6	5	1041	-	245489
5	1	65.9	5	-	-	609113
6	3	83.8	5	1292	1419	970852
7	1	65.5	5	-	-	1335913
8	3	98.6	5	1796	1728	200406
9						
10						
11						
12						
13						
14						
15						
16						
17						
18						
19						
20						

**DFS Radar Parameters**  
**FCC Radar Type 5**  
**Channel 106 Bandwidth 80MHz**

Trial Number:			3			Detection (Yes/No)
Number of Bursts in Trial:			11			
Chirp Center Frequency:			5530			
Burst	Number of Pulses	Pulse Width (Microseconds)	Chirp Width (MHz)	Pulse 1-to-2 Spacing (µsec)	Pulse 2-to-3 Spacing (µsec)	Starting Location Within Interval (µsec)
1	2	73.8	9	1538	-	409565
2	2	69.5	9	1649	-	673692
3	1	51.9	9	-	-	938562
4	3	84.6	9	1032	1271	113209
5	3	95.4	9	1903	1388	376726
6	2	68	9	1351	-	641212
7	3	89.6	9	1514	1573	903714
8	2	81.9	9	1689	-	80863
9	3	88.3	9	1330	1838	344067
10	1	53.7	9	-	-	609331
11	3	91.3	9	1106	1001	871542
12						
13						
14						
15						
16						
17						
18						
19						
20						

Trial Number:			4			Detection (Yes/No)
Number of Bursts in Trial:			11			
Chirp Center Frequency:			5530			
Burst	Number of Pulses	Pulse Width (Microseconds)	Chirp Width (MHz)	Pulse 1-to-2 Spacing (µsec)	Pulse 2-to-3 Spacing (µsec)	Starting Location Within Interval (µsec)
1	2	68.1	19	1355	-	26541
2	1	58.7	19	-	-	171821
3	2	75.3	19	1640	-	316229
4	1	56.4	19	-	-	461864
5	3	99.7	19	1708	1159	8677
6	1	57.7	19	-	-	153995
7	1	59.5	19	-	-	299238
8	2	80	19	1369	-	443177
9	2	82	19	1197	-	587671
10	2	82.8	19	1005	-	135674
11	3	88	19	1928	1101	279928
12	3	93.2	19	1907	1223	424279
13	2	70.4	19	1360	-	570132
14	3	95.3	19	1955	1775	117439
15	2	81.9	19	1545	-	262502
16	3	98.5	19	1169	1062	406573
17	1	65	19	-	-	553328
18	3	85.4	19	1637	1425	99799
19	3	91.6	19	1445	1325	244095
20	2	67.3	19	1218	-	390012



**DFS Radar Parameters**  
**FCC Radar Type 5**  
**Channel 106 Bandwidth 80MHz**

Trial Number:			5			Detection (Yes/No)
Number of Bursts in Trial:			17			
Chirp Center Frequency:			5530			Yes
Burst	Number of Pulses	Pulse Width (Microseconds)	Chirp Width (MHz)	Pulse 1-to-2 Spacing ( $\mu$ sec)	Pulse 2-to-3 Spacing ( $\mu$ sec)	Starting Location Within Interval ( $\mu$ sec)
1	2	67.9	16	1133	-	629614
2	1	62.3	16	-	-	96856
3	1	53.3	16	-	-	267719
4	3	90	16	1153	1346	436784
5	2	77.1	16	1646	-	608289
6	3	83.9	16	1232	1459	75610
7	3	89.1	16	1384	1939	245638
8	2	81.8	16	1676	-	416355
9	1	50.3	16	-	-	588736
10	3	87.1	16	1996	1756	54571
11	2	71.3	16	1815	-	225175
12	3	97.5	16	1465	1132	394825
13	3	90.6	16	1040	1354	565361
14	3	86.3	16	1183	1792	33643
15	3	97.6	16	1073	1361	203957
16	3	84.7	16	1718	1854	373812
17	3	99.7	16	1244	1988	544060
18						
19						
20						

Trial Number:			6			Detection (Yes/No)
Number of Bursts in Trial:			14			
Chirp Center Frequency:			5530			Yes
Burst	Number of Pulses	Pulse Width (Microseconds)	Chirp Width (MHz)	Pulse 1-to-2 Spacing ( $\mu$ sec)	Pulse 2-to-3 Spacing ( $\mu$ sec)	Starting Location Within Interval ( $\mu$ sec)
1	3	92.9	12	1564	1407	15438
2	2	67.7	12	1747	-	222486
3	1	65.8	12	-	-	430731
4	1	56.3	12	-	-	637784
5	1	53.7	12	-	-	845342
6	3	83.5	12	1930	1025	196720
7	1	65.8	12	-	-	404955
8	3	85.9	12	1034	1808	610711
9	2	76.3	12	1926	-	818057
10	2	81.5	12	1714	-	171459
11	3	89.4	12	1594	1827	377969
12	1	63.4	12	-	-	586875
13	2	69.6	12	1925	-	792834
14	2	74.5	12	1846	-	146044
15						
16						
17						
18						
19						
20						

**DFS Radar Parameters**  
**FCC Radar Type 5**  
**Channel 106 Bandwidth 80MHz**

Trial Number:			7			Detection (Yes/No)
Number of Bursts in Trial:			15			
Chirp Center Frequency:			5530			
Burst	Number of Pulses	Pulse Width (Microseconds)	Chirp Width (MHz)	Pulse 1-to-2 Spacing (µsec)	Pulse 2-to-3 Spacing (µsec)	Starting Location Within Interval (µsec)
1	1	52.6	10	-	-	51446
2	3	84.1	10	1725	1529	292696
3	3	97.7	10	1868	1805	533989
4	3	97.3	10	1446	1755	775564
5	3	98.8	10	1386	1302	21542
6	2	72.2	10	1184	-	263385
7	2	67.6	10	1027	-	505581
8	2	75.7	10	1871	-	747058
9	1	60.9	10	-	-	989976
10	1	64.2	10	-	-	234024
11	2	78.8	10	1604	-	475207
12	3	87.5	10	1712	1683	715825
13						
14						
15						
16						
17						
18						
19						
20						

Trial Number:			8			Detection (Yes/No)
Number of Bursts in Trial:			12			
Chirp Center Frequency:			5530			
Burst	Number of Pulses	Pulse Width (Microseconds)	Chirp Width (MHz)	Pulse 1-to-2 Spacing (µsec)	Pulse 2-to-3 Spacing (µsec)	Starting Location Within Interval (µsec)
1	1	52.6	10	-	-	51446
2	3	84.1	10	1725	1529	292696
3	3	97.7	10	1868	1805	533989
4	3	97.3	10	1446	1755	775564
5	3	98.8	10	1386	1302	21542
6	2	72.2	10	1184	-	263385
7	2	67.6	10	1027	-	505581
8	2	75.7	10	1871	-	747058
9	1	60.9	10	-	-	989976
10	1	64.2	10	-	-	234024
11	2	78.8	10	1604	-	475207
12	3	87.5	10	1712	1683	715825
13						
14						
15						
16						
17						
18						
19						
20						

**DFS Radar Parameters**  
**FCC Radar Type 5**  
**Channel 106 Bandwidth 80MHz**

Trial Number:			9			Detection (Yes/No)
Number of Bursts in Trial:			14			
Chirp Center Frequency:			5530			
Burst	Number of Pulses	Pulse Width (Microseconds)	Chirp Width (MHz)	Pulse 1-to-2 Spacing (µsec)	Pulse 2-to-3 Spacing (µsec)	Starting Location Within Interval (µsec)
1	1	54.1	13	-	-	823112
2	1	50.7	13	-	-	174965
3	1	52.3	13	-	-	382216
4	3	99.8	13	1696	1949	587395
5	2	68.4	13	1099	-	796897
6	2	80.8	13	1505	-	149042
7	1	62.5	13	-	-	356750
8	2	74.8	13	1204	-	563824
9	1	50.8	13	-	-	772314
10	1	54	13	-	-	123796
11	1	63	13	-	-	331215
12	3	91.8	13	1270	1347	537402
13	2	79.3	13	1992	-	744805
14	1	64.3	13	-	-	98172
15						
16						
17						
18						
19						
20						

Trial Number:			10			Detection (Yes/No)
Number of Bursts in Trial:			8			
Chirp Center Frequency:			5530			
Burst	Number of Pulses	Pulse Width (Microseconds)	Chirp Width (MHz)	Pulse 1-to-2 Spacing (µsec)	Pulse 2-to-3 Spacing (µsec)	Starting Location Within Interval (µsec)
1	1	63.4	6	-	-	535615
2	1	52	6	-	-	898668
3	3	97.2	6	1605	1583	1259235
4	2	78.7	6	1743	-	127106
5	2	74.2	6	1219	-	490358
6	3	88.7	6	1934	1273	852409
7	1	54.3	6	-	-	1217152
8	3	95.4	6	1555	1791	82296
9						
10						
11						
12						
13						
14						
15						
16						
17						
18						
19						
20						

**DFS Radar Parameters**  
**FCC Radar Type 5**  
**Channel 106 Bandwidth 80MHz**

Trial Number:			11			Detection (Yes/No)
Number of Bursts in Trial:			17			
Chirp Center Frequency:			5497			
Burst	Number of Pulses	Pulse Width (Microseconds)	Chirp Width (MHz)	Pulse 1-to-2 Spacing (µsec)	Pulse 2-to-3 Spacing (µsec)	Starting Location Within Interval (µsec)
1	2	73.7	16	1497	-	209249
2	3	97.4	16	1754	1613	378386
3	3	91.7	16	1702	1462	548411
4	1	66.2	16	-	-	17733
5	2	70.8	16	1821	-	187952
6	1	52.3	16	-	-	359277
7	2	78.9	16	1984	-	528886
8	2	70.9	16	1358	-	700166
9	2	75.6	16	1430	-	167197
10	1	59.1	16	-	-	338262
11	2	77	16	1304	-	508324
12	2	67.9	16	1083	-	678689
13	2	81.2	16	1932	-	146031
14	2	78.7	16	1121	-	316923
15	1	63.3	16	-	-	488056
16	2	68.9	16	1423	-	657326
17	1	59.3	16	-	-	125509
18						
19						
20						

Trial Number:			12			Detection (Yes/No)
Number of Bursts in Trial:			19			
Chirp Center Frequency:			5499			
Burst	Number of Pulses	Pulse Width (Microseconds)	Chirp Width (MHz)	Pulse 1-to-2 Spacing (µsec)	Pulse 2-to-3 Spacing (µsec)	Starting Location Within Interval (µsec)
1	3	98.9	19	1680	1488	263736
2	2	82.3	19	1855	-	416459
3	3	86.7	19	1400	1919	567902
4	3	89.7	19	1068	1282	92979
5	3	98.6	19	1194	1461	245155
6	2	71.1	19	1789	-	397609
7	1	55.9	19	-	-	551431
8	2	67.9	19	1372	-	74413
9	3	84.4	19	1107	1443	226559
10	1	58.8	19	-	-	380056
11	1	65.6	19	-	-	533408
12	2	78.5	19	1704	-	55547
13	2	82.3	19	1686	-	207876
14	3	90.1	19	1071	1266	359771
15	3	90.2	19	1089	1950	511297
16	2	83.1	19	1406	-	36803
17	1	58.8	19	-	-	189652
18	2	77	19	1657	-	341809
19	1	55	19	-	-	495737
20						

**DFS Radar Parameters**  
**FCC Radar Type 5**  
**Channel 106 Bandwidth 80MHz**

Trial Number:			13			Detection (Yes/No)
Number of Bursts in Trial:			15			
Chirp Center Frequency:			5496			
Burst	Number of Pulses	Pulse Width (Microseconds)	Chirp Width (MHz)	Pulse 1-to-2 Spacing (µsec)	Pulse 2-to-3 Spacing (µsec)	Starting Location Within Interval (µsec)
1	1	58.1	13	-	-	22911
2	1	52.1	13	-	-	216473
3	1	59.9	13	-	-	410004
4	1	60.2	13	-	-	603671
5	3	95.9	13	1906	1608	794160
6	2	79.9	13	1859	-	192251
7	2	78.5	13	1917	-	385590
8	1	53.8	13	-	-	579862
9	1	64.7	13	-	-	773423
10	1	61.4	13	-	-	168898
11	2	83.2	13	1858	-	361606
12	3	84.7	13	1677	1638	553866
13	3	88.7	13	1528	1058	747241
14	2	78.3	13	1951	-	144710
15	2	69.3	13	1717	-	337856
16						
17						
18						
19						
20						

Trial Number:			14			Detection (Yes/No)
Number of Bursts in Trial:			12			
Chirp Center Frequency:			5495			
Burst	Number of Pulses	Pulse Width (Microseconds)	Chirp Width (MHz)	Pulse 1-to-2 Spacing (µsec)	Pulse 2-to-3 Spacing (µsec)	Starting Location Within Interval (µsec)
1	2	75.3	10	1612	-	664275
2	1	56.3	10	-	-	907886
3	2	67.7	10	1185	-	151316
4	1	55.6	10	-	-	393746
5	2	75.2	10	1267	-	635093
6	2	76.3	10	1305	-	876993
7	3	85.7	10	1362	1924	121278
8	3	98.4	10	1550	1249	362696
9	3	86.4	10	1439	1046	604342
10	3	93.6	10	1031	1452	846453
11	1	63.3	10	-	-	91871
12	3	92.4	10	1673	1322	333050
13						
14						
15						
16						
17						
18						
19						
20						

**DFS Radar Parameters**  
**FCC Radar Type 5**  
**Channel 106 Bandwidth 80MHz**

Trial Number:		15				Detection (Yes/No)
Number of Bursts in Trial:		19				
Chirp Center Frequency:		5498				
Burst	Number of Pulses	Pulse Width (Microseconds )	Chirp Width (MHz)	Pulse 1-to-2 Spacing (µsec)	Pulse 2-to-3 Spacing (µsec)	Starting Location Within Interval (µsec)
1	3	93.3	18	1912	1535	361323
2	2	69.1	18	1794	-	515261
3	3	86.9	18	1152	1148	39025
4	3	84.9	18	1948	1118	190900
5	2	72.3	18	1916	-	343941
6	1	51.7	18	-	-	497624
7	1	58.3	18	-	-	20319
8	1	60.8	18	-	-	172999
9	1	57.1	18	-	-	325872
10	3	88.9	18	1964	1489	475841
11	2	72	18	1297	-	1489
12	3	90.9	18	1566	1370	153647
13	1	59.8	18	-	-	307096
14	2	70	18	1291	-	458804
15	2	67.2	18	1881	-	610798
16	3	91.2	18	1832	1661	134759
17	1	56.5	18	-	-	288306
18	1	51.2	18	-	-	441296
19	2	74.1	18	1245	-	592780
20						

Trial Number:		16				Detection (Yes/No)
Number of Bursts in Trial:		14				
Chirp Center Frequency:		5496				
Burst	Number of Pulses	Pulse Width (Microseconds )	Chirp Width (MHz)	Pulse 1-to-2 Spacing (µsec)	Pulse 2-to-3 Spacing (µsec)	Starting Location Within Interval (µsec)
1	2	76.9	12	1140	-	158286
2	1	50.2	12	-	-	366024
3	1	62.9	12	-	-	573452
4	1	64.7	12	-	-	780619
5	3	83.8	12	1097	1621	132455
6	1	65.4	12	-	-	340207
7	1	53.2	12	-	-	548208
8	1	51.7	12	-	-	755333
9	2	78.7	12	1168	-	107117
10	2	72.4	12	1343	-	314500
11	1	53.8	12	-	-	522447
12	2	73.6	12	1553	-	728517
13	2	66.7	12	1122	-	81611
14	2	82.5	12	1019	-	288948
15						
16						
17						
18						
19						
20						

**DFS Radar Parameters**  
**FCC Radar Type 5**  
**Channel 106 Bandwidth 80MHz**

Trial Number:			17			Detection (Yes/No)
Number of Bursts in Trial:			20			
Chirp Center Frequency:			5499			
Burst	Number of Pulses	Pulse Width (Microseconds)	Chirp Width (MHz)	Pulse 1-to-2 Spacing ( $\mu$ sec)	Pulse 2-to-3 Spacing ( $\mu$ sec)	Starting Location Within Interval ( $\mu$ sec)
1	3	87.6	20	1055	1840	345766
2	3	85.2	20	1541	1408	490019
3	3	84.8	20	1889	1463	39073
4	2	77.9	20	1460	-	183923
5	2	76.5	20	1485	-	328777
6	1	60.9	20	-	-	474728
7	2	83	20	1010	-	21394
8	2	80.4	20	1752	-	165992
9	2	67.5	20	1181	-	310973
10	1	62.1	20	-	-	456884
11	3	86.4	20	1966	1263	3515
12	3	84.3	20	1188	1788	147928
13	2	76.9	20	1537	-	293225
14	3	95.8	20	1298	1844	436922
15	1	55.2	20	-	-	584015
16	1	59	20	-	-	130832
17	3	94.5	20	1700	1283	274684
18	3	91.9	20	1978	1165	418579
19	3	85.2	20	1551	1189	563464
20	2	69.5	20	1224	-	112787

Trial Number:			18			Detection (Yes/No)
Number of Bursts in Trial:			12			
Chirp Center Frequency:			5495			
Burst	Number of Pulses	Pulse Width (Microseconds)	Chirp Width (MHz)	Pulse 1-to-2 Spacing ( $\mu$ sec)	Pulse 2-to-3 Spacing ( $\mu$ sec)	Starting Location Within Interval ( $\mu$ sec)
1	3	86.4	10	1918	1455	429224
2	3	92.2	10	1719	1895	670241
3	2	80.4	10	1899	-	912880
4	1	54.3	10	-	-	158603
5	1	53.1	10	-	-	400824
6	2	69.4	10	1546	-	641915
7	2	69.1	10	1639	-	883823
8	3	100	10	1438	1595	128373
9	2	79.6	10	1705	-	370379
10	3	88.4	10	1579	1623	611194
11	1	53.3	10	-	-	855665
12	1	65.3	10	-	-	98897
13						
14						
15						
16						
17						
18						
19						
20						

**DFS Radar Parameters**  
**FCC Radar Type 5**  
**Channel 106 Bandwidth 80MHz**

Trial Number:			19			Detection (Yes/No)
Number of Bursts in Trial:			14			
Chirp Center Frequency:			5496			
Burst	Number of Pulses	Pulse Width (Microseconds)	Chirp Width (MHz)	Pulse 1-to-2 Spacing (µsec)	Pulse 2-to-3 Spacing (µsec)	Starting Location Within Interval (µsec)
1	1	55.3	12	-	-	292143
2	1	58.3	12	-	-	499633
3	2	72.3	12	1039.000	-	706377
4	3	84.8	12	1761.000	1721.000	58989
5	2	82.5	12	1431.000	-	266161
6	1	63.3	12	-	-	474469
7	2	80	12	1913.000	-	680544
8	3	90.3	12	1853.000	1123.000	33519
9	3	91.1	12	1783.000	1172.000	240319
10	3	96.6	12	1036.000	1385.000	447400
11	2	82.7	12	1990.000	-	654516
12	1	50.7	12	-	-	8083
13	2	78.4	12	1109.000	-	215435
14	3	99.5	12	1965.000	1869.000	421325
15						
16						
17						
18						
19						
20						

Trial Number:			20			Detection (Yes/No)
Number of Bursts in Trial:			12			
Chirp Center Frequency:			5495			
Burst	Number of Pulses	Pulse Width (Microseconds)	Chirp Width (MHz)	Pulse 1-to-2 Spacing (µsec)	Pulse 2-to-3 Spacing (µsec)	Starting Location Within Interval (µsec)
1	3	88.6	10	1067	1927	733725
2	1	57.4	10	-	-	977882
3	3	96.6	10	1658	1324	221197
4	2	69.7	10	1945	-	462915
5	2	77.9	10	1317	-	705071
6	1	62	10	-	-	947923
7	3	88.4	10	1077	1366	191373
8	3	97.3	10	1896	1367	432561
9	3	96.2	10	1787	1672	674004
10	3	95.4	10	1892	1414	915842
11	1	54.8	10	-	-	162176
12	2	80.4	10	1436	-	403553
13						
14						
15						
16						
17						
18						
19						
20						



**DFS Radar Parameters**  
**FCC Radar Type 5**  
**Channel 106 Bandwidth 80MHz**

Trial Number:			21			Detection (Yes/No)
Number of Bursts in Trial:			16			
Chirp Center Frequency:			5563			
Burst	Number of Pulses	Pulse Width (Microseconds)	Chirp Width (MHz)	Pulse 1-to-2 Spacing (µsec)	Pulse 2-to-3 Spacing (µsec)	Starting Location Within Interval (µsec)
1	2	74.7	15	1611	-	483470
2	1	57.1	15	-	-	666072
3	3	91.9	15	1475	1276	98810
4	2	83.1	15	1772	-	279914
5	1	50.7	15	-	-	462536
6	2	79.2	15	1600	-	642324
7	1	58.7	15	-	-	76831
8	2	71	15	1567	-	257785
9	2	79	15	1960	-	438554
10	2	68.5	15	1428	-	620397
11	2	73.5	15	1352	-	54310
12	2	70.5	15	1115	-	235506
13	2	76.6	15	1300	-	417036
14	2	81.2	15	1675	-	597974
15	1	61.8	15	-	-	32086
16	3	94.9	15	1206	1860	212751
17						
18						
19						
20						

Trial Number:			22			Detection (Yes/No)
Number of Bursts in Trial:			12			
Chirp Center Frequency:			5565			
Burst	Number of Pulses	Pulse Width (Microseconds)	Chirp Width (MHz)	Pulse 1-to-2 Spacing (µsec)	Pulse 2-to-3 Spacing (µsec)	Starting Location Within Interval (µsec)
1	2	78.5	9	1698	-	526149
2	3	89.8	9	1962	1167	767135
3	1	59.4	9	-	-	12955
4	2	79.6	9	1890	-	254612
5	2	76	9	1811	-	496588
6	1	53.6	9	-	-	739728
7	2	80.9	9	1053	-	980872
8	1	61.6	9	-	-	225249
9	1	53.4	9	-	-	467279
10	1	59.9	9	-	-	709720
11	1	60.4	9	-	-	951847
12	3	91.4	9	1726	1227	194839
13						
14						
15						
16						
17						
18						
19						
20						

**DFS Radar Parameters**  
**FCC Radar Type 5**  
**Channel 106 Bandwidth 80MHz**

Trial Number:		23				Detection (Yes/No)
Number of Bursts in Trial:		20				
Chirp Center Frequency:		5561				
Burst	Number of Pulses	Pulse Width (Microseconds)	Chirp Width (MHz)	Pulse 1-to-2 Spacing (µsec)	Pulse 2-to-3 Spacing (µsec)	Starting Location Within Interval (µsec)
1	2	77	20	1363	-	261858
2	1	58.1	20	-	-	407646
3	1	62.1	20	-	-	552319
4	2	76.9	20	1236	-	99107
5	2	80	20	1852	-	243514
6	1	52	20	-	-	389464
7	3	88.6	20	1995	1905	531093
8	2	72.9	20	1387	-	81159
9	3	98.5	20	1746	1389	225245
10	1	57.9	20	-	-	371906
11	3	95.9	20	1870	1066	514197
12	1	53.5	20	-	-	63561
13	3	92	20	1654	1458	207510
14	1	57.3	20	-	-	353638
15	2	70.5	20	1586	-	497515
16	2	70	20	1664	-	45553
17	3	84	20	1630	1176	189821
18	2	76.1	20	1057	-	335330
19	3	93.2	20	1018	1340	478825
20	3	96.8	20	1614	1817	27594

Trial Number:		24				Detection (Yes/No)
Number of Bursts in Trial:		14				
Chirp Center Frequency:		5564				
Burst	Number of Pulses	Pulse Width (Microseconds)	Chirp Width (MHz)	Pulse 1-to-2 Spacing (µsec)	Pulse 2-to-3 Spacing (µsec)	Starting Location Within Interval (µsec)
1	1	50.1	12	-	-	247117
2	3	93.5	12	1081	1413	453362
3	2	68.8	12	1577	-	660875
4	1	56.3	12	-	-	14140
5	3	86	12	1108	1987	220734
6	2	75.2	12	1536	-	428367
7	1	54.4	12	-	-	636681
8	2	71.1	12	1243	-	843157
9	2	76.2	12	1770	-	195585
10	2	80.2	12	1209	-	403231
11	2	79.7	12	1214	-	610202
12	3	90.9	12	1862	1601	815229
13	2	68.7	12	1441	-	170267
14	2	67.4	12	1313	-	377306
15						
16						
17						
18						
19						
20						

**DFS Radar Parameters**  
**FCC Radar Type 5**  
**Channel 106 Bandwidth 80MHz**

Trial Number:			25			Detection (Yes/No)
Number of Bursts in Trial:			13			
Chirp Center Frequency:			5565			
Burst	Number of Pulses	Pulse Width (Microseconds)	Chirp Width (MHz)	Pulse 1-to-2 Spacing (µsec)	Pulse 2-to-3 Spacing (µsec)	Starting Location Within Interval (µsec)
1	3	94	11	1748	1941	628071
2	2	70.8	11	1201	-	853391
3	1	56.3	11	-	-	156223
4	3	96.7	11	1163	1332	378734
5	3	90.6	11	1582	1498	601331
6	2	74.5	11	1281	-	825462
7	3	92.6	11	1669	1222	128265
8	3	89	11	1135	1380	351161
9	3	96.5	11	1822	1602	573425
10	2	70.5	11	1178	-	798431
11	3	94	11	1629	1956	100737
12	1	55.8	11	-	-	324661
13	3	87.7	11	1963	1164	546278
14						
15						
16						
17						
18						
19						
20						

Trial Number:			26			Detection (Yes/No)
Number of Bursts in Trial:			8			
Chirp Center Frequency:			5567			
Burst	Number of Pulses	Pulse Width (Microseconds)	Chirp Width (MHz)	Pulse 1-to-2 Spacing (µsec)	Pulse 2-to-3 Spacing (µsec)	Starting Location Within Interval (µsec)
1	2	68.6	5	1161	-	1253842
2	2	83.1	5	1315	-	119486
3	1	60.9	5	-	-	482958
4	2	77.7	5	1158	-	845641
5	2	77.4	5	1510	-	1208428
6	2	66.8	5	1323	-	74748
7	1	63.7	5	-	-	438300
8	3	91.2	5	1681	1275	800152
9						
10						
11						
12						
13						
14						
15						
16						
17						
18						
19						
20						

**DFS Radar Parameters**  
**FCC Radar Type 5**  
**Channel 106 Bandwidth 80MHz**

Trial Number:			27			Detection (Yes/No)
Number of Bursts in Trial:			17			
Chirp Center Frequency:			5563			
Burst	Number of Pulses	Pulse Width (Microseconds)	Chirp Width (MHz)	Pulse 1-to-2 Spacing (µsec)	Pulse 2-to-3 Spacing (µsec)	Starting Location Within Interval (µsec)
1	3	83.6	16	1195	1000	545865
2	3	89.4	16	1627	1656	14067
3	1	55.8	16	-	-	184953
4	3	90.9	16	1554	1998	353759
5	1	54.7	16	-	-	526388
6	3	97.7	16	1202	1250	694806
7	2	67.5	16	1434	-	163568
8	3	96.7	16	1469	1268	333410
9	2	68.3	16	1954	-	504006
10	2	78.3	16	1082	-	675297
11	1	55	16	-	-	142890
12	3	84.9	16	1936	1199	312479
13	2	74.6	16	1856	-	482953
14	1	63.3	16	-	-	655022
15	3	99.8	16	1515	1120	121457
16	1	63.6	16	-	-	292606
17	3	87.3	16	1051	1831	461322
18						
19						
20						

Trial Number:			28			Detection (Yes/No)
Number of Bursts in Trial:			19			
Chirp Center Frequency:			5561			
Burst	Number of Pulses	Pulse Width (Microseconds)	Chirp Width (MHz)	Pulse 1-to-2 Spacing (µsec)	Pulse 2-to-3 Spacing (µsec)	Starting Location Within Interval (µsec)
1	3	85.6	19	1078	1015	565136
2	2	68.6	19	1780	-	89970
3	1	54.2	19	-	-	243121
4	1	61.2	19	-	-	396034
5	3	97.1	19	1969	1100	546225
6	3	98.3	19	1699	1622	70998
7	1	62.4	19	-	-	224093
8	2	80.2	19	1769	-	376127
9	3	87.5	19	1448	1179	527806
10	3	85.8	19	1348	1472	52247
11	3	88.1	19	1124	1631	204582
12	1	65.3	19	-	-	357941
13	1	52.5	19	-	-	510977
14	1	52.3	19	-	-	33698
15	2	74.1	19	1200	-	186023
16	1	54.9	19	-	-	339327
17	2	76.2	19	1502	-	491053
18	1	60.4	19	-	-	14858
19	2	81.5	19	1103	-	167387
20						

**DFS Radar Parameters**  
**FCC Radar Type 5**  
**Channel 106 Bandwidth 80MHz**

Trial Number:			29			Detection (Yes/No)
Number of Bursts in Trial:			12			
Chirp Center Frequency:			5565			
Burst	Number of Pulses	Pulse Width (Microseconds)	Chirp Width (MHz)	Pulse 1-to-2 Spacing (µsec)	Pulse 2-to-3 Spacing (µsec)	Starting Location Within Interval (µsec)
1	1	50.5	10	-	-	507709
2	1	55.7	10	-	-	750249
3	3	85.8	10	1002	1967	989003
4	2	76.9	10	1474	-	235634
5	2	75.1	10	1052	-	477675
6	3	92.3	10	1486	1492	718312
7	2	78.1	10	1757	-	960895
8	3	92.2	10	1252	1713	205370
9	3	89	10	1706	1411	446940
10	2	70.9	10	1620	-	689225
11	1	63.1	10	-	-	932305
12	1	55.3	10	-	-	176231
13						
14						
15						
16						
17						
18						
19						
20						

Trial Number:			30			Detection (Yes/No)
Number of Bursts in Trial:			18			
Chirp Center Frequency:			5562			
Burst	Number of Pulses	Pulse Width (Microseconds)	Chirp Width (MHz)	Pulse 1-to-2 Spacing (µsec)	Pulse 2-to-3 Spacing (µsec)	Starting Location Within Interval (µsec)
1	3	83.4	17	1205	1801	277485
2	3	97.3	17	1826	1635	437880
3	3	90.4	17	1986	1674	598445
4	3	91.8	17	1151	1802	97088
5	3	98.2	17	1977	1766	257251
6	1	59.5	17	-	-	419893
7	2	80	17	1137	-	580724
8	3	86.5	17	1128	1828	77366
9	3	91.1	17	1599	1442	238032
10	3	93.5	17	1373	1087	398605
11	1	60.7	17	-	-	562025
12	2	67.2	17	1405	-	57684
13	1	61.8	17	-	-	219083
14	2	79.4	17	1667	-	379234
15	2	81.4	17	1464	-	540896
16	1	65.7	17	-	-	37916
17	2	76	17	1255	-	198794
18	2	81	17	1668	-	359754
19						
20						

—THE END—