

FCC Test Report

Report No.: RF150728C08-1

FCC ID: TVE-23155111

Test Model: FORTIWIFI-60E-DR

Series Model: FORTIWIFI-60E-DRxxxxxx, FWF-60E-DRxxxxxx (where "x" can be used for "A-Z", or "0-9", or "-", or blank for software changes or marketing purposes only)

Received Date: Aug. 07, 2015

Test Date: Sep. 03 ~ Sep. 08, 2015

Issued Date: Oct. 06, 2015

Applicant: Fortinet Inc.

Address: 899 Kifer Road Sunnyvale, CA 94086 USA

Issued By: Bureau Veritas Consumer Products Services (H.K.) Ltd., Taoyuan Branch

Lab Address: No. 47-2, 14th Ling, Chia Pau Vil., Lin Kou Dist., New Taipei City, Taiwan

Test Location: No. 19, Hwa Ya 2nd Rd., Wen Hwa Vil., Kwei Shan Dist., Taoyuan City 33383, TAIWAN (R.O.C.)



This report is for your exclusive use. Any copying or replication of this report to or for any other person or entity, or use of our name or trademark, is permitted only with our prior written permission. This report sets forth our findings solely with respect to the test samples identified herein. The results set forth in this report are not indicative or representative of the quality or characteristics of the lot from which a test sample was taken or any similar or identical product unless specifically and expressly noted. Our report includes all of the tests requested by you and the results thereof based upon the information that you provided to us. You have 60 days from date of issuance of this report to notify us of any material error or omission caused by our negligence, provided, however, that such notice shall be in writing and shall specifically address the issue you wish to raise. A failure to raise such issue within the prescribed time shall constitute your unqualified acceptance of the completeness of this report, the tests conducted and the correctness of the report contents. Unless specifically mentioned, the uncertainty of measurement has been explicitly taken into account to declare the compliance or non-compliance to the specification. The report must not be used by the client to claim product certification, approval, or endorsement by TAF or any government agencies.

Table of Contents

Release Control Record	4
1 Certificate of Conformity	5
2 Summary of Test Results	6
2.1 Measurement Uncertainty.....	6
2.2 Modification Record.....	6
3 General Information	7
3.1 General Description of EUT.....	7
3.2 Description of Test Modes.....	9
3.2.1 Test Mode Applicability and Tested Channel Detail.....	10
3.3 Duty Cycle of Test Signal.....	12
3.4 Description of Support Units.....	13
3.4.1 Configuration of System under Test.....	13
3.5 General Description of Applied Standard.....	14
4 Test Types and Results	15
4.1 Radiated Emission and Bandedge Measurement.....	15
4.1.1 Limits of Radiated Emission and Bandedge Measurement.....	15
4.1.2 Test Instruments.....	16
4.1.3 Test Procedure.....	17
4.1.4 Deviation from Test Standard.....	17
4.1.5 Test Setup.....	18
4.1.6 EUT Operating Conditions.....	18
4.1.7 Test Results.....	19
4.2 Conducted Emission Measurement.....	38
4.2.1 Limits of Conducted Emission Measurement.....	38
4.2.2 Test Instruments.....	38
4.2.3 Test Procedure.....	39
4.2.4 Deviation from Test Standard.....	39
4.2.5 Test Setup.....	39
4.2.6 EUT Operating Conditions.....	39
4.2.7 Test Results.....	40
4.3 Transmit Power Measurement.....	42
4.3.1 Limits of Transmit Power Measurement.....	42
4.3.2 Test Setup.....	42
4.3.3 Test Instruments.....	42
4.3.4 Test Procedure.....	43
4.3.5 Deviation from Test Standard.....	43
4.3.6 EUT Operating Conditions.....	43
4.3.7 Test Result.....	44
4.4 Peak Power Spectral Density Measurement.....	50
4.4.1 Limits of Peak Power Spectral Density Measurement.....	50
4.4.2 Test Setup.....	50
4.4.3 Test Instruments.....	50
4.4.4 Test Procedure.....	50
4.4.5 Deviation from Test Standard.....	51
4.4.6 EUT Operating Condition.....	51
4.4.7 Test Results.....	52
4.5 Frequency Stability.....	58
4.5.1 Limits of Frequency Stability Measurement.....	58
4.5.2 Test Setup.....	58
4.5.3 Test Instruments.....	58
4.5.4 Test Procedure.....	58
4.5.5 Deviation from Test Standard.....	58
4.5.6 EUT Operating Condition.....	58



4.5.7 Test Results	59
4.6 6dB Bandwidth Measurement	60
4.6.1 Limits of 6dB Bandwidth Measurement	60
4.6.2 Test Setup	60
4.6.3 Test Instruments	60
4.6.4 Test Procedure	60
4.6.5 Deviation from Test Standard	60
4.6.6 EUT Operating Condition	60
4.6.7 Test Results	61
5 Pictures of Test Arrangements	63
Appendix – Information on the Testing Laboratories	64



A D T

Release Control Record

Issue No.	Description	Date Issued
RF150728C08-1	Original release.	Oct. 06, 2015

1 Certificate of Conformity

Product: Network Security Gateway

Brand: Fortinet Inc.

Test Model: FORTIWIFI-60E-DR

Series Model: FORTIWIFI-60E-DRxxxxxx, FWF-60E-DRxxxxxx (where "x" can be used for "A-Z", or "0-9", or "-", or blank for software changes or marketing purposes only)

Sample Status: Engineering sample

Applicant: Fortinet Inc.

Test Date: Sep. 03 ~ Sep. 08, 2015

Standard: 47 CFR FCC Part 15, Subpart E (Section 15.407)
ANSI C63.10:2013

The above equipment has been tested by **Bureau Veritas Consumer Products Services (H.K.) Ltd., Taoyuan Branch**, and found compliance with the requirement of the above standards. The test record, data evaluation & Equipment Under Test (EUT) configurations represented herein are true and accurate accounts of the measurements of the sample's EMC characteristics under the Conditions specified in this report.

Prepared by :  , **Date:** Oct. 06, 2015
Pettie Chen / Senior Specialist

Approved by :  , **Date:** Oct. 06, 2015
Ken Liu / Senior Manager

2 Summary of Test Results

47 CFR FCC Part 15, Subpart E (SECTION 15.407)			
FCC Clause	Test Item	Result	Remarks
15.407(b)(6)	AC Power Conducted Emissions	PASS	Meet the requirement of limit. Minimum passing margin is -21.31dB at 0.50156MHz.
15.407(b)(1/2/3/4/6)	Radiated Emissions & Band Edge Measurement	PASS	Meet the requirement of limit. Minimum passing margin is -1.0dB at 5714.00, 5714.90MHz.
15.407(a)(1/2/3)	Max Average Transmit Power	PASS	Meet the requirement of limit.
15.407(a)(1/2/3)	Peak Power Spectral Density	PASS	Meet the requirement of limit.
15.407(e)	6dB bandwidth	PASS	Meet the requirement of limit. (U-NII-3 Band only)
15.407(g)	Frequency Stability	PASS	Meet the requirement of limit.
15.203	Antenna Requirement	Pass	Antenna connector is RP-SMA not a standard connector.

2.1 Measurement Uncertainty

Where relevant, the following measurement uncertainty levels have been estimated for tests performed on the EUT as specified in CISPR 16-4-2:

Measurement	Frequency	Expanded Uncertainty (k=2) (\pm)
Conducted Emissions at mains ports	150kHz ~ 30MHz	2.44 dB
Radiated Emissions up to 1 GHz	30MHz ~ 200MHz	3.86 dB
	200MHz ~ 1000MHz	3.87 dB
Radiated Emissions above 1 GHz	1GHz ~ 18GHz	2.29 dB
	18GHz ~ 40GHz	2.29 dB

2.2 Modification Record

There were no modifications required for compliance.

3 General Information

3.1 General Description of EUT

Product	Network Security Gateway
Brand	Fortinet Inc.
Test Model	FORTIWIFI-60E-DR
Series Model	FORTIWIFI-60E-DRxxxxxx, FWF-60E-DRxxxxxx (where "x" can be used for "A-Z", or "0-9", or "-", or blank for software changes or marketing purposes only)
Status of EUT	Engineering sample
Power Supply Rating	12Vdc from adapter
Modulation Type	256QAM, 64QAM, 16QAM, QPSK, BPSK
Modulation Technology	OFDM
Transfer Rate	802.11a: 54.0/ 48.0/ 36.0/ 24.0/ 18.0/ 12.0/ 9.0/ 6.0Mbps 802.11n: up to 450.0Mbps 802.11ac: up to 1300Mbps
Operating Frequency	5180 ~ 5240MHz & 5745 ~ 5825MHz
Number of Channel	5180 ~ 5240MHz: 4 for 802.11a, 802.11n (HT20), 802.11ac (VHT20) 2 for 802.11n (HT40), 802.11ac (VHT40) 1 for 802.11ac (VHT80) 5745 ~ 5825MHz: 5 for 802.11a, 802.11n (HT20), 802.11ac (VHT20) 2 for 802.11n (HT40), 802.11ac (VHT40) 1 for 802.11ac (VHT80)
Output Power	5180 ~ 5240MHz: 498.434mW 5745 ~ 5825MHz: 390.614mW
Antenna Type	Refer to Note
Antenna Connector	Refer to Note
Accessory Device	NA
Data Cable Supplied	1.85m non-shielded console cable without core 2.2m non-shielded RJ45 cable without core

Note:

1. All models are listed as below.

Brand	Model	
Fortinet Inc.	FORTIWIFI-60E-DRxxxxxx	where "x" can be used for "A-Z", or "0-9", or "-", or blank for software changes or marketing purposes only
	(Main test model: FORTIWIFI-60E-DR)	
	FWF-60E-DRxxxxxx	

2. The EUT incorporates a MIMO function. Physically, the EUT provides 3 completed transmitters and 3 receivers.

Modulation Mode	TX Function
802.11a	3TX
802.11n (HT20)	3TX
802.11n (HT40)	3TX
802.11ac (VHT20)	3TX
802.11ac (VHT40)	3TX
802.11ac (VHT80)	3TX

* The EUT doesn't support diversity function.

* The modulation and bandwidth are similar between 802.11n mode for HT20 / HT40 and 802.11ac mode for VHT20 / VHT40, and therefore investigated worst case to representative mode in test report. (Final test mode refer section 3.2.1)

3. The EUT consumes power from the following adapter.

Adapter	
Brand	Asian Power Devices Inc.
Model	WA-30B12
Input Power	100-240Vac~50-60Hz, 0.8A Max
Output Power	12Vdc / 2.5A
Power Line	DC 1.5m power cable with 1 core attached on adapter

4. The following antennas were provided to the EUT.

Type	Gain(dBi)		Connector
	2.4GHz Band	5GHz Band	
Dipole	3dBi	3dBi	RP-SMA

5. The above EUT information is declared by manufacturer and for more detailed features description, please refer to the manufacturer's specifications or user's manual.

3.2 Description of Test Modes

FOR 5180 ~ 5240MHz

4 channels are provided for 802.11a, 802.11n (HT20), 802.11ac (VHT20):

Channel	Frequency	Channel	Frequency
36	5180 MHz	44	5220 MHz
40	5200 MHz	48	5240 MHz

2 channels are provided for 802.11n (HT40), 802.11ac (40MHz):

Channel	Frequency	Channel	Frequency
38	5190 MHz	46	5230 MHz

1 channel is provided for 802.11ac (VHT80):

Channel	Frequency
42	5210MHz

FOR 5745 ~ 5825MHz:

5 channels are provided for 802.11a, 802.11n (HT20), 802.11ac (VHT20):

Channel	Frequency	Channel	Frequency
149	5745MHz	161	5805MHz
153	5765MHz	165	5825MHz
157	5785MHz		

2 channels are provided for 802.11n (HT40), 802.11ac (VHT40):

Channel	Frequency	Channel	Frequency
151	5755MHz	159	5795MHz

1 channel is provided for 802.11ac (VHT80):

Channel	Frequency
155	5775MHz

3.2.1 Test Mode Applicability and Tested Channel Detail

EUT CONFIGURE MODE	APPLICABLE TO				DESCRIPTION
	RE≥1G	RE<1G	PLC	APCM	
-	√	√	√	√	-

Where **RE≥1G**: Radiated Emission above 1GHz **RE<1G**: Radiated Emission below 1GHz
PLC: Power Line Conducted Emission **APCM**: Antenna Port Conducted Measurement

Note: 1. The EUT had been pre-tested on the positioned of each 3 axis. The worst case was found when positioned on **X-plane**.

Radiated Emission Test (Above 1GHz):

- Pre-Scan has been conducted to determine the worst-case mode from all possible combinations between available modulations, data rates and antenna ports (if EUT with antenna diversity architecture).
- Following channel(s) was (were) selected for the final test as listed below.

EUT CONFIGURE MODE	MODE	FREQ. BAND (MHz)	AVAILABLE CHANNEL	TESTED CHANNEL	MODULATION TECHNOLOGY	MODULATION TYPE	DATA RATE (Mbps)
-	802.11a	5180-5240	36 to 48	36, 40, 48	OFDM	BPSK	6.0
-	802.11n (HT20)		36 to 48	36, 40, 48	OFDM	BPSK	6.5
-	802.11n (HT40)		38 to 46	38, 46	OFDM	BPSK	13.5
-	802.11ac (VHT80)		42	42	OFDM	BPSK	97.5
-	802.11a	5745-5825	149 to 165	149, 157, 165	OFDM	BPSK	6.0
-	802.11n (HT20)		149 to 165	149, 157, 165	OFDM	BPSK	6.5
-	802.11n (HT40)		151 to 159	151, 159	OFDM	BPSK	13.5
-	802.11ac (VHT80)		155	155	OFDM	BPSK	97.5

Radiated Emission Test (Below 1GHz):

- Pre-Scan has been conducted to determine the worst-case mode from all possible combinations between available modulations, data rates and antenna ports (if EUT with antenna diversity architecture).
- Following channel(s) was (were) selected for the final test as listed below.

EUT CONFIGURE MODE	MODE	FREQ. BAND (MHz)	AVAILABLE CHANNEL	TESTED CHANNEL	MODULATION TECHNOLOGY	MODULATION TYPE	DATA RATE (Mbps)
-	802.11n (HT20)	5180-5320 5745-5825	36 to 64 149 to 165	40	OFDM	BPSK	6.5

Power Line Conducted Emission Test:

- Pre-Scan has been conducted to determine the worst-case mode from all possible combinations between available modulations, data rates and antenna ports (if EUT with antenna diversity architecture).
- Following channel(s) was (were) selected for the final test as listed below.

EUT CONFIGURE MODE	MODE	FREQ. BAND (MHz)	AVAILABLE CHANNEL	TESTED CHANNEL	MODULATION TECHNOLOGY	MODULATION TYPE	DATA RATE (Mbps)
-	802.11n (HT20)	5180-5320 5745-5825	36 to 64 149 to 165	40	OFDM	BPSK	6.5

Antenna Port Conducted Measurement:

- This item includes all test value of each mode, but only includes spectrum plot of worst value of each mode.
- Pre-Scan has been conducted to determine the worst-case mode from all possible combinations between available modulations, data rates and antenna ports (if EUT with antenna diversity architecture).
- Following channel(s) was (were) selected for the final test as listed below.

EUT CONFIGURE MODE	MODE	FREQ. BAND (MHz)	AVAILABLE CHANNEL	TESTED CHANNEL	MODULATION TECHNOLOGY	MODULATION TYPE	DATA RATE (Mbps)
-	802.11a	5180-5240	36 to 48	36, 40, 48	OFDM	BPSK	6.0
-	802.11n (HT20)		36 to 48	36, 40, 48	OFDM	BPSK	6.5
-	802.11n (HT40)		38 to 46	38, 46	OFDM	BPSK	13.5
-	802.11ac (VHT80)		42	42	OFDM	BPSK	97.5
-	802.11a	5745-5825	149 to 165	149, 157, 165	OFDM	BPSK	6.0
-	802.11n (HT20)		149 to 165	149, 157, 165	OFDM	BPSK	6.5
-	802.11n (HT40)		151 to 159	151, 159	OFDM	BPSK	13.5
-	802.11ac (VHT80)		155	155	OFDM	BPSK	97.5

Test Condition:

APPLICABLE TO	ENVIRONMENTAL CONDITIONS	INPUT POWER	TESTED BY
RE≥1G	18deg. C, 70%RH	120Vac, 60Hz	Nick Hsu
RE<1G	18deg. C, 70%RH	120Vac, 60Hz	Jones Chang
PLC	20deg. C, 66%RH	120Vac, 60Hz	Jones Chang
APCM	25deg. C, 60%RH	120Vac, 60Hz	Antony Lee

3.3 Duty Cycle of Test Signal

Duty cycle of test signal is < 98%, duty factor shall be considered.

802.11a: Duty cycle = $1.963/2.213 = 0.887$, Duty factor = $10 * \log(1/0.887) = 0.52$

802.11n (HT20): Duty cycle = $1.825/1.963 = 0.93$, Duty factor = $10 * \log(1/0.93) = 0.32$

802.11n (HT40): Duty cycle = $0.862/1.075 = 0.802$, Duty factor = $10 * \log(1/0.802) = 0.96$

802.11ac (VHT80): Duty cycle = $0.425/0.588 = 0.723$, Duty factor = $10 * \log(1/0.723) = 1.41$

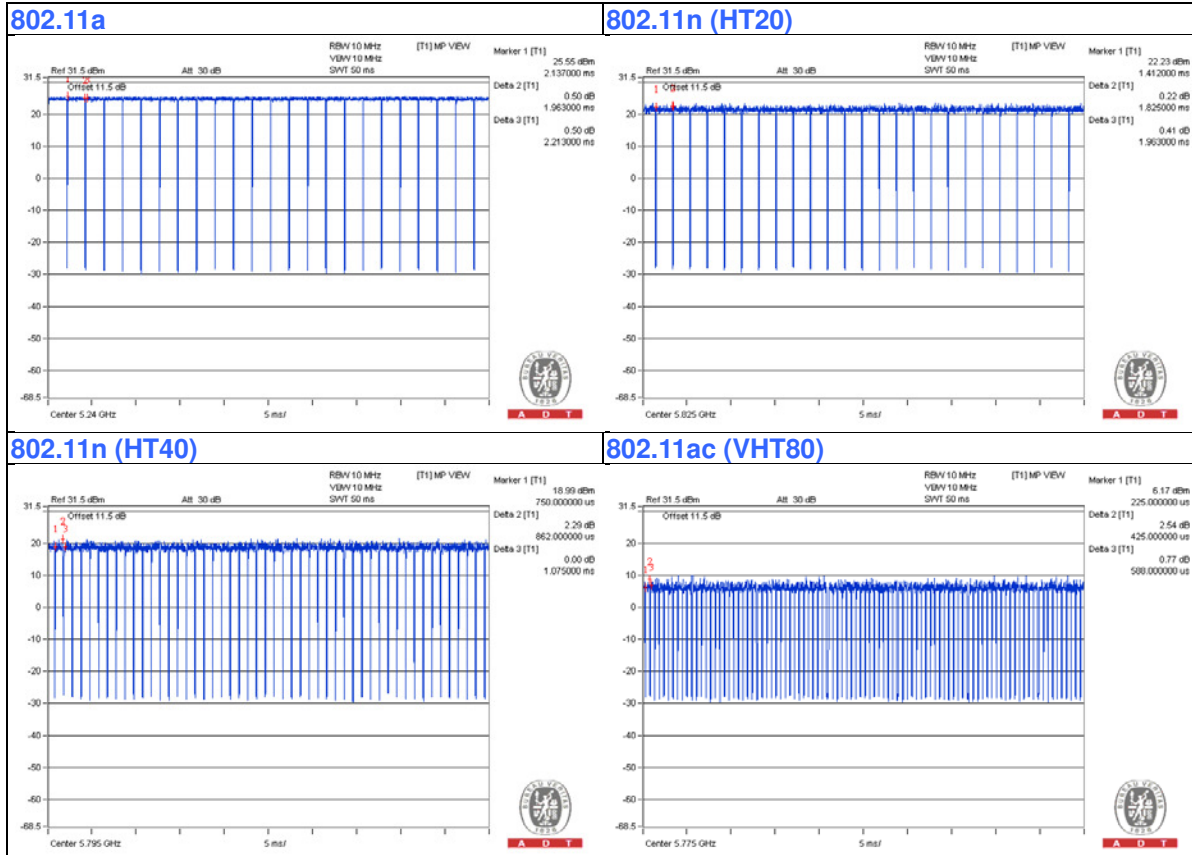

3.4 Description of Support Units

The EUT has been tested as an independent unit together with other necessary accessories or support units. The following support units or accessories were used to form a representative test configuration during the tests.

ID	Product	Brand	Model No.	Serial No.	FCC ID	Remarks
A.	Notebook	DELL	E5410	1HC2XM1	FCC DoC Approved	-
B.	USB 3.0 Hard Disk	WD	WDBACY5000ABL	WX41A81P8576	FCC DoC Approved	-
C.	Load	NA	NA	NA	NA	-

Note:

1. All power cords of the above support units are non-shielded (1.8m).
2. Item A acted as communication partners to transfer data.

ID	Descriptions	Qty.	Length (m)	Shielding (Yes/No)	Cores (Qty.)	Remarks
1.	LAN cable	1	3	N	0	Cat5e
2.	LAN cable	9	1.8	N	0	Cat5e
3.	USB cable	1	0.5	Y	0	-
4.	Console cable	1	1.85	N	0	Accessory of EUT

Note: The core(s) is(are) originally attached to the cable(s).

3.4.1 Configuration of System under Test

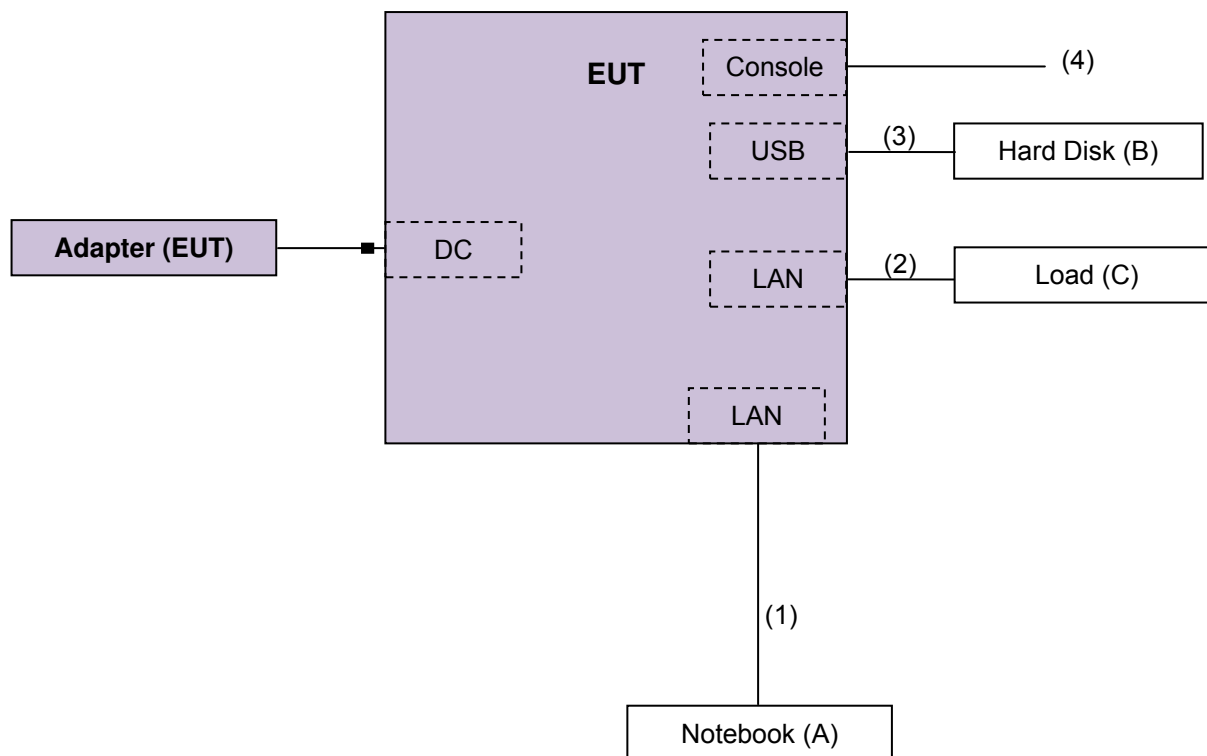

3.5 General Description of Applied Standard

The EUT is a RF Product. According to the specifications of the manufacturer, it must comply with the requirements of the following standards:

FCC Part 15, Subpart E (15.407)
789033 D02 General UNII Test Procedure New Rules v01
662911 D01 Multiple Transmitter Output v02r01
ANSI C63.10-2013

All test items have been performed and recorded as per the above standards.

NOTE: The EUT has been verified to comply with the requirements of FCC Part 15, Subpart B, Class B (DoC). The test report has been issued separately.

4 Test Types and Results

4.1 Radiated Emission and Bandedge Measurement

4.1.1 Limits of Radiated Emission and Bandedge Measurement

Radiated emissions which fall in the restricted bands must comply with the radiated emission limits specified as below table.

Frequencies (MHz)	Field Strength (microvolts/meter)	Measurement Distance (meters)
0.009 ~ 0.490	2400/F(kHz)	300
0.490 ~ 1.705	24000/F(kHz)	30
1.705 ~ 30.0	30	30
30 ~ 88	100	3
88 ~ 216	150	3
216 ~ 960	200	3
Above 960	500	3

NOTE:

1. The lower limit shall apply at the transition frequencies.
2. Emission level (dBuV/m) = 20 log Emission level (uV/m).
3. For frequencies above 1000MHz, the field strength limits are based on average detector, however, the peak field strength of any emission shall not exceed the maximum permitted average limits, specified above by more than 20dB under any Condition of modulation.

LIMITS OF UNWANTED EMISSION OUT OF THE RESTRICTED BANDS

APPLICABLE TO	LIMIT	
789033 D02 General UNII Test Procedure New Rules v01	FIELD STRENGTH AT 3m	
	PK:74 (dBuV/m)	AV:54 (dBuV/m)
APPLICABLE TO	EIRP LIMIT	EQUIVALENT FIELD STRENGTH AT 3m
15.407(b)(1)	PK:-27 (dBm/MHz)	PK:68.2(dBuV/m)
15.407(b)(2)		
15.407(b)(3)		
15.407(b)(4)	PK:-27 (dBm/MHz) ^{*1} PK:-17 (dBm/MHz) ^{*2}	PK: 68.2(dBuV/m) ^{*1} PK:78.2 (dBuV/m) ^{*2}

NOTE: ^{*1} beyond 10MHz of the band edge ^{*2} within 10 MHz of band edge

The following formula is used to convert the equipment isotropic radiated power (eirp) to field strength:

$$E = \frac{1000000\sqrt{30P}}{3} \mu\text{V/m, where P is the eirp (Watts).}$$

4.1.2 Test Instruments

Description & Manufacturer	Model No.	Serial No.	Cal. Date	Cal. Due
Test Receiver ROHDE & SCHWARZ	ESIB7	100187	Apr. 10, 2015	Apr. 09, 2016
Spectrum Analyzer ROHDE & SCHWARZ	FSP40	100041	Sep. 02, 2015	Sep. 01, 2016
BILOG Antenna SCHWARZBECK	VULB9168	9168-160	Feb. 05, 2015	Feb. 04, 2016
HORN Antenna SCHWARZBECK	9120D	209	Feb. 09, 2015	Feb. 08, 2016
HORN Antenna SCHWARZBECK	BBHA 9170	BBHA9170241	Feb. 09, 2015	Feb. 08, 2016
Preamplifier Agilent	8447D	2944A10738	Oct.18, 2014	Oct. 17, 2015
Preamplifier Agilent	8449B	3008A01964	Aug. 22, 2015	Aug. 21, 2016
RF signal cable HUBER+SUHNNER	SUCOFLEX 104	Cable-CH3-03 (214378)	Aug. 22, 2015	Aug. 21, 2016
RF signal cable HUBER+SUHNNER	SUCOFLEX 106	Cable-CH3-03 (309224+12738)	Aug. 22, 2015	Aug. 21, 2016
Software BV ADT	ADT_Radiated_ V7.6.15.9.4	NA	NA	NA
Antenna Tower inn-co GmbH	MA 4000	013303	NA	NA
Antenna Tower Controller BV ADT	AT100	AT93021702	NA	NA
Turn Table BV ADT	TT100	TT93021702	NA	NA
Turn Table Controller BV ADT	SC100	SC93021702	NA	NA
High Speed Peak Power Meter	ML2495A	0824011	Jul. 09, 2015	Jul. 08, 2016
Power Sensor	MA2411B	0738171	Jul. 09, 2015	Jul. 08, 2016
26GHz ~ 40GHz Amplifier	EM26400	815221	Oct. 18, 2014	Oct. 17, 2015
WIT Standard Temperature And Humidity Chamber	TH-4S-C	W981030	Jun. 08, 2015	Jun. 07, 2016

NOTE: 1. The calibration interval of the above test instruments is 12 months and the calibrations are traceable to NML/ROC and NIST/USA.

2. The test was performed in HwaYa Chamber 3.

3. The horn antenna and HP preamplifier (model: 8449B) are used only for the measurement of emission frequency above 1GHz if tested.

4. The FCC Site Registration No. is 988962.

5. The IC Site Registration No. is IC 7450F-3.

4.1.3 Test Procedure

- a. The EUT was placed on the top of a rotating table 0.8 meters (for below 1GHz) / 1.5 meters (for above 1GHz) above the ground at 3 meter chamber room for test. The table was rotated 360 degrees to determine the position of the highest radiation.
- b. The EUT was set 3 meters away from the interference-receiving antenna, which was mounted on the top of a variable-height antenna tower.
- c. The height of antenna is varied from one meter to four meters above the ground to determine the maximum value of the field strength. Both horizontal and vertical polarizations of the antenna are set to make the measurement.
- d. For each suspected emission, the EUT was arranged to its worst case and then the antenna was tuned to heights from 1 meter to 4 meters and the rotatable table was turned from 0 degrees to 360 degrees to find the maximum reading.
- e. The test-receiver system was set to quasi-peak detect function and specified bandwidth with maximum hold mode when the test frequency is below 1 GHz.
- f. The test-receiver system was set to peak and average detect function and specified bandwidth with maximum hold mode when the test frequency is above 1 GHz. If the peak reading value also meets average limit, measurement with the average detector is unnecessary.

Note:

1. The resolution bandwidth and video bandwidth of test receiver/spectrum analyzer is 120kHz for Quasi-peak detection (QP) at frequency below 1GHz.
2. The resolution bandwidth of test receiver/spectrum analyzer is 1 MHz and the video bandwidth is 3 MHz for Peak detection (PK) at frequency above 1GHz.
3. The resolution bandwidth of test receiver/spectrum analyzer is 1MHz and the video bandwidth is 3MHz for RMS Average (Duty cycle < 98%) for Average detection (AV) at frequency above 1GHz, then the measurement results was added to a correction factor ($10 \log(1/\text{duty cycle})$).
4. The resolution bandwidth of test receiver/spectrum analyzer is 1MHz and the video bandwidth is 10Hz (Duty cycle \geq 98%) for Average detection (AV) at frequency above 1GHz.
5. All modes of operation were investigated and the worst-case emissions are reported.

4.1.4 Deviation from Test Standard

No deviation.

4.1.5 Test Setup

<Frequency Range below 1GHz>

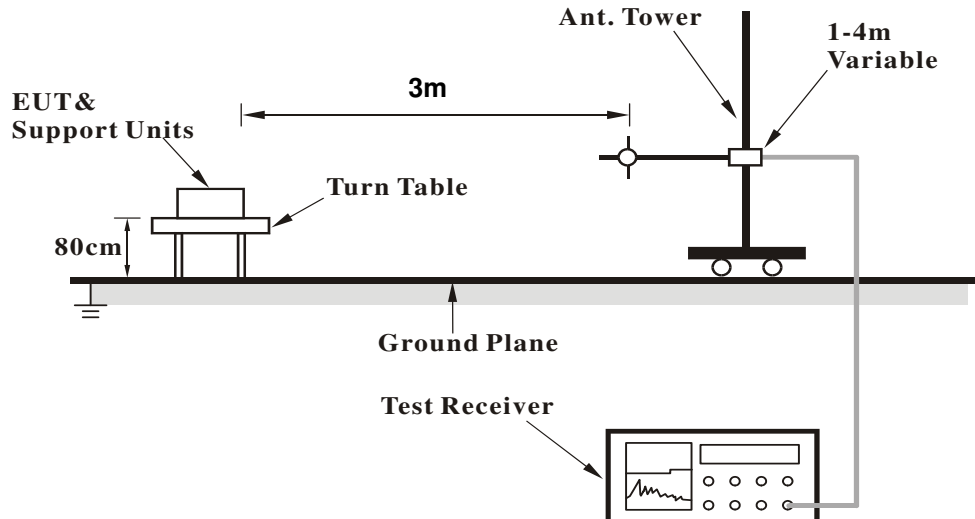

<Frequency Range above 1GHz>

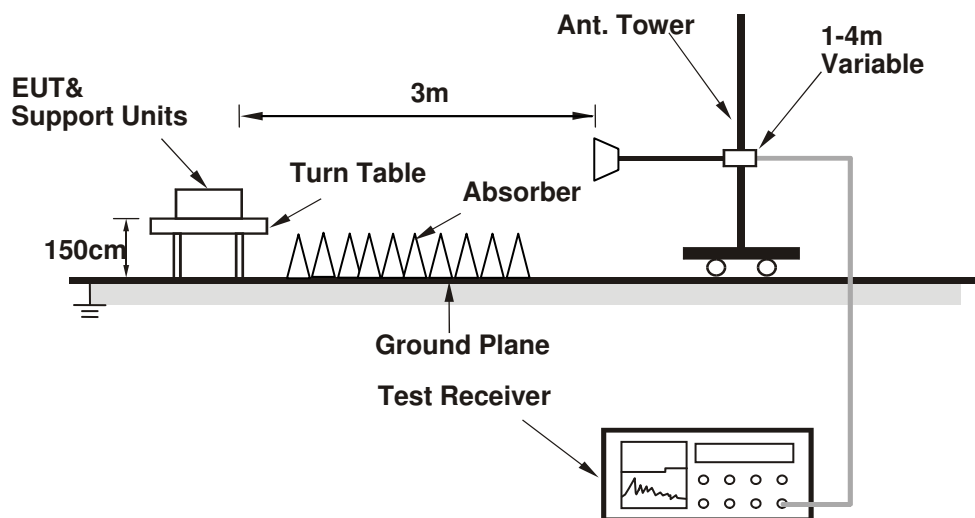

For the actual test configuration, please refer to the attached file (Test Setup Photo).

4.1.6 EUT Operating Conditions

- Placed the EUT on the testing table.
- Prepared notebook to act as communication partner and placed it outside of testing area.
- The communication partner connected with EUT via a RJ45 cable and ran a test program (provided by manufacturer) to enable EUT under transmission condition continuously at specific channel frequency.
- The communication partner sent data to EUT by command "PING".
- The necessary accessories enable the system in full functions.

4.1.7 Test Results
ABOVE 1GHz DATA :
802.11a

CHANNEL	TX Channel 36	DETECTOR FUNCTION	Peak (PK)
FREQUENCY RANGE	1GHz ~ 40GHz		Average (AV)

ANTENNA POLARITY & TEST DISTANCE: HORIZONTAL AT 3 M

NO.	FREQ. (MHz)	EMISSION LEVEL (dBuV/m)	LIMIT (dBuV/m)	MARGIN (dB)	ANTENNA HEIGHT (m)	TABLE ANGLE (Degree)	RAW VALUE (dBuV)	CORRECTION FACTOR (dB/m)
1	5150.00	58.1 PK	74.0	-15.9	1.26 H	345	51.90	6.20
2	5150.00	46.3 AV	54.0	-7.7	1.26 H	345	40.10	6.20
3	*5180.00	104.6 PK			1.00 H	50	65.10	39.50
4	*5180.00	95.1 AV			1.00 H	50	55.60	39.50
5	#10360.00	57.8 PK	74.0	-16.2	1.42 H	238	40.80	17.00
6	#10360.00	47.4 AV	54.0	-6.6	1.42 H	238	30.40	17.00

ANTENNA POLARITY & TEST DISTANCE: VERTICAL AT 3 M

NO.	FREQ. (MHz)	EMISSION LEVEL (dBuV/m)	LIMIT (dBuV/m)	MARGIN (dB)	ANTENNA HEIGHT (m)	TABLE ANGLE (Degree)	RAW VALUE (dBuV)	CORRECTION FACTOR (dB/m)
1	5150.00	61.5 PK	74.0	-12.5	2.14 V	108	55.30	6.20
2	5150.00	52.2 AV	54.0	-1.8	2.14 V	108	46.00	6.20
3	*5180.00	118.7 PK			1.96 V	173	79.20	39.50
4	*5180.00	109.1 AV			1.96 V	173	69.60	39.50
5	#10360.00	58.3 PK	74.0	-15.7	1.54 V	29	41.30	17.00
6	#10360.00	47.6 AV	54.0	-6.4	1.54 V	29	30.60	17.00

REMARKS:

1. Emission Level(dBuV/m) = Raw Value(dBuV) + Correction Factor(dB/m)
2. Correction Factor(dB/m) = Antenna Factor(dB/m) + Cable Factor(dB)
3. The other emission levels were very low against the limit.
4. Margin value = Emission Level – Limit value
5. " * ": Fundamental frequency.
6. " # ": The radiated frequency is out of the restricted band.

CHANNEL	TX Channel 40	DETECTOR FUNCTION	Peak (PK)
FREQUENCY RANGE	1GHz ~ 40GHz		Average (AV)

ANTENNA POLARITY & TEST DISTANCE: HORIZONTAL AT 3 M

NO.	FREQ. (MHz)	EMISSION LEVEL (dBuV/m)	LIMIT (dBuV/m)	MARGIN (dB)	ANTENNA HEIGHT (m)	TABLE ANGLE (Degree)	RAW VALUE (dBuV)	CORRECTION FACTOR (dB/m)
1	5150.00	57.7 PK	74.0	-16.3	1.06 H	235	51.50	6.20
2	5150.00	46.5 AV	54.0	-7.5	1.06 H	235	40.30	6.20
3	*5200.00	107.5 PK			1.00 H	63	67.90	39.60
4	*5200.00	98.6 AV			1.00 H	63	59.00	39.60
5	#10400.00	59.7 PK	74.0	-14.3	1.25 H	102	42.70	17.00
6	#10400.00	47.6 AV	54.0	-6.4	1.25 H	102	30.60	17.00

ANTENNA POLARITY & TEST DISTANCE: VERTICAL AT 3 M

NO.	FREQ. (MHz)	EMISSION LEVEL (dBuV/m)	LIMIT (dBuV/m)	MARGIN (dB)	ANTENNA HEIGHT (m)	TABLE ANGLE (Degree)	RAW VALUE (dBuV)	CORRECTION FACTOR (dB/m)
1	5150.00	64.5 PK	74.0	-9.5	1.39 V	250	58.30	6.20
2	5150.00	52.4 AV	54.0	-1.6	1.39 V	250	46.20	6.20
3	*5200.00	123.1 PK			2.04 V	163	83.50	39.60
4	*5200.00	113.4 AV			2.04 V	163	73.80	39.60
5	#10400.00	58.8 PK	74.0	-15.2	1.52 V	69	41.80	17.00
6	#10400.00	47.7 AV	54.0	-6.3	1.52 V	69	30.70	17.00

REMARKS:

1. Emission Level(dBuV/m) = Raw Value(dBuV) + Correction Factor(dB/m)
2. Correction Factor(dB/m) = Antenna Factor(dB/m) + Cable Factor(dB)
3. The other emission levels were very low against the limit.
4. Margin value = Emission Level – Limit value
5. " * ": Fundamental frequency.
6. " # ": The radiated frequency is out of the restricted band.

CHANNEL	TX Channel 48	DETECTOR FUNCTION	Peak (PK)
FREQUENCY RANGE	1GHz ~ 40GHz		Average (AV)

ANTENNA POLARITY & TEST DISTANCE: HORIZONTAL AT 3 M

NO.	FREQ. (MHz)	EMISSION LEVEL (dBuV/m)	LIMIT (dBuV/m)	MARGIN (dB)	ANTENNA HEIGHT (m)	TABLE ANGLE (Degree)	RAW VALUE (dBuV)	CORRECTION FACTOR (dB/m)
1	*5240.00	107.4 PK			1.00 H	51	67.80	39.60
2	*5240.00	97.9 AV			1.00 H	51	58.30	39.60
3	5440.00	57.8 PK	74.0	-16.2	1.45 H	313	51.10	6.70
4	5440.00	46.6 AV	54.0	-7.4	1.45 H	313	39.90	6.70
5	#10480.00	57.8 PK	74.0	-16.2	1.20 H	65	39.80	18.00
6	#10480.00	48.3 AV	54.0	-5.7	1.20 H	65	30.30	18.00
7	15720.00	62.1 PK	74.0	-11.9	1.14 H	194	43.60	18.50
8	15720.00	50.9 AV	54.0	-3.1	1.14 H	194	32.40	18.50

ANTENNA POLARITY & TEST DISTANCE: VERTICAL AT 3 M

NO.	FREQ. (MHz)	EMISSION LEVEL (dBuV/m)	LIMIT (dBuV/m)	MARGIN (dB)	ANTENNA HEIGHT (m)	TABLE ANGLE (Degree)	RAW VALUE (dBuV)	CORRECTION FACTOR (dB/m)
1	*5240.00	123.8 PK			1.68 V	168	84.20	39.60
2	*5240.00	114.0 AV			1.68 V	168	74.40	39.60
3	5440.00	60.8 PK	74.0	-13.2	1.84 V	169	54.10	6.70
4	5440.00	49.8 AV	54.0	-4.2	1.84 V	169	43.10	6.70
5	#10480.00	58.5 PK	74.0	-15.5	1.14 V	141	40.50	18.00
6	#10480.00	48.3 AV	54.0	-5.7	1.14 V	141	30.30	18.00
7	15720.00	62.0 PK	74.0	-12.0	1.29 V	272	43.50	18.50
8	15720.00	51.5 AV	54.0	-2.5	1.29 V	272	33.00	18.50

REMARKS:

1. Emission Level(dBuV/m) = Raw Value(dBuV) + Correction Factor(dB/m)
2. Correction Factor(dB/m) = Antenna Factor(dB/m) + Cable Factor(dB)
3. The other emission levels were very low against the limit.
4. Margin value = Emission Level – Limit value
5. " * ": Fundamental frequency.
6. " # ": The radiated frequency is out of the restricted band.

802.11n (HT20)

CHANNEL	TX Channel 36	DETECTOR FUNCTION	Peak (PK)
FREQUENCY RANGE	1GHz ~ 40GHz		Average (AV)

ANTENNA POLARITY & TEST DISTANCE: HORIZONTAL AT 3 M								
NO.	FREQ. (MHz)	EMISSION LEVEL (dBuV/m)	LIMIT (dBuV/m)	MARGIN (dB)	ANTENNA HEIGHT (m)	TABLE ANGLE (Degree)	RAW VALUE (dBuV)	CORRECTION FACTOR (dB/m)
1	5150.00	56.8 PK	74.0	-17.2	1.17 H	345	50.60	6.20
2	5150.00	46.2 AV	54.0	-7.8	1.17 H	345	40.00	6.20
3	*5180.00	106.2 PK			1.65 H	120	66.70	39.50
4	*5180.00	96.3 AV			1.65 H	120	56.80	39.50
5	#10360.00	58.8 PK	74.0	-15.2	1.17 H	83	41.80	17.00
6	#10360.00	47.6 AV	54.0	-6.4	1.17 H	83	30.60	17.00

ANTENNA POLARITY & TEST DISTANCE: VERTICAL AT 3 M								
NO.	FREQ. (MHz)	EMISSION LEVEL (dBuV/m)	LIMIT (dBuV/m)	MARGIN (dB)	ANTENNA HEIGHT (m)	TABLE ANGLE (Degree)	RAW VALUE (dBuV)	CORRECTION FACTOR (dB/m)
1	5150.00	61.3 PK	74.0	-12.7	1.33 V	235	55.10	6.20
2	5150.00	52.3 AV	54.0	-1.7	1.33 V	235	46.10	6.20
3	*5180.00	119.2 PK			2.05 V	169	79.70	39.50
4	*5180.00	109.6 AV			2.05 V	169	70.10	39.50
5	#10360.00	59.2 PK	74.0	-14.8	1.51 V	100	42.20	17.00
6	#10360.00	47.9 AV	54.0	-6.1	1.51 V	100	30.90	17.00

REMARKS:

1. Emission Level(dBuV/m) = Raw Value(dBuV) + Correction Factor(dB/m)
2. Correction Factor(dB/m) = Antenna Factor(dB/m) + Cable Factor(dB)
3. The other emission levels were very low against the limit.
4. Margin value = Emission Level – Limit value
5. " * ": Fundamental frequency.
6. " # ": The radiated frequency is out of the restricted band.

CHANNEL	TX Channel 40	DETECTOR FUNCTION	Peak (PK)
FREQUENCY RANGE	1GHz ~ 40GHz		Average (AV)

ANTENNA POLARITY & TEST DISTANCE: HORIZONTAL AT 3 M

NO.	FREQ. (MHz)	EMISSION LEVEL (dBuV/m)	LIMIT (dBuV/m)	MARGIN (dB)	ANTENNA HEIGHT (m)	TABLE ANGLE (Degree)	RAW VALUE (dBuV)	CORRECTION FACTOR (dB/m)
1	5150.00	59.0 PK	74.0	-15.0	1.95 H	232	52.80	6.20
2	5150.00	46.8 AV	54.0	-7.2	1.95 H	232	40.60	6.20
3	*5200.00	107.4 PK			1.00 H	51	67.80	39.60
4	*5200.00	98.6 AV			1.00 H	51	59.00	39.60
5	#10400.00	57.8 PK	74.0	-16.2	1.12 H	82	40.80	17.00
6	#10400.00	47.3 AV	54.0	-6.7	1.12 H	82	30.30	17.00

ANTENNA POLARITY & TEST DISTANCE: VERTICAL AT 3 M

NO.	FREQ. (MHz)	EMISSION LEVEL (dBuV/m)	LIMIT (dBuV/m)	MARGIN (dB)	ANTENNA HEIGHT (m)	TABLE ANGLE (Degree)	RAW VALUE (dBuV)	CORRECTION FACTOR (dB/m)
1	5150.00	65.4 PK	74.0	-8.6	2.40 V	256	59.20	6.20
2	5150.00	52.4 AV	54.0	-1.6	2.40 V	256	46.20	6.20
3	*5200.00	123.3 PK			1.94 V	163	83.70	39.60
4	*5200.00	113.7 AV			1.94 V	163	74.10	39.60
5	#10400.00	59.3 PK	74.0	-14.7	1.55 V	62	42.30	17.00
6	#10400.00	47.5 AV	54.0	-6.5	1.55 V	62	30.50	17.00

REMARKS:

1. Emission Level(dBuV/m) = Raw Value(dBuV) + Correction Factor(dB/m)
2. Correction Factor(dB/m) = Antenna Factor(dB/m) + Cable Factor(dB)
3. The other emission levels were very low against the limit.
4. Margin value = Emission Level – Limit value
5. " * ": Fundamental frequency.
6. " # ": The radiated frequency is out of the restricted band.

CHANNEL	TX Channel 48	DETECTOR FUNCTION	Peak (PK)
FREQUENCY RANGE	1GHz ~ 40GHz		Average (AV)

ANTENNA POLARITY & TEST DISTANCE: HORIZONTAL AT 3 M

NO.	FREQ. (MHz)	EMISSION LEVEL (dBuV/m)	LIMIT (dBuV/m)	MARGIN (dB)	ANTENNA HEIGHT (m)	TABLE ANGLE (Degree)	RAW VALUE (dBuV)	CORRECTION FACTOR (dB/m)
1	*5240.00	107.5 PK			1.00 H	51	67.90	39.60
2	*5240.00	98.2 AV			1.00 H	51	58.60	39.60
3	5400.00	57.9 PK	74.0	-16.1	1.26 H	144	51.20	6.70
4	5400.00	46.7 AV	54.0	-7.3	1.26 H	144	40.00	6.70
5	#10480.00	59.9 PK	74.0	-14.1	1.32 H	59	41.90	18.00
6	#10480.00	48.1 AV	54.0	-5.9	1.32 H	59	30.10	18.00
7	15720.00	61.8 PK	74.0	-12.2	1.35 H	150	43.30	18.50
8	15720.00	50.6 AV	54.0	-3.4	1.35 H	150	32.10	18.50

ANTENNA POLARITY & TEST DISTANCE: VERTICAL AT 3 M

NO.	FREQ. (MHz)	EMISSION LEVEL (dBuV/m)	LIMIT (dBuV/m)	MARGIN (dB)	ANTENNA HEIGHT (m)	TABLE ANGLE (Degree)	RAW VALUE (dBuV)	CORRECTION FACTOR (dB/m)
1	*5240.00	123.8 PK			1.94 V	165	84.20	39.60
2	*5240.00	114.4 AV			1.94 V	165	74.80	39.60
3	5400.00	62.0 PK	74.0	-12.0	1.76 V	166	55.30	6.70
4	5400.00	49.8 AV	54.0	-4.2	1.76 V	166	43.10	6.70
5	#10480.00	59.1 PK	74.0	-14.9	1.25 V	223	41.10	18.00
6	#10480.00	48.3 AV	54.0	-5.7	1.25 V	223	30.30	18.00
7	15720.00	61.8 PK	74.0	-12.2	1.29 V	105	43.30	18.50
8	15720.00	51.0 AV	54.0	-3.0	1.29 V	105	32.50	18.50

REMARKS:

1. Emission Level(dBuV/m) = Raw Value(dBuV) + Correction Factor(dB/m)
2. Correction Factor(dB/m) = Antenna Factor(dB/m) + Cable Factor(dB)
3. The other emission levels were very low against the limit.
4. Margin value = Emission Level – Limit value
5. " * ": Fundamental frequency.
6. " # ": The radiated frequency is out of the restricted band.

802.11n (HT40)

CHANNEL	TX Channel 38	DETECTOR FUNCTION	Peak (PK)
FREQUENCY RANGE	1GHz ~ 40GHz		Average (AV)

ANTENNA POLARITY & TEST DISTANCE: HORIZONTAL AT 3 M								
NO.	FREQ. (MHz)	EMISSION LEVEL (dBuV/m)	LIMIT (dBuV/m)	MARGIN (dB)	ANTENNA HEIGHT (m)	TABLE ANGLE (Degree)	RAW VALUE (dBuV)	CORRECTION FACTOR (dB/m)
1	5150.00	56.7 PK	74.0	-17.3	1.12 H	211	50.50	6.20
2	5150.00	46.2 AV	54.0	-7.8	1.12 H	211	40.00	6.20
3	*5190.00	96.6 PK			1.00 H	61	57.10	39.50
4	*5190.00	87.7 AV			1.00 H	61	48.20	39.50
5	#10380.00	58.6 PK	74.0	-15.4	1.03 H	250	41.60	17.00
6	#10380.00	48.1 AV	54.0	-5.9	1.03 H	250	31.10	17.00

ANTENNA POLARITY & TEST DISTANCE: VERTICAL AT 3 M								
NO.	FREQ. (MHz)	EMISSION LEVEL (dBuV/m)	LIMIT (dBuV/m)	MARGIN (dB)	ANTENNA HEIGHT (m)	TABLE ANGLE (Degree)	RAW VALUE (dBuV)	CORRECTION FACTOR (dB/m)
1	5150.00	63.7 PK	74.0	-10.3	2.40 V	189	57.50	6.20
2	5150.00	52.9 AV	54.0	-1.1	2.40 V	189	46.70	6.20
3	*5190.00	112.3 PK			2.14 V	171	72.80	39.50
4	*5190.00	103.2 AV			2.14 V	171	63.70	39.50
5	#10380.00	59.3 PK	74.0	-14.7	1.61 V	282	42.30	17.00
6	#10380.00	48.1 AV	54.0	-5.9	1.61 V	282	31.10	17.00

REMARKS:

1. Emission Level(dBuV/m) = Raw Value(dBuV) + Correction Factor(dB/m)
2. Correction Factor(dB/m) = Antenna Factor(dB/m) + Cable Factor(dB)
3. The other emission levels were very low against the limit.
4. Margin value = Emission Level – Limit value
5. " * ": Fundamental frequency.
6. " # ": The radiated frequency is out of the restricted band.

CHANNEL	TX Channel 46	DETECTOR FUNCTION	Peak (PK)
FREQUENCY RANGE	1GHz ~ 40GHz		Average (AV)

ANTENNA POLARITY & TEST DISTANCE: HORIZONTAL AT 3 M

NO.	FREQ. (MHz)	EMISSION LEVEL (dBuV/m)	LIMIT (dBuV/m)	MARGIN (dB)	ANTENNA HEIGHT (m)	TABLE ANGLE (Degree)	RAW VALUE (dBuV)	CORRECTION FACTOR (dB/m)
1	5150.00	57.5 PK	74.0	-16.5	1.11 H	251	51.30	6.20
2	5150.00	47.0 AV	54.0	-7.0	1.11 H	251	40.80	6.20
3	*5230.00	104.7 PK			1.50 H	115	65.10	39.60
4	*5230.00	96.0 AV			1.50 H	115	56.40	39.60
5	#10460.00	58.9 PK	74.0	-15.1	1.12 H	320	41.10	17.80
6	#10460.00	48.0 AV	54.0	-6.0	1.12 H	320	30.20	17.80

ANTENNA POLARITY & TEST DISTANCE: VERTICAL AT 3 M

NO.	FREQ. (MHz)	EMISSION LEVEL (dBuV/m)	LIMIT (dBuV/m)	MARGIN (dB)	ANTENNA HEIGHT (m)	TABLE ANGLE (Degree)	RAW VALUE (dBuV)	CORRECTION FACTOR (dB/m)
1	5150.00	63.4 PK	74.0	-10.6	2.44 V	78	57.20	6.20
2	5150.00	52.6 AV	54.0	-1.4	2.44 V	78	46.40	6.20
3	*5230.00	117.6 PK			1.94 V	161	78.00	39.60
4	*5230.00	108.9 AV			1.94 V	161	69.30	39.60
5	#10460.00	59.2 PK	74.0	-14.8	1.73 V	102	41.40	17.80
6	#10460.00	48.5 AV	54.0	-5.5	1.73 V	102	30.70	17.80

REMARKS:

1. Emission Level(dBuV/m) = Raw Value(dBuV) + Correction Factor(dB/m)
2. Correction Factor(dB/m) = Antenna Factor(dB/m) + Cable Factor(dB)
3. The other emission levels were very low against the limit.
4. Margin value = Emission Level – Limit value
5. " * ": Fundamental frequency.
6. " # ": The radiated frequency is out of the restricted band.

802.11ac (VHT80)

CHANNEL	TX Channel 42	DETECTOR FUNCTION	Peak (PK)
FREQUENCY RANGE	1GHz ~ 40GHz		Average (AV)

ANTENNA POLARITY & TEST DISTANCE: HORIZONTAL AT 3 M								
NO.	FREQ. (MHz)	EMISSION LEVEL (dBuV/m)	LIMIT (dBuV/m)	MARGIN (dB)	ANTENNA HEIGHT (m)	TABLE ANGLE (Degree)	RAW VALUE (dBuV)	CORRECTION FACTOR (dB/m)
1	5150.00	57.4 PK	74.0	-16.6	1.43 H	121	51.20	6.20
2	5150.00	47.4 AV	54.0	-6.6	1.43 H	121	41.20	6.20
3	*5210.00	94.2 PK			1.95 H	235	54.60	39.60
4	*5210.00	84.0 AV			1.95 H	235	44.40	39.60
5	#10420.00	57.9 PK	74.0	-16.1	1.15 H	82	40.70	17.20
6	#10420.00	48.2 AV	54.0	-5.8	1.15 H	82	31.00	17.20

ANTENNA POLARITY & TEST DISTANCE: VERTICAL AT 3 M								
NO.	FREQ. (MHz)	EMISSION LEVEL (dBuV/m)	LIMIT (dBuV/m)	MARGIN (dB)	ANTENNA HEIGHT (m)	TABLE ANGLE (Degree)	RAW VALUE (dBuV)	CORRECTION FACTOR (dB/m)
1	5150.00	62.4 PK	74.0	-11.6	2.34 V	279	56.20	6.20
2	5150.00	52.3 AV	54.0	-1.7	2.34 V	279	46.10	6.20
3	*5210.00	106.3 PK			2.14 V	152	66.70	39.60
4	*5210.00	95.3 AV			2.14 V	152	55.70	39.60
5	#10420.00	59.4 PK	74.0	-14.6	1.66 V	86	42.20	17.20
6	#10420.00	48.2 AV	54.0	-5.8	1.66 V	86	31.00	17.20

REMARKS:

1. Emission Level(dBuV/m) = Raw Value(dBuV) + Correction Factor(dB/m)
2. Correction Factor(dB/m) = Antenna Factor(dB/m) + Cable Factor(dB)
3. The other emission levels were very low against the limit.
4. Margin value = Emission Level – Limit value
5. " * ": Fundamental frequency.
6. " # ": The radiated frequency is out of the restricted band.

802.11a

CHANNEL	TX Channel 149	DETECTOR FUNCTION	Peak (PK)
FREQUENCY RANGE	1GHz ~ 40GHz		Average (AV)

ANTENNA POLARITY & TEST DISTANCE: HORIZONTAL AT 3 M

NO.	FREQ. (MHz)	EMISSION LEVEL (dBuV/m)	LIMIT (dBuV/m)	MARGIN (dB)	ANTENNA HEIGHT (m)	TABLE ANGLE (Degree)	RAW VALUE (dBuV)	CORRECTION FACTOR (dB/m)
1	#5714.90	59.1 PK	74.0	-14.9	1.24 H	192	51.90	7.20
2	#5714.90	47.8 AV	54.0	-6.2	1.24 H	192	40.60	7.20
3	#5722.90	59.6 PK	78.2	-18.6	1.11 H	159	52.40	7.20
4	#5725.00	44.6 PK	78.2	-33.6	1.13 H	165	37.40	7.20
5	*5745.00	104.4 PK			1.06 H	233	64.00	40.40
6	*5745.00	95.8 AV			1.06 H	233	55.40	40.40
7	11490.00	59.8 PK	74.0	-14.2	1.38 H	316	41.50	18.30
8	11490.00	48.1 AV	54.0	-5.9	1.38 H	316	29.80	18.30

ANTENNA POLARITY & TEST DISTANCE: VERTICAL AT 3 M

NO.	FREQ. (MHz)	EMISSION LEVEL (dBuV/m)	LIMIT (dBuV/m)	MARGIN (dB)	ANTENNA HEIGHT (m)	TABLE ANGLE (Degree)	RAW VALUE (dBuV)	CORRECTION FACTOR (dB/m)
1	#5714.90	67.2 PK	74.0	-6.8	1.82 V	203	60.00	7.20
2	#5714.90	53.0 AV	54.0	-1.0	1.82 V	203	45.80	7.20
3	#5722.90	69.0 PK	78.2	-9.2	1.93 V	199	61.80	7.20
4	#5725.00	54.8 PK	78.2	-23.4	1.78 V	204	47.60	7.20
5	*5745.00	117.6 PK			1.64 V	163	77.20	40.40
6	*5745.00	108.6 AV			1.64 V	163	68.20	40.40
7	11490.00	59.0 PK	74.0	-15.0	1.08 V	254	40.70	18.30
8	11490.00	48.1 AV	54.0	-5.9	1.08 V	254	29.80	18.30

REMARKS:

1. Emission Level(dBuV/m) = Raw Value(dBuV) + Correction Factor(dB/m)
2. Correction Factor(dB/m) = Antenna Factor(dB/m) + Cable Factor(dB)
3. The other emission levels were very low against the limit.
4. Margin value = Emission Level – Limit value
5. " * ": Fundamental frequency.
6. " # ": The radiated frequency is out of the restricted band.

CHANNEL	TX Channel 157	DETECTOR FUNCTION	Peak (PK)
FREQUENCY RANGE	1GHz ~ 40GHz		Average (AV)

ANTENNA POLARITY & TEST DISTANCE: HORIZONTAL AT 3 M

NO.	FREQ. (MHz)	EMISSION LEVEL (dBuV/m)	LIMIT (dBuV/m)	MARGIN (dB)	ANTENNA HEIGHT (m)	TABLE ANGLE (Degree)	RAW VALUE (dBuV)	CORRECTION FACTOR (dB/m)
1	*5785.00	110.6 PK			1.44 H	119	70.10	40.50
2	*5785.00	101.2 AV			1.44 H	119	60.70	40.50
3	11570.00	60.5 PK	74.0	-13.5	1.30 H	188	42.30	18.20
4	11570.00	49.9 AV	54.0	-4.1	1.30 H	188	31.70	18.20

ANTENNA POLARITY & TEST DISTANCE: VERTICAL AT 3 M

NO.	FREQ. (MHz)	EMISSION LEVEL (dBuV/m)	LIMIT (dBuV/m)	MARGIN (dB)	ANTENNA HEIGHT (m)	TABLE ANGLE (Degree)	RAW VALUE (dBuV)	CORRECTION FACTOR (dB/m)
1	*5785.00	124.1 PK			1.43 V	166	83.60	40.50
2	*5785.00	115.1 AV			1.43 V	166	74.60	40.50
3	11570.00	61.3 PK	74.0	-12.7	1.13 V	63	43.10	18.20
4	11570.00	50.7 AV	54.0	-3.3	1.13 V	63	32.50	18.20

REMARKS:

1. Emission Level(dBuV/m) = Raw Value(dBuV) + Correction Factor(dB/m)
2. Correction Factor(dB/m) = Antenna Factor(dB/m) + Cable Factor(dB)
3. The other emission levels were very low against the limit.
4. Margin value = Emission Level – Limit value
5. " * ": Fundamental frequency.



CHANNEL	TX Channel 165	DETECTOR FUNCTION	Peak (PK)
FREQUENCY RANGE	1GHz ~ 40GHz		Average (AV)

ANTENNA POLARITY & TEST DISTANCE: HORIZONTAL AT 3 M

NO.	FREQ. (MHz)	EMISSION LEVEL (dBuV/m)	LIMIT (dBuV/m)	MARGIN (dB)	ANTENNA HEIGHT (m)	TABLE ANGLE (Degree)	RAW VALUE (dBuV)	CORRECTION FACTOR (dB/m)
1	*5825.00	105.0 PK			1.00 H	229	64.50	40.50
2	*5825.00	96.4 AV			1.00 H	229	55.90	40.50
3	#5850.00	44.0 PK	78.2	-34.2	1.10 H	238	36.50	7.50
4	#5852.10	60.1 PK	78.2	-18.1	1.28 H	230	52.50	7.60
5	#5860.10	58.4 PK	74.0	-15.6	1.11 H	162	50.80	7.60
6	#5860.10	47.3 AV	54.0	-6.7	1.11 H	162	39.70	7.60
7	11650.00	60.1 PK	74.0	-13.9	1.49 H	130	41.40	18.70
8	11650.00	48.1 AV	54.0	-5.9	1.49 H	130	29.40	18.70

ANTENNA POLARITY & TEST DISTANCE: VERTICAL AT 3 M

NO.	FREQ. (MHz)	EMISSION LEVEL (dBuV/m)	LIMIT (dBuV/m)	MARGIN (dB)	ANTENNA HEIGHT (m)	TABLE ANGLE (Degree)	RAW VALUE (dBuV)	CORRECTION FACTOR (dB/m)
1	*5825.00	119.3 PK			1.56 V	165	78.80	40.50
2	*5825.00	109.8 AV			1.56 V	165	69.30	40.50
3	#5850.00	57.8 PK	78.2	-20.4	1.92 V	320	50.30	7.50
4	#5852.10	73.9 PK	78.2	-4.3	1.88 V	133	66.30	7.60
5	#5860.10	68.0 PK	74.0	-6.0	1.54 V	163	60.40	7.60
6	#5860.10	52.2 AV	54.0	-1.8	1.54 V	163	44.60	7.60
7	11650.00	59.1 PK	74.0	-14.9	1.35 V	351	40.40	18.70
8	11650.00	48.9 AV	54.0	-5.1	1.35 V	351	30.20	18.70

REMARKS:

1. Emission Level(dBuV/m) = Raw Value(dBuV) + Correction Factor(dB/m)
2. Correction Factor(dB/m) = Antenna Factor(dB/m) + Cable Factor(dB)
3. The other emission levels were very low against the limit.
4. Margin value = Emission Level – Limit value
5. " * ": Fundamental frequency.
6. " # ": The radiated frequency is out of the restricted band.

802.11n (HT20)

CHANNEL	TX Channel 149	DETECTOR FUNCTION	Peak (PK)
FREQUENCY RANGE	1GHz ~ 40GHz		Average (AV)

ANTENNA POLARITY & TEST DISTANCE: HORIZONTAL AT 3 M

NO.	FREQ. (MHz)	EMISSION LEVEL (dBuV/m)	LIMIT (dBuV/m)	MARGIN (dB)	ANTENNA HEIGHT (m)	TABLE ANGLE (Degree)	RAW VALUE (dBuV)	CORRECTION FACTOR (dB/m)
1	#5714.90	60.1 PK	74.0	-13.9	1.37 H	189	52.90	7.20
2	#5714.90	47.5 AV	54.0	-6.5	1.37 H	189	40.30	7.20
3	#5722.90	58.7 PK	78.2	-19.5	1.36 H	283	51.50	7.20
4	#5725.00	44.5 PK	78.2	-33.7	1.43 H	352	37.30	7.20
5	*5745.00	106.3 PK			1.41 H	123	65.90	40.40
6	*5745.00	96.5 AV			1.41 H	123	56.10	40.40
7	11490.00	59.1 PK	74.0	-14.9	1.22 H	157	40.80	18.30
8	11490.00	48.5 AV	54.0	-5.5	1.22 H	157	30.20	18.30

ANTENNA POLARITY & TEST DISTANCE: VERTICAL AT 3 M

NO.	FREQ. (MHz)	EMISSION LEVEL (dBuV/m)	LIMIT (dBuV/m)	MARGIN (dB)	ANTENNA HEIGHT (m)	TABLE ANGLE (Degree)	RAW VALUE (dBuV)	CORRECTION FACTOR (dB/m)
1	#5714.90	67.3 PK	74.0	-6.7	1.56 V	161	60.10	7.20
2	#5714.90	52.8 AV	54.0	-1.2	1.56 V	161	45.60	7.20
3	#5722.90	72.3 PK	78.2	-5.9	1.78 V	132	65.10	7.20
4	#5725.00	58.0 PK	78.2	-20.2	1.75 V	139	50.80	7.20
5	*5745.00	118.1 PK			1.65 V	167	77.70	40.40
6	*5745.00	108.5 AV			1.65 V	167	68.10	40.40
7	11490.00	59.2 PK	74.0	-14.8	1.12 V	85	40.90	18.30
8	11490.00	48.9 AV	54.0	-5.1	1.12 V	85	30.60	18.30

REMARKS:

1. Emission Level(dBuV/m) = Raw Value(dBuV) + Correction Factor(dB/m)
2. Correction Factor(dB/m) = Antenna Factor(dB/m) + Cable Factor(dB)
3. The other emission levels were very low against the limit.
4. Margin value = Emission Level – Limit value
5. " * ": Fundamental frequency.
6. " # ": The radiated frequency is out of the restricted band.



CHANNEL	TX Channel 157	DETECTOR FUNCTION	Peak (PK)
FREQUENCY RANGE	1GHz ~ 40GHz		Average (AV)

ANTENNA POLARITY & TEST DISTANCE: HORIZONTAL AT 3 M

NO.	FREQ. (MHz)	EMISSION LEVEL (dBuV/m)	LIMIT (dBuV/m)	MARGIN (dB)	ANTENNA HEIGHT (m)	TABLE ANGLE (Degree)	RAW VALUE (dBuV)	CORRECTION FACTOR (dB/m)
1	*5785.00	111.0 PK			1.20 H	125	70.50	40.50
2	*5785.00	101.1 AV			1.20 H	125	60.60	40.50
3	11570.00	61.3 PK	74.0	-12.7	1.15 H	186	43.10	18.20
4	11570.00	50.0 AV	54.0	-4.0	1.15 H	186	31.80	18.20

ANTENNA POLARITY & TEST DISTANCE: VERTICAL AT 3 M

NO.	FREQ. (MHz)	EMISSION LEVEL (dBuV/m)	LIMIT (dBuV/m)	MARGIN (dB)	ANTENNA HEIGHT (m)	TABLE ANGLE (Degree)	RAW VALUE (dBuV)	CORRECTION FACTOR (dB/m)
1	*5785.00	125.0 PK			1.65 V	174	84.50	40.50
2	*5785.00	115.6 AV			1.65 V	174	75.10	40.50
3	11570.00	61.1 PK	74.0	-12.9	1.69 V	140	42.90	18.20
4	11570.00	50.3 AV	54.0	-3.7	1.69 V	140	32.10	18.20

REMARKS:

1. Emission Level(dBuV/m) = Raw Value(dBuV) + Correction Factor(dB/m)
2. Correction Factor(dB/m) = Antenna Factor(dB/m) + Cable Factor(dB)
3. The other emission levels were very low against the limit.
4. Margin value = Emission Level – Limit value
5. " * ": Fundamental frequency.



CHANNEL	TX Channel 165	DETECTOR FUNCTION	Peak (PK)
FREQUENCY RANGE	1GHz ~ 40GHz		Average (AV)

ANTENNA POLARITY & TEST DISTANCE: HORIZONTAL AT 3 M

NO.	FREQ. (MHz)	EMISSION LEVEL (dBuV/m)	LIMIT (dBuV/m)	MARGIN (dB)	ANTENNA HEIGHT (m)	TABLE ANGLE (Degree)	RAW VALUE (dBuV)	CORRECTION FACTOR (dB/m)
1	*5825.00	106.2 PK			1.38 H	119	65.70	40.50
2	*5825.00	96.7 AV			1.38 H	119	56.20	40.50
3	#5850.00	45.5 PK	78.2	-32.7	1.32 H	118	38.00	7.50
4	#5852.10	62.4 PK	78.2	-15.8	1.31 H	120	54.80	7.60
5	#5860.10	60.0 PK	74.0	-14.0	1.10 H	121	52.40	7.60
6	#5860.10	47.5 AV	54.0	-6.5	1.10 H	121	39.90	7.60
7	11650.00	59.4 PK	74.0	-14.6	1.22 H	205	40.70	18.70
8	11650.00	48.2 AV	54.0	-5.8	1.22 H	205	29.50	18.70

ANTENNA POLARITY & TEST DISTANCE: VERTICAL AT 3 M

NO.	FREQ. (MHz)	EMISSION LEVEL (dBuV/m)	LIMIT (dBuV/m)	MARGIN (dB)	ANTENNA HEIGHT (m)	TABLE ANGLE (Degree)	RAW VALUE (dBuV)	CORRECTION FACTOR (dB/m)
1	*5825.00	119.6 PK			1.58 V	164	79.10	40.50
2	*5825.00	109.9 AV			1.58 V	164	69.40	40.50
3	#5850.00	56.0 PK	78.2	-22.2	2.01 V	99	48.50	7.50
4	#5852.10	73.5 PK	78.2	-4.7	2.14 V	24	65.90	7.60
5	#5860.10	66.9 PK	74.0	-7.1	1.96 V	78	59.30	7.60
6	#5860.10	52.2 AV	54.0	-1.8	1.96 V	78	44.60	7.60
7	11650.00	59.8 PK	74.0	-14.2	1.13 V	124	41.10	18.70
8	11650.00	48.7 AV	54.0	-5.3	1.13 V	124	30.00	18.70

REMARKS:

1. Emission Level(dBuV/m) = Raw Value(dBuV) + Correction Factor(dB/m)
2. Correction Factor(dB/m) = Antenna Factor(dB/m) + Cable Factor(dB)
3. The other emission levels were very low against the limit.
4. Margin value = Emission Level – Limit value
5. " * ": Fundamental frequency.
6. " # ": The radiated frequency is out of the restricted band.

802.11n (HT40)

CHANNEL	TX Channel 151	DETECTOR FUNCTION	Peak (PK)
FREQUENCY RANGE	1GHz ~ 40GHz		Average (AV)

ANTENNA POLARITY & TEST DISTANCE: HORIZONTAL AT 3 M

NO.	FREQ. (MHz)	EMISSION LEVEL (dBuV/m)	LIMIT (dBuV/m)	MARGIN (dB)	ANTENNA HEIGHT (m)	TABLE ANGLE (Degree)	RAW VALUE (dBuV)	CORRECTION FACTOR (dB/m)
1	#5714.00	62.3 PK	74.0	-11.7	1.00 H	118	55.10	7.20
2	#5714.00	49.2 AV	54.0	-4.8	1.00 H	118	42.00	7.20
3	#5722.00	64.1 PK	78.2	-14.1	1.31 H	128	56.90	7.20
4	#5725.00	57.9 PK	78.2	-20.3	1.31 H	128	50.70	7.20
5	*5755.00	98.4 PK			1.36 H	119	57.90	40.50
6	*5755.00	89.4 AV			1.36 H	119	48.90	40.50
7	11490.00	60.6 PK	74.0	-13.4	1.40 H	319	42.30	18.30
8	11490.00	47.9 AV	54.0	-6.1	1.40 H	319	29.60	18.30

ANTENNA POLARITY & TEST DISTANCE: VERTICAL AT 3 M

NO.	FREQ. (MHz)	EMISSION LEVEL (dBuV/m)	LIMIT (dBuV/m)	MARGIN (dB)	ANTENNA HEIGHT (m)	TABLE ANGLE (Degree)	RAW VALUE (dBuV)	CORRECTION FACTOR (dB/m)
1	#5714.00	63.8 PK	74.0	-10.2	1.68 V	138	56.60	7.20
2	#5714.00	52.6 AV	54.0	-1.4	1.68 V	138	45.40	7.20
3	#5722.00	69.5 PK	78.2	-8.7	1.74 V	195	62.30	7.20
4	#5725.00	61.5 PK	78.2	-16.7	1.74 V	195	54.30	7.20
5	*5755.00	111.0 PK			2.12 V	19	70.50	40.50
6	*5755.00	101.9 AV			2.12 V	19	61.40	40.50
7	11490.00	60.8 PK	74.0	-13.2	1.21 V	260	42.50	18.30
8	11490.00	47.7 AV	54.0	-6.3	1.21 V	260	29.40	18.30

REMARKS:

1. Emission Level(dBuV/m) = Raw Value(dBuV) + Correction Factor(dB/m)
2. Correction Factor(dB/m) = Antenna Factor(dB/m) + Cable Factor(dB)
3. The other emission levels were very low against the limit.
4. Margin value = Emission Level – Limit value
5. " * ": Fundamental frequency.
6. " # ": The radiated frequency is out of the restricted band.

CHANNEL	TX Channel 159	DETECTOR FUNCTION	Peak (PK)
FREQUENCY RANGE	1GHz ~ 40GHz		Average (AV)

ANTENNA POLARITY & TEST DISTANCE: HORIZONTAL AT 3 M

NO.	FREQ. (MHz)	EMISSION LEVEL (dBuV/m)	LIMIT (dBuV/m)	MARGIN (dB)	ANTENNA HEIGHT (m)	TABLE ANGLE (Degree)	RAW VALUE (dBuV)	CORRECTION FACTOR (dB/m)
1	*5795.00	103.5 PK			1.40 H	122	63.00	40.50
2	*5795.00	94.1 AV			1.40 H	122	53.60	40.50
3	#5850.00	60.5 PK	78.2	-17.7	1.23 H	196	53.00	7.50
4	#5853.00	62.6 PK	78.2	-15.6	1.23 H	196	55.00	7.60
5	#5861.00	60.1 PK	74.0	-13.9	1.41 H	333	52.50	7.60
6	#5861.00	48.3 AV	54.0	-5.7	1.41 H	333	40.70	7.60
7	11590.00	60.0 PK	74.0	-14.0	1.19 H	172	41.70	18.30
8	11590.00	47.3 AV	54.0	-6.7	1.19 H	172	29.00	18.30

ANTENNA POLARITY & TEST DISTANCE: VERTICAL AT 3 M

NO.	FREQ. (MHz)	EMISSION LEVEL (dBuV/m)	LIMIT (dBuV/m)	MARGIN (dB)	ANTENNA HEIGHT (m)	TABLE ANGLE (Degree)	RAW VALUE (dBuV)	CORRECTION FACTOR (dB/m)
1	*5795.00	117.2 PK			2.02 V	344	76.70	40.50
2	*5795.00	107.8 AV			2.02 V	344	67.30	40.50
3	#5850.00	57.5 PK	78.2	-20.7	1.80 V	202	50.00	7.50
4	#5853.00	67.9 PK	78.2	-10.3	1.80 V	202	60.30	7.60
5	#5861.00	63.8 PK	74.0	-10.2	1.70 V	139	56.20	7.60
6	#5861.00	52.1 AV	54.0	-1.9	1.70 V	139	44.50	7.60
7	11590.00	61.3 PK	74.0	-12.7	1.30 V	250	43.00	18.30
8	11590.00	48.6 AV	54.0	-5.4	1.30 V	250	30.30	18.30

REMARKS:

1. Emission Level(dBuV/m) = Raw Value(dBuV) + Correction Factor(dB/m)
2. Correction Factor(dB/m) = Antenna Factor(dB/m) + Cable Factor(dB)
3. The other emission levels were very low against the limit.
4. Margin value = Emission Level – Limit value
5. " * ": Fundamental frequency.
6. " # ": The radiated frequency is out of the restricted band.

802.11ac (VHT80)

CHANNEL	TX Channel 155	DETECTOR FUNCTION	Peak (PK)
FREQUENCY RANGE	1GHz ~ 40GHz		Average (AV)

ANTENNA POLARITY & TEST DISTANCE: HORIZONTAL AT 3 M

NO.	FREQ. (MHz)	EMISSION LEVEL (dBuV/m)	LIMIT (dBuV/m)	MARGIN (dB)	ANTENNA HEIGHT (m)	TABLE ANGLE (Degree)	RAW VALUE (dBuV)	CORRECTION FACTOR (dB/m)
1	#5714.00	58.5 PK	74.0	-15.5	1.30 H	177	51.30	7.20
2	#5714.00	47.9 AV	54.0	-6.1	1.30 H	177	40.70	7.20
3	#5722.00	57.2 PK	78.2	-21.0	1.23 H	188	50.00	7.20
4	#5725.00	52.7 PK	78.2	-25.5	1.23 H	188	45.50	7.20
5	*5775.00	91.3 PK			1.31 H	119	50.80	40.50
6	*5775.00	82.4 AV			1.31 H	119	41.90	40.50
7	#5850.00	56.3 PK	78.2	-21.9	1.40 H	181	48.80	7.50
8	#5853.00	60.1 PK	78.2	-18.1	1.40 H	181	52.50	7.60
9	#5861.00	50.0 PK	74.0	-24.0	1.26 H	128	42.40	7.60
10	#5861.00	37.5 AV	54.0	-16.5	1.26 H	128	29.90	7.60
11	11550.00	59.7 PK	74.0	-14.3	1.16 H	200	41.50	18.20
12	11550.00	46.7 AV	54.0	-7.3	1.16 H	200	28.50	18.20

ANTENNA POLARITY & TEST DISTANCE: VERTICAL AT 3 M

NO.	FREQ. (MHz)	EMISSION LEVEL (dBuV/m)	LIMIT (dBuV/m)	MARGIN (dB)	ANTENNA HEIGHT (m)	TABLE ANGLE (Degree)	RAW VALUE (dBuV)	CORRECTION FACTOR (dB/m)
1	#5714.00	67.3 PK	74.0	-6.7	1.67 V	160	60.10	7.20
2	#5714.00	53.0 AV	54.0	-1.0	1.67 V	160	45.80	7.20
3	#5722.00	73.2 PK	78.2	-5.0	1.71 V	135	66.00	7.20
4	#5725.00	63.4 PK	78.2	-14.8	1.71 V	35	56.20	7.20
5	*5775.00	106.9 PK			1.64 V	143	66.40	40.50
6	*5775.00	95.8 AV			1.64 V	143	55.30	40.50
7	#5850.00	57.9 PK	78.2	-20.3	1.60 V	177	50.40	7.50
8	#5853.00	61.1 PK	78.2	-17.1	1.57 V	183	53.50	7.60
9	#5860.00	59.7 PK	74.0	-14.3	1.57 V	183	52.10	7.60
10	#5860.00	48.3 AV	54.0	-5.7	1.57 V	183	40.70	7.60
11	11550.00	60.1 PK	74.0	-13.9	1.50 V	168	41.90	18.20
12	11550.00	47.0 AV	54.0	-7.0	1.50 V	168	28.80	18.20

REMARKS:

1. Emission Level(dBuV/m) = Raw Value(dBuV) + Correction Factor(dB/m)
2. Correction Factor(dB/m) = Antenna Factor(dB/m) + Cable Factor(dB)
3. The other emission levels were very low against the limit.
4. Margin value = Emission Level – Limit value
5. " * ": Fundamental frequency.
6. " # ": The radiated frequency is out of the restricted band.

BELOW 1GHz WORST-CASE DATA

802.11n (HT20)

CHANNEL	TX Channel 40	DETECTOR FUNCTION	Quasi-Peak (QP)
FREQUENCY RANGE	30MHz ~ 1GHz		

ANTENNA POLARITY & TEST DISTANCE: HORIZONTAL AT 3 M

NO.	FREQ. (MHz)	EMISSION LEVEL (dBuV/m)	LIMIT (dBuV/m)	MARGIN (dB)	ANTENNA HEIGHT (m)	TABLE ANGLE (Degree)	RAW VALUE (dBuV)	CORRECTION FACTOR (dB/m)
1	84.34	33.7 QP	40.0	-6.3	1.99 H	257	53.10	-19.40
2	212.66	39.0 QP	43.5	-4.5	1.49 H	235	55.70	-16.70
3	285.16	41.8 QP	46.0	-4.2	1.00 H	329	54.60	-12.80
4	298.21	41.9 QP	46.0	-4.1	1.00 H	63	54.40	-12.50
5	374.04	41.7 QP	46.0	-4.3	1.00 H	54	52.70	-11.00
6	624.85	35.4 QP	46.0	-10.6	1.00 H	227	40.80	-5.40

ANTENNA POLARITY & TEST DISTANCE: VERTICAL AT 3 M

NO.	FREQ. (MHz)	EMISSION LEVEL (dBuV/m)	LIMIT (dBuV/m)	MARGIN (dB)	ANTENNA HEIGHT (m)	TABLE ANGLE (Degree)	RAW VALUE (dBuV)	CORRECTION FACTOR (dB/m)
1	47.40	37.0 QP	40.0	-3.0	1.00 V	356	51.60	-14.60
2	125.17	34.2 QP	43.5	-9.3	1.00 V	2	50.10	-15.90
3	298.21	35.7 QP	46.0	-10.3	1.50 V	217	48.20	-12.50
4	436.26	38.3 QP	46.0	-7.7	1.00 V	14	47.70	-9.40
5	500.42	34.7 QP	46.0	-11.3	1.00 V	270	43.00	-8.30
6	745.40	40.2 QP	46.0	-5.8	2.00 V	310	43.50	-3.30

REMARKS:

1. Emission Level(dBuV/m) = Raw Value(dBuV) + Correction Factor(dB/m)
2. Correction Factor(dB/m) = Antenna Factor(dB/m) + Cable Factor(dB)
3. The other emission levels were very low against the limit.
4. Margin value = Emission Level – Limit value

4.2 Conducted Emission Measurement

4.2.1 Limits of Conducted Emission Measurement

Frequency (MHz)	Conducted Limit (dBuV)	
	Quasi-peak	Average
0.15 - 0.5	66 - 56	56 - 46
0.50 - 5.0	56	46
5.0 - 30.0	60	50

Note: 1. The lower limit shall apply at the transition frequencies.

2. The limit decreases in line with the logarithm of the frequency in the range of 0.15 to 0.50MHz.

4.2.2 Test Instruments

Description & Manufacturer	Model No.	Serial No.	Date Of Calibration	Due Date Of Calibration
Test Receiver ROHDE & SCHWARZ	ESCS 30	100288	Apr. 27, 2015	Apr. 26, 2016
RF signal cable (with 10dB PAD) Woken	5D-FB	Cable-cond2-01	Dec. 26, 2014	Dec. 25, 2015
LISN ROHDE & SCHWARZ (EUT)	ESH2-Z5	100100	Dec. 30, 2014	Dec. 29, 2015
LISN ROHDE & SCHWARZ (Peripheral)	ESH3-Z5	100312	Jul. 21, 2015	Jul. 20, 2016
Software ADT	BV ADT_Cond_ V7.3.7.3	NA	NA	NA

Notes: 1. The calibration interval of the above test instruments is 12 months and the calibrations are traceable to NML/ROC and NIST/USA.

2. The test was performed in HwaYa Shielded Room 2.

3. The VCCI Site Registration No. is C-2047.

4.2.3 Test Procedure

- a. The EUT was placed 0.4 meters from the conducting wall of the shielded room with EUT being connected to the power mains through a line impedance stabilization network (LISN). Other support units were connected to the power mains through another LISN. The two LISNs provide 50 ohm/ 50uH of coupling impedance for the measuring instrument.
- b. Both lines of the power mains connected to the EUT were checked for maximum conducted interference.
- c. The frequency range from 150kHz to 30MHz was searched. Emission levels under (Limit - 20dB) was not recorded.

NOTE: The resolution bandwidth and video bandwidth of test receiver is 9kHz for quasi-peak detection (QP) and average detection (AV) at frequency 0.15MHz-30MHz.

4.2.4 Deviation from Test Standard

No deviation.

4.2.5 Test Setup

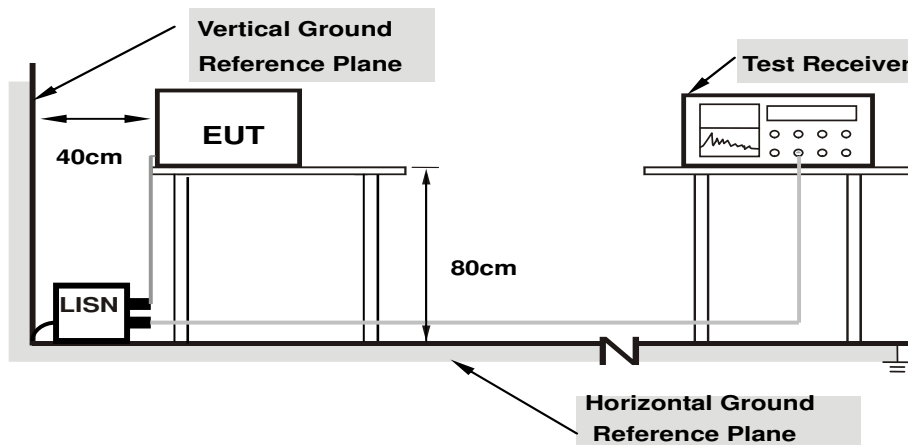

- Note:**
- 1.Support units were connected to second LISN.
 - 2.Both of LISNs (AMN) are 80 cm from EUT and at least 80 from other units and other metal planes

For the actual test configuration, please refer to the attached file (Test Setup Photo).

4.2.6 EUT Operating Conditions

Same as 4.1.6.

4.2.7 Test Results

802.11n (HT20)

Phase	Line (L)	Detector Function	Quasi-Peak (QP) / Average (AV)
-------	----------	-------------------	--------------------------------

No	Freq. [MHz]	Corr. Factor (dB)	Reading Value [dB (uV)]		Emission Level [dB (uV)]		Limit [dB (uV)]		Margin (dB)	
			Q.P.	AV.	Q.P.	AV.	Q.P.	AV.	Q.P.	AV.
			1	0.18125	0.20	38.41	29.54	38.61	29.74	64.43
2	0.24375	0.20	34.16	26.16	34.36	26.36	61.97	51.97	-27.61	-25.61
3	0.41563	0.20	32.63	20.05	32.83	20.25	57.54	47.54	-24.70	-27.28
4	0.48984	0.21	33.90	23.24	34.11	23.45	56.17	46.17	-22.06	-22.72
5	0.83750	0.27	27.93	18.29	28.20	18.56	56.00	46.00	-27.80	-27.44
6	1.17969	0.31	25.70	17.26	26.01	17.57	56.00	46.00	-29.99	-28.43

REMARKS:

1. Q.P. and AV. are abbreviations of quasi-peak and average individually.
2. The emission levels of other frequencies were very low against the limit.
3. Margin value = Emission level - Limit value
4. Correction factor = Insertion loss + Cable loss
5. Emission Level = Correction Factor + Reading Value.

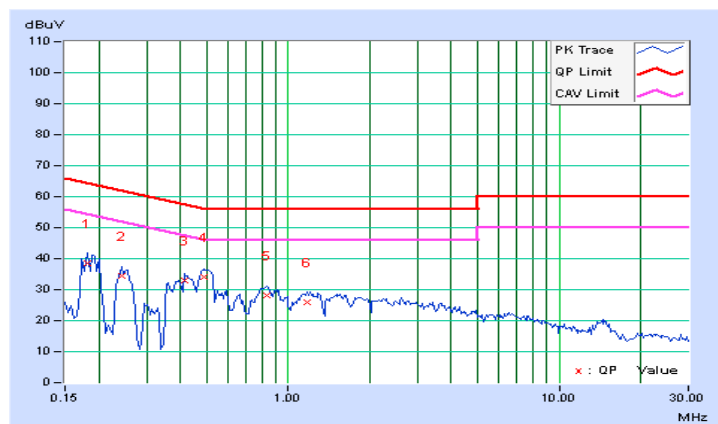

Phase	Neutral (N)	Detector Function	Quasi-Peak (QP) / Average (AV)
-------	-------------	-------------------	--------------------------------

No	Freq. [MHz]	Corr. Factor (dB)	Reading Value [dB (uV)]		Emission Level [dB (uV)]		Limit [dB (uV)]		Margin (dB)	
			Q.P.	AV.	Q.P.	AV.	Q.P.	AV.	Q.P.	AV.
			1	0.19297	0.22	35.51	26.11	35.73	26.33	63.91
2	0.23594	0.23	32.60	19.43	32.83	19.66	62.24	52.24	-29.41	-32.58
3	0.41563	0.25	33.33	21.18	33.58	21.43	57.54	47.54	-23.95	-26.10
4	0.50156	0.26	34.43	23.89	34.69	24.15	56.00	46.00	-21.31	-21.85
5	0.80625	0.29	25.42	12.72	25.71	13.01	56.00	46.00	-30.29	-32.99
6	1.20703	0.33	22.71	12.80	23.04	13.13	56.00	46.00	-32.96	-32.87

REMARKS:

1. Q.P. and AV. are abbreviations of quasi-peak and average individually.
2. The emission levels of other frequencies were very low against the limit.
3. Margin value = Emission level - Limit value
4. Correction factor = Insertion loss + Cable loss
5. Emission Level = Correction Factor + Reading Value.

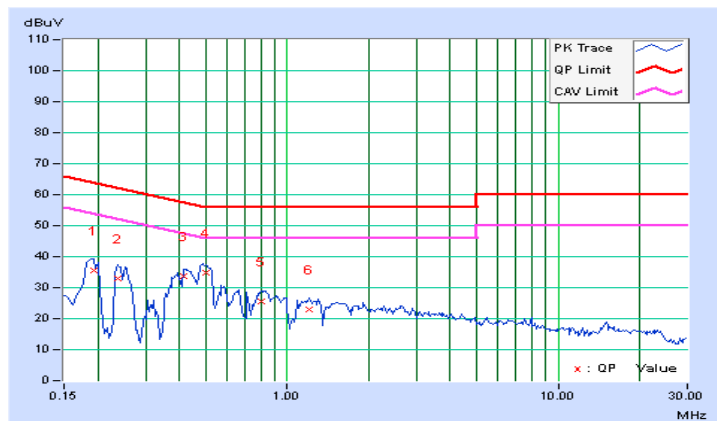

4.3 Transmit Power Measurement

4.3.1 Limits of Transmit Power Measurement

Operation Band	EUT Category		LIMIT
U-NII-1		Outdoor Access Point	1 Watt (30 dBm) (Max. e.i.r.p \leq 125mW(21 dBm) at any elevation angle above 30 degrees as measured from the horizon)
		Fixed point-to-point Access Point	1 Watt (30 dBm)
	√	Indoor Access Point	1 Watt (30 dBm)
		Mobile and Portable client device	250mW (24 dBm)
U-NII-2A	---		250mW (24 dBm) or 11 dBm+10 log B*
U-NII-2C	---		250mW (24 dBm) or 11 dBm+10 log B*
U-NII-3	√		1 Watt (30 dBm)

*B is the 26 dB emission bandwidth in megahertz

Per KDB 662911 Method of conducted output power measurement on IEEE 802.11 devices,

Array Gain = 0 dB (i.e., no array gain) for $N_{ANT} \leq 4$;

Array Gain = 0 dB (i.e., no array gain) for channel widths ≥ 40 MHz for any N_{ANT} ;

Array Gain = $5 \log(N_{ANT}/N_{SS})$ dB or 3 dB, whichever is less for 20-MHz channel widths with $N_{ANT} \geq 5$.

For power measurements on all other devices: Array Gain = $10 \log(N_{ANT}/N_{SS})$ dB.

4.3.2 Test Setup

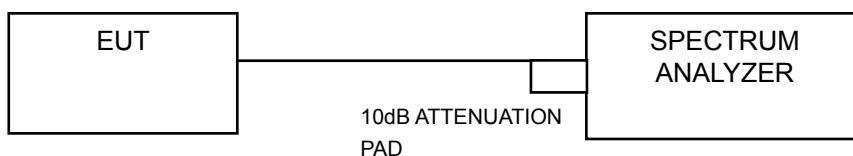
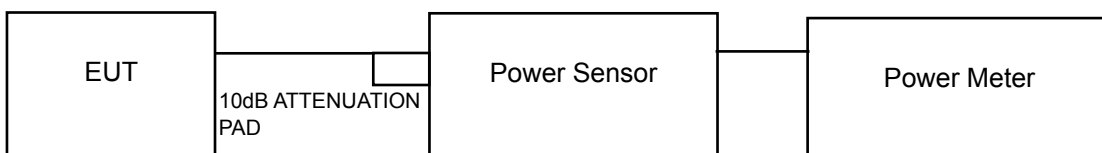

4.3.3 Test Instruments

Refer to section 4.1.2 to get information of above instrument.

4.3.4 Test Procedure

FOR AVERAGE POWER MEASUREMENT

For 802.11a, 802.11n (HT20), 802.11n (HT40)

Method PM is used to perform output power measurement, trigger and gating function of wide band power meter is enabled to measure max output power of TX on burst. Duty factor is not added to measured value.

For 802.11ac (VHT80)

- 1) Set span to encompass the entire 26 dB EBW (or, alternatively, the entire 99% occupied bandwidth) of the signal.
- 2) Set sweep trigger to "free run".
- 3) Set RBW = 1 MHz.
- 4) Set VBW \geq 3 MHz
- 5) Number of points in sweep \geq 2 Span / RBW.
- 6) Sweep time \leq (number of points in sweep) * T
- 7) Using emission bandwidth to determine the frequency span for integration the channel bandwidth.
- 8) Detector = RMS.
- 9) Trace mode = max hold.
- 10) Allow max hold to run for at least 60 seconds, or longer as needed to allow the trace to stabilize.
- 11) Compute power by integrating the spectrum across the EBW (or, alternatively, the entire 99% occupied bandwidth) of the signal using the instrument's band power measurement function with band limits set equal to the EBW (or occupied bandwidth) band edges. If the instrument does not have a band power function, sum the spectrum levels (in power units) at 1 MHz intervals extending across the EBW (or, alternatively, the entire 99% occupied bandwidth) of the spectrum.

4.3.5 Deviation from Test Standard

No deviation.

4.3.6 EUT Operating Conditions

The software provided by client to enable the EUT under transmission Condition continuously at lowest, middle and highest channel frequencies individually.

4.3.7 Test Result

POWER OUTPUT:

802.11a

Chan.	Chan. Freq. (MHz)	Maximum Conducted Power (dBm)			Total Power (mW)	Total Power (dBm)	Power Limit (dBm)	Pass / Fail
		Chain 0	Chain 1	Chain 2				
36	5180	18.01	17.99	16.77	173.726	22.40	30.00	Pass
40	5200	21.33	21.22	20.23	373.704	25.73	30.00	Pass
48	5240	19.68	19.88	18.75	265.161	24.24	30.00	Pass
149	5745	16.10	14.85	15.47	106.524	20.27	30.00	Pass
157	5785	21.69	20.61	20.86	384.550	25.85	30.00	Pass
165	5825	17.77	17.25	16.27	155.293	21.91	30.00	Pass

802.11n (HT20)

Chan.	Chan. Freq. (MHz)	Maximum Conducted Power (dBm)			Total Power (mW)	Total Power (dBm)	Power Limit (dBm)	Pass / Fail
		Chain 0	Chain 1	Chain 2				
36	5180	17.78	17.79	16.61	165.91	22.20	30.00	Pass
40	5200	22.51	22.43	21.62	498.434	26.98	30.00	Pass
48	5240	19.88	20.83	18.97	297.221	24.73	30.00	Pass
149	5745	16.13	14.92	15.26	105.640	20.24	30.00	Pass
157	5785	21.60	20.95	20.85	390.614	25.92	30.00	Pass
165	5825	17.63	17.29	16.23	153.499	21.86	30.00	Pass

802.11n (HT40)

Chan.	Chan. Freq. (MHz)	Maximum Conducted Power (dBm)			Total Power (mW)	Total Power (dBm)	Power Limit (dBm)	Pass / Fail
		Chain 0	Chain 1	Chain 2				
38	5190	13.67	13.82	12.85	66.655	18.24	30.00	Pass
46	5230	19.85	20.16	19.38	287.054	24.58	30.00	Pass
151	5755	12.05	10.66	10.92	40.032	16.02	30.00	Pass
159	5795	17.22	16.32	16.03	135.665	21.32	30.00	Pass

802.11ac (VHT80)

Chan.	Chan. Freq. (MHz)	Maximum Conducted Power (dBm)			Total Power (mW)	Total Power (dBm)	Power Limit (dBm)	Pass / Fail
		Chain 0	Chain 1	Chain 2				
42	5210	12.05	12.25	11.29	46.279	16.65	30.00	Pass
155	5775	8.31	7.11	6.98	16.905	12.28	30.00	Pass

26dB BANDWIDTH:
802.11a

Channel	Channel Frequency (MHz)	26dBc Bandwidth (MHz)			Pass / Fail
		Chain 0	Chain 1	Chain 2	
36	5180	22.77	21.85	22.17	PASS
40	5200	31.93	36.02	31.74	PASS
48	5240	27.17	24.30	22.94	PASS

802.11n (HT20)

Channel	Channel Frequency (MHz)	26dBc Bandwidth (MHz)			Pass / Fail
		Chain 0	Chain 1	Chain 2	
36	5180	23.17	22.78	22.80	PASS
40	5200	41.49	37.20	38.26	PASS
48	5240	27.46	25.02	24.51	PASS

802.11n (HT40)

Channel	Channel Frequency (MHz)	26dBc Bandwidth (MHz)			Pass / Fail
		Chain 0	Chain 1	Chain 2	
38	5190	46.65	45.00	44.54	PASS
46	5230	49.93	51.42	45.87	PASS

802.11ac (VHT80)

Channel	Channel Frequency (MHz)	26dBc Bandwidth (MHz)			Pass / Fail
		Chain 0	Chain 1	Chain 2	
42	5210	89.79	87.34	86.50	PASS

SPECTRUM PLOT OF WORST VALUE

802.11a

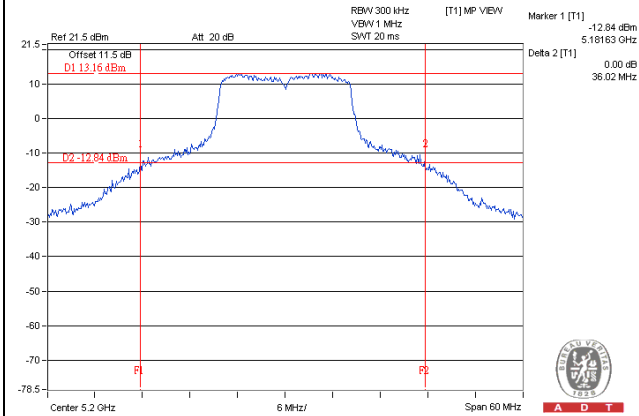

802.11n (HT20)

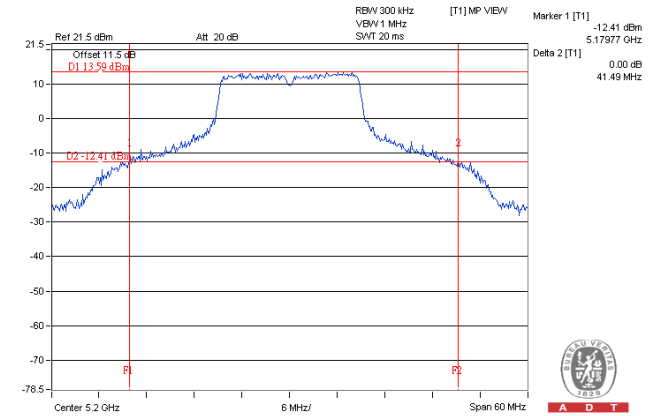

802.11n (HT40)

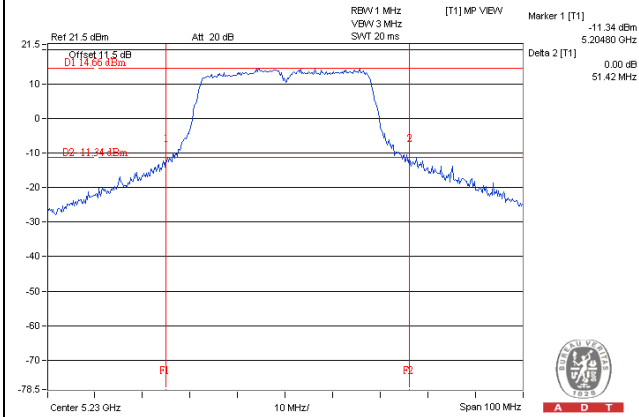

802.11ac (VHT80)

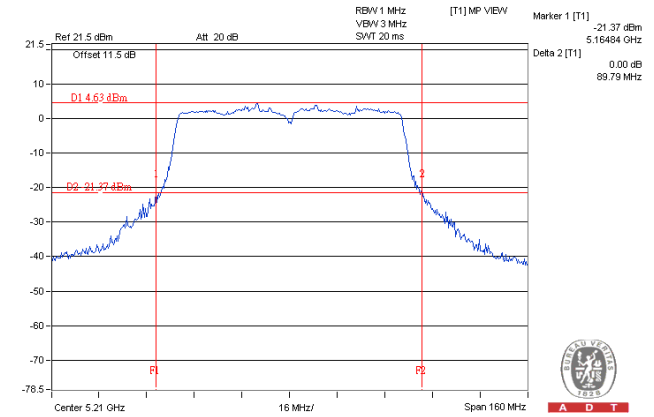

OCCUPIED BANDWIDTH:
802.11a

Channel	Channel Frequency (MHz)	Occupied Bandwidth (MHz)			Pass / Fail
		Chain 0	Chain 1	Chain 2	
36	5180	16.80	16.80	16.80	PASS
40	5200	17.52	17.76	17.28	PASS
48	5240	17.04	16.92	16.80	PASS
149	5745	16.87	16.78	16.70	PASS
157	5785	26.04	21.84	20.40	PASS
165	5825	16.80	16.68	16.56	PASS

802.11n (HT20)

Channel	Channel Frequency (MHz)	Occupied Bandwidth (MHz)			Pass / Fail
		Chain 0	Chain 1	Chain 2	
36	5180	17.88	17.76	17.76	PASS
40	5200	21.12	20.16	20.04	PASS
48	5240	18.00	18.00	18.00	PASS
149	5745	17.88	17.88	17.76	PASS
157	5785	26.16	20.40	20.64	PASS
165	5825	17.88	17.76	17.76	PASS

802.11n (HT40)

Channel	Channel Frequency (MHz)	Occupied Bandwidth (MHz)			Pass / Fail
		Chain 0	Chain 1	Chain 2	
38	5190	36.84	36.72	36.96	PASS
46	5230	37.08	37.08	36.96	PASS
151	5755	37.08	36.72	36.96	PASS
159	5795	36.96	36.96	36.84	PASS

802.11ac (VHT80)

Channel	Channel Frequency (MHz)	Occupied Bandwidth (MHz)			Pass / Fail
		Chain 0	Chain 1	Chain 2	
42	5210	76.08	75.84	75.84	PASS
155	5775	75.84	75.84	75.84	PASS

SPECTRUM PLOT OF WORST VALUE

802.11a

802.11n (HT20)

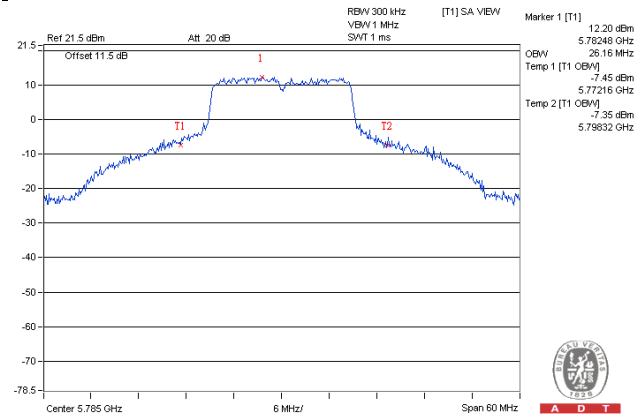
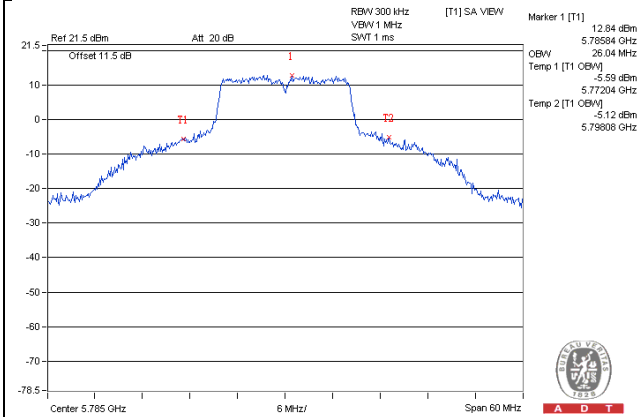

802.11n (HT40)

802.11ac (VHT80)

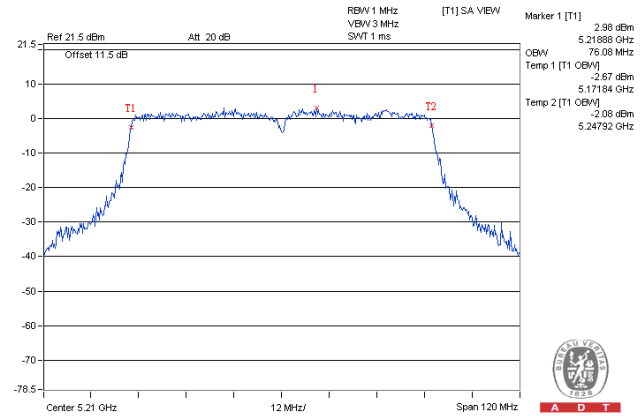
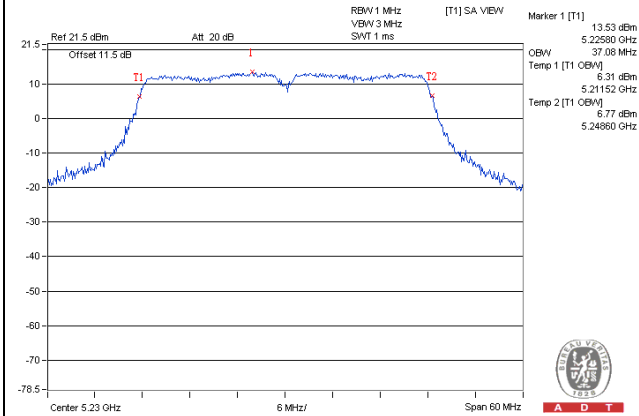

4.4 Peak Power Spectral Density Measurement

4.4.1 Limits of Peak Power Spectral Density Measurement

Operation Band	EUT Category		LIMIT
U-NII-1		Outdoor Access Point	17dBm/ MHz
		Fixed point-to-point Access Point	
	√	Indoor Access Point	
		Mobile and Portable client device	11dBm/ MHz
U-NII-2A	---		11dBm/ MHz
U-NII-2C	---		11dBm/ MHz
U-NII-3	√		30dBm/ 500kHz

4.4.2 Test Setup

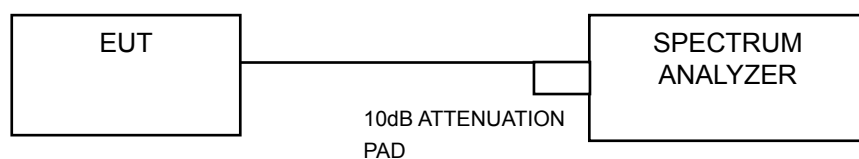

4.4.3 Test Instruments

Refer to section 4.1.2 to get information of above instrument.

4.4.4 Test Procedure

For U-NII-1 band:

Using method SA-2

- 1) Set span to encompass the entire emission bandwidth (EBW) of the signal.
- 2) Set RBW = 1MHz, Set VBW ≥ 3MHz, Detector = RMS
- 3) Set Channel power measure = 1MHz
- 4) Sweep time = auto, trigger set to “free run”.
- 5) Trace average at least 100 traces in power averaging mode.
- 6) Record the max value and add 10 log (1/duty cycle)

For U-NII-3 band:

- 1) Set span to encompass the entire emission bandwidth (EBW) of the signal.
- 2) Set RBW = 300 kHz, Set VBW ≥ 3 RBW, Detector = RMS
- 3) Sweep time = auto, trigger set to “free run”.
- 4) Trace average at least 100 traces in power averaging mode.
- 5) Record the max value and add 10 log (1/duty cycle)
- 6) Scale the observed power level to an equivalent value in 500 kHz by adjusting (reducing) the measured power by a bandwidth correction factor (BWCF) where $BWCF = 10\log(500\text{kHz}/300\text{kHz})$

4.4.5 Deviation from Test Standard

No deviation.

4.4.6 EUT Operating Condition

Same as Item 4.3.6.

4.4.7 Test Results

For U-NII-1 Band

802.11a

Chan.	Freq. (MHz)	PSD (dBm)			Total PSD w/o Duty Factor (dBm)	Duty Factor	Total PSD with Duty Factor (dBm)	Max. Limit (dBm)	Pass / Fail
		Chain 0	Chain 1	Chain 2					
36	5180	4.99	4.07	3.32	8.95	0.52	9.47	15.23	Pass
40	5200	7.97	8.44	7.33	12.71	0.52	13.23	15.23	Pass
48	5240	7.64	6.66	5.34	11.42	0.52	11.94	15.23	Pass

NOTE: 1. Method 1 of power density measurement of KDB 662911 is using for calculating total power density. Total power density is summing entire spectra across corresponding frequency bins on the various outputs by computer.

2. For U-NII-1 Band:

Directional gain = 3dBi + 10log(3) = 7.77dBi > 6dBi, so the power density limit shall be reduced to 17-(7.77-6) = 15.23dBm.

802.11n (HT20)

Chan.	Freq. (MHz)	PSD (dBm)			Total PSD w/o Duty Factor (dBm)	Duty Factor	Total PSD with Duty Factor (dBm)	Max. Limit (dBm)	Pass / Fail
		Chain 0	Chain 1	Chain 2					
36	5180	4.12	4.45	3.24	8.73	0.32	9.05	15.23	Pass
40	5200	9.15	8.37	7.43	13.14	0.32	13.46	15.23	Pass
48	5240	6.52	6.96	5.63	11.17	0.32	11.49	15.23	Pass

NOTE: 1. Method 1 of power density measurement of KDB 662911 is using for calculating total power density. Total power density is summing entire spectra across corresponding frequency bins on the various outputs by computer.

2. For U-NII-1 Band:

Directional gain = 3dBi + 10log(3) = 7.77dBi > 6dBi, so the power density limit shall be reduced to 17-(7.77-6) = 15.23dBm.

802.11n (HT40)

Chan.	Freq. (MHz)	PSD (dBm)			Total PSD w/o Duty Factor (dBm)	Duty Factor	Total PSD with Duty Factor (dBm)	Max. Limit (dBm)	Pass / Fail
		Chain 0	Chain 1	Chain 2					
38	5190	-2.77	-2.57	-4.07	1.68	0.96	2.64	14.46	Pass
46	5230	3.39	3.55	2.60	7.97	0.96	8.93	14.46	Pass

NOTE: 1. Method 1 of power density measurement of KDB 662911 is using for calculating total power density. Total power density is summing entire spectra across corresponding frequency bins on the various outputs by computer.

2. For U-NII-1 Band:

Directional gain = 3dBi + 10log(3) = 7.77dBi > 6dBi, so the power density limit shall be reduced to 17-(7.77-6) = 15.23dBm.

802.11n (VHT80)

Chan.	Freq. (MHz)	PSD (dBm)			Total PSD w/o Duty Factor (dBm)	Duty Factor	Total PSD with Duty Factor (dBm)	Max. Limit (dBm)	Pass / Fail
		Chain 0	Chain 1	Chain 2					
42	5210	-7.99	-7.52	-9.60	-3.51	1.41	-2.10	15.23	Pass

NOTE: 1. Method 1 of power density measurement of KDB 662911 is using for calculating total power density. Total power density is summing entire spectra across corresponding frequency bins on the various outputs by computer.

2. For U-NII-1 Band:

Directional gain = 3dBi + 10log(3) = 7.77dBi > 6dBi, so the power density limit shall be reduced to 17-(7.77-6) = 15.23dBm.

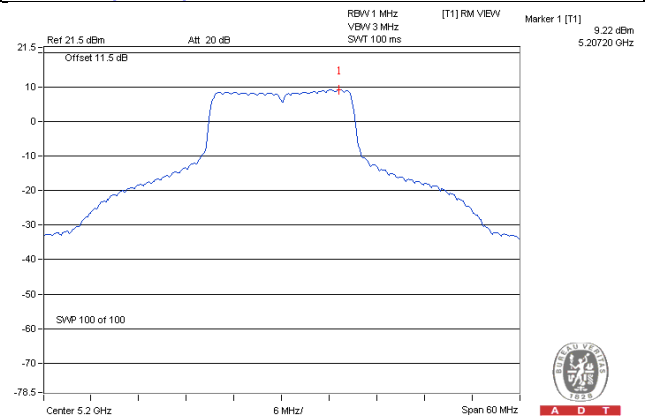
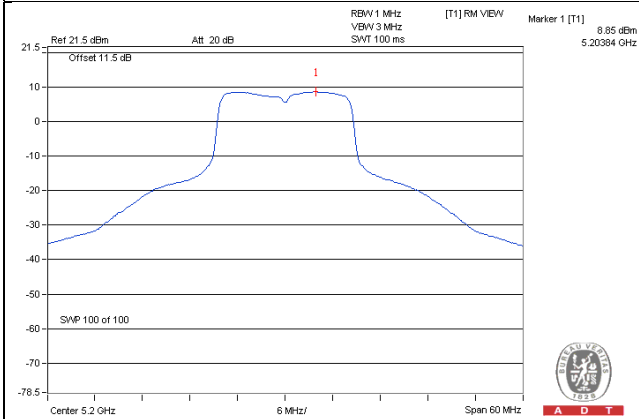
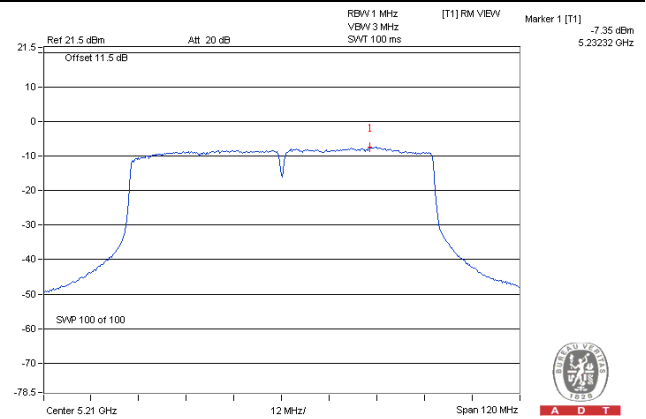
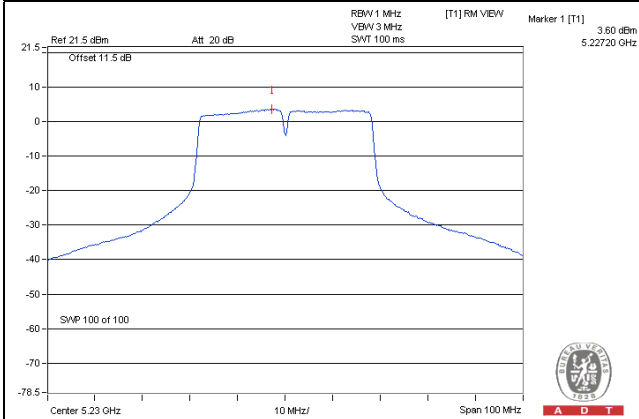
SPECTRUM PLOT OF WORST VALUE**802.11a / Ch 40 / Chain 1****802.11n (HT20) / Ch 40 / Chain 0****802.11n (HT40) / Ch 46 / Chain 1****802.11ac (VHT80) / Ch 42 / Chain 1**

For U-NII-3 Band

802.11a

TX chain	Chan.	Freq. (MHz)	PSD (dBm /300kHz)	PSD (dBm /500kHz)	10 log (N=3) dB	Duty Factor	Total PSD (dBm /500kHz)	Limit (dBm /500kHz)	Pass /Fail
0	149	5745	-4.74	-2.52	4.77	0.52	2.77	28.23	Pass
	157	5785	0.12	2.34	4.77	0.52	7.63	28.23	Pass
	165	5825	-3.51	-1.29	4.77	0.52	4.00	28.23	Pass
1	149	5745	-6.71	-4.49	4.77	0.52	0.80	28.23	Pass
	157	5785	0.05	2.27	4.77	0.52	7.56	28.23	Pass
	165	5825	-4.08	-1.86	4.77	0.52	3.43	28.23	Pass
2	149	5745	-6.13	-3.91	4.77	0.52	1.38	28.23	Pass
	157	5785	-0.38	1.84	4.77	0.52	7.13	28.23	Pass
	165	5825	-4.82	-2.60	4.77	0.52	2.69	28.23	Pass

NOTE: Directional gain = $3\text{dBi} + 10\log(3) = 7.77\text{dBi} > 6\text{dBi}$, so the power density limit shall be reduced to $30 - (7.77 - 6) = 28.23\text{dBm}$.

802.11n (HT20)

TX chain	Chan.	Freq. (MHz)	PSD (dBm /300kHz)	PSD (dBm /500kHz)	10 log (N=3) dB	Duty Factor	Total PSD (dBm /500kHz)	Limit (dBm /500kHz)	Pass /Fail
0	149	5745	-5.03	-2.81	4.77	0.32	2.28	28.23	Pass
	157	5785	-0.09	2.13	4.77	0.32	7.22	28.23	Pass
	165	5825	-3.51	-1.29	4.77	0.32	3.80	28.23	Pass
1	149	5745	-7.08	-4.86	4.77	0.32	0.23	28.23	Pass
	157	5785	-0.86	1.36	4.77	0.32	6.45	28.23	Pass
	165	5825	-4.30	-2.08	4.77	0.32	3.01	28.23	Pass
2	149	5745	-6.36	-4.14	4.77	0.32	0.95	28.23	Pass
	157	5785	-0.81	1.41	4.77	0.32	6.50	28.23	Pass
	165	5825	-5.37	-3.15	4.77	0.32	1.94	28.23	Pass

NOTE: Directional gain = $3\text{dBi} + 10\log(3) = 7.77\text{dBi} > 6\text{dBi}$, so the power density limit shall be reduced to $30 - (7.77 - 6) = 28.23\text{dBm}$.

802.11n (HT40)

TX chain	Chan.	Freq. (MHz)	PSD (dBm /300kHz)	PSD (dBm /500kHz)	10 log (N=3) dB	Duty Factor	Total PSD (dBm /500kHz)	Limit (dBm /500kHz)	Pass /Fail
0	151	5755	-13.15	-10.93	4.77	0.96	-5.20	28.23	Pass
	159	5795	-7.38	-5.16	4.77	0.96	0.57	28.23	Pass
1	151	5755	-14.23	-12.01	4.77	0.96	-6.28	28.23	Pass
	159	5795	-8.71	-6.49	4.77	0.96	-0.76	28.23	Pass
2	151	5755	-14.05	-11.83	4.77	0.96	-6.10	28.23	Pass
	159	5795	-8.98	-6.76	4.77	0.96	-1.03	28.23	Pass

NOTE: Directional gain = 3dBi + 10log(3) = 7.77dBi > 6dBi, so the power density limit shall be reduced to 30-(7.77-6) = 28.23dBm.

802.11ac (VHT80)

TX chain	Chan.	Freq. (MHz)	PSD (dBm /300kHz)	PSD (dBm /500kHz)	10 log (N=3) dB	Duty Factor	Total PSD (dBm /500kHz)	Limit (dBm /500kHz)	Pass /Fail
0	155	5775	-19.88	-17.66	4.77	1.41	-11.48	28.23	Pass
1	155	5775	-20.97	-18.75	4.77	1.41	-12.57	28.23	Pass
2	155	5775	-21.06	-18.84	4.77	1.41	-12.66	28.23	Pass

NOTE: Directional gain = 3dBi + 10log(3) = 7.77dBi > 6dBi, so the power density limit shall be reduced to 30-(7.77-6) = 28.23dBm.

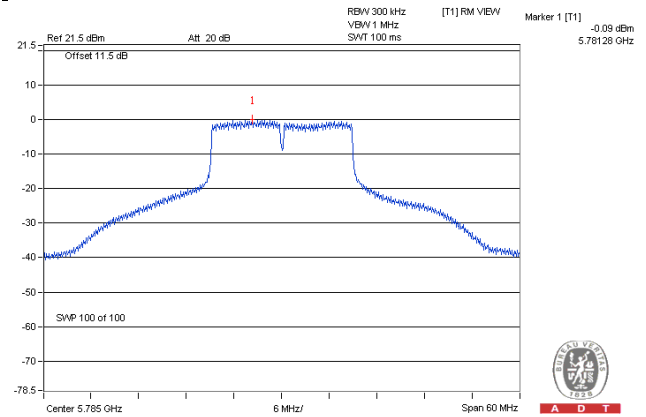
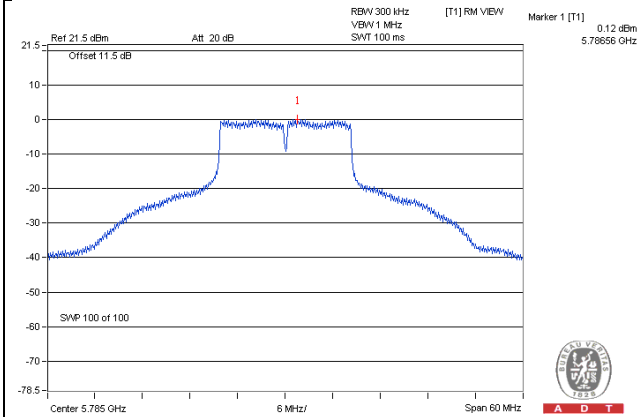
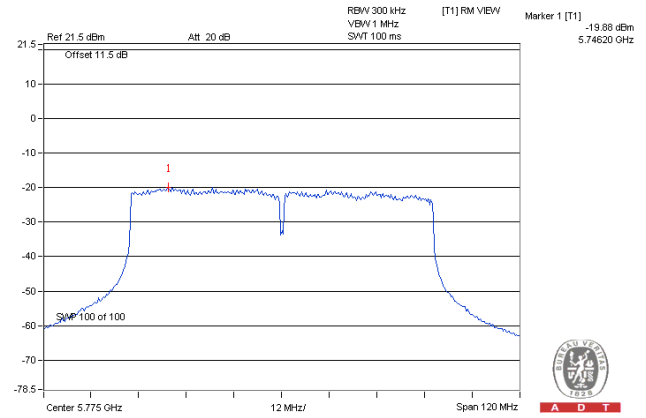
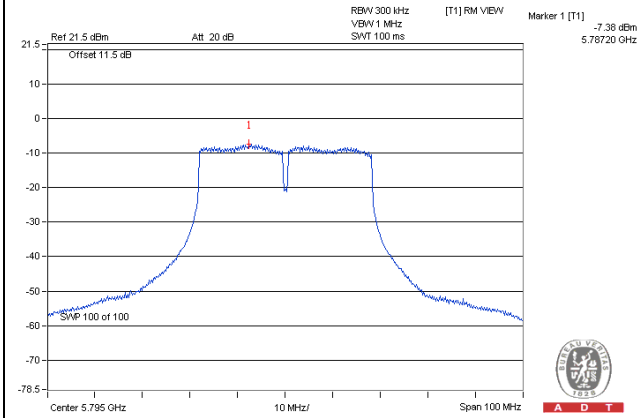
SPECTRUM PLOT OF WORST VALUE**802.11a****802.11n (HT20)****802.11n (HT40)****802.11ac (VHT80)**

4.5 Frequency Stability

4.5.1 Limits of Frequency Stability Measurement

The frequency of the carrier signal shall be maintained within band of operation

4.5.2 Test Setup

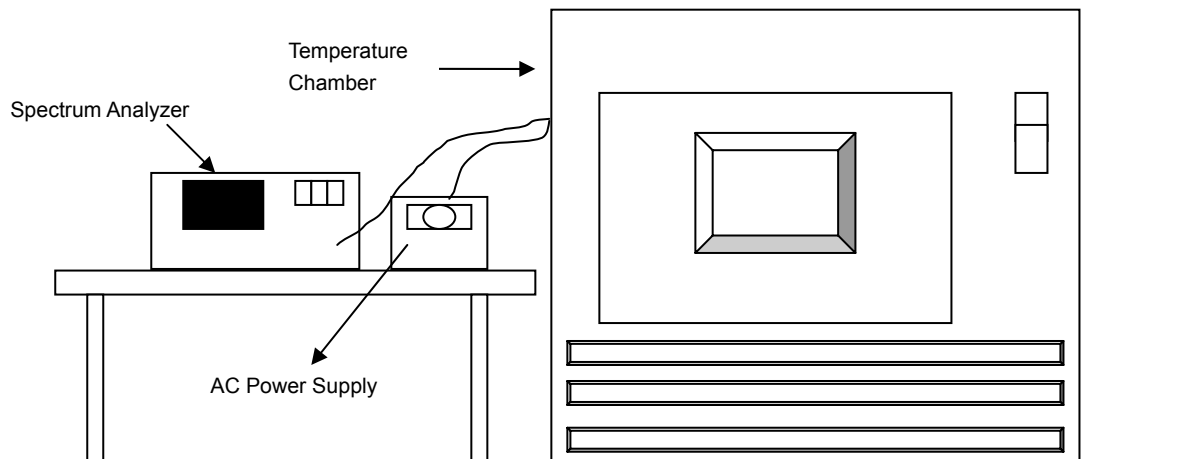

4.5.3 Test Instruments

Refer to section 4.1.2 to get information of above instrument.

4.5.4 Test Procedure

- The EUT was placed inside the environmental test chamber and powered by nominal AC voltage.
- Turn the EUT on and couple its output to a spectrum analyzer.
- Turn the EUT off and set the chamber to the highest temperature specified.
- Allow sufficient time (approximately 30 min) for the temperature of the chamber to stabilize, turn the EUT on and measure the operating frequency after 2, 5, and 10 minutes.
- Repeat step 2 and 3 with the temperature chamber set to the lowest temperature.
- The test chamber was allowed to stabilize at +20 degree C for a minimum of 30 minutes. The supply voltage was then adjusted on the EUT from 85% to 115% and the frequency record.

4.5.5 Deviation from Test Standard

No deviation.

4.5.6 EUT Operating Condition

Set the EUT transmit at un-modulation mode to test frequency stability.

4.5.7 Test Results

FREQUENCY STABILITY VERSUS TEMP.									
OPERATING FREQUENCY: 5180MHz									
TEMP. (°C)	POWER SUPPLY (Vac)	0 MINUTE		2 MINUTE		5 MINUTE		10 MINUTE	
		Measured Frequency (MHz)	Frequency Drift (%)	Measured Frequency (MHz)	Frequency Drift (%)	Measured Frequency (MHz)	Frequency Drift (%)	Measured Frequency (MHz)	Frequency Drift (%)
45	120	5179.9909	-0.00018	5179.9896	-0.00020	5179.9904	-0.00019	5179.9904	-0.00019
40	120	5179.9875	-0.00024	5179.9919	-0.00016	5179.9921	-0.00015	5179.9921	-0.00015
30	120	5180.0127	0.00025	5180.0170	0.00033	5180.0161	0.00031	5180.0144	0.00028
20	120	5179.9933	-0.00013	5179.9933	-0.00013	5179.9949	-0.00010	5179.9935	-0.00013
10	120	5179.9854	-0.00028	5179.9856	-0.00028	5179.9848	-0.00029	5179.9863	-0.00026
0	120	5179.9920	-0.00015	5179.9894	-0.00020	5179.9920	-0.00015	5179.9892	-0.00021

FREQUENCY STABILITY VERSUS TEMP.									
OPERATING FREQUENCY: 5180MHz									
TEMP. (°C)	POWER SUPPLY (Vac)	0 MINUTE		2 MINUTE		5 MINUTE		10 MINUTE	
		Measured Frequency (MHz)	Frequency Drift (%)	Measured Frequency (MHz)	Frequency Drift (%)	Measured Frequency (MHz)	Frequency Drift (%)	Measured Frequency (MHz)	Frequency Drift (%)
20	138	5179.9932	-0.00013	5179.9929	-0.00014	5179.9942	-0.00011	5179.9932	-0.00013
	120	5179.9933	-0.00013	5179.9933	-0.00013	5179.9949	-0.00010	5179.9935	-0.00013
	102	5179.9935	-0.00013	5179.994	-0.00012	5179.9958	-0.00008	5179.9942	-0.00011

4.6 6dB Bandwidth Measurement

4.6.1 Limits of 6dB Bandwidth Measurement

The minimum of 6dB Bandwidth Measurement is 0.5MHz.

4.6.2 Test Setup

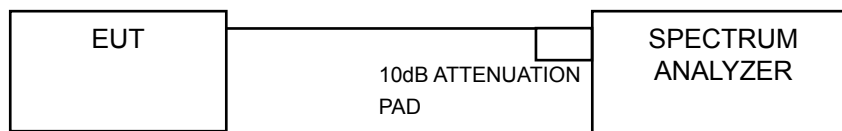

4.6.3 Test Instruments

Refer to section 4.1.2 to get information of above instrument.

4.6.4 Test Procedure

MEASUREMENT PROCEDURE REF

- a. Set resolution bandwidth (RBW) = 100kHz
- b. Set the video bandwidth (VBW) $\geq 3 \times$ RBW, Detector = Peak.
- c. Trace mode = max hold.
- d. Sweep = auto couple.
- e. Measure the maximum width of the emission that is constrained by the frequencies associated with the two amplitude points (upper and lower) that are attenuated by 6 dB relative to the maximum level measured in the fundamental emission

4.6.5 Deviation from Test Standard

No deviation.

4.6.6 EUT Operating Condition

The software provided by client to enable the EUT under transmission Condition continuously at lowest, middle and highest channel frequencies individually.

4.6.7 Test Results

802.11a

Channel	Frequency (MHz)	6dB Bandwidth (MHz)			Minimum Limit (MHz)	Pass / Fail
		Chain 0	Chain 1	Chain 2		
149	5745	16.40	16.38	16.40	0.5	PASS
157	5785	16.41	16.08	16.39	0.5	PASS
165	5825	16.43	16.42	16.42	0.5	PASS

802.11n (HT20)

Channel	Frequency (MHz)	6dB Bandwidth (MHz)			Minimum Limit (MHz)	Pass / Fail
		Chain 0	Chain 1	Chain 2		
149	5745	17.64	17.65	17.65	0.5	PASS
157	5785	17.61	17.59	17.63	0.5	PASS
165	5825	17.63	17.62	17.66	0.5	PASS

802.11n (HT40)

Channel	Frequency (MHz)	6dB Bandwidth (MHz)			Minimum Limit (MHz)	Pass / Fail
		Chain 0	Chain 1	Chain 2		
151	5755	35.92	36.05	36.44	0.5	PASS
159	5795	36.14	36.44	36.44	0.5	PASS

802.11ac (VHT80)

Channel	Frequency (MHz)	6dB Bandwidth (MHz)			Minimum Limit (MHz)	Pass / Fail
		Chain 0	Chain 1	Chain 2		
155	5775	75.86	73.61	75.83	0.5	PASS

SPECTRUM PLOT OF WORST VALUE

802.11a

802.11n (HT20)

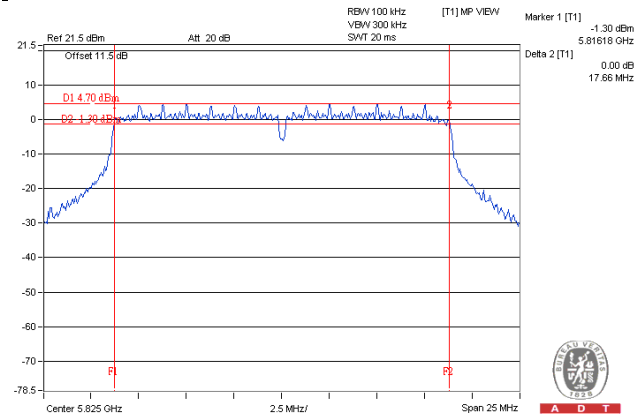
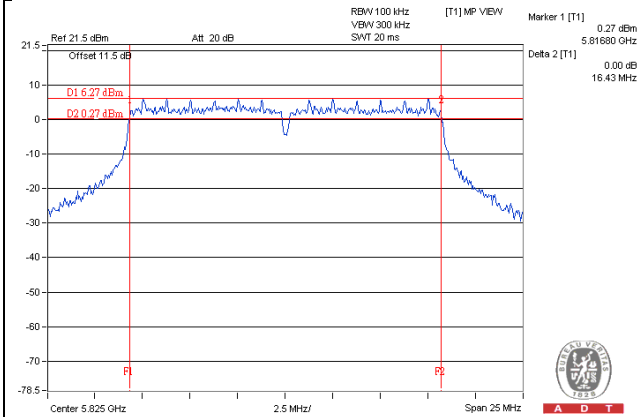

802.11n (HT40)

802.11ac (VHT80)

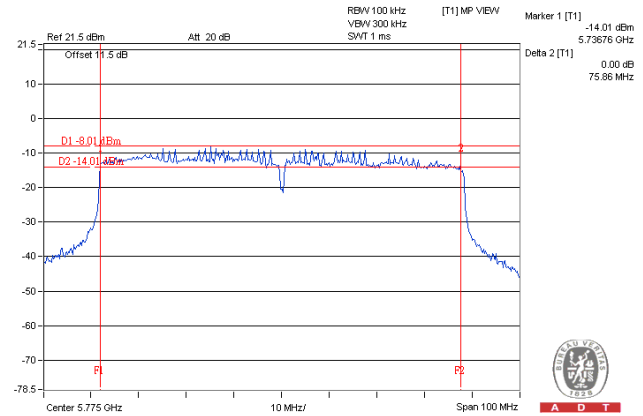
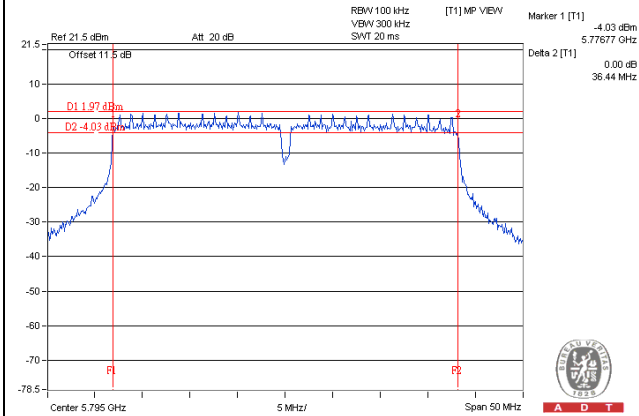

5 Pictures of Test Arrangements

Please refer to the attached file (Test Setup Photo).

Appendix – Information on the Testing Laboratories

We, Bureau Veritas Consumer Products Services (H.K.) Ltd., Taoyuan Branch, were founded in 1988 to provide our best service in EMC, Radio, Telecom and Safety consultation. Our laboratories are accredited and approved according to ISO/IEC 17025.

If you have any comments, please feel free to contact us at the following:

Linko EMC/RF Lab

Tel: 886-2-26052180

Fax: 886-2-26051924

Hsin Chu EMC/RF Lab/Telecom Lab

Tel: 886-3-5935343

Fax: 886-3-5935342

Hwa Ya EMC/RF/Safety

Tel: 886-3-3183232

Fax: 886-3-3270892

Email: service.adt@tw.bureauveritas.com

Web Site: www.bureauveritas-adt.com

The address and road map of all our labs can be found in our web site also.

--- END ---